



# SAR TEST REPORT

No. 23T04Z80611-06

For

**TCL Communication Ltd.  
GSM/UMTS/LTE Mobile phone**

**Model Name: T611B**

with

**Hardware Version: 05**

**Software Version: 3FS2**

**FCC ID: 2ACCJH176**

**Issued Date: 2023-12-4**

**Note:**

The test results in this test report relate only to the devices specified in this report. This report shall not be reproduced except in full without the written approval of CTTL.

**Test Laboratory:**

**CTTL, Telecommunication Technology Labs, CAICT**

No. 52, Huayuan North Road, Haidian District, Beijing, P. R. China 100191.

Tel:+86(0)10-62304633-2512, Fax:+86(0)10-62304633-2504

Email: [ctl\\_terminals@caict.ac.cn](mailto:ctl_terminals@caict.ac.cn), website: [www.caict.ac.cn](http://www.caict.ac.cn)



## **REPORT HISTORY**

<b>Report Number</b>	<b>Revision</b>	<b>Issue Date</b>	<b>Description</b>
23T04Z80611-06	Rev.0	2023-12-4	Initial creation of test report

## TABLE OF CONTENT

<b>1 TEST LABORATORY</b> .....	<b>5</b>
1.1 INTRODUCTION & ACCREDITATION .....	5
1.2 TESTING LOCATION .....	5
1.3 TESTING ENVIRONMENT.....	6
1.4 PROJECT DATA .....	6
1.5 SIGNATURE.....	6
<b>2 STATEMENT OF COMPLIANCE</b> .....	<b>7</b>
<b>3 CLIENT INFORMATION</b> .....	<b>9</b>
3.1 APPLICANT INFORMATION .....	9
3.2 MANUFACTURER INFORMATION .....	9
<b>4 EQUIPMENT UNDER TEST (EUT) AND ANCILLARY EQUIPMENT (AE)</b> .....	<b>10</b>
4.1 ABOUT EUT .....	10
4.2 INTERNAL IDENTIFICATION OF EUT USED DURING THE TEST .....	11
4.3 INTERNAL IDENTIFICATION OF AE USED DURING THE TEST .....	11
<b>5 TEST METHODOLOGY</b> .....	<b>12</b>
5.1 APPLICABLE LIMIT REGULATIONS .....	12
5.2 APPLICABLE MEASUREMENT STANDARDS.....	12
<b>6 SPECIFIC ABSORPTION RATE (SAR)</b> .....	<b>13</b>
6.1 INTRODUCTION.....	13
6.2 SAR DEFINITION.....	13
7.1 TARGETS FOR TISSUE SIMULATING LIQUID .....	14
7.2 DIELECTRIC PERFORMANCE .....	14
<b>8 SYSTEM VERIFICATION</b> .....	<b>16</b>
8.1 SYSTEM SETUP.....	16
8.2 SYSTEM VERIFICATION.....	17
<b>9 MEASUREMENT PROCEDURES</b> .....	<b>18</b>
9.1 TESTS TO BE PERFORMED .....	18
9.2 GENERAL MEASUREMENT PROCEDURE.....	20
9.3 WCDMA MEASUREMENT PROCEDURES FOR SAR .....	21
9.4 SAR MEASUREMENT FOR LTE.....	22
9.5 BLUETOOTH & WI-FI MEASUREMENT PROCEDURES FOR SAR .....	24
9.6 POWER DRIFT.....	24
<b>10 AREA SCAN BASED 1-G SAR</b> .....	<b>25</b>
10.1 REQUIREMENT OF KDB.....	25
10.2 FAST SAR ALGORITHMS .....	25
<b>11 CONDUCTED OUTPUT POWER</b> .....	<b>26</b>

11.1 GSM MEASUREMENT RESULT .....	26
11.2 WCDMA MEASUREMENT RESULT.....	30
11.3 LTE MEASUREMENT RESULT .....	34
11.4 WI-FI AND BT MEASUREMENT RESULT .....	75
<b>12 SAR MEASUREMENT POSITIONS .....</b>	<b>79</b>
12.1 SAR MEASUREMENT POSITIONS .....	79
<b>13 EVALUATION OF SIMULTANEOUS.....</b>	<b>79</b>
<b>14 SAR TEST RESULT .....</b>	<b>80</b>
14.1 SAR RESULTS FOR 2G/3G/4G .....	82
14.2 WLAN EVALUATION FOR 2.4G .....	87
14.3 WLAN EVALUATION FOR 5G.....	89
14.4 SAR RESULTS FOR BT .....	92
<b>15 SAR MEASUREMENT VARIABILITY.....</b>	<b>93</b>
<b>16 MEASUREMENT UNCERTAINTY .....</b>	<b>94</b>
16.1 MEASUREMENT UNCERTAINTY FOR NORMAL SAR TESTS (300MHZ~3GHZ) .....	94
16.2 MEASUREMENT UNCERTAINTY FOR NORMAL SAR TESTS (3~6GHZ) .....	95
16.3 MEASUREMENT UNCERTAINTY FOR FAST SAR TESTS (300MHZ~3GHZ) .....	96
16.4 MEASUREMENT UNCERTAINTY FOR FAST SAR TESTS (3~6GHZ).....	97
<b>17 MAIN TEST INSTRUMENTS.....</b>	<b>99</b>
<b>ANNEX A GRAPH RESULTS.....</b>	<b>100</b>
<b>ANNEX B SYSTEM VERIFICATION RESULTS .....</b>	<b>150</b>
<b>ANNEX C SAR MEASUREMENT SETUP .....</b>	<b>160</b>
<b>ANNEX D POSITION OF THE WIRELESS DEVICE IN RELATION TO THE PHANTOM .....</b>	<b>166</b>
<b>ANNEX E EQUIVALENT MEDIA RECIPES .....</b>	<b>169</b>
<b>ANNEX F PROBE CALIBRATION CERTIFICATE .....</b>	<b>170</b>
<b>ANNEX G DIPOLE CALIBRATION CERTIFICATE .....</b>	<b>181</b>
<b>ANNEX H NEW BAND OF LTE B26 .....</b>	<b>229</b>
<b>ANNEX I SPOT CHECK .....</b>	<b>250</b>
<b>ANNEX J ACCREDITATION CERTIFICATE.....</b>	<b>278</b>



## 1 Test Laboratory

### 1.1 Introduction & Accreditation

**Telecommunication Technology Labs, CAICT** is an ISO/IEC 17025:2017 accredited test laboratory under American Association for Laboratory Accreditation (A2LA) with lab code 7049.01, and is also an FCC accredited test laboratory (CN5017), and ISED accredited test laboratory (CAB identifier:CN0066). The detail accreditation scope can be found on A2LA website.

### 1.2 Testing Location

CompanyName:	CTTL
Address:	No. 52, Huayuan North Road, Haidian District, Beijing, P. R. China 100191.

### 1.3 Testing Environment

Temperature:	18°C~25°C,
Relative humidity:	30%~ 70%
Ground system resistance:	< 0.5 $\Omega$
Ambient noise is checked and found very low and in compliance with requirement of standards. Reflection of surrounding objects is minimized and in compliance with requirement of standards	

### 1.4 Project Data

Project Leader:	Qi Dianyuan
Test Engineer:	Yao Juming
Testing Start Date:	July 10, 2023
Testing End Date:	November 29, 2023

### 1.5 Signature



Yao Juming  
(Prepared this test report)



Qi Dianyuan  
(Reviewed this test report)

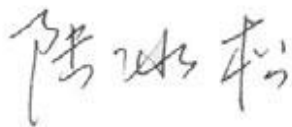

Lu Bingsong  
Deputy Director of the laboratory  
(Approved this test report)

## 2 Statement of Compliance

This EUT is a variant product and the report of original sample is No. 23T04Z80611-01. We share the original results and do the spot check on highest value point of the original report for head and body respectively in the annex I.

The maximum results of Specific Absorption Rate (SAR) found during testing for TCL Communication Ltd. GSM/UMTS/LTE Mobile phone T611B are as follows:

**Table 2.1: Highest Reported SAR (1g)**

Technology Band	Head (Separation Distance 0mm)	Hotspot (Separation Distance 10mm)	Body-Worn (Separation Distance 15mm)	Equipment Class
GSM850	0.18	0.13	0.13 <sup>[1]</sup>	PCE
GSM1900	0.13	0.35	0.15	
WCDMA1900	0.17	0.56	0.41	
WCDMA 1700	0.12	0.62	0.29	
WCDMA 850	0.64	0.68	0.68 <sup>[1]</sup>	
LTE Band2	0.21	0.55	0.34	
LTE Band5	0.63	0.34	0.34 <sup>[1]</sup>	
LTE Band7	0.06	0.83	0.32	
LTE Band12/17	0.74	0.40	0.40 <sup>[1]</sup>	
LTE Band13	0.94	0.38	0.38 <sup>[1]</sup>	
LTE Band26	0.84	0.59	0.59 <sup>[1]</sup>	
LTE Band41/38	0.03	0.38	0.08	
LTE Band66/4	0.13	0.48	0.21	
WLAN 2.4GHz	0.62	0.20	0.20 <sup>[1]</sup>	
WLAN 5GHz	0.80	0.82	0.82 <sup>[1]</sup>	NII
BT	<0.01	<0.01	<0.01	DSS

The SAR values found for the Mobile Phone are below the maximum recommended levels of 1.6 W/kg as averaged over any 1g tissue according to the ANSI C95.1-1992.

For body operation, this device has been tested and meets FCC RF exposure guidelines when used with any accessory that contains no metal and which provides a minimum separation distance of 10/15 mm between this device and the body of the user. Use of other accessories may not ensure compliance with FCC RF exposure guidelines.

The EUT battery must be fully charged and checked periodically during the test to ascertain uniform power output.

The measurement together with the test system set-up is described in annex C of this test report. A detailed description of the equipment under test can be found in chapter 4 of this test report. The highest reported SAR value is obtained at the case of **(Table 2.1)**, and the values are:

**Head: 0.94 W/kg (1g)**

**Body: 0.83 W/kg (1g)**

Remark:

**NOTE1:** SAR result at 10mm is used for conservative evaluation.

**NOTE2:** This device supports both LTE B4/B17/B38 and B66/B12/B41. Since the supported frequency span for LTE B4/B17/B38 falls completely within the supported frequency span for LTE B66/B12/B41, both LTE bands have the same target power, and both LTE bands share the same transmission path; therefore, SAR was only assessed for LTE B66/B12/B41.

**Table 2.2: The sum of SAR values for Main antenna + WiFi-2.4G (1g)**

	Position	Main antenna	WiFi-2.4G	Sum
<b>Highest SAR value for Head</b>	Left head, Cheek (LTE B13)	0.84	0.36	<b>1.2</b>
<b>Highest SAR value for Body</b>	Bottom Edge 10mm (LTE B7)	0.83	/	<b>0.83</b>

**Table 2.3: The sum of SAR values for Main antenna + WiFi-5G (1g)**

	Position	Main antenna	WiFi-5G	Sum
<b>Highest SAR value for Head</b>	Left head, Cheek (LTE B13)	0.84	0.48	<b>1.32</b>
<b>Highest SAR value for Body</b>	Rear 10mm (WCDMA850)	0.64	0.53	<b>1.17</b>

**Conclusion:**

According to the above tables, the sum of reported SAR values is  $< 1.6 \text{ W/kg}$ . So the simultaneous transmission SAR with volume scans is not required.

According to the above tables, the highest sum of reported SAR values is **1.32 W/kg (1g)**. The detail for simultaneous transmission consideration is described in chapter 13.





### 3 Client Information

#### 3.1 Applicant Information

Company Name:	TCL Communication Ltd.
Address/Post:	5/F, Building 22E, 22 Science Park East Avenue, Hong Kong Science Park, Shatin, NT, Hong Kong
Contact Person:	Annie Jiang
Contact Email:	nianxiang.jiang@tcl.com
Telephone:	+86 755 3661 1621
Fax	+86 755 3661 2000-81722

#### 3.2 Manufacturer Information

Company Name:	TCL Communication Ltd.
Address/Post:	5/F, Building 22E, 22 Science Park East Avenue, Hong Kong Science Park, Shatin, NT, Hong Kong
Contact Person:	Annie Jiang
Contact Email:	nianxiang.jiang@tcl.com
Telephone:	+86 755 3661 1621
Fax	+86 755 3661 2000-81722

## 4 Equipment Under Test (EUT) and Ancillary Equipment (AE)

### 4.1 About EUT

Description:	GSM/UMTS/LTE Mobile phone
Model name:	T611B
Operating mode(s):	GSM850/1900, WCDMA850/1700/1900 LTE Band 2/4/5/7/12/13/17/26/38/41/66 BT, Wi-Fi(2.4G/5G)
Tested Tx Frequency:	824 – 849 MHz (GSM 850)
	1850 – 1910 MHz (GSM 1900)
	824 – 849 MHz (WCDMA 850 Band V)
	1850 – 1910 MHz (WCDMA1700 Band IV)
	1850 – 1910 MHz (WCDMA1900 Band II)
	1850.7 – 1909.3 MHz (LTE Band 2)
	824.7 – 848.3 MHz (LTE Band 5)
	2500 – 2570 MHz (LTE Band 7)
	699.7 – 715.3 MHz (LTE Band 12)
	779.5 – 784.5 MHz (LTE Band 13)
	814 – 849 MHz (LTE Band 26)
	2498.5 – 2687.5 MHz (LTE Band 41)
	1710.7 – 1779.3 MHz (LTE Band 66)
	2412 – 2462 MHz (Wi-Fi 2.4G)
	5180 – 5240 MHz (Wi-Fi 5.2G)
	5260 – 5320 MHz (Wi-Fi 5.3G)
5500 – 5700 MHz (Wi-Fi 5.5G)	
5745 – 5825 MHz (Wi-Fi 5.8G)	
2400 – 2483.5 MHz (Bluetooth)	
GPRS/EGPRS Multislot Class:	12
Test device Production information:	Production unit
Device type:	Portable device
Antenna type:	Integrated antenna
Hotspot mode:	Support

#### 4.2 Internal Identification of EUT used during the test

EUT ID*	IMEI	HW Version	SW Version
EUT1	358464410203919 358464410203927	05	3FS2
EUT2	358464410203893 358464410203901	05	3FS2

\*EUT ID: is used to identify the test sample in the lab internally.

**Note:** It is performed to test SAR with the EUT1 and conducted power with the EUT2.

#### 4.3 Internal Identification of AE used during the test

AE ID*	Description	Model	SN	Manufacturer
AE1	Battery	CAC4900009CA	/	TIANMAO
AE2	Battery	CAC4900007C7	/	VEKEN
AE3	Headset	CCB0046A15C1	/	DALIN

\*AE ID: is used to identify the test sample in the lab internally.

## 5 TEST METHODOLOGY

### 5.1 Applicable Limit Regulations

**ANSI C95.1–1992:** IEEE Standard for Safety Levels with Respect to Human Exposure to Radio Frequency Electromagnetic Fields, 3 kHz to 300 GHz.

It specifies the maximum exposure limit of **1.6 W/kg** as averaged over any 1 gram of tissue for portable devices being used within 20 cm of the user in the uncontrolled environment.

### 5.2 Applicable Measurement Standards

**IEEE 1528–2013:** Recommended Practice for Determining the Peak Spatial-Average Specific Absorption Rate (SAR) in the Human Head from Wireless Communications Devices: Measurement Techniques.

**KDB447498 D01: General RF Exposure Guidance v06:** Mobile and Portable Devices RF Exposure Procedures and Equipment Authorization Policies.

**KDB648474 D04 Handset SAR v01r03:** SAR Evaluation Considerations for Wireless Handsets.

**KDB941225 D01 SAR test for 3G devices v03r01:** SAR Measurement Procedures for 3G Devices

**KDB941225 D05 SAR for LTE Devices v02r05:** SAR Evaluation Considerations for LTE Devices

**KDB941225 D06 Hotspot Mode SAR v02r01:** SAR Evaluation Procedures for Portable Devices with Wireless Router Capabilities

**KDB248227 D01 802.11 Wi-Fi SAR v02r02:** SAR GUIDANCE FOR IEEE 802.11 (Wi-Fi) TRANSMITTERS

**KDB865664 D01 SAR measurement 100 MHz to 6 GHz v01r04:** SAR Measurement Requirements for 100 MHz to 6 GHz.

**KDB865664 D02 RF Exposure Reporting v01r02:** RF Exposure Compliance Reporting and Documentation Considerations

## 6 Specific Absorption Rate (SAR)

### 6.1 Introduction

SAR is related to the rate at which energy is absorbed per unit mass in an object exposed to a radio field. The SAR distribution in a biological body is complicated and is usually carried out by experimental techniques or numerical modeling. The standard recommends limits for two tiers of groups, occupational/controlled and general population/uncontrolled, based on a person's awareness and ability to exercise control over his or her exposure. In general, occupational/controlled exposure limits are higher than the limits for general population/uncontrolled.

### 6.2 SAR Definition

The SAR definition is the time derivative (rate) of the incremental energy ( $dW$ ) absorbed by (dissipated in) an incremental mass ( $dm$ ) contained in a volume element ( $dv$ ) of a given density ( $\rho$ ). The equation description is as below:

$$SAR = \frac{d}{dt} \left( \frac{dW}{dm} \right) = \frac{d}{dt} \left( \frac{dW}{\rho dv} \right)$$

SAR is expressed in units of Watts per kilogram (W/kg)

SAR measurement can be either related to the temperature elevation in tissue by

$$SAR = c \left( \frac{\delta T}{\delta t} \right)$$

Where:  $C$  is the specific heat capacity,  $\delta T$  is the temperature rise and  $\delta t$  is the exposure duration, or related to the electrical field in the tissue by

$$SAR = \frac{\sigma |E|^2}{\rho}$$

Where:  $\sigma$  is the conductivity of the tissue,  $\rho$  is the mass density of tissue and  $E$  is the RMS electrical field strength.

However for evaluating SAR of low power transmitter, electrical field measurement is typically applied.

## 7 Tissue Simulating Liquids

### 7.1 Targets for tissue simulating liquid

**Table 7.1: Targets for tissue simulating liquid**

Frequency(MHz)	Liquid Type	Conductivity( $\sigma$ )	$\pm 5\%$ Range	Permittivity( $\epsilon$ )	$\pm 5\%$ Range
750	Head	0.89	0.85~0.93	41.94	39.8~44.0
835	Head	0.90	0.86~0.95	41.5	39.4~43.6
1800	Head	1.40	1.33~1.47	40.0	38.0~42.0
1900	Head	1.40	1.33~1.47	40.0	38.0~42.0
2450	Head	1.67	1.59~1.75	39.47	37.5~41.4
2600	Head	1.96	1.86~2.06	39.01	37.1~41.0
5250	Head	4.66	4.43~4.89	35.99	34.19~37.79
5600	Head	5.07	4.82~5.32	35.53	33.75~37.31
5750	Head	5.22	4.96~5.48	35.36	33.59~37.13

### 7.2 Dielectric Performance

**Table 7.2: Dielectric Performance of Tissue Simulating Liquid**

Measurement Date (yyyy-mm-dd)	Type	Frequency	Permittivity $\epsilon$	Drift (%)	Conductivity $\sigma$ (S/m)	Drift (%)
2023/7/10	Head	2450 MHz	39.32	0.31	1.815	0.83
2023/7/19	Head	5250 MHz	35.89	-0.11	4.626	-1.78
2023/7/20	Head	5600 MHz	34.97	-1.58	5.085	0.30
2023/7/21	Head	5750 MHz	34.77	-1.67	5.154	-1.26
2023/7/23	Head	750 MHz	42.07	0.31	0.897	0.79
2023/7/24	Head	835 MHz	41.45	-0.12	0.884	-1.78
2023/7/25	Head	1800 MHz	39.44	-1.60	1.374	0.29
2023/7/26	Head	1900 MHz	39.33	-1.68	1.382	-1.29
2023/7/10	Head	2600 MHz	39.03	0.05	1.974	0.71

Note: The liquid temperature is 22.0°C

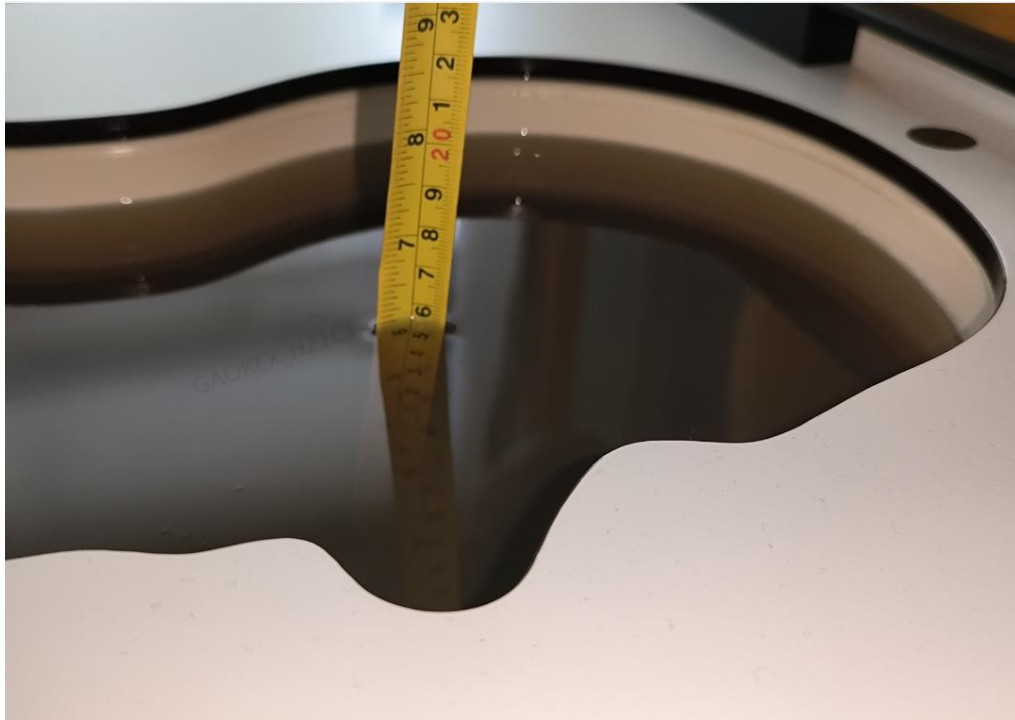

Picture 7-1 Liquid depth in the Head Phantom

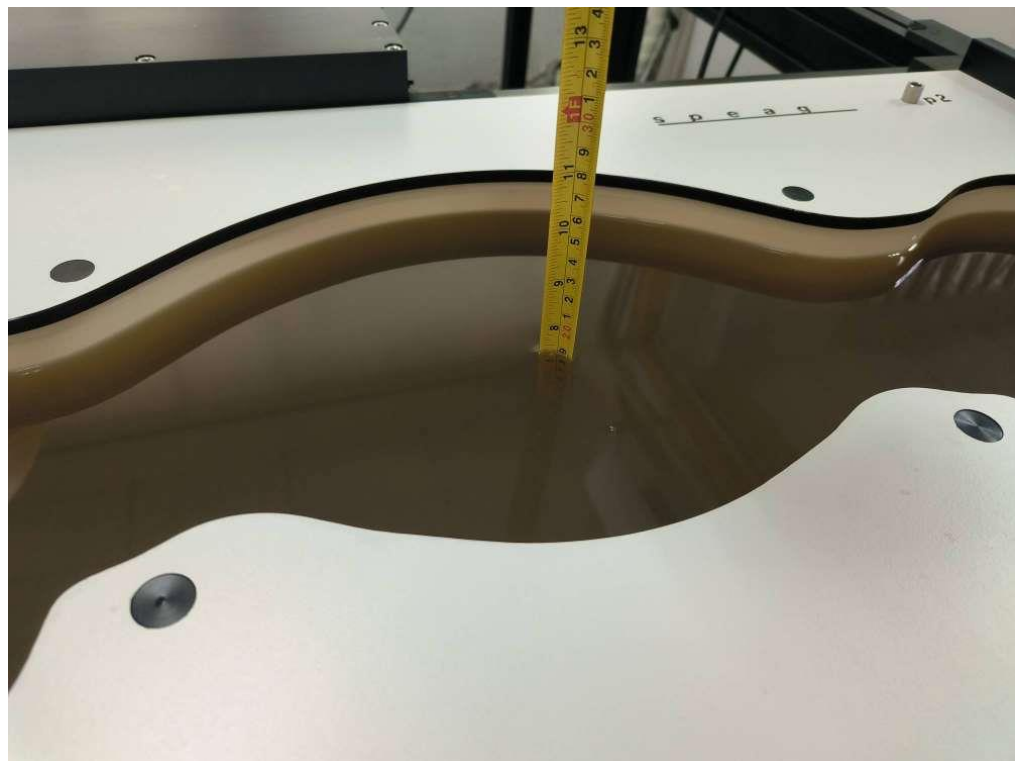

Picture 7-2 Liquid depth in the Flat Phantom

## 8 System verification

### 8.1 System Setup

In the simplified setup for system evaluation, the DUT is replaced by a calibrated dipole and the power source is replaced by a continuous wave that comes from a signal generator. The calibrated dipole must be placed beneath the flat phantom section of the SAM twin phantom with the correct distance holder. The distance holder should touch the phantom surface with a light pressure at the reference marking and be oriented parallel to the long side of the phantom. The equipment setup is shown below:

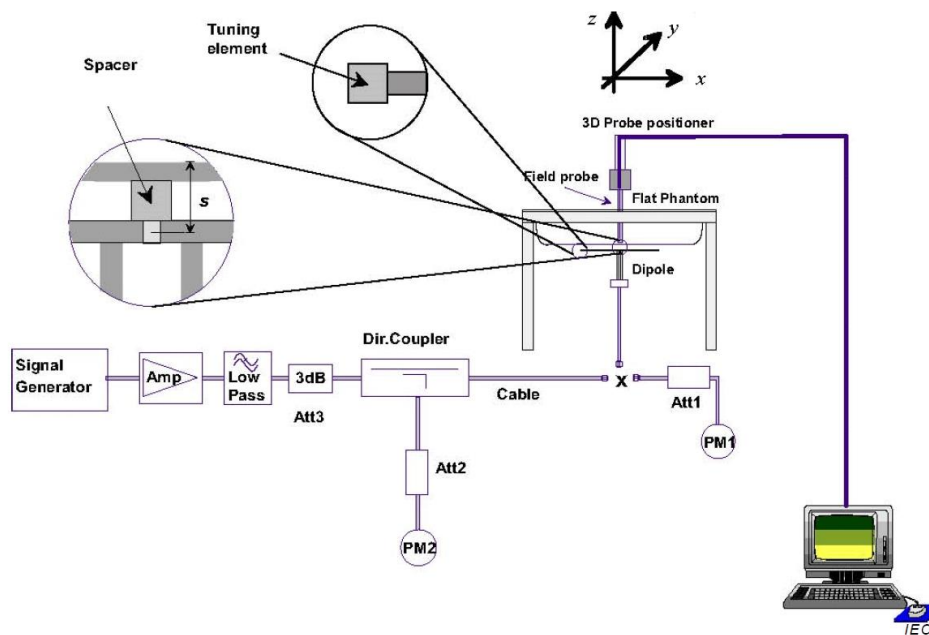

Picture 8.1 System Setup for System Evaluation

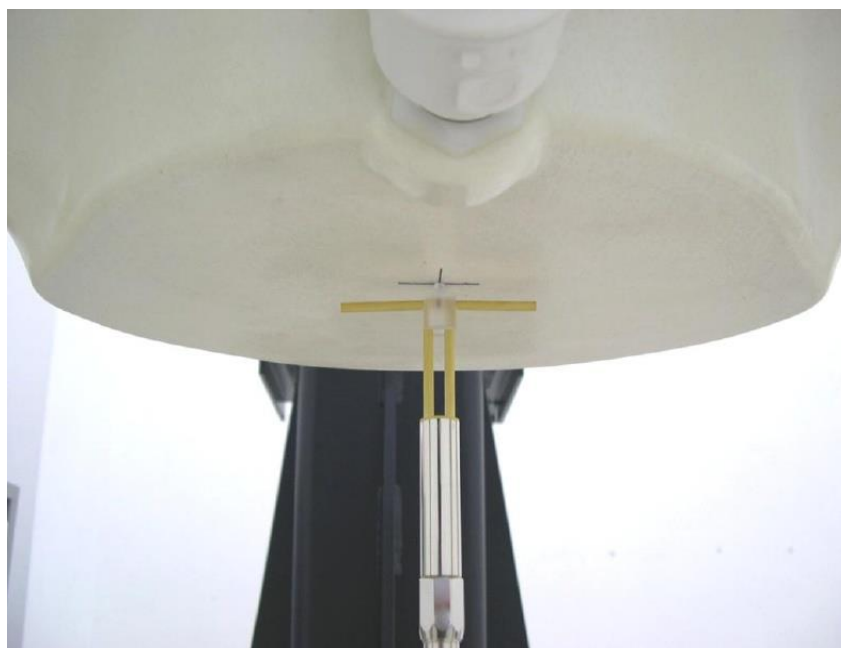

Picture 8.2 Photo of Dipole Setup



## 8.2 System Verification

SAR system verification is required to confirm measurement accuracy, according to the tissue dielectric media, probe calibration points and other system operating parameters required for measuring the SAR of a test device. The system verification must be performed for each frequency band and within the valid range of each probe calibration point required for testing the device.

The system verification results are required that the area scan estimated 1-g SAR is within 3% of the zoom scan 1-g SAR. The details are presented in annex B.

**Table 8.1: System Verification of Head**

Measurement Date (yyyy-mm-dd)	Frequency	Target value (W/kg)		Measured value(W/kg)		Deviation	
		10 g Average	1 g Average	10 g Average	1 g Average	10 g Average	1 g Average
2023/7/10	2450 MHz	24.5	52.5	24.88	52.24	1.55%	-0.50%
2023/7/19	5250 MHz	22.9	80.5	22.7	81.1	-0.96%	0.77%
2023/7/20	5600 MHz	23.6	83.3	23.5	82.2	-0.34%	-1.37%
2023/7/21	5750 MHz	22.7	80.4	23.1	80.6	1.67%	0.25%
2023/7/23	750 MHz	5.53	8.47	5.6	8.44	1.27%	-0.35%
2023/7/24	835 MHz	6.25	9.60	6.2	9.68	-0.80%	0.83%
2023/7/25	1800 MHz	19.1	36.5	19.04	36	-0.31%	-1.37%
2023/7/26	1900 MHz	20.6	39.6	20.96	39.68	1.75%	0.20%
2023/7/10	2600 MHz	25.3	57.0	25.04	56.2	-1.03%	-1.40%

## 9 Measurement Procedures

### 9.1 Tests to be performed

In order to determine the highest value of the peak spatial-average SAR of a handset, all device positions, configurations and operational modes shall be tested for each frequency band according to steps 1 to 3 below. A flowchart of the test process is shown in picture 9.1.

**Step 1:** The tests described in 9.2 shall be performed at the channel that is closest to the centre of the transmit frequency band ( $f_c$ ) for:

- a) all device positions (cheek and tilt, for both left and right sides of the SAM phantom, as described in annex D),
- b) all configurations for each device position in a), e.g., antenna extended and retracted, and
- c) all operational modes, e.g., analogue and digital, for each device position in a) and configuration in b) in each frequency band.

If more than three frequencies need to be tested according to 11.1 (i.e.,  $N_c > 3$ ), then all frequencies, configurations and modes shall be tested for all of the above test conditions.

**Step 2:** For the condition providing highest peak spatial-average SAR determined in Step 1, perform all tests described in 9.2 at all other test frequencies, i.e., lowest and highest frequencies. In addition, for all other conditions (device position, configuration and operational mode) where the peak spatial-average SAR value determined in Step 1 is within 3 dB of the applicable SAR limit, it is recommended that all other test frequencies shall be tested as well.

**Step 3:** Examine all data to determine the highest value of the peak spatial-average SAR found in Steps 1 to 2.

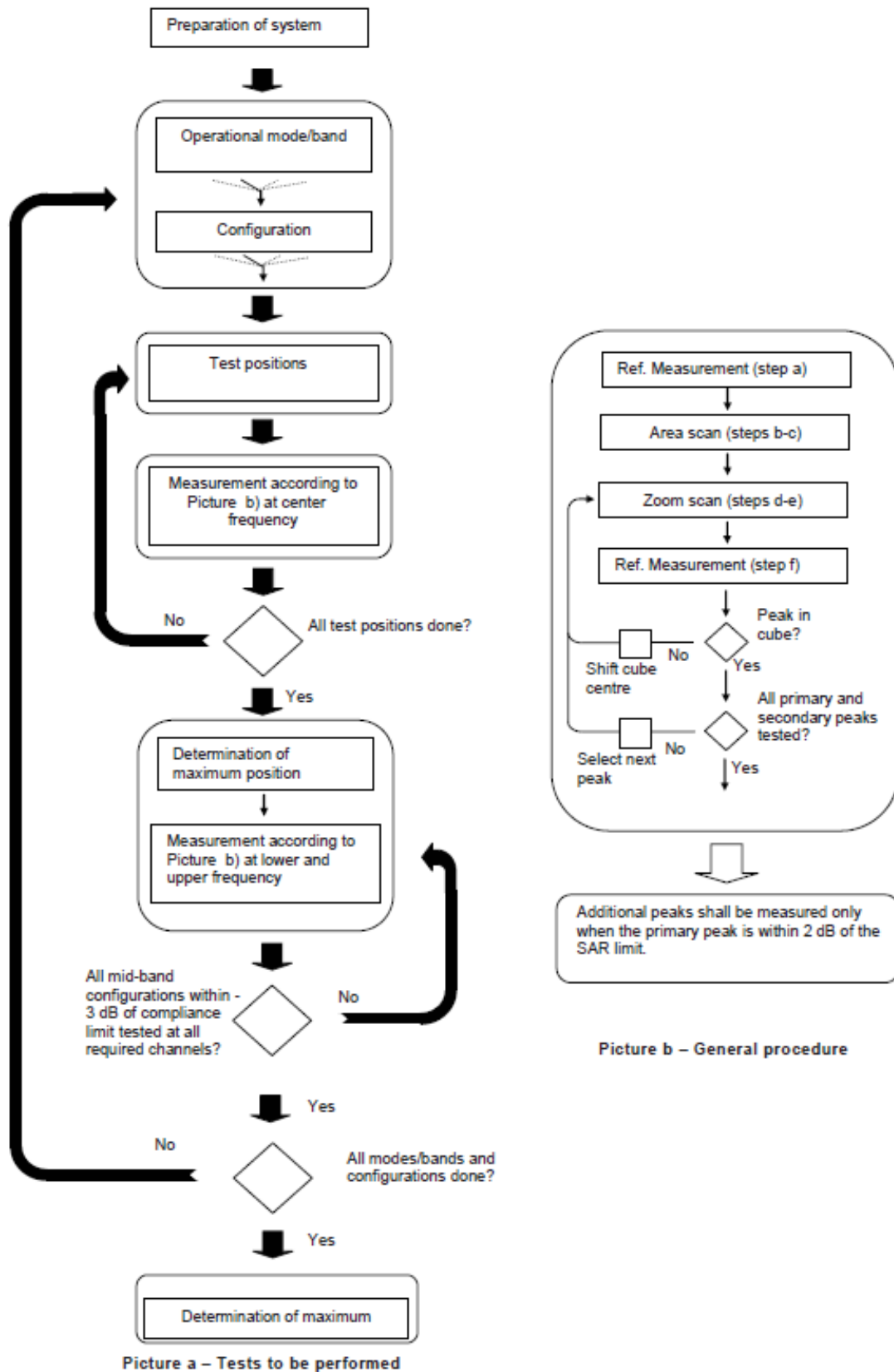

Picture 9.1 Block diagram of the tests to be performed

## 9.2 General Measurement Procedure

The area and zoom scan resolutions specified in the table below must be applied to the SAR measurements and fully documented in SAR reports to qualify for TCB approval. Probe boundary effect error compensation is required for measurements with the probe tip closer than half a probe tip diameter to the phantom surface. Both the probe tip diameter and sensor offset distance must satisfy measurement protocols; to ensure probe boundary effect errors are minimized and the higher fields closest to the phantom surface can be correctly measured and extrapolated to the phantom surface for computing 1-g SAR. Tolerances of the post-processing algorithms must be verified by the test laboratory for the scan resolutions used in the SAR measurements, according to the reference distribution functions specified in IEEE Std 1528-2013. The results should be documented as part of the system validation records and may be requested to support test results when all the measurement parameters in the following table are not satisfied.

		$\leq 3$ GHz	$> 3$ GHz
Maximum distance from closest measurement point (geometric center of probe sensors) to phantom surface		$5 \pm 1$ mm	$\frac{1}{2} \cdot \delta \cdot \ln(2) \pm 0.5$ mm
Maximum probe angle from probe axis to phantom surface normal at the measurement location		$30^\circ \pm 1^\circ$	$20^\circ \pm 1^\circ$
Maximum area scan spatial resolution: $\Delta x_{Area}$ , $\Delta y_{Area}$		$\leq 2$ GHz: $\leq 15$ mm 2 – 3 GHz: $\leq 12$ mm	3 – 4 GHz: $\leq 12$ mm 4 – 6 GHz: $\leq 10$ mm
		When the x or y dimension of the test device, in the measurement plane orientation, is smaller than the above, the measurement resolution must be $\leq$ the corresponding x or y dimension of the test device with at least one measurement point on the test device.	
Maximum zoom scan spatial resolution: $\Delta x_{Zoom}$ , $\Delta y_{Zoom}$		$\leq 2$ GHz: $\leq 8$ mm 2 – 3 GHz: $\leq 5$ mm*	3 – 4 GHz: $\leq 5$ mm* 4 – 6 GHz: $\leq 4$ mm*
Maximum zoom scan spatial resolution, normal to phantom surface	uniform grid: $\Delta z_{Zoom}(n)$	$\leq 5$ mm	3 – 4 GHz: $\leq 4$ mm 4 – 5 GHz: $\leq 3$ mm 5 – 6 GHz: $\leq 2$ mm
	graded grid	$\Delta z_{Zoom}(1)$ : between 1 <sup>st</sup> two points closest to phantom surface	$\leq 4$ mm
		$\Delta z_{Zoom}(n>1)$ : between subsequent points	$\leq 1.5 \cdot \Delta z_{Zoom}(n-1)$
Minimum zoom scan volume	x, y, z	$\geq 30$ mm	3 – 4 GHz: $\geq 28$ mm 4 – 5 GHz: $\geq 25$ mm 5 – 6 GHz: $\geq 22$ mm
Note: $\delta$ is the penetration depth of a plane-wave at normal incidence to the tissue medium; see draft standard IEEE P1528-2011 for details. * When zoom scan is required and the <i>reported</i> SAR from the area scan based 1-g SAR estimation procedures of KDB 447498 is $\leq 1.4$ W/kg, $\leq 8$ mm, $\leq 7$ mm and $\leq 5$ mm zoom scan resolution may be applied, respectively, for 2 GHz to 3 GHz, 3 GHz to 4 GHz and 4 GHz to 6 GHz.			

### 9.3 WCDMA Measurement Procedures for SAR

The following procedures are applicable to WCDMA handsets operating under 3GPP Release99, Release 5 and Release 6. The default test configuration is to measure SAR with an established radio link between the DUT and a communication test set using a 12.2kbps RMC (reference measurement channel) configured in Test Loop Mode 1. SAR is selectively confirmed for other physical channel configurations (DPCCH & DPDCH<sub>n</sub>), HSDPA and HSPA (HSUPA/HSDPA) modes according to output power, exposure conditions and device operating capabilities. Both uplink and downlink should be configured with the same RMC or AMR, when required. SAR for Release 5 HSDPA and Release 6 HSPA are measured using the applicable FRC (fixed reference channel) and E-DCH reference channel configurations. Maximum output power is verified according to applicable versions of 3GPP TS 34.121 and SAR must be measured according to these maximum output conditions. When Maximum Power Reduction (MPR) is not implemented according to Cubic Metric (CM) requirements for Release 6 HSPA, the following procedures do not apply.

#### For Release 5 HSDPA Data Devices:

Sub-test	$\beta_c$	$\beta_d$	$\beta_d$ (SF)	$\beta_c / \beta_d$	$\beta_{hs}$	CM/dB
1	2/15	15/15	64	2/15	4/15	0.0
2	12/15	15/15	64	12/15	24/25	1.0
3	15/15	8/15	64	15/8	30/15	1.5
4	15/15	4/15	64	15/4	30/15	1.5

#### For Release 6 HSPA Data Devices

Sub-test	$\beta_c$	$\beta_d$	$\beta_d$ (SF)	$\beta_c / \beta_d$	$\beta_{hs}$	$\beta_{ec}$	$\beta_{ed}$	$\beta_{ed}$ (SF)	$\beta_{ed}$ (codes)	CM (dB)	MPR (dB)	AG Index	E-TFCI
1	11/15	15/15	64	11/15	22/15	209/225	1039/225	4	1	1.5	1.5	20	75
2	6/15	15/15	64	6/15	12/15	12/15	12/15	4	1	1.5	1.5	12	67
3	15/15	9/15	64	15/9	30/15	30/15	$\beta_{ed1}:47/15$ $\beta_{ed2}:47/15$	4	2	1.5	1.5	15	92
4	2/15	15/15	64	2/15	4/15	4/15	56/75	4	1	1.5	1.5	17	71
5	15/15	15/15	64	15/15	24/15	30/15	134/15	4	1	1.5	1.5	21	81

#### Rel.8 DC-HSDPA (Cat 24)

SAR test exclusion for Rel.8 DC-HSDPA must satisfy the SAR test exclusion requirements of Rel.5 HSDPA. SAR test exclusion for DC-HSDPA devices is determined by power measurements according to the H-Set 12, Fixed Reference Channel (FRC) configuration in Table C.8.1.12 of 3GPP TS 34.121-1. A primary and a secondary serving HS-DSCH Cell are required to perform the power measurement and for the results to qualify for SAR test exclusion.

## 9.4 SAR Measurement for LTE

SAR tests for LTE are performed with a base station simulator, Rohde & Schwarz CMW500. Closed loop power control was used so the UE transmits with maximum output power during SAR testing. All powers were measured with the CMW 500.

It is performed for conducted power and SAR based on the KDB941225 D05.

SAR is evaluated separately according to the following procedures for the different test positions in each exposure condition – head, body, body-worn accessories and other use conditions. The procedures in the following subsections are applied separately to test each LTE frequency band.

### 1) QPSK with 1 RB allocation

Start with the largest channel bandwidth and measure SAR for QPSK with 1 RB allocation, using the RB offset and required test channel combination with the highest maximum output power among RB offsets at the upper edge, middle and lower edge of each required test channel. When the reported SAR is  $\leq 0.8$  W/kg, testing of the remaining RB offset configurations and required test channels is not required for 1 RB allocation; otherwise, SAR is required for the remaining required test channels and only for the RB offset configuration with the highest output power for that channel. When the reported SAR of a required test channel is  $> 1.45$  W/kg, SAR is required for all three RB offset configurations for that required test channel.

### 2) QPSK with 50% RB allocation

The procedures required for 1 RB allocation in 1) are applied to measure the SAR for QPSK with 50% RB allocation.

### 3) QPSK with 100% RB allocation

For QPSK with 100% RB allocation, SAR is not required when the highest maximum output power for 100 % RB allocation is less than the highest maximum output power in 50% and 1 RB allocations and the highest reported SAR for 1 RB and 50% RB allocation in 1) and 2) are  $\leq 0.8$  W/kg. Otherwise, SAR is measured for the highest output power channel; and if the reported SAR is  $> 1.45$  W/kg, the remaining required test channels must also be tested.

## TDD test:

TDD testing is performed using guidance from FCC KDB 941225 D05 and the SAR test guidance provided in April 2013 TCB works hop notes. TDD is tested at the highest duty factor using UL-DL configuration 0 with special subframe configuration 6 and applying the FDD LTE procedures in KDB 941225 D05. SAR testing is performed using the extended cyclic prefix listed in 3GPP TS 36.211.

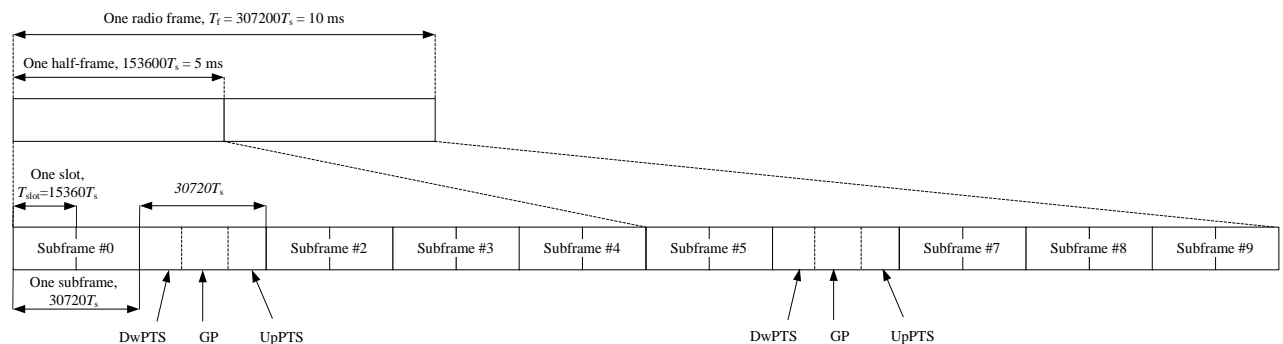

**Figure 9.2: Frame structure type 2 (for 5 ms switch-point periodicity)**

**Table 9.1: Configuration of special subframe (lengths of DwPTS/GP/UpPTS)**

Special subframe configuration	Normal cyclic prefix in downlink			Extended cyclic prefix in downlink		
	DwPTS	UpPTS		DwPTS	UpPTS	
		Normal cyclic prefix in uplink	Extended cyclic prefix in uplink		Normal cyclic prefix in uplink	Extended cyclic prefix in uplink
0	$6592 \cdot T_s$	$2192 \cdot T_s$	$2560 \cdot T_s$	$7680 \cdot T_s$	$2192 \cdot T_s$	$2560 \cdot T_s$
1	$19760 \cdot T_s$			$20480 \cdot T_s$		
2	$21952 \cdot T_s$			$23040 \cdot T_s$		
3	$24144 \cdot T_s$			$25600 \cdot T_s$		
4	$26336 \cdot T_s$			$7680 \cdot T_s$		
5	$6592 \cdot T_s$	$4384 \cdot T_s$	$5120 \cdot T_s$	$20480 \cdot T_s$	$4384 \cdot T_s$	$5120 \cdot T_s$
6	$19760 \cdot T_s$			$23040 \cdot T_s$		
7	$21952 \cdot T_s$			$12800 \cdot T_s$		
8	$24144 \cdot T_s$			-		
9	$13168 \cdot T_s$			-		

**Table 9.2: Uplink-downlink configurations**

Uplink-downlink configuration	Downlink-to-Uplink Switch-point periodicity	Subframe number									
		0	1	2	3	4	5	6	7	8	9
0	5 ms	D	S	U	U	U	D	S	U	U	U
1	5 ms	D	S	U	U	D	D	S	U	U	D
2	5 ms	D	S	U	D	D	D	S	U	D	D
3	10 ms	D	S	U	U	U	D	D	D	D	D
4	10 ms	D	S	U	U	D	D	D	D	D	D
5	10 ms	D	S	U	D	D	D	D	D	D	D
6	5 ms	D	S	U	U	U	D	S	U	U	D

Duty factor is calculated by:

Duty factor = uplink frame\*6+UpPTS\*2/one frame length

$$= (30720 \cdot T_s * 6 + 5120 \cdot T_s * 2) / 307200 \cdot T_s$$

$$= 0.633$$

## 9.5 Bluetooth & Wi-Fi Measurement Procedures for SAR

Normal network operating configurations are not suitable for measuring the SAR of 802.11 transmitters in general. Unpredictable fluctuations in network traffic and antenna diversity conditions can introduce undesirable variations in SAR results. The SAR for these devices should be measured using chipset based test mode software to ensure that the results are consistent and reliable.

Chipset based test mode software is hardware dependent and generally varies among manufacturers. The device operating parameters established in a test mode for SAR measurements must be identical to those programmed in production units, including output power levels, amplifier gain settings and other RF performance tuning parameters. The test frequencies should correspond to actual channel frequencies defined for domestic use. SAR for devices with switched diversity should be measured with only one antenna transmitting at a time during each SAR measurement, according to a fixed modulation and data rate. The same data pattern should be used for all measurements.

## 9.6 Power Drift

To control the output power stability during the SAR test, DASY4 system calculates the power drift by measuring the E-field at the same location at the beginning and at the end of the measurement for each test position. These drift values can be found in section 14 labeled as: (Power Drift [dB]). This ensures that the power drift during one measurement is within 5%.



## 10 Area Scan Based 1-g SAR

### 10.1 Requirement of KDB

According to the KDB447498 D01, when the implementation is based the specific polynomial fit algorithm as presented at the 29th Bioelectromagnetics Society meeting (2007) and the estimated 1-gSAR is  $\leq 1.2$  W/kg, a zoom scan measurement is not required provided it is also not needed for any other purpose; for example, if the peak SAR location required for simultaneous transmission SAR test exclusion can be determined accurately by the SAR system or manually to discriminate between distinctive peaks and scattered noisy SAR distributions from area scans.

There must not be any warning or alert messages due to various measurement concerns identified by the SAR system; for example, noise in measurements, peaks too close to scan boundary, peaks are too sharp, spatial resolution and uncertainty issues etc. The SAR system verification must also demonstrate that the area scan estimated 1-g SAR is within 3% of the zoom scan 1-g SAR (See Annex B). When all the SAR results for each exposure condition in a frequency band and wireless mode are based on estimated 1-g SAR, the 1-g SAR for the highest SAR configuration must be determined by a zoom scan.

### 10.2 Fast SAR Algorithms

The approach is based on the area scan measurement applying a frequency dependent attenuation parameter. This attenuation parameter was empirically determined by analyzing a large number of phones. The MOTOROLA FAST SAR was developed and validated by the MOTOROLA Research Group in Ft. Lauderdale.

In the initial study, an approximation algorithm based on Linear fit was developed. The accuracy of the algorithm has been demonstrated across a broad frequency range (136-2450 MHz) and for both 1- and 10-g averaged SAR using a sample of 264 SAR measurements from 55 wireless handsets. For the sample size studied, the root-mean-squared errors of the algorithm are 1.2% and 5.8% for 1- and 10-g averaged SAR, respectively. The paper describing the algorithm in detail is expected to be published in August 2004 within the Special Issue of Transactions on MTT.

In the second step, the same research group optimized the fitting algorithm to an Polynomial fit whereby the frequency validity was extended to cover the range 30-6000MHz. Details of this study can be found in the BEMS 2007 Proceedings.

Both algorithms are implemented in DASY software.

## 11 Conducted Output Power

**Table11: Summary of Receiver detection mechanism**

Antenna	Receiver off, Hotspot off	Receiver on, Hotspot off/on	Receiver off, Hotspot on
Main Antenna	SET 0	SET 1	SET 2

For WWAN, When the phone is in body mode (receiver off) and hotspot worked, then power reduction will be implemented immediately at GSM1900, WCDMA B2/B4 and LTEB2/B7/B41/B66. When the phone is in body mode (receiver off) and hotspot not worked, then power reduction will be implemented immediately at GSM1900, WCDMA B2/B4 and LTEB2/B7/B41/B66.

### 11.1 GSM Measurement result

**Table 11.1-1: The conducted power measurement results-GSM850 SET 0/1/2**

GSM 850 Speech (GMSK)	Measured timeslot-averaged output power (dBm)			Tune up	calculation	Source-based time-averaged output power (dBm)		
	251	190	128			251	190	128
1 Txslot	31.04	31.09	31.11	32	/	/	/	/
GSM 850 GPRS (GMSK)	Measured timeslot-averaged output power (dBm)				calculation	Source-based time-averaged output power (dBm)		
	251	190	128			251	190	128
1 Txslot	31.05	31.11	31.09	32	-9.03	22.02	22.08	22.06
2 Txslots	28.57	28.51	28.55	30	-6.02	22.55	22.49	22.53
3 Txslots	26.64	26.68	26.79	28	-4.26	22.38	22.42	22.53
4 Txslots	25.18	25.24	25.40	27	-3.01	22.17	22.23	22.39
GSM 850 EGPRS (GMSK)	Measured timeslot-averaged output power (dBm)				calculation	Source-based time-averaged output power (dBm)		
	251	190	128			251	190	128
1 Txslot	31.07	31.09	31.04	32	-9.03	22.04	22.06	22.01
2 Txslots	28.49	28.43	28.48	30	-6.02	22.47	22.41	22.46
3 Txslots	26.55	26.60	26.72	28	-4.26	22.29	22.34	22.46
4 Txslots	25.10	25.16	25.32	27	-3.01	22.09	22.15	22.31
GSM 850 EGPRS (8PSK)	Measured timeslot-averaged output power (dBm)				calculation	Source-based time-averaged output power (dBm)		
	251	190	128			251	190	128
1 Txslot	26.08	26.05	26.08	28	-9.03	17.05	17.02	17.05
2 Txslots	23.17	23.02	23.22	25	-6.02	17.15	17.00	17.20
3Txslots	21.00	21.51	21.18	23	-4.26	16.74	17.25	16.92
4 Txslots	19.54	19.63	19.81	21	-3.01	16.53	16.62	16.80

NOTES:

1) Division Factors

To average the power, the division factor is as follows:

1TX-slot = 1 transmit time slot out of 8 time slots=> conducted power divided by (8/1) => -9.03dB

2TX-slots = 2 transmit time slots out of 8 time slots=> conducted power divided by (8/2) => -6.02dB

3TX-slots = 3 transmit time slots out of 8 time slots=> conducted power divided by (8/3) => -4.26dB

4TX-slots = 4 transmit time slots out of 8 time slots=> conducted power divided by (8/4) => -3.01dB

**According to the conducted power as above, the body measurements are performed with 2Txslots for GSM850.**

**Table 11.1-2: The conducted power measurement results-GSM1900 Power SET 1**

PCS1900 Speech (GMSK)	Measured timeslot-averaged output power (dBm)			Tune up	calculation	Source-based time-averaged output power (dBm)		
	810	661	512			810	661	512
1 Txslot	28.93	28.90	29.03	30	/	/	/	/
PCS1900 GPRS (GMSK)	Measured timeslot-averaged output power (dBm)				calculation	Source-based time-averaged output power (dBm)		
	810	661	512			810	661	512
1 Txslot	29.34	29.38	29.40	30	-9.03	20.31	20.35	20.37
2 Txslots	28.57	28.59	28.63	29.5	-6.02	22.55	22.57	22.61
3 Txslots	26.72	26.72	26.73	28	-4.26	22.46	22.46	22.47
4 Txslots	25.54	25.55	25.54	27	-3.01	22.53	22.54	22.53
PCS1900 EGPRS (GMSK)	Measured timeslot-averaged output power (dBm)				calculation	Source-based time-averaged output power (dBm)		
	810	661	512			810	661	512
1 Txslot	28.99	28.91	29.03	30	-9.03	19.96	19.88	20.00
2 Txslots	28.32	28.20	28.35	29.5	-6.02	22.30	22.18	22.33
3Txslots	26.61	26.43	26.58	28	-4.26	22.35	22.17	22.32
4 Txslots	25.47	25.30	25.41	27	-3.01	22.46	22.29	22.40
PCS1900 EGPRS (8PSK)	Measured timeslot-averaged output power (dBm)				calculation	Source-based time-averaged output power (dBm)		
	810	661	512			810	661	512
1 Txslot	26.31	26.28	26.57	26.8	-9.03	17.28	17.25	17.54
2 Txslots	25.68	25.31	25.49	26	-6.02	19.66	19.29	19.47
3Txslots	23.49	23.54	23.47	24	-4.26	19.23	19.28	19.21
4 Txslots	22.47	22.34	22.56	23	-3.01	19.46	19.33	19.55

NOTES:

1) Division Factors

To average the power, the division factor is as follows:

1TX-slot = 1 transmit time slot out of 8 time slots=> conducted power divided by (8/1) => -9.03dB

2TX-slots = 2 transmit time slots out of 8 time slots=> conducted power divided by (8/2) => -6.02dB

3TX-slots = 3 transmit time slots out of 8 time slots=> conducted power divided by (8/3) => -4.26dB

4TX-slots = 4 transmit time slots out of 8 time slots=> conducted power divided by (8/4) => -3.01dB

According to the conducted power as above, the body measurements are performed with 2Txslots for GSM1900.

**Table 11.1-3: The conducted power measurement results-GSM1900 SET 0**

PCS1900 Speech (GMSK)	Measured timeslot-averaged output power (dBm)			Tune up	calculation	Source-based time-averaged output power (dBm)		
	810	661	512			810	661	512
1 Txslot	28.98	28.91	28.97	29.5	/	/	/	/
PCS1900 GPRS (GMSK)	Measured timeslot-averaged output power (dBm)				calculation	Source-based time-averaged output power (dBm)		
	810	661	512			810	661	512
1 Txslot	29.04	28.88	28.95	29.5	-9.03	20.01	19.85	19.92
2 Txslots	28.34	28.20	28.37	28.5	-6.02	22.32	22.18	22.35
3 Txslots	26.46	26.41	26.49	26.5	-4.26	22.20	22.15	22.23
4 Txslots	25.24	25.17	25.21	26	-3.01	22.23	22.16	22.20
PCS1900 EGPRS (GMSK)	Measured timeslot-averaged output power (dBm)				calculation	Source-based time-averaged output power (dBm)		
	810	661	512			810	661	512
1 Txslot	28.88	28.82	28.86	29.5	-9.03	19.85	19.79	19.83
2 Txslots	28.23	28.14	28.34	28.5	-6.02	22.21	22.12	22.32
3Txslots	26.45	26.36	26.46	26.5	-4.26	22.19	22.10	22.20
4 Txslots	25.16	25.13	25.28	26	-3.01	22.15	22.12	22.27
PCS1900 EGPRS (8PSK)	Measured timeslot-averaged output power (dBm)				calculation	Source-based time-averaged output power (dBm)		
	810	661	512			810	661	512
1 Txslot	26.33	26.27	26.37	26.8	-9.03	17.30	17.24	17.34
2 Txslots	25.38	25.34	25.48	26	-6.02	19.36	19.32	19.46
3Txslots	23.51	23.43	23.50	24	-4.26	19.25	19.17	19.24
4 Txslots	22.29	22.34	22.39	23	-3.01	19.28	19.33	19.38

NOTES:

1) Division Factors

To average the power, the division factor is as follows:

1TX-slot = 1 transmit time slot out of 8 time slots=> conducted power divided by (8/1) => -9.03dB

2TX-slots = 2 transmit time slots out of 8 time slots=> conducted power divided by (8/2) => -6.02dB

3TX-slots = 3 transmit time slots out of 8 time slots=> conducted power divided by (8/3) => -4.26dB

4TX-slots = 4 transmit time slots out of 8 time slots=> conducted power divided by (8/4) => -3.01dB

According to the conducted power as above, the body measurements are performed with 2Txslots for GSM1900.

**Table 11.1-3: The conducted power measurement results-GSM1900 SET 2**

PCS1900 Speech (GMSK)	Measured timeslot-averaged output power (dBm)			Tune up	calculation	Source-based time-averaged output power (dBm)		
	810	661	512			810	661	512
1 Txslot	29.06	29.01	29.20	29.5	/	/	/	/
PCS1900 GPRS (GMSK)	Measured timeslot-averaged output power (dBm)				calculation	Source-based time-averaged output power (dBm)		
	810	661	512			810	661	512
1 Txslot	28.42	28.32	28.53	29.5	-9.03	19.39	19.29	19.50
2 Txslots	25.57	25.56	25.60	27.5	-6.02	19.55	19.54	19.58
3 Txslots	23.66	23.64	23.78	25	-4.26	19.40	19.38	19.52
4 Txslots	22.48	22.34	22.47	24	-3.01	19.47	19.33	19.46
PCS1900 EGPRS (GMSK)	Measured timeslot-averaged output power (dBm)				calculation	Source-based time-averaged output power (dBm)		
	810	661	512			810	661	512
1 Txslot	28.46	28.28	27.74	29.5	-9.03	19.43	19.25	18.71
2 Txslots	25.56	25.55	25.66	27.5	-6.02	19.54	19.53	19.64
3Txslots	23.75	23.66	23.05	25	-4.26	19.49	19.40	18.79
4 Txslots	22.49	22.13	22.23	24	-3.01	19.48	19.12	19.22
PCS1900 EGPRS (8PSK)	Measured timeslot-averaged output power (dBm)				calculation	Source-based time-averaged output power (dBm)		
	810	661	512			810	661	512
1 Txslot	24.44	24.55	24.55	26	-9.03	15.41	15.52	15.52
2 Txslots	22.12	22.24	22.03	24	-6.02	16.10	16.22	16.01
3Txslots	20.27	20.14	20.18	22	-4.26	16.01	15.88	15.92
4 Txslots	18.57	18.54	18.53	20.5	-3.01	15.56	15.53	15.52

**NOTES:**

## 1) Division Factors

To average the power, the division factor is as follows:

1TX-slot = 1 transmit time slot out of 8 time slots=> conducted power divided by (8/1) => -9.03dB

2TX-slots = 2 transmit time slots out of 8 time slots=> conducted power divided by (8/2) => -6.02dB

3TX-slots = 3 transmit time slots out of 8 time slots=> conducted power divided by (8/3) => -4.26dB

4TX-slots = 4 transmit time slots out of 8 time slots=> conducted power divided by (8/4) => -3.01dB

**According to the conducted power as above, the body measurements are performed with 2Txslots for GSM1900.**

## 11.2 WCDMA Measurement result

**Table 11.2-1: The conducted Power for WCDMA Band5 SET 0/1/2**

WCDMA850	Sub test	FDDV result (dBm)			Tune up
		4233/4458	4183/4408	4132/4357	
		(846.6MHz)	(836.6MHz)	(826.4MHz)	
	/	22.93	23.01	23.20	24
HSUPA	1	21.20	20.63	21.04	21.5
	2	19.54	19.43	19.50	20.5
	3	20.11	20.18	20.31	21.5
	4	19.43	19.32	19.45	20.5
	5	20.54	20.54	20.65	22.5
HSPA+	1	21.66	21.23	20.78	22
DC-HSDPA	1	21.05	21.09	21.10	23
	2	20.65	20.61	20.65	22.5
	3	20.05	20.12	20.08	22
	4	20.05	20.09	20.04	22

**Table 11.2-2: The conducted Power for WCDMA Band2 SET 1**

WCDMA1900	Sub test	FDDII result (dBm)			Tune up
		9538/9938	9400/9800	9262/9662	
		(1907.6MHz)	(1880MHz)	(1852.4MHz)	
	/	22.91	22.88	22.82	24
HSUPA	1	21.01	20.53	20.54	22.5
	2	19.12	19.04	19.05	21
	3	20.04	20.09	20.08	22
	4	18.6	18.54	18.65	20.5
	5	20.6	20.59	20.61	22.5
HSPA+	1	21.33	20.88	20.64	22
DC-HSDPA	1	21.13	21.04	21.23	23
	2	21.05	21.05	21.11	23
	3	20.65	20.54	20.61	22.5
	4	20.65	20.54	20.66	22.5

Table 11.2-3: The conducted Power for WCDMA Band4 SET 1

WCDMA1700	Sub test	FDDIV result (dBm)			Tune up
		1513/1738	1412/1637	1312/1537	
		(1752.6MHz)	(1732.4MHz)	(1712.4MHz)	
	/	22.51	22.45	22.40	24
HSUPA	1	20.45	20.45	20.49	20.5
	2	19.32	19.40	19.23	19.5
	3	20.11	20.43	20.31	20.5
	4	19.65	19.70	19.54	20
	5	20.11	20.43	20.43	20.5
HSPA+	1	20.9	20.85	20.78	21
DC-HSDPA	1	20.56	20.81	20.78	21
	2	20.94	20.85	20.65	21
	3	20.75	20.89	20.90	21
	4	20.55	20.12	20.54	21

**Table 11.2-4: The conducted Power for WCDMA Band2 SET 0**

WCDMA1900	Sub test	FDDII result (dBm)			Tune up
		9538/9938	9400/9800	9262/9662	
		(1907.6MHz)	(1880MHz)	(1852.4MHz)	
	/	22.49	22.38	22.25	23.50
HSUPA	1	20.45	20.37	20.49	20.5
	2	19.45	19.13	19.51	19.5
	3	19.85	19.65	19.90	20.5
	4	19.84	19.66	19.98	20
	5	19.86	19.63	19.99	20.5
HSPA+	1	20.65	20.54	20.91	21
DC-HSDPA	1	19.88	20.25	19.90	21
	2	19.84	20.09	19.76	21
	3	19.28	19.65	19.31	21
	4	19.29	19.66	19.28	21

**Table 11.2-5: The conducted Power for WCDMA Band4 SET 0**

WCDMA1700	Sub test	FDDIV result (dBm)			Tune up
		1513/1738	1412/1637	1312/1537	
		(1752.6MHz)	(1732.4MHz)	(1712.4MHz)	
	/	22.20	22.17	22.12	23.50
HSUPA	1	20.32	19.66	20.15	20.5
	2	19.38	18.70	19.55	19.5
	3	19.87	19.14	20.01	20.5
	4	19.87	19.10	19.97	20
	5	19.93	19.20	19.95	20.5
HSPA+	1	20.54	20.64	20.74	21
DC-HSDPA	1	19.87	20.40	20.15	21
	2	19.83	20.37	20.11	21
	3	19.38	19.91	19.65	21
	4	19.30	19.89	19.58	21



Table 11.2-6: The conducted Power for WCDMA Band2 SET 2

WCDMA1900	Sub test	FDDII result (dBm)			Tune up
		9538/9938	9400/9800	9262/9662	
		(1907.6MHz)	(1880MHz)	(1852.4MHz)	
	/	22.35	22.30	22.09	23
HSUPA	1	18.85	19.02	18.95	20
	2	17.54	17.84	17.55	19
	3	18.12	18.23	18.43	20
	4	17.65	17.66	17.74	19.5
	5	18.21	18.32	18.32	20
HSPA+	1	18.65	18.94	19.30	19.5
DC-HSDPA	1	20.18	19.65	19.23	20.5
	2	20.12	20.09	20.11	20.5
	3	20.03	20.09	20.11	20.5
	4	20.05	20.12	20.05	20.5

Table 11.2-7: The conducted Power for WCDMA Band4 SET 2

WCDMA1700	Sub test	FDDIV result (dBm)			Tune up
		1513/1738	1412/1637	1312/1537	
		(1752.6MHz)	(1732.4MHz)	(1712.4MHz)	
	/	21.01	21.86	21.93	22.00
HSUPA	1	19.65	19.28	19.84	20.5
	2	19.04	19.11	19.05	19.5
	3	19.04	19.01	18.76	20.5
	4	18.85	18.43	18.65	20
	5	20.11	20.43	20.12	20.5
HSPA+	1	19.62	20.54	20.48	21
DC-HSDPA	1	19.04	19.23	19.15	21
	2	19.43	19.43	19.01	21
	3	19.32	19.43	19.12	21
	4	19.14	19.32	19.40	21

### 11.3 LTE Measurement result

#### Maximum Target Power for Production Unit – SET\_0/1/2

Band	Tune up (dBm)		
	Receiver off, Hotspot off	Receiver on, Hotspot off/on	Receiver off, Hotspot on
	SET_0	SET_1	SET_2
FDD Band 2	22	23	21
FDD Band 4	22	23	21
FDD Band 5	24.5	23.5	24.5
FDD Band 7	21.5	23	21
FDD Band 12	24.5	24.5	24.5
FDD Band 13	24.5	24.5	24.5
FDD Band 17	24.5	24.5	24.5
TDD Band 41	23	24	22.5
FDD Band 66	22	23	21

LTE B2 SET0						
BANDWIDTH	Number of RBs	Frequency	QPSK	16QAM	64QAM	
1.4MHz	1RB-High (5)	1909.3 (19193)	20.15	20.26	19.81	
		1880 (18900)	20.08	20.19	19.74	
		1850.7 (18607)	19.96	20.07	19.62	
	1RB-Middle (3)	1909.3 (19193)	20.44	20.55	20.08	
		1880 (18900)	20.21	20.32	19.86	
		1850.7 (18607)	20.32	20.43	19.97	
	1RB-Low (0)	1909.3 (19193)	20.07	20.18	19.73	
		1880 (18900)	19.91	20.02	19.58	
		1850.7 (18607)	20.13	20.24	19.79	
	3RB-High (3)	1909.3 (19193)	20.26	20.37	19.91	
		1880 (18900)	20.22	20.33	19.87	
		1850.7 (18607)	19.97	20.08	19.63	
	3RB-Middle (1)	1909.3 (19193)	20.03	20.14	19.69	
		1880 (18900)	20.09	20.20	19.75	
		1850.7 (18607)	20.15	20.26	19.81	
	3RB-Low (0)	1909.3 (19193)	20.37	20.48	20.02	
		1880 (18900)	20.02	20.13	19.68	
		1850.7 (18607)	20.19	20.30	19.84	
	6RB (0)	1909.3 (19193)	20.37	20.48	20.02	
		1880 (18900)	20.26	20.37	19.91	
		1850.7 (18607)	20.15	20.26	19.81	
	3MHz	1RB-High (14)	1908.5 (19185)	20.26	19.95	19.79
			1880 (18900)	20.19	19.88	19.72
			1851.5 (18615)	20.07	19.76	19.61
1RB-Middle (7)		1908.5 (19185)	20.55	20.24	20.06	
		1880 (18900)	20.32	20.01	19.84	
		1851.5 (18615)	20.43	20.12	19.95	
1RB-Low (0)		1908.5 (19185)	20.18	19.87	19.71	
		1880 (18900)	20.02	19.72	19.56	
		1851.5 (18615)	20.24	19.93	19.77	
8RB-High (7)		1908.5 (19185)	20.37	20.06	19.89	
		1880 (18900)	20.33	20.02	19.85	
		1851.5 (18615)	20.08	19.77	19.61	
8RB-Middle (4)		1908.5 (19185)	20.14	19.83	19.67	
		1880 (18900)	20.20	19.89	19.73	
		1851.5 (18615)	20.26	19.95	19.79	
8RB-Low (0)		1908.5 (19185)	20.48	20.17	20.00	
		1880 (18900)	20.13	19.82	19.66	
		1851.5 (18615)	20.30	19.99	19.82	
15RB (0)		1908.5 (19185)	20.48	20.17	20.00	

5MHz		1880 (18900)	20.37	20.06	19.89	
		1851.5 (18615)	20.26	19.95	19.79	
		1907.5 (19175)	20.16	20.70	20.34	
	1RB-High (24)	1880 (18900)	20.09	20.63	20.27	
		1852.5 (18625)	19.97	20.50	20.16	
		1907.5 (19175)	20.45	20.99	20.63	
	1RB-Middle (12)	1880 (18900)	20.22	20.76	20.40	
		1852.5 (18625)	20.33	20.87	20.51	
		1907.5 (19175)	20.08	20.61	20.26	
	1RB-Low (0)	1880 (18900)	19.92	20.45	20.11	
		1852.5 (18625)	20.14	20.68	20.32	
		1907.5 (19175)	20.27	20.81	20.45	
	12RB-High (13)	1880 (18900)	20.23	20.77	20.41	
		1852.5 (18625)	19.98	20.51	20.17	
		1907.5 (19175)	20.04	20.57	20.22	
	12RB-Middle (6)	1880 (18900)	20.10	20.64	20.28	
		1852.5 (18625)	20.16	20.70	20.34	
		1907.5 (19175)	20.38	20.92	20.56	
	12RB-Low (0)	1880 (18900)	20.03	20.56	20.21	
		1852.5 (18625)	20.20	20.74	20.38	
		1907.5 (19175)	20.38	20.92	20.56	
	25RB (0)	1880 (18900)	20.27	20.81	20.45	
		1852.5 (18625)	20.16	20.70	20.34	
		1905 (19150)	20.67	20.72	20.24	
	10MHz	1RB-High (49)	1880 (18900)	20.60	20.65	20.17
			1855 (18650)	20.47	20.52	20.04
			1905 (19150)	20.96	21.01	20.51
		1RB-Middle (24)	1880 (18900)	20.73	20.78	20.29
			1855 (18650)	20.84	20.89	20.40
			1905 (19150)	20.58	20.63	20.15
		1RB-Low (0)	1880 (18900)	20.42	20.47	20.00
			1855 (18650)	20.65	20.70	20.22
			1905 (19150)	20.78	20.83	20.34
		25RB-High (25)	1880 (18900)	20.74	20.79	20.30
			1855 (18650)	20.48	20.53	20.05
			1905 (19150)	20.54	20.59	20.11
25RB-Middle (12)		1880 (18900)	20.61	20.66	20.18	
		1855 (18650)	20.67	20.72	20.24	
		1905 (19150)	20.89	20.94	20.45	
25RB-Low (0)		1880 (18900)	20.53	20.58	20.10	
		1855 (18650)	20.71	20.76	20.27	
		1905 (19150)	20.89	20.94	20.45	
50RB (0)		1905 (19150)	20.89	20.94	20.45	

15MHz		1880 (18900)	20.78	20.83	20.34	
		1855 (18650)	20.67	20.72	20.24	
		1902.5 (19125)	20.85	20.62	20.19	
	1RB-High (74)	1880 (18900)	20.78	20.55	20.12	
		1857.5 (18675)	20.65	20.42	20.00	
		1902.5 (19125)	21.14	20.91	20.46	
	1RB-Middle (37)	1880 (18900)	20.91	20.68	20.24	
		1857.5 (18675)	21.02	20.79	20.35	
		1902.5 (19125)	20.76	20.53	20.10	
	1RB-Low (0)	1880 (18900)	20.60	20.37	19.95	
		1857.5 (18675)	20.83	20.60	20.17	
		1902.5 (19125)	20.96	20.73	20.29	
	36RB-High (38)	1880 (18900)	20.92	20.69	20.25	
		1857.5 (18675)	20.66	20.43	20.01	
		1902.5 (19125)	20.72	20.49	20.06	
	36RB-Middle (19)	1880 (18900)	20.79	20.56	20.13	
		1857.5 (18675)	20.85	20.62	20.19	
		1902.5 (19125)	21.07	20.84	20.39	
	36RB-Low (0)	1880 (18900)	20.71	20.48	20.05	
		1857.5 (18675)	20.89	20.66	20.22	
		1902.5 (19125)	21.07	20.84	20.39	
	75RB (0)	1880 (18900)	20.96	20.73	20.29	
		1857.5 (18675)	20.85	20.62	20.19	
		1900 (19100)	20.48	20.98	20.41	
	20MHz	1RB-High (99)	1880 (18900)	20.41	20.91	20.34
			1860 (18700)	20.29	20.79	20.22
			1900 (19100)	20.24	21.28	20.69
		1RB-Middle (50)	1880 (18900)	20.54	21.04	20.46
			1860 (18700)	20.65	21.15	20.57
			1900 (19100)	20.39	20.89	20.32
		1RB-Low (0)	1880 (18900)	20.77	20.73	20.17
			1860 (18700)	20.46	20.96	20.39
			1900 (19100)	20.59	21.09	20.51
		50RB-High (50)	1880 (18900)	20.55	21.05	20.47
			1860 (18700)	20.30	20.80	20.23
			1900 (19100)	20.35	20.85	20.28
50RB-Middle (25)		1880 (18900)	20.72	20.92	20.35	
		1860 (18700)	20.48	20.98	20.41	
		1900 (19100)	20.42	21.21	20.62	
50RB-Low (0)		1880 (18900)	20.34	20.84	20.27	
		1860 (18700)	20.52	21.02	20.45	
		1900 (19100)	20.70	21.21	20.62	
100RB (0)						

		1880 (18900)	20.59	21.09	20.51
		1860 (18700)	20.48	20.98	20.41

LTE B7 SET0						
BANDWIDTH	Number of RBs	Frequency	QPSK	16QAM	64QAM	
5MHz	1RB-High (24)	2567.5 (21425)	20.04	19.86	19.75	
		2535 (21100)	20.11	20.03	19.92	
		2502.5 (20775)	20.01	19.93	19.82	
	1RB-Middle (12)	2567.5 (21425)	20.23	20.15	20.03	
		2535 (21100)	20.29	20.21	20.09	
		2502.5 (20775)	20.35	20.27	20.15	
	1RB-Low (0)	2567.5 (21425)	20.09	20.01	19.90	
		2535 (21100)	20.01	19.93	19.82	
		2502.5 (20775)	20.09	19.90	19.79	
	12RB-High (13)	2567.5 (21425)	20.09	19.87	19.76	
		2535 (21100)	20.25	20.17	20.05	
		2502.5 (20775)	20.06	19.98	19.87	
	12RB-Middle (6)	2567.5 (21425)	20.13	20.05	19.94	
		2535 (21100)	20.28	20.20	20.08	
		2502.5 (20775)	20.17	20.09	19.97	
	12RB-Low (0)	2567.5 (21425)	20.20	20.12	20.00	
		2535 (21100)	20.23	20.15	20.03	
		2502.5 (20775)	20.13	20.05	19.94	
	25RB (0)	2567.5 (21425)	20.12	20.04	19.93	
		2535 (21100)	20.28	20.20	20.08	
		2502.5 (20775)	20.08	20.00	19.89	
	10MHz	1RB-High (49)	2565 (21400)	20.04	20.02	19.57
			2535 (21100)	20.21	20.19	19.73
			2505 (20800)	20.11	20.09	19.63
1RB-Middle (24)		2565 (21400)	20.33	20.31	19.84	
		2535 (21100)	20.39	20.37	19.90	
		2505 (20800)	20.45	20.43	19.96	
1RB-Low (0)		2565 (21400)	20.19	20.17	19.71	
		2535 (21100)	20.11	20.09	19.63	
		2505 (20800)	20.08	20.06	19.61	
25RB-High (25)		2565 (21400)	20.05	20.03	19.58	
		2535 (21100)	20.35	20.33	19.86	
		2505 (20800)	20.16	20.14	19.68	
25RB-Middle (12)		2565 (21400)	20.23	20.21	19.75	
		2535 (21100)	20.38	20.36	19.89	
		2505 (20800)	20.27	20.25	19.79	
25RB-Low (0)		2565 (21400)	20.30	20.28	19.81	

		2535 (21100)	20.33	20.31	19.84	
		2505 (20800)	20.23	20.21	19.75	
		50RB (0)	2565 (21400)	20.22	20.20	19.74
			2535 (21100)	20.38	20.36	19.89
			2505 (20800)	20.18	20.16	19.70
15MHz	1RB-High (74)	2562.5 (21375)	20.01	19.95	19.62	
		2535 (21100)	20.18	20.12	19.78	
		2507.5 (20825)	20.08	20.02	19.68	
	1RB-Middle (37)	2562.5 (21375)	20.30	20.24	19.89	
		2535 (21100)	20.36	20.30	19.95	
		2507.5 (20825)	20.42	20.36	20.01	
	1RB-Low (0)	2562.5 (21375)	20.16	20.10	19.76	
		2535 (21100)	20.08	20.02	19.68	
		2507.5 (20825)	20.05	19.99	19.66	
	36RB-High (38)	2562.5 (21375)	20.02	19.96	19.63	
		2535 (21100)	20.32	20.26	19.91	
		2507.5 (20825)	20.13	20.07	19.73	
	36RB-Middle (19)	2562.5 (21375)	20.20	20.14	19.80	
		2535 (21100)	20.35	20.29	19.94	
		2507.5 (20825)	20.24	20.18	19.84	
	36RB-Low (0)	2562.5 (21375)	20.27	20.21	19.86	
		2535 (21100)	20.30	20.24	19.89	
		2507.5 (20825)	20.20	20.14	19.80	
	75RB (0)	2562.5 (21375)	20.19	20.13	19.79	
		2535 (21100)	20.35	20.29	19.94	
		2507.5 (20825)	20.15	20.09	19.75	
	20MHz	1RB-High (99)	2560 (21350)	20.18	20.10	19.63
			2535 (21100)	20.35	20.27	19.79
			2510 (20850)	20.25	20.17	19.69
		1RB-Middle (50)	2560 (21350)	20.47	20.39	19.90
			2535 (21100)	20.53	20.45	19.96
			2510 (20850)	20.33	20.51	20.01
		1RB-Low (0)	2560 (21350)	20.59	20.25	19.77
			2535 (21100)	20.25	20.17	19.69
			2510 (20850)	20.22	20.14	19.66
50RB-High (50)		2560 (21350)	20.19	20.11	19.64	
		2535 (21100)	20.49	20.41	19.92	
		2510 (20850)	20.30	20.22	19.74	
50RB-Middle (25)		2560 (21350)	20.37	20.29	19.81	
		2535 (21100)	20.44	20.44	19.95	
		2510 (20850)	20.41	20.33	19.84	
50RB-Low (0)	2560 (21350)	20.52	20.36	19.87		

		2535 (21100)	20.47	20.39	19.90
		2510 (20850)	20.37	20.29	19.81
	100RB (0)	2560 (21350)	20.36	20.28	19.80
		2535 (21100)	20.52	20.44	19.95
		2510 (20850)	20.32	20.24	19.76

LTE B41 SET0					
BANDWIDTH	Number of RBs	Frequency	QPSK	16QAM	64QAM
5MHz	1RB-High (24)	2687.5 (41565)	21.70	21.06	21.33
		2640.3(41093)	21.89	21.24	21.52
		2593 (40620)	22.00	21.35	21.63
		2545.8(40148)	21.75	21.11	21.38
		2498.5 (39675)	21.67	21.03	21.30
	1RB-Middle (12)	2687.5 (41565)	21.52	20.89	21.15
		2640.3(41093)	21.81	21.17	21.44
		2593 (40620)	21.75	21.11	21.38
		2545.8(40148)	21.60	20.96	21.23
		2498.5 (39675)	21.63	20.99	21.26
	1RB-Low (0)	2687.5 (41565)	21.74	21.10	21.37
		2640.3(41093)	21.95	21.30	21.58
		2593 (40620)	21.81	21.17	21.44
		2545.8(40148)	21.64	21.00	21.27
		2498.5 (39675)	21.72	21.08	21.35
	12RB-High (13)	2687.5 (41565)	21.83	21.19	21.46
		2640.3(41093)	21.97	21.32	21.60
		2593 (40620)	22.03	21.38	21.65
		2545.8(40148)	21.95	21.30	21.58
		2498.5 (39675)	21.76	21.12	21.39
	12RB-Middle (6)	2687.5 (41565)	21.90	21.25	21.53
		2640.3(41093)	22.02	21.37	21.65
		2593 (40620)	22.02	21.37	21.65
		2545.8(40148)	21.89	21.24	21.52
		2498.5 (39675)	21.78	21.14	21.41
	12RB-Low (0)	2687.5 (41565)	21.80	21.16	21.43
		2640.3(41093)	21.88	21.23	21.51
		2593 (40620)	21.95	21.30	21.58
		2545.8(40148)	21.85	21.21	21.48
		2498.5 (39675)	21.88	21.23	21.51
	25RB (0)	2687.5 (41565)	21.84	21.20	21.47
		2640.3(41093)	22.01	21.36	21.64
2593 (40620)		22.04	21.39	21.66	
2545.8(40148)		21.93	21.28	21.56	



		2498.5 (39675)	21.77	21.13	21.40
10MHz	1RB-High (49)	2685 (41540)	21.56	21.36	21.88
		2639(41080)	21.75	21.55	22.07
		2593 (40620)	21.86	21.66	22.18
		2547(40160)	21.61	21.41	21.93
		2501 (39700)	21.53	21.33	21.85
	1RB-Middle (24)	2685 (41540)	21.38	21.18	21.70
		2639(41080)	21.67	21.47	21.99
		2593 (40620)	21.61	21.41	21.93
		2547(40160)	21.46	21.26	21.78
		2501 (39700)	21.49	21.29	21.81
	1RB-Low (0)	2685 (41540)	21.60	21.40	21.92
		2639(41080)	21.81	21.61	22.13
		2593 (40620)	21.67	21.47	21.99
		2547(40160)	21.50	21.30	21.82
		2501 (39700)	21.58	21.38	21.90
	25RB-High (25)	2685 (41540)	21.69	21.49	22.01
		2639(41080)	21.83	21.63	22.15
		2593 (40620)	21.89	21.69	22.22
		2547(40160)	21.81	21.61	22.13
		2501 (39700)	21.62	21.42	21.94
	25RB-Middle (12)	2685 (41540)	21.76	21.56	22.08
		2639(41080)	21.88	21.68	22.21
		2593 (40620)	21.88	21.68	22.21
		2547(40160)	21.75	21.55	22.07
		2501 (39700)	21.64	21.44	21.96
25RB-Low (0)	2685 (41540)	21.66	21.46	21.98	
	2639(41080)	21.74	21.54	22.06	
	2593 (40620)	21.81	21.61	22.13	
	2547(40160)	21.71	21.51	22.03	
	2501 (39700)	21.74	21.54	22.06	
50RB (0)	2685 (41540)	21.70	21.50	22.02	
	2639(41080)	21.87	21.67	22.20	
	2593 (40620)	21.90	21.70	22.23	
	2547(40160)	21.79	21.59	22.11	
	2501 (39700)	21.63	21.43	21.95	
15MHz	1RB-High (74)	2682.5 (41515)	21.19	21.67	21.30
		2637.8(41068)	21.38	21.86	21.49
		2593 (40620)	21.48	21.97	21.59
		2548.3(40173)	21.24	21.72	21.35
		2503.5 (39725)	21.16	21.64	21.27
	1RB-Middle (37)	2682.5 (41515)	21.01	21.49	21.12

		2637.8(41068)	21.30	21.78	21.41
		2593 (40620)	21.24	21.72	21.35
		2548.3(40173)	21.09	21.57	21.20
		2503.5 (39725)	21.12	21.60	21.23
	1RB-Low (0)	2682.5 (41515)	21.23	21.71	21.34
		2637.8(41068)	21.44	21.93	21.55
		2593 (40620)	21.30	21.78	21.41
		2548.3(40173)	21.13	21.61	21.24
		2503.5 (39725)	21.21	21.69	21.32
	36RB-High (38)	2682.5 (41515)	21.32	21.80	21.43
		2637.8(41068)	21.46	21.95	21.57
		2593 (40620)	21.51	22.00	21.62
		2548.3(40173)	21.44	21.93	21.55
		2503.5 (39725)	21.25	21.73	21.36
	36RB-Middle (19)	2682.5 (41515)	21.39	21.87	21.50
		2637.8(41068)	21.50	21.99	21.61
		2593 (40620)	21.50	21.99	21.61
		2548.3(40173)	21.38	21.86	21.49
		2503.5 (39725)	21.27	21.75	21.38
	36RB-Low (0)	2682.5 (41515)	21.29	21.77	21.40
		2637.8(41068)	21.37	21.85	21.48
		2593 (40620)	21.44	21.93	21.55
		2548.3(40173)	21.34	21.82	21.45
		2503.5 (39725)	21.37	21.85	21.48
	75RB (0)	2682.5 (41515)	21.33	21.81	21.44
2637.8(41068)		21.49	21.98	21.60	
2593 (40620)		21.52	22.01	21.63	
2548.3(40173)		21.42	21.91	21.53	
2503.5 (39725)		21.26	21.74	21.37	
20MHz	1RB-High (99)	2680 (41490)	21.12	20.95	21.06
		2636.5(41055)	21.31	21.14	21.25
		2593 (40620)	21.41	21.24	21.35
		2549.5(40185)	21.17	21.00	21.11
		2506 (39750)	21.09	20.92	21.03
	1RB-Middle (50)	2680 (41490)	20.94	20.77	20.88
		2636.5(41055)	21.23	21.06	21.17
		2593 (40620)	21.17	21.00	21.11
		2549.5(40185)	21.02	20.85	20.96
		2506 (39750)	21.05	20.88	20.99
	1RB-Low (0)	2680 (41490)	21.16	20.99	21.10
		2636.5(41055)	21.37	21.20	21.31
		2593 (40620)	21.23	21.06	21.17

		2549.5(40185)	21.06	20.89	21.00
		2506 (39750)	21.14	20.97	21.08
	50RB-High (50)	2680 (41490)	21.25	21.08	21.19
		2636.5(41055)	21.39	21.22	21.33
		2593 (40620)	21.44	21.27	21.38
		2549.5(40185)	21.37	21.20	21.31
		2506 (39750)	21.18	21.01	21.12
	50RB-Middle (25)	2680 (41490)	21.32	21.15	21.26
		2636.5(41055)	21.43	21.26	21.37
		2593 (40620)	21.43	21.26	21.37
		2549.5(40185)	21.31	21.14	21.25
		2506 (39750)	21.20	21.03	21.14
	50RB-Low (0)	2680 (41490)	21.22	21.05	21.16
		2636.5(41055)	21.30	21.13	21.24
		2593 (40620)	21.37	21.20	21.31
		2549.5(40185)	21.27	21.10	21.21
		2506 (39750)	21.30	21.13	21.24
	100RB (0)	2680 (41490)	21.26	21.09	21.20
		2636.5(41055)	21.42	21.25	21.36
		2593 (40620)	21.45	21.28	21.39
2549.5(40185)		21.35	21.18	21.29	
2506 (39750)		21.19	21.02	21.13	

LTE B66 SET0					
BANDWIDTH	Number of RBs	Frequency	QPSK	16QAM	64QAM
1.4MHz	1RB-High (5)	1779.3 (132665)	20.39	20.42	20.00
		1745 (132322)	20.56	20.59	20.16
		1710.7 (131979)	20.46	20.49	20.06
	1RB-Middle (3)	1779.3 (132665)	20.67	20.70	20.26
		1745 (132322)	20.73	20.76	20.32
		1710.7 (131979)	20.79	20.82	20.38
	1RB-Low (0)	1779.3 (132665)	20.54	20.57	20.14
		1745 (132322)	20.46	20.49	20.06
		1710.7 (131979)	20.43	20.46	20.03
	3RB-High (3)	1779.3 (132665)	20.40	20.43	20.00
		1745 (132322)	20.69	20.72	20.28
		1710.7 (131979)	20.51	20.54	20.11
	3RB-Middle (1)	1779.3 (132665)	20.58	20.61	20.18
		1745 (132322)	20.72	20.75	20.31
		1710.7 (131979)	20.61	20.64	20.21
	3RB-Low (0)	1779.3 (132665)	20.64	20.67	20.23
		1745 (132322)	20.67	20.70	20.26

		1710.7 (131979)	20.58	20.61	20.18
	6RB (0)	1779.3 (132665)	20.57	20.60	20.17
		1745 (132322)	20.72	20.75	20.31
		1710.7 (131979)	20.53	20.56	20.13
3MHz	1RB-High (14)	1778.5 (132657)	20.40	20.50	20.03
		1745 (132322)	20.57	20.67	20.19
		1711.5 (131987)	20.47	20.57	20.09
	1RB-Middle (7)	1778.5 (132657)	20.68	20.78	20.29
		1745 (132322)	20.74	20.84	20.35
		1711.5 (131987)	20.80	20.90	20.41
	1RB-Low (0)	1778.5 (132657)	20.55	20.65	20.17
		1745 (132322)	20.47	20.57	20.09
		1711.5 (131987)	20.44	20.54	20.06
	8RB-High (7)	1778.5 (132657)	20.41	20.51	20.03
		1745 (132322)	20.70	20.80	20.31
		1711.5 (131987)	20.52	20.62	20.14
	8RB-Middle (4)	1778.5 (132657)	20.59	20.69	20.21
		1745 (132322)	20.73	20.83	20.34
		1711.5 (131987)	20.62	20.72	20.24
	8RB-Low (0)	1778.5 (132657)	20.65	20.75	20.26
		1745 (132322)	20.68	20.78	20.29
		1711.5 (131987)	20.59	20.69	20.21
	15RB (0)	1778.5 (132657)	20.58	20.68	20.20
		1745 (132322)	20.73	20.83	20.34
		1711.5 (131987)	20.54	20.64	20.16
5MHz	1RB-High (24)	1549.5 (132647)	20.55	20.42	19.93
		1745 (132322)	20.72	20.59	20.09
		1712.5 (131997)	20.62	20.49	20.00
	1RB-Middle (12)	1549.5 (132647)	20.83	20.70	20.19
		1745 (132322)	20.89	20.76	20.25
		1712.5 (131997)	20.95	20.82	20.31
	1RB-Low (0)	1549.5 (132647)	20.70	20.57	20.07
		1745 (132322)	20.62	20.49	20.00
		1712.5 (131997)	20.59	20.46	19.97
	12RB-High (13)	1549.5 (132647)	20.56	20.43	19.94
		1745 (132322)	20.85	20.72	20.21
		1712.5 (131997)	20.67	20.54	20.04
	12RB-Middle (6)	1549.5 (132647)	20.74	20.61	20.11
		1745 (132322)	20.88	20.75	20.24
		1712.5 (131997)	20.77	20.64	20.14
	12RB-Low (0)	1549.5 (132647)	20.80	20.67	20.17
		1745 (132322)	20.83	20.70	20.19

		1712.5 (131997)	20.74	20.61	20.11
	25RB (0)	1549.5 (132647)	20.73	20.60	20.10
		1745 (132322)	20.88	20.75	20.24
		1712.5 (131997)	20.69	20.56	20.06
10MHz	1RB-High (49)	1775 (132622)	20.58	20.57	20.01
		1745 (132322)	20.75	20.74	20.17
		1715 (132022)	20.65	20.64	20.07
	1RB-Middle (24)	1775 (132622)	20.86	20.85	20.27
		1745 (132322)	20.92	20.91	20.33
		1715 (132022)	20.98	20.97	20.39
	1RB-Low (0)	1775 (132622)	20.73	20.72	20.15
		1745 (132322)	20.65	20.64	20.07
		1715 (132022)	20.62	20.61	20.05
	25RB-High (25)	1775 (132622)	20.59	20.58	20.02
		1745 (132322)	20.88	20.87	20.29
		1715 (132022)	20.70	20.69	20.12
	25RB-Middle (12)	1775 (132622)	20.77	20.76	20.19
		1745 (132322)	20.91	20.90	20.32
		1715 (132022)	20.80	20.79	20.22
	25RB-Low (0)	1775 (132622)	20.83	20.82	20.24
		1745 (132322)	20.86	20.85	20.27
		1715 (132022)	20.77	20.76	20.19
50RB (0)	1775 (132622)	20.76	20.75	20.18	
	1745 (132322)	20.91	20.90	20.32	
	1715 (132022)	20.72	20.71	20.14	
15MHz	1RB-High (74)	1772.5 (132597)	20.40	20.62	20.03
		1745 (132322)	20.57	20.79	20.19
		1717.5 (132047)	20.47	20.69	20.09
	1RB-Middle (37)	1772.5 (132597)	20.68	20.90	20.29
		1745 (132322)	20.74	20.96	20.35
		1717.5 (132047)	20.80	21.02	20.41
	1RB-Low (0)	1772.5 (132597)	20.55	20.77	20.17
		1745 (132322)	20.47	20.69	20.09
		1717.5 (132047)	20.44	20.66	20.06
	36RB-High (38)	1772.5 (132597)	20.41	20.63	20.03
		1745 (132322)	20.70	20.92	20.31
		1717.5 (132047)	20.52	20.74	20.14
	36RB-Middle (19)	1772.5 (132597)	20.59	20.81	20.21
		1745 (132322)	20.73	20.95	20.34
		1717.5 (132047)	20.62	20.84	20.24
	36RB-Low (0)	1772.5 (132597)	20.65	20.87	20.26
		1745 (132322)	20.68	20.90	20.29

20MHz	75RB (0)	1717.5 (132047)	20.59	20.81	20.21
		1772.5 (132597)	20.58	20.80	20.20
		1745 (132322)	20.73	20.95	20.34
		1717.5 (132047)	20.54	20.76	20.16
	1RB-High (99)	1770 (132572)	20.16	20.61	20.13
		1745 (132322)	20.33	20.79	20.29
		1720 (132072)	20.23	20.69	20.20
	1RB-Middle (50)	1770 (132572)	20.44	20.90	20.40
		1745 (132322)	20.50	20.96	20.46
		1720 (132072)	20.57	21.02	20.52
	1RB-Low (0)	1770 (132572)	20.31	20.77	20.27
		1745 (132322)	20.23	20.69	20.20
		1720 (132072)	20.20	20.65	20.17
	50RB-High (50)	1770 (132572)	20.17	20.62	20.14
		1745 (132322)	20.46	20.92	20.42
		1720 (132072)	20.28	20.74	20.24
	50RB-Middle (25)	1770 (132572)	20.35	20.81	20.31
		1745 (132322)	20.49	20.95	20.45
		1720 (132072)	20.38	20.84	20.34
	50RB-Low (0)	1770 (132572)	20.41	20.87	20.37
		1745 (132322)	20.44	20.90	20.40
		1720 (132072)	20.35	20.81	20.31
	100RB (0)	1770 (132572)	20.34	20.80	20.30
		1745 (132322)	20.49	20.95	20.45
		1720 (132072)	20.30	20.76	20.26

LTE B2 SET1					
BANDWIDTH	Number of RBs	Frequency	QPSK	16QAM	64QAM
1.4MHz	1RB-High (5)	1909.3 (19193)	22.05	20.98	20.26
		1880 (18900)	21.88	20.81	20.10
		1850.7 (18607)	21.90	20.83	20.12
	1RB-Middle (3)	1909.3 (19193)	22.17	21.09	20.37
		1880 (18900)	21.88	20.81	20.10
		1850.7 (18607)	22.06	20.99	20.27
	1RB-Low (0)	1909.3 (19193)	22.10	21.02	20.31
		1880 (18900)	21.80	20.74	20.03
		1850.7 (18607)	22.08	21.00	20.29
	3RB-High (3)	1909.3 (19193)	21.23	20.20	19.51
		1880 (18900)	21.05	20.03	19.34
		1850.7 (18607)	21.09	21.04	19.26
	3RB-Middle (1)	1909.3 (19193)	21.21	20.18	19.49
		1880 (18900)	21.05	21.04	19.26

		1850.7 (18607)	21.11	21.01	19.40	
		3RB-Low (0)	1909.3 (19193)	21.25	20.22	19.53
			1880 (18900)	21.04	21.02	19.24
		6RB (0)	1850.7 (18607)	21.12	20.09	19.41
			1909.3 (19193)	21.27	20.24	19.55
			1880 (18900)	20.97	19.95	19.27
3MHz	1RB-High (14)	1850.7 (18607)	21.05	20.03	19.34	
		1908.5 (19185)	22.11	21.15	20.11	
		1880 (18900)	21.94	20.99	19.96	
	1RB-Middle (7)	1851.5 (18615)	21.96	21.01	19.97	
		1908.5 (19185)	22.23	21.27	20.22	
		1880 (18900)	21.94	20.99	19.96	
	1RB-Low (0)	1851.5 (18615)	22.12	21.16	20.12	
		1908.5 (19185)	22.16	21.20	20.16	
		1880 (18900)	21.86	20.91	19.88	
	8RB-High (7)	1851.5 (18615)	22.14	21.18	20.14	
		1908.5 (19185)	21.29	20.37	19.37	
		1880 (18900)	21.11	20.20	19.20	
	8RB-Middle (4)	1851.5 (18615)	21.02	20.11	19.12	
		1908.5 (19185)	21.27	20.35	19.35	
		1880 (18900)	21.02	20.11	19.12	
	8RB-Low (0)	1851.5 (18615)	21.17	20.25	19.26	
		1908.5 (19185)	21.31	20.39	19.38	
		1880 (18900)	21.00	20.09	19.10	
	15RB (0)	1851.5 (18615)	21.18	20.26	19.27	
		1908.5 (19185)	21.33	20.41	19.40	
		1880 (18900)	21.03	20.12	19.13	
	5MHz	1RB-High (24)	1851.5 (18615)	21.11	20.20	19.20
			1907.5 (19175)	21.33	20.41	19.40
			1880 (18900)	21.03	20.12	19.13
1RB-Middle (12)		1907.5 (19175)	22.09	21.12	20.19	
		1880 (18900)	21.92	20.96	20.03	
		1852.5 (18625)	21.94	20.98	20.05	
1RB-Low (0)		1907.5 (19175)	22.21	21.24	20.29	
		1880 (18900)	21.92	20.96	20.03	
		1852.5 (18625)	22.10	21.13	20.19	
12RB-High (13)		1907.5 (19175)	22.14	21.17	20.23	
		1880 (18900)	21.84	20.88	19.96	
		1852.5 (18625)	22.12	21.15	20.21	
12RB-Middle (6)		1907.5 (19175)	21.27	20.34	19.44	
		1880 (18900)	21.09	20.17	19.27	
		1852.5 (18625)	21.00	20.08	19.19	
			1907.5 (19175)	21.25	20.32	19.42
			1880 (18900)	21.00	20.08	19.19

	12RB-Low (0)	1852.5 (18625)	21.15	20.22	19.33	
		1907.5 (19175)	21.29	20.36	19.46	
		1880 (18900)	20.98	20.06	19.17	
		1852.5 (18625)	21.16	20.23	19.34	
		1907.5 (19175)	21.31	20.38	19.47	
		1880 (18900)	21.01	20.09	19.20	
	25RB (0)	1852.5 (18625)	21.09	20.17	19.27	
		1905 (19150)	22.15	21.14	20.21	
		1880 (18900)	21.98	20.98	20.06	
10MHz	1RB-High (49)	1855 (18650)	22.00	21.00	20.08	
		1905 (19150)	22.27	21.25	20.32	
		1880 (18900)	21.98	20.98	20.06	
	1RB-Middle (24)	1855 (18650)	22.16	21.15	20.22	
		1905 (19150)	22.20	21.19	20.26	
		1880 (18900)	21.90	20.90	19.99	
	1RB-Low (0)	1855 (18650)	22.18	21.17	20.24	
		1905 (19150)	21.33	20.36	19.47	
		1880 (18900)	21.15	20.19	19.30	
	25RB-High (25)	1855 (18650)	21.06	20.10	19.22	
		1905 (19150)	21.31	20.34	19.45	
		1880 (18900)	21.06	20.10	19.22	
	25RB-Middle (12)	1855 (18650)	21.21	20.24	19.36	
		1905 (19150)	21.35	20.38	19.49	
		1880 (18900)	21.04	20.08	19.20	
	25RB-Low (0)	1855 (18650)	21.22	20.25	19.37	
		1905 (19150)	21.37	20.40	19.50	
		1880 (18900)	21.07	20.11	19.23	
	50RB (0)	1855 (18650)	21.15	20.19	19.30	
		1902.5 (19125)	22.48	21.81	20.04	
		1880 (18900)	22.30	21.32	19.88	
	15MHz	1RB-High (74)	1857.5 (18675)	22.32	21.06	19.90
			1902.5 (19125)	22.60	21.97	20.14
			1880 (18900)	22.30	21.31	19.88
1RB-Middle (37)		1857.5 (18675)	22.49	20.94	20.05	
		1902.5 (19125)	22.53	21.94	20.08	
		1880 (18900)	22.22	21.22	19.81	
1RB-Low (0)		1857.5 (18675)	22.51	21.36	20.06	
		1902.5 (19125)	21.64	20.63	19.29	
		1880 (18900)	21.46	20.42	19.13	
36RB-High (38)		1857.5 (18675)	21.37	20.17	19.05	
		1902.5 (19125)	21.62	20.52	19.27	
		1880 (18900)	21.37	20.32	19.05	
36RB-Middle (19)						



20MHz	36RB-Low (0)	1857.5 (18675)	21.52	20.40	19.18
		1902.5 (19125)	21.66	20.60	19.31
		1880 (18900)	21.35	20.33	19.03
		1857.5 (18675)	21.53	19.87	19.19
	75RB (0)	1902.5 (19125)	21.68	20.61	19.33
		1880 (18900)	21.38	20.37	19.06
		1857.5 (18675)	21.46	20.02	19.13
	1RB-High (99)	1900 (19100)	22.36	21.84	20.46
		1880 (18900)	22.25	21.74	20.37
		1860 (18700)	22.13	21.76	20.39
	1RB-Middle (50)	1900 (19100)	21.56	21.11	20.71
		1880 (18900)	22.41	21.89	20.51
1860 (18700)		22.44	21.33	20.65	
1RB-Low (0)	1900 (19100)	22.30	21.80	20.42	
	1880 (18900)	22.56	21.61	20.25	
	1860 (18700)	22.33	21.88	20.50	
50RB-High (50)	1900 (19100)	21.54	20.57	19.27	
	1880 (18900)	21.49	20.46	19.17	
	1860 (18700)	21.19	20.28	19.00	
50RB-Middle (25)	1900 (19100)	21.54	20.63	19.33	
	1880 (18900)	21.59	20.33	19.05	
	1860 (18700)	21.37	20.44	19.15	
50RB-Low (0)	1900 (19100)	21.37	20.64	19.34	
	1880 (18900)	21.28	20.30	19.02	
	1860 (18700)	21.42	20.47	19.18	
100RB (0)	1900 (19100)	21.62	20.61	19.31	
	1880 (18900)	21.43	20.46	19.17	
	1860 (18700)	21.36	20.43	19.14	

LTE B5 SET1					
BANDWIDTH	Number of RBs	Frequency	QPSK	16QAM	64QAM
1.4MHz	1RB-High (5)	848.3 (20643)	22.31	21.21	20.24
		836.5 (20525)	22.19	21.10	20.13
		824.7 (20407)	22.08	20.99	20.03
	1RB-Middle (3)	848.3 (20643)	22.51	21.40	20.42
		836.5 (20525)	22.36	21.26	20.29
		824.7 (20407)	22.39	21.29	20.32
	1RB-Low (0)	848.3 (20643)	22.25	21.16	20.19
		836.5 (20525)	22.05	20.97	20.01
		824.7 (20407)	22.28	21.18	20.22
	3RB-High (3)	848.3 (20643)	21.48	20.42	19.49

		836.5 (20525)	21.42	20.37	19.43	
		824.7 (20407)	21.12	20.08	19.16	
		848.3 (20643)	21.48	20.42	19.49	
	3RB-Middle (1)	836.5 (20525)	21.30	20.25	19.33	
		824.7 (20407)	21.30	20.25	19.33	
		848.3 (20643)	21.52	20.46	19.53	
	3RB-Low (0)	836.5 (20525)	21.21	20.17	19.24	
		824.7 (20407)	21.35	20.30	19.37	
		848.3 (20643)	21.55	20.49	19.55	
	6RB (0)	836.5 (20525)	21.36	20.31	19.38	
		824.7 (20407)	21.29	20.24	19.32	
		847.5 (20635)	22.27	21.37	20.23	
3MHz	1RB-High (14)	836.5 (20525)	22.15	21.26	20.12	
		825.5 (20415)	22.04	21.15	20.02	
		847.5 (20635)	22.47	21.56	20.42	
	1RB-Middle (7)	836.5 (20525)	22.32	21.42	20.28	
		825.5 (20415)	22.35	21.45	20.31	
		847.5 (20635)	22.21	21.31	20.18	
	1RB-Low (0)	836.5 (20525)	22.01	21.12	20.00	
		825.5 (20415)	22.24	21.34	20.21	
		847.5 (20635)	21.44	20.58	19.48	
	8RB-High (7)	836.5 (20525)	21.38	20.52	19.43	
		825.5 (20415)	21.08	20.23	19.15	
		847.5 (20635)	21.44	20.58	19.48	
	8RB-Middle (4)	836.5 (20525)	21.26	20.40	19.32	
		825.5 (20415)	21.26	20.40	19.32	
		847.5 (20635)	21.48	20.61	19.52	
	8RB-Low (0)	836.5 (20525)	21.17	20.32	19.23	
		825.5 (20415)	21.31	20.45	19.36	
		847.5 (20635)	21.51	20.64	19.54	
	15RB (0)	836.5 (20525)	21.32	20.46	19.37	
		825.5 (20415)	21.25	20.39	19.31	
		846.5 (20625)	22.89	22.31	20.17	
	5MHz	1RB-High (24)	836.5 (20525)	22.85	22.27	20.13
			826.5 (20425)	23.06	22.47	20.31
			846.5 (20625)	23.04	22.46	20.30
		1RB-Middle (12)	836.5 (20525)	23.07	22.49	20.32
			826.5 (20425)	23.37	22.78	20.59
			846.5 (20625)	22.79	22.21	20.08
		1RB-Low (0)	836.5 (20525)	22.91	22.33	20.19
			826.5 (20425)	23.13	22.54	20.38
			846.5 (20625)	21.84	21.29	19.24
12RB-High (13)		846.5 (20625)	21.84	21.29	19.24	

	12RB-Middle (6)	836.5 (20525)	21.88	21.32	19.27	
		826.5 (20425)	22.15	21.59	19.51	
		846.5 (20625)	21.91	21.35	19.30	
	12RB-Low (0)	836.5 (20525)	22.01	21.45	19.39	
		826.5 (20425)	22.25	21.69	19.61	
		846.5 (20625)	21.92	21.36	19.31	
	25RB (0)	836.5 (20525)	22.00	21.44	19.38	
		826.5 (20425)	22.18	21.62	19.54	
		846.5 (20625)	21.87	21.31	19.26	
	10MHz	1RB-High (49)	844 (20600)	23.00	22.25	20.27
			836.5 (20525)	22.88	21.81	20.17
			829 (20450)	22.76	21.83	20.06
1RB-Middle (24)		844 (20600)	22.97	22.27	20.46	
		836.5 (20525)	23.05	21.85	20.32	
		829 (20450)	23.08	22.16	20.34	
1RB-Low (0)		844 (20600)	22.94	22.20	20.22	
		836.5 (20525)	22.73	22.00	20.04	
		829 (20450)	23.21	22.12	20.25	
25RB-High (25)		844 (20600)	22.14	20.84	19.52	
		836.5 (20525)	22.08	21.02	19.46	
		829 (20450)	21.77	21.15	19.19	
25RB-Middle (12)		844 (20600)	22.14	20.94	19.52	
		836.5 (20525)	21.96	21.07	19.36	
		829 (20450)	21.96	21.22	19.36	
25RB-Low (0)		844 (20600)	22.01	20.97	19.56	
		836.5 (20525)	21.86	21.09	19.27	
		829 (20450)	22.19	21.23	19.40	
50RB (0)		844 (20600)	22.22	20.90	19.59	
		836.5 (20525)	22.02	20.99	19.41	
		829 (20450)	21.95	21.12	19.35	

LTE B7 SET1					
BANDWIDTH	Number of RBs	Frequency	QPSK	16QAM	64QAM
5MHz	1RB-High (24)	2567.5 (21425)	21.97	21.08	19.92
		2535 (21100)	21.86	20.98	19.82
		2502.5 (20775)	21.73	20.85	19.71
	1RB-Middle (12)	2567.5 (21425)	22.17	21.27	20.10
		2535 (21100)	22.02	21.13	19.97
		2502.5 (20775)	22.05	21.16	20.00
	1RB-Low (0)	2567.5 (21425)	21.91	21.02	19.87

		2535 (21100)	21.70	20.82	19.68	
		2502.5 (20775)	21.94	21.05	19.90	
		2567.5 (21425)	21.15	20.30	19.18	
	12RB-High (13)	2535 (21100)	21.09	20.24	19.12	
		2502.5 (20775)	20.79	19.95	18.85	
	12RB-Middle (6)	2567.5 (21425)	21.15	20.30	19.18	
		2535 (21100)	20.97	20.12	19.02	
		2502.5 (20775)	20.97	20.12	19.02	
	12RB-Low (0)	2567.5 (21425)	21.19	20.33	19.22	
		2535 (21100)	20.88	20.04	18.93	
		2502.5 (20775)	21.02	20.17	19.06	
	25RB (0)	2567.5 (21425)	21.22	20.36	19.24	
		2535 (21100)	21.03	20.18	19.07	
		2502.5 (20775)	20.96	20.11	19.01	
	10MHz	1RB-High (49)	2565 (21400)	22.17	21.05	20.04
2535 (21100)			22.06	20.95	19.94	
2505 (20800)			21.93	20.82	19.82	
1RB-Middle (24)		2565 (21400)	22.37	21.24	20.22	
		2535 (21100)	22.22	21.10	20.08	
		2505 (20800)	22.25	21.13	20.11	
1RB-Low (0)		2565 (21400)	22.11	21.00	19.98	
		2535 (21100)	21.90	20.80	19.80	
		2505 (20800)	22.14	21.02	20.01	
25RB-High (25)		2565 (21400)	21.34	20.26	19.29	
		2535 (21100)	21.28	20.21	19.23	
		2505 (20800)	20.98	19.92	18.96	
25RB-Middle (12)		2565 (21400)	21.34	20.26	19.29	
		2535 (21100)	21.16	20.09	19.13	
		2505 (20800)	21.16	20.09	19.13	
25RB-Low (0)		2565 (21400)	21.38	20.30	19.33	
		2535 (21100)	21.07	20.01	19.04	
		2505 (20800)	21.21	20.14	19.17	
50RB (0)		2565 (21400)	21.41	20.33	19.35	
		2535 (21100)	21.22	20.15	19.18	
		2505 (20800)	21.15	20.08	19.12	
15MHz		1RB-High (74)	2562.5 (21375)	22.02	21.02	19.98
			2535 (21100)	21.91	20.91	19.88
			2507.5 (20825)	21.79	20.80	19.77
	1RB-Middle (37)	2562.5 (21375)	22.22	21.21	20.17	
		2535 (21100)	22.07	21.06	20.03	
		2507.5 (20825)	22.10	21.09	20.06	
	1RB-Low (0)	2562.5 (21375)	21.96	20.96	19.93	

20MHz	36RB-High (38)	2535 (21100)	21.76	20.77	19.75
		2507.5 (20825)	21.99	20.99	19.96
		2562.5 (21375)	21.20	20.23	19.24
		2535 (21100)	21.14	20.18	19.19
		2507.5 (20825)	20.84	19.89	18.91
		2562.5 (21375)	21.20	20.23	19.24
	36RB-Middle (19)	2535 (21100)	21.02	20.06	19.08
		2507.5 (20825)	21.02	20.06	19.08
		2562.5 (21375)	21.24	20.27	19.28
	36RB-Low (0)	2535 (21100)	20.93	19.98	18.99
		2507.5 (20825)	21.07	20.11	19.12
		2562.5 (21375)	21.27	20.30	19.30
	75RB (0)	2535 (21100)	21.08	20.12	19.13
		2507.5 (20825)	21.01	20.05	19.07
		2560 (21350)	22.04	21.07	20.10
	1RB-High (99)	2535 (21100)	21.93	20.97	20.00
		2510 (20850)	21.81	20.85	19.90
		2560 (21350)	21.98	21.26	20.29
	1RB-Middle (50)	2535 (21100)	22.09	21.12	20.15
		2510 (20850)	22.12	21.15	20.18
		2560 (21350)	22.24	21.01	20.05
	1RB-Low (0)	2535 (21100)	21.78	20.82	19.87
		2510 (20850)	22.01	21.04	20.08
		2560 (21350)	21.22	20.29	19.36
50RB-High (50)	2535 (21100)	21.16	20.23	19.30	
	2510 (20850)	20.86	19.94	19.03	
	2560 (21350)	21.22	20.29	19.36	
50RB-Middle (25)	2535 (21100)	21.04	20.12	19.19	
	2510 (20850)	21.04	20.12	19.19	
	2560 (21350)	21.26	20.33	19.39	
50RB-Low (0)	2535 (21100)	20.95	20.03	19.11	
	2510 (20850)	21.09	20.16	19.24	
	2560 (21350)	21.29	20.36	19.42	
100RB (0)	2535 (21100)	21.10	20.17	19.25	
	2510 (20850)	21.03	20.11	19.18	

LTE B12 SET0/12					
BANDWIDTH	Number of RBs	Frequency	QPSK	16QAM	64QAM
1.4MHz	1RB-High (5)	715.3	23.15	22.12	21.32
		707.5	23.23	22.20	21.39
		699.7	23.15	22.12	21.32
	1RB-Middle (3)	715.3	23.45	22.41	21.60

		707.5	23.50	22.45	21.64	
		699.7	23.39	22.35	21.54	
		715.3	23.23	22.20	21.39	
	1RB-Low (0)	707.5	23.25	22.22	21.41	
		699.7	23.00	21.98	21.18	
	3RB-High (3)	715.3	22.25	21.25	20.49	
		707.5	22.20	21.20	20.45	
		699.7	22.25	21.25	20.49	
	3RB-Middle (1)	715.3	22.33	21.33	20.56	
		707.5	22.28	21.28	20.52	
		699.7	22.29	21.29	20.53	
	3RB-Low (0)	715.3	22.26	21.26	20.50	
		707.5	22.30	21.30	20.54	
		699.7	22.19	21.19	20.44	
	6RB (0)	715.3	22.24	21.24	20.48	
707.5		22.23	21.23	20.47		
699.7		22.22	21.11	20.46		
3MHz	1RB-High (14)	714.5	23.23	22.45	21.73	
		707.5	23.19	22.16	21.69	
		700.5	23.21	22.07	21.71	
	1RB-Middle (7)	714.5	23.13	22.68	21.88	
		707.5	23.32	22.32	21.81	
		700.5	23.35	22.30	21.84	
	1RB-Low (0)	714.5	23.23	22.57	21.73	
		707.5	23.39	22.16	21.64	
		700.5	23.10	22.02	21.61	
	8RB-High (7)	714.5	22.27	21.31	20.82	
		707.5	22.24	21.36	20.80	
		700.5	22.27	21.29	20.82	
	8RB-Middle (4)	714.5	22.33	21.42	20.88	
		707.5	22.28	21.46	20.83	
		700.5	22.29	21.35	20.84	
	8RB-Low (0)	714.5	22.38	21.44	20.93	
		707.5	22.39	21.48	20.94	
		700.5	22.31	21.34	20.86	
	15RB (0)	714.5	22.33	21.37	20.88	
		707.5	22.26	21.36	20.81	
		700.5	22.29	21.34	20.84	
	5MHz	1RB-High (24)	713.5	23.27	22.23	21.43
			707.5	23.35	22.31	21.50
			701.5	23.27	22.23	21.43
1RB-Middle (12)		713.5	23.57	22.52	21.71	

	1RB-Low (0)	707.5	23.62	22.56	21.75	
		701.5	23.51	22.46	21.65	
		713.5	23.35	22.31	21.50	
		707.5	23.37	22.33	21.52	
		701.5	23.12	22.09	21.29	
		713.5	22.36	21.36	20.59	
	12RB-High (13)	707.5	22.31	21.31	20.55	
		701.5	22.36	21.36	20.59	
		713.5	22.44	21.44	20.67	
	12RB-Middle (6)	707.5	22.39	21.39	20.62	
		701.5	22.40	21.40	20.63	
		713.5	22.37	21.37	20.60	
	12RB-Low (0)	707.5	22.41	21.41	20.64	
		701.5	22.30	21.30	20.54	
		713.5	22.35	21.35	20.58	
	25RB (0)	707.5	22.34	21.34	20.57	
		701.5	22.33	21.22	20.56	
		711	23.35	22.56	21.84	
	10MHz	1RB-High (49)	707.5	23.31	22.27	21.80
			704	23.33	22.18	21.82
			711	23.25	22.80	21.99
		1RB-Middle (24)	707.5	23.44	22.43	21.92
			704	23.47	22.41	21.95
			711	23.35	22.69	21.84
		1RB-Low (0)	707.5	23.51	22.27	21.75
			704	23.22	22.13	21.72
			711	22.38	21.42	20.93
		25RB-High (25)	707.5	22.35	21.47	20.91
			704	22.38	21.40	20.93
			711	22.44	21.53	20.99
25RB-Middle (12)		707.5	22.39	21.57	20.94	
		704	22.40	21.46	20.95	
		711	22.49	21.55	21.04	
25RB-Low (0)		707.5	22.50	21.59	21.05	
		704	22.42	21.45	20.97	
		711	22.44	21.48	20.99	
50RB (0)		707.5	22.37	21.47	20.92	
		704	22.40	21.45	20.95	

LTE B13 SET0/1/2					
BANDWIDTH	Number of RBs	Frequency	QPSK	16QAM	64QAM

5MHz	1RB-High (24)	784.5 (23255)	23.03	22.47	21.78	
		782 (23230)	23.10	22.14	21.85	
		779.5 (23205)	23.13	22.21	21.88	
	1RB-Middle (12)	784.5 (23255)	23.35	22.78	22.08	
		782 (23230)	23.37	22.43	22.10	
		779.5 (23205)	23.42	22.49	22.15	
	1RB-Low (0)	784.5 (23255)	23.08	22.53	21.83	
		782 (23230)	23.13	22.18	21.88	
		779.5 (23205)	23.14	22.22	21.88	
	12RB-High (13)	784.5 (23255)	22.15	21.31	20.95	
		782 (23230)	22.14	21.25	20.94	
		779.5 (23205)	22.08	21.17	20.88	
	12RB-Middle (6)	784.5 (23255)	22.19	21.34	20.99	
		782 (23230)	22.23	21.32	21.02	
		779.5 (23205)	22.19	21.29	20.99	
	12RB-Low (0)	784.5 (23255)	22.17	21.34	20.97	
		782 (23230)	22.29	21.36	21.08	
		779.5 (23205)	22.12	21.22	20.92	
	25RB (0)	784.5 (23255)	22.17	21.25	20.97	
		782 (23230)	22.19	21.18	20.99	
		779.5 (23205)	22.11	21.10	20.91	
	10MHz	1RB-High (49)	782 (23230)	23.06	21.96	21.22
		1RB-Middle (24)	782 (23230)	23.13	22.15	21.40
		1RB-Low (0)	782 (23230)	23.25	22.08	21.28
25RB-High (25)		782 (23230)	22.19	21.24	20.42	
25RB-Middle (12)		782 (23230)	22.19	21.28	20.42	
25RB-Low (0)		782 (23230)	22.21	21.31	20.44	
50RB (0)		782 (23230)	22.25	21.29	20.48	

LTE B41 SET1					
BANDWIDTH	Number of RBs	Frequency	QPSK	16QAM	64QAM
5MHz	1RB-High (24)	2687.5 (41565)	22.61	22.19	20.76
		2640.3(41093)	22.81	22.39	20.94
		2593 (40620)	22.91	22.49	21.03
		2545.8(40148)	22.66	22.24	20.81
		2498.5 (39675)	22.58	22.17	20.73
	1RB-Middle (12)	2687.5 (41565)	22.42	22.01	20.59
		2640.3(41093)	22.73	22.31	20.87
		2593 (40620)	22.66	22.24	20.81
		2545.8(40148)	22.51	22.10	20.67
		2498.5 (39675)	22.54	22.13	20.70
	1RB-Low (0)	2687.5 (41565)	22.65	22.23	20.80



		2640.3(41093)	22.87	22.45	21.00
		2593 (40620)	22.73	22.31	20.87
		2545.8(40148)	22.55	22.14	20.71
		2498.5 (39675)	22.63	22.21	20.78
	12RB-High (13)	2687.5 (41565)	22.75	22.33	20.89
		2640.3(41093)	22.89	22.47	21.02
		2593 (40620)	22.94	22.52	21.06
		2545.8(40148)	22.87	22.45	21.00
		2498.5 (39675)	22.67	22.25	20.82
	12RB-Middle (6)	2687.5 (41565)	22.82	22.40	20.95
		2640.3(41093)	22.93	22.51	21.05
		2593 (40620)	22.92	22.50	21.04
		2545.8(40148)	22.81	22.39	20.94
		2498.5 (39675)	22.69	22.27	20.83
	12RB-Low (0)	2687.5 (41565)	22.71	22.29	20.85
		2640.3(41093)	22.80	22.38	20.93
		2593 (40620)	22.87	22.45	21.00
		2545.8(40148)	22.77	22.35	20.91
		2498.5 (39675)	22.80	22.38	20.93
	25RB (0)	2687.5 (41565)	22.76	22.34	20.90
2640.3(41093)		22.92	22.50	21.04	
2593 (40620)		22.96	22.54	21.08	
2545.8(40148)		22.85	22.43	20.98	
2498.5 (39675)		22.68	22.26	20.82	
10MHz	1RB-High (49)	2685 (41540)	22.33	22.08	20.95
		2639(41080)	22.53	22.28	21.13
		2593 (40620)	22.63	22.38	21.23
		2547(40160)	22.38	22.13	20.99
		2501 (39700)	22.30	22.05	20.92
	1RB-Middle (24)	2685 (41540)	22.15	21.90	20.78
		2639(41080)	22.45	22.20	21.06
		2593 (40620)	22.38	22.13	20.99
		2547(40160)	22.23	21.98	20.85
		2501 (39700)	22.26	22.01	20.88
	1RB-Low (0)	2685 (41540)	22.37	22.12	20.98
		2639(41080)	22.59	22.34	21.19
		2593 (40620)	22.45	22.20	21.06
		2547(40160)	22.27	22.02	20.89
		2501 (39700)	22.35	22.10	20.96
	25RB-High (25)	2685 (41540)	22.47	22.22	21.08
		2639(41080)	22.61	22.36	21.21
		2593 (40620)	22.66	22.41	21.25

		2547(40160)	22.59	22.34	21.19	
		2501 (39700)	22.39	22.14	21.00	
	25RB-Middle (12)	2685 (41540)	22.54	22.29	21.14	
		2639(41080)	22.65	22.40	21.24	
		2593 (40620)	22.64	22.39	21.24	
		2547(40160)	22.53	22.28	21.13	
		2501 (39700)	22.41	22.16	21.02	
	25RB-Low (0)	2685 (41540)	22.43	22.18	21.04	
		2639(41080)	22.52	22.27	21.12	
		2593 (40620)	22.59	22.34	21.19	
		2547(40160)	22.49	22.24	21.10	
		2501 (39700)	22.52	22.27	21.12	
	50RB (0)	2685 (41540)	22.48	22.23	21.09	
		2639(41080)	22.64	22.39	21.24	
		2593 (40620)	22.68	22.43	21.27	
		2547(40160)	22.57	22.32	21.17	
		2501 (39700)	22.40	22.15	21.01	
	15MHz	1RB-High (74)	2682.5 (41515)	22.39	22.15	20.84
			2637.8(41068)	22.59	22.35	21.02
			2593 (40620)	22.69	22.45	21.12
2548.3(40173)			22.44	22.20	20.88	
2503.5 (39725)			22.36	22.12	20.81	
1RB-Middle (37)		2682.5 (41515)	22.21	21.97	20.67	
		2637.8(41068)	22.51	22.27	20.95	
		2593 (40620)	22.44	22.20	20.88	
		2548.3(40173)	22.29	22.05	20.74	
		2503.5 (39725)	22.32	22.08	20.77	
1RB-Low (0)		2682.5 (41515)	22.43	22.19	20.87	
		2637.8(41068)	22.65	22.41	21.08	
		2593 (40620)	22.51	22.27	20.95	
		2548.3(40173)	22.33	22.09	20.78	
		2503.5 (39725)	22.41	22.17	20.86	
36RB-High (38)		2682.5 (41515)	22.53	22.29	20.97	
		2637.8(41068)	22.67	22.43	21.10	
		2593 (40620)	22.72	22.48	21.14	
		2548.3(40173)	22.65	22.41	21.08	
		2503.5 (39725)	22.45	22.21	20.89	
36RB-Middle (19)	2682.5 (41515)	22.60	22.36	21.03		
	2637.8(41068)	22.71	22.47	21.13		
	2593 (40620)	22.70	22.46	21.13		
	2548.3(40173)	22.59	22.35	21.02		
	2503.5 (39725)	22.47	22.23	20.91		

	36RB-Low (0)	2682.5 (41515)	22.49	22.25	20.93
		2637.8(41068)	22.58	22.34	21.01
		2593 (40620)	22.65	22.41	21.08
		2548.3(40173)	22.55	22.31	20.99
		2503.5 (39725)	22.58	22.34	21.01
	75RB (0)	2682.5 (41515)	22.54	22.30	20.98
		2637.8(41068)	22.70	22.46	21.13
		2593 (40620)	22.74	22.50	21.16
		2548.3(40173)	22.63	22.39	21.06
		2503.5 (39725)	22.46	22.22	20.90
20MHz	1RB-High (99)	2680 (41490)	22.53	21.94	21.12
		2636.5(41055)	22.73	22.13	21.30
		2593 (40620)	22.83	22.23	21.40
		2549.5(40185)	22.58	21.99	21.16
		2506 (39750)	22.50	21.91	21.09
	1RB-Middle (50)	2680 (41490)	22.35	21.76	20.95
		2636.5(41055)	22.65	22.05	21.23
		2593 (40620)	22.58	21.99	21.16
		2549.5(40185)	22.43	21.84	21.02
		2506 (39750)	22.46	21.87	21.05
	1RB-Low (0)	2680 (41490)	22.57	21.98	21.15
		2636.5(41055)	22.79	22.19	21.36
		2593 (40620)	22.65	22.05	21.23
		2549.5(40185)	22.47	21.88	21.06
		2506 (39750)	22.55	21.96	21.13
	50RB-High (50)	2680 (41490)	22.67	22.07	21.25
		2636.5(41055)	22.81	22.21	21.38
		2593 (40620)	22.86	22.26	21.42
		2549.5(40185)	22.79	22.19	21.36
		2506 (39750)	22.59	21.99	21.17
	50RB-Middle (25)	2680 (41490)	22.74	22.14	21.31
		2636.5(41055)	22.85	22.25	21.41
		2593 (40620)	22.84	22.24	21.41
		2549.5(40185)	22.73	22.13	21.30
		2506 (39750)	22.61	22.01	21.19
	50RB-Low (0)	2680 (41490)	22.63	22.03	21.21
		2636.5(41055)	22.72	22.12	21.29
		2593 (40620)	22.79	22.19	21.36
2549.5(40185)		22.69	22.09	21.27	
2506 (39750)		22.72	22.12	21.29	
100RB (0)	2680 (41490)	22.68	22.08	21.26	
	2636.5(41055)	22.84	22.24	21.41	

		2593 (40620)	22.88	22.28	21.44
		2549.5(40185)	22.77	22.17	21.34
		2506 (39750)	22.60	22.00	21.18

LTE B66 SET1						
BANDWIDTH	Number of RBs	Frequency	QPSK	16QAM	64QAM	
1.4MHz	1RB-High (5)	1779.3 (132665)	21.81	20.88	19.82	
		1745 (132322)	21.64	20.72	19.66	
		1710.7 (131979)	21.88	20.95	19.88	
	1RB-Middle (3)	1779.3 (132665)	21.83	20.90	19.84	
		1745 (132322)	22.18	21.23	20.15	
		1710.7 (131979)	21.93	21.00	19.93	
	1RB-Low (0)	1779.3 (132665)	21.58	20.66	19.61	
		1745 (132322)	21.95	21.01	19.94	
		1710.7 (131979)	22.02	21.08	20.01	
	3RB-High (3)	1779.3 (132665)	20.67	19.79	18.78	
		1745 (132322)	21.12	20.22	19.19	
		1710.7 (131979)	20.87	19.98	18.96	
	3RB-Middle (1)	1779.3 (132665)	20.73	19.85	18.84	
		1745 (132322)	21.18	20.28	19.25	
		1710.7 (131979)	20.86	19.97	18.96	
	3RB-Low (0)	1779.3 (132665)	20.74	19.86	18.85	
		1745 (132322)	21.15	20.25	19.22	
		1710.7 (131979)	20.80	19.91	18.90	
	6RB (0)	1779.3 (132665)	20.71	19.83	18.82	
		1745 (132322)	21.13	20.23	19.20	
		1710.7 (131979)	20.86	19.97	18.96	
	3MHz	1RB-High (14)	1778.5 (132657)	22.06	21.01	21.01
			1745 (132322)	21.89	20.84	20.85
			1711.5 (131987)	22.13	21.07	21.07
1RB-Middle (7)		1778.5 (132657)	22.08	21.03	21.03	
		1745 (132322)	22.43	21.36	21.36	
		1711.5 (131987)	22.18	21.12	21.12	
1RB-Low (0)		1778.5 (132657)	21.83	20.79	20.79	
		1745 (132322)	22.20	21.14	21.14	
		1711.5 (131987)	22.27	21.21	21.21	
8RB-High (7)		1778.5 (132657)	20.90	19.90	19.90	
		1745 (132322)	21.36	20.34	20.34	
		1711.5 (131987)	21.11	20.10	20.10	
8RB-Middle (4)		1778.5 (132657)	20.97	19.97	19.97	
		1745 (132322)	21.42	20.40	20.40	
		1711.5 (131987)	21.10	20.09	20.09	

	8RB-Low (0)	1778.5 (132657)	20.98	19.98	19.98	
		1745 (132322)	21.39	20.37	20.37	
		1711.5 (131987)	21.04	20.04	20.04	
	15RB (0)	1778.5 (132657)	20.95	19.95	19.95	
		1745 (132322)	21.37	20.35	20.35	
		1711.5 (131987)	21.10	20.09	20.09	
5MHz	1RB-High (24)	1549.5 (132647)	21.83	20.99	19.88	
		1745 (132322)	21.66	20.83	19.72	
		1712.5 (131997)	21.90	21.06	19.94	
	1RB-Middle (12)	1549.5 (132647)	21.85	21.01	19.90	
		1745 (132322)	22.20	21.35	20.21	
		1712.5 (131997)	21.95	21.11	19.99	
	1RB-Low (0)	1549.5 (132647)	21.60	20.77	19.67	
		1745 (132322)	21.97	21.13	20.01	
		1712.5 (131997)	22.04	21.20	20.07	
	12RB-High (13)	1549.5 (132647)	20.68	19.89	18.83	
		1745 (132322)	21.14	20.33	19.25	
		1712.5 (131997)	20.89	20.09	19.02	
	12RB-Middle (6)	1549.5 (132647)	20.75	19.96	18.90	
		1745 (132322)	21.20	20.39	19.31	
		1712.5 (131997)	20.88	20.08	19.02	
	12RB-Low (0)	1549.5 (132647)	20.76	19.97	18.91	
		1745 (132322)	21.17	20.36	19.28	
		1712.5 (131997)	20.82	20.02	18.96	
	25RB (0)	1549.5 (132647)	20.73	19.94	18.88	
		1745 (132322)	21.15	20.34	19.26	
		1712.5 (131997)	20.88	20.08	19.02	
	10MHz	1RB-High (49)	1775 (132622)	21.96	20.84	19.95
			1745 (132322)	21.79	20.68	19.79
			1715 (132022)	22.03	20.91	20.01
1RB-Middle (24)		1775 (132622)	21.98	20.86	19.96	
		1745 (132322)	22.34	21.20	20.29	
		1715 (132022)	22.09	20.97	20.06	
1RB-Low (0)		1775 (132622)	21.73	20.63	19.74	
		1745 (132322)	22.11	20.99	20.08	
		1715 (132022)	22.18	21.05	20.15	
25RB-High (25)		1775 (132622)	20.81	19.75	18.90	
		1745 (132322)	21.27	20.19	19.32	
		1715 (132022)	21.02	19.95	19.09	
25RB-Middle (12)		1775 (132622)	20.88	19.82	18.97	
		1745 (132322)	21.33	20.25	19.38	
		1715 (132022)	21.01	19.94	19.09	

	25RB-Low (0)	1775 (132622)	20.89	19.83	18.98	
		1745 (132322)	21.30	20.22	19.35	
		1715 (132022)	20.95	19.89	19.03	
	50RB (0)	1775 (132622)	20.86	19.80	18.95	
		1745 (132322)	21.28	20.20	19.33	
		1715 (132022)	21.01	19.94	19.09	
15MHz	1RB-High (74)	1772.5 (132597)	21.89	20.88	19.91	
		1745 (132322)	21.72	20.72	19.75	
		1717.5 (132047)	21.96	20.94	19.97	
	1RB-Middle (37)	1772.5 (132597)	21.91	20.90	19.93	
		1745 (132322)	22.27	21.24	20.25	
		1717.5 (132047)	22.02	21.00	20.03	
	1RB-Low (0)	1772.5 (132597)	21.66	20.66	19.70	
		1745 (132322)	22.04	21.02	20.04	
		1717.5 (132047)	22.11	21.09	20.11	
	36RB-High (38)	1772.5 (132597)	20.74	19.78	18.86	
		1745 (132322)	21.20	20.22	19.28	
		1717.5 (132047)	20.95	19.98	19.05	
	36RB-Middle (19)	1772.5 (132597)	20.81	19.85	18.93	
		1745 (132322)	21.26	20.28	19.34	
		1717.5 (132047)	20.94	19.97	19.05	
	36RB-Low (0)	1772.5 (132597)	20.82	19.86	18.94	
		1745 (132322)	21.23	20.25	19.31	
		1717.5 (132047)	20.88	19.92	18.99	
	75RB (0)	1772.5 (132597)	20.79	19.83	18.91	
		1745 (132322)	21.21	20.23	19.29	
		1717.5 (132047)	20.94	19.97	19.05	
	20MHz	1RB-High (99)	1770 (132572)	22.04	21.00	19.82
			1745 (132322)	21.87	20.84	19.67
			1720 (132072)	22.12	21.07	19.89
1RB-Middle (50)		1770 (132572)	22.07	21.03	19.85	
		1745 (132322)	22.18	21.37	20.17	
		1720 (132072)	22.43	21.13	19.95	
1RB-Low (0)		1770 (132572)	21.81	20.78	19.61	
		1745 (132322)	22.20	21.15	19.96	
		1720 (132072)	22.27	21.22	20.03	
50RB-High (50)		1770 (132572)	20.89	19.90	18.79	
		1745 (132322)	21.35	20.34	19.20	
		1720 (132072)	21.10	20.10	18.98	
50RB-Middle (25)		1770 (132572)	20.96	19.97	18.85	
		1745 (132322)	21.09	20.40	19.26	
		1720 (132072)	21.41	20.09	18.97	

	50RB-Low (0)	1770 (132572)	20.97	19.98	18.86
		1745 (132322)	21.38	20.37	19.23
		1720 (132072)	21.03	20.04	18.91
	100RB (0)	1770 (132572)	20.94	19.95	18.83
		1745 (132322)	21.36	20.35	19.21
		1720 (132072)	21.09	20.09	18.97

LTE B2-SET2					
BANDWIDTH	Number of RBs	Frequency	QPSK	16QAM	64QAM
1.4MHz	1RB-High (5)	1909.3 (19193)	19.72	19.64	19.83
		1880 (18900)	19.60	19.52	19.71
		1850.7 (18607)	19.64	19.56	19.75
	1RB-Middle (3)	1909.3 (19193)	19.86	19.78	19.97
		1880 (18900)	19.61	19.53	19.72
		1850.7 (18607)	19.81	19.73	19.92
	1RB-Low (0)	1909.3 (19193)	19.75	19.67	19.86
		1880 (18900)	19.50	19.42	19.61
		1850.7 (18607)	19.81	19.73	19.92
	3RB-High (3)	1909.3 (19193)	19.95	19.87	20.06
		1880 (18900)	19.76	19.68	19.87
		1850.7 (18607)	19.70	19.62	19.81
	3RB-Middle (1)	1909.3 (19193)	19.88	19.80	19.99
		1880 (18900)	19.66	19.58	19.77
		1850.7 (18607)	19.80	19.72	19.91
	3RB-Low (0)	1909.3 (19193)	19.92	19.84	20.03
		1880 (18900)	19.62	19.54	19.73
		1850.7 (18607)	19.82	19.74	19.93
	6RB (0)	1909.3 (19193)	19.89	19.81	20.00
		1880 (18900)	19.68	19.60	19.79
		1850.7 (18607)	19.76	19.68	19.87
3MHz	1RB-High (14)	1908.5 (19185)	19.27	19.66	19.92
		1880 (18900)	19.15	19.54	19.80
		1851.5 (18615)	19.19	19.58	19.84
	1RB-Middle (7)	1908.5 (19185)	19.41	19.80	20.07
		1880 (18900)	19.16	19.55	19.81
		1851.5 (18615)	19.36	19.75	20.01
	1RB-Low (0)	1908.5 (19185)	19.30	19.69	19.95
		1880 (18900)	19.05	19.44	19.69
		1851.5 (18615)	19.36	19.75	20.01
	8RB-High (7)	1908.5 (19185)	19.49	19.89	20.15
		1880 (18900)	19.31	19.70	19.96
		1851.5 (18615)	19.25	19.64	19.90

	8RB-Middle (4)	1908.5 (19185)	19.43	19.82	20.09	
		1880 (18900)	19.21	19.60	19.86	
		1851.5 (18615)	19.35	19.74	20.00	
	8RB-Low (0)	1908.5 (19185)	19.46	19.85	20.12	
		1880 (18900)	19.17	19.56	19.82	
		1851.5 (18615)	19.37	19.76	20.03	
	15RB (0)	1908.5 (19185)	19.44	19.83	20.10	
		1880 (18900)	19.23	19.62	19.88	
		1851.5 (18615)	19.31	19.70	19.96	
5MHz	1RB-High (24)	1907.5 (19175)	19.81	19.87	19.51	
		1880 (18900)	19.69	19.75	19.39	
		1852.5 (18625)	19.73	19.79	19.43	
	1RB-Middle (12)	1907.5 (19175)	19.95	20.01	19.65	
		1880 (18900)	19.70	19.76	19.40	
		1852.5 (18625)	19.90	19.96	19.60	
	1RB-Low (0)	1907.5 (19175)	19.84	19.90	19.54	
		1880 (18900)	19.58	19.64	19.28	
		1852.5 (18625)	19.90	19.96	19.60	
	12RB-High (13)	1907.5 (19175)	20.04	20.10	19.74	
		1880 (18900)	19.85	19.91	19.55	
		1852.5 (18625)	19.79	19.85	19.49	
	12RB-Middle (6)	1907.5 (19175)	19.98	20.04	19.68	
		1880 (18900)	19.75	19.81	19.45	
		1852.5 (18625)	19.89	19.95	19.59	
	12RB-Low (0)	1907.5 (19175)	20.01	20.07	19.71	
		1880 (18900)	19.71	19.77	19.41	
		1852.5 (18625)	19.91	19.97	19.61	
	25RB (0)	1907.5 (19175)	19.99	20.05	19.69	
		1880 (18900)	19.77	19.83	19.47	
		1852.5 (18625)	19.85	19.91	19.55	
	10MHz	1RB-High (49)	1905 (19150)	19.52	19.79	20.08
			1880 (18900)	19.40	19.67	19.96
			1855 (18650)	19.44	19.71	20.00
1RB-Middle (24)		1905 (19150)	19.66	19.93	20.23	
		1880 (18900)	19.41	19.68	19.97	
		1855 (18650)	19.61	19.88	20.17	
1RB-Low (0)		1905 (19150)	19.55	19.82	20.11	
		1880 (18900)	19.29	19.56	19.85	
		1855 (18650)	19.61	19.88	20.17	
25RB-High (25)		1905 (19150)	19.75	20.02	20.32	
		1880 (18900)	19.56	19.83	20.12	
		1855 (18650)	19.50	19.77	20.06	



	25RB-Middle (12)	1905 (19150)	19.69	19.96	20.26
		1880 (18900)	19.46	19.73	20.02
		1855 (18650)	19.60	19.87	20.16
	25RB-Low (0)	1905 (19150)	19.72	19.99	20.29
		1880 (18900)	19.42	19.69	19.98
		1855 (18650)	19.62	19.89	20.18
	50RB (0)	1905 (19150)	19.70	19.97	20.27
		1880 (18900)	19.48	19.75	20.04
		1855 (18650)	19.56	19.83	20.12
15MHz	1RB-High (74)	1902.5 (19125)	20.00	20.46	19.80
		1880 (18900)	19.88	19.87	19.68
		1857.5 (18675)	19.92	20.30	19.72
	1RB-Middle (37)	1902.5 (19125)	20.14	20.63	19.94
		1880 (18900)	19.89	19.89	19.69
		1857.5 (18675)	20.09	20.42	19.89
	1RB-Low (0)	1902.5 (19125)	20.03	20.53	19.83
		1880 (18900)	19.77	19.81	19.57
		1857.5 (18675)	20.09	20.40	19.89
	36RB-High (38)	1902.5 (19125)	20.24	20.18	20.04
		1880 (18900)	20.04	19.99	19.84
		1857.5 (18675)	19.98	20.01	19.78
	36RB-Middle (19)	1902.5 (19125)	20.18	20.11	19.98
		1880 (18900)	19.94	19.93	19.74
		1857.5 (18675)	20.08	20.09	19.88
	36RB-Low (0)	1902.5 (19125)	20.21	20.18	20.01
		1880 (18900)	19.90	19.91	19.70
		1857.5 (18675)	20.10	20.12	19.90
	75RB (0)	1902.5 (19125)	20.19	20.19	19.99
		1880 (18900)	19.96	19.96	19.76
		1857.5 (18675)	20.04	20.04	19.84
20MHz	1RB-High (99)	1900 (19100)	20.28	20.58	19.60
		1880 (18900)	20.13	20.41	19.45
		1860 (18700)	19.99	20.26	19.32
	1RB-Middle (50)	1900 (19100)	19.97	20.82	19.78
		1880 (18900)	20.30	20.58	19.62
		1860 (18700)	20.39	20.55	19.71
	1RB-Low (0)	1900 (19100)	20.13	20.01	19.45
		1880 (18900)	20.46	20.27	19.30
		1860 (18700)	20.17	20.38	19.49
50RB-High (50)	1900 (19100)	20.34	20.17	19.66	
	1880 (18900)	20.29	20.10	19.61	
	1860 (18700)	20.06	19.82	19.38	

	50RB-Middle (25)	1900 (19100)	20.37	20.19	19.69
		1880 (18900)	20.45	19.96	19.49
		1860 (18700)	20.24	19.93	19.56
	50RB-Low (0)	1900 (19100)	20.17	20.20	19.77
		1880 (18900)	20.08	19.93	19.40
		1860 (18700)	20.28	20.01	19.60
	100RB (0)	1900 (19100)	20.42	20.23	19.74
		1880 (18900)	20.24	20.02	19.56
		1860 (18700)	20.20	20.00	19.52

LTE B7-SET2					
BANDWIDTH	Number of RBs	Frequency	QPSK	16QAM	64QAM
5MHz	1RB-High (24)	2567.5 (21425)	19.07	19.18	19.32
		2535 (21100)	19.20	19.31	19.45
		2502.5 (20775)	19.19	19.30	19.44
	1RB-Middle (12)	2567.5 (21425)	19.16	19.27	19.41
		2535 (21100)	19.24	19.35	19.49
		2502.5 (20775)	19.35	19.46	19.60
	1RB-Low (0)	2567.5 (21425)	19.16	19.27	19.41
		2535 (21100)	19.13	19.24	19.38
		2502.5 (20775)	19.23	19.34	19.48
	12RB-High (13)	2567.5 (21425)	19.12	19.23	19.37
		2535 (21100)	19.35	19.46	19.60
		2502.5 (20775)	19.31	19.42	19.56
	12RB-Middle (6)	2567.5 (21425)	19.20	19.31	19.45
		2535 (21100)	19.27	19.38	19.52
		2502.5 (20775)	19.27	19.38	19.52
	12RB-Low (0)	2567.5 (21425)	19.20	19.31	19.45
		2535 (21100)	19.26	19.37	19.51
		2502.5 (20775)	19.21	19.32	19.46
	25RB (0)	2567.5 (21425)	19.14	19.25	19.39
		2535 (21100)	19.33	19.44	19.58
		2502.5 (20775)	19.22	19.33	10.52
10MHz	1RB-High (49)	2565 (21400)	19.15	19.21	19.28
		2535 (21100)	19.28	19.34	19.41
		2505 (20800)	19.27	19.33	19.40
	1RB-Middle (24)	2565 (21400)	19.24	19.30	19.37
		2535 (21100)	19.32	19.38	19.45
		2505 (20800)	19.43	19.49	19.56
	1RB-Low (0)	2565 (21400)	19.24	19.30	19.37
		2535 (21100)	19.21	19.27	19.34
		2505 (20800)	19.31	19.37	19.44

	25RB-High (25)	2565 (21400)	19.20	19.26	19.33	
		2535 (21100)	19.43	19.49	19.56	
		2505 (20800)	19.39	19.45	19.52	
	25RB-Middle (12)	2565 (21400)	19.28	19.34	19.41	
		2535 (21100)	19.35	19.41	19.48	
		2505 (20800)	19.35	19.41	19.48	
	25RB-Low (0)	2565 (21400)	19.28	19.34	19.41	
		2535 (21100)	19.34	19.40	19.47	
		2505 (20800)	19.29	19.35	19.42	
	50RB (0)	2565 (21400)	19.22	19.28	19.35	
		2535 (21100)	19.41	19.47	19.54	
		2505 (20800)	19.30	19.36	19.43	
15MHz	1RB-High (74)	2562.5 (21375)	20.22	20.70	19.11	
		2535 (21100)	20.35	20.46	19.23	
		2507.5 (20825)	20.34	20.79	19.22	
	1RB-Middle (37)	2562.5 (21375)	20.31	20.86	19.19	
		2535 (21100)	20.40	20.52	19.28	
		2507.5 (20825)	20.51	20.96	19.38	
	1RB-Low (0)	2562.5 (21375)	20.31	20.81	19.19	
		2535 (21100)	20.28	20.40	19.16	
		2507.5 (20825)	20.38	20.78	19.26	
	36RB-High (38)	2562.5 (21375)	20.27	20.23	19.15	
		2535 (21100)	20.51	20.57	19.38	
		2507.5 (20825)	20.47	20.37	19.34	
	36RB-Middle (19)	2562.5 (21375)	20.35	20.33	19.23	
		2535 (21100)	20.43	20.49	19.30	
		2507.5 (20825)	20.43	20.85	19.30	
	36RB-Low (0)	2562.5 (21375)	20.35	20.34	19.23	
		2535 (21100)	20.42	20.46	19.29	
		2507.5 (20825)	20.36	20.35	19.24	
	75RB (0)	2562.5 (21375)	20.29	20.32	19.17	
		2535 (21100)	20.49	20.51	19.36	
		2507.5 (20825)	20.37	20.39	19.25	
	20MHz	1RB-High (99)	2560 (21350)	20.18	20.79	19.15
			2535 (21100)	20.34	20.94	19.31
			2510 (20850)	20.20	20.71	19.17
1RB-Middle (50)		2560 (21350)	20.50	21.05	19.46	
		2535 (21100)	20.31	21.16	19.53	
		2510 (20850)	20.48	21.03	19.52	
1RB-Low (0)		2560 (21350)	20.58	20.85	19.28	
		2535 (21100)	20.50	20.84	19.22	
		2510 (20850)	20.57	20.67	19.16	

	50RB-High (50)	2560 (21350)	20.20	20.27	19.17
		2535 (21100)	20.49	20.55	19.45
		2510 (20850)	20.26	20.31	19.23
	50RB-Middle (25)	2560 (21350)	20.35	20.41	19.32
		2535 (21100)	20.42	20.57	19.46
		2510 (20850)	20.40	20.40	19.36
	50RB-Low (0)	2560 (21350)	20.50	20.49	19.38
		2535 (21100)	20.46	20.52	19.42
		2510 (20850)	20.34	20.36	19.31
	100RB (0)	2560 (21350)	20.33	20.39	19.30
		2535 (21100)	20.50	20.59	19.46
		2510 (20850)	20.35	20.35	19.32

LTE B41-SET2					
BANDWIDTH	Number of RBs	Frequency	QPSK	16QAM	64QAM
5MHz	1RB-High (24)	2687.5 (41565)	21.07	21.57	21.36
		2640.3(41093)	21.33	21.84	21.62
		2593 (40620)	21.28	21.78	21.57
		2545.8(40148)	21.17	21.67	21.46
		2498.5 (39675)	21.32	21.83	21.61
	1RB-Middle (12)	2687.5 (41565)	21.21	21.71	21.50
		2640.3(41093)	21.42	21.93	21.72
		2593 (40620)	21.38	21.89	21.67
		2545.8(40148)	21.14	21.64	21.43
		2498.5 (39675)	21.22	21.72	21.51
	1RB-Low (0)	2687.5 (41565)	21.12	21.62	21.41
		2640.3(41093)	21.32	21.83	21.61
		2593 (40620)	21.28	21.78	21.57
		2545.8(40148)	21.22	21.72	21.51
		2498.5 (39675)	21.37	21.88	21.66
	12RB-High (13)	2687.5 (41565)	21.32	21.83	21.61
		2640.3(41093)	21.33	21.84	21.62
		2593 (40620)	21.35	21.86	21.64
		2545.8(40148)	21.26	21.76	21.55
		2498.5 (39675)	21.33	21.84	21.62
	12RB-Middle (6)	2687.5 (41565)	21.35	21.86	21.64
		2640.3(41093)	21.31	21.82	21.60
		2593 (40620)	21.36	21.87	21.65
		2545.8(40148)	21.29	21.80	21.58
2498.5 (39675)		21.41	21.92	21.71	
12RB-Low (0)	2687.5 (41565)	21.35	21.86	21.64	

		2640.3(41093)	21.34	21.85	21.63	
		2593 (40620)	21.39	21.90	21.68	
		2545.8(40148)	21.39	21.90	21.68	
		2498.5 (39675)	21.43	21.94	21.73	
		25RB (0)	2687.5 (41565)	21.34	21.85	21.63
		2640.3(41093)	21.33	21.84	21.62	
		2593 (40620)	21.39	21.90	21.68	
		2545.8(40148)	21.20	21.70	21.49	
	2498.5 (39675)	21.08	21.58	21.37		
	10MHz	1RB-High (49)	2685 (41540)	20.53	20.25	20.16
			2639(41080)	20.78	20.50	20.40
			2593 (40620)	20.73	20.45	20.35
			2547(40160)	20.63	20.35	20.25
			2501 (39700)	20.77	20.49	20.39
		1RB-Middle (24)	2685 (41540)	20.67	20.39	20.29
			2639(41080)	20.87	20.59	20.49
2593 (40620)			20.83	20.55	20.45	
2547(40160)			20.60	20.32	20.22	
2501 (39700)			20.68	20.40	20.30	
1RB-Low (0)		2685 (41540)	20.58	20.30	20.21	
		2639(41080)	20.77	20.49	20.39	
		2593 (40620)	20.73	20.45	20.35	
		2547(40160)	20.68	20.40	20.30	
		2501 (39700)	20.82	20.54	20.44	
25RB-High (25)		2685 (41540)	20.77	20.49	20.39	
		2639(41080)	20.78	20.50	20.40	
		2593 (40620)	20.80	20.52	20.42	
		2547(40160)	20.72	20.44	20.34	
		2501 (39700)	20.78	20.50	20.40	
25RB-Middle (12)		2685 (41540)	20.80	20.52	20.42	
		2639(41080)	20.76	20.48	20.38	
		2593 (40620)	20.81	20.53	20.43	
		2547(40160)	20.74	20.46	20.36	
	2501 (39700)	20.86	20.58	20.48		
25RB-Low (0)	2685 (41540)	20.80	20.52	20.42		
	2639(41080)	20.79	20.51	20.41		
	2593 (40620)	20.84	20.56	20.46		
	2547(40160)	20.84	20.56	20.46		
	2501 (39700)	20.88	20.60	20.50		
50RB (0)	2685 (41540)	20.79	20.51	20.41		
	2639(41080)	20.78	20.50	20.40		
	2593 (40620)	20.84	20.56	20.46		

		2547(40160)	20.66	20.38	20.28
		2501 (39700)	20.54	20.26	20.17
15MHz	1RB-High (74)	2682.5 (41515)	21.12	21.35	21.28
		2637.8(41068)	20.98	21.60	21.14
		2593 (40620)	21.24	21.39	21.40
		2548.3(40173)	21.19	21.45	21.35
		2503.5 (39725)	21.09	21.71	21.25
	1RB-Middle (37)	2682.5 (41515)	21.23	21.41	21.39
		2637.8(41068)	21.13	21.66	21.29
		2593 (40620)	21.33	21.51	21.49
		2548.3(40173)	21.29	21.54	21.45
		2503.5 (39725)	21.05	21.28	21.21
	1RB-Low (0)	2682.5 (41515)	21.14	21.41	21.30
		2637.8(41068)	21.03	21.61	21.19
		2593 (40620)	21.23	21.48	21.39
		2548.3(40173)	21.19	21.42	21.35
		2503.5 (39725)	21.14	21.64	21.30
	36RB-High (38)	2682.5 (41515)	21.28	20.21	21.44
		2637.8(41068)	21.23	20.28	21.39
		2593 (40620)	21.24	20.28	21.40
		2548.3(40173)	21.26	20.32	21.42
		2503.5 (39725)	21.18	20.32	21.34
	36RB-Middle (19)	2682.5 (41515)	21.24	20.21	21.40
		2637.8(41068)	21.26	20.31	21.42
		2593 (40620)	21.22	20.29	21.38
		2548.3(40173)	21.27	20.31	21.43
		2503.5 (39725)	21.20	20.33	21.36
36RB-Low (0)	2682.5 (41515)	21.32	20.21	21.48	
	2637.8(41068)	21.26	20.33	21.42	
	2593 (40620)	21.25	21.48	21.41	
	2548.3(40173)	21.30	20.29	21.46	
	2503.5 (39725)	21.30	20.32	21.46	
75RB (0)	2682.5 (41515)	21.34	20.26	21.50	
	2637.8(41068)	21.25	20.38	21.41	
	2593 (40620)	21.24	20.27	21.40	
	2548.3(40173)	21.30	20.32	21.46	
	2503.5 (39725)	21.19	20.34	21.35	
20MHz	1RB-High (99)	2680 (41490)	21.06	21.36	21.25
		2636.5(41055)	21.25	21.28	21.44
		2593 (40620)	21.35	21.50	21.54
		2549.5(40185)	21.11	21.45	21.30
		2506 (39750)	21.03	21.35	21.22

	1RB-Middle (50)	2680 (41490)	20.89	21.63	21.08
		2636.5(41055)	21.17	21.62	21.36
		2593 (40620)	21.11	21.83	21.30
		2549.5(40185)	20.96	21.75	21.15
		2506 (39750)	20.99	21.68	21.18
	1RB-Low (0)	2680 (41490)	21.10	21.30	21.29
		2636.5(41055)	21.31	21.34	21.50
		2593 (40620)	21.17	21.54	21.36
		2549.5(40185)	21.00	21.45	21.19
		2506 (39750)	21.08	21.29	21.27
	50RB-High (50)	2680 (41490)	21.19	20.10	21.38
		2636.5(41055)	21.33	20.22	21.52
		2593 (40620)	21.38	20.23	21.57
		2549.5(40185)	21.31	20.28	21.50
		2506 (39750)	21.12	20.24	21.31
	50RB-Middle (25)	2680 (41490)	21.26	20.17	21.45
		2636.5(41055)	21.37	20.30	21.56
		2593 (40620)	21.36	20.29	21.55
		2549.5(40185)	21.25	20.26	21.44
		2506 (39750)	21.14	20.36	21.33
50RB-Low (0)	2680 (41490)	21.16	20.10	21.35	
	2636.5(41055)	21.24	20.28	21.43	
	2593 (40620)	21.31	20.31	21.50	
	2549.5(40185)	21.21	20.21	21.40	
	2506 (39750)	21.24	20.37	21.43	
100RB (0)	2680 (41490)	21.20	20.17	21.39	
	2636.5(41055)	21.36	20.30	21.55	
	2593 (40620)	21.39	20.28	21.58	
	2549.5(40185)	21.29	20.26	21.48	
	2506 (39750)	21.13	20.23	21.32	

LTE B66-SET2					
BANDWIDTH	Number of RBs	Frequency	QPSK	16QAM	64QAM
1.4MHz	1RB-High (5)	1779.3 (132665)	19.00	19.07	18.99
		1745 (132322)	18.86	18.93	18.85
		1710.7 (131979)	19.07	19.14	19.06
	1RB-Middle (3)	1779.3 (132665)	19.08	19.15	19.07
		1745 (132322)	19.36	19.43	19.35
		1710.7 (131979)	19.06	19.13	19.05
	1RB-Low (0)	1779.3 (132665)	18.78	18.85	18.77
		1745 (132322)	19.09	19.16	19.08

		1710.7 (131979)	19.17	19.24	19.16
	3RB-High (3)	1779.3 (132665)	18.84	18.91	18.83
		1745 (132322)	19.26	19.33	19.25
		1710.7 (131979)	19.08	19.15	19.07
	3RB-Middle (1)	1779.3 (132665)	18.90	18.97	18.89
		1745 (132322)	19.37	19.44	19.36
		1710.7 (131979)	19.07	19.14	19.06
	3RB-Low (0)	1779.3 (132665)	18.94	19.01	18.93
		1745 (132322)	19.31	19.38	19.30
		1710.7 (131979)	19.02	19.09	19.01
	6RB (0)	1779.3 (132665)	18.91	18.98	18.90
		1745 (132322)	19.30	19.37	19.29
		1710.7 (131979)	19.07	19.14	19.06
3MHz	1RB-High (14)	1778.5 (132657)	19.01	19.17	19.08
		1745 (132322)	18.87	19.03	18.94
		1711.5 (131987)	19.08	19.24	19.15
	1RB-Middle (7)	1778.5 (132657)	19.09	19.25	19.16
		1745 (132322)	19.37	19.53	19.44
		1711.5 (131987)	19.07	19.23	19.14
	1RB-Low (0)	1778.5 (132657)	18.79	18.95	18.86
		1745 (132322)	19.10	19.26	19.17
		1711.5 (131987)	19.18	19.34	19.25
	8RB-High (7)	1778.5 (132657)	18.85	19.01	18.92
		1745 (132322)	19.27	19.43	19.34
		1711.5 (131987)	19.09	19.25	19.16
	8RB-Middle (4)	1778.5 (132657)	18.91	19.07	18.98
		1745 (132322)	19.38	19.54	19.45
		1711.5 (131987)	19.08	19.24	19.15
	8RB-Low (0)	1778.5 (132657)	18.95	19.11	19.02
		1745 (132322)	19.32	19.48	19.39
		1711.5 (131987)	19.03	19.19	19.10
15RB (0)	1778.5 (132657)	18.92	19.08	18.99	
	1745 (132322)	19.31	19.47	19.38	
	1711.5 (131987)	19.08	19.24	19.15	
5MHz	1RB-High (24)	1549.5 (132647)	19.15	19.20	19.01
		1745 (132322)	19.01	19.06	18.87
		1712.5 (131997)	19.22	19.27	19.08
	1RB-Middle (12)	1549.5 (132647)	19.23	19.28	19.09
		1745 (132322)	19.51	19.56	19.37
		1712.5 (131997)	19.21	19.26	19.07
1RB-Low (0)	1549.5 (132647)	18.93	18.98	18.79	
	1745 (132322)	19.24	19.29	19.10	



		1712.5 (131997)	19.32	19.37	19.18
	12RB-High (13)	1549.5 (132647)	18.99	19.04	18.85
		1745 (132322)	19.41	19.46	19.27
		1712.5 (131997)	19.23	19.28	19.09
	12RB-Middle (6)	1549.5 (132647)	19.05	19.10	18.91
		1745 (132322)	19.52	19.57	19.38
		1712.5 (131997)	19.22	19.27	19.08
	12RB-Low (0)	1549.5 (132647)	19.09	19.14	18.95
		1745 (132322)	19.46	19.51	19.32
		1712.5 (131997)	19.17	19.22	19.03
	25RB (0)	1549.5 (132647)	19.06	19.11	18.92
		1745 (132322)	19.45	19.50	19.31
		1712.5 (131997)	19.22	19.27	19.08
10MHz	1RB-High (49)	1775 (132622)	19.12	19.18	19.19
		1745 (132322)	18.98	19.04	19.04
		1715 (132022)	19.19	19.25	19.26
	1RB-Middle (24)	1775 (132622)	19.20	19.26	19.27
		1745 (132322)	19.48	19.54	19.55
		1715 (132022)	19.18	19.24	19.25
	1RB-Low (0)	1775 (132622)	18.90	18.96	18.97
		1745 (132322)	19.21	19.27	19.28
		1715 (132022)	19.29	19.35	19.36
	25RB-High (25)	1775 (132622)	18.96	19.02	19.03
		1745 (132322)	19.38	19.44	19.45
		1715 (132022)	19.20	19.26	19.27
	25RB-Middle (12)	1775 (132622)	19.02	19.08	19.09
		1745 (132322)	19.49	19.55	19.56
		1715 (132022)	19.19	19.25	19.26
	25RB-Low (0)	1775 (132622)	19.06	19.12	19.13
		1745 (132322)	19.43	19.49	19.50
		1715 (132022)	19.14	19.20	19.21
50RB (0)	1775 (132622)	19.03	19.09	19.10	
	1745 (132322)	19.42	19.48	19.49	
	1715 (132022)	19.19	19.25	19.26	
15MHz	1RB-High (74)	1772.5 (132597)	19.79	19.11	19.07
		1745 (132322)	19.64	18.96	18.93
		1717.5 (132047)	19.86	19.17	19.14
	1RB-Middle (37)	1772.5 (132597)	19.87	19.18	19.15
		1745 (132322)	20.16	19.47	19.43
		1717.5 (132047)	19.85	19.16	19.13
1RB-Low (0)	1772.5 (132597)	19.56	18.88	18.85	
	1745 (132322)	19.88	19.19	19.16	

		1717.5 (132047)	19.97	19.28	19.25
	36RB-High (38)	1772.5 (132597)	19.62	18.95	18.91
		1745 (132322)	20.06	19.37	19.33
		1717.5 (132047)	19.87	19.18	19.15
	36RB-Middle (19)	1772.5 (132597)	19.69	19.01	18.98
		1745 (132322)	20.17	19.48	19.44
		1717.5 (132047)	19.86	19.17	19.14
	36RB-Low (0)	1772.5 (132597)	19.73	19.05	19.01
		1745 (132322)	20.11	19.42	19.38
		1717.5 (132047)	19.81	19.13	19.09
	75RB (0)	1772.5 (132597)	19.70	19.02	18.99
		1745 (132322)	20.10	19.41	19.37
		1717.5 (132047)	19.86	19.17	19.14
20MHz	1RB-High (99)	1770 (132572)	19.68	20.14	19.10
		1745 (132322)	19.53	19.99	18.95
		1720 (132072)	19.75	20.21	19.17
	1RB-Middle (50)	1770 (132572)	19.76	20.22	19.18
		1745 (132322)	19.74	20.52	19.46
		1720 (132072)	20.05	20.20	19.16
	1RB-Low (0)	1770 (132572)	19.45	19.90	18.88
		1745 (132322)	19.77	20.23	19.19
		1720 (132072)	19.86	20.32	19.27
	50RB-High (50)	1770 (132572)	19.51	19.97	18.93
		1745 (132322)	19.95	20.42	19.36
		1720 (132072)	19.76	20.22	19.18
	50RB-Middle (25)	1770 (132572)	19.58	20.04	19.00
		1745 (132322)	20.06	20.53	19.47
		1720 (132072)	19.75	20.21	19.17
	50RB-Low (0)	1770 (132572)	19.62	20.08	19.04
		1745 (132322)	20.00	20.47	19.41
		1720 (132072)	19.70	20.16	19.12
	100RB (0)	1770 (132572)	19.59	20.05	19.01
		1745 (132322)	19.99	20.46	19.40
		1720 (132072)	19.75	20.21	19.17

### 11.4 Wi-Fi and BT Measurement result

The maximum tune up of BT antenna is 9.5dBm.

Antenna	Receiver on, Hotspot off Transmit alone (Head scenario)	Receiver off, Hotspot off Transmit alone (Body scenario)	Receiver on, Hotspot off Simultaneous transmission (Head scenario)	Receiver on, Hotspot on Simultaneous transmission (Body scenario)	Receiver off, Hotspot off Simultaneous transmission (Body scenario)
Power	SET 0	SET 4	SET 1	SET 2	SET 3

WiFi 2.4G SET0/4		
802.11b	Channel\data rate	1Mbps
WLAN2450	11(2462MHz)	17.82
	6(2437(MHz)	17.58
	1(2412MHz)	17.78
Tuneup		18.00
802.11g	Channel\data rate	6Mbps
WLAN2450	11(2462MHz)	17.38
	6(2437(MHz)	17.55
	1(2412MHz)	17.34
Tuneup		18.00
802.11n-20MHz	Channel\data rate	MCS0
WLAN2450	11(2462MHz)	17.36
	6(2437(MHz)	17.38
	1(2412MHz)	17.41
Tuneup		18.00
802.11n-40MHz	Channel\data rate	MCS0
WLAN2450	9(2452MHz)	16.85
	6(2437MHz)	16.65
	3(2422MHz)	16.34
Tuneup		17.00

WiFi 2.4G SET1/2/3		
802.11b	Channel\data rate	1Mbps
WLAN2450	11(2462MHz)	15.96
	6(2437(MHz)	15.93
	1(2412MHz)	15.88
Tuneup		16.00
802.11g	Channel\data rate	6Mbps
WLAN2450	11(2462MHz)	15.38
	6(2437(MHz)	15.42
	1(2412MHz)	15.57
Tuneup		16.00
802.11n-20MHz	Channel\data rate	MCS0
WLAN2450	11(2462MHz)	15.51
	6(2437(MHz)	15.47
	1(2412MHz)	15.48
Tuneup		16.00
802.11n-40MHz	Channel\data rate	MCS0
WLAN2450	9(2452MHz)	15.77
	6(2437MHz)	15.94
	3(2422MHz)	15.48
Tuneup		16.00



WiFi 5G 802.11a(dBm) SET1/2/3	
Channel\data rate	6Mbps
36(5180 MHz)	14.12
40(5200 MHz)	14.36
44(5220 MHz)	14.44
48(5240 MHz)	14.87
52(5260 MHz)	14.06
56(5280 MHz)	14.15
60(5300 MHz)	14.07
64(5320 MHz)	14.08
100(5500 MHz)	14.66
104(5520 MHz)	14.45
108(5540 MHz)	14.52
112(5560 MHz)	14.45
116(5580 MHz)	14.78
120(5600 MHz)	14.86
124(5620 MHz)	15.14
128(5640 MHz)	14.89
132(5660 MHz)	14.79
136(5680 MHz)	14.76
140(5700 MHz)	14.93
144(5720 MHz)	14.72
149(5745 MHz)	15.37
153(5765 MHz)	15.55
157(5785 MHz)	15.92
161(5805 MHz)	15.73
165(5825 MHz)	15.45
Tune up	16.00



WiFi 5G 802.11a(dBm) SET0/4	
Channel\data rate	6Mbps
36(5180 MHz)	16.18
40(5200 MHz)	16.53
44(5220 MHz)	16.16
48(5240 MHz)	16.38
52(5260 MHz)	15.64
56(5280 MHz)	15.81
60(5300 MHz)	15.74
64(5320 MHz)	15.67
100(5500 MHz)	16.25
104(5520 MHz)	16.12
108(5540 MHz)	16.06
112(5560 MHz)	16.19
116(5580 MHz)	16.68
120(5600 MHz)	16.55
124(5620 MHz)	16.68
128(5640 MHz)	16.66
132(5660 MHz)	16.63
136(5680 MHz)	16.31
140(5700 MHz)	16.38
144(5720 MHz)	16.44
149(5745 MHz)	16.99
153(5765 MHz)	17.09
157(5785 MHz)	17.23
161(5805 MHz)	17.34
165(5825 MHz)	17.38
Tune up	17.50

## 12 SAR Measurement Positions

### 12.1 SAR Measurement Positions

According to the KDB941225 D06 Hot Spot SAR, the edges with less than 2.5 cm distance to the antennas need to be tested for SAR.

SAR measurement positions						
Mode	Front	Rear	Left	Right	Top	Bottom
Bottom ANT	Yes	Yes	Yes	Yes	No	Yes
Top ANT	Yes	Yes	Yes	Yes	Yes	No
WiFi ANT	Yes	Yes	Yes	No	Yes	No

## 13 Evaluation of Simultaneous

**Table 13.1: The sum of SAR values for Main antenna + WiFi-2.4G (1g)**

	Position	Main antenna	WiFi-2.4G	Sum
<b>Highest SAR value for Head</b>	Left head, Cheek (LTE B13)	0.84	0.36	<b>1.2</b>
<b>Highest SAR value for Body</b>	Bottom Edge 10mm (LTE B7)	0.83	/	<b>0.83</b>

**Table 13.2: The sum of SAR values for Main antenna + WiFi-5G (1g)**

	Position	Main antenna	WiFi-5G	Sum
<b>Highest SAR value for Head</b>	Left head, Cheek (LTE B13)	0.84	0.48	<b>1.32</b>
<b>Highest SAR value for Body</b>	Rear 10mm (WCDMA850)	0.64	0.53	<b>1.17</b>

## 14 SAR Test Result

It is determined by user manual for the distance between the EUT and the phantom bottom. The distance is 10/15 mm and just applied to the condition of body worn accessory.

It is performed for all SAR measurements with area scan based 1-g SAR estimation (Fast SAR). A zoom scan measurement is added when the estimated 1-g SAR is the highest measured SAR in each exposure configuration, wireless mode and frequency band combination or more than 1.2W/kg.

The calculated SAR is obtained by the following formula:

$$\text{Reported SAR} = \text{Measured SAR} \times 10^{(P_{\text{Target}} - P_{\text{Measured}})/10}$$

Where  $P_{\text{Target}}$  is the power of manufacturing upper limit;

$P_{\text{Measured}}$  is the measured power in chapter 11.

**Table 14.1: Duty Cycle**

Mode	Duty Cycle
GPRS&EGPRS for GSM 850/1900	1:4
WCDMA&LTE FDD	1:1
LTE TDD	1:1.58



**The evaluation of multi-Batteries:**

We'll perform the head measurement in all bands with the primary battery depending on the evaluation of multi-batteries and retest on highest value point with other batteries. Then, repeat the measurement in the Body test.

**Table 14.1: The evaluation of Multi-batteries for Head Test**

Frequency		Side	Test Position	Battery	SAR(1g) (W/kg)	Power Drift(dB)
MHz	Ch.					
1732.4	1412	Left	Touch	B1	0.085	0.16
1732.4	1412	Left	Touch	B2	0.079	-0.18

Note: According to the values in the above table, the **B1** is the primary battery.

We'll perform the head measurement with the **B1** and retest on highest value point with others.

**Table 14.2: The evaluation of Multi-batteries for Body Test**

Frequency		Position	Battery	SAR(1g) (W/kg)	Power Drift
MHz	Channel				
1732.5	1412	Rear 10mm	B1	0.475	0.04
1732.5	1412	Rear 10mm	B2	0.466	0.08

Note: According to the values in the above table, the **B1** is the primary battery.

We'll perform the head measurement with the **B1** and retest on highest value point with others.

**Table 14.3: The evaluation of Multi-batteries for Head Test**

Frequency		Side	Test Position	Battery	SAR(1g) (W/kg)	Power Drift(dB)
MHz	Ch.					
1907.6	9538	Right	Touch	SIM1	0.135	-0.17
1907.6	9538	Right	Touch	SIM2	0.120	-0.17

Note: According to the values in the above table, the **SIM1** is the primary slot.

We'll perform the head measurement with the **SIM1** and retest on highest value point with others.

**Table 14.4: The evaluation of Multi-batteries for Body Test**

Frequency		Position	Battery	SAR(1g) (W/kg)	Power Drift
MHz	Channel				
1732.5	1412	Rear 10mm	SIM1	0.475	0.04
1732.5	1412	Rear 10mm	SIM2	0.460	-0.16

Note: According to the values in the above table, the **SIM1** is the primary slot.

We'll perform the head measurement with the **SIM1** and retest on highest value point with others.

**Note**

**B1:** The battery of CAC4900009CA by TIANMAO

**B2:** The battery of CAC4900007C7 by VEKEN

**SS:** Single SIM card slot

**14.1 SAR results for 2G/3G/4G**

RF Exposure Conditions	Frequency Band	Channel Number	Frequency (MHz)	Mode/RB	Test Position	Distance	Figure No./Note	EUT Measured Power (dBm)	Tune up (dBm)	Measured SAR 1g (W/kg)	Calculated SAR 1g (W/kg)	Measured SAR 10g (W/kg)	Calculated SAR 10g (W/kg)	Power Drift
Head	GSM850	190	836.6	2TX	Left Cheek	0mm	\	28.51	30.00	0.104	0.15	0.082	0.12	0.05
Head	GSM850	128	824.2	2TX	Left Cheek	0mm	\	28.55	30.00	0.098	0.14	0.075	0.10	-0.18
Head	GSM850	251	848.8	2TX	Left Cheek	0mm	Fig.A1	28.57	30.00	0.129	0.18	0.099	0.14	0.13
Head	GSM850	190	836.6	2TX	Left Tilt	0mm	\	28.51	30.00	0.031	0.04	0.020	0.03	0.18
Head	GSM850	190	836.6	2TX	Right Cheek	0mm	\	28.51	30.00	0.085	0.12	0.068	0.10	-0.13
Head	GSM850	190	836.6	2TX	Right Tilt	0mm	\	28.51	30.00	0.023	0.03	0.019	0.03	-0.11
Head	GSM850	251	848.8	2TX	Left Cheek	0mm	SS	28.57	30.00	0.127	0.18	0.094	0.13	0.12
Head	GSM850	251	848.8	2TX	Left Cheek	0mm	SIM2	28.57	30.00	0.122	0.17	0.085	0.12	0.02
Head	GSM850	251	848.8	2TX	Left Cheek	0mm	B2	28.57	30.00	0.123	0.17	0.091	0.13	0.13
Body	GSM850	190	836.6	2TX	Front	10mm	\	28.51	30.00	0.061	0.09	0.037	0.05	0.12
Body	GSM850	251	848.8	2TX	Rear	10mm	Fig.A2	28.57	30.00	0.090	0.13	0.056	0.08	0.01
Body	GSM850	190	836.6	2TX	Rear	10mm	\	28.51	30.00	0.076	0.11	0.046	0.06	-0.15
Body	GSM850	128	824.2	2TX	Rear	10mm	\	28.55	30.00	0.064	0.09	0.039	0.05	-0.16
Body	GSM850	190	836.6	2TX	Left Edge	10mm	\	28.51	30.00	0.043	0.06	0.025	0.04	-0.04
Body	GSM850	190	836.6	2TX	Right Edge	10mm	\	28.51	30.00	0.023	0.03	0.019	0.03	0.12
Body	GSM850	190	836.6	2TX	Bottom Edge	10mm	\	28.51	30.00	0.039	0.05	0.021	0.03	-0.17
Body	GSM850	251	848.8	2TX	Rear	10mm	SS	28.57	30.00	0.084	0.12	0.050	0.07	0.01
Body	GSM850	251	848.8	2TX	Rear	10mm	SIM2	28.57	30.00	0.081	0.11	0.052	0.07	0.02
Body	GSM850	251	848.8	2TX	Rear	10mm	B2	28.57	30.00	0.084	0.12	0.051	0.07	0.10
Head	GSM1900	661	1880	2TX	Left Cheek	0mm	\	28.59	29.50	0.095	0.12	0.060	0.07	-0.02
Head	GSM1900	661	1880	2TX	Left Tilt	0mm	\	28.59	29.50	0.073	0.09	0.047	0.06	0.13
Head	GSM1900	661	1880	2TX	Right Cheek	0mm	\	28.59	29.50	0.085	0.10	0.057	0.07	0.13
Head	GSM1900	661	1880	2TX	Right Tilt	0mm	\	28.59	29.50	0.103	0.13	0.062	0.08	-0.19
Head	GSM1900	810	1909.8	2TX	Right Tilt	0mm	Fig.A3	28.57	29.50	0.136	0.17	0.084	0.10	-0.05
Head	GSM1900	512	1850.2	2TX	Right Edge	0mm	\	28.63	29.50	0.077	0.09	0.047	0.06	0.17
Head	GSM1900	810	1909.8	2TX	Right Tilt	0mm	SS	28.57	29.50	0.120	0.15	0.077	0.10	0.20
Head	GSM1900	810	1909.8	2TX	Right Tilt	0mm	SIM2	28.57	29.50	0.131	0.16	0.080	0.10	0.12
Head	GSM1900	810	1909.8	2TX	Right Tilt	0mm	B2	28.57	29.50	0.131	0.16	0.081	0.10	-0.17
Body	GSM1900	661	1880	2TX	Front	10mm	\	25.56	27.50	0.113	0.18	0.070	0.11	-0.11
Body	GSM1900	661	1880	2TX	Rear	10mm	Fig.A4	25.56	27.50	0.227	0.35	0.134	0.21	-0.21
Body	GSM1900	810	1909.8	2TX	Rear	10mm	\	25.57	27.50	0.219	0.34	0.132	0.21	-0.15
Body	GSM1900	512	1850.2	2TX	Rear	10mm	\	25.60	27.50	0.185	0.29	0.110	0.17	0.19
Body	GSM1900	661	1880	2TX	Left Edge	10mm	\	25.56	27.50	0.033	0.05	0.018	0.03	-0.07
Body	GSM1900	661	1880	2TX	Right Edge	10mm	\	25.56	27.50	0.054	0.08	0.031	0.05	0.15
Body	GSM1900	661	1880	2TX	Bottom Edge	10mm	\	25.56	27.50	0.188	0.29	0.106	0.17	0.01
Body	GSM1900	661	1880	2TX	Rear	10mm	SS	25.56	27.50	0.201	0.31	0.128	0.20	0.15
Body	GSM1900	661	1880	2TX	Rear	10mm	SIM2	25.56	27.50	0.209	0.33	0.119	0.19	-0.14
Body	GSM1900	661	1880	2TX	Rear	10mm	B2	25.56	27.50	0.219	0.34	0.123	0.19	0.13
Body	GSM1900	661	1880	2TX	Front	15mm	\	28.20	28.50	0.094	0.10	0.061	0.07	0.02
Body	GSM1900	661	1880	2TX	Rear	15mm	Fig.A5	28.20	28.50	0.139	0.15	0.085	0.09	0.19
Body	GSM1900	810	1909.8	2TX	Rear	15mm	\	28.34	28.50	0.134	0.14	0.078	0.08	0.11
Body	GSM1900	512	1850.2	2TX	Rear	15mm	\	28.37	28.50	0.138	0.14	0.081	0.08	-0.02
Body	GSM1900	661	1880	2TX	Rear	15mm	SS	28.20	28.50	0.130	0.14	0.081	0.09	0.14
Body	GSM1900	661	1880	2TX	Rear	15mm	SIM2	28.20	28.50	0.131	0.14	0.080	0.09	-0.10
Body	GSM1900	661	1880	2TX	Rear	15mm	B2	28.20	28.50	0.132	0.14	0.079	0.08	-0.18
Head	WCDMA1900	9400	1880	RMC	Left Cheek	0mm	\	22.88	24.00	0.113	0.15	0.071	0.09	0.16
Head	WCDMA1900	9400	1880	RMC	Left Tilt	0mm	\	22.88	24.00	0.053	0.07	0.034	0.04	0.19
Head	WCDMA1900	9400	1880	RMC	Right Cheek	0mm	\	22.88	24.00	0.117	0.15	0.071	0.09	-0.10
Head	WCDMA1900	9262	1852.4	RMC	Right Cheek	0mm	\	22.82	24.00	0.093	0.12	0.058	0.08	0.19
Head	WCDMA1900	9538	1907.6	RMC	Right Cheek	0mm	Fig.A6	22.91	24.00	0.135	0.17	0.085	0.11	-0.17
Head	WCDMA1900	9400	1880	RMC	Right Tilt	0mm	\	22.88	24.00	0.088	0.11	0.053	0.07	0.10
Head	WCDMA1900	9538	1907.6	RMC	Right Cheek	0mm	SS	22.91	24.00	0.120	0.16	0.084	0.10	-0.17
Head	WCDMA1900	9538	1907.6	RMC	Right Cheek	0mm	SIM2	22.91	24.00	0.120	0.15	0.084	0.11	-0.17
Head	WCDMA1900	9538	1907.6	RMC	Right Cheek	0mm	B2	22.91	24.00	0.128	0.16	0.081	0.10	-0.14
Body	WCDMA1900	9400	1880	RMC	Front	10mm	\	22.30	23.00	0.275	0.32	0.170	0.20	-0.22
Body	WCDMA1900	9400	1880	RMC	Rear	10mm	\	22.30	23.00	0.472	0.55	0.279	0.33	-0.17
Body	WCDMA1900	9538	1907.6	RMC	Rear	10mm	Fig.A7	22.35	23.00	0.485	0.56	0.284	0.33	-0.01
Body	WCDMA1900	9262	1852.4	RMC	Rear	10mm	\	22.09	23.00	0.450	0.55	0.282	0.35	-0.10
Body	WCDMA1900	9400	1880	RMC	Left Edge	10mm	\	22.30	23.00	0.110	0.13	0.066	0.08	-0.12
Body	WCDMA1900	9400	1880	RMC	Right Edge	10mm	\	22.30	23.00	0.173	0.20	0.101	0.12	0.07
Body	WCDMA1900	9400	1880	RMC	Bottom Edge	10mm	\	22.30	23.00	0.432	0.51	0.246	0.29	0.02
Body	WCDMA1900	9538	1907.6	RMC	Rear	10mm	SS	22.35	23.00	0.471	0.55	0.274	0.32	0.11
Body	WCDMA1900	9538	1907.6	RMC	Rear	10mm	SIM2	22.35	23.00	0.469	0.54	0.270	0.31	0.12
Body	WCDMA1900	9538	1907.6	RMC	Rear	10mm	B2	22.35	23.00	0.470	0.55	0.269	0.31	-0.06
Body	WCDMA1900	9400	1880	RMC	Front	15mm	\	22.38	23.50	0.195	0.25	0.123	0.16	0.10
Body	WCDMA1900	9400	1880	RMC	Rear	15mm	Fig.A8	22.38	23.50	0.317	0.41	0.193	0.25	0.12
Body	WCDMA1900	9538	1907.6	RMC	Rear	15mm	\	22.49	23.50	0.303	0.38	0.183	0.23	-0.19
Body	WCDMA1900	9262	1852.4	RMC	Rear	15mm	\	22.25	23.50	0.306	0.41	0.188	0.25	0.13
Body	WCDMA1900	9400	1880	RMC	Rear	15mm	SS	22.38	23.50	0.301	0.39	0.179	0.23	0.17
Body	WCDMA1900	9400	1880	RMC	Rear	15mm	SIM2	22.38	23.50	0.300	0.39	0.177	0.23	0.10
Body	WCDMA1900	9400	1880	RMC	Rear	15mm	B2	22.38	23.50	0.311	0.40	0.180	0.23	-0.16

RF Exposure Conditions	Frequency Band	Channel Number	Frequency (MHz)	Mode/RB	Test Position	Distance	Figure No./Note	EUT Measured Power (dBm)	Tune up (dBm)	Measured SAR 1g (W/kg)	Calculated SAR 1g (W/kg)	Measured SAR 10g (W/kg)	Calculated SAR 10g (W/kg)	Power Drift
Head	WCDMA1700	1412	1732.4	RMC	Left Cheek	0mm	Fig.A9	22.45	24.00	0.085	0.12	0.054	0.08	0.16
Head	WCDMA1700	1312	1712.4	RMC	Left Cheek	0mm	\	22.40	24.00	0.083	0.12	0.053	0.08	0.15
Head	WCDMA1700	1513	1752.6	RMC	Left Cheek	0mm	\	22.51	24.00	0.084	0.12	0.054	0.08	-0.17
Head	WCDMA1700	1412	1732.4	RMC	Left Tilt	0mm	\	22.45	24.00	0.045	0.06	0.028	0.04	-0.12
Head	WCDMA1700	1412	1732.4	RMC	Right Cheek	0mm	\	22.45	24.00	0.056	0.08	0.038	0.05	0.10
Head	WCDMA1700	1412	1732.4	RMC	Right Tilt	0mm	\	22.45	24.00	0.048	0.07	0.031	0.04	-0.04
Head	WCDMA1700	1412	1732.4	RMC	Left Cheek	0mm	SS	22.45	24.00	0.081	0.12	0.040	0.06	0.16
Head	WCDMA1700	1412	1732.4	RMC	Left Cheek	0mm	SIM2	22.45	24.00	0.075	0.11	0.043	0.06	-0.12
Head	WCDMA1700	1412	1732.4	RMC	Left Cheek	0mm	B2	22.45	24.00	0.079	0.11	0.052	0.07	-0.18
RF Exposure Conditions	Frequency Band	Channel Number	Frequency (MHz)	Mode/RB	Test Position	Distance	Figure No./Note	EUT Measured Power (dBm)	Tune up (dBm)	Measured SAR 1g (W/kg)	Calculated SAR 1g (W/kg)	Measured SAR 10g (W/kg)	Calculated SAR 10g (W/kg)	Power Drift
Body	WCDMA1700	1412	1732.5	RMC	Front	10mm	\	21.86	23.00	0.217	0.28	0.136	0.18	0.17
Body	WCDMA1700	1412	1732.5	RMC	Rear	10mm	Fig.A10	21.86	23.00	0.475	0.62	0.285	0.37	0.04
Body	WCDMA1700	1513	1752.6	RMC	Rear	10mm	\	22.06	23.00	0.447	0.56	0.265	0.33	0.15
Body	WCDMA1700	1312	1712.4	RMC	Rear	10mm	\	21.93	23.00	0.469	0.60	0.280	0.36	0.15
Body	WCDMA1700	1412	1732.5	RMC	Left Edge	10mm	\	21.86	23.00	0.062	0.08	0.039	0.05	0.02
Body	WCDMA1700	1412	1732.5	RMC	Right Edge	10mm	\	21.86	23.00	0.092	0.12	0.055	0.07	-0.10
Body	WCDMA1700	1412	1732.5	RMC	Bottom Edge	10mm	\	21.86	23.00	0.418	0.54	0.243	0.32	0.11
Body	WCDMA1700	1412	1732.5	RMC	Rear	10mm	SS	21.86	23.00	0.470	0.61	0.261	0.34	0.18
Body	WCDMA1700	1412	1732.5	RMC	Rear	10mm	SIM2	21.86	23.00	0.460	0.60	0.271	0.35	-0.16
Body	WCDMA1700	1412	1732.5	RMC	Rear	10mm	B2	21.86	23.00	0.466	0.61	0.270	0.35	0.08
RF Exposure Conditions	Frequency Band	Channel Number	Frequency (MHz)	Mode/RB	Test Position	Distance	Figure No./Note	EUT Measured Power (dBm)	Tune up (dBm)	Measured SAR 1g (W/kg)	Calculated SAR 1g (W/kg)	Measured SAR 10g (W/kg)	Calculated SAR 10g (W/kg)	Power Drift
Body	WCDMA1700	1412	1732.5	RMC	Front	15mm	\	22.17	23.50	0.114	0.15	0.075	0.10	0.13
Body	WCDMA1700	1412	1732.5	RMC	Rear	15mm	Fig.A11	22.17	23.50	0.216	0.29	0.139	0.19	0.02
Body	WCDMA1700	1513	1752.6	RMC	Rear	15mm	\	22.20	23.50	0.211	0.28	0.132	0.18	0.19
Body	WCDMA1700	1312	1712.4	RMC	Rear	15mm	\	22.12	23.50	0.189	0.26	0.137	0.19	-0.03
Body	WCDMA1700	1412	1732.5	RMC	Rear	15mm	SS	22.17	23.50	0.213	0.29	0.134	0.18	0.15
Body	WCDMA1700	1412	1732.5	RMC	Rear	15mm	SIM2	22.17	23.50	0.209	0.28	0.130	0.18	-0.11
Body	WCDMA1700	1412	1732.5	RMC	Rear	15mm	B2	22.17	23.50	0.211	0.29	0.129	0.18	-0.20
RF Exposure Conditions	Frequency Band	Channel Number	Frequency (MHz)	Mode/RB	Test Position	Distance	Figure No./Note	EUT Measured Power (dBm)	Tune up (dBm)	Measured SAR 1g (W/kg)	Calculated SAR 1g (W/kg)	Measured SAR 10g (W/kg)	Calculated SAR 10g (W/kg)	Power Drift
Head	WCDMA 850	4182	836.6	RMC	Left Cheek	0mm	\	23.01	24.00	0.388	0.49	0.238	0.30	0.16
Head	WCDMA 850	4182	836.6	RMC	Left Tilt	0mm	\	23.01	24.00	0.391	0.49	0.232	0.29	-0.11
Head	WCDMA 850	4182	836.6	RMC	Right Cheek	0mm	\	23.01	24.00	0.488	0.61	0.290	0.36	0.17
Head	WCDMA 850	4182	836.6	RMC	Right Tilt	0mm	\	23.01	24.00	0.492	0.62	0.265	0.33	-0.14
Head	WCDMA 850	4132	826.4	RMC	Right Tilt	0mm	\	23.20	24.00	0.444	0.53	0.238	0.29	-0.14
Head	WCDMA 850	4233	846.6	RMC	Right Tilt	0mm	Fig.A12	22.93	24.00	0.504	0.64	0.276	0.35	-0.06
Head	WCDMA 850	4233	846.6	RMC	Right Tilt	0mm	SS	22.93	24.00	0.485	0.62	0.276	0.35	0.19
Head	WCDMA 850	4233	846.6	RMC	Right Tilt	0mm	SIM2	22.93	24.00	0.481	0.62	0.260	0.33	-0.18
Head	WCDMA 850	4233	846.6	RMC	Right Tilt	0mm	B2	22.93	24.00	0.473	0.61	0.260	0.33	-0.16
RF Exposure Conditions	Frequency Band	Channel Number	Frequency (MHz)	Mode/RB	Test Position	Distance	Figure No./Note	EUT Measured Power (dBm)	Tune up (dBm)	Measured SAR 1g (W/kg)	Calculated SAR 1g (W/kg)	Measured SAR 10g (W/kg)	Calculated SAR 10g (W/kg)	Power Drift
Body	WCDMA 850	4182	836.6	RMC	Front	10mm	\	23.01	24.00	0.313	0.39	0.202	0.25	-0.12
Body	WCDMA 850	4182	836.6	RMC	Rear	10mm	\	23.01	24.00	0.510	0.64	0.303	0.38	-0.07
Body	WCDMA 850	4182	836.6	RMC	Left Edge	10mm	\	23.01	24.00	0.354	0.44	0.417	0.52	-0.17
Body	WCDMA 850	4182	836.6	RMC	Right Edge	10mm	\	23.01	24.00	0.168	0.21	0.118	0.15	0.13
Body	WCDMA 850	4182	836.6	RMC	Top Edge	10mm	Fig.A13	23.01	24.00	0.540	0.68	0.296	0.37	0.13
Body	WCDMA 850	4132	826.4	RMC	Top Edge	10mm	\	23.20	24.00	0.472	0.57	0.264	0.32	0.11
Body	WCDMA 850	4233	846.6	RMC	Top Edge	10mm	\	22.93	24.00	0.447	0.57	0.251	0.32	-0.14
Body	WCDMA 850	4182	836.6	RMC	Top Edge	10mm	SS	23.01	24.00	0.530	0.67	0.279	0.35	0.12
Body	WCDMA 850	4182	836.6	RMC	Top Edge	10mm	SIM2	23.01	24.00	0.520	0.65	0.277	0.35	0.06
Body	WCDMA 850	4182	836.6	RMC	Top Edge	10mm	B2	23.01	24.00	0.523	0.66	0.284	0.36	-0.08
RF Exposure Conditions	Frequency Band	Channel Number	Frequency (MHz)	Mode/RB	Test Position	Distance	Figure No./Note	EUT Measured Power (dBm)	Tune up (dBm)	Measured SAR 1g (W/kg)	Calculated SAR 1g (W/kg)	Measured SAR 10g (W/kg)	Calculated SAR 10g (W/kg)	Power Drift
Head	LTE Band2	18900	1880	1RB-Low	Left Cheek	0mm	\	22.06	23.00	0.096	0.12	0.059	0.07	0.20
Head	LTE Band2	18900	1880	1RB-Low	Left Tilt	0mm	\	22.06	23.00	0.076	0.09	0.047	0.06	-0.11
Head	LTE Band2	18900	1880	1RB-Low	Right Cheek	0mm	\	22.06	23.00	0.083	0.10	0.053	0.07	-0.03
Head	LTE Band2	18900	1880	1RB-Low	Right Tilt	0mm	\	22.06	23.00	0.092	0.11	0.055	0.07	-0.15
Head	LTE Band2	18900	1880	50RB-Middle	Left Cheek	0mm	\	21.09	22.00	0.102	0.13	0.064	0.08	-0.01
Head	LTE Band2	18900	1880	50RB-Middle	Left Tilt	0mm	\	21.09	22.00	0.069	0.09	0.043	0.05	0.15
Head	LTE Band2	18900	1880	50RB-Middle	Right Cheek	0mm	Fig.A14	21.09	22.00	0.167	0.21	0.107	0.13	0.12
Head	LTE Band2	18900	1880	50RB-Middle	Right Tilt	0mm	\	21.09	22.00	0.098	0.12	0.059	0.07	0.18
Head	LTE Band2	18900	1880	50RB-Middle	Right Cheek	0mm	SS	21.09	22.00	0.149	0.18	0.080	0.10	0.15
Head	LTE Band2	18900	1880	50RB-Middle	Right Cheek	0mm	SIM2	21.09	22.00	0.150	0.18	0.095	0.12	-0.11
Head	LTE Band2	18900	1880	50RB-Middle	Right Cheek	0mm	B2	21.09	22.00	0.156	0.19	0.095	0.12	0.19
RF Exposure Conditions	Frequency Band	Channel Number	Frequency (MHz)	Mode/RB	Test Position	Distance	Figure No./Note	EUT Measured Power (dBm)	Tune up (dBm)	Measured SAR 1g (W/kg)	Calculated SAR 1g (W/kg)	Measured SAR 10g (W/kg)	Calculated SAR 10g (W/kg)	Power Drift
Body	LTE Band2	18900	1880	1RB-Low	Front	10mm	\	20.21	21.00	0.241	0.29	0.150	0.18	-0.10
Body	LTE Band2	18900	1880	1RB-Low	Rear	10mm	Fig.A15	20.21	21.00	0.457	0.55	0.272	0.33	0.11
Body	LTE Band2	18900	1880	1RB-Low	Left Edge	10mm	\	20.21	21.00	0.082	0.10	0.051	0.06	-0.15
Body	LTE Band2	18900	1880	1RB-Low	Right Edge	10mm	\	20.21	21.00	0.146	0.18	0.087	0.10	-0.06
Body	LTE Band2	18900	1880	1RB-Low	Bottom Edge	10mm	\	20.21	21.00	0.378	0.45	0.222	0.27	-0.20
Body	LTE Band2	18900	1880	50RB-Middle	Front	10mm	\	20.20	21.00	0.250	0.30	0.157	0.19	-0.04
Body	LTE Band2	18900	1880	50RB-Middle	Rear	10mm	\	20.20	21.00	0.428	0.51	0.255	0.31	-0.05
Body	LTE Band2	18900	1880	50RB-Middle	Left Edge	10mm	\	20.20	21.00	0.085	0.10	0.053	0.06	-0.01
Body	LTE Band2	18900	1880	50RB-Middle	Right Edge	10mm	\	20.20	21.00	0.148	0.18	0.087	0.10	-0.12
Body	LTE Band2	18900	1880	50RB-Middle	Bottom Edge	10mm	\	20.20	21.00	0.370	0.44	0.216	0.26	-0.18
Body	LTE Band2	18900	1880	1RB-Low	Rear	10mm	SS	20.21	21.00	0.439	0.53	0.261	0.31	0.14
Body	LTE Band2	18900	1880	1RB-Low	Rear	10mm	SIM2	20.21	21.00	0.441	0.53	0.265	0.32	-0.03
Body	LTE Band2	18900	1880	1RB-Low	Rear	10mm	B2	20.21	21.00	0.449	0.54	0.261	0.31	-0.14
RF Exposure Conditions	Frequency Band	Channel Number	Frequency (MHz)	Mode/RB	Test Position	Distance	Figure No./Note	EUT Measured Power (dBm)	Tune up (dBm)	Measured SAR 1g (W/kg)	Calculated SAR 1g (W/kg)	Measured SAR 10g (W/kg)	Calculated SAR 10g (W/kg)	Power Drift
Body	LTE Band2	18900	1880	1RB-Low	Front	15mm	\	20.27	22.00	0.129	0.19	0.079	0.12	0.15
Body	LTE Band2	18900	1880	1RB-Low	Rear	15mm	\	20.27	22.00	0.224	0.33	0.137	0.20	-0.04
Body	LTE Band2	18900	1880	50RB-Middle	Front	15mm	\	20.22	22.00	0.127	0.19	0.081	0.12	0.12
Body	LTE Band2	18900	1880	50RB-Middle	Rear	15mm	Fig.A16	20.22	22.00	0.225	0.34	0.138	0.21	-0.04
Body	LTE Band2	18900	1880	50RB-Middle	Rear	15mm	SS	20.22	22.00	0.214	0.32	0.130	0.20	0.15
Body	LTE Band2	18900	1880	50RB-Middle	Rear	15mm	SIM2	20.22	22.00	0.219	0.33	0.120	0.18	-0.09
Body	LTE Band2	18900	1880	50RB-Middle	Rear	15mm	B2	20.22	22.00	0.212	0.32	0.120	0.18	0.14

RF Exposure Conditions	Frequency Band	Channel Number	Frequency (MHz)	Mode/RB	Test Position	Distance	Figure No./Note	EUT Measured Power (dBm)	Tune up (dBm)	Measured SAR 1g (W/kg)	Calculated SAR 1g (W/kg)	Measured SAR 10g (W/kg)	Calculated SAR 10g (W/kg)	Power Drift
Head	LTE Band5	20450	829	1RB-Low	Left Cheek	0mm	\	23.21	23.50	0.493	0.53	0.341	0.36	-0.09
Head	LTE Band5	20450	829	1RB-Low	Left Tilt	0mm	\	23.21	23.50	0.446	0.48	0.291	0.31	0.06
Head	LTE Band5	20450	829	1RB-Low	Right Cheek	0mm	\	23.21	23.50	0.580	0.62	0.399	0.43	0.04
Head	LTE Band5	20450	829	1RB-Low	Right Tilt	0mm	Fig.A17	23.21	23.50	0.592	0.63	0.336	0.36	-0.06
Head	LTE Band5	20450	829	25RB-Low	Left Cheek	0mm	\	22.19	22.50	0.375	0.40	0.266	0.29	0.15
Head	LTE Band5	20450	829	25RB-Low	Left Tilt	0mm	\	22.19	22.50	0.348	0.37	0.224	0.24	0.08
Head	LTE Band5	20450	829	25RB-Low	Right Cheek	0mm	\	22.19	22.50	0.421	0.45	0.302	0.32	0.13
Head	LTE Band5	20450	829	25RB-Low	Right Tilt	0mm	\	22.19	22.50	0.488	0.52	0.275	0.30	0.14
Head	LTE Band5	20450	829	1RB-Low	Right Tilt	0mm	SS	23.21	23.50	0.562	0.60	0.319	0.34	0.14
Head	LTE Band5	20450	829	1RB-Low	Right Tilt	0mm	SIM2	23.21	23.50	0.579	0.62	0.320	0.34	-0.10
Head	LTE Band5	20450	829	1RB-Low	Right Tilt	0mm	B2	23.21	23.50	0.580	0.62	0.312	0.33	-0.19
RF Exposure Conditions	Frequency Band	Channel Number	Frequency (MHz)	Mode/RB	Test Position	Distance	Figure No./Note	EUT Measured Power (dBm)	Tune up (dBm)	Measured SAR 1g (W/kg)	Calculated SAR 1g (W/kg)	Measured SAR 10g (W/kg)	Calculated SAR 10g (W/kg)	Power Drift
Body	LTE Band5	20450	829	1RB-Low	Front	10mm	\	23.21	23.50	0.229	0.24	0.149	0.16	0.11
Body	LTE Band5	20450	829	1RB-Low	Rear	10mm	Fig.A18	23.21	23.50	0.320	0.34	0.242	0.26	-0.12
Body	LTE Band5	20450	829	1RB-Low	Left Edge	10mm	\	23.21	23.50	0.283	0.30	0.197	0.21	0.10
Body	LTE Band5	20450	829	1RB-Low	Right Edge	10mm	\	23.21	23.50	0.164	0.18	0.114	0.12	-0.12
Body	LTE Band5	20450	829	1RB-Low	Top Edge	10mm	\	23.21	23.50	0.304	0.32	0.168	0.18	0.17
Body	LTE Band5	20450	829	25RB-Low	Front	10mm	\	22.19	22.50	0.194	0.21	0.126	0.14	-0.03
Body	LTE Band5	20450	829	25RB-Low	Rear	10mm	\	22.19	22.50	0.265	0.28	0.200	0.21	-0.16
Body	LTE Band5	20450	829	25RB-Low	Left Edge	10mm	\	22.19	22.50	0.227	0.24	0.158	0.17	-0.10
Body	LTE Band5	20450	829	25RB-Low	Right Edge	10mm	\	22.19	22.50	0.133	0.14	0.092	0.10	-0.16
Body	LTE Band5	20450	829	25RB-Low	Top Edge	10mm	\	22.19	22.50	0.268	0.29	0.146	0.16	-0.12
Body	LTE Band5	20450	829	1RB-Low	Rear	10mm	SS	23.21	23.50	0.309	0.33	0.214	0.23	0.15
Body	LTE Band5	20450	829	1RB-Low	Rear	10mm	SIM2	23.21	23.50	0.311	0.33	0.229	0.24	-0.13
Body	LTE Band5	20450	829	1RB-Low	Rear	10mm	B2	23.21	23.50	0.312	0.33	0.228	0.24	0.15
RF Exposure Conditions	Frequency Band	Channel Number	Frequency (MHz)	Mode/RB	Test Position	Distance	Figure No./Note	EUT Measured Power (dBm)	Tune up (dBm)	Measured SAR 1g (W/kg)	Calculated SAR 1g (W/kg)	Measured SAR 10g (W/kg)	Calculated SAR 10g (W/kg)	Power Drift
Head	LTE Band7	21350	2560	1RB-Low	Left Cheek	0mm	Fig.A19	22.24	23.00	0.053	0.06	0.027	0.03	0.15
Head	LTE Band7	21350	2560	1RB-Low	Left Tilt	0mm	\	22.24	23.00	0.015	0.02	0.008	0.01	0.11
Head	LTE Band7	21350	2560	1RB-Low	Right Cheek	0mm	\	22.24	23.00	0.029	0.03	0.015	0.02	-0.14
Head	LTE Band7	21350	2560	1RB-Low	Right Tilt	0mm	\	22.24	23.00	0.018	0.02	0.009	0.01	0.10
Head	LTE Band7	21350	2560	50RB-Low	Left Cheek	0mm	\	21.26	22.00	0.032	0.04	0.012	0.01	0.06
Head	LTE Band7	21350	2560	50RB-Low	Left Tilt	0mm	\	21.26	22.00	0.027	0.03	0.011	0.01	0.19
Head	LTE Band7	21350	2560	50RB-Low	Right Cheek	0mm	\	21.26	22.00	0.021	0.02	0.011	0.01	-0.04
Head	LTE Band7	21350	2560	50RB-Low	Right Tilt	0mm	\	21.26	22.00	0.018	0.02	0.009	0.01	0.13
Head	LTE Band7	21350	2560	1RB-Low	Left Cheek	0mm	SS	22.24	23.00	0.043	0.05	0.025	0.03	0.12
Head	LTE Band7	21350	2560	1RB-Low	Left Cheek	0mm	SIM2	22.24	23.00	0.050	0.06	0.024	0.03	0.19
Head	LTE Band7	21350	2560	1RB-Low	Left Cheek	0mm	B2	22.24	23.00	0.048	0.06	0.021	0.03	0.13
RF Exposure Conditions	Frequency Band	Channel Number	Frequency (MHz)	Mode/RB	Test Position	Distance	Figure No./Note	EUT Measured Power (dBm)	Tune up (dBm)	Measured SAR 1g (W/kg)	Calculated SAR 1g (W/kg)	Measured SAR 10g (W/kg)	Calculated SAR 10g (W/kg)	Power Drift
Body	LTE Band7	21350	2560	1RB-Low	Front	10mm	\	20.58	21.00	0.202	0.22	0.113	0.12	-0.19
Body	LTE Band7	21350	2560	1RB-Low	Rear	10mm	\	20.58	21.00	0.302	0.33	0.182	0.20	-0.11
Body	LTE Band7	21350	2560	1RB-Low	Left Edge	10mm	\	20.58	21.00	0.055	0.06	0.034	0.04	-0.15
Body	LTE Band7	21350	2560	1RB-Low	Right Edge	10mm	\	20.58	21.00	0.142	0.16	0.077	0.08	0.06
Body	LTE Band7	21100	2535	1RB-Low	Bottom Edge	10mm	Fig.A20	20.50	21.00	0.739	0.83	0.368	0.41	-0.19
Body	LTE Band7	21350	2560	1RB-Low	Bottom Edge	10mm	\	20.58	21.00	0.510	0.56	0.271	0.30	-0.19
Body	LTE Band7	20850	2510	1RB-Low	Bottom Edge	10mm	\	20.57	21.00	0.600	0.66	0.303	0.33	0.04
Body	LTE Band7	21100	2535	100RB	Bottom Edge	10mm	\	20.50	21.00	0.701	0.79	0.285	0.32	0.12
Body	LTE Band7	21350	2560	50RB-Low	Front	10mm	\	20.50	21.00	0.203	0.23	0.113	0.13	-0.07
Body	LTE Band7	21350	2560	50RB-Low	Rear	10mm	\	20.50	21.00	0.365	0.41	0.184	0.21	-0.16
Body	LTE Band7	21350	2560	50RB-Low	Left Edge	10mm	\	20.50	21.00	0.057	0.06	0.036	0.04	-0.05
Body	LTE Band7	21350	2560	50RB-Low	Right Edge	10mm	\	20.50	21.00	0.127	0.14	0.072	0.08	-0.04
Body	LTE Band7	21350	2560	50RB-Low	Bottom Edge	10mm	\	20.50	21.00	0.505	0.57	0.265	0.30	-0.12
Body	LTE Band7	21350	2560	1RB-Low	Bottom Edge	10mm	SS	20.50	21.00	0.720	0.81	0.360	0.40	0.18
Body	LTE Band7	21350	2560	1RB-Low	Bottom Edge	10mm	SIM2	20.50	21.00	0.713	0.80	0.350	0.39	-0.14
Body	LTE Band7	21350	2560	1RB-Low	Bottom Edge	10mm	B2	20.50	21.00	0.720	0.81	0.349	0.39	0.14
RF Exposure Conditions	Frequency Band	Channel Number	Frequency (MHz)	Mode/RB	Test Position	Distance	Figure No./Note	EUT Measured Power (dBm)	Tune up (dBm)	Measured SAR 1g (W/kg)	Calculated SAR 1g (W/kg)	Measured SAR 10g (W/kg)	Calculated SAR 10g (W/kg)	Power Drift
Body	LTE Band7	21350	2560	1RB-Low	Front	15mm	\	20.59	21.50	0.170	0.21	0.100	0.12	-0.04
Body	LTE Band7	21350	2560	1RB-Low	Rear	15mm	\	20.59	21.50	0.238	0.29	0.130	0.16	-0.15
Body	LTE Band7	21350	2560	50RB-Low	Front	15mm	\	20.52	21.50	0.169	0.21	0.100	0.13	-0.16
Body	LTE Band7	21350	2560	50RB-Low	Rear	15mm	Fig.A21	20.52	21.50	0.253	0.32	0.136	0.17	-0.11
Body	LTE Band7	21350	2560	50RB-Low	Rear	15mm	SS	20.52	21.50	0.229	0.29	0.124	0.16	0.19
Body	LTE Band7	21350	2560	50RB-Low	Rear	15mm	SIM2	20.52	21.50	0.240	0.30	0.120	0.15	-0.11
Body	LTE Band7	21350	2560	50RB-Low	Rear	15mm	B2	20.52	21.50	0.248	0.31	0.128	0.16	0.12
RF Exposure Conditions	Frequency Band	Channel Number	Frequency (MHz)	Mode/RB	Test Position	Distance	Figure No./Note	EUT Measured Power (dBm)	Tune up (dBm)	Measured SAR 1g (W/kg)	Calculated SAR 1g (W/kg)	Measured SAR 10g (W/kg)	Calculated SAR 10g (W/kg)	Power Drift
Head	LTE Band12	23095	707.5	1RB-Low	Left Cheek	0mm	\	23.51	24.50	0.439	0.55	0.279	0.35	0.19
Head	LTE Band12	23095	707.5	1RB-Low	Left Tilt	0mm	\	23.51	24.50	0.356	0.45	0.213	0.27	-0.17
Head	LTE Band12	23095	707.5	1RB-Low	Right Cheek	0mm	Fig.A22	23.51	24.50	0.586	0.74	0.352	0.44	0.04
Head	LTE Band12	23095	707.5	1RB-Low	Right Tilt	0mm	\	23.51	24.50	0.566	0.71	0.289	0.36	-0.09
Head	LTE Band12	23095	707.5	25RB-Low	Left Cheek	0mm	\	22.50	23.50	0.387	0.49	0.244	0.31	0.03
Head	LTE Band12	23095	707.5	25RB-Low	Left Tilt	0mm	\	22.50	23.50	0.319	0.40	0.188	0.24	-0.11
Head	LTE Band12	23095	707.5	25RB-Low	Right Cheek	0mm	\	22.50	23.50	0.458	0.58	0.285	0.36	-0.11
Head	LTE Band12	23095	707.5	25RB-Low	Right Tilt	0mm	\	22.50	23.50	0.468	0.59	0.238	0.30	0.13
Head	LTE Band12	23095	707.5	1RB-Low	Right Cheek	0mm	SS	23.51	24.50	0.570	0.72	0.339	0.43	0.16
Head	LTE Band12	23095	707.5	1RB-Low	Right Cheek	0mm	SIM2	23.51	24.50	0.561	0.70	0.339	0.43	-0.06
Head	LTE Band12	23095	707.5	1RB-Low	Right Cheek	0mm	B2	23.51	24.50	0.571	0.72	0.340	0.43	0.12
RF Exposure Conditions	Frequency Band	Channel Number	Frequency (MHz)	Mode/RB	Test Position	Distance	Figure No./Note	EUT Measured Power (dBm)	Tune up (dBm)	Measured SAR 1g (W/kg)	Calculated SAR 1g (W/kg)	Measured SAR 10g (W/kg)	Calculated SAR 10g (W/kg)	Power Drift
Body	LTE Band12	23095	707.5	1RB-Low	Front	10mm	\	23.51	24.50	0.177	0.22	0.133	0.17	0.06
Body	LTE Band12	23095	707.5	1RB-Low	Rear	10mm	\	23.51	24.50	0.294	0.37	0.221	0.28	-0.04
Body	LTE Band12	23095	707.5	1RB-Low	Left Edge	10mm	Fig.A23	23.51	24.50	0.318	0.40	0.220	0.28	0.12
Body	LTE Band12	23095	707.5	1RB-Low	Right Edge	10mm	\	23.51	24.50	0.207	0.26	0.144	0.18	0.19
Body	LTE Band12	23095	707.5	1RB-Low	Top Edge	10mm	\	23.51	24.50	0.136	0.17	0.073	0.09	0.11
Body	LTE Band12	23095	707.5	25RB-Low	Front	10mm	\	22.50	23.50	0.144	0.18	0.109	0.14	0.18
Body	LTE Band12	23095	707.5	25RB-Low	Rear	10mm	\	22.50	23.50	0.244	0.31	0.183	0.23	0.14
Body	LTE Band12	23095	707.5	25RB-Low	Left Edge	10mm	\	22.50	23.50	0.272	0.34	0.188	0.24	0.20
Body	LTE Band12	23095	707.5	25RB-Low	Right Edge	10mm	\	22.50	23.50	0.175	0.22	0.121	0.15	-0.12
Body	LTE Band12	23095	707.5	25RB-Low	Top Edge	10mm	\	22.50	23.50	0.118	0.15	0.065	0.08	-0.05
Body	LTE Band12	23095	707.5	1RB-Low	Left Edge	10mm	SS	23.51	24.50	0.285	0.36	0.211	0.27	0.21
Body	LTE Band12	23095	707.5	1RB-Low	Left Edge	10mm	SIM2	23.51	24.50	0.290	0.36	0.209	0.26	0.12
Body	LTE Band12	23095	707.5	1RB-Low	Left Edge	10mm	B2	23.51	24.50					



RF Exposure Conditions	Frequency Band	Channel Number	Frequency (MHz)	Mode/RB	Test Position	Distance	Figure No./Note	EUT Measured Power (dBm)	Tune up (dBm)	Measured SAR 1g (W/kg)	Calculated SAR 1g (W/kg)	Measured SAR 10g (W/kg)	Calculated SAR 10g (W/kg)	Power Drift
Head	LTE Band13	23230	782	1RB-Low	Left Cheek	0mm	\	23.25	24.50	0.631	0.64	0.391	0.52	-0.01
Head	LTE Band13	23230	782	1RB-Low	Left Tilt	0mm	\	23.25	24.50	0.508	0.68	0.300	0.40	-0.11
Head	LTE Band13	23230	782	1RB-Low	Right Cheek	0mm	Fig.A24	23.25	24.50	0.703	0.94	0.425	0.57	0.07
Head	LTE Band13	23230	782	1RB-Low	Right Tilt	0mm	\	23.25	24.50	0.669	0.89	0.338	0.45	0.02
Head	LTE Band13	23230	782	25RB-Low	Left Cheek	0mm	\	22.21	23.50	0.472	0.64	0.295	0.40	0.11
Head	LTE Band13	23230	782	25RB-Low	Left Tilt	0mm	\	22.21	23.50	0.396	0.53	0.233	0.31	-0.02
Head	LTE Band13	23230	782	25RB-Low	Right Cheek	0mm	\	22.21	23.50	0.530	0.71	0.321	0.43	0.17
Head	LTE Band13	23230	782	25RB-Low	Right Tilt	0mm	\	22.21	23.50	0.507	0.68	0.258	0.35	-0.14
Head	LTE Band13	23230	782	1RB-Low	Right Cheek	0mm	SS	23.25	24.50	0.671	0.89	0.392	0.52	0.11
Head	LTE Band13	23230	782	1RB-Low	Right Cheek	0mm	SIM2	23.25	24.50	0.684	0.91	0.419	0.56	0.06
Head	LTE Band13	23230	782	1RB-Low	Right Cheek	0mm	B2	23.25	24.50	0.689	0.92	0.411	0.55	0.05
RF Exposure Conditions	Frequency Band	Channel Number	Frequency (MHz)	Mode/RB	Test Position	Distance	Figure No./Note	EUT Measured Power (dBm)	Tune up (dBm)	Measured SAR 1g (W/kg)	Calculated SAR 1g (W/kg)	Measured SAR 10g (W/kg)	Calculated SAR 10g (W/kg)	Power Drift
Body	LTE Band13	23230	782	1RB-Low	Front	10mm	\	23.25	24.50	0.184	0.25	0.121	0.16	-0.06
Body	LTE Band13	23230	782	1RB-Low	Rear	10mm	Fig.A25	23.25	24.50	0.287	0.38	0.218	0.29	0.17
Body	LTE Band13	23230	782	1RB-Low	Left Edge	10mm	\	23.25	24.50	0.259	0.35	0.183	0.24	-0.12
Body	LTE Band13	23230	782	1RB-Low	Right Edge	10mm	\	23.25	24.50	0.159	0.21	0.112	0.15	0.20
Body	LTE Band13	23230	782	1RB-Low	Top Edge	10mm	\	23.25	24.50	0.248	0.33	0.138	0.18	-0.15
Body	LTE Band13	23230	782	25RB-Low	Front	10mm	\	22.21	23.50	0.139	0.19	0.093	0.13	-0.19
Body	LTE Band13	23230	782	25RB-Low	Rear	10mm	\	22.21	23.50	0.208	0.28	0.157	0.21	-0.14
Body	LTE Band13	23230	782	25RB-Low	Left Edge	10mm	\	22.21	23.50	0.202	0.27	0.142	0.19	0.18
Body	LTE Band13	23230	782	25RB-Low	Right Edge	10mm	\	22.21	23.50	0.123	0.17	0.087	0.12	0.04
Body	LTE Band13	23230	782	25RB-Low	Top Edge	10mm	\	22.21	23.50	0.198	0.27	0.107	0.14	0.12
Body	LTE Band13	23230	782	1RB-Low	Rear	10mm	SS	23.25	24.50	0.265	0.35	0.194	0.26	0.12
Body	LTE Band13	23230	782	1RB-Low	Rear	10mm	SIM2	23.25	24.50	0.279	0.37	0.200	0.27	-0.16
Body	LTE Band13	23230	782	1RB-Low	Rear	10mm	B2	23.25	24.50	0.275	0.37	0.209	0.28	0.02
RF Exposure Conditions	Frequency Band	Channel Number	Frequency (MHz)	Mode/RB	Test Position	Distance	Figure No./Note	EUT Measured Power (dBm)	Tune up (dBm)	Measured SAR 1g (W/kg)	Calculated SAR 1g (W/kg)	Measured SAR 10g (W/kg)	Calculated SAR 10g (W/kg)	Power Drift
Head	LTE Band41	40620	2593	1RB-High	Left Cheek	0mm	Fig.A26	22.33	24.00	0.019	0.03	0.008	0.01	0.02
Head	LTE Band41	40620	2593	1RB-High	Left Tilt	0mm	\	22.33	24.00	0.005	0.01	0.002	0.00	-0.02
Head	LTE Band41	40620	2593	1RB-High	Right Cheek	0mm	\	22.33	24.00	0.010	0.01	0.005	0.01	0.03
Head	LTE Band41	40620	2593	1RB-High	Right Tilt	0mm	\	22.33	24.00	0.006	0.01	0.003	0.00	0.16
Head	LTE Band41	40620	2593	50RB-High	Left Cheek	0mm	\	22.36	23.00	0.015	0.02	0.004	0.00	0.15
Head	LTE Band41	40620	2593	50RB-High	Left Tilt	0mm	\	22.36	23.00	0.011	0.01	0.005	0.01	-0.12
Head	LTE Band41	40620	2593	50RB-High	Right Cheek	0mm	\	22.36	23.00	0.007	0.01	0.003	0.00	0.06
Head	LTE Band41	40620	2593	50RB-High	Right Tilt	0mm	\	22.36	23.00	0.006	0.01	0.003	0.00	0.02
Head	LTE Band41	40620	2593	1RB-High	Left Cheek	0mm	SS	22.33	24.00	0.015	0.02	0.008	0.01	0.02
Head	LTE Band41	40620	2593	1RB-High	Left Cheek	0mm	SIM2	22.33	24.00	0.016	0.02	0.008	0.01	-0.14
Head	LTE Band41	40620	2593	1RB-High	Left Cheek	0mm	B2	22.33	24.00	0.017	0.02	0.007	0.01	-0.02
RF Exposure Conditions	Frequency Band	Channel Number	Frequency (MHz)	Mode/RB	Test Position	Distance	Figure No./Note	EUT Measured Power (dBm)	Tune up (dBm)	Measured SAR 1g (W/kg)	Calculated SAR 1g (W/kg)	Measured SAR 10g (W/kg)	Calculated SAR 10g (W/kg)	Power Drift
Body	LTE Band41	40620	2593	1RB-High	Front	10mm	\	21.38	22.50	0.107	0.14	0.053	0.07	-0.03
Body	LTE Band41	40620	2593	1RB-High	Rear	10mm	\	21.35	22.50	0.164	0.21	0.072	0.09	-0.14
Body	LTE Band41	40620	2593	1RB-High	Left Edge	10mm	\	21.35	22.50	0.026	0.03	0.009	0.01	-0.17
Body	LTE Band41	40620	2593	1RB-High	Right Edge	10mm	\	21.35	22.50	0.069	0.09	0.034	0.04	-0.10
Body	LTE Band41	40620	2593	1RB-High	Bottom Edge	10mm	\	21.35	22.50	0.242	0.32	0.112	0.15	-0.16
Body	LTE Band41	40620	2593	50RB-High	Front	10mm	\	21.38	22.50	0.114	0.15	0.055	0.07	0.02
Body	LTE Band41	40620	2593	50RB-High	Rear	10mm	\	21.38	22.50	0.209	0.27	0.091	0.12	0.10
Body	LTE Band41	40620	2593	50RB-High	Left Edge	10mm	\	21.38	22.50	0.028	0.04	0.009	0.01	-0.15
Body	LTE Band41	40620	2593	50RB-High	Right Edge	10mm	\	21.38	22.50	0.073	0.09	0.035	0.05	0.06
Body	LTE Band41	40620	2593	50RB-High	Bottom Edge	10mm	Fig.A27	21.38	22.50	0.290	0.38	0.132	0.17	0.19
Body	LTE Band41	40620	2593	50RB-High	Bottom Edge	10mm	SS	21.38	22.50	0.280	0.36	0.120	0.16	0.14
Body	LTE Band41	40620	2593	50RB-High	Bottom Edge	10mm	SIM2	21.38	22.50	0.274	0.35	0.111	0.14	0.13
Body	LTE Band41	40620	2593	50RB-High	Bottom Edge	10mm	B2	21.38	22.50	0.290	0.38	0.132	0.17	0.19
RF Exposure Conditions	Frequency Band	Channel Number	Frequency (MHz)	Mode/RB	Test Position	Distance	Figure No./Note	EUT Measured Power (dBm)	Tune up (dBm)	Measured SAR 1g (W/kg)	Calculated SAR 1g (W/kg)	Measured SAR 10g (W/kg)	Calculated SAR 10g (W/kg)	Power Drift
Body	LTE Band41	40620	2593	1RB-High	Front	15mm	\	21.41	23.00	0.029	0.04	0.016	0.02	-0.19
Body	LTE Band41	40620	2593	1RB-High	Rear	15mm	\	21.41	23.00	0.050	0.07	0.026	0.04	-0.08
Body	LTE Band41	40620	2593	50RB-High	Front	15mm	\	21.44	23.00	0.031	0.04	0.018	0.03	0.17
Body	LTE Band41	40620	2593	50RB-High	Rear	15mm	Fig.A28	21.44	23.00	0.053	0.08	0.027	0.04	0.05
Body	LTE Band41	40620	2593	50RB-High	Rear	15mm	SS	21.44	23.00	0.046	0.07	0.023	0.03	0.02
Body	LTE Band41	40620	2593	50RB-High	Rear	15mm	SIM2	21.44	23.00	0.041	0.06	0.021	0.03	0.16
Body	LTE Band41	40620	2593	50RB-High	Rear	15mm	B2	21.44	23.00	0.050	0.07	0.024	0.03	0.14

RF Exposure Conditions	Frequency Band	Channel Number	Frequency (MHz)	Mode/RB	Test Position	Distance	Figure No./Note	EUT Measured Power (dBm)	Tune up (dBm)	Measured SAR 1g (W/kg)	Calculated SAR 1g (W/kg)	Measured SAR 10g (W/kg)	Calculated SAR 10g (W/kg)	Power Drift
Head	LTE Band66	41100	1720	1RB-Middle	Left Cheek	0mm	Fig.A29	21.93	23.00	0.098	0.13	0.062	0.08	0.13
Head	LTE Band66	41101	1720	1RB-Middle	Left Tilt	0mm	\	21.93	23.00	0.052	0.07	0.033	0.04	0.11
Head	LTE Band66	41102	1720	1RB-Middle	Right Cheek	0mm	\	21.93	23.00	0.063	0.08	0.042	0.05	0.15
Head	LTE Band66	41103	1720	1RB-Middle	Right Tilt	0mm	\	21.93	23.00	0.058	0.07	0.038	0.05	0.11
Head	LTE Band66	41104	1745	50RB-Middle	Left Cheek	0mm	\	20.91	22.00	0.079	0.10	0.051	0.07	0.15
Head	LTE Band66	41105	1745	50RB-Middle	Left Tilt	0mm	\	20.91	22.00	0.038	0.05	0.024	0.03	0.18
Head	LTE Band66	41106	1745	50RB-Middle	Right Cheek	0mm	\	20.91	22.00	0.053	0.07	0.035	0.04	-0.15
Head	LTE Band66	41107	1745	50RB-Middle	Right Tilt	0mm	\	20.91	22.00	0.045	0.06	0.029	0.04	-0.17
Head	LTE Band66	41100	1720	1RB-Middle	Left Cheek	0mm	SS	21.93	23.00	0.092	0.12	0.060	0.08	0.14
Head	LTE Band66	41100	1720	1RB-Middle	Left Cheek	0mm	SIM2	21.93	23.00	0.095	0.12	0.054	0.07	-0.01
Head	LTE Band66	41100	1720	1RB-Middle	Left Cheek	0mm	B2	21.93	23.00	0.090	0.12	0.050	0.06	-0.02
RF Exposure Conditions	Frequency Band	Channel Number	Frequency (MHz)	Mode/RB	Test Position	Distance	Figure No./Note	EUT Measured Power (dBm)	Tune up (dBm)	Measured SAR 1g (W/kg)	Calculated SAR 1g (W/kg)	Measured SAR 10g (W/kg)	Calculated SAR 10g (W/kg)	Power Drift
Body	LTE Band66	41109	1720	1RB-Middle	Front	10mm	\	20.05	21.00	0.205	0.26	0.128	0.16	0.11
Body	LTE Band66	41110	1720	1RB-Middle	Rear	10mm	\	20.05	21.00	0.372	0.46	0.218	0.27	0.15
Body	LTE Band66	41111	1720	1RB-Middle	Left Edge	10mm	\	20.05	21.00	0.050	0.06	0.031	0.04	-0.18
Body	LTE Band66	41111	1720	1RB-Middle	Right Edge	10mm	\	20.05	21.00	0.065	0.08	0.038	0.05	-0.11
Body	LTE Band66	41112	1720	1RB-Middle	Bottom Edge	10mm	\	20.05	21.00	0.307	0.38	0.176	0.22	0.17
Body	LTE Band66	41113	1745	50RB-Middle	Front	10mm	\	20.06	21.00	0.186	0.23	0.113	0.14	0.05
Body	LTE Band66	41114	1745	50RB-Middle	Rear	10mm	Fig.A30	20.06	21.00	0.386	0.48	0.228	0.28	0.12
Body	LTE Band66	41115	1745	50RB-Middle	Left Edge	10mm	\	20.06	21.00	0.049	0.06	0.031	0.04	-0.09
Body	LTE Band66	41116	1745	50RB-Middle	Right Edge	10mm	\	20.06	21.00	0.066	0.08	0.038	0.05	0.12
Body	LTE Band66	41116	1745	50RB-Middle	Bottom Edge	10mm	\	20.06	21.00	0.315	0.39	0.181	0.22	-0.13
Body	LTE Band66	41114	1745	50RB-Middle	Rear	10mm	SS	20.06	21.00	0.379	0.47	0.210	0.26	0.14
Body	LTE Band66	41114	1745	50RB-Middle	Rear	10mm	SIM2	20.06	21.00	0.377	0.47	0.209	0.26	0.04
Body	LTE Band66	41114	1745	50RB-Middle	Rear	10mm	B2	20.06	21.00	0.370	0.46	0.200	0.25	-0.04
RF Exposure Conditions	Frequency Band	Channel Number	Frequency (MHz)	Mode/RB	Test Position	Distance	Figure No./Note	EUT Measured Power (dBm)	Tune up (dBm)	Measured SAR 1g (W/kg)	Calculated SAR 1g (W/kg)	Measured SAR 10g (W/kg)	Calculated SAR 10g (W/kg)	Power Drift
Body	LTE Band66	41109	1720	1RB-Middle	Front	15mm	\	20.07	22.00	0.071	0.11	0.047	0.07	0.16
Body	LTE Band66	41110	1720	1RB-Middle	Rear	15mm	Fig.A31	20.07	22.00	0.134	0.21	0.087	0.14	0.12
Body	LTE Band66	41109	1720	50RB-Middle	Front	15mm	\	20.91	22.00	0.070	0.09	0.047	0.06	0.11
Body	LTE Band66	41110	1720	50RB-Middle	Rear	15mm	\	20.91	22.00	0.129	0.17	0.083	0.11	-0.12
Body	LTE Band66	41110	1720	1RB-Middle	Rear	15mm	SS	20.07	22.00	0.130	0.20	0.081	0.13	-0.18
Body	LTE Band66	41110	1720	1RB-Middle	Rear	15mm	SIM2	20.07	22.00	0.120	0.19	0.080	0.12	0.14
Body	LTE Band66	41110	1720	1RB-Middle	Rear	15mm	B2	20.07	22.00	0.129	0.20	0.074	0.12	0.12

## 14.2 WLAN Evaluation for 2.4G

According to the KDB248227 D01, SAR is measured for 2.4GHz 802.11b DSSS using the initial test position procedure.

Frequency Band	Channel Number	Frequency (MHz)	Test setup	Figure No./Note	EUT Measured Power (dBm)	Tune up (dBm)	Measured SAR 1g (W/kg)	Calculated SAR 1g (W/kg)	Measured SAR 10g (W/kg)	Calculated SAR 10g (W/kg)	Power Drift
WLAN 2.4G	11	2462	Left Cheek	Fig.A32	17.82	18	0.591	0.62	0.281	0.29	0.03
WLAN 2.4G	11	2462	Left Tilt	\	17.82	18	0.553	0.58	0.255	0.27	-0.06
WLAN 2.4G	1	2412	Left Cheek	\	17.78	18	0.550	0.58	0.250	0.26	0.11
WLAN 2.4G	1	2412	Left Tilt	\	17.78	18	0.527	0.55	0.233	0.25	0.14
WLAN 2.4G	11	2462	Right Cheek	\	17.82	18	0.232	0.24	0.126	0.13	-0.18
WLAN 2.4G	11	2462	Right Tilt	\	17.82	18	0.321	0.33	0.152	0.16	-0.20
WLAN 2.4G	11	2462	Left Cheek	B2	17.82	18	0.570	0.59	0.261	0.27	0.043
Frequency Band	Channel Number	Frequency (MHz)	Test setup	Figure No./Note	EUT Measured Power (dBm)	Tune up (dBm)	Measured SAR 1g (W/kg)	Calculated SAR 1g (W/kg)	Measured SAR 10g (W/kg)	Calculated SAR 10g (W/kg)	Power Drift
WLAN 2.4G	11	2462	Front 10mm	\	17.82	18	0.165	0.17	0.088	0.09	0.03
WLAN 2.4G	11	2462	Rear 10mm	Fig.A33	17.82	18	0.190	0.20	0.093	0.10	-0.13
WLAN 2.4G	11	2462	Right Edge 10mm	\	17.82	18	0.167	0.17	0.083	0.09	-0.08
WLAN 2.4G	11	2462	Top Edge 10mm	\	17.82	18	0.105	0.11	0.049	0.05	-0.04
WLAN 2.4G	11	2462	Rear 10mm	B2	17.82	18	0.174	0.18	0.091	0.09	0.018
Frequency Band	Channel Number	Frequency (MHz)	Test setup	Figure No./Note	EUT Measured Power (dBm)	Tune up (dBm)	Measured SAR 1g (W/kg)	Calculated SAR 1g (W/kg)	Measured SAR 10g (W/kg)	Calculated SAR 10g (W/kg)	Power Drift
WLAN 2.4G	11	2462	Left Cheek	Fig.A34	15.96	16	0.360	0.36	0.172	0.17	0.08
WLAN 2.4G	11	2462	Left Tilt	\	15.96	16	0.341	0.34	0.155	0.16	-0.08
WLAN 2.4G	11	2462	Right Cheek	\	15.96	16	0.154	0.16	0.083	0.08	0.19
WLAN 2.4G	11	2462	Right Tilt	\	15.96	16	0.209	0.21	0.096	0.10	-0.11
WLAN 2.4G	11	2462	Left Cheek	B2	15.96	16	0.341	0.34	0.160	0.16	0.012
Frequency Band	Channel Number	Frequency (MHz)	Test setup	Figure No./Note	EUT Measured Power (dBm)	Tune up (dBm)	Measured SAR 1g (W/kg)	Calculated SAR 1g (W/kg)	Measured SAR 10g (W/kg)	Calculated SAR 10g (W/kg)	Power Drift
WLAN 2.4G	11	2462	Front 10mm	\	15.96	16	0.102	0.10	0.055	0.06	0.02
WLAN 2.4G	11	2462	Rear 10mm	Fig.A35	15.96	16	0.116	0.12	0.057	0.06	-0.15
WLAN 2.4G	11	2462	Right Edge 10mm	\	15.96	16	0.099	0.10	0.050	0.05	0.20
WLAN 2.4G	11	2462	Top Edge 10mm	\	15.96	16	0.065	0.07	0.030	0.03	-0.15
WLAN 2.4G	11	2462	Rear 10mm	B2	15.96	16	0.102	0.10	0.050	0.05	0.02

According to the KDB248227 D01, The reported SAR must be scaled to 100% transmission duty factor to determine compliance at the maximum tune-up tolerance limit. The scaled reported SAR is presented as below.

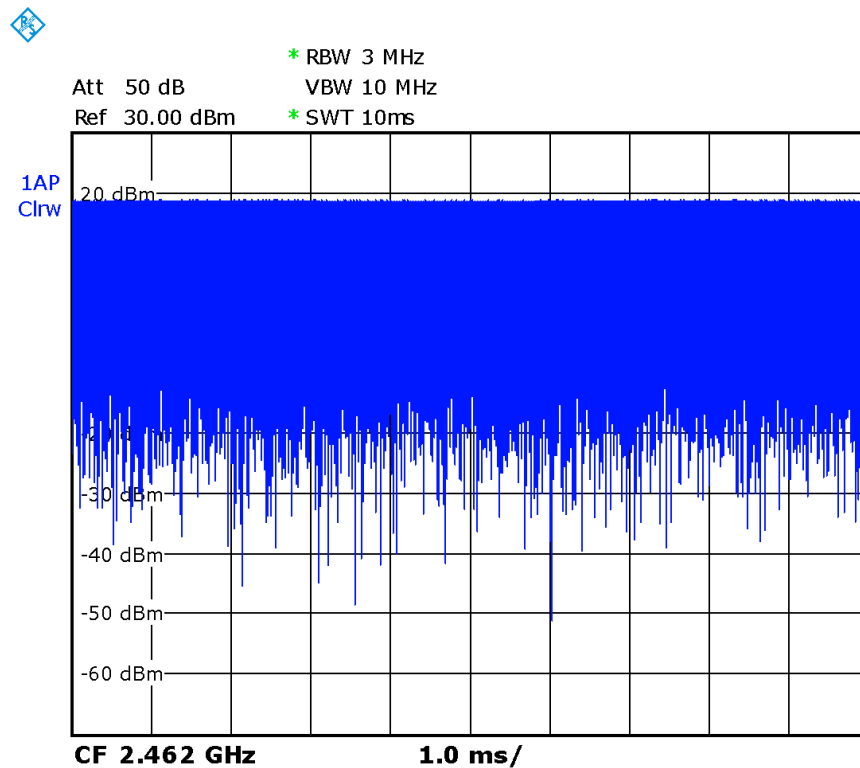

Picture 14.2-1 Duty factor plot

Table 14.2-3: SAR Values (WLAN - Head) – 802.11b (Scaled Reported SAR)

Frequency		Side	Test Position	Actual duty factor	maximum duty factor	Reported SAR (1g)(W/kg)	Scaled reported SAR (1g)(W/kg)
Ch.	MHz						
6	2437	Left	Cheek	100%	100%	<b>0.62</b>	<b>0.62</b>

SAR is not required for OFDM because the 802.11b adjusted SAR  $\leq$  1.2 W/kg.



**14.3 WLAN Evaluation For 5G**

Frequency Band	Channel Number	Frequency (MHz)	Test setup	Figure No./Note	EUT Measured Power (dBm)	Tune up (dBm)	Measured SAR 1g (W/kg)	Calculated SAR 1g (W/kg)	Measured SAR 10g (W/kg)	Calculated SAR 10g (W/kg)	Power Drift
WLAN 5G	56	5280	Left Cheek	\	15.81	17.5	0.446	0.66	0.152	0.22	-0.03
WLAN 5G	56	5280	Left Tilt	Fig.A36	15.81	17.5	0.542	0.80	0.173	0.26	0.06
WLAN 5G	60	5300	Left Cheek	\	15.74	17.5	0.412	0.62	0.146	0.22	0.11
WLAN 5G	60	5300	Left Tilt	\	15.74	17.5	0.533	0.80	0.160	0.24	0.12
WLAN 5G	64	5320	Left Tilt	\	15.67	17.5	0.477	0.73	0.154	0.23	-0.16
WLAN 5G	116	5580	Left Cheek	\	16.68	17.5	0.371	0.45	0.117	0.14	-0.16
WLAN 5G	116	5580	Left Tilt	\	16.68	17.5	0.416	0.50	0.129	0.16	0.10
WLAN 5G	124	5620	Left Cheek	\	16.68	17.5	0.360	0.43	0.109	0.13	0.11
WLAN 5G	124	5620	Left Tilt	\	16.68	17.5	0.401	0.48	0.112	0.14	0.02
WLAN 5G	116	5580	Right Cheek	\	16.68	17.5	0.151	0.18	0.050	0.06	-0.12
WLAN 5G	116	5580	Right Tilt	\	16.68	17.5	0.193	0.23	0.069	0.08	-0.17
WLAN 5G	165	5825	Left Cheek	\	17.38	17.5	0.286	0.29	0.096	0.10	-0.05
WLAN 5G	165	5825	Left Tilt	\	17.38	17.5	0.296	0.30	0.100	0.10	-0.04
WLAN 5G	165	5825	Right Cheek	\	17.38	17.5	0.152	0.16	0.067	0.07	0.07
WLAN 5G	165	5825	Right Tilt	\	17.38	17.5	0.134	0.14	0.084	0.09	-0.12
WLAN 5G	56	5280	Left Tilt	B2	15.81	17.5	0.525	0.77	0.161	0.24	0.11
Frequency Band	Channel Number	Frequency (MHz)	Test setup	Figure No./Note	EUT Measured Power (dBm)	Tune up (dBm)	Measured SAR 1g (W/kg)	Calculated SAR 1g (W/kg)	Measured SAR 10g (W/kg)	Calculated SAR 10g (W/kg)	Power Drift
WLAN 5G	56	5280	11a-6M Front 10mm	\	15.81	17.5	0.270	0.40	0.088	0.13	-0.10
WLAN 5G	56	5280	11a-6M Rear 10mm	\	15.81	17.5	0.525	0.77	0.206	0.30	-0.06
WLAN 5G	56	5280	11a-6M Right Edge 10mm	\	15.81	17.5	0.551	0.81	0.193	0.28	-0.12
WLAN 5G	56	5280	11a-6M Right Edge 10mm	\	15.81	17.5	0.551	0.81	0.193	0.28	-0.12
WLAN 5G	60	5300	11a-6M Right Edge 10mm	\	15.74	17.5	0.520	0.78	0.184	0.28	0.19
WLAN 5G	56	5280	11a-6M Top Edge 10mm	\	15.81	17.5	0.371	0.55	0.142	0.21	-0.06
WLAN 5G	116	5580	11a-6M Front 10mm	\	16.68	17.5	0.222	0.27	0.077	0.09	0.10
WLAN 5G	116	5580	11a-6M Rear 10mm	Fig.A37	16.68	17.5	0.681	0.82	0.225	0.27	-0.06
WLAN 5G	124	5620	11a-6M Rear 10mm	\	16.68	17.5	0.656	0.79	0.201	0.24	0.11
WLAN 5G	116	5580	11a-6M Right Edge 10mm	\	16.68	17.5	0.404	0.49	0.149	0.18	0.04
WLAN 5G	116	5580	11a-6M Top Edge 10mm	\	16.68	17.5	0.393	0.47	0.138	0.17	-0.03
WLAN 5G	165	5825	11a-6M Front 10mm	\	17.38	17.5	0.184	0.19	0.068	0.07	0.10
WLAN 5G	165	5825	11a-6M Rear 10mm	\	17.38	17.5	0.430	0.44	0.149	0.15	0.15
WLAN 5G	165	5825	11a-6M Right Edge 10mm	\	17.38	17.5	0.271	0.28	0.105	0.11	-0.13
WLAN 5G	165	5825	11a-6M Top Edge 10mm	\	17.38	17.5	0.208	0.21	0.068	0.07	0.10
WLAN 5G	116	5580	11a-6M Rear 10mm	B2	16.68	17.5	0.661	0.80	0.201	0.24	0.09
Frequency Band	Channel Number	Frequency (MHz)	Test setup	Figure No./Note	EUT Measured Power (dBm)	Tune up (dBm)	Measured SAR 1g (W/kg)	Calculated SAR 1g (W/kg)	Measured SAR 10g (W/kg)	Calculated SAR 10g (W/kg)	Power Drift
WLAN 5G	56	5280	Left Cheek	\	14.15	16	0.311	0.48	0.095	0.15	0.03
WLAN 5G	56	5280	Left Tilt	Fig.A38	14.15	16	0.350	0.54	0.107	0.16	-0.01
WLAN 5G	64	5320	Left Cheek	\	14.08	16	0.301	0.47	0.085	0.13	0.02
WLAN 5G	64	5320	Left Tilt	\	14.08	16	0.339	0.53	0.094	0.15	0.11
WLAN 5G	56	5280	Right Cheek	\	14.15	16	0.116	0.18	0.037	0.06	-0.04
WLAN 5G	56	5280	Right Tilt	\	14.15	16	0.144	0.22	0.045	0.07	-0.01
WLAN 5G	140	5700	Left Cheek	\	14.93	16	0.180	0.23	0.058	0.07	0.16
WLAN 5G	140	5700	Left Tilt	\	14.93	16	0.197	0.25	0.063	0.08	-0.05
WLAN 5G	140	5700	Right Cheek	\	14.93	16	0.100	0.13	0.031	0.04	0.15
WLAN 5G	140	5700	Right Tilt	\	14.93	16	0.116	0.15	0.034	0.04	0.02
WLAN 5G	157	5785	Left Cheek	\	15.92	16	0.200	0.20	0.067	0.07	0.19
WLAN 5G	157	5785	Left Tilt	\	15.92	16	0.220	0.22	0.068	0.07	0.19
WLAN 5G	157	5785	Right Cheek	\	15.92	16	0.105	0.11	0.031	0.03	-0.10
WLAN 5G	157	5785	Right Tilt	\	15.92	16	0.105	0.11	0.032	0.03	0.11
WLAN 5G	56	5280	Left Tilt	B2	14.15	16	0.331	0.51	0.094	0.14	0.13
Frequency Band	Channel Number	Frequency (MHz)	Test setup	Figure No./Note	EUT Measured Power (dBm)	Tune up (dBm)	Measured SAR 1g (W/kg)	Calculated SAR 1g (W/kg)	Measured SAR 10g (W/kg)	Calculated SAR 10g (W/kg)	Power Drift
WLAN 5G	56	5280	11a-6M Front 10mm	\	14.15	16	0.138	0.21	0.043	0.07	-0.07
WLAN 5G	56	5280	11a-6M Rear 10mm	Fig.A39	14.15	16	0.348	0.53	0.116	0.18	-0.04
WLAN 5G	64	5320	11a-6M Rear 10mm	\	14.15	16	0.330	0.51	0.102	0.16	0.14
WLAN 5G	56	5280	11a-6M Right Edge 10mm	\	14.15	16	0.256	0.39	0.092	0.14	0.10
WLAN 5G	56	5280	11a-6M Top Edge 10mm	\	14.15	16	0.251	0.38	0.088	0.13	0.16
WLAN 5G	140	5700	11a-6M Front 10mm	\	14.93	16	0.144	0.18	0.052	0.07	-0.06
WLAN 5G	140	5700	11a-6M Rear 10mm	\	14.93	16	0.315	0.40	0.102	0.13	-0.09
WLAN 5G	140	5700	11a-6M Right Edge 10mm	\	14.93	16	0.185	0.24	0.067	0.09	0.07
WLAN 5G	140	5700	11a-6M Top Edge 10mm	\	14.93	16	0.154	0.20	0.053	0.07	0.08
WLAN 5G	157	5785	11a-6M Front 10mm	\	15.92	16	0.111	0.11	0.038	0.04	-0.14
WLAN 5G	157	5785	11a-6M Rear 10mm	\	15.92	16	0.264	0.27	0.086	0.09	-0.17
WLAN 5G	157	5785	11a-6M Right Edge 10mm	\	15.92	16	0.257	0.26	0.089	0.09	0.11
WLAN 5G	157	5785	11a-6M Top Edge 10mm	\	15.92	16	0.130	0.13	0.047	0.05	-0.03
WLAN 5G	56	5280	11a-6M Rear 10mm	B2	14.15	16	0.331	0.51	0.102	0.16	0.12

According to the KDB248227 D01, The reported SAR must be scaled to 100% transmission duty factor to determine compliance at the maximum tune-up tolerance limit. The scaled reported SAR is presented as below.

**Table 14.3-14: SAR Values (WLAN 5G - Head) (Scaled Reported SAR)**

Frequency		Side	Test Position	Actual duty factor	maximum duty factor	Reported SAR (1g) (W/kg)	Scaled reported SAR (1g) (W/kg)
Ch.	MHz						
56	5280	Left	Tilt	100%	100%	<b>0.80</b>	<b>0.80</b>

**Table 14.3-15: SAR Values (WLAN 5G - Body) (Scaled Reported SAR)**

Frequency		Test Position	Distance (mm)	Actual duty factor	maximum duty factor	Reported SAR (1g) (W/kg)	Scaled reported SAR (1g) (W/kg)
Ch.	MHz						
116	5580	Rear	10	100%	100%	<b>0.82</b>	<b>0.82</b>

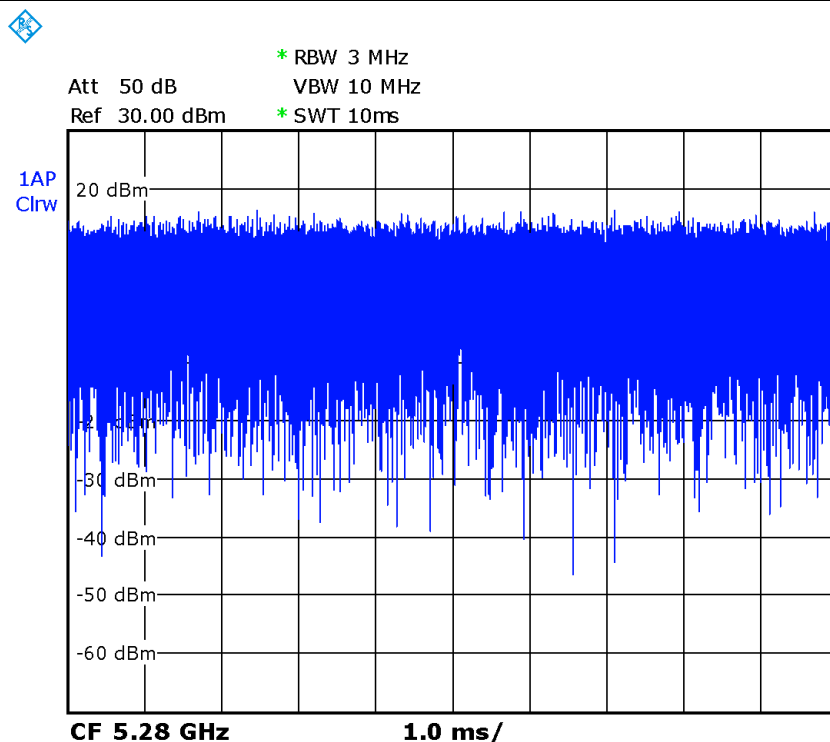

**Picture 14.3-1 The plot of duty factor for CH56**

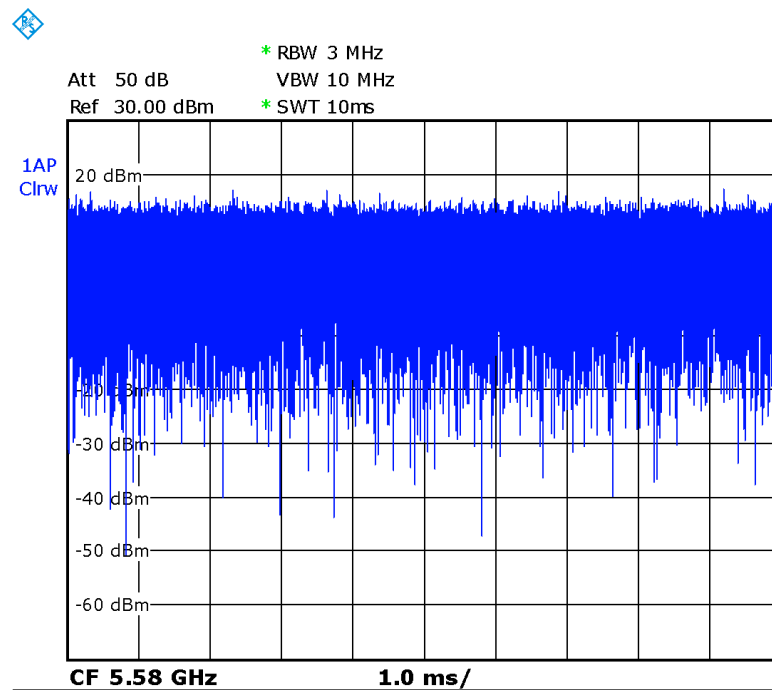

Picture 14.3-2 The plot of duty factor for CH116

### 14.4 SAR results for BT

**Table 14.4-1: SAR Values (BT - Head)**

Frequency		Side	Test Position	Conducted Power (dBm)	Max. tune-up Power (dBm)	Measured SAR(10g) (W/kg)	Reported SAR(10g) (W/kg)	Measured SAR(1g) (W/kg)	Reported SAR(1g)(W/kg)	Power Drift (dB)
Ch.	MHz									
78	2480	Left	Cheek	8.54	9.5	<0.01	<0.01	<0.01	<0.01	/
78	2480	Left	Tilt	8.54	9.5	<0.01	<0.01	<0.01	<0.01	/
78	2480	Right	Cheek	8.54	9.5	<0.01	<0.01	<0.01	<0.01	/
78	2480	Right	Tilt	8.54	9.5	<0.01	<0.01	<0.01	<0.01	/

**Table 14.4-2: SAR Values (BT - Body)**

Frequency		Test Position	Conducted Power (dBm)	Max. tune-up Power (dBm)	Measured SAR(10g) (W/kg)	Reported SAR(10g) (W/kg)	Measured SAR(1g) (W/kg)	Reported SAR(1g)(W/kg)	Power Drift (dB)
Ch.	MHz								
78	2441	Front	8.54	9.5	<0.01	<0.01	<0.01	<0.01	/
78	2441	Rear	8.54	9.5	<0.01	<0.01	<0.01	<0.01	/
78	2441	Right	8.54	9.5	<0.01	<0.01	<0.01	<0.01	/
78	2441	Top	8.54	9.5	<0.01	<0.01	<0.01	<0.01	/

Note1: The distance between the EUT and the phantom bottom is 10mm.

## 15 SAR Measurement Variability

SAR measurement variability must be assessed for each frequency band, which is determined by the SAR probe calibration point and tissue-equivalent medium used for the device measurements. When both head and body tissue-equivalent media are required for SAR measurements in a frequency band, the variability measurement procedures should be applied to the tissue medium with the highest measured SAR, using the highest measured SAR configuration for that tissue-equivalent medium.

The following procedures are applied to determine if repeated measurements are required.

- 1) Repeated measurement is not required when the original highest measured SAR is  $< 0.80$  W/kg; steps 2) through 4) do not apply.
- 2) When the original highest measured SAR is  $\geq 0.80$  W/kg, repeat that measurement once.
- 3) Perform a second repeated measurement only if the ratio of largest to smallest SAR for the original and first repeated measurements is  $> 1.20$  or when the original or repeated measurement is  $\geq 1.45$  W/kg ( $\sim 10\%$  from the 1-g SAR limit).
- 4) Perform a third repeated measurement only if the original, first or second repeated measurement is  $\geq 1.5$  W/kg and the ratio of largest to smallest SAR for the original, first and second repeated measurements is  $> 1.20$

## 16 Measurement Uncertainty

### 16.1 Measurement Uncertainty for Normal SAR Tests (300MHz~3GHz)

No.	Error Description	Type	Uncertainty value	Probably Distribution	Div.	(Ci) 1g	(Ci) 10g	Std. Unc. (1g)	Std. Unc. (10g)	Degree of freedom
<b>Measurement system</b>										
1	Probe calibration	B	6.0	N	1	1	1	6.0	6.0	$\infty$
2	Isotropy	B	4.7	R	$\sqrt{3}$	0.7	0.7	1.9	1.9	$\infty$
3	Boundary effect	B	1.0	R	$\sqrt{3}$	1	1	0.6	0.6	$\infty$
4	Linearity	B	4.7	R	$\sqrt{3}$	1	1	2.7	2.7	$\infty$
5	Detection limit	B	1.0	N	1	1	1	0.6	0.6	$\infty$
6	Readout electronics	B	0.3	R	$\sqrt{3}$	1	1	0.3	0.3	$\infty$
7	Response time	B	0.8	R	$\sqrt{3}$	1	1	0.5	0.5	$\infty$
8	Integration time	B	2.6	R	$\sqrt{3}$	1	1	1.5	1.5	$\infty$
9	RF ambient conditions-noise	B	0	R	$\sqrt{3}$	1	1	0	0	$\infty$
10	RFambient conditions-reflection	B	0	R	$\sqrt{3}$	1	1	0	0	$\infty$
11	Probe positioned mech. restrictions	B	0.4	R	$\sqrt{3}$	1	1	0.2	0.2	$\infty$
12	Probe positioning with respect to phantom shell	B	2.9	R	$\sqrt{3}$	1	1	1.7	1.7	$\infty$
13	Post-processing	B	1.0	R	$\sqrt{3}$	1	1	0.6	0.6	$\infty$
<b>Test sample related</b>										
14	Test sample positioning	A	3.3	N	1	1	1	3.3	3.3	71
15	Device holder uncertainty	A	3.4	N	1	1	1	3.4	3.4	5
16	Drift of output power	B	5.0	R	$\sqrt{3}$	1	1	2.9	2.9	$\infty$
<b>Phantom and set-up</b>										
17	Phantom uncertainty	B	4.0	R	$\sqrt{3}$	1	1	2.3	2.3	$\infty$
18	Liquid conductivity (target)	B	5.0	R	$\sqrt{3}$	0.64	0.43	1.8	1.2	$\infty$
19	Liquid conductivity (meas.)	A	2.06	N	1	0.64	0.43	1.32	0.89	43
20	Liquid permittivity (target)	B	5.0	R	$\sqrt{3}$	0.6	0.49	1.7	1.4	$\infty$
21	Liquid permittivity (meas.)	A	1.6	N	1	0.6	0.49	1.0	0.8	521

Combined standard uncertainty	$u_c = \sqrt{\sum_{i=1}^{21} c_i^2 u_i^2}$							9.55	9.43	257
Expanded uncertainty (confidence interval of 95 %)	$u_e = 2u_c$							19.1	18.9	

**16.2 Measurement Uncertainty for Normal SAR Tests (3~6GHz)**

No.	Error Description	Type	Uncertainty value	Probably Distribution	Div.	(Ci) 1g	(Ci) 10g	Std. Unc. (1g)	Std. Unc. (10g)	Degree of freedom
<b>Measurement system</b>										
1	Probe calibration	B	6.55	N	1	1	1	6.55	6.55	$\infty$
2	Isotropy	B	4.7	R	$\sqrt{3}$	0.7	0.7	1.9	1.9	$\infty$
3	Boundary effect	B	2.0	R	$\sqrt{3}$	1	1	1.2	1.2	$\infty$
4	Linearity	B	4.7	R	$\sqrt{3}$	1	1	2.7	2.7	$\infty$
5	Detection limit	B	1.0	R	$\sqrt{3}$	1	1	0.6	0.6	$\infty$
6	Readout electronics	B	0.3	R	$\sqrt{3}$	1	1	0.3	0.3	$\infty$
7	Response time	B	0.8	R	$\sqrt{3}$	1	1	0.5	0.5	$\infty$
8	Integration time	B	2.6	R	$\sqrt{3}$	1	1	1.5	1.5	$\infty$
9	RF ambient conditions-noise	B	0	R	$\sqrt{3}$	1	1	0	0	$\infty$
10	RFambient conditions-reflection	B	0	R	$\sqrt{3}$	1	1	0	0	$\infty$
11	Probe positioned mech. restrictions	B	0.8	R	$\sqrt{3}$	1	1	0.5	0.5	$\infty$
12	Probe positioning with respect to phantom shell	B	6.7	R	$\sqrt{3}$	1	1	3.9	3.9	$\infty$
13	Post-processing	B	4.0	R	$\sqrt{3}$	1	1	2.3	2.3	$\infty$
<b>Test sample related</b>										
14	Test sample positioning	A	3.3	N	1	1	1	3.3	3.3	71
15	Device holder uncertainty	A	3.4	N	1	1	1	3.4	3.4	5
16	Drift of output power	B	5.0	R	$\sqrt{3}$	1	1	2.9	2.9	$\infty$
<b>Phantom and set-up</b>										
17	Phantom uncertainty	B	4.0	R	$\sqrt{3}$	1	1	2.3	2.3	$\infty$
18	Liquid conductivity (target)	B	5.0	R	$\sqrt{3}$	0.64	0.43	1.8	1.2	$\infty$
19	Liquid conductivity (meas.)	A	2.06	N	1	0.64	0.43	1.32	0.89	43
20	Liquid permittivity (target)	B	5.0	R	$\sqrt{3}$	0.6	0.49	1.7	1.4	$\infty$

21	Liquid permittivity (meas.)	A	1.6	N	1	0.6	0.49	1.0	0.8	521
Combined standard uncertainty		$u_c = \sqrt{\sum_{i=1}^{21} c_i^2 u_i^2}$						10.7	10.6	257
Expanded uncertainty (confidence interval of 95 %)		$u_e = 2u_c$						21.4	21.1	

### 16.3 Measurement Uncertainty for Fast SAR Tests (300MHz~3GHz)

No.	Error Description	Type	Uncertainty value	Probably Distribution	Div.	(Ci) 1g	(Ci) 10g	Std. Unc. (1g)	Std. Unc. (10g)	Degree of freedom
<b>Measurement system</b>										
1	Probe calibration	B	6.0	N	1	1	1	6.0	6.0	∞
2	Isotropy	B	4.7	R	$\sqrt{3}$	0.7	0.7	1.9	1.9	∞
3	Boundary effect	B	1.0	R	$\sqrt{3}$	1	1	0.6	0.6	∞
4	Linearity	B	4.7	R	$\sqrt{3}$	1	1	2.7	2.7	∞
5	Detection limit	B	1.0	R	$\sqrt{3}$	1	1	0.6	0.6	∞
6	Readout electronics	B	0.3	R	$\sqrt{3}$	1	1	0.3	0.3	∞
7	Response time	B	0.8	R	$\sqrt{3}$	1	1	0.5	0.5	∞
8	Integration time	B	2.6	R	$\sqrt{3}$	1	1	1.5	1.5	∞
9	RF ambient conditions-noise	B	0	R	$\sqrt{3}$	1	1	0	0	∞
10	RFambient conditions-reflection	B	0	R	$\sqrt{3}$	1	1	0	0	∞
11	Probe positioned mech. Restrictions	B	0.4	R	$\sqrt{3}$	1	1	0.2	0.2	∞
12	Probe positioning with respect to phantom shell	B	2.9	R	$\sqrt{3}$	1	1	1.7	1.7	∞
13	Post-processing	B	1.0	R	$\sqrt{3}$	1	1	0.6	0.6	∞
14	Fast SAR z-Approximation	B	7.0	R	$\sqrt{3}$	1	1	4.0	4.0	∞
<b>Test sample related</b>										
15	Test sample positioning	A	3.3	N	1	1	1	3.3	3.3	71
16	Device holder uncertainty	A	3.4	N	1	1	1	3.4	3.4	5
17	Drift of output power	B	5.0	R	$\sqrt{3}$	1	1	2.9	2.9	∞
<b>Phantom and set-up</b>										
18	Phantom uncertainty	B	4.0	R	$\sqrt{3}$	1	1	2.3	2.3	∞
19	Liquid conductivity (target)	B	5.0	R	$\sqrt{3}$	0.64	0.43	1.8	1.2	∞



20	Liquid conductivity (meas.)	A	2.06	N	1	0.64	0.43	1.32	0.89	43
21	Liquid permittivity (target)	B	5.0	R	$\sqrt{3}$	0.6	0.49	1.7	1.4	$\infty$
22	Liquid permittivity (meas.)	A	1.6	N	1	0.6	0.49	1.0	0.8	521
Combined standard uncertainty		$u_c = \sqrt{\sum_{i=1}^{22} c_i^2 u_i^2}$						10.4	10.3	257
Expanded uncertainty (confidence interval of 95 %)		$u_e = 2u_c$						20.8	20.6	

#### 16.4 Measurement Uncertainty for Fast SAR Tests (3~6GHz)

No.	Error Description	Type	Uncertainty value	Probably Distribution	Div.	(Ci) 1g	(Ci) 10g	Std. Unc. (1g)	Std. Unc. (10g)	Degree of freedom
<b>Measurement system</b>										
1	Probe calibration	B	6.55	N	1	1	1	6.55	6.55	$\infty$
2	Isotropy	B	4.7	R	$\sqrt{3}$	0.7	0.7	1.9	1.9	$\infty$
3	Boundary effect	B	2.0	R	$\sqrt{3}$	1	1	1.2	1.2	$\infty$
4	Linearity	B	4.7	R	$\sqrt{3}$	1	1	2.7	2.7	$\infty$
5	Detection limit	B	1.0	R	$\sqrt{3}$	1	1	0.6	0.6	$\infty$
6	Readout electronics	B	0.3	R	$\sqrt{3}$	1	1	0.3	0.3	$\infty$
7	Response time	B	0.8	R	$\sqrt{3}$	1	1	0.5	0.5	$\infty$
8	Integration time	B	2.6	R	$\sqrt{3}$	1	1	1.5	1.5	$\infty$
9	RF ambient conditions-noise	B	0	R	$\sqrt{3}$	1	1	0	0	$\infty$
10	RFambient conditions-reflection	B	0	R	$\sqrt{3}$	1	1	0	0	$\infty$
11	Probe positioned mech. Restrictions	B	0.8	R	$\sqrt{3}$	1	1	0.5	0.5	$\infty$
12	Probe positioning with respect to phantom shell	B	6.7	R	$\sqrt{3}$	1	1	3.9	3.9	$\infty$
13	Post-processing	B	1.0	R	$\sqrt{3}$	1	1	0.6	0.6	$\infty$
14	Fast SAR z-Approximation	B	14.0	R	$\sqrt{3}$	1	1	8.1	8.1	$\infty$
<b>Test sample related</b>										
15	Test sample positioning	A	3.3	N	1	1	1	3.3	3.3	71
16	Device holder uncertainty	A	3.4	N	1	1	1	3.4	3.4	5

17	Drift of output power	B	5.0	R	$\sqrt{3}$	1	1	2.9	2.9	$\infty$	
<b>Phantom and set-up</b>											
18	Phantom uncertainty	B	4.0	R	$\sqrt{3}$	1	1	2.3	2.3	$\infty$	
19	Liquid conductivity (target)	B	5.0	R	$\sqrt{3}$	0.64	0.43	1.8	1.2	$\infty$	
20	Liquid conductivity (meas.)	A	2.06	N	1	0.64	0.43	1.32	0.89	43	
21	Liquid permittivity (target)	B	5.0	R	$\sqrt{3}$	0.6	0.49	1.7	1.4	$\infty$	
22	Liquid permittivity (meas.)	A	1.6	N	1	0.6	0.49	1.0	0.8	521	
Combined standard uncertainty		$u_c = \sqrt{\sum_{i=1}^{22} c_i^2 u_i^2}$							13.5	13.4	257
Expanded uncertainty (confidence interval of 95 %)		$u_e = 2u_c$							27.0	26.8	

## 17 MAIN TEST INSTRUMENTS

**Table 17.1: List of Main Instruments**

No.	Name	Type	Serial Number	Calibration Date	Valid Period
01	Network analyzer	E5071C	MY46110673	January 10, 2023	One year
02	Power sensor	NRP110T	101139	January 13, 2023	One year
03	Power sensor	NRP110T	101159	January 13, 2023	One year
04	Signal Generator	E4438C	MY49071430	January 19, 2023	One year
05	Amplifier	60S1G4	0331848	No Calibration Requested	
06	BTS	CMW500	159890	January 12, 2023	One year
07	E-field Probe	SPEAG EX3DV4	3846	May 31, 2023	One year
08	DAE	SPEAG DAE4	549	January 23, 2023	One year
09	Dipole Validation Kit	SPEAG D750V3	1196	May 24,,2023	One year
10	Dipole Validation Kit	SPEAG D835V2	4d260	May 23,,2023	One year
11	Dipole Validation Kit	SPEAG D1800V2	2d222	May 23,,2023	One year
12	Dipole Validation Kit	SPEAG D1900V2	5d234	May 22,,2023	One year
13	Dipole Validation Kit	SPEAG D2450V2	853	July 20,2022	One year
14	Dipole Validation Kit	SPEAG D2600V2	1012	July 20,2022	One year
15	Dipole Validation Kit	SPEAG D5GHzV2	1060	June 19,2023	One year

\*\*\*END OF REPORT BODY\*\*\*

## ANNEX A Graph Results

### GSM850\_CH251 Left Cheek 2TX

Date: 7/24/2023

Electronics: DAE4 Sn549

Medium: head 835 MHz

Medium parameters used:  $f = 848.8$ ;  $\sigma = 0.897$  mho/m;  $\epsilon_r = 41.43$ ;  $\rho = 1000$  kg/m<sup>3</sup>

Ambient Temperature: 22.5°C, Liquid Temperature: 22.3°C

Communication System: GSM850 848.8 Duty Cycle: 1:4

Probe: EX3DV4 – SN3846 ConvF(8.50,9.01,9.47)

**Area Scan (71x121x1):** Interpolated grid: dx=1.500 mm, dy=1.500 mm  
Maximum value of SAR (interpolated) = 0.145 W/kg

**Zoom Scan (7x7x7)/Cube 0:** Measurement grid: dx=8mm, dy=8mm, dz=5mm  
Reference Value = 2.381 V/m; Power Drift = 0.23 dB  
Peak SAR (extrapolated) = 0.16 W/kg  
**SAR(1 g) = 0.129 W/kg; SAR(10 g) = 0.099 W/kg**  
Maximum value of SAR (measured) = 0.152 W/kg

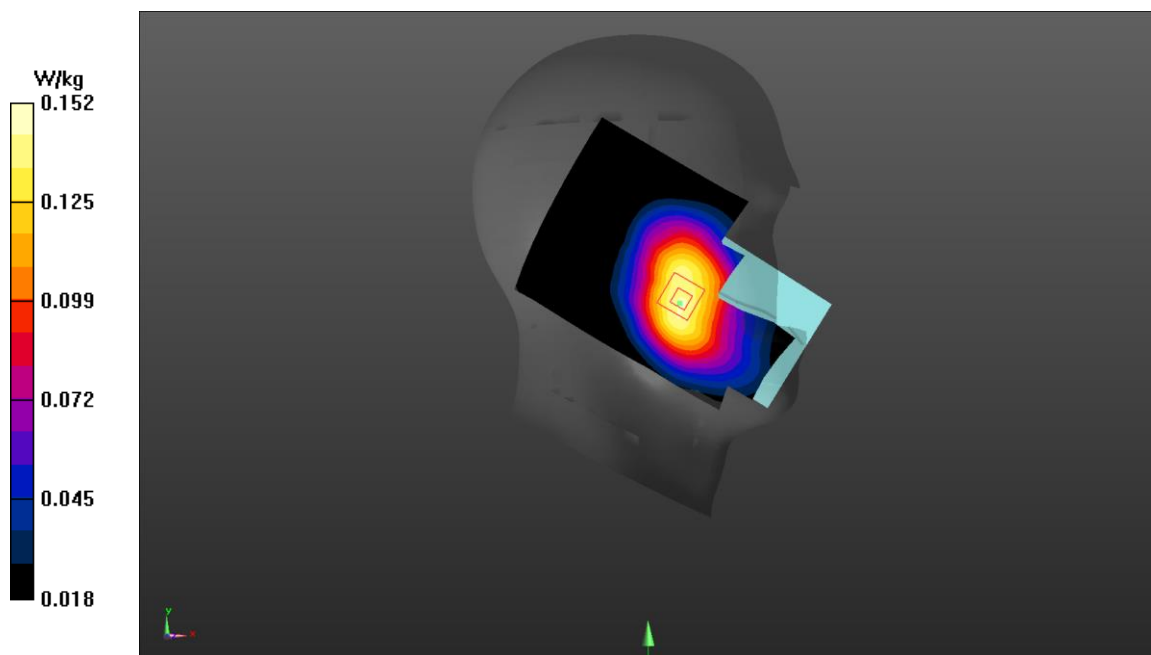

Fig A.1

**GSM850\_CH251 Rear 2TX 10mm**

Date: 7/24/2023

Electronics: DAE4 Sn549

Medium: body 835 MHz

Medium parameters used:  $f = 848.8$ ;  $\sigma = 0.897$  mho/m;  $\epsilon_r = 41.43$ ;  $\rho = 1000$  kg/m<sup>3</sup>

Ambient Temperature: 22.5°C, Liquid Temperature: 22.3°C

Communication System: GSM850 848.8 Duty Cycle: 1:4

Probe: EX3DV4 – SN3846 ConvF(8.50,9.01,9.47)

**Area Scan (71x121x1):** Interpolated grid: dx=1.500 mm, dy=1.500 mm

Maximum value of SAR (interpolated) = 0.1 W/kg

**Zoom Scan (7x7x7)/Cube 0:** Measurement grid: dx=8mm, dy=8mm, dz=5mm

Reference Value = 10.09 V/m; Power Drift = 0.01 dB

Peak SAR (extrapolated) = 0.146 W/kg

**SAR(1 g) = 0.09 W/kg; SAR(10 g) = 0.056 W/kg**

Maximum value of SAR (measured) = 0.0973 W/kg

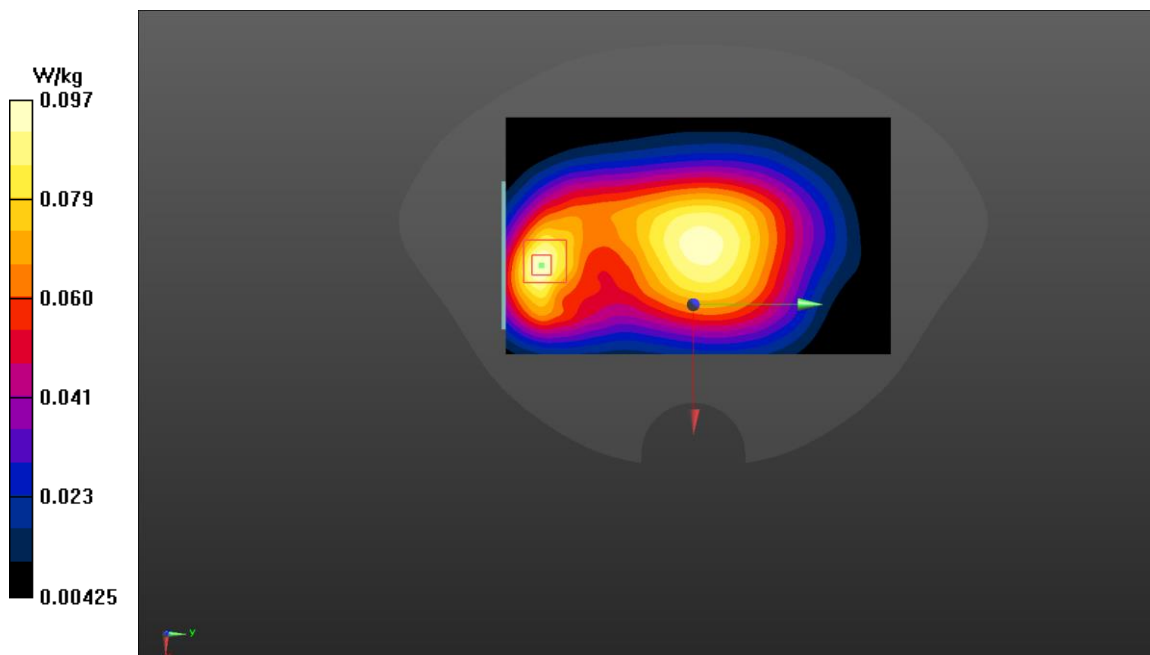

**Fig A.2**

**PCS1900\_CH810 Right Tilt 2TX**

Date: 7/26/2023

Electronics: DAE4 Sn549

Medium: head 1900 MHz

Medium parameters used:  $f = 1909.8$ ;  $\sigma = 1.392$  mho/m;  $\epsilon_r = 39.32$ ;  $\rho = 1000$  kg/m<sup>3</sup>

Ambient Temperature: 22.5°C, Liquid Temperature: 22.3°C

Communication System: PCS1900 1909.8 Duty Cycle: 1:4

Probe: EX3DV4 – SN3846 ConvF(7.27,7.55,8.11)

**Area Scan (71x121x1):** Interpolated grid: dx=1.500 mm, dy=1.500 mm

Maximum value of SAR (interpolated) = 0.187 W/kg

**Zoom Scan (7x7x7)/Cube 0:** Measurement grid: dx=8mm, dy=8mm, dz=5mm

Reference Value = 5.754 V/m; Power Drift = -0.05 dB

Peak SAR (extrapolated) = 0.2 W/kg

**SAR(1 g) = 0.136 W/kg; SAR(10 g) = 0.084 W/kg**

Maximum value of SAR (measured) = 0.145 W/kg

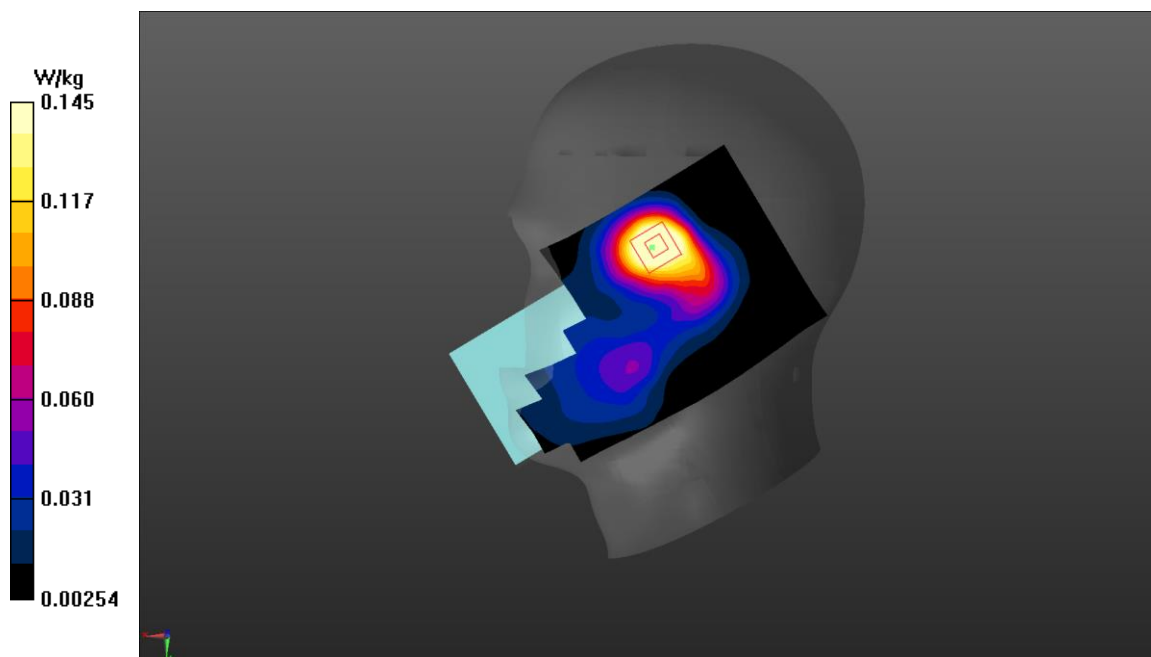
**Fig A.3**

**PCS1900\_CH661 Rear 2TX 10mm**

Date: 7/26/2023

Electronics: DAE4 Sn549

Medium: body 1900 MHz

Medium parameters used:  $f = 1880$ ;  $\sigma = 1.363$  mho/m;  $\epsilon_r = 39.35$ ;  $\rho = 1000$  kg/m<sup>3</sup>

Ambient Temperature: 22.5°C, Liquid Temperature: 22.3°C

Communication System: PCS1900 1880 Duty Cycle: 1:4

Probe: EX3DV4 – SN3846 ConvF(7.27,7.55,8.11)

**Area Scan (71x121x1):** Interpolated grid: dx=1.500 mm, dy=1.500 mm

Maximum value of SAR (interpolated) = 0.249 W/kg

**Zoom Scan (7x7x7)/Cube 0:** Measurement grid: dx=8mm, dy=8mm, dz=5mm

Reference Value = 6.605 V/m; Power Drift = -0.21 dB

Peak SAR (extrapolated) = 0.375 W/kg

**SAR(1 g) = 0.227 W/kg; SAR(10 g) = 0.134 W/kg**

Maximum value of SAR (measured) = 0.242 W/kg

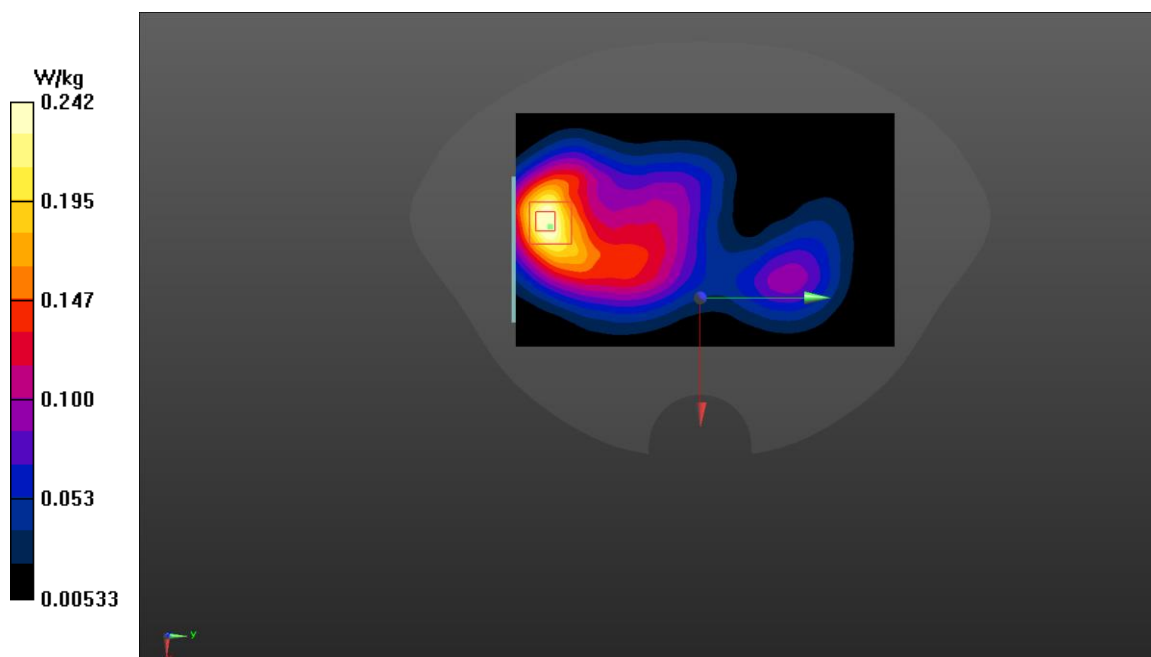
**Fig A.4**

**PCS1900\_CH661 Rear 2TX 15mm**

Date: 7/26/2023

Electronics: DAE4 Sn549

Medium: body 1900 MHz

Medium parameters used:  $f = 1880$ ;  $\sigma = 1.363$  mho/m;  $\epsilon_r = 39.35$ ;  $\rho = 1000$  kg/m<sup>3</sup>

Ambient Temperature: 22.5°C, Liquid Temperature: 22.3°C

Communication System: PCS1900 1880 Duty Cycle: 1:4

Probe: EX3DV4 – SN3846 ConvF(7.27,7.55,8.11)

**Area Scan (71x121x1):** Interpolated grid: dx=1.500 mm, dy=1.500 mm

Maximum value of SAR (interpolated) = 0.147 W/kg

**Zoom Scan (7x7x7)/Cube 0:** Measurement grid: dx=8mm, dy=8mm, dz=5mm

Reference Value = 6.162 V/m; Power Drift = 0.19 dB

Peak SAR (extrapolated) = 0.223 W/kg

**SAR(1 g) = 0.139 W/kg; SAR(10 g) = 0.085 W/kg**

Maximum value of SAR (measured) = 0.147 W/kg

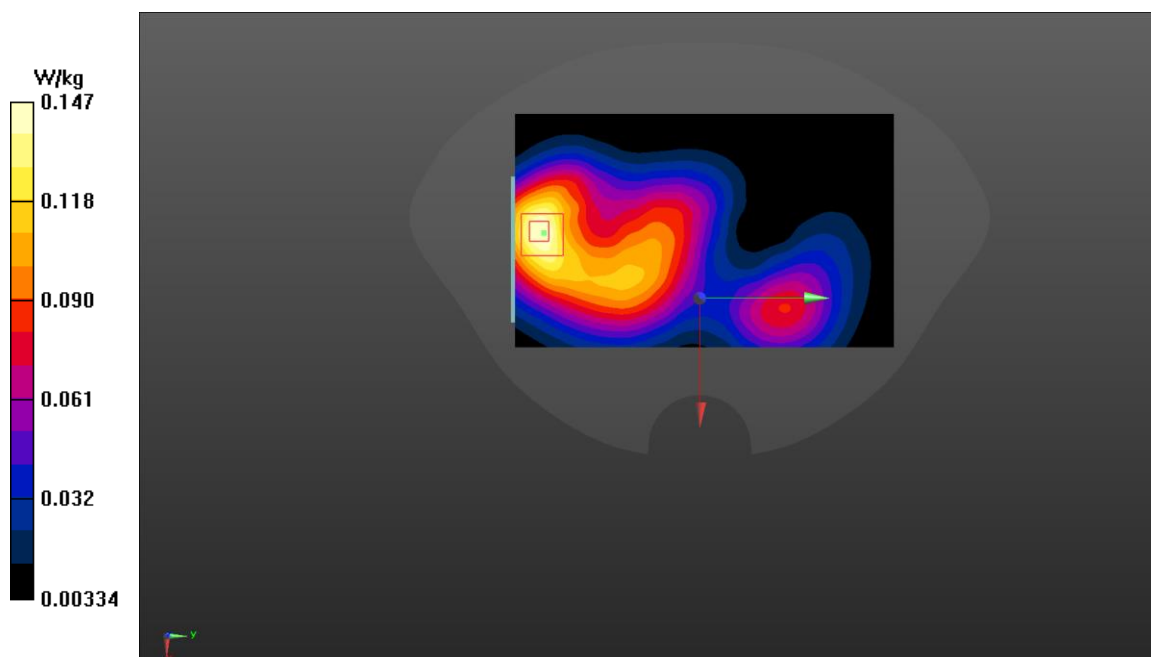

Fig A.5



**WCDMA1900-BII\_CH9538 Right Cheek**

Date: 7/26/2023

Electronics: DAE4 Sn549

Medium: head 1900 MHz

Medium parameters used:  $f = 1907.6$ ;  $\sigma = 1.39$  mho/m;  $\epsilon_r = 39.32$ ;  $\rho = 1000$  kg/m<sup>3</sup>

Ambient Temperature: 22.5°C, Liquid Temperature: 22.3°C

Communication System: WCDMA1900-BII 1907.6 Duty Cycle: 1:1

Probe: EX3DV4 – SN3846 ConvF(7.27,7.55,8.11)

**Area Scan (71x121x1):** Interpolated grid: dx=1.500 mm, dy=1.500 mm

Maximum value of SAR (interpolated) = 0.213 W/kg

**Zoom Scan (7x7x7)/Cube 0:** Measurement grid: dx=8mm, dy=8mm, dz=5mm

Reference Value = 3.395 V/m; Power Drift = -0.17 dB

Peak SAR (extrapolated) = 0.217 W/kg

**SAR(1 g) = 0.135 W/kg; SAR(10 g) = 0.085 W/kg**

Maximum value of SAR (measured) = 0.150 W/kg

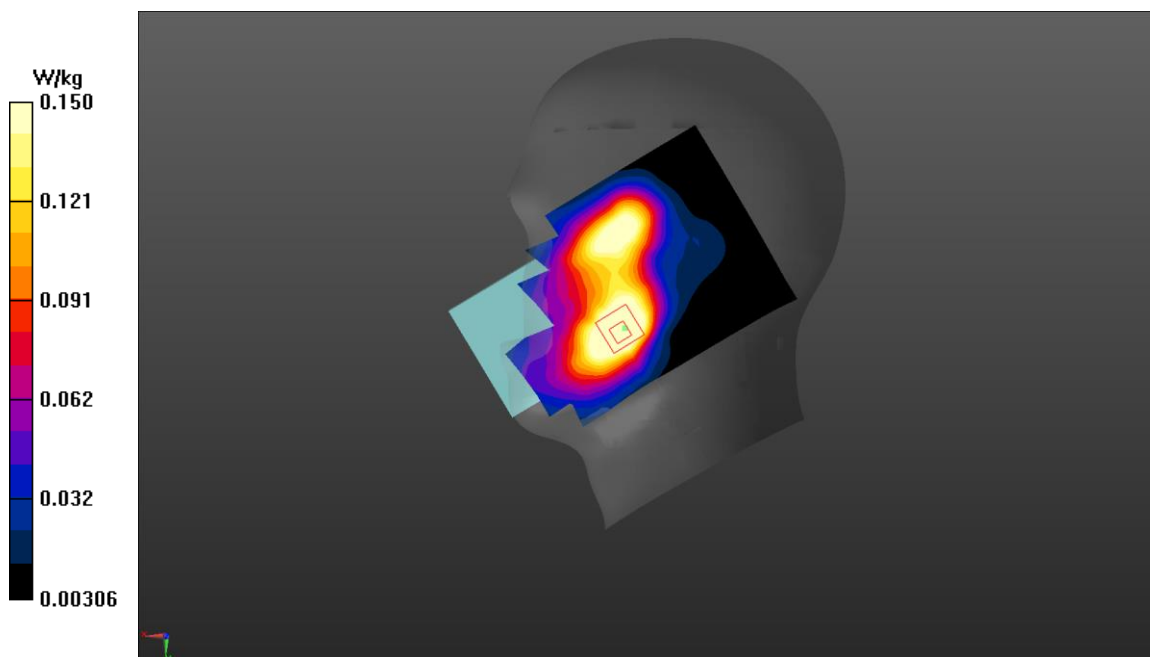

**Fig A.6**

**WCDMA1900-BII\_CH9538 Rear 10mm**

Date: 7/26/2023

Electronics: DAE4 Sn549

Medium: body 1900 MHz

Medium parameters used:  $f = 1907.6$ ;  $\sigma = 1.39$  mho/m;  $\epsilon_r = 39.32$ ;  $\rho = 1000$  kg/m<sup>3</sup>

Ambient Temperature: 22.5°C, Liquid Temperature: 22.3°C

Communication System: WCDMA1900-BII 1907.6 Duty Cycle: 1:1

Probe: EX3DV4 – SN3846 ConvF(7.27,7.55,8.11)

**Area Scan (71x121x1):** Interpolated grid: dx=1.500 mm, dy=1.500 mm

Maximum value of SAR (interpolated) = 0.534 W/kg

**Zoom Scan (7x7x7)/Cube 0:** Measurement grid: dx=8mm, dy=8mm, dz=5mm

Reference Value = 11.9 V/m; Power Drift = -0.01 dB

Peak SAR (extrapolated) = 0.805 W/kg

**SAR(1 g) = 0.485 W/kg; SAR(10 g) = 0.284 W/kg**

Maximum value of SAR (measured) = 0.531 W/kg

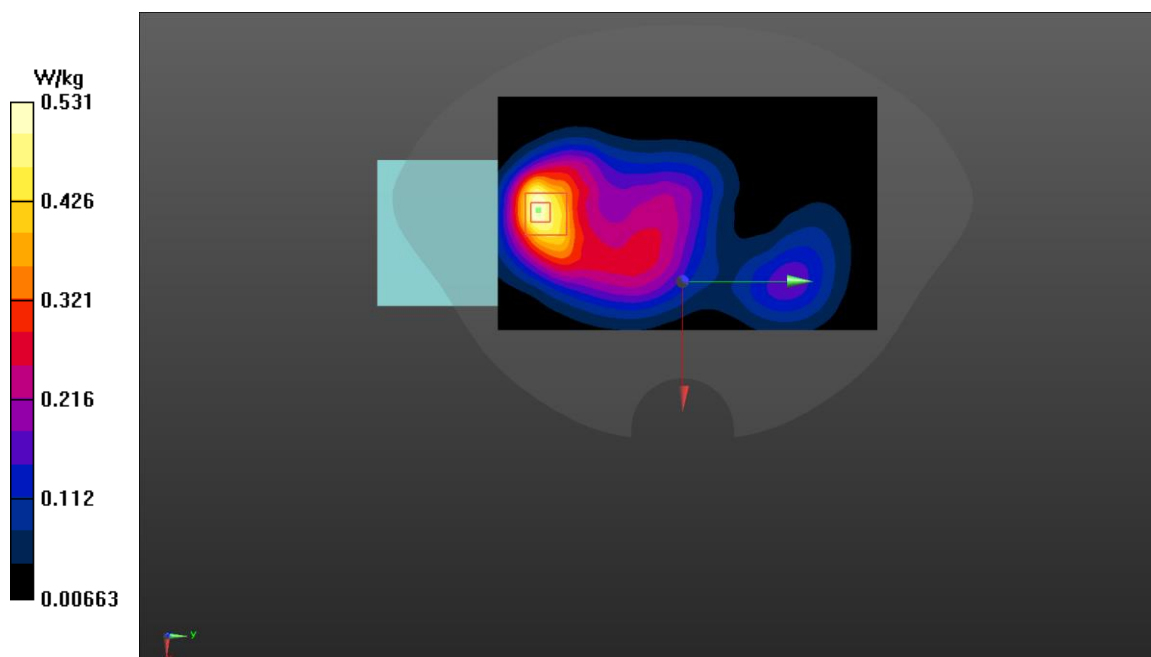

Fig A.7

**WCDMA1900-BII\_CH9400 Rear 15mm**

Date: 7/26/2023

Electronics: DAE4 Sn549

Medium: body 1900 MHz

Medium parameters used:  $f = 1880$ ;  $\sigma = 1.363$  mho/m;  $\epsilon_r = 39.35$ ;  $\rho = 1000$  kg/m<sup>3</sup>

Ambient Temperature: 22.5°C, Liquid Temperature: 22.3°C

Communication System: WCDMA1900-BII 1880 Duty Cycle: 1:1

Probe: EX3DV4 – SN3846 ConvF(7.27,7.55,8.11)

**Area Scan (71x121x1):** Interpolated grid: dx=1.500 mm, dy=1.500 mm

Maximum value of SAR (interpolated) = 0.347 W/kg

**Zoom Scan (7x7x7)/Cube 0:** Measurement grid: dx=8mm, dy=8mm, dz=5mm

Reference Value = 11.56 V/m; Power Drift = 0.22 dB

Peak SAR (extrapolated) = 0.506 W/kg

**SAR(1 g) = 0.317 W/kg; SAR(10 g) = 0.193 W/kg**

Maximum value of SAR (measured) = 0.341 W/kg

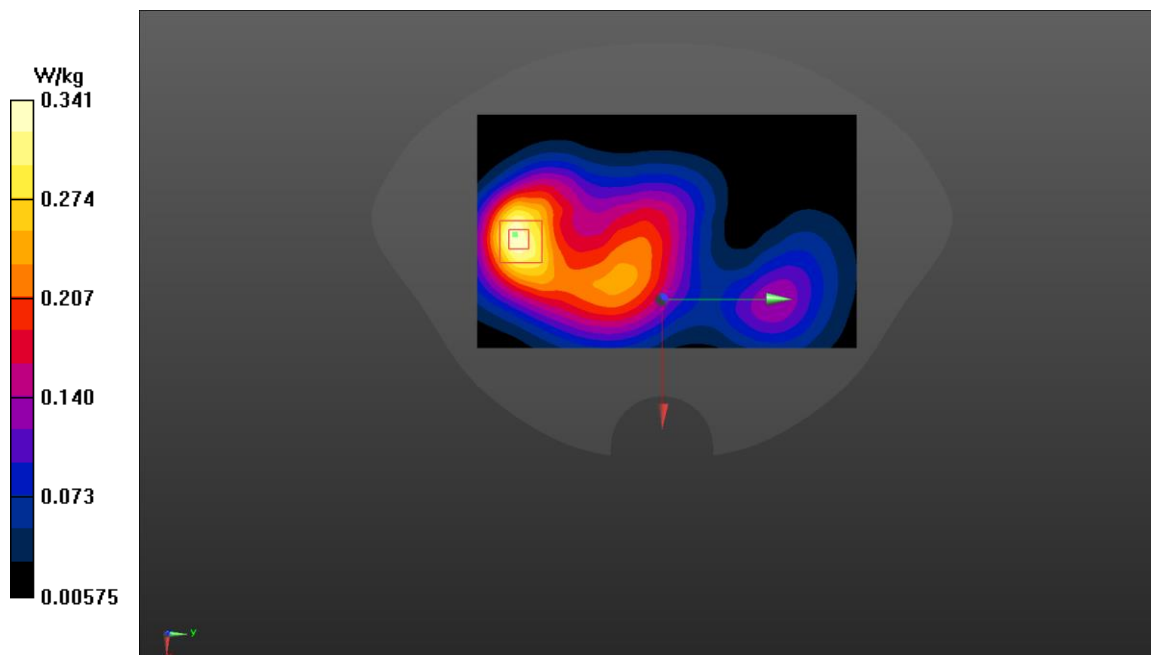
**Fig A.8**

**WCDMA1700-BIV\_CH1412 Left Cheek**

Date: 7/25/2023

Electronics: DAE4 Sn549

Medium: head 1800 MHz

Medium parameters used:  $f = 1732.4$ ;  $\sigma = 1.357$  mho/m;  $\epsilon_r = 39.46$ ;  $\rho = 1000$  kg/m<sup>3</sup>

Ambient Temperature: 22.5°C, Liquid Temperature: 22.3°C

Communication System: WCDMA1700-BIV 1732.4 Duty Cycle: 1:1

Probe: EX3DV4 – SN3846 ConvF(7.47,7.79,8.45)

**Area Scan (71x121x1):** Interpolated grid: dx=1.500 mm, dy=1.500 mm

Maximum value of SAR (interpolated) = 0.168 W/kg

**Zoom Scan (7x7x7)/Cube 0:** Measurement grid: dx=8mm, dy=8mm, dz=5mm

Reference Value = 3.695 V/m; Power Drift = 0.16 dB

Peak SAR (extrapolated) = 0.195 W/kg

**SAR(1 g) = 0.085 W/kg; SAR(10 g) = 0.054 W/kg**

Maximum value of SAR (measured) = 0.141 W/kg

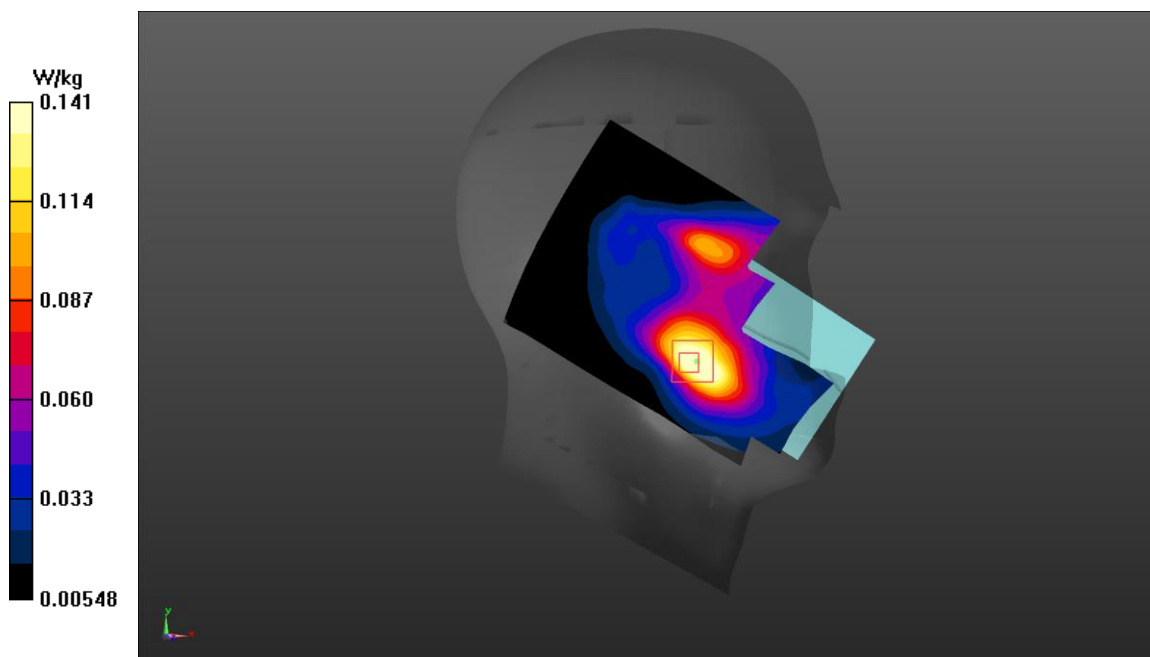

**Fig A.9**

**WCDMA1700-BIV\_CH1412 Rear 10mm**

Date: 7/25/2023

Electronics: DAE4 Sn549

Medium: body 1800 MHz

Medium parameters used:  $f = 1732.5$ ;  $\sigma = 1.357$  mho/m;  $\epsilon_r = 39.46$ ;  $\rho = 1000$  kg/m<sup>3</sup>

Ambient Temperature: 22.5°C, Liquid Temperature: 22.3°C

Communication System: WCDMA1700-BIV 1732.5 Duty Cycle: 1:1

Probe: EX3DV4 – SN3846 ConvF(7.47,7.79,8.45)

**Area Scan (71x121x1):** Interpolated grid: dx=1.500 mm, dy=1.500 mm

Maximum value of SAR (interpolated) = 0.52 W/kg

**Zoom Scan (7x7x7)/Cube 0:** Measurement grid: dx=8mm, dy=8mm, dz=5mm

Reference Value = 7.762 V/m; Power Drift = 0.04 dB

Peak SAR (extrapolated) = 0.755 W/kg

**SAR(1 g) = 0.475 W/kg; SAR(10 g) = 0.285 W/kg**

Maximum value of SAR (measured) = 0.513 W/kg

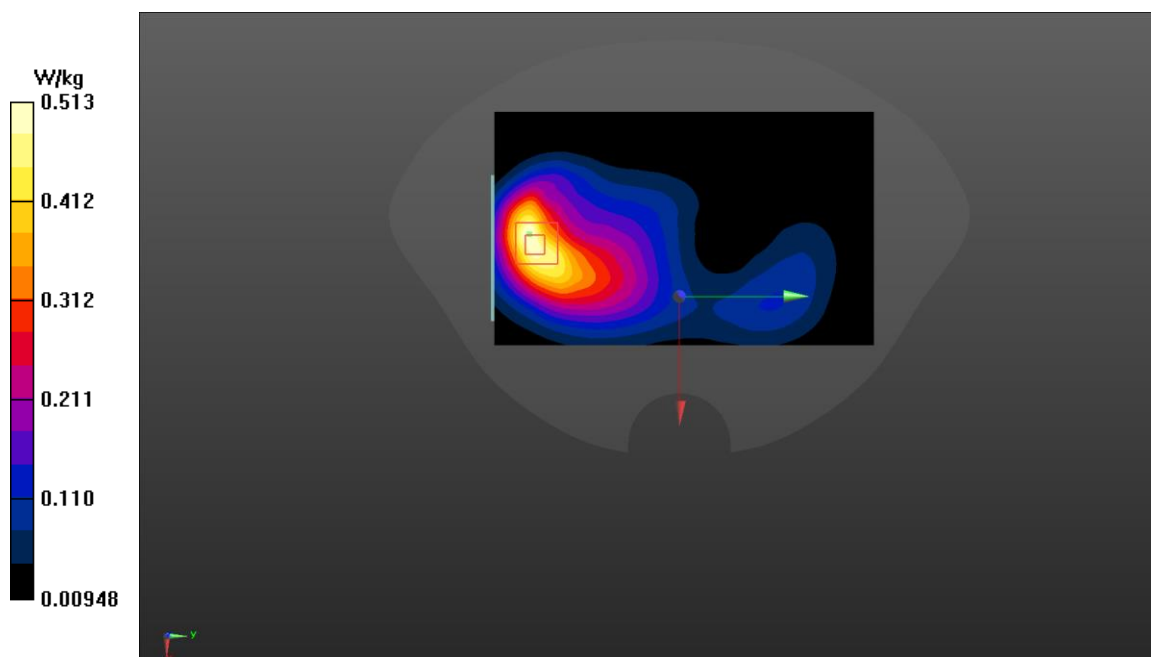
**Fig A.10**

**WCDMA1700-BIV\_CH1412 Rear 15mm**

Date: 7/25/2023

Electronics: DAE4 Sn549

Medium: body 1800 MHz

Medium parameters used:  $f = 1732.5$ ;  $\sigma = 1.357$  mho/m;  $\epsilon_r = 39.46$ ;  $\rho = 1000$  kg/m<sup>3</sup>

Ambient Temperature: 22.5°C, Liquid Temperature: 22.3°C

Communication System: WCDMA1700-BIV 1732.5 Duty Cycle: 1:1

Probe: EX3DV4 – SN3846 ConvF(7.47,7.79,8.45)

**Area Scan (71x121x1):** Interpolated grid: dx=1.500 mm, dy=1.500 mm

Maximum value of SAR (interpolated) = 0.234 W/kg

**Zoom Scan (7x7x7)/Cube 0:** Measurement grid: dx=8mm, dy=8mm, dz=5mm

Reference Value = 6.75 V/m; Power Drift = 0.02 dB

Peak SAR (extrapolated) = 0.326 W/kg

**SAR(1 g) = 0.216 W/kg; SAR(10 g) = 0.139 W/kg**

Maximum value of SAR (measured) = 0.229 W/kg

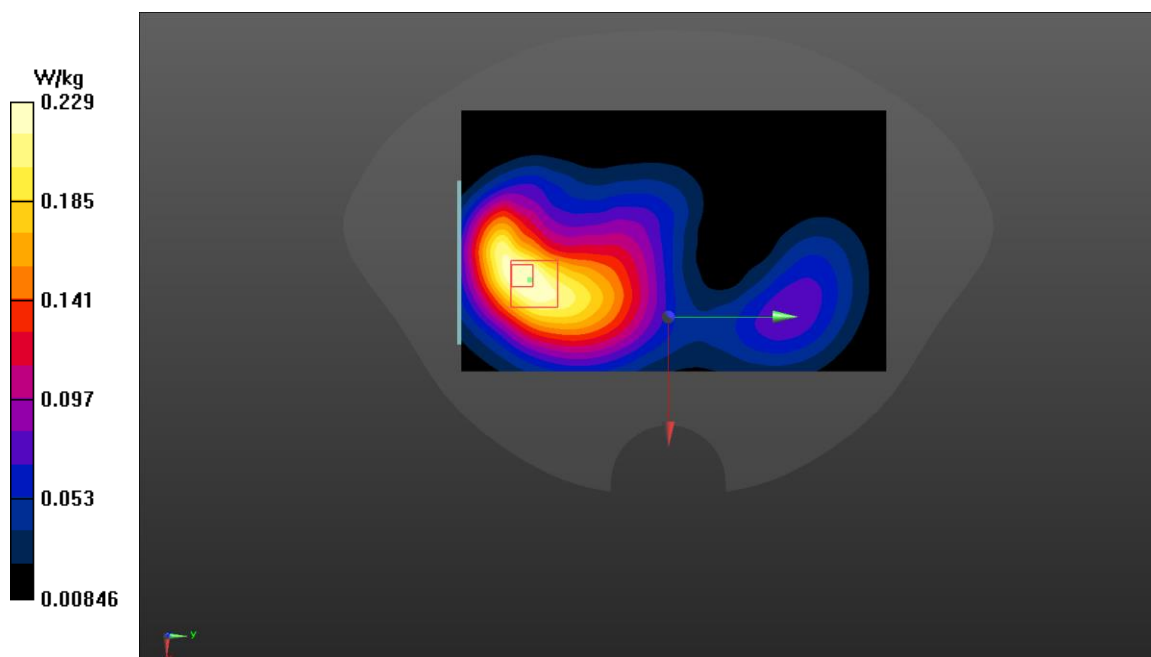

Fig A.11

**WCDMA850-BV\_CH4233 Right Tilt**

Date: 7/24/2023

Electronics: DAE4 Sn549

Medium: head 835 MHz

Medium parameters used:  $f = 846.6$ ;  $\sigma = 0.895$  mho/m;  $\epsilon_r = 41.44$ ;  $\rho = 1000$  kg/m<sup>3</sup>

Ambient Temperature: 22.5°C, Liquid Temperature: 22.3°C

Communication System: WCDMA850-BV 846.6 Duty Cycle: 1:1

Probe: EX3DV4 – SN3846 ConvF(8.50,9.01,9.47)

**Area Scan (71x121x1):** Interpolated grid: dx=1.500 mm, dy=1.500 mm

Maximum value of SAR (interpolated) = 0.679 W/kg

**Zoom Scan (7x7x7)/Cube 0:** Measurement grid: dx=8mm, dy=8mm, dz=5mm

Reference Value = 18.04 V/m; Power Drift = -0.06 dB

Peak SAR (extrapolated) = 1.13 W/kg

**SAR(1 g) = 0.504 W/kg; SAR(10 g) = 0.276 W/kg**

Maximum value of SAR (measured) = 0.544 W/kg

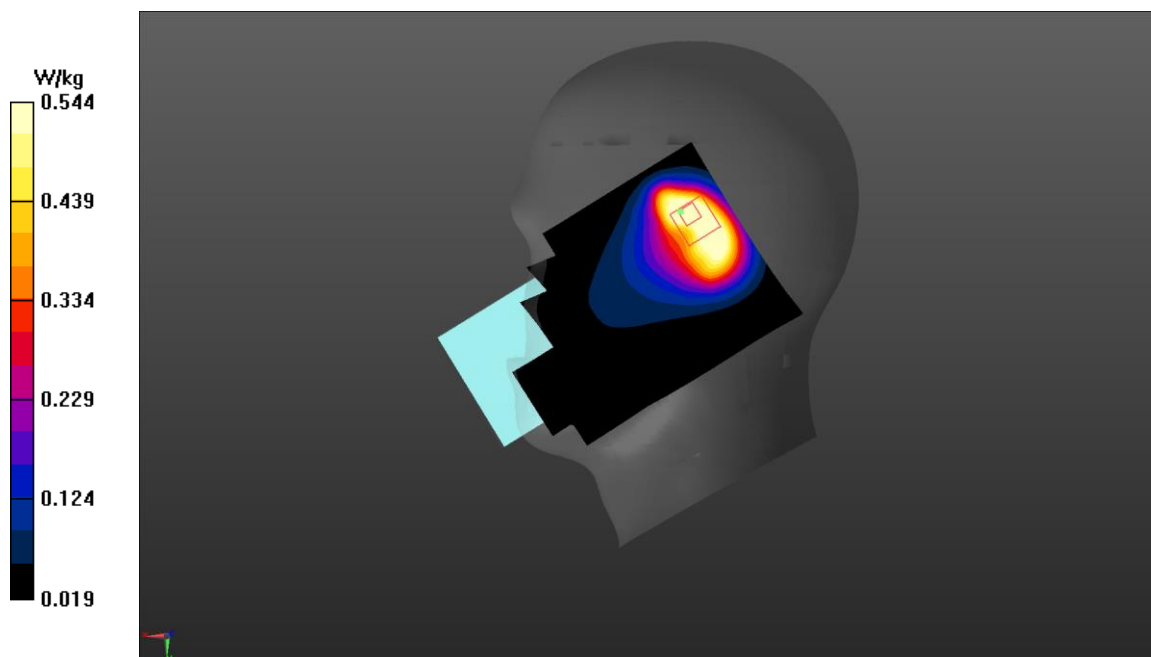

Fig A.12

**WCDMA850-BV\_CH4182 Top Edge 10mm**

Date: 7/24/2023

Electronics: DAE4 Sn549

Medium: body 835 MHz

Medium parameters used:  $f = 836.6$ ;  $\sigma = 0.886$  mho/m;  $\epsilon_r = 41.45$ ;  $\rho = 1000$  kg/m<sup>3</sup>

Ambient Temperature: 22.5°C, Liquid Temperature: 22.3°C

Communication System: WCDMA850-BV 836.6 Duty Cycle: 1:1

Probe: EX3DV4 – SN3846 ConvF(8.50,9.01,9.47)

**Area Scan (71x121x1):** Interpolated grid: dx=1.500 mm, dy=1.500 mm

Maximum value of SAR (interpolated) = 0.619 W/kg

**Zoom Scan (7x7x7)/Cube 0:** Measurement grid: dx=8mm, dy=8mm, dz=5mm

Reference Value = 19.34 V/m; Power Drift = 0.23 dB

Peak SAR (extrapolated) = 0.991 W/kg

**SAR(1 g) = 0.54 W/kg; SAR(10 g) = 0.296 W/kg**

Maximum value of SAR (measured) = 0.596 W/kg

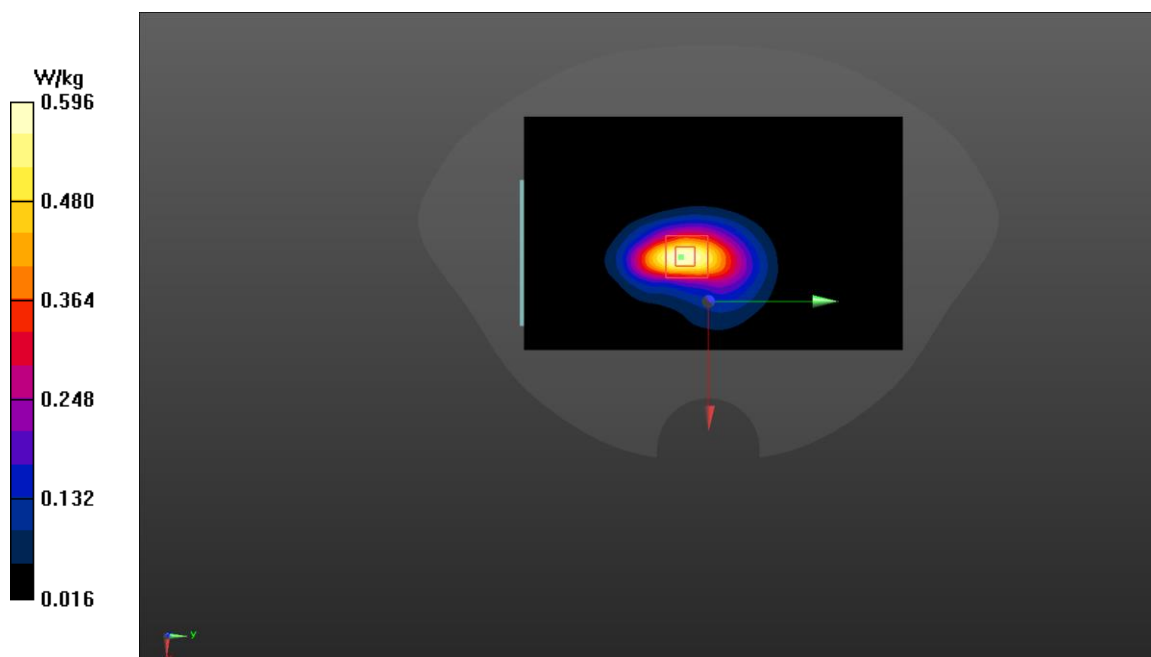

Fig A.13



**LTE1900-FDD2\_CH18900 Right Cheek 50RB-Middle**

Date: 7/26/2023

Electronics: DAE4 Sn549

Medium: head 1900 MHz

Medium parameters used:  $f = 1880$  MHz;  $\sigma = 1.363$  mho/m;  $\epsilon_r = 39.35$ ;  $\rho = 1000$  kg/m<sup>3</sup>

Ambient Temperature: 22.5°C, Liquid Temperature: 22.3°C

Communication System: LTE1900-FDD2 1880 MHz Duty Cycle: 1:1

Probe: EX3DV4 – SN3846 ConvF(7.27,7.55,8.11)

**Area Scan (71x121x1):** Interpolated grid: dx=1.500 mm, dy=1.500 mm

Maximum value of SAR (interpolated) = 0.236 W/kg

**Zoom Scan (7x7x7)/Cube 0:** Measurement grid: dx=8mm, dy=8mm, dz=5mm

Reference Value = 3.54 V/m; Power Drift = 0.22 dB

Peak SAR (extrapolated) = 0.253 W/kg

**SAR(1 g) = 0.167 W/kg; SAR(10 g) = 0.107 W/kg**

Maximum value of SAR (measured) = 0.178 W/kg

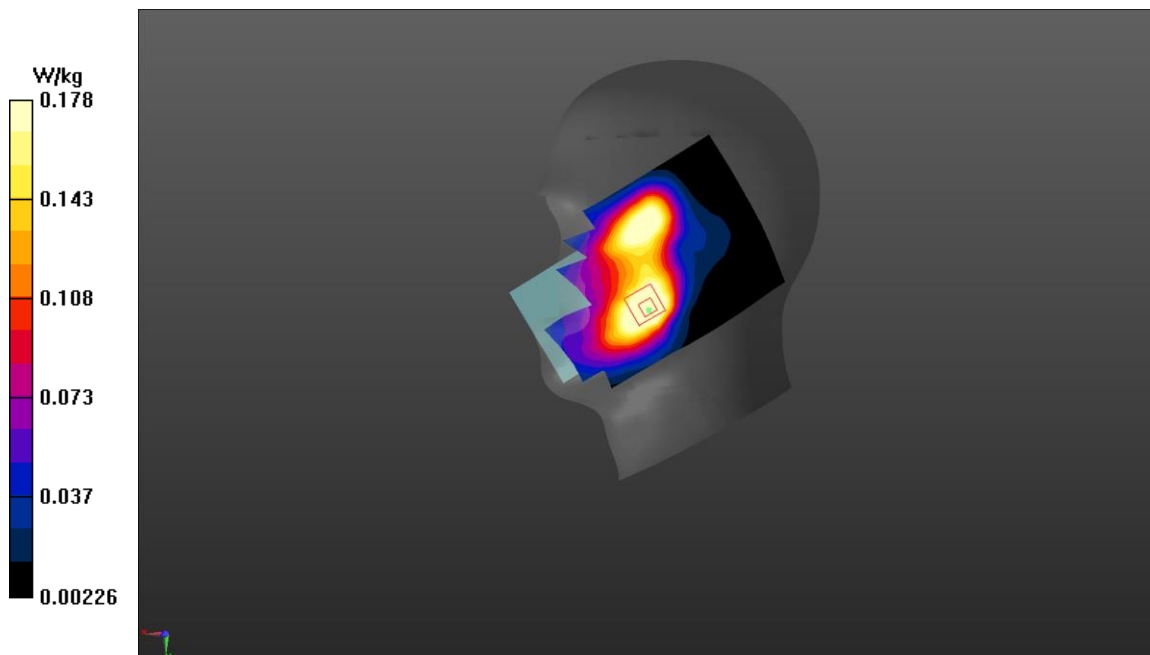

**Fig A.14**

**LTE1900-FDD2\_CH18900 Rear 1RB-Low 10mm**

Date: 7/26/2023

Electronics: DAE4 Sn549

Medium: body 1900 MHz

Medium parameters used:  $f = 1880$  MHz;  $\sigma = 1.363$  mho/m;  $\epsilon_r = 39.35$ ;  $\rho = 1000$  kg/m<sup>3</sup>

Ambient Temperature: 22.5°C, Liquid Temperature: 22.3°C

Communication System: LTE1900-FDD2 1880 MHz Duty Cycle: 1:1

Probe: EX3DV4 – SN3846 ConvF(7.27,7.55,8.11)

**Area Scan (71x121x1):** Interpolated grid: dx=1.500 mm, dy=1.500 mm

Maximum value of SAR (interpolated) = 0.519 W/kg

**Zoom Scan (7x7x7)/Cube 0:** Measurement grid: dx=8mm, dy=8mm, dz=5mm

Reference Value = 10.91 V/m; Power Drift = 0.21 dB

Peak SAR (extrapolated) = 0.746 W/kg

**SAR(1 g) = 0.457 W/kg; SAR(10 g) = 0.272 W/kg**

Maximum value of SAR (measured) = 0.497 W/kg

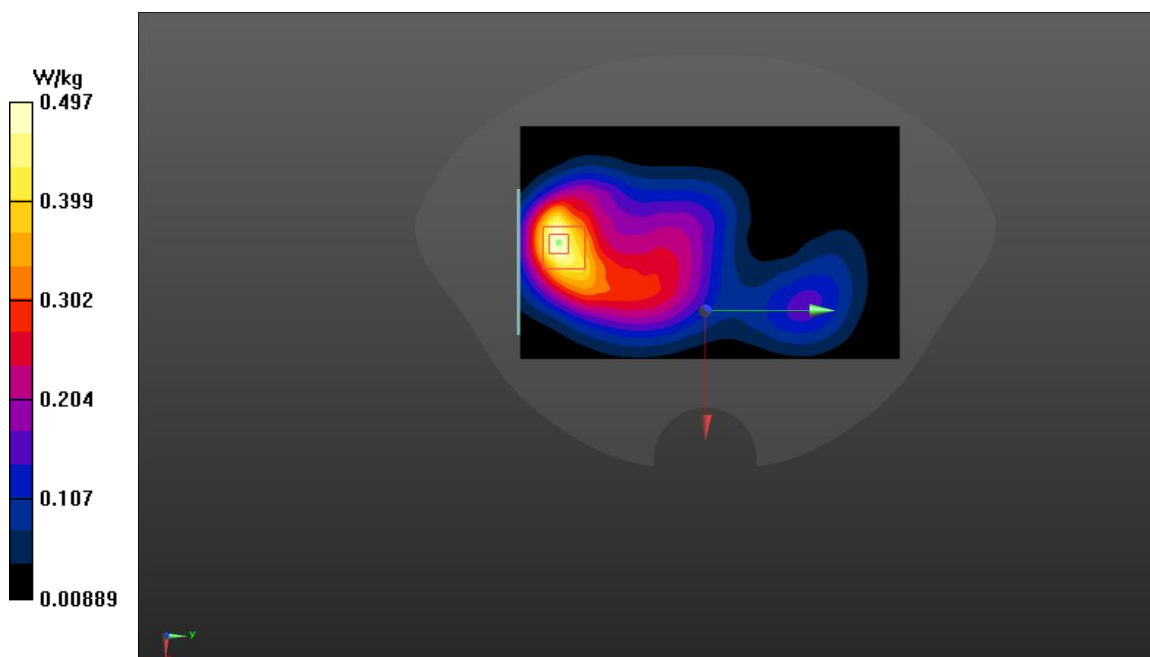

Fig A.15

**LTE1900-FDD2\_CH18900 Rear 50RB-Middle 15mm**

Date: 7/26/2023

Electronics: DAE4 Sn549

Medium: body 1900 MHz

Medium parameters used:  $f = 1880$  MHz;  $\sigma = 1.363$  mho/m;  $\epsilon_r = 39.35$ ;  $\rho = 1000$  kg/m<sup>3</sup>

Ambient Temperature: 22.5°C, Liquid Temperature: 22.3°C

Communication System: LTE1900-FDD2 1880 MHz Duty Cycle: 1:1

Probe: EX3DV4 – SN3846 ConvF(7.27,7.55,8.11)

**Area Scan (71x121x1):** Interpolated grid: dx=1.500 mm, dy=1.500 mm

Maximum value of SAR (interpolated) = 0.236 W/kg

**Zoom Scan (7x7x7)/Cube 0:** Measurement grid: dx=8mm, dy=8mm, dz=5mm

Reference Value = 8.158 V/m; Power Drift = -0.04 dB

Peak SAR (extrapolated) = 0.359 W/kg

**SAR(1 g) = 0.225 W/kg; SAR(10 g) = 0.138 W/kg**

Maximum value of SAR (measured) = 0.240 W/kg

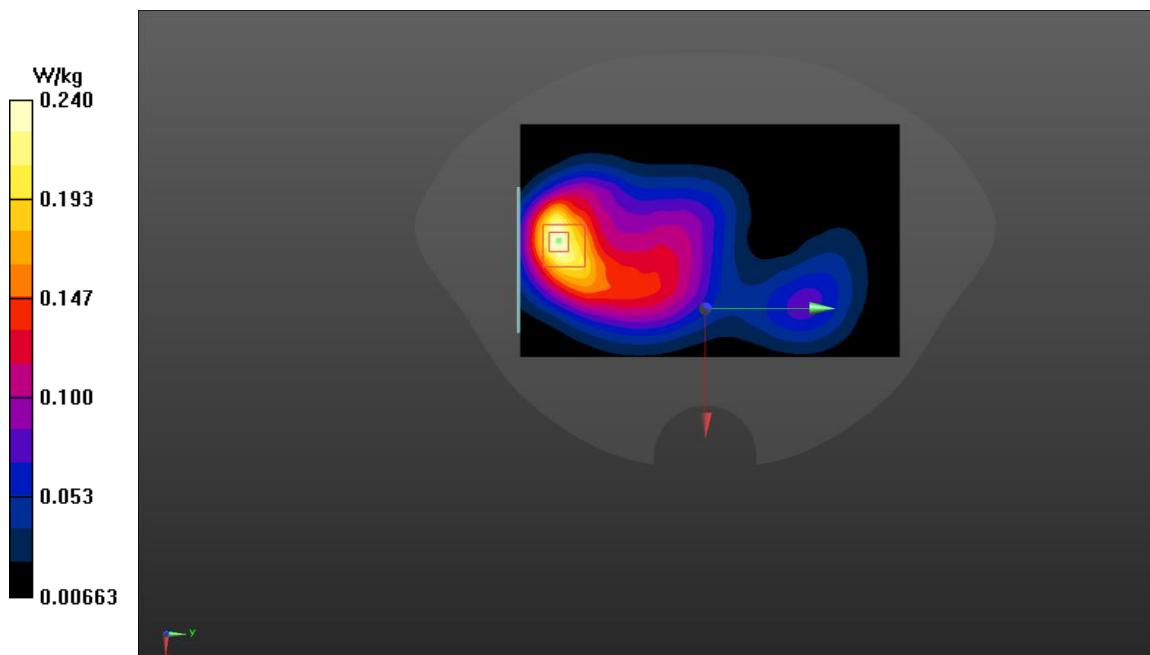
**Fig A.16**

**LTE850-FDD5\_CH20450 Right Tilt 1RB-Low**

Date: 7/24/2023

Electronics: DAE4 Sn549

Medium: head 835 MHz

Medium parameters used:  $f = 829$  MHz;  $\sigma = 0.878$  mho/m;  $\epsilon_r = 41.46$ ;  $\rho = 1000$  kg/m<sup>3</sup>

Ambient Temperature: 22.5°C, Liquid Temperature: 22.3°C

Communication System: LTE850-FDD5 829 MHz Duty Cycle: 1:1

Probe: EX3DV4 – SN3846 ConvF(8.50,9.01,9.47)

**Area Scan (71x121x1):** Interpolated grid: dx=1.500 mm, dy=1.500 mm

Maximum value of SAR (interpolated) = 1.03 W/kg

**Zoom Scan (7x7x7)/Cube 0:** Measurement grid: dx=8mm, dy=8mm, dz=5mm

Reference Value = 25.15 V/m; Power Drift = -0.06 dB

Peak SAR (extrapolated) = 1.36 W/kg

**SAR(1 g) = 0.592 W/kg; SAR(10 g) = 0.336 W/kg**

Maximum value of SAR (measured) = 0.614 W/kg

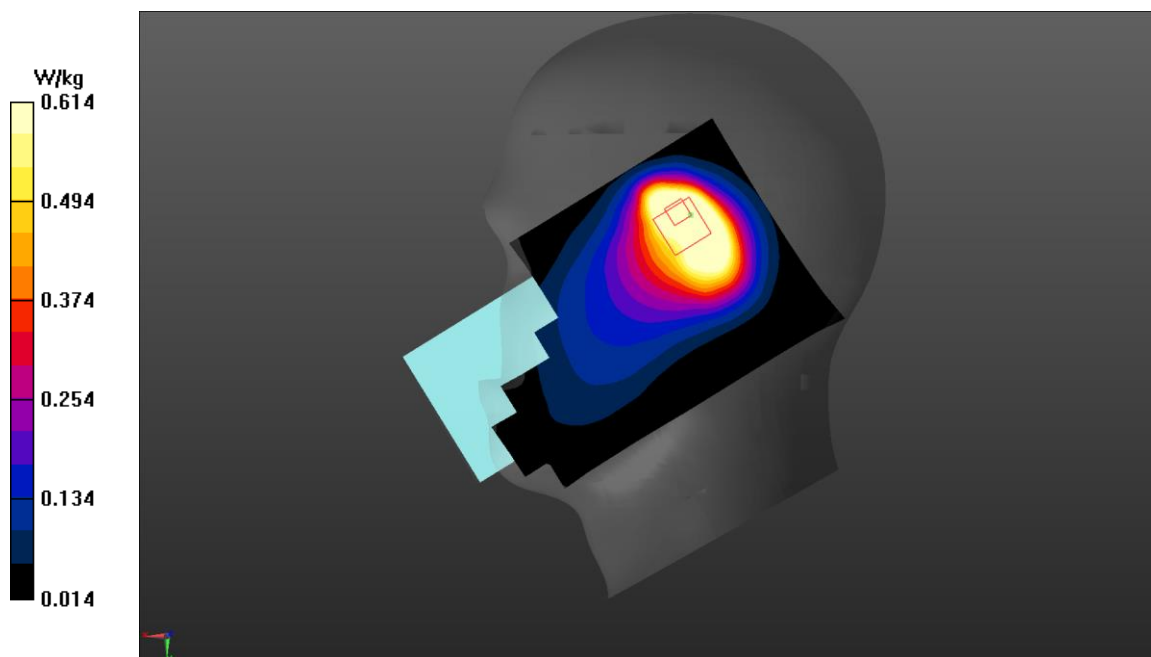

Fig A.17

**LTE850-FDD5\_CH20450 Rear 1RB-Low 10mm**

Date: 7/24/2023

Electronics: DAE4 Sn549

Medium: body 835 MHz

Medium parameters used:  $f = 829$  MHz;  $\sigma = 0.878$  mho/m;  $\epsilon_r = 41.46$ ;  $\rho = 1000$  kg/m<sup>3</sup>

Ambient Temperature: 22.5°C, Liquid Temperature: 22.3°C

Communication System: LTE850-FDD5 829 MHz Duty Cycle: 1:1

Probe: EX3DV4 – SN3846 ConvF(8.50,9.01,9.47)

**Area Scan (71x121x1):** Interpolated grid: dx=1.500 mm, dy=1.500 mm

Maximum value of SAR (interpolated) = 0.335 W/kg

**Zoom Scan (7x7x7)/Cube 0:** Measurement grid: dx=8mm, dy=8mm, dz=5mm

Reference Value = 18.98 V/m; Power Drift = -0.22 dB

Peak SAR (extrapolated) = 0.405 W/kg

**SAR(1 g) = 0.32 W/kg; SAR(10 g) = 0.242 W/kg**

Maximum value of SAR (measured) = 0.335 W/kg

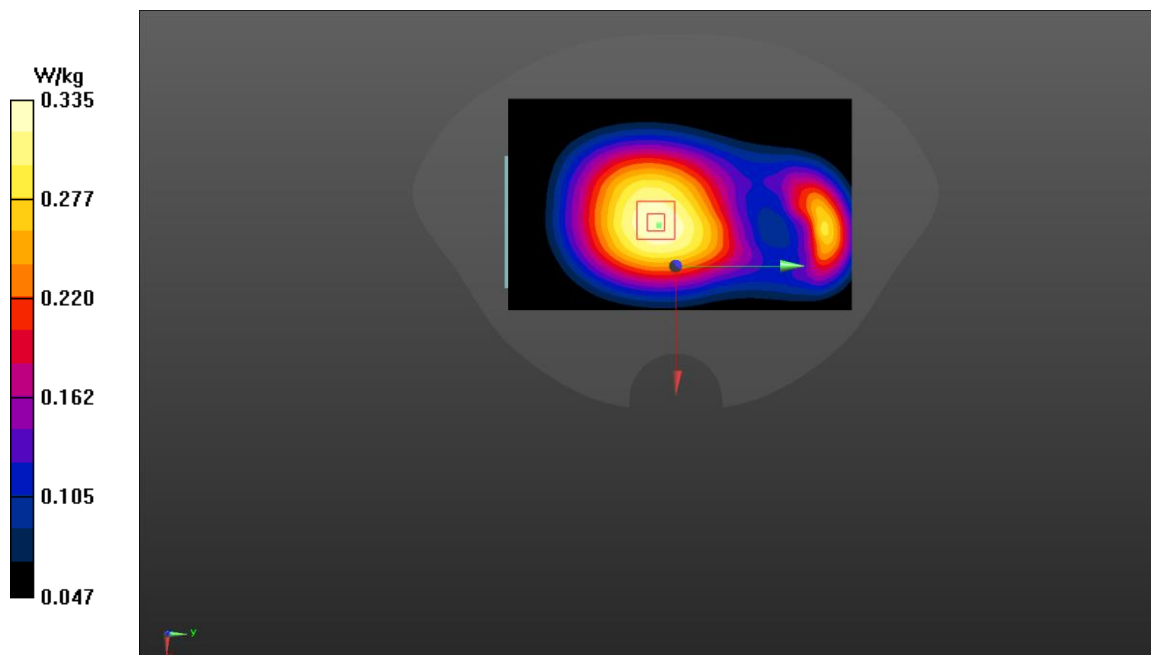

Fig A.18

**LTE2500-FDD7\_CH21350 Left Cheek 1RB-Low**

Date: 7/10/2023

Electronics: DAE4 Sn549

Medium: head 2600 MHz

Medium parameters used:  $f = 2535$  MHz;  $\sigma = 1.918$  mho/m;  $\epsilon_r = 38.51$ ;  $\rho = 1000$  kg/m<sup>3</sup>

Ambient Temperature: 22.5°C, Liquid Temperature: 22.3°C

Communication System: LTE2500-FDD7 2535 MHz Duty Cycle: 1:1

Probe: EX3DV4 – SN3846 ConvF(6.72,7.04,7.50)

**Area Scan (71x121x1):** Interpolated grid: dx=1.200 mm, dy=1.200 mm

Maximum value of SAR (interpolated) = 0.0942 W/kg

**Zoom Scan (7x7x7)/Cube 0:** Measurement grid: dx=5mm, dy=5mm, dz=5mm

Reference Value = 0.602 V/m; Power Drift = 0.15 dB

Peak SAR (extrapolated) = 0.101 W/kg

**SAR(1 g) = 0.053 W/kg; SAR(10 g) = 0.027 W/kg**

Maximum value of SAR (measured) = 0.0832 W/kg

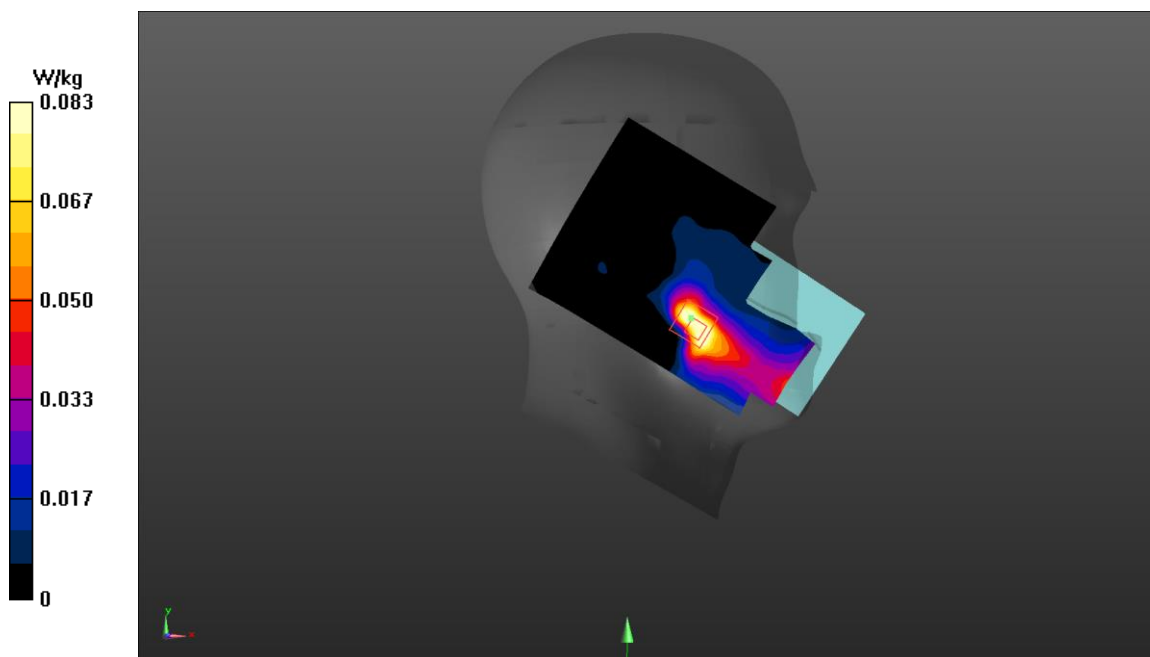

**Fig A.19**

**LTE2500-FDD7\_CH21350 Bottom Edge 1RB-Low 10mm**

Date: 7/10/2023

Electronics: DAE4 Sn549

Medium: body 2600 MHz

Medium parameters used:  $f = 2560$  MHz;  $\sigma = 1.918$  mho/m;  $\epsilon_r = 38.51$ ;  $\rho = 1000$  kg/m<sup>3</sup>

Ambient Temperature: 22.5°C, Liquid Temperature: 22.3°C

Communication System: LTE2500-FDD7 2560 MHz Duty Cycle: 1:1

Probe: EX3DV4 – SN3846 ConvF(6.72,7.04,7.50)

**Area Scan (71x121x1):** Interpolated grid: dx=1.200 mm, dy=1.200 mm

Maximum value of SAR (interpolated) = 0.741 W/kg

**Zoom Scan (7x7x7)/Cube 0:** Measurement grid: dx=5mm, dy=5mm, dz=5mm

Reference Value = 2.428 V/m; Power Drift = -0.19 dB

Peak SAR (extrapolated) = 1.52 W/kg

**SAR(1 g) = 0.739 W/kg; SAR(10 g) = 0.368 W/kg**

Maximum value of SAR (measured) = 0.811 W/kg

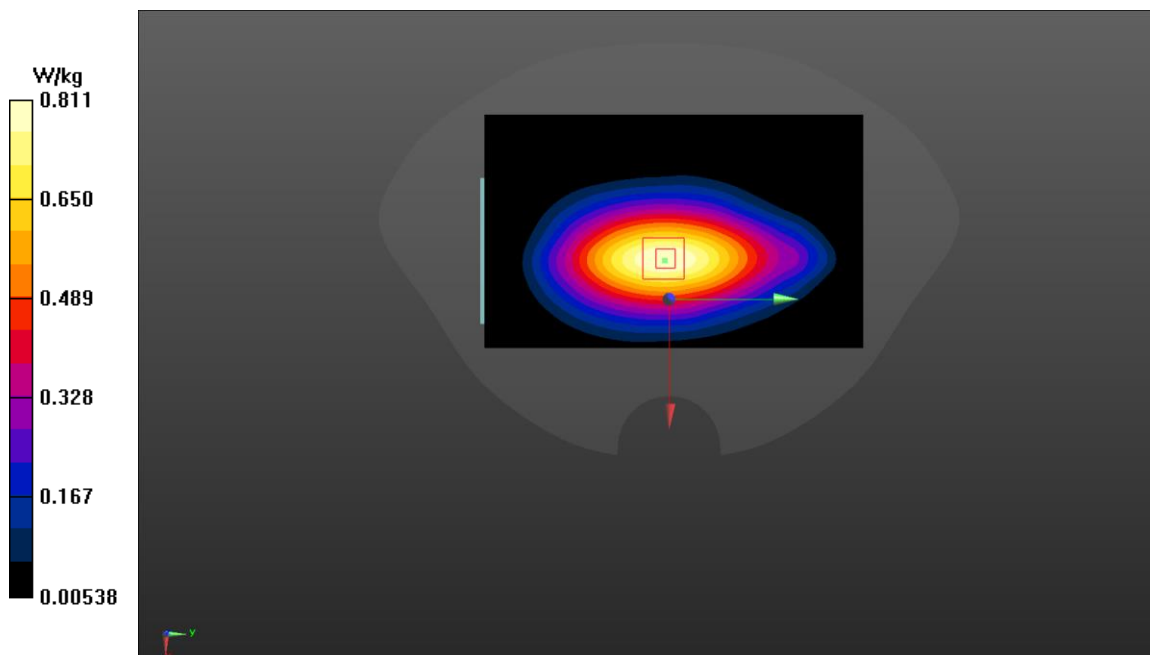

**Fig A.20**

**LTE2500-FDD7\_CH21350 Rear 50RB-Low 15mm**

Date: 7/10/2023

Electronics: DAE4 Sn549

Medium: body 2600 MHz

Medium parameters used:  $f = 2560$  MHz;  $\sigma = 1.918$  mho/m;  $\epsilon_r = 38.51$ ;  $\rho = 1000$  kg/m<sup>3</sup>

Ambient Temperature: 22.5°C, Liquid Temperature: 22.3°C

Communication System: LTE2500-FDD7 2560 MHz Duty Cycle: 1:1

Probe: EX3DV4 – SN3846 ConvF(6.72,7.04,7.50)

**Area Scan (71x121x1):** Interpolated grid: dx=1.200 mm, dy=1.200 mm

Maximum value of SAR (interpolated) = 0.279 W/kg

**Zoom Scan (7x7x7)/Cube 0:** Measurement grid: dx=5mm, dy=5mm, dz=5mm

Reference Value = 0.97 V/m; Power Drift = -0.11 dB

Peak SAR (extrapolated) = 0.482 W/kg

**SAR(1 g) = 0.253 W/kg; SAR(10 g) = 0.136 W/kg**

Maximum value of SAR (measured) = 0.270 W/kg

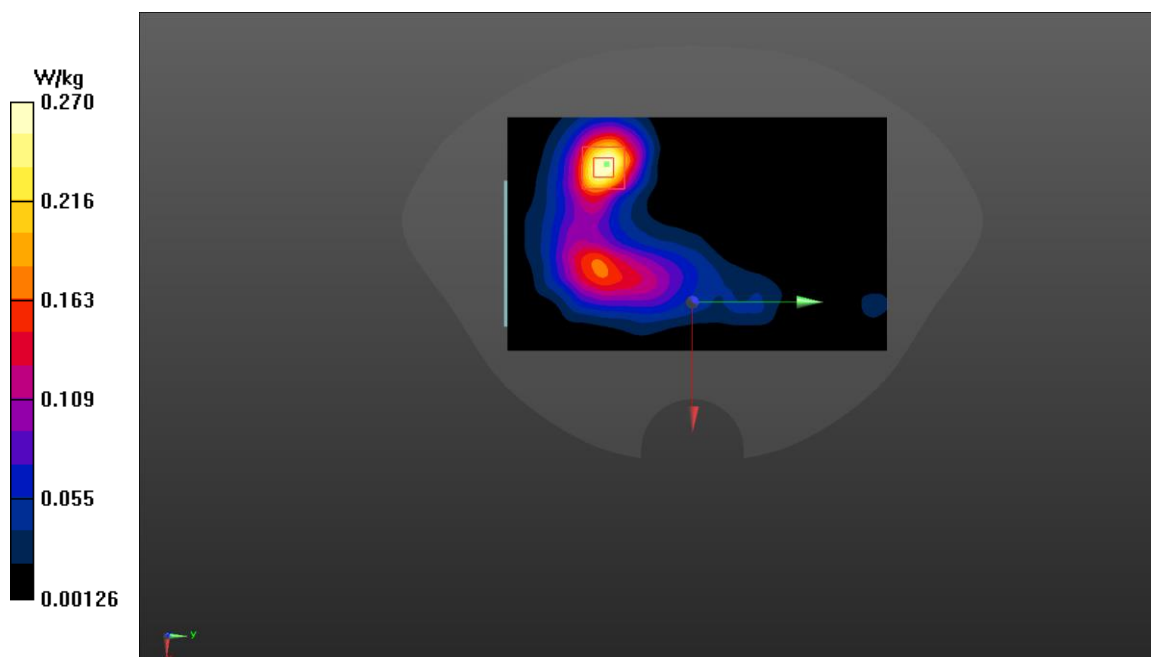

Fig A.21



**LTE700-FDD12\_CH23095 Right Cheek 1RB-Low**

Date: 7/23/2023

Electronics: DAE4 Sn549

Medium: head 750 MHz

Medium parameters used:  $f = 707.5$  MHz;  $\sigma = 0.857$  mho/m;  $\epsilon_r = 42.12$ ;  $\rho = 1000$  kg/m<sup>3</sup>

Ambient Temperature: 22.5°C, Liquid Temperature: 22.3°C

Communication System: LTE700-FDD12 707.5 MHz Duty Cycle: 1:1

Probe: EX3DV4 – SN3846 ConvF(8.98,8.99,10.08)

**Area Scan (71x121x1):** Interpolated grid: dx=1.500 mm, dy=1.500 mm

Maximum value of SAR (interpolated) = 0.337 W/kg

**Zoom Scan (7x7x7)/Cube 0:** Measurement grid: dx=8mm, dy=8mm, dz=5mm

Reference Value = 19.51 V/m; Power Drift = 0.04 dB

Peak SAR (extrapolated) = 0.483 W/kg

**SAR(1 g) = 0.586 W/kg; SAR(10 g) = 0.352 W/kg**

Maximum value of SAR (measured) = 0.644 W/kg

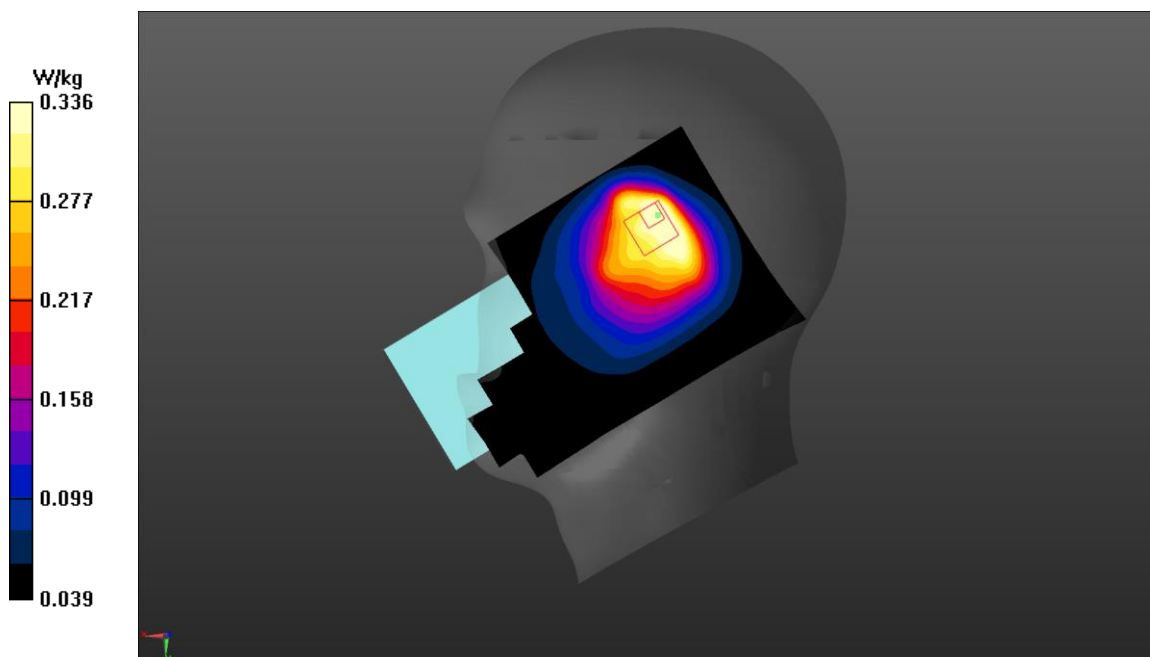

**Fig A.22**

**LTE700-FDD12\_CH23095 Left Edge 1RB-Low 10mm**

Date: 7/23/2023

Electronics: DAE4 Sn549

Medium: body 750 MHz

Medium parameters used:  $f = 707.5$  MHz;  $\sigma = 0.857$  mho/m;  $\epsilon_r = 42.12$ ;  $\rho = 1000$  kg/m<sup>3</sup>

Ambient Temperature: 22.5°C, Liquid Temperature: 22.3°C

Communication System: LTE700-FDD12 707.5 MHz Duty Cycle: 1:1

Probe: EX3DV4 – SN3846 ConvF(8.98,8.99,10.08)

**Area Scan (71x121x1):** Interpolated grid: dx=1.500 mm, dy=1.500 mm

Maximum value of SAR (interpolated) = 0.337 W/kg

**Zoom Scan (7x7x7)/Cube 0:** Measurement grid: dx=8mm, dy=8mm, dz=5mm

Reference Value = 19.51 V/m; Power Drift = 0.12 dB

Peak SAR (extrapolated) = 0.483 W/kg

**SAR(1 g) = 0.318 W/kg; SAR(10 g) = 0.22 W/kg**

Maximum value of SAR (measured) = 0.336 W/kg

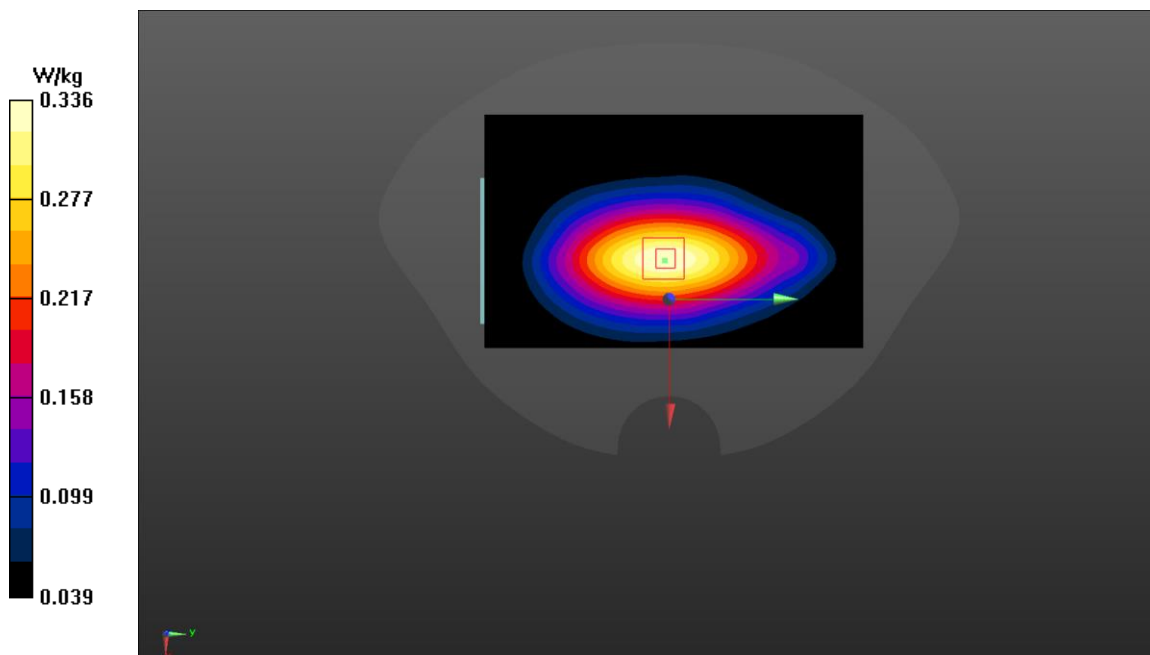

**Fig A.23**

**LTE750-FDD13\_CH23230 Right Cheek 1RB-Low**

Date: 7/23/2023

Electronics: DAE4 Sn549

Medium: head 750 MHz

Medium parameters used:  $f = 782$  MHz;  $\sigma = 0.927$  mho/m;  $\epsilon_r = 42.03$ ;  $\rho = 1000$  kg/m<sup>3</sup>

Ambient Temperature: 22.5°C, Liquid Temperature: 22.3°C

Communication System: LTE750-FDD13 782 MHz Duty Cycle: 1:1

Probe: EX3DV4 – SN3846 ConvF(8.98,8.99,10.08)

**Area Scan (71x121x1):** Interpolated grid: dx=1.500 mm, dy=1.500 mm

Maximum value of SAR (interpolated) = 0.973 W/kg

**Zoom Scan (7x7x7)/Cube 0:** Measurement grid: dx=8mm, dy=8mm, dz=5mm

Reference Value = 21.04 V/m; Power Drift = 0.07 dB

Peak SAR (extrapolated) = 1.37 W/kg

**SAR(1 g) = 0.703 W/kg; SAR(10 g) = 0.425 W/kg**

Maximum value of SAR (measured) = 0.783W/kg

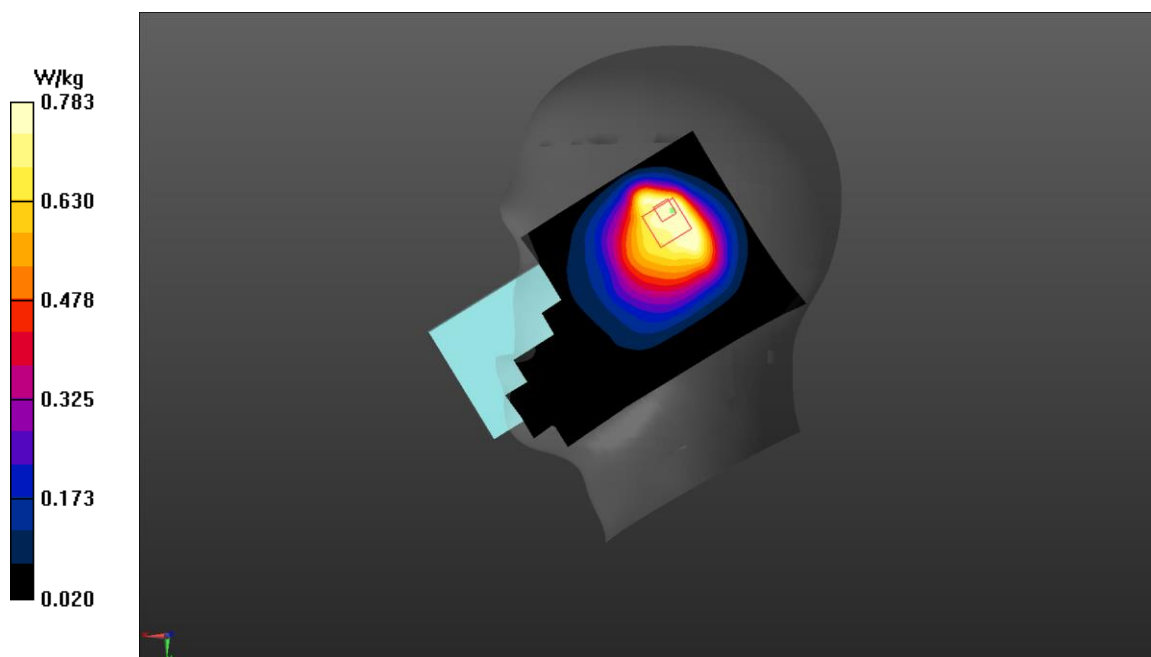

Fig A.24

**LTE750-FDD13\_CH23230 Rear 1RB-Low 10mm**

Date: 7/23/2023

Electronics: DAE4 Sn549

Medium: body 750 MHz

Medium parameters used:  $f = 782$  MHz;  $\sigma = 0.927$  mho/m;  $\epsilon_r = 42.03$ ;  $\rho = 1000$  kg/m<sup>3</sup>

Ambient Temperature: 22.5°C, Liquid Temperature: 22.3°C

Communication System: LTE750-FDD13 782 MHz Duty Cycle: 1:1

Probe: EX3DV4 – SN3846 ConvF(8.98,8.99,10.08)

**Area Scan (71x121x1):** Interpolated grid: dx=1.500 mm, dy=1.500 mm

Maximum value of SAR (interpolated) = 0.301 W/kg

**Zoom Scan (7x7x7)/Cube 0:** Measurement grid: dx=8mm, dy=8mm, dz=5mm

Reference Value = 17.32 V/m; Power Drift = 0.17 dB

Peak SAR (extrapolated) = 0.389 W/kg

**SAR(1 g) = 0.287 W/kg; SAR(10 g) = 0.218 W/kg**

Maximum value of SAR (measured) = 0.300 W/kg

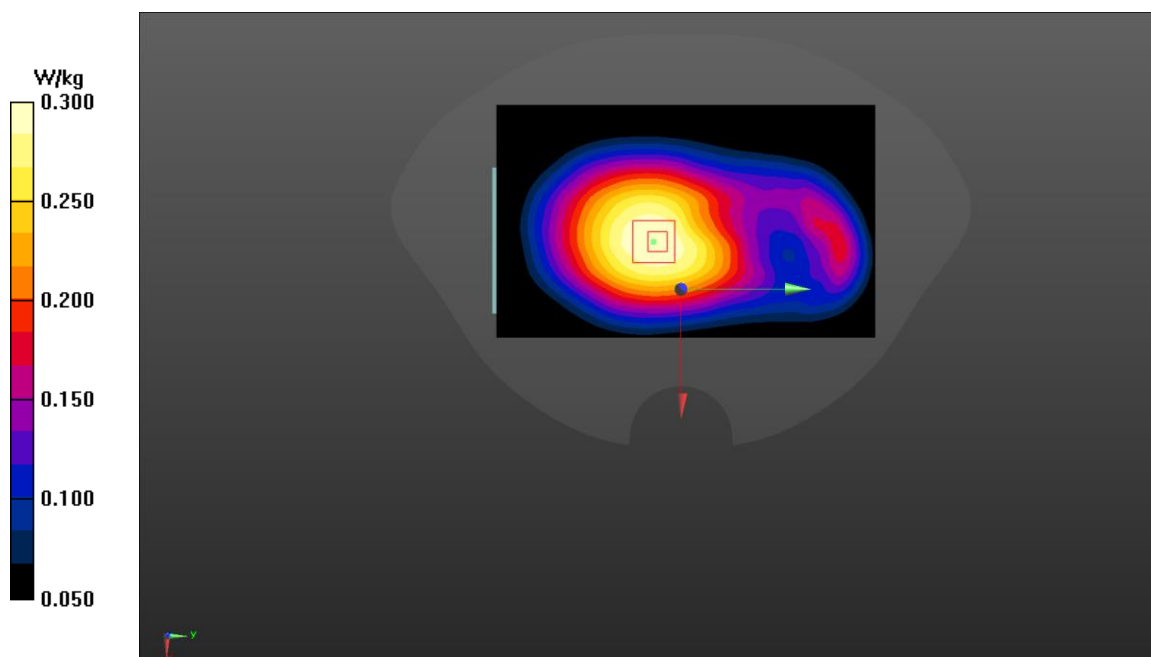

Fig A.25

**LTE2600-TDD41\_CH40620 Left Cheek 1RB-High**

Date: 7/10/2023

Electronics: DAE4 Sn549

Medium: head 2600 MHz

Medium parameters used:  $f = 2593$  MHz;  $\sigma = 1.918$  mho/m;  $\epsilon_r = 38.51$ ;  $\rho = 1000$  kg/m<sup>3</sup>

Ambient Temperature: 22.5°C, Liquid Temperature: 22.3°C

Communication System: LTE2600-TDD41 2593 MHz Duty Cycle: 1:1.5787

Probe: EX3DV4 – SN3846 ConvF(6.72,7.04,7.50)

**Area Scan (71x121x1):** Interpolated grid: dx=1.200 mm, dy=1.200 mm

Maximum value of SAR (interpolated) = 0.0462 W/kg

**Zoom Scan (7x7x7)/Cube 0:** Measurement grid: dx=5mm, dy=5mm, dz=5mm

Reference Value = 0.429 V/m; Power Drift = 0.02 dB

Peak SAR (extrapolated) = 0.039 W/kg

**SAR(1 g) = 0.019 W/kg; SAR(10 g) = 0.008 W/kg**

Maximum value of SAR (measured) = 0.030 W/kg

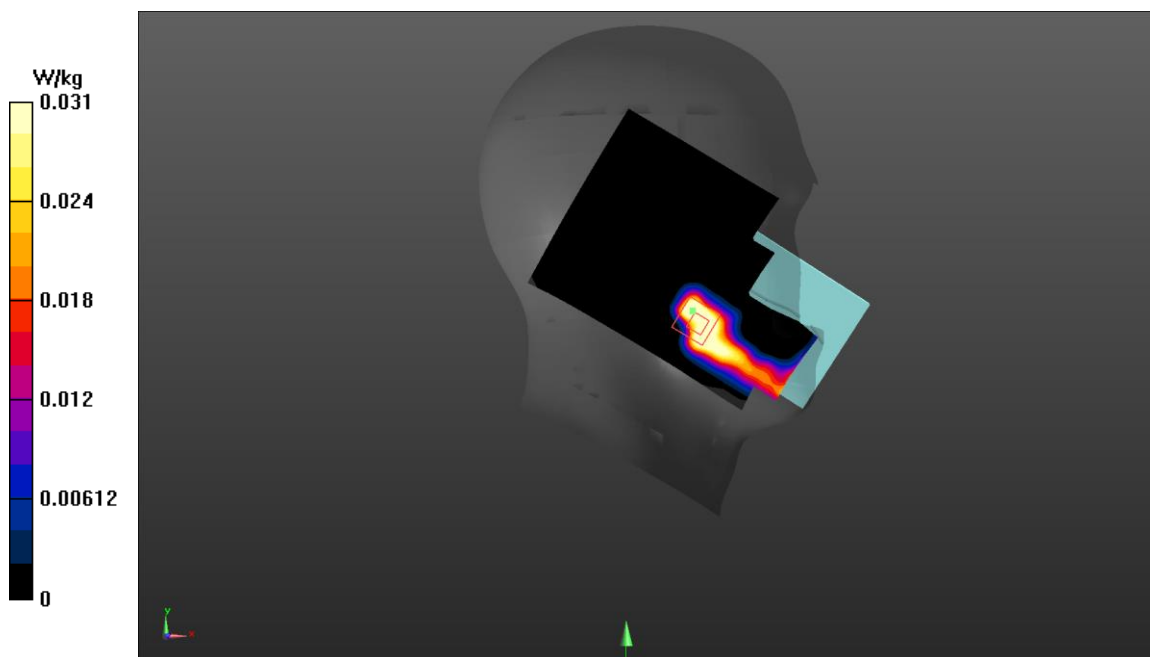

**Fig A.26**

**LTE2600-TDD41\_CH40620 Bottom Edge 50RB-High 10mm**

Date: 7/10/2023

Electronics: DAE4 Sn549

Medium: body 2600 MHz

Medium parameters used:  $f = 2593$  MHz;  $\sigma = 1.918$  mho/m;  $\epsilon_r = 38.51$ ;  $\rho = 1000$  kg/m<sup>3</sup>

Ambient Temperature: 22.5°C, Liquid Temperature: 22.3°C

Communication System: LTE2600-TDD41 2593 MHz Duty Cycle: 1:1.5787

Probe: EX3DV4 – SN3846 ConvF(6.72,7.04,7.50)

**Area Scan (71x121x1):** Interpolated grid: dx=1.200 mm, dy=1.200 mm

Maximum value of SAR (interpolated) = 0.311 W/kg

**Zoom Scan (7x7x7)/Cube 0:** Measurement grid: dx=5mm, dy=5mm, dz=5mm

Reference Value = 10.43 V/m; Power Drift = 0.19 dB

Peak SAR (extrapolated) = 0.597 W/kg

**SAR(1 g) = 0.29 W/kg; SAR(10 g) = 0.132 W/kg**

Maximum value of SAR (measured) = 0.323 W/kg

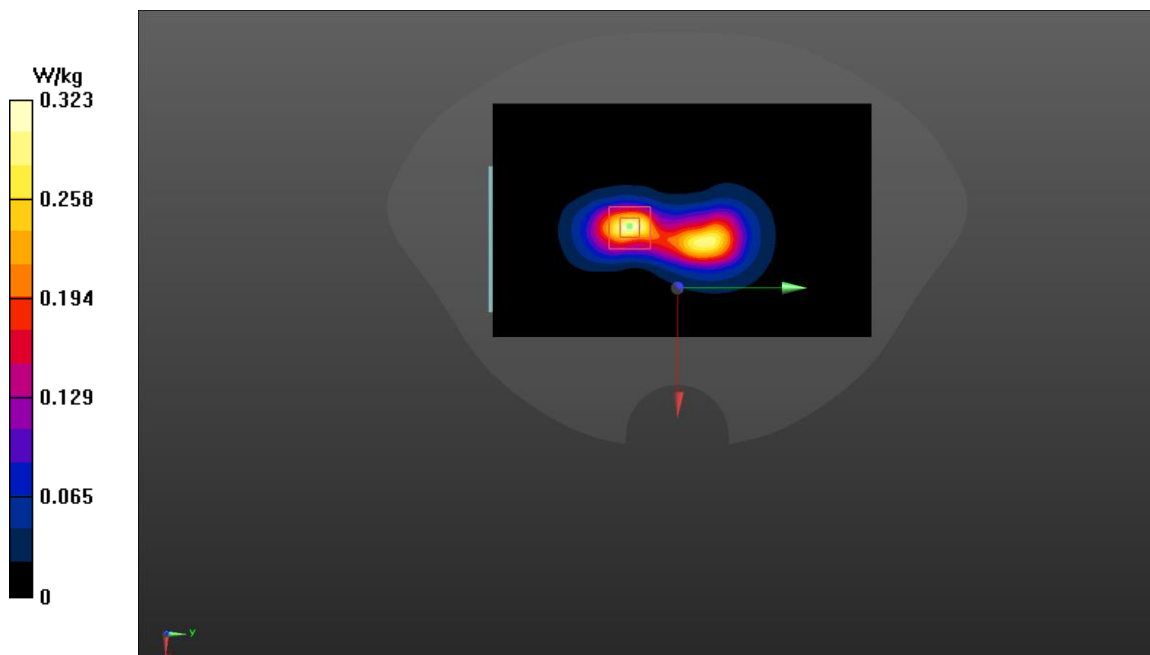

Fig A.27

**LTE2600-TDD41\_CH40620 Rear 50RB-High 15mm**

Date: 7/10/2023

Electronics: DAE4 Sn549

Medium: body 2600 MHz

Medium parameters used:  $f = 2593$  MHz;  $\sigma = 1.918$  mho/m;  $\epsilon_r = 38.51$ ;  $\rho = 1000$  kg/m<sup>3</sup>

Ambient Temperature: 22.5°C, Liquid Temperature: 22.3°C

Communication System: LTE2600-TDD41 2593 MHz Duty Cycle: 1:1.5787

Probe: EX3DV4 – SN3846 ConvF(6.72,7.04,7.50)

**Area Scan (71x121x1):** Interpolated grid: dx=1.200 mm, dy=1.200 mm

Maximum value of SAR (interpolated) = 0.0917 W/kg

**Zoom Scan (7x7x7)/Cube 0:** Measurement grid: dx=5mm, dy=5mm, dz=5mm

Reference Value = 3.164 V/m; Power Drift = 0.05 dB

Peak SAR (extrapolated) = 0.162 W/kg

**SAR(1 g) = 0.053 W/kg; SAR(10 g) = 0.027 W/kg**

Maximum value of SAR (measured) = 0.088W/kg

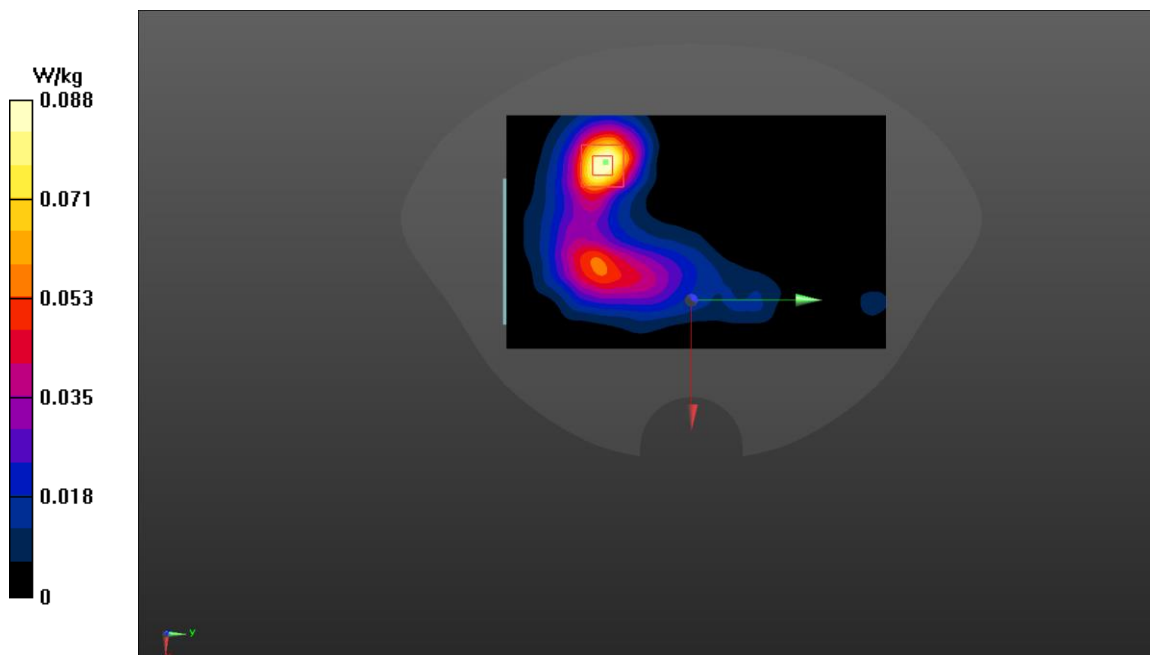

**Fig A.28**

**LTE1700-FDD66\_CH41100 Left Cheek 1RB-Middle**

Date: 7/25/2023

Electronics: DAE4 Sn549

Medium: head 1800 MHz

Medium parameters used:  $f = 1720$  MHz;  $\sigma = 1.357$  mho/m;  $\epsilon_r = 39.46$ ;  $\rho = 1000$  kg/m<sup>3</sup>

Ambient Temperature: 22.5°C, Liquid Temperature: 22.3°C

Communication System: LTE1700-FDD66 1720 MHz Duty Cycle: 1:1

Probe: EX3DV4 – SN3846 ConvF(7.47,7.79,8.45)

**Area Scan (71x121x1):** Interpolated grid: dx=1.500 mm, dy=1.500 mm

Maximum value of SAR (interpolated) = 0.13 W/kg

**Zoom Scan (7x7x7)/Cube 0:** Measurement grid: dx=8mm, dy=8mm, dz=5mm

Reference Value = 3.384 V/m; Power Drift = 0.13 dB

Peak SAR (extrapolated) = 0.15 W/kg

**SAR(1 g) = 0.098 W/kg; SAR(10 g) = 0.062 W/kg**

Maximum value of SAR (measured) = 0.132 W/kg

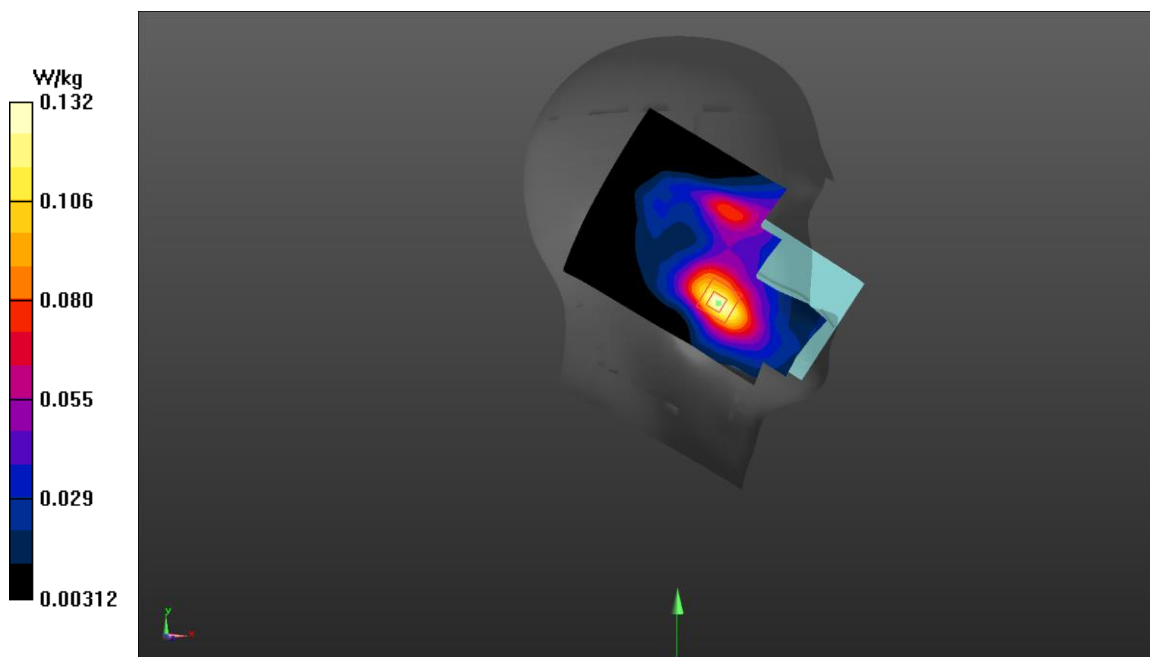

**Fig A.29**



**LTE1700-FDD66\_CH41114 Rear 50RB-Middle 10mm**

Date: 7/25/2023

Electronics: DAE4 Sn549

Medium: body 1800 MHz

Medium parameters used:  $f = 1745$  MHz;  $\sigma = 1.357$  mho/m;  $\epsilon_r = 39.46$ ;  $\rho = 1000$  kg/m<sup>3</sup>

Ambient Temperature: 22.5°C, Liquid Temperature: 22.3°C

Communication System: LTE1700-FDD66 1745 MHz Duty Cycle: 1:1

Probe: EX3DV4 – SN3846 ConvF(7.47,7.79,8.45)

**Area Scan (71x121x1):** Interpolated grid: dx=1.500 mm, dy=1.500 mm

Maximum value of SAR (interpolated) = 0.381 W/kg

**Zoom Scan (7x7x7)/Cube 0:** Measurement grid: dx=8mm, dy=8mm, dz=5mm

Reference Value = 7.763 V/m; Power Drift = 0.12 dB

Peak SAR (extrapolated) = 0.671 W/kg

**SAR(1 g) = 0.386 W/kg; SAR(10 g) = 0.228 W/kg**

Maximum value of SAR (measured) = 0.391 W/kg

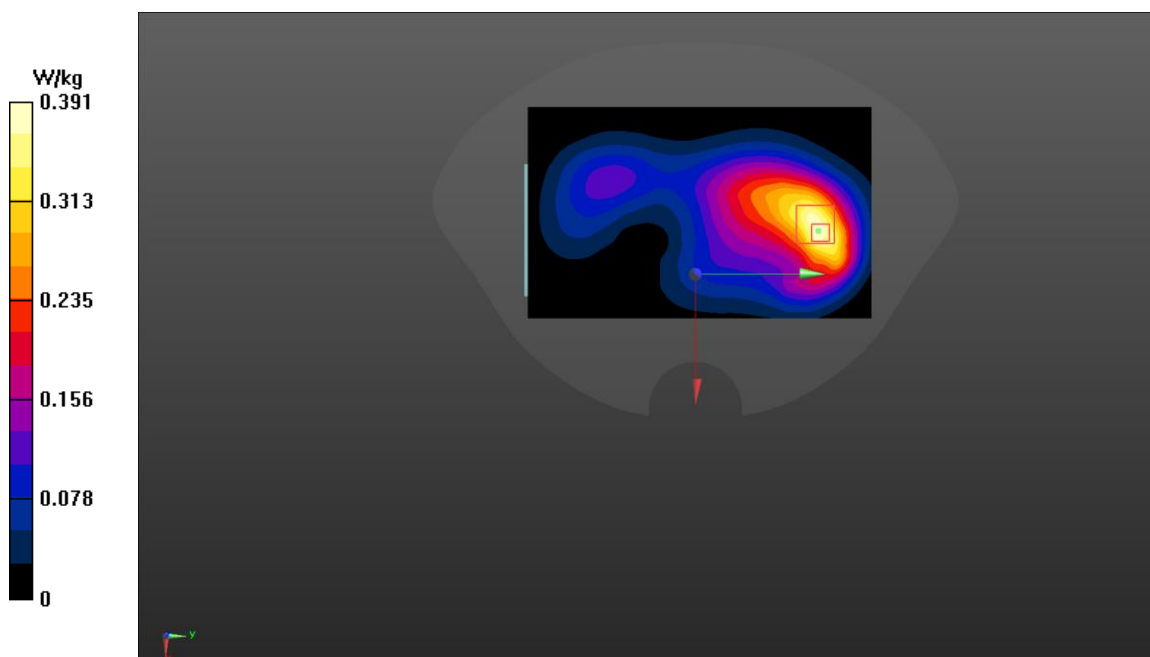

**Fig A.30**

**LTE1700-FDD66\_CH41110 Rear 1RB-Middle 15mm**

Date: 7/25/2023

Electronics: DAE4 Sn549

Medium: body 1800 MHz

Medium parameters used:  $f = 1720$  MHz;  $\sigma = 1.357$  mho/m;  $\epsilon_r = 39.46$ ;  $\rho = 1000$  kg/m<sup>3</sup>

Ambient Temperature: 22.5°C, Liquid Temperature: 22.3°C

Communication System: LTE1700-FDD66 1720 MHz Duty Cycle: 1:1

Probe: EX3DV4 – SN3846 ConvF(7.47,7.79,8.45)

**Area Scan (71x121x1):** Interpolated grid: dx=1.500 mm, dy=1.500 mm

Maximum value of SAR (interpolated) = 0.142 W/kg

**Zoom Scan (7x7x7)/Cube 0:** Measurement grid: dx=8mm, dy=8mm, dz=5mm

Reference Value = 4.68 V/m; Power Drift = 0.12 dB

Peak SAR (extrapolated) = 0.202 W/kg

**SAR(1 g) = 0.134 W/kg; SAR(10 g) = 0.087 W/kg**

Maximum value of SAR (measured) = 0.144 W/kg

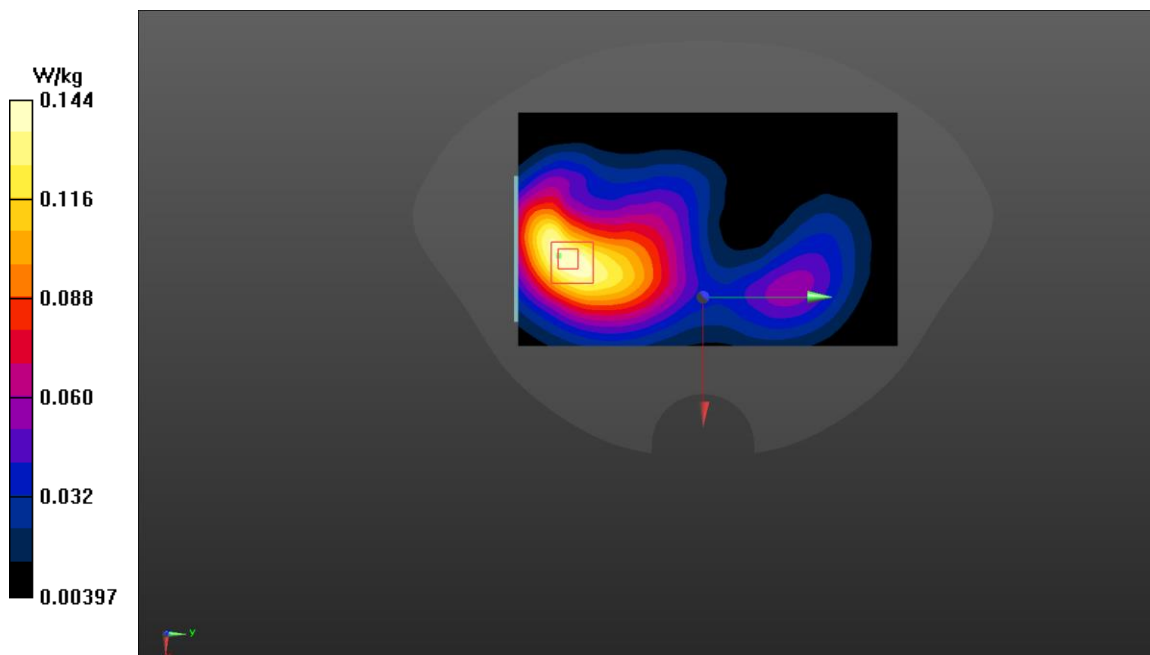

**Fig A.31**

**WLAN2450\_CH11 Left Cheek**

Date: 7/10/2023

Electronics: DAE4 Sn549

Medium: head 2450 MHz

Medium parameters used:  $f = 2462$ ;  $\sigma = 1.811$  mho/m;  $\epsilon_r = 38.57$ ;  $\rho = 1000$  kg/m<sup>3</sup>

Ambient Temperature: 22.5°C, Liquid Temperature: 22.3°C

Communication System: WLAN2450 2462 Duty Cycle: 1:1

Probe: EX3DV4 – SN3846 ConvF(6.80,7.06,7.55)

**Area Scan (71x121x1):** Interpolated grid: dx=1.200 mm, dy=1.200 mm

Maximum value of SAR (interpolated) = 0.971 W/kg

**Zoom Scan (7x7x7)/Cube 0:** Measurement grid: dx=5mm, dy=5mm, dz=5mm

Reference Value = 8.694 V/m; Power Drift = 0.03 dB

Peak SAR (extrapolated) = 1.12 W/kg

**SAR(1 g) = 0.591 W/kg; SAR(10 g) = 0.281 W/kg**

Maximum value of SAR (measured) = 0.929 W/kg

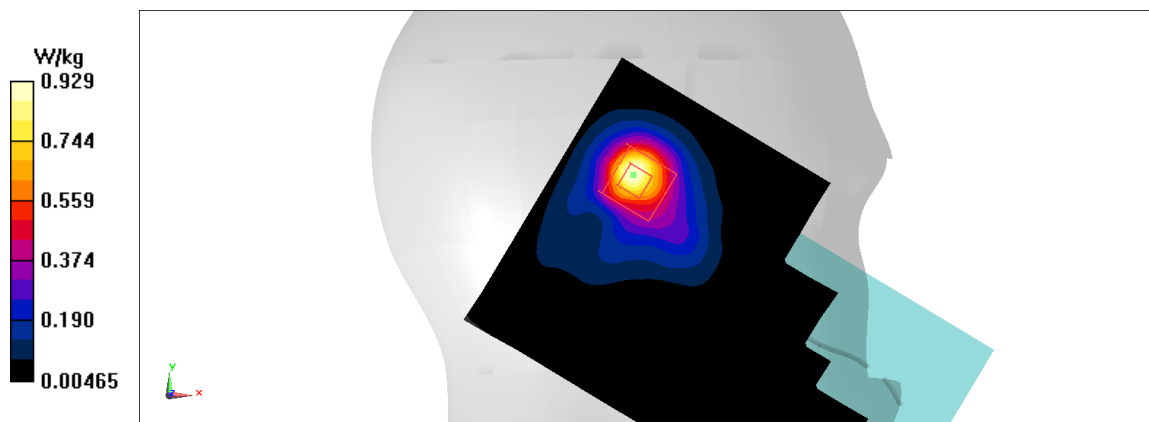

Fig A.32

**WLAN2450\_CH11 Rear 10mm**

Date: 7/10/2023

Electronics: DAE4 Sn549

Medium: body 2450 MHz

Medium parameters used:  $f = 2462$ ;  $\sigma = 1.811$  mho/m;  $\epsilon_r = 38.57$ ;  $\rho = 1000$  kg/m<sup>3</sup>

Ambient Temperature: 22.5°C, Liquid Temperature: 22.3°C

Communication System: WLAN2450 2462 Duty Cycle: 1:1

Probe: EX3DV4 – SN3846 ConvF(6.80,7.06,7.55)

**Area Scan (71x121x1):** Interpolated grid: dx=1.200 mm, dy=1.200 mm

Maximum value of SAR (interpolated) = 0.326 W/kg

**Zoom Scan (7x7x7)/Cube 0:** Measurement grid: dx=5mm, dy=5mm, dz=5mm

Reference Value = 5.509 V/m; Power Drift = -0.13 dB

Peak SAR (extrapolated) = 0.395 W/kg

**SAR(1 g) = 0.19 W/kg; SAR(10 g) = 0.093 W/kg**

Maximum value of SAR (measured) = 0.31 W/kg

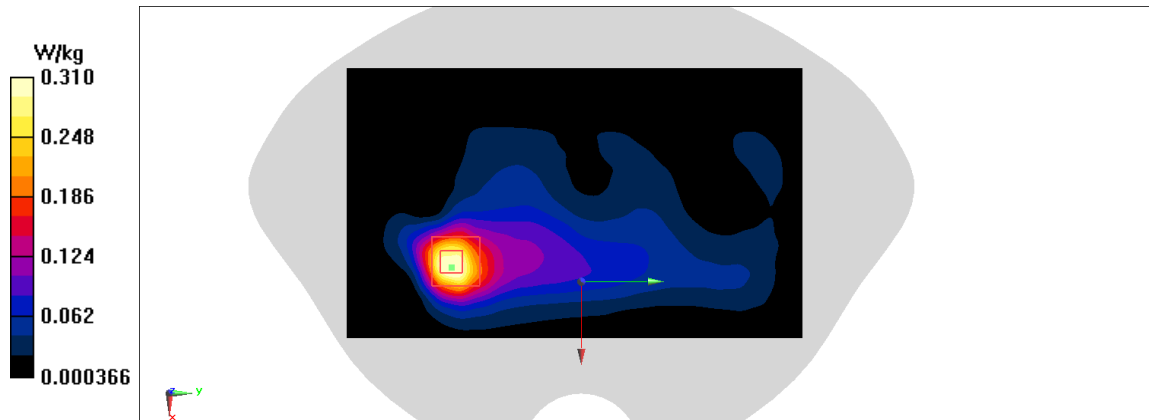
**Fig A.33**

**WLAN2450\_CH11 Left Cheek**

Date: 7/10/2023

Electronics: DAE4 Sn549

Medium: head 2450 MHz

Medium parameters used:  $f = 2462$ ;  $\sigma = 1.811$  mho/m;  $\epsilon_r = 38.57$ ;  $\rho = 1000$  kg/m<sup>3</sup>

Ambient Temperature: 22.5°C, Liquid Temperature: 22.3°C

Communication System: WLAN2450 2462 Duty Cycle: 1:1

Probe: EX3DV4 – SN3846 ConvF(6.80,7.06,7.55)

**Area Scan (71x121x1):** Interpolated grid: dx=1.200 mm, dy=1.200 mm

Maximum value of SAR (interpolated) = 0.593 W/kg

**Zoom Scan (7x7x7)/Cube 0:** Measurement grid: dx=5mm, dy=5mm, dz=5mm

Reference Value = 6.496 V/m; Power Drift = 0.08 dB

Peak SAR (extrapolated) = 0.692 W/kg

**SAR(1 g) = 0.36 W/kg; SAR(10 g) = 0.172 W/kg**

Maximum value of SAR (measured) = 0.566 W/kg

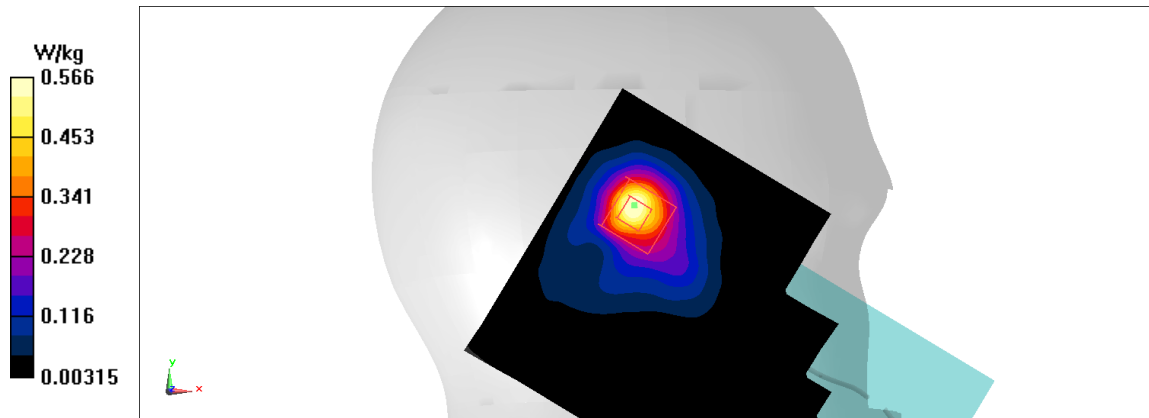

Fig A.34

**WLAN2450\_CH11 Rear 10mm**

Date: 7/10/2023

Electronics: DAE4 Sn549

Medium: body 2450 MHz

Medium parameters used:  $f = 2462$ ;  $\sigma = 1.811$  mho/m;  $\epsilon_r = 38.57$ ;  $\rho = 1000$  kg/m<sup>3</sup>

Ambient Temperature: 22.5°C, Liquid Temperature: 22.3°C

Communication System: WLAN2450 2462 Duty Cycle: 1:1

Probe: EX3DV4 – SN3846 ConvF(6.80,7.06,7.55)

**Area Scan (71x121x1):** Interpolated grid: dx=1.200 mm, dy=1.200 mm

Maximum value of SAR (interpolated) = 0.2 W/kg

**Zoom Scan (7x7x7)/Cube 0:** Measurement grid: dx=5mm, dy=5mm, dz=5mm

Reference Value = 4.356 V/m; Power Drift = -0.15 dB

Peak SAR (extrapolated) = 0.245 W/kg

**SAR(1 g) = 0.116 W/kg; SAR(10 g) = 0.057 W/kg**

Maximum value of SAR (measured) = 0.189 W/kg

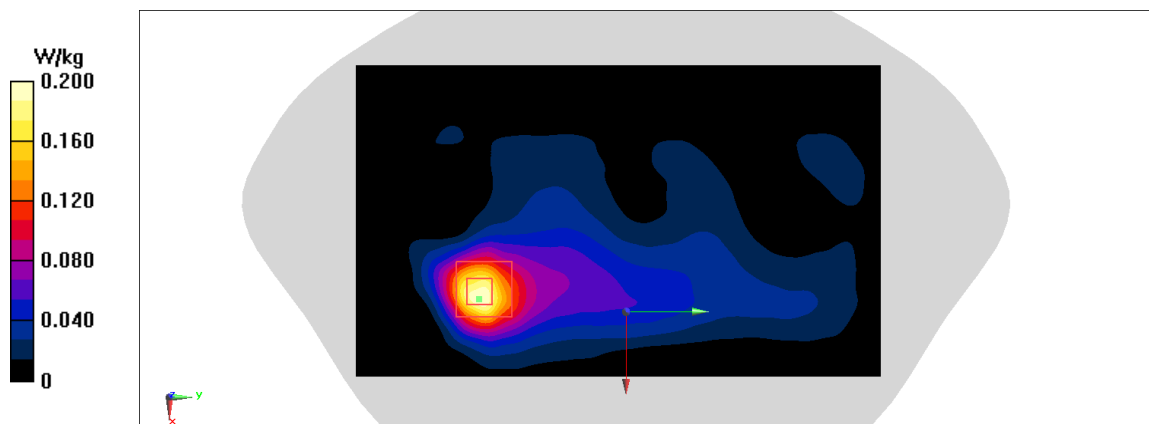

Fig A.35

**WLAN\_CH56 Left Tilt**

Date: 7/18/2023

Electronics: DAE4 Sn549

Medium: head 5G

Medium parameters used:  $f = 5280$ ;  $\sigma = 4.771$  mho/m;  $\epsilon_r = 35.397$ ;  $\rho = 1000$  kg/m<sup>3</sup>

Ambient Temperature: 22.5°C, Liquid Temperature: 22.3°C

Communication System: WLAN 5280 Duty Cycle: 1:1

Probe: EX3DV4 – SN3846 ConvF(5.61,5.61,5.61)

**Area Scan (71x121x1):** Interpolated grid: dx=1.000 mm, dy=1.000 mm

Maximum value of SAR (interpolated) = 1.28 W/kg

**Zoom Scan (7x7x7)/Cube 0:** Measurement grid: dx=4mm, dy=4mm, dz=1.4mm

Reference Value = 6.607 V/m; Power Drift = 0.06 dB

Peak SAR (extrapolated) = 2.01 W/kg

**SAR(1 g) = 0.542 W/kg; SAR(10 g) = 0.173 W/kg**

Maximum value of SAR (measured) = 1.27 W/kg

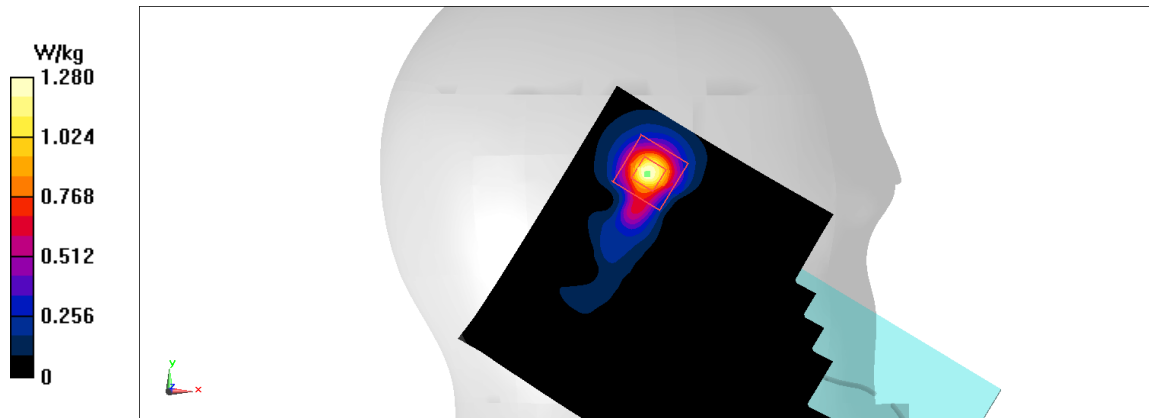

Fig A.36

**WLAN\_CH116 11a-6M Rear 10mm**

Date: 7/18/2023

Electronics: DAE4 Sn549

Medium: body 5G

Medium parameters used:  $f = 5580$ ;  $\sigma = 5.067$  mho/m;  $\epsilon_r = 35.032$ ;  $\rho = 1000$  kg/m<sup>3</sup>

Ambient Temperature: 22.5°C, Liquid Temperature: 22.3°C

Communication System: WLAN 5580 Duty Cycle: 1:1

Probe: EX3DV4 – SN3846 ConvF(4.44,4.64,4.90)

**Area Scan (71x121x1):** Interpolated grid: dx=1.000 mm, dy=1.000 mm

Maximum value of SAR (interpolated) = 1.76 W/kg

**Zoom Scan (7x7x7)/Cube 0:** Measurement grid: dx=4mm, dy=4mm, dz=1.4mm

Reference Value = 2.53 V/m; Power Drift = -0.06 dB

Peak SAR (extrapolated) = 2.81 W/kg

**SAR(1 g) = 0.681 W/kg; SAR(10 g) = 0.225 W/kg**

Maximum value of SAR (measured) = 1.64 W/kg

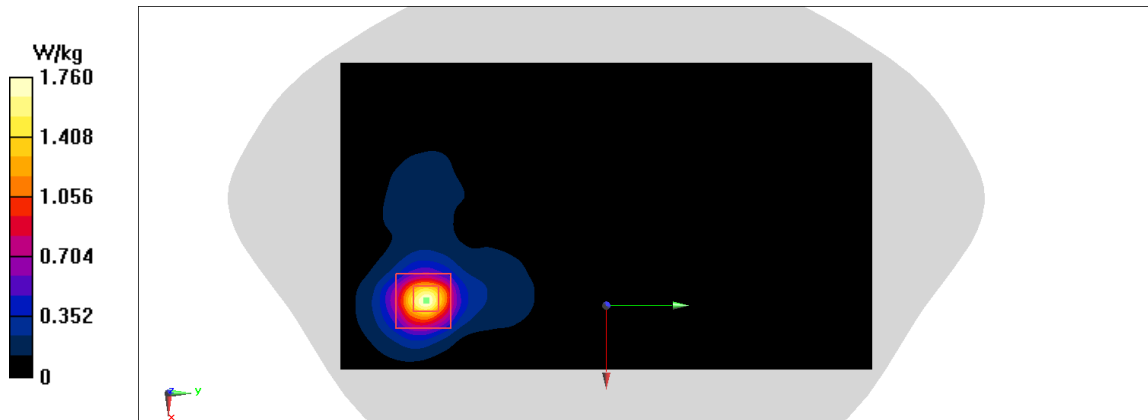

Fig A.37



**WLAN\_CH56 Left Tilt**

Date: 7/18/2023

Electronics: DAE4 Sn549

Medium: head 5G

Medium parameters used:  $f = 5280$ ;  $\sigma = 4.771$  mho/m;  $\epsilon_r = 35.397$ ;  $\rho = 1000$  kg/m<sup>3</sup>

Ambient Temperature: 22.5°C, Liquid Temperature: 22.3°C

Communication System: WLAN 5280 Duty Cycle: 1:1

Probe: EX3DV4 – SN3846 ConvF(5.61,5.61,5.61)

**Area Scan (71x121x1):** Interpolated grid: dx=1.000 mm, dy=1.000 mm

Maximum value of SAR (interpolated) = 0.864 W/kg

**Zoom Scan (7x7x7)/Cube 0:** Measurement grid: dx=4mm, dy=4mm, dz=1.4mm

Reference Value = 5.012 V/m; Power Drift = -0.01 dB

Peak SAR (extrapolated) = 1.34 W/kg

**SAR(1 g) = 0.35 W/kg; SAR(10 g) = 0.107 W/kg**

Maximum value of SAR (measured) = 0.844 W/kg

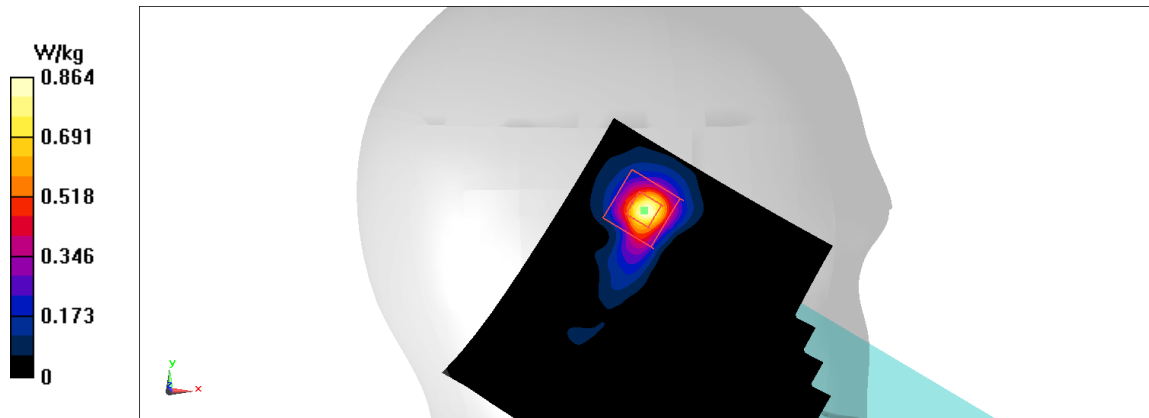

Fig A.38

**WLAN\_CH56 11a-6M Rear 10mm**

Date: 7/18/2023

Electronics: DAE4 Sn549

Medium: body 5G

Medium parameters used:  $f = 5280$ ;  $\sigma = 4.771$  mho/m;  $\epsilon_r = 35.397$ ;  $\rho = 1000$  kg/m<sup>3</sup>

Ambient Temperature: 22.5°C, Liquid Temperature: 22.3°C

Communication System: WLAN 5280 Duty Cycle: 1:1

Probe: EX3DV4 – SN3846 ConvF(5.61,5.61,5.61)

**Area Scan (71x121x1):** Interpolated grid: dx=1.000 mm, dy=1.000 mm

Maximum value of SAR (interpolated) = 0.826 W/kg

**Zoom Scan (7x7x7)/Cube 0:** Measurement grid: dx=4mm, dy=4mm, dz=1.4mm

Reference Value = 2.516 V/m; Power Drift = -0.04 dB

Peak SAR (extrapolated) = 1.36 W/kg

**SAR(1 g) = 0.348 W/kg; SAR(10 g) = 0.116 W/kg**

Maximum value of SAR (measured) = 0.835 W/kg

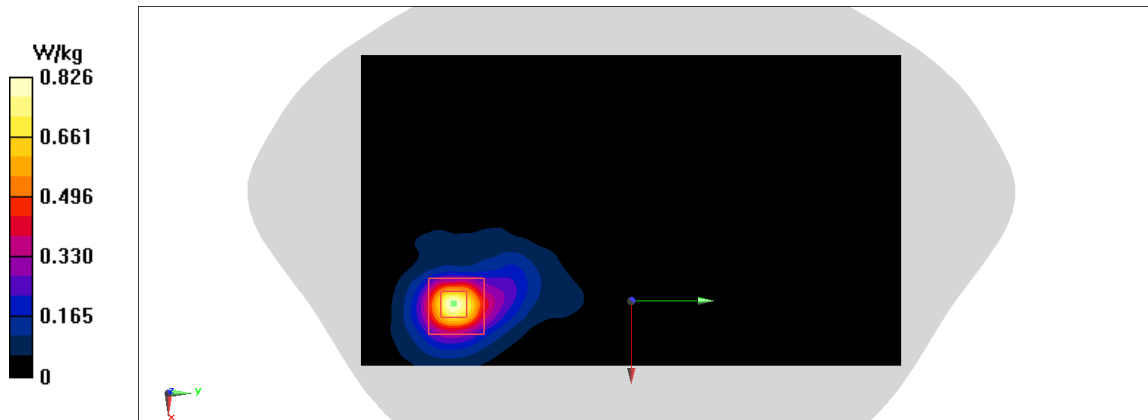
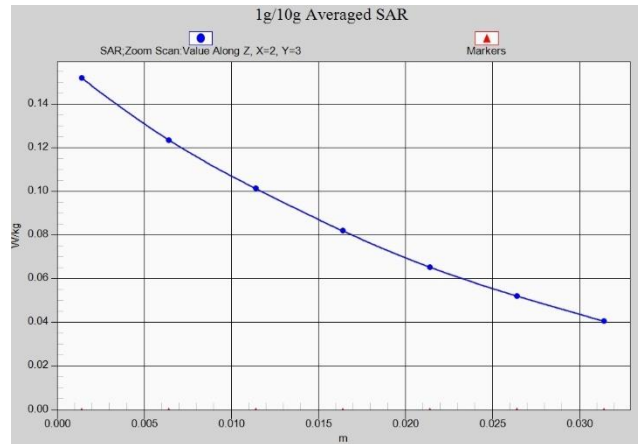
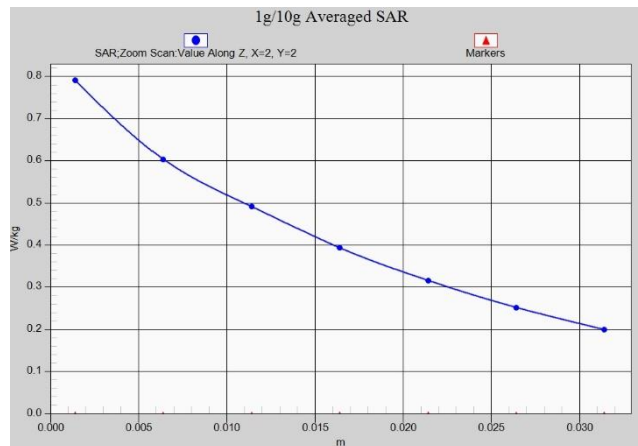

Fig A.39



**Z-Scan at power reference point (850 MHz)**



**Z-Scan at power reference point (850 MHz)**

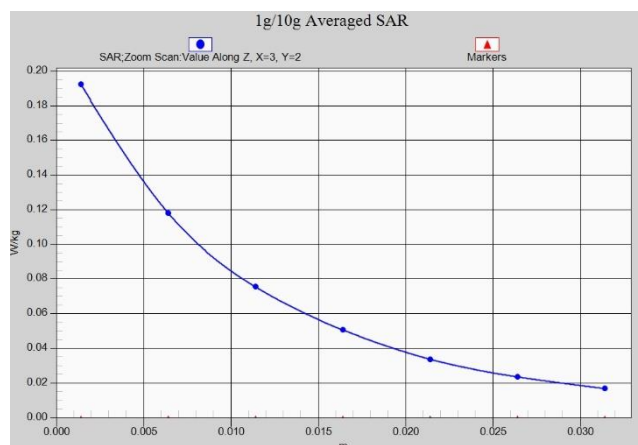

**Z-Scan at power reference point (1900 MHz)**

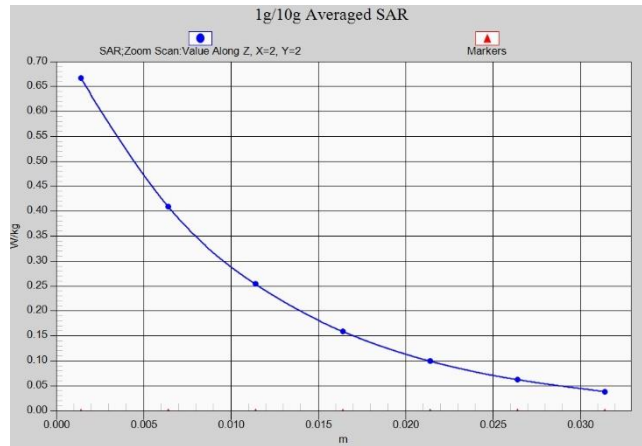

**Z-Scan at power reference point (GSM1900)**



**Z-Scan at power reference point (WCDMA1900)**

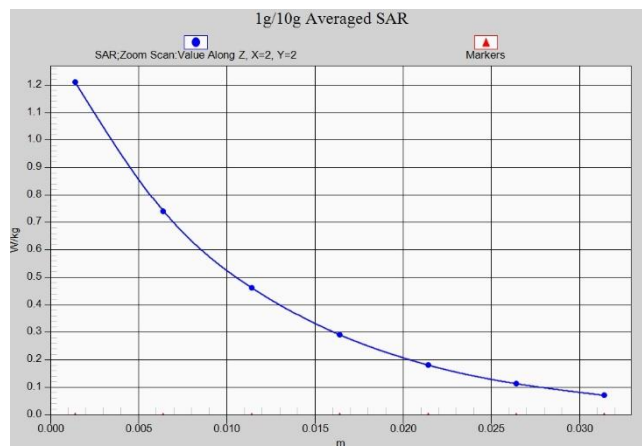

**Z-Scan at power reference point (WCDMA1900)**

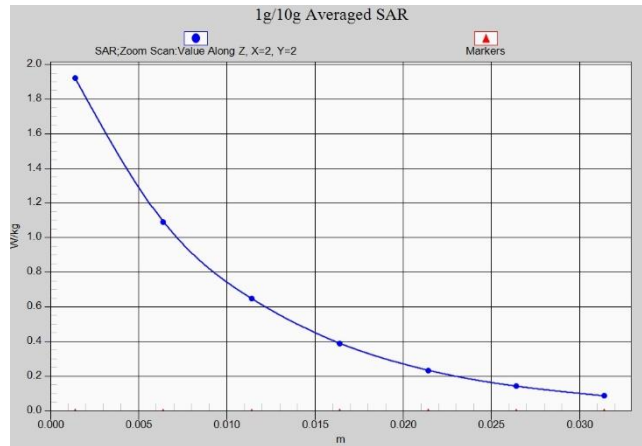

**Z-Scan at power reference point (WCDMA1900)**

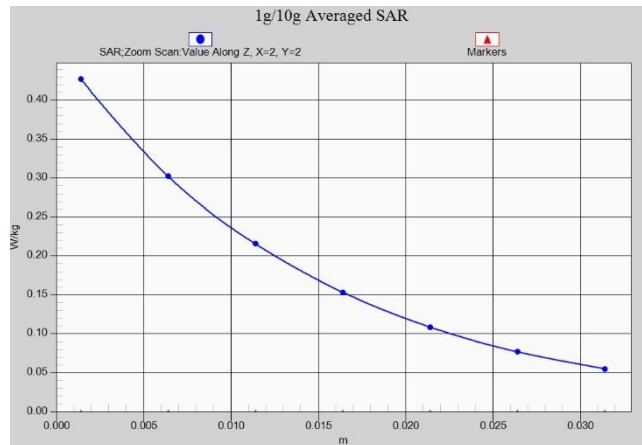

**Z-Scan at power reference point (WCDMA1700)**

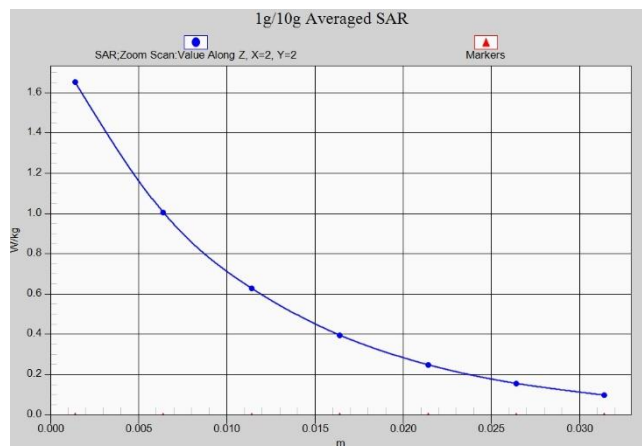

**Z-Scan at power reference point (WCDMA1700)**

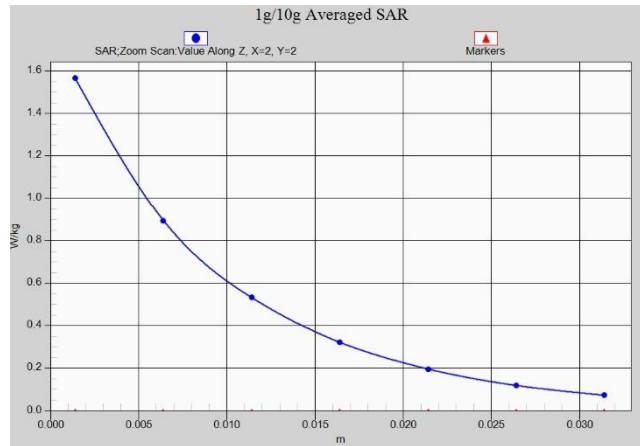

**Z-Scan at power reference point (WCDMA1700)**



**Z-Scan at power reference point (WCDMA850)**

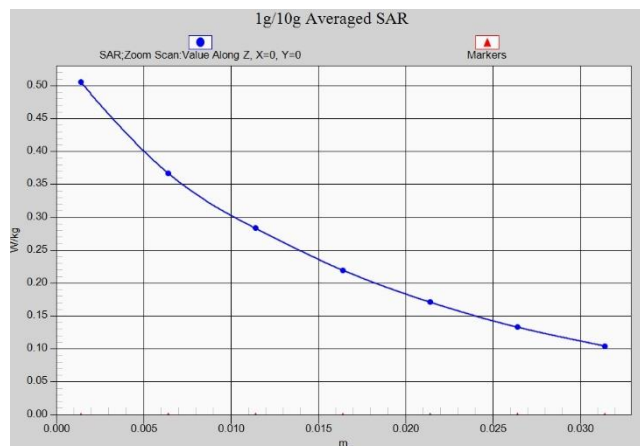

**Z-Scan at power reference point (WCDMA850)**

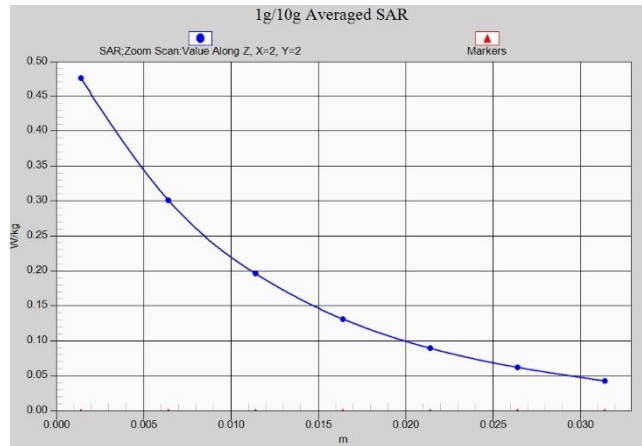

**Z-Scan at power reference point (LTEB2)**

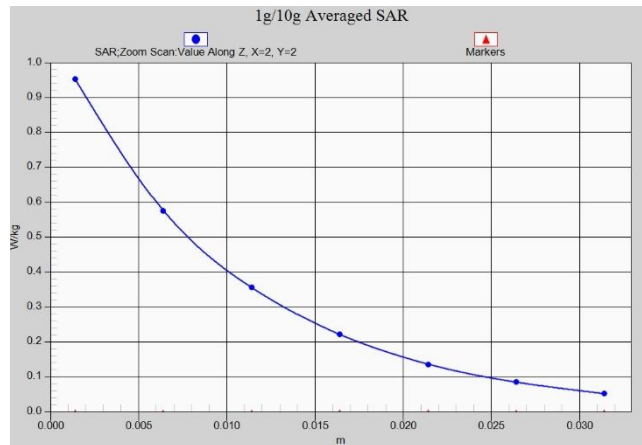

**Z-Scan at power reference point (LTEB2)**

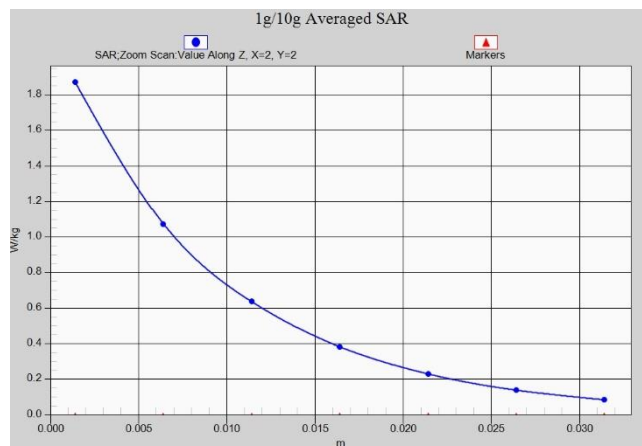

**Z-Scan at power reference point (LTEB2)**

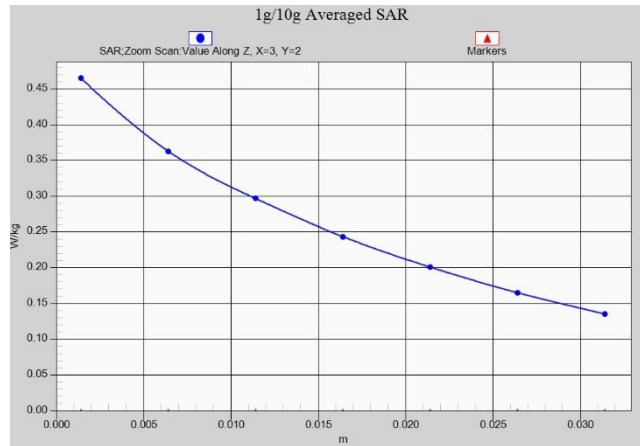

**Z-Scan at power reference point (LTEB5)**

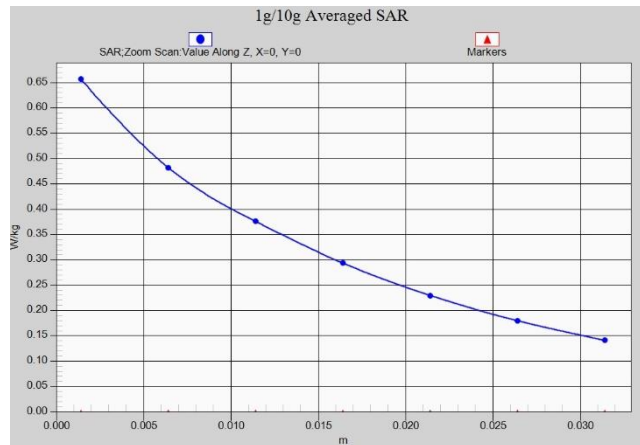

**Z-Scan at power reference point (LTEB5)**

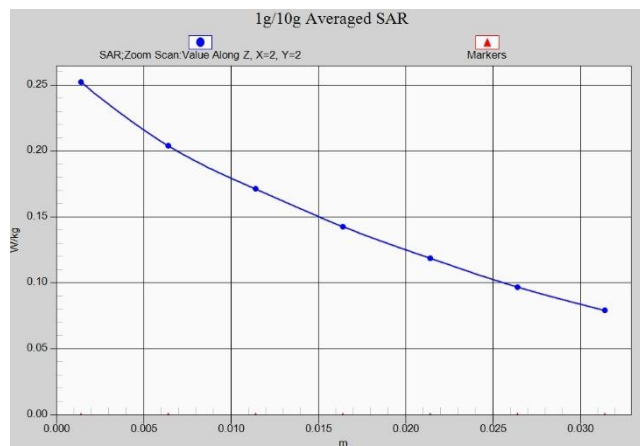

**Z-Scan at power reference point (LTEB12)**



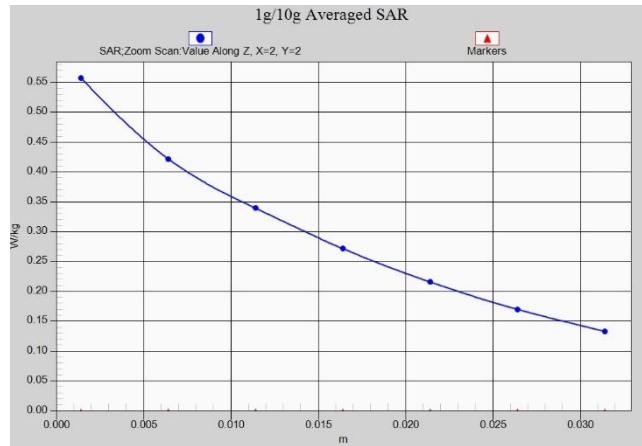

**Z-Scan at power reference point (LTEB12)**



**Z-Scan at power reference point (LTEB13)**

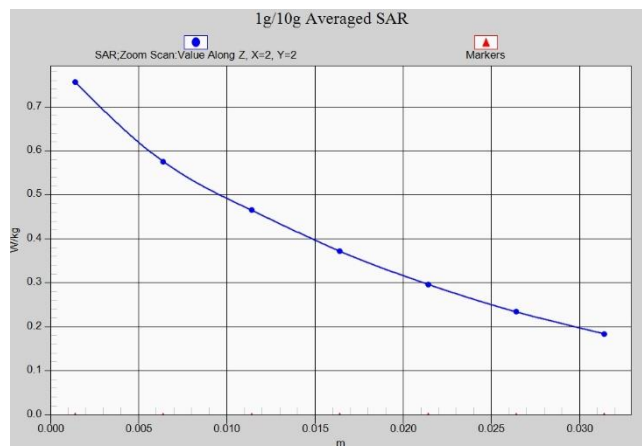

**Z-Scan at power reference point (LTEB13)**

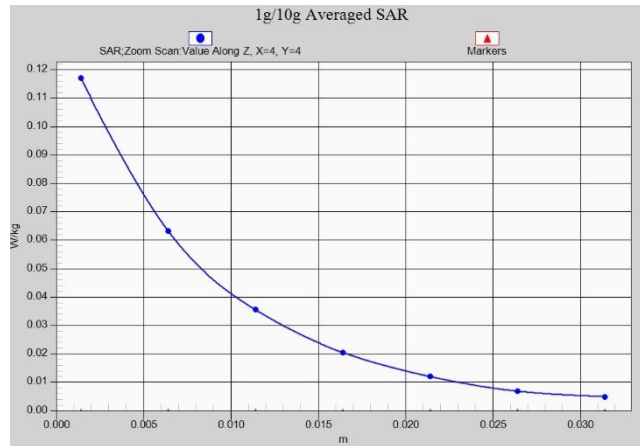

**Z-Scan at power reference point (LTEB41)**

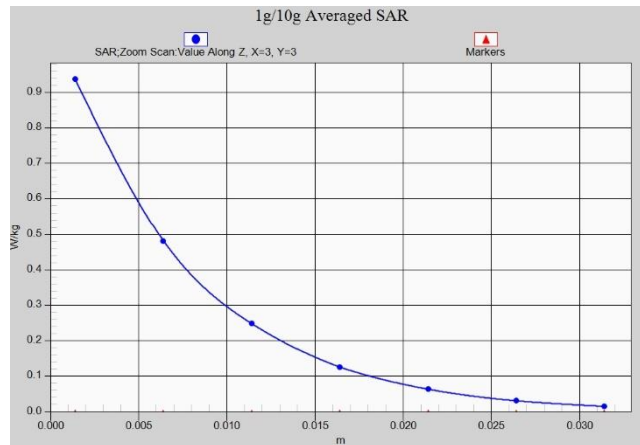

**Z-Scan at power reference point (LTEB41)**

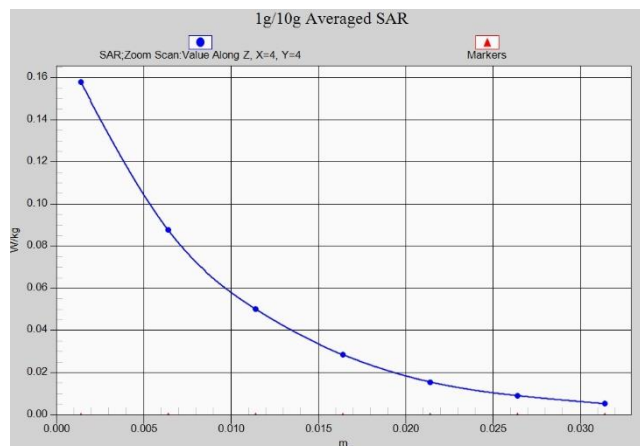

**Z-Scan at power reference point (LTEB41)**

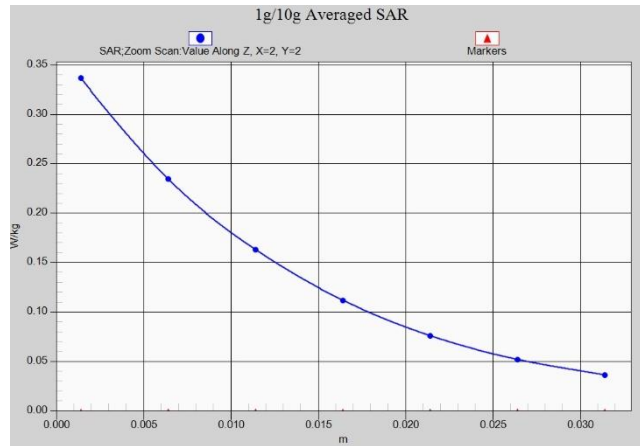

**Z-Scan at power reference point (LTEB66)**

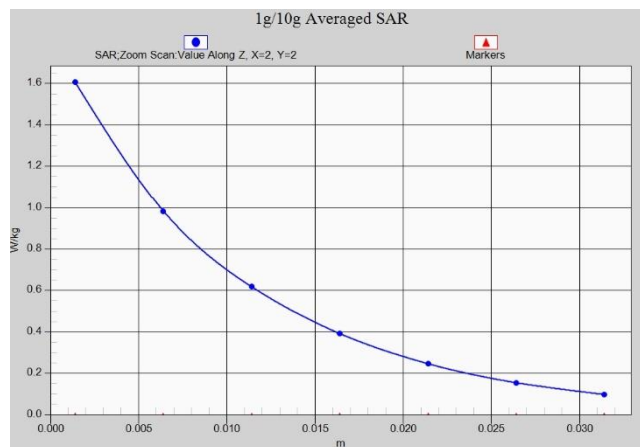

**Z-Scan at power reference point (LTEB66)**

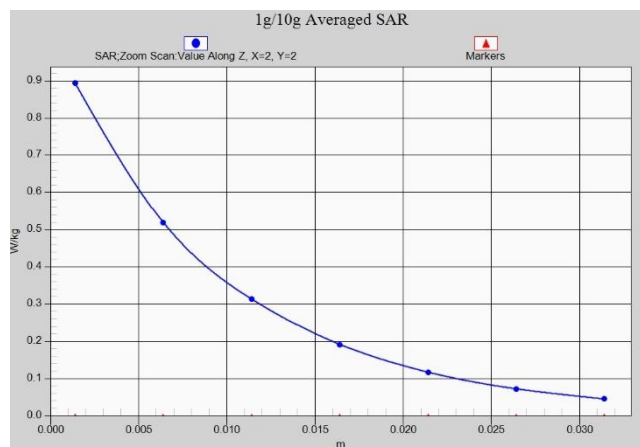

**Z-Scan at power reference point (LTEB66)**

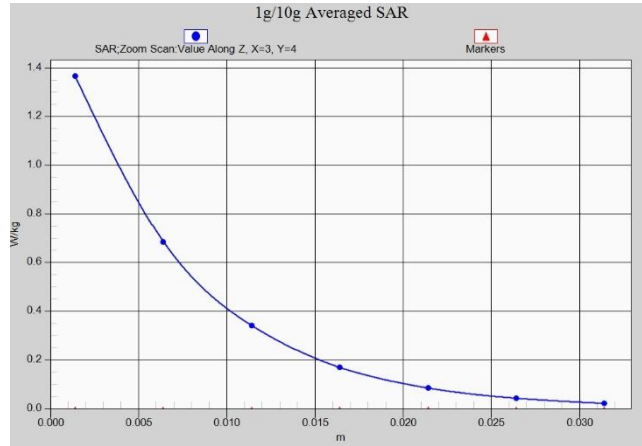

**Z-Scan at power reference point (WiFi2.4G)**

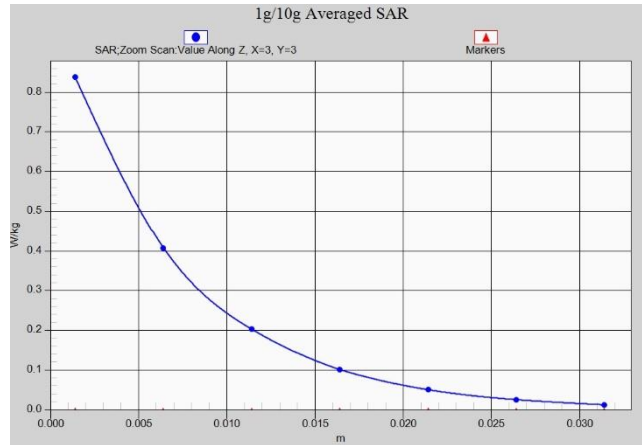

**Z-Scan at power reference point (WiFi2.4G)**

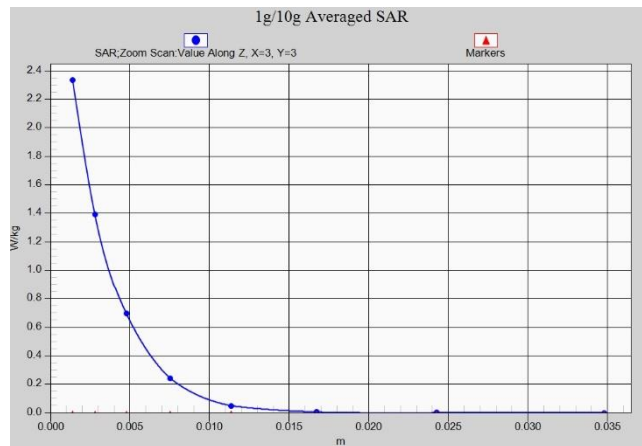

**Z-Scan at power reference point (WiFi5G)**

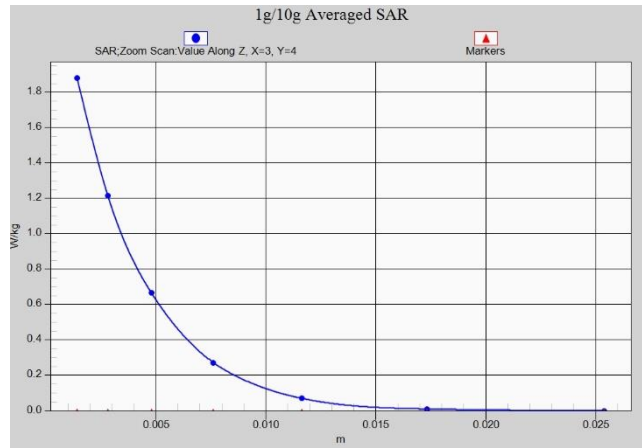

**Z-Scan at power reference point (WIFI5G)**

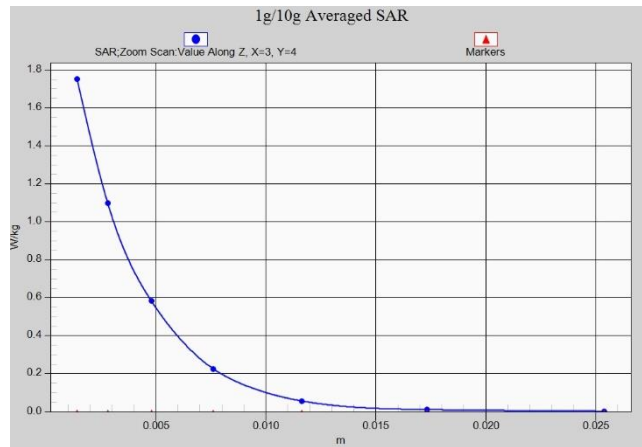

**Z-Scan at power reference point (WIFI5G)**

## ANNEX B System Verification Results

### 750 MHz

Date: 2023/7/23

Electronics: DAE4 Sn549

Medium: Head 750 MHz

Medium parameters used:  $f=750$  MHz;  $\sigma=0.897$  mho/m;  $\epsilon_r=42.07$ ;  $\rho=1000$  kg/m<sup>3</sup>

Ambient Temperature: 22.5°C Liquid Temperature: 22.3°C

Communication System: CW Frequency: 750 MHz Duty Cycle: 1:1

Probe: EX3DV4 – SN3846 ConvF(8.98,8.99,10.08)

**System Validation /Area Scan (81x191x1):** Interpolated grid: dx=1.500 mm, dy=1.500 mm

Reference Value = 58.99 V/m; Power Drift = -0.1

**Fast SAR: SAR(1 g) = 2.08 W/kg; SAR(10 g) = 1.4 W/kg**

Maximum value of SAR (interpolated) = 2.81 W/kg

**System Validation /Zoom Scan (7x7x7)/Cube 0:** Measurement grid: dx=8mm, dy=8mm, dz=5mm

Reference Value =58.99 V/m; Power Drift = -0.1 dB

Peak SAR (extrapolated) = 3.3 W/kg

**SAR(1 g) = 2.11 W/kg; SAR(10 g) = 1.4 W/kg**

Maximum value of SAR (measured) = 2.92 W/kg

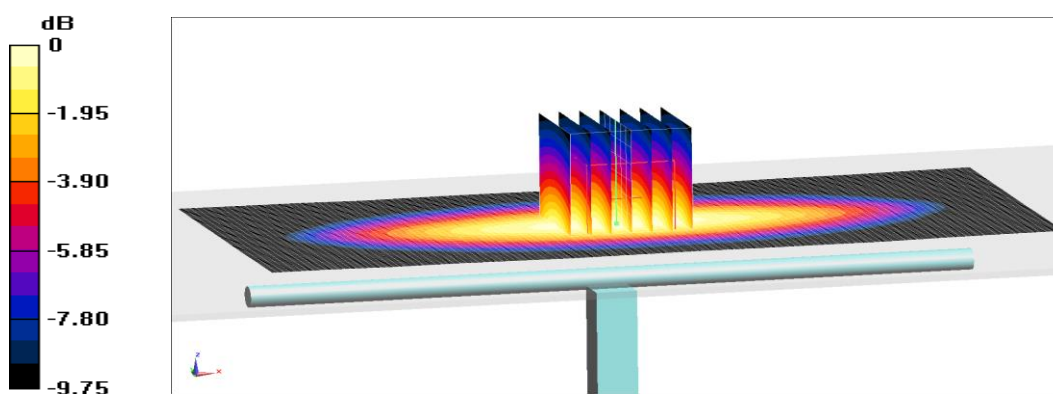

0 dB = 2.92 W/kg = 4.65 dB W/kg

**Fig.B.1 validation 750 MHz 250mW**

## 835 MHz

Date: 2023/7/24

Electronics: DAE4 Sn549

Medium: Head 835 MHz

Medium parameters used:  $f = 835 \text{ MHz}$ ;  $\sigma = 0.884 \text{ mho/m}$ ;  $\epsilon_r = 41.45$ ;  $\rho = 1000 \text{ kg/m}^3$

Ambient Temperature:  $22.5^\circ\text{C}$  Liquid Temperature:  $22.3^\circ\text{C}$

Communication System: CW Frequency: 835 MHz Duty Cycle: 1:1

Probe: EX3DV4 – SN3846 ConvF(8.50,9.01,9.47)

**System Validation /Area Scan (81x191x1):** Interpolated grid:  $dx=1.500 \text{ mm}$ ,  
 $dy=1.500 \text{ mm}$

Reference Value =  $63.45 \text{ V/m}$ ; Power Drift =  $-0.05$

**Fast SAR: SAR(1 g) =  $2.41 \text{ W/kg}$ ; SAR(10 g) =  $1.59 \text{ W/kg}$**

Maximum value of SAR (interpolated) =  $3.2 \text{ W/kg}$

**System Validation /Zoom Scan (7x7x7)/Cube 0:** Measurement grid:  $dx=8\text{mm}$ ,  
 $dy=8\text{mm}$ ,  $dz=5\text{mm}$

Reference Value =  $63.45 \text{ V/m}$ ; Power Drift =  $-0.05 \text{ dB}$

Peak SAR (extrapolated) =  $3.7 \text{ W/kg}$

**SAR(1 g) =  $2.42 \text{ W/kg}$ ; SAR(10 g) =  $1.55 \text{ W/kg}$**

Maximum value of SAR (measured) =  $3.21 \text{ W/kg}$

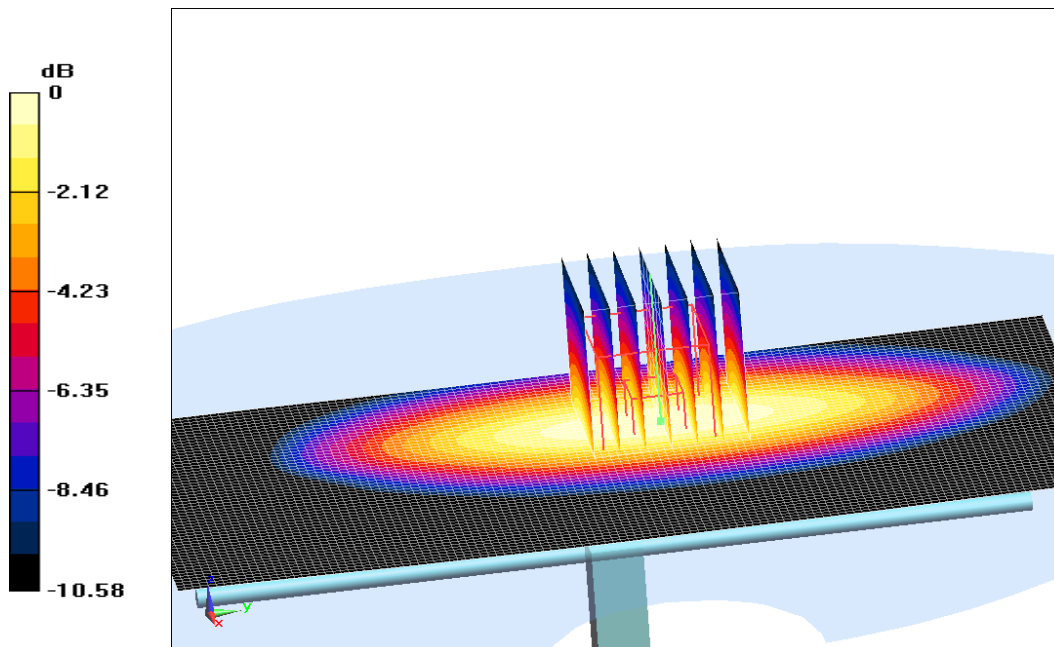

0 dB =  $3.21 \text{ W/kg}$  =  $5.07 \text{ dB W/kg}$

**Fig.B.2 validation 835 MHz 250mW**

## 1800 MHz

Date: 2023/7/25

Electronics: DAE4 Sn549

Medium: Head 1800 MHz

Medium parameters used:  $f = 1800$  MHz;  $\sigma = 1.374$  mho/m;  $\epsilon_r = 39.44$ ;  $\rho = 1000$  kg/m<sup>3</sup>

Ambient Temperature: 22.5°C Liquid Temperature: 22.3°C

Communication System: CW Frequency: 1800 MHz Duty Cycle: 1:1

Probe: EX3DV4 – SN3846 ConvF(7.47,7.79,8.45)

**System Validation /Area Scan (81x191x1):** Interpolated grid:  $dx=1.500$  mm,  $dy=1.500$  mm

Reference Value = 105.19 V/m; Power Drift = -0.04

**Fast SAR: SAR(1 g) = 9.3 W/kg; SAR(10 g) = 4.73 W/kg**

Maximum value of SAR (interpolated) = 14.12 W/kg

**System Validation /Zoom Scan (7x7x7)/Cube 0:** Measurement grid:  $dx=8$ mm,  $dy=8$ mm,  $dz=5$ mm

Reference Value = 105.19 V/m; Power Drift = -0.04 dB

Peak SAR (extrapolated) = 16.67 W/kg

**SAR(1 g) = 9 W/kg; SAR(10 g) = 4.76 W/kg**

Maximum value of SAR (measured) = 14.22 W/kg

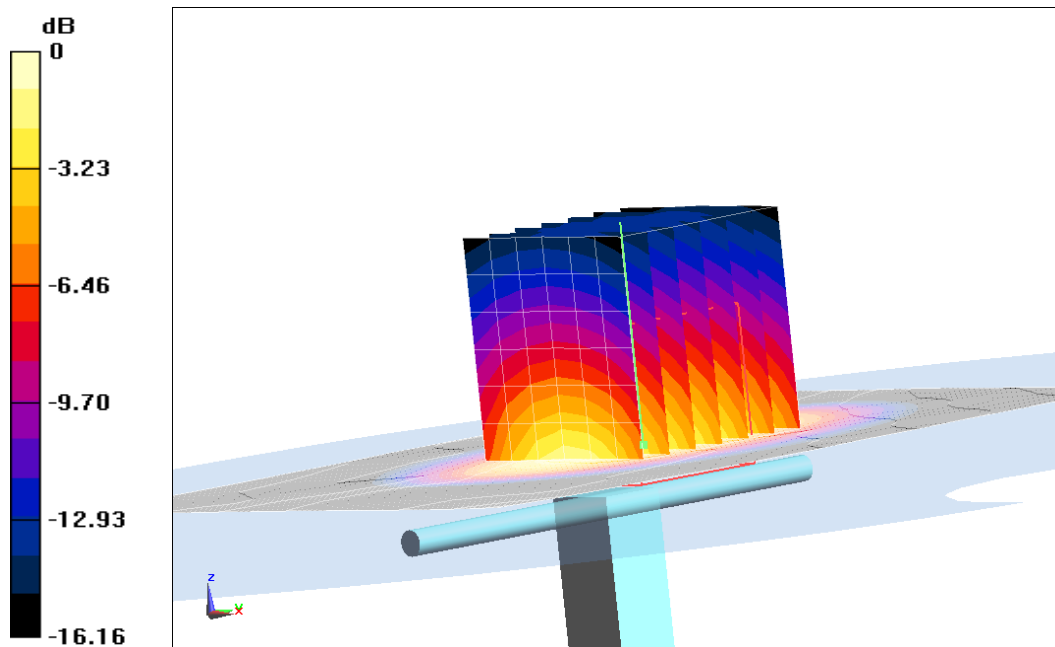

0 dB = 14.22 W/kg = 11.53 dB W/kg

**Fig.B.3 validation 1800 MHz 250mW**



## 1900 MHz

Date: 2023/7/26

Electronics: DAE4 Sn549

Medium: Head 1900 MHz

Medium parameters used:  $f = 1900$  MHz;  $\sigma = 1.382$  mho/m;  $\epsilon_r = 39.33$ ;  $\rho = 1000$  kg/m<sup>3</sup>

Ambient Temperature: 22.5°C Liquid Temperature: 22.3°C

Communication System: CW Frequency: 1900 MHz Duty Cycle: 1:1

Probe: EX3DV4 – SN3846 ConvF(7.27,7.55,8.11)

**System Validation /Area Scan (81x191x1):** Interpolated grid: dx=1.500 mm, dy=1.500 mm

Reference Value = 110.67 V/m; Power Drift = 0.06

**Fast SAR: SAR(1 g) = 9.95 W/kg; SAR(10 g) = 5.14 W/kg**

Maximum value of SAR (interpolated) = 15.41 W/kg

**System Validation /Zoom Scan (7x7x7)/Cube 0:** Measurement grid: dx=8mm, dy=8mm, dz=5mm

Reference Value = 110.67 V/m; Power Drift = 0.06 dB

Peak SAR (extrapolated) = 18.05 W/kg

**SAR(1 g) = 9.92 W/kg; SAR(10 g) = 5.24 W/kg**

Maximum value of SAR (measured) = 14.91 W/kg

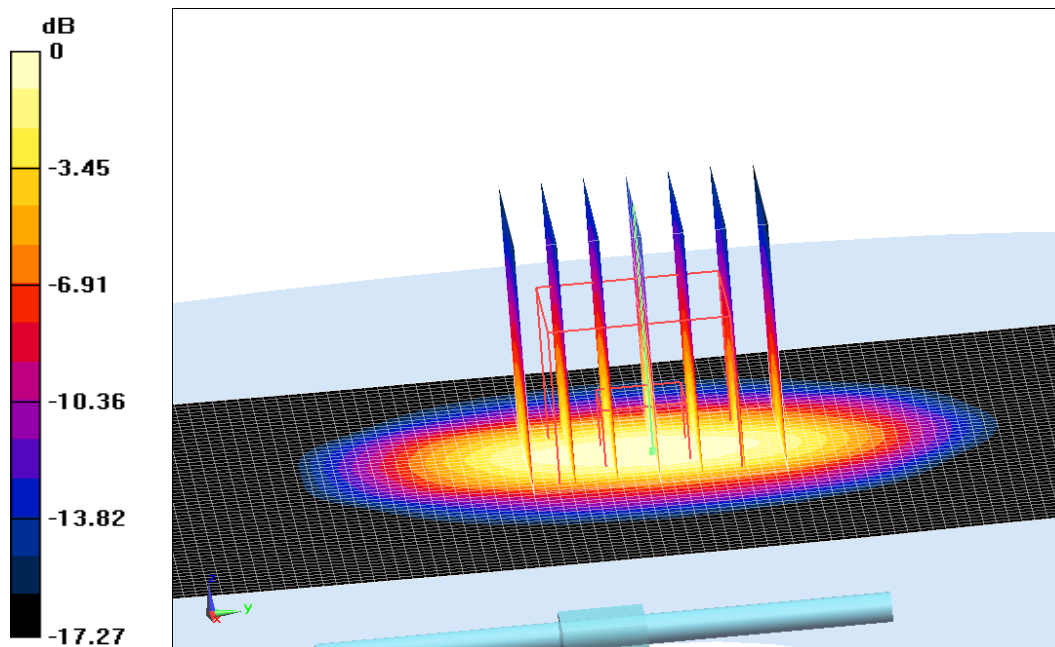

0 dB = 14.91 W/kg = 11.73 dB W/kg

**Fig.B.4 validation 1900 MHz 250mW**

## 2600 MHz

Date: 2023/7/10

Electronics: DAE4 Sn549

Medium: Head 2600 MHz

Medium parameters used:  $f = 2600$  MHz;  $\sigma = 1.974$  mho/m;  $\epsilon_r = 39.03$ ;  $\rho = 1000$  kg/m<sup>3</sup>

Ambient Temperature: 22.5°C Liquid Temperature: 22.3°C

Communication System: CW Frequency: 2600 MHz Duty Cycle: 1:1

Probe: EX3DV4 – SN3846 ConvF(6.72,7.04,7.50)

**System Validation /Area Scan (81x191x1):** Interpolated grid: dx=1.200 mm, dy=1.200 mm

Reference Value = 120.49 V/m; Power Drift = -0.05

**Fast SAR: SAR(1 g) = 14 W/kg; SAR(10 g) = 6.29 W/kg**

Maximum value of SAR (interpolated) = 24.74 W/kg

**System Validation /Zoom Scan (7x7x7)/Cube 0:** Measurement grid: dx=5mm, dy=5mm, dz=5mm

Reference Value = 120.49 V/m; Power Drift = -0.05 dB

Peak SAR (extrapolated) = 29 W/kg

**SAR(1 g) = 14.05 W/kg; SAR(10 g) = 6.26 W/kg**

Maximum value of SAR (measured) = 24.44 W/kg

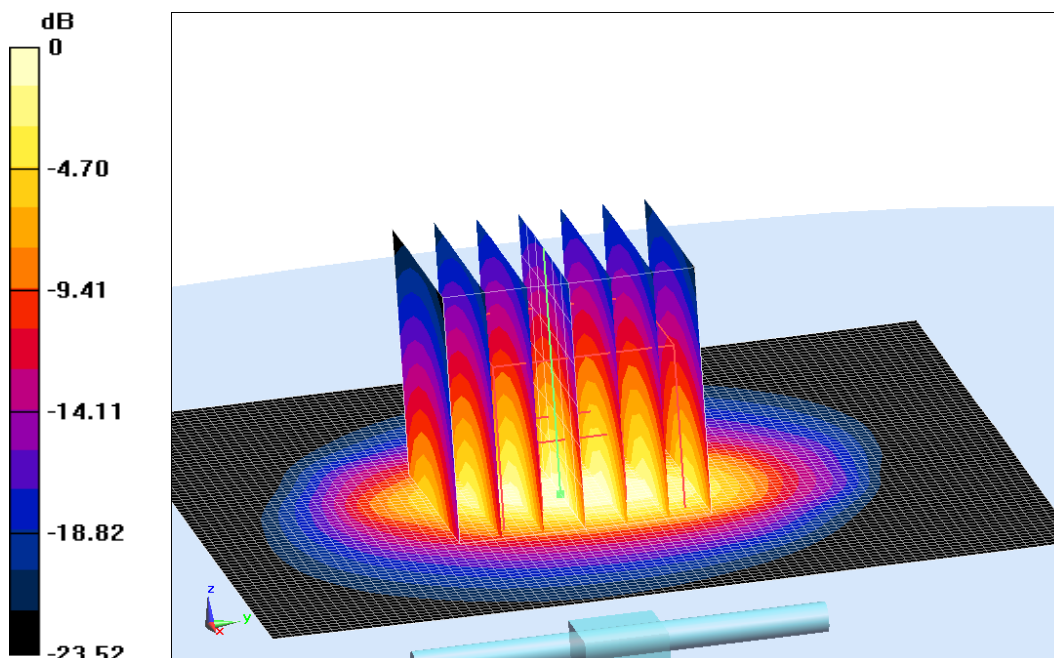

0 dB = 24.44 W/kg = 13.88 dB W/kg

**Fig.B.5 validation 2600 MHz 250mW**

## 2450 MHz

Date: 7/18/2023

Electronics: DAE4 Sn777

Medium: Head 2450 MHz

Medium parameters used:  $f = 2450 \text{ MHz}$ ;  $\sigma = 1.815 \text{ mho/m}$ ;  $\epsilon_r = 39.32$ ;  $\rho = 1000 \text{ kg/m}^3$

Ambient Temperature:  $22.5^\circ\text{C}$  Liquid Temperature:  $22.3^\circ\text{C}$

Communication System: CW Frequency: 2450 MHz Duty Cycle: 1:1

Probe: EX3DV4 – SN3846 ConvF(6.80,7.06,7.55)

**System Validation /Area Scan (81x191x1):** Interpolated grid:  $dx=1.200 \text{ mm}$ ,  
 $dy=1.200 \text{ mm}$

Reference Value =  $117.26 \text{ V/m}$ ; Power Drift =  $-0.1$

Fast SAR: SAR(1 g) =  $12.89 \text{ W/kg}$ ; SAR(10 g) =  $6.21 \text{ W/kg}$

Maximum value of SAR (interpolated) =  $21.73 \text{ W/kg}$

**System Validation /Zoom Scan (7x7x7)/Cube 0:** Measurement grid:  $dx=5\text{mm}$ ,  
 $dy=5\text{mm}$ ,  $dz=5\text{mm}$

Reference Value =  $117.26 \text{ V/m}$ ; Power Drift =  $-0.1 \text{ dB}$

Peak SAR (extrapolated) =  $26.53 \text{ W/kg}$

**SAR(1 g) =  $13.06 \text{ W/kg}$ ; SAR(10 g) =  $6.22 \text{ W/kg}$**

Maximum value of SAR (measured) =  $22.19 \text{ W/kg}$

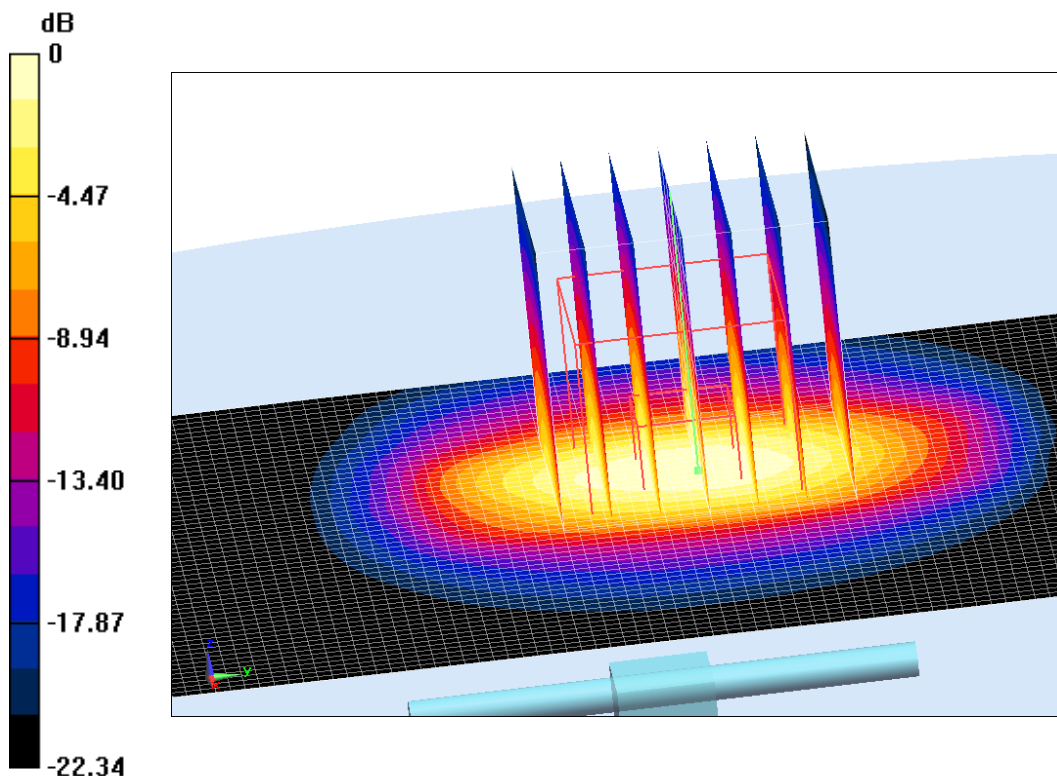

$0 \text{ dB} = 22.19 \text{ W/kg} = 13.46 \text{ dB W/kg}$

**Fig.B.6 validation 2450 MHz 250mW**

## 5250 MHz

Date: 7/19/2023

Electronics: DAE4 Sn777

Medium: Head 5250 MHz

Medium parameters used:  $f = 5250$  MHz;  $\sigma = 4.626$  mho/m;  $\epsilon_r = 35.89$ ;  $\rho = 1000$  kg/m<sup>3</sup>

Ambient Temperature: 22.5°C Liquid Temperature: 22.3°C

Communication System: CW Frequency: 5250 MHz Duty Cycle: 1:1

Probe: EX3DV4 – SN3846 ConvF(5.05,5.27,5.51)

**System Validation /Area Scan (81x191x1):** Interpolated grid: dx=1.000 mm, dy=1.000 mm

Maximum value of SAR (interpolated) = 18.4 W/kg

**System Validation /Zoom Scan (7x7x7)/Cube 0:** Measurement grid: dx=4mm, dy=4mm, dz=1.4mm

Reference Value =79.46 V/m; Power Drift = -0.05 dB

Peak SAR (extrapolated) = 28.57 W/kg

**SAR(1 g) = 20.28 W/kg; SAR(10 g) = 5.67 W/kg**

Maximum value of SAR (measured) = 18.11 W/kg

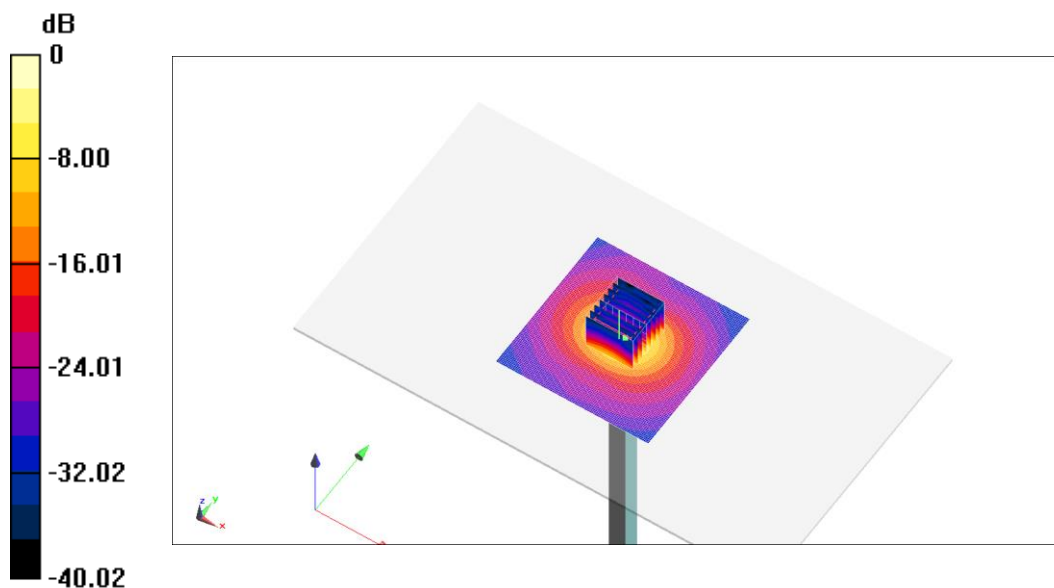

0 dB = 18.11 W/kg = 12.58 dB W/kg

**Fig.B.7 validation 5250 MHz 100mW**

## 5600 MHz

Date: 7/20/2023

Electronics: DAE4 Sn777

Medium: Head 5600 MHz

Medium parameters used:  $f = 5600 \text{ MHz}$ ;  $\sigma = 5.085 \text{ mho/m}$ ;  $\epsilon_r = 34.97$ ;  $\rho = 1000 \text{ kg/m}^3$

Ambient Temperature:  $22.5^\circ\text{C}$  Liquid Temperature:  $22.3^\circ\text{C}$

Communication System: CW Frequency: 5600 MHz Duty Cycle: 1:1

Probe: EX3DV4 – SN3846 ConvF(4.27,4.47,4.70)

**System Validation /Area Scan (81x191x1):** Interpolated grid:  $dx=1.000 \text{ mm}$ ,  
 $dy=1.000 \text{ mm}$

Maximum value of SAR (interpolated) =  $20.09 \text{ W/kg}$

**System Validation /Zoom Scan (7x7x7)/Cube 0:** Measurement grid:  $dx=4\text{mm}$ ,  
 $dy=4\text{mm}$ ,  $dz=1.4\text{mm}$

Reference Value =  $78.21 \text{ V/m}$ ; Power Drift =  $-0.04 \text{ dB}$

Peak SAR (extrapolated) =  $31.35 \text{ W/kg}$

**SAR(1 g) =  $20.54 \text{ W/kg}$ ; SAR(10 g) =  $5.88 \text{ W/kg}$**

Maximum value of SAR (measured) =  $20.37 \text{ W/kg}$

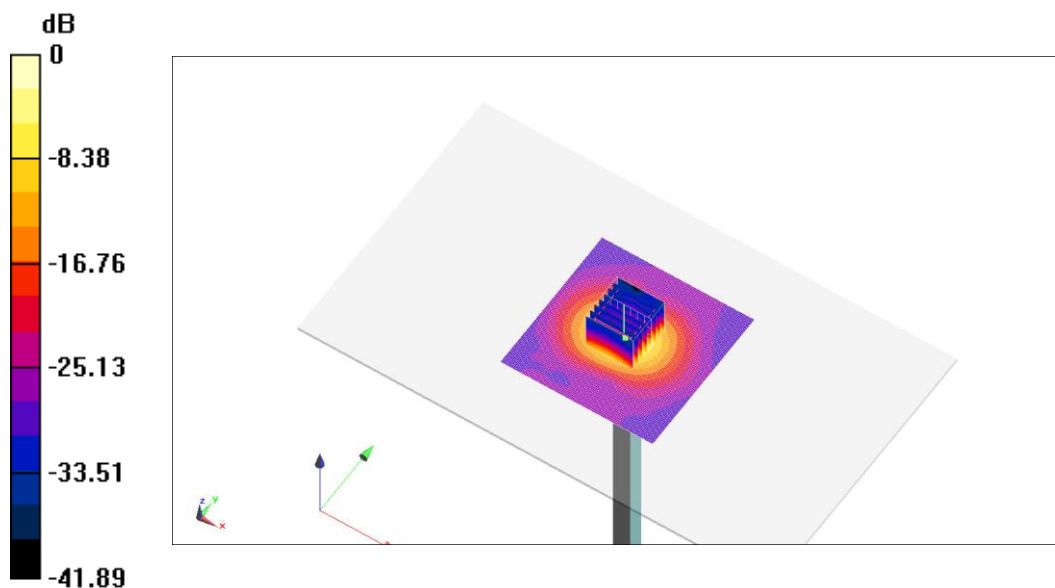

$0 \text{ dB} = 20.37 \text{ W/kg} = 13.09 \text{ dB W/kg}$

**Fig.B.8 validation 5600 MHz 100mW**

## 5750 MHz

Date: 7/21/2023

Electronics: DAE4 Sn777

Medium: Head 5750 MHz

Medium parameters used:  $f = 5750 \text{ MHz}$ ;  $\sigma = 5.154 \text{ mho/m}$ ;  $\epsilon_r = 34.77$ ;  $\rho = 1000 \text{ kg/m}^3$

Ambient Temperature:  $22.5^\circ\text{C}$  Liquid Temperature:  $22.3^\circ\text{C}$

Communication System: CW Frequency: 5750 MHz Duty Cycle: 1:1

Probe: EX3DV4 – SN3846 ConvF(4.54,4.76,4.98)

**System Validation /Area Scan (81x191x1):** Interpolated grid:  $dx=1.000 \text{ mm}$ ,  
 $dy=1.000 \text{ mm}$

Maximum value of SAR (interpolated) = 20.15 W/kg

**System Validation /Zoom Scan (7x7x7)/Cube 0:** Measurement grid:  $dx=4\text{mm}$ ,  
 $dy=4\text{mm}$ ,  $dz=1.4\text{mm}$

Reference Value = 76.92 V/m; Power Drift = 0.06 dB

Peak SAR (extrapolated) = 31.83 W/kg

**SAR(1 g) = 20.15 W/kg; SAR(10 g) = 5.77 W/kg**

Maximum value of SAR (measured) = 19.52 W/kg

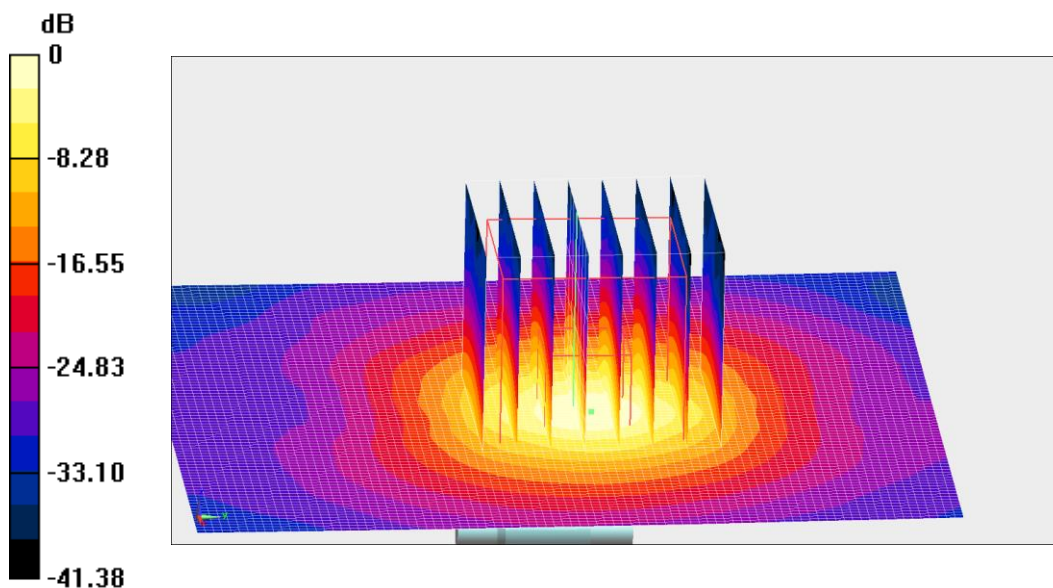

0 dB = 19.52 W/kg = 12.9 dB W/kg

**Fig.B.9 validation 5750 MHz 100mW**

The SAR system verification must be required that the area scan estimated 1-g SAR is within 3% of the zoom scan 1-g SAR.

**Table B.1 Comparison between area scan and zoom scan for system verification**

<b>Date</b>	<b>Band</b>	<b>Position</b>	<b>Area scan (1g)</b>	<b>Zoom scan (1g)</b>	<b>Drift (%)</b>
2023/7/23	750 MHz	Head	2.08	2.11	-1.42%
2023/7/24	835 MHz	Head	2.41	2.42	-0.41%
2023/7/25	1800 MHz	Head	9.3	9.1	2.20%
2023/7/26	1900 MHz	Head	9.95	9.92	0.30%
2023/7/10	2600 MHz	Head	14	14.05	-0.36%
2023/7/18	2450 MHz	Head	13.01	12.89	-0.9%



## ANNEX C SAR Measurement Setup

### C.1 Measurement Set-up

The Dasy4 or DASY5 system for performing compliance tests is illustrated above graphically. This system consists of the following items:

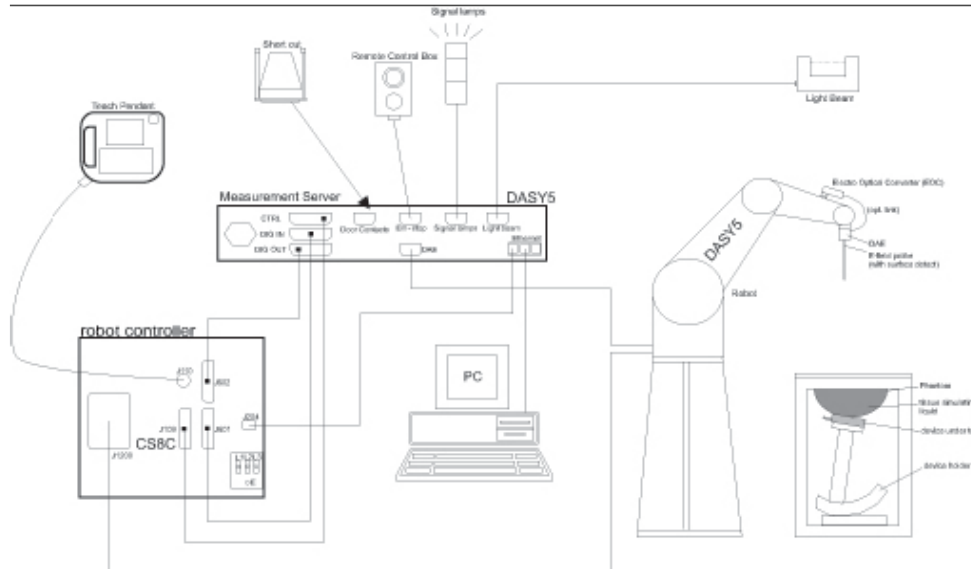

Picture C.1 SAR Lab Test Measurement Set-up

- A standard high precision 6-axis robot (StäubliTX=RX family) with controller, teach pendant and software. An arm extension for accommodating the data acquisition electronics (DAE).
- An isotropic field probe optimized and calibrated for the targeted measurement.
- A data acquisition electronics (DAE) which performs the signal amplification, signal multiplexing, AD-conversion, offset measurements, mechanical surface detection, collision detection, etc. The unit is battery powered with standard or rechargeable batteries. The signal is optically transmitted to the EOC.
- The Electro-optical converter (EOC) performs the conversion from optical to electrical signals for the digital communication to the DAE. To use optical surface detection, a special version of the EOC is required. The EOC signal is transmitted to the measurement server.
- The function of the measurement server is to perform the time critical tasks such as signal filtering, control of the robot operation and fast movement interrupts.
- The Light Beam used is for probe alignment. This improves the (absolute) accuracy of the probe positioning.
- A computer running WinXP and the DASY4 or DASY5 software.
- Remote control and teach pendant as well as additional circuitry for robot safety such as
- warning lamps, etc.
- The phantom, the device holder and other accessories according to the targeted measurement.



## C.2 Dasy4 or DASY5 E-field Probe System

The SAR measurements were conducted with the dosimetric probe designed in the classical triangular configuration and optimized for dosimetric evaluation. The probe is constructed using the thick film technique; with printed resistive lines on ceramic substrates. The probe is equipped with an optical multifiber line ending at the front of the probe tip. It is connected to the EOC box on the robot arm and provides an automatic detection of the phantom surface. Half of the fibers are connected to a pulsed infrared transmitter, the other half to a synchronized receiver. As the probe approaches the surface, the reflection from the surface produces a coupling from the transmitting to the receiving fibers. This reflection increases first during the approach, reaches maximum and then decreases. If the probe is flatly touching the surface, the coupling is zero. The distance of the coupling maximum to the surface is independent of the surface reflectivity and largely independent of the surface to probe angle. The DASY4 or DASY5 software reads the reflection during a software approach and looks for the maximum using 2<sup>nd</sup> ord curve fitting. The approach is stopped at reaching the maximum.

### Probe Specifications:

<b>Model:</b>	<b>ES3DV3, EX3DV4</b>
<b>Frequency</b>	<b>10MHz — 6.0GHz(EX3DV4)</b>
<b>Range:</b>	<b>10MHz — 4GHz(ES3DV3)</b>
<b>Calibration:</b>	<b>In head and body simulating tissue at Frequencies from 835 up to 5800MHz</b>
<b>Linearity:</b>	<b>± 0.2 dB(30 MHz to 6 GHz) for EX3DV4 ± 0.2 dB(30 MHz to 4 GHz) for ES3DV3</b>
<b>DynamicRange:</b>	<b>10 mW/kg — 100W/kg</b>
<b>Probe Length:</b>	<b>330 mm</b>
<b>Probe Tip</b>	
<b>Length:</b>	<b>20 mm</b>
<b>Body Diameter:</b>	<b>12 mm</b>
<b>Tip Diameter:</b>	<b>2.5 mm (3.9 mm for ES3DV3)</b>
<b>Tip-Center:</b>	<b>1 mm (2.0mm for ES3DV3)</b>
<b>Application:</b>	<b>SAR Dosimetry Testing Compliance tests of mobile phones Dosimetry in strong gradient fields</b>



Picture C.2Near-field Probe



Picture C.3E-field Probe

## C.3 E-field Probe Calibration

Each E-Probe/Probe Amplifier combination has unique calibration parameters. A TEM cell calibration procedure is conducted to determine the proper amplifier settings to enter in the probe parameters. The amplifier settings are determined for a given frequency by subjecting the probe to a known E-field density (1 mW/cm<sup>2</sup>) using an RF Signal generator, TEM cell, and RF Power Meter.

The free space E-field from amplified probe outputs is determined in a test chamber. This calibration can be performed in a TEM cell if the frequency is below 1 GHz and inn a waveguide or

other methodologies above 1 GHz for free space. For the free space calibration, the probe is placed in the volumetric center of the cavity and at the proper orientation with the field. The probe is then rotated 360 degrees until the three channels show the maximum reading. The power density readings equates to 1 mW/cm<sup>2</sup>.

E-field temperature correlation calibration is performed in a flat phantom filled with the appropriate simulated brain tissue. The E-field in the medium correlates with the temperature rise in the dielectric medium. For temperature correlation calibration a RF transparent thermistor-based temperature probe is used in conjunction with the E-field probe.

$$SAR = C \frac{\Delta T}{\Delta t}$$

Where:

$\Delta t$  = Exposure time (30 seconds),

C = Heat capacity of tissue (brain or muscle),

$\Delta T$  = Temperature increase due to RF exposure.

$$SAR = \frac{|E|^2 \cdot \sigma}{\rho}$$

Where:

$\sigma$  = Simulated tissue conductivity,

$\rho$  = Tissue density (kg/m<sup>3</sup>).

## C.4 Other Test Equipment

### C.4.1 Data Acquisition Electronics(DAE)

The data acquisition electronics consist of a highly sensitive electrometer-grade preamplifier with auto-zeroing, a channel and gain-switching multiplexer, a fast 16 bit AD-converter and a command decoder with a control logic unit. Transmission to the measurement server is accomplished through an optical downlink for data and status information, as well as an optical uplink for commands and the clock.

The mechanical probe mounting device includes two different sensor systems for frontal and sideways probe contacts. They are used for mechanical surface detection and probe collision detection.

The input impedance of the DAE is 200 MOhm; the inputs are symmetrical and floating. Common mode rejection is above 80 dB.



**PictureC.4: DAE**

### C.4.2 Robot

The SPEAG DASY system uses the high precision robots (DASY4: RX90XL; DASY5: RX160L) type from Stäubli SA (France). For the 6-axis controller system, the robot controller version from Stäubli is used. The Stäubli robot series have many features that are important for our application:

- High precision (repeatability 0.02mm)
- High reliability (industrial design)
- Low maintenance costs (virtually maintenance free due to direct drive gears; no belt drives)
- Jerk-free straight movements (brushless synchron motors; no stepper motors)
- Low ELF interference (motor control fields shielded via the closed metallic construction shields)



Picture C.5 DASY 4



Picture C.6 DASY 5

### C.4.3 Measurement Server

The Measurement server is based on a PC/104 CPU board with CPU (dasy4: 166 MHz, Intel Pentium; DASY5: 400 MHz, Intel Celeron), chipdisk (DASY4: 32 MB; DASY5: 128MB), RAM (DASY4: 64 MB, DASY5: 128MB). The necessary circuits for communication with the DAE electronic box, as well as the 16 bit AD converter system for optical detection and digital I/O interface are contained on the DASY I/O board, which is directly connected to the PC/104 bus of the CPU board.

The measurement server performs all real-time data evaluation of field measurements and surface detection, controls robot movements and handles safety operation. The PC operating system cannot interfere with these time critical processes. All connections are supervised by a watchdog, and disconnection of any of the cables to the measurement server will automatically disarm the robot and disable all program-controlled robot movements. Furthermore, the measurement server is equipped with an expansion port which is reserved for future applications. Please note that this expansion port does not have a standardized pinout, and therefore only devices provided by SPEAG can be connected. Devices from any other supplier could seriously damage the measurement server.



Picture C.7 Server for DASY 4



Picture C.8 Server for DASY 5

#### C.4.4 Device Holder for Phantom

The SAR in the phantom is approximately inversely proportional to the square of the distance between the source and the liquid surface. For a source at 5mm distance, a positioning uncertainty of  $\pm 0.5\text{mm}$  would produce a SAR uncertainty of  $\pm 20\%$ . Accurate device positioning is therefore crucial for accurate and repeatable measurements. The positions in which the devices must be measured are defined by the standards.

The DASY device holder is designed to cope with the different positions given in the standard. It has two scales for device rotation (with respect to the body axis) and device inclination (with respect to the line between the ear reference points). The rotation centers for both scales are the ear reference point (ERP). Thus the device needs no repositioning when changing the angles.

The DASY device holder is constructed of low-loss POM material having the following dielectric parameters: relative permittivity  $\epsilon = 3$  and loss tangent  $\delta = 0.02$ . The amount of dielectric material has been reduced in the closest vicinity of the device, since measurements have suggested that the influence of the clamp on the test results could thus be lowered.

<Laptop Extension Kit>

The extension is lightweight and made of POM, acrylic glass and foam. It fits easily on the upper part of the Mounting Device in place of the phone positioner. The extension is fully compatible with the Twin-SAM and ELI phantoms.



Picture C.9-1: Device Holder

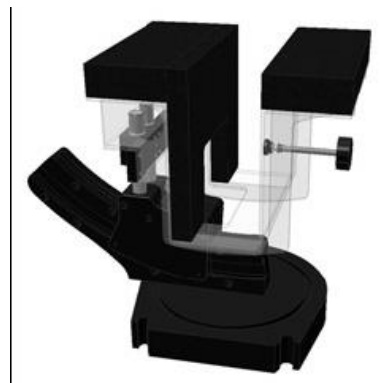

Picture C.9-2: Laptop Extension Kit

### C.4.5 Phantom

The SAM Twin Phantom V4.0 is constructed of a fiberglass shell integrated in a table. The shape of the shell is based on data from an anatomical study designed to represent the 90<sup>th</sup> percentile of the population. The phantom enables the dissymmetric evaluation of SAR for both left and right handed handset usage, as well as body-worn usage using the flat phantom region. Reference markings on the Phantom allow the complete setup of all predefined phantom positions and measurement grids by manually teaching three points in the robot. The shell phantom has a 2mm shell thickness (except the ear region where shell thickness increases to 6 mm).

Shell Thickness:  $2 \pm 0.2$  mm

Filling Volume: Approx. 25 liters

Dimensions: 810 x 1000 x 500 mm (H x L x W)

Available: Special



**Picture C.10: SAM Twin Phantom**