



# HAC RF TEST REPORT

No.I23Z61283-SEM02

For

**TCL Communication Ltd.**

**GSM/UMTS/LTE Mobile phone**

**Model Name: T612B**

With

**Hardware Version: 05**

**Software Version: 2BS7**

**FCC ID: 2ACCJH176**

**Results Summary: M Category = M4**

**Issued Date: 2023-8-9**

**Note:**

The test results in this test report relate only to the devices specified in this report. This report shall not be reproduced except in full without the written approval of CTTL.

**Test Laboratory:**

**CTTL, Telecommunication Technology Labs, CAICT**

No. 52, Huayuan North Road, Haidian District, Beijing, P. R. China 100191.

Tel:+86(0)10-62304633-2512, Fax:+86(0)10-62304633-2504

Email: [ctl\\_terminals@caict.ac.cn](mailto:ctl_terminals@caict.ac.cn), website: [www.caict.ac.cn](http://www.caict.ac.cn)



No.I23Z61283-SEM02

## **REPORT HISTORY**

<b>Report Number</b>	<b>Revision</b>	<b>Issue Date</b>	<b>Description</b>
I23Z61283-SEM02	Rev.0	2023-7-28	Initial creation of test report
I23Z61283-SEM02	Rev.1	2023-8-9	Update information in section10.3 on page18

## TABLE OF CONTENT

<b>1 TEST LABORATORY</b> .....	<b>5</b>
1.1 TESTING LOCATION.....	5
1.2 TESTING ENVIRONMENT.....	5
1.3 PROJECT DATA .....	5
1.4 SIGNATURE.....	5
<b>2 CLIENT INFORMATION</b> .....	<b>6</b>
2.1 APPLICANT INFORMATION.....	6
2.2 MANUFACTURER INFORMATION .....	6
<b>3 EQUIPMENT UNDER TEST (EUT) AND ANCILLARY EQUIPMENT (AE) .....</b>	<b>7</b>
3.1 ABOUT EUT.....	7
3.2 INTERNAL IDENTIFICATION OF EUT USED DURING THE TEST .....	7
3.3 INTERNAL IDENTIFICATION OF AE USED DURING THE TEST .....	7
3.4 AIR INTERFACES / BANDS INDICATING OPERATING MODES.....	8
<b>4 MAXIMUM OUTPUT POWER</b> .....	<b>9</b>
<b>5 REFERENCE DOCUMENTS .....</b>	<b>9</b>
5.1 REFERENCE DOCUMENTS FOR TESTING .....	9
<b>6 OPERATIONAL CONDITIONS DURING TEST .....</b>	<b>10</b>
6.1 HAC MEASUREMENT SET-UP.....	10
6.2 PROBE SPECIFICATION .....	11
6.3 TEST ARCH PHANTOM & PHONE POSITIONER .....	12
6.4 ROBOTIC SYSTEM SPECIFICATIONS.....	12
<b>7 EUT ARRANGEMENT .....</b>	<b>13</b>
7.1 WD RF EMISSION MEASUREMENTS REFERENCE AND PLANE .....	13
<b>8 SYSTEM VALIDATION.....</b>	<b>14</b>
8.1 VALIDATION PROCEDURE.....	14
8.2 VALIDATION RESULT .....	14
<b>9 EVALUATION OF MIF .....</b>	<b>15</b>
9.1 INTRODUCTION.....	15
9.2 MIF MEASUREMENT WITH THE AIA .....	16
9.3 TEST EQUIPMENT FOR THE MIF MEASUREMENT .....	16
9.4 DUT MIF RESULTS.....	16
<b>10 EVALUATION FOR LOW-POWER EXEMPTION .....</b>	<b>18</b>
10.1 PRODUCT TESTING THRESHOLD .....	18
10.2 CONDUCTED POWER.....	18
10.3 CONCLUSION .....	18
<b>11 RF TEST PROCEDURES .....</b>	<b>19</b>



12 MEASUREMENT RESULTS (E-FIELD).....20

13 ANSIC 63.19-2011 LIMITS .....21

14 MEASUREMENT UNCERTAINTY .....22

15 MAIN TEST INSTRUMENTS .....23

16 CONCLUSION.....23

ANNEX A TEST LAYOUT.....24

ANNEX B TEST PLOTS.....25

ANNEX C SYSTEM VALIDATION RESULT .....33

ANNEX D PROBE CALIBRATION CERTIFICATE .....41

ANNEX E DIPOLE CALIBRATION CERTIFICATE .....62

## 1 Test Laboratory

### 1.1 Testing Location

CompanyName:	CTTL
Address:	No. 52, Huayuan North Road, Haidian District, Beijing, P. R. China 100191.

### 1.2 Testing Environment

Temperature:	18°C~25°C,
Relative humidity:	30%~ 70%
Ground system resistance:	< 0.5 $\Omega$
Ambient noise is checked and found very low and in compliance with requirement of standards. Reflection of surrounding objects is minimized and in compliance with requirement of standards	

### 1.3 Project Data

Project Leader:	Qi Dianyuan
Test Engineer:	Wang Tian
Testing Start Date:	July 11, 2023
Testing End Date:	July 14, 2023

### 1.4 Signature

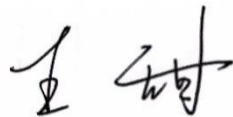

---

Wang Tian  
(Prepared this test report)

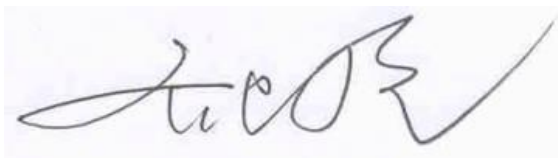

---

Qi Dianyuan  
(Reviewed this test report)

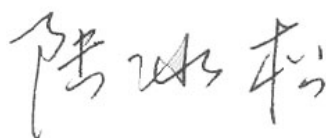

---

Lu Bingsong  
Deputy Director of the laboratory  
(Approved this test report)



## 2 Client Information

### 2.1 Applicant Information

Company Name:	TCL Communication Ltd.
Address/Post:	5/F, Building 22E, 22 Science Park East Avenue, Hong Kong Science Park, Shatin, NT, Hong Kong
Contact Person:	Annie Jiang
Contact Email:	nianxiang.jiang@tcl.com
Telephone:	+86 755 3661 1621
Fax	+86 755 3661 2000-81722

### 2.2 Manufacturer Information

Company Name:	TCL Communication Ltd.
Address/Post:	5/F, Building 22E, 22 Science Park East Avenue, Hong Kong Science Park, Shatin, NT, Hong Kong
Contact Person:	Annie Jiang
Contact Email:	nianxiang.jiang@tcl.com
Telephone:	+86 755 3661 1621
Fax	+86 755 3661 2000-81722

### 3 Equipment Under Test (EUT) and Ancillary Equipment (AE)

#### 3.1 About EUT

Description:	GSM/UMTS/LTE Mobile phone
Model name:	T612B
Operating mode(s):	GSM850/900/1800/1900, WCDMA B1/2/4/5/6 LTE Band 1/2/3/4/5/7/8/12/13/17/20/28/38/40/41/66 BT, Wi-Fi 2.4G/5G

#### 3.2 Internal Identification of EUT used during the test

EUT ID*	IMEI	HW Version	SW Version
EUT1	352051810201258	05	2BS7
EUT2	352051810201175	05	2BS7

\*EUT ID: is used to identify the test sample in the lab internally.

#### 3.3 Internal Identification of AE used during the test

AE ID*	Description	Model	SN	Manufacturer
AE1	Battery	CAC4900009CA	\	TIANMAO
AE2	Battery	CAC4900007C7	\	VEKEN

\*AE ID: is used to identify the test sample in the lab internally.

### 3.4 Air Interfaces / Bands Indicating Operating Modes

Air-interface	Band(MHz)	Type	C63.19/tested	Simultaneous Transmissions	Name of Voice Service
GSM	850	VO	Yes	BT, WLAN	CMRS Voice
	1900				
GPRS/EDGE	850	DT	Yes		MEET
	1900				
WCDMA (UMTS)	850	VO	NO <sup>(1)</sup>	BT, WLAN	CMRS Voice
	1700				
	1900	DT	NO <sup>(1)</sup>		MEET
LTE TDD	Band41	V/D	Yes	BT, WLAN	VoLTE, MEET
LTE FDD	Band2/4/5/7/12/13/17/66	V/D	NO <sup>(1)</sup>	BT, WLAN	VoLTE, MEET
BT	2450	DT	NA	GSM,WCDMA,LTE	NA
WLAN	2450	V/D	NO <sup>(1)</sup>	GSM,WCDMA,LTE	VoWiFi, MEET
WLAN	5G	V/D	NO <sup>(1)</sup>	GSM,WCDMA,LTE	VoWiFi, MEET

NA: Not Applicable VO: Voice Only V/D: CMRS and IP Voice Service over Digital Transport

DT: Digital Transport

\* HAC Rating was not based on concurrent voice and data modes, Non current mode was found to represent worst case rating for both M and T rating

Note1 = The air interface is exempted from testing by low power exemption that its average antenna input power plus its MIF is  $\leq 17$  dBm, and is rated as M4.

Note2= The device have similar frequency in some LTE bands : 4/66,12/17 since the supported frequency spans for the smaller LTE bands are completely cover by the larger LTE bands, therefore, only larger LTE bands were required to be tested for hearing-aid compliance.



## 4 Maximum Output Power.

Bands	Conducted Power (dBm)
GSM 850	32
GSM 1900	30
WCDMA 850	24
WCDMA 1700	24
WCDMA 1900	24
LTE Band2	23
LTE Band4	23
LTE Band5	24.5
LTE Band7	23
LTE Band12	24.5
LTE Band13	24.5
LTE Band17	24.5
LTE Band41	24
LTE Band66	23
WLAN 2.4GHz	18
WLAN 5GHz	17.5

Note: For the frequency band with multiple antennas, the highest power value is selected to reflect in the list

## 5 Reference Documents

### 5.1 Reference Documents for testing

The following document listed in this section is referred for testing.

Reference	Title	Version
ANSI C63.19-2011	American National Standard for Methods of Measurement of Compatibility between Wireless Communication Devices and Hearing Aids	2011 Edition
FCC 47 CFR §20.19	Hearing Aid Compatible Mobile Headsets	2015 Edition
KDB 285076 D01	Equipment Authorization Guidance for Hearing Aid Compatibility	v06r03

## 6 OPERATIONAL CONDITIONS DURING TEST

### 6.1 HAC MEASUREMENT SET-UP

These measurements are performed using the DASY5 NEO automated dosimetric assessment system. It is made by Schmid & Partner Engineering AG (SPEAG) in Zurich, Switzerland. It consists of high precision robotics system (Stäubli), robot controller, Intel Core2 computer, near-field probe, probe alignment sensor. The robot is a six-axis industrial robot performing precise movements. A cell controller system contains the power supply, robot controller, teach pendant (Joystick), and remote control, is used to drive the robot motors. The PC consists of the HP Intel Core2 1.86 GHz computer with Windows XP system and HAC Measurement Software DASY5 NEO, A/D interface card, monitor, mouse, and keyboard. The Stäubli Robot is connected to the cell controller to allow software manipulation of the robot. A data acquisition electronic (DAE) circuit performs the signal amplification, signal multiplexing, AD-conversion, offset measurements, mechanical surface detection, collision detection, etc. is connected to the Electro-optical coupler (EOC). The EOC performs the conversion from the optical into digital electric signal of the DAE and transfers data to the PC plug-in card.

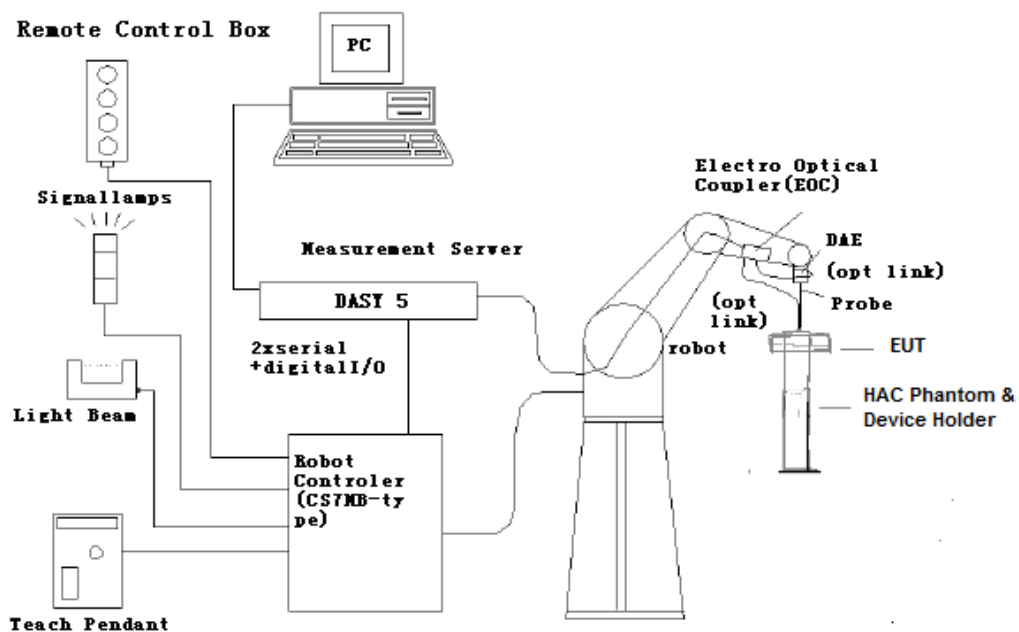

**Fig. 1 HAC Test Measurement Set-up**

The DAE4 consists of a highly sensitive electrometer-grade preamplifier with auto-zeroing, a channel and gain-switching multiplexer, a fast 16 bit AD-converter and a command decoder and control logic unit. Transmission to the PC-card is accomplished through an optical downlink for data and status information and an optical uplink for commands and clock lines. The mechanical probe mounting device includes two different sensor systems for frontal and sidewise probe contacts. They are also used for mechanical surface detection and probe collision detection. The robot uses its own controller with a built in VME-bus computer.

## 6.2 Probe Specification

### E-Field Probe Description

Construction	One dipole parallel, two dipoles normal to probe axis Built-in shielding against static charges PEEK enclosure material
Calibration	In air from 100 MHz to 3.0 GHz (absolute accuracy $\pm 6.0\%$ , $k=2$ )
Frequency	40 MHz to > 6 GHz (can be extended to < 20 MHz) Linearity: $\pm 0.2$ dB (100 MHz to 3 GHz)
Directivity	$\pm 0.2$ dB in air (rotation around probe axis) $\pm 0.4$ dB in air (rotation normal to probe axis)
Dynamic Range	2 V/m to > 1000 V/m; Linearity: $\pm 0.2$ dB
Dimensions	Overall length: 330 mm (Tip: 16 mm) Tip diameter: 8 mm (Body: 12 mm) Distance from probe tip to dipole centers: 2.5 mm
Application	General near-field measurements up to 6 GHz Field component measurements Fast automatic scanning in phantoms

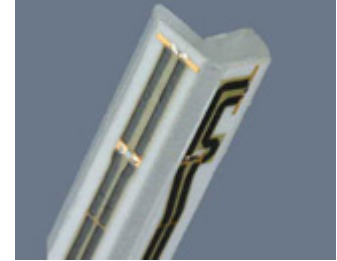

[ER3DV6]

### 6.3 Test Arch Phantom & Phone Positioner

The Test Arch phantom should be positioned horizontally on a stable surface. Reference markings on the Phantom allow the complete setup of all predefined phantom positions and measurement grids by manually teaching three points in the robot. It enables easy and well defined positioning of the phone and validation dipoles as well as simple teaching of the robot (Dimensions: 370 x 370 x 370 mm).

The Phone Positioner supports accurate and reliable positioning of any phone with effect on near field  $< \pm 0.5$  dB.

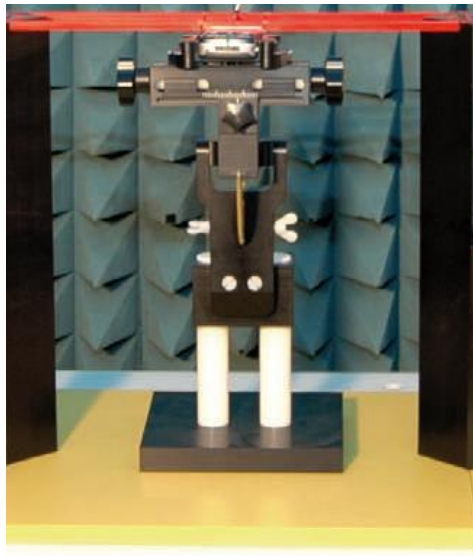

Fig. 2 HAC Phantom & Device Holder

### 6.4 Robotic System Specifications

#### Specifications

**Positioner:** Stäubli Unimation Corp. Robot Model: RX160L

**Repeatability:**  $\pm 0.02$  mm

**No. of Axis:** 6

#### Data Acquisition Electronic (DAE) System

##### Cell Controller

**Processor:** Intel Core2

**Clock Speed:** 1.86GHz

**Operating System:** Windows XP

##### Data Converter

**Features:** Signal Amplifier, multiplexer, A/D converter, and control logic

**Software:** DASY5 software

**Connecting Lines:** Optical downlink for data and status info.

Optical uplink for commands and clock

## 7 EUT ARRANGEMENT

### 7.1 WD RF Emission Measurements Reference and Plane

Figure 4 illustrates the references and reference plane that shall be used in the WD emissions measurement.

- The grid is 5 cm by 5 cm area that is divided into 9 evenly sized blocks or sub-grids.
- The grid is centered on the audio frequency output transducer of the WD (speaker or T-coil).
- The grid is located by reference to a reference plane. This reference plane is the planar area that contains the highest point in the area of the WD that normally rests against the user's ear
- The measurement plane is located parallel to the reference plane and 15 mm from it, out from the phone. The grid is located in the measurement plane.

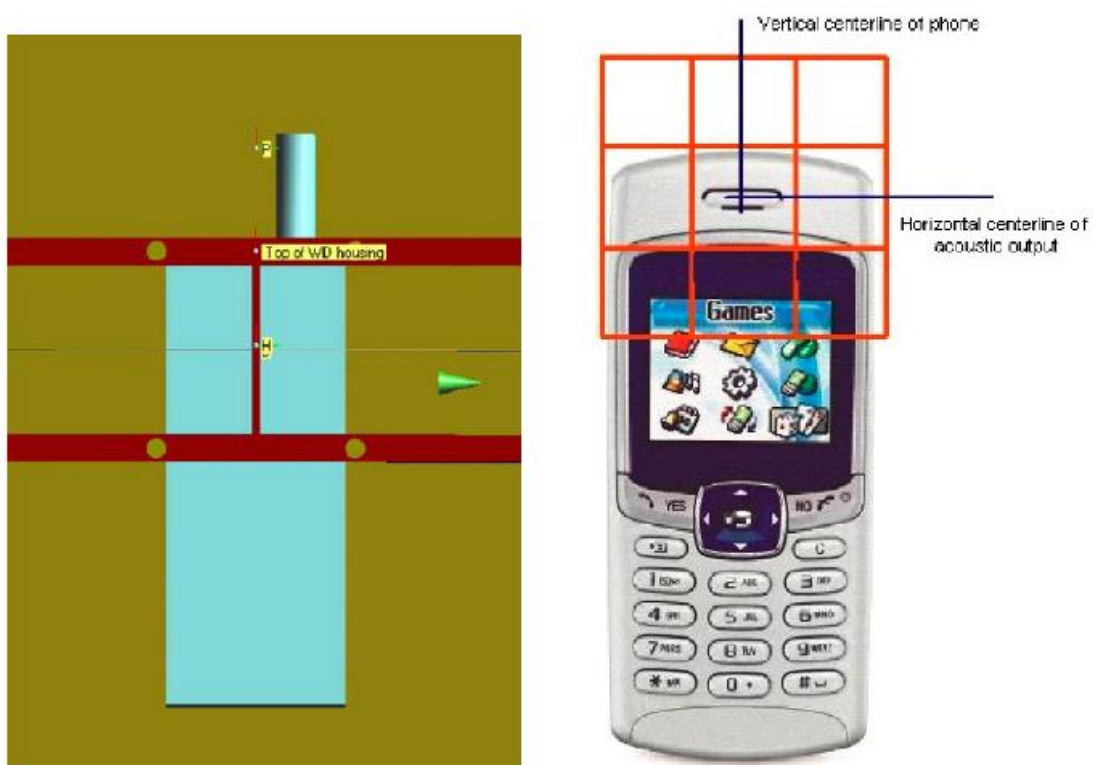

Fig. 3 WD reference and plane for RF emission measurements

## 8 SYSTEM VALIDATION

### 8.1 Validation Procedure

Place a dipole antenna meeting the requirements given in ANSI C63.19 in the position normally occupied by the WD. The dipole antenna serves as a known source for an electrical output. Position the E-field probes so that:

- The probes and their cables are parallel to the coaxial feed of the dipole antenna
- The probe cables and the coaxial feed of the dipole antenna approach the measurement area from opposite directions
- The center point of the probe element(s) are 15 mm from the closest surface of the dipole elements.

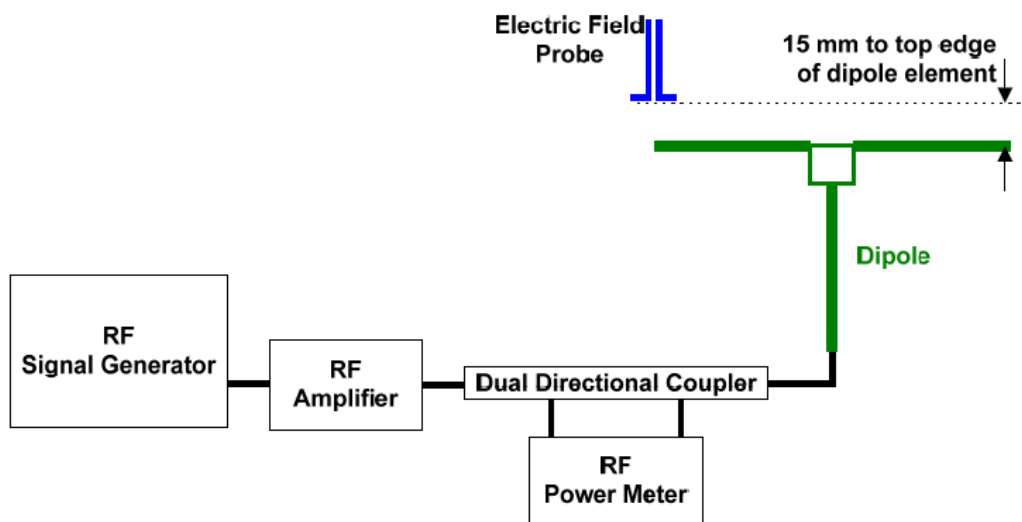

Fig. 4 Dipole Validation Setup

### 8.2 Validation Result

E-Field Scan						
Mode	Frequency (MHz)	Input Power (mW)	Measured <sup>1</sup> Value(dBV/m)	Target <sup>2</sup> Value(dBV/m)	Deviation <sup>3</sup> (%)	Limit <sup>4</sup> (%)
CW	835	100	41.17	41	1.98	± 18
CW	1880	100	38.90	38.78	1.39	± 18
CW	2450	100	38.18	38.69	-5.70	± 18
CW	2600	100	38.22	38.69	-5.27	± 18

Notes:

1. Please refer to the attachment for detailed measurement data and plot.
2. Target value is provided by SPEAG in the calibration certificate of specific dipoles.
3. Deviation (%) =  $100 * (\text{Measured value minus Target value}) / \text{Target value}$ .
4. ANSI C63.19 requires values within  $\pm 18\%$  are acceptable, of which 12% is deviation and 13% is measurement uncertainty. Values independently validated for the dipole actually used in the measurements should be used, when available.

## 9 Evaluation of MIF

### 9.1 Introduction

The MIF (Modulation Interference Factor) is used to classify E-field emission to determine Hearing Aid Compatibility (HAC). It scales the power-averaged signal to the RF audio interference level and is characteristic to a modulation scheme. The HAC standard preferred "indirect" measurement method is based on average field measurement with separate scaling by the MIF. With an Audio Interference Analyzer (AIA) designed by SPEAG specifically for the MIF measurement, these values have been verified by practical measurements on an RF signal modulated with each of the waveforms. The resulting deviations from the simulated values are within the requirements of the HAC standard.

The AIA (Audio Interference Analyzer) is an USB powered electronic sensor to evaluate signals in the frequency range 698MHz - 6 GHz. It contains RMS detector and audio frequency circuits for sampling of the RF envelope.

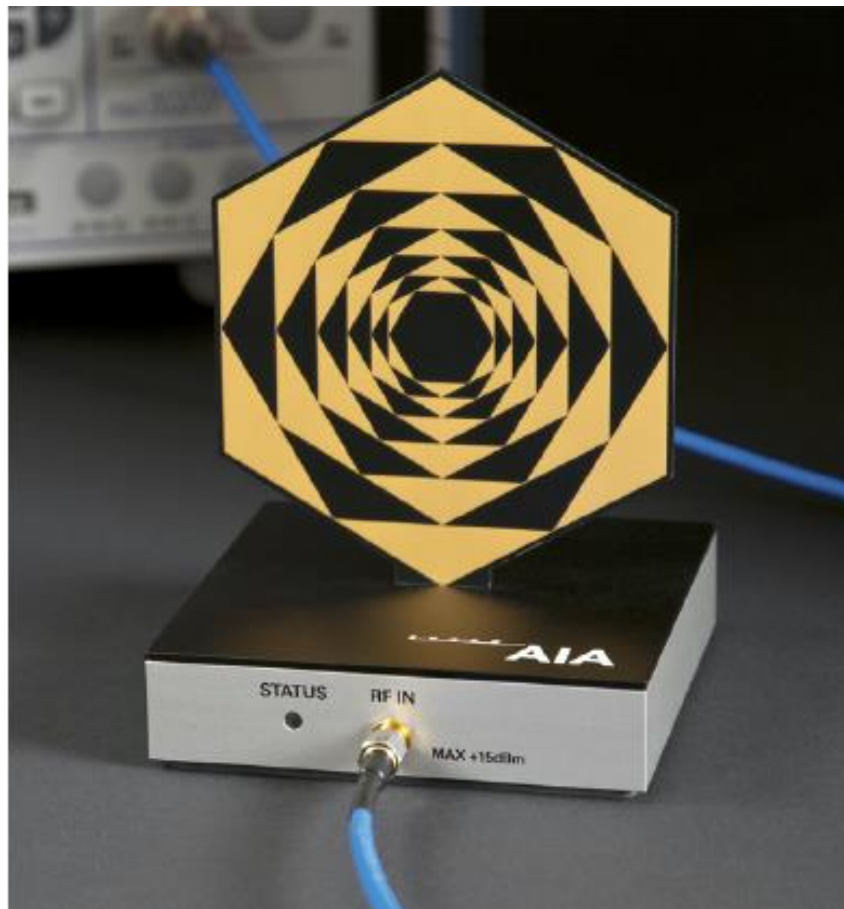

Fig. 5 AIA Front View

## 9.2 MIF measurement with the AIA

The MIF is measured with the AIA as follows:

1. Connect the AIA via USB to the DASY5 PC and verify the configuration settings.
2. Couple the RF signal to be evaluated to an AIA via cable or antenna.
3. Generate a MIF measurement job for the unknown signal and select the measurement port and timing settings.
4. Document the results via the post processor in a report.

## 9.3 Test equipment for the MIF measurement

No.	Name	Type	Serial Number	Manufacturer
01	Signal Generator	SMW200A	107732	R&S
02	AIA	SE UMS 170 CB	1029	SPEAG
03	BTS	CMW500	166370	R&S

## 9.4 DUT MIF results

Based on the KDB285076D01, the handset can also use the MIF values predetermined by the test equipment manufacturer. MIF values applied in this test report were provided by the HAC equipment provider of SPEAG, and the worst values for all air interface are listed below to be determine the Low-power Exemption.

Typical MIF levels in ANSI C63.19-2011	
Transmission protocol	Modulation interference factor
GSM-FDD (TDMA, GMSK)	+3.63 dB
EDGE-FDD (TDMA, 8PSK, TN 0-1)	+1.23dB
EDGE-FDD (TDMA, 8PSK, TN 0-1-2)	-0.52dB
EDGE-FDD (TDMA, 8PSK, TN 0-1-2-3)	-1.82dB
UMTS-FDD(WCDMA, AMR)	-25.43dB
UMTS-FDD (HSPA)	-20.75dB
LTE-FDD (SC-FDMA, 1RB, 20MHz, QPSK)	-15.63 dB
LTE-FDD (SC-FDMA, 1RB, 20MHz, 16QAM)	-9.76 dB
LTE-FDD (SC-FDMA, 1RB, 20MHz, 64QAM)	-9.93 dB
LTE-TDD (SC-FDMA, 1RB, 20MHz, QPSK)	-1.62 dB
LTE-TDD (SC-FDMA, 1RB, 20MHz, 16QAM)	-1.44 dB
LTE-TDD (SC-FDMA, 1RB, 20MHz, 64QAM)	-1.54 dB
LTE-TDD(SC-FDMA,1RB,20MHz,QPSK,UL Subframe=2,3,4,7,8,9)	-3.41 dB
LTE-TDD(SC-FDMA,1RB,20MHz,16QAM,UL Subframe=2,3,4,7,8,9)	-3.17 dB
LTE-TDD(SC-FDMA,1RB,20MHz,64QAM,UL Subframe=2,3,4,7,8,9)	-3.31 dB
IEEE 802.11b WiFi 2.4 GHz (DSSS, 1 Mbps)	-5.90 dB
IEEE 802.11b WiFi 2.4 GHz (DSSS, 2 Mbps)	-5.17 dB



IEEE 802.11b WiFi 2.4 GHz (DSSS, 5.5 Mbps)	-3.37 dB
IEEE 802.11b WiFi 2.4 GHz (DSSS, 11 Mbps)	-2.02 dB
IEEE 802.11g WiFi 2.4 GHz (DSSS-OFDM, 6 Mbps)	-0.36dB
IEEE 802.11n (HT Greenfield, 6.5 Mbps, BPSK)	-15.80 dB
IEEE 802.11a/h WiFi 5 GHz (OFDM, 6 Mbps)	-5.82 dB
IEEE 802.11ac WiFi (20MHz, MCS0, 99pc duty cycle)	-12.23dB
5G NR (DFT-s-OFDM, 1 RB, 20 MHz, QPSK, 15 kHz)	-15.06dB
5G NR (CP-OFDM, 1 RB, 5 MHz, QPSK, 15 kHz)	-12.18dB
5G NR (CP-OFDM, 1 RB, 10 MHz, QPSK, 15 kHz)	-12.26dB
5G NR (CP-OFDM, 1 RB, 15 MHz, QPSK, 15 kHz)	-12.08dB
5G NR (CP-OFDM, 1 RB, 20 MHz, QPSK, 15 kHz)	-12.20dB
5G NR (CP-OFDM, 1 RB, 5 MHz, QPSK, 30 kHz)	-14.39dB
5G NR (CP-OFDM, 1 RB, 10 MHz, QPSK, 30 kHz)	-14.47dB
5G NR (CP-OFDM, 1 RB, 15 MHz, QPSK, 30 kHz)	-14.33dB
5G NR (CP-OFDM, 1 RB, 20 MHz, QPSK, 30 kHz)	-14.46dB
5G NR (CP-OFDM, 1 RB, 25 MHz, QPSK, 30 kHz)	-14.35dB
5G NR (CP-OFDM, 1 RB, 30 MHz, QPSK, 30 kHz)	-14.32dB
5G NR (CP-OFDM, 1 RB, 40 MHz, QPSK, 30 kHz)	-14.32dB
5G NR (CP-OFDM, 1 RB, 50 MHz, QPSK, 30 kHz)	-14.55dB
5G NR (CP-OFDM, 1 RB, 60 MHz, QPSK, 30 kHz)	-14.45dB
5G NR (CP-OFDM, 1 RB, 80 MHz, QPSK, 30 kHz)	-14.47dB
5G NR (CP-OFDM, 1 RB, 90 MHz, QPSK, 30 kHz)	-14.43dB
5G NR (CP-OFDM, 1 RB, 100 MHz, QPSK, 30 kHz)	-14.38dB
5G NR (DFT-s-OFDM, 1 RB, 5 MHz, QPSK, 15 kHz)	-15.06dB
5G NR (DFT-s-OFDM, 1 RB, 10 MHz, QPSK, 15 kHz)	-15.06dB
5G NR (DFT-s-OFDM, 1 RB, 15 MHz, QPSK, 15 kHz)	-15.06dB
5G NR (DFT-s-OFDM, 1 RB, 20 MHz, QPSK, 15 kHz)	-15.06dB

## 10 Evaluation for low-power exemption

### 10.1 Product testing threshold

There are two methods for exempting an RF air interface technology from testing. The first method requires evaluation of the MIF for the worst-case operating mode. An RF air interface technology of a device is exempt from testing when its average antenna input power plus its MIF is  $\leq 17$  dBm for any of its operating modes. The second method does not require determination of the MIF. The RF emissions testing exemption shall be applied to an RF air interface technology in a device whose peak antenna input power, averaged over intervals  $\leq 50 \mu s$ , is  $\leq 23$  dBm. An RF air interface technology that is exempted from testing by either method shall be rated as M4.

The first method is used to be exempt from testing for the RF air interface technology in this report.

### 10.2 Conducted power

Band	Average power (dBm)	MIF (dB)	Sum (dBm)	C63.19 Tested
GSM 850	32	3.63	35.63	Yes
GSM 1900	30	3.63	33.63	Yes
WCDMA 850	24	-25.43	-1.43	No
WCDMA 1700	24	-25.43	-1.43	No
WCDMA 1900	24	-25.43	-1.43	No
LTE Band2	23	-15.63	7.37	No
LTE Band4	23	-15.63	7.37	No
LTE Band5	24.5	-15.63	8.87	No
LTE Band7	23	-15.63	7.37	No
LTE Band12	24.5	-15.63	8.87	No
LTE Band13	24.5	-15.63	8.87	No
LTE Band17	24.5	-15.63	8.87	No
LTE Band41	24	-3.41	20.59	Yes
LTE Band66	23	-15.63	7.37	No
WLAN 2.4GHz	18	-0.36	17.64	Yes
WLAN 5GHz	17.5	-5.82	11.68	No

### 10.3 Conclusion

According to the above table, the sums of average power and MIF for WCDMA LTE FDD and WIFI5G are less than 17dBm. So it is measured for GSM WiFi2.4G and LTE TDD bands. The WCDMA LTE FDD and WIFI5G are exempt from testing and rated as M4.

## 11 RF TEST PROCEDURES

**The evaluation was performed with the following procedure:**

- 1) Confirm proper operation of the field probe, probe measurement system and other instrumentation and the positioning system.
- 2) Position the WD in its intended test position. The gauge block can simplify this positioning.
- 3) Configure the WD normal operation for maximum rated RF output power, at the desired channel and other operating parameters (e.g., test mode), as intended for the test.
- 4) The center sub-grid shall be centered on the center of the T-Coil mode axial measurement point or the acoustic output, as appropriate. Locate the field probe at the initial test position in the 50 mm by 50 mm grid, which is contained in the measurement plane. If the field alignment method is used, align the probe for maximum field reception.
- 5) Record the reading.
- 6) Scan the entire 50 mm by 50 mm region in equally spaced increments and record the reading at each measurement point. The distance between measurement points shall be sufficient to assure the identification of the maximum reading.
- 7) Identify the five contiguous sub-grids around the center sub-grid whose maximum reading is the lowest of all available choices. This eliminates the three sub-grids with the maximum readings. Thus, the six areas to be used to determine the WD's highest emissions are identified.
- 8) Identify the maximum field reading within the non-excluded sub-grids identified in Step 7)
- 9) Evaluate the MIF and add to the maximum steady-state rms field-strength reading to obtain the RF audio interference level..
- 10) Compare this RF audio interference level with the categories and record the resulting WD category rating.

## 12 Measurement Results (E-Field)

Frequency		Measured Value(dBV/m)	Power Drift (dB)	Category
MHz	Channel			
<b>GSM 850</b>				
848.8	251	32.86	0.01	<b>M4</b> (see Fig B.1)
836.6	190	31.37	0.12	<b>M4</b>
824.2	128	29.35	0.09	<b>M4</b>
<b>GSM 1900</b>				
1909.8	810	24.46	0.01	<b>M4</b>
1880	661	25.73	-0.19	<b>M4</b>
1850.2	512	26.43	0.04	<b>M4</b> (see Fig B.2)
<b>LTE Band41 QPSK</b>				
2680	41490	16.21	0.01	<b>M4</b>
2636.5	41055	17.23	0.15	<b>M4</b> (see Fig B.3)
2593	40620	16.77	-0.07	<b>M4</b>
2549.5	40185	15.40	0.13	<b>M4</b>
2506	39750	15.13	-0.04	<b>M4</b>
<b>LTE Band41 16-QAM</b>				
2680	41490	11.24	-0.05	<b>M4</b>
2636.5	41055	16.92	0.03	<b>M4</b>
2593	40620	16.36	0.04	<b>M4</b>
2549.5	40185	15.93	0.12	<b>M4</b>
2506	39750	15.24	0.05	<b>M4</b>
<b>LTE Band41 64-QAM</b>				
2680	41490	9.70	-0.02	<b>M4</b>
2636.5	41055	8.23	-0.05	<b>M4</b>
2593	40620	10.94	-0.11	<b>M4</b>
2549.5	40185	14.03	0.05	<b>M4</b>
2506	39750	16.87	0.04	<b>M4</b>
<b>WiFi2.4G 11g</b>				
2462	11	20.48	0.03	<b>M4</b> (see Fig B.4)
2437	6	19.90	-0.01	<b>M4</b>
2412	1	19.49	-0.01	<b>M4</b>

### 13 ANSIC 63.19-2011 LIMITS

#### WD RF audio interference level categories in logarithmic units

<b>Emission categories</b>	<b>&lt; 960 MHz</b>	<b>E-field emissions</b>
Category M1	50 to 55	dB (V/m)
Category M2	45 to 50	dB (V/m)
Category M3	40 to 45	dB (V/m)
Category M4	< 40	dB (V/m)
<b>Emission categories</b>	<b>&gt; 960 MHz</b>	<b>E-field emissions</b>
Category M1	40 to 45	dB (V/m)
Category M2	35 to 40	dB (V/m)
Category M3	30 to 35	dB (V/m)
Category M4	< 30	dB (V/m)

## 14 MEASUREMENT UNCERTAINTY

No.	Error source	Type	Uncertainty Value(%)	Prob. Dist.	k	c <sub>i</sub> E	Standard Uncertainty (%) $u_i$ (%E)	Degree of freedom $V_{eff}$ or $\nu_i$
<b>Measurement System</b>								
1	Probe Calibration	B	5.	N	1	1	5.1	$\infty$
2	Axial Isotropy	B	4.7	R	$\sqrt{3}$	1	2.7	$\infty$
3	Sensor Displacement	B	16.5	R	$\sqrt{3}$	1	9.5	$\infty$
4	Boundary Effects	B	2.4	R	$\sqrt{3}$	1	1.4	$\infty$
5	Linearity	B	4.7	R	$\sqrt{3}$	1	2.7	$\infty$
6	Scaling to Peak Envelope Power	B	2.0	R	$\sqrt{3}$	1	1.2	$\infty$
7	System Detection Limit	B	1.0	R	$\sqrt{3}$	1	0.6	$\infty$
8	Readout Electronics	B	0.3	N	1	1	0.3	$\infty$
9	Response Time	B	0.8	R	$\sqrt{3}$	1	0.5	$\infty$
10	Integration Time	B	2.6	R	$\sqrt{3}$	1	1.5	$\infty$
11	RF Ambient Conditions	B	3.0	R	$\sqrt{3}$	1	1.7	$\infty$
12	RF Reflections	B	12.0	R	$\sqrt{3}$	1	6.9	$\infty$
13	Probe Positioner	B	1.2	R	$\sqrt{3}$	1	0.7	$\infty$
14	Probe Positioning	A	4.7	R	$\sqrt{3}$	1	2.7	$\infty$
15	Extra. And Interpolation	B	1.0	R	$\sqrt{3}$	1	0.6	$\infty$
<b>Test Sample Related</b>								
16	Device Positioning Vertical	B	4.7	R	$\sqrt{3}$	1	2.7	$\infty$
17	Device Positioning Lateral	B	1.0	R	$\sqrt{3}$	1	0.6	$\infty$
18	Device Holder and Phantom	B	2.4	R	$\sqrt{3}$	1	1.4	$\infty$
19	Power Drift	B	5.0	R	$\sqrt{3}$	1	2.9	$\infty$

20	AIA measurement	B	12	R	$\sqrt{3}$	1	6.9	$\infty$
<b>Phantom and Setup related</b>								
21	Phantom Thickness	B	2.4	R	$\sqrt{3}$	1	1.4	$\infty$
Combined standard uncertainty(%)							16.2	
Expanded uncertainty (confidence interval of 95 %)		$u_e = 2u_c$		N	k=2		32.4	

## 15 MAIN TEST INSTRUMENTS

**Table 1: List of Main Instruments**

No.	Name	Type	Serial Number	Calibration Date	Valid Period
01	Signal Generator	SMW200A	107732	January 17, 2023	One Year
02	Power meter	NRP2	106277	September 22, 2022	One year
03	Power sensor	NRP8S	104291		
04	Amplifier	60S1G4	0331848	No Calibration Requested	
05	E-Field Probe	EF3DV3	4060	May 24, 2023	One year
06	DAE	SPEAG DAE4	1524	October 17, 2022	One year
07	HAC Dipole	CD835V3	1023	August 25, 2022	One year
08	HAC Dipole	CD1880V3	1018	August 25, 2022	One year
09	HAC Dipole	CD2450V3	1021	August 25, 2022	One year
10	HAC Dipole	CD2600V3	1017	August 25, 2022	One year
11	BTS	CMW500	159890	January 12, 2023	One year
12	AIA	SE UMS 170 CB	1029	No Calibration Requested	

## 16 CONCLUSION

The HAC measurement indicates that the EUT complies with the HAC limits of the ANSIC63.19-2011. The total M-rating is **M4**.

\*\*\*END OF REPORT BODY\*\*\*

## ANNEX A TEST LAYOUT

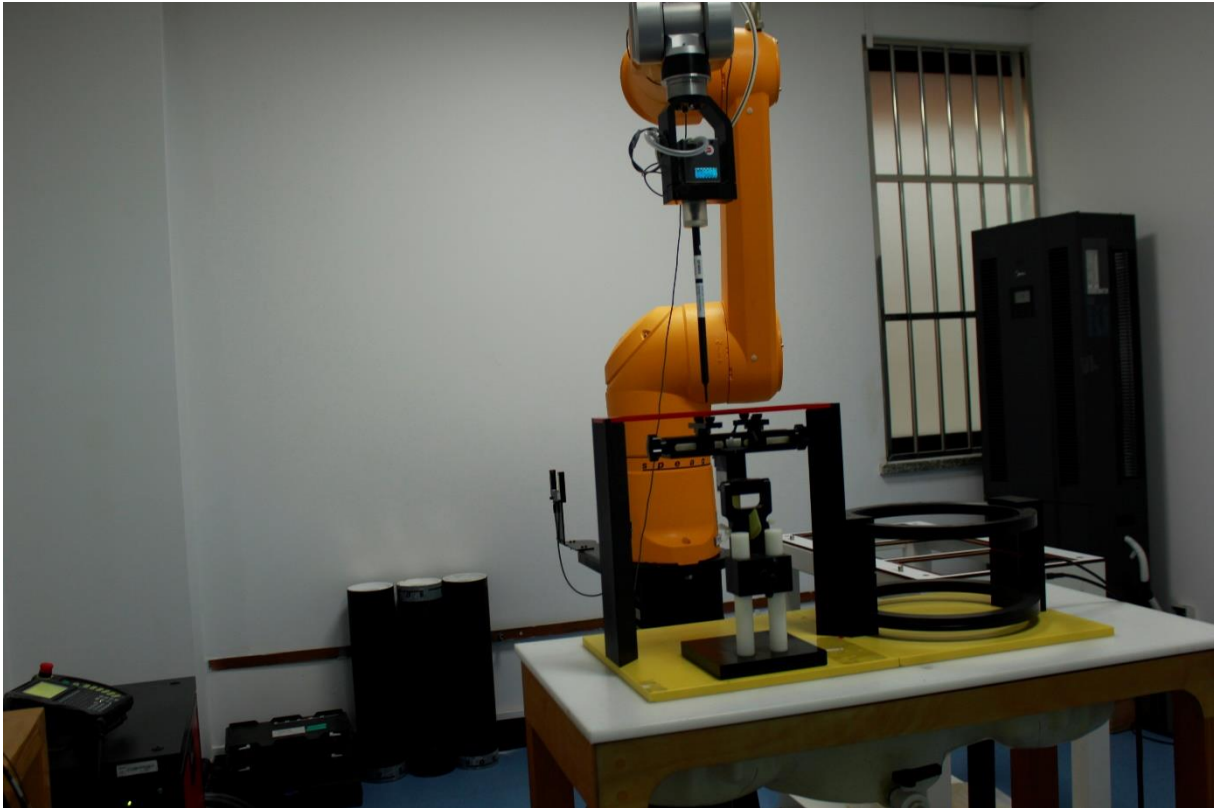

Picture A1:HAC RF System Layout



## ANNEX B TEST PLOTS

### HAC RF E-Field GSM 850

Date/Time: 2023-07-11

Electronics: DAE4 Sn1524

Medium: Air

Medium parameters used:  $\sigma = 0$  S/m,  $\epsilon_r = 1$ ;  $\rho = 1000$  kg/m<sup>3</sup>

Ambient Temperature:23.3°C

Liquid Temperature: 22.5°C

Communication System: UID 0, 1GSM 850 (0) Frequency: 848.8 MHz Duty Cycle: 1:8.30042

Probe: EF3DV3 - SN4060 ConvF(1, 1, 1) @ 848.8 MHz

GSM850/E Scan - ER3DV6 - 2011: 15 mm from Probe Center to the

Device 3/Hearing Aid Compatibility Test (101x101x1): Interpolated

grid: dx=0.5000 mm, dy=0.5000 mm

Device Reference Point: 0, 0, -6.3 mm

Reference Value = 34.37 V/m; Power Drift = 0.01 dB

Applied MIF = 3.50 dB

RF audio interference level = 32.86 dBV/m

Emission category: **M4**

MIF scaled E-field

Grid 1 M4 33.34 dBV/m	Grid 2 M4 33.32 dBV/m	Grid 3 M4 31.27 dBV/m
Grid 4 M4 32.85 dBV/m	Grid 5 M4 32.86 dBV/m	Grid 6 M4 31.54 dBV/m
Grid 7 M4	Grid 8 M4	Grid 9 M4

32.39 dBV/m	32.41 dBV/m	31.35 dBV/m
-------------	-------------	-------------

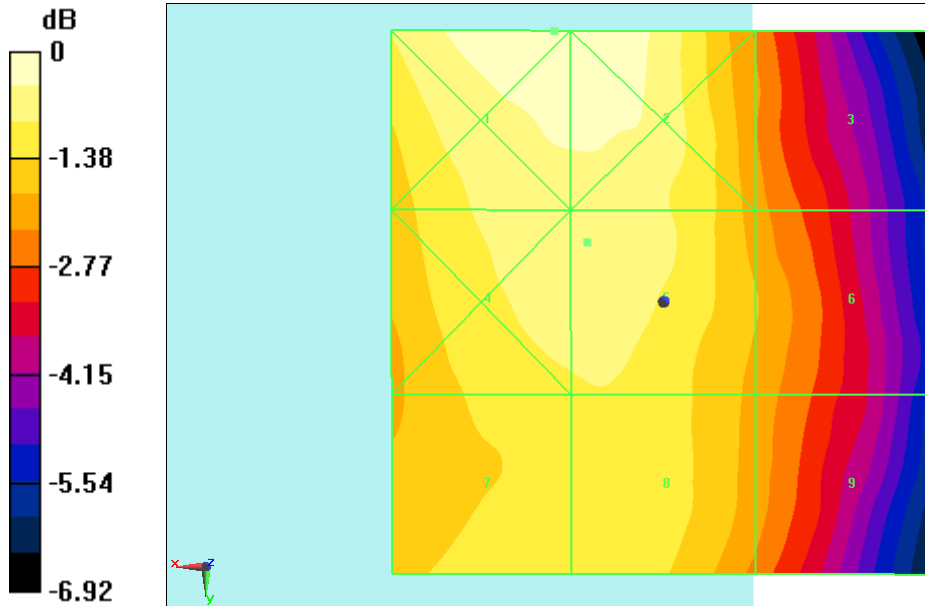

0 dB = 46.47 V/m = 33.34 dBV/m

**Fig B.1 HAC RF E-Field GSM 850**

**HAC RF E-Field GSM 1900**

Date/Time: 2023-07-12

Electronics: DAE4 Sn1524

Medium: Air

Medium parameters used:  $\sigma = 0$  S/m,  $\epsilon_r = 1$ ;  $\rho = 1000$  kg/m<sup>3</sup>

Ambient Temperature:23.3°C

Liquid Temperature: 22.5°C

Communication System: UID 0, 1GSM 1900 (0) Frequency: 1850.2 MHz Duty Cycle: 1:8.30042

Probe: EF3DV3 – SN4060 ConvF(1, 1, 1) @ 1850.2 MHz

**GSM1900/E Scan – ER3DV6 – 2011: 15 mm from Probe Center to the****Device 2 2 2 2/Hearing Aid Compatibility Test (101x101x1):**

Interpolated grid: dx=0.5000 mm, dy=0.5000 mm

Device Reference Point: 0, 0, -6.3 mm

Reference Value = 14.22 V/m; Power Drift = 0.04 dB

Applied MIF = 3.49 dB

RF audio interference level = 26.43 dBV/m

**Emission category: M4**

MIF scaled E-field

Grid 1 M4 25.99 dBV/m	Grid 2 M4 26.65 dBV/m	Grid 3 M4 25.94 dBV/m
Grid 4 M4 24.93 dBV/m	Grid 5 M4 25.68 dBV/m	Grid 6 M4 26.04 dBV/m
Grid 7 M4 26.32 dBV/m	Grid 8 M4 26.43 dBV/m	Grid 9 M4 26.09 dBV/m

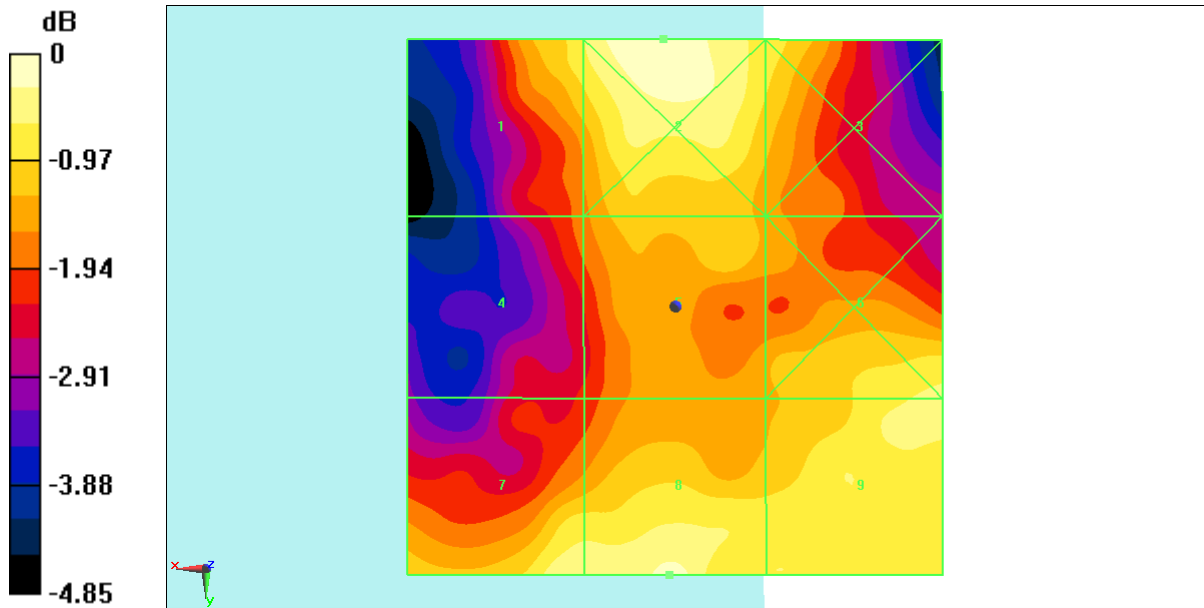

0 dB = 21.50 V/m = 26.65 dBV/m

**Fig B.2 HAC RF E-Field GSM1900**

**HAC RF E-Field LTE Band41**

Date/Time: 2023-07-14

Electronics: DAE4 Sn1524

Medium: Air

Medium parameters used:  $\sigma = 0$  S/m,  $\epsilon_r = 1$ ;  $\rho = 1000$  kg/m<sup>3</sup>

Ambient Temperature:23.3°C

Liquid Temperature: 22.5°C

Communication System: UID 0, LTE Band41 (0) Frequency: 2636.5 MHz Duty Cycle: 1:1.5787

Probe: EF3DV3 – SN4060 ConvF(1, 1, 1) @ 2636.5 MHz

**B41/E Scan – ER3DV6 – 2011: 15 mm from Probe Center to the Device****2/Hearing Aid Compatibility Test (101x101x1):** Interpolated grid:

dx=0.5000 mm, dy=0.5000 mm

Device Reference Point: 0, 0, -6.3 mm

Reference Value = 11.14 V/m; Power Drift = 0.15 dB

Applied MIF = -3.39 dB

RF audio interference level = 17.23 dBV/m

**Emission category: M4**

MIF scaled E-field

Grid 1 M4 16.53 dBV/m	Grid 2 M4 15.6 dBV/m	Grid 3 M4 15.25 dBV/m
Grid 4 M4 17.21 dBV/m	Grid 5 M4 17.22 dBV/m	Grid 6 M4 17.23 dBV/m
Grid 7 M4 17.84 dBV/m	Grid 8 M4 17.72 dBV/m	Grid 9 M4 17.59 dBV/m

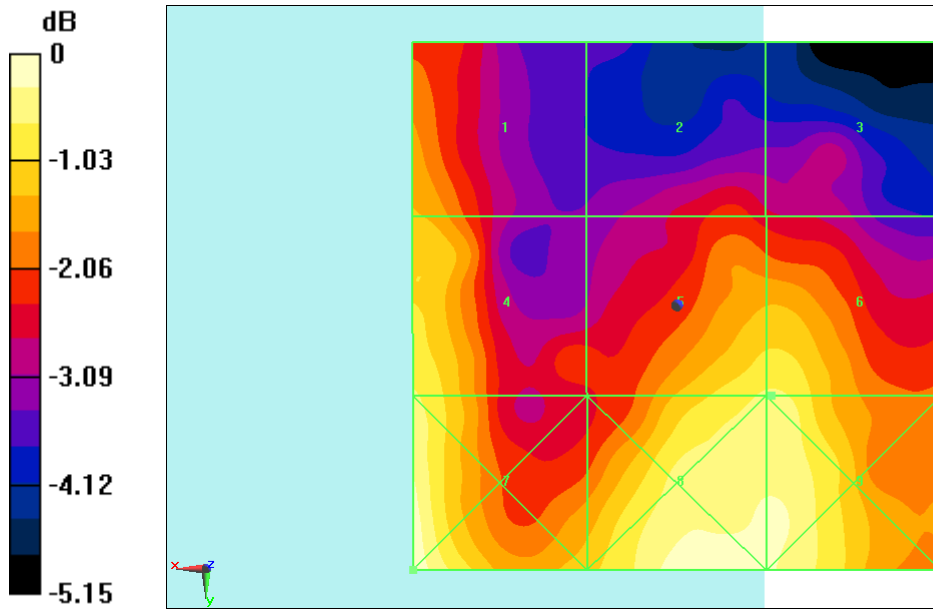

0 dB = 7.799 V/m = 17.84 dBV/m

**Fig B.3 HAC RF E-Field LTE Band41**

**HAC RF E-Field WIFI2.4G**

Date/Time: 2023-07-13

Electronics: DAE4 Sn1524

Medium: Air

Medium parameters used:  $\sigma = 0$  S/m,  $\epsilon_r = 1$ ;  $\rho = 1000$  kg/m<sup>3</sup>

Ambient Temperature:23.3°C

Liquid Temperature: 22.5°C

Communication System: UID 0, 1WIFI 2450 (0) Frequency: 2462 MHz Duty Cycle: 1:1

Probe: EF3DV3 - SN4060 ConvF(1, 1, 1) @ 2462 MHz

**WIFI2.4G 11g 6M 17DB/E Scan - ER3DV6 - 2011: 15 mm from Probe****Center to the Device 3/Hearing Aid Compatibility Test (101x101x1):**

Interpolated grid: dx=0.5000 mm, dy=0.5000 mm

Device Reference Point: 0, 0, -6.3 mm

Reference Value = 26.12 V/m; Power Drift = 0.03 dB

Applied MIF = -6.23 dB

RF audio interference level = 20.48 dBV/m

**Emission category: M4**

MIF scaled E-field

Grid 1 M4 18.62 dBV/m	Grid 2 M4 18.73 dBV/m	Grid 3 M4 17.75 dBV/m
Grid 4 M4 20.39 dBV/m	Grid 5 M4 20.48 dBV/m	Grid 6 M4 19.72 dBV/m
Grid 7 M4 21.26 dBV/m	Grid 8 M4 20.52 dBV/m	Grid 9 M4 19.91 dBV/m

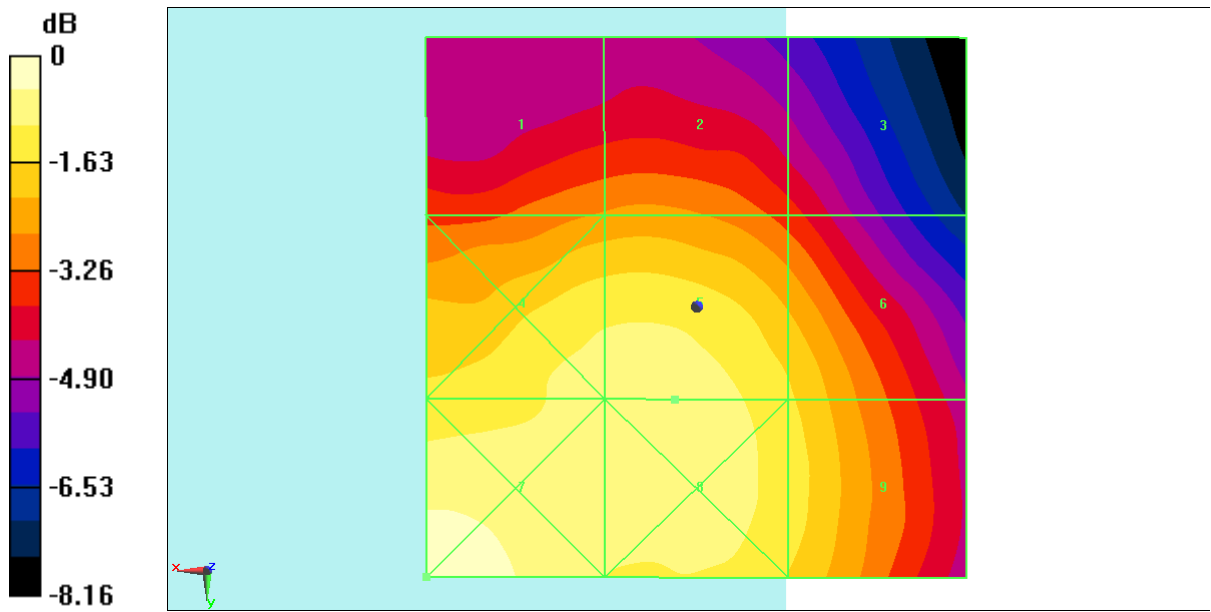

0 dB = 11.56 V/m = 21.26 dBV/m

**Fig B.4 HAC RF E-Field WIFI2.4G**



## ANNEX C SYSTEM VALIDATION RESULT

### E SCAN of Dipole 835 MHz

Date/Time: 2023-07-11

Electronics: DAE4 Sn1524

Medium: Air

Medium parameters used:  $\sigma = 0$  S/m,  $\epsilon_r = 1$ ;  $\rho = 1000$  kg/m<sup>3</sup>

Ambient Temperature: 23.3°C

Liquid Temperature: 22.5°C

Communication System: UID 0, CW Frequency: 835 MHz Duty Cycle: 1:1

Probe: EF3DV3 - SN4060 ConvF(1, 1, 1) @ 835 MHz

Dipole E-Field measurement (E-field scan for ANSI C63.19-2007 & -  
2011 compliance)/E Scan - measurement distance from the probe

sensor center to CD835 = 15mm/Hearing Aid Compatibility Test at

15mm distance (41x361x1): Interpolated grid: dx=0.5000 mm, dy=0.5000 mm

Device Reference Point: 0, 0, -6.3 mm

Reference Value = 143.3 V/m; Power Drift = -0.01 dB

Applied MIF = 0.00 dB

RF audio interference level = 41.17 dBV/m

Emission category: **M3**

MIF scaled E-field

Grid 1 <b>M3</b> 41.11 dBV/m	Grid 2 <b>M3</b> 41.17 dBV/m	Grid 3 <b>M3</b> 40.91 dBV/m
Grid 4 <b>M4</b> 36.89 dBV/m	Grid 5 <b>M4</b> 36.94 dBV/m	Grid 6 <b>M4</b> 36.70 dBV/m

Grid 7 M3	Grid 8 M3	Grid 9 M3
41.49 dBV/m	41.55 dBV/m	41.28 dBV/m

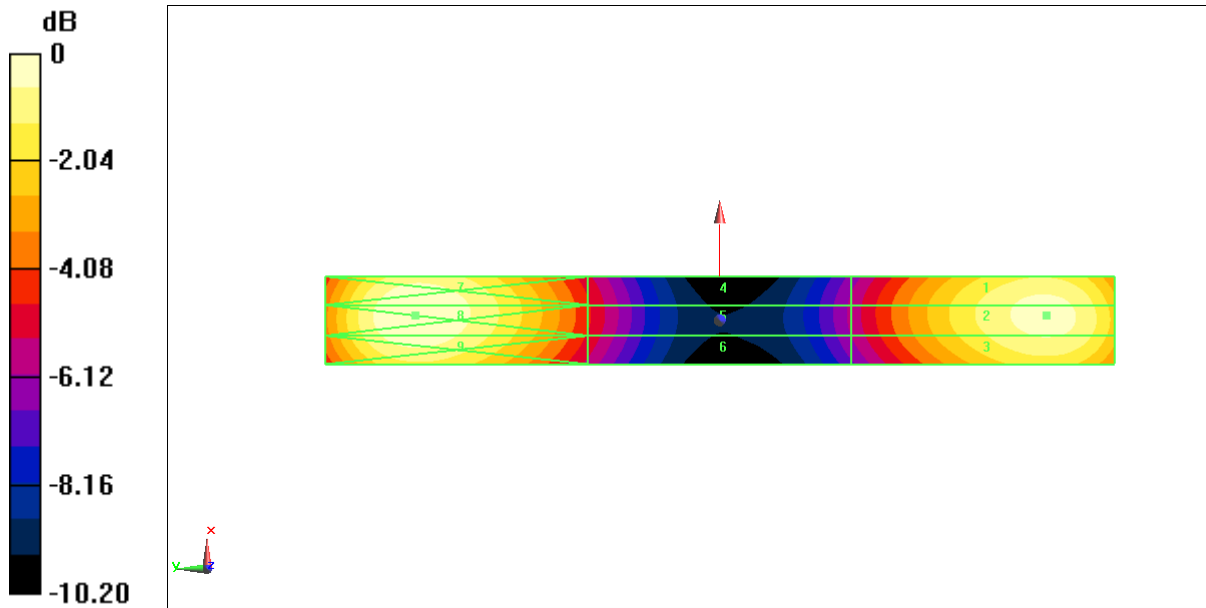

**E SCAN of Dipole 1880 MHz**

Date/Time: 2023-07-12

Electronics: DAE4 Sn1524

Medium: Air

Medium parameters used:  $\sigma = 0$  S/m,  $\epsilon_r = 1$ ;  $\rho = 1000$  kg/m<sup>3</sup>

Ambient Temperature:23.3°C

Liquid Temperature: 22.5°C

Communication System: UID 0, CW Frequency: 1880 MHz Duty Cycle: 1:1

Probe: EF3DV3 - SN4060 ConvF(1, 1, 1) @ 1880 MHz

Dipole E-Field measurement (E-field scan for ANSI C63.19-2007 & -  
2011 compliance)/E Scan - measurement distance from the probe

sensor center to CD1880 = 15mm 2/Hearing Aid Compatibility Test at

15mm distance (41x181x1): Interpolated grid: dx=0.5000 mm, dy=0.5000 mm

Device Reference Point: 0, 0, -6.3 mm

Reference Value = 129.6 V/m; Power Drift = 0.02 dB

Applied MIF = 0.00 dB

RF audio interference level = 38.90 dBV/m

**Emission category: M2**

MIF scaled E-field

Grid 1 M2 39.34 dBV/m	Grid 2 M2 39.36 dBV/m	Grid 3 M2 39.00 dBV/m
Grid 4 M2 36.99 dBV/m	Grid 5 M2 37.03 dBV/m	Grid 6 M2 36.94 dBV/m
Grid 7 M2	Grid 8 M2	Grid 9 M2

38.75 dBV/m	38.90 dBV/m	38.75 dBV/m
-------------	-------------	-------------

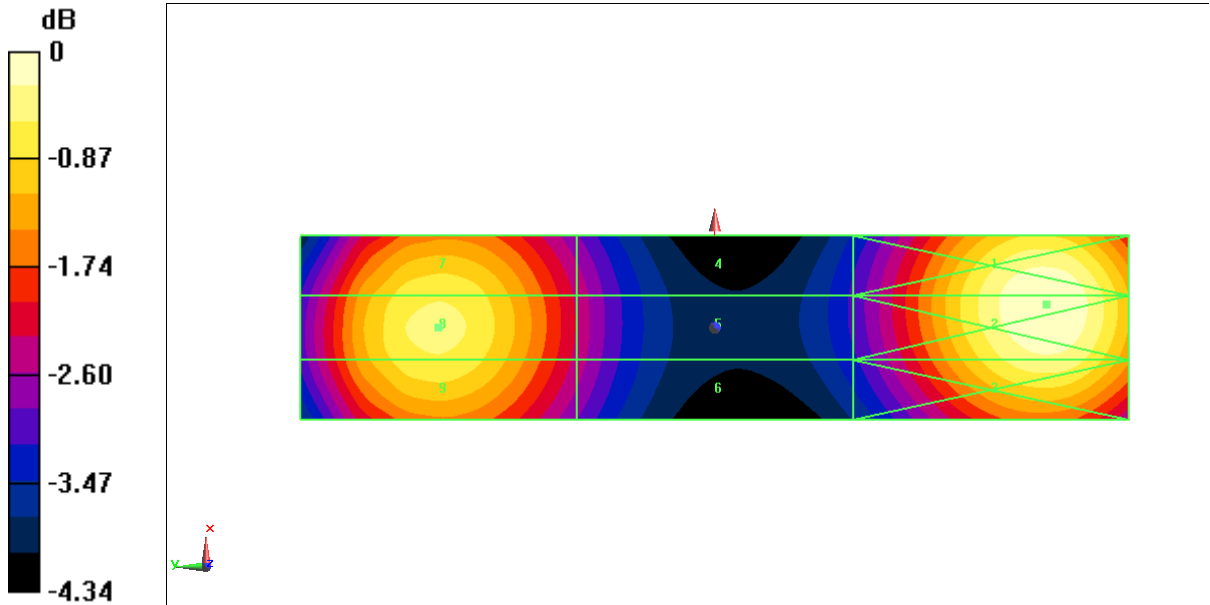



**E SCAN of Dipole 2450 MHz**

Date/Time: 2023-07-13

Electronics: DAE4 Sn1524

Medium: Air

Medium parameters used:  $\sigma = 0$  S/m,  $\epsilon_r = 1$ ;  $\rho = 1000$  kg/m<sup>3</sup>

Ambient Temperature:23.3°C

Liquid Temperature: 22.5°C

Communication System: UID 0, CW Frequency: 2450 MHz Duty Cycle: 1:1

Probe: EF3DV3 - SN4060 ConvF(1, 1, 1) @ 2450 MHz

Dipole E-Field measurement (E-field scan for ANSI C63.19-2007 & -2011 compliance)/E Scan - measurement distance from the probe

sensor center to CD2450 = 15mm/Hearing Aid Compatibility Test at

15mm distance (41x181x1): Interpolated grid: dx=0.5000 mm, dy=0.5000 mm

Device Reference Point: 0, 0, -6.3 mm

Reference Value = 66.03 V/m; Power Drift = -0.03 dB

Applied MIF = 0.00 dB

RF audio interference level = 38.18 dBV/m

Emission category: M2

MIF scaled E-field

Grid 1 M2 38.40 dBV/m	Grid 2 M2 38.47 dBV/m	Grid 3 M2 38.26 dBV/m
Grid 4 M2 37.68 dBV/m	Grid 5 M2 37.76 dBV/m	Grid 6 M2 37.63 dBV/m
Grid 7 M2	Grid 8 M2	Grid 9 M2

38.08 dBV/m	38.18 dBV/m	38.02 dBV/m
-------------	-------------	-------------

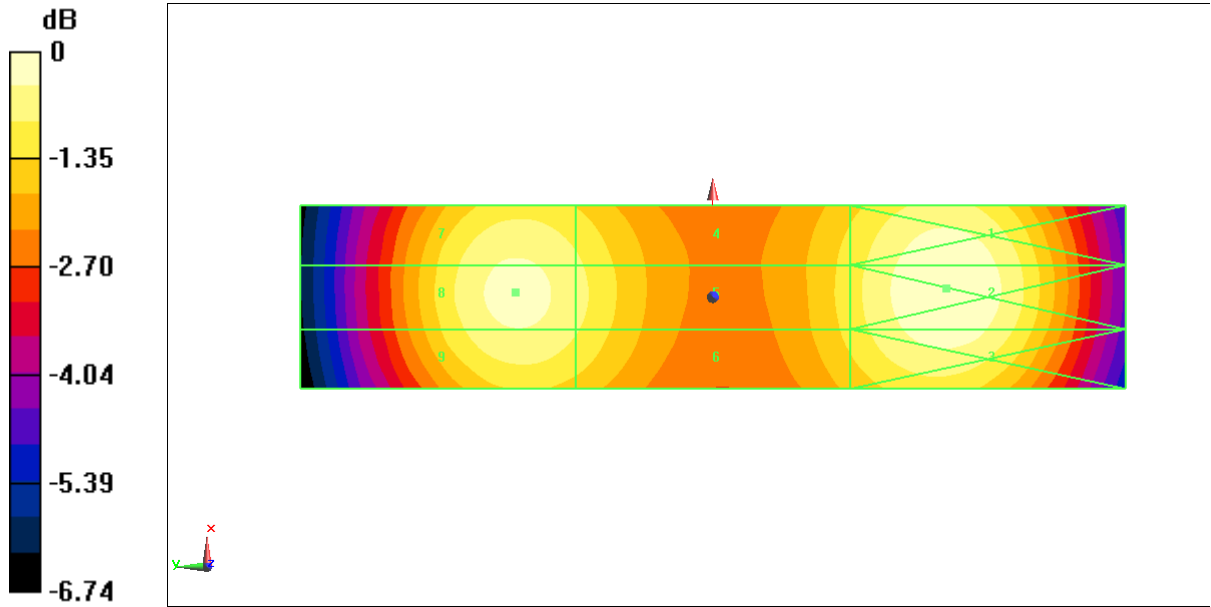

**E SCAN of Dipole 2600 MHz**

Date/Time: 2023-07-14

Electronics: DAE4 Sn1524

Medium: Air

Medium parameters used:  $\sigma = 0$  S/m,  $\epsilon_r = 1$ ;  $\rho = 1000$  kg/m<sup>3</sup>

Ambient Temperature: 23.3°C      Liquid Temperature: 22.5°C

Communication System: UID 0, CW (0) Frequency: 2600 MHz Duty Cycle: 1:1

Probe: EF3DV3 - SN4060 ConvF(1, 1, 1) @ 2600 MHz

**Dipole E-Field measurement (E-field scan for ANSI C63.19-2007 & -2011 compliance)/E Scan - measurement distance from the probe sensor center to CD2600 = 15mm/Hearing Aid Compatibility Test at 15mm distance (41x141x1):**

Interpolated grid: dx=0.5000 mm, dy=0.5000 mm

Device Reference Point: 0, 0, -6.3 mm

Reference Value = 59.78 V/m; Power Drift = -0.12 dB

Applied MIF = 0.00 dB

RF audio interference level = 38.22 dBV/m

**Emission category: M2**

MIF scaled E-field

<b>Grid 1 M2</b> <b>38.38 dBV/m</b>	<b>Grid 2 M2</b> <b>38.44 dBV/m</b>	<b>Grid 3 M2</b> <b>38.22 dBV/m</b>
<b>Grid 4 M2</b> <b>37.63 dBV/m</b>	<b>Grid 5 M2</b> <b>37.67 dBV/m</b>	<b>Grid 6 M2</b> <b>37.49 dBV/m</b>
<b>Grid 7 M2</b> <b>38.18 dBV/m</b>	<b>Grid 8 M2</b> <b>38.22 dBV/m</b>	<b>Grid 9 M2</b> <b>37.99 dBV/m</b>

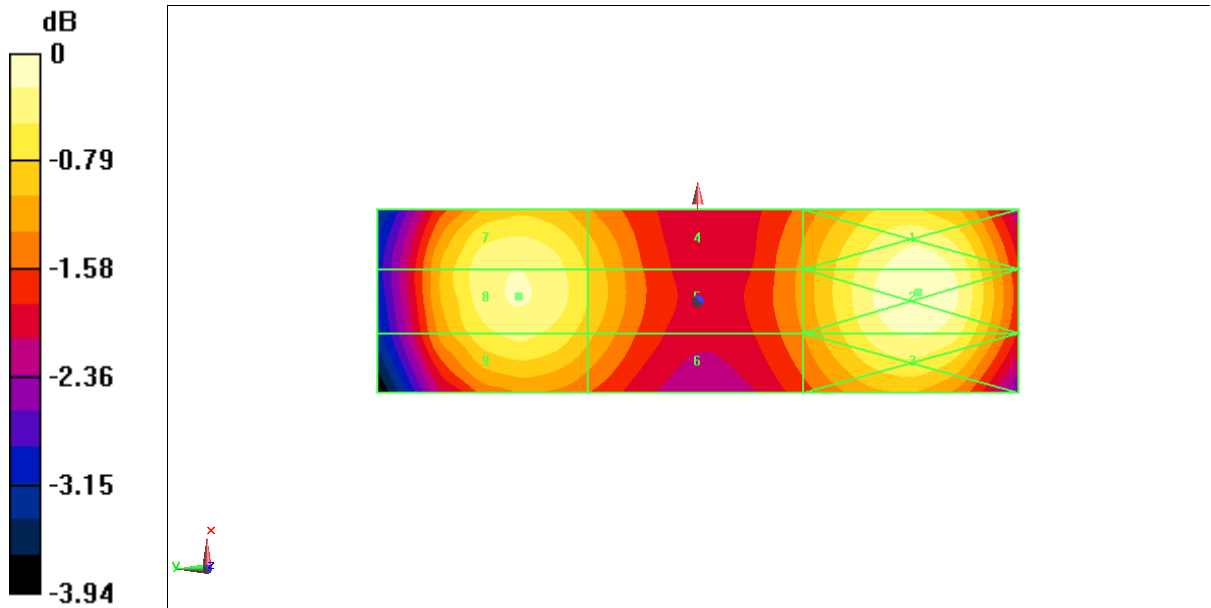



# ANNEX D PROBE CALIBRATION CERTIFICATE

**Calibration Laboratory of**  
 Schmid & Partner  
 Engineering AG  
 Zeughausstrasse 43, 8004 Zurich, Switzerland



**S** Schweizerischer Kalibrierdienst  
**C** Service suisse d'étalonnage  
**S** Servizio svizzero di taratura  
**S** Swiss Calibration Service

Accredited by the Swiss Accreditation Service (SAS)  
 The Swiss Accreditation Service is one of the signatories to the EA  
 Multilateral Agreement for the recognition of calibration certificates

Accreditation No.: **SCS 0108**

Client **CTTL**  
 Beijing

Certificate No. **EF-4060\_May23**

## CALIBRATION CERTIFICATE

Object **EF3DV3 - SN:4060**

Calibration procedure(s) **QA CAL-02.v9, QA CAL-25.v8**  
 Calibration procedure for E-field probes optimized for close near field evaluations in air

Calibration date **May 24, 2023**

This calibration certificate documents the traceability to national standards, which realize the physical units of measurements (SI). The measurements and the uncertainties with confidence probability are given on the following pages and are part of the certificate.

All calibrations have been conducted in the closed laboratory facility: environment temperature (22 ± 3) °C and humidity < 70%.

Calibration Equipment used (M&TE critical for calibration)

Primary Standards	ID	Cal Date (Certificate No.)	Scheduled Calibration
Power meter NRP2	SN: 104778	30-Mar-23 (No. 217-03804/03805)	Mar-24
Power sensor NRP-Z91	SN: 103244	30-Mar-23 (No. 217-03804)	Mar-24
Power sensor NRP-Z91	SN: 103245	30-Mar-23 (No. 217-03805)	Mar-24
Reference 20 dB Attenuator	SN: CC2552 (20x)	30-Mar-23 (No. 217-03809)	Mar-24
DAE4	SN: 789	03-Jan-23 (No. DAE4-789_Jan23)	Jan-24
Reference Probe ER3DV6	SN: 2328	06-Oct-22 (No. ER3-2328_Oct22)	Oct-23

Secondary Standards	ID	Check Date (in house)	Scheduled Check
Power meter E4419B	SN: GB41293874	06-Apr-16 (in house check Jun-22)	In house check: Jun-24
Power sensor E4412A	SN: MY41498087	06-Apr-16 (in house check Jun-22)	In house check: Jun-24
Power sensor E4412A	SN: 000110210	06-Apr-16 (in house check Jun-22)	In house check: Jun-24
RF generator HP 8648C	SN: US3642U01700	04-Aug-99 (in house check Jun-22)	In house check: Jun-24
Network Analyzer E8358A	SN: US41080477	31-Mar-14 (in house check Oct-22)	In house check: Oct-24

	Name	Function	Signature
Calibrated by	Jeffrey Katzman	Laboratory Technician	
Approved by	Sven Kühn	Technical Manager	

Issued: May 24, 2023

This calibration certificate shall not be reproduced except in full without written approval of the laboratory.