



HAC RF TEST REPORT

No.I23Z61303-SEM02

For

TCL Communication Ltd.

GSM/UMTS/LTE Mobile phone

Model Name: T432J

With

Hardware Version: 03

Software Version: MYS0

FCC ID: 2ACCJH175

Results Summary: M Category = M3

Issued Date: 2023-7-28

Note:

The test results in this test report relate only to the devices specified in this report. This report shall not be reproduced except in full without the written approval of CTTL.

Test Laboratory:

CTTL, Telecommunication Technology Labs, CAICT

No. 52, Huayuan North Road, Haidian District, Beijing, P. R. China 100191.

Tel:+86(0)10-62304633-2512, Fax:+86(0)10-62304633-2504

Email: ctl_terminals@caict.ac.cn, website: www.caict.ac.cn



No.I23Z61303-SEM02

REPORT HISTORY

Report Number	Revision	Issue Date	Description
I23Z61303-SEM02	Rev.0	2023-7-28	Initial creation of test report

TABLE OF CONTENT

1 TEST LABORATORY	5
1.1 TESTING LOCATION.....	5
1.2 TESTING ENVIRONMENT.....	5
1.3 PROJECT DATA	5
1.4 SIGNATURE.....	5
2 CLIENT INFORMATION	6
2.1 APPLICANT INFORMATION.....	6
2.2 MANUFACTURER INFORMATION	6
3 EQUIPMENT UNDER TEST (EUT) AND ANCILLARY EQUIPMENT (AE)	7
3.1 ABOUT EUT.....	7
3.2 INTERNAL IDENTIFICATION OF EUT USED DURING THE TEST	7
3.3 INTERNAL IDENTIFICATION OF AE USED DURING THE TEST	7
3.4 AIR INTERFACES / BANDS INDICATING OPERATING MODES.....	8
4 MAXIMUM OUTPUT POWER	9
5 REFERENCE DOCUMENTS	10
5.1 REFERENCE DOCUMENTS FOR TESTING	10
6 OPERATIONAL CONDITIONS DURING TEST	11
6.1 HAC MEASUREMENT SET-UP.....	11
6.2 PROBE SPECIFICATION	12
6.3 TEST ARCH PHANTOM & PHONE POSITIONER	13
6.4 ROBOTIC SYSTEM SPECIFICATIONS.....	13
7 EUT ARRANGEMENT	14
7.1 WD RF EMISSION MEASUREMENTS REFERENCE AND PLANE	14
8 SYSTEM VALIDATION	15
8.1 VALIDATION PROCEDURE.....	15
8.2 VALIDATION RESULT	15
9 EVALUATION OF MIF	16
9.1 INTRODUCTION.....	16
9.2 MIF MEASUREMENT WITH THE AIA	17
9.3 TEST EQUIPMENT FOR THE MIF MEASUREMENT	17
9.4 DUT MIF RESULTS.....	17
10 EVALUATION FOR LOW-POWER EXEMPTION	19
10.1 PRODUCT TESTING THRESHOLD	19
10.2 CONDUCTED POWER.....	19
10.3 CONCLUSION	19
11 RF TEST PROCEDURES	20



12 MEASUREMENT RESULTS (E-FIELD).....21

13 ANSIC 63.19-2011 LIMITS21

14 MEASUREMENT UNCERTAINTY22

15 MAIN TEST INSTRUMENTS23

16 CONCLUSION.....23

ANNEX A TEST LAYOUT.....24

ANNEX B TEST PLOTS.....25

ANNEX C SYSTEM VALIDATION RESULT31

ANNEX D PROBE CALIBRATION CERTIFICATE37

ANNEX E DIPOLE CALIBRATION CERTIFICATE58

1 Test Laboratory

1.1 Testing Location

CompanyName:	CTTL
Address:	No. 52, Huayuan North Road, Haidian District, Beijing, P. R. China 100191.

1.2 Testing Environment

Temperature:	18°C~25°C,
Relative humidity:	30%~ 70%
Ground system resistance:	< 0.5 Ω
Ambient noise is checked and found very low and in compliance with requirement of standards. Reflection of surrounding objects is minimized and in compliance with requirement of standards	

1.3 Project Data

Project Leader:	Qi Dianyuan
Test Engineer:	Wang Tian
Testing Start Date:	June 20, 2023
Testing End Date:	June 23, 2023

1.4 Signature

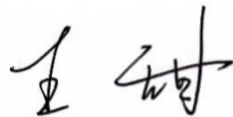

Wang Tian
(Prepared this test report)

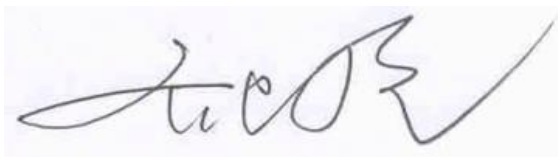

Qi Dianyuan
(Reviewed this test report)

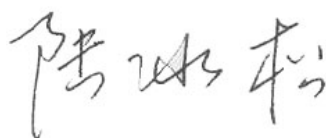

Lu Bingsong
Deputy Director of the laboratory
(Approved this test report)



2 Client Information

2.1 Applicant Information

Company Name:	TCL Communication Ltd.
Address/Post:	5/F, Building 22E, 22 Science Park East Avenue, Hong Kong Science Park, Shatin, NT, Hong Kong
Contact Person:	Annie Jiang
Contact Email:	nianxiang.jiang@tcl.com
Telephone:	+86 755 3661 1621
Fax	+86 755 3661 2000-81722

2.2 Manufacturer Information

Company Name:	TCL Communication Ltd.
Address/Post:	5/F, Building 22E, 22 Science Park East Avenue, Hong Kong Science Park, Shatin, NT, Hong Kong
Contact Person:	Annie Jiang
Contact Email:	nianxiang.jiang@tcl.com
Telephone:	+86 755 3661 1621
Fax	+86 755 3661 2000-81722

3 Equipment Under Test (EUT) and Ancillary Equipment (AE)

This EUT is a variant product and the report of original sample is No.I23Z60906-SEM01.

Add LTE band2/5/7/13 and delete LTE band25/26/41.We share the other test results of original sample

3.1 About EUT

Description:	GSM/UMTS/LTE Mobile phone
Model name:	T432J
Operating mode(s):	GSM850/900/1800/1900, WCDMA B2/4/5 LTE Band 2/4/5/7/12/13/17/66/71 BT, Wi-Fi 2.4G

3.2 Internal Identification of EUT used during the test

EUT ID*	IMEI	HW Version	SW Version
EUT1	\	\	\

*EUT ID: is used to identify the test sample in the lab internally.

3.3 Internal Identification of AE used during the test

AE ID*	Description	Model	SN	Manufacturer
AE1	Battery	TLi028C7	\	NINGBO VEKEN BATTERY CO.,LTD

*AE ID: is used to identify the test sample in the lab internally.

3.4 Air Interfaces / Bands Indicating Operating Modes

Air-interface	Band(MHz)	Type	C63.19/tested	Simultaneous Transmissions	Name of Voice Service
GSM	850	VO	Yes	BT, WLAN	CMRS Voice
	1900				
GPRS/EDGE	850	DT	Yes		MEET
	1900				
WCDMA (UMTS)	850	VO	NO ⁽¹⁾	BT, WLAN	CMRS Voice
	1700				
	1900	DT	NO ⁽¹⁾		MEET
LTE FDD	Band2/4/5/7/12/13/17/66/71	V/D	NO ⁽¹⁾	BT, WLAN	VoLTE, MEET
BT	2450	DT	NA	GSM,WCDMA ,LTE	NA
WLAN	2450	V/D	Yes	GSM,WCDMA ,LTE	VoWiFi, MEET

NA: Not Applicable VO: Voice Only V/D: CMRS and IP Voice Service over Digital Transport

DT: Digital Transport

* HAC Rating was not based on concurrent voice and data modes, Non current mode was found to represent worst case rating for both M and T rating

Note1 = The air interface is exempted from testing by low power exemption that its average antenna input power plus its MIF is ≤ 17 dBm, and is rated as M4.

4 Maximum Output Power

Bands	Conducted Power (dBm)
GSM 850	33.3
GSM 1900	28.3
WCDMA 850	24.5
WCDMA 1700	21.5
WCDMA 1900	21.5
LTE Band2	22
LTE Band4	22
LTE Band5	24
LTE Band7	21
LTE Band12	25
LTE Band13	25
LTE Band17	25
LTE Band66	25
LTE Band71	24.5
WLAN 2.4GHz	21

Note: For the frequency band with multiple antennas, the highest power value is selected to reflect in the list

5 Reference Documents

5.1 Reference Documents for testing

The following document listed in this section is referred for testing.

Reference	Title	Version
ANSI C63.19-2011	American National Standard for Methods of Measurement of Compatibility between Wireless Communication Devices and Hearing Aids	2011 Edition
FCC 47 CFR §20.19	Hearing Aid Compatible Mobile Headsets	2015 Edition
KDB 285076 D01	Equipment Authorization Guidance for Hearing Aid Compatibility	v06r03

6 OPERATIONAL CONDITIONS DURING TEST

6.1 HAC MEASUREMENT SET-UP

These measurements are performed using the DASY5 NEO automated dosimetric assessment system. It is made by Schmid & Partner Engineering AG (SPEAG) in Zurich, Switzerland. It consists of high precision robotics system (Stäubli), robot controller, Intel Core2 computer, near-field probe, probe alignment sensor. The robot is a six-axis industrial robot performing precise movements. A cell controller system contains the power supply, robot controller, teach pendant (Joystick), and remote control, is used to drive the robot motors. The PC consists of the HP Intel Core2 1.86 GHz computer with Windows XP system and HAC Measurement Software DASY5 NEO, A/D interface card, monitor, mouse, and keyboard. The Stäubli Robot is connected to the cell controller to allow software manipulation of the robot. A data acquisition electronic (DAE) circuit performs the signal amplification, signal multiplexing, AD-conversion, offset measurements, mechanical surface detection, collision detection, etc. is connected to the Electro-optical coupler (EOC). The EOC performs the conversion from the optical into digital electric signal of the DAE and transfers data to the PC plug-in card.

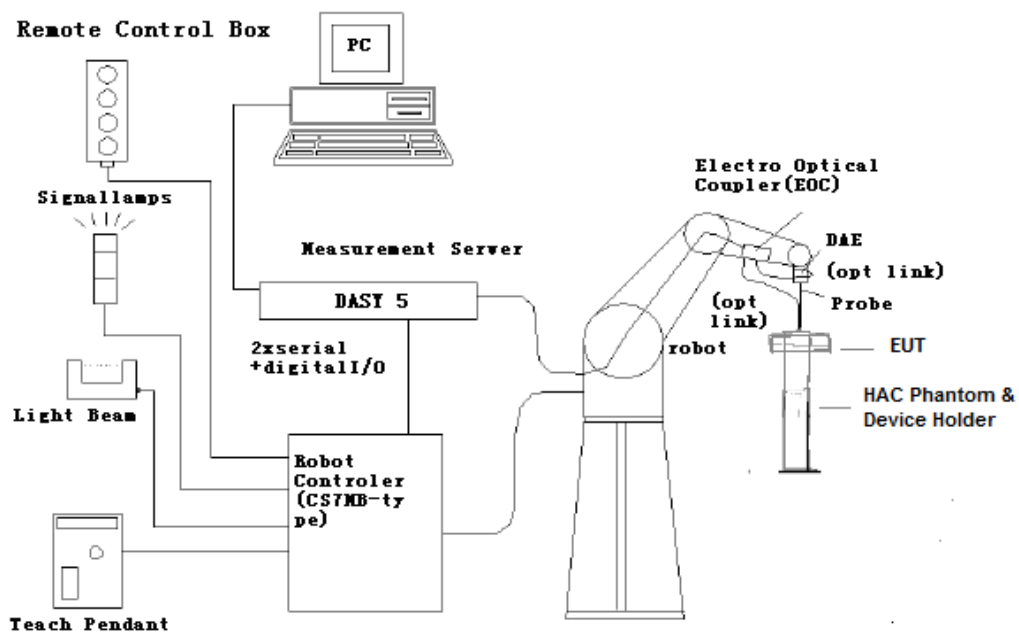

Fig. 1 HAC Test Measurement Set-up

The DAE4 consists of a highly sensitive electrometer-grade preamplifier with auto-zeroing, a channel and gain-switching multiplexer, a fast 16 bit AD-converter and a command decoder and control logic unit. Transmission to the PC-card is accomplished through an optical downlink for data and status information and an optical uplink for commands and clock lines. The mechanical probe mounting device includes two different sensor systems for frontal and sidewise probe contacts. They are also used for mechanical surface detection and probe collision detection. The robot uses its own controller with a built in VME-bus computer.

6.2 Probe Specification

E-Field Probe Description

Construction	<p>One dipole parallel, two dipoles normal to probe axis</p> <p>Built-in shielding against static charges</p> <p>PEEK enclosure material</p>
Calibration	<p>In air from 100 MHz to 3.0 GHz (absolute accuracy $\pm 6.0\%$, $k=2$)</p>
Frequency	<p>40 MHz to > 6 GHz (can be extended to < 20 MHz)</p> <p>Linearity: ± 0.2 dB (100 MHz to 3 GHz)</p>
Directivity	<p>± 0.2 dB in air (rotation around probe axis)</p> <p>± 0.4 dB in air (rotation normal to probe axis)</p>
Dynamic Range	<p>2 V/m to > 1000 V/m; Linearity: ± 0.2 dB</p>
Dimensions	<p>Overall length: 330 mm (Tip: 16 mm)</p> <p>Tip diameter: 8 mm (Body: 12 mm)</p> <p>Distance from probe tip to dipole centers: 2.5 mm</p>
Application	<p>General near-field measurements up to 6 GHz</p> <p>Field component measurements</p> <p>Fast automatic scanning in phantoms</p>



[ER3DV6]

6.3 Test Arch Phantom & Phone Positioner

The Test Arch phantom should be positioned horizontally on a stable surface. Reference markings on the Phantom allow the complete setup of all predefined phantom positions and measurement grids by manually teaching three points in the robot. It enables easy and well defined positioning of the phone and validation dipoles as well as simple teaching of the robot (Dimensions: 370 x 370 x 370 mm).

The Phone Positioner supports accurate and reliable positioning of any phone with effect on near field $< \pm 0.5$ dB.

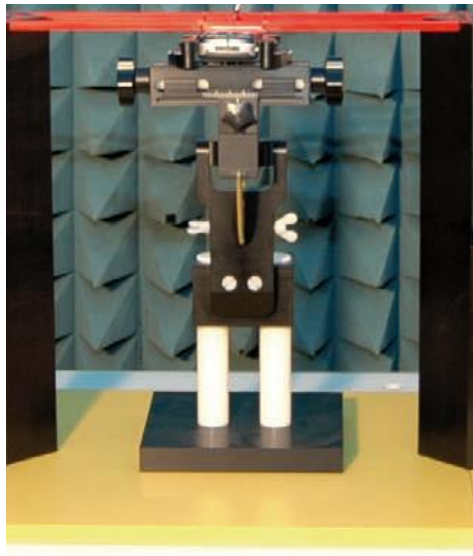

Fig. 2 HAC Phantom & Device Holder

6.4 Robotic System Specifications

Specifications

Positioner: Stäubli Unimation Corp. Robot Model: RX160L

Repeatability: ± 0.02 mm

No. of Axis: 6

Data Acquisition Electronic (DAE) System

Cell Controller

Processor: Intel Core2

Clock Speed: 1.86GHz

Operating System: Windows XP

Data Converter

Features: Signal Amplifier, multiplexer, A/D converter, and control logic

Software: DASY5 software

Connecting Lines: Optical downlink for data and status info.

Optical uplink for commands and clock

7 EUT ARRANGEMENT

7.1 WD RF Emission Measurements Reference and Plane

Figure 4 illustrates the references and reference plane that shall be used in the WD emissions measurement.

- The grid is 5 cm by 5 cm area that is divided into 9 evenly sized blocks or sub-grids.
- The grid is centered on the audio frequency output transducer of the WD (speaker or T-coil).
- The grid is located by reference to a reference plane. This reference plane is the planar area that contains the highest point in the area of the WD that normally rests against the user's ear
- The measurement plane is located parallel to the reference plane and 15 mm from it, out from the phone. The grid is located in the measurement plane.

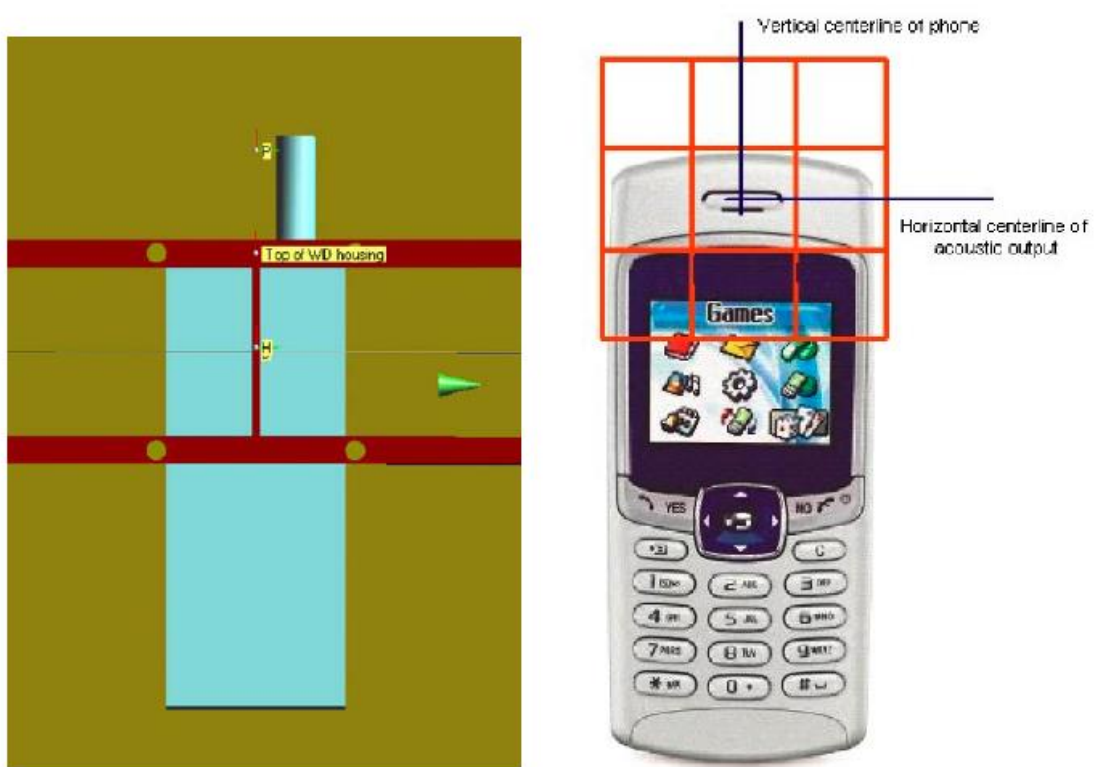

Fig. 3 WD reference and plane for RF emission measurements

8 SYSTEM VALIDATION

8.1 Validation Procedure

Place a dipole antenna meeting the requirements given in ANSI C63.19 in the position normally occupied by the WD. The dipole antenna serves as a known source for an electrical output. Position the E-field probes so that:

- The probes and their cables are parallel to the coaxial feed of the dipole antenna
- The probe cables and the coaxial feed of the dipole antenna approach the measurement area from opposite directions
- The center point of the probe element(s) are 15 mm from the closest surface of the dipole elements.

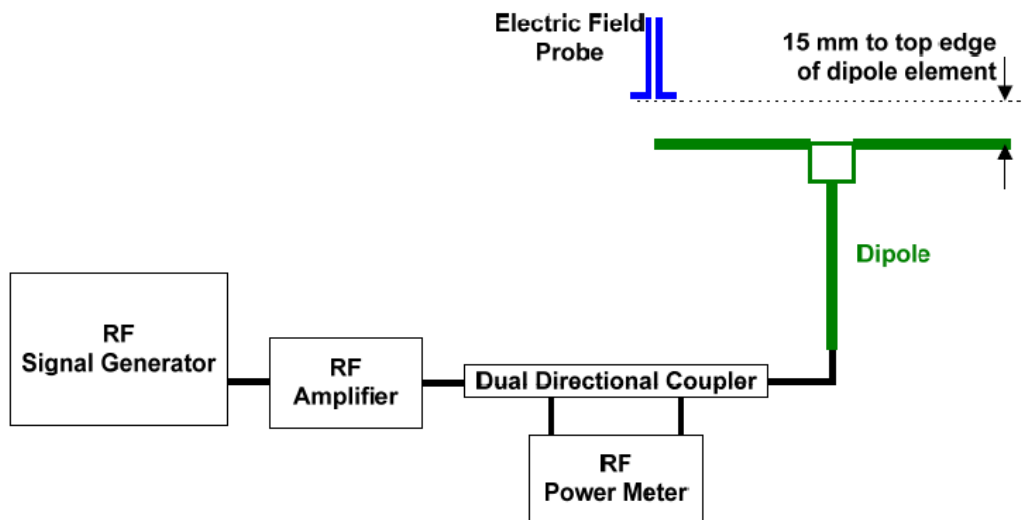

Fig. 4 Dipole Validation Setup

8.2 Validation Result

E-Field Scan						
Mode	Frequency (MHz)	Input Power (mW)	Measured ¹ Value(dBV/m)	Target ² Value(dBV/m)	Deviation ³ (%)	Limit ⁴ (%)
CW	835	100	40.66	41	-3.84	± 18
CW	1880	100	38.98	38.78	2.33	± 18
CW	2450	100	38.4	38.69	-3.28	± 18

Notes:

1. Please refer to the attachment for detailed measurement data and plot.
2. Target value is provided by SPEAG in the calibration certificate of specific dipoles.
3. Deviation (%) = $100 * (\text{Measured value minus Target value}) / \text{Target value}$.
4. ANSI C63.19 requires values within $\pm 18\%$ are acceptable, of which 12% is deviation and 13% is measurement uncertainty. Values independently validated for the dipole actually used in the measurements should be used, when available.

9 Evaluation of MIF

9.1 Introduction

The MIF (Modulation Interference Factor) is used to classify E-field emission to determine Hearing Aid Compatibility (HAC). It scales the power-averaged signal to the RF audio interference level and is characteristic to a modulation scheme. The HAC standard preferred "indirect" measurement method is based on average field measurement with separate scaling by the MIF. With an Audio Interference Analyzer (AIA) designed by SPEAG specifically for the MIF measurement, these values have been verified by practical measurements on an RF signal modulated with each of the waveforms. The resulting deviations from the simulated values are within the requirements of the HAC standard.

The AIA (Audio Interference Analyzer) is an USB powered electronic sensor to evaluate signals in the frequency range 698MHz - 6 GHz. It contains RMS detector and audio frequency circuits for sampling of the RF envelope.



Fig. 5 AIA Front View

9.2 MIF measurement with the AIA

The MIF is measured with the AIA as follows:

1. Connect the AIA via USB to the DASY5 PC and verify the configuration settings.
2. Couple the RF signal to be evaluated to an AIA via cable or antenna.
3. Generate a MIF measurement job for the unknown signal and select the measurement port and timing settings.
4. Document the results via the post processor in a report.

9.3 Test equipment for the MIF measurement

No.	Name	Type	Serial Number	Manufacturer
01	Signal Generator	SMW200A	107732	R&S
02	AIA	SE UMS 170 CB	1029	SPEAG
03	BTS	CMW500	166370	R&S

9.4 DUT MIF results

Based on the KDB285076D01, the handset can also use the MIF values predetermined by the test equipment manufacturer. MIF values applied in this test report were provided by the HAC equipment provider of SPEAG, and the worst values for all air interface are listed below to be determine the Low-power Exemption.

Typical MIF levels in ANSI C63.19-2011	
Transmission protocol	Modulation interference factor
GSM-FDD (TDMA, GMSK)	+3.63 dB
EDGE-FDD (TDMA, 8PSK, TN 0-1)	+1.23dB
EDGE-FDD (TDMA, 8PSK, TN 0-1-2)	-0.52dB
EDGE-FDD (TDMA, 8PSK, TN 0-1-2-3)	-1.82dB
UMTS-FDD(WCDMA, AMR)	-25.43dB
UMTS-FDD (HSPA)	-20.75dB
LTE-FDD (SC-FDMA, 1RB, 20MHz, QPSK)	-15.63 dB
LTE-FDD (SC-FDMA, 1RB, 20MHz, 16QAM)	-9.76 dB
LTE-FDD (SC-FDMA, 1RB, 20MHz, 64QAM)	-9.93 dB
LTE-TDD (SC-FDMA, 1RB, 20MHz, QPSK)	-1.62 dB
LTE-TDD (SC-FDMA, 1RB, 20MHz, 16QAM)	-1.44 dB
LTE-TDD (SC-FDMA, 1RB, 20MHz, 64QAM)	-1.54 dB
LTE-TDD(SC-FDMA,1RB,20MHz,QPSK,UL Subframe=2,3,4,7,8,9)	-3.41 dB
LTE-TDD(SC-FDMA,1RB,20MHz,16QAM,UL Subframe=2,3,4,7,8,9)	-3.17 dB
LTE-TDD(SC-FDMA,1RB,20MHz,64QAM,UL Subframe=2,3,4,7,8,9)	-3.31 dB
IEEE 802.11b WiFi 2.4 GHz (DSSS, 1 Mbps)	-5.90 dB
IEEE 802.11b WiFi 2.4 GHz (DSSS, 2 Mbps)	-5.17 dB

IEEE 802.11b WiFi 2.4 GHz (DSSS, 5.5 Mbps)	-3.37 dB
IEEE 802.11b WiFi 2.4 GHz (DSSS, 11 Mbps)	-2.02 dB
IEEE 802.11g WiFi 2.4 GHz (DSSS-OFDM, 6 Mbps)	-0.36dB
IEEE 802.11n (HT Greenfield, 6.5 Mbps, BPSK)	-15.80 dB
IEEE 802.11a/h WiFi 5 GHz (OFDM, 6 Mbps)	-5.82 dB
IEEE 802.11ac WiFi (20MHz, MCS0, 99pc duty cycle)	-12.23dB
5G NR (DFT-s-OFDM, 1 RB, 20 MHz, QPSK, 15 kHz)	-15.06dB
5G NR (CP-OFDM, 1 RB, 5 MHz, QPSK, 15 kHz)	-12.18dB
5G NR (CP-OFDM, 1 RB, 10 MHz, QPSK, 15 kHz)	-12.26dB
5G NR (CP-OFDM, 1 RB, 15 MHz, QPSK, 15 kHz)	-12.08dB
5G NR (CP-OFDM, 1 RB, 20 MHz, QPSK, 15 kHz)	-12.20dB
5G NR (CP-OFDM, 1 RB, 5 MHz, QPSK, 30 kHz)	-14.39dB
5G NR (CP-OFDM, 1 RB, 10 MHz, QPSK, 30 kHz)	-14.47dB
5G NR (CP-OFDM, 1 RB, 15 MHz, QPSK, 30 kHz)	-14.33dB
5G NR (CP-OFDM, 1 RB, 20 MHz, QPSK, 30 kHz)	-14.46dB
5G NR (CP-OFDM, 1 RB, 25 MHz, QPSK, 30 kHz)	-14.35dB
5G NR (CP-OFDM, 1 RB, 30 MHz, QPSK, 30 kHz)	-14.32dB
5G NR (CP-OFDM, 1 RB, 40 MHz, QPSK, 30 kHz)	-14.32dB
5G NR (CP-OFDM, 1 RB, 50 MHz, QPSK, 30 kHz)	-14.55dB
5G NR (CP-OFDM, 1 RB, 60 MHz, QPSK, 30 kHz)	-14.45dB
5G NR (CP-OFDM, 1 RB, 80 MHz, QPSK, 30 kHz)	-14.47dB
5G NR (CP-OFDM, 1 RB, 90 MHz, QPSK, 30 kHz)	-14.43dB
5G NR (CP-OFDM, 1 RB, 100 MHz, QPSK, 30 kHz)	-14.38dB
5G NR (DFT-s-OFDM, 1 RB, 5 MHz, QPSK, 15 kHz)	-15.06dB
5G NR (DFT-s-OFDM, 1 RB, 10 MHz, QPSK, 15 kHz)	-15.06dB
5G NR (DFT-s-OFDM, 1 RB, 15 MHz, QPSK, 15 kHz)	-15.06dB
5G NR (DFT-s-OFDM, 1 RB, 20 MHz, QPSK, 15 kHz)	-15.06dB

10 Evaluation for low-power exemption

10.1 Product testing threshold

There are two methods for exempting an RF air interface technology from testing. The first method requires evaluation of the MIF for the worst-case operating mode. An RF air interface technology of a device is exempt from testing when its average antenna input power plus its MIF is ≤ 17 dBm for any of its operating modes. The second method does not require determination of the MIF. The RF emissions testing exemption shall be applied to an RF air interface technology in a device whose peak antenna input power, averaged over intervals $\leq 50 \mu s$, is ≤ 23 dBm. An RF air interface technology that is exempted from testing by either method shall be rated as M4.

The first method is used to be exempt from testing for the RF air interface technology in this report.

10.2 Conducted power

Band	Average power (dBm)	MIF (dB)	Sum (dBm)	C63.19 Tested
GSM 850	33.3	3.63	36.93	Yes
GSM 1900	28.3	3.63	31.93	Yes
WCDMA 850	24.5	-25.43	-0.93	No
WCDMA 1700	21.5	-25.43	-3.93	No
WCDMA 1900	21.5	-25.43	-3.93	No
LTE Band2	22	-15.63	6.37	No
LTE Band4	22	-15.63	6.37	No
LTE Band5	24	-15.63	8.37	No
LTE Band7	21	-15.63	5.37	No
LTE Band12	25	-15.63	9.37	No
LTE Band13	25	-15.63	9.37	No
LTE Band17	25	-15.63	9.37	No
LTE Band66	25	-15.63	9.37	No
LTE Band71	24.5	-15.63	8.87	No
WLAN 2.4GHz	21	-0.36	21.36	Yes

10.3 Conclusion

According to the above table, the sums of average power and MIF for WCDMA and LTE FDD are less than 17dBm. So it is measured for GSM and WIFI2.4G. The WCDMA and LTE FDD are exempt from testing and rated as M4.

11 RF TEST PROCEDURES

The evaluation was performed with the following procedure:

- 1) Confirm proper operation of the field probe, probe measurement system and other instrumentation and the positioning system.
- 2) Position the WD in its intended test position. The gauge block can simplify this positioning.
- 3) Configure the WD normal operation for maximum rated RF output power, at the desired channel and other operating parameters (e.g., test mode), as intended for the test.
- 4) The center sub-grid shall be centered on the center of the T-Coil mode axial measurement point or the acoustic output, as appropriate. Locate the field probe at the initial test position in the 50 mm by 50 mm grid, which is contained in the measurement plane. If the field alignment method is used, align the probe for maximum field reception.
- 5) Record the reading.
- 6) Scan the entire 50 mm by 50 mm region in equally spaced increments and record the reading at each measurement point. The distance between measurement points shall be sufficient to assure the identification of the maximum reading.
- 7) Identify the five contiguous sub-grids around the center sub-grid whose maximum reading is the lowest of all available choices. This eliminates the three sub-grids with the maximum readings. Thus, the six areas to be used to determine the WD's highest emissions are identified.
- 8) Identify the maximum field reading within the non-excluded sub-grids identified in Step 7)
- 9) Evaluate the MIF and add to the maximum steady-state rms field-strength reading to obtain the RF audio interference level..
- 10) Compare this RF audio interference level with the categories and record the resulting WD category rating.

12 Measurement Results (E-Field)

Frequency		Measured Value(dBV/m)	Power Drift (dB)	Category
MHz	Channel			
GSM 850				
848.8	251	31.35	0.06	M4 (see Fig B.1)
836.6	190	30.98	0.05	M4
824.2	128	30.46	0.01	M4
GSM 1900				
1909.8	810	29.11	0.07	M4
1880	661	29.80	0.05	M4
1850.2	512	30.20	0.05	M3 (see Fig B.2)
WiFi2.4G 11b				
2462	11	20.72	-0.04	M4
2437	6	21.74	0.06	M4 (see Fig B.3)
2412	1	21.59	-0.06	M4

13 ANSIC 63.19-2011 LIMITS

WD RF audio interference level categories in logarithmic units

Emission categories	< 960 MHz E-field emissions	
Category M1	50 to 55	dB (V/m)
Category M2	45 to 50	dB (V/m)
Category M3	40 to 45	dB (V/m)
Category M4	< 40	dB (V/m)
Emission categories	> 960 MHz E-field emissions	
Category M1	40 to 45	dB (V/m)
Category M2	35 to 40	dB (V/m)
Category M3	30 to 35	dB (V/m)
Category M4	< 30	dB (V/m)

14 MEASUREMENT UNCERTAINTY

No.	Error source	Type	Uncertainty Value(%)	Prob. Dist.	k	c _i E	Standard Uncertainty (%) u_i ; (%)E	Degree of freedom V_{eff} or V_i
Measurement System								
1	Probe Calibration	B	5.	N	1	1	5.1	∞
2	Axial Isotropy	B	4.7	R	$\sqrt{3}$	1	2.7	∞
3	Sensor Displacement	B	16.5	R	$\sqrt{3}$	1	9.5	∞
4	Boundary Effects	B	2.4	R	$\sqrt{3}$	1	1.4	∞
5	Linearity	B	4.7	R	$\sqrt{3}$	1	2.7	∞
6	Scaling to Peak Envelope Power	B	2.0	R	$\sqrt{3}$	1	1.2	∞
7	System Detection Limit	B	1.0	R	$\sqrt{3}$	1	0.6	∞
8	Readout Electronics	B	0.3	N	1	1	0.3	∞
9	Response Time	B	0.8	R	$\sqrt{3}$	1	0.5	∞
10	Integration Time	B	2.6	R	$\sqrt{3}$	1	1.5	∞
11	RF Ambient Conditions	B	3.0	R	$\sqrt{3}$	1	1.7	∞
12	RF Reflections	B	12.0	R	$\sqrt{3}$	1	6.9	∞
13	Probe Positioner	B	1.2	R	$\sqrt{3}$	1	0.7	∞
14	Probe Positioning	A	4.7	R	$\sqrt{3}$	1	2.7	∞
15	Extra. And Interpolation	B	1.0	R	$\sqrt{3}$	1	0.6	∞
Test Sample Related								
16	Device Positioning Vertical	B	4.7	R	$\sqrt{3}$	1	2.7	∞
17	Device Positioning Lateral	B	1.0	R	$\sqrt{3}$	1	0.6	∞
18	Device Holder and Phantom	B	2.4	R	$\sqrt{3}$	1	1.4	∞
19	Power Drift	B	5.0	R	$\sqrt{3}$	1	2.9	∞

20	AIA measurement	B	12	R	$\sqrt{3}$	1	6.9	∞
Phantom and Setup related								
21	Phantom Thickness	B	2.4	R	$\sqrt{3}$	1	1.4	∞
Combined standard uncertainty(%)							16.2	
Expanded uncertainty (confidence interval of 95 %)		$u_e = 2u_c$		N	k=2		32.4	

15 MAIN TEST INSTRUMENTS

Table 1: List of Main Instruments

No.	Name	Type	Serial Number	Calibration Date	Valid Period
01	Signal Generator	SMW200A	107732	January 17, 2023	One Year
02	Power meter	NRP2	106277	September 22, 2022	One year
03	Power sensor	NRP8S	104291		
04	Amplifier	60S1G4	0331848	No Calibration Requested	
05	E-Field Probe	EF3DV3	4060	May 24, 2023	One year
06	DAE	SPEAG DAE4	1524	October 17, 2022	One year
07	HAC Dipole	CD835V3	1023	August 25, 2022	One year
08	HAC Dipole	CD1880V3	1018	August 25, 2022	One year
09	HAC Dipole	CD2450V3	1021	August 25, 2022	One year
10	BTS	CMW500	166370	June 28,2022	One year
11	AIA	SE UMS 170 CB	1029	No Calibration Requested	

16 CONCLUSION

The HAC measurement indicates that the EUT complies with the HAC limits of the ANSIC63.19-2011. The total M-rating is **M3**.

END OF REPORT BODY

ANNEX A TEST LAYOUT

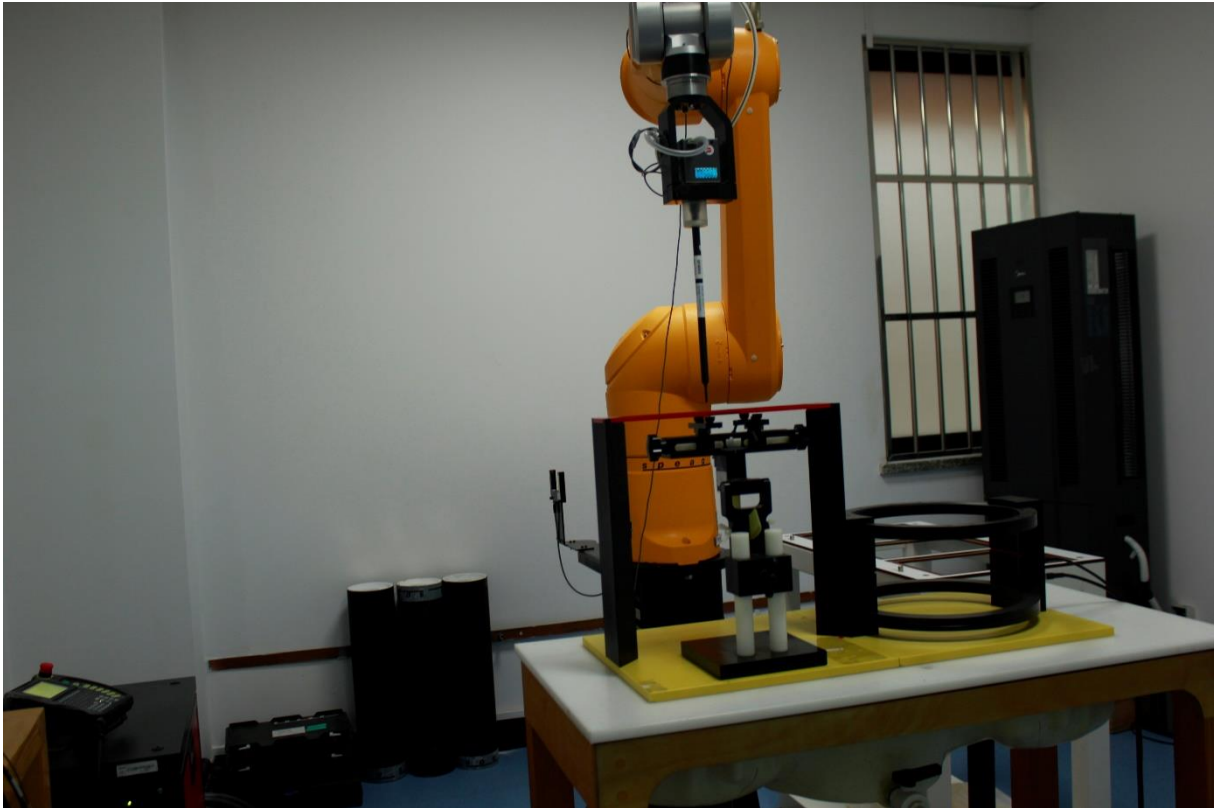

Picture A1:HAC RF System Layout

ANNEX B TEST PLOTS

HAC RF E-Field GSM 850

Date/Time: 2023-06-20

Electronics: DAE4 Sn1524

Medium: Air

Medium parameters used: $\sigma = 0$ S/m, $\epsilon_r = 1$; $\rho = 1000$ kg/m³

Ambient Temperature: 23.3oC Liquid Temperature: 22.5oC

Communication System: GSM 850 Frequency: 848.8MHz Duty Cycle: 1:8.3

Probe: EF3DV3 - SN4060 ConvF(1, 1, 1)

E Scan - ER3DV6 - 2011: 15 mm from Probe Center to the Device

3/Hearing Aid Compatibility Test (101x101x1): Interpolated grid:

dx=0.5000 mm, dy=0.5000 mm

Device Reference Point: 0, 0, -6.3 mm

Reference Value = 29.61 V/m; Power Drift = 0.06 dB

Applied MIF = 3.45 dB

RF audio interference level = 31.35 dBV/m

Emission category: **M4**

MIF scaled E-field

Grid 1 M4 31.24 dBV/m	Grid 2 M4 31.31 dBV/m	Grid 3 M4 30.61 dBV/m
Grid 4 M4 31.15 dBV/m	Grid 5 M4 31.35 dBV/m	Grid 6 M4 30.91 dBV/m
Grid 7 M4 30.83 dBV/m	Grid 8 M4 31.22 dBV/m	Grid 9 M4 30.96 dBV/m

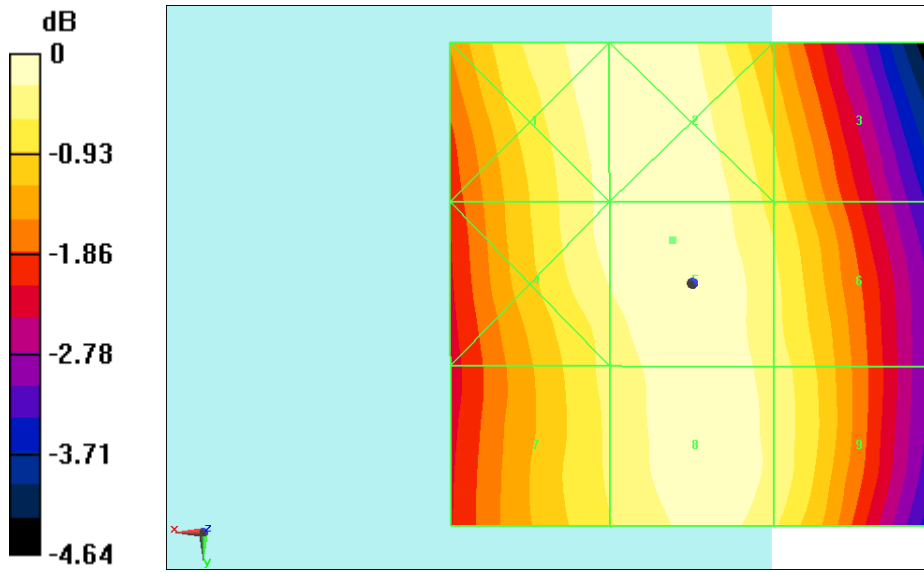

0 dB = 36.92 V/m = 31.35 dBV/m

Fig B.1 HAC RF E-Field GSM 850

HAC RF E-Field GSM 1900

Date: 2023-06-21

Electronics: DAE4 Sn1524

Medium: Air

Medium parameters used: $\sigma = 0$ mho/m, $\epsilon_r = 1$; $\rho = 1000$ kg/m³

Ambient Temperature: 22.0°C

Communication System:GSM1900; Frequency: 1850.2MHz; Duty Cycle: 1:8.3

Probe: EF3DV3 - SN4060;ConvF(1, 1, 1)

E Scan - ER3DV6 - 2011: 15 mm from Probe Center to the Device 2 2

2 2/Hearing Aid Compatibility Test (101x101x1): Interpolated grid:

dx=0.5000 mm, dy=0.5000 mm

Device Reference Point: 0, 0, -6.3 mm

Reference Value = 20.95 V/m; Power Drift = 0.05 dB

Applied MIF = 3.05 dB

RF audio interference level = 30.20 dBV/m

Emission category: **M3**

MIF scaled E-field

Grid 1 M4 28.95 dBV/m	Grid 2 M3 31.35 dBV/m	Grid 3 M3 31.32 dBV/m
Grid 4 M4 27.09 dBV/m	Grid 5 M3 30.2 dBV/m	Grid 6 M3 30.2 dBV/m
Grid 7 M4 27.7 dBV/m	Grid 8 M4 27.89 dBV/m	Grid 9 M4 27.9 dBV/m

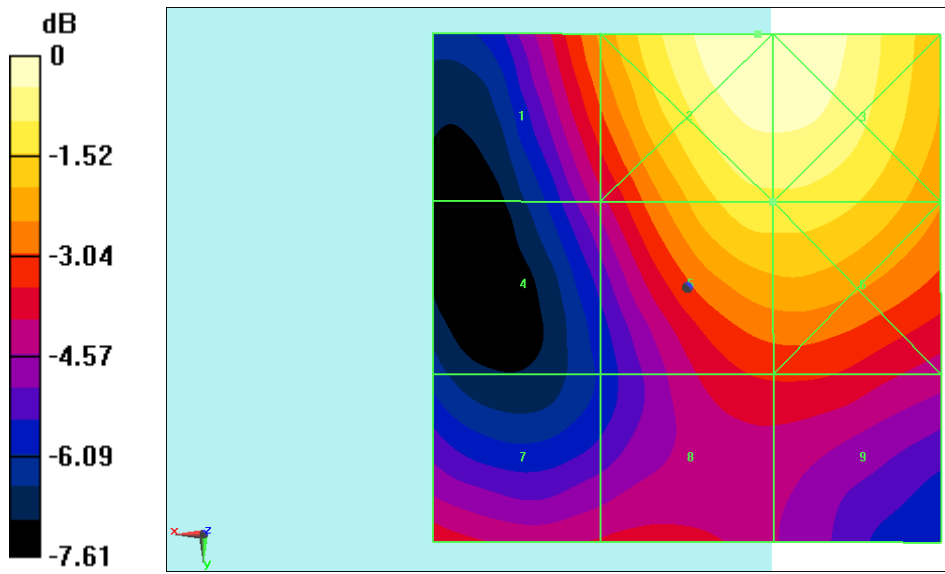

0 dB = 36.93 V/m = 31.35 dBV/m

Fig B.2 HAC RF E-Field GSM1900

HAC RF E-Field WIFI2.4G

Date: 2023-06-22

Electronics: DAE4 Sn1524

Medium: Air

Medium parameters used: $\sigma = 0$ mho/m, $\epsilon_r = 1$; $\rho = 1000$ kg/m³

Ambient Temperature: 22.0°C

Communication System: WIFI2.4G; Frequency: 2437 MHz; Duty Cycle: 1:1

Probe: EF3DV3 - SN4060;ConvF(1, 1, 1)

E Scan - ER3DV6 - 2011: 15 mm from Probe Center to the

Device/Hearing Aid Compatibility Test (101x101x1): Interpolated

grid: dx=0.5000 mm, dy=0.5000 mm

Device Reference Point: 0, 0, -6.3 mm

Reference Value = 30.38 V/m; Power Drift = 0.06 dB

Applied MIF = -6.16 dB

RF audio interference level = 21.74 dBV/m

Emission category: **M4**

MIF scaled E-field

Grid 1 M4 16.51 dBV/m	Grid 2 M4 19.63 dBV/m	Grid 3 M4 19.66 dBV/m
Grid 4 M4 19.48 dBV/m	Grid 5 M4 21.74 dBV/m	Grid 6 M4 21.48 dBV/m
Grid 7 M4 23.95 dBV/m	Grid 8 M4 23.72 dBV/m	Grid 9 M4 22.42 dBV/m

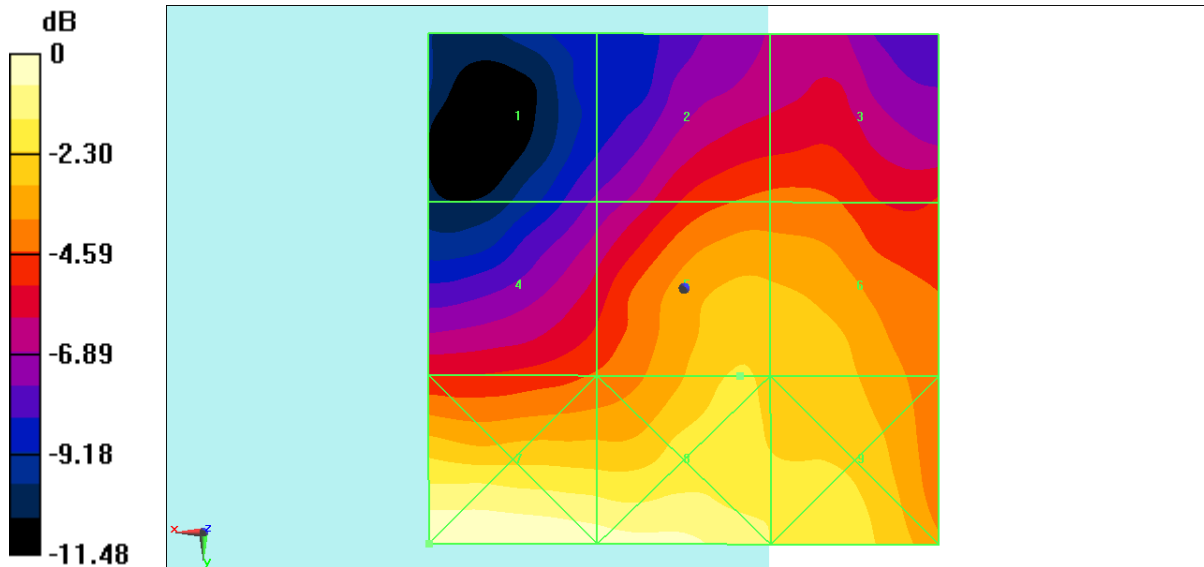

0 dB = 15.77 V/m = 23.96 dBV/m

Fig B.3HAC RF E-Field WiFi2.4G

ANNEX C SYSTEM VALIDATION RESULT

E SCAN of Dipole 835 MHz

Date: 2023-06-20

Electronics: DAE4 Sn1524

Medium: Air

Medium parameters used: $\sigma = 0$ mho/m, $\epsilon_r = 1$; $\rho = 1000$ kg/m³

Communication System: CW; Frequency: 835 MHz; Duty Cycle: 1:1

Probe: EF3DV3 - SN4060;ConvF(1, 1, 1)

Dipole E-Field measurement (E-field scan for ANSI C63.19-2007 & -2011 compliance)/E Scan - measurement distance from the probe sensor

center to CD835 = 15mm/Hearing Aid Compatibility Test at 15mm

distance (41x361x1): Interpolated grid: dx=0.5000 mm, dy=0.5000 mm

Device Reference Point: 0, 0, -6.3 mm

Reference Value = 126.8 V/m; Power Drift = 0.02 dB

Applied MIF = 0.00 dB

RF audio interference level = 40.66 dBV/m

Emission category: M3

MIF scaled E-field

Grid 1 M3 40.84 dBV/m	Grid 2 M3 40.94 dBV/m	Grid 3 M3 40.75 dBV/m
Grid 4 M4 36.04 dBV/m	Grid 5 M4 36.18 dBV/m	Grid 6 M4 36.08 dBV/m
Grid 7 M3 40.49 dBV/m	Grid 8 M3 40.66 dBV/m	Grid 9 M3 40.51 dBV/m

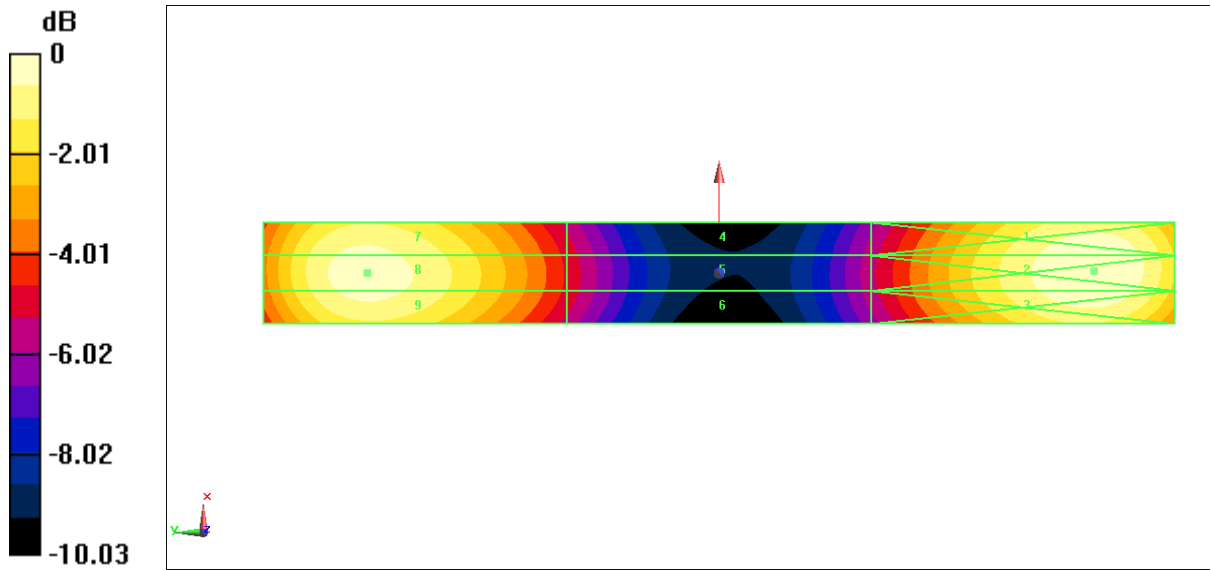

**E SCAN of Dipole 1880 MHz****Date: 2023-06-21**

Electronics: DAE4 Sn1524

Medium: Air

Medium parameters used: $\sigma = 0$ mho/m, $\epsilon_r = 1$; $\rho = 1000$ kg/m³

Communication System: CW; Frequency: 1880 MHz; Duty Cycle: 1:1

Probe: EF3DV3 - SN4060;ConvF(1, 1, 1)

Dipole E-Field measurement (E-field scan for ANSI C63.19-2007 & -
2011 compliance)/E Scan - measurement distance from the probe sensor
center to CD1880 = 15mm 2/Hearing Aid Compatibility Test at 15mm

distance (41x181x1): Interpolated grid: dx=0.5000 mm, dy=0.5000 mm

Device Reference Point: 0, 0, -6.3 mm

Reference Value = 130.7 V/m; Power Drift = 0.02 dB

Applied MIF = 0.00 dB

RF audio interference level = 38.98 dBV/m

Emission category: M2

MIF scaled E-field

Grid 1 M2 39.44 dBV/m	Grid 2 M2 39.46 dBV/m	Grid 3 M2 39.10 dBV/m
Grid 4 M2 37.08 dBV/m	Grid 5 M2 37.12 dBV/m	Grid 6 M2 37.03 dBV/m
Grid 7 M2 38.83 dBV/m	Grid 8 M2 38.98 dBV/m	Grid 9 M2 38.83 dBV/m

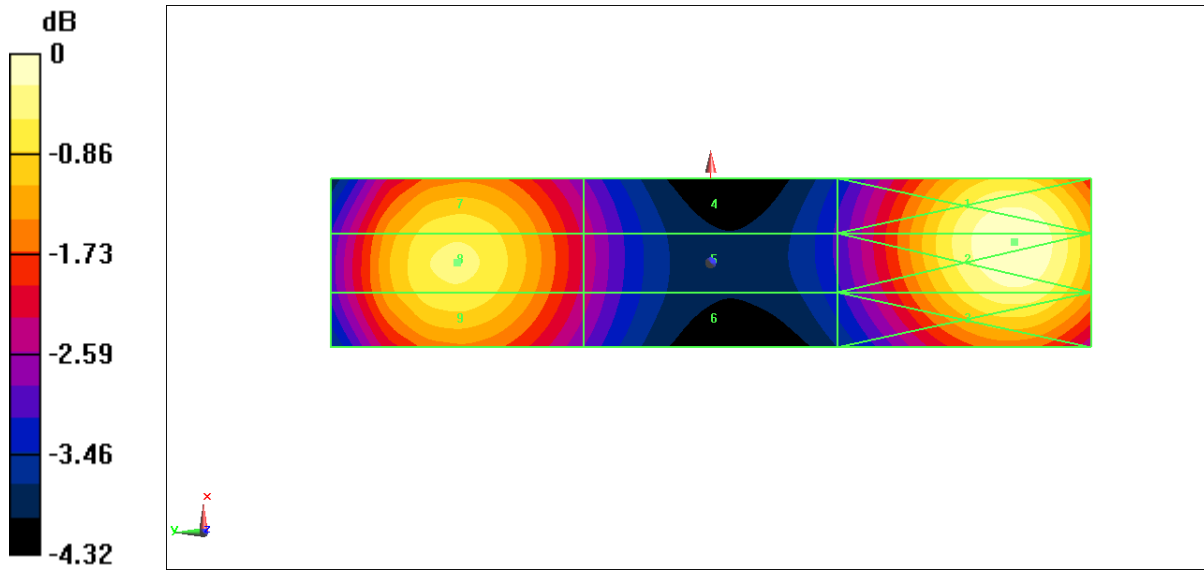

E SCAN of Dipole 2450 MHz

Date: 2023-06-22

Electronics: DAE4 Sn1524

Medium: Air

Medium parameters used: $\sigma = 0$ mho/m, $\epsilon_r = 1$; $\rho = 1000$ kg/m³

Communication System: CW; Frequency: 2450 MHz; Duty Cycle: 1:1

Probe: EF3DV3 - SN4060;ConvF(1, 1, 1)

Dipole E-Field measurement (E-field scan for ANSI C63.19-2007 & -
2011 compliance)/E Scan - measurement distance from the probe sensor
center to CD2450 = 15mm/Hearing Aid Compatibility Test at 15mm

distance (41x181x1): Interpolated grid: dx=0.5000 mm, dy=0.5000 mm

Device Reference Point: 0, 0, -6.3 mm

Reference Value = 67.64 V/m; Power Drift = 0.04 dB

Applied MIF = 0.00 dB

RF audio interference level = 38.40 dBV/m

Emission category: M2

MIF scaled E-field

Grid 1 M2 38.59 dBV/m	Grid 2 M2 38.68 dBV/m	Grid 3 M2 38.47 dBV/m
Grid 4 M2 37.89 dBV/m	Grid 5 M2 37.98 dBV/m	Grid 6 M2 37.84 dBV/m
Grid 7 M2 38.30 dBV/m	Grid 8 M2 38.40 dBV/m	Grid 9 M2 38.23 dBV/m

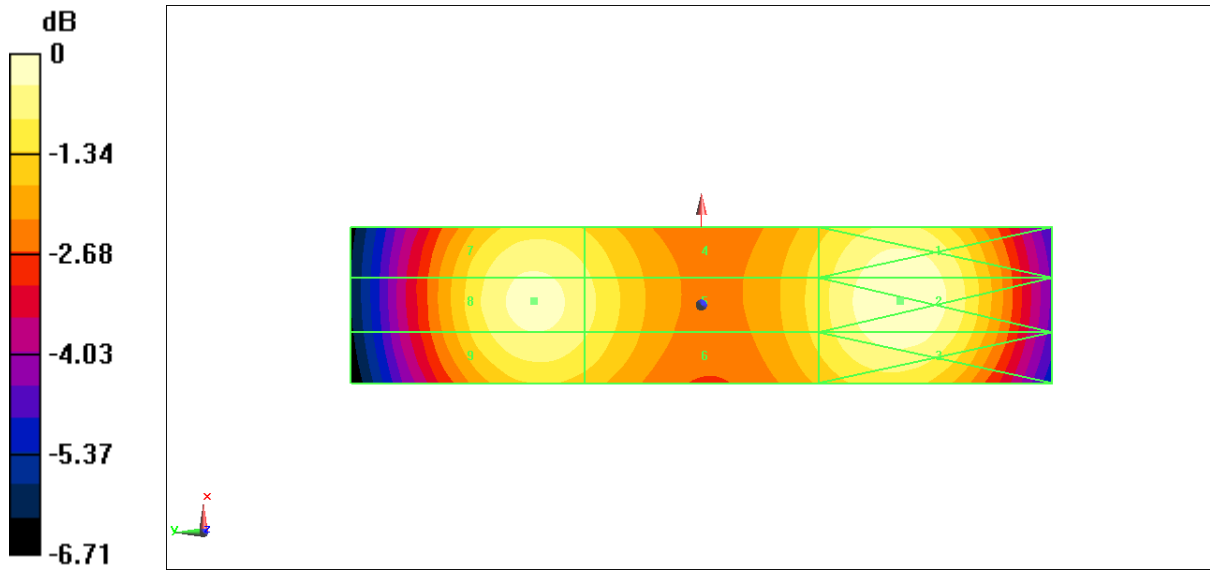

ANNEX D PROBE CALIBRATION CERTIFICATE

Calibration Laboratory of
 Schmid & Partner
 Engineering AG
 Zeughausstrasse 43, 8004 Zurich, Switzerland



S Schweizerischer Kalibrierdienst
C Service suisse d'étalonnage
S Servizio svizzero di taratura
S Swiss Calibration Service

Accredited by the Swiss Accreditation Service (SAS)
 The Swiss Accreditation Service is one of the signatories to the EA
 Multilateral Agreement for the recognition of calibration certificates

Accreditation No.: **SCS 0108**

Client **CTTL**
 Beijing

Certificate No. **EF-4060_May23**

CALIBRATION CERTIFICATE

Object **EF3DV3 - SN:4060**

Calibration procedure(s) **QA CAL-02.v9, QA CAL-25.v8**
 Calibration procedure for E-field probes optimized for close near field evaluations in air

Calibration date **May 24, 2023**

This calibration certificate documents the traceability to national standards, which realize the physical units of measurements (SI). The measurements and the uncertainties with confidence probability are given on the following pages and are part of the certificate.

All calibrations have been conducted in the closed laboratory facility: environment temperature (22 ± 3) °C and humidity < 70%.

Calibration Equipment used (M&TE critical for calibration)

Primary Standards	ID	Cal Date (Certificate No.)	Scheduled Calibration
Power meter NRP2	SN: 104778	30-Mar-23 (No. 217-03804/03805)	Mar-24
Power sensor NRP-Z91	SN: 103244	30-Mar-23 (No. 217-03804)	Mar-24
Power sensor NRP-Z91	SN: 103245	30-Mar-23 (No. 217-03805)	Mar-24
Reference 20 dB Attenuator	SN: CC2552 (20x)	30-Mar-23 (No. 217-03809)	Mar-24
DAE4	SN: 789	03-Jan-23 (No. DAE4-789_Jan23)	Jan-24
Reference Probe ER3DV6	SN: 2328	06-Oct-22 (No. ER3-2328_Oct22)	Oct-23

Secondary Standards	ID	Check Date (in house)	Scheduled Check
Power meter E4419B	SN: GB41293874	06-Apr-16 (in house check Jun-22)	In house check: Jun-24
Power sensor E4412A	SN: MY41498087	06-Apr-16 (in house check Jun-22)	In house check: Jun-24
Power sensor E4412A	SN: 000110210	06-Apr-16 (in house check Jun-22)	In house check: Jun-24
RF generator HP 8648C	SN: US3642U01700	04-Aug-99 (in house check Jun-22)	In house check: Jun-24
Network Analyzer E8358A	SN: US41080477	31-Mar-14 (in house check Oct-22)	In house check: Oct-24

	Name	Function	Signature
Calibrated by	Jeffrey Katzman	Laboratory Technician	
Approved by	Sven Kühn	Technical Manager	

Issued: May 24, 2023

This calibration certificate shall not be reproduced except in full without written approval of the laboratory.

Calibration Laboratory ofSchmid & Partner
Engineering AG

Zeughausstrasse 43, 8004 Zurich, Switzerland

**S** Schweizerischer Kalibrierdienst
C Service suisse d'étalonnage
S Servizio svizzero di taratura
S Swiss Calibration Service

Accredited by the Swiss Accreditation Service (SAS)

The Swiss Accreditation Service is one of the signatories to the EA Multilateral Agreement for the recognition of calibration certificatesAccreditation No.: **SCS 0108****Glossary**

NORM _{x,y,z}	sensitivity in free space
DCP	diode compression point
CF	crest factor (1/duty_cycle) of the RF signal
A, B, C, D	modulation dependent linearization parameters
En	incident E-field orientation normal to probe axis
Ep	incident E-field orientation parallel to probe axis
Polarization φ	φ rotation around probe axis
Polarization θ	θ rotation around an axis that is in the plane normal to probe axis (at measurement center), i.e., $\theta = 0$ is normal to probe axis
Connector Angle	information used in DASY system to align probe sensor X to the robot coordinate system

Calibration is Performed According to the Following Standards:

- IEEE Std 1309-2005, "IEEE Standard for calibration of electromagnetic field sensors and probes, excluding antennas, from 9 kHz to 40 GHz", December 2005
- CTIA Test Plan for Hearing Aid Compatibility, Rev 3.1.1, May 2017

Methods Applied and Interpretation of Parameters:

- NORM_{x,y,z}**: Assessed for E-field polarization $\theta = 0$ for XY sensors and $\theta = 90$ for Z sensor ($f \leq 900$ MHz in TEM-cell; $f > 1800$ MHz in R22 waveguide).
- NORM(f)_{x,y,z} = NORM_{x,y,z} * frequency_response** (see Frequency Response Chart).
- DCP_{x,y,z}**: DCP are numerical linearization parameters assessed based on the data of power sweep with CW signal. DCP does not depend on frequency nor media.
- PAR**: PAR is the Peak to Average Ratio that is not calibrated but determined based on the signal characteristics
- A_{x,y,z}; B_{x,y,z}; C_{x,y,z}; D_{x,y,z}; VR_{x,y,z}**: A, B, C, D are numerical linearization parameters assessed based on the data of power sweep for specific modulation signal. The parameters do not depend on frequency nor media. VR is the maximum calibration range expressed in RMS voltage across the diode.
- Spherical isotropy (3D deviation from isotropy)**: in a locally homogeneous field realized using an open waveguide setup
- Sensor Offset**: The sensor offset corresponds to the offset of virtual measurement center from the probe tip (on probe axis). No tolerance required.
- Connector Angle**: The angle is assessed using the information gained by determining the **NORM_x** (no uncertainty required).

EF3DV3 - SN:4060

May 24, 2023

Parameters of Probe: EF3DV3 - SN:4060
Basic Calibration Parameters

	Sensor X	Sensor Y	Sensor Z	Unc (k = 2)
Norm ($\mu\text{V}/(\text{V}/\text{m})^2$)	0.79	0.74	1.28	$\pm 10.1\%$
DCP (mV) ^B	96.0	99.0	96.0	$\pm 4.7\%$

Calibration Results for Frequency Response (30 MHz – 5.8 GHz)

Frequency MHz	Target E-field (En) V/m	Measured E-field (En) V/m	Deviation E-field (En)	Target E-field (Ep) V/m	Measured E-field (Ep) V/m	Deviation E-field (Ep)	Unc (k = 2)
30	77.1	77.2	0.0%	77.1	76.7	-0.5%	$\pm 5.1\%$
100	76.9	78.0	1.4%	76.9	78.1	1.5%	$\pm 5.1\%$
450	77.2	78.2	1.3%	77.1	78.2	1.4%	$\pm 5.1\%$
600	77.1	77.7	0.8%	77.1	77.8	0.9%	$\pm 5.1\%$
750	77.1	77.5	0.5%	77.1	77.5	0.4%	$\pm 5.1\%$
1800	143.1	139.9	-2.2%	143.2	139.9	-2.3%	$\pm 5.1\%$
2000	135.0	129.5	-4.1%	135.0	129.4	-4.2%	$\pm 5.1\%$
2200	127.6	124.5	-2.4%	127.6	125.5	-1.6%	$\pm 5.1\%$
2500	125.5	120.2	-4.2%	125.4	120.9	-3.6%	$\pm 5.1\%$
3000	79.4	76.2	-4.1%	79.4	77.1	-2.9%	$\pm 5.1\%$
3500	256.1	255.1	-0.4%	256.2	251.5	-1.8%	$\pm 5.1\%$
3700	250.4	244.0	-2.6%	250.6	241.6	-3.6%	$\pm 5.1\%$
5200	50.8	50.8	0.0%	50.8	51.1	0.7%	$\pm 5.1\%$
5500	49.6	48.8	-1.6%	49.6	49.1	-1.0%	$\pm 5.1\%$
5800	48.8	47.9	-1.8%	48.8	47.5	-2.7%	$\pm 5.1\%$

The reported uncertainty of measurement is stated as the standard uncertainty of measurement multiplied by the coverage factor k=2, which for a normal distribution corresponds to a coverage probability of approximately 95%.

^B Linearization parameter uncertainty for maximum specified field strength.

^E Uncertainty is determined using the max. deviation from linear response applying rectangular distribution and is expressed for the square of the field value.

EF3DV3 - SN:4060

May 24, 2023

Parameters of Probe: EF3DV3 - SN:4060
Calibration Results for Modulation Response

UID	Communication System Name		A dB	B dB $\sqrt{\mu\text{V}}$	C	D dB	VR mV	Max dev.	Max Unc ^E k = 2
0	CW	X	0.00	0.00	1.00	0.00	170.4	±3.3%	±4.7%
		Y	0.00	0.00	1.00		163.0		
		Z	0.00	0.00	1.00		171.2		
10352	Pulse Waveform (200Hz, 10%)	X	2.09	63.68	8.65	10.00	60.0	±3.0%	±9.6%
		Y	3.02	67.16	10.44		60.0		
		Z	2.32	64.82	9.38		60.0		
10353	Pulse Waveform (200Hz, 20%)	X	1.37	63.21	7.37	6.99	80.0	±1.0%	±9.6%
		Y	1.65	64.91	8.54		80.0		
		Z	1.59	64.51	8.20		80.0		
10354	Pulse Waveform (200Hz, 40%)	X	0.59	61.11	5.39	3.98	95.0	±0.8%	±9.6%
		Y	0.81	63.31	6.95		95.0		
		Z	0.72	62.40	6.27		95.0		
10355	Pulse Waveform (200Hz, 60%)	X	0.33	60.52	4.33	2.22	120.0	±0.8%	±9.6%
		Y	0.44	62.39	5.87		120.0		
		Z	0.45	62.08	5.26		120.0		
10387	QPSK Waveform, 1 MHz	X	1.82	70.10	16.42	1.00	150.0	±2.5%	±9.6%
		Y	1.64	68.24	15.36		150.0		
		Z	1.85	70.86	16.70		150.0		
10388	QPSK Waveform, 10 MHz	X	2.33	69.87	16.90	0.00	150.0	±1.0%	±9.6%
		Y	2.16	68.46	16.04		150.0		
		Z	2.33	70.07	17.03		150.0		
10396	64-QAM Waveform, 100 kHz	X	2.27	69.05	18.68	3.01	150.0	±2.2%	±9.6%
		Y	1.80	65.34	17.49		150.0		
		Z	2.20	68.34	18.30		150.0		
10399	64-QAM Waveform, 40 MHz	X	3.49	67.41	16.17	0.00	150.0	±1.8%	±9.6%
		Y	3.37	66.77	15.70		150.0		
		Z	3.48	67.47	16.22		150.0		
10414	WLAN CCDF, 64-QAM, 40 MHz	X	4.74	65.93	15.90	0.00	150.0	±3.3%	±9.6%
		Y	4.64	65.55	15.57		150.0		
		Z	4.72	66.00	15.96		150.0		

Note: For details on UID parameters see Appendix

The reported uncertainty of measurement is stated as the standard uncertainty of measurement multiplied by the coverage factor k=2, which for a normal distribution corresponds to a coverage probability of approximately 95%.

^B Linearization parameter uncertainty for maximum specified field strength.

^E Uncertainty is determined using the max. deviation from linear response applying rectangular distribution and is expressed for the square of the field value.



EF3DV3 - SN:4060

May 24, 2023

Parameters of Probe: EF3DV3 - SN:4060**Sensor Frequency Model Parameters**

	Sensor X	Sensor Y	Sensor Z
Frequency Corr. (LF)	0.14	0.22	4.61
Frequency Corr. (HF)	2.82	2.82	2.82

Sensor Model Parameters

	C1 fF	C2 fF	α V ⁻¹	T1 msV ⁻²	T2 msV ⁻¹	T3 ms	T4 V ⁻²	T5 V ⁻¹	T6
x	35.5	238.24	37.85	6.57	0.07	4.96	0.76	0.05	1.00
y	35.1	232.38	36.75	6.91	0.01	4.99	0.00	0.02	1.01
z	33.6	225.86	37.95	6.74	0.08	4.98	0.49	0.09	1.00

Other Probe Parameters

Sensor Arrangement	Rectangular
Connector Angle	145.2°
Mechanical Surface Detection Mode	enabled
Optical Surface Detection Mode	disabled
Probe Overall Length	337 mm
Probe Body Diameter	12 mm
Tip Length	25 mm
Tip Diameter	4 mm
Probe Tip to Sensor X Calibration Point	1.5 mm
Probe Tip to Sensor Y Calibration Point	1.5 mm
Probe Tip to Sensor Z Calibration Point	1.5 mm

EF3DV3 - SN:4060

May 24, 2023

Receiving Pattern (ϕ), $\theta = 0^\circ$

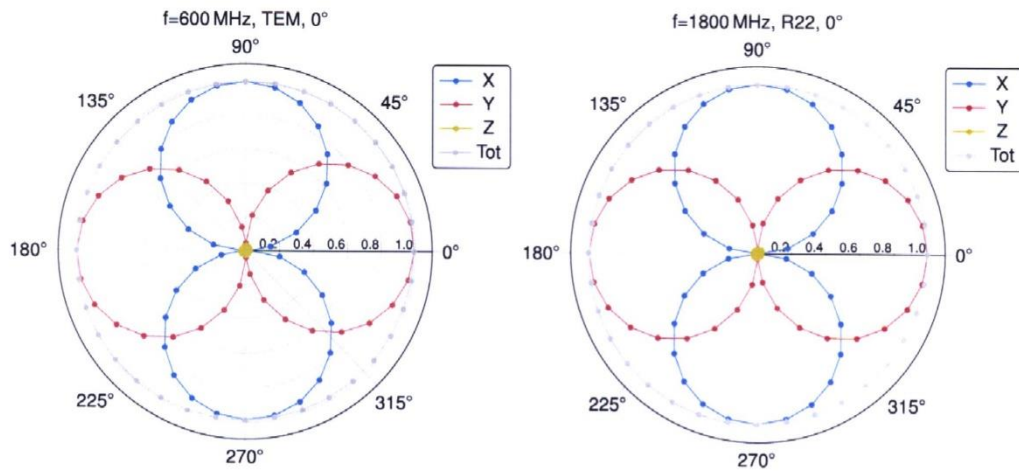

Receiving Pattern (ϕ), $\theta = 90^\circ$

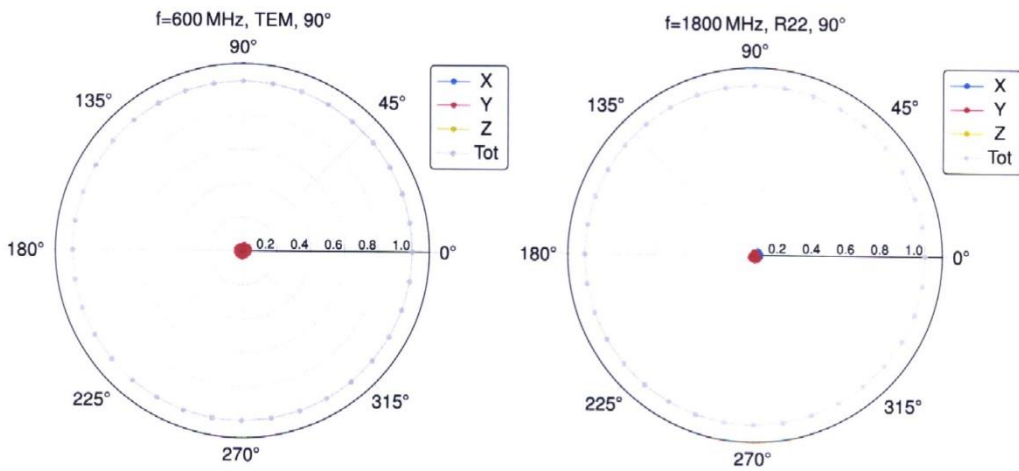

EF3DV3 - SN:4060

May 24, 2023

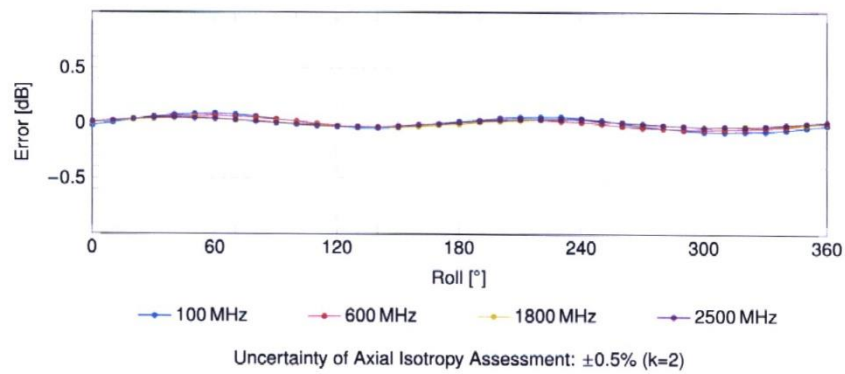
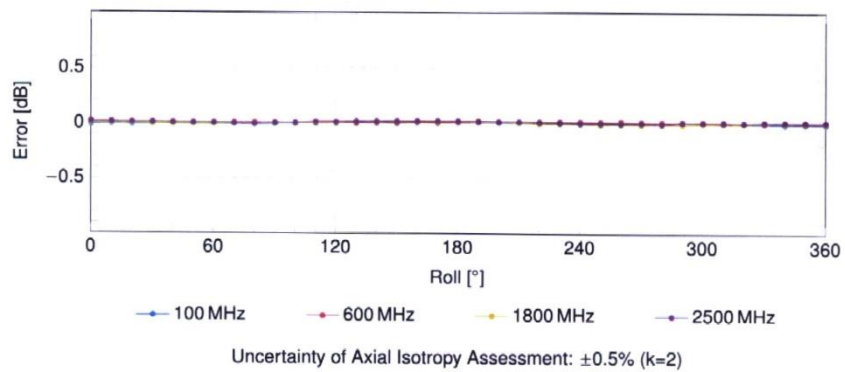
Receiving Pattern (ϕ), $\theta = 0^\circ$ **Receiving Pattern (ϕ), $\theta = 90^\circ$** 

EF3DV3 - SN:4060

May 24, 2023

Dynamic Range f(E-field)

(TEM cell, $f_{eval} = 900\text{ MHz}$)

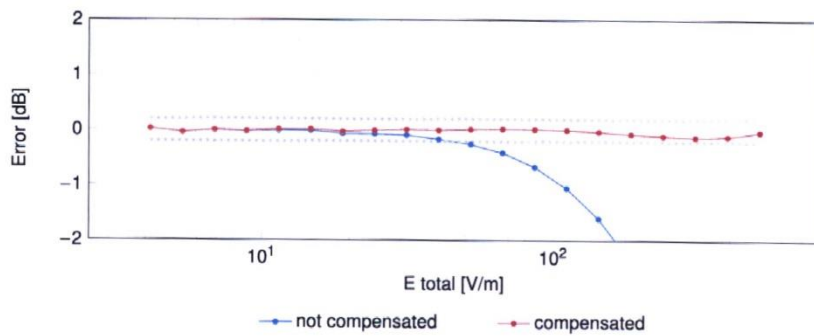
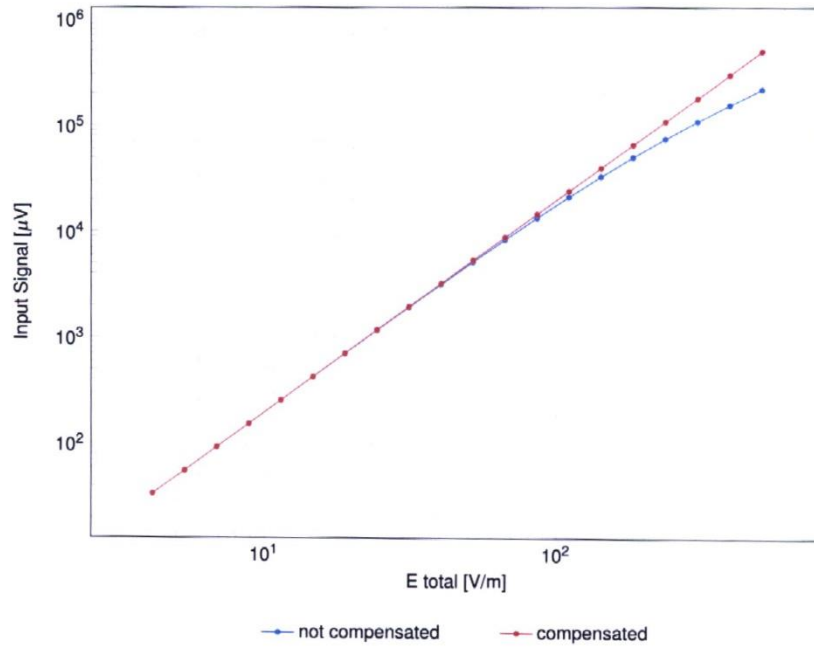

Uncertainty of Linearity Assessment: $\pm 0.6\%$ ($k=2$)

EF3DV3 - SN:4060

May 24, 2023

Deviation from Isotropy in Air

Error (ϕ, θ), $f = 900\text{ MHz}$

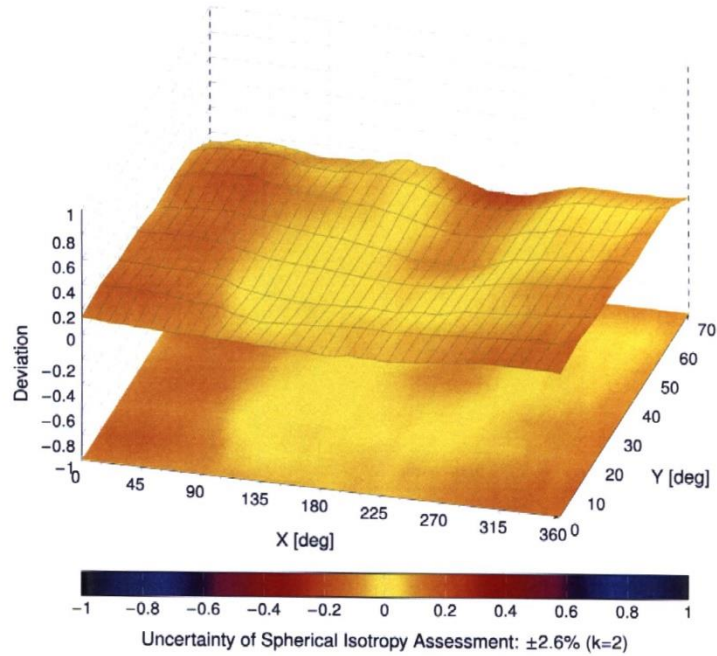

EF3DV3 - SN:4060

May 24, 2023

Appendix: Modulation Calibration Parameters

UID	Rev	Communication System Name	Group	PAR (dB)	Unc ^E $k = 2$
0		CW	CW	0.00	±4.7
10010	CAB	SAR Validation (Square, 100 ms, 10 ms)	Test	10.00	±9.6
10011	CAC	UMTS-FDD (WCDMA)	WCDMA	2.91	±9.6
10012	CAB	IEEE 802.11b WiFi 2.4 GHz (DSSS, 1 Mbps)	WLAN	1.87	±9.6
10013	CAB	IEEE 802.11g WiFi 2.4 GHz (DSSS-OFDM, 6 Mbps)	WLAN	9.46	±9.6
10021	DAC	GSM-FDD (TDMA, GMSK)	GSM	9.39	±9.6
10023	DAC	GPRS-FDD (TDMA, GMSK, TN 0)	GSM	9.57	±9.6
10024	DAC	GPRS-FDD (TDMA, GMSK, TN 0-1)	GSM	6.56	±9.6
10025	DAC	EDGE-FDD (TDMA, 8PSK, TN 0)	GSM	12.62	±9.6
10026	DAC	EDGE-FDD (TDMA, 8PSK, TN 0-1)	GSM	9.55	±9.6
10027	DAC	GPRS-FDD (TDMA, GMSK, TN 0-1-2)	GSM	4.80	±9.6
10028	DAC	GPRS-FDD (TDMA, GMSK, TN 0-1-2-3)	GSM	3.55	±9.6
10029	DAC	EDGE-FDD (TDMA, 8PSK, TN 0-1-2)	GSM	7.78	±9.6
10030	CAA	IEEE 802.15.1 Bluetooth (GFSK, DH1)	Bluetooth	5.30	±9.6
10031	CAA	IEEE 802.15.1 Bluetooth (GFSK, DH3)	Bluetooth	1.87	±9.6
10032	CAA	IEEE 802.15.1 Bluetooth (GFSK, DH5)	Bluetooth	1.16	±9.6
10033	CAA	IEEE 802.15.1 Bluetooth (PI/4-DQPSK, DH1)	Bluetooth	7.74	±9.6
10034	CAA	IEEE 802.15.1 Bluetooth (PI/4-DQPSK, DH3)	Bluetooth	4.53	±9.6
10035	CAA	IEEE 802.15.1 Bluetooth (PI/4-DQPSK, DH5)	Bluetooth	3.83	±9.6
10036	CAA	IEEE 802.15.1 Bluetooth (8-DPSK, DH1)	Bluetooth	8.01	±9.6
10037	CAA	IEEE 802.15.1 Bluetooth (8-DPSK, DH3)	Bluetooth	4.77	±9.6
10038	CAA	IEEE 802.15.1 Bluetooth (8-DPSK, DH5)	Bluetooth	4.10	±9.6
10039	CAB	CDMA2000 (1xRTT, RC1)	CDMA2000	4.57	±9.6
10042	CAB	IS-54 / IS-136 FDD (TDMA/FDM, PI/4-DQPSK, Halfrate)	AMPS	7.78	±9.6
10044	CAA	IS-91/EIA/TIA-553 FDD (FDMA, FM)	AMPS	0.00	±9.6
10048	CAA	DECT (TDD, TDMA/FDM, GFSK, Full Slot, 24)	DECT	13.80	±9.6
10049	CAA	DECT (TDD, TDMA/FDM, GFSK, Double Slot, 12)	DECT	10.79	±9.6
10056	CAA	UMTS-TDD (TD-SCDMA, 1.28 Mcps)	TD-SCDMA	11.01	±9.6
10058	DAC	EDGE-FDD (TDMA, 8PSK, TN 0-1-2-3)	GSM	6.52	±9.6
10059	CAB	IEEE 802.11b WiFi 2.4 GHz (DSSS, 2 Mbps)	WLAN	2.12	±9.6
10060	CAB	IEEE 802.11b WiFi 2.4 GHz (DSSS, 5.5 Mbps)	WLAN	2.83	±9.6
10061	CAB	IEEE 802.11b WiFi 2.4 GHz (DSSS, 11 Mbps)	WLAN	3.60	±9.6
10062	CAD	IEEE 802.11a/h WiFi 5 GHz (OFDM, 6 Mbps)	WLAN	8.68	±9.6
10063	CAD	IEEE 802.11a/h WiFi 5 GHz (OFDM, 9 Mbps)	WLAN	8.63	±9.6
10064	CAD	IEEE 802.11a/h WiFi 5 GHz (OFDM, 12 Mbps)	WLAN	9.09	±9.6
10065	CAD	IEEE 802.11a/h WiFi 5 GHz (OFDM, 18 Mbps)	WLAN	9.00	±9.6
10066	CAD	IEEE 802.11a/h WiFi 5 GHz (OFDM, 24 Mbps)	WLAN	9.38	±9.6
10067	CAD	IEEE 802.11a/h WiFi 5 GHz (OFDM, 36 Mbps)	WLAN	10.12	±9.6
10068	CAD	IEEE 802.11a/h WiFi 5 GHz (OFDM, 48 Mbps)	WLAN	10.24	±9.6
10069	CAD	IEEE 802.11a/h WiFi 5 GHz (OFDM, 54 Mbps)	WLAN	10.56	±9.6
10071	CAB	IEEE 802.11g WiFi 2.4 GHz (DSSS/OFDM, 9 Mbps)	WLAN	9.83	±9.6
10072	CAB	IEEE 802.11g WiFi 2.4 GHz (DSSS/OFDM, 12 Mbps)	WLAN	9.62	±9.6
10073	CAB	IEEE 802.11g WiFi 2.4 GHz (DSSS/OFDM, 18 Mbps)	WLAN	9.94	±9.6
10074	CAB	IEEE 802.11g WiFi 2.4 GHz (DSSS/OFDM, 24 Mbps)	WLAN	10.30	±9.6
10075	CAB	IEEE 802.11g WiFi 2.4 GHz (DSSS/OFDM, 36 Mbps)	WLAN	10.77	±9.6
10076	CAB	IEEE 802.11g WiFi 2.4 GHz (DSSS/OFDM, 48 Mbps)	WLAN	10.94	±9.6
10077	CAB	IEEE 802.11g WiFi 2.4 GHz (DSSS/OFDM, 54 Mbps)	WLAN	11.00	±9.6
10081	CAB	CDMA2000 (1xRTT, RC3)	CDMA2000	3.97	±9.6
10082	CAB	IS-54 / IS-136 FDD (TDMA/FDM, PI/4-DQPSK, Fullrate)	AMPS	4.77	±9.6
10090	DAC	GPRS-FDD (TDMA, GMSK, TN 0-4)	GSM	6.56	±9.6
10097	CAC	UMTS-FDD (HSDPA)	WCDMA	3.98	±9.6
10098	CAC	UMTS-FDD (HSUPA, Subtest 2)	WCDMA	3.98	±9.6
10099	DAC	EDGE-FDD (TDMA, 8PSK, TN 0-4)	GSM	9.55	±9.6
10100	CAF	LTE-FDD (SC-FDMA, 100% RB, 20 MHz, QPSK)	LTE-FDD	5.67	±9.6
10101	CAF	LTE-FDD (SC-FDMA, 100% RB, 20 MHz, 16-QAM)	LTE-FDD	6.42	±9.6
10102	CAF	LTE-FDD (SC-FDMA, 100% RB, 20 MHz, 64-QAM)	LTE-FDD	6.60	±9.6
10103	CAH	LTE-TDD (SC-FDMA, 100% RB, 20 MHz, QPSK)	LTE-TDD	9.29	±9.6
10104	CAH	LTE-TDD (SC-FDMA, 100% RB, 20 MHz, 16-QAM)	LTE-TDD	9.97	±9.6
10105	CAH	LTE-TDD (SC-FDMA, 100% RB, 20 MHz, 64-QAM)	LTE-TDD	10.01	±9.6
10108	CAH	LTE-FDD (SC-FDMA, 100% RB, 10 MHz, QPSK)	LTE-FDD	5.80	±9.6
10109	CAH	LTE-FDD (SC-FDMA, 100% RB, 10 MHz, 16-QAM)	LTE-FDD	6.43	±9.6
10110	CAH	LTE-FDD (SC-FDMA, 100% RB, 5 MHz, QPSK)	LTE-FDD	5.75	±9.6
10111	CAH	LTE-FDD (SC-FDMA, 100% RB, 5 MHz, 16-QAM)	LTE-FDD	6.44	±9.6

Certificate No: EF-4060_May23

Page 10 of 21



EF3DV3 - SN:4060

May 24, 2023

UID	Rev	Communication System Name	Group	PAR (dB)	Unc ^F k = 2
10112	CAH	LTE-FDD (SC-FDMA, 100% RB, 10 MHz, 64-QAM)	LTE-FDD	6.59	±9.6
10113	CAH	LTE-FDD (SC-FDMA, 100% RB, 5 MHz, 64-QAM)	LTE-FDD	6.62	±9.6
10114	CAD	IEEE 802.11n (HT Greenfield, 13.5 Mbps, BPSK)	WLAN	8.10	±9.6
10115	CAD	IEEE 802.11n (HT Greenfield, 81 Mbps, 16-QAM)	WLAN	8.46	±9.6
10116	CAD	IEEE 802.11n (HT Greenfield, 135 Mbps, 64-QAM)	WLAN	8.15	±9.6
10117	CAD	IEEE 802.11n (HT Mixed, 13.5 Mbps, BPSK)	WLAN	8.07	±9.6
10118	CAD	IEEE 802.11n (HT Mixed, 81 Mbps, 16-QAM)	WLAN	8.59	±9.6
10119	CAD	IEEE 802.11n (HT Mixed, 135 Mbps, 64-QAM)	WLAN	8.13	±9.6
10140	CAF	LTE-FDD (SC-FDMA, 100% RB, 15 MHz, 16-QAM)	LTE-FDD	6.49	±9.6
10141	CAF	LTE-FDD (SC-FDMA, 100% RB, 15 MHz, 64-QAM)	LTE-FDD	6.53	±9.6
10142	CAF	LTE-FDD (SC-FDMA, 100% RB, 3 MHz, QPSK)	LTE-FDD	5.73	±9.6
10143	CAF	LTE-FDD (SC-FDMA, 100% RB, 3 MHz, 16-QAM)	LTE-FDD	6.35	±9.6
10144	CAF	LTE-FDD (SC-FDMA, 100% RB, 3 MHz, 64-QAM)	LTE-FDD	6.65	±9.6
10145	CAG	LTE-FDD (SC-FDMA, 100% RB, 1.4 MHz, QPSK)	LTE-FDD	5.76	±9.6
10146	CAG	LTE-FDD (SC-FDMA, 100% RB, 1.4 MHz, 16-QAM)	LTE-FDD	6.41	±9.6
10147	CAG	LTE-FDD (SC-FDMA, 100% RB, 1.4 MHz, 64-QAM)	LTE-FDD	6.72	±9.6
10149	CAF	LTE-FDD (SC-FDMA, 50% RB, 20 MHz, 16-QAM)	LTE-FDD	6.42	±9.6
10150	CAF	LTE-FDD (SC-FDMA, 50% RB, 20 MHz, 64-QAM)	LTE-FDD	6.60	±9.6
10151	CAH	LTE-TDD (SC-FDMA, 50% RB, 20 MHz, QPSK)	LTE-TDD	9.28	±9.6
10152	CAH	LTE-TDD (SC-FDMA, 50% RB, 20 MHz, 16-QAM)	LTE-TDD	9.92	±9.6
10153	CAH	LTE-TDD (SC-FDMA, 50% RB, 20 MHz, 64-QAM)	LTE-TDD	10.05	±9.6
10154	CAH	LTE-FDD (SC-FDMA, 50% RB, 10 MHz, QPSK)	LTE-FDD	5.75	±9.6
10155	CAH	LTE-FDD (SC-FDMA, 50% RB, 10 MHz, 16-QAM)	LTE-FDD	6.43	±9.6
10156	CAH	LTE-FDD (SC-FDMA, 50% RB, 5 MHz, QPSK)	LTE-FDD	5.79	±9.6
10157	CAH	LTE-FDD (SC-FDMA, 50% RB, 5 MHz, 16-QAM)	LTE-FDD	6.49	±9.6
10158	CAH	LTE-FDD (SC-FDMA, 50% RB, 10 MHz, 64-QAM)	LTE-FDD	6.62	±9.6
10159	CAH	LTE-FDD (SC-FDMA, 50% RB, 5 MHz, 64-QAM)	LTE-FDD	6.56	±9.6
10160	CAF	LTE-FDD (SC-FDMA, 50% RB, 15 MHz, QPSK)	LTE-FDD	5.82	±9.6
10161	CAF	LTE-FDD (SC-FDMA, 50% RB, 15 MHz, 16-QAM)	LTE-FDD	6.43	±9.6
10162	CAF	LTE-FDD (SC-FDMA, 50% RB, 15 MHz, 64-QAM)	LTE-FDD	6.58	±9.6
10166	CAG	LTE-FDD (SC-FDMA, 50% RB, 1.4 MHz, QPSK)	LTE-FDD	5.46	±9.6
10167	CAG	LTE-FDD (SC-FDMA, 50% RB, 1.4 MHz, 16-QAM)	LTE-FDD	6.21	±9.6
10168	CAG	LTE-FDD (SC-FDMA, 50% RB, 1.4 MHz, 64-QAM)	LTE-FDD	6.79	±9.6
10169	CAF	LTE-FDD (SC-FDMA, 1 RB, 20 MHz, QPSK)	LTE-FDD	5.73	±9.6
10170	CAF	LTE-FDD (SC-FDMA, 1 RB, 20 MHz, 16-QAM)	LTE-FDD	6.52	±9.6
10171	AAF	LTE-FDD (SC-FDMA, 1 RB, 20 MHz, 64-QAM)	LTE-FDD	6.49	±9.6
10172	CAH	LTE-TDD (SC-FDMA, 1 RB, 20 MHz, QPSK)	LTE-TDD	9.21	±9.6
10173	CAH	LTE-TDD (SC-FDMA, 1 RB, 20 MHz, 16-QAM)	LTE-TDD	9.48	±9.6
10174	CAH	LTE-TDD (SC-FDMA, 1 RB, 20 MHz, 64-QAM)	LTE-TDD	10.25	±9.6
10175	CAH	LTE-FDD (SC-FDMA, 1 RB, 10 MHz, QPSK)	LTE-FDD	5.72	±9.6
10176	CAH	LTE-FDD (SC-FDMA, 1 RB, 10 MHz, 16-QAM)	LTE-FDD	6.52	±9.6
10177	CAJ	LTE-FDD (SC-FDMA, 1 RB, 5 MHz, QPSK)	LTE-FDD	5.73	±9.6
10178	CAH	LTE-FDD (SC-FDMA, 1 RB, 5 MHz, 16-QAM)	LTE-FDD	6.52	±9.6
10179	CAH	LTE-FDD (SC-FDMA, 1 RB, 10 MHz, 64-QAM)	LTE-FDD	6.50	±9.6
10180	CAH	LTE-FDD (SC-FDMA, 1 RB, 5 MHz, 64-QAM)	LTE-FDD	6.50	±9.6
10181	CAF	LTE-FDD (SC-FDMA, 1 RB, 15 MHz, QPSK)	LTE-FDD	5.72	±9.6
10182	CAF	LTE-FDD (SC-FDMA, 1 RB, 15 MHz, 16-QAM)	LTE-FDD	6.52	±9.6
10183	AAE	LTE-FDD (SC-FDMA, 1 RB, 15 MHz, 64-QAM)	LTE-FDD	6.50	±9.6
10184	CAF	LTE-FDD (SC-FDMA, 1 RB, 3 MHz, QPSK)	LTE-FDD	5.73	±9.6
10185	CAF	LTE-FDD (SC-FDMA, 1 RB, 3 MHz, 16-QAM)	LTE-FDD	6.51	±9.6
10186	AAF	LTE-FDD (SC-FDMA, 1 RB, 3 MHz, 64-QAM)	LTE-FDD	6.50	±9.6
10187	CAG	LTE-FDD (SC-FDMA, 1 RB, 1.4 MHz, QPSK)	LTE-FDD	5.73	±9.6
10188	CAG	LTE-FDD (SC-FDMA, 1 RB, 1.4 MHz, 16-QAM)	LTE-FDD	6.52	±9.6
10189	AAG	LTE-FDD (SC-FDMA, 1 RB, 1.4 MHz, 64-QAM)	LTE-FDD	6.50	±9.6
10193	CAD	IEEE 802.11n (HT Greenfield, 6.5 Mbps, BPSK)	WLAN	8.09	±9.6
10194	CAD	IEEE 802.11n (HT Greenfield, 39 Mbps, 16-QAM)	WLAN	8.12	±9.6
10195	CAD	IEEE 802.11n (HT Greenfield, 65 Mbps, 64-QAM)	WLAN	8.21	±9.6
10196	CAD	IEEE 802.11n (HT Mixed, 6.5 Mbps, BPSK)	WLAN	8.10	±9.6
10197	CAD	IEEE 802.11n (HT Mixed, 39 Mbps, 16-QAM)	WLAN	8.13	±9.6
10198	CAD	IEEE 802.11n (HT Mixed, 65 Mbps, 64-QAM)	WLAN	8.27	±9.6
10219	CAD	IEEE 802.11n (HT Mixed, 7.2 Mbps, BPSK)	WLAN	8.03	±9.6
10220	CAD	IEEE 802.11n (HT Mixed, 43.3 Mbps, 16-QAM)	WLAN	8.13	±9.6
10221	CAD	IEEE 802.11n (HT Mixed, 72.2 Mbps, 64-QAM)	WLAN	8.27	±9.6
10222	CAD	IEEE 802.11n (HT Mixed, 15 Mbps, BPSK)	WLAN	8.06	±9.6
10223	CAD	IEEE 802.11n (HT Mixed, 90 Mbps, 16-QAM)	WLAN	8.48	±9.6
10224	CAD	IEEE 802.11n (HT Mixed, 150 Mbps, 64-QAM)	WLAN	8.08	±9.6

Certificate No: EF-4060_May23

Page 11 of 21

EF3DV3 - SN:4060

May 24, 2023

UID	Rev	Communication System Name	Group	PAR (dB)	Unc ^E k = 2
10225	CAC	UMTS-FDD (HSPA+)	WCDMA	5.97	±9.6
10226	CAC	LTE-TDD (SC-FDMA, 1 RB, 1.4 MHz, 16-QAM)	LTE-TDD	9.49	±9.6
10227	CAC	LTE-TDD (SC-FDMA, 1 RB, 1.4 MHz, 64-QAM)	LTE-TDD	10.26	±9.6
10228	CAC	LTE-TDD (SC-FDMA, 1 RB, 1.4 MHz, QPSK)	LTE-TDD	9.22	±9.6
10229	CAE	LTE-TDD (SC-FDMA, 1 RB, 3 MHz, 16-QAM)	LTE-TDD	9.48	±9.6
10230	CAE	LTE-TDD (SC-FDMA, 1 RB, 3 MHz, 64-QAM)	LTE-TDD	10.25	±9.6
10231	CAE	LTE-TDD (SC-FDMA, 1 RB, 3 MHz, QPSK)	LTE-TDD	9.19	±9.6
10232	CAH	LTE-TDD (SC-FDMA, 1 RB, 5 MHz, 16-QAM)	LTE-TDD	9.48	±9.6
10233	CAH	LTE-TDD (SC-FDMA, 1 RB, 5 MHz, 64-QAM)	LTE-TDD	10.25	±9.6
10234	CAH	LTE-TDD (SC-FDMA, 1 RB, 5 MHz, QPSK)	LTE-TDD	9.21	±9.6
10235	CAH	LTE-TDD (SC-FDMA, 1 RB, 10 MHz, 16-QAM)	LTE-TDD	9.48	±9.6
10236	CAH	LTE-TDD (SC-FDMA, 1 RB, 10 MHz, 64-QAM)	LTE-TDD	10.25	±9.6
10237	CAH	LTE-TDD (SC-FDMA, 1 RB, 10 MHz, QPSK)	LTE-TDD	9.21	±9.6
10238	CAG	LTE-TDD (SC-FDMA, 1 RB, 15 MHz, 16-QAM)	LTE-TDD	9.48	±9.6
10239	CAG	LTE-TDD (SC-FDMA, 1 RB, 15 MHz, 64-QAM)	LTE-TDD	10.25	±9.6
10240	CAG	LTE-TDD (SC-FDMA, 1 RB, 15 MHz, QPSK)	LTE-TDD	9.21	±9.6
10241	CAC	LTE-TDD (SC-FDMA, 50% RB, 1.4 MHz, 16-QAM)	LTE-TDD	9.82	±9.6
10242	CAC	LTE-TDD (SC-FDMA, 50% RB, 1.4 MHz, 64-QAM)	LTE-TDD	9.86	±9.6
10243	CAC	LTE-TDD (SC-FDMA, 50% RB, 1.4 MHz, QPSK)	LTE-TDD	9.46	±9.6
10244	CAE	LTE-TDD (SC-FDMA, 50% RB, 3 MHz, 16-QAM)	LTE-TDD	10.06	±9.6
10245	CAE	LTE-TDD (SC-FDMA, 50% RB, 3 MHz, 64-QAM)	LTE-TDD	10.06	±9.6
10246	CAE	LTE-TDD (SC-FDMA, 50% RB, 3 MHz, QPSK)	LTE-TDD	9.30	±9.6
10247	CAH	LTE-TDD (SC-FDMA, 50% RB, 5 MHz, 16-QAM)	LTE-TDD	9.91	±9.6
10248	CAH	LTE-TDD (SC-FDMA, 50% RB, 5 MHz, 64-QAM)	LTE-TDD	10.09	±9.6
10249	CAH	LTE-TDD (SC-FDMA, 50% RB, 5 MHz, QPSK)	LTE-TDD	9.29	±9.6
10250	CAH	LTE-TDD (SC-FDMA, 50% RB, 10 MHz, 16-QAM)	LTE-TDD	9.81	±9.6
10251	CAH	LTE-TDD (SC-FDMA, 50% RB, 10 MHz, 64-QAM)	LTE-TDD	10.17	±9.6
10252	CAH	LTE-TDD (SC-FDMA, 50% RB, 10 MHz, QPSK)	LTE-TDD	9.24	±9.6
10253	CAG	LTE-TDD (SC-FDMA, 50% RB, 15 MHz, 16-QAM)	LTE-TDD	9.90	±9.6
10254	CAG	LTE-TDD (SC-FDMA, 50% RB, 15 MHz, 64-QAM)	LTE-TDD	10.14	±9.6
10255	CAG	LTE-TDD (SC-FDMA, 50% RB, 15 MHz, QPSK)	LTE-TDD	9.20	±9.6
10256	CAC	LTE-TDD (SC-FDMA, 100% RB, 1.4 MHz, 16-QAM)	LTE-TDD	9.96	±9.6
10257	CAC	LTE-TDD (SC-FDMA, 100% RB, 1.4 MHz, 64-QAM)	LTE-TDD	10.08	±9.6
10258	CAC	LTE-TDD (SC-FDMA, 100% RB, 1.4 MHz, QPSK)	LTE-TDD	9.34	±9.6
10259	CAE	LTE-TDD (SC-FDMA, 100% RB, 3 MHz, 16-QAM)	LTE-TDD	9.98	±9.6
10260	CAE	LTE-TDD (SC-FDMA, 100% RB, 3 MHz, 64-QAM)	LTE-TDD	9.97	±9.6
10261	CAE	LTE-TDD (SC-FDMA, 100% RB, 3 MHz, QPSK)	LTE-TDD	9.24	±9.6
10262	CAH	LTE-TDD (SC-FDMA, 100% RB, 5 MHz, 16-QAM)	LTE-TDD	9.83	±9.6
10263	CAH	LTE-TDD (SC-FDMA, 100% RB, 5 MHz, 64-QAM)	LTE-TDD	10.16	±9.6
10264	CAH	LTE-TDD (SC-FDMA, 100% RB, 5 MHz, QPSK)	LTE-TDD	9.23	±9.6
10265	CAH	LTE-TDD (SC-FDMA, 100% RB, 10 MHz, 16-QAM)	LTE-TDD	9.92	±9.6
10266	CAH	LTE-TDD (SC-FDMA, 100% RB, 10 MHz, 64-QAM)	LTE-TDD	10.07	±9.6
10267	CAH	LTE-TDD (SC-FDMA, 100% RB, 10 MHz, QPSK)	LTE-TDD	9.30	±9.6
10268	CAG	LTE-TDD (SC-FDMA, 100% RB, 15 MHz, 16-QAM)	LTE-TDD	10.06	±9.6
10269	CAG	LTE-TDD (SC-FDMA, 100% RB, 15 MHz, 64-QAM)	LTE-TDD	10.13	±9.6
10270	CAG	LTE-TDD (SC-FDMA, 100% RB, 15 MHz, QPSK)	LTE-TDD	9.58	±9.6
10274	CAC	UMTS-FDD (HSUPA, Subtest 5, 3GPP Rel8.10)	WCDMA	4.87	±9.6
10275	CAC	UMTS-FDD (HSUPA, Subtest 5, 3GPP Rel8.4)	WCDMA	3.96	±9.6
10277	CAA	PHS (QPSK)	PHS	11.81	±9.6
10278	CAA	PHS (QPSK, BW 884 MHz, Rolloff 0.5)	PHS	11.81	±9.6
10279	CAA	PHS (QPSK, BW 884 MHz, Rolloff 0.38)	PHS	12.18	±9.6
10290	AAB	CDMA2000, RC1, SQ55, Full Rate	CDMA2000	3.91	±9.6
10291	AAB	CDMA2000, RC3, SQ55, Full Rate	CDMA2000	3.46	±9.6
10292	AAB	CDMA2000, RC3, SQ32, Full Rate	CDMA2000	3.39	±9.6
10293	AAB	CDMA2000, RC3, SQ3, Full Rate	CDMA2000	3.50	±9.6
10295	AAB	CDMA2000, RC1, SQ3, 1/8th Rate 25 fr.	CDMA2000	12.49	±9.6
10297	AAE	LTE-FDD (SC-FDMA, 50% RB, 20 MHz, QPSK)	LTE-FDD	5.81	±9.6
10298	AAE	LTE-FDD (SC-FDMA, 50% RB, 3 MHz, QPSK)	LTE-FDD	5.72	±9.6
10299	AAE	LTE-FDD (SC-FDMA, 50% RB, 3 MHz, 16-QAM)	LTE-FDD	6.39	±9.6
10300	AAE	LTE-FDD (SC-FDMA, 50% RB, 3 MHz, 64-QAM)	LTE-FDD	6.60	±9.6
10301	AAA	IEEE 802.16e WIMAX (29:18, 5 ms, 10 MHz, QPSK, PUSC)	WIMAX	12.03	±9.6
10302	AAA	IEEE 802.16e WIMAX (29:18, 5 ms, 10 MHz, QPSK, PUSC, 3 CTRL symbols)	WIMAX	12.57	±9.6
10303	AAA	IEEE 802.16e WIMAX (31:15, 5 ms, 10 MHz, 64QAM, PUSC)	WIMAX	12.52	±9.6
10304	AAA	IEEE 802.16e WIMAX (29:18, 5 ms, 10 MHz, 64QAM, PUSC)	WIMAX	11.86	±9.6
10305	AAA	IEEE 802.16e WIMAX (31:15, 10 ms, 10 MHz, 64QAM, PUSC, 15 symbols)	WIMAX	15.24	±9.6
10306	AAA	IEEE 802.16e WIMAX (29:18, 10 ms, 10 MHz, 64QAM, PUSC, 18 symbols)	WIMAX	14.67	±9.6

Certificate No: EF-4060_May23

Page 12 of 21

EF3DV3 - SN:4060

May 24, 2023

UID	Rev	Communication System Name	Group	PAR (dB)	Unc ^E k = 2
10307	AAA	IEEE 802.16e WiMAX (29:18, 10 ms, 10 MHz, QPSK, PUSC, 18 symbols)	WiMAX	14.49	±9.6
10308	AAA	IEEE 802.16e WiMAX (29:18, 10 ms, 10 MHz, 16QAM, PUSC)	WiMAX	14.46	±9.6
10309	AAA	IEEE 802.16e WiMAX (29:18, 10 ms, 10 MHz, 16QAM, AMC 2x3, 18 symbols)	WiMAX	14.58	±9.6
10310	AAA	IEEE 802.16e WiMAX (29:18, 10 ms, 10 MHz, QPSK, AMC 2x3, 18 symbols)	WiMAX	14.57	±9.6
10311	AAE	LTE-FDD (SC-FDMA, 100% RB, 15 MHz, QPSK)	LTE-FDD	6.06	±9.6
10313	AAA	iDEN 1:3	iDEN	10.51	±9.6
10314	AAA	iDEN 1:6	iDEN	13.48	±9.6
10315	AAB	IEEE 802.11b WiFi 2.4 GHz (DSSS, 1 Mbps, 96pc duty cycle)	WLAN	1.71	±9.6
10316	AAB	IEEE 802.11g WiFi 2.4 GHz (ERP-OFDM, 6 Mbps, 96pc duty cycle)	WLAN	8.36	±9.6
10317	AAD	IEEE 802.11a WiFi 5 GHz (OFDM, 6 Mbps, 96pc duty cycle)	WLAN	8.36	±9.6
10352	AAA	Pulse Waveform (200Hz, 10%)	Generic	10.00	±9.6
10353	AAA	Pulse Waveform (200Hz, 20%)	Generic	6.99	±9.6
10354	AAA	Pulse Waveform (200Hz, 40%)	Generic	3.98	±9.6
10355	AAA	Pulse Waveform (200Hz, 60%)	Generic	2.22	±9.6
10356	AAA	Pulse Waveform (200Hz, 80%)	Generic	0.97	±9.6
10387	AAA	QPSK Waveform, 1 MHz	Generic	5.10	±9.6
10388	AAA	QPSK Waveform, 10 MHz	Generic	5.22	±9.6
10396	AAA	64-QAM Waveform, 100 kHz	Generic	6.27	±9.6
10399	AAA	64-QAM Waveform, 40 MHz	Generic	6.27	±9.6
10400	AAE	IEEE 802.11ac WiFi (20 MHz, 64-QAM, 99pc duty cycle)	WLAN	8.37	±9.6
10401	AAE	IEEE 802.11ac WiFi (40 MHz, 64-QAM, 99pc duty cycle)	WLAN	8.60	±9.6
10402	AAE	IEEE 802.11ac WiFi (80 MHz, 64-QAM, 99pc duty cycle)	WLAN	8.53	±9.6
10403	AAB	CDMA2000 (1xEV-DO, Rev. 0)	CDMA2000	3.76	±9.6
10404	AAB	CDMA2000 (1xEV-DO, Rev. A)	CDMA2000	3.77	±9.6
10406	AAB	CDMA2000, RC3, SO32, SCH0, Full Rate	CDMA2000	5.22	±9.6
10410	AAH	LTE-TDD (SC-FDMA, 1 RB, 10 MHz, QPSK, UL Subframe=2,3,4,7,8,9, Subframe Conf=4)	LTE-TDD	7.82	±9.6
10414	AAA	WLAN CCDF, 64-QAM, 40 MHz	Generic	8.54	±9.6
10415	AAA	IEEE 802.11b WiFi 2.4 GHz (DSSS, 1 Mbps, 99pc duty cycle)	WLAN	1.54	±9.6
10416	AAA	IEEE 802.11g WiFi 2.4 GHz (ERP-OFDM, 6 Mbps, 99pc duty cycle)	WLAN	8.23	±9.6
10417	AAC	IEEE 802.11a/h WiFi 5 GHz (OFDM, 6 Mbps, 99pc duty cycle)	WLAN	8.23	±9.6
10418	AAA	IEEE 802.11g WiFi 2.4 GHz (DSSS-OFDM, 6 Mbps, 99pc duty cycle, Long preamble)	WLAN	8.14	±9.6
10419	AAA	IEEE 802.11g WiFi 2.4 GHz (DSSS-OFDM, 6 Mbps, 99pc duty cycle, Short preamble)	WLAN	8.19	±9.6
10422	AAC	IEEE 802.11n (HT Greenfield, 7.2 Mbps, BPSK)	WLAN	8.32	±9.6
10423	AAC	IEEE 802.11n (HT Greenfield, 43.3 Mbps, 16-QAM)	WLAN	8.47	±9.6
10424	AAC	IEEE 802.11n (HT Greenfield, 72.2 Mbps, 64-QAM)	WLAN	8.40	±9.6
10425	AAC	IEEE 802.11n (HT Greenfield, 15 Mbps, BPSK)	WLAN	8.41	±9.6
10426	AAC	IEEE 802.11n (HT Greenfield, 90 Mbps, 16-QAM)	WLAN	8.45	±9.6
10427	AAC	IEEE 802.11n (HT Greenfield, 150 Mbps, 64-QAM)	WLAN	8.41	±9.6
10430	AAE	LTE-FDD (OFDMA, 5 MHz, E-TM 3.1)	LTE-FDD	8.28	±9.6
10431	AAE	LTE-FDD (OFDMA, 10 MHz, E-TM 3.1)	LTE-FDD	8.38	±9.6
10432	AAD	LTE-FDD (OFDMA, 15 MHz, E-TM 3.1)	LTE-FDD	8.34	±9.6
10433	AAD	LTE-FDD (OFDMA, 20 MHz, E-TM 3.1)	LTE-FDD	8.34	±9.6
10434	AAB	W-CDMA (BS Test Model 1, 64 DPCH)	WCDMA	8.60	±9.6
10435	AAG	LTE-TDD (SC-FDMA, 1 RB, 20 MHz, QPSK, UL Subframe=2,3,4,7,8,9)	LTE-TDD	7.82	±9.6
10447	AAE	LTE-FDD (OFDMA, 5 MHz, E-TM 3.1, Clipping 44%)	LTE-FDD	7.56	±9.6
10448	AAE	LTE-FDD (OFDMA, 10 MHz, E-TM 3.1, Clipping 44%)	LTE-FDD	7.53	±9.6
10449	AAD	LTE-FDD (OFDMA, 15 MHz, E-TM 3.1, Clipping 44%)	LTE-FDD	7.51	±9.6
10450	AAD	LTE-FDD (OFDMA, 20 MHz, E-TM 3.1, Clipping 44%)	LTE-FDD	7.48	±9.6
10451	AAB	W-CDMA (BS Test Model 1, 64 DPCH, Clipping 44%)	WCDMA	7.59	±9.6
10453	AAE	Validation (Square, 10 ms, 1 ms)	Test	10.00	±9.6
10456	AAC	IEEE 802.11ac WiFi (160 MHz, 64-QAM, 99pc duty cycle)	WLAN	8.63	±9.6
10457	AAB	UMTS-FDD (DC-HSDPA)	WCDMA	6.62	±9.6
10458	AAA	CDMA2000 (1xEV-DO, Rev. B, 2 carriers)	CDMA2000	6.55	±9.6
10459	AAA	CDMA2000 (1xEV-DO, Rev. B, 3 carriers)	CDMA2000	8.25	±9.6
10460	AAB	UMTS-FDD (WCDMA, AMR)	WCDMA	2.39	±9.6
10461	AAC	LTE-TDD (SC-FDMA, 1 RB, 1.4 MHz, QPSK, UL Subframe=2,3,4,7,8,9)	LTE-TDD	7.82	±9.6
10462	AAC	LTE-TDD (SC-FDMA, 1 RB, 1.4 MHz, 16-QAM, UL Subframe=2,3,4,7,8,9)	LTE-TDD	8.30	±9.6
10463	AAC	LTE-TDD (SC-FDMA, 1 RB, 1.4 MHz, 64-QAM, UL Subframe=2,3,4,7,8,9)	LTE-TDD	8.56	±9.6
10464	AAD	LTE-TDD (SC-FDMA, 1 RB, 3 MHz, QPSK, UL Subframe=2,3,4,7,8,9)	LTE-TDD	7.82	±9.6
10465	AAD	LTE-TDD (SC-FDMA, 1 RB, 3 MHz, 16-QAM, UL Subframe=2,3,4,7,8,9)	LTE-TDD	8.32	±9.6
10466	AAD	LTE-TDD (SC-FDMA, 1 RB, 3 MHz, 64-QAM, UL Subframe=2,3,4,7,8,9)	LTE-TDD	8.57	±9.6
10467	AAG	LTE-TDD (SC-FDMA, 1 RB, 5 MHz, QPSK, UL Subframe=2,3,4,7,8,9)	LTE-TDD	7.82	±9.6
10468	AAG	LTE-TDD (SC-FDMA, 1 RB, 5 MHz, 16-QAM, UL Subframe=2,3,4,7,8,9)	LTE-TDD	8.32	±9.6
10469	AAG	LTE-TDD (SC-FDMA, 1 RB, 5 MHz, 64-QAM, UL Subframe=2,3,4,7,8,9)	LTE-TDD	8.56	±9.6
10470	AAG	LTE-TDD (SC-FDMA, 1 RB, 10 MHz, QPSK, UL Subframe=2,3,4,7,8,9)	LTE-TDD	7.82	±9.6
10471	AAG	LTE-TDD (SC-FDMA, 1 RB, 10 MHz, 16-QAM, UL Subframe=2,3,4,7,8,9)	LTE-TDD	8.32	±9.6

Certificate No: EF-4060_May23

Page 13 of 21

EF3DV3 - SN:4060

May 24, 2023

UID	Rev	Communication System Name	Group	PAR (dB)	Unc ^k k = 2
10472	AAG	LTE-TDD (SC-FDMA, 1 RB, 10 MHz, 64-QAM, UL Subframe=2,3,4,7,8,9)	LTE-TDD	8.57	±9.6
10473	AAF	LTE-TDD (SC-FDMA, 1 RB, 15 MHz, QPSK, UL Subframe=2,3,4,7,8,9)	LTE-TDD	7.82	±9.6
10474	AAF	LTE-TDD (SC-FDMA, 1 RB, 15 MHz, 16-QAM, UL Subframe=2,3,4,7,8,9)	LTE-TDD	8.32	±9.6
10475	AAF	LTE-TDD (SC-FDMA, 1 RB, 15 MHz, 64-QAM, UL Subframe=2,3,4,7,8,9)	LTE-TDD	8.57	±9.6
10477	AAG	LTE-TDD (SC-FDMA, 1 RB, 20 MHz, 16-QAM, UL Subframe=2,3,4,7,8,9)	LTE-TDD	8.32	±9.6
10478	AAG	LTE-TDD (SC-FDMA, 1 RB, 20 MHz, 64-QAM, UL Subframe=2,3,4,7,8,9)	LTE-TDD	8.57	±9.6
10479	AAC	LTE-TDD (SC-FDMA, 50% RB, 1.4 MHz, QPSK, UL Subframe=2,3,4,7,8,9)	LTE-TDD	7.74	±9.6
10480	AAC	LTE-TDD (SC-FDMA, 50% RB, 1.4 MHz, 16-QAM, UL Subframe=2,3,4,7,8,9)	LTE-TDD	8.18	±9.6
10481	AAC	LTE-TDD (SC-FDMA, 50% RB, 1.4 MHz, 64-QAM, UL Subframe=2,3,4,7,8,9)	LTE-TDD	8.45	±9.6
10482	AAD	LTE-TDD (SC-FDMA, 50% RB, 3 MHz, QPSK, UL Subframe=2,3,4,7,8,9)	LTE-TDD	7.71	±9.6
10483	AAD	LTE-TDD (SC-FDMA, 50% RB, 3 MHz, 16-QAM, UL Subframe=2,3,4,7,8,9)	LTE-TDD	8.39	±9.6
10484	AAD	LTE-TDD (SC-FDMA, 50% RB, 3 MHz, 64-QAM, UL Subframe=2,3,4,7,8,9)	LTE-TDD	8.47	±9.6
10485	AAG	LTE-TDD (SC-FDMA, 50% RB, 5 MHz, QPSK, UL Subframe=2,3,4,7,8,9)	LTE-TDD	7.59	±9.6
10486	AAG	LTE-TDD (SC-FDMA, 50% RB, 5 MHz, 16-QAM, UL Subframe=2,3,4,7,8,9)	LTE-TDD	8.38	±9.6
10487	AAG	LTE-TDD (SC-FDMA, 50% RB, 5 MHz, 64-QAM, UL Subframe=2,3,4,7,8,9)	LTE-TDD	8.60	±9.6
10488	AAG	LTE-TDD (SC-FDMA, 50% RB, 10 MHz, QPSK, UL Subframe=2,3,4,7,8,9)	LTE-TDD	7.70	±9.6
10489	AAG	LTE-TDD (SC-FDMA, 50% RB, 10 MHz, 16-QAM, UL Subframe=2,3,4,7,8,9)	LTE-TDD	8.31	±9.6
10490	AAG	LTE-TDD (SC-FDMA, 50% RB, 10 MHz, 64-QAM, UL Subframe=2,3,4,7,8,9)	LTE-TDD	8.54	±9.6
10491	AAF	LTE-TDD (SC-FDMA, 100% RB, 1.4 MHz, QPSK, UL Subframe=2,3,4,7,8,9)	LTE-TDD	7.74	±9.6
10492	AAF	LTE-TDD (SC-FDMA, 50% RB, 15 MHz, 16-QAM, UL Subframe=2,3,4,7,8,9)	LTE-TDD	8.41	±9.6
10493	AAF	LTE-TDD (SC-FDMA, 50% RB, 15 MHz, 64-QAM, UL Subframe=2,3,4,7,8,9)	LTE-TDD	8.55	±9.6
10494	AAG	LTE-TDD (SC-FDMA, 50% RB, 20 MHz, QPSK, UL Subframe=2,3,4,7,8,9)	LTE-TDD	7.74	±9.6
10495	AAG	LTE-TDD (SC-FDMA, 50% RB, 20 MHz, 16-QAM, UL Subframe=2,3,4,7,8,9)	LTE-TDD	8.37	±9.6
10496	AAG	LTE-TDD (SC-FDMA, 50% RB, 20 MHz, 64-QAM, UL Subframe=2,3,4,7,8,9)	LTE-TDD	8.54	±9.6
10497	AAC	LTE-TDD (SC-FDMA, 100% RB, 1.4 MHz, QPSK, UL Subframe=2,3,4,7,8,9)	LTE-TDD	7.67	±9.6
10498	AAC	LTE-TDD (SC-FDMA, 100% RB, 1.4 MHz, 16-QAM, UL Subframe=2,3,4,7,8,9)	LTE-TDD	8.40	±9.6
10499	AAC	LTE-TDD (SC-FDMA, 100% RB, 1.4 MHz, 64-QAM, UL Subframe=2,3,4,7,8,9)	LTE-TDD	8.68	±9.6
10500	AAD	LTE-TDD (SC-FDMA, 100% RB, 3 MHz, QPSK, UL Subframe=2,3,4,7,8,9)	LTE-TDD	7.67	±9.6
10501	AAD	LTE-TDD (SC-FDMA, 100% RB, 3 MHz, 16-QAM, UL Subframe=2,3,4,7,8,9)	LTE-TDD	8.44	±9.6
10502	AAD	LTE-TDD (SC-FDMA, 100% RB, 3 MHz, 64-QAM, UL Subframe=2,3,4,7,8,9)	LTE-TDD	8.52	±9.6
10503	AAG	LTE-TDD (SC-FDMA, 100% RB, 5 MHz, QPSK, UL Subframe=2,3,4,7,8,9)	LTE-TDD	7.72	±9.6
10504	AAG	LTE-TDD (SC-FDMA, 100% RB, 5 MHz, 16-QAM, UL Subframe=2,3,4,7,8,9)	LTE-TDD	8.31	±9.6
10505	AAG	LTE-TDD (SC-FDMA, 100% RB, 5 MHz, 64-QAM, UL Subframe=2,3,4,7,8,9)	LTE-TDD	8.54	±9.6
10506	AAG	LTE-TDD (SC-FDMA, 100% RB, 10 MHz, QPSK, UL Subframe=2,3,4,7,8,9)	LTE-TDD	7.74	±9.6
10507	AAG	LTE-TDD (SC-FDMA, 100% RB, 10 MHz, 16-QAM, UL Subframe=2,3,4,7,8,9)	LTE-TDD	8.36	±9.6
10508	AAG	LTE-TDD (SC-FDMA, 100% RB, 10 MHz, 64-QAM, UL Subframe=2,3,4,7,8,9)	LTE-TDD	8.55	±9.6
10509	AAF	LTE-TDD (SC-FDMA, 100% RB, 15 MHz, QPSK, UL Subframe=2,3,4,7,8,9)	LTE-TDD	7.99	±9.6
10510	AAF	LTE-TDD (SC-FDMA, 100% RB, 15 MHz, 16-QAM, UL Subframe=2,3,4,7,8,9)	LTE-TDD	8.49	±9.6
10511	AAF	LTE-TDD (SC-FDMA, 100% RB, 15 MHz, 64-QAM, UL Subframe=2,3,4,7,8,9)	LTE-TDD	8.51	±9.6
10512	AAG	LTE-TDD (SC-FDMA, 100% RB, 20 MHz, QPSK, UL Subframe=2,3,4,7,8,9)	LTE-TDD	7.74	±9.6
10513	AAG	LTE-TDD (SC-FDMA, 100% RB, 20 MHz, 16-QAM, UL Subframe=2,3,4,7,8,9)	LTE-TDD	8.42	±9.6
10514	AAG	LTE-TDD (SC-FDMA, 100% RB, 20 MHz, 64-QAM, UL Subframe=2,3,4,7,8,9)	LTE-TDD	8.45	±9.6
10515	AAA	IEEE 802.11b WiFi 2.4 GHz (DSSS, 2 Mbps, 99pc duty cycle)	WLAN	1.58	±9.6
10516	AAA	IEEE 802.11b WiFi 2.4 GHz (DSSS, 5.5 Mbps, 99pc duty cycle)	WLAN	1.57	±9.6
10517	AAA	IEEE 802.11b WiFi 2.4 GHz (DSSS, 11 Mbps, 99pc duty cycle)	WLAN	1.58	±9.6
10518	AAC	IEEE 802.11a/h WiFi 5 GHz (OFDM, 9 Mbps, 99pc duty cycle)	WLAN	8.23	±9.6
10519	AAC	IEEE 802.11a/h WiFi 5 GHz (OFDM, 12 Mbps, 99pc duty cycle)	WLAN	8.39	±9.6
10520	AAC	IEEE 802.11a/h WiFi 5 GHz (OFDM, 18 Mbps, 99pc duty cycle)	WLAN	8.12	±9.6
10521	AAC	IEEE 802.11a/h WiFi 5 GHz (OFDM, 24 Mbps, 99pc duty cycle)	WLAN	7.97	±9.6
10522	AAC	IEEE 802.11a/h WiFi 5 GHz (OFDM, 36 Mbps, 99pc duty cycle)	WLAN	8.45	±9.6
10523	AAC	IEEE 802.11a/h WiFi 5 GHz (OFDM, 48 Mbps, 99pc duty cycle)	WLAN	8.08	±9.6
10524	AAC	IEEE 802.11a/h WiFi 5 GHz (OFDM, 54 Mbps, 99pc duty cycle)	WLAN	8.27	±9.6
10525	AAC	IEEE 802.11ac WiFi (20 MHz, MCS0, 99pc duty cycle)	WLAN	8.36	±9.6
10526	AAC	IEEE 802.11ac WiFi (20 MHz, MCS1, 99pc duty cycle)	WLAN	8.42	±9.6
10527	AAC	IEEE 802.11ac WiFi (20 MHz, MCS2, 99pc duty cycle)	WLAN	8.21	±9.6
10528	AAC	IEEE 802.11ac WiFi (20 MHz, MCS3, 99pc duty cycle)	WLAN	8.36	±9.6
10529	AAC	IEEE 802.11ac WiFi (20 MHz, MCS4, 99pc duty cycle)	WLAN	8.36	±9.6
10531	AAC	IEEE 802.11ac WiFi (20 MHz, MCS6, 99pc duty cycle)	WLAN	8.43	±9.6
10532	AAC	IEEE 802.11ac WiFi (20 MHz, MCS7, 99pc duty cycle)	WLAN	8.29	±9.6
10533	AAC	IEEE 802.11ac WiFi (20 MHz, MCS8, 99pc duty cycle)	WLAN	8.38	±9.6
10534	AAC	IEEE 802.11ac WiFi (40 MHz, MCS0, 99pc duty cycle)	WLAN	8.45	±9.6
10535	AAC	IEEE 802.11ac WiFi (40 MHz, MCS1, 99pc duty cycle)	WLAN	8.45	±9.6
10536	AAC	IEEE 802.11ac WiFi (40 MHz, MCS2, 99pc duty cycle)	WLAN	8.32	±9.6
10537	AAC	IEEE 802.11ac WiFi (40 MHz, MCS3, 99pc duty cycle)	WLAN	8.44	±9.6
10538	AAC	IEEE 802.11ac WiFi (40 MHz, MCS4, 99pc duty cycle)	WLAN	8.54	±9.6
10540	AAC	IEEE 802.11ac WiFi (40 MHz, MCS6, 99pc duty cycle)	WLAN	8.39	±9.6

Certificate No: EF-4060_May23

Page 14 of 21

EF3DV3 - SN:4060

May 24, 2023

UID	Rev	Communication System Name	Group	PAR (dB)	Unc ^F k = 2
10541	AAC	IEEE 802.11ac WiFi (40 MHz, MCS7, 99pc duty cycle)	WLAN	8.46	±9.6
10542	AAC	IEEE 802.11ac WiFi (40 MHz, MCS8, 99pc duty cycle)	WLAN	8.65	±9.6
10543	AAC	IEEE 802.11ac WiFi (40 MHz, MCS9, 99pc duty cycle)	WLAN	8.65	±9.6
10544	AAC	IEEE 802.11ac WiFi (80 MHz, MCS0, 99pc duty cycle)	WLAN	8.47	±9.6
10545	AAC	IEEE 802.11ac WiFi (80 MHz, MCS1, 99pc duty cycle)	WLAN	8.55	±9.6
10546	AAC	IEEE 802.11ac WiFi (80 MHz, MCS2, 99pc duty cycle)	WLAN	8.35	±9.6
10547	AAC	IEEE 802.11ac WiFi (80 MHz, MCS3, 99pc duty cycle)	WLAN	8.49	±9.6
10548	AAC	IEEE 802.11ac WiFi (80 MHz, MCS4, 99pc duty cycle)	WLAN	8.37	±9.6
10550	AAC	IEEE 802.11ac WiFi (80 MHz, MCS6, 99pc duty cycle)	WLAN	8.38	±9.6
10551	AAC	IEEE 802.11ac WiFi (80 MHz, MCS7, 99pc duty cycle)	WLAN	8.50	±9.6
10552	AAC	IEEE 802.11ac WiFi (80 MHz, MCS8, 99pc duty cycle)	WLAN	8.42	±9.6
10553	AAC	IEEE 802.11ac WiFi (80 MHz, MCS9, 99pc duty cycle)	WLAN	8.45	±9.6
10554	AAD	IEEE 802.11ac WiFi (160 MHz, MCS0, 99pc duty cycle)	WLAN	8.48	±9.6
10555	AAD	IEEE 802.11ac WiFi (160 MHz, MCS1, 99pc duty cycle)	WLAN	8.47	±9.6
10556	AAD	IEEE 802.11ac WiFi (160 MHz, MCS2, 99pc duty cycle)	WLAN	8.50	±9.6
10557	AAD	IEEE 802.11ac WiFi (160 MHz, MCS3, 99pc duty cycle)	WLAN	8.52	±9.6
10558	AAD	IEEE 802.11ac WiFi (160 MHz, MCS4, 99pc duty cycle)	WLAN	8.61	±9.6
10560	AAD	IEEE 802.11ac WiFi (160 MHz, MCS6, 99pc duty cycle)	WLAN	8.73	±9.6
10561	AAD	IEEE 802.11ac WiFi (160 MHz, MCS7, 99pc duty cycle)	WLAN	8.56	±9.6
10562	AAD	IEEE 802.11ac WiFi (160 MHz, MCS8, 99pc duty cycle)	WLAN	8.69	±9.6
10563	AAD	IEEE 802.11ac WiFi (160 MHz, MCS9, 99pc duty cycle)	WLAN	8.77	±9.6
10564	AAA	IEEE 802.11g WiFi 2.4 GHz (DSSS-OFDM, 9 Mbps, 99pc duty cycle)	WLAN	8.25	±9.6
10565	AAA	IEEE 802.11g WiFi 2.4 GHz (DSSS-OFDM, 12 Mbps, 99pc duty cycle)	WLAN	8.45	±9.6
10566	AAA	IEEE 802.11g WiFi 2.4 GHz (DSSS-OFDM, 18 Mbps, 99pc duty cycle)	WLAN	8.13	±9.6
10567	AAA	IEEE 802.11g WiFi 2.4 GHz (DSSS-OFDM, 24 Mbps, 99pc duty cycle)	WLAN	8.00	±9.6
10568	AAA	IEEE 802.11g WiFi 2.4 GHz (DSSS-OFDM, 36 Mbps, 99pc duty cycle)	WLAN	8.37	±9.6
10569	AAA	IEEE 802.11g WiFi 2.4 GHz (DSSS-OFDM, 48 Mbps, 99pc duty cycle)	WLAN	8.10	±9.6
10570	AAA	IEEE 802.11g WiFi 2.4 GHz (DSSS-OFDM, 54 Mbps, 99pc duty cycle)	WLAN	8.30	±9.6
10571	AAA	IEEE 802.11b WiFi 2.4 GHz (DSSS, 1 Mbps, 90pc duty cycle)	WLAN	1.99	±9.6
10572	AAA	IEEE 802.11b WiFi 2.4 GHz (DSSS, 2 Mbps, 90pc duty cycle)	WLAN	1.99	±9.6
10573	AAA	IEEE 802.11b WiFi 2.4 GHz (DSSS, 5.5 Mbps, 90pc duty cycle)	WLAN	1.98	±9.6
10574	AAA	IEEE 802.11b WiFi 2.4 GHz (DSSS, 11 Mbps, 90pc duty cycle)	WLAN	1.98	±9.6
10575	AAA	IEEE 802.11g WiFi 2.4 GHz (DSSS-OFDM, 6 Mbps, 90pc duty cycle)	WLAN	8.59	±9.6
10576	AAA	IEEE 802.11g WiFi 2.4 GHz (DSSS-OFDM, 9 Mbps, 90pc duty cycle)	WLAN	8.60	±9.6
10577	AAA	IEEE 802.11g WiFi 2.4 GHz (DSSS-OFDM, 12 Mbps, 90pc duty cycle)	WLAN	8.70	±9.6
10578	AAA	IEEE 802.11g WiFi 2.4 GHz (DSSS-OFDM, 18 Mbps, 90pc duty cycle)	WLAN	8.49	±9.6
10579	AAA	IEEE 802.11g WiFi 2.4 GHz (DSSS-OFDM, 24 Mbps, 90pc duty cycle)	WLAN	8.36	±9.6
10580	AAA	IEEE 802.11g WiFi 2.4 GHz (DSSS-OFDM, 36 Mbps, 90pc duty cycle)	WLAN	8.76	±9.6
10581	AAA	IEEE 802.11g WiFi 2.4 GHz (DSSS-OFDM, 48 Mbps, 90pc duty cycle)	WLAN	8.35	±9.6
10582	AAA	IEEE 802.11g WiFi 2.4 GHz (DSSS-OFDM, 54 Mbps, 90pc duty cycle)	WLAN	8.67	±9.6
10583	AAC	IEEE 802.11a/h WiFi 5 GHz (OFDM, 6 Mbps, 90pc duty cycle)	WLAN	8.59	±9.6
10584	AAC	IEEE 802.11a/h WiFi 5 GHz (OFDM, 9 Mbps, 90pc duty cycle)	WLAN	8.60	±9.6
10585	AAC	IEEE 802.11a/h WiFi 5 GHz (OFDM, 12 Mbps, 90pc duty cycle)	WLAN	8.70	±9.6
10586	AAC	IEEE 802.11a/h WiFi 5 GHz (OFDM, 18 Mbps, 90pc duty cycle)	WLAN	8.49	±9.6
10587	AAC	IEEE 802.11a/h WiFi 5 GHz (OFDM, 24 Mbps, 90pc duty cycle)	WLAN	8.36	±9.6
10588	AAC	IEEE 802.11a/h WiFi 5 GHz (OFDM, 36 Mbps, 90pc duty cycle)	WLAN	8.76	±9.6
10589	AAC	IEEE 802.11a/h WiFi 5 GHz (OFDM, 48 Mbps, 90pc duty cycle)	WLAN	8.35	±9.6
10590	AAC	IEEE 802.11a/h WiFi 5 GHz (OFDM, 54 Mbps, 90pc duty cycle)	WLAN	8.67	±9.6
10591	AAC	IEEE 802.11n (HT Mixed, 20 MHz, MCS0, 90pc duty cycle)	WLAN	8.63	±9.6
10592	AAC	IEEE 802.11n (HT Mixed, 20 MHz, MCS1, 90pc duty cycle)	WLAN	8.79	±9.6
10593	AAC	IEEE 802.11n (HT Mixed, 20 MHz, MCS2, 90pc duty cycle)	WLAN	8.64	±9.6
10594	AAC	IEEE 802.11n (HT Mixed, 20 MHz, MCS3, 90pc duty cycle)	WLAN	8.74	±9.6
10595	AAC	IEEE 802.11n (HT Mixed, 20 MHz, MCS4, 90pc duty cycle)	WLAN	8.74	±9.6
10596	AAC	IEEE 802.11n (HT Mixed, 20 MHz, MCS5, 90pc duty cycle)	WLAN	8.71	±9.6
10597	AAC	IEEE 802.11n (HT Mixed, 20 MHz, MCS6, 90pc duty cycle)	WLAN	8.72	±9.6
10598	AAC	IEEE 802.11n (HT Mixed, 20 MHz, MCS7, 90pc duty cycle)	WLAN	8.50	±9.6
10599	AAC	IEEE 802.11n (HT Mixed, 40 MHz, MCS0, 90pc duty cycle)	WLAN	8.79	±9.6
10600	AAC	IEEE 802.11n (HT Mixed, 40 MHz, MCS1, 90pc duty cycle)	WLAN	8.88	±9.6
10601	AAC	IEEE 802.11n (HT Mixed, 40 MHz, MCS2, 90pc duty cycle)	WLAN	8.82	±9.6
10602	AAC	IEEE 802.11n (HT Mixed, 40 MHz, MCS3, 90pc duty cycle)	WLAN	8.94	±9.6
10603	AAC	IEEE 802.11n (HT Mixed, 40 MHz, MCS4, 90pc duty cycle)	WLAN	9.03	±9.6
10604	AAC	IEEE 802.11n (HT Mixed, 40 MHz, MCS5, 90pc duty cycle)	WLAN	8.76	±9.6
10605	AAC	IEEE 802.11n (HT Mixed, 40 MHz, MCS6, 90pc duty cycle)	WLAN	8.97	±9.6
10606	AAC	IEEE 802.11n (HT Mixed, 40 MHz, MCS7, 90pc duty cycle)	WLAN	8.82	±9.6
10607	AAC	IEEE 802.11ac WiFi (20 MHz, MCS0, 90pc duty cycle)	WLAN	8.64	±9.6
10608	AAC	IEEE 802.11ac WiFi (20 MHz, MCS1, 90pc duty cycle)	WLAN	8.77	±9.6