



SAR TEST REPORT

No. I23Z61303-SEM01

For

TCL Communication Ltd.

GSM/UMTS/LTE Mobile phone

Model Name: T432J

With

Hardware Version: 03

Software Version: MYS0

FCC ID: 2ACCJH175

Issued Date: 2023-7-28

Note:

The test results in this test report relate only to the devices specified in this report. This report shall not be reproduced except in full without the written approval of CTTL.

Test Laboratory:

CTTL, Telecommunication Technology Labs, CAICT

No. 52, Huayuan North Road, Haidian District, Beijing, P. R. China 100191.

Tel:+86(0)10-62304633-2512, Fax:+86(0)10-62304633-2504

Email: ctl_terminals@caict.ac.cn, website: www.caict.ac.cn



No. I23Z61303-SEM01

REPORT HISTORY

Report Number	Revision	Issue Date	Description
I23Z61303-SEM01	Rev.0	2023-7-28	Initial creation of test report



TABLE OF CONTENT

1 TEST LABORATORY	5
1.1 TESTING LOCATION	5
1.2 TESTING ENVIRONMENT.....	5
1.3 PROJECT DATA	5
1.4 SIGNATURE.....	5
2 STATEMENT OF COMPLIANCE	6
3 CLIENT INFORMATION	8
3.1 APPLICANT INFORMATION	8
3.2 MANUFACTURER INFORMATION	8
4 EQUIPMENT UNDER TEST (EUT) AND ANCILLARY EQUIPMENT (AE)	9
4.1 ABOUT EUT	9
4.2 INTERNAL IDENTIFICATION OF EUT USED DURING THE TEST	9
4.3 INTERNAL IDENTIFICATION OF AE USED DURING THE TEST	9
5 TEST METHODOLOGY	10
5.1 APPLICABLE LIMIT REGULATIONS	10
5.2 APPLICABLE MEASUREMENT STANDARDS.....	10
6 SPECIFIC ABSORPTION RATE (SAR)	11
6.1 INTRODUCTION.....	11
6.2 SAR DEFINITION.....	11
7 TISSUE SIMULATING LIQUIDS	12
7.1 TARGETS FOR TISSUE SIMULATING LIQUID	12
7.2 DIELECTRIC PERFORMANCE	12
8 SYSTEM VERIFICATION	14
8.1 SYSTEM SETUP.....	14
8.2 SYSTEM VERIFICATION.....	15
9 GENERAL MEASUREMENT PROCEDURE	16
9.1 <i>POWER REFERENCE MEASUREMENT</i>	16
9.2 <i>AREA SCAN</i>	16
9.3 <i>ZOOM SCAN</i>	17
9.4 <i>POWER DRIFT MEASUREMENT</i>	17
10 MEASUREMENT PROCEDURE FOR DIFFERENT TECHNOLOGIES	18
10.1 GSM/GPRS MEASUREMENT PROCEDURES FOR SAR	18
10.2 WCDMA MEASUREMENT PROCEDURES FOR SAR	18
10.3 LTE MEASUREMENT PROCEDURES FOR SAR	20
10.4 BLUETOOTH & WI-FI MEASUREMENT PROCEDURES FOR SAR	20



11 CONDUCTED OUTPUT POWER.....	21
11.1 GSM MEASUREMENT RESULT	21
11.2 WCDMA MEASUREMENT RESULT.....	21
11.3 LTE MEASUREMENT RESULT	26
11.4 WI-FI AND BT MEASUREMENT RESULT	55
12 ANTENNA LOCATION	57
12.1 TRANSMIT ANTENNA SEPARATION DISTANCES	57
12.2 SAR MEASUREMENT POSITIONS	57
13 SAR TEST RESULT	58
13.1 SAR RESULTS FOR CELLULAR	61
13.2 SAR RESULTS FOR WLAN/BT	64
13.3 SAR EVALUATION FOR PHABLET	67
14 SAR MEASUREMENT VARIABILITY.....	68
15 EVALUATION OF SIMULTANEOUS.....	69
15.1 INTRODUCTION.....	69
15.2 SIMULTANEOUS TRANSMISSION CAPABILITIES	70
15.3 SAR SIMULTANEOUS TRANSMISSION ANALYSIS	70
15.4 CONCLUSION	70
16 MEASUREMENT UNCERTAINTY	71
17 MAIN TEST INSTRUMENTS.....	71
APPENDIXES	72

1 Test Laboratory

1.1 Testing Location

Company Name:	CTTL
Address:	No. 52, Huayuan North Road, Haidian District, Beijing, P. R. China 100191.

1.2 Testing Environment

Temperature:	18°C~25°C,
Relative humidity:	30%~ 70%
Ground system resistance:	< 0.5 Ω
Ambient noise & Reflection:	< 0.012 W/kg

1.3 Project Data

Project Leader:	Qi Dianyuan
Test Engineer:	Wang Tian
Testing Start Date:	June 17, 2023
Testing End Date:	July 14, 2023

1.4 Signature

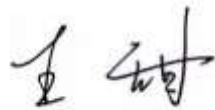

Wang Tian
(Prepared this test report)

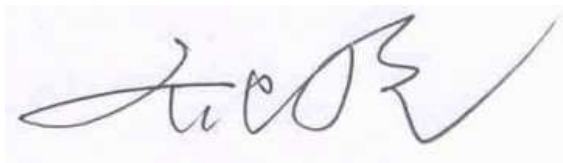

Qi Dianyuan
(Reviewed this test report)

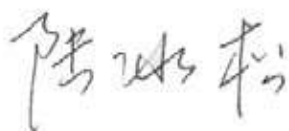

Lu Bingsong
Deputy Director of the laboratory
(Approved this test report)

2 Statement of Compliance

This EUT is a variant product and the report of original sample is No. I23Z60906-SEM01. We share all of the test results of original sample, remove the band of LTE B25/26/41 and do full test for newly add bands – LTE B2/5/7/13. All of the test results are presented in the section 13.

The maximum results of SAR found during testing for TCL Communication Ltd. GSM/UMTS/LTE Mobile phone T432J is as follows:

Table 2.1: Highest Reported SAR -Standalone(1g)

Mode		Highest Reported SAR (1g)			Product Specific 10-g SAR 0mm
		1g SAR Head	1g SAR Body-worn 15mm	1g SAR Hotspot 10mm	
GSM	GSM 850	0.10	0.16 ^[1]	0.16	/
	PCS 1900	0.17	0.08	0.17	/
WCDMA	UMTS FDD 2	0.33	0.17	0.40	/
	UMTS FDD 4	0.40	0.36	0.58	/
	UMTS FDD 5	0.66	0.54 ^[1]	0.54	/
LTE	LTE Band 12/17	0.67	0.46 ^[1]	0.46	/
	LTE Band 2	0.42	0.36	0.99	/
	LTE Band 5	0.67	0.64 ^[1]	0.64	/
	LTE Band 7	0.23	1.01 ^[1]	1.01	/
	LTE Band 13	0.74	0.72 ^[1]	0.72	/
	LTE Band 4/66	0.66	0.20	0.49	/
	LTE Band 71	0.46	0.32 ^[1]	0.32	/
WLAN 2.4 GHz		1.47	0.35 ^[1]	0.35	/

Note1: SAR result at 10mm is used for conservative evaluation.

Note2: The device have similar frequency in some LTE bands : LTE B4/66 and B12/17 since the supported frequency spans for the smaller LTE bands are completely cover by the larger LTE bands and the channel bandwidth and other operating parameters for the smaller band be fully supported by the larger band, therefore, only larger LTE bands were required to be tested for SAR.

The SAR values found for the Mobile Phone are below the maximum recommended levels of 1.6 W/kg as averaged over any 1g tissue according to the ANSI C95.1-1992.

For body operation, this device has been tested and meets FCC RF exposure guidelines when used with any accessory that contains no metal and which provides a minimum separation distance of 10 mm for hotspot and 15mm for body worn between this device and the body of the user. Use of other accessories may not ensure compliance with FCC RF exposure guidelines.

The EUT battery must be fully charged and checked periodically during the test to ascertain uniform power output.

The measurement together with the test system set-up is described in annex C. A detailed description of the equipment under test can be found in chapter 4 of this test report. The highest reported SAR value is obtained at the case of (Table 2.1), and the values are:

Head: 1.47 W/kg(1g)

Body: 1.01 W/kg(1g)

**Table 2.2: Highest Reported SAR -Simultaneous transmission**

Reported SAR 1g (W/kg)			
Head	WWAN	WLAN 2.4G	WWAN+WiFi2.4G
	LTE Band 66		
Left Cheek	0.66	0.55	1.21
Body	WWAN	WLAN 2.4G	WWAN+WiFi2.4G
	LTE Band 7		
Rear 10mm	1.01	0.21	1.22

Conclusion:

According to the above tables, the sum of reported SAR values is $<1.6\text{W/kg}$. So the simultaneous transmission SAR with volume scans is not required.

According to the above tables, the highest sum of reported SAR values is **1.22 W/kg (1g)**. The detail for simultaneous transmission consideration is described in chapter 15.



3 Client Information

3.1 Applicant Information

Company Name:	TCL Communication Ltd.
City:	5/F, Building 22E, 22 Science Park East Avenue, Hong Kong Science Park, Shatin, NT, Hong Kong
Contact Person:	Annie Jiang
E-mail:	nianxiang.jiang@tcl.com
Telephone:	+86 755 3661 1621
Fax:	+86 755 3661 2000-81722

3.2 Manufacturer Information

Company Name:	TCL Communication Ltd.
Address /Post:	5/F, Building 22E, 22 Science Park East Avenue, Hong Kong Science Park, Shatin, NT, Hong Kong
Contact Person:	Annie Jiang
E-mail:	nianxiang.jiang@tcl.com
Telephone:	+86 755 3661 1621
Fax:	+86 755 3661 2000-81722

4 Equipment Under Test (EUT) and Ancillary Equipment (AE)

4.1 About EUT

Description:	GSM/UMTS/LTE Mobile phone
Model name:	T432J
Operating mode(s):	GSM850/900/1800/1900, WCDMA B2/4/5 LTE Band 2/4/5/7/12/13/66/71, BT, Wi-Fi 2.4G
Tested Tx Frequency:	824 – 849 MHz (GSM 850)
	1850 – 1910 MHz (GSM 1900)
	824–849 MHz (WCDMA 850 Band V)
	1710 – 1755 MHz (WCDMA 1700 Band IV)
	1850–1910 MHz (WCDMA1900 Band II)
	1850 – 1910 MHz(LTE Band 2)
	1710 – 1755 MHz (LTE Band 4)
	824 – 849 MHz (LTE Band 5)
	2502.5 – 2567.5 MHz (LTE Band 7)
	699 – 716 MHz (LTE Band 12)
	777 – 787 MHz (LTE Band 13)
	1710 – 1780 MHz (LTE Band 66)
	665.5 – 695.5 MHz (LTE Band 71)
	2402 – 2480 MHz (Bluetooth)
2412 – 2462 MHz (Wi-Fi 2.4G)	
GPRS/EGPRS Multislot Class:	12
GPRS capability Class:	B
Antenna type:	Integrated antenna
Hotspot mode:	Support
Note:	WLAN transmit with WWAN/BT simultaneously, WLAN will invoke reduced power level

4.2 Internal Identification of EUT used during the test

EUT ID*	IMEI	HW	SW Version
EUT1	016458000201238	03	MYS0
EUT2	016458000201311	03	MYS0
EUT3	016458000201378	03	MYS0

*EUT ID: is used to identify the test sample in the lab internally.

Note: It is performed to test SAR with the EUT1 and conducted power with the EUT2~3.

4.3 Internal Identification of AE used during the test

AE ID*	Description	Model	SN	Manufacturer
AE1	Battery	TLi028C7	\	NINGBO VEKEN BATTERY CO.,LTD
AE2	Battery	TLi028CA	\	ZHONGSHAN TIANMAOBATTERY CO.,LTD

*AE ID: is used to identify the test sample in the lab internally.



5 TEST METHODOLOGY

5.1 Applicable Limit Regulations

ANSI C95.1–1992: IEEE Standard for Safety Levels with Respect to Human Exposure to Radio Frequency Electromagnetic Fields, 3 kHz to 300 GHz.

It specifies the maximum exposure limit of **1.6 W/kg** as averaged over any 1 gram of tissue for portable devices being used within 20 cm of the user in the uncontrolled environment.

5.2 Applicable Measurement Standards

IEEE 1528–2013: Recommended Practice for Determining the Peak Spatial-Average Specific Absorption Rate (SAR) in the Human Head from Wireless Communications Devices: Measurement Techniques.

KDB447498 D01: General RF Exposure Guidance v06: Mobile and Portable Devices RF Exposure Procedures and Equipment Authorization Policies.

KDB648474 D04 Handset SAR v01r03: SAR Evaluation Considerations for Wireless Handsets.

KDB941225 D01 SAR test for 3G devices v03r01: SAR Measurement Procedures for 3G Devices

KDB941225 D05 SAR for LTE Devices v02r05: SAR Evaluation Considerations for LTE Devices

KDB941225 D06 Hotspot Mode SAR v02r01: SAR Evaluation Procedures for Portable Devices with Wireless Router Capabilities

KDB248227 D01 802.11 Wi-Fi SAR v02r02: SAR GUIDANCE FOR IEEE 802.11 (Wi-Fi) TRANSMITTERS

KDB865664 D01 SAR measurement 100 MHz to 6 GHz v01r04: SAR Measurement Requirements for 100 MHz to 6 GHz.

KDB865664 D02 RF Exposure Reporting v01r02: RF Exposure Compliance Reporting and Documentation Considerations

6 Specific Absorption Rate (SAR)

6.1 Introduction

SAR is related to the rate at which energy is absorbed per unit mass in an object exposed to a radio field. The SAR distribution in a biological body is complicated and is usually carried out by experimental techniques or numerical modeling. The standard recommends limits for two tiers of groups, occupational/controlled and general population/uncontrolled, based on a person's awareness and ability to exercise control over his or her exposure. In general, occupational/controlled exposure limits are higher than the limits for general population/uncontrolled.

6.2 SAR Definition

The SAR definition is the time derivative (rate) of the incremental energy (dW) absorbed by (dissipated in) an incremental mass (dm) contained in a volume element (dv) of a given density (ρ). The equation description is as below:

$$SAR = \frac{d}{dt} \left(\frac{dW}{dm} \right) = \frac{d}{dt} \left(\frac{dW}{\rho dv} \right)$$

SAR is expressed in units of Watts per kilogram (W/kg)

SAR measurement can be either related to the temperature elevation in tissue by

$$SAR = c \left(\frac{\delta T}{\delta t} \right)$$

Where: C is the specific heat capacity, δT is the temperature rise and δt is the exposure duration, or related to the electrical field in the tissue by

$$SAR = \frac{\sigma |E|^2}{\rho}$$

Where: σ is the conductivity of the tissue, ρ is the mass density of tissue and E is the RMS electrical field strength.

However for evaluating SAR of low power transmitter, electrical field measurement is typically applied.

7 Tissue Simulating Liquids

The temperature of the tissue-equivalent medium used during measurement must also be within 18 °C to 25 °C and within ± 2 °C of the temperature when the tissue parameters are characterized. The dielectric parameters must be measured before the tissue-equivalent medium is used in a series of SAR measurements. The parameters should be re-measured after each 3 – 4 days of use; or earlier if the dielectric parameters can become out of tolerance; for example, when the parameters are marginal at the beginning of the measurement series.

The dielectric constant (ϵ_r) and conductivity (σ) of typical tissue-equivalent media recipes are expected to be within $\pm 5\%$ of the required target values; but for SAR measurement systems that have implemented the SAR error compensation algorithms documented in IEEE Std 1528-2013, to automatically compensate the measured SAR results for deviations between the measured and required tissue dielectric parameters, the tolerance for ϵ_r and σ may be relaxed to $\pm 10\%$. This is limited to frequencies ≤ 3 GHz.

7.1 Targets for tissue simulating liquid

Table 7.1: Targets for tissue simulating liquid

Frequency(MHz)	Liquid Type	Conductivity(σ)	$\pm 10\%$ Range	Permittivity(ϵ)	$\pm 10\%$ Range
750	Head	0.89	0.80~0.98	41.94	37.75~46.13
835	Head	0.90	0.81~0.99	41.5	37.35~45.65
1750	Head	1.37	1.26~1.54	40.0	36~44
1900	Head	1.40	1.26~1.54	40.0	36~44
2450	Head	1.80	1.62~1.98	39.2	35.28~43.12
2600	Head	1.96	1.76~2.16	39.01	35.11~42.91

7.2 Dielectric Performance

Table 7.2: Dielectric Performance of Tissue Simulating Liquid

Measurement Date (yyyy-mm-dd)	Type	Frequency	Permittivity ϵ	Drift (%)	Conductivity σ (S/m)	Drift (%)
2023/6/20	Head	750 MHz	44.23	5.46	0.8308	-6.65
2023/6/21	Head	835 MHz	44.06	6.17	0.8757	-2.70
2023/6/22	Head	1750 MHz	41.46	3.44	1.384	1.02
2023/6/28	Head	1900 MHz	40.96	2.40	1.475	5.36
2023/6/26	Head	2450 MHz	40.15	2.42	1.893	5.17
2023/6/23	Head	2600 MHz	39.88	2.23	2.025	3.32
2023/7/11	Head	750 MHz	43.22	3.05	0.873	-1.91
2023/7/12	Head	835 MHz	42.95	3.49	0.909	-1.20
2023/7/13	Head	1900 MHz	40.79	1.98	1.42	1.43
2023/7/14	Head	2600 MHz	39.67	1.69	1.905	-2.81

Note: The liquid temperature is 22.0°C

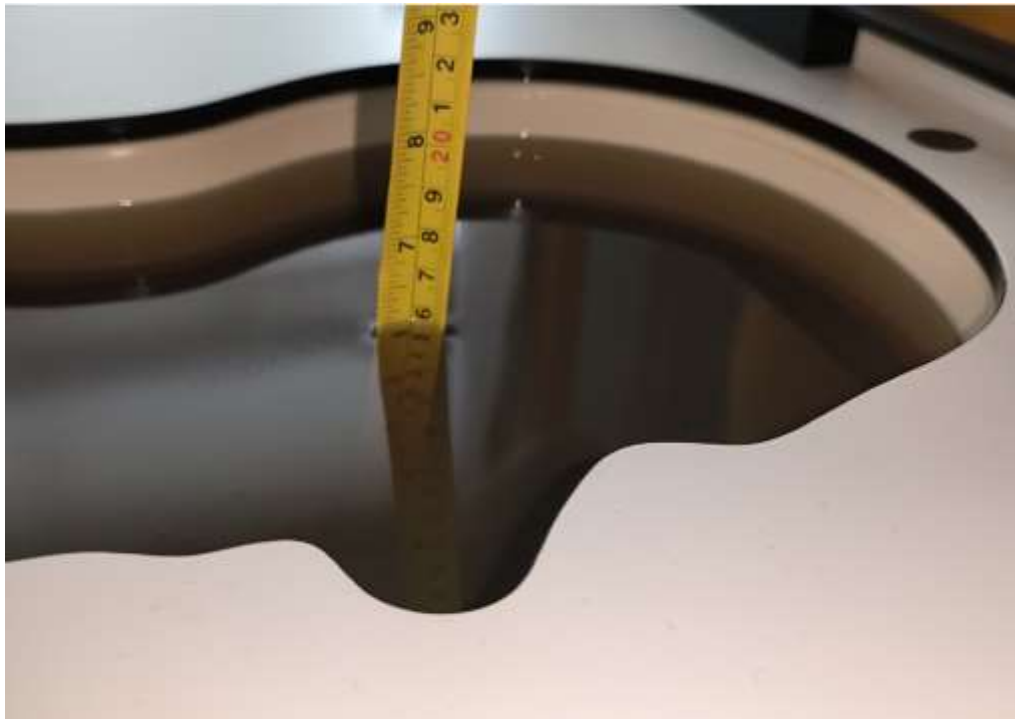

Picture 7-1 Liquid depth in the Head Phantom



Picture 7-2 Liquid depth in the Body Phantom

8 System verification

8.1 System Setup

In the simplified setup for system evaluation, the DUT is replaced by a calibrated dipole and the power source is replaced by a continuous wave that comes from a signal generator. The calibrated dipole must be placed beneath the flat phantom section of the SAM twin phantom with the correct distance holder. The distance holder should touch the phantom surface with a light pressure at the reference marking and be oriented parallel to the long side of the phantom. The equipment setup is shown below:

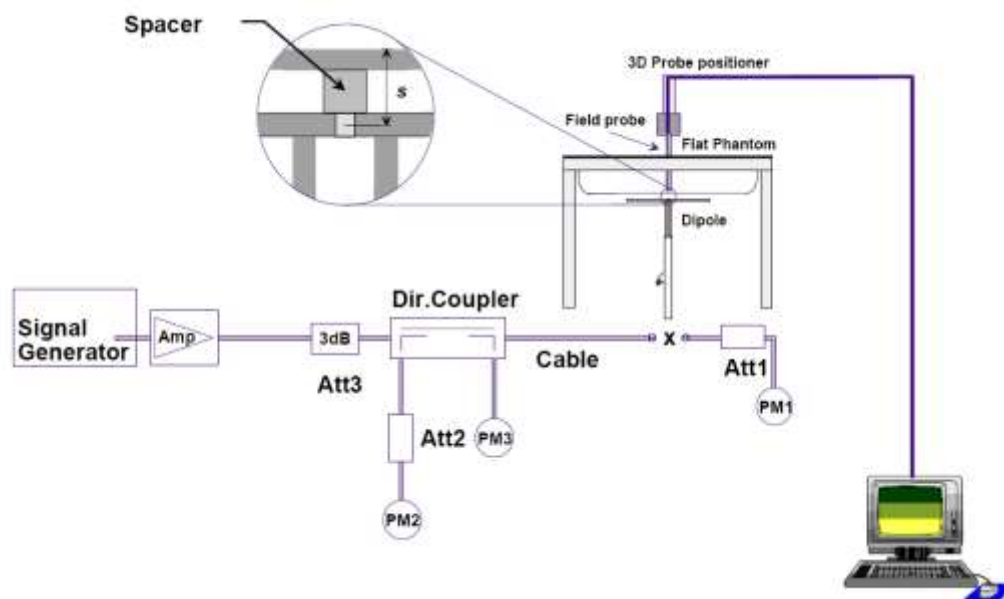

Picture 8.1 System Setup for System Evaluation



Picture 8.2 Photo of Dipole Setup

8.2 System Verification

SAR system verification is required to confirm measurement accuracy, according to the tissue dielectric media, probe calibration points and other system operating parameters required for measuring the SAR of a test device. The system verification must be performed for each frequency band and within the valid range of each probe calibration point required for testing the device.

Table 8.1: System Verification of Head

Measurement Date (yyyy-mm-dd)	Frequency	Target value (W/kg)	Measured value(W/kg)	Deviation
		1 g Average	1 g Average	1 g Average
2023/6/20	750 MHz	8.63	8.44	-2.20%
2023/6/21	835 MHz	9.73	9.52	-2.16%
2023/6/22	1750 MHz	36.8	35.40	-3.80%
2023/6/28	1900 MHz	39.7	40.24	1.36%
2023/6/26	2450 MHz	52.7	51.20	-2.85%
2023/6/23	2600 MHz	55.8	58.00	3.94%
2023/7/11	750 MHz	8.63	8.36	-3.13%
2023/7/12	835 MHz	9.73	9.52	-2.16%
2023/7/13	1900 MHz	39.7	39.4	-0.65%
2023/7/14	2600 MHz	55.8	56.8	1.79%

9 General Measurement Procedure

9.1 Power Reference Measurement

The Power Reference Measurement and Power Drift Measurements are for monitoring the power drift of the device under test in the batch process. The minimum distance of probe sensors to surface determines the closest measurement point to phantom surface. This distance cannot be smaller than the distance of sensor calibration points to probe tip as defined in the probe properties.

9.2 Area Scan

The area scan is used as a fast scan in two dimensions to find the area of high field values, before doing a fine measurement around the hot spot. The sophisticated interpolation routines implemented in DASY software can find the maximum found in the scanned area, within a range of the global maximum. The range (in dB) is specified in the standards for compliance testing. For example, a 2 dB range is required in IEEE standard 1528 and IEC 62209 standards, whereby 3 dB is a requirement when compliance is assessed in accordance with the ARIB standard (Japan), if only one zoom scan follows the area scan, then only the absolute maximum will be taken as reference. For cases where multiple maximums are detected, the number of zoom scans has to be increased accordingly.

Area scan parameters extracted from FCC KDB 865664 D01v01r04 SAR measurement 100 MHz to 6 GHz.

	≤ 3 GHz	> 3 GHz
Maximum distance from closest measurement point (geometric center of probe sensors) to phantom surface	5 ± 1 mm	$\frac{1}{2} \cdot \delta \cdot \ln(2) \pm 0.5$ mm
Maximum probe angle from probe axis to phantom surface normal at the measurement location	30° ± 1°	20° ± 1°
Maximum area scan spatial resolution: Δx_{Area} , Δy_{Area}	≤ 2 GHz: ≤ 15 mm 2 – 3 GHz: ≤ 12 mm	3 – 4 GHz: ≤ 12 mm 4 – 6 GHz: ≤ 10 mm
	When the x or y dimension of the test device, in the measurement plane orientation, is smaller than the above, the measurement resolution must be ≤ the corresponding x or y dimension of the test device with at least one measurement point on the test device.	

9.3 Zoom Scan

Zoom Scans are used to assess the peak spatial SAR values within a cubic averaging volume containing 1 g and 10g of simulated tissue. The Zoom Scan measures points (refer to table below) within a cube whose base faces are centered on the maxima found in a preceding area scan job within the same procedure. When the measurement is done, the Zoom Scan evaluates the averaged SAR for 1 g and 10 g and displays these values next to the job' s label.

Zoom Scan Parameters extracted from KDB 865664 D01 SAR Measurement 100 MHz to 6 GHz

Maximum zoom scan spatial resolution: $\Delta x_{Zoom}, \Delta y_{Zoom}$		≤ 2 GHz: ≤ 8 mm 2 – 3 GHz: ≤ 5 mm*	3 – 4 GHz: ≤ 5 mm* 4 – 6 GHz: ≤ 4 mm*
Maximum zoom scan spatial resolution, normal to phantom surface	uniform grid: $\Delta z_{Zoom}(n)$	≤ 5 mm	3 – 4 GHz: ≤ 4 mm 4 – 5 GHz: ≤ 3 mm 5 – 6 GHz: ≤ 2 mm
	graded grid	$\Delta z_{Zoom}(1)$: between 1 st two points closest to phantom surface	≤ 4 mm 3 – 4 GHz: ≤ 3 mm 4 – 5 GHz: ≤ 2.5 mm 5 – 6 GHz: ≤ 2 mm
		$\Delta z_{Zoom}(n>1)$: between subsequent points	$\leq 1.5 \cdot \Delta z_{Zoom}(n-1)$
Minimum zoom scan volume	x, y, z	≥ 30 mm	3 – 4 GHz: ≥ 28 mm 4 – 5 GHz: ≥ 25 mm 5 – 6 GHz: ≥ 22 mm
Note: δ is the penetration depth of a plane-wave at normal incidence to the tissue medium; see draft standard IEEE P1528-2011 for details. * When zoom scan is required and the <i>reported</i> SAR from the <i>area scan based 1-g SAR estimation</i> procedures of KDB 447498 is ≤ 1.4 W/kg, ≤ 8 mm, ≤ 7 mm and ≤ 5 mm zoom scan resolution may be applied, respectively, for 2 GHz to 3 GHz, 3 GHz to 4 GHz and 4 GHz to 6 GHz.			

9.4 Power drift measurement

The Power Drift Measurement measures the field at the same location as the most recent power reference measurement within the same procedure, and with the same settings. The Power Drift Measurement gives the field difference in dB from the reading conducted within the last Power Reference Measurement. This allows a user to monitor the power drift of the device under test within a batch process. The measurement procedure is the same as 9.1.

10 Measurement Procedure for different technologies

10.1 GSM/GPRS Measurement Procedures for SAR

GSM / GPRS / EDGE modes is determined by the source-based time-averaged output power including tune-up tolerance. The mode with highest specified time-averaged output power should be tested for SAR compliance in the applicable exposure conditions. For modes with the same specified maximum output power and tolerance, the higher number time-slot configuration should be tested. Other configurations of GSM / GPRS / EDGE are considered as secondary modes. The 3G SAR test reduction procedure is applied, when the maximum output power and tune-up tolerance specified for production units in a secondary mode is $\leq \frac{1}{4}$ dB higher than the primary mode, SAR measurement is not required for the secondary mode.

10.2 WCDMA Measurement Procedures for SAR

The following procedures are applicable to WCDMA handsets operating under 3GPP Release99, Release 5 and Release 6. The default test configuration is to measure SAR with an established radio link between the DUT and a communication test set using a 12.2kbps RMC (reference measurement channel) configured in Test Loop Mode 1. SAR is selectively confirmed for other physical channel configurations (DPCCH & DPDCH_n), HSDPA and HSPA (HSUPA/HSDPA) modes according to output power, exposure conditions and device operating capabilities. Both uplink and downlink should be configured with the same RMC or AMR, when required. SAR for Release 5 HSDPA and Release 6 HSPA are measured using the applicable FRC (fixed reference channel) and E-DCH reference channel configurations. Maximum output power is verified according to applicable versions of 3GPP TS 34.121 and SAR must be measured according to these maximum output conditions. When Maximum Power Reduction (MPR) is not implemented according to Cubic Metric (CM) requirements for Release 6 HSPA, the following procedures do not apply.

For Release 5 HSDPA Data Devices:

Sub-test	β_c	β_d	β_d (SF)	β_c / β_d	β_{hs}	CM/dB
1	2/15	15/15	64	2/15	4/15	0.0
2	12/15	15/15	64	12/15	24/25	1.0
3	15/15	8/15	64	15/8	30/15	1.5
4	15/15	4/15	64	15/4	30/15	1.5

For Release 6 HSPA Data Devices

Sub-test	β_c	β_d	β_d (SF)	β_c / β_d	β_{hs}	β_{ec}	β_{ed}	β_{ed} (SF)	β_{ed} (codes)	CM (dB)	MPR (dB)	AG Index	E-TFCI
1	11/15	15/15	64	11/15	22/15	209/225	1039/225	4	1	1.5	1.5	20	75
2	6/15	15/15	64	6/15	12/15	12/15	12/15	4	1	1.5	1.5	12	67

3	15/15	9/15	64	15/9	30/15	30/15	$\beta_{ed1}:47/15$ $\beta_{ed2}:47/15$	4	2	1.5	1.5	15	92
4	2/15	15/15	64	2/15	4/15	4/15	56/75	4	1	1.5	1.5	17	71
5	15/15	15/15	64	15/15	24/15	30/15	134/15	4	1	1.5	1.5	21	81

Rel.7 Release 7 HSPA+ Data Devices

Table C.11.1.4: β values for transmitter characteristics tests with HS-DPCCH and E-DCH with 16QAM

Sub-test	β_c (Note3)	β_d	β_{HS} (Note1)	β_{ec}	β_{ed} (2xSF2) (Note 4)	β_{ed} (2xSF4) (Note 4)	CM (dB) (Note 2)	MPR (dB) (Note 2)	AG Index (Note 4)	E-TFCI (Note 5)	E-TFCI (boost)
1	1	0	30/15	30/15	$\beta_{ed1}: 30/15$ $\beta_{ed2}: 30/15$	$\beta_{ed3}: 24/15$ $\beta_{ed4}: 24/15$	3.5	2.5	14	105	105

Note 1: $\Delta_{ACK}, \Delta_{NACK}$ and $\Delta_{CQI} = 30/15$ with $\beta_{HS} = 30/15 * \beta_c$.

Note 2: CM = 3.5 and the MPR is based on the relative CM difference, MPR = MAX(CM-1,0).

Note 3: DPDCH is not configured, therefore the β_c is set to 1 and $\beta_d = 0$ by default.

Note 4: β_{ed} can not be set directly; it is set by Absolute Grant Value.

Note 5: All the sub-tests require the UE to transmit 2SF2+2SF4 16QAM EDCH and they apply for UE using E-DPDCH category 7. E-DCH TTI is set to 2ms TTI and E-DCH table index = 2. To support these E-DCH configurations DPDCH is not allocated. The UE is signalled to use the extrapolation algorithm.

Rel.8 DC-HSDPA (Cat 24)

SAR test exclusion for Rel.8 DC-HSDPA must satisfy the SAR test exclusion requirements of Rel.5 HSDPA. SAR test exclusion for DC-HSDPA devices is determined by power measurements according to the H-Set 12, Fixed Reference Channel (FRC) configuration in Table C.8.1.12 of 3GPP TS 34.121-1. A primary and a secondary serving HS-DSCH Cell are required to perform the power measurement and for the results to qualify for SAR test exclusion.

Table C.8.1.12: Fixed Reference Channel H-Set 12

Parameter	Unit	Value
Nominal Avg. Inf. Bit Rate	kbps	60
Inter-TTI Distance	TTI's	1
Number of HARQ Processes	Processes	6
Information Bit Payload (N_{INF})	Bits	120
Number Code Blocks	Blocks	1
Binary Channel Bits Per TTI	Bits	960
Total Available SML's in UE	SML's	19200
Number of SML's per HARQ Proc.	SML's	3200
Coding Rate		0.15
Number of Physical Channel Codes	Codes	1
Modulation		QPSK
Note 1: The RMC is intended to be used for DC-HSDPA mode and both cells shall transmit with identical parameters as listed in the table. Note 2: Maximum number of transmission is limited to 1, i.e., retransmission is not allowed. The redundancy and constellation version 0 shall be used.		

10.3 LTE Measurement Procedures for SAR

SAR tests for LTE are performed with a base station simulator, Rohde & Schwarz CMW500 or Anritsu MT8821C Closed loop power control was used so the UE transmits with maximum output power during SAR testing.

It is performed for conducted power and SAR based on the KDB941225 D05.

SAR is evaluated separately according to the following procedures for the different test positions in each exposure condition – head, body, body-worn accessories and other use conditions. The procedures in the following subsections are applied separately to test each LTE frequency band.

1) QPSK with 1 RB allocation

Start with the largest channel bandwidth and measure SAR for QPSK with 1 RB allocation, using the RB offset and required test channel combination with the highest maximum output power among RB offsets at the upper edge, middle and lower edge of each required test channel. When the reported SAR is ≤ 0.8 W/kg, testing of the remaining RB offset configurations and required test channels is not required for 1 RB allocation; otherwise, SAR is required for the remaining required test channels and only for the RB offset configuration with the highest output power for that channel. When the reported SAR of a required test channel is > 1.45 W/kg, SAR is required for all three RB offset configurations for that required test channel.

2) QPSK with 50% RB allocation

The procedures required for 1 RB allocation in 1) are applied to measure the SAR for QPSK with 50% RB allocation.

3) QPSK with 100% RB allocation

For QPSK with 100% RB allocation, SAR is not required when the highest maximum output power for 100 % RB allocation is less than the highest maximum output power in 50% and 1 RB allocations and the highest reported SAR for 1 RB and 50% RB allocation in 1) and 2) are ≤ 0.8 W/kg. Otherwise, SAR is measured for the highest output power channel; and if the reported SAR is > 1.45 W/kg, the remaining required test channels must also be tested.

10.4 Bluetooth & Wi-Fi Measurement Procedures for SAR

Normal network operating configurations are not suitable for measuring the SAR of 802.11 transmitters in general. Unpredictable fluctuations in network traffic and antenna diversity conditions can introduce undesirable variations in SAR results. The SAR for these devices should be measured using chipset based test mode software to ensure that the results are consistent and reliable.

Chipset based test mode software is hardware dependent and generally varies among manufacturers. The device operating parameters established in a test mode for SAR measurements must be identical to those programmed in production units, including output power levels, amplifier gain settings and other RF performance tuning parameters. The test frequencies should correspond to actual channel frequencies defined for domestic use. SAR for devices with switched diversity should be measured with only one antenna transmitting at a time during each SAR measurement, according to a fixed modulation and data rate. The same data pattern should be used for all measurements.

11 Conducted Output Power

This device has several different power modes for head, body-worn, hotspot SAR compliance; power selection is determined by the device's positioning and usage scenarios. The details of test scenarios categorization in the table below

Antenna	Body worn receiver off	Head receiver on	Body receiver off	Head receiver on
	Hotspot off	Hotspot off	Hotspot on	Hotspot on
Main antenna	DSI0	DSI1	DSI2	DSI3

11.1 GSM Measurement result

During the process of testing, the EUT was controlled via R&S Digital Radio Communication tester (CMW500) to ensure the maximum power transmission and proper modulation. This result contains conducted output power for the EUT. In all cases, the measured peak output power should be greater and within 5% than EMI measurement.

GSM850 DSI0/1/2/3

GSM 850 Speech (GMSK)	Measured Power (dBm)			Tune up	calculation	Averaged Power (dBm)		
	251	190	128			251	190	128
1 Txslot	32.40	32.45	31.94	33.30	/	/	/	/
GSM 850 GPRS (GMSK)	Measured Power (dBm)				calculation	Averaged Power (dBm)		
	251	190	128			251	190	128
1 Txslot	32.64	32.44	31.93	33.30	-9.03	23.61	23.41	22.90
2 Txslots	29.52	29.41	29.00	30.50	-6.02	23.50	23.39	22.98
3Txslots	27.62	27.63	27.26	28.50	-4.26	23.36	23.37	23.00
4 Txslots	26.64	26.71	26.37	27.50	-3.01	23.63	23.70	23.36
GSM 850 EGPRS (GMSK)	Measured Power (dBm)				calculation	Averaged Power (dBm)		
	251	190	128			251	190	128
1 Txslot	31.13	31.57	31.77	33.30	-9.03	22.10	22.54	22.74
2 Txslots	28.79	28.96	29.81	30.50	-6.02	22.77	22.94	23.79
3Txslots	26.82	27.52	28.07	28.50	-4.26	22.56	23.26	23.81
4 Txslots	25.76	25.89	26.18	27.50	-3.01	22.75	22.88	23.17
GSM 850 EGPRS (8PSK)	Measured Power (dBm)				calculation	Averaged Power (dBm)		
	251	190	128			251	190	128
1 Txslot	24.65	25.02	25.43	26.50	-9.03	15.62	15.99	16.40
2 Txslots	22.77	22.98	23.61	24.50	-6.02	16.75	16.96	17.59
3Txslots	21.15	22.29	21.61	23.00	-4.26	16.89	18.03	17.35
4 Txslots	19.36	19.91	20.27	21.00	-3.01	16.35	16.90	17.26

GSM1900 DSI0/1/3

GSM 1900 Speech (GMSK)	Measured Power (dBm)			Tune up	calculation	Averaged Power (dBm)		
	810	661	512			810	661	512
1 Txslot	27.37	27.35	27.38	28.30	/	/	/	/
GSM 1900 GPRS (GMSK)	Measured Power (dBm)				calculation	Averaged Power (dBm)		
	251	190	128			251	190	128
1 Txslot	27.44	27.34	27.33	28.30	-9.03	18.41	18.31	18.30
2 Txslots	24.41	24.31	24.20	25.00	-6.02	18.39	18.29	18.18
3Txslots	22.76	22.62	22.59	23.50	-4.26	18.50	18.36	18.33
4 Txslots	21.37	21.35	21.15	22.00	-3.01	18.36	18.34	18.14
GSM 1900 EGPRS (GMSK)	Measured Power (dBm)				calculation	Averaged Power (dBm)		
	810	661	512			810	661	512
1 Txslot	27.29	27.25	27.25	28.30	-9.03	18.26	18.22	18.22
2 Txslots	24.30	24.22	24.12	25.00	-6.02	18.28	18.20	18.10
3Txslots	22.66	22.54	22.52	23.50	-4.26	18.40	18.28	18.26
4 Txslots	21.39	21.27	21.08	22.00	-3.01	18.38	18.26	18.07
GSM 1900 EGPRS (8PSK)	Measured Power (dBm)				calculation	Averaged Power (dBm)		
	810	661	512			810	661	512
1 Txslot	22.50	22.61	22.56	23.50	-9.03	13.47	13.58	13.53
2 Txslots	19.38	19.92	19.45	21.00	-6.02	13.36	13.90	13.43
3Txslots	17.65	17.75	17.74	19.00	-4.26	13.39	13.49	13.48
4 Txslots	16.84	16.47	16.46	18.00	-3.01	13.83	13.46	13.45

GSM1900 DSI2

GSM 1900 Speech (GMSK)	Measured Power (dBm)			Tune up	calculation	Averaged Power (dBm)		
	810	661	512			810	661	512
1 Txslot	26.35	26.32	26.27	27.30	/	/	/	/
GSM 1900 GPRS (GMSK)	Measured Power (dBm)				calculation	Averaged Power (dBm)		
	251	190	128			251	190	128
1 Txslot	26.27	26.25	26.19	27.30	-9.03	17.24	17.22	17.16
2 Txslots	23.47	23.32	23.22	25.00	-6.02	17.45	17.30	17.20
3Txslots	21.73	21.59	21.51	23.50	-4.26	17.47	17.33	17.25
4 Txslots	20.45	20.25	20.05	22.00	-3.01	17.44	17.24	17.04
GSM 1900 EGPRS (GMSK)	Measured Power (dBm)				calculation	Averaged Power (dBm)		
	810	661	512			810	661	512
1 Txslot	26.22	26.21	26.14	27.30	-9.03	17.19	17.18	17.11
2 Txslots	23.43	23.28	23.18	25.00	-6.02	17.41	17.26	17.16
3Txslots	21.69	21.55	21.56	23.50	-4.26	17.43	17.29	17.30
4 Txslots	20.36	20.22	20.01	22.00	-3.01	17.35	17.21	17.00
GSM 1900 EGPRS (8PSK)	Measured Power (dBm)				calculation	Averaged Power (dBm)		
	810	661	512			810	661	512
1 Txslot	21.57	21.66	21.61	22.50	-9.03	12.54	12.63	12.58

2 Txslots	18.47	18.57	18.52	20.00	-6.02	12.45	12.55	12.50
3Txslots	16.73	18.25	16.73	18.00	-4.26	12.47	13.99	12.47
4 Txslots	15.46	15.53	15.51	17.00	-3.01	12.45	12.52	12.50

11.2 WCDMA Measurement result

WCDMA1900 DSI0/1/3

Item	band	FDDII result			
	ARFCN	9538 (1907.6MHz)	9400 (1880MHz)	9262 (1852.4MHz)	Tune up
WCDMA	\	21.47	21.48	21.45	21.5
HSUPA	1	19.82	19.63	19.78	21
	2	19.87	19.42	19.38	21
	3	20.68	20.64	20.42	21.5
	4	18.56	18.67	18.94	20
	5	20.56	20.18	20.41	21
HSPA+		20.87	20.69	20.99	22
DC-HSDPA	1	20.16	20.27	20.34	21.5
	2	20.39	20.16	20.33	21.5
	3	19.57	19.67	19.82	21
	4	19.83	19.56	19.77	21

WCDMA1900 DSI2

Item	band	FDDII result			
	ARFCN	9538 (1907.6MHz)	9400 (1880MHz)	9262 (1852.4MHz)	Tune up
WCDMA	\	20.43	20.52	20.35	21
HSUPA	1	18.68	18.72	18.78	19.5
	2	18.57	18.56	18.41	19.5
	3	19.24	19.36	19.40	20.5
	4	17.95	17.58	17.89	18.5
	5	19.09	19.24	19.39	20
HSPA+		19.58	19.73	19.89	20.5
DC-HSDPA	1	19.25	19.28	19.33	20.5
	2	19.16	19.67	19.36	20.5
	3	18.63	18.25	18.81	20
	4	18.96	18.75	18.84	20

WCDMA1700 DSI0/1/3

Item	band	FDDIV result			
	ARFCN	1513 (1752.6MHz)	1412 (1732.4MHz)	1312 (1712.4MHz)	Tune up
WCDMA	\	20.96	20.91	20.79	21.5
HSUPA	1	19.57	19.26	19.25	20.5
	2	19.11	19.05	18.91	20.5
	3	19.96	19.58	19.86	20.5
	4	18.26	18.79	18.38	19.5
	5	19.98	19.67	19.83	21
HSPA+		20.36	20.78	20.38	21
DC-HSDPA	1	19.62	19.98	19.84	20.5
	2	19.98	19.57	19.85	21
	3	19.73	19.88	19.41	20.5
	4	19.56	19.72	19.34	20.5

WCDMA1700 DSI2

Item	band	FDDIV result			
	ARFCN	1513 (1752.6MHz)	1412 (1732.4MHz)	1312 (1712.4MHz)	Tune up
WCDMA	\	20.06	19.92	19.96	20.5
HSUPA	1	18.57	18.36	18.27	19.5
	2	17.85	17.56	17.84	19
	3	17.65	17.92	17.88	19
	4	17.36	17.58	17.41	19
	5	18.98	18.57	18.86	20
HSPA+		19.52	19.37	19.35	20.5
DC-HSDPA	1	18.86	18.35	18.79	20
	2	18.27	18.67	18.81	20
	3	18.63	18.52	18.42	20
	4	18.27	18.16	18.32	20

WCDMA850 DSI0/2

Item	band	FDDV result			
	ARFCN	4233 (846.6MHz)	4183 (836.6MHz)	4132 (826.4MHz)	Tune up
WCDMA	\	23.03	22.97	23.06	24.5
HSUPA	1	20.15	20.46	20.39	21.5
	2	20.13	20.11	20.00	21.5
	3	21.05	21.06	21.01	22.5
	4	19.71	19.57	19.60	21
	5	20.58	20.69	21.00	22
HSPA+		21.5	21.64	21.69	22.5
DC-HSDPA	1	20.78	20.46	20.89	22
	2	20.47	20.63	20.69	22
	3	20.43	20.59	20.47	21.5
	4	20.69	20.47	20.43	21.5

WCDMA850 DSI1/3

Item	band	FDDV result			
	ARFCN	4233 (846.6MHz)	4183 (836.6MHz)	4132 (826.4MHz)	Tune up
WCDMA	\	21.08	20.94	20.95	22.5
HSUPA	1	19.56	19.75	19.39	21
	2	19.63	19.57	19.07	20.5
	3	20.36	20.14	20.21	21.5
	4	19.05	18.56	18.58	20
	5	20.13	20.17	20.00	21.5
HSPA+		20.68	20.63	20.71	21.5
DC-HSDPA	1	19.85	19.57	19.86	21
	2	19.38	19.75	19.64	21
	3	19.56	19.36	19.41	21
	4	19.57	19.38	19.45	21

11.3 LTE Measurement result

The maximum output power(Tune-up Limit)

Band	Tune up			
	DSI0	DSI1	DSI2	DSI3
LTE Band 2	21+/-1	21+/-1	20+/-1	21+/-1
LTE Band 4	21+/-1	21+/-1	20+/-1	21+/-1
LTE Band 5	24+/-1	22+/-1	24+/-1	22+/-1
LTE Band 7	20.3-21	20.3-21	20.3-21	20.3-21
LTE Band 12	24+/-1	22+/-1	24+/-1	22+/-1
LTE Band 13	24+/-1	22+/-1	24+/-1	22+/-1
LTE Band 66	21+/-1	21+/-1	20+/-1	21+/-1
LTE Band 71	23.5+/-1	22+/-1	23.5+/-1	22+/-1

The following tests were conducted according to the test requirements outlined in section 6.2 of the 3GPP TS36.101 specification. UE Power Class: 3 (23 +/- 2dBm). The allowed Maximum Power Reduction (MPR) for the maximum output power due to higher order modulation and transmit bandwidth configuration (resource blocks) is specified in Table 6.2.3-1 of the 3GPP TS36.101.

Table 6.2.3-1: Maximum Power Reduction (MPR) for Power Class 1, 2 and 3

Modulation	Channel bandwidth / Transmission bandwidth (N _{RB})						MPR (dB)
	1.4 MHz	3.0 MHz	5 MHz	10 MHz	15 MHz	20 MHz	
QPSK	> 5	> 4	> 8	> 12	> 16	> 18	≤ 1
16 QAM	≤ 5	≤ 4	≤ 8	≤ 12	≤ 16	≤ 18	≤ 1
16 QAM	> 5	> 4	> 8	> 12	> 16	> 18	≤ 2
64 QAM	≤ 5	≤ 4	≤ 8	≤ 12	≤ 16	≤ 18	≤ 2
64 QAM	> 5	> 4	> 8	> 12	> 16	> 18	≤ 3
256 QAM	≥ 1						≤ 5

LTE B12 DSI0/2

Band 12						
Bandwidth (MHz)	RB allocation	Frequency (MHz)	Actual output power (dBm)			
	RB offset		QPSK	16QAM	64QAM	
1.4MHz	1RB-High	715.3	23.52	22.32	21.46	
		707.5	23.93	22.51	21.81	
		699.7	23.66	23.41	22.34	
	1RB-Middle (3)	715.3	23.70	22.84	21.99	
		707.5	23.87	22.65	21.68	
		699.7	23.48	22.40	21.29	
	1RB-Low (0)	715.3	24.18	23.24	22.39	
		707.5	23.38	22.57	21.32	
		699.7	23.42	22.32	21.80	
	3RB-High (3)	715.3	23.61	23.32	21.66	
		707.5	23.85	22.68	21.94	
		699.7	23.60	23.21	21.74	
	3RB-Middle (1)	715.3	23.47	22.66	21.32	
		707.5	24.32	22.62	21.53	
		699.7	24.24	22.38	22.34	
	3RB-Low (0)	715.3	24.34	22.44	21.96	
		707.5	23.83	22.46	21.42	
		699.7	23.40	22.41	21.29	
	6RB (0)	715.3	23.94	22.76	21.71	
		707.5	23.42	22.81	21.83	
		699.7	23.77	22.58	21.98	
	3MHz	1RB-High (14)	714.5	23.79	22.47	21.90
			707.5	24.04	22.30	22.04
			700.5	23.35	22.42	22.07
		1RB-Middle (7)	714.5	23.59	22.62	21.41
			707.5	24.15	22.73	21.95
			700.5	24.16	23.45	21.99
1RB-Low (0)		714.5	23.55	23.02	21.67	
		707.5	23.48	22.58	21.62	
		700.5	23.91	22.48	21.72	
8RB-High (7)		714.5	23.89	22.97	21.28	
		707.5	23.51	22.76	21.85	
		700.5	23.91	22.97	21.91	
8RB-Middle (4)		714.5	23.78	22.46	21.94	
		707.5	23.99	22.08	21.18	
		700.5	23.94	23.00	21.11	
8RB-Low (0)		714.5	23.33	22.37	21.88	
		707.5	23.63	22.67	21.39	
		700.5	23.73	22.86	21.71	
15RB (0)		714.5	23.46	22.88	21.95	

		707.5	23.34	23.00	21.74
		700.5	23.74	22.82	21.53
5MHz	1RB-High (24)	713.5	24.04	23.35	22.37
		707.5	24.11	22.41	21.47
		701.5	23.58	23.41	22.27
		713.5	23.47	23.33	21.40
	1RB-Middle (12)	707.5	24.00	22.81	21.94
		701.5	23.36	23.06	21.49
		713.5	24.13	22.57	22.28
	1RB-Low (0)	707.5	24.33	23.43	21.84
		701.5	23.39	22.57	22.35
		713.5	23.77	22.74	21.32
	12RB-High (13)	707.5	23.91	22.87	21.90
		701.5	23.80	22.93	21.76
		713.5	23.71	22.98	21.63
	12RB-Middle (6)	707.5	23.43	22.43	21.70
		701.5	23.57	22.38	21.74
		713.5	23.66	22.72	21.84
	12RB-Low (0)	707.5	23.85	22.98	21.91
		701.5	23.50	22.88	21.33
		713.5	23.31	22.84	21.36
	25RB (0)	707.5	23.57	22.36	21.66
		701.5	23.81	22.88	21.71
711		24.16	23.34	22.29	
10MHz	1RB-High (49)	707.5	24.15	23.35	22.31
		704	24.16	23.41	22.29
		711	24.30	23.50	22.50
	1RB-Middle (24)	707.5	24.36	23.44	22.44
		704	24.28	23.45	22.43
		711	24.19	23.45	22.42
	1RB-Low (0)	707.5	24.23	23.39	22.38
		704	24.20	23.37	22.36
		711	23.22	22.25	21.23
	25RB-High (25)	707.5	23.30	22.35	21.31
		704	23.27	22.27	21.29
		711	23.30	22.31	21.27
	25RB-Middle (12)	707.5	23.31	22.30	21.31
		704	23.31	22.29	21.29
		711	23.35	22.38	21.34
	25RB-Low (0)	707.5	23.37	22.37	21.37
		704	23.34	22.31	21.35
		711	23.31	22.31	21.31
	50RB (0)	707.5	23.33	22.34	21.33
		704	23.33	22.32	21.30

LTE B12 DSI1/3

Band 12					
Bandwidth (MHz)	RB allocation	Frequency (MHz)	Actual output power (dBm)		
	RB offset		QPSK	16QAM	64QAM
1.4MHz	1RB-High	715.3	22.35	22.33	21.59
		707.5	22.34	22.44	21.31
		699.7	22.25	22.40	21.35
	1RB-Middle (3)	715.3	22.34	22.34	21.93
		707.5	22.34	22.54	21.97
		699.7	22.26	22.49	21.37
	1RB-Low (0)	715.3	22.23	22.53	21.69
		707.5	22.35	22.26	21.90
		699.7	22.23	22.45	21.55
	3RB-High (3)	715.3	22.25	22.32	22.33
		707.5	22.21	22.52	21.71
		699.7	22.34	22.43	21.78
	3RB-Middle (1)	715.3	22.20	22.44	21.28
		707.5	22.28	22.39	21.43
		699.7	22.24	22.51	22.10
	3RB-Low (0)	715.3	22.34	22.41	21.25
		707.5	22.22	22.31	22.16
		699.7	22.31	22.41	21.42
	6RB (0)	715.3	22.29	22.54	21.30
		707.5	22.35	22.50	21.45
		699.7	22.33	22.47	22.31
3MHz	1RB-High (14)	714.5	22.24	22.47	21.33
		707.5	22.31	22.41	22.37
		700.5	22.29	22.52	21.39
	1RB-Middle (7)	714.5	22.24	22.57	21.40
		707.5	22.25	22.27	22.09
		700.5	22.32	22.41	22.24
	1RB-Low (0)	714.5	22.35	22.32	22.16
		707.5	22.23	22.43	22.26
		700.5	22.26	22.42	21.51
	8RB-High (7)	714.5	22.22	22.27	21.77
		707.5	22.24	22.56	21.82
		700.5	22.32	22.56	21.89
	8RB-Middle (4)	714.5	22.32	22.27	21.66
		707.5	22.33	22.56	22.14
		700.5	22.33	22.31	21.72
	8RB-Low (0)	714.5	22.21	22.36	22.07
		707.5	22.25	22.56	21.55
		700.5	22.25	22.35	21.79
15RB (0)	714.5	22.21	22.49	22.38	

		707.5	22.20	22.53	21.49
		700.5	22.30	22.52	22.10
5MHz	1RB-High (24)	713.5	22.22	22.31	21.25
		707.5	22.35	22.40	21.99
		701.5	22.35	22.45	22.33
	1RB-Middle (12)	713.5	22.33	22.45	22.30
		707.5	22.27	22.46	21.39
		701.5	22.35	22.30	21.29
	1RB-Low (0)	713.5	22.22	22.32	22.44
		707.5	22.33	22.56	22.40
		701.5	22.26	22.37	21.56
	12RB-High (13)	713.5	22.31	22.44	21.99
		707.5	22.25	22.27	22.10
		701.5	22.21	22.53	21.46
	12RB-Middle (6)	713.5	22.32	22.55	21.48
		707.5	22.33	22.40	22.43
		701.5	22.25	22.36	22.05
	12RB-Low (0)	713.5	22.26	22.44	22.30
		707.5	22.20	22.44	21.93
		701.5	22.24	22.51	21.65
	25RB (0)	713.5	22.25	22.43	22.16
		707.5	22.27	22.34	21.36
		701.5	22.24	22.49	22.26
10MHz	1RB-High (49)	711	22.19	22.43	22.34
		707.5	22.19	22.41	22.38
		704	22.20	22.48	22.38
	1RB-Middle (24)	711	22.33	22.59	22.50
		707.5	22.35	22.57	22.41
		704	22.32	22.48	22.44
	1RB-Low (0)	711	22.26	22.47	22.38
		707.5	22.28	22.42	22.44
		704	22.25	22.55	22.40
	25RB-High (25)	711	22.24	22.25	21.22
		707.5	22.32	22.33	21.30
		704	22.28	22.30	21.31
	25RB-Middle (12)	711	22.31	22.31	21.28
		707.5	22.33	22.31	21.28
		704	22.30	22.32	21.31
	25RB-Low (0)	711	22.35	22.37	21.36
		707.5	22.37	22.38	21.35
		704	22.34	22.34	21.33
	50RB (0)	711	22.31	22.33	21.31
		707.5	22.34	22.35	21.34
		704	22.32	22.33	21.32

LTE B2 DSI0/1/3

Band 2					
Bandwidth (MHz)	RB allocation	Frequency (MHz)	Actual output power (dBm)		
	RB offset		QPSK	16QAM	64QAM
1.4MHz	1RB-High (5)	1909.3 (19193)	21.17	21.33	21.26
		1880 (18900)	21.15	21.40	21.24
		1850.7 (18607)	21.15	21.50	21.39
	1RB-Middle (3)	1909.3 (19193)	21.30	21.53	21.40
		1880 (18900)	21.28	21.65	21.49
		1850.7 (18607)	21.32	21.61	21.48
	1RB-Low (0)	1909.3 (19193)	21.18	21.42	21.41
		1880 (18900)	21.14	21.37	21.35
		1850.7 (18607)	21.15	21.36	21.35
	3RB-High (3)	1909.3 (19193)	21.31	21.27	21.33
		1880 (18900)	21.28	21.29	21.33
		1850.7 (18607)	21.26	21.31	21.33
	3RB-Middle (1)	1909.3 (19193)	21.36	21.29	21.41
		1880 (18900)	21.30	21.27	21.37
		1850.7 (18607)	21.38	21.32	21.38
	3RB-Low (0)	1909.3 (19193)	21.33	21.28	21.34
		1880 (18900)	21.25	21.25	21.36
		1850.7 (18607)	21.27	21.25	21.39
	6RB (0)	1909.3 (19193)	21.32	21.41	21.29
		1880 (18900)	21.25	21.30	21.22
		1850.7 (18607)	21.26	21.36	21.27
3MHz	1RB-High (14)	1908.5 (19185)	21.19	21.41	21.27
		1880 (18900)	21.18	21.45	21.32
		1851.5 (18615)	21.13	21.39	21.23
	1RB-Middle (7)	1908.5 (19185)	21.32	21.61	21.53
		1880 (18900)	21.32	21.69	21.47
		1851.5 (18615)	21.32	21.63	21.55
	1RB-Low (0)	1908.5 (19185)	21.21	21.53	21.40
		1880 (18900)	21.15	21.35	21.37
		1851.5 (18615)	21.16	21.45	21.32
	8RB-High (7)	1908.5 (19185)	21.23	21.25	21.27
		1880 (18900)	21.21	21.25	21.21
		1851.5 (18615)	21.17	21.21	21.18
	8RB-Middle (4)	1908.5 (19185)	21.29	21.31	21.30
		1880 (18900)	21.20	21.24	21.25
		1851.5 (18615)	21.21	21.23	21.23
	8RB-Low (0)	1908.5 (19185)	21.24	21.29	21.26
		1880 (18900)	21.18	21.23	21.19
		1851.5 (18615)	21.19	21.23	21.21
15RB (0)	1908.5 (19185)	21.25	21.23	21.19	
	1880 (18900)	21.19	21.22	21.18	
	1851.5 (18615)	21.16	21.14	21.13	

5MHz	1RB-High (24)	1907.5 (19175)	21.09	21.31	21.23
		1880 (18900)	21.09	21.34	21.18
		1852.5 (18625)	21.02	21.35	21.21
	1RB-Middle (12)	1907.5 (19175)	21.39	21.67	21.56
		1880 (18900)	21.33	21.63	21.40
		1852.5 (18625)	21.27	21.57	21.45
	1RB-Low (0)	1907.5 (19175)	21.13	21.41	21.29
		1880 (18900)	21.06	21.42	21.15
		1852.5 (18625)	21.08	21.28	21.27
	12RB-High (13)	1907.5 (19175)	21.27	21.22	21.23
		1880 (18900)	21.21	21.13	21.17
		1852.5 (18625)	21.14	21.12	21.13
	12RB-Middle (6)	1907.5 (19175)	21.30	21.28	21.29
		1880 (18900)	21.25	21.25	21.24
		1852.5 (18625)	21.21	21.19	21.21
	12RB-Low (0)	1907.5 (19175)	21.26	21.24	21.24
		1880 (18900)	21.19	21.17	21.18
		1852.5 (18625)	21.12	21.09	21.11
25RB (0)	1907.5 (19175)	21.28	21.27	21.23	
	1880 (18900)	21.21	21.20	21.18	
	1852.5 (18625)	21.13	21.13	21.12	
10MHz	1RB-High (49)	1905 (19150)	21.18	21.39	21.40
		1880 (18900)	21.19	21.47	21.33
		1855 (18650)	21.07	21.40	21.22
	1RB-Middle (24)	1905 (19150)	21.31	21.60	21.41
		1880 (18900)	21.28	21.50	21.45
		1855 (18650)	21.20	21.50	21.45
	1RB-Low (0)	1905 (19150)	21.23	21.52	21.42
		1880 (18900)	21.17	21.50	21.37
		1855 (18650)	21.14	21.50	21.30
	25RB-High (25)	1905 (19150)	21.30	21.28	21.26
		1880 (18900)	21.18	21.18	21.17
		1855 (18650)	21.13	21.13	21.13
	25RB-Middle (12)	1905 (19150)	21.31	21.33	21.30
		1880 (18900)	21.23	21.21	21.24
		1855 (18650)	21.20	21.20	21.18
	25RB-Low (0)	1905 (19150)	21.42	21.44	21.42
		1880 (18900)	21.22	21.18	21.19
		1855 (18650)	21.16	21.18	21.14
50RB (0)	1905 (19150)	21.37	21.35	21.32	
	1880 (18900)	21.21	21.19	21.19	
	1855 (18650)	21.12	21.14	21.11	
15MHz	1RB-High (74)	1902.5 (19125)	21.10	21.33	21.26
		1880 (18900)	21.14	21.50	21.29
		1857.5 (18675)	21.04	21.26	21.23
	1RB-Middle (37)	1902.5 (19125)	21.21	21.55	21.40
		1880 (18900)	21.18	21.40	21.30
		1857.5 (18675)	21.11	21.32	21.29

	1RB-Low (0)	1902.5 (19125)	21.18	21.50	21.37
		1880 (18900)	21.10	21.32	21.30
		1857.5 (18675)	21.08	21.44	21.21
	36RB-High (38)	1902.5 (19125)	21.30	21.26	21.26
		1880 (18900)	21.26	21.21	21.23
		1857.5 (18675)	21.13	21.08	21.09
	36RB-Middle (19)	1902.5 (19125)	21.34	21.30	21.30
		1880 (18900)	21.28	21.23	21.23
		1857.5 (18675)	21.19	21.14	21.16
	36RB-Low (0)	1902.5 (19125)	21.35	21.36	21.38
		1880 (18900)	21.22	21.19	21.20
		1857.5 (18675)	21.22	21.13	21.17
	75RB (0)	1902.5 (19125)	21.33	21.34	21.33
		1880 (18900)	21.26	21.23	21.22
		1857.5 (18675)	21.15	21.15	21.11
20MHz	1RB-High (99)	1900 (19100)	20.96	21.25	21.07
		1880 (18900)	21.03	21.18	21.18
		1860 (18700)	20.86	21.28	21.04
	1RB-Middle (50)	1900 (19100)	21.32	21.57	21.51
		1880 (18900)	21.25	21.55	21.44
		1860 (18700)	21.19	21.51	21.36
	1RB-Low (0)	1900 (19100)	21.06	21.36	21.19
		1880 (18900)	20.94	21.30	21.09
		1860 (18700)	20.96	21.18	21.10
	50RB-High (50)	1900 (19100)	21.20	21.23	21.21
		1880 (18900)	21.23	21.24	21.23
		1860 (18700)	21.12	21.13	21.11
	50RB-Middle (25)	1900 (19100)	21.30	21.32	21.28
		1880 (18900)	21.25	21.27	21.25
		1860 (18700)	21.17	21.17	21.17
	50RB-Low (0)	1900 (19100)	21.44	21.45	21.44
		1880 (18900)	21.20	21.21	21.20
		1860 (18700)	21.17	21.17	21.18
	100RB (0)	1900 (19100)	21.31	21.30	21.31
		1880 (18900)	21.23	21.23	21.24
		1860 (18700)	21.14	21.13	21.12

LTE B2 DS12

Band 2					
Bandwidth (MHz)	RB allocation	Frequency (MHz)	Actual output power (dBm)		
	RB offset		QPSK	16QAM	64QAM
1.4MHz	1RB-High (5)	1909.3 (19193)	20.13	20.39	20.28
		1880 (18900)	20.09	20.40	20.31
		1850.7 (18607)	20.09	20.33	20.31
	1RB-Middle (3)	1909.3 (19193)	20.26	20.58	20.39
		1880 (18900)	20.20	20.54	20.33
		1850.7 (18607)	20.23	20.52	20.41
	1RB-Low (0)	1909.3 (19193)	20.13	20.35	20.35
		1880 (18900)	20.10	20.38	20.30
		1850.7 (18607)	20.12	20.38	20.27
	3RB-High (3)	1909.3 (19193)	20.26	20.27	20.31
		1880 (18900)	20.22	20.25	20.33
		1850.7 (18607)	20.26	20.29	20.34
	3RB-Middle (1)	1909.3 (19193)	20.29	20.27	20.37
		1880 (18900)	20.25	20.21	20.35
		1850.7 (18607)	20.31	20.22	20.35
	3RB-Low (0)	1909.3 (19193)	20.25	20.27	20.31
		1880 (18900)	20.20	20.20	20.34
		1850.7 (18607)	20.23	20.27	20.30
	6RB (0)	1909.3 (19193)	20.22	20.34	20.25
		1880 (18900)	20.20	20.24	20.20
		1850.7 (18607)	20.23	20.32	20.23
3MHz	1RB-High (14)	1908.5 (19185)	20.10	20.37	20.33
		1880 (18900)	20.11	20.48	20.32
		1851.5 (18615)	20.07	20.27	20.28
	1RB-Middle (7)	1908.5 (19185)	20.33	20.67	20.47
		1880 (18900)	20.23	20.58	20.38
		1851.5 (18615)	20.30	20.66	20.44
	1RB-Low (0)	1908.5 (19185)	20.15	20.46	20.28
		1880 (18900)	20.06	20.46	20.31
		1851.5 (18615)	20.08	20.42	20.30
	8RB-High (7)	1908.5 (19185)	20.18	20.22	20.24
		1880 (18900)	20.13	20.21	20.18
		1851.5 (18615)	20.11	20.18	20.16
	8RB-Middle (4)	1908.5 (19185)	20.23	20.30	20.26
		1880 (18900)	20.17	20.25	20.21
		1851.5 (18615)	20.13	20.21	20.18
8RB-Low (0)	1908.5 (19185)	20.19	20.29	20.23	
	1880 (18900)	20.12	20.17	20.17	
	1851.5 (18615)	20.11	20.20	20.18	
15RB (0)	1908.5 (19185)	20.18	20.20	20.15	
	1880 (18900)	20.13	20.15	20.15	
	1851.5 (18615)	20.08	20.10	20.11	

5MHz	1RB-High (24)	1907.5 (19175)	20.04	20.29	20.23
		1880 (18900)	20.02	20.27	20.18
		1852.5 (18625)	19.95	20.19	20.18
	1RB-Middle (12)	1907.5 (19175)	20.37	20.67	20.58
		1880 (18900)	20.26	20.64	20.53
		1852.5 (18625)	20.26	20.41	20.46
	1RB-Low (0)	1907.5 (19175)	20.07	20.32	20.25
		1880 (18900)	20.01	20.34	20.21
		1852.5 (18625)	20.03	20.37	20.18
	12RB-High (13)	1907.5 (19175)	20.14	20.18	20.18
		1880 (18900)	20.12	20.15	20.13
		1852.5 (18625)	20.08	20.08	20.09
	12RB-Middle (6)	1907.5 (19175)	20.24	20.25	20.26
		1880 (18900)	20.24	20.21	20.21
		1852.5 (18625)	20.15	20.13	20.15
	12RB-Low (0)	1907.5 (19175)	20.21	20.20	20.22
		1880 (18900)	20.13	20.13	20.13
		1852.5 (18625)	20.07	20.05	20.07
25RB (0)	1907.5 (19175)	20.19	20.22	20.21	
	1880 (18900)	20.14	20.18	20.16	
	1852.5 (18625)	20.10	20.08	20.11	
10MHz	1RB-High (49)	1905 (19150)	20.18	20.38	20.35
		1880 (18900)	20.14	20.49	20.38
		1855 (18650)	20.01	20.28	20.24
	1RB-Middle (24)	1905 (19150)	20.28	20.56	20.47
		1880 (18900)	20.22	20.60	20.41
		1855 (18650)	20.15	20.49	20.35
	1RB-Low (0)	1905 (19150)	20.17	20.39	20.34
		1880 (18900)	20.11	20.43	20.30
		1855 (18650)	20.11	20.43	20.32
	25RB-High (25)	1905 (19150)	20.18	20.24	20.24
		1880 (18900)	20.09	20.12	20.12
		1855 (18650)	20.08	20.13	20.09
	25RB-Middle (12)	1905 (19150)	20.25	20.26	20.27
		1880 (18900)	20.16	20.18	20.16
		1855 (18650)	20.15	20.14	20.13
	25RB-Low (0)	1905 (19150)	20.35	20.39	20.39
		1880 (18900)	20.15	20.17	20.13
		1855 (18650)	20.10	20.12	20.11
50RB (0)	1905 (19150)	20.27	20.33	20.31	
	1880 (18900)	20.14	20.16	20.13	
	1855 (18650)	20.10	20.09	20.10	
15MHz	1RB-High (74)	1902.5 (19125)	20.05	20.25	20.19
		1880 (18900)	20.08	20.34	20.28
		1857.5 (18675)	20.00	20.31	20.15
	1RB-Middle (37)	1902.5 (19125)	20.17	20.53	20.31
		1880 (18900)	20.12	20.30	20.32
		1857.5 (18675)	20.07	20.35	20.24

	1RB-Low (0)	1902.5 (19125)	20.11	20.38	20.34
		1880 (18900)	20.04	20.34	20.17
		1857.5 (18675)	20.04	20.37	20.27
	36RB-High (38)	1902.5 (19125)	20.16	20.18	20.22
		1880 (18900)	20.18	20.17	20.16
		1857.5 (18675)	20.06	20.06	20.05
	36RB-Middle (19)	1902.5 (19125)	20.29	20.22	20.24
		1880 (18900)	20.21	20.21	20.23
		1857.5 (18675)	20.14	20.10	20.12
	36RB-Low (0)	1902.5 (19125)	20.31	20.27	20.32
		1880 (18900)	20.18	20.15	20.16
		1857.5 (18675)	20.11	20.12	20.11
	75RB (0)	1902.5 (19125)	20.27	20.23	20.25
		1880 (18900)	20.19	20.17	20.15
		1857.5 (18675)	20.08	20.08	20.09
20MHz	1RB-High (99)	1900 (19100)	19.91	20.13	20.06
		1880 (18900)	19.96	20.27	20.15
		1860 (18700)	19.81	20.20	19.98
	1RB-Middle (50)	1900 (19100)	20.29	20.60	20.38
		1880 (18900)	20.17	20.42	20.44
		1860 (18700)	20.17	20.42	20.38
	1RB-Low (0)	1900 (19100)	19.96	20.19	20.13
		1880 (18900)	19.90	20.21	20.12
		1860 (18700)	19.91	20.17	20.11
	50RB-High (50)	1900 (19100)	20.11	20.16	20.13
		1880 (18900)	20.18	20.21	20.17
		1860 (18700)	20.07	20.08	20.08
	50RB-Middle (25)	1900 (19100)	20.26	20.22	20.25
		1880 (18900)	20.20	20.22	20.22
		1860 (18700)	20.14	20.13	20.12
	50RB-Low (0)	1900 (19100)	20.38	20.40	20.37
		1880 (18900)	20.21	20.16	20.17
		1860 (18700)	20.15	20.13	20.14
	100RB (0)	1900 (19100)	20.21	20.22	20.21
		1880 (18900)	20.24	20.18	20.20
		1860 (18700)	20.08	20.07	20.09

LTE B5 DSI0/2

Band 5					
Bandwidth (MHz)	RB allocation	Frequency (MHz)	Actual output power (dBm)		
	RB offset		QPSK	16QAM	64QAM
1.4MHz	1RB-High	848.3 (20643)	24.46	23.68	22.59
		836.5 (20525)	24.14	23.28	22.19
		824.7 (20407)	24.31	23.48	22.54
	1RB-Middle (3)	848.3 (20643)	24.58	23.84	22.74
		836.5 (20525)	24.19	23.36	22.37
		824.7 (20407)	24.47	23.68	22.66
	1RB-Low (0)	848.3 (20643)	24.43	23.58	22.61
		836.5 (20525)	24.12	23.25	22.27
		824.7 (20407)	24.35	23.53	22.42
	3RB-High (3)	848.3 (20643)	24.57	23.42	22.57
		836.5 (20525)	24.25	23.15	22.22
		824.7 (20407)	24.47	23.30	22.53
	3RB-Middle (1)	848.3 (20643)	24.61	23.59	22.62
		836.5 (20525)	24.26	23.19	22.31
		824.7 (20407)	24.52	23.46	22.56
	3RB-Low (0)	848.3 (20643)	24.53	23.48	22.61
		836.5 (20525)	24.22	23.16	22.30
		824.7 (20407)	24.44	23.42	22.53
	6RB (0)	848.3 (20643)	23.60	22.65	21.59
		836.5 (20525)	23.27	22.29	21.22
		824.7 (20407)	23.47	22.53	21.49
3MHz	1RB-High (14)	847.5 (20635)	24.50	23.69	22.66
		836.5 (20525)	24.20	23.33	22.31
		825.5 (20415)	24.33	23.53	22.51
	1RB-Middle (7)	847.5 (20635)	24.59	23.92	22.84
		836.5 (20525)	24.36	23.43	22.39
		825.5 (20415)	24.58	23.79	22.65
	1RB-Low (0)	847.5 (20635)	24.45	23.62	22.59
		836.5 (20525)	24.21	23.33	22.36
		825.5 (20415)	24.42	23.56	22.50
	8RB-High (7)	847.5 (20635)	23.53	22.55	21.62
		836.5 (20525)	23.21	22.28	21.26
		825.5 (20415)	23.37	22.42	21.47
	8RB-Middle (4)	847.5 (20635)	23.56	22.59	21.61
		836.5 (20525)	23.25	22.29	21.32
		825.5 (20415)	23.40	22.46	21.48
	8RB-Low (0)	847.5 (20635)	23.52	22.57	21.59
		836.5 (20525)	23.22	22.27	21.30
		825.5 (20415)	23.41	22.44	21.50
15RB (0)	847.5 (20635)	23.53	22.52	21.55	
	836.5 (20525)	23.24	22.25	21.29	
	825.5 (20415)	23.43	22.46	21.46	

5MHz	1RB-High (24)	846.5 (20625)	24.41	23.62	22.60
		836.5 (20525)	24.10	23.30	22.20
		826.5 (20425)	24.22	23.45	22.42
	1RB-Middle (12)	846.5 (20625)	24.60	23.76	22.70
		836.5 (20525)	24.36	23.55	22.44
		826.5 (20425)	24.54	23.75	22.70
	1RB-Low (0)	846.5 (20625)	24.26	23.50	22.44
		836.5 (20525)	24.13	23.40	22.24
		826.5 (20425)	24.31	23.56	22.45
	12RB-High (13)	846.5 (20625)	23.56	22.53	21.56
		836.5 (20525)	23.21	22.18	21.27
		826.5 (20425)	23.32	22.35	21.39
	12RB-Middle (6)	846.5 (20625)	23.55	22.49	21.59
		836.5 (20525)	23.30	22.27	21.33
		826.5 (20425)	23.44	22.40	21.46
	12RB-Low (0)	846.5 (20625)	23.49	22.45	21.55
		836.5 (20525)	23.25	22.25	21.29
		826.5 (20425)	23.40	22.37	21.46
25RB (0)	846.5 (20625)	23.53	22.51	21.53	
	836.5 (20525)	23.25	22.26	21.27	
	826.5 (20425)	23.39	22.40	21.42	
10MHz	1RB-High (49)	844 (20600)	24.48	23.68	22.64
		836.5 (20525)	24.23	23.36	22.36
		829 (20450)	24.20	23.45	22.35
	1RB-Middle (24)	844 (20600)	24.52	23.56	22.56
		836.5 (20525)	24.29	23.38	22.44
		829 (20450)	24.39	23.60	22.54
	1RB-Low (0)	844 (20600)	24.24	23.42	22.33
		836.5 (20525)	24.25	23.43	22.33
		829 (20450)	24.38	23.59	22.55
	25RB-High (25)	844 (20600)	23.46	22.44	21.48
		836.5 (20525)	23.28	22.22	21.28
		829 (20450)	23.42	22.41	21.44
	25RB-Middle (12)	844 (20600)	23.49	22.42	21.46
		836.5 (20525)	23.28	22.24	21.30
		829 (20450)	23.38	22.38	21.39
	25RB-Low (0)	844 (20600)	23.46	22.45	21.49
		836.5 (20525)	23.34	22.34	21.36
		829 (20450)	23.43	22.42	21.45
50RB (0)	844 (20600)	23.50	22.47	21.49	
	836.5 (20525)	23.31	22.28	21.32	
	829 (20450)	23.42	22.41	21.43	

LTE B5 DS11/3

Band 5					
Bandwidth (MHz)	RB allocation	Frequency (MHz)	Actual output power (dBm)		
	RB offset		QPSK	16QAM	64QAM
1.4MHz	1RB-High	848.3 (20643)	22.49	22.72	22.63
		836.5 (20525)	22.14	22.42	22.32
		824.7 (20407)	22.34	22.60	22.47
	1RB-Middle (3)	848.3 (20643)	22.60	22.82	22.73
		836.5 (20525)	22.26	22.49	22.39
		824.7 (20407)	22.46	22.71	22.65
	1RB-Low (0)	848.3 (20643)	22.44	22.63	22.61
		836.5 (20525)	22.15	22.33	22.25
		824.7 (20407)	22.38	22.64	22.57
	3RB-High (3)	848.3 (20643)	22.59	22.51	22.67
		836.5 (20525)	22.29	22.23	22.27
		824.7 (20407)	22.48	22.41	22.55
	3RB-Middle (1)	848.3 (20643)	22.65	22.58	22.66
		836.5 (20525)	22.32	22.23	22.34
		824.7 (20407)	22.54	22.47	22.54
	3RB-Low (0)	848.3 (20643)	22.54	22.57	22.61
		836.5 (20525)	22.24	22.19	22.29
		824.7 (20407)	22.49	22.41	22.51
	6RB (0)	848.3 (20643)	22.61	22.65	21.64
		836.5 (20525)	22.26	22.26	21.27
		824.7 (20407)	22.47	22.52	21.46
3MHz	1RB-High (14)	847.5 (20635)	22.55	22.72	22.69
		836.5 (20525)	22.22	22.53	22.33
		825.5 (20415)	22.35	22.55	22.56
	1RB-Middle (7)	847.5 (20635)	22.66	22.91	22.82
		836.5 (20525)	22.33	22.57	22.40
		825.5 (20415)	22.55	22.77	22.70
	1RB-Low (0)	847.5 (20635)	22.48	22.67	22.62
		836.5 (20525)	22.21	22.56	22.32
		825.5 (20415)	22.44	22.71	22.49
	8RB-High (7)	847.5 (20635)	22.54	22.59	21.60
		836.5 (20525)	22.24	22.32	21.31
		825.5 (20415)	22.41	22.43	21.47
	8RB-Middle (4)	847.5 (20635)	22.57	22.62	21.62
		836.5 (20525)	22.31	22.33	21.37
		825.5 (20415)	22.43	22.50	21.50
	8RB-Low (0)	847.5 (20635)	22.52	22.57	21.59
		836.5 (20525)	22.25	22.29	21.32
		825.5 (20415)	22.44	22.50	21.51
	15RB (0)	847.5 (20635)	22.55	22.55	21.58
		836.5 (20525)	22.26	22.26	21.31
		825.5 (20415)	22.45	22.45	21.46

5MHz	1RB-High (24)	846.5 (20625)	22.46	22.66	22.58
		836.5 (20525)	22.12	22.31	22.27
		826.5 (20425)	22.21	22.58	22.32
	1RB-Middle (12)	846.5 (20625)	22.66	22.90	22.75
		836.5 (20525)	22.32	22.57	22.46
		826.5 (20425)	22.52	22.72	22.69
	1RB-Low (0)	846.5 (20625)	22.32	22.56	22.50
		836.5 (20525)	22.15	22.41	22.24
		826.5 (20425)	22.32	22.55	22.43
	12RB-High (13)	846.5 (20625)	22.57	22.55	21.59
		836.5 (20525)	22.26	22.21	21.28
		826.5 (20425)	22.35	22.36	21.44
	12RB-Middle (6)	846.5 (20625)	22.55	22.52	21.59
		836.5 (20525)	22.31	22.27	21.36
		826.5 (20425)	22.46	22.43	21.51
	12RB-Low (0)	846.5 (20625)	22.50	22.50	21.53
		836.5 (20525)	22.28	22.26	21.30
		826.5 (20425)	22.43	22.40	21.47
25RB (0)	846.5 (20625)	22.52	22.52	21.56	
	836.5 (20525)	22.29	22.26	21.30	
	826.5 (20425)	22.41	22.41	21.43	
10MHz	1RB-High (49)	844 (20600)	22.50	22.72	22.63
		836.5 (20525)	22.25	22.48	22.36
		829 (20450)	22.22	22.47	22.39
	1RB-Middle (24)	844 (20600)	22.53	22.62	22.56
		836.5 (20525)	22.27	22.52	22.39
		829 (20450)	22.43	22.73	22.57
	1RB-Low (0)	844 (20600)	22.27	22.54	22.40
		836.5 (20525)	22.30	22.61	22.36
		829 (20450)	22.44	22.62	22.60
	25RB-High (25)	844 (20600)	22.49	22.47	21.51
		836.5 (20525)	22.27	22.29	21.30
		829 (20450)	22.43	22.42	21.49
	25RB-Middle (12)	844 (20600)	22.51	22.48	21.47
		836.5 (20525)	22.29	22.28	21.31
		829 (20450)	22.39	22.39	21.44
	25RB-Low (0)	844 (20600)	22.48	22.44	21.52
		836.5 (20525)	22.35	22.33	21.37
		829 (20450)	22.45	22.44	21.47
50RB (0)	844 (20600)	22.50	22.48	21.52	
	836.5 (20525)	22.31	22.30	21.35	
	829 (20450)	22.44	22.43	21.46	

LTE B7 DSI0/1/2/3

Band 7					
Bandwidth (MHz)	RB allocation	Frequency (MHz)	Actual output power (dBm)		
	RB offset		QPSK	16QAM	64QAM
5MHz	1RB-High (24)	2567.5 (21425)	20.45	20.81	20.60
		2535 (21100)	20.50	20.80	20.68
		2502.5 (20775)	20.61	20.93	20.78
	1RB-Middle (12)	2567.5 (21425)	20.70	20.96	20.95
		2535 (21100)	20.89	20.90	20.98
		2502.5 (20775)	20.96	20.99	20.98
	1RB-Low (0)	2567.5 (21425)	20.39	20.63	20.55
		2535 (21100)	20.54	20.87	20.73
		2502.5 (20775)	20.68	20.93	20.88
	12RB-High (13)	2567.5 (21425)	20.56	20.57	20.55
		2535 (21100)	20.66	20.61	20.64
		2502.5 (20775)	20.76	20.74	20.76
	12RB-Middle (6)	2567.5 (21425)	20.64	20.61	20.63
		2535 (21100)	20.75	20.73	20.75
		2502.5 (20775)	20.89	20.86	20.89
	12RB-Low (0)	2567.5 (21425)	20.57	20.57	20.52
		2535 (21100)	20.70	20.70	20.67
		2502.5 (20775)	20.80	20.76	20.78
	25RB (0)	2567.5 (21425)	20.59	20.57	20.56
		2535 (21100)	20.68	20.67	20.67
		2502.5 (20775)	20.81	20.83	20.81
10MHz	1RB-High (49)	2565 (21400)	20.53	20.85	20.66
		2535 (21100)	20.55	20.90	20.67
		2505 (20800)	20.77	20.96	20.97
	1RB-Middle (24)	2565 (21400)	20.58	20.85	20.79
		2535 (21100)	20.73	20.99	20.92
		2505 (20800)	20.84	20.95	20.92
	1RB-Low (0)	2565 (21400)	20.48	20.82	20.66
		2535 (21100)	20.73	20.90	20.93
		2505 (20800)	20.83	20.94	20.99
	25RB-High (25)	2565 (21400)	20.54	20.58	20.55
		2535 (21100)	20.65	20.68	20.65
		2505 (20800)	20.81	20.83	20.84
	25RB-Middle (12)	2565 (21400)	20.61	20.58	20.60
		2535 (21100)	20.70	20.74	20.74
		2505 (20800)	20.82	20.83	20.84
25RB-Low (0)	2565 (21400)	20.56	20.57	20.56	
	2535 (21100)	20.75	20.79	20.78	
	2505 (20800)	20.85	20.85	20.83	
50RB (0)	2565 (21400)	20.54	20.57	20.56	
	2535 (21100)	20.72	20.73	20.73	
	2505 (20800)	20.83	20.83	20.84	

15MHz	1RB-High (74)	2562.5 (21375)	20.44	20.65	20.64
		2535 (21100)	20.43	20.79	20.63
		2507.5 (20825)	20.71	20.93	20.81
	1RB-Middle (37)	2562.5 (21375)	20.51	20.87	20.67
		2535 (21100)	20.67	20.90	20.86
		2507.5 (20825)	20.77	20.93	20.93
	1RB-Low (0)	2562.5 (21375)	20.40	20.74	20.60
		2535 (21100)	20.69	20.91	20.85
		2507.5 (20825)	20.73	20.94	20.96
	36RB-High (38)	2562.5 (21375)	20.55	20.53	20.56
		2535 (21100)	20.63	20.62	20.60
		2507.5 (20825)	20.85	20.81	20.82
	36RB-Middle (19)	2562.5 (21375)	20.55	20.52	20.55
		2535 (21100)	20.74	20.73	20.74
		2507.5 (20825)	20.83	20.80	20.82
	36RB-Low (0)	2562.5 (21375)	20.51	20.49	20.50
		2535 (21100)	20.78	20.76	20.77
		2507.5 (20825)	20.83	20.83	20.82
75RB (0)	2562.5 (21375)	20.50	20.52	20.49	
	2535 (21100)	20.69	20.67	20.67	
	2507.5 (20825)	20.82	20.81	20.80	
20MHz	1RB-High (99)	2560 (21350)	20.76	20.51	20.48
		2535 (21100)	20.31	20.56	20.44
		2510 (20850)	20.50	20.81	20.68
	1RB-Middle (50)	2560 (21350)	20.77	20.89	20.75
		2535 (21100)	20.73	20.91	20.88
		2510 (20850)	20.78	20.95	20.93
	1RB-Low (0)	2560 (21350)	20.34	20.55	20.35
		2535 (21100)	20.54	20.77	20.70
		2510 (20850)	20.61	20.88	20.72
	50RB-High (50)	2560 (21350)	20.47	20.52	20.51
		2535 (21100)	20.63	20.64	20.65
		2510 (20850)	20.84	20.84	20.84
	50RB-Middle (25)	2560 (21350)	20.55	20.58	20.57
		2535 (21100)	20.75	20.77	20.77
		2510 (20850)	20.85	20.83	20.83
	50RB-Low (0)	2560 (21350)	20.52	20.56	20.54
		2535 (21100)	20.72	20.85	20.83
		2510 (20850)	20.83	20.81	20.82
100RB (0)	2560 (21350)	20.50	20.53	20.53	
	2535 (21100)	20.72	20.72	20.70	
	2510 (20850)	20.84	20.81	20.83	

LTE B13 DSI0/2

Band 13					
Bandwidth (MHz)	RB allocation	Frequency (MHz)	Actual output power (dBm)		
	RB offset		QPSK	16QAM	64QAM
5MHz	1RB-High (24)	779.5 (23205)	24.51	23.59	22.41
		784.5 (23255)	24.26	23.24	22.26
		782 (23230)	24.23	23.33	22.16
	1RB-Middle (12)	779.5 (23205)	24.19	23.14	22.18
		784.5 (23255)	23.34	22.22	21.27
		782 (23230)	23.34	22.22	21.30
	1RB-Low (0)	779.5 (23205)	23.31	22.18	21.30
		784.5 (23255)	23.39	22.28	21.34
		782 (23230)	23.41	22.29	21.40
	12RB-High (13)	779.5 (23205)	23.39	22.26	21.34
		784.5 (23255)	23.37	22.25	21.31
		782 (23230)	23.39	22.28	21.35
	12RB-Middle (6)	779.5 (23205)	23.33	22.22	21.26
		784.5 (23255)	23.40	22.27	21.31
		782 (23230)	23.42	22.28	21.33
	12RB-Low (0)	779.5 (23205)	23.36	22.25	21.28
		782 (23230)	24.30	23.24	22.27
		782 (23230)	24.46	23.47	22.47
25RB (0)	782 (23230)	24.35	23.45	22.41	
	782 (23230)	23.45	22.34	21.38	
	782 (23230)	23.50	22.41	21.42	
10MHz	1RB-High (49)	782 (23230)	23.49	22.39	21.42
	1RB-Middle (24)	782 (23230)	23.50	22.37	21.46
	1RB-Low (0)	779.5 (23205)	24.51	23.59	22.41
	25RB-High (25)	784.5 (23255)	24.26	23.24	22.26
	25RB-Middle (12)	782 (23230)	24.23	23.33	22.16
	25RB-Low (0)	779.5 (23205)	24.19	23.14	22.18
	50RB (0)	784.5 (23255)	23.34	22.22	21.27

LTE B13 DSI1/3

Band 13					
Bandwidth (MHz)	RB allocation	Frequency (MHz)	Actual output power (dBm)		
	RB offset		QPSK	16QAM	64QAM
5MHz	1RB-High (24)	779.5 (23205)	22.41	22.59	22.40
		784.5 (23255)	22.17	22.38	22.22
		782 (23230)	22.17	22.35	22.20
	1RB-Middle (12)	779.5 (23205)	22.15	22.24	22.17
		784.5 (23255)	22.25	22.12	21.22
		782 (23230)	22.28	22.20	21.24
	1RB-Low (0)	779.5 (23205)	22.25	22.15	21.24
		784.5 (23255)	22.31	22.23	21.31
		782 (23230)	22.35	22.24	21.34
	12RB-High (13)	779.5 (23205)	22.34	22.20	21.30
		784.5 (23255)	22.30	22.21	21.26
		782 (23230)	22.33	22.23	21.28
	12RB-Middle (6)	779.5 (23205)	22.28	22.16	21.24
		784.5 (23255)	22.32	22.20	21.25
		782 (23230)	22.32	22.23	21.30
	12RB-Low (0)	779.5 (23205)	22.30	22.22	21.28
		782 (23230)	22.20	22.30	22.20
		782 (23230)	22.39	22.46	22.43
25RB (0)	782 (23230)	22.29	22.47	22.34	
	782 (23230)	22.36	22.25	21.33	
	782 (23230)	22.39	22.30	21.36	
10MHz	1RB-High (49)	782 (23230)	22.38	22.29	21.37
	1RB-Middle (24)	782 (23230)	22.40	22.30	21.39
	1RB-Low (0)	779.5 (23205)	22.41	22.59	22.40
	25RB-High (25)	784.5 (23255)	22.17	22.38	22.22
	25RB-Middle (12)	782 (23230)	22.17	22.35	22.20
	25RB-Low (0)	779.5 (23205)	22.15	22.24	22.17
	50RB (0)	784.5 (23255)	22.25	22.12	21.22

LTE B66 DSI0/1/3

Band 66						
Bandwidth (MHz)	RB allocation	Frequency (MHz)	Actual output power (dBm)			
	RB offset		QPSK	16QAM	64QAM	
1.4MHz	1RB-High	1779.3	20.87	21.13	21.05	
		1745	20.89	21.24	21.13	
		1710.7	20.89	21.18	21.08	
	1RB-Middle (3)	1779.3	21.02	21.31	21.13	
		1745	21.04	21.30	21.21	
		1710.7	21.02	21.19	21.16	
	1RB-Low (0)	1779.3	20.85	21.14	21.05	
		1745	20.91	21.18	21.09	
		1710.7	20.91	21.06	21.12	
	3RB-High (3)	1779.3	20.98	20.99	21.08	
		1745	20.99	20.93	21.08	
		1710.7	20.98	20.93	21.03	
	3RB-Middle (1)	1779.3	21.06	20.94	21.05	
		1745	21.08	21.04	21.17	
		1710.7	21.07	21.05	21.14	
	3RB-Low (0)	1779.3	20.99	20.88	21.03	
		1745	21.03	20.99	21.09	
		1710.7	21.03	20.92	21.09	
	6RB (0)	1779.3	21.01	21.05	20.99	
		1745	21.03	21.10	20.98	
		1710.7	21.03	21.11	21.00	
	3MHz	1RB-High (14)	1778.5	20.96	21.27	21.14
			1745	21.01	21.29	21.18
			1711.5	20.98	21.22	21.11
1RB-Middle (7)		1778.5	21.12	21.28	21.35	
		1745	21.17	21.45	21.27	
		1711.5	21.14	21.37	21.29	
1RB-Low (0)		1778.5	20.96	21.15	21.07	
		1745	20.98	21.32	21.09	
		1711.5	20.99	21.14	21.05	
8RB-High (7)		1778.5	20.99	20.99	21.01	
		1745	20.99	21.09	21.05	
		1711.5	21.01	21.03	21.02	
8RB-Middle (4)		1778.5	21.02	21.06	21.07	
		1745	21.05	21.10	21.06	
		1711.5	21.05	21.07	21.03	
8RB-Low (0)		1778.5	21.01	21.05	21.00	
		1745	21.02	21.06	21.02	
		1711.5	21.00	21.05	20.99	
15RB (0)		1778.5	20.99	21.00	20.99	

		1745	21.01	21.02	21.01
		1711.5	21.01	21.01	20.97
5MHz	1RB-High (24)	1777.5	20.84	21.15	21.01
		1745	20.85	21.19	21.06
		1712.5	20.88	21.19	21.04
	1RB-Middle (12)	1777.5	21.07	21.32	21.28
		1745	21.18	21.36	21.29
		1712.5	21.10	21.40	21.33
	1RB-Low (0)	1777.5	20.86	21.14	21.03
		1745	20.89	21.18	21.02
		1712.5	20.85	21.00	20.99
	12RB-High (13)	1777.5	20.94	20.94	20.94
		1745	21.01	21.00	21.03
		1712.5	21.02	20.99	21.03
	12RB-Middle (6)	1777.5	21.05	21.03	21.07
		1745	21.06	21.04	21.06
		1712.5	21.04	21.05	21.04
	12RB-Low (0)	1777.5	21.08	21.03	21.05
		1745	21.01	20.98	21.03
		1712.5	20.97	20.96	20.96
25RB (0)	1777.5	21.01	21.02	21.01	
	1745	21.00	21.04	21.03	
	1712.5	21.01	21.00	20.98	
10MHz	1RB-High (49)	1775	20.92	21.19	21.08
		1745	20.99	21.25	21.17
		1715	20.93	21.17	21.12
	1RB-Middle (24)	1775	21.09	21.44	21.24
		1745	21.08	21.43	21.27
		1715	21.12	21.36	21.29
	1RB-Low (0)	1775	20.99	21.28	21.14
		1745	20.96	21.20	21.14
		1715	20.95	21.20	21.14
	25RB-High (25)	1775	20.92	20.92	20.91
		1745	21.03	21.05	21.03
		1715	21.03	21.04	21.01
	25RB-Middle (12)	1775	21.08	21.06	21.04
		1745	21.09	21.07	21.07
		1715	21.08	21.07	21.02
	25RB-Low (0)	1775	21.10	21.10	21.08
		1745	21.05	21.05	21.05
		1715	20.98	20.95	20.91
50RB (0)	1775	21.04	21.02	21.00	
	1745	21.06	21.03	21.05	
	1715	21.00	21.01	20.98	
15MHz	1RB-High (74)	1772.5	20.90	21.15	21.07
		1745	20.94	21.23	21.03
		1717.5	20.92	21.23	21.08
	1RB-Middle	1772.5	21.05	21.25	21.15

	(37)	1745	21.05	21.29	21.16
		1717.5 (132047)	21.05	21.36	21.15
	1RB-Low (0)	1772.5	20.94	21.28	21.05
		1745	20.91	21.15	21.10
		1717.5 (132047)	20.93	21.19	21.07
	36RB-High (38)	1772.5	21.02	20.98	20.97
		1745	21.11	21.07	21.06
		1717.5	21.05	21.01	21.01
	36RB-Middle (19)	1772.5	21.12	21.09	21.11
		1745	21.13	21.07	21.09
		1717.5	21.09	21.06	21.05
	36RB-Low (0)	1772.5	21.13	21.06	21.10
		1745	21.08	21.05	21.05
		1717.5	21.03	21.00	20.98
	75RB (0)	1772.5	21.10	21.07	21.05
		1745	21.11	21.09	21.04
		1717.5	21.06	21.02	21.00
	20MHz	1RB-High (99)	1770	20.80	21.01
1745			20.86	21.10	21.00
1720			20.80	21.09	20.92
1RB-Middle (50)		1770	21.24	21.49	21.29
		1745	21.21	21.36	21.36
		1720	21.14	21.45	21.31
1RB-Low (0)		1770	20.84	21.06	21.00
		1745	20.86	21.06	21.02
		1720	20.84	21.14	20.92
50RB-High (50)		1770	21.05	21.02	21.00
		1745	21.18	21.16	21.14
		1720	21.12	21.09	21.06
50RB-Middle (25)		1770	21.18	21.14	21.12
		1745	21.18	21.17	21.15
		1720	21.14	21.12	21.08
50RB-Low (0)		1770	21.22	21.18	21.19
		1745	21.18	21.16	21.11
		1720	21.07	21.07	21.06
100RB (0)		1770	21.19	21.06	21.05
		1745	21.18	21.16	21.14
		1720	21.08	21.04	21.02

LTE B66 DS12

Band 66					
Bandwidth (MHz)	RB allocation	Frequency (MHz)	Actual output power (dBm)		
	RB offset		QPSK	16QAM	64QAM
1.4MHz	1RB-High	1779.3	20.10	19.63	20.20
		1745	19.95	19.40	19.97
		1710.7	19.74	19.70	20.18
	1RB-Middle (3)	1779.3	19.95	19.63	20.10
		1745	20.09	19.76	19.54
		1710.7	19.60	19.94	19.91
	1RB-Low (0)	1779.3	20.00	19.73	19.65
		1745	20.03	19.40	19.46
		1710.7	19.94	19.69	20.14
	3RB-High (3)	1779.3	19.59	20.17	20.14
		1745	20.07	20.34	19.63
		1710.7	20.02	19.87	19.91
	3RB-Middle (1)	1779.3	19.63	20.20	19.62
		1745	19.46	20.32	19.77
		1710.7	20.16	20.24	19.89
	3RB-Low (0)	1779.3	19.54	20.29	19.83
		1745	20.09	19.90	19.67
		1710.7	20.01	20.04	19.68
	6RB (0)	1779.3	20.05	20.08	20.00
		1745	20.00	19.88	19.82
		1710.7	19.46	19.81	19.53
3MHz	1RB-High (14)	1778.5	19.63	19.55	19.41
		1745	19.76	19.56	19.62
		1711.5	19.75	20.03	19.92
	1RB-Middle (7)	1778.5	19.49	20.11	19.67
		1745	20.04	20.36	20.01
		1711.5	19.40	19.77	19.95
	1RB-Low (0)	1778.5	19.65	19.46	19.41
		1745	20.08	20.04	20.01
		1711.5	19.78	19.87	19.62
	8RB-High (7)	1778.5	20.16	19.88	19.75
		1745	19.60	20.30	19.46
		1711.5	20.03	20.32	19.74
	8RB-Middle (4)	1778.5	19.87	20.10	20.00
		1745	20.07	20.14	19.45
		1711.5	19.62	20.13	20.06
8RB-Low (0)	1778.5	19.63	19.60	19.79	
	1745	19.76	20.40	20.01	
	1711.5	19.46	20.38	19.44	
15RB (0)	1778.5	19.89	19.48	19.55	

		1745	19.56	19.60	19.84
		1711.5	19.96	20.34	20.15
5MHz	1RB-High (24)	1777.5	19.95	19.81	20.09
		1745	19.80	20.30	19.61
		1712.5	19.85	20.30	19.55
	1RB-Middle (12)	1777.5	19.68	20.26	19.74
		1745	19.85	19.80	19.42
		1712.5	20.13	20.32	19.56
	1RB-Low (0)	1777.5	19.61	20.38	19.42
		1745	20.17	19.84	19.58
		1712.5	19.54	19.74	19.64
	12RB-High (13)	1777.5	19.69	20.22	19.72
		1745	20.08	19.66	19.46
		1712.5	19.53	19.46	19.72
	12RB-Middle (6)	1777.5	19.54	20.04	19.75
		1745	19.96	19.59	20.20
		1712.5	19.53	20.19	19.96
	12RB-Low (0)	1777.5	19.46	20.25	19.95
		1745	19.57	19.87	19.81
		1712.5	19.40	20.15	20.06
25RB (0)	1777.5	19.41	20.17	19.68	
	1745	19.46	20.24	20.04	
	1712.5	19.63	19.82	19.70	
10MHz	1RB-High (49)	1775	20.12	19.88	19.91
		1745	19.60	20.05	19.45
		1715	19.83	20.12	19.84
	1RB-Middle (24)	1775	19.53	19.52	20.14
		1745	19.76	19.48	19.96
		1715	20.03	20.21	20.15
	1RB-Low (0)	1775	19.78	19.46	20.12
		1745	20.19	19.92	19.80
		1715	19.99	20.15	19.73
	25RB-High (25)	1775	19.42	19.73	20.17
		1745	19.59	19.94	19.99
		1715	20.09	20.01	19.64
	25RB-Middle (12)	1775	19.64	19.48	19.65
		1745	19.55	19.78	19.64
		1715	20.16	20.03	19.58
	25RB-Low (0)	1775	19.43	19.69	19.95
		1745	19.97	19.48	19.96
		1715	20.08	19.89	19.92
50RB (0)	1775	19.94	20.09	20.07	
	1745	19.84	19.87	19.45	
	1715	19.49	19.75	19.67	
15MHz	1RB-High (74)	1772.5	20.02	19.82	19.56
		1745	20.19	19.87	20.16
		1717.5	19.78	19.67	19.81
	1RB-Middle	1772.5	19.91	19.56	20.09

	(37)	1745	19.92	19.74	19.79
		1717.5 (132047)	19.97	20.01	19.96
	1RB-Low (0)	1772.5	19.60	20.37	19.89
		1745	19.69	19.44	20.07
		1717.5 (132047)	20.10	19.44	19.85
	36RB-High (38)	1772.5	19.55	19.66	19.58
		1745	19.93	20.02	19.83
		1717.5	19.75	20.04	20.09
	36RB-Middle (19)	1772.5	20.00	19.58	20.13
		1745	20.25	19.56	19.76
		1717.5	19.67	20.21	19.62
	36RB-Low (0)	1772.5	19.43	20.22	19.75
		1745	19.80	19.80	20.18
		1717.5	19.55	20.14	19.63
	75RB (0)	1772.5	20.13	19.60	20.07
		1745	20.02	19.97	19.95
		1717.5	19.63	19.42	19.91
	20MHz	1RB-High (99)	1770	19.68	19.88
1745			19.75	19.96	19.85
1720			19.68	19.95	19.78
1RB-Middle (50)		1770	20.12	20.30	20.23
		1745	20.10	20.41	20.25
		1720	20.06	20.31	20.23
1RB-Low (0)		1770	19.70	19.94	19.94
		1745	19.73	19.93	19.92
		1720	19.71	19.88	19.84
50RB-High (50)		1770	19.91	19.91	19.88
		1745	20.08	20.05	20.06
		1720	20.00	20.00	19.99
50RB-Middle (25)		1770	20.06	20.04	20.03
		1745	20.08	20.07	20.06
		1720	20.04	20.00	20.02
50RB-Low (0)		1770	20.13	20.10	20.09
		1745	20.07	20.05	20.03
		1720	20.01	19.99	19.98
100RB (0)		1770	20.09	19.98	19.96
		1745	20.08	20.04	20.04
		1720	19.97	19.94	19.93

LTE B71 DSI0/2

Band 71						
Bandwidth (MHz)	RB allocation	Frequency (MHz)	Actual output power (dBm)			
	RB offset		QPSK	16QAM	64QAM	
5MHz	1RB-High	695.5	23.15	21.99	20.54	
		680.5	22.65	21.68	20.65	
		665.5	23.16	21.80	21.01	
	1RB-Middle (12)	695.5	23.16	21.92	20.86	
		680.5	23.29	22.53	20.65	
		665.5	22.85	21.95	21.23	
	1RB-Low (0)	695.5	23.08	21.99	21.46	
		680.5	23.12	22.00	20.83	
		665.5	23.10	21.92	20.96	
	12RB-High (13)	695.5	22.76	21.75	21.40	
		680.5	23.02	21.85	20.43	
		665.5	22.50	21.87	20.73	
	12RB-Middle (6)	695.5	22.86	22.11	20.92	
		680.5	23.07	21.19	21.45	
		665.5	22.46	22.00	21.47	
	12RB-Low (0)	695.5	22.31	21.68	20.27	
		680.5	22.78	21.59	20.64	
		665.5	22.80	21.05	20.75	
	25RB (0)	695.5	22.80	21.93	20.80	
		680.5	22.31	22.37	20.53	
		665.5	23.06	22.19	21.32	
	10MHz	1RB-High (49)	693	23.11	21.96	21.13
			680.5	23.24	22.36	21.08
			668	23.08	22.30	21.25
1RB-Middle (24)		693	23.28	21.76	21.11	
		680.5	22.84	22.57	21.44	
		668	22.58	22.01	21.28	
1RB-Low (0)		693	23.16	21.76	20.70	
		680.5	22.97	21.82	21.44	
		668	22.92	21.63	20.59	
25RB-High (25)		693	23.03	21.99	20.28	
		680.5	22.79	21.97	20.55	
		668	23.00	21.52	21.05	
25RB-Middle (12)		693	22.93	21.50	20.17	
		680.5	22.21	21.57	20.24	
		668	22.58	21.18	20.24	
25RB-Low (0)		693	22.27	21.73	20.82	
		680.5	22.30	22.50	20.40	
		668	22.74	22.20	20.71	
50RB (0)		693	22.53	21.39	20.49	

		680.5	23.31	21.57	21.29
		668	22.78	22.12	20.37
15MHz	1RB-High (74)	690.5	22.97	21.83	21.11
		680.5	22.92	21.64	20.55
		670.5	22.91	21.81	20.98
	1RB-Middle (37)	690.5	22.92	22.48	21.24
		680.5	22.93	22.06	21.25
		670.5	22.80	21.54	21.17
	1RB-Low (0)	690.5	23.22	21.82	21.18
		680.5	22.89	22.33	21.47
		670.5	23.26	21.84	20.62
	36RB-High (38)	690.5	22.46	21.52	21.05
		680.5	22.95	21.41	21.42
		670.5	23.21	21.53	20.76
	36RB-Middle (19)	690.5	22.22	22.29	21.36
		680.5	22.98	22.47	20.89
		670.5	22.24	22.23	20.87
	36RB-Low (0)	690.5	22.59	21.94	20.17
		680.5	22.59	22.37	20.42
		670.5	23.26	21.44	20.99
75RB (0)	690.5	23.18	21.35	20.33	
	680.5	22.58	21.51	20.79	
	670.5	23.11	21.43	21.06	
20MHz	1RB-High (99)	688	22.91	22.13	21.11
		683	22.88	22.15	21.07
		673	22.95	22.10	21.07
	1RB-Middle (50)	688	23.34	22.62	21.46
		683	23.32	22.60	21.37
		673	23.29	22.53	21.49
	1RB-Low (0)	688	22.96	22.23	21.06
		683	23.01	22.26	21.17
		673	23.03	22.23	21.20
	50RB-High (50)	688	22.60	21.60	20.60
		683	22.21	21.20	20.20
		673	22.68	21.67	20.72
	50RB-Middle (25)	688	22.34	21.32	20.30
		683	22.30	21.31	20.33
		673	22.35	21.35	20.39
	50RB-Low (0)	688	22.73	21.71	20.77
		683	22.05	21.03	20.05
		673	22.70	21.72	20.71
100RB (0)	688	22.68	21.65	20.63	
	683	22.10	21.09	20.11	
	673	22.64	21.62	20.71	

LTE B71 DSI1/3

Band 71						
Bandwidth (MHz)	RB allocation	Frequency (MHz)	Actual output power (dBm)			
	RB offset		QPSK	16QAM	64QAM	
5MHz	1RB-High	695.5	21.22	21.27	21.18	
		680.5	21.55	21.14	20.76	
		665.5	21.46	21.59	20.32	
	1RB-Middle (12)	695.5	21.20	21.46	21.14	
		680.5	21.50	21.22	21.37	
		665.5	21.30	21.24	20.86	
	1RB-Low (0)	695.5	21.17	21.15	21.37	
		680.5	21.25	21.62	21.52	
		665.5	21.46	21.35	21.12	
	12RB-High (13)	695.5	21.27	21.31	20.40	
		680.5	21.39	21.32	21.49	
		665.5	21.27	21.17	20.26	
	12RB-Middle (6)	695.5	21.65	21.48	21.34	
		680.5	21.31	21.25	21.16	
		665.5	21.49	21.47	20.51	
	12RB-Low (0)	695.5	21.61	21.11	20.94	
		680.5	21.18	21.61	20.78	
		665.5	21.60	21.63	21.38	
	25RB (0)	695.5	21.46	21.25	21.27	
		680.5	21.37	21.19	21.55	
		665.5	21.54	21.38	21.46	
	10MHz	1RB-High (49)	693	21.51	21.24	20.35
			680.5	21.40	21.31	20.73
			668	21.60	21.30	20.56
1RB-Middle (24)		693	21.63	21.40	20.99	
		680.5	21.28	21.59	21.08	
		668	21.15	21.49	20.60	
1RB-Low (0)		693	21.44	21.29	20.12	
		680.5	21.69	21.08	20.81	
		668	21.36	21.30	21.55	
25RB-High (25)		693	21.12	21.47	21.32	
		680.5	21.31	21.20	20.64	
		668	21.22	21.14	20.74	
25RB-Middle (12)		693	21.08	21.06	20.45	
		680.5	21.70	21.65	20.20	
		668	21.36	21.35	21.48	
25RB-Low (0)		693	21.62	21.55	21.49	
		680.5	21.51	21.63	21.30	
		668	21.04	21.62	21.50	
50RB (0)		693	21.36	21.29	20.73	

		680.5	21.33	21.09	20.33
		668	21.09	21.11	20.12
15MHz	1RB-High (74)	690.5	21.59	21.41	21.43
		680.5	21.49	21.38	20.68
		670.5	21.64	21.44	20.23
	1RB-Middle (37)	690.5	21.49	21.57	21.07
		680.5	21.53	21.18	21.34
		670.5	21.57	21.22	20.08
	1RB-Low (0)	690.5	21.12	21.12	21.00
		680.5	21.47	21.35	20.22
		670.5	21.06	21.23	20.65
	36RB-High (38)	690.5	21.45	21.09	20.92
		680.5	21.69	21.50	20.80
		670.5	21.12	21.10	20.82
	36RB-Middle (19)	690.5	21.65	21.35	20.19
		680.5	21.42	21.66	21.08
		670.5	21.31	21.16	20.32
	36RB-Low (0)	690.5	21.42	21.27	20.36
		680.5	21.33	21.06	21.30
		670.5	21.11	21.12	21.06
75RB (0)	690.5	21.23	21.55	20.74	
	680.5	21.59	21.47	21.55	
	670.5	21.30	21.54	20.97	
20MHz	1RB-High (99)	688	21.05	21.27	21.15
		683	21.09	21.23	21.15
		673	21.02	21.20	21.07
	1RB-Middle (50)	688	21.32	21.55	21.46
		683	21.31	21.60	21.56
		673	21.31	21.64	21.59
	1RB-Low (0)	688	21.00	21.27	21.14
		683	21.03	21.36	21.21
		673	21.03	21.37	21.19
	50RB-High (50)	688	21.63	21.65	20.61
		683	21.23	21.23	20.21
		673	21.69	21.68	20.74
	50RB-Middle (25)	688	21.34	21.35	20.34
		683	21.30	21.29	20.33
		673	21.35	21.34	20.41
	50RB-Low (0)	688	21.72	21.73	20.72
		683	21.05	21.04	20.05
		673	21.70	21.73	20.76
100RB (0)	688	21.69	21.64	20.63	
	683	21.08	21.09	20.13	
	673	21.68	21.65	20.71	

11.4 Wi-Fi and BT Measurement result

When the same transmission mode configurations have the same maximum output power on the same channel for the 802.11 a/n/ac/ax modes, the channel in the lower order/sequence 802.11 mode (i.e. a, n, ac then ax) is selected. Therefore the SAR measurements performed for the 802.11n/ac modes, as the lowest order modulation, cover 802.11ax modes.

When the specified maximum output power is the same for both UNII 1 and UNII 2A, begin SAR measurements in UNII 2A with the channel with the highest measured output power. If the reported SAR for UNII 2A is ≤ 1.2 W/kg, SAR is not required for UNII 1; otherwise treat the remaining bands separately and test them independently for SAR.

According to KDB 248227 D01, simultaneous SAR provisions in KDB 447498 D01 apply to determine simultaneous transmission SAR test exclusion for Wi-Fi MIMO. If the sum of 1-g single transmission chain SAR measurements is < 1.6 W/kg and/or the MIMO output power is equal or less than a single chain, then no additional SAR measurements for simultaneously at the specified maximum output power of MIMO operation.

When antennas are spatially separated to the extent that SAR distributions do not overlap and can be treated independently, SAR compliance for simultaneous transmission is determined separately for each individual antenna.

The average conducted power for Wi-Fi is as following:

FCC WIFI standalone		
802.11b	Channel\data rate	1Mbps
WLAN2450	11(2462MHz)	19.86
	6(2437(MHz)	20.25
	1(2412MHz)	20.18
Tune up		21.00
802.11g	Channel\data rate	6Mbps
WLAN2450	11(2462MHz)	17.70
	6(2437(MHz)	17.56
	1(2412MHz)	17.25
Tune up		19.00
802.11n-20MHz	Channel\data rate	MCS0
WLAN2450	11(2462MHz)	17.80
	6(2437(MHz)	18.00
	1(2412MHz)	17.87
Tune up		19.00
802.11n-40MHz	Channel\data rate	MCS0
WLAN2450	9(2452MHz)	16.01
	6(2437MHz)	15.92



	3(2422MHz)	15.62
Tune up		17.00

FCC WIFI +WWAN		
802.11b	Channel\data rate	1Mbps
WLAN2450	11(2462MHz)	16.55
	6(2437(MHz)	16.69
	1(2412MHz)	16.47
Tune up		18.00
802.11g	Channel\data rate	6Mbps
WLAN2450	11(2462MHz)	14.88
	6(2437(MHz)	15.04
	1(2412MHz)	14.88
Tune up		16.00
802.11n-20MHz	Channel\data rate	MCS0
WLAN2450	11(2462MHz)	13.68
	6(2437(MHz)	13.84
	1(2412MHz)	14.75
Tune up		15.00
802.11n-40MHz	Channel\data rate	MCS0
WLAN2450	9(2452MHz)	13.52
	6(2437MHz)	12.78
	3(2422MHz)	12.61
Tune up		14.00

The average conducted power for BT is as following:

BR/EDR									
	GFSK			EDR2M-4_DQPSK			EDR3M-8DPSK		
	Ch0	Ch 39	Ch 78	Ch 0	Ch 39	Ch 78	Ch 0	Ch 39	Ch 78
Maximum Transmit Power(<20dBm)	6.36	8.46	7.25	6.34	8.12	7.24	6.34	8.10	7.25
Tune up	7.5	8.5	8.0	7.5	8.5	8.0	7.5	8.5	8.0

12 Antenna Location

12.1 Transmit Antenna Separation Distances

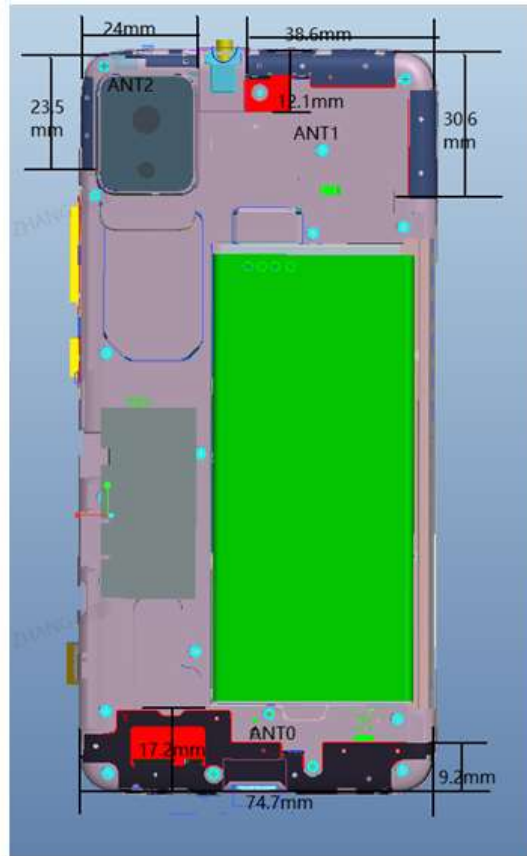

ANT0	TX/DRX	W5/B5/B12/B13/B17/B71	DRX
ANT1	TX/PRX	W5/B5/B12/B13/B17/B71	DRX
ANT2	GPS/2.4GWIFI/BT		

12.2 SAR Measurement Positions

According to the KDB941225 D06 Hot Spot SAR v01, the edges with less than 2.5 cm distance to the antennas need to be tested for SAR.

SAR measurement positions						
Mode	Front	Rear	Left edge	Right edge	Top edge	Bottom edge
Top MAIN ANT	Yes	Yes	Yes	Yes	Yes	No
Bottom MAIN ANT	Yes	Yes	Yes	Yes	No	Yes
WiFi/BT ANT	Yes	Yes	Yes	No	Yes	No

13 SAR Test Result

Note:

KDB 447498 D01 General RF Exposure Guidance:

For WWAN: Reported SAR(W/kg)= Measured SAR(W/kg)*Tune-up Scaling Factor

For BT/WLAN: Reported SAR(W/kg)= Measured SAR(W/kg)* Duty Cycle scaling factor * Tune-up scaling factor

Testing of other required channels within the operating mode of a frequency band is not required when the reported 1-g or 10-g SAR for the mid-band or highest output power channel is:

≤ 0.8 W/kg or 2.0 W/kg, for 1-g or 10-g respectively, when the transmission band is ≤ 100 MHz

≤ 0.6 W/kg or 1.5 W/kg, for 1-g or 10-g respectively, when the transmission band is between 100 MHz and 200 MHz

≤ 0.4 W/kg or 1.0 W/kg, for 1-g or 10-g respectively, when the transmission band is ≥ 200 MHz

KDB 648474 D04 Handset SAR:

With headset attached, when the reported SAR for body-worn accessory, measured without a headset connected to the handset, is > 1.2 W/kg, the highest reported SAR configuration for that wireless mode and frequency band should be repeated for that body-worn accessory with a headset attached to the handset.

KDB 941225 D01 SAR test for 3G devices:

When the maximum output power and tune-up tolerance specified for production units in a secondary mode is $\leq \frac{1}{4}$ dB higher than the primary mode or when the highest reported SAR of the primary mode is scaled by the ratio of specified maximum output power and tune-up tolerance of secondary to primary mode and the adjusted SAR is ≤ 1.2 W/kg, SAR measurement is not required for the secondary mode.

KDB 941225 D05 SAR for LTE Devices:

SAR test reduction is applied using the following criteria:

Start with the largest channel bandwidth and measure SAR for QPSK with 1 RB, and 50% RB allocation, using the RB offset and required test channel combination with the highest maximum output power among RB offsets at the upper edge, middle and lower edge of each required test channel.

When the reported SAR is > 0.8 W/kg, testing for other Channels is performed at the highest output power level for 1RB, and 50% RB configuration for that channel.

Testing for 100% RB configuration is performed at the highest output power level for 100% RB configuration across the Low, Mid and High Channel when the highest reported SAR for 1 RB and 50% RB are > 0.8 W/kg. Testing for the remaining required channels is not needed because the reported SAR for 100% RB Allocation < 1.45 W/kg.

Testing for 16-QAM modulation is not required because the reported SAR for QPSK is < 1.45 W/Kg and its output power is not more than 0.5 dB higher than that of QPSK.

Testing for the other channel bandwidths is not required because the reported SAR for the highest channel bandwidth is < 1.45 W/Kg and its output power is not more than 0.5 dB higher than that of the highest channel bandwidth.

For LTE bands that do not support at least three non-overlapping channels in certain channel bandwidths, test the available non-overlapping channels instead. When a device supports overlapping channel assignment in a channel bandwidth configuration, the middle channel of the

group of overlapping channels should be selected for testing; therefore, the requirement for H, M and L channels may not fully apply.

KDB 248227 D01 SAR meas for 802.11:

SAR test reduction for 802.11 Wi-Fi transmission mode configurations are considered separately for DSSS and OFDM. An initial test position is determined to reduce the number of tests required for certain exposure configurations with multiple test positions. An initial test configuration is determined for each frequency band and aggregated band according to maximum output power, channel bandwidth, wireless mode configurations and other operating parameters to streamline the measurement requirements. For 2.4 GHz DSSS, either the initial test position or DSSS procedure is applied to reduce the number of SAR tests; these are mutually exclusive. For OFDM, an initial test position is only applicable to next to the ear, UMPC mini-tablet and hotspot mode configurations, which is tested using the initial test configuration to facilitate test reduction. For other exposure conditions with a fixed test position, SAR test reduction is determined using only the initial test configuration.

To determine the initial test position, Area Scans were performed to determine the position with the Maximum Value of SAR (measured). The position that produced the highest Maximum Value of SAR is considered the worst case position; thus used as the initial test position.

The multiple test positions require SAR measurements in head, hotspot mode or UMPC mini-tablet configurations may be reduced according to the highest reported SAR determined using the initial test position(s) by applying the DSSS or OFDM SAR measurement procedures in the required wireless mode test configuration(s). The initial test position(s) is measured using the highest measured maximum output power channel in the required wireless mode test configuration(s).

When the reported SAR for the initial test position is:

≤ 0.4 W/kg, further SAR measurement is not required for the other test positions in that exposure configuration and wireless mode combination within the frequency band or aggregated band. DSSS and OFDM configurations are considered separately according to the required SAR procedures.
> 0.4 W/kg, SAR is repeated using the same wireless mode test configuration tested in the initial test position to measure the subsequent next closet/smallest test separation distance and maximum coupling test position, on the highest maximum output power channel, until the reported SAR is ≤ 0.8 W/kg or all required test positions are tested.

- For subsequent test positions with equivalent test separation distance or when exposure is dominated by coupling conditions, the position for maximum coupling condition should be tested.
- When it is unclear, all equivalent conditions must be tested.

For all positions/configurations tested using the initial test position and subsequent test positions, when the reported SAR is > 0.8 W/kg, measure the SAR for these positions/configurations on the subsequent next highest measured output power channel(s) until the reported SAR is ≤ 1.2 W/kg or all required test channels are considered.

- The additional power measurements required for this step should be limited to those necessary for identifying subsequent highest output power channels to apply the test reduction.

When the specified maximum output power is the same for both UNII 1 and UNII 2A, begin SAR measurements in UNII 2A with the channel with the highest measured output power. If the reported SAR for UNII 2A is ≤ 1.2 W/kg, SAR is not required for UNII 1; otherwise treat the remaining bands separately and test them independently for SAR.

When the specified maximum output power is different between UNII 1 and UNII 2A, begin SAR



No. I23Z61303-SEM01

with the band that has the higher specified maximum output. If the highest reported SAR for the band with the highest specified power is ≤ 1.2 W/kg, testing for the band with the lower specified output power is not required; otherwise test the remaining bands independently for SAR.

Duty Cycle

Mode	Duty Cycle
Speech for GSM	1:8.3
GPRS&EGPRS 1 Slot	1:8.3
GPRS&EGPRS 2 Slot	1:4
GPRS&EGPRS 3 Slot	1:2.67
GPRS&EGPRS 4 Slot	1:2
WCDMA<E FDD	1:1
LTE TDD PC3	1:1.58
LTE TDD PC2	1:2.309

Ambient Temperature: 21.5-23.5 °C Liquid Temperature: 21.5-23.5 °C



13.1 SAR results for Cellular

Head

RF Exposure Conditions	Frequency Band	Channel Number	Frequency (MHz)	Mode/RB	Test Position	Distance	Figure No./Note	EUT Measured Power (dBm)	Tune up (dBm)	Measured SAR 1g (W/kg)	Reported SAR 1g (W/kg)	Measured SAR 10g (W/kg)	Reported SAR 10g (W/kg)	Power Drift
Head	GSM850	251	848.8	VOIP(3TX)	Cheek Left	0mm	A.1	27.62	28.5	0.084	0.10	0.065	0.08	0.14
Head	GSM850	190	836.6	VOIP(3TX)	Cheek Left	0mm	\	27.63	28.5	0.078	0.10	0.065	0.08	0.15
Head	GSM850	128	824.2	VOIP(3TX)	Cheek Left	0mm	\	27.26	28.5	0.062	0.08	0.047	0.06	-0.16
Head	GSM850	190	836.6	VOIP(3TX)	Tilt Left	0mm	\	27.63	28.5	<0.01	<0.01	<0.01	<0.01	\
Head	GSM850	190	836.6	VOIP(3TX)	Cheek Right	0mm	\	27.63	28.5	0.072	0.09	0.055	0.07	-0.12
Head	GSM850	190	836.6	VOIP(3TX)	Tilt Right	0mm	\	27.63	28.5	<0.01	<0.01	<0.01	<0.01	\
Head	GSM1900	810	1909.8	VOIP(3TX)	Cheek Left	0mm	\	22.76	23.5	0.107	0.13	0.067	0.08	0.08
Head	GSM1900	661	1880	VOIP(3TX)	Cheek Left	0mm	\	22.62	23.5	0.111	0.14	0.069	0.08	-0.18
Head	GSM1900	512	1850.2	VOIP(3TX)	Cheek Left	0mm	A.2	22.59	23.5	0.134	0.17	0.083	0.10	0.09
Head	GSM1900	661	1880	VOIP(3TX)	Tilt Left	0mm	\	22.62	23.5	0.046	0.06	0.031	0.04	0.11
Head	GSM1900	661	1880	VOIP(3TX)	Cheek Right	0mm	\	22.62	23.5	0.071	0.09	0.046	0.06	0.03
Head	GSM1900	661	1880	VOIP(3TX)	Tilt Right	0mm	\	22.62	23.5	0.048	0.06	0.033	0.04	0.08
Head	WCDMA1900	9538	1907.6	RMC	Cheek Left	0mm	\	21.47	21.5	0.278	0.28	0.174	0.18	-0.07
Head	WCDMA1900	9400	1880	RMC	Cheek Left	0mm	\	21.48	21.5	0.305	0.31	0.191	0.19	-0.02
Head	WCDMA1900	9262	1852.4	RMC	Cheek Left	0mm	A.3	21.45	21.5	0.330	0.33	0.207	0.21	0.08
Head	WCDMA1900	9400	1880	RMC	Tilt Left	0mm	\	21.48	21.5	0.121	0.12	0.081	0.08	-0.15
Head	WCDMA1900	9400	1880	RMC	Cheek Right	0mm	\	21.48	21.5	0.081	0.08	0.053	0.05	-0.14
Head	WCDMA1900	9400	1880	RMC	Tilt Right	0mm	\	21.48	21.5	0.113	0.11	0.076	0.08	0.10
Head	WCDMA1700	1513	1752.6	RMC	Cheek Left	0mm	A.4	20.96	21.5	0.355	0.40	0.224	0.25	0.07
Head	WCDMA1700	1412	1732.6	RMC	Cheek Left	0mm	\	20.91	21.5	0.337	0.39	0.223	0.26	0.09
Head	WCDMA1700	1312	1712.4	RMC	Cheek Left	0mm	\	20.79	21.5	0.322	0.38	0.204	0.24	-0.02
Head	WCDMA1700	1412	1732.6	RMC	Tilt Left	0mm	\	20.91	21.5	0.127	0.15	0.086	0.10	-0.04
Head	WCDMA1700	1412	1732.6	RMC	Cheek Right	0mm	\	20.91	21.5	0.197	0.23	0.131	0.15	-0.08
Head	WCDMA1700	1412	1732.6	RMC	Tilt Right	0mm	\	20.91	21.5	0.127	0.15	0.086	0.10	0.03
Head	WCDMA 850	4183	836.6	RMC	Cheek Left	0mm	\	20.94	22.5	0.284	0.41	0.160	0.23	-0.11
Head	WCDMA 850	4183	836.6	RMC	Tilt Left	0mm	\	20.94	22.5	0.317	0.45	0.176	0.25	0.05
Head	WCDMA 850	4183	836.6	RMC	Cheek Right	0mm	\	20.94	22.5	0.345	0.49	0.190	0.27	0.14
Head	WCDMA 850	4233	846.6	RMC	Tilt Right	0mm	\	21.08	22.5	0.415	0.58	0.215	0.30	0.20
Head	WCDMA 850	4183	836.6	RMC	Tilt Right	0mm	\	20.94	22.5	0.426	0.61	0.223	0.32	0.13
Head	WCDMA 850	4132	826.4	RMC	Tilt Right	0mm	A.5	20.95	22.5	0.461	0.66	0.239	0.34	-0.01
Head	LTE Band12	23095	707.5	1RB-Mid	Cheek Left	0mm	\	22.35	23	0.366	0.43	0.225	0.26	-0.03
Head	LTE Band12	23095	707.5	1RB-Mid	Tilt Left	0mm	\	22.35	23	0.372	0.43	0.215	0.25	-0.03
Head	LTE Band12	23095	707.5	1RB-Mid	Cheek Right	0mm	\	22.35	23	0.533	0.62	0.312	0.36	0.14
Head	LTE Band12	23095	707.5	1RB-Mid	Tilt Right	0mm	A.6	22.35	23	0.580	0.67	0.303	0.35	0.00
Head	LTE Band12	23095	707.5	25RB-Low	Cheek Left	0mm	\	22.37	23	0.369	0.43	0.226	0.26	0.09
Head	LTE Band12	23095	707.5	25RB-Low	Tilt Left	0mm	\	22.37	23	0.373	0.43	0.215	0.25	0.20
Head	LTE Band12	23095	707.5	25RB-Low	Cheek Right	0mm	\	22.37	23	0.529	0.61	0.311	0.36	-0.17
Head	LTE Band12	23095	707.5	25RB-Low	Tilt Right	0mm	\	22.37	23	0.577	0.67	0.301	0.35	0.14
Head	LTE Band2	19100	1900	1RB-Mid	Cheek Left	0mm	A.7	21.32	22	0.357	0.42	0.231	0.27	0.09
Head	LTE Band2	19100	1900	1RB-Mid	Tilt Left	0mm	\	21.32	22	0.243	0.28	0.160	0.19	-0.05
Head	LTE Band2	19100	1900	1RB-Mid	Cheek Right	0mm	\	21.32	22	0.331	0.39	0.217	0.25	-0.06
Head	LTE Band2	19100	1900	1RB-Mid	Tilt Right	0mm	\	21.32	22	0.270	0.32	0.172	0.20	-0.10
Head	LTE Band2	19100	1900	50RB-Low	Cheek Left	0mm	\	21.44	22	0.280	0.32	0.179	0.20	0.11
Head	LTE Band2	19100	1900	50RB-Low	Tilt Left	0mm	\	21.44	22	0.186	0.21	0.123	0.14	0.03
Head	LTE Band2	19100	1900	50RB-Low	Cheek Right	0mm	\	21.44	22	0.256	0.29	0.168	0.19	-0.06
Head	LTE Band2	19100	1900	50RB-Low	Tilt Right	0mm	\	21.44	22	0.211	0.24	0.134	0.15	0.19
Head	LTE Band5	20600	844	1RB-Mid	Cheek Left	0mm	\	22.53	23	0.378	0.42	0.205	0.23	0.16
Head	LTE Band5	20600	844	1RB-Mid	Tilt Left	0mm	\	22.53	23	0.402	0.45	0.216	0.24	-0.17
Head	LTE Band5	20600	844	1RB-Mid	Cheek Right	0mm	\	22.53	23	0.482	0.54	0.259	0.29	0.03
Head	LTE Band5	20600	844	1RB-Mid	Tilt Right	0mm	A.8	22.53	23	0.599	0.67	0.303	0.34	0.07
Head	LTE Band5	20600	844	25RB-Mid	Cheek Left	0mm	\	22.51	23	0.370	0.41	0.201	0.23	-0.14
Head	LTE Band5	20600	844	25RB-Mid	Tilt Left	0mm	\	22.51	23	0.400	0.45	0.215	0.24	-0.18
Head	LTE Band5	20600	844	25RB-Mid	Cheek Right	0mm	\	22.51	23	0.459	0.51	0.247	0.28	0.01
Head	LTE Band5	20600	844	25RB-Mid	Tilt Right	0mm	\	22.51	23	0.584	0.65	0.295	0.33	-0.01
Head	LTE Band7	20850	2510	1RB-Mid	Cheek Left	0mm	A.9	20.78	21	0.223	0.23	0.117	0.12	0.08
Head	LTE Band7	20850	2510	1RB-Mid	Tilt Left	0mm	\	20.78	21	0.089	0.09	0.047	0.05	0.04
Head	LTE Band7	20850	2510	1RB-Mid	Cheek Right	0mm	\	20.78	21	0.102	0.11	0.059	0.06	0.03
Head	LTE Band7	20850	2510	1RB-Mid	Tilt Right	0mm	\	20.78	21	0.136	0.14	0.070	0.07	0.04
Head	LTE Band7	20850	2510	50RB-Mid	Cheek Left	0mm	\	20.85	21	0.175	0.18	0.092	0.10	0.15
Head	LTE Band7	20850	2510	50RB-Mid	Tilt Left	0mm	\	20.85	21	0.065	0.07	0.034	0.04	-0.07
Head	LTE Band7	20850	2510	50RB-Mid	Cheek Right	0mm	\	20.85	21	0.082	0.08	0.048	0.05	0.14
Head	LTE Band7	20850	2510	50RB-Mid	Tilt Right	0mm	\	20.85	21	0.103	0.11	0.053	0.05	0.10
Head	LTE Band13	23230	782	1RB-Mid	Cheek Left	0mm	\	22.39	23	0.496	0.57	0.290	0.33	0.15
Head	LTE Band13	23230	782	1RB-Mid	Tilt Left	0mm	\	22.39	23	0.478	0.55	0.275	0.32	0.16
Head	LTE Band13	23230	782	1RB-Mid	Cheek Right	0mm	\	22.39	23	0.627	0.72	0.351	0.40	0.17
Head	LTE Band13	23230	782	1RB-Mid	Tilt Right	0mm	A.10	22.39	23	0.643	0.74	0.329	0.38	-0.01
Head	LTE Band13	23230	782	25RB-Mid	Cheek Left	0mm	\	22.39	23	0.473	0.54	0.275	0.32	-0.12
Head	LTE Band13	23230	782	25RB-Mid	Tilt Left	0mm	\	22.39	23	0.463	0.53	0.267	0.31	0.15
Head	LTE Band13	23230	782	25RB-Mid	Cheek Right	0mm	\	22.39	23	0.631	0.73	0.350	0.40	-0.08
Head	LTE Band13	23230	782	25RB-Mid	Tilt Right	0mm	\	22.39	23	0.624	0.72	0.319	0.37	0.00
Head	LTE Band66	132572	1770	1RB-Mid	Cheek Left	0mm	A.11	21.24	22	0.554	0.66	0.350	0.42	0.06
Head	LTE Band66	132572	1770	1RB-Mid	Tilt Left	0mm	\	21.24	22	0.208	0.25	0.140	0.17	-0.08
Head	LTE Band66	132572	1770	1RB-Mid	Cheek Right	0mm	\	21.24	22	0.272	0.32	0.181	0.22	0.19
Head	LTE Band66	132572	1770	1RB-Mid	Tilt Right	0mm	\	21.24	22	0.193	0.23	0.129	0.15	0.07
Head	LTE Band66	132572	1770	50RB-Low	Cheek Left	0mm	\	21.22	22	0.422	0.51	0.267	0.32	-0.14
Head	LTE Band66	132572	1770	50RB-Low	Tilt Left	0mm	\	21.22	22	0.159	0.19	0.108	0.13	0.07
Head	LTE Band66	132572	1770	50RB-Low	Cheek Right	0mm	\	21.22	22	0.209	0.25	0.139	0.17	0.17
Head	LTE Band66	132572	1770	50RB-Low	Tilt Right	0mm	\	21.22	22	0.149	0.18	0.101	0.12	0.19
Head	LTE Band71	133372	688	1RB-Mid	Cheek Left	0mm	\	21.32	23	0.198	0.29	0.121	0.18	0.01
Head	LTE Band71	133372	688	1RB-Mid	Tilt Left	0mm	\	21.32	23	0.196	0.29	0.112	0.16	0.16
Head	LTE Band71	133372	688	1RB-Mid	Cheek Right	0mm	A.12	21.32	23	0.313	0.46	0.177	0.26	-0.13
Head	LTE Band71	133372	688	1RB-Mid	Tilt Right	0mm	\	21.32	23	0.311	0.46	0.155	0.23	-0.12
Head	LTE Band71	133372	688	50RB-Low	Cheek Left	0mm	\	21.72	23	0.210	0.28	0.126	0.17	-0.13
Head	LTE Band71	133372	688	50RB-Low	Tilt Left	0mm	\	21.72	23	0.191	0.26	0.110	0.15	-0.05
Head	LTE Band71	133372	688	50RB-Low	Cheek Right	0mm	\	21.72	23	0.302	0.41	0.172	0.23	-0.11
Head	LTE Band71	133372	688	50RB-Low	Tilt Right	0mm	\	21.72	23	0.308	0.41	0.153	0.21	0.20



No. I23Z61303-SEM01

Body

RF Exposure Conditions	Frequency Band	Channel Number	Frequency (MHz)	Mode/RB	Test Position	Distance	Figure No./Note	EUT Measured Power (dBm)	Tune up (dBm)	Measured SAR 1g (W/kg)	Reported SAR 1g (W/kg)	Measured SAR 10g (W/kg)	Reported SAR 10g (W/kg)	Power Drift
Hotspot	GSM850	190	836.6	GPRS(3TX)	Front	10mm	\	27.63	28.5	0.051	0.06	0.040	0.05	0.07
Hotspot	GSM850	251	848.8	GPRS(3TX)	Rear	10mm	A.13	27.62	28.5	0.131	0.16	0.100	0.12	-0.13
Hotspot	GSM850	190	836.6	GPRS(3TX)	Rear	10mm	\	27.63	28.5	0.105	0.13	0.083	0.10	0.10
Hotspot	GSM850	128	824.2	GPRS(3TX)	Rear	10mm	\	27.26	28.5	0.107	0.14	0.085	0.11	-0.11
Hotspot	GSM850	190	836.6	GPRS(3TX)	Left	10mm	\	27.63	28.5	0.056	0.07	0.041	0.05	0.12
Hotspot	GSM850	190	836.6	GPRS(3TX)	Right	10mm	\	27.63	28.5	0.072	0.09	0.052	0.06	-0.04
Hotspot	GSM850	190	836.6	GPRS(3TX)	Bottom	10mm	\	27.63	28.5	<0.01	<0.01	<0.01	<0.01	\
Hotspot	GSM850	251	848.8	EGPRS(3TX)	Rear	10mm	\	26.82	28.5	0.098	0.14	0.075	0.11	-0.18
Hotspot	GSM1900	661	1880	GPRS(3TX)	Front	10mm	\	21.59	23.5	0.062	0.10	0.034	0.05	-0.17
Hotspot	GSM1900	810	1909.8	GPRS(3TX)	Rear	10mm	A.14	21.73	23.5	0.113	0.17	0.062	0.09	0.12
Hotspot	GSM1900	661	1880	GPRS(3TX)	Rear	10mm	\	21.59	23.5	0.102	0.16	0.055	0.09	0.09
Hotspot	GSM1900	512	1850.2	GPRS(3TX)	Rear	10mm	\	21.51	23.5	0.101	0.16	0.059	0.09	-0.04
Hotspot	GSM1900	661	1880	GPRS(3TX)	Left	10mm	\	21.59	23.5	0.043	0.07	0.024	0.04	0.18
Hotspot	GSM1900	661	1880	GPRS(3TX)	Right	10mm	\	21.59	23.5	<0.01	<0.01	<0.01	<0.01	\
Hotspot	GSM1900	661	1880	GPRS(3TX)	Bottom	10mm	\	21.59	23.5	0.069	0.11	0.035	0.05	-0.06
Hotspot	GSM1900	810	1909.8	EGPRS(3TX)	Rear	10mm	\	21.69	23.5	0.111	0.17	0.061	0.09	-0.12
Body	GSM1900	661	1880	GPRS(3TX)	Front	15mm	\	22.62	23.5	0.036	0.04	0.020	0.02	0.14
Body	GSM1900	810	1909.8	GPRS(3TX)	Rear	15mm	A.15	22.76	23.5	0.070	0.08	0.039	0.05	-0.03
Body	GSM1900	661	1880	GPRS(3TX)	Rear	15mm	\	22.62	23.5	0.057	0.07	0.032	0.04	0.01
Body	GSM1900	512	1850.2	GPRS(3TX)	Rear	15mm	\	22.59	23.5	0.057	0.07	0.032	0.04	-0.20
Body	GSM1900	810	1909.8	EGPRS(3TX)	Rear	15mm	\	22.66	23.5	0.051	0.06	0.038	0.05	0.05
Hotspot	WCDMA1900	9400	1880	RMC	Front	10mm	\	20.52	21	0.184	0.21	0.103	0.12	-0.09
Hotspot	WCDMA1900	9538	1907.6	RMC	Rear	10mm	A.16	20.43	21	0.352	0.40	0.191	0.22	0.14
Hotspot	WCDMA1900	9400	1880	RMC	Rear	10mm	\	20.52	21	0.335	0.37	0.181	0.20	-0.09
Hotspot	WCDMA1900	9262	1852.4	RMC	Rear	10mm	\	20.35	21	0.317	0.37	0.191	0.22	-0.06
Hotspot	WCDMA1900	9400	1880	RMC	Left	10mm	\	20.52	21	0.074	0.08	0.042	0.05	-0.07
Hotspot	WCDMA1900	9400	1880	RMC	Right	10mm	\	20.52	21	<0.01	<0.01	<0.01	<0.01	\
Hotspot	WCDMA1900	9400	1880	RMC	Bottom	10mm	\	20.52	21	0.242	0.27	0.115	0.13	0.13
Body	WCDMA1900	9400	1880	RMC	Front	15mm	\	21.48	21.5	0.097	0.10	0.057	0.06	-0.06
Body	WCDMA1900	9538	1907.6	RMC	Rear	15mm	A.17	21.47	21.5	0.170	0.17	0.095	0.10	0.08
Body	WCDMA1900	9400	1880	RMC	Rear	15mm	\	21.48	21.5	0.150	0.15	0.086	0.09	-0.15
Body	WCDMA1900	9262	1852.4	RMC	Rear	15mm	\	21.45	21.5	0.157	0.16	0.091	0.09	0.14
Hotspot	WCDMA1700	1412	1732.6	RMC	Front	10mm	\	19.92	20.5	0.208	0.24	0.115	0.13	0.00
Hotspot	WCDMA1700	1513	1752.6	RMC	Rear	10mm	\	20.06	20.5	0.365	0.40	0.197	0.22	0.14
Hotspot	WCDMA1700	1412	1732.6	RMC	Rear	10mm	\	19.92	20.5	0.453	0.52	0.246	0.28	-0.03
Hotspot	WCDMA1700	1312	1712.4	RMC	Rear	10mm	A.18	19.96	20.5	0.514	0.58	0.274	0.31	0.10
Hotspot	WCDMA1700	1412	1732.6	RMC	Left	10mm	\	19.92	20.5	0.032	0.04	0.020	0.02	-0.02
Hotspot	WCDMA1700	1412	1732.6	RMC	Right	10mm	\	19.92	20.5	0.032	0.04	0.021	0.02	-0.09
Hotspot	WCDMA1700	1412	1732.6	RMC	Bottom	10mm	\	19.92	20.5	0.386	0.44	0.206	0.24	-0.17
Body	WCDMA1700	1412	1732.6	RMC	Front	15mm	\	20.91	21.5	0.128	0.15	0.077	0.09	-0.03
Body	WCDMA1700	1513	1752.6	RMC	Rear	15mm	\	20.96	21.5	0.205	0.23	0.119	0.13	0.14
Body	WCDMA1700	1412	1732.6	RMC	Rear	15mm	\	20.91	21.5	0.258	0.30	0.149	0.17	-0.15
Body	WCDMA1700	1312	1712.4	RMC	Rear	15mm	A.19	20.79	21.5	0.307	0.36	0.177	0.21	0.04
Hotspot	WCDMA 850	4183	836.6	RMC	Front	10mm	\	22.97	24.5	0.231	0.33	0.134	0.19	0.16
Hotspot	WCDMA 850	4233	846.6	RMC	Rear	10mm	\	23.03	24.5	0.359	0.50	0.200	0.28	0.06
Hotspot	WCDMA 850	4183	836.6	RMC	Rear	10mm	\	22.97	24.5	0.378	0.54	0.220	0.31	0.00
Hotspot	WCDMA 850	4132	826.4	RMC	Rear	10mm	A.20	23.06	24.5	0.387	0.54	0.217	0.30	-0.06
Hotspot	WCDMA 850	4183	836.6	RMC	Left	10mm	\	22.97	24.5	0.135	0.19	0.090	0.13	-0.12
Hotspot	WCDMA 850	4183	836.6	RMC	Right	10mm	\	22.97	24.5	0.043	0.06	0.029	0.04	0.16
Hotspot	WCDMA 850	4183	836.6	RMC	Top	10mm	\	22.97	24.5	0.331	0.47	0.168	0.24	0.12
Hotspot	LTE Band12	23095	707.5	1RB-Mid	Front	10mm	\	24.36	25	0.225	0.26	0.146	0.17	-0.10
Hotspot	LTE Band12	23095	707.5	1RB-Mid	Rear	10mm	A.21	24.36	25	0.393	0.46	0.239	0.28	0.05
Hotspot	LTE Band12	23095	707.5	1RB-Mid	Left	10mm	\	24.36	25	0.227	0.26	0.155	0.18	0.00
Hotspot	LTE Band12	23095	707.5	1RB-Mid	Right	10mm	\	24.36	25	0.043	0.05	0.031	0.04	-0.13
Hotspot	LTE Band12	23095	707.5	1RB-Mid	Top	10mm	\	24.36	25	0.268	0.31	0.151	0.17	-0.07
Hotspot	LTE Band12	23095	707.5	25RB-Low	Front	10mm	\	23.37	24	0.182	0.21	0.115	0.13	-0.09
Hotspot	LTE Band12	23095	707.5	25RB-Low	Rear	10mm	\	23.37	24	0.305	0.35	0.185	0.21	0.04
Hotspot	LTE Band12	23095	707.5	25RB-Low	Left	10mm	\	23.37	24	0.186	0.22	0.123	0.14	0.15
Hotspot	LTE Band12	23095	707.5	25RB-Low	Right	10mm	\	23.37	24	0.058	0.07	0.041	0.05	0.17
Hotspot	LTE Band12	23095	707.5	25RB-Low	Top	10mm	\	23.37	24	0.21	0.24	0.117	0.14	0.02
Hotspot	LTE Band2	19100	1900	1RB-Mid	Front	10mm	\	20.29	21	0.286	0.34	0.161	0.19	0.01
Hotspot	LTE Band2	19100	1900	1RB-Mid	Rear	10mm	\	20.29	21	0.482	0.57	0.261	0.31	0.09
Hotspot	LTE Band2	19100	1900	1RB-Mid	Left	10mm	\	20.29	21	0.067	0.08	0.039	0.05	-0.12
Hotspot	LTE Band2	19100	1900	1RB-Mid	Right	10mm	\	20.29	21	0.082	0.10	0.050	0.06	-0.16
Hotspot	LTE Band2	19100	1900	1RB-Mid	Bottom	10mm	\	20.29	21	0.715	0.84	0.367	0.43	-0.02
Hotspot	LTE Band2	18900	1880	1RB-Mid	Bottom	10mm	A.22	20.17	21	0.815	0.99	0.424	0.51	0.07
Hotspot	LTE Band2	18700	1860	1RB-Mid	Bottom	10mm	\	20.17	21	0.774	0.94	0.410	0.50	-0.01



No. I23Z61303-SEM01

RF Exposure Conditions	Frequency Band	Channel Number	Frequency (MHz)	Mode/RB	Test Position	Distance	Figure No./Note	EUT Measured Power (dBm)	Tune up (dBm)	Measured SAR 1g (W/kg)	Reported SAR 1g (W/kg)	Measured SAR 10g (W/kg)	Reported SAR 10g (W/kg)	Power Drift
Hotspot	LTE Band2	19100	1900	50RB-Low	Front	10mm	\	20.38	21	0.269	0.31	0.160	0.18	0.16
Hotspot	LTE Band2	19100	1900	50RB-Low	Rear	10mm	\	20.38	21	0.460	0.53	0.246	0.28	0.08
Hotspot	LTE Band2	19100	1900	50RB-Low	Left	10mm	\	20.38	21	0.050	0.06	0.031	0.04	0.08
Hotspot	LTE Band2	19100	1900	50RB-Low	Right	10mm	\	20.38	21	0.102	0.12	0.062	0.07	-0.17
Hotspot	LTE Band2	19100	1900	50RB-Low	Bottom	10mm	\	20.38	21	0.699	0.81	0.365	0.42	-0.18
Hotspot	LTE Band2	18900	1880	50RB-Low	Bottom	10mm	\	20.21	21	0.724	0.87	0.379	0.45	0.14
Hotspot	LTE Band2	18700	1860	50RB-Low	Bottom	10mm	\	20.15	21	0.765	0.93	0.382	0.46	0.16
Hotspot	LTE Band2	18900	1880	100RB	Bottom	10mm	\	20.24	21	0.744	0.89	0.392	0.47	-0.12
Body	LTE Band2	19100	1900	1RB-Mid	Front	15mm	\	21.32	22	0.213	0.25	0.122	0.14	-0.20
Body	LTE Band2	19100	1900	1RB-Mid	Rear	15mm	A.23	21.32	22	0.312	0.36	0.173	0.20	-0.02
Body	LTE Band2	19100	1900	50RB-Low	Front	15mm	\	21.44	22	0.210	0.24	0.121	0.14	-0.13
Body	LTE Band2	19100	1900	50RB-Low	Rear	15mm	\	21.44	22	0.303	0.34	0.169	0.19	0.20
Hotspot	LTE Band5	20600	844	1RB-Mid	Front	10mm	\	24.52	25	0.368	0.41	0.211	0.24	-0.08
Hotspot	LTE Band5	20600	844	1RB-Mid	Rear	10mm	A.24	24.52	25	0.576	0.64	0.321	0.36	0.03
Hotspot	LTE Band5	20600	844	1RB-Mid	Left	10mm	\	24.52	25	0.189	0.21	0.106	0.12	-0.20
Hotspot	LTE Band5	20600	844	1RB-Mid	Right	10mm	\	24.52	25	0.092	0.10	0.060	0.07	0.00
Hotspot	LTE Band5	20600	844	1RB-Mid	Top	10mm	\	24.52	25	0.472	0.53	0.237	0.26	0.17
Hotspot	LTE Band5	20600	844	25RB-Mid	Front	10mm	\	23.49	24	0.279	0.31	0.160	0.18	0.17
Hotspot	LTE Band5	20600	844	25RB-Mid	Rear	10mm	\	23.49	24	0.433	0.49	0.241	0.27	-0.08
Hotspot	LTE Band5	20600	844	25RB-Mid	Left	10mm	\	23.49	24	0.159	0.18	0.102	0.11	-0.13
Hotspot	LTE Band5	20600	844	25RB-Mid	Right	10mm	\	23.49	24	0.056	0.06	0.036	0.04	0.02
Hotspot	LTE Band5	20600	844	25RB-Mid	Top	10mm	\	23.49	24	0.364	0.41	0.183	0.21	0.01
Hotspot	LTE Band7	20850	2510	1RB-Mid	Front	10mm	\	20.78	21	0.24	0.25	0.123	0.13	-0.19
Hotspot	LTE Band7	21350	2560	1RB-Mid	Rear	10mm	A.25	20.77	21	0.957	1.01	0.392	0.41	0.07
Hotspot	LTE Band7	21100	2535	1RB-Mid	Rear	10mm	\	20.73	21	0.891	0.95	0.360	0.38	0.15
Hotspot	LTE Band7	20850	2510	1RB-Mid	Rear	10mm	\	20.78	21	0.766	0.81	0.320	0.34	-0.11
Hotspot	LTE Band7	20850	2510	1RB-Mid	Left	10mm	\	20.78	21	0.094	0.10	0.049	0.05	-0.19
Hotspot	LTE Band7	20850	2510	1RB-Mid	Right	10mm	\	20.78	21	0.059	0.06	0.032	0.03	0.19
Hotspot	LTE Band7	20850	2510	1RB-Mid	Bottom	10mm	\	20.78	21	0.507	0.53	0.222	0.23	0.06
Hotspot	LTE Band7	20850	2510	50RB-Mid	Front	10mm	\	20.85	21	0.227	0.23	0.118	0.12	0.02
Hotspot	LTE Band7	20850	2510	50RB-Mid	Rear	10mm	\	20.85	21	0.724	0.75	0.308	0.32	-0.18
Hotspot	LTE Band7	20850	2510	50RB-Mid	Left	10mm	\	20.85	21	0.109	0.11	0.059	0.06	0.00
Hotspot	LTE Band7	20850	2510	50RB-Mid	Right	10mm	\	20.85	21	0.063	0.07	0.025	0.03	0.01
Hotspot	LTE Band7	20850	2510	50RB-Mid	Bottom	10mm	\	20.85	21	0.515	0.53	0.216	0.22	-0.14
Hotspot	LTE Band7	20850	2510	100RB	Rear	10mm	\	20.84	21	0.845	0.88	0.357	0.37	-0.09
Hotspot	LTE Band13	23230	782	1RB-Mid	Front	10mm	\	24.46	25	0.431	0.49	0.250	0.28	0.18
Hotspot	LTE Band13	23230	782	1RB-Mid	Rear	10mm	A.26	24.46	25	0.633	0.72	0.364	0.41	-0.09
Hotspot	LTE Band13	23230	782	1RB-Mid	Left	10mm	\	24.46	25	0.423	0.48	0.278	0.31	0.04
Hotspot	LTE Band13	23230	782	1RB-Mid	Right	10mm	\	24.46	25	0.222	0.25	0.145	0.16	-0.13
Hotspot	LTE Band13	23230	782	1RB-Mid	Top	10mm	\	24.46	25	0.565	0.64	0.277	0.31	-0.07
Hotspot	LTE Band13	23230	782	25RB-Mid	Front	10mm	\	23.50	24	0.358	0.40	0.203	0.23	-0.06
Hotspot	LTE Band13	23230	782	25RB-Mid	Rear	10mm	\	23.50	24	0.485	0.54	0.279	0.31	-0.06
Hotspot	LTE Band13	23230	782	25RB-Mid	Left	10mm	\	23.50	24	0.326	0.37	0.213	0.24	-0.12
Hotspot	LTE Band13	23230	782	25RB-Mid	Right	10mm	\	23.50	24	0.173	0.19	0.114	0.13	0.05
Hotspot	LTE Band13	23230	782	25RB-Mid	Top	10mm	\	23.50	24	0.458	0.51	0.225	0.25	0.12
Hotspot	LTE Band66	132572	1770	1RB-Mid	Front	10mm	\	20.12	21	0.187	0.23	0.107	0.13	0.18
Hotspot	LTE Band66	132572	1770	1RB-Mid	Rear	10mm	\	20.12	21	0.401	0.49	0.211	0.26	-0.15
Hotspot	LTE Band66	132572	1770	1RB-Mid	Left	10mm	\	20.12	21	0.114	0.14	0.065	0.08	0.11
Hotspot	LTE Band66	132572	1770	1RB-Mid	Right	10mm	\	20.12	21	0.041	0.05	0.024	0.03	-0.17
Hotspot	LTE Band66	132572	1770	1RB-Mid	Bottom	10mm	\	20.12	21	0.400	0.49	0.192	0.24	0.00
Hotspot	LTE Band66	132572	1770	50RB-Mid	Front	10mm	\	20.13	21	0.192	0.23	0.108	0.13	-0.10
Hotspot	LTE Band66	132572	1770	50RB-Mid	Rear	10mm	A.29	20.13	21	0.405	0.49	0.215	0.26	0.12
Hotspot	LTE Band66	132572	1770	50RB-Mid	Left	10mm	\	20.13	21	0.122	0.15	0.068	0.08	0.18
Hotspot	LTE Band66	132572	1770	50RB-Mid	Right	10mm	\	20.13	21	0.046	0.06	0.027	0.03	-0.10
Hotspot	LTE Band66	132572	1770	50RB-Mid	Bottom	10mm	\	20.13	21	0.367	0.45	0.180	0.22	0.08
Body	LTE Band66	132572	1770	1RB-Mid	Front	15mm	\	21.24	22	0.093	0.11	0.059	0.07	-0.09
Body	LTE Band66	132572	1770	1RB-Mid	Rear	15mm	A.30	21.24	22	0.164	0.20	0.103	0.12	-0.04
Body	LTE Band66	132572	1770	50RB-Mid	Front	15mm	\	21.22	22	0.089	0.11	0.057	0.07	-0.04
Body	LTE Band66	132572	1770	50RB-Mid	Rear	15mm	\	21.22	22	0.163	0.20	0.102	0.12	0.09
Hotspot	LTE Band71	133372	688	1RB-Mid	Front	10mm	\	23.34	24.5	0.169	0.22	0.098	0.13	-0.06
Hotspot	LTE Band71	133372	688	1RB-Mid	Rear	10mm	A.31	23.34	24.5	0.248	0.32	0.142	0.19	-0.11
Hotspot	LTE Band71	133372	688	1RB-Mid	Left	10mm	\	23.34	24.5	0.178	0.23	0.096	0.13	0.09
Hotspot	LTE Band71	133372	688	1RB-Mid	Right	10mm	\	23.34	24.5	0.053	0.07	0.028	0.04	0.16
Hotspot	LTE Band71	133372	688	1RB-Mid	Top	10mm	\	23.34	24.5	0.152	0.20	0.063	0.08	0.16
Hotspot	LTE Band71	133372	688	50RB-Mid	Front	10mm	\	22.73	23.5	0.135	0.16	0.078	0.09	0.11
Hotspot	LTE Band71	133372	688	50RB-Mid	Rear	10mm	\	22.73	23.5	0.188	0.22	0.110	0.13	0.14
Hotspot	LTE Band71	133372	688	50RB-Mid	Left	10mm	\	22.73	23.5	0.141	0.17	0.076	0.09	0.17
Hotspot	LTE Band71	133372	688	50RB-Mid	Right	10mm	\	22.73	23.5	0.080	0.10	0.044	0.05	-0.08
Hotspot	LTE Band71	133372	688	50RB-Mid	Top	10mm	\	22.73	23.5	0.141	0.17	0.055	0.07	0.12



13.2 SAR results for WLAN/BT

The maximum output power specified for production units are determined for all applicable 802.11 transmission modes in each standalone and aggregated frequency band. Maximum output power is measured for the highest maximum output power configuration(s) in each frequency band according to the default power measurement procedures.

When the same transmission mode configurations have the same maximum output power on the same channel for the 802.11 a/g/n/ac/ax modes, the channel in the lower order/sequence 802.11 mode (i.e. a, g, n ac then ax) is selected.

SAR Test reduction was applied from KDB 248227 guidance, when the same maximum power is specified for multiple transmission modes in a frequency band, the largest channel bandwidth, lowest order modulation, lowest data rate and lowest order 802.11a/g/n/ac mode is used for SAR measurement, on the highest measured output power channel in the initial test configuration, for each frequency band. Additional output power measurements were not deemed necessary.

Duty factor plot

CH1

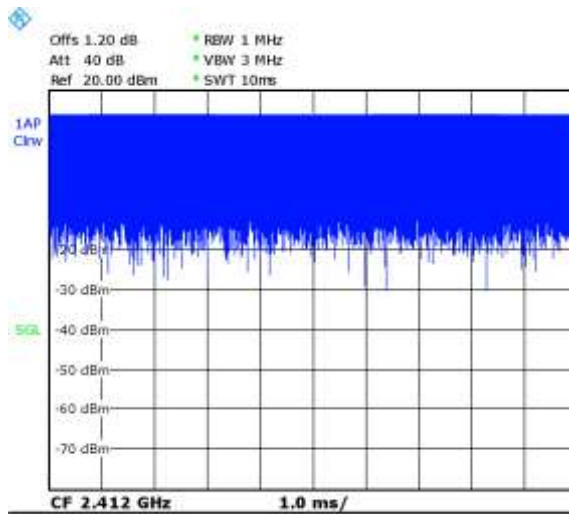

CH6

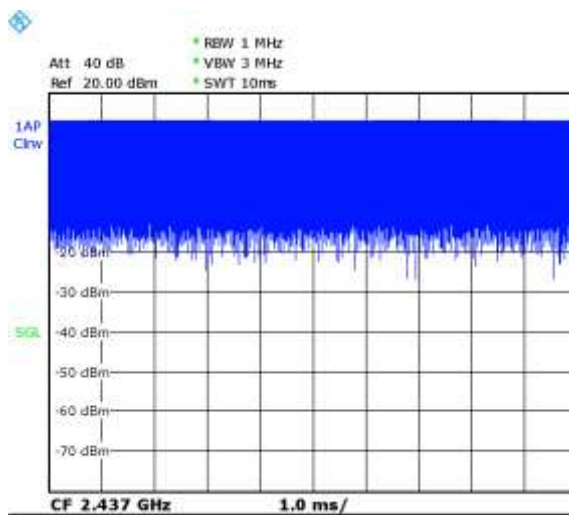

CH11

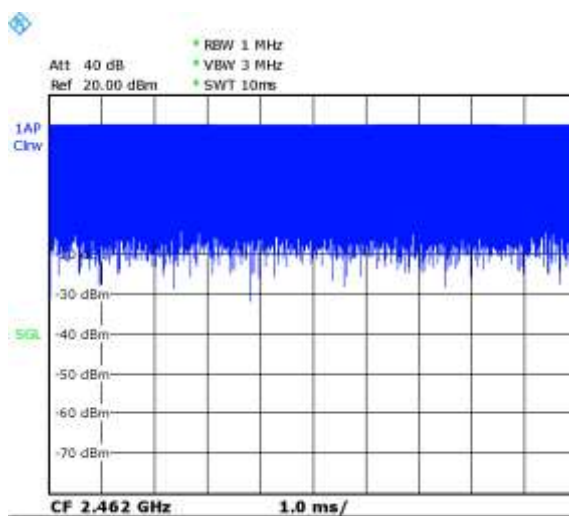

WLAN 2.4G SISO Standalone

Test Position	Frequency Band	Channel Number	Frequency (MHz)	Mode/RB	Test Position	Distance	Figure No./Note	EUT Measured Power (dBm)	Tune up (dBm)	Duty Cycle	Measured SAR 1g (W/kg)	Reported SAR 1g (W/kg)	Measured SAR 10g (W/kg)	Reported SAR 10g (W/kg)	Power Drift
Head	WLAN 2.4G	1	2412	11b	Cheek Left	0mm	\	20.18	21	100%	1.06	1.28	0.504	0.61	-0.16
Head	WLAN 2.4G	6	2437	11b	Cheek Left	0mm	\	20.25	21	100%	0.926	1.10	0.453	0.54	-0.19
Head	WLAN 2.4G	11	2462	11b	Cheek Left	0mm	\	19.86	21	100%	1.10	1.43	0.510	0.66	0.16
Head	WLAN 2.4G	1	2412	11b	Tilt Left	0mm	\	20.18	21	100%	1.10	1.33	0.454	0.55	0.18
Head	WLAN 2.4G	6	2437	11b	Tilt Left	0mm	\	20.25	21	100%	0.947	1.13	0.383	0.46	-0.04
Head	WLAN 2.4G	11	2462	11b	Tilt Left	0mm	A.32	19.86	21	100%	1.13	1.47	0.485	0.63	0.13
Head	WLAN 2.4G	6	2437	11b	Cheek Right	0mm	\	20.25	21	100%	0.298	0.35	0.144	0.17	-0.02
Head	WLAN 2.4G	6	2437	11b	Tilt Right	0mm	\	20.25	21	100%	0.308	0.37	0.131	0.16	-0.17
Head	WLAN 2.4G	11	2462	11b	Tilt Left	0mm	B2	19.86	21	100%	0.985	1.28	0.406	0.53	0.09
Body	WLAN 2.4G	6	2437	11b	Front	10mm	\	20.25	21	100%	0.199	0.24	0.113	0.13	-0.09
Body	WLAN 2.4G	6	2437	11b	Rear	10mm	\	20.25	21	100%	0.180	0.21	0.099	0.12	-0.03
Body	WLAN 2.4G	6	2437	11b	Right	10mm	A.33	20.25	21	100%	0.30	0.35	0.153	0.18	0.14
Body	WLAN 2.4G	6	2437	11b	Top	10mm	\	20.25	21	100%	0.133	0.16	0.060	0.07	-0.18

WLAN 2.4G SISO Simultaneous transmission

Test Position	Frequency Band	Channel Number	Frequency (MHz)	Mode/RB	Test Position	Distance	Figure No./Note	EUT Measured Power (dBm)	Tune up (dBm)	Duty Cycle	Measured SAR 1g (W/kg)	Reported SAR 1g (W/kg)	Measured SAR 10g (W/kg)	Reported SAR 10g (W/kg)	Power Drift
Head	WLAN 2.4G	1	2412	11b	Cheek Left	0mm	\	16.47	18	100%	0.298	0.42	0.141	0.20	0.18
Head	WLAN 2.4G	6	2437	11b	Cheek Left	0mm	\	16.69	18	100%	0.361	0.49	0.177	0.24	0.09
Head	WLAN 2.4G	11	2462	11b	Cheek Left	0mm	\	16.55	18	100%	0.391	0.55	0.195	0.27	0.13
Head	WLAN 2.4G	1	2412	11b	Tilt Left	0mm	\	16.47	18	100%	0.295	0.42	0.124	0.18	0.07
Head	WLAN 2.4G	6	2437	11b	Tilt Left	0mm	\	16.69	18	100%	0.387	0.52	0.164	0.22	-0.07
Head	WLAN 2.4G	11	2462	11b	Tilt Left	0mm	\	16.55	18	100%	0.44	0.61	0.189	0.26	0.09
Head	WLAN 2.4G	6	2437	11b	Cheek Right	0mm	\	16.69	18	100%	0.129	0.17	0.063	0.09	0.13
Head	WLAN 2.4G	6	2437	11b	Tilt Right	0mm	\	16.69	18	100%	0.127	0.17	0.057	0.08	0.19

BT

Test Position	Frequency Band	Channel Number	Frequency (MHz)	Mode/RB	Test Position	Distance	Figure No./Note	Measured SAR 1g (W/kg)	Reported SAR 1g (W/kg)	Measured SAR 10g (W/kg)	Reported SAR 10g (W/kg)	Power Drift
Head	BT	0	2402	GFSK	Cheek Left	0mm	\	<0.01	<0.01	<0.01	<0.01	\
Head	BT	0	2402	GFSK	Tilt Left	0mm	\	<0.01	<0.01	<0.01	<0.01	\
Head	BT	0	2402	GFSK	Cheek Right	0mm	\	<0.01	<0.01	<0.01	<0.01	\
Head	BT	0	2402	GFSK	Tilt Right	0mm	\	<0.01	<0.01	<0.01	<0.01	\
Body	BT	0	2402	GFSK	Front	10mm	\	<0.01	<0.01	<0.01	<0.01	\
Body	BT	0	2402	GFSK	Rear	10mm	\	<0.01	<0.01	<0.01	<0.01	\
Body	BT	0	2402	GFSK	Right	10mm	\	<0.01	<0.01	<0.01	<0.01	\
Body	BT	0	2402	GFSK	Top	10mm	\	<0.01	<0.01	<0.01	<0.01	\

13.3 SAR Evaluation for Phablet

According to the KDB648474 D04, for smart phones, with a display diagonal dimension > 15.0 cm or an overall diagonal dimension > 16.0 cm, that can provide similar mobile web access and multimedia support found in mini-tablets or UMPC mini-tablets and support voice calls next to the ear, unless it is confirmed otherwise through KDB inquiries, the following phablet procedures should be applied to evaluate SAR compliance for each applicable wireless modes and frequency band. Devices marketed as phablets, regardless of form factors and operating characteristics must be tested as a phablet to determine SAR compliance.

1. The normally required head and body-worn accessory SAR test procedures for handsets, including hotspot mode, must be applied.
2. The UMPC mini-tablet procedures must also be applied to test the SAR of all surfaces and edges with an antenna located at ≤ 25 mm from that surface or edge, in direct contact with a flat phantom, for 10-g extremity SAR according to the body-equivalent tissue dielectric parameters in KDB Publication 865664 D01 to address interactive hand use exposure conditions. When hotspot mode applies, 10-g extremity SAR is required only for the surfaces and edges with hotspot mode 1-g reported SAR > 1.2 W/kg; however, when power reduction applies to hotspot mode the measured SAR must be scaled to the maximum output power, including tolerance, allowed for phablet modes to compare with the 1.2 W/kg SAR test reduction threshold. The normal tablet procedures in KDB Publication 616217 are required when the overall diagonal dimension of the device is > 20.0 cm. Hotspot mode SAR is not required when normal tablet procedures are applied. Extremity 10-g SAR is also not required for the front (top) surface of larger form factor full size tablets. The more conservative normal tablet SAR results can be used to support phablet mode 10-g extremity SAR.
3. The simultaneous transmission operating configurations applicable to voice and data transmissions for both phone and mini-tablet modes must be taken into consideration separately for 1-g and 10-g SAR to determine the simultaneous transmission SAR test exclusion and measurement requirements for the relevant wireless modes and exposure conditions

According to above evaluation procedure , the 10-g extremity SAR is not required

14 SAR Measurement Variability

SAR measurement variability must be assessed for each frequency band, which is determined by the SAR probe calibration point and tissue-equivalent medium used for the device measurements. When both head and body tissue-equivalent media are required for SAR measurements in a frequency band, the variability measurement procedures should be applied to the tissue medium with the highest measured SAR, using the highest measured SAR configuration for that tissue-equivalent medium.

The following procedures are applied to determine if repeated measurements are required.

- 1) Repeated measurement is not required when the original highest measured SAR is < 0.80 W/kg; steps 2) through 4) do not apply.
- 2) When the original highest measured SAR is ≥ 0.80 W/kg, repeat that measurement once.
- 3) Perform a second repeated measurement only if the ratio of largest to smallest SAR for the original and first repeated measurements is > 1.20 or when the original or repeated measurement is ≥ 1.45 W/kg (~ 10% from the 1-g SAR limit).
- 4) Perform a third repeated measurement only if the original, first or second repeated measurement is ≥ 1.5 W/kg and the ratio of largest to smallest SAR for the original, first and second repeated measurements is > 1.20 .

Frequency		Mode	Test Position	Distance (mm)	Highest Measured SAR (W/kg)	First Repeated SAR (W/kg)	The Ratio	Second Repeated SAR (W/kg)
Ch.	MHz							
18900	1880	LTE B2 1RB-Mid	Bottom	10mm	0.815	0.804	1.01	/
21350	2560	LTE B7 1RB-Mid	Rear	10mm	0.957	0.939	1.02	/
1	2412	WLAN2.4G 11b	Cheek Left	0mm	1.06	0.929	1.14	/
6	2437	WLAN2.4G 11b	Cheek Left	0mm	0.926	0.915	1.01	/
11	2462	WLAN2.4G 11b	Cheek Left	0mm	1.1	1.02	1.08	/
1	2412	WLAN2.4G 11b	Tilt Left	0mm	1.1	1.07	1.03	/
6	2437	WLAN2.4G 11b	Tilt Left	0mm	0.947	0.905	1.05	/
11	2462	WLAN2.4G 11b	Tilt Left	0mm	1.13	0.976	1.16	/

15 Evaluation of Simultaneous

15.1 Introduction

The following procedures adopted from “FCC SAR Considerations for Cell Phones with Multiple Transmitters” are applicable to handsets with built-in unlicensed transmitters such as WLAN and Bluetooth devices which may simultaneously transmit with the licensed transmitter. KDB 447498 D01 provides two procedures for determining simultaneous transmission SAR test exclusion: Sum of SAR and SAR to Peak Location Ratio (SPLSR)

15.1.1 Sum of SAR

To qualify for simultaneous transmission SAR test exclusion based upon Sum of SAR the sum of the reported standalone SARs for all simultaneously transmitting antennas shall be below the applicable standalone SAR limit. If the sum of the SARs is above the applicable limit then simultaneous transmission SAR test exclusion may still apply if the requirements of the SAR to Peak Location Ratio (SPLSR) evaluation are met.

15.1.2 SAR to Peak Location Ratio (SPLSR)

KDB 447498 D01 General RF Exposure Guidance explains how to calculate the SAR to Peak Location Ratio (SPLSR) between pairs of simultaneously transmitting antennas:

$$SPLSR = (SAR1 + SAR2)^{1.5} / R_i$$

Where:

SAR1 is the highest reported or estimated SAR for the first of a pair of simultaneous transmitting antennas, in a specific test operating mode and exposure condition.

SAR2 is the highest reported or estimated SAR for the second of a pair of simultaneous transmitting antennas, in the same test operating mode and exposure condition as the first .

R_i is the separation distance between the pair of simultaneous transmitting antennas. When the SAR is measured, for both antennas in the pair, it is determined by the actual x, y and z coordinates in the 1-g SAR for each SAR peak location, based on the extrapolated and interpolated result in the zoom scan measurement, using the formula of

$$[(x1-x2)^2 + (y1-y2)^2 + (z1-z2)^2]$$

In order for a pair of simultaneous transmitting antennas with the sum of 1-g SAR > 1.6 W/kg to qualify for exemption from Simultaneous Transmission SAR measurements, it has to satisfy the condition of:

$$(SAR1 + SAR2)^{1.5} / R_i \leq 0.04$$

When an individual antenna transmits at on two bands simultaneously, the sum of the highest reported SAR for the frequency bands should be used to determine *SAR1* or *SAR2*. When SPLSR is necessary, the smallest distance between the peak SAR locations for the antenna pair with respect to the peaks from each antenna should be used.

15.2 Simultaneous Transmission Capabilities

The simultaneous transmission possibilities for this device are listed as below:

Capable Transmit Configurations	Head	Body	Product Specific 10-g (0mm)
WWAN + BT	Yes	Yes	Yes
WWAN + Wi-Fi 2.4G SISO	Yes	Yes	Yes

Note:

1. Wi-Fi 2.4GHz & Bluetooth can not transmit simultaneously.
2. WWAN cannot transmit simultaneously.
3. The reported SAR summation is calculated based on the same configuration and test position.
4. For the devices edges with antennas more than 2.5 cm from edge are not required to be evaluated for SAR, we determined the SAR of this edges were less than 0.01. For the convenience of simultaneous transmission calculation, all SAR values less than 0.01 are uniformly written as 0.00

15.3 SAR Simultaneous Transmission Analysis

Reported SAR 1g (W/kg)																	
Head		GSM850	GSM1900	WCDMA850	WCDMA1700	WCDMA1900	LTE Band2	LTE Band5	LTE Band7	LTE Band12	LTE Band13	LTE Band66	LTE Band71	2.4G	BT	+Wif2.4G	+BT
Cheek	L	0.10	0.17	0.41	0.40	0.33	0.42	0.42	0.23	0.43	0.57	0.66	0.29	0.55	<0.01	1.21	0.66
Tilt	L	0.00	0.06	0.45	0.15	0.12	0.28	0.45	0.09	0.43	0.55	0.25	0.29	0.61	<0.01	1.16	0.55
Cheek	R	0.09	0.09	0.49	0.23	0.08	0.39	0.54	0.11	0.62	0.73	0.32	0.46	0.17	<0.01	0.90	0.73
Tilt	R	0.00	0.06	0.66	0.15	0.11	0.32	0.67	0.14	0.67	0.74	0.23	0.46	0.17	<0.01	0.91	0.74
Hotspot		GSM850	GSM1900	WCDMA850	WCDMA1700	WCDMA1900	LTE Band2	LTE Band5	LTE Band7	LTE Band12	LTE Band13	LTE Band66	LTE Band71	2.4G	BT	+Wif2.4G	+BT
Front	10mm	0.06	0.10	0.33	0.24	0.21	0.34	0.41	0.25	0.26	0.49	0.23	0.22	0.24	<0.01	0.73	0.49
Rear	10mm	0.16	0.17	0.54	0.58	0.40	0.57	0.64	1.01	0.46	0.72	0.49	0.32	0.21	<0.01	1.22	1.01
Left	10mm	0.07	0.07	0.19	0.04	0.08	0.08	0.21	0.11	0.26	0.48	0.15	0.23	/	<0.01	0.48	0.48
Right	10mm	0.09	0.00	0.06	0.04	0.00	0.12	0.10	0.07	0.07	0.25	0.06	0.10	0.35	<0.01	0.60	0.25
Bottom	10mm	0.00	0.11	/	0.44	0.27	0.99	/	0.53	/	/	/	0.49	0.20	<0.01	0.99	0.99
Top	10mm	/	/	0.47	/	/	/	0.53	/	0.31	0.64	/	/	0.16	<0.01	0.80	0.64
Body worn		GSM850	GSM1900	WCDMA850	WCDMA1700	WCDMA1900	LTE Band2	LTE Band5	LTE Band7	LTE Band12	LTE Band13	LTE Band66	LTE Band71	2.4G	BT	+Wif2.4G	+BT
Front	15mm	/	0.04	/	0.15	0.10	0.25	/	/	/	/	0.11	/	0.24	<0.01	0.49	0.25
Rear	15mm	/	0.08	/	0.36	0.17	0.36	/	/	/	/	0.20	/	0.21	<0.01	0.57	0.36

15.4 Conclusion

According to the above tables, the highest simultaneous transmission reported SAR values is **1.22W/kg (1g)**. The sum of reported SAR values is <1.6W/kg. So the simultaneous transmission SAR with volume scans is not required.

16 Measurement Uncertainty

Per KDB 865664 D01 SAR Measurement 100 MHz to 6 GHz, when the highest measured 1-g SAR within a frequency band is < 1.5 W/kg and the measured 10-g SAR within a frequency band is < 3.75 W/kg. The expanded SAR measurement uncertainty must be $\leq 30\%$, for a confidence interval of $k = 2$. If these conditions are met, extensive SAR measurement uncertainty analysis described in IEEE Std 1528-2013 is not required in SAR reports submitted for equipment approval.

Therefore, the measurement uncertainty is not required.

17 MAIN TEST INSTRUMENTS

No.	Name	Type	Serial Number	Calibration Date	Valid Period
01	Network analyzer	E5071C	MY46110673	January 10, 2023	One year
02	Power meter	NRP110T	101139	January 13, 2023	One year
03	Power sensor	NRP110T	101159	January 13, 2023	One year
04	Signal Generator	E4438C	MY49071430	January 19, 2023	One year
05	Amplifier	60S1G4	0331848	No Calibration Requested	
06	BTS	CMW500	159890	January 12, 2023	One year
07	BTS	CMW500	159889	January 6, 2023	One year
08	E-field Probe	SPEAG EX3DV4	3617	March 31, 2023	One year
09	DAE	SPEAG DAE4	1556	January 11, 2023	One year
10	Dipole Validation Kit	SPEAG D750V3	1017	July 20, 2022	One year
11	Dipole Validation Kit	SPEAG D835V2	4d069	July 20, 2022	One year
12	Dipole Validation Kit	SPEAG D1750V2	1003	July 18, 2022	One year
13	Dipole Validation Kit	SPEAG D1900V2	5d101	July 26, 2022	One year
14	Dipole Validation Kit	SPEAG D2450V2	853	July 20, 2022	One year
15	Dipole Validation Kit	SPEAG D2600V2	1012	July 20, 2022	One year

END OF REPORT BODY



No. I23Z61303-SEM01

Appendixes

Refer to separated files for the following appendixes

ANNEX A Graph Results

ANNEX B System Verification Results

ANNEX C SAR Measurement Setup

ANNEX D Position of the wireless device in relation to the phantom

ANNEX E Equivalent Media Recipes

ANNEX F System Validation

ANNEX G Probe Calibration Certificate

ANNEX H Dipole Calibration Certificate

ANNEX I Accreditation Certificate