



# NFC TEST REPORT

No.I22Z62424-IOT01

for

**TCL Communication Ltd.**

**UMTS/LTE /NR Mobile phone**

**Model Name: T609J**

**FCC ID: 2ACCJH174**

with

**Hardware Version: 03**

**Software Version: LUS7**

**Issued Date: 2023-01-09**

**Note:**

The test results in this test report relate only to the devices specified in this report. This report shall not be reproduced except in full without the written approval of CTTL.

The report must not be used by the client to claim product certification, approval, or endorsement by NVLAP, NIST, or any agency of the U.S.Government.

**Test Laboratory:**

**CTTL-Telecommunication Technology Labs, CAICT**

No. 52, Huayuan North Road, Haidian District, Beijing, P. R. China 100191.

Tel:+86(0)10-62304633-2512, Fax:+86(0)10-62304633-2504

Email: [ctl\\_terminals@caict.ac.cn](mailto:ctl_terminals@caict.ac.cn), website: [www.caict.ac.cn](http://www.caict.ac.cn)



## **REPORT HISTORY**

<b>Report Number</b>	<b>Revision</b>	<b>Description</b>	<b>Issue Date</b>
I22Z62424-IOT01	Rev.0	1 <sup>st</sup> edition	2023-01-09

Note: the latest revision of the test report supersedes all previous version.

## **CONTENTS**

<b>1. TEST LABORATORY .....</b>	<b>4</b>
<b>1.1. INTRODUCTION &amp; ACCREDITATION.....</b>	<b>4</b>
<b>1.2. TESTING LOCATION .....</b>	<b>4</b>
<b>1.3. TESTING ENVIRONMENT .....</b>	<b>5</b>
<b>1.4. PROJECT DATA .....</b>	<b>5</b>
<b>1.5. SIGNATURE.....</b>	<b>5</b>
<b>2. CLIENT INFORMATION.....</b>	<b>6</b>
<b>2.1. APPLICANT INFORMATION.....</b>	<b>6</b>
<b>2.2. MANUFACTURER INFORMATION.....</b>	<b>6</b>
<b>3. EQUIPMENT UNDER TEST (EUT) AND ANCILLARY EQUIPMENT (AE) .....</b>	<b>7</b>
<b>3.1. ABOUT EUT .....</b>	<b>7</b>
<b>3.2. INTERNAL IDENTIFICATION OF EUT .....</b>	<b>7</b>
<b>3.3. INTERNAL IDENTIFICATION OF AE .....</b>	<b>7</b>
<b>3.4. EUT SET-UPS.....</b>	<b>8</b>
<b>4. REFERENCE DOCUMENTS .....</b>	<b>9</b>
<b>4.1. DOCUMENTS SUPPLIED BY APPLICANT .....</b>	<b>9</b>
<b>4.2. REFERENCE DOCUMENTS FOR TESTING.....</b>	<b>9</b>
<b>5. TEST RESULTS .....</b>	<b>10</b>
<b>5.1. SUMMARY OF TEST RESULTS .....</b>	<b>10</b>
<b>5.2. STATEMENTS.....</b>	<b>10</b>
<b>6. TEST FACILITIES UTILIZED .....</b>	<b>11</b>
<b>7. MEASUREMENT UNCERTAINTY .....</b>	<b>12</b>
<b>ANNEX A: EUT PARAMETERS.....</b>	<b>13</b>
<b>ANNEX B: DETAILED TEST RESULTS.....</b>	<b>14</b>
<b>ANNEX C: PERSONS INVOLVED IN THIS TESTING .....</b>	<b>27</b>
<b>ANNEX D: ACCREDITATION CERTIFICATE .....</b>	<b>28</b>



## **1. Test Laboratory**

### **1.1. Introduction & Accreditation**

Telecommunication Technology Labs, CAICT is an ISO/IEC 17025:2017 accredited test laboratory under NATIONAL VOLUNTARY LABORATORY ACCREDITATION PROGRAM (NVLAP) with lab code 600118-0, and is also an FCC accredited test laboratory (CN5017), and ISED accredited test laboratory (ISED#: 24849). The detail accreditation scope can be found on NVLAP website.

### **1.2. Testing Location**

Location 1: CTTL(huayuan North Road)

Address: No. 52, Huayuan North Road, Haidian District, Beijing,  
P. R. China 100191

### 1.3. Testing Environment

Normal Temperature:	15-35°C
Extreme Temperature:	-20/+50°C
Normal Relative Humidity:	20-75%
Normal Air Pressure	86Kpa-106Kpa

### 1.4. Project data

Testing Start Date:	2022-12-28
Testing End Date:	2023-01-09

### 1.5. Signature

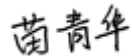

---

Miao Qinghua  
(Prepared this test report)



---

Zhou Bin  
(Reviewed this test report)



---

Pang Shuai  
(Approved this test report)



## **2. Client Information**

### **2.1. Applicant Information**

Company Name: TCL Communication Ltd.  
Address: 5/F, Building 22E, 22 Science Park East Avenue, Hong Kong Science Park, Shatin, NT, Hong Kong  
Contact: Annie Jiang  
Telephone: +86 755 3661 1621  
Email: nianxiang.jiang@tcl.com

### **2.2. Manufacturer Information**

Company Name: TCL Communication Ltd.  
Address: 5/F, Building 22E, 22 Science Park East Avenue, Hong Kong Science Park, Shatin, NT, Hong Kong  
Contact: Annie Jiang  
Telephone: +86 755 3661 1621  
Email: nianxiang.jiang@tcl.com

### 3. Equipment Under Test (EUT) and Ancillary Equipment (AE)

#### 3.1. About EUT

Description	UMTS/LTE /NR Mobile phone
Model Name	T609J
FCC ID	2ACCJH174
UMTS Frequency bands	FDD I/II/IV/V
E-UTRA Frequency bands	FDD 1/2/3/4/5/7/12/13/17/20/25/26/29/66/71 TDD 38/41
5G NR Frequency bands	NSA n2/n5/n25/n41/n66/n71/n77/n78/ SA n2/n5/n7/n25/n38/n41/n66/n71/n77/n78/
Operating temperature	-10/+55°C
Extreme low voltage	3.6 V
Normal voltage	3.85 V
Extreme high voltage	4.4 V

#### 3.2. Internal Identification of EUT

EUT ID*	SN or IMEI	HW Version	SW Version
UT25a	016388000200122	03	LUS7
UT27a	016388000200403	03	LUS7

\*EUT ID: is used to identify the test sample in the lab internally.

#### 3.3. Internal Identification of AE

AE ID*	Description	SN	Remarks
AE1	Battery	/	/
AE2	USB Cable	/	/
AE3	Charger	/	/
AE1			
Model		CAC4850009CA	
Manufacturer		TMB	
Capacity		4850 mAh, typ 5000mAh	
Nominal Voltage		3.87V	
AE2			
Model		CDA0000198C1	
Manufacturer		JUWEI	
Length of cable		/	
AE3			
Model		CBA0064BGTC5	
Manufacturer		PUAN	
Length of cable		/	

\*AE ID: is used to identify the ancillary equipment in the lab internally.



### 3.4. EUT Set-ups

<b>EUT set-up No.</b>	<b>Combination of EUT and AE</b>	<b>Remarks</b>
Set.NFC01	UT27a + AE1 + AE2+ AE3 + NFC Card	Charge
Set.NFC02	UT27a + AE1 + NFC card	NFC
Set.NFC03	UT25a	---

The Transmit State of NFC: the NFC function is on. The EUT will transmit the NFC data and command continuously during the test.

The Transmit state without modulation: The EUT will transmit the CW signal at the operating frequency.



## 4. Reference Documents

### 4.1. Documents supplied by applicant

EUT parameters, referring to Annex A for detailed information, are supplied by the client or manufacturer, which are the bases of testing.

### 4.2. Reference Documents for testing

The following documents listed in this section are referred for testing.

<b>Reference</b>	<b>Title</b>	<b>Version</b>
CFR 47 Part 2	Part 2 — Frequency Allocations and Radio Treaty Matters; General Rules and Regulations.	2019
CFR 47 Part 15	Part 15 — Radio Frequency Devices. Subpart C — Intentional Radiators. § 15.35 Measurement detector functions and bandwidths. § 15.207 Conducted limits. § 15.209 Radiated emission limits, general requirements. § 15.215 Additional provisions to the general radiated emission limitations. § 15.225 Operation within the band 13.110–14.010 MHz.	2019
ANSI C63.10	American National Standard of Procedures for Compliance Testing of Unlicensed Wireless Devices	2013

## 5. Test Results

### 5.1. Summary of Test Results

No	Test Cases	Clause in Regulation	Section in This Report	Verdict
1	Electric Field Strength of Fundamental Emissions	CFR 47 § 15.225(a)	B.1	P(Set. NFC02)
2	Electric Field Strength of Outside the Allocated Bands	CFR 47 § 15.225(b) CFR 47 § 15.225(c)		P(Set. NFC02)
3	Electric Field Radiated Emissions	CFR 47 § 15.209	B.2	P(Set. NFC01)
		CFR 47 § 15.225(d)	B.3	P(Set. NFC01)
4	Frequency Tolerance	CFR 47 § 15.225(e)	B.4	P(Set. NFC03)
5	20dB Bandwidth	CFR 47 § 15.215(c)	B.5	P(Set. NFC03)
6	Conducted Emissions	CFR 47 § 15.207	B.6	P(Set. NFC01)
The measurement is carried out according to ANSI C63.10. See <b>ANNEX B</b> for details.				

#### Test Conditions:

For this report, all the test cases listed above were tested under normal Temperature, Voltage, humidity and Air Pressure except the Frequency Tolerance test case. The specific conditions of Frequency Tolerance test case are listed in section B.4.3

See **Table 3** for terms for result verdict:

**Table 1 Terms for result verdict**

P	Pass, The EUT complies with the essential requirements in the standard.
NP	Not Perform, The test was not performed by CTTL
NA	Not Applicable, The test was not applicable
F	Fail, The EUT does not comply with the essential requirements in the standard

### 5.2. Statements

The test cases listed in Section 5.1 of this report for the EUT specified in Section 3 were performed by CTTL according to the reference documents in Section 4.

The EUT meets all applicable requirements of the regulations and standards in Section 4.2.



## 6. Test Facilities Utilized

NO.	NAME	TYPE	SERIES NUMBER	PRODUCER	CAL. DUE DATE	CAL. INTERVAL
1.	Spectrum Analyzer	FSL 6	100869	Rohde & schwarz	2023-10-21	1 Year
2.	Climatic chamber	SH242	93008658	ESPEC	2023-02-21	2 Year
3.	Spectrum Analyzer	FSQ26	200136	Rohde & schwarz	2023-01-13	1 Year
4.	Test Receiver	ESW44	103015	R&S	2023-01-23	1 Year
5.	H-field Antenna	HFH2-Z2	829324/007	R&S	2023-12-23	1 Year
6.	EMI Antenna	VULB 9163	01223	SCHWARZBECK	2023-07-25	1 Year
7.	Test Receiver	ESCI	100344	R&S	2023-03-21	1 Year
8.	LISN	ENV216	101200	R&S	2023-05-30	1 Year

## 7. Measurement Uncertainty

Item	Uncertainty
Frequency Tolerance	$U = 73 \text{ Hz}, k=2$
20dB Bandwidth	$U = 72 \text{ Hz}, k=2$
Radiated Emissions(9kHz-30MHz)	$U = 4.92 \text{ dB}, k=2$
Radiated Emissions (30MHz-1GHz)	$U = 5.15 \text{ dB}, k=2$
Radiated Emissions (>1GHz)	$U = 5.54 \text{ dB}, k=2$
Conducted emission	$U = 3.08 \text{ dB}, k=2$



**ANNEX A: EUT parameters**

/

## **ANNEX B: Detailed Test Results**

### **B.1. Electric Field Strength of Fundamental and Outside the Allocated bands**

#### **B.1.1. Reference**

See CFR 47 Part 15 § 15.209

See CFR 47 Part 15 § 15.225

See Clause 4, Clause 5 of ANSI C63.10-2013 generally.

#### **B.1.2. Measurement Methods**

The transmitter carrier output levels (E-Field) from the EUT are measured in a semi-anechoic chamber. The EUT is placed on a non-conductive stand of 80cm high, and at a measurement distance of 3m from the receiving antenna. The center of the receiving loop antenna is 1.0 meter above the ground. The E-field is measured with a shielded loop antenna connected to a measurement receiver. Detected E-field was maximized by rotating the EUT through 360° and adjusting the receiving antenna polarizations. The maximization processes were repeated with the EUT positioned respectively in its three orthogonal axes. The measurements were performed with the peak detector and if required, the quasi-peak detector.

The measurement bandwidth is:

**Table B-1: Measurement bandwidth**

Frequency of Emission (MHz)	RBW/VBW
12.56-14.56	10/30 kHz

The E-field measured at 3m is calculated as:

$$\text{E-field (dB}\mu\text{V/m)} = \text{Rx (dB}\mu\text{V)} + \text{Cable Loss (dB)} + \text{AF@3m (dB/m)}$$

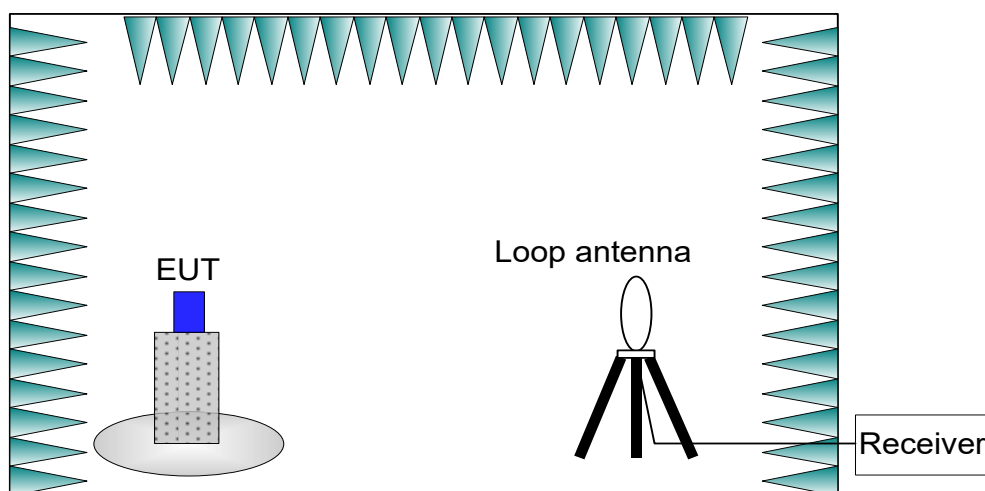

**Figure B-1: Measurement Setup**

#### **B.1.3. EUT Operating Mode and Test Conditions**

The measurement of EUT is carried out under the transmit state of NFC(See 3.4).

The EUT is powered by a travel adapter.

During the measurements, the ambient temperature of the electromagnetic anechoic chamber is in the range of 15 ~ 25 °C.

**B.1.4. Limits**

**Table B-2: Limits**

Frequency Range (MHz)	E-field Strength Limit @ 30 m (μV/m)	E-field Strength Limit @ 3 m (dBμV/m)
13.560 ± 0.007	+15,848	124
13.410 to 13.553 13.567 to 13.710	+334	90
13.110 to 13.410 13.710 to 14.010	+106	81

Note: Where the limits have been defined at one distance, and a signal level measured at another, the limits have been extrapolated using the following formula:  

$$\text{Extrapolation (dB)} = 40 \log_{10} (\text{Measurement Distance} / \text{Specification Distance})$$

**B.1.5. Measurement Results**

Measurement results of normal conditions see Figure B-2 for different set-ups of EUT. The results displayed take into account applicable antenna factors and cable losses.

**Conclusions:** Set.NFC02, **PASS.**

Full Spectrum

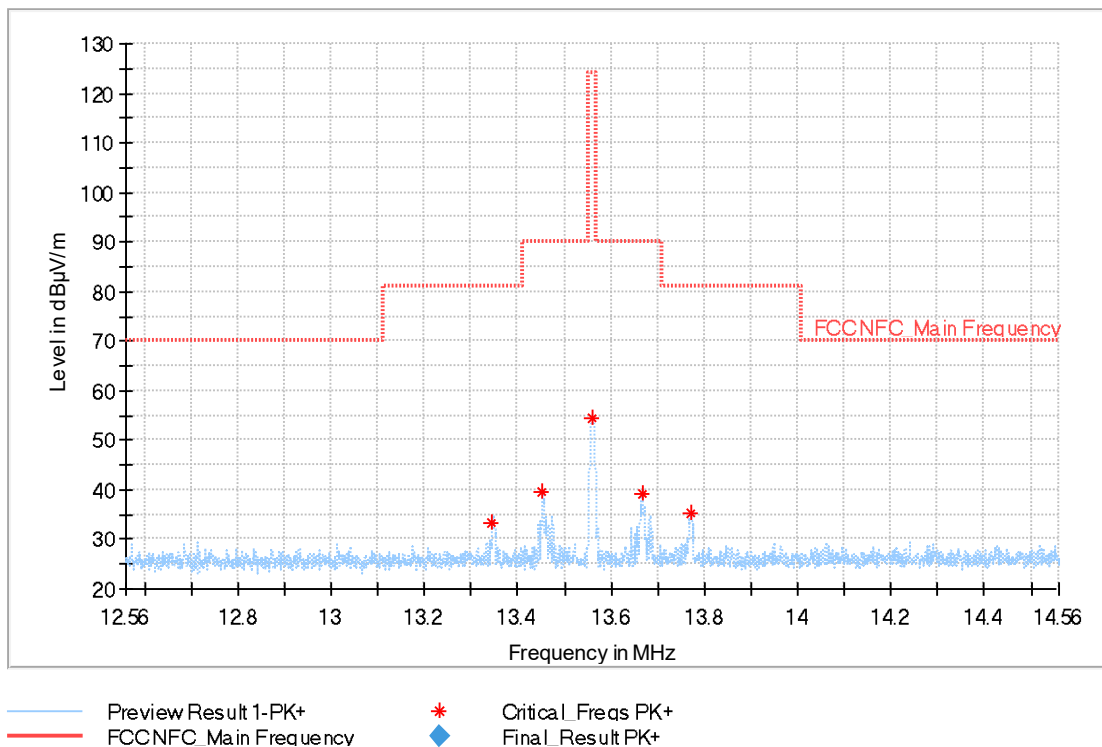

**Figure B-2: Measurement results for Electric Field Strength of Fundamental and Outside the Allocated bands**

### Critical\_Freqs

Frequency (MHz)	MaxPeak (dBμV/m)	Limit (dBμV/m)	Margin (dB)	Pol	Azimuth (deg)	Corr. (dB/m)
13.345250	33.26	81.00	47.74	V	188.0	18.0
13.453750	39.57	90.00	50.43	V	172.0	18.0
13.559000	54.38	124.00	69.62	V	179.0	17.9
13.668000	39.18	90.00	50.82	V	179.0	17.9
13.770500	35.16	81.00	45.84	V	213.0	17.9

## **B.2. Electric Field Radiated Emissions (< 30MHz)**

### **B.2.1. Reference**

See CFR 47 Part 15 § 15.209

See Clause 6.4 of ANSI C63.10-2013 specifically.

See Clause 4 and Clause 5 of ANSI C63.10-2013 generally.

### **B.2.2. Measurement Methods**

The transmitter carrier output levels (E-Field) from the EUT are measured in a semi-anechoic chamber. The EUT is placed on a non-conductive stand of 80cm high, and at a measurement distance of 3m from the receiving antenna. The center of the receiving loop antenna is 1.0 meter above the ground. The E-field is measured with a shielded loop antenna connected to a measurement receiver. Detected E-field was maximized by rotating the EUT through 360° and adjusting the receiving antenna polarizations. The maximization processes were repeated with the EUT positioned respectively in its three orthogonal axes. The measurements were performed with the peak detector and if required, the quasi-peak detector.

The measurement bandwidth is:

Frequency of Emission (MHz)	RBW/VBW
0.009-0.15	100/300 Hz
0.15-30	10/30 kHz

The E-field measured at 3m is calculated as:

$$\text{E-field (dB}\mu\text{V/m)} = \text{Rx (dB}\mu\text{V)} + \text{Cable Loss (dB)} + \text{AF@3m (dB/m)}$$



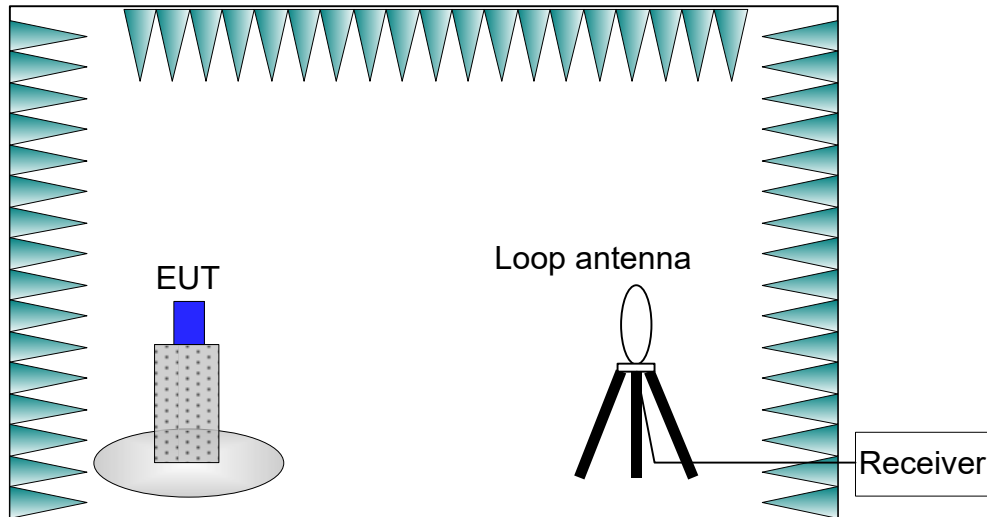

**Figure B-3: Measurement Setup**

### B.2.3. EUT Operating Mode and Test Conditions

The measurement of EUT is carried out under the transmit state of NFC(See 3.4).

The EUT is powered by a travel adapter.

During the measurements, the ambient temperature of the electromagnetic anechoic chamber is in the range of 15 ~ 25 °C.

### B.2.4. Limits

Frequency Range (MHz)	E-field Strength Limit @ 30m (mV/m)	E-field Strength Limit @ 3m (dB $\mu$ V/m)
0.009-0.490	2400/F(kHz)	129-94
0.490-1.705	24000/F(kHz)	74-63
1.705-30	30	70

Note: Where the limits have been defined at one distance, and a signal level measured at another, the limits have been extrapolated using the following formula:

$$\text{Extrapolation(dB)} = 40\log_{10}(\text{Measurement Distance}/\text{Specification Distance})$$

### B.2.5. Measurement Results

Measurement results of normal conditions see Figure B-4 for different set-ups of EUT. The results displayed take into account applicable antenna factors and cable losses.

**Conclusions:** Set.NFC01, **PASS**.

Full Spectrum

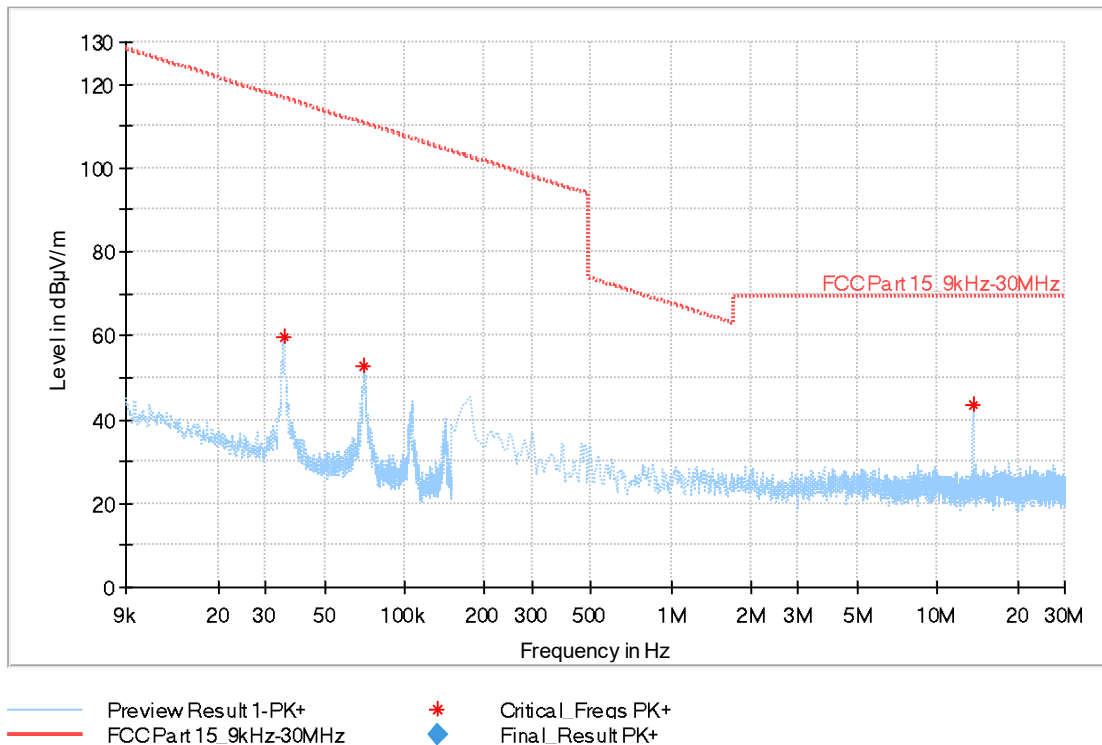
**Figure B-4: Measurement results for Electric Field Radiated Emissions (< 30MHz)**
**Critical\_Freqs**

Frequency (MHz)	MaxPeak (dBµV/m)	Limit (dBµV/m)	Margin (dB)	Pol	Azimuth (deg)	Corr. (dB/m)
0.035282	59.75	116.64	56.89	V	270.0	18.2
0.070772	52.75	110.60	57.85	V	270.0	18.1
13.560113	43.39	69.50	26.11	V	180.0	17.9

**B.3. Electric Field Radiated Emissions (≥30MHz)**
**B.3.1. Reference**

See CFR 47 Part 15 § 15.209

See Clause 6.5 of ANSI C63.10-2013 specifically.

See Clause 4 and Clause 5 of ANSI C63.10-2013 generally.

**B.3.2. Measurement Methods**

The electric field radiated emissions from the EUT are measured in a semi-anechoic chamber. The EUT is placed on a non-conductive stand of 80cm high, and at a measurement distance of 10m from the receiving antenna. The receiving antennas connected to a measurement receiver. In order to search for maximum field strength emitted from the EUT, the receiving antenna can be moved between the height of 1.0 m to 4.0 m. Detected E-field was maximized at each frequency by rotating the EUT through 360° and adjusting the receiving antenna positions for both vertical and horizontal antenna polarizations. The maximization processes were repeated with the EUT

positioned respectively in its three orthogonal axes. The measurements were performed with the peak detector and if required, the quasi-peak detector.

The measurement bandwidth is:

Frequency of Emission (MHz)	RBW/VBW
30-1000	120kHz

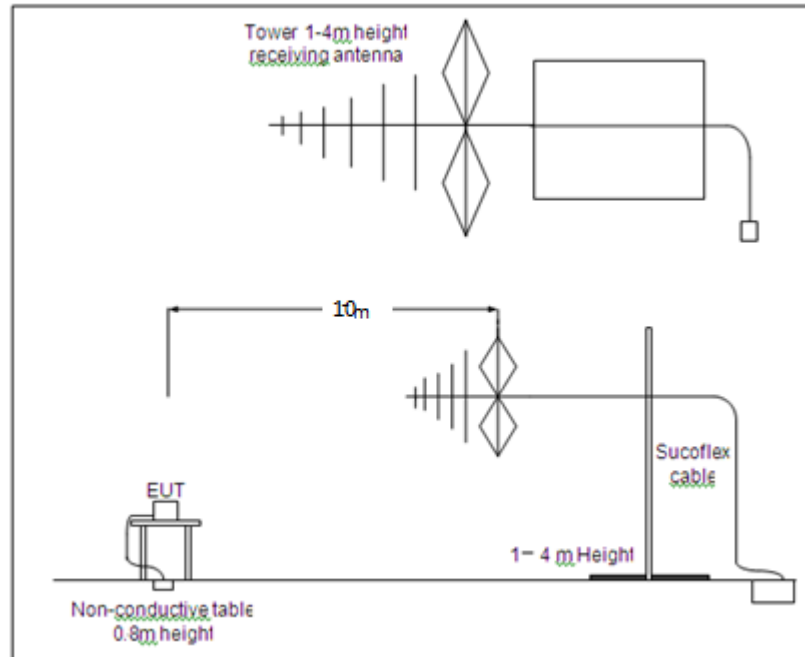

Figure B-5: Measurement Setup

### B.3.3. EUT Operating Mode and Test Conditions

The measurement of EUT is carried out under the transmit state of NFC(See 3.4).

The EUT had been connected to a travel adapter.

During the measurements, the ambient temperature of the electromagnetic anechoic chamber is in the range of 15 ~ 25 °C.

### B.3.4. Limits

Frequency Range (MHz)	E-field Strength Limit @ 3m (mV/m)	E-field Strength Limit @ 3m (dB $\mu$ V/m)	E-field Strength Limit @ 10m (dB $\mu$ V/m)
30-88	100	40	30
88-216	150	43.5	33.5
216-960	200	46	36
960-1000	500	54	44

### B.3.5. Measurement Results

Measurement results of normal conditions see Figure B-6 for different set-ups of EUT. The results displayed take into account applicable antenna factors and cable losses.

**Conclusions:** Set.NFC01, **PASS**.

Full Spectrum

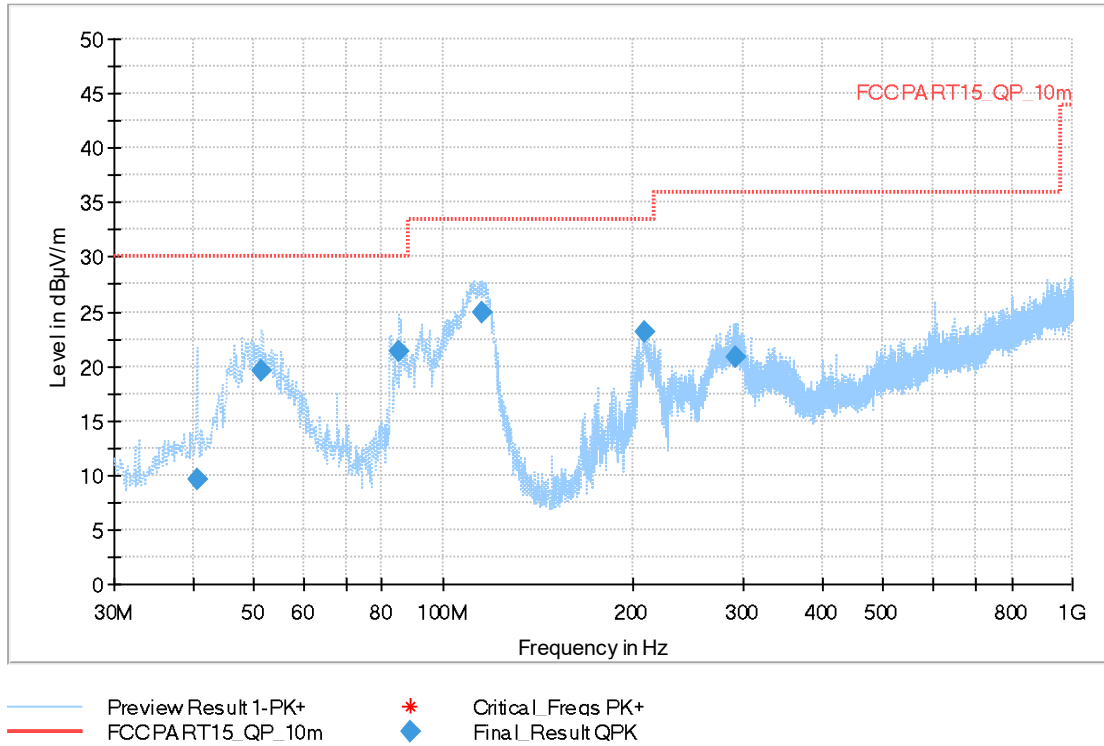
**Figure B-6: Measurement results for Electric Field Radiated Emissions ( $\geq 30\text{MHz}$ )**
**Final\_Result**

Frequency (MHz)	QuasiPeak (dBµV/m)	Limit (dBµV/m)	Margin (dB)	Height (cm)	Pol	Azimuth (deg)
40.573000	9.53	30.00	20.47	125.0	V	225.0
51.534000	19.64	30.00	10.36	100.0	V	268.0
85.096000	21.39	30.00	8.61	125.0	V	-19.0
114.875000	24.96	33.52	8.56	100.0	V	175.0
209.256000	23.11	33.52	10.41	108.0	V	73.0
291.609000	20.81	36.02	15.21	100.0	V	137.0

## **B.4. Frequency Tolerance**

### **B.4.1. Reference**

See CFR 47 Part 15 § 15.225(e)

See Clause 6.8 of ANSI C63.10-2013 specifically.

See Clause 4 and Clause 5 of ANSI C63.10-2013 generally.

### **B.4.2. Measurement Methods**

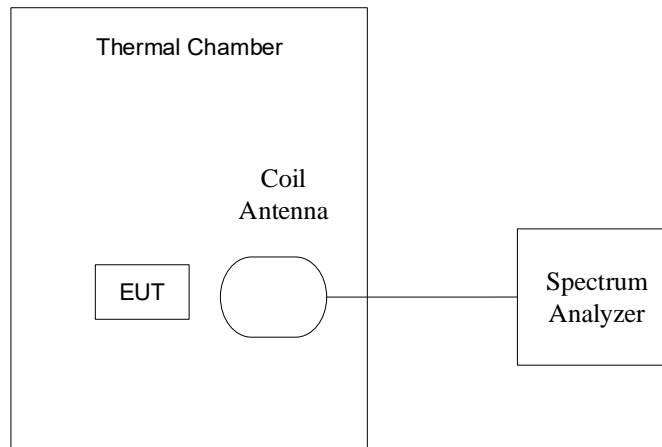

**Figure B-7: Measurement Setup**

The transmitter output signal was picked up by coil antenna connected to the spectrum analyzer. The center frequency was measured with 30Hz RBW and 1kHz span. During the test, the EUT was placed in a thermal chamber until thermal balance and lasting appropriate time.

### **B.4.3. EUT Operating Mode and Test Conditions**

The measurement of EUT was carried out under the transmit state of without modulation(See 3.4). EUT had not been connected to a travel adapter. The frequency stability was measured with the different voltage and temperature combinations:

- a) The nominal voltage 3.85V(See 3.1)was used and the temperature was varied from -20°C to +50°C in 10°C increments using an environmental chamber.
- b) The 20°C was used and the voltages were 3.6V, 3.85V and 4.4V (The extreme low voltage ,the normal voltage and the normal voltage defined in section 3.1).

The details were as following:

**Table B-3: Combinations of Voltage andTemperature**

Test items	Voltage	Temperature
Frequency stability with respect to ambient temperature	3.85 V	-20°C
		-10°C
		0°C
		10°C
		20°C
		30°C

		40°C
		50°C
Frequency stability when varying supply voltage	3.6 V	20°C
	3.85V	
	4.4V	

#### B.4.4. Test Layouts

See B.4.2.

#### B.4.5. Limits

The frequency tolerance of the carrier signal shall be maintained within +/- 0.01% of the operating frequency.

#### B.4.6. Measurement Results

Measurement results see Table B-4 for different test conditions.

**Conclusions:** Set.NFC03, **PASS**.

**Table B-4: Measurement results for Frequency Tolerance**

Temperature	Voltage	Frequency (MHz)			
		Startup	2 Min Later	5 Min Later	10 Min Later
-20°C	3.85V	13.560182000	13.560168000	13.560168000	13.560168000
-10°C	3.85V	13.560192000	13.560192000	13.560176000	13.560176000
0°C	3.85V	13.560198000	13.560198000	13.560216000	13.560216000
10°C	3.85V	13.560176000	13.560192000	13.560208000	13.560208000
20°C	3.85V	13.560162000	13.560162000	13.560154000	13.560144000
30°C	3.85V	13.560144000	13.560126000	13.560126000	13.560112000
40°C	3.85V	13.560096000	13.560084000	13.560064000	13.560056000
50°C	3.85V	13.560072000	13.560072000	13.560054000	13.560054000
20°C	3.6V	13.560126000	13.560144000	13.560154000	13.560154000
20°C	4.4V	13.560144000	13.560144000	13.560154000	13.560154000

Temperature	Voltage	Frequency Error (%)			
		Startup	2 Min Later	5 Min Later	10 Min Later
-20°C	3.85V	0.001	0.001	0.001	0.001
-10°C	3.85V	0.001	0.001	0.001	0.001
0°C	3.85V	0.001	0.001	0.002	0.002
10°C	3.85V	0.001	0.001	0.002	0.002
20°C	3.85V	0.001	0.001	0.001	0.001
30°C	3.85V	0.001	0.001	0.001	0.001
40°C	3.85V	0.001	0.001	0.000	0.000
50°C	3.85V	0.001	0.001	0.000	0.000
20°C	3.6V	0.001	0.001	0.001	0.001
20°C	4.4V	0.001	0.001	0.001	0.001

#### B.4.7. Measurement Uncertainty

Measurement uncertainty:  $U = 73 \text{ Hz}$ ,  $k=2$

### B.5. 20dB Bandwidth

#### B.5.1. Reference

See CFR 47 Part 15 § 15.215(c)

See Clause 6.9 of ANSI C63.10-2013 specifically.

See Clause 4 and Clause 5 of ANSI C63.10-2013 generally.

#### B.5.2. Measurement Methods

The transmitter output signal was picked up by coil antenna connected to the spectrum analyzer. The bandwidth of the center frequency was measured with 100Hz RBW, 300Hz VBW and 12kHz span.

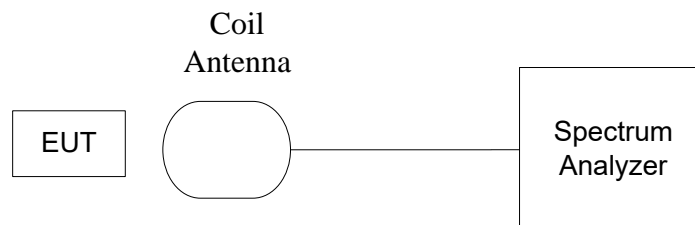

**Figure B-8: Measurement Setup**

#### B.5.3. EUT Operating Mode and Test Conditions

The measurement of EUT was carried out under the transmit state of NFC (See 3.4).

EUT had not been connected to a travel adapter.

During the measurements, the ambient temperature was in the range of 15 ~ 25 °C.

#### B.5.4. Test Layouts

See B.5.2.

#### B.5.5. Limits

The 20dB bandwidth shall be less than 80% of the permitted frequency band. For 13.56 MHz NFC, the permitted frequency band is 14kHz, so the limit is 11.2 kHz.

#### B.5.6. Measurement Results

Measurement results see Figure B-9.

**Conclusions:** Set.NFC03, **PASS**.

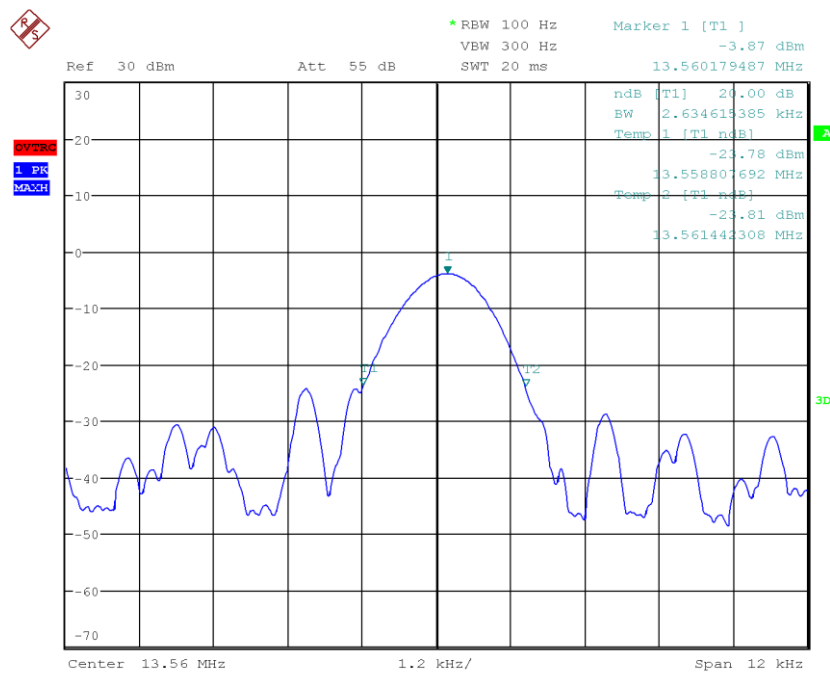

**Figure B-9: Measurement results for 20dB Bandwidth**

### B.5.7. Measurement Uncertainty

Measurement uncertainty:  $U = 72 \text{ Hz}$ ,  $k=2$

## B.6. Conducted emission

### B.6.1. Reference

See CFR 47 Part 15 § 15.207

See Clause 6.2 of ANSI C63.10-2013 specifically.

See Clause 4 and Clause 5 of ANSI C63.10-2013 generally.

### B.6.2. Measurement Methods

The conducted emissions from the AC port of the EUT are measured in a shielding room. The EUT is connected to a Line Impedance Stabilization Network (LISN). An overview sweep with peak detection was performed. The measurements were performed with a quasi-peak detector and if required, an average detector.

The conducted emission measurements were made with the following detector of the test receiver: Quasi-Peak / Average Detector.

The measurement bandwidth is:

**Table B-5: Measurement Bandwidth**

Frequency of Emission (MHz)	RBW/VBW
0.15-30	9kHz



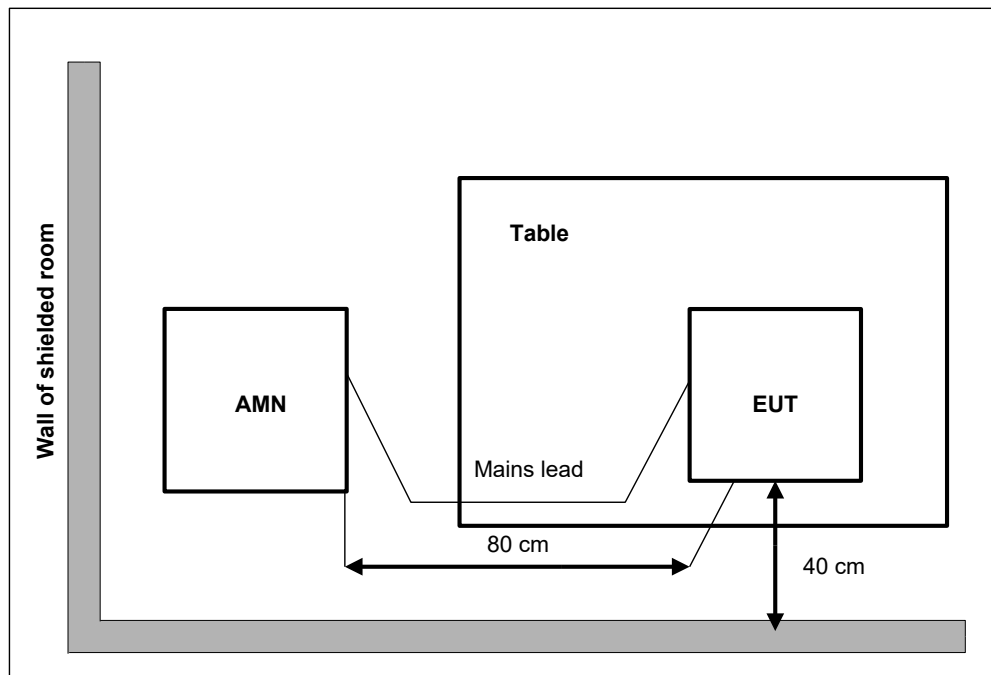

**Figure B-10: Measurement Setup**

### B.6.3. EUT Operating Mode and Test Conditions

The measurement of EUT is carried out under the transmit state of NFC(See 3.4).

The EUT is powered by a travel adapter.

During the measurements, the ambient temperature is in the range of 15 ~ 25 °C.

### B.6.4. Limits

Frequency range (MHz)	Quasi-peak Limit (dB $\mu$ V)	Average Limit (dB $\mu$ V)
0.15 to 0.5	66 to 56	56 to 46
0.5 to 5	56	46
5 to 30	60	50

### B.6.5. Measurement Results

Measurement results see Figure B-11.

**Conclusions: Set.NFC01, PASS.**

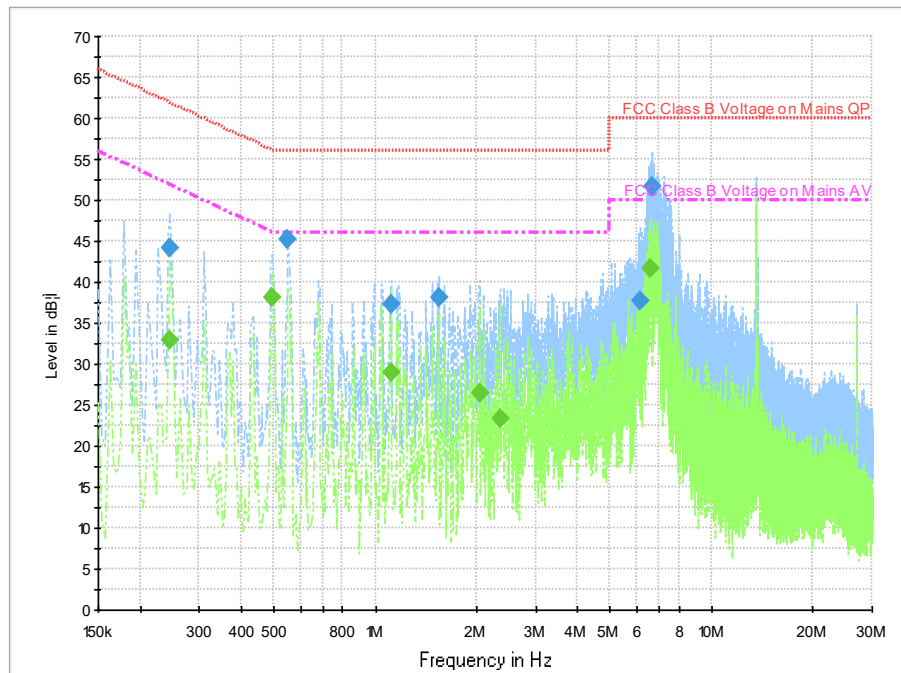

Figure B-11: Measurement results for Conducted Emission

**Final Result 1**

Frequency (MHz)	QuasiPeak (dBuV)	Line	Corr. (dB)	Margin (dB)	Limit (dBuV)
0.246000	44.2	N	19.7	17.7	61.9
0.550000	45.2	L1	19.7	10.8	56.0
1.110000	37.2	L1	19.6	18.8	56.0
1.546000	38.2	L1	19.6	17.8	56.0
6.118000	37.7	N	19.6	22.3	60.0
6.662000	51.8	L1	19.6	8.2	60.0

**Final Result 2**

Frequency (MHz)	Average (dBuV)	Line	Corr. (dB)	Margin (dB)	Limit (dBuV)
0.246000	33.0	N	19.7	18.9	51.9
0.494000	38.2	L1	19.7	7.9	46.1
1.110000	28.9	L1	19.6	17.1	46.0
2.038000	26.4	L1	19.6	19.6	46.0
2.346000	23.3	L1	19.6	22.7	46.0
6.590000	41.7	L1	19.6	8.3	50.0

**ANNEX C: Persons involved in this testing**

Test Item	Tester
20dB Bandwidth	Miao Qinghua
Frequency Tolerance	Miao Qinghua
Electric Field Strength of Fundamental and Outside the Allocated bands	Ding Zai
Electric Field Radiated Emissions (< 30MHz)	Ding Zai
Electric Field Radiated Emissions ( $\geq 30$ MHz)	Ding Zai
Conducted Emissions	Zhang Tianli

## ANNEX D: Accreditation Certificate

<p>United States Department of Commerce National Institute of Standards and Technology</p> <p><b>NVLAP</b>® </p> <hr/> <p><b>Certificate of Accreditation to ISO/IEC 17025:2017</b></p> <hr/> <p>NVLAP LAB CODE: 600118-0</p> <p><b>Telecommunication Technology Labs, CAICT</b> Beijing China</p> <p><i>is accredited by the National Voluntary Laboratory Accreditation Program for specific services, listed on the Scope of Accreditation, for:</i></p> <p><b>Electromagnetic Compatibility &amp; Telecommunications</b></p> <p><i>This laboratory is accredited in accordance with the recognized International Standard ISO/IEC 17025:2017. This accreditation demonstrates technical competence for a defined scope and the operation of a laboratory quality management system (refer to joint ISO-ILAC-IAF Communique dated January 2009).</i></p> <hr/> <p>2022-10-01 through 2023-09-30 <i>Effective Dates</i></p> <p style="text-align: center;"></p> <p style="text-align: right;"> <i>For the National Voluntary Laboratory Accreditation Program</i></p>	
--	--

\*\*\*END OF REPORT\*\*\*