



TEST REPORT

No.B23N00897-HAC RF

For

TCL Communication Ltd.

GSM/UMTS/LTE/NR Mobile phone

Model Name: T609L

With

Hardware Version: 04

Software Version: WES0

FCC ID: 2ACCJH168

Results Summary: M Category = M3

Issued Date: 2023-6-8

Designation Number: CN1210

Note:

The test results in this test report relate only to the devices specified in this report. This report shall not be reproduced except in full without the written approval of SAICT.

Test Laboratory:

SAICT, Shenzhen Academy of Information and Communications Technology

Building G, Shenzhen International Innovation Center, No.1006 Shennan Road, Futian District, Shenzhen, Guangdong, P. R. China 518000.

Tel:+86(0)755-33322000, Fax:+86(0)755-33322001

Email: yewu@caict.ac.cn www.saict.ac.cn



REPORT HISTORY

Report Number	Revision	Description	Issue Date
B23N00897-HAC RF	Rev.0	1st edition	2023-6-8



CONTENTS

1. SUMMARY OF TEST REPORT	5
1.1. TEST ITEMS	5
1.2. TEST STANDARDS	5
1.3. TEST RESULT.....	5
1.4. TESTING LOCATION	5
1.5. PROJECT DATA	5
1.6. SIGNATURE	5
2. CLIENT INFORMATION	6
2.1. APPLICANT INFORMATION.....	6
2.2. MANUFACTURER INFORMATION	6
3. EQUIPMENT UNDER TEST (EUT) AND ANCILLARY EQUIPMENT (AE)	7
3.1. ABOUT EUT.....	7
3.2. INTERNAL IDENTIFICATION OF EUT USED DURING THE TEST	7
3.3. INTERNAL IDENTIFICATION OF AE USED DURING THE TEST.....	7
3.4. AIR INTERFACES / BANDS INDICATING OPERATING MODES.....	8
4. REFERENCE DOCUMENTS	9
5. OPERATIONAL CONDITIONS DURING TEST	10
5.1. HAC MEASUREMENT SET-UP	10
5.2. PROBE SPECIFICATION	11
5.3. TEST ARCH PHANTOM & PHONE POSITIONER	12
5.4. ROBOTIC SYSTEM SPECIFICATIONS.....	12
6. EUT ARRANGEMENT	13
6.1. WD RF EMISSION MEASUREMENTS REFERENCE AND PLANE	13
7. SYSTEM VALIDATION	14
7.1. VALIDATION PROCEDURE	14
7.2. VALIDATION RESULT	14
8. MODULATION INTERFERENCE FACTOR (MIF)	15
9. EVALUATION FOR LOW-POWER EXEMPTION	17
9.1. PRODUCT TESTING THRESHOLD	17
9.2. AVERAGE CONDUCTED POWER.....	18
10. RF TEST PROCEDURES	19
11. MEASUREMENT RESULTS (E-FIELD)	20
12. ANSI C 63.19-2011 LIMITS	21



13. MEASUREMENT UNCERTAINTY	22
14. MAIN TEST INSTRUMENTS	23
ANNEX A: RF EMISSION TEST PLOT	24
ANNEX B: SYSTEM VALIDATION RESULT	43
ANNEX C: DIPOLE CALIBRATION CERTIFICATE	47
ANNEX D: PROBE CALIBRATION CERTIFICATE	67
ANNEX E: DAE CALIBRATION CERTIFICATE	76
ANNEX F: UID SPECIFICATION.....	81



1. Summary of Test Report

1.1. Test Items

Description: GSM/UMTS/LTE/NR Mobile phone
Model Name: T609L
Applicant's Name: TCL Communication Ltd.
Manufacturer's Name: TCL Communication Ltd.

1.2. Test Standards

ANSI C63.19-2011

1.3. Test Result

Pass

1.4. Testing Location

Address: Building G, Shenzhen International Innovation Center, No.1006 Shennan Road, Futian District, Shenzhen, Guangdong, P. R. China

1.5. Project Data

Testing Start Date: 2022-11-21

Testing End Date: 2023-5-20

1.6. Signature

Li Yongfu
(Prepared this test report)

Liu Jian
(Reviewed this test report)

Cao Junfei
(Approved this test report)



2. Client Information

2.1. Applicant Information

Company Name:	TCL Communication Ltd.
Address:	5/F, Building 22E, 22 Science Park East Avenue, Hong Kong Science Park, Shatin, NT
City:	Hong Kong
Country:	China
Telephone:	+86 755 3661 1621

2.2. Manufacturer Information

Company Name:	TCL Communication Ltd.
Address:	5/F, Building 22E, 22 Science Park East Avenue, Hong Kong Science Park, Shatin, NT
City:	Hong Kong
Country:	China
Telephone:	+86 755 3661 1621



3. Equipment under Test (EUT) and Ancillary Equipment (AE)

This EUT is a variant product and the report of original sample is No B22N02447-HAC RF. We add NR n12 /n48 and share other bands results of original sample.

3.1. About EUT

Description:	GSM/UMTS/LTE/NR Mobile phone
Mode Name:	T609L
Condition of EUT as received:	No obvious damage in appearance
Frequency Bands:	GSM 850/1900, WCDMA Band 2/4/5, LTE Band 2/4/5/7/12/13/25/26/41/48/66/71, NR n2/n5/n12/n25/n41/n48/n66/n71/n77, Bluetooth, WLAN 2.4GHz, WLAN 5GHz
Remark: The LTE Band 48 test data is referenced to I22Z61606-SEM01 report.	

3.2. Internal Identification of EUT used during the test

EUT ID*	IMEI	HW Version	SW Version	Receipt Date
UT01aa	016320000013189	04	WES0	2022-11-21

*EUT ID: is used to identify the test sample in the lab internally.

Note: It is performed to test HAC with the UT01aa.

3.3. Internal Identification of AE used during the test

AE ID*	Description	Model	Manufacturer
AE1	Battery	TLp048D7	VEKEN

*AE ID: is used to identify the test sample in the lab internally.



3.4. Air Interfaces / Bands Indicating Operating Modes

Air-interface	Band(MHz)	Type	C63.19 / tested	Simultaneous Transmissions	Name of Voice Service	Power Reduction
GSM	850 /1900	VO	Yes	BT,WLAN	CMRS Voice	No
EDGE	850 /1900	DT	No	BT,WLAN	NA	No
WCDMA	B2 / B4/ B5	VO	No	BT,WLAN	CMRS Voice	No
	HSPA	VD	No	BT,WLAN	Google Duo	No
LTE (FDD)	2/4/5/7/12/13/25/ 26/66/71	VD	No	NR,BT,WLAN	VoLTE, Google Duo	No
LTE (TDD)	41/48	VD	Yes	NR,BT,WLAN	VoLTE, Google Duo	No
NR (FDD)	n2/n5/n12/n25/n66/n71	VD	No	LTE,BT,WLAN	Google Duo	No
NR (TDD)	n41/n48/n77	VD	No	LTE,BT,WLAN	Google Duo	No
WLAN	2.4GHz	VD	Yes	WWAN	VoWIFI Google Duo	No
WLAN	5GHz	VD	No	WWAN	VoWIFI Google Duo	No
Bluetooth	2.4GHz	DT	No	WWAN	NA	No

VO: Voice CMRS/PSTN Service Only

VD: Voice CMRS/PSTN and Data Service

DT: Digital Transport

* HAC Rating was not based on concurrent voice and data modes; Non-current mode was found to represent worst case rating for both M and T rating.



4. Reference Documents

The following document listed in this section is referred for testing.

Reference	Title	Version
ANSI C63.19-2011	American National Standard for Methods of Measurement of Compatibility between Wireless Communication Devices and Hearing Aids	2011
KDB 285076 D01	Equipment Authorization Guidance for Hearing Aid Compatibility	v06r02
KDB 285076 D02	Guidance for performing T-Coil tests for air interfaces supporting voice over IP (e.g., LTE and WiFi) to support CMRS based telephone services	v04
KDB 285076 D03	Hearing Aid Compatibility Frequently Asked Questions	v01r06

5. Operational Conditions During Test

5.1. HAC Measurement Set-up

These measurements are performed using the DASY5 NEO automated dosimetric assessment system. It is made by Schmid & Partner Engineering AG (SPEAG) in Zurich, Switzerland. It consists of high precision robotics system (Stäubli), robot controller, Intel Core2 computer, near-field probe, probe alignment sensor. The robot is a six-axis industrial robot performing precise movements. A cell controller system contains the power supply, robot controller, teach pendant (Joystick), and remote control, is used to drive the robot motors. The PC consists of the HP Intel Core2 1.86 GHz computer with Windows XP system and HAC Measurement Software DASY5 NEO, A/D interface card, monitor, mouse, and keyboard. The Stäubli Robot is connected to the cell controller to allow software manipulation of the robot. A data acquisition electronic (DAE) circuit performs the signal amplification, signal multiplexing, AD-conversion, offset measurements, mechanical surface detection, collision detection, etc. is connected to the Electro-optical coupler (EOC). The EOC performs the conversion from the optical into digital electric signal of the DAE and transfers data to the PC plug-in card.

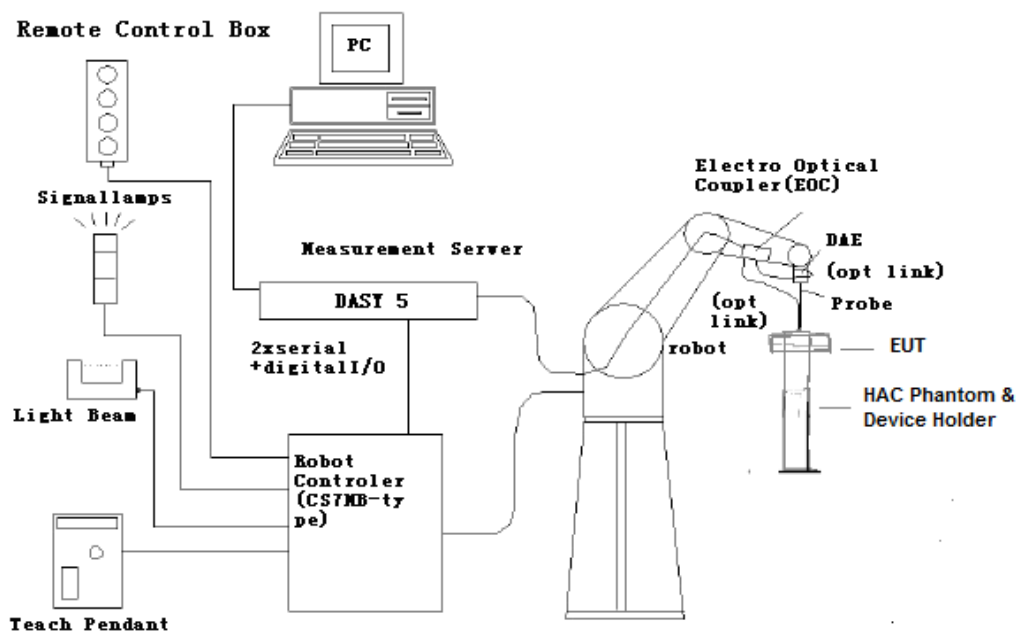

Fig. 1 HAC Test Measurement Set-up

The DAE4 consists of a highly sensitive electrometer-grade preamplifier with auto-zeroing, a channel and gain-switching multiplexer, a fast 16 bit AD-converter and a command decoder and control logic unit. Transmission to the PC-card is accomplished through an optical downlink for data and status information and an optical uplink for commands and clock lines. The mechanical probe mounting device includes two different sensor systems for frontal and sidewise probe contacts. They are also used for mechanical surface detection and probe collision detection. The robot uses its own controller with a built in VME-bus computer.



5.2. Probe Specification

E-Field Probe Description

Construction	One dipole parallel, two dipoles normal to probe axis Built-in shielding against static charges PEEK enclosure material
Calibration	In air from 100 MHz to 3.0 GHz (absolute accuracy $\pm 6.0\%$, $k=2$)
Frequency	40 MHz to > 6 GHz (can be extended to < 20 MHz) Linearity: ± 0.2 dB (100 MHz to 3 GHz)
Directivity	± 0.2 dB in air (rotation around probe axis) ± 0.4 dB in air (rotation normal to probe axis)
Dynamic Range	2 V/m to > 1000 V/m; Linearity: ± 0.2 dB
Dimensions	Overall length: 330 mm (Tip: 16 mm) Tip diameter: 8 mm (Body: 12 mm) Distance from probe tip to dipole centers: 2.5 mm
Application	General near-field measurements up to 6 GHz Field component measurements Fast automatic scanning in phantoms



[ER3DV6]

5.3. Test Arch Phantom & Phone Positioner

The Test Arch phantom should be positioned horizontally on a stable surface. Reference markings on the Phantom allow the complete setup of all predefined phantom positions and measurement grids by manually teaching three points in the robot. It enables easy and well defined positioning of the phone and validation dipoles as well as simple teaching of the robot (Dimensions: 370 x 370 x 370 mm).

The Phone Positioner supports accurate and reliable positioning of any phone with effect on near field $<\pm 0.5$ dB.

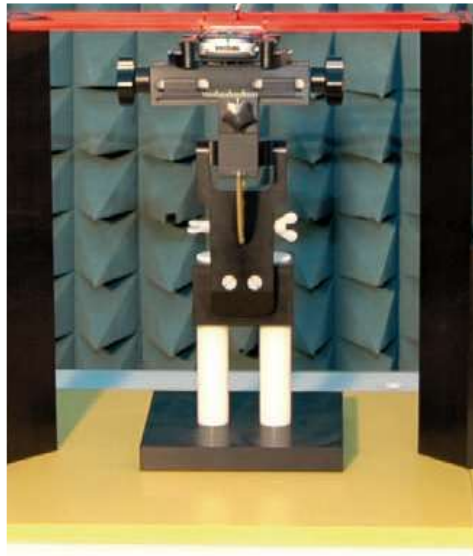

Fig. 2 HAC Phantom & Device Holder

5.4. Robotic System Specifications

Specifications

Positioner: Stäubli Unimation Corp. Robot Model: RX160XL

Repeatability: ± 0.02 mm

No. of Axis: 6

Data Acquisition Electronic (DAE) System

Cell Controller

Processor: Intel Core2

Clock Speed: 1.86 GHz

Operating System: Windows XP

Data Converter

Features: Signal Amplifier, multiplexer, A/D converter, and control logic

Software: DASY5 software

Connecting Lines: Optical downlink for data and status info.

Optical uplink for commands and clock

6. EUT Arrangement

6.1. WD RF Emission Measurements Reference and Plane

Figure 4 illustrates the references and reference plane that shall be used in the WD emissions measurement.

- The grid is 5 cm by 5 cm area that is divided into 9 evenly sized blocks or sub-grids.
- The grid is centered on the audio frequency output transducer of the WD (speaker or T-coil).
- The grid is located by reference to a reference plane. This reference plane is the planar area that contains the highest point in the area of the WD that normally rests against the user's ear
- The measurement plane is located parallel to the reference plane and 15 mm from it, out from the phone. The grid is located in the measurement plane.

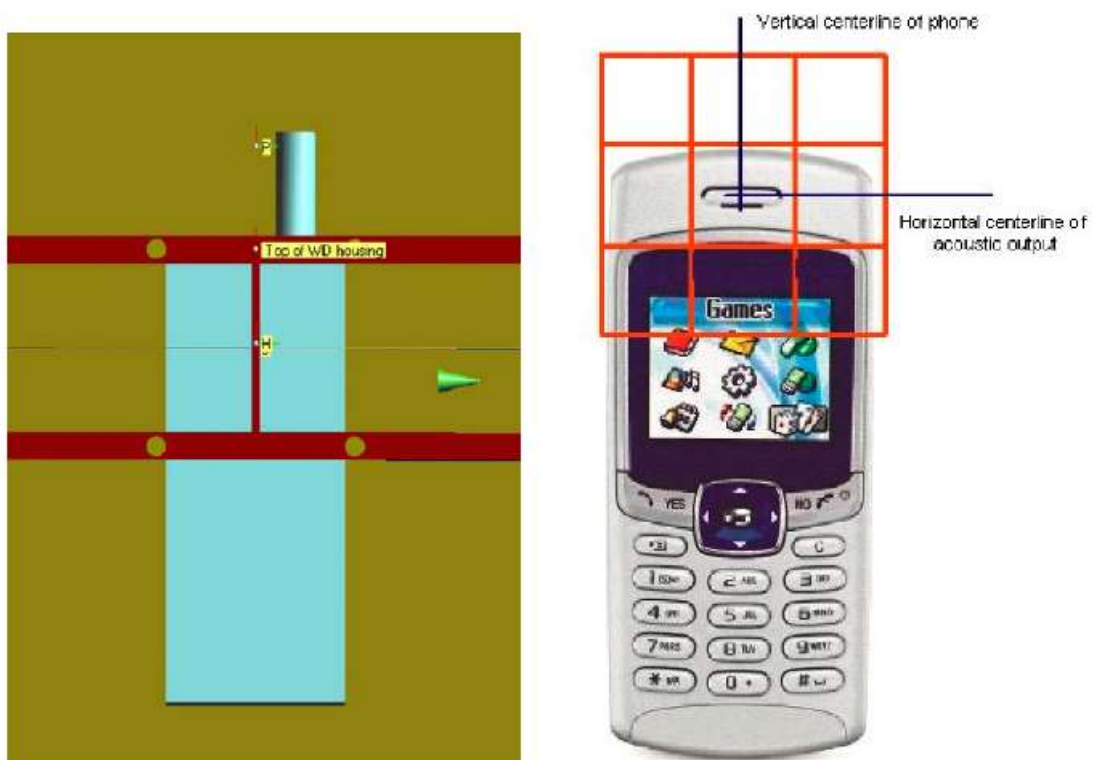

Fig. 3 WD reference and plane for RF emission measurements

7. System Validation

7.1. Validation Procedure

Place a dipole antenna meeting the requirements given in ANSI C63.19 in the position normally occupied by the WD. The dipole antenna serves as a known source for an electrical output. Position the E-field probes so that:

- The probes and their cables are parallel to the coaxial feed of the dipole antenna
- The probe cables and the coaxial feed of the dipole antenna approach the measurement area from opposite directions
- The center point of the probe element(s) are 15 mm from the closest surface of the dipole elements.

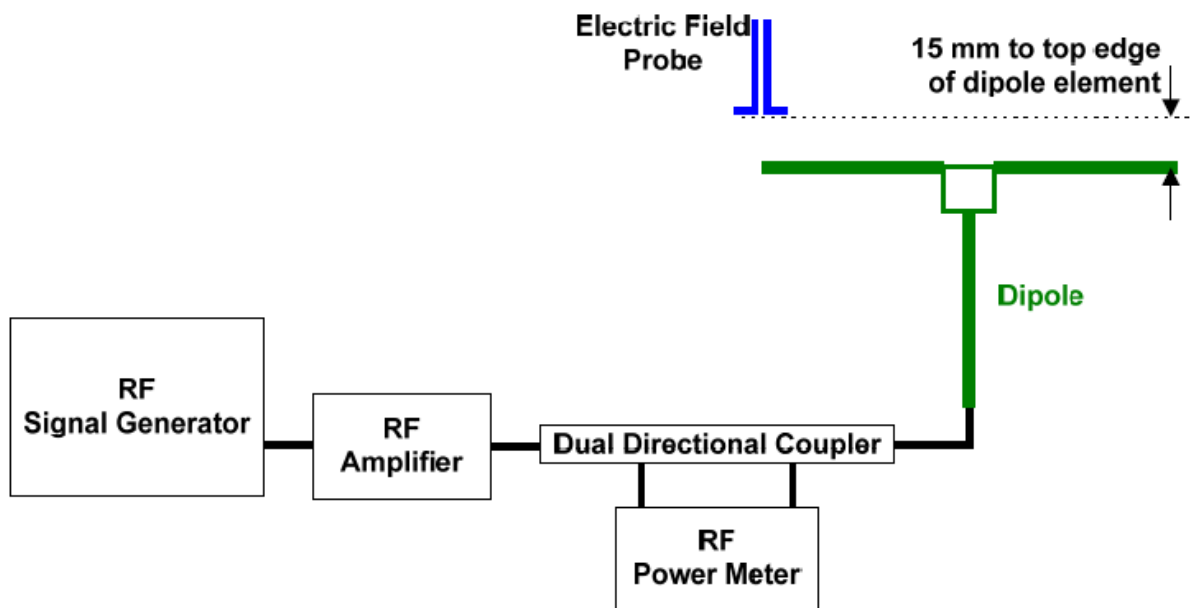

Fig. 4 Dipole Validation Setup

7.2. Validation Result

E-Field Scan						
Mode	Frequency (MHz)	Input Power (mW)	Measured ¹ Value(dBV/m)	Target ² Value(dBV/m)	Deviation ³ (%)	Limit ⁴ (%)
CW	835	100	42.28	41.15	2.75	±25
CW	1880	100	39.66	38.93	1.88	±25
CW	2450	100	39.74	38.76	2.53	±25
CW	2600	100	39.53	38.62	2.36	±25

Notes:

1. Please refer to the attachment for detailed measurement data and plot.
2. Target value is provided by SPEAD in the calibration certificate of specific dipoles.
3. Deviation (%) = 100 * (Measured value minus Target value) divided by Target value.
4. ANSI C63.19 requires values within ± 25% are acceptable, of which 12% is deviation and 13% is measurement uncertainty. Values independently validated for the dipole actually used in the measurements should be used, when available.



8. Modulation Interference Factor (MIF)

The HAC Standard ANSI C63.19-2011 defines a new scaling using the Modulation Interference Factor (MIF) which replaces the need for the Articulation Weighting Factor (AWF) during the evaluation and is applicable to any modulation scheme.

The Modulation Interference factor (MIF, in dB) is added to the measured average E-field (in dBV/m) and converts it to the RF Audio Interference level (in dBV/m). This level considers the audible amplitude modulation components in the RF E-field. CW fields without amplitude modulation are assumed to not interfere with the hearing aid electronics. Modulations without time slots and low fluctuations at low frequencies have low MIF values, TDMA modulations with narrow transmission and repetition rates of few 100 Hz have high MIF values and give similar classifications as ANSI C63-2007.

Definitions

ER3D, E-field probes have a bandwidth <10 kHz and can therefore not evaluate the RF envelope in the full audio band. DASY52 is therefore using the “indirect” measurement method according to ANSI C63.19-2011 which is the primary method. These near field probes read the averaged E-field measurement. Especially for the new high peak-to-average (PAR) signal types, the probes shall be linearized by probe modulation response (PMR) calibration in order to not overestimate the field reading.

The evaluation method or the MIF is defined in ANSI C63.19-2011 section D.7. An RMS demodulated RF signal is fed to a spectral filter (similar to an A weighting filter) and forwarded to a temporal filter acting as a quasi-peak detector. The averaged output of these filtering is called to a 1 kHz 80% AM signal as reference. MIF measurement requires additional instrumentation and is not well suited for evaluation by the end user with reasonable uncertainty It may alternatively be determined through analysis and simulation, because it is constraint and characteristic for a communication signal. DASY52 uses well defined signals for PMR calibration. The MIF of these signals has been determined by simulation and is automatically applied.

MIF values were not tested by a probe or as specified in the standards but are based on analysis provided by SPEAG for all the air interfaces (GSM, WCDMA, CDMA, LTE). The data included in this report are for the worst case operating modes. The UIDs used are listed below:



UID	Communication System Name	MIF (dB)
10021	GSM-FDD (TDMA, GMSK)	3.63
10460	UMTS-FDD (WCDMA, AMR)	-25.43
10097	UMTS-FDD (HSDPA)	-20.75
10170	LTE-FDD(SC-FDMA, 1RB, 20MHz, 16-QAM)	-9.76
10176	LTE-FDD(SC-FDMA, 1RB, 10MHz, 16-QAM)	-9.76
10173	LTE-TDD (SC-FDMA, 1 RB, 20 MHz, 16QAM)	-1.44
10769	5G NR (CP-OFDM, 1 RB, 15 MHz, QPSK, 15 kHz)	-12.08
10061	IEEE 802.11b WiFi 2.4 GHz (DSSS, 11 Mbps)	-2.02
10069	IEEE 802.11a/h WiFi 5 GHz (OFDM, 54 Mbps)	-3.15

A PMR calibrated probe is linearized for the selected waveform over the full dynamic range within the uncertainty specified in its calibration certificate. ER3D, EF3D and EU2D E-field probes have a bandwidth <10 kHz and can therefore not evaluate the RF envelope in the full audio band. DASY52 is therefore using the "indirect" measurement method according to ANSI C63.19-2011 which is the primary method. These near field probes read the averaged E-field measurement. Especially for the new high peak-to-average (PAR) signal types, the probes shall be linearized by PMR calibration in order to not overestimate the field reading.

The MIF measurement uncertainty is estimated as follows, for modulation frequencies from slotted waveforms with fundamental frequency and at least 2 harmonics within 10 kHz:

- 0.2 dB for MIF -7 to +5 dB,
- 0.5 dB for MIF -13 to +11 dB
- 1 dB for MIF > -20 dB



9. Evaluation for low-power exemption

9.1. Product testing threshold

There are two methods for exempting an RF air interface technology from testing. The first method requires evaluation of the MIF for the worst-case operating mode. An RF air interface technology of a device is exempt from testing when its average antenna input power plus its MIF is ≤ 17 dBm for any of its operating modes. The second method does not require determination of the MIF. The RF emissions testing exemption shall be applied to an RF air interface technology in a device whose peak antenna input power, averaged over intervals $\leq 50 \mu\text{s}$, is ≤ 23 dBm. An RF air interface technology that is exempted from testing by either method shall be rated as M4. The two methods are used to be exempt from testing for the RF air interface technology in this report.

**9.2. Average conducted power**

Band	power (dBm)	MIF (dB)	Sum (dBm)	HAC Test
GSM 850	32.0	3.63	35.63	Yes
GSM 1900	30.0	3.63	33.63	Yes
WCDMA Band 2	24.0	-25.43	-1.43	No
WCDMA Band 2 - HSDPA	23.0	-20.75	2.25	No
WCDMA Band 4	24.0	-25.43	-1.43	No
WCDMA Band 4 - HSDPA	23.0	-20.75	2.25	No
WCDMA Band 5	24.0	-25.43	-1.43	No
WCDMA Band 5 - HSDPA	23.0	-20.75	2.25	No
LTE Band 2	24.5	-9.76	14.74	No
LTE Band 4	24.5	-9.76	14.74	No
LTE Band 5	24.5	-9.76	14.74	No
LTE Band 7	24.0	-9.76	14.24	No
LTE Band 12	24.5	-9.76	14.74	No
LTE Band 13	24.5	-9.76	14.74	No
LTE Band 25	24.5	-9.76	14.74	No
LTE Band 26	24.5	-9.76	14.74	No
LTE Band 66	24.5	-9.76	14.74	No
LTE Band 71	24.5	-9.76	14.74	No
LTE Band 41 PC3	24.0	-1.44	22.56	Yes
LTE Band 41 PC2	26.5	-1.44	25.06	Yes
NR n2	24.8	-12.08	12.72	No
NR n5	24.5	-12.08	12.42	No
NR n12	24.5	-12.08	12.42	No
NR n25	24.8	-12.08	12.72	No
NR n41	26.5	-12.08	14.42	No
NR n48	23	-12.08	10.92	No
NR n66	24.0	-12.08	11.92	No
NR n71	24.5	-12.08	12.42	No
NR n77	27.2	-12.08	15.12	No
WLAN 2.4GHz	21.0	-2.02	18.98	Yes
WLAN 5GHz	19.5	-3.15	16.35	No

Note: Power = Max tune-up limit



10. RF Test Procedures

The evaluation was performed with the following procedure:

- 1) Confirm proper operation of the field probe, probe measurement system and other instrumentation and the positioning system.
- 2) Position the WD in its intended test position. The gauge block can simplify this positioning.
- 3) Configure the WD normal operation for maximum rated RF output power, at the desired channel and other operating parameters (e.g., test mode), as intended for the test.
- 4) The center sub-grid shall be centered on the center of the T-Coil mode axial measurement point or the acoustic output, as appropriate. Locate the field probe at the initial test position in the 50 mm by 50 mm grid, which is contained in the measurement plane. If the field alignment method is used, align the probe for maximum field reception.
- 5) Record the reading.
- 6) Scan the entire 50 mm by 50 mm region in equally spaced increments and record the reading at each measurement point. The distance between measurement points shall be sufficient to assure the identification of the maximum reading.
- 7) Identify the five contiguous sub-grids around the center sub-grid whose maximum reading is the lowest of all available choices. This eliminates the three sub-grids with the maximum readings. Thus, the six areas to be used to determine the WD's highest emissions are identified.
- 8) Identify the maximum field reading within the non-excluded sub-grids identified in Step 7)
- 9) Evaluate the MIF and add to the maximum steady-state rms field-strength reading to obtain the RF audio interference level..
- 10) Compare this RF audio interference level with the categories and record the resulting WD category rating.



11. Measurement Results (E-Field)

Frequency		Measured Value (dBV/m)	Power Drift (dB)	Category
Channel	MHz			
GSM 850				
251	848.8	39.45	0.02	M4 (see Fig A.1)
190	836.6	39.78	0.03	M4 (see Fig A.2)
128	824.2	39.19	0.02	M4 (see Fig A.3)
GSM 1900				
810	1909.8	33.55	0.04	M3 (see Fig A.4)
661	1880.0	33.81	-0.04	M3 (see Fig A.5)
512	1850.2	33.92	0.01	M3 (see Fig A.6)
LTE Band 41 PC3				
41490	2680.0	24.49	-0.01	M4 (see Fig A.7)
41055	2636.5	24.24	-0.02	M4 (see Fig A.8)
40620	2593.0	24.21	-0.06	M4 (see Fig A.9)
40185	2549.5	23.48	-0.04	M4 (see Fig A.10)
39750	2506.0	23.77	-0.01	M4 (see Fig A.11)
LTE Band 41 PC2				
41490	2680.0	17.47	0.02	M4 (see Fig A.12)
41055	2636.5	16.93	0.01	M4 (see Fig A.13)
40620	2593.0	17.42	0.02	M4 (see Fig A.14)
40185	2549.5	15.98	-0.07	M4 (see Fig A.15)
39750	2506.0	17.25	-0.02	M4 (see Fig A.16)
WALN 2.4GHz				
11	2462	13.53	0.05	M4 (see Fig A.17)
6	2437	13.58	0.08	M4 (see Fig A.18)
1	2412	12.14	0.09	M4 (see Fig A.19)



12. ANSI C 63.19-2011 Limits

WD RF audio interference level categories in logarithmic units

Emission categories	< 960 MHz	
	E-field emissions	
Category M1	50 to 55	dB (V/m)
Category M2	45 to 50	dB (V/m)
Category M3	40 to 45	dB (V/m)
Category M4	< 40	dB (V/m)
Emission categories	> 960 MHz	
	E-field emissions	
Category M1	40 to 45	dB (V/m)
Category M2	35 to 40	dB (V/m)
Category M3	30 to 35	dB (V/m)
Category M4	< 30	dB (V/m)

13. Measurement Uncertainty

No.	Error source	Type	Uncertainty Value u_i (%)	Prob. Dist.	Div.	ABM1 c_i	ABM2 c_i	Std. Unc. ABM1 u_i (%)	Std. Unc. ABM2 u_i (%)
1	System Repeatability	A	0.016	N	1	1	1	0.016	0.016
Probe Sensitivity									
2	Reference Level	B	3.0	R	$\sqrt{3}$	1	1	3.0	3.0
3	AMCC Geometry	B	0.4	R	$\sqrt{3}$	1	1	0.2	0.2
4	AMCC Current	B	0.6	R	$\sqrt{3}$	1	1	0.4	0.4
5	Probe Positioning during Calibration	B	0.1	R	$\sqrt{3}$	1	1	0.1	0.1
6	Noise Contribution	B	0.7	R	$\sqrt{3}$	0.014 3	1	0.0	0.4
7	Frequency Slope	B	5.9	R	$\sqrt{3}$	0.1	1	0.3	3.5
Probe System									
8	Repeatability / Drift	B	1.0	R	$\sqrt{3}$	1	1	0.6	0.6
9	Linearity / Dynamic Range	B	0.6	N	1	1	1	0.4	0.4
10	Acoustic Noise	B	1.0	R	$\sqrt{3}$	0.1	1	0.1	0.6
11	Probe Angle	B	2.3	R	$\sqrt{3}$	1	1	1.4	1.4
12	Spectral Processing	B	0.9	R	$\sqrt{3}$	1	1	0.5	0.5
13	Integration Time	B	0.6	N	1	1	5	0.6	3.0
14	Field Distribution	B	0.2	R	$\sqrt{3}$	1	1	0.1	0.1
Test Signal									
15	Ref. Signal Spectral Response	B	0.6	R	$\sqrt{3}$	0	1	0.0	0.4
Positioning									
16	Probe Positioning	B	1.9	R	$\sqrt{3}$	1	1	1.1	1.1
17	Phantom Thickness	B	0.9	R	$\sqrt{3}$	1	1	0.5	0.5
18	DUT Positioning	B	1.9	R	$\sqrt{3}$	1	1	1.1	1.1
External Contributions									
19	RF Interference	B	0.0	R	$\sqrt{3}$	1	0.3	0.0	0.0
20	Test Signal Variation	B	2.0	R	$\sqrt{3}$	1	1	1.2	1.2
Combined Std. Uncertainty (ABM Field)		$u_c = \sqrt{\sum_{i=1}^{20} c_i^2 u_i^2}$						4.1	6.1
Expanded Std. Uncertainty		$u_e = 2u_c$		N	$k = 2$		8.2		12.2



14. Main Test Instruments

Table 14-1: List of Main Instruments

No.	Name	Type	Serial Number	Calibration Date	Valid Period
01	Signal Generator	E8257D	MY47461211	2022-01-14	One year
02	Power meter	NRP	101260	2021-12-30	One year
03	Power sensor	NRP-Z91	102211	2021-12-30	One year
04	Amplifier	VTL5400	0404	/	
05	HAC Test Arch	N/A	1150	/	
06	DAE	DAE4	1527	2022-06-21	One year
07	E-Field Probe	ER3DV6	2424	2021-03-04	Three years
08	HAC Dipole	CD835V3	1165	2021-05-18	Three years
09	HAC Dipole	CD1880V3	1149	2021-05-18	Three years
10	HAC Dipole	CD2450V3	1139	2021-05-18	Three years
11	HAC Dipole	CD2600V3	1020	2021-05-18	Three years
12	BTS	CMW500	152499	2022-07-15	One year
13	Software	DASY5	/	/	/

ANNEX A: RF Emission Test Plot

HAC RF E-Field GSM 850 High

Date: 2022-11-21

Electronics: DAE4 Sn1527

Medium: Air

Medium parameters used: $\sigma = 0$ S/m, $\epsilon_r = 1$; $\rho = 1000$ kg/m³

Communication System: UID 0, GSM Frequency: 848.8 MHz Duty Cycle: 1:8.3

Probe: ER3DV6 - SN2424 ConvF (1, 1, 1);

E Scan - ER3DV6 - 2011: 15 mm from Probe Center to the Device /Hearing Aid Compatibility

Test (101x101x1): Interpolated grid: dx=0.5000 mm, dy=0.5000 mm

Device Reference Point: 0, 0, -6.3 mm

Reference Value = 71.16 V/m; Power Drift = 0.02 dB

Applied MIF = 3.63 dB

RF audio interference level = 39.45 dBV/m

Emission category: M4

MIF scaled E-field

Grid 1 M3 41.43 dBV/m	Grid 2 M3 41.7 dBV/m	Grid 3 M4 38.84 dBV/m
Grid 4 M4 39.27 dBV/m	Grid 5 M4 39.45 dBV/m	Grid 6 M4 36.92 dBV/m
Grid 7 M4 35.71 dBV/m	Grid 8 M4 35.62 dBV/m	Grid 9 M4 33.42 dBV/m

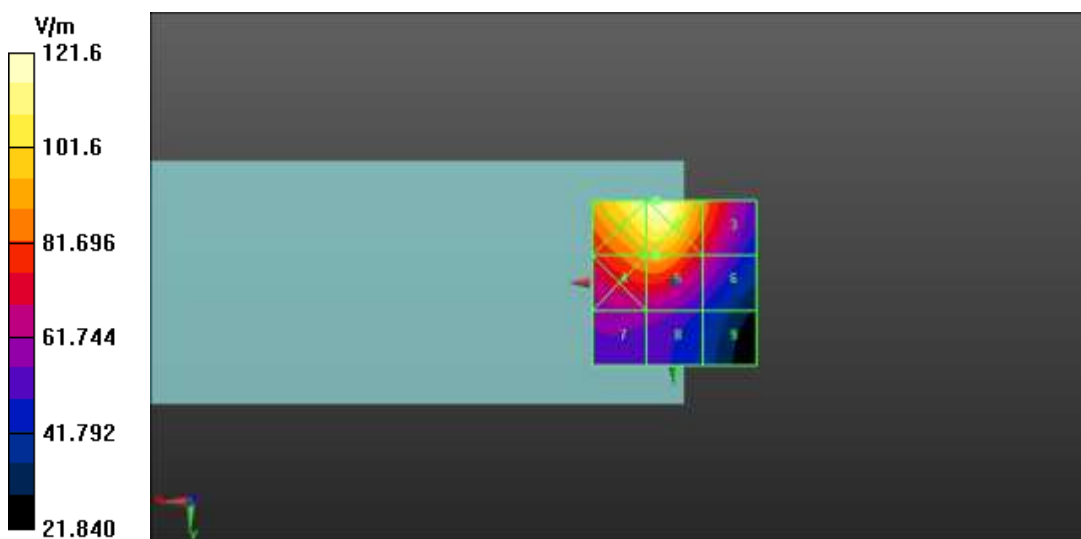

Fig A.1 HAC RF E-Field GSM850

HAC RF E-Field GSM 850 Middle

Date: 2022-11-21

Electronics: DAE4 Sn1527

Medium: Air

Medium parameters used: $\sigma = 0$ S/m, $\epsilon_r = 1$; $\rho = 1000$ kg/m³

Communication System: UID 0, GSM Frequency: 836.6 MHz Duty Cycle: 1:8.3

Probe: ER3DV6 - SN2424 ConvF (1, 1, 1);

E Scan - ER3DV6 - 2011: 15 mm from Probe Center to the Device /Hearing Aid Compatibility

Test (101x101x1): Interpolated grid: dx=0.5000 mm, dy=0.5000 mm

Device Reference Point: 0, 0, -6.3 mm

Reference Value = 76.27 V/m; Power Drift = 0.03 dB

Applied MIF = 3.63 dB

RF audio interference level = 39.78 dBV/m

Emission category: M4

MIF scaled E-field

Grid 1 M3 41.62 dBV/m	Grid 2 M3 41.93 dBV/m	Grid 3 M4 39.31 dBV/m
Grid 4 M4 39.52 dBV/m	Grid 5 M4 39.78 dBV/m	Grid 6 M4 37.51 dBV/m
Grid 7 M4 35.91 dBV/m	Grid 8 M4 35.9 dBV/m	Grid 9 M4 33.97 dBV/m

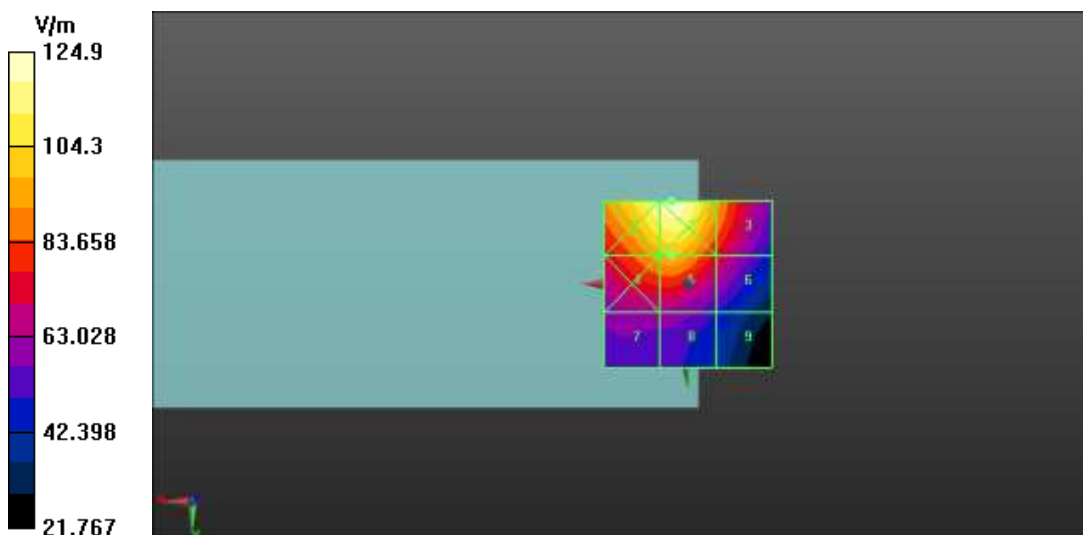

Fig A.2 HAC RF E-Field GSM850

HAC RF E-Field GSM 850 Low

Date: 2022-11-21

Electronics: DAE4 Sn1527

Medium: Air

Medium parameters used: $\sigma = 0$ S/m, $\epsilon_r = 1$; $\rho = 1000$ kg/m³

Communication System: UID 0, GSM Frequency: 824.2 MHz Duty Cycle: 1:8.3

Probe: ER3DV6 - SN2424 ConvF (1, 1, 1);

E Scan - ER3DV6 - 2011: 15 mm from Probe Center to the Device /Hearing Aid Compatibility

Test (101x101x1): Interpolated grid: dx=0.5000 mm, dy=0.5000 mm

Device Reference Point: 0, 0, -6.3 mm

Reference Value = 73.27 V/m; Power Drift = 0.02 dB

Applied MIF = 3.63 dB

RF audio interference level = 39.19 dBV/m

Emission category: M4

MIF scaled E-field

Grid 1 M3 40.82 dBV/m	Grid 2 M3 41.18 dBV/m	Grid 3 M4 38.65 dBV/m
Grid 4 M4 38.92 dBV/m	Grid 5 M4 39.19 dBV/m	Grid 6 M4 36.93 dBV/m
Grid 7 M4 35.47 dBV/m	Grid 8 M4 35.48 dBV/m	Grid 9 M4 33.59 dBV/m

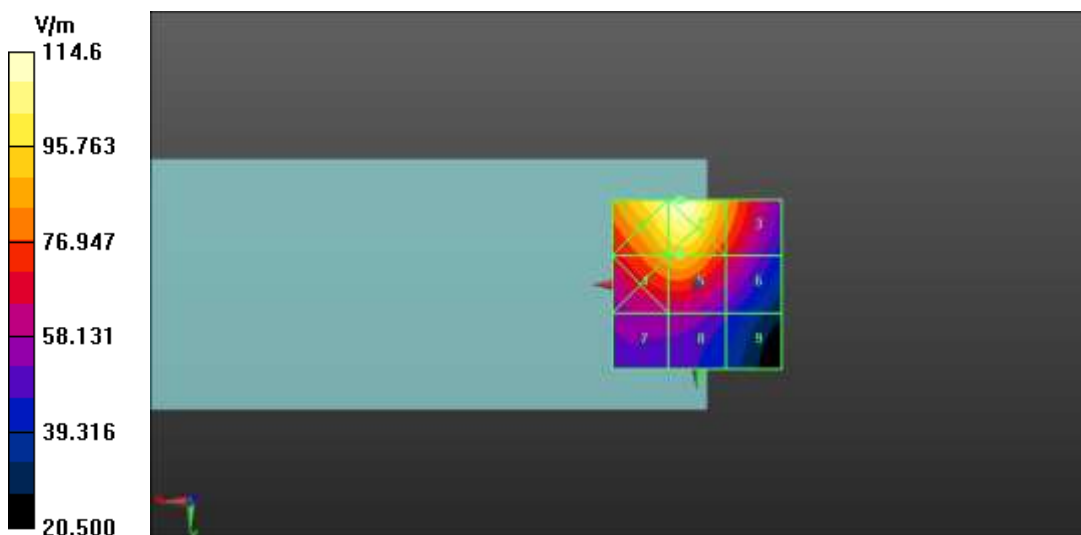

Fig A.3 HAC RF E-Field GSM850

HAC RF E-Field GSM 1900 High

Date: 2022-11-21

Electronics: DAE4 Sn1527

Medium: Air

Medium parameters used: $\sigma = 0$ S/m, $\epsilon_r = 1$; $\rho = 1000$ kg/m³

Communication System: UID 0, GSM Frequency: 1909.8 MHz Duty Cycle: 1:8.3

Probe: ER3DV6 - SN2424 ConvF (1, 1, 1);

E Scan - ER3DV6 - 2011: 15 mm from Probe Center to the Device /Hearing Aid Compatibility

Test (101x101x1): Interpolated grid: dx=0.5000 mm, dy=0.5000 mm

Device Reference Point: 0, 0, -6.3 mm

Reference Value = 33.29 V/m; Power Drift = 0.04 dB

Applied MIF = 3.63 dB

RF audio interference level = 33.55 dBV/m

Emission category: M3

MIF scaled E-field

Grid 1 M3 33.06 dBV/m	Grid 2 M3 33.34 dBV/m	Grid 3 M3 32.41 dBV/m
Grid 4 M3 33.17 dBV/m	Grid 5 M3 33.55 dBV/m	Grid 6 M3 33 dBV/m
Grid 7 M2 36.84 dBV/m	Grid 8 M2 36.85 dBV/m	Grid 9 M2 35.17 dBV/m

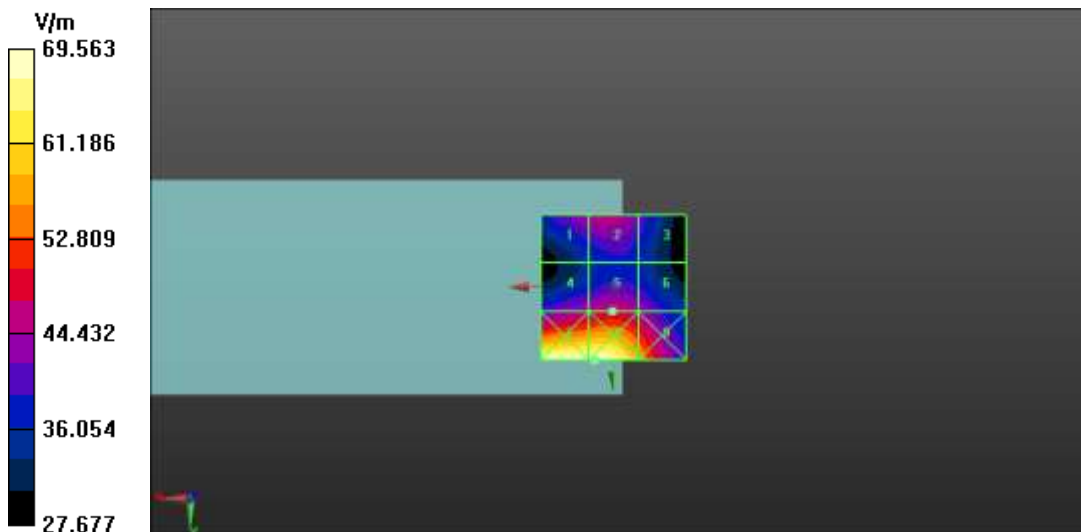

Fig A.4 HAC RF E-Field GSM1900

HAC RF E-Field GSM 1900 Middle

Date: 2022-11-21

Electronics: DAE4 Sn1527

Medium: Air

Medium parameters used: $\sigma = 0$ S/m, $\epsilon_r = 1$; $\rho = 1000$ kg/m³

Communication System: UID 0, GSM Frequency: 1880 MHz Duty Cycle: 1:8.3

Probe: ER3DV6 - SN2424 ConvF (1, 1, 1);

E Scan - ER3DV6 - 2011: 15 mm from Probe Center to the Device /Hearing Aid Compatibility

Test (101x101x1): Interpolated grid: dx=0.5000 mm, dy=0.5000 mm

Device Reference Point: 0, 0, -6.3 mm

Reference Value = 35.07 V/m; Power Drift = -0.04 dB

Applied MIF = 3.63 dB

RF audio interference level = 33.81 dBV/m

Emission category: M3

MIF scaled E-field

Grid 1 M3 33.43 dBV/m	Grid 2 M3 33.66 dBV/m	Grid 3 M3 32.64 dBV/m
Grid 4 M3 33.38 dBV/m	Grid 5 M3 33.81 dBV/m	Grid 6 M3 33.31 dBV/m
Grid 7 M2 36.95 dBV/m	Grid 8 M2 37.03 dBV/m	Grid 9 M2 35.43 dBV/m

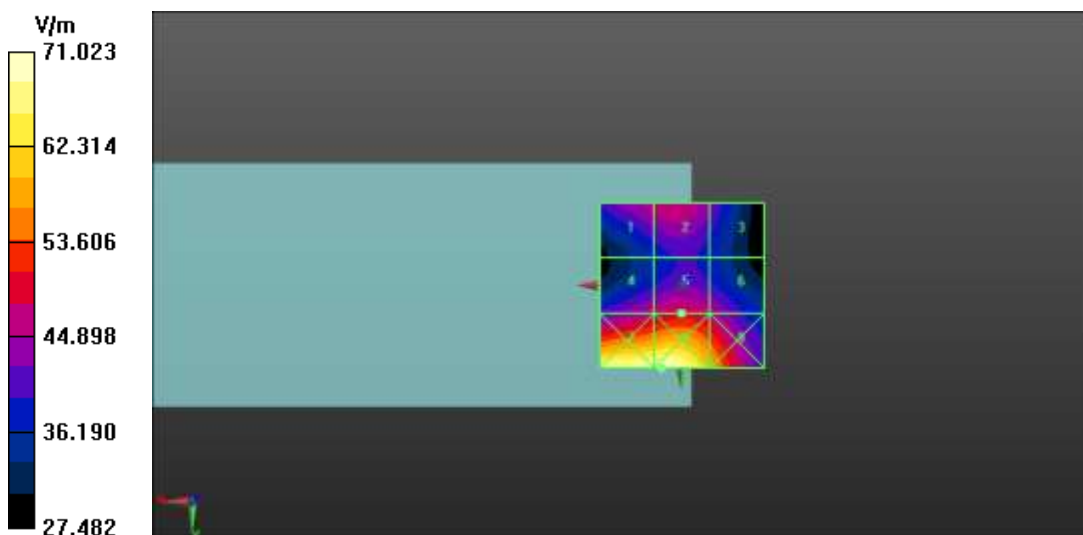

Fig A.5 HAC RF E-Field GSM1900

HAC RF E-Field GSM 1900 Low

Date: 2022-11-21

Electronics: DAE4 Sn1527

Medium: Air

Medium parameters used: $\sigma = 0$ S/m, $\epsilon_r = 1$; $\rho = 1000$ kg/m³

Communication System: UID 0, GSM Frequency: 1850.2 MHz Duty Cycle: 1:8.3

Probe: ER3DV6 - SN2424 ConvF (1, 1, 1);

E Scan - ER3DV6 - 2011: 15 mm from Probe Center to the Device /Hearing Aid Compatibility

Test (101x101x1): Interpolated grid: dx=0.5000 mm, dy=0.5000 mm

Device Reference Point: 0, 0, -6.3 mm

Reference Value = 35.56 V/m; Power Drift = 0.01 dB

Applied MIF = 3.63 dB

RF audio interference level = 33.92 dBV/m

Emission category: M3

MIF scaled E-field

Grid 1 M3 33.36 dBV/m	Grid 2 M3 33.56 dBV/m	Grid 3 M3 32.39 dBV/m
Grid 4 M3 33.52 dBV/m	Grid 5 M3 33.92 dBV/m	Grid 6 M3 33.21 dBV/m
Grid 7 M2 36.93 dBV/m	Grid 8 M2 36.97 dBV/m	Grid 9 M2 35.19 dBV/m

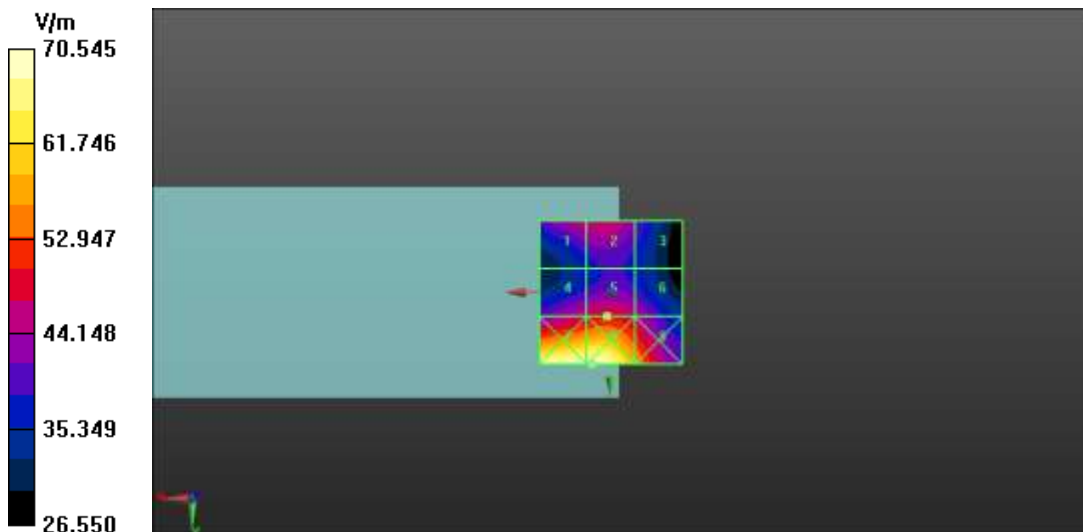

Fig A.6 HAC RF E-Field GSM1900

HAC RF E-Field LTE-Band 41 PC3 High

Date: 2022-12-13

Electronics: DAE4 Sn1527

Medium: Air

Medium parameters used: $\sigma = 0 \text{ S/m}$, $\epsilon_r = 1$; $\rho = 1000 \text{ kg/m}^3$

Communication System: UID 0, LTE_TDD Frequency: 2680 MHz Duty Cycle: 1:1.58

Probe: ER3DV6 - SN2424 ConvF (1, 1, 1);

E Scan - ER3DV6 - 2011: 15 mm from Probe Center to the Device /Hearing Aid Compatibility

Test (101x101x1): Interpolated grid: dx=0.5000 mm, dy=0.5000 mm

Device Reference Point: 0, 0, -6.3 mm

Reference Value = 26.46 V/m; Power Drift = -0.01 dB

Applied MIF = -1.44 dB

RF audio interference level = 24.49 dBV/m

Emission category: M4

MIF scaled E-field

Grid 1 M4 24.83 dBV/m	Grid 2 M4 25.13 dBV/m	Grid 3 M4 24.36 dBV/m
Grid 4 M4 22.69 dBV/m	Grid 5 M4 24.49 dBV/m	Grid 6 M4 24.34 dBV/m
Grid 7 M4 21.91 dBV/m	Grid 8 M4 23.84 dBV/m	Grid 9 M4 23.63 dBV/m

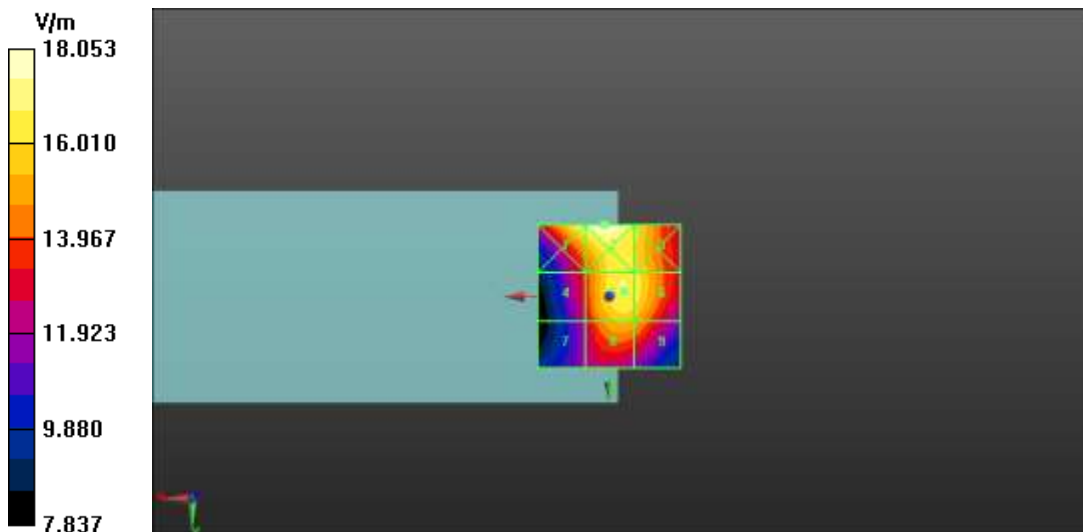

Fig A.7 HAC RF E-Field LTE-Band 41

HAC RF E-Field LTE-Band 41 PC3 Middle-H

Date: 2022-12-13

Electronics: DAE4 Sn1527

Medium: Air

Medium parameters used: $\sigma = 0$ S/m, $\epsilon_r = 1$; $\rho = 1000$ kg/m³

Communication System: UID 0, LTE_TDD Frequency: 2636.5 MHz Duty Cycle: 1:1.58

Probe: ER3DV6 - SN2424 ConvF (1, 1, 1);

E Scan - ER3DV6 - 2011: 15 mm from Probe Center to the Device /Hearing Aid Compatibility

Test (101x101x1): Interpolated grid: dx=0.5000 mm, dy=0.5000 mm

Device Reference Point: 0, 0, -6.3 mm

Reference Value = 25.34 V/m; Power Drift = -0.02 dB

Applied MIF = -1.44 dB

RF audio interference level = 24.24 dBV/m

Emission category: M4

MIF scaled E-field

Grid 1 M4 24.73 dBV/m	Grid 2 M4 24.95 dBV/m	Grid 3 M4 24.04 dBV/m
Grid 4 M4 22.66 dBV/m	Grid 5 M4 24.24 dBV/m	Grid 6 M4 24.04 dBV/m
Grid 7 M4 21.13 dBV/m	Grid 8 M4 23 dBV/m	Grid 9 M4 22.8 dBV/m

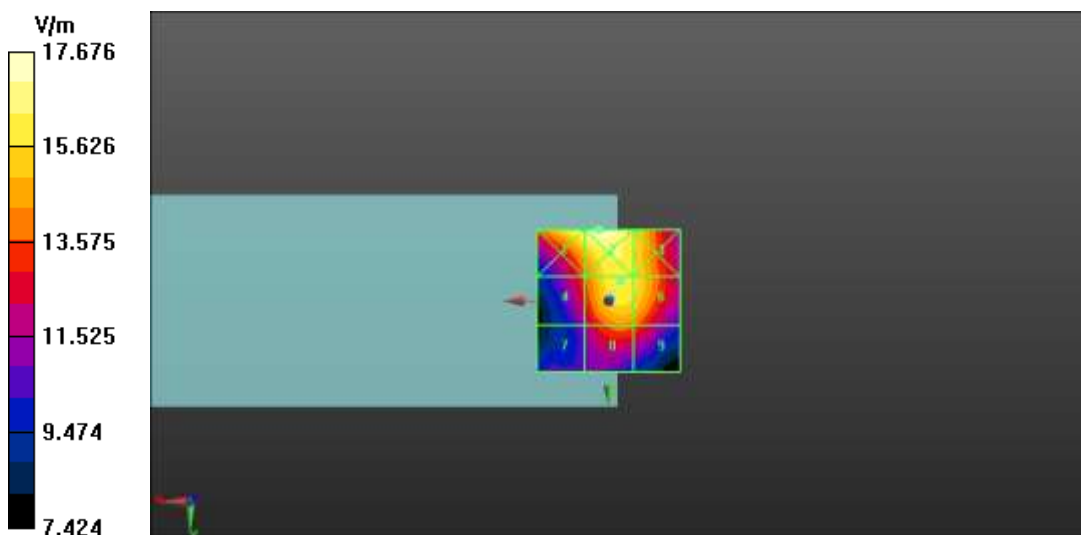

Fig A.8 HAC RF E-Field LTE-Band 41

HAC RF E-Field LTE-Band 41 PC3 Middle-M

Date: 2022-12-13

Electronics: DAE4 Sn1527

Medium: Air

Medium parameters used: $\sigma = 0$ S/m, $\epsilon_r = 1$; $\rho = 1000$ kg/m³

Communication System: UID 0, LTE_TDD Frequency: 2593 MHz Duty Cycle: 1:1.58

Probe: ER3DV6 - SN2424 ConvF (1, 1, 1);

E Scan - ER3DV6 - 2011: 15 mm from Probe Center to the Device /Hearing Aid Compatibility

Test (101x101x1): Interpolated grid: dx=0.5000 mm, dy=0.5000 mm

Device Reference Point: 0, 0, -6.3 mm

Reference Value = 24.91 V/m; Power Drift = -0.06 dB

Applied MIF = -1.44 dB

RF audio interference level = 24.21 dBV/m

Emission category: M4

MIF scaled E-field

Grid 1 M4 24.77 dBV/m	Grid 2 M4 25.12 dBV/m	Grid 3 M4 24.33 dBV/m
Grid 4 M4 22.31 dBV/m	Grid 5 M4 24.21 dBV/m	Grid 6 M4 24.05 dBV/m
Grid 7 M4 20.65 dBV/m	Grid 8 M4 22.83 dBV/m	Grid 9 M4 22.66 dBV/m

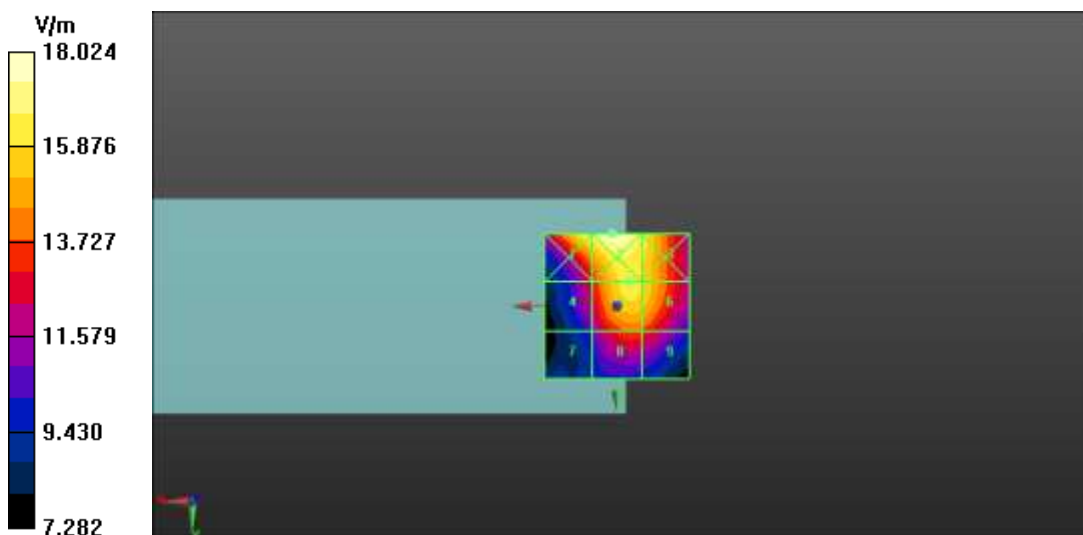

Fig A.9 HAC RF E-Field LTE-Band 41

HAC RF E-Field LTE-Band 41 PC3 Middle-L

Date: 2022-12-13

Electronics: DAE4 Sn1527

Medium: Air

Medium parameters used: $\sigma = 0$ S/m, $\epsilon_r = 1$; $\rho = 1000$ kg/m³

Communication System: UID 0, LTE_TDD Frequency: 2549.5 MHz Duty Cycle: 1:1.58

Probe: ER3DV6 - SN2424 ConvF (1, 1, 1);

E Scan - ER3DV6 - 2011: 15 mm from Probe Center to the Device /Hearing Aid Compatibility

Test (101x101x1): Interpolated grid: dx=0.5000 mm, dy=0.5000 mm

Device Reference Point: 0, 0, -6.3 mm

Reference Value = 21.01 V/m; Power Drift = -0.04 dB

Applied MIF = -1.44 dB

RF audio interference level = 23.48 dBV/m

Emission category: M4

MIF scaled E-field

Grid 1 M4 24.92 dBV/m	Grid 2 M4 25.06 dBV/m	Grid 3 M4 24.12 dBV/m
Grid 4 M4 21.62 dBV/m	Grid 5 M4 23.48 dBV/m	Grid 6 M4 23.35 dBV/m
Grid 7 M4 19.34 dBV/m	Grid 8 M4 21.83 dBV/m	Grid 9 M4 21.82 dBV/m

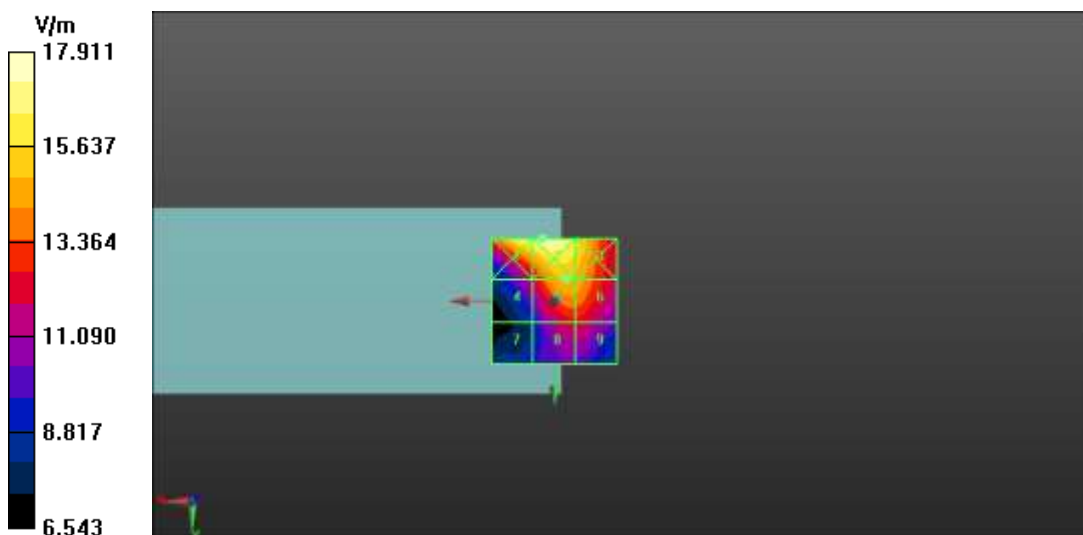

Fig A.10 HAC RF E-Field LTE-Band 41

HAC RF E-Field LTE-Band 41 PC3 Low

Date: 2022-12-13

Electronics: DAE4 Sn1527

Medium: Air

Medium parameters used: $\sigma = 0$ S/m, $\epsilon_r = 1$; $\rho = 1000$ kg/m³

Communication System: UID 0, LTE_TDD Frequency: 2506 MHz Duty Cycle: 1:1.58

Probe: ER3DV6 - SN2424 ConvF (1, 1, 1);

E Scan - ER3DV6 - 2011: 15 mm from Probe Center to the Device /Hearing Aid Compatibility

Test (101x101x1): Interpolated grid: dx=0.5000 mm, dy=0.5000 mm

Device Reference Point: 0, 0, -6.3 mm

Reference Value = 21.41 V/m; Power Drift = -0.01 dB

Applied MIF = -1.44 dB

RF audio interference level = 23.77 dBV/m

Emission category: M4

MIF scaled E-field

Grid 1 M4 24.15 dBV/m	Grid 2 M4 25.19 dBV/m	Grid 3 M4 24.63 dBV/m
Grid 4 M4 21.78 dBV/m	Grid 5 M4 23.77 dBV/m	Grid 6 M4 23.62 dBV/m
Grid 7 M4 20.66 dBV/m	Grid 8 M4 22.51 dBV/m	Grid 9 M4 22.45 dBV/m

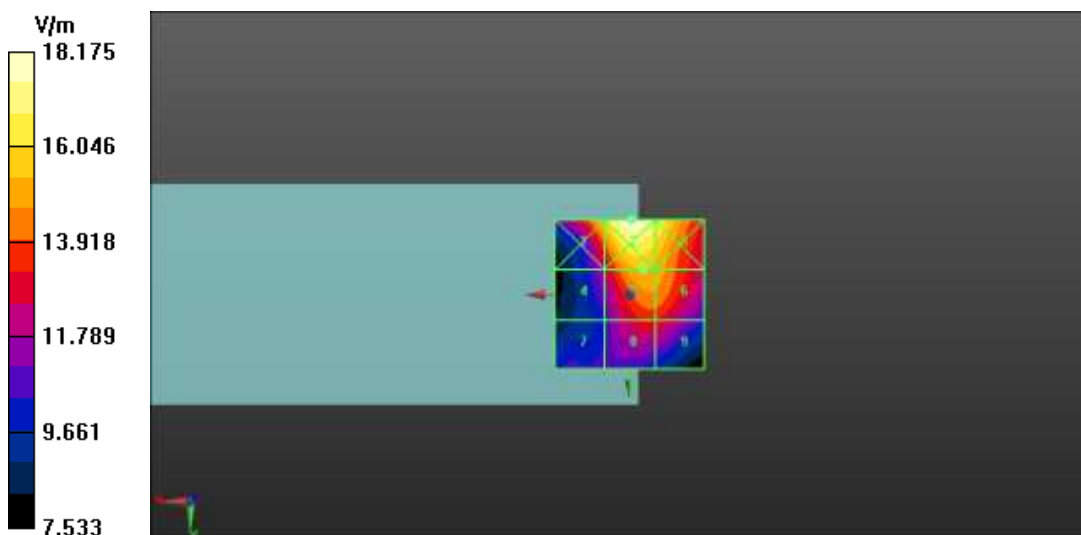

Fig A.11 HAC RF E-Field LTE-Band 41

HAC RF E-Field LTE-Band 41 PC2 High

Date: 2022-12-13

Electronics: DAE4 Sn1527

Medium: Air

Medium parameters used: $\sigma = 0$ S/m, $\epsilon_r = 1$; $\rho = 1000$ kg/m³

Communication System: UID 0, LTE_TDD Frequency: 2680 MHz Duty Cycle: 1:2.31

Probe: ER3DV6 - SN2424 ConvF (1, 1, 1);

E Scan - ER3DV6 - 2011: 15 mm from Probe Center to the Device /Hearing Aid Compatibility

Test (101x101x1): Interpolated grid: dx=0.5000 mm, dy=0.5000 mm

Device Reference Point: 0, 0, -6.3 mm

Reference Value = 23.22 V/m; Power Drift = 0.02 dB

Applied MIF = -1.44 dB

RF audio interference level = 17.47 dBV/m

Emission category: M4

E-field displayed

Grid 1 M4 18.37 dBV/m	Grid 2 M4 18.85 dBV/m	Grid 3 M4 17.26 dBV/m
Grid 4 M4 14.41 dBV/m	Grid 5 M4 17.47 dBV/m	Grid 6 M4 17.15 dBV/m
Grid 7 M4 12.81 dBV/m	Grid 8 M4 15.56 dBV/m	Grid 9 M4 15.51 dBV/m

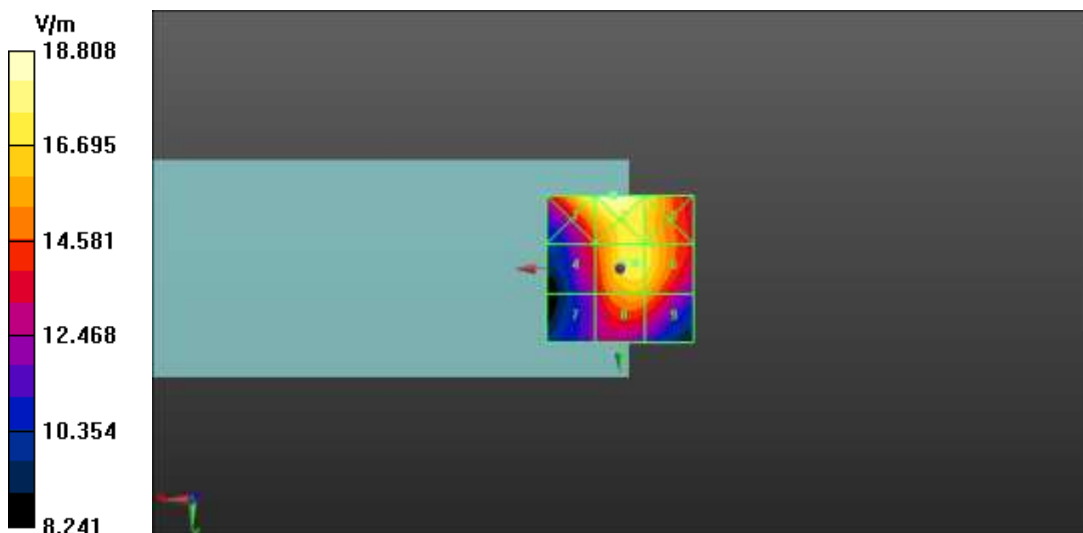

Fig A.12 HAC RF E-Field LTE-Band 41

HAC RF E-Field LTE-Band 41 PC2 Middle-H

Date: 2022-12-13

Electronics: DAE4 Sn1527

Medium: Air

Medium parameters used: $\sigma = 0$ S/m, $\epsilon_r = 1$; $\rho = 1000$ kg/m³

Communication System: UID 0, LTE_TDD Frequency: 2636.5 MHz Duty Cycle: 1:2.31

Probe: ER3DV6 - SN2424 ConvF (1, 1, 1);

E Scan - ER3DV6 - 2011: 15 mm from Probe Center to the Device /Hearing Aid Compatibility

Test (101x101x1): Interpolated grid: dx=0.5000 mm, dy=0.5000 mm

Device Reference Point: 0, 0, -6.3 mm

Reference Value = 22.34 V/m; Power Drift = 0.01 dB

Applied MIF = -1.44 dB

RF audio interference level = 16.93 dBV/m

Emission category: M4

E-field displayed

Grid 1 M4 17.89 dBV/m	Grid 2 M4 18.06 dBV/m	Grid 3 M4 16.52 dBV/m
Grid 4 M4 14.22 dBV/m	Grid 5 M4 16.93 dBV/m	Grid 6 M4 16.62 dBV/m
Grid 7 M4 11.86 dBV/m	Grid 8 M4 14.53 dBV/m	Grid 9 M4 14.25 dBV/m

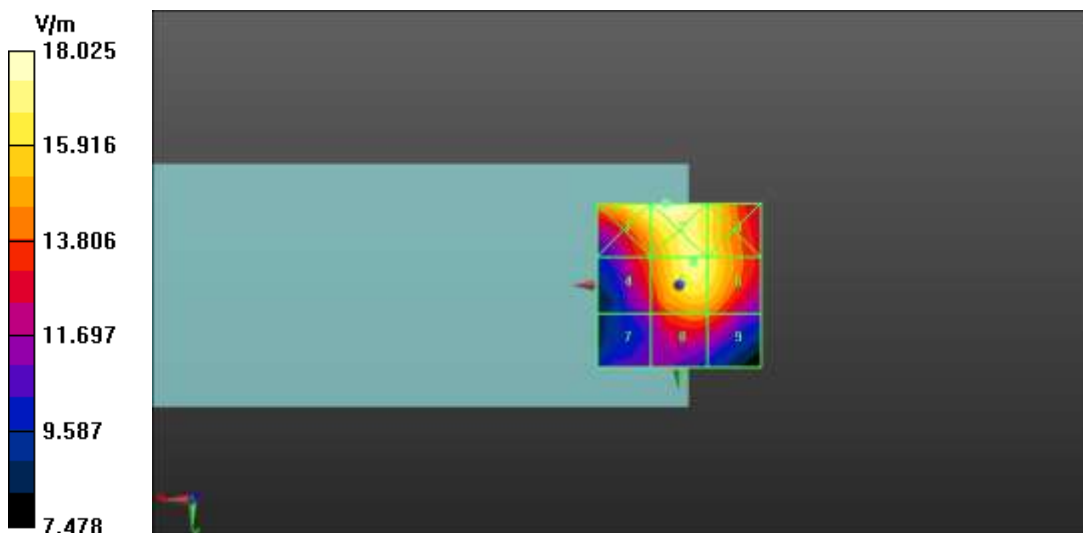

Fig A.13 HAC RF E-Field LTE-Band 41

HAC RF E-Field LTE-Band 41 PC2 Middle-M

Date: 2022-12-13

Electronics: DAE4 Sn1527

Medium: Air

Medium parameters used: $\sigma = 0$ S/m, $\epsilon_r = 1$; $\rho = 1000$ kg/m³

Communication System: UID 0, LTE_TDD Frequency: 2593 MHz Duty Cycle: 1:2.31

Probe: ER3DV6 - SN2424 ConvF (1, 1, 1);

E Scan - ER3DV6 - 2011: 15 mm from Probe Center to the Device /Hearing Aid Compatibility

Test (101x101x1): Interpolated grid: dx=0.5000 mm, dy=0.5000 mm

Device Reference Point: 0, 0, -6.3 mm

Reference Value = 22.48 V/m; Power Drift = 0.02 dB

Applied MIF = -1.44 dB

RF audio interference level = 17.42 dBV/m

Emission category: M4

E-field displayed

Grid 1 M4 18.37 dBV/m	Grid 2 M4 19.04 dBV/m	Grid 3 M4 17.56 dBV/m
Grid 4 M4 14.13 dBV/m	Grid 5 M4 17.42 dBV/m	Grid 6 M4 17.16 dBV/m
Grid 7 M4 11.54 dBV/m	Grid 8 M4 14.72 dBV/m	Grid 9 M4 14.48 dBV/m

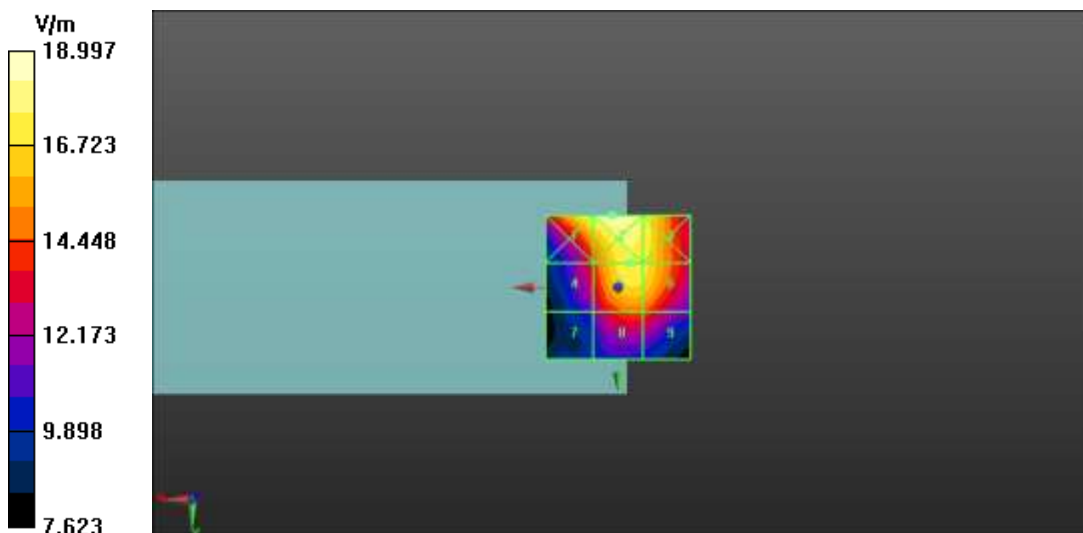

Fig A.14 HAC RF E-Field LTE-Band 41

HAC RF E-Field LTE-Band 41 PC2 Middle-L

Date: 2022-12-13

Electronics: DAE4 Sn1527

Medium: Air

Medium parameters used: $\sigma = 0$ S/m, $\epsilon_r = 1$; $\rho = 1000$ kg/m³

Communication System: UID 0, LTE_TDD Frequency: 2549.5 MHz Duty Cycle: 1:2.31

Probe: ER3DV6 - SN2424 ConvF (1, 1, 1);

E Scan - ER3DV6 - 2011: 15 mm from Probe Center to the Device /Hearing Aid Compatibility

Test (101x101x1): Interpolated grid: dx=0.5000 mm, dy=0.5000 mm

Device Reference Point: 0, 0, -6.3 mm

Reference Value = 18.83 V/m; Power Drift = -0.07 dB

Applied MIF = -1.44 dB

RF audio interference level = 15.98 dBV/m

Emission category: M4

E-field displayed

Grid 1 M4 18.64 dBV/m	Grid 2 M4 18.91 dBV/m	Grid 3 M4 17.22 dBV/m
Grid 4 M4 12.85 dBV/m	Grid 5 M4 15.98 dBV/m	Grid 6 M4 15.71 dBV/m
Grid 7 M4 9.88 dBV/m	Grid 8 M4 13.05 dBV/m	Grid 9 M4 12.96 dBV/m

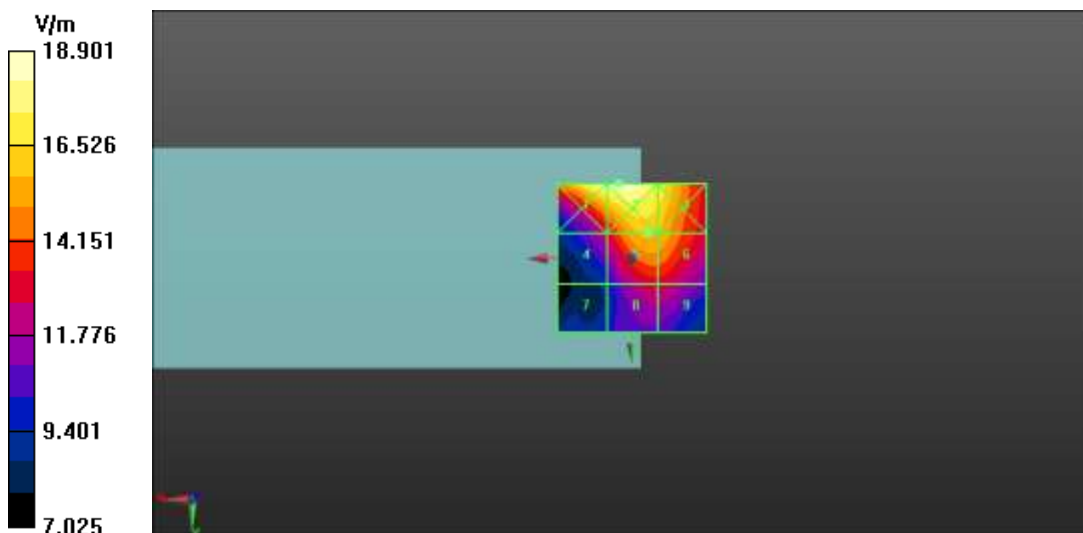

Fig A.15 HAC RF E-Field LTE-Band 41

HAC RF E-Field LTE-Band 41 PC2 Low

Date: 2022-12-13

Electronics: DAE4 Sn1527

Medium: Air

Medium parameters used: $\sigma = 0$ S/m, $\epsilon_r = 1$; $\rho = 1000$ kg/m³

Communication System: UID 0, LTE_TDD Frequency: 2506 MHz Duty Cycle: 1:2.31

Probe: ER3DV6 - SN2424 ConvF (1, 1, 1);

E Scan - ER3DV6 - 2011: 15 mm from Probe Center to the Device /Hearing Aid Compatibility

Test (101x101x1): Interpolated grid: dx=0.5000 mm, dy=0.5000 mm

Device Reference Point: 0, 0, -6.3 mm

Reference Value = 20.07 V/m; Power Drift = -0.02 dB

Applied MIF = -1.44 dB

RF audio interference level =17.25 dBV/m

Emission category: M4

E-field displayed

Grid 1 M4 17.55 dBV/m	Grid 2 M4 20.03 dBV/m	Grid 3 M4 18.94 dBV/m
Grid 4 M4 13.72 dBV/m	Grid 5 M4 17.25 dBV/m	Grid 6 M4 16.94 dBV/m
Grid 7 M4 11.76 dBV/m	Grid 8 M4 14.72 dBV/m	Grid 9 M4 14.66 dBV/m

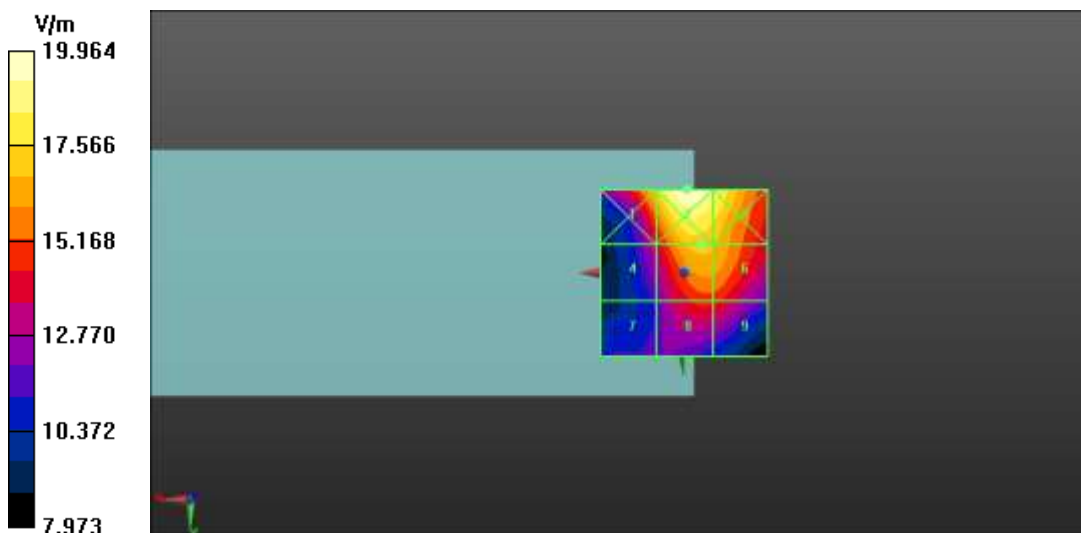

Fig A.16 HAC RF E-Field LTE-Band 41

HAC RF E-Field WLAN 2.4GHz High

Date: 2022-12-13

Electronics: DAE4 Sn1527

Medium: Air

Medium parameters used: $\sigma = 0$ S/m, $\epsilon_r = 1$; $\rho = 1000$ kg/m³

Communication System: UID 0, WLAN Frequency: 2462 MHz Duty Cycle: 1:1

Probe: ER3DV6 - SN2424 ConvF (1, 1, 1);

E Scan - ER3DV6 - 2011: 15 mm from Probe Center to the Device /Hearing Aid Compatibility

Test (101x101x1): Interpolated grid: dx=0.5000 mm, dy=0.5000 mm

Device Reference Point: 0, 0, -6.3 mm

Reference Value = 4.464 V/m; Power Drift = 0.05 dB

Applied MIF = -2.02 dB

RF audio interference level = 13.53 dBV/m

Emission category: M4

MIF scaled E-field

Grid 1 M4 11.79 dBV/m	Grid 2 M4 14.87 dBV/m	Grid 3 M4 12.27 dBV/m
Grid 4 M4 12.24 dBV/m	Grid 5 M4 12.73 dBV/m	Grid 6 M4 10.96 dBV/m
Grid 7 M4 13.31 dBV/m	Grid 8 M4 13.53 dBV/m	Grid 9 M4 12.18 dBV/m

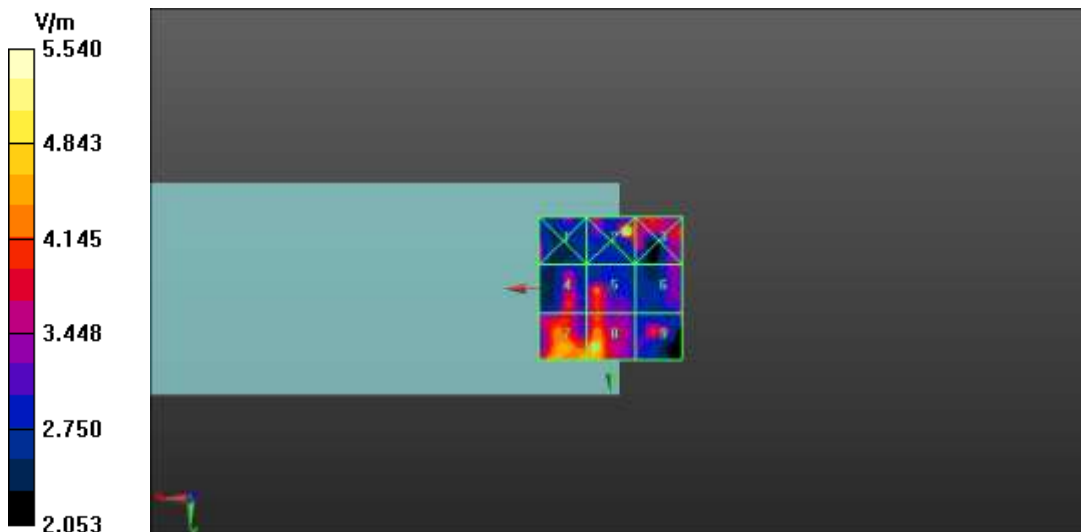

Fig A.17 HAC RF E-Field WLAN 2.4GHz

HAC RF E-Field WLAN 2.4GHz Middle

Date: 2022-12-13

Electronics: DAE4 Sn1527

Medium: Air

Medium parameters used: $\sigma = 0$ S/m, $\epsilon_r = 1$; $\rho = 1000$ kg/m³

Communication System: UID 0, WLAN Frequency: 2437 MHz Duty Cycle: 1:1

Probe: ER3DV6 - SN2424 ConvF (1, 1, 1);

E Scan - ER3DV6 - 2011: 15 mm from Probe Center to the Device /Hearing Aid Compatibility

Test (101x101x1): Interpolated grid: dx=0.5000 mm, dy=0.5000 mm

Device Reference Point: 0, 0, -6.3 mm

Reference Value = 4.871 V/m; Power Drift = 0.08 dB

Applied MIF = -2.02 dB

RF audio interference level = 13.58 dBV/m

Emission category: M4

MIF scaled E-field

Grid 1 M4 21.03 dBV/m	Grid 2 M4 10.79 dBV/m	Grid 3 M4 11.9 dBV/m
Grid 4 M4 12.14 dBV/m	Grid 5 M4 13.58 dBV/m	Grid 6 M4 10.88 dBV/m
Grid 7 M4 13.3 dBV/m	Grid 8 M4 13.36 dBV/m	Grid 9 M4 11.01 dBV/m

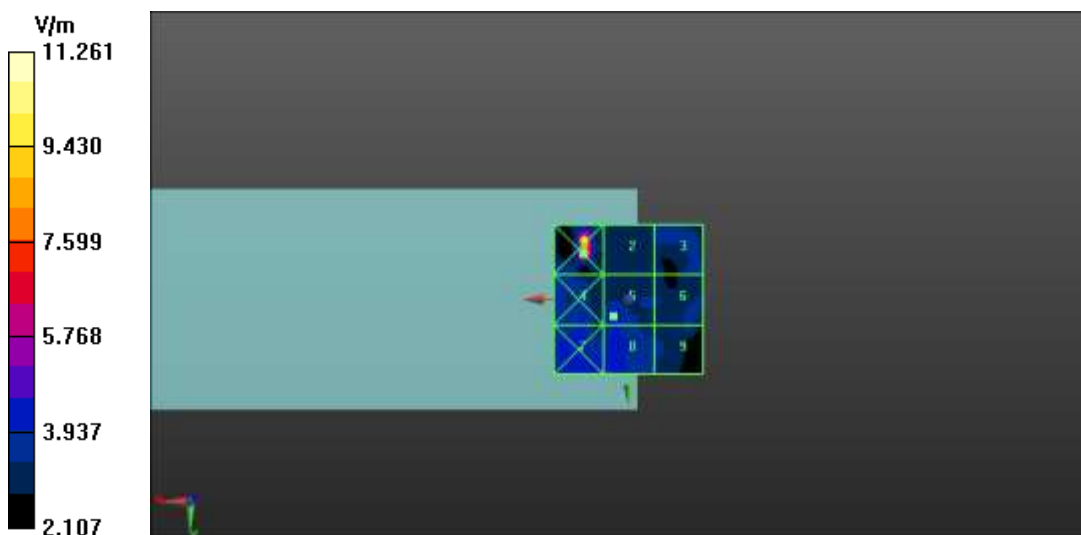

Fig A.18 HAC RF E-Field WLAN 2.4GHz

HAC RF E-Field WLAN 2.4GHz Low

Date: 2022-12-13

Electronics: DAE4 Sn1527

Medium: Air

Medium parameters used: $\sigma = 0$ S/m, $\epsilon_r = 1$; $\rho = 1000$ kg/m³

Communication System: UID 0, WLAN Frequency: 2412 MHz Duty Cycle: 1:1

Probe: ER3DV6 - SN2424 ConvF (1, 1, 1);

E Scan - ER3DV6 - 2011: 15 mm from Probe Center to the Device /Hearing Aid Compatibility

Test (101x101x1): Interpolated grid: dx=0.5000 mm, dy=0.5000 mm

Device Reference Point: 0, 0, -6.3 mm

Reference Value = 9.350 V/m; Power Drift = 0.09 dB

Applied MIF = -2.02 dB

RF audio interference level = 12.14 dBV/m

Emission category: M4

MIF scaled E-field

Grid 1 M4 22.15 dBV/m	Grid 2 M4 8.35 dBV/m	Grid 3 M4 12.14 dBV/m
Grid 4 M4 22.77 dBV/m	Grid 5 M4 9.64 dBV/m	Grid 6 M4 9.78 dBV/m
Grid 7 M4 14.77 dBV/m	Grid 8 M4 9.8 dBV/m	Grid 9 M4 9.75 dBV/m

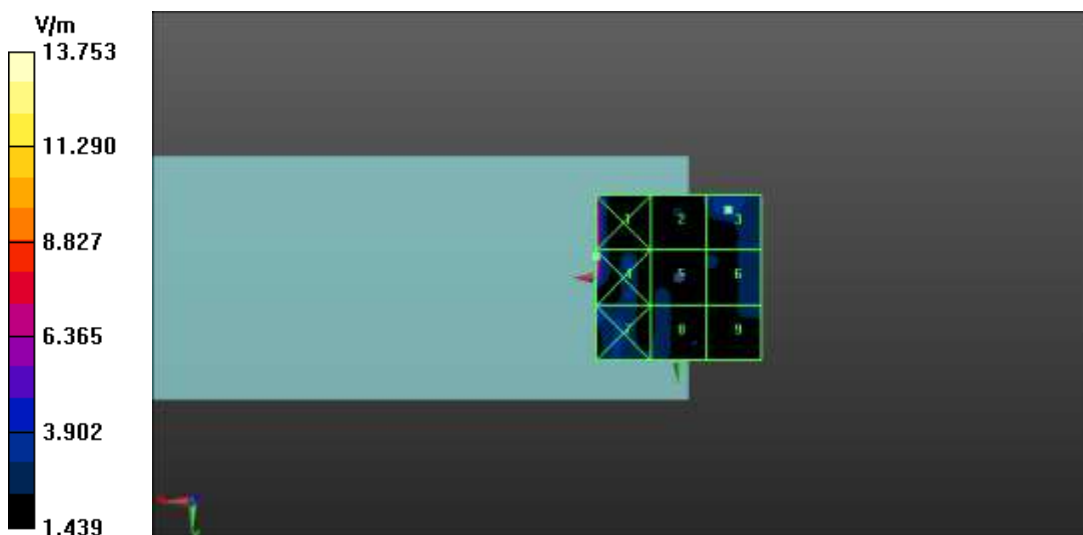

Fig A.19 HAC RF E-Field WLAN 2.4GHz

ANNEX B: System Validation Result

835MHz

Date: 2022-11-21

Electronics: DAE4 Sn1527

Medium: Air

Medium parameters used: $\sigma = 0$ S/m, $\epsilon_r = 1$; $\rho = 1000$ kg/m³

Communication System: CW; Frequency: 835 MHz; Duty Cycle: 1:1

Probe: ER3DV6 - SN2424; ConvF (1, 1, 1)

E Scan - measurement distance from the probe sensor center to CD835 Dipole = 15mm

/Hearing Aid Compatibility Test (41x361x1): Interpolated grid: dx=0.5000 mm, dy=0.5000 mm

Device Reference Point: 0, 0, -6.3 mm

Reference Value = 111.2 V/m; Power Drift = 0.05 dB

Applied MIF = 0.00 dB

RF audio interference level = 42.28 dBV/m

Emission category: M3

MIF scaled E-field

Grid 1 M3 41.64 dBV/m	Grid 2 M3 42.18 dBV/m	Grid 3 M3 42.05 dBV/m
Grid 4 M4 37.13 dBV/m	Grid 5 M4 37.46 dBV/m	Grid 6 M4 37.38 dBV/m
Grid 7 M3 41.75 dBV/m	Grid 8 M3 42.28 dBV/m	Grid 9 M3 42.08 dBV/m

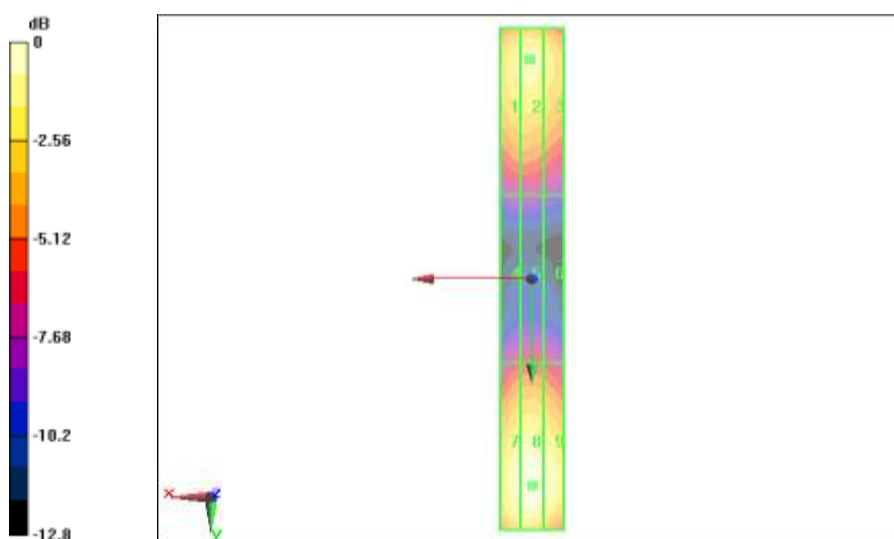

0 dB = 42.28 dBV/m



1880MHz

Date: 2022-11-21

Electronics: DAE4 Sn1527

Medium: Air

Medium parameters used: $\sigma = 0$ S/m, $\epsilon_r = 1$; $\rho = 1000$ kg/m³

Communication System: CW; Frequency: 1880 MHz; Duty Cycle: 1:1

Probe: ER3DV6 - SN2424; ConvF (1, 1, 1)

E Scan - measurement distance from the probe sensor center to CD1880 Dipole = 15mm

/Hearing Aid Compatibility Test (41x181x1): Interpolated grid: dx=0.5000 mm, dy=0.5000 mm

Device Reference Point: 0, 0, -6.3 mm

Reference Value = 107.5 V/m; Power Drift = 0.09 dB

Applied MIF = 0.00 dB

RF audio interference level = 39.66 dBV/m

Emission category: M2

MIF scaled E-field

Grid 1 M2 39.19 dBV/m	Grid 2 M2 39.66 dBV/m	Grid 3 M2 39.58 dBV/m
Grid 4 M2 37.38 dBV/m	Grid 5 M2 37.73 dBV/m	Grid 6 M2 37.66 dBV/m
Grid 7 M2 39.16 dBV/m	Grid 8 M2 39.62 dB V/m	Grid 9 M2 39.52 dBV/m

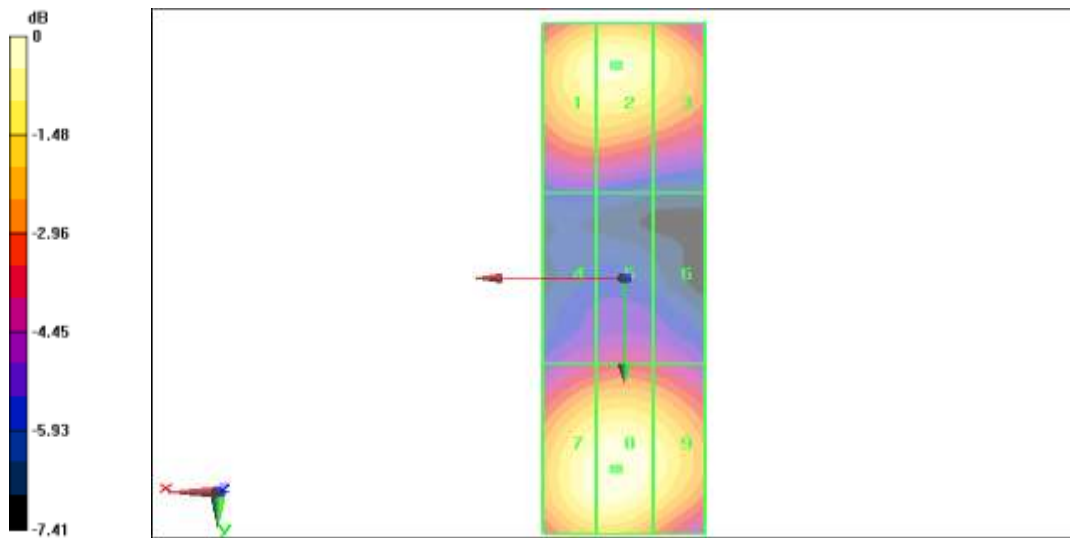

0 dB = 39.66 dBV/m



2450MHz

Date: 2022-12-13

Electronics: DAE4 Sn1527

Medium: Air

Medium parameters used: $\sigma = 0$ S/m, $\epsilon_r = 1$; $\rho = 1000$ kg/m³

Communication System: CW; Frequency: 2450 MHz; Duty Cycle: 1:1

Probe: ER3DV6 - SN2424; ConvF (1, 1, 1)

E Scan - measurement distance from the probe sensor center to CD2450 Dipole = 15mm

/Hearing Aid Compatibility Test (41x181x1): Interpolated grid: dx=0.5000 mm, dy=0.5000 mm

Device Reference Point: 0, 0, -6.3 mm

Reference Value = 72.93 V/m; Power Drift = 0.11 dB

Applied MIF = 0.00 dB

RF audio interference level = 39.74 dBV/m

Emission category: M2

MIF scaled E-field

Grid 1 M2 39.31 dBV/m	Grid 2 M2 39.57 dBV/m	Grid 3 M2 39.46 dBV/m
Grid 4 M2 38.94 dBV/m	Grid 5 M2 39.05 dBV/m	Grid 6 M2 38.99 dBV/m
Grid 7 M2 39.51 dBV/m	Grid 8 M2 39.74 dB V/m	Grid 9 M2 39.62 dBV/m

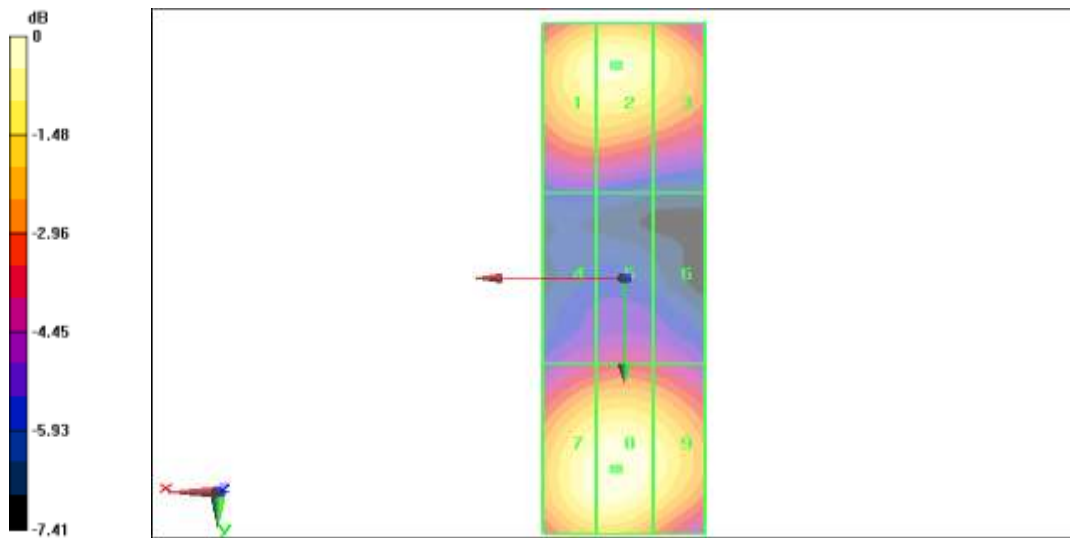

0 dB = 39.74 dBV/m



2600MHz

Date: 2022-12-13

Electronics: DAE4 Sn1527

Medium: Air

Medium parameters used: $\sigma = 0$ S/m, $\epsilon_r = 1$; $\rho = 1000$ kg/m³

Communication System: CW; Frequency: 1880 MHz; Duty Cycle: 1:1

Probe: ER3DV6 - SN2424; ConvF (1, 1, 1)

E Scan - measurement distance from the probe sensor center to CD2600 Dipole = 15mm

/Hearing Aid Compatibility Test (41x181x1): Interpolated grid: dx=0.5000 mm, dy=0.5000 mm

Device Reference Point: 0, 0, -6.3 mm

Reference Value = 70.42 V/m; Power Drift = 0.03 dB

Applied MIF = 0.00 dB

RF audio interference level = 39.53 dBV/m

Emission category: M2

MIF scaled E-field

Grid 1 M2 39.06 dBV/m	Grid 2 M2 39.33 dBV/m	Grid 3 M2 39.28 dBV/m
Grid 4 M2 38.73 dBV/m	Grid 5 M2 38.89 dBV/m	Grid 6 M2 38.85 dBV/m
Grid 7 M2 39.34 dBV/m	Grid 8 M2 39.53 dB V/m	Grid 9 M2 39.45 dBV/m

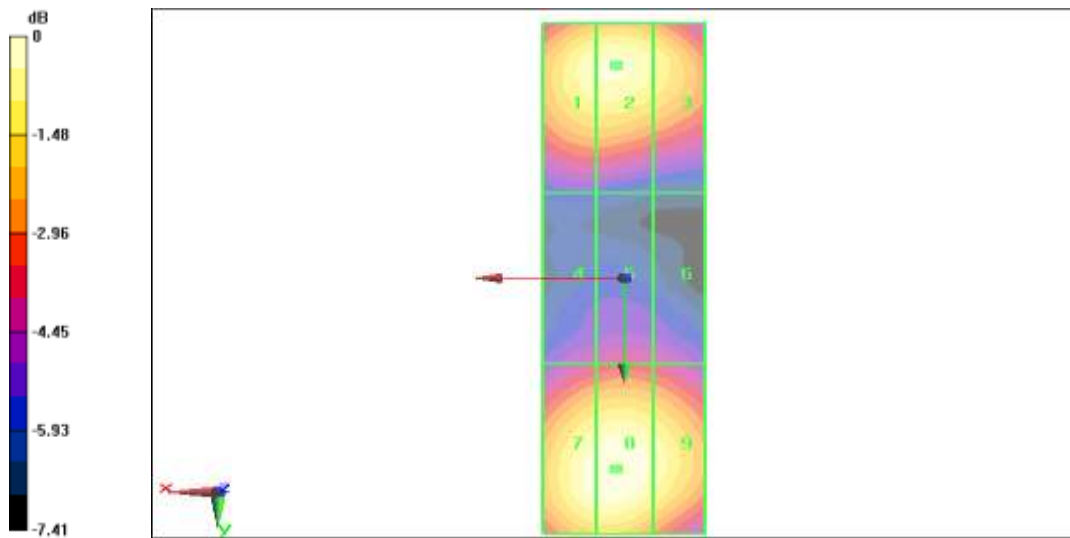

0 dB = 39.53 dBV/m



ANNEX C: Dipole Calibration Certificate

CD835V3

**Calibration Laboratory of
Schmid & Partner
Engineering AG**
Zeughausstrasse 43, 8004 Zurich, Switzerland



S Schweizerischer Kalibrierdienst
C Service suisse d'étalonnage
S Servizio svizzero di taratura
S Swiss Calibration Service

Accredited by the Swiss Accreditation Service (SAS)
The Swiss Accreditation Service is one of the signatories to the EA
Multilateral Agreement for the recognition of calibration certificates

Accreditation No.: **SCS 0108**

Client **TMC-SZ (Auden)**

Certificate No: **CD835V3-1165_May21**

CALIBRATION CERTIFICATE

Object: **CD835V3 - SN: 1165**

Calibration procedure(s): **QA CAL-20.v7
Calibration Procedure for Validation Sources in air**

Calibration date: **May 18, 2021**

This calibration certificate documents the traceability to national standards, which realize the physical units of measurements (SI).
The measurements and the uncertainties with confidence probability are given on the following pages and are part of the certificate.

All calibrations have been conducted in the closed laboratory facility: environment temperature (22 ± 3)°C and humidity < 70%.

Calibration Equipment used (M&TE critical for calibration)

Primary Standards	ID #	Cal Date (Certificate No.)	Scheduled Calibration
Power meter NRP	SN: 104775	09-Apr-21 (No. 217-03291/03292)	Apr-22
Power sensor NRP-Z91	SN: 163244	09-Apr-21 (No. 217-03291)	Apr-22
Power sensor NRP-Z91	SN: 163245	09-Apr-21 (No. 217-03292)	Apr-22
Reference 20 dB Attenuator	SN: B14304 (20k)	09-Apr-21 (No. 217-03343)	Apr-22
Type-N mismatch combination	SN: 010362 / 00327	09-Apr-21 (No. 217-03344)	Apr-22
Probe EF3DV3	SN: 4013	28-Dec-20 (No. EF3-4013_Dec20)	Dec-21
DAE4	SN: 781	23-Dec-20 (No. DAE4-781_Dec20)	Dec-21

Secondary Standards	ID #	Check Date (in house)	Scheduled Check
Power meter Agilent 4419B	SN: GB42420191	09-Oct-09 (in house check Oct-20)	In house check: Oct-23
Power sensor HP E4412A	SN: US38485102	05-Jan-10 (in house check Oct-20)	In house check: Oct-23
Power sensor HP 8482A	SN: US37295597	09-Oct-09 (in house check Oct-20)	In house check: Oct-23
RF generator R&S SMT-06	SN: 837633/005	10-Jan-18 (in house check Oct-20)	In house check: Oct-23
Network Analyzer Agilent E8358A	SN: US41080477	31-Mar-14 (in house check Oct-20)	In house check: Oct-21

Calibrated by:	Name	Function	Signature
	Leif Rysner	Laboratory Technician	
Approved by:	Katja Pokovic	Technical Manager	

Issued: May 18, 2021

This calibration certificate shall not be reproduced except in full without written approval of the laboratory.

**Calibration Laboratory of
Schmid & Partner
Engineering AG**
Zeughausstrasse 43, 8004 Zurich, Switzerland



S Schweizerischer Kalibrierdienst
C Service suisse d'étalonnage
S Servizio svizzero di taratura
S Swiss Calibration Service

Accredited by the Swiss Accreditation Service (SAS)
The Swiss Accreditation Service is one of the signatories to the EA
Multilateral Agreement for the recognition of calibration certificates

Accreditation No.: **SCS 0108**

References

- [1] ANSI-C63.19-2011
American National Standard, Methods of Measurement of Compatibility between Wireless Communications Devices and Hearing Aids.

Methods Applied and Interpretation of Parameters:

- **Coordinate System:** y-axis is in the direction of the dipole arms. z-axis is from the basis of the antenna (mounted on the table) towards its feed point between the two dipole arms. x-axis is normal to the other axes. In coincidence with the standards [1], the measurement planes (probe sensor center) are selected to be at a distance of 15 mm above the top metal edge of the dipole arms.
- **Measurement Conditions:** Further details are available from the hardcopies at the end of the certificate. All figures stated in the certificate are valid at the frequency indicated. The forward power to the dipole connector is set with a calibrated power meter connected and monitored with an auxiliary power meter connected to a directional coupler. While the dipole under test is connected, the forward power is adjusted to the same level.
- **Antenna Positioning:** The dipole is mounted on a HAC Test Arch phantom using the matching dipole positioner with the arms horizontal and the feeding cable coming from the floor. The measurements are performed in a shielded room with absorbers around the setup to reduce the reflections. It is verified before the mounting of the dipole under the Test Arch phantom, that its arms are perfectly in a line. It is installed on the HAC dipole positioner with its arms parallel below the dielectric reference wire and able to move elastically in vertical direction without changing its relative position to the top center of the Test Arch phantom. The vertical distance to the probe is adjusted after dipole mounting with a DASY5 Surface Check job. Before the measurement, the distance between phantom surface and probe tip is verified. The proper measurement distance is selected by choosing the matching section of the HAC Test Arch phantom with the proper device reference point (upper surface of the dipole) and the matching grid reference point (tip of the probe) considering the probe sensor offset. The vertical distance to the probe is essential for the accuracy.
- **Feed Point Impedance and Return Loss:** These parameters are measured using a Vector Network Analyzer. The impedance is specified at the SMA connector of the dipole. The influence of reflections was eliminated by applying the averaging function while moving the dipole in the air, at least 70cm away from any obstacles.
- **E-field distribution:** E field is measured in the x-y-plane with an isotropic E-field probe with 100 mW forward power to the antenna feed point. In accordance with [1], the scan area is 20mm wide, its length exceeds the dipole arm length (180 or 90mm). The sensor center is 15 mm (in z) above the metal top of the dipole arms. Two 3D maxima are available near the end of the dipole arms. Assuming the dipole arms are perfectly in one line, the average of these two maxima (in subgrid 2 and subgrid 8) is determined to compensate for any non-parallelity to the measurement plane as well as the sensor displacement. The E-field value stated as calibration value represents the maximum of the interpolated 3D-E-field, in the plane above the dipole surface.

The reported uncertainty of measurement is stated as the standard uncertainty of measurement multiplied by the coverage factor $k=2$, which for a normal distribution corresponds to a coverage probability of approximately 95%.

Measurement Conditions

DASY system configuration, as far as not given on page 1.

DASY Version	DASY5	V52.10.4
Phantom	HAC Test Arch	
Distance Dipole Top - Probe Center	15 mm	
Scan resolution	dx, dy = 5 mm	
Frequency	835 MHz ± 1 MHz	
Input power drift	< 0.05 dB	

Maximum Field values at 835 MHz

E-field 15 mm above dipole surface	condition	Interpolated maximum
Maximum measured above high end	100 mW input power	114.1 V/m = 41.15 dBV/m
Maximum measured above low end	100 mW input power	108.4 V/m = 40.70 dBV/m
Averaged maximum above arm	100 mW input power	111.3 V/m ± 12.8 % (k=2)

Appendix (Additional assessments outside the scope of SCS 0108)

Antenna Parameters

Frequency	Return Loss	Impedance
800 MHz	17.5 dB	41.5 Ω - 8.8 jΩ
835 MHz	27.8 dB	53.2 Ω + 2.7 jΩ
880 MHz	17.0 dB	60.4 Ω - 11.8 jΩ
900 MHz	16.7 dB	51.8 Ω - 14.9 jΩ
945 MHz	24.9 dB	46.0 Ω + 3.7 jΩ

3.2 Antenna Design and Handling

The calibration dipole has a symmetric geometry with a built-in two stub matching network, which leads to the enhanced bandwidth.

The dipole is built of standard semirigid coaxial cable. The internal matching line is open ended. The antenna is therefore open for DC signals.

Do not apply force to dipole arms, as they are liable to bend. The soldered connections near the feedpoint may be damaged. After excessive mechanical stress or overheating, check the impedance characteristics to ensure that the internal matching network is not affected.

After long term use with 40W radiated power, only a slight warming of the dipole near the feedpoint can be measured.

Impedance Measurement Plot

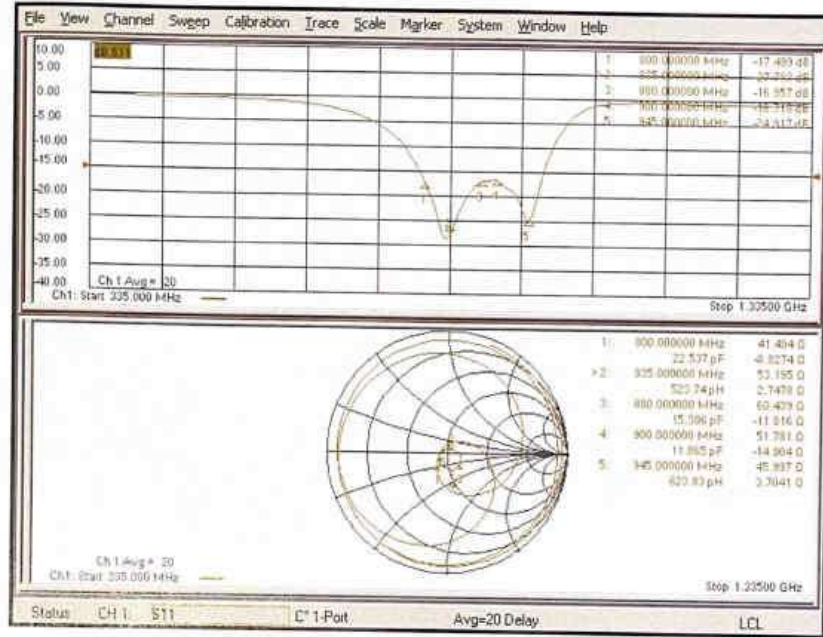

DASY5 E-field Result

Date: 18.05.2021

Test Laboratory: SPEAG Lab2

DUT: HAC-Dipole 835 MHz; Type: CD835V3; Serial: CD835V3 - SN: 1165

Communication System: UID 0 - CW ; Frequency: 835 MHz
 Medium parameters used: $\sigma = 0 \text{ S/m}$, $\epsilon_r = 1$; $\rho = 0 \text{ kg/m}^3$
 Phantom section: RF Section
 Measurement Standard: DASY5 (IEEE/IEC/ANSI C63.19-2011)

DASY52 Configuration:

- Probe: EF3DV3 - SN4013; ConvF(1, 1, 1) @ 835 MHz; Calibrated: 28.12.2020
- Sensor-Surface: (Fix Surface)
- Electronics: DAE4 Sn781; Calibrated: 23.12.2020
- Phantom: HAC Test Arch with AMCC; Type: 5D HAC P01 BA; Serial: 1070
- DASY52 52.10.4(1527); SEMCAD X 14.6.14(7483)

Dipole E-Field measurement @ 835MHz/E-Scan - 835MHz d=15mm/Hearing Aid Compatibility Test (41x361x1):

Interpolated grid: dx=0.5000 mm, dy=0.5000 mm
 Device Reference Point: 0, 0, -6.3 mm
 Reference Value = 135.0 V/m; Power Drift = 0.01 dB
 Applied MIF = 0.00 dB
 RF audio interference level = 41.15 dBV/m
Emission category: M3

MIF scaled E-field

Grid 1 M3	Grid 2 M3	Grid 3 M3
40.65 dBV/m	40.7 dBV/m	40.35 dBV/m
Grid 4 M4	Grid 5 M4	Grid 6 M4
35.83 dBV/m	35.86 dBV/m	35.57 dBV/m
Grid 7 M3	Grid 8 M3	Grid 9 M3
41.07 dBV/m	41.15 dBV/m	40.84 dBV/m

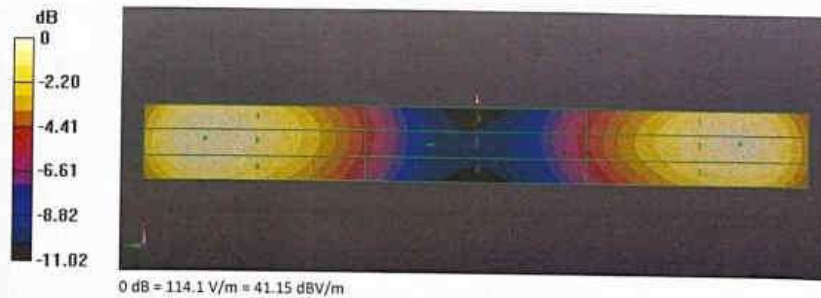



CD1880V3

Calibration Laboratory of
Schmid & Partner
Engineering AG
Zeughausstrasse 43, 8004 Zurich, Switzerland



S Schweizerischer Kalibrierdienst
C Service suisse d'étalonnage
S Servizio svizzero di taratura
S Swiss Calibration Service

Accredited by the Swiss Accreditation Service (SAS)
The Swiss Accreditation Service is one of the signatories to the EA
Multilateral Agreement for the recognition of calibration certificates

Accreditation No.: SCS 0108

Client **TMC-SZ (Auden)**

Certificate No: CD1880V3-1149_May21

CALIBRATION CERTIFICATE

Object **CD1880V3 - SN: 1149**

Calibration procedure(s) **QA CAL-20.v7
Calibration Procedure for Validation Sources in air**

Calibration date: **May 18, 2021**

This calibration certificate documents the traceability to national standards, which realize the physical units of measurements (SI).
The measurements and the uncertainties with confidence probability are given on the following pages and are part of the certificate.

All calibrations have been conducted in the closed laboratory facility: environment temperature (22 ± 3)°C and humidity < 70%.

Calibration Equipment used (M&TE critical for calibration)

Primary Standards	ID #	Cal Date (Certificate No.)	Scheduled Calibration
Power meter NRP	SN: 104778	09-Apr-21 (No. 217-03291/03292)	Apr-22
Power sensor NRP-Z91	SN: 103244	09-Apr-21 (No. 217-03291)	Apr-22
Power sensor NRP-Z91	SN: 103245	09-Apr-21 (No. 217-03292)	Apr-22
Reference 20 dB Attenuator	SN: BH9394 (20k)	09-Apr-21 (No. 217-03343)	Apr-22
Type-N mismatch combination	SN: 310982 / 06327	09-Apr-21 (No. 217-03344)	Apr-22
Probe EF3DV3	SN: 4013	28-Dec-20 (No. EF3-4013_Dec20)	Dec-21
DAE4	SN: 781	23-Dec-20 (No. DAE4-781_Dec20)	Dec-21

Secondary Standards	ID #	Check Date (in house)	Scheduled Check
Power meter Agilent 4419B	SN: GB42420191	09-Oct-09 (in house check Oct-20)	In house check: Oct-23
Power sensor HP E4412A	SN: US38485102	05-Jan-10 (in house check Oct-20)	In house check: Oct-23
Power sensor HP 8482A	SN: US37295597	09-Oct-09 (in house check Oct-20)	In house check: Oct-23
RF generator R&S SMT-06	SN: 837833/005	10-Jan-19 (in house check Oct-20)	In house check: Oct-23
Network Analyzer Agilent E8358A	SN: US41080477	31-Mar-14 (in house check Oct-20)	In house check: Oct-21

	Name	Function	Signature
Calibrated by:	Lell Klymner	Laboratory Technician	
Approved by:	Katja Pokovic	Technical Manager	

Issued: May 18, 2021

This calibration certificate shall not be reproduced except in full without written approval of the laboratory.

Calibration Laboratory of
Schmid & Partner
Engineering AG
Zeughausstrasse 43, 8004 Zurich, Switzerland



S Schweizerischer Kalibrierdienst
C Service suisse d'étalonnage
S Servizio svizzero di taratura
S Swiss Calibration Service

Accredited by the Swiss Accreditation Service (SAS)
The Swiss Accreditation Service is one of the signatories to the EA
Multilateral Agreement for the recognition of calibration certificates

Accreditation No.: SCS 0108

References

- [1] ANSI-C63.19-2011
American National Standard, Methods of Measurement of Compatibility between Wireless Communications Devices and Hearing Aids.

Methods Applied and Interpretation of Parameters:

- **Coordinate System:** y-axis is in the direction of the dipole arms, z-axis is from the basis of the antenna (mounted on the table) towards its feed point between the two dipole arms, x-axis is normal to the other axes. In coincidence with the standards [1], the measurement planes (probe sensor center) are selected to be at a distance of 15 mm above the top metal edge of the dipole arms.
- **Measurement Conditions:** Further details are available from the hardcopies at the end of the certificate. All figures stated in the certificate are valid at the frequency indicated. The forward power to the dipole connector is set with a calibrated power meter connected and monitored with an auxiliary power meter connected to a directional coupler. While the dipole under test is connected, the forward power is adjusted to the same level.
- **Antenna Positioning:** The dipole is mounted on a HAC Test Arch phantom using the matching dipole positioner with the arms horizontal and the feeding cable coming from the floor. The measurements are performed in a shielded room with absorbers around the setup to reduce the reflections. It is verified before the mounting of the dipole under the Test Arch phantom, that its arms are perfectly in a line. It is installed on the HAC dipole positioner with its arms parallel below the dielectric reference wire and able to move elastically in vertical direction without changing its relative position to the top center of the Test Arch phantom. The vertical distance to the probe is adjusted after dipole mounting with a DASY5 Surface Check job. Before the measurement, the distance between phantom surface and probe tip is verified. The proper measurement distance is selected by choosing the matching section of the HAC Test Arch phantom with the proper device reference point (upper surface of the dipole) and the matching grid reference point (tip of the probe) considering the probe sensor offset. The vertical distance to the probe is essential for the accuracy.
- **Feed Point Impedance and Return Loss:** These parameters are measured using a Vector Network Analyzer. The impedance is specified at the SMA connector of the dipole. The influence of reflections was eliminating by applying the averaging function while moving the dipole in the air, at least 70cm away from any obstacles.
- **E-field distribution:** E field is measured in the x-y-plane with an isotropic E-field probe with 100 mW forward power to the antenna feed point. In accordance with [1], the scan area is 20mm wide, its length exceeds the dipole arm length (180 or 90mm). The sensor center is 15 mm (in z) above the metal top of the dipole arms. Two 3D maxima are available near the end of the dipole arms. Assuming the dipole arms are perfectly in one line, the average of these two maxima (in subgrid 2 and subgrid 8) is determined to compensate for any non-parallelity to the measurement plane as well as the sensor displacement. The E-field value stated as calibration value represents the maximum of the interpolated 3D-E-field, in the plane above the dipole surface.

The reported uncertainty of measurement is stated as the standard uncertainty of measurement multiplied by the coverage factor $k=2$, which for a normal distribution corresponds to a coverage probability of approximately 95%.

Measurement Conditions

DASY system configuration, as far as not given on page 1.

DASY Version	DASY5	V52.10.4
Phantom	HAC Test Arch	
Distance Dipole Top - Probe Center	15 mm	
Scan resolution	dx, dy = 5 mm	
Frequency	1880 MHz ± 1 MHz	
Input power drift	< 0.05 dB	

Maximum Field values at 1880 MHz

E-field 15 mm above dipole surface	condition	Interpolated maximum
Maximum measured above high end	100 mW input power	88.4 V/m = 38.93 dBV/m
Maximum measured above low end	100 mW input power	86.7 V/m = 38.76 dBV/m
Averaged maximum above arm	100 mW input power	87.5 V/m ± 12.8 % (k=2)

Appendix (Additional assessments outside the scope of SCS 0108)

Antenna Parameters

Frequency	Return Loss	Impedance
1730 MHz	24.1 dB	54.4 Ω + 4.8 jΩ
1880 MHz	22.6 dB	54.8 Ω + 6.2 jΩ
1900 MHz	23.1 dB	56.3 Ω + 3.9 jΩ
1950 MHz	30.8 dB	52.7 Ω - 1.3 jΩ
2000 MHz	21.6 dB	44.8 Ω + 5.9 jΩ

3.2 Antenna Design and Handling

The calibration dipole has a symmetric geometry with a built-in two stub matching network, which leads to the enhanced bandwidth.

The dipole is built of standard semirigid coaxial cable. The internal matching line is open ended. The antenna is therefore open for DC signals.

Do not apply force to dipole arms, as they are liable to bend. The soldered connections near the feedpoint may be damaged. After excessive mechanical stress or overheating, check the impedance characteristics to ensure that the internal matching network is not affected.

After long term use with 40W radiated power, only a slight warming of the dipole near the feedpoint can be measured.

Impedance Measurement Plot

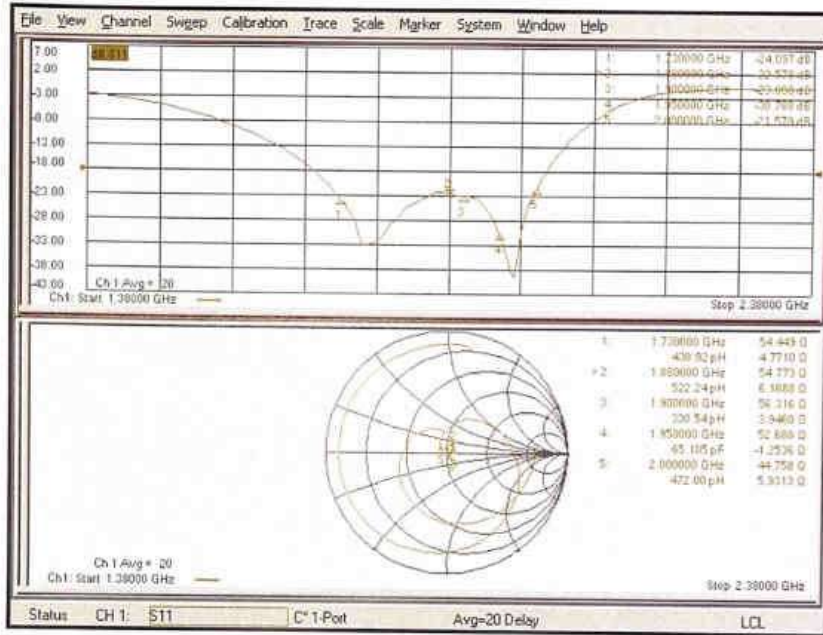

DASY5 E-field Result

Date: 18.05.2021

Test Laboratory: SPEAG Lab2

DUT: HAC Dipole 1880 MHz; Type: CD1880V3; Serial: CD1880V3 - SN: 1149

Communication System: UID 0 - CW ; Frequency: 1880 MHz

Medium parameters used: $\sigma = 0 \text{ S/m}$, $\epsilon_r = 1$; $\rho = 0 \text{ kg/m}^3$

Phantom section: RF Section

Measurement Standard: DASY5 (IEEE/IEC/ANSI C63.19-2011)

DASY52 Configuration:

- Probe: EF3DV3 - SN4013; ConvF(1, 1, 1) @ 1880 MHz; Calibrated: 28.12.2020
- Sensor-Surface: (Fix Surface)
- Electronics: DAE4 Sn781; Calibrated: 23.12.2020
- Phantom: HAC Test Arch with AMCC; Type: 5D HAC P01 BA; Serial: 1070
- DASY52 52.10.4(1527); SEMCAD X 14.6.14(7483)

Dipole E-Field measurement @ 1880MHz/E-Scan - 1880MHz $d=15\text{mm}$ /Hearing Aid Compatibility Test (41x181x1):

Interpolated grid: $dx=0.5000 \text{ mm}$, $dy=0.5000 \text{ mm}$

Device Reference Point: 0, 0, -6.3 mm

Reference Value = 161.6 V/m; Power Drift = -0.01 dB

Applied MIF = 0.00 dB

RF audio interference level = 38.93 dBV/m

Emission category: M2

MIF scaled E-field

Grid 1 M2 38.66 dBV/m	Grid 2 M2 38.76 dBV/m	Grid 3 M2 38.5 dBV/m
Grid 4 M2 36.09 dBV/m	Grid 5 M2 36.12 dBV/m	Grid 6 M2 35.97 dBV/m
Grid 7 M2 38.83 dBV/m	Grid 8 M2 38.93 dBV/m	Grid 9 M2 38.63 dBV/m

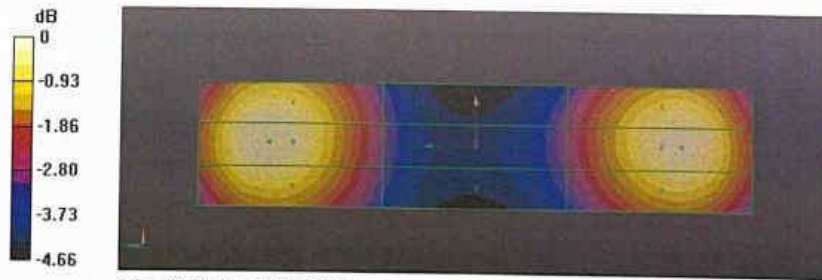

0 dB = 88.38 V/m = 38.93 dBV/m



CD2450V3

Calibration Laboratory of Schmid & Partner Engineering AG
Zeughausstrasse 43, 8004 Zurich, Switzerland



S Schweizerischer Kalibrierdienst
C Service suisse d'étalonnage
S Servizio svizzero di taratura
S Swiss Calibration Service

Accredited by the Swiss Accreditation Service (SAS)
The Swiss Accreditation Service is one of the signatories to the EA Multilateral Agreement for the recognition of calibration certificates

Accreditation No.: SCS 0108

Client TMC-SZ (Auden)

Certificate No: CD2450V3-1139_May21

CALIBRATION CERTIFICATE

Object CD2450V3 - SN: 1139

Calibration procedure(s) QA CAL-20.v7
Calibration Procedure for Validation Sources in air

Calibration date: May 18, 2021

This calibration certificate documents the traceability to national standards, which realize the physical units of measurements (SI). The measurements and the uncertainties with confidence probability are given on the following pages and are part of the certificate.

All calibrations have been conducted in the closed laboratory facility: environment temperature (22 ± 3)°C and humidity < 70%.

Calibration Equipment used (M&E critical for calibration)

Primary Standards	ID #	Cal Date (Certificate No.)	Scheduled Calibration
Power meter NRP	SN: 104776	00-Apr-21 (No. 217-03291/03292)	Apr-22
Power sensor NRP-Z91	SN: 103244	00-Apr-21 (No. 217-03291)	Apr-22
Power sensor NRP-Z91	SN: 103245	00-Apr-21 (No. 217-03292)	Apr-22
Reference 20 dB Attenuator	SN: BH9394 (20k)	09-Apr-21 (No. 217-03343)	Apr-22
Type-N mismatch combination	SN: 310682 / 06327	09-Apr-21 (No. 217-03344)	Apr-22
Probe EF3DV3	SN: 4013	28-Dec-20 (No. EF3-4013_Dec20)	Dec-21
DAE4	SN: 781	23-Dec-20 (No. DAE4-781_Dec20)	Dec-21

Secondary Standards	ID #	Check Date (in house)	Scheduled Check
Power meter Agilent 4419B	SN: GB42420191	09-Oct-09 (in house check Oct-20)	In house check: Oct-23
Power sensor HP E4412A	SN: US38485102	05-Jan-10 (in house check Oct-20)	In house check: Oct-23
Power sensor HP 8482A	SN: US37295597	09-Oct-09 (in house check Oct-20)	In house check: Oct-23
RF generator R&S SMT-06	SN: 837633/005	10-Jan-19 (in house check Oct-20)	In house check: Oct-23
Network Analyzer Agilent E8358A	SN: US41060477	31-Mar-14 (in house check Oct-20)	In house check: Oct-21

	Name	Function	Signature
Calibrated by:	Leif Klysner	Laboratory Technician	
Approved by:	Katja Prokovic	Technical Manager	

Issued: May 18, 2021

This calibration certificate shall not be reproduced except in full without written approval of the laboratory.

**Calibration Laboratory of
Schmid & Partner
Engineering AG**
Zeughausstrasse 43, 8004 Zurich, Switzerland



S Schweizerischer Kalibrierdienst
C Service suisse d'étalonnage
S Servizio svizzero di taratura
S Swiss Calibration Service

Accredited by the Swiss Accreditation Service (SAS)
The Swiss Accreditation Service is one of the signatories to the EA
Multilateral Agreement for the recognition of calibration certificates

Accreditation No.: SCS 0108

References

- [1] ANSI-C63.19-2011
American National Standard, Methods of Measurement of Compatibility between Wireless Communications Devices and Hearing Aids.

Methods Applied and Interpretation of Parameters:

- **Coordinate System:** y-axis is in the direction of the dipole arms. z-axis is from the basis of the antenna (mounted on the table) towards its feed point between the two dipole arms. x-axis is normal to the other axes. In coincidence with the standards [1], the measurement planes (probe sensor center) are selected to be at a distance of 15 mm above the top metal edge of the dipole arms.
- **Measurement Conditions:** Further details are available from the hardcopies at the end of the certificate. All figures stated in the certificate are valid at the frequency indicated. The forward power to the dipole connector is set with a calibrated power meter connected and monitored with an auxiliary power meter connected to a directional coupler. While the dipole under test is connected, the forward power is adjusted to the same level.
- **Antenna Positioning:** The dipole is mounted on a HAC Test Arch phantom using the matching dipole positioner with the arms horizontal and the feeding cable coming from the floor. The measurements are performed in a shielded room with absorbers around the setup to reduce the reflections. It is verified before the mounting of the dipole under the Test Arch phantom, that its arms are perfectly in a line. It is installed on the HAC dipole positioner with its arms parallel below the dielectric reference wire and able to move elastically in vertical direction without changing its relative position to the top center of the Test Arch phantom. The vertical distance to the probe is adjusted after dipole mounting with a DASY5 Surface Check job. Before the measurement, the distance between phantom surface and probe tip is verified. The proper measurement distance is selected by choosing the matching section of the HAC Test Arch phantom with the proper device reference point (upper surface of the dipole) and the matching grid reference point (tip of the probe) considering the probe sensor offset. The vertical distance to the probe is essential for the accuracy.
- **Feed Point Impedance and Return Loss:** These parameters are measured using a Vector Network Analyzer. The impedance is specified at the SMA connector of the dipole. The influence of reflections was eliminated by applying the averaging function while moving the dipole in the air, at least 70cm away from any obstacles.
- **E-field distribution:** E field is measured in the x-y-plane with an isotropic E-field probe with 100 mW forward power to the antenna feed point. In accordance with [1], the scan area is 20mm wide, its length exceeds the dipole arm length (180 or 90mm). The sensor center is 15 mm (in z) above the metal top of the dipole arms. Two 3D maxima are available near the end of the dipole arms. Assuming the dipole arms are perfectly in one line, the average of these two maxima (in subgrid 2 and subgrid 8) is determined to compensate for any non-parallelity to the measurement plane as well as the sensor displacement. The E-field value stated as calibration value represents the maximum of the interpolated 3D-E-field, in the plane above the dipole surface.

The reported uncertainty of measurement is stated as the standard uncertainty of measurement multiplied by the coverage factor k=2, which for a normal distribution corresponds to a coverage probability of approximately 95%.

Measurement Conditions

DASY system configuration, as far as not given on page 1.

DASY Version	DASY5	V52.10.4
Phantom	HAC Test Arch	
Distance Dipole Top - Probe Center	15 mm	
Scan resolution	dx, dy = 5 mm	
Frequency	2450 MHz ± 1 MHz	
Input power drift	< 0.05 dB	

Maximum Field values at 2450 MHz

E-field 15 mm above dipole surface	condition	Interpolated maximum
Maximum measured above high end	100 mW input power	86.7 V/m = 38.76 dBV/m
Maximum measured above low end	100 mW input power	83.9 V/m = 38.47 dBV/m
Averaged maximum above arm	100 mW input power	85.3 V/m ± 12.8 % (k=2)

Appendix (Additional assessments outside the scope of SCS 0108)

Antenna Parameters

Frequency	Return Loss	Impedance
2250 MHz	20.6 dB	58.3 Ω + 5.9 jΩ
2350 MHz	32.2 dB	52.1 Ω + 1.3 jΩ
2450 MHz	23.7 dB	56.8 Ω + 1.7 jΩ
2550 MHz	23.9 dB	54.3 Ω - 5.1 jΩ
2650 MHz	21.2 dB	58.3 Ω - 4.5 jΩ

3.2 Antenna Design and Handling

The calibration dipole has a symmetric geometry with a built-in two stub matching network, which leads to the enhanced bandwidth.

The dipole is built of standard semirigid coaxial cable. The internal matching line is open ended. The antenna is therefore open for DC signals.

Do not apply force to dipole arms, as they are liable to bend. The soldered connections near the feedpoint may be damaged. After excessive mechanical stress or overheating, check the impedance characteristics to ensure that the internal matching network is not affected.

After long term use with 40W radiated power, only a slight warming of the dipole near the feedpoint can be measured.

Impedance Measurement Plot

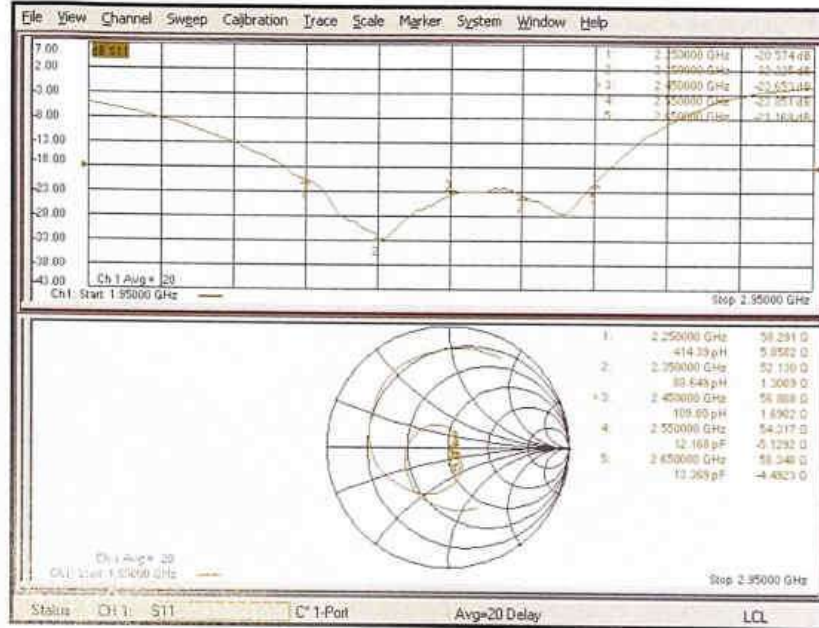

DASY5 E-field Result

Date: 18.05.2021

Test Laboratory: SPEAG Lab2

DUT: HAC Dipole 2450 MHz; Type: CD2450V3; Serial: CD2450V3 - SN: 1139

Communication System: UID 0 - CW ; Frequency: 2450 MHz
 Medium parameters used: $\sigma = 0$ S/m, $\epsilon_r = 1$; $\rho = 0$ kg/m³
 Phantom section: RF Section
 Measurement Standard: DASY5 (IEEE/IEC/ANSI C63.19-2011)

DASY52 Configuration:

- Probe: EF3DV3 - SN4013; ConvF(1, 1, 1) @ 2450 MHz; Calibrated: 28.12.2020
- Sensor-Surface: (Fix Surface)
- Electronics: DAE4 Sn781; Calibrated: 23.12.2020
- Phantom: HAC Test Arch with AMCC; Type: SD HAC P01 BA; Serial: 1070
- DASY52 52.10.4(1527); SEMCAD X 14.6.14(7483)

Dipole E-Field measurement @ 2450MHz/E-Scan - 2450MHz d=15mm/Hearing Aid Compatibility Test (41x181x1):

Interpolated grid: dx=0.5000 mm, dy=0.5000 mm
 Device Reference Point: 0, 0, +6.3 mm
 Reference Value = 77.98 V/m; Power Drift = -0.03 dB
 Applied MIF = 0.00 dB
 RF audio interference level = 38.76 dBV/m
 Emission category: M2

MIF scaled E-field

Grid 1 M2	Grid 2 M2	Grid 3 M2
38.62 dBV/m	38.76 dBV/m	38.5 dBV/m
Grid 4 M2	Grid 5 M2	Grid 6 M2
37.76 dBV/m	37.82 dBV/m	37.66 dBV/m
Grid 7 M2	Grid 8 M2	Grid 9 M2
38.38 dBV/m	38.47 dBV/m	38.21 dBV/m

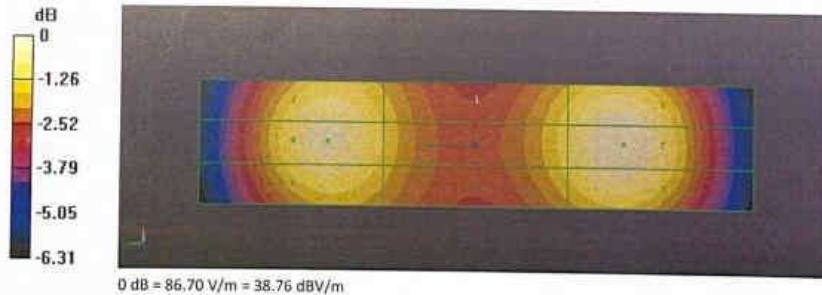



CD2600V3

Calibration Laboratory of Schmid & Partner Engineering AG
Zeughausstrasse 43, 8004 Zurich, Switzerland



S Schweizerischer Kalibrierdienst
C Service suisse d'étalonnage
S Servizio svizzero di taratura
S Swiss Calibration Service

Accredited by the Swiss Accreditation Service (SAS)
The Swiss Accreditation Service is one of the signatories to the EA Multilateral Agreement for the recognition of calibration certificates

Accreditation No.: SCS 0108

Client TMC-SZ (Auden)

Certificate No: CD2600V3-1020_May21

CALIBRATION CERTIFICATE

Object CD2600V3 - SN: 1020
Calibration procedure(s) QA CAL-20.v7
Calibration Procedure for Validation Sources in air
Calibration date: May 18, 2021

This calibration certificate documents the traceability to national standards, which realize the physical units of measurements (SI). The measurements and the uncertainties with confidence probability are given on the following pages and are part of the certificate.

All calibrations have been conducted in the closed laboratory facility: environment temperature (22 ± 3)°C and humidity < 70%.

Calibration Equipment used (M&TE critical for calibration)

Primary Standards	ID #	Cal Date (Certificate No.)	Scheduled Calibration
Power meter NRP	SN: 104778	09-Apr-21 (No. 217-03291/03292)	Apr-22
Power sensor NRP-Z91	SN: 103244	09-Apr-21 (No. 217-03291)	Apr-22
Power sensor NRP-Z91	SN: 103245	09-Apr-21 (No. 217-03292)	Apr-22
Reference 20 dB Attenuator	SN: BHP9394 (20k)	09-Apr-21 (No. 217-03343)	Apr-22
Type-N mismatch combination	SN: 310982 / 06327	09-Apr-21 (No. 217-03344)	Apr-22
Probe EF3DV3	SN: 4013	28-Dec-20 (No. EF3-4013_Dec20)	Dec-21
DAE4	SN: 781	23-Dec-20 (No. DAE4-781_Dec20)	Dec-21

Secondary Standards	ID #	Check Date (in house)	Scheduled Check
Power meter Agilent 4419B	SN: GB42420191	09-Oct-09 (in house check Oct-20)	In house check: Oct-23
Power sensor HP E4412A	SN: US38485102	05-Jan-10 (in house check Oct-20)	In house check: Oct-23
Power sensor HP 8482A	SN: US37295597	09-Oct-09 (in house check Oct-20)	In house check: Oct-23
RF generator R&S SMT-06	SN: 837633/005	10-Jan-19 (in house check Oct-20)	In house check: Oct-23
Network Analyzer Agilent E8358A	SN: US41080477	31-Mar-14 (in house check Oct-20)	In house check: Oct-21

	Name	Function	Signature
Calibrated by:	Leif Klysner	Laboratory Technician	
Approved by:	Katja Pokovic	Technical Manager	

Issued: May 18, 2021

This calibration certificate shall not be reproduced except in full without written approval of the laboratory.

**Calibration Laboratory of
Schmid & Partner
Engineering AG**
Zeughausstrasse 43, 8004 Zurich, Switzerland



S Schweizerischer Kalibrierdienst
C Service suisse d'étalonnage
S Servizio svizzero di taratura
Swiss Calibration Service

Accredited by the Swiss Accreditation Service (SAS)
The Swiss Accreditation Service is one of the signatories to the EA
Multilateral Agreement for the recognition of calibration certificates

Accreditation No.: **SCS 0108**

References

- [1] ANSI-C63.19-2011
American National Standard, Methods of Measurement of Compatibility between Wireless Communications Devices and Hearing Aids.

Methods Applied and Interpretation of Parameters:

- **Coordinate System:** y-axis is in the direction of the dipole arms. z-axis is from the basis of the antenna (mounted on the table) towards its feed point between the two dipole arms. x-axis is normal to the other axes. In coincidence with the standards [1], the measurement planes (probe sensor center) are selected to be at a distance of 15 mm above the top metal edge of the dipole arms.
- **Measurement Conditions:** Further details are available from the hardcopies at the end of the certificate. All figures stated in the certificate are valid at the frequency indicated. The forward power to the dipole connector is set with a calibrated power meter connected and monitored with an auxiliary power meter connected to a directional coupler. While the dipole under test is connected, the forward power is adjusted to the same level.
- **Antenna Positioning:** The dipole is mounted on a HAC Test Arch phantom using the matching dipole positioner with the arms horizontal and the feeding cable coming from the floor. The measurements are performed in a shielded room with absorbers around the setup to reduce the reflections. It is verified before the mounting of the dipole under the Test Arch phantom, that its arms are perfectly in a line. It is installed on the HAC dipole positioner with its arms parallel below the dielectric reference wire and able to move elastically in vertical direction without changing its relative position to the top center of the Test Arch phantom. The vertical distance to the probe is adjusted after dipole mounting with a DASYS Surface Check job. Before the measurement, the distance between phantom surface and probe tip is verified. The proper measurement distance is selected by choosing the matching section of the HAC Test Arch phantom with the proper device reference point (upper surface of the dipole) and the matching grid reference point (tip of the probe) considering the probe sensor offset. The vertical distance to the probe is essential for the accuracy.
- **Feed Point Impedance and Return Loss:** These parameters are measured using a Vector Network Analyzer. The impedance is specified at the SMA connector of the dipole. The influence of reflections was eliminated by applying the averaging function while moving the dipole in the air, at least 70cm away from any obstacles.
- **E-field distribution:** E field is measured in the x-y-plane with an isotropic E-field probe with 100 mW forward power to the antenna feed point. In accordance with [1], the scan area is 20mm wide, its length exceeds the dipole arm length (180 or 90mm). The sensor center is 15 mm (in z) above the metal top of the dipole arms. Two 3D maxima are available near the end of the dipole arms. Assuming the dipole arms are perfectly in one line, the average of these two maxima (in subgrid 2 and subgrid 8) is determined to compensate for any non-parallelity to the measurement plane as well as the sensor displacement. The E-field value stated as calibration value represents the maximum of the interpolated 3D-E-field, in the plane above the dipole surface.

The reported uncertainty of measurement is stated as the standard uncertainty of measurement multiplied by the coverage factor k=2, which for a normal distribution corresponds to a coverage probability of approximately 95%.

Measurement Conditions

DASY system configuration, as far as not given on page 1.

DASY Version	DASY5	V52.10.4
Phantom	HAC Test Arch	
Distance Dipole Top - Probe Center	15 mm	
Scan resolution	dx, dy = 5 mm	
Frequency	2600 MHz ± 1 MHz	
Input power drift	< 0.05 dB	

Maximum Field values at 2600 MHz

E-field 15 mm above dipole surface	condition	Interpolated maximum
Maximum measured above high end	100 mW input power	85.3 V/m = 38.62 dBV/m
Maximum measured above low end	100 mW input power	83.2 V/m = 38.40 dBV/m
Averaged maximum above arm	100 mW input power	84.3 V/m ± 12.8 % (k=2)

Appendix (Additional assessments outside the scope of SCS 0108)

Antenna Parameters

Frequency	Return Loss	Impedance
2450 MHz	18.0 dB	42.7 Ω - 9.2 jΩ
2550 MHz	26.7 dB	45.9 Ω + 1.6 jΩ
2600 MHz	34.5 dB	49.3 Ω + 1.7 jΩ
2650 MHz	33.6 dB	52.1 Ω + 0.5 jΩ
2750 MHz	19.9 dB	50.7 Ω - 10.2 jΩ

3.2 Antenna Design and Handling

The calibration dipole has a symmetric geometry with a built-in two stub matching network, which leads to the enhanced bandwidth.

The dipole is built of standard semirigid coaxial cable. The internal matching line is open ended. The antenna is therefore open for DC signals.

Do not apply force to dipole arms, as they are liable to bend. The soldered connections near the feedpoint may be damaged. After excessive mechanical stress or overheating, check the impedance characteristics to ensure that the internal matching network is not affected.

After long term use with 40W radiated power, only a slight warming of the dipole near the feedpoint can be measured.

Impedance Measurement Plot

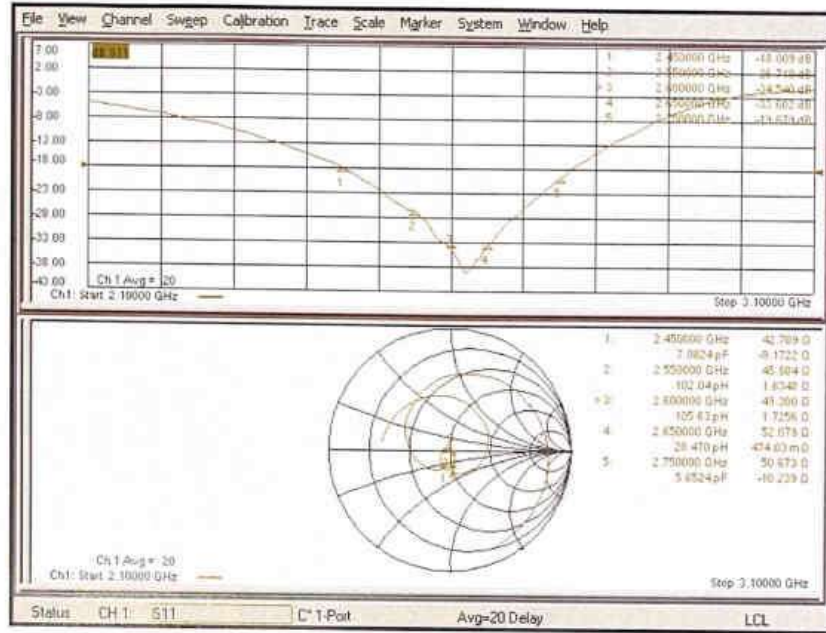

DASY5 E-field Result

Date: 18.05.2021

Test Laboratory: SPEAG Lab2

DUT: HAC Dipole 2600 MHz; Type: CD2600V3; Serial: CD2600V3 - SN: 1020

Communication System: UID 0 - CW ; Frequency: 2600 MHz:

Medium parameters used: $\sigma = 0$ S/m, $\epsilon_r = 1$; $\rho = 0$ kg/m³

Phantom section: RF Section

Measurement Standard: DASY5 (IEEE/IEC/ANSI C63.19-2011)

DASY52 Configuration:

- Probe: EF3DV3 - SN4013; ConvF(1, 1, 1) @ 2600 MHz; Calibrated: 28.12.2020
- Sensor-Surface: (Fix Surface)
- Electronics: DAE4 Sn781; Calibrated: 23.12.2020
- Phantom: HAC Test Arch with AMCC; Type: SD HAC P01 BA; Serial: 1070
- DASY52 52.10.4(1527); SEMCAD X 14.6.14(7483)

Dipole E-Field measurement @ 2600MHz/E-Scan - 2600MHz d=15mm/Hearing Aid Compatibility Test (41x181x1):

Interpolated grid: dx=0.5000 mm, dy=0.5000 mm

Device Reference Point: 0, 0, -6.3 mm

Reference Value = 67.80 V/m; Power Drift = 0.00 dB

Applied MIF = 0.00 dB

RF audio interference level = 38.62 dBV/m

Emission category: M2

MIF scaled E-field

Grid 1 M2	Grid 2 M2	Grid 3 M2
38.28 dBV/m	38.4 dBV/m	38.16 dBV/m
Grid 4 M2	Grid 5 M2	Grid 6 M2
37.79 dBV/m	37.85 dBV/m	37.68 dBV/m
Grid 7 M2	Grid 8 M2	Grid 9 M2
38.51 dBV/m	38.62 dBV/m	38.37 dBV/m

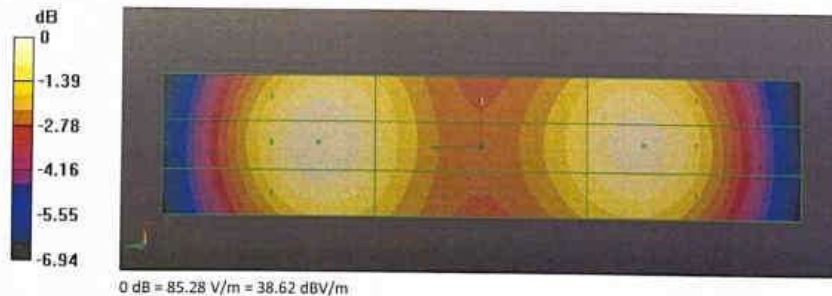



ANNEX D: Probe Calibration Certificate

**Calibration Laboratory of
Schmid & Partner
Engineering AG**
Zeughausstrasse 43, 8004 Zurich, Switzerland



S Schweizerischer Kalibrierdienst
C Service suisse d'étalonnage
S Servizio svizzero di taratura
Swiss Calibration Service

Accredited by the Swiss Accreditation Service (SAS)
The Swiss Accreditation Service is one of the signatories to the EA
Multilateral Agreement for the recognition of calibration certificates.

Accreditation No.: **SCS 0108**

Client **TMC-SZ (Auden)**

Certificate No: **ER3-2424_Mar21**

CALIBRATION CERTIFICATE

Object: **ER3DV6- SN:2424**

Calibration procedure(s): **QA CAL-02.v9, QA CAL-25.v7**
Calibration procedure for E-field probes optimized for close near field evaluations in air

Calibration date: **March 4, 2021**

This calibration certificate documents the traceability to national standards, which realize the physical units of measurements (SI).
The measurements and the uncertainties with confidence probability are given on the following pages and are part of the certificate.

All calibrations have been conducted in the closed laboratory facility: environment temperature (22 ± 3) °C and humidity < 70%.

Calibration Equipment used (M&TE critical for calibration)

Primary Standards	ID	Cal Date (Certificate No.)	Scheduled Calibration
Power meter NRP	SN: 104778	01-Apr-20 (No. 217-03100/03101)	Apr-21
Power sensor NRP-Z91	SN: 103244	01-Apr-20 (No. 217-03100)	Apr-21
Power sensor NRP-Z91	SN: 103245	01-Apr-20 (No. 217-03101)	Apr-21
Reference 20 dB Attenuator	SN: CC2552 (20x)	31-Mar-20 (No. 217-03106)	Apr-21
DAE4	SN: 789	23-Dec-20 (No. DAE4-789_Dec20)	Dec-21
Reference Probe ER3DV6	SN: 2328	05-Oct-20 (No. ER3-2328_Oct20)	Oct-21
Secondary Standards:	ID	Check Date (in house)	Scheduled Check:
Power meter E4419B	SN: GB41293874	06-Apr-16 (in house check Jun-20)	In house check: Jun-22
Power sensor E4412A	SN: MY41498087	06-Apr-16 (in house check Jun-20)	In house check: Jun-22
Power sensor E4412A	SN: 000110210	06-Apr-16 (in house check Jun-20)	In house check: Jun-22
RF generator HP 8648C	SN: US3642U01700	04-Aug-99 (in house check Jun-20)	In house check: Jun-22
Network Analyzer E8358A	SN: US41080477	31-Mar-14 (in house check Oct-20)	In house check: Oct-21

Calibrated by:	Name Michael Weber	Function Laboratory Technician	Signature
Approved by:	Name Katja Pokovic	Function Technical Manager	Signature

Issued: March 4, 2021

This calibration certificate shall not be reproduced except in full without written approval of the laboratory.



Calibration Laboratory of
Schmid & Partner
Engineering AG
Zeughausstrasse 43, 8004 Zurich, Switzerland



S Schweizerischer Kalibrierdienst
C Service suisse d'étalonnage
S Servizio svizzero di taratura
Swiss Calibration Service

Accredited by the Swiss Accreditation Service (SAS)
The Swiss Accreditation Service is one of the signatories to the EA
Multilateral Agreement for the recognition of calibration certificates

Accreditation No.: SCS 0108

Glossary:

NORM _{x,y,z}	sensitivity in free space
DCP	diode compression point
CF	crest factor (1/duty_cycle) of the RF signal
A, B, C, D	modulation dependent linearization parameters
En	incident E-field orientation normal to probe axis
Ep	incident E-field orientation parallel to probe axis
Polarization φ	φ rotation around probe axis
Polarization ϑ	ϑ rotation around an axis that is in the plane normal to probe axis (at measurement center), i.e., $\vartheta = 0$ is normal to probe axis
Connector Angle	information used in DASY system to align probe sensor X to the robot coordinate system

Calibration is Performed According to the Following Standards:

- a) IEEE Std 1309-2005, "IEEE Standard for calibration of electromagnetic field sensors and probes, excluding antennas, from 9 kHz to 40 GHz", December 2005
- b) CTIA Test Plan for Hearing Aid Compatibility, Rev 3.1.1, May 2017

Methods Applied and Interpretation of Parameters:

- *NORM_{x,y,z}*: Assessed for E-field polarization: $\vartheta = 0$ for XY sensors and $\vartheta = 90$ for Z sensor ($f \leq 900$ MHz in: TEM-cell; $f > 1800$ MHz: R22 waveguide).
- *NORM(f)_{x,y,z} = NORM_{x,y,z} * frequency_response* (see Frequency Response Chart).
- *DCP_{x,y,z}*: DCP are numerical linearization parameters assessed based on the data of power sweep with CW signal (no uncertainty required). DCP does not depend on frequency nor media.
- *PAR*: PAR is the Peak to Average Ratio that is not calibrated but determined based on the signal characteristics
- *A_{x,y,z}; B_{x,y,z}; C_{x,y,z}; D_{x,y,z}; VR_{x,y,z}*: A, B, C, D are numerical linearization parameters assessed based on the data of power sweep for specific modulation signal. The parameters do not depend on frequency nor media. VR is the maximum calibration range expressed in RMS voltage across the diode.
- *Spherical isotropy (3D deviation from isotropy)*: in a locally homogeneous field realized using an open waveguide setup.
- *Sensor Offset*: The sensor offset corresponds to the offset of virtual measurement center from the probe tip (on probe axis). No tolerance required.
- *Connector Angle*: The angle is assessed using the information gained by determining the *NORM_x* (no uncertainty required).



ER3DV6 – SN:2424

March 4, 2021

DASY/EASY - Parameters of Probe: ER3DV6 - SN:2424

Basic Calibration Parameters

	Sensor X	Sensor Y	Sensor Z	Unc (k=2)
Norm ($\mu\text{V}/(\text{V/m})^2$)	1.53	1.55	1.83	$\pm 10.1\%$
DCP (mV) ^b	99.3	99.8	101.3	

Calibration results for Frequency Response (30 MHz – 3 GHz)

Frequency MHz	Target E-Field V/m	Measured E-field (En) V/m	Deviation E-normal in %	Measured E-field (Ep) V/m	Deviation E-normal in %	Unc (k=2) %
30	77.1	76.6	-0.7%	77.4	0.4%	$\pm 5.1\%$
100	77.2	78.5	1.8%	77.9	0.9%	$\pm 5.1\%$
450	77.2	78.6	1.9%	77.8	0.8%	$\pm 5.1\%$
600	77.0	78.2	1.5%	77.5	0.6%	$\pm 5.1\%$
750	77.0	78.1	1.5%	77.5	0.7%	$\pm 5.1\%$
1800	143.0	141.7	-0.9%	141.1	-1.3%	$\pm 5.1\%$
2000	135.1	134.4	-0.5%	133.5	-1.2%	$\pm 5.1\%$
2200	127.7	126.2	-1.2%	127.5	-0.1%	$\pm 5.1\%$
2500	125.5	126.0	0.4%	126.8	1.1%	$\pm 5.1\%$
3000	79.4	78.2	-1.6%	81.3	2.4%	$\pm 5.1\%$

The reported uncertainty of measurement is stated as the standard uncertainty of measurement multiplied by the coverage factor k=2, which for a normal distribution corresponds to a coverage probability of approximately 95%.

^b Numerical linearization parameter; uncertainty not required.

^c Uncertainty is determined using the max. deviation from linear response applying rectangular distribution and is expressed for the square of the field value.



ER3DV6 – SN:2424

March 4, 2021

DASY/EASY - Parameters of Probe: ER3DV6 - SN:2424

Calibration Results for Modulation Response

UID	Communication System Name		A dB	B dB√μV	C	D dB	VR mV	Max dev.	Unc ^E (k=2)
0	CW	X	0.0	0.0	1.0	0.00	207.1	±3.5 %	± 4.7 %
		Y	0.0	0.0	1.0		194.8		
		Z	0.0	0.0	1.0		208.5		
10021-DAC	GSM-FDD (TDMA, GMSK)	X	13.38	91.7	25.7	9.39	127.8	±3.0 %	± 4.7 %
		Y	20.31	99.9	28.1		115.1		
		Z	25.39	99.9	28.1		145.9		
10061-CAB	IEEE 802.11b WiFi 2.4 GHz (DSSS, 11 Mbps)	X	4.95	75.3	21.8	3.60	114.8	±2.2 %	± 4.7 %
		Y	4.11	72.3	20.5		106.0		
		Z	5.66	76.6	21.8		117.0		
10077-CAB	IEEE 802.11g WiFi 2.4 GHz (DSSS/OFDM, 54 Mbps)	X	12.21	74.8	27.6	11.00	104.9	±2.2 %	± 4.7 %
		Y	13.33	78.3	29.7		144.6		
		Z	12.02	73.8	26.5		107.7		
10172-CAG	LTE-TDD (SC-FDMA, 1 RB, 20 MHz, QPSK)	X	10.38	84.9	32.0	9.21	140.1	±2.5 %	± 4.7 %
		Y	8.50	78.8	28.9		126.9		
		Z	11.14	85.0	31.1		148.0		
10173-CAG	LTE-TDD (SC-FDMA, 1 RB, 20 MHz, 16-QAM)	X	10.60	84.6	31.9	9.48	139.5	±2.5 %	± 4.7 %
		Y	9.11	80.2	29.6		127.0		
		Z	12.00	86.6	31.9		148.3		
10295-AAB	CDMA2000, RC1, SO3, 1/8th Rate 25 fr.	X	16.51	99.7	40.5	12.49	113.2	±3.5 %	± 4.7 %
		Y	15.91	100.0	40.9		101.3		
		Z	18.42	100.0	39.2		126.2		

The reported uncertainty of measurement is stated as the standard uncertainty of measurement multiplied by the coverage factor k=2, which for a normal distribution corresponds to a coverage probability of approximately 95%.

^A Numerical linearization parameter; uncertainty not required.

^E Uncertainty is determined using the max. deviation from linear response applying rectangular distribution and is expressed for the square of the field value.



ER3DV6 – SN:2424

March 4, 2021

DASY/EASY - Parameters of Probe: ER3DV6 - SN:2424

Sensor Frequency Model Parameters

	Sensor X	Sensor Y	Sensor Z
Frequency Corr. (LF)	-1.78	-1.32	0.22
Frequency Corr. (HF)	0.00	0.00	0.00

Other Probe Parameters

Sensor Arrangement	Rectangular
Connector Angle (°)	105.5
Mechanical Surface Detection Mode	enabled
Optical Surface Detection Mode	disabled
Probe Overall Length	337 mm
Probe Body Diameter	10 mm
Tip Length	10 mm
Tip Diameter	8 mm
Probe Tip to Sensor X Calibration Point	2.5 mm
Probe Tip to Sensor Y Calibration Point	2.5 mm
Probe Tip to Sensor Z Calibration Point	2.5 mm

ER3DV6 – SN:2424

March 4, 2021

Receiving Pattern (ϕ), $\vartheta = 0^\circ$

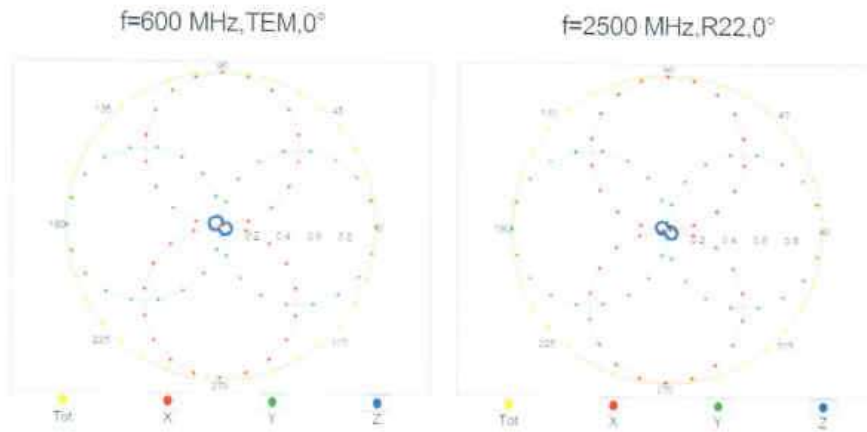

Receiving Pattern (ϕ), $\vartheta = 90^\circ$

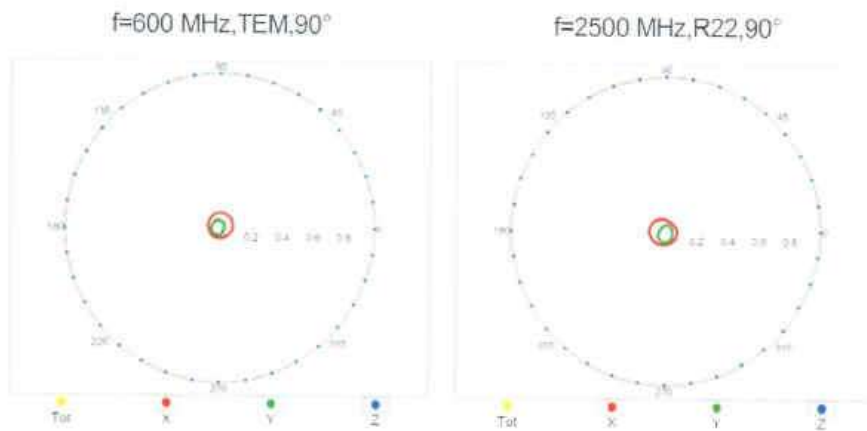

Receiving Pattern (ϕ), $\vartheta = 0^\circ$

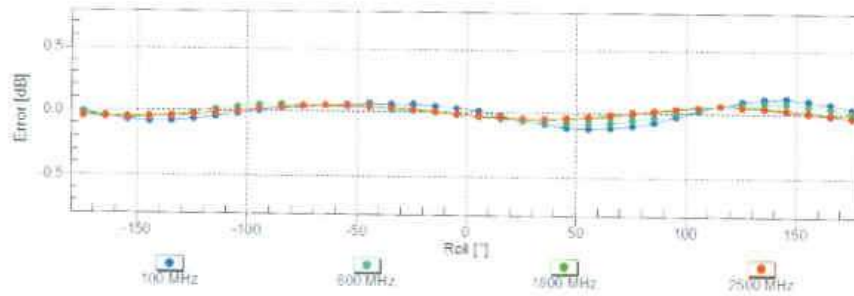

Uncertainty of Axial Isotropy Assessment: $\pm 0.5\%$ ($k=2$)

Receiving Pattern (ϕ), $\vartheta = 90^\circ$

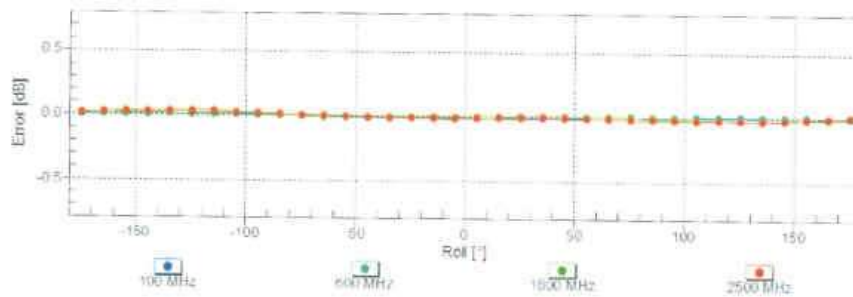

Uncertainty of Axial Isotropy Assessment: $\pm 0.5\%$ ($k=2$)

ER3DV6 – SN:2424

March 4, 2021

Dynamic Range f(E-field) (TEM cell, f = 900 MHz)

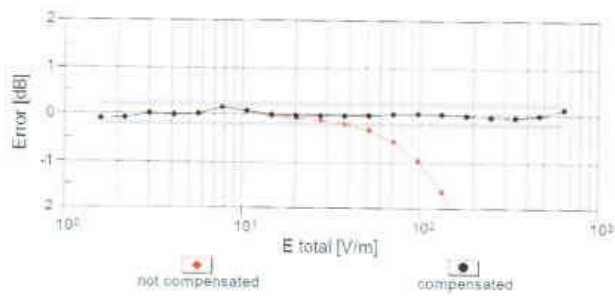
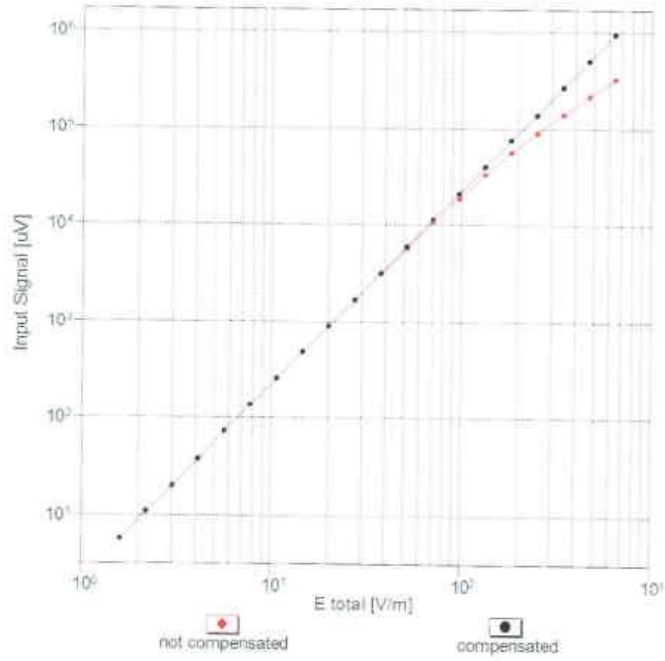

Uncertainty of Linearity Assessment: $\pm 0.6\%$ (k=2)

ER3DV6 – SN:2424

March 4, 2021

Deviation from Isotropy in Air Error (ϕ, θ), $f = 900$ MHz

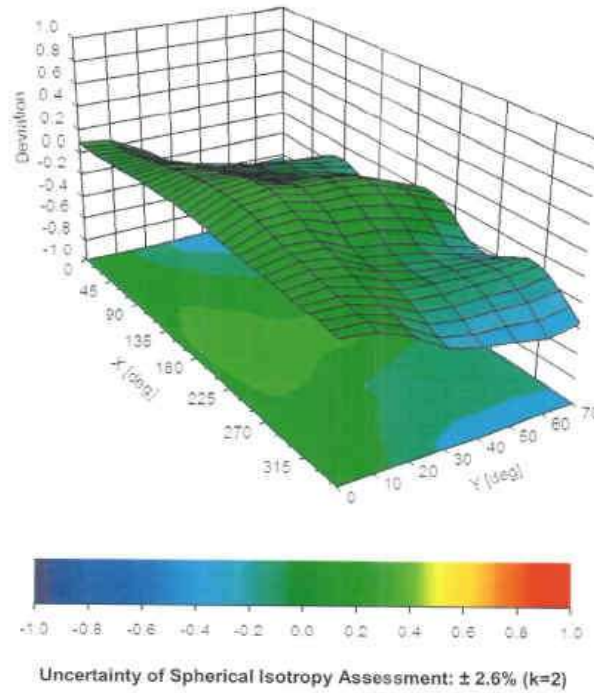



ANNEX E: DAE Calibration Certificate

Calibration Laboratory of
Schmid & Partner
Engineering AG
Zeughausstrasse 43, 8004 Zurich, Switzerland



S Schweizerischer Kalibrierdienst
C Service suisse d'étalonnage
S Servizio svizzero di taratura
S Swiss Calibration Service

Accredited by the Swiss Accreditation Service (SAS)
The Swiss Accreditation Service is one of the signatories to the EA
Multilateral Agreement for the recognition of calibration certificates

Accreditation No.: SCS 0108

Client **Saict-SZ (Auden)**

Certificate No: **DAE4-1527_Jun22**

CALIBRATION CERTIFICATE

Object **DAE4 - SD 000 D04 BM - SN: 1527**

Calibration procedure(s) **QA CAL-06.v30
Calibration procedure for the data acquisition electronics (DAE)**

Calibration date: **June 21, 2022**

This calibration certificate documents the traceability to national standards, which realize the physical units of measurements (SI).
The measurements and the uncertainties with confidence probability are given on the following pages and are part of the certificate.

All calibrations have been conducted in the closed laboratory facility: environment temperature (22 ± 3)°C and humidity < 70%.

Calibration Equipment used (M&TE critical for calibration)

Primary Standards	ID #	Cal Date (Certificate No.)	Scheduled Calibration
Keithley Multimeter Type 2001	SN: 6810278	31-Aug-21 (No:31368)	Aug-22
Secondary Standards	ID #	Check Date (in house)	Scheduled Check
Auto DAE Calibration Unit	SE UWS 053 AA 1001	24-Jan-22 (in house check)	In house check: Jan-23
Calibrator Box V2.1	SE UMS 006 AA 1002	24-Jan-22 (in house check)	In house check: Jan-23

	Name	Function	Signature
Calibrated by:	Adrian Gehring	Laboratory Technician	
Approved by:	Sven Kühn	Technical Manager	

Issued: June 21, 2022

This calibration certificate shall not be reproduced except in full without written approval of the laboratory.

**Calibration Laboratory of
Schmid & Partner
Engineering AG**
Zeughausstrasse 43, 8004 Zurich, Switzerland



S Schweizerischer Kalibrierdienst
C Service suisse d'étalonnage
S Servizio svizzero di taratura
S Swiss Calibration Service

Accredited by the Swiss Accreditation Service (SAS)
The Swiss Accreditation Service is one of the signatories to the EA
Multilateral Agreement for the recognition of calibration certificates

Accreditation No.: **SCS 0108**

Glossary

DAE data acquisition electronics.
Connector angle information used in DASY system to align probe sensor X to the robot coordinate system.

Methods Applied and Interpretation of Parameters

- **DC Voltage Measurement:** Calibration Factor assessed for use in DASY system by comparison with a calibrated instrument traceable to national standards. The figure given corresponds to the full scale range of the voltmeter in the respective range.
- **Connector angle:** The angle of the connector is assessed measuring the angle mechanically by a tool inserted. Uncertainty is not required.
- The following parameters as documented in the Appendix contain technical information as a result from the performance test and require no uncertainty.
 - **DC Voltage Measurement Linearity:** Verification of the Linearity at +10% and -10% of the nominal calibration voltage. Influence of offset voltage is included in this measurement.
 - **Common mode sensitivity:** Influence of a positive or negative common mode voltage on the differential measurement.
 - **Channel separation:** Influence of a voltage on the neighbor channels not subject to an input voltage.
 - **AD Converter Values with inputs shorted:** Values on the internal AD converter corresponding to zero input voltage
 - **Input Offset Measurement:** Output voltage and statistical results over a large number of zero voltage measurements.
 - **Input Offset Current:** Typical value for information; Maximum channel input offset current, not considering the input resistance.
 - **Input resistance:** Typical value for information: DAE input resistance at the connector, during internal auto-zeroing and during measurement.
 - **Low Battery Alarm Voltage:** Typical value for information. Below this voltage, a battery alarm signal is generated.
 - **Power consumption:** Typical value for information. Supply currents in various operating modes.



DC Voltage Measurement

AD - Converter Resolution nominal

High Range: 1LSB = 6.1 μ V , full range = -100...+300 mV

Low Range: 1LSB = 61nV , full range = -1.....+3mV

DASY measurement parameters: Auto Zero Time: 3 sec; Measuring time: 3 sec

Calibration Factors	X	Y	Z
High Range	403.865 \pm 0.02% (k=2)	403.595 \pm 0.02% (k=2)	403.805 \pm 0.02% (k=2)
Low Range	3.95898 \pm 1.50% (k=2)	3.98939 \pm 1.50% (k=2)	3.96763 \pm 1.50% (k=2)

Connector Angle

Connector Angle to be used in DASY system	61.0 $^{\circ}$ \pm 1 $^{\circ}$
---	------------------------------------

Appendix (Additional assessments outside the scope of SCS0108)

1. DC Voltage Linearity

High Range	Reading (μV)	Difference (μV)	Error (%)
Channel X + Input	200037.59	1.98	0.00
Channel X + Input	20007.61	1.34	0.01
Channel X - Input	-20004.09	1.79	-0.01
Channel Y + Input	200037.45	1.53	0.00
Channel Y + Input	20002.68	-3.42	-0.02
Channel Y - Input	-20007.17	-1.14	0.01
Channel Z + Input	200037.73	2.17	0.00
Channel Z + Input	20005.72	-0.34	-0.00
Channel Z - Input	-20006.63	-0.49	0.00

Low Range	Reading (μV)	Difference (μV)	Error (%)
Channel X + Input	2001.36	-0.15	-0.01
Channel X + Input	201.70	0.16	0.08
Channel X - Input	-198.10	0.49	-0.24
Channel Y + Input	2001.44	0.07	0.00
Channel Y + Input	201.07	-0.21	-0.11
Channel Y - Input	-199.66	-0.98	0.50
Channel Z + Input	2001.52	0.21	0.01
Channel Z + Input	200.81	-0.41	-0.20
Channel Z - Input	-199.00	-0.15	0.07

2. Common mode sensitivity

DASY measurement parameters: Auto Zero Time: 3 sec; Measuring time: 3 sec

	Common mode Input Voltage (mV)	High Range Average Reading (μV)	Low Range Average Reading (μV)
Channel X	200	-3.95	-5.31
	-200	5.96	4.97
Channel Y	200	-16.18	-16.25
	-200	14.41	14.34
Channel Z	200	3.01	2.86
	-200	-3.93	-4.13

3. Channel separation

DASY measurement parameters: Auto Zero Time: 3 sec; Measuring time: 3 sec

	Input Voltage (mV)	Channel X (μV)	Channel Y (μV)	Channel Z (μV)
Channel X	200	-	-0.68	-2.76
Channel Y	200	5.43	-	-0.31
Channel Z	200	10.73	3.29	-

4. AD-Converter Values with inputs shorted

DASY measurement parameters: Auto Zero Time: 3 sec; Measuring time: 3 sec

	High Range (LSB)	Low Range (LSB)
Channel X	16059	17078
Channel Y	15965	16219
Channel Z	15888	13556

5. Input Offset Measurement

DASY measurement parameters: Auto Zero Time: 3 sec; Measuring time: 3 sec

Input 10M Ω

	Average (μ V)	min. Offset (μ V)	max. Offset (μ V)	Std. Deviation (μ V)
Channel X	1.40	0.30	2.25	0.35
Channel Y	-0.62	-1.30	0.47	0.33
Channel Z	-0.18	-0.90	0.60	0.31

6. Input Offset Current

Nominal Input circuitry offset current on all channels: <25fA

7. Input Resistance (Typical values for information)

	Zeroing (kOhm)	Measuring (MOhm)
Channel X	200	200
Channel Y	200	200
Channel Z	200	200

8. Low Battery Alarm Voltage (Typical values for information)

Typical values	Alarm Level (VDC)
Supply (+ Vcc)	+7.9
Supply (- Vcc)	-7.6

9. Power Consumption (Typical values for information)

Typical values	Switched off (mA)	Stand by (mA)	Transmitting (mA)
Supply (+ Vcc)	+0.01	+6	+14
Supply (- Vcc)	-0.01	-8	-9

ANNEX F: UID Specification

**Calibration Laboratory of
Schmid & Partner
Engineering AG**
Zeughausstrasse 43, 8004 Zurich, Switzerland

Name:	GSM-FDD (TDMA, GMSK)
Group:	GSM
UID:	10021-DAC
PAR: ¹	9.39 dB
MIF: ²	3.63 dB
Standard Reference:	ETSI TS 100 909 V8.9.0 (2005-01) FCC OET KDB 941225, D03 and D04 Periodic pulsed modulation
Category:	GMSK
Modulation:	GMSK
Frequency Band:	GSM 450 (450.4 - 457.6 MHz) GSM 460 (478.0 - 486.0 MHz) GSM 710 (698.0 - 716.0 MHz) GSM 750 (747.0 - 763.0 MHz) GSM 850 (824.0 - 849.0 MHz) P-GSM 900 (890.0 - 915.0 MHz) E-GSM 900 (890.0 - 915.0 MHz) R-GSM 900 (876.0 - 915.0 MHz) DCS 1800 (1710.0 - 1785.0 MHz) PCS 1900 (1850.0 - 1910.0 MHz) ER-GSM 900 (873.0 - 915.0 MHz) Validation band (0.0 - 6000.0 MHz)
Detailed Specification:	Active Slot: TND Data: PN9 continuous Frame: composed out of 8 Slots Multiframe: 28th (IDLE) Frame set blank Slottype & -timing: Normal burst for GMSK
Bandwidth:	0.2 MHz
Integration Time:	120.0 ms

¹ PAR (0.1%) in accordance with FCC KDB 971168, Section 6.0 "Measurement of the Peak-to-Average Power Ratio (PAPR)"
² Modulation Interference Factor (MIF) value valid only in conjunction with advanced probe response linearization calibration for the same communication system (same UID and version).

**Calibration Laboratory of
Schmid & Partner
Engineering AG**
Zeughausstrasse 43, 8004 Zurich, Switzerland

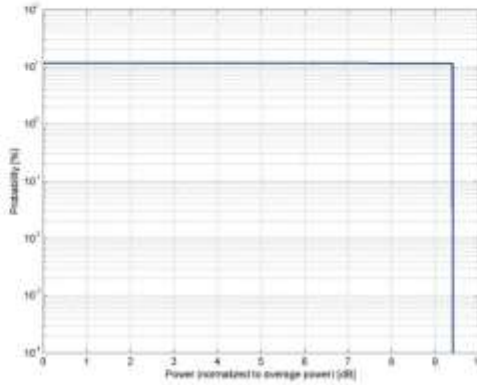

Complementary Cumulative Distribution Function (CCDF)

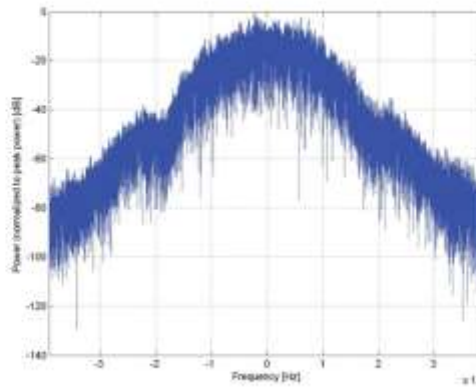

Frequency Domain

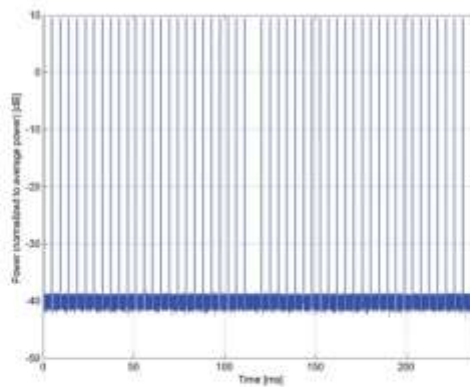

Time Domain



**Calibration Laboratory of
Schmid & Partner
Engineering AG**
Zeughausstrasse 43, 8004 Zurich, Switzerland

Name:	UMTS-FDD (WCDMA, AMR)
Group:	WCDMA
UID:	10460-AAA
PAR: ¹	2.39 dB
MIF: ²	-25.43 dB
Standard Reference:	FCC OET KDB 941225 D01 SAR test for 3G devices v03
Category:	Random amplitude modulation
Modulation:	QPSK
Frequency Band:	Band 1, UTRA/FDD (1920.0-1980.0 MHz, 20000) Band 2, UTRA/FDD (1850.0-1910.0 MHz, 20001) Band 3, UTRA/FDD (1710.0-1785.0 MHz, 20002) Band 4, UTRA/FDD (1710.0-1755.0 MHz, 20003) Band 5, UTRA/FDD (824.0-849.0 MHz, 20004) Band 6, UTRA/FDD (830.0-840.0 MHz, 20005) Band 7, UTRA/FDD (2500.0-2570.0 MHz, 20006) Band 8, UTRA/FDD (880.0-915.0 MHz, 20007) Band 9, UTRA/FDD (1749.9-1784.9 MHz, 20008) Band 10, UTRA/FDD (1710.0-1770.0 MHz, 20009) Band 11, UTRA/FDD (1427.9-1452.9 MHz, 20010) Band 12, UTRA/FDD (698.0-716.0 MHz, 20011) Band 13, UTRA/FDD (777.0-787.0 MHz, 20012) Band 14, UTRA/FDD (788.0-798.0 MHz, 20013) Band 19, UTRA/FDD (830.0-845.0 MHz, 20130) Band 20, UTRA/FDD (832.0-862.0 MHz, 20131) Band 21, UTRA/FDD (1447.9-1462.9 MHz, 20132) Band 22, UTRA/FDD (3410.0-3490.0 MHz, 20217) Band 25, UTRA/FDD (1850.0-1915.0 MHz, 20218) Band 26, UTRA/FDD (814.0-849.0 MHz, 20219)
Detailed Specification:	Dedicated Channel Type: 12.2 kbps AMR 3.4 kbps SRB
Bandwidth:	5.0 MHz
Integration Time:	100.0 ms

¹ PAR (0.1%) in accordance with FCC KDB 971168, Section 6.0 "Measurement of the Peak-to-Average Power Ratio (PAPR)"
² Modulation Interference Factor (MIF) value valid only in conjunction with advanced probe response linearization calibration for the same communication system (same UID and version).

**Calibration Laboratory of
Schmid & Partner
Engineering AG**
Zeughausstrasse 43, 8004 Zurich, Switzerland

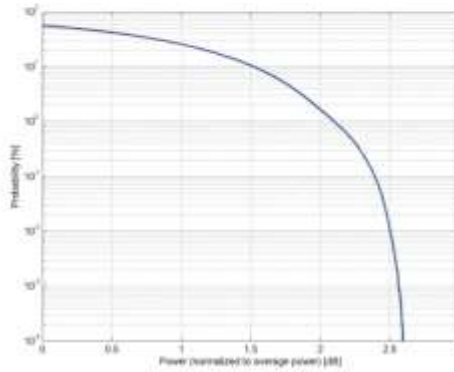

Complementary Cumulative Distribution Function (CCDF)

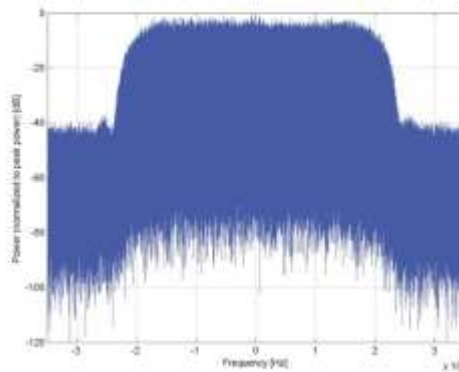

Frequency Domain

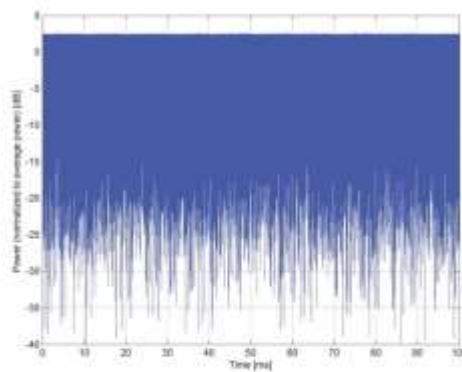

Time Domain

**Calibration Laboratory of
Schmid & Partner
Engineering AG**
Zeughausstrasse 43, 8004 Zurich, Switzerland

Name:	UMTS-FDD (HSDPA)
Group:	WCDMA
UID:	10097-CAB
PAR: ¹	3.98 dB
MIF: ²	-20.75 dB
Standard Reference:	ETSI-3GPP TS 134.121 Rel. 5
Category:	FCC OET KDB 941225 D01 SAR test for 3G devices v02
Modulation:	Random amplitude modulation
Frequency Band:	QPSK
	Band 1, UTRA/FDD (1920.0-1980.0 MHz, 20000)
	Band 2, UTRA/FDD (1850.0-1910.0 MHz, 20001)
	Band 3, UTRA/FDD (1710.0-1785.0 MHz, 20002)
	Band 4, UTRA/FDD (1710.0-1755.0 MHz, 20003)
	Band 5, UTRA/FDD (824.0-849.0 MHz, 20004)
	Band 6, UTRA/FDD (830.0-840.0 MHz, 20005)
	Band 7, UTRA/FDD (2500.0-2570.0 MHz, 20006)
	Band 8, UTRA/FDD (880.0-915.0 MHz, 20007)
	Band 9, UTRA/FDD (1749.9-1784.9 MHz, 20008)
	Band 10, UTRA/FDD (1710.0-1770.0 MHz, 20009)
	Band 11, UTRA/FDD (1427.9-1452.9 MHz, 20010)
	Band 12, UTRA/FDD (698.0-716.0 MHz, 20011)
	Band 13, UTRA/FDD (777.0-787.0 MHz, 20012)
	Band 14, UTRA/FDD (788.0-798.0 MHz, 20013)
	Band 19, UTRA/FDD (830.0-845.0 MHz, 20130)
	Band 20, UTRA/FDD (832.0-862.0 MHz, 20131)
	Band 21, UTRA/FDD (1447.9-1462.9 MHz, 20132)
	Band 22, UTRA/FDD (3410.0-3490.0 MHz, 20217)
	Band 25, UTRA/FDD (1850.0-1915.0 MHz, 20218)
	Band 26, UTRA/FDD (814.0-849.0 MHz, 20219)
Detailed Specification:	CQI value: 2
	Sub-test 2 Conditions:
	DPCH gain factor (Beta _{cc}) = 12/15
	DPDCH gain factor (Beta _{dc}): 15/15
Bandwidth:	5.0 MHz
Integration Time:	100.0 ms

¹ PAR (0.1%) in accordance with FCC KDB 971168, Section 6.0 "Measurement of the Peak-to-Average Power Ratio (PAPR)"
² Modulation Interference Factor (MIF) value valid only in conjunction with advanced probe response linearization calibration for the same communication system (same UID and version).

**Calibration Laboratory of
Schmid & Partner
Engineering AG**
Zeughausstrasse 43, 8004 Zurich, Switzerland

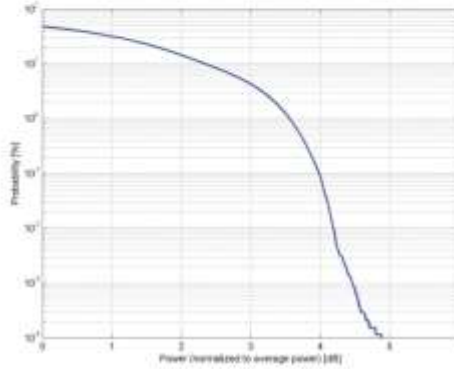

Complementary Cumulative Distribution Function (CCDF)

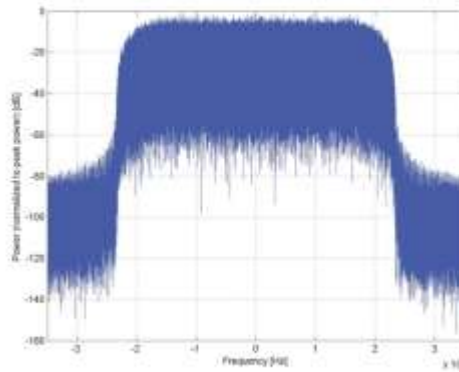

Frequency Domain

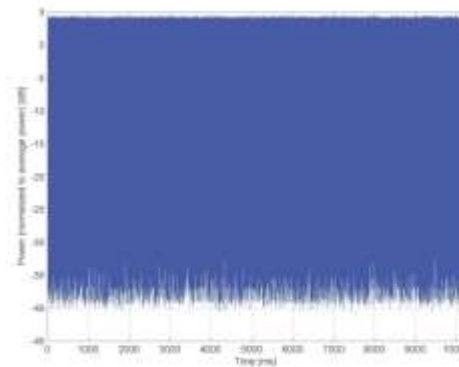

Time Domain



**Calibration Laboratory of
Schmid & Partner
Engineering AG**
Zeughausstrasse 43, 8004 Zurich, Switzerland

Name:	LTE-FDD (SC-FDMA, 1 RB, 20 MHz, 16-QAM)
Group:	LTE-FDD
UID:	10170-CAE
PAR: ¹	6.52 dB
MIF: ²	-9.76 dB
Standard Reference:	3GPP / ETSI TS 136.101 V8.4.0 3GPP / ETSI TS 136.213 V8.4.0 FCC OET KDB 941225 D05 SAR for LTE Devices v01 Random amplitude modulation
Category:	16-QAM
Modulation:	Band 1, E-UTRA/FDD (1920.0 - 1980.0 MHz) Band 2, E-UTRA/FDD (1850.0 - 1910.0 MHz) Band 3, E-UTRA/FDD (1710.0 - 1785.0 MHz) Band 4, E-UTRA/FDD (1710.0 - 1755.0 MHz) Band 7, E-UTRA/FDD (2500.0 - 2570.0 MHz) Band 9, E-UTRA/FDD (1749.9 - 1784.9 MHz) Band 10, E-UTRA/FDD (1710.0 - 1770.0 MHz) Band 20, E-UTRA/FDD (832.0 - 882.0 MHz) Band 22, E-UTRA/FDD (3410.0 - 3490.0 MHz) Band 23, E-UTRA/FDD (2000.0 - 2020.0 MHz) Band 25, E-UTRA/FDD (1850.0 - 1915.0 MHz) Band 28, E-UTRA/FDD (703.0 - 740.0 MHz) Band 65, E-UTRA/FDD (1920.0 - 2010.0 MHz) Band 66, E-UTRA/FDD (1710.0 - 1780.0 MHz) Band 70, E-UTRA/FDD (1695.0 - 1710.0 MHz) Band 71, E-UTRA/FDD (653.0 - 698.0 MHz) Band 74, E-UTRA/FDD (1427.0 - 1470.0 MHz) Validation band (0.0 - 6000.0 MHz)
Frequency Band:	
Detailed Specification:	Modulation Scheme: SC-FDMA Number of PUSCHs: 1 Settings for Subframe #0 to #9: Modulation Scheme: 16QAM Data Type: UL-SCH Number RB: 1 Transport Block Size: 256 TBS Index: 14 MCS Index: 15 Data Type: PUSCH
Bandwidth:	20.0 MHz
Integration Time:	10.0 ms

¹ PAR (0.1%) in accordance with FCC KDB 971168, Section 6.0 "Measurement of the Peak-to-Average Power Ratio (PAPR)"
² Modulation Interference Factor (MIF) value valid only in conjunction with advanced probe response linearization calibration for the same communication system (same UID and version).

**Calibration Laboratory of
Schmid & Partner
Engineering AG**
Zeughausstrasse 43, 8004 Zurich, Switzerland

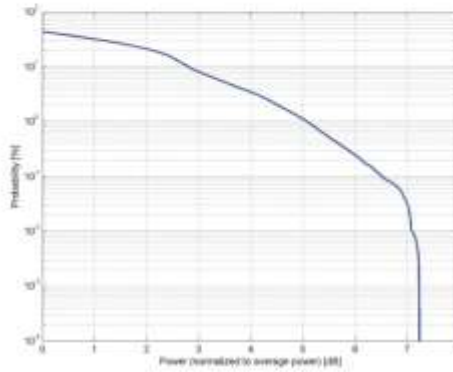

Complementary Cumulative Distribution Function (CCDF)

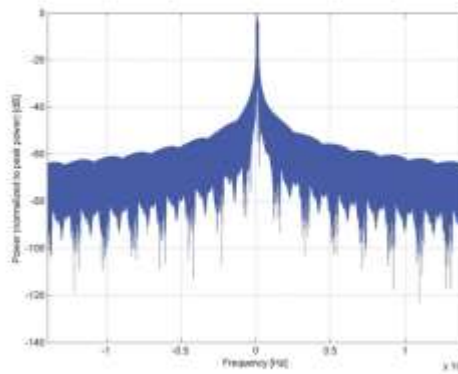

Frequency Domain

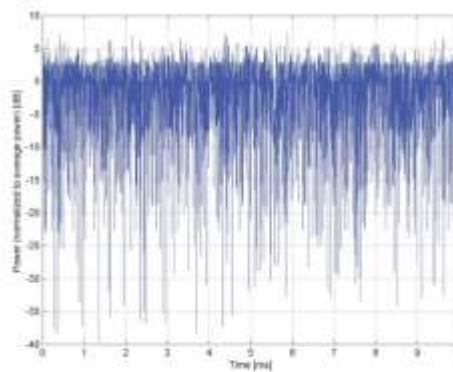

Time Domain



Calibration Laboratory of
Schmid & Partner
Engineering AG
Zeughausstrasse 43, 8004 Zurich, Switzerland

Name:	LTE-FDD (SC-FDMA, 1 RB, 10 MHz, 16-QAM)
Group:	LTE-FDD
UID:	10176-CAG
PAR: ¹	6.52 dB
MIF: ²	-9.76 dB
Standard Reference:	3GPP / ETSI TS 136.101 V8.4.0 3GPP / ETSI TS 136.213 V8.4.0 FCC OET KDB 941225 D05 SAR for LTE Devices v01 Random amplitude modulation
Category:	16-QAM
Modulation:	
Frequency Band:	Band 1, E-UTRA/FDD (1920.0 - 1980.0 MHz) Band 2, E-UTRA/FDD (1850.0 - 1910.0 MHz) Band 3, E-UTRA/FDD (1710.0 - 1785.0 MHz) Band 4, E-UTRA/FDD (1710.0 - 1755.0 MHz) Band 5, E-UTRA/FDD (824.0 - 840.0 MHz) Band 6, E-UTRA/FDD (830.0 - 840.0 MHz) Band 7, E-UTRA/FDD (2500.0 - 2570.0 MHz) Band 8, E-UTRA/FDD (880.0 - 915.0 MHz) Band 9, E-UTRA/FDD (1749.9 - 1784.9 MHz) Band 10, E-UTRA/FDD (1710.0 - 1770.0 MHz) Band 11, E-UTRA/FDD (1427.9 - 1447.9 MHz) Band 12, E-UTRA/FDD (699.0 - 716.0 MHz) Band 13, E-UTRA/FDD (777.0 - 787.0 MHz) Band 14, E-UTRA/FDD (788.0 - 798.0 MHz) Band 17, E-UTRA/FDD (704.0 - 716.0 MHz) Band 18, E-UTRA/FDD (815.0 - 830.0 MHz) Band 19, E-UTRA/FDD (830.0 - 845.0 MHz) Band 20, E-UTRA/FDD (832.0 - 862.0 MHz) Band 21, E-UTRA/FDD (1447.9 - 1462.0 MHz) Band 22, E-UTRA/FDD (3410.0 - 3490.0 MHz) Band 23, E-UTRA/FDD (2000.0 - 2020.0 MHz) Band 24, E-UTRA/FDD (1825.5 - 1860.5 MHz) Band 25, E-UTRA/FDD (1850.0 - 1915.0 MHz) Band 26 E-UTRA/FDD (814.0 - 840.0 MHz) Band 27 E-UTRA/FDD (807.0 - 824.0 MHz) Band 28 E-UTRA/FDD (703.0 - 748.0 MHz) Band 30, E-UTRA/FDD (2305.0 - 2315.0 MHz) Band 65, E-UTRA/FDD (1920.0 - 2010.0 MHz) Band 66, E-UTRA/FDD (1710.0 - 1790.0 MHz) Band 68, E-UTRA/FDD (698.0 - 728.0 MHz) Band 70, E-UTRA/FDD (1595.0 - 1710.0 MHz) Band 71, E-UTRA/FDD (663.0 - 698.0 MHz) Band 74, E-UTRA/FDD (1427.0 - 1470.0 MHz) Band 95, E-UTRA/FDD (698.0 - 716.0 MHz) Validation band (0.0 - 6000.0 MHz)
Detailed Specification:	Modulation Scheme: SC-FDMA Number of PUSCHs: 1 Settings for Subframe #0 to #9: Modulation Scheme: QPSK Data Type: UL-SCH Number RB: 1 Transport Block Size: 256 TBS Index: 14 MCS Index: 15 Data Type: PUSCH
Bandwidth:	10.0 MHz
Integration Time:	10.0 ms

¹ PAR (0.1%) in accordance with FCC KDB 971168, Section 6.0 "Measurement of the Peak-to-Average Power Ratio (PAPR)"
² Modulation Interference Factor (MIF) value valid only in conjunction with advanced probe response linearization calibration for the same communication system (same UID and version).

**Calibration Laboratory of
Schmid & Partner
Engineering AG**
Zeughausstrasse 43, 8004 Zurich, Switzerland

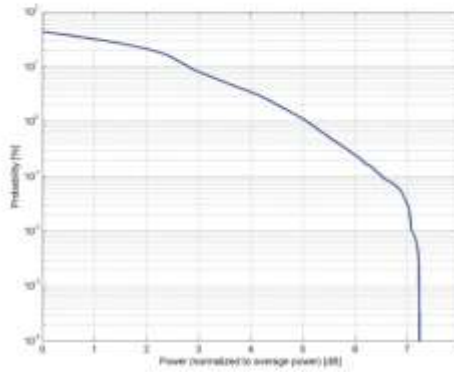

Complementary Cumulative Distribution Function (CCDF)

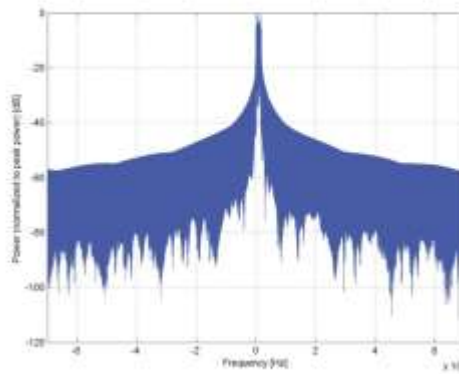

Frequency Domain

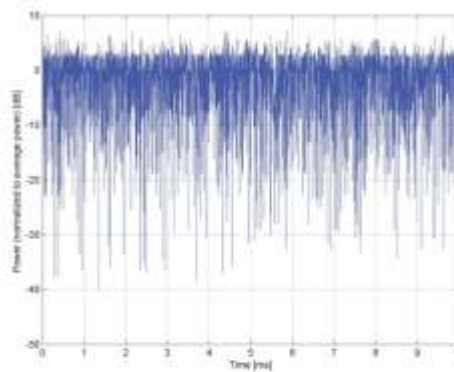

Time Domain

**Calibration Laboratory of
Schmid & Partner
Engineering AG**
Zeughausstrasse 43, 8004 Zurich, Switzerland

Name:	LTE-TDD (SC-FDMA, 1 RB, 20 MHz, 16-QAM)
Group:	LTE-TDD
UID:	10173-CAD
PAR: ¹	9.48 dB
MIF: ²	-1.44 dB
Standard Reference:	3GPP / ETSI TS 136.101 V8.4.0 3GPP / ETSI TS 136.213 V8.4.0 FCC OET KDB 941225 D05 SAR for LTE Devices v02 Random amplitude modulation
Category:	16-QAM
Modulation:	
Frequency Band:	Band 33, E-UTRA/TDD (1900.0 - 1920.0 MHz) Band 35, E-UTRA/TDD (1850.0 - 1910.0 MHz) Band 36, E-UTRA/TDD (1930.0 - 1990.0 MHz) Band 37, E-UTRA/TDD (1910.0 - 1930.0 MHz) Band 38, E-UTRA/TDD (2570.0 - 2620.0 MHz) Band 39, E-UTRA/TDD (1880.0 - 1920.0 MHz) Band 40, E-UTRA/TDD (2300.0 - 2400.0 MHz) Band 41, E-UTRA/TDD (2496.0 - 2690.0 MHz) Band 42, E-UTRA/TDD (3400.0 - 3600.0 MHz) Band 43, E-UTRA/TDD (3600.0 - 3800.0 MHz) Band 44, E-UTRA/TDD (703.0 - 803.0 MHz) Band 45, E-UTRA/FDD (1447.0 - 1467.0 MHz) Band 46, E-UTRA/FDD (5150.0 - 5925.0 MHz) Band 47, E-UTRA/TDD (5855.0 - 5925.0 MHz) Band 48, E-UTRA/TDD (3550.0 - 3700.0 MHz) Validation band (0.0 - 6000.0 MHz)
Detailed Specification:	Modulation Scheme: SC-FDMA Uplink-downlink configuration: 1 Special Subframe configuration: 4 Number of Frames: 1 Settings for UL Subframe 2,3,7,8: Number of PUSCHs: 1 Modulation Scheme: 16QAM Allocated RB: 1 Start Number of RB: 50 Data Type: PNGfx
Bandwidth:	20.0 MHz
Integration Time:	5.0 ms

¹ PAR (0.1%) in accordance with FCC KDB 971168, Section 6.0 "Measurement of the Peak-to-Average Power Ratio (PAPR)"
² Modulation Interference Factor (MIF) value valid only in conjunction with advanced probe response linearization calibration for the same communication system (same UID and version).

**Calibration Laboratory of
Schmid & Partner
Engineering AG**
Zeughausstrasse 43, 8004 Zurich, Switzerland

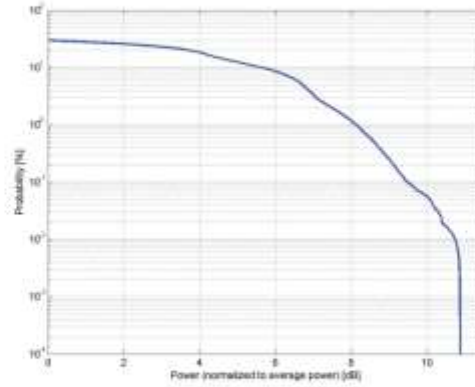

Complementary Cumulative Distribution Function (CCDF)

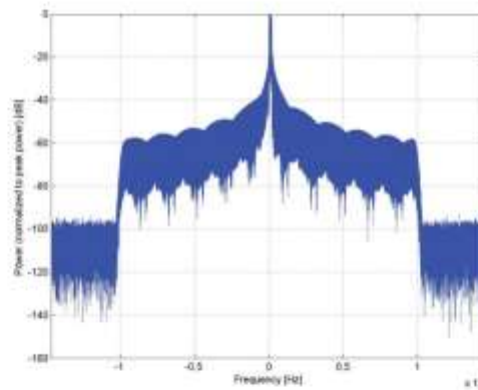

Frequency Domain

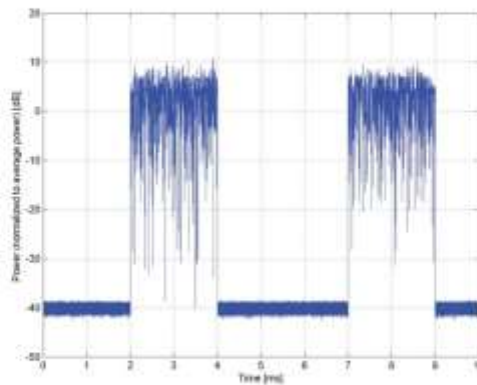

Time Domain



**Calibration Laboratory of
Schmid & Partner
Engineering AG**
Zeughausstrasse 43, 8004 Zurich, Switzerland

Name:	5G NR (CP-OFDM, 1 RB, 15 MHz, QPSK, 15 kHz)
Group:	5G NR FR1 TDD
UID:	10769-AAD
PAR: ¹	8.01 dB
MIF: ²	-12.06 dB
Standard Reference:	SPEAG
Category:	Random amplitude modulation
Modulation:	QPSK
Frequency Band:	Band n34 (2010 - 2025 MHz) Band n38 (2570 - 2620 MHz) Band n39 (1880 - 1920 MHz) Band n40 (2300 - 2400 MHz) Band n41 (2496 - 2690 MHz) Band n48 (3550 - 3700 MHz) Band n50 (1432 - 1517 MHz) Band n77 (3300 - 4200 MHz) Band n78 (3300 - 3800 MHz) Band n90 (2496 - 2690 MHz) Validation band (0.0 - 6000.0 MHz)
Detailed Specification:	Multiplexing Scheme: CP-OFDM Modulation Scheme: QPSK Subcarrier Spacing: 15 kHz Number RBs: 1 Slot Format Index: 1 Data Type: PNB
Bandwidth:	15.0 MHz
Integration Time:	10.0 ms

¹ PAR (0.1%) in accordance with FCC KDB 871168, Section 6.0 "Measurement of the Peak-to-Average Power Ratio (PAPR)".

² Modulation Interference Factor (MIF) value valid only in conjunction with advanced probe response linearization calibration for the same communication system (same UID and version).

**Calibration Laboratory of
Schmid & Partner
Engineering AG**
Zeughausstrasse 43, 8004 Zurich, Switzerland

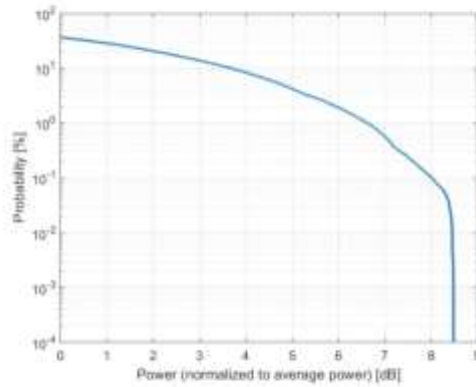

Complementary Cumulative Distribution Function (CCDF)

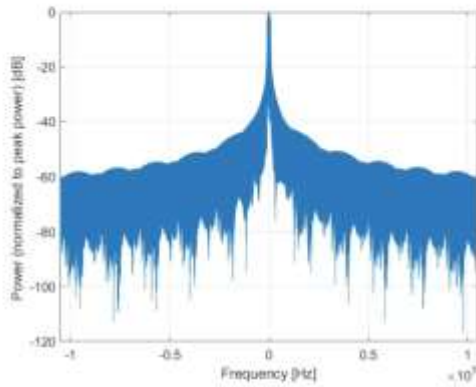

Frequency Domain

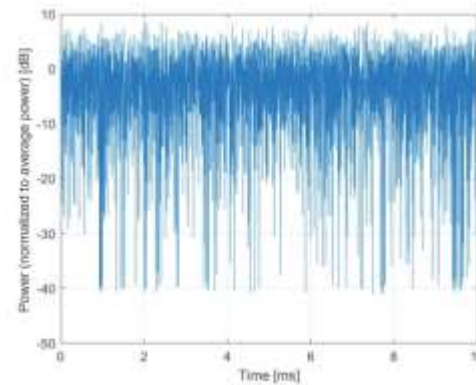

Time Domain



**Calibration Laboratory of
Schmid & Partner
Engineering AG**
Zeughausstrasse 43, 8004 Zurich, Switzerland

Name:	IEEE 802.11b WiFi 2.4 GHz (DSSS, 11 Mbps)
Group:	WLAN
UID:	10061-CAB
PAR: ¹	3.60 dB
MIF: ²	-2.02 dB
Standard Reference:	IEEE 802.11b-1999 , Part 11, FCC SAR meas for 802 11 a b g v01r02 (248227 D01)
Category:	Random amplitude modulation
Modulation:	DQPSK
Frequency Band:	WLAN 2.4GHz (2412.0-2484.0 MHz, 20230)
Detailed Specification:	Data Rate: 11 Mbps Spreading, Coding: CCK PPDU format: Long Preamble & Heading PSDU Length: 1024 PSDU Data: PN9
Bandwidth:	20.0 MHz
Integration Time:	1.5 ms

¹ PAR (0.1%) in accordance with FCC KDB 971168, Section 6.0 "Measurement of the Peak-to-Average Power Ratio (PAPR)"
² Modulation Interference Factor (MIF) value valid only in conjunction with advanced probe response linearization calibration for the same communication system (same UID and version).

**Calibration Laboratory of
Schmid & Partner
Engineering AG**
Zeughausstrasse 43, 8004 Zurich, Switzerland

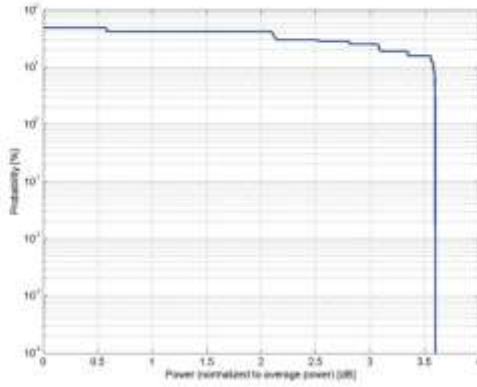

Complementary Cumulative Distribution Function (CCDF)

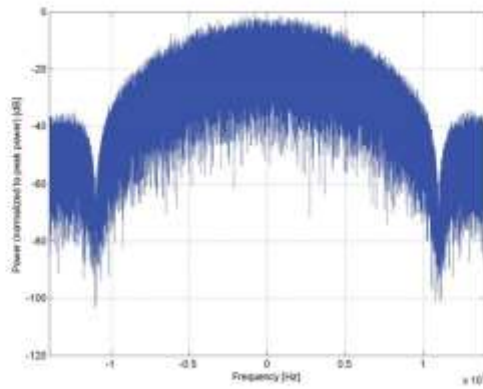

Frequency Domain

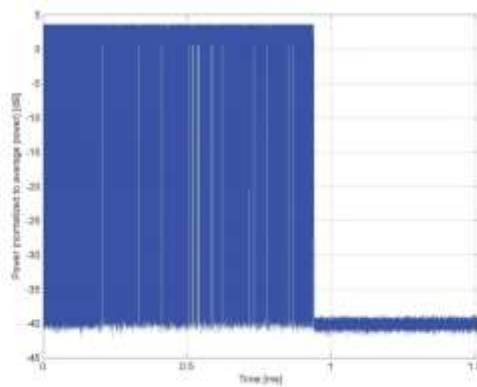

Time Domain



**Calibration Laboratory of
Schmid & Partner
Engineering AG**
Zeughausstrasse 43, 8004 Zurich, Switzerland

Name:	IEEE 802.11a/h WIFI 5 GHz (OFDM, 54 Mbps)
Group:	WLAN
UID:	10069-CAD
PAR: ¹	10.56 dB
MIF: ²	-3.15 dB
Standard Reference:	IEEE 802.11a-1999 (R2003) , Part 11 IEEE 802.11h-2003 , Part 11 FCC SAR meas for 802.11 a b/g v01/02 (248227 D01)
Category:	Random amplitude modulation
Modulation:	84-QAM
Frequency Band:	WLAN 5GHz (4915.0 - 5825.0 MHz) U-NII-1, U-NII-2A (5170 - 5330 MHz) U-NII-2C Standalone (5490 - 5710 MHz) U-NII-2C < 5.65 GHz (5490 - 5650 MHz) U-NII-3 Standalone (5735 - 5835 MHz) U-NII-2C, U-NII-3 (5650 - 5835 MHz) U-NII-4 (5.825 - 5.925 MHz) Validation band (0.0 - 6000.0 MHz)
Detailed Specification:	Data Rate: 54 Mbps Coding Rate: 3/4 Coded bits per subcarrier: 6 Coded bits per OFDM symbol: 288 Data bits per OFDM symbol: 216 PSDU Length: 1000 Bytes PSDU Data: PNG
Bandwidth:	20.0 MHz
Integration Time:	0.3 ms

¹ PAR (0.1%) in accordance with FCC KDB 971168, Section 6.0 "Measurement of the Peak-to-Average Power Ratio (PAPR)"
² Modulation Interference Factor (MIF) value valid only in conjunction with advanced probe response linearization calibration for the same communication system (same UID and version).

Calibration Laboratory of
Schmid & Partner
Engineering AG
Zeughausstrasse 43, 8004 Zurich, Switzerland

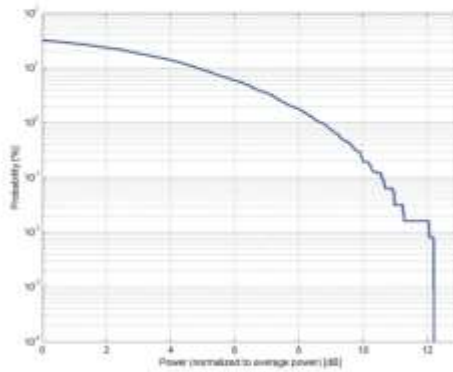

Complementary Cumulative Distribution Function (CCDF)

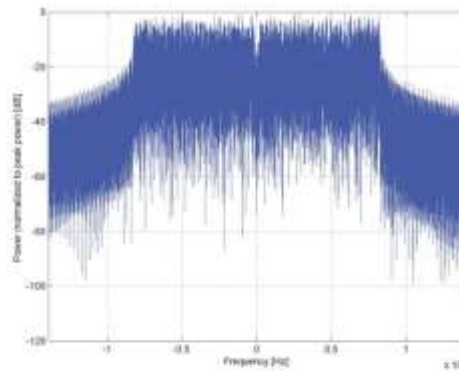

Frequency Domain

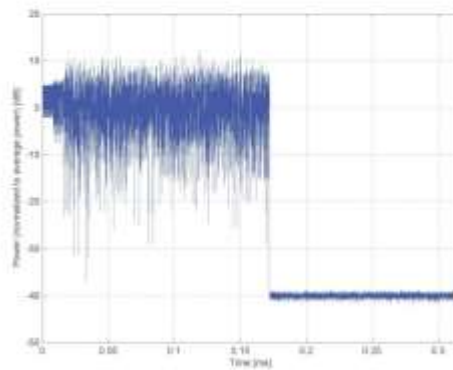

Time Domain

END OF REPORT