



# HAC RF TEST REPORT

No. I22Z60793-SEM01

For

**TCL Communication Ltd.**

**GSM/UMTS/LTE Mobile phone**

**Model Name: T501L**

With

**Hardware Version: 03**

**Software Version: FS38**

**FCC ID: 2ACCJH166**

**Results Summary: M Category = M4**

**Issued Date: 2022-06-28**

**Note:**

The test results in this test report relate only to the devices specified in this report. This report shall not be reproduced except in full without the written approval of CTTL.

**Test Laboratory:**

**CTTL, Telecommunication Technology Labs, CAICT**

No. 51, Xueyuan Road, Haidian District, Beijing, P. R. China 100191.

Tel:+86(0)10-62304633-2512, Fax:+86(0)10-62304633-2504

Email: [ctl\\_terminals@caict.ac.cn](mailto:ctl_terminals@caict.ac.cn), website: [www.caict.ac.cn](http://www.caict.ac.cn)



No.I22Z60793-SEM01

## **REPORT HISTORY**

<b>Report Number</b>	<b>Revision</b>	<b>Issue Date</b>	<b>Description</b>
I22Z60793-SEM01	Rev.0	2022-06-28	Initial creation of test report

## TABLE OF CONTENT

<b>1 TEST LABORATORY</b> .....	<b>5</b>
1.1 TESTING LOCATION.....	5
1.2 TESTING ENVIRONMENT.....	5
1.3 PROJECT DATA .....	5
1.4 SIGNATURE.....	5
<b>2 CLIENT INFORMATION</b> .....	<b>6</b>
2.1 APPLICANT INFORMATION.....	6
2.2 MANUFACTURER INFORMATION .....	6
<b>3 EQUIPMENT UNDER TEST (EUT) AND ANCILLARY EQUIPMENT (AE) .....</b>	<b>7</b>
3.1 ABOUT EUT.....	7
3.2 INTERNAL IDENTIFICATION OF EUT USED DURING THE TEST .....	7
3.3 INTERNAL IDENTIFICATION OF AE USED DURING THE TEST .....	7
3.4 AIR INTERFACES / BANDS INDICATING OPERATING MODES.....	8
<b>4 MAXIMUM OUTPUT POWER</b> .....	<b>9</b>
<b>5 REFERENCE DOCUMENTS .....</b>	<b>10</b>
5.1 REFERENCE DOCUMENTS FOR TESTING .....	10
<b>6 OPERATIONAL CONDITIONS DURING TEST .....</b>	<b>11</b>
6.1 HAC MEASUREMENT SET-UP.....	11
6.2 PROBE SPECIFICATION .....	12
6.3 TEST ARCH PHANTOM & PHONE POSITIONER .....	13
6.4 ROBOTIC SYSTEM SPECIFICATIONS.....	13
<b>7 EUT ARRANGEMENT .....</b>	<b>14</b>
7.1 WD RF EMISSION MEASUREMENTS REFERENCE AND PLANE .....	14
<b>8 SYSTEM VALIDATION</b> .....	<b>15</b>
8.1 VALIDATION PROCEDURE.....	15
8.2 VALIDATION RESULT .....	15
<b>9 EVALUATION OF MIF</b> .....	<b>16</b>
9.1 INTRODUCTION.....	16
9.2 MIF MEASUREMENT WITH THE AIA .....	17
9.3 TEST EQUIPMENT FOR THE MIF MEASUREMENT .....	17
9.4 DUT MIF RESULTS.....	17
<b>10 EVALUATION FOR LOW-POWER EXEMPTION .....</b>	<b>18</b>
10.1 PRODUCT TESTING THRESHOLD .....	18
10.2 CONDUCTED POWER.....	18
10.3 CONCLUSION .....	18
<b>11 RF TEST PROCEDURES</b> .....	<b>19</b>



**12 MEASUREMENT RESULTS (E-FIELD).....20**

**13 ANSIC 63.19-2011 LIMITS .....21**

**14 MEASUREMENT UNCERTAINTY .....22**

**15 MAIN TEST INSTRUMENTS .....23**

**16 CONCLUSION.....23**

**ANNEX A TEST LAYOUT.....24**

**ANNEX B TEST PLOTS.....25**

**ANNEX C SYSTEM VALIDATION RESULT .....33**

**ANNEX D PROBE CALIBRATION CERTIFICATE .....36**

**ANNEX E DIPOLE CALIBRATION CERTIFICATE .....58**

## 1 Test Laboratory

### 1.1 Testing Location

CompanyName:	CTTL(Shouxiang)
Address:	No. 51 Shouxiang Science Building, Xueyuan Road, Haidian District, Beijing, P. R. China100191

### 1.2 Testing Environment

Temperature:	18°C~25°C,
Relative humidity:	30%~ 70%
Ground system resistance:	< 0.5 $\Omega$
Ambient noise is checked and found very low and in compliance with requirement of standards. Reflection of surrounding objects is minimized and in compliance with requirement of standards	

### 1.3 Project Data

Project Leader:	Qi Dianyuan
Test Engineer:	Lin Xiaojun
Testing Start Date:	May 25, 2022
Testing End Date:	June 24, 2022

### 1.4 Signature



Lin Xiaojun  
(Prepared this test report)



Qi Dianyuan  
(Reviewed this test report)



Lu Bingsong  
Deputy Director of the laboratory  
(Approved this test report)



## 2 Client Information

### 2.1 Applicant Information

HMD Global Oy	TCL Communication Ltd.
Address/Post:	5/F, Building 22E, 22 Science Park East Avenue, Hong Kong Science Park, Shatin, NT, Hong Kong
Contact Person:	Peter Yang
Contact Email:	peter.yang@tcl.com
Telephone:	+86 755 3664 5759
Fax	+86 755 3661 2000-81722

### 2.2 Manufacturer Information

Company Name:	TCL Communication Ltd.
Address/Post:	5/F, Building 22E, 22 Science Park East Avenue, Hong Kong Science Park, Shatin, NT, Hong Kong
Contact Person:	Peter Yang
Contact Email:	peter.yang@tcl.com
Telephone:	+86 755 3664 5759
Fax	+86 755 3661 2000-81722

### 3 Equipment Under Test (EUT) and Ancillary Equipment (AE)

This EUT is a variant product and the report of original sample is No.I22Z60839-SEM01. we Add LTE B13/25/26/41/71 and share otherbands results of original sample.

#### 3.1 About EUT

Description:	GSM/UMTS/LTE Mobile phone
Model name:	T501L
Operating mode(s):	GSM850/GSM900/GSM1800/GSM1900 WCDMA B2/B4/B5, BT, Wi-Fi, LTE Band 2/4/5/12/13/25/26/66/71/41

#### 3.2 Internal Identification of EUT used during the test

EUT ID*	IMEI	HW Version	SW Version
EUT	016256000010686	03	FS38
EUT	016256000010512	03	FS38
EUT	016256000010777	03	FS38

\*EUT ID: is used to identify the test sample in the lab internally.

#### 3.3 Internal Identification of AE used during the test

AE ID*	Description	Model	SN	Manufacturer
AE1	Battery	TLi028C7	\	VEKEN
AE2	Battery	TLi028C1	\	BYD

\*AE ID: is used to identify the test sample in the lab internally.

### 3.4 Air Interfaces / Bands Indicating Operating Modes

Air-interface	Band(MHz)	Type	C63.19/tested	Simultaneous Transmissions	Name of Voice Service
GSM	850	VO	Yes	BT, WLAN	CMRS Voice
	1900				
GPRS/EDGE	850	DT	Yes		Google duo
	1900				
WCDMA (UMTS)	850	VO	NO <sup>(1)</sup>	BT, WLAN	CMRS Voice
	1700				
	1900	DT	NO <sup>(1)</sup>		Google duo
LTE TDD	Band41	V/D	Yes	BT, WLAN	VoLTE, Google duo
LTE FDD	Band2/4/5/12/13/25/26/66	V/D	NO <sup>(1)</sup>	BT, WLAN	VoLTE, Google duo
BT	2450	DT	NA	GSM,WCDMA ,LTE	NA
WLAN	2450	V/D	Yes	GSM,WCDMA ,LTE	VoWiFi, Google duo

NA: Not Applicable VO: Voice Only V/D: CMRS and IP Voice Service over Digital Transport  
DT: Digital Transport

\* HAC Rating was not based on concurrent voice and data modes, Non current mode was found to represent worst case rating for both M and T rating

Note1 = The air interface is exempted from testing by low power exemption that its average antenna input power plus its MIF is  $\leq 17$  dBm, and is rated as M4.

Note2= The device have similar frequency in some LTE bands: 4/66 since the supported frequency spans for the smaller LTE bands are completely cover by the larger LTE bands, therefore, only larger LTE bands were required to be tested for hearing-aid compliance.



#### 4 Maximum Output Power.

<b>GSM 850MHz</b>	<b>Conducted Power (dBm)</b>		
	<b>Channel 251(848.8MHz)</b>	<b>Channel 190(836.6MHz)</b>	<b>Channel 128(824.2MHz)</b>
Voice	33.3	33.3	33.3
EDGE	28	28	28
<b>GSM 1900MHz</b>	<b>Conducted Power(dBm)</b>		
	<b>Channel 810(1909.8MHz)</b>	<b>Channel 661(1880MHz)</b>	<b>Channel 512(1850.2MHz)</b>
Voice	31	31	31
EDGE	26.5	26.5	26.5
<b>WCDMA 850MHz</b>	<b>Conducted Power (dBm)</b>		
	<b>Channel 4233(846.6MHz)</b>	<b>Channel 4182(836.4MHz)</b>	<b>Channel 4132(826.4MHz)</b>
RMC	25	25	25
HSPA	23.5	23.5	23.5
<b>WCDMA 1700MHz</b>	<b>Conducted Power (dBm)</b>		
	<b>Channel1513(1752.6MHz)</b>	<b>Channel1412(1732.4MHz)</b>	<b>Channel1312(1712.4MHz)</b>
RMC	25	25	25
HSPA	22.5	22.5	22.5
<b>WCDMA 1900MHz</b>	<b>Conducted Power (dBm)</b>		
	<b>Channel 9538(1907.6MHz)</b>	<b>Channel 9400(1880MHz)</b>	<b>Channel 9262(1852.4MHz)</b>
RMC	25	25	25
HSPA	22.5	22.5	22.5
<b>LTE Band2 QPSK</b>	<b>Conducted Power (dBm)</b>		
	<b>Channel 19100(1900MHz)</b>	<b>Channel 18900(1880MHz)</b>	<b>Channel18700(1860MHz)</b>
	25	25	25
<b>LTE Band5 QPSK</b>	<b>Conducted Power (dBm)</b>		
	<b>Channel 20600(844MHz)</b>	<b>Channel 20525(836.5MHz)</b>	<b>Channel20450(829MHz)</b>
	25	25	25
<b>LTE Band12 QPSK</b>	<b>Conducted Power (dBm)</b>		
	<b>Channel 23130(711MHz)</b>	<b>Channel 23095(707.5MHz)</b>	<b>Channel23060(704MHz)</b>
	25	25	25
<b>LTE Band13 QPSK</b>	<b>Conducted Power (dBm)</b>		
	<b>Channel23230(782MHz)</b>		
	25		
<b>LTE Band25 QPSK</b>	<b>Conducted Power (dBm)</b>		
	<b>Channel 26590 (1905MHz)</b>	<b>Channel 26365 (1882.5MHz)</b>	<b>Channel26140 (1860MHz)</b>
	25	25	25
<b>LTE Band26 QPSK</b>	<b>Conducted Power (dBm)</b>		
	<b>Channel 26965(841.5MHz)</b>	<b>Channel 26865(831.5MHz)</b>	<b>Channel26775(822.5MHz)</b>
	25	25	25
<b>LTE Band66 QPSK</b>	<b>Conducted Power (dBm)</b>		
	<b>Channel 132572(1770MHz)</b>	<b>Channel 132322(1745MHz)</b>	<b>Channel 132072(1720MHz)</b>

	25	25	25
<b>LTE Band71 QPSK</b>	<b>Conducted Power (dBm)</b>		
	<b>Channel 133372(688MHz)</b>	<b>Channel 133322(683MHz)</b>	<b>Channel 133222(673MHz)</b>
	25	25	25
<b>LTE Band41 PC2 QPSK</b>	<b>Conducted Power (dBm)</b>		
	<b>Channel 41490(2680MHz)</b>	<b>Channel 40620(2593MHz)</b>	<b>Channel 39750(2506MHz)</b>
	26	26	26
<b>LTE Band41 PC3 QPSK</b>	<b>Conducted Power (dBm)</b>		
	<b>Channel 41490(2680MHz)</b>	<b>Channel 40620(2593MHz)</b>	<b>Channel 39750(2506MHz)</b>
	23	23	23
<b>2.4GHz 802.11b</b>	<b>Conducted Power (dBm)</b>		
	<b>Channel 11 (2462MHz)</b>	<b>Channel 6 (2437MHz)</b>	<b>Channel 1 (2412MHz)</b>
	17	17	17

## 5 Reference Documents

### 5.1 Reference Documents for testing

The following document listed in this section is referred for testing.

Reference	Title	Version
ANSI C63.19-2011	American National Standard for Methods of Measurement of Compatibility between Wireless Communication Devices and Hearing Aids	2011 Edition
FCC 47 CFR §20.19	Hearing Aid Compatible Mobile Headsets	2015 Edition
KDB 285076 D01	Equipment Authorization Guidance for Hearing Aid Compatibility	v06

## 6 OPERATIONAL CONDITIONS DURING TEST

### 6.1 HAC MEASUREMENT SET-UP

These measurements are performed using the DASY5 NEO automated dosimetric assessment system. It is made by Schmid & Partner Engineering AG (SPEAG) in Zurich, Switzerland. It consists of high precision robotics system (Stäubli), robot controller, Intel Core2 computer, near-field probe, probe alignment sensor. The robot is a six-axis industrial robot performing precise movements. A cell controller system contains the power supply, robot controller, teach pendant (Joystick), and remote control, is used to drive the robot motors. The PC consists of the HP Intel Core2 1.86 GHz computer with Windows XP system and HAC Measurement Software DASY5 NEO, A/D interface card, monitor, mouse, and keyboard. The Stäubli Robot is connected to the cell controller to allow software manipulation of the robot. A data acquisition electronic (DAE) circuit performs the signal amplification, signal multiplexing, AD-conversion, offset measurements, mechanical surface detection, collision detection, etc. is connected to the Electro-optical coupler (EOC). The EOC performs the conversion from the optical into digital electric signal of the DAE and transfers data to the PC plug-in card.

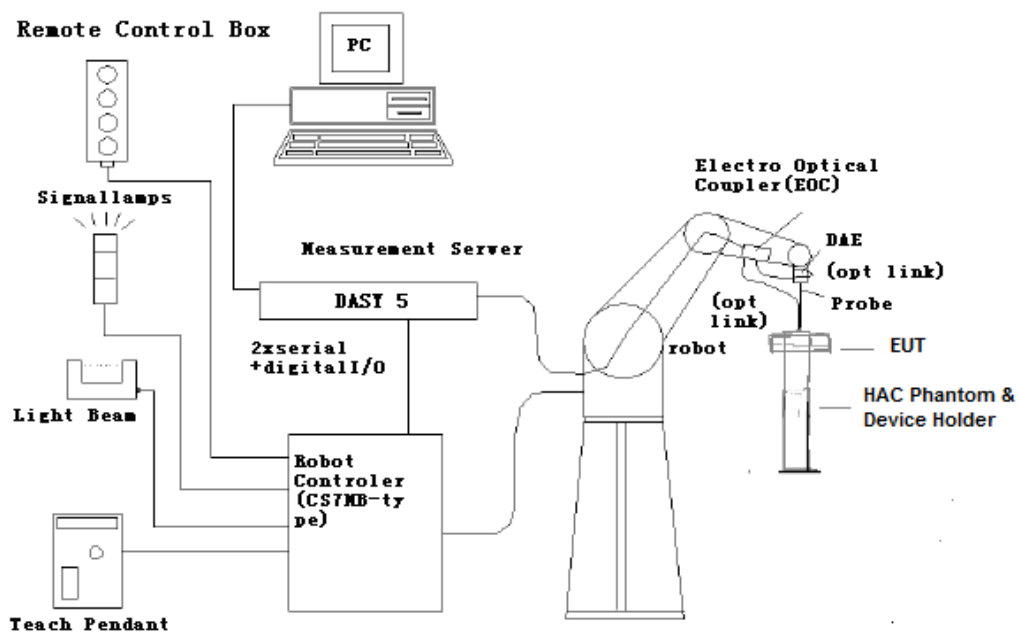

**Fig. 1 HAC Test Measurement Set-up**

The DAE4 consists of a highly sensitive electrometer-grade preamplifier with auto-zeroing, a channel and gain-switching multiplexer, a fast 16 bit AD-converter and a command decoder and control logic unit. Transmission to the PC-card is accomplished through an optical downlink for data and status information and an optical uplink for commands and clock lines. The mechanical probe mounting device includes two different sensor systems for frontal and sidewise probe contacts. They are also used for mechanical surface detection and probe collision detection. The robot uses its own controller with a built in VME-bus computer.

## 6.2 Probe Specification

### E-Field Probe Description

Construction	<p>One dipole parallel, two dipoles normal to probe axis</p> <p>Built-in shielding against static charges</p> <p>PEEK enclosure material</p>
Calibration	<p>In air from 100 MHz to 3.0 GHz (absolute accuracy <math>\pm 6.0\%</math>, <math>k=2</math>)</p>
Frequency	<p>40 MHz to &gt; 6 GHz (can be extended to &lt; 20 MHz)</p> <p>Linearity: <math>\pm 0.2</math> dB (100 MHz to 3 GHz)</p>
Directivity	<p><math>\pm 0.2</math> dB in air (rotation around probe axis)</p> <p><math>\pm 0.4</math> dB in air (rotation normal to probe axis)</p>
Dynamic Range	<p>2 V/m to &gt; 1000 V/m; Linearity: <math>\pm 0.2</math> dB</p>
Dimensions	<p>Overall length: 330 mm (Tip: 16 mm)</p> <p>Tip diameter: 8 mm (Body: 12 mm)</p> <p>Distance from probe tip to dipole centers: 2.5 mm</p>
Application	<p>General near-field measurements up to 6 GHz</p> <p>Field component measurements</p> <p>Fast automatic scanning in phantoms</p>



**[ER3DV6]**

### 6.3 Test Arch Phantom & Phone Positioner

The Test Arch phantom should be positioned horizontally on a stable surface. Reference markings on the Phantom allow the complete setup of all predefined phantom positions and measurement grids by manually teaching three points in the robot. It enables easy and well defined positioning of the phone and validation dipoles as well as simple teaching of the robot (Dimensions: 370 x 370 x 370 mm).

The Phone Positioner supports accurate and reliable positioning of any phone with effect on near field  $< \pm 0.5$  dB.

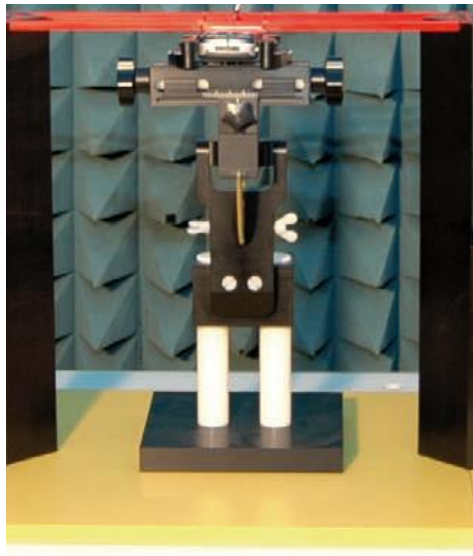

Fig. 2 HAC Phantom & Device Holder

### 6.4 Robotic System Specifications

#### Specifications

**Positioner:** Stäubli Unimation Corp. Robot Model: RX160L

**Repeatability:**  $\pm 0.02$  mm

**No. of Axis:** 6

#### Data Acquisition Electronic (DAE) System

##### Cell Controller

**Processor:** Intel Core2

**Clock Speed:** 1.86GHz

**Operating System:** Windows XP

##### Data Converter

**Features:** Signal Amplifier, multiplexer, A/D converter, and control logic

**Software:** DASY5 software

**Connecting Lines:** Optical downlink for data and status info.

Optical uplink for commands and clock

## 7 EUT ARRANGEMENT

### 7.1 WD RF Emission Measurements Reference and Plane

Figure 4 illustrates the references and reference plane that shall be used in the WD emissions measurement.

- The grid is 5 cm by 5 cm area that is divided into 9 evenly sized blocks or sub-grids.
- The grid is centered on the audio frequency output transducer of the WD (speaker or T-coil).
- The grid is located by reference to a reference plane. This reference plane is the planar area that contains the highest point in the area of the WD that normally rests against the user's ear
- The measurement plane is located parallel to the reference plane and 15 mm from it, out from the phone. The grid is located in the measurement plane.

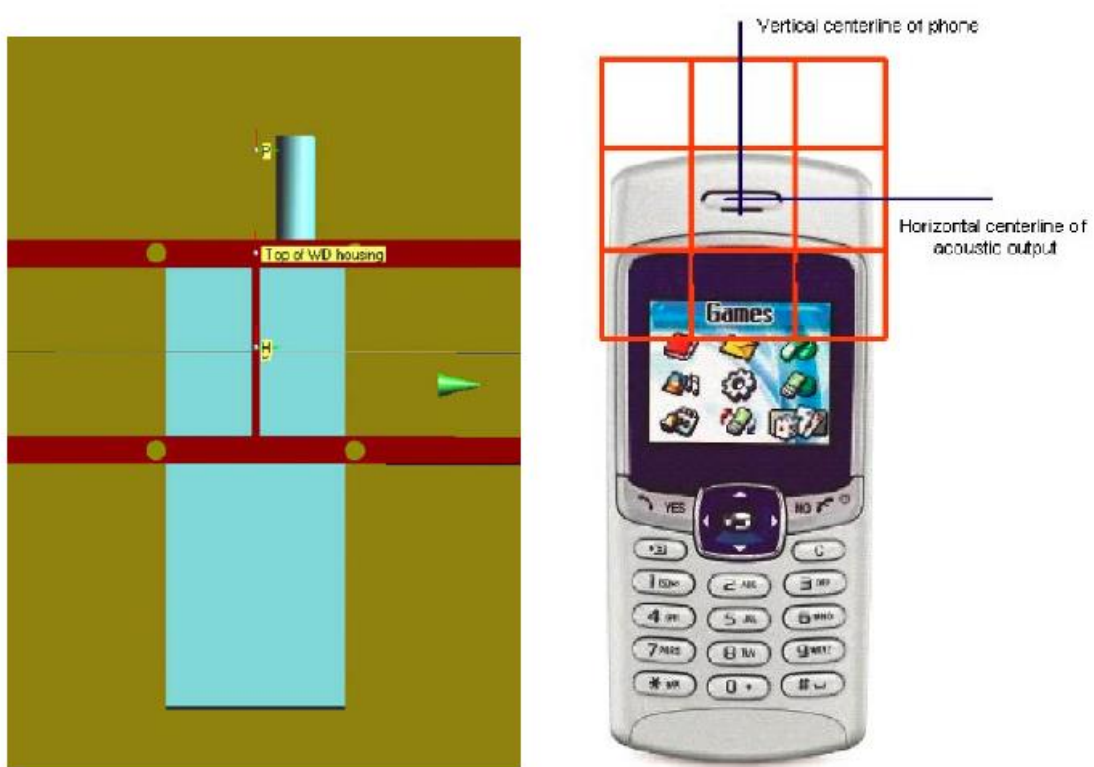

Fig. 3 WD reference and plane for RF emission measurements

## 8 SYSTEM VALIDATION

### 8.1 Validation Procedure

Place a dipole antenna meeting the requirements given in ANSI C63.19 in the position normally occupied by the WD. The dipole antenna serves as a known source for an electrical output. Position the E-field probes so that:

- The probes and their cables are parallel to the coaxial feed of the dipole antenna
- The probe cables and the coaxial feed of the dipole antenna approach the measurement area from opposite directions
- The center point of the probe element(s) are 15 mm from the closest surface of the dipole elements.

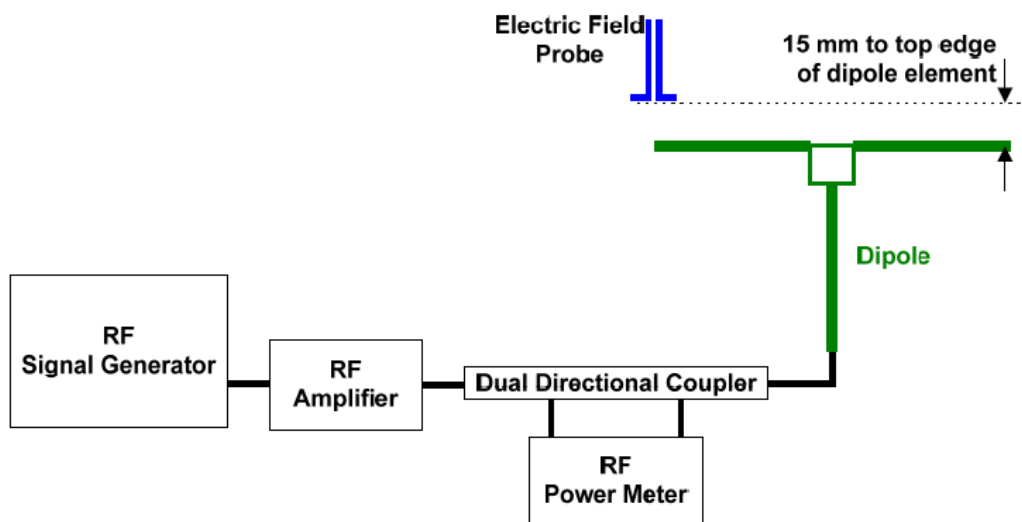

Fig. 4 Dipole Validation Setup

### 8.2 Validation Result

E-Field Scan						
Mode	Frequency (MHz)	Input Power (mW)	Measured <sup>1</sup> Value(dBV/m)	Target <sup>2</sup> Value(dBV/m)	Deviation <sup>3</sup> (%)	Limit <sup>4</sup> (%)
CW	835	100	40.84	41	-1.83	± 25
CW	1880	100	38.60	38.8	-2.28	± 25
CW	2600	100	38.72	38.64	0.93	± 25

Notes:

1. Please refer to the attachment for detailed measurement data and plot.
2. Target value is provided by SPEAD in the calibration certificate of specific dipoles.
3. Deviation (%) =  $100 * (\text{Measured value minus Target value}) / \text{Target value}$ .
4. ANSI C63.19 requires values within  $\pm 25\%$  are acceptable, of which 12% is deviation and 13% is measurement uncertainty. Values independently validated for the dipole actually used in the measurements should be used, when available.

## 9 Evaluation of MIF

### 9.1 Introduction

The MIF (Modulation Interference Factor) is used to classify E-field emission to determine Hearing Aid Compatibility (HAC). It scales the power-averaged signal to the RF audio interference level and is characteristic to a modulation scheme. The HAC standard preferred "indirect" measurement method is based on average field measurement with separate scaling by the MIF. With an Audio Interference Analyzer (AIA) designed by SPEAG specifically for the MIF measurement, these values have been verified by practical measurements on an RF signal modulated with each of the waveforms. The resulting deviations from the simulated values are within the requirements of the HAC standard.

The AIA (Audio Interference Analyzer) is an USB powered electronic sensor to evaluate signals in the frequency range 698MHz - 6 GHz. It contains RMS detector and audio frequency circuits for sampling of the RF envelope.

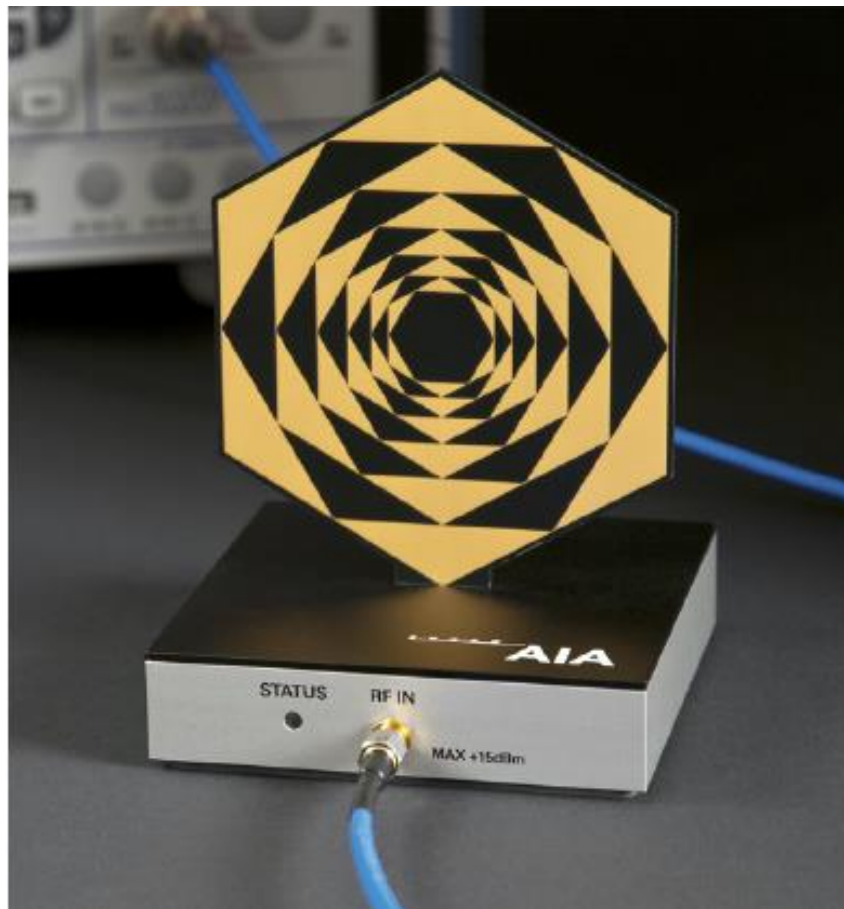

Fig. 5 AIA Front View



## 9.2 MIF measurement with the AIA

The MIF is measured with the AIA as follows:

1. Connect the AIA via USB to the DASY5 PC and verify the configuration settings.
2. Couple the RF signal to be evaluated to an AIA via cable or antenna.
3. Generate a MIF measurement job for the unknown signal and select the measurement port and timing settings.
4. Document the results via the post processor in a report.

## 9.3 Test equipment for the MIF measurement

No.	Name	Type	Serial Number	Manufacturer
01	Signal Generator	E4438C	MY49071430	Agilent
02	AIA	SE UMS 170 CB	1029	SPEAG
03	BTS	CMW500	166370	R&S

## 9.4 DUT MIF results

Based on the KDB285076D01v05, the handset can also use the MIF values predetermined by the test equipment manufacturer. MIF values applied in this test report were provided by the HAC equipment provider of SPEAG, and the worst values for all air interface are listed below to be determine the Low-power Exemption.

Typical MIF levels in ANSI C63.19-2011	
Transmission protocol	Modulation interference factor
GSM-FDD (TDMA, GMSK)	+3.63 dB
EDGE-FDD (TDMA, 8PSK, TN 0-1)	+1.23dB
EDGE-FDD (TDMA, 8PSK, TN 0-1-2)	-0.52dB
EDGE-FDD (TDMA, 8PSK, TN 0-1-2-3)	-1.82dB
UMTS-FDD(WCDMA, AMR)	-25.43dB
UMTS-FDD (HSPA)	-20.75dB
LTE-FDD (SC-FDMA, 1RB, 20MHz, QPSK)	-15.63 dB
LTE-FDD (SC-FDMA, 1RB, 20MHz, 16QAM)	-9.76 dB
LTE-FDD (SC-FDMA, 1RB, 20MHz, 64QAM)	-9.93 dB
LTE-TDD (SC-FDMA, 1RB, 20MHz, QPSK)	-1.62 dB
LTE-TDD (SC-FDMA, 1RB, 20MHz, 16QAM)	-1.44 dB
LTE-TDD (SC-FDMA, 1RB, 20MHz, 64QAM)	-1.54 dB
IEEE 802.11b WiFi 2.4 GHz (DSSS, 1 Mbps)	-5.90 dB
IEEE 802.11b WiFi 2.4 GHz (DSSS, 2 Mbps)	-5.17 dB
IEEE 802.11b WiFi 2.4 GHz (DSSS, 5.5 Mbps)	-3.37 dB
IEEE 802.11b WiFi 2.4 GHz (DSSS, 11 Mbps)	-2.02 dB
IEEE 802.11g WiFi 2.4 GHz (DSSS-OFDM, 6 Mbps)	-0.36dB
IEEE 802.11n (HT Greenfield, 6.5 Mbps, BPSK)	-15.80 dB

## 10 Evaluation for low-power exemption

### 10.1 Product testing threshold

There are two methods for exempting an RF air interface technology from testing. The first method requires evaluation of the MIF for the worst-case operating mode. An RF air interface technology of a device is exempt from testing when its average antenna input power plus its MIF is  $\leq 17$  dBm for any of its operating modes. The second method does not require determination of the MIF. The RF emissions testing exemption shall be applied to an RF air interface technology in a device whose peak antenna input power, averaged over intervals  $\leq 50 \mu s$ , is  $\leq 23$  dBm. An RF air interface technology that is exempted from testing by either method shall be rated as M4.

The first method is used to be exempt from testing for the RF air interface technology in this report.

### 10.2 Conducted power

Band	Average power (dBm)	MIF (dB)	Sum (dBm)	C63.19 Tested
GSM 850 - Voice	33.3	3.63	36.93	Yes
GSM 850 - EDGE	28	-1.82	26.18	Yes*
GSM 1900 - Voice	31	3.63	34.63	Yes
GSM 1900 - EDGE	26.5	-1.82	24.68	Yes*
WCDMA 850 - RMC	25	-25.43	-0.43	No
WCDMA 850 - HSPA	23.5	-20.75	2.75	No
WCDMA 1700 - RMC	25	-25.43	-0.43	No
WCDMA 1700 - HSPA	22.5	-20.75	1.75	No
WCDMA 1900 - RMC	25	-25.43	-0.43	No
WCDMA 1900 - HSPA	22.5	-20.75	1.75	No
LTE Band 2 QPSK	25	-15.63	9.37	No
LTE Band 5 QPSK	25	-15.63	9.37	No
LTE Band 12 QPSK	25	-15.63	9.37	No
LTE Band 13 QPSK	25	-15.63	9.37	No
LTE Band 25 QPSK	25	-15.63	9.37	No
LTE Band 26 QPSK	25	-15.63	9.37	No
LTE Band 66 QPSK	25	-15.63	9.37	No
LTE Band 71 QPSK	25	-15.63	9.37	No
LTE Band 41 PC2 QPSK	26	-3.41	22.59	Yes
LTE Band 41 PC3 QPSK	23	-3.41	19.59	Yes
WiFi-2.4G	17	-2.02	14.98	No

### 10.3 Conclusion

According to the above table, the sums of average power and MIF for WCDMA, LTE FDD and WiFi2.4G are less than 17dBm. So it is measured for GSM and LTE TDD. The WCDMA, LTE FDD and WiFi2.4G are exempt from testing and rated as M4.

## 11 RF TEST PROCEDURES

**The evaluation was performed with the following procedure:**

- 1) Confirm proper operation of the field probe, probe measurement system and other instrumentation and the positioning system.
- 2) Position the WD in its intended test position. The gauge block can simplify this positioning.
- 3) Configure the WD normal operation for maximum rated RF output power, at the desired channel and other operating parameters (e.g., test mode), as intended for the test.
- 4) The center sub-grid shall be centered on the center of the T-Coil mode axial measurement point or the acoustic output, as appropriate. Locate the field probe at the initial test position in the 50 mm by 50 mm grid, which is contained in the measurement plane. If the field alignment method is used, align the probe for maximum field reception.
- 5) Record the reading.
- 6) Scan the entire 50 mm by 50 mm region in equally spaced increments and record the reading at each measurement point. The distance between measurement points shall be sufficient to assure the identification of the maximum reading.
- 7) Identify the five contiguous sub-grids around the center sub-grid whose maximum reading is the lowest of all available choices. This eliminates the three sub-grids with the maximum readings. Thus, the six areas to be used to determine the WD's highest emissions are identified.
- 8) Identify the maximum field reading within the non-excluded sub-grids identified in Step 7)
- 9) Evaluate the MIF and add to the maximum steady-state rms field-strength reading to obtain the RF audio interference level..
- 10) Compare this RF audio interference level with the categories and record the resulting WD category rating.

## 12 Measurement Results (E-Field)

Frequency		Measured Value(dBV/m)	Power Drift (dB)	Category
MHz	Channel			
<b>GSM 850</b>				
848.8	251	29.99	-0.05	<b>M4</b>
836.6	190	30.58	-0.04	<b>M4(see Fig B.1)</b>
824.2	128	29.20	0.20	<b>M4</b>
<b>GSM 1900</b>				
1909.8	810	28.25	-0.14	<b>M4</b>
1880	661	27.85	-0.05	<b>M4</b>
1850.2	512	28.84	0.02	<b>M4(see Fig B.2)</b>
<b>LTE Band 41 PC2 QPSK</b>				
2680	41490	21.23	0.05	<b>M4</b>
2636.5	41055	22.94	-0.11	<b>M4(see Fig B.3)</b>
2593	40620	22.01	0.07	<b>M4</b>
2549.5	40185	21.07	0.07	<b>M4</b>
2506	39750	20.38	0.20	<b>M4</b>
<b>LTE Band 41 PC2 16QAM</b>				
2680	41490	21.76	0.03	<b>M4</b>
2636.5	41055	21.99	-0.01	<b>M4</b>
2593	40620	21.85	0.06	<b>M4</b>
2549.5	40185	21.12	-0.12	<b>M4</b>
2506	39750	20.56	0.08	<b>M4</b>
<b>LTE Band 41 PC2 64QAM</b>				
2680	41490	20.94	0.06	<b>M4</b>
2636.5	41055	20.51	-0.03	<b>M4</b>
2593	40620	20.33	0.16	<b>M4</b>
2549.5	40185	20.48	-0.11	<b>M4</b>
2506	39750	20.09	-0.08	<b>M4</b>
<b>LTE Band 41 PC3 QPSK</b>				
2680	41490	18.44	0.04	<b>M4</b>
2636.5	41055	20.24	0.11	<b>M4(see Fig B.4)</b>
2593	40620	19.21	-0.02	<b>M4</b>
2549.5	40185	18.14	0.01	<b>M4</b>
2506	39750	18.34	0.04	<b>M4</b>
<b>LTE Band 41 PC3 16QAM</b>				
2680	41490	18.37	0.09	<b>M4</b>
2636.5	41055	19.69	0.08	<b>M4</b>
2593	40620	18.98	-0.06	<b>M4</b>
2549.5	40185	18.36	0.03	<b>M4</b>
2506	39750	18.22	-0.01	<b>M4</b>
<b>LTE Band 41 PC3 64QAM</b>				

2680	41490	18.24	-0.06	<b>M4</b>
2636.5	41055	18.71	0.07	<b>M4</b>
2593	40620	18.03	-0.12	<b>M4</b>
2549.5	40185	18.17	-0.09	<b>M4</b>
2506	39750	18.22	0.03	<b>M4</b>

### 13 ANSIC 63.19-2011 LIMITS

#### WD RF audio interference level categories in logarithmic units

<b>Emission categories</b>	<b>&lt; 960 MHz</b>	<b>E-field emissions</b>
Category M1	50 to 55	dB (V/m)
Category M2	45 to 50	dB (V/m)
Category M3	40 to 45	dB (V/m)
Category M4	< 40	dB (V/m)
<b>Emission categories</b>	<b>&gt; 960 MHz</b>	<b>E-field emissions</b>
Category M1	40 to 45	dB (V/m)
Category M2	35 to 40	dB (V/m)
Category M3	30 to 35	dB (V/m)
Category M4	< 30	dB (V/m)

## 14 MEASUREMENT UNCERTAINTY

No.	Error source	Type	Uncertainty Value(%)	Prob. Dist.	k	c <sub>i</sub> E	Standard Uncertainty (%) $u_i$ ; (%)E	Degree of freedom $V_{eff}$ or $v_i$
<b>Measurement System</b>								
1	Probe Calibration	B	5.	N	1	1	5.1	∞
2	Axial Isotropy	B	4.7	R	$\sqrt{3}$	1	2.7	∞
3	Sensor Displacement	B	16.5	R	$\sqrt{3}$	1	9.5	∞
4	Boundary Effects	B	2.4	R	$\sqrt{3}$	1	1.4	∞
5	Linearity	B	4.7	R	$\sqrt{3}$	1	2.7	∞
6	Scaling to Peak Envelope Power	B	2.0	R	$\sqrt{3}$	1	1.2	∞
7	System Detection Limit	B	1.0	R	$\sqrt{3}$	1	0.6	∞
8	Readout Electronics	B	0.3	N	1	1	0.3	∞
9	Response Time	B	0.8	R	$\sqrt{3}$	1	0.5	∞
10	Integration Time	B	2.6	R	$\sqrt{3}$	1	1.5	∞
11	RF Ambient Conditions	B	3.0	R	$\sqrt{3}$	1	1.7	∞
12	RF Reflections	B	12.0	R	$\sqrt{3}$	1	6.9	∞
13	Probe Positioner	B	1.2	R	$\sqrt{3}$	1	0.7	∞
14	Probe Positioning	A	4.7	R	$\sqrt{3}$	1	2.7	∞
15	Extra. And Interpolation	B	1.0	R	$\sqrt{3}$	1	0.6	∞
<b>Test Sample Related</b>								
16	Device Positioning Vertical	B	4.7	R	$\sqrt{3}$	1	2.7	∞
17	Device Positioning Lateral	B	1.0	R	$\sqrt{3}$	1	0.6	∞
18	Device Holder and Phantom	B	2.4	R	$\sqrt{3}$	1	1.4	∞
19	Power Drift	B	5.0	R	$\sqrt{3}$	1	2.9	∞

20	AIA measurement	B	12	R	$\sqrt{3}$	1	6.9	$\infty$
<b>Phantom and Setup related</b>								
21	Phantom Thickness	B	2.4	R	$\sqrt{3}$	1	1.4	$\infty$
Combined standard uncertainty(%)							16.2	
Expanded uncertainty (confidence interval of 95 %)		$u_e = 2u_c$		N	k=2		32.4	

## 15 MAIN TEST INSTRUMENTS

**Table 1: List of Main Instruments**

No.	Name	Type	Serial Number	Calibration Date	Valid Period
01	Signal Generator	E4483C	MY49071430	January 13, 2022	One Year
02	Power meter	NRP2	106277	September 24, 2021	One year
03	Power sensor	NRP8S	104291		
04	Amplifier	60S1G4	0331848	No Calibration Requested	
05	E-Field Probe	EF3DV3	4062	December 17, 2021	One year
06	DAE	SPEAG DAE4	1524	October 08, 2021	One year
07	HAC Dipole	CD835V3	1023	August 24, 2021	One year
08	HAC Dipole	CD1880V3	1018	August 24, 2021	One year
09	HAC Dipole	CD2600V3	1017	August 24, 2021	One year
10	BTS	CMW500	166370	June 25,2021	One year
11	AIA	SE UMS 170 CB	1029	No Calibration Requested	

## 16 CONCLUSION

The HAC measurement indicates that the EUT complies with the HAC limits of the ANSIC63.19-2011. The total M-rating is **M4**.

\*\*\*END OF REPORT BODY\*\*\*

## ANNEX A TEST LAYOUT

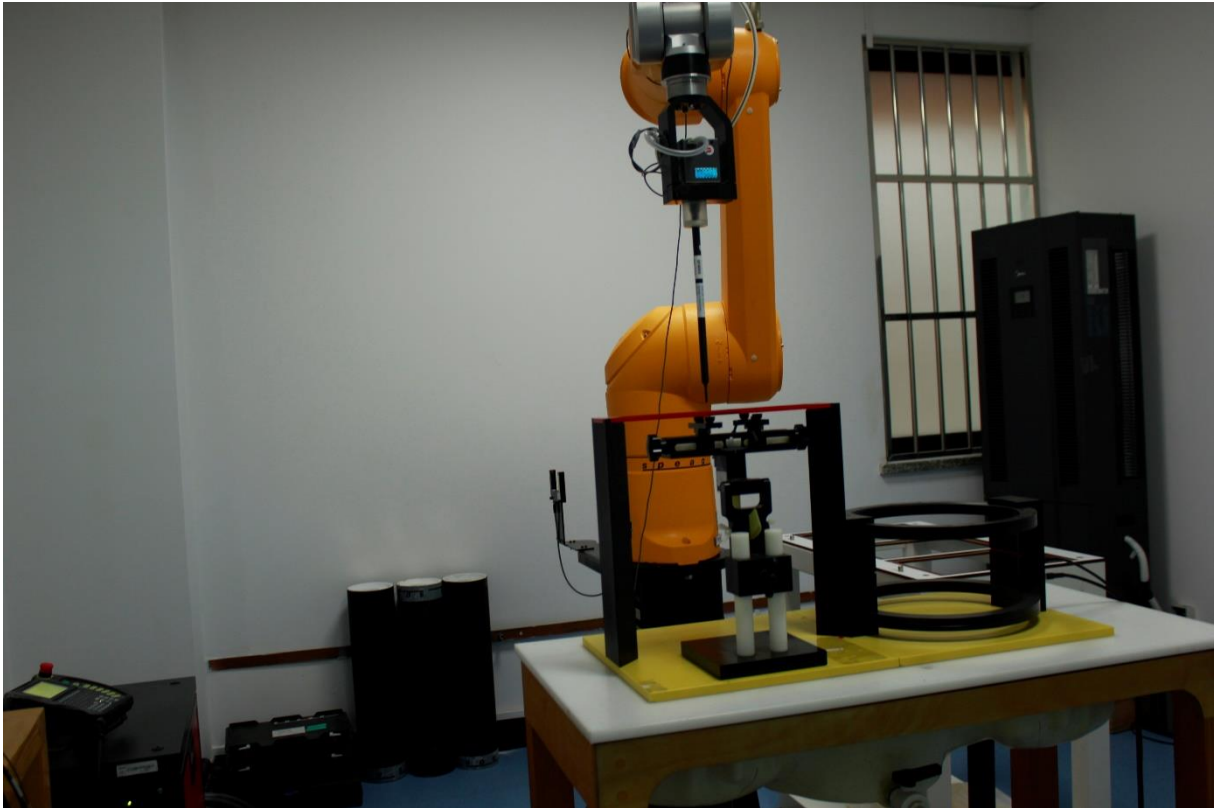

Picture A1:HAC RF System Layout



## ANNEX B TEST PLOTS

### HAC RF E-Field GSM 850

Date/Time: 2022-05-30

Electronics: DAE4 Sn1524

Medium: Air

Medium parameters used:  $\sigma = 0$  S/m,  $\epsilon_r = 1$ ;  $\rho = 1000$  kg/m<sup>3</sup>

Ambient Temperature: 23.30C      Liquid Temperature: 22.50C

Communication System: GSM 850 Frequency: 836.5 MHz Duty Cycle: 1:8.3

Probe: EF3DV3 – SN4062

E Scan – ER3DV6 – 2011: 15 mm from Probe Center to the Device

2/Hearing Aid Compatibility Test (101x101x1): Interpolated grid:

dx=0.5000 mm, dy=0.5000 mm

Device Reference Point: 0, 0, -6.3 mm

Reference Value = 27.79 V/m; Power Drift = -0.04 dB

Applied MIF = 3.28 dB

RF audio interference level = 30.58 dBV/m

Emission category: **M4**

MIF scaled E-field

Grid 1 M4 30.64 dBV/m	Grid 2 M4 30.78 dBV/m	Grid 3 M4 30.11 dBV/m
Grid 4 M4 30.46 dBV/m	Grid 5 M4 30.58 dBV/m	Grid 6 M4 29.89 dBV/m
Grid 7 M4 30.15 dBV/m	Grid 8 M4 30.16 dBV/m	Grid 9 M4 29.47 dBV/m

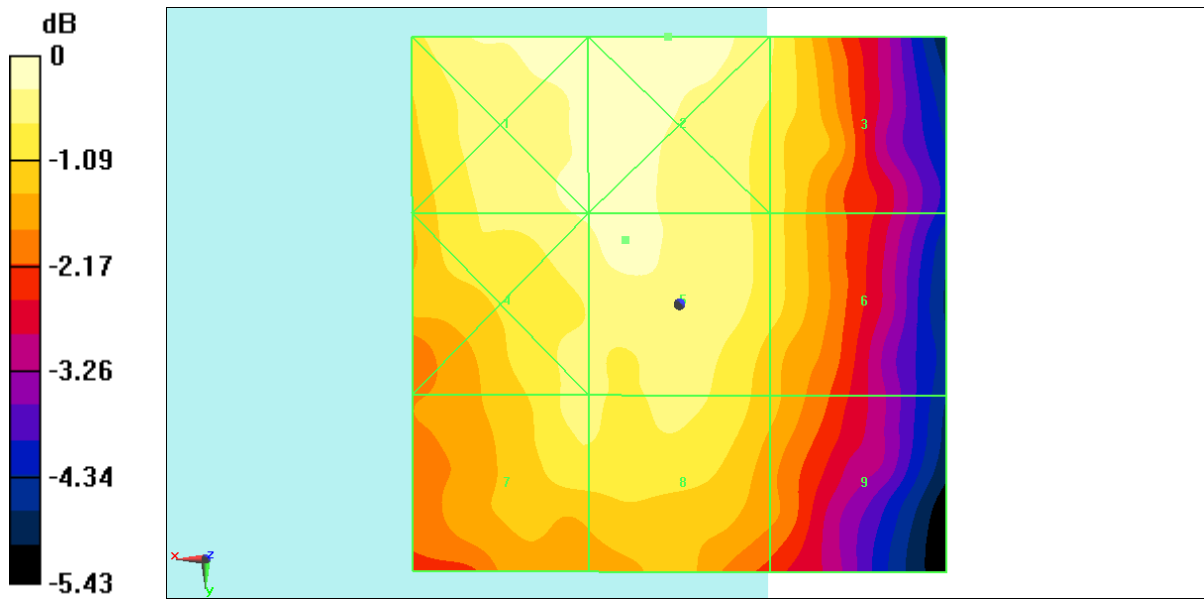

0 dB = 34.58 V/m = 30.78 dBV/m

**Fig B.1 HAC RF E-Field GSM 850**

**HAC RF E-Field GSM 1900**

Date: 2022-05-30

Electronics: DAE4 Sn1524

Medium: Air

Medium parameters used:  $\sigma = 0$  mho/m,  $\epsilon_r = 1$ ;  $\rho = 1000$  kg/m<sup>3</sup>

Ambient Temperature: 22.0°C

Communication System:GSM1900; Frequency: 1850.2MHz; Duty Cycle: 1:8.3

Probe: EF3DV3 – SN4062

E Scan – ER3DV6 – 2011: 15 mm from Probe Center to the Device 2 2

2 2/Hearing Aid Compatibility Test (101x101x1): Interpolated grid:

dx=0.5000 mm, dy=0.5000 mm

Device Reference Point: 0, 0, -6.3 mm

Reference Value = 17.37 V/m; Power Drift = 0.02dB

Applied MIF = 3.46 dB

RF audio interference level = 28.84 dBV/m

Emission category: **M4**

MIF scaled E-field

Grid 1 <b>M4</b> 28.46 dBV/m	Grid 2 <b>M4</b> 28.84 dBV/m	Grid 3 <b>M4</b> 28.26 dBV/m
Grid 4 <b>M4</b> 26.97 dBV/m	Grid 5 <b>M4</b> 27.87 dBV/m	Grid 6 <b>M4</b> 27.83 dBV/m
Grid 7 <b>M4</b> 29.09 dBV/m	Grid 8 <b>M4</b> 29.51 dBV/m	Grid 9 <b>M4</b> 29.12 dBV/m

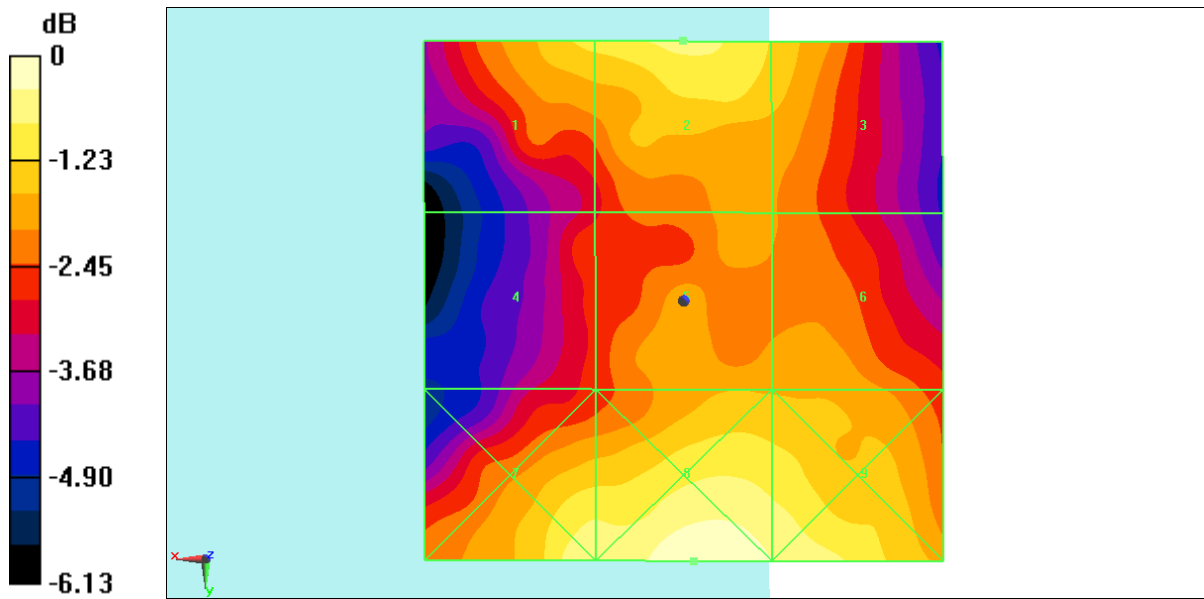

0 dB = 29.87 V/m = 29.50 dBV/m

**Fig B.2 HAC RF E-Field GSM1900**

**HAC RF E-Field LTE Band41 PC2 QPSK**

Date: 2022-06-24

Electronics: DAE4 Sn1524

Medium: Air

Medium parameters used:  $\sigma = 0$  mho/m,  $\epsilon_r = 1$ ;  $\rho = 1000$  kg/m<sup>3</sup>

Ambient Temperature: 22.0°C

Communication System: LTE Band41; Frequency: 2636.5 MHz; Duty Cycle: 1:1.58

Probe: EF3DV3 - SN4062

E Scan - ER3DV6 - 2011: 15 mm from Probe Center to the Device

2/Hearing Aid Compatibility Test (101x101x1): Interpolated grid:

dx=0.5000 mm, dy=0.5000 mm

Device Reference Point: 0, 0, -6.3 mm

Reference Value = 17.73 V/m; Power Drift = -0.11 dB

Applied MIF = -1.68 dB

RF audio interference level = 22.94 dBV/m

Emission category: **M4**

MIF scaled E-field

Grid 1 <b>M4</b> 20.96 dBV/m	Grid 2 <b>M4</b> 22.47 dBV/m	Grid 3 <b>M4</b> 22.52 dBV/m
Grid 4 <b>M4</b> 21.48 dBV/m	Grid 5 <b>M4</b> 22.89 dBV/m	Grid 6 <b>M4</b> 22.94 dBV/m
Grid 7 <b>M4</b> 23.09 dBV/m	Grid 8 <b>M4</b> 22.71 dBV/m	Grid 9 <b>M4</b> 22.75 dBV/m

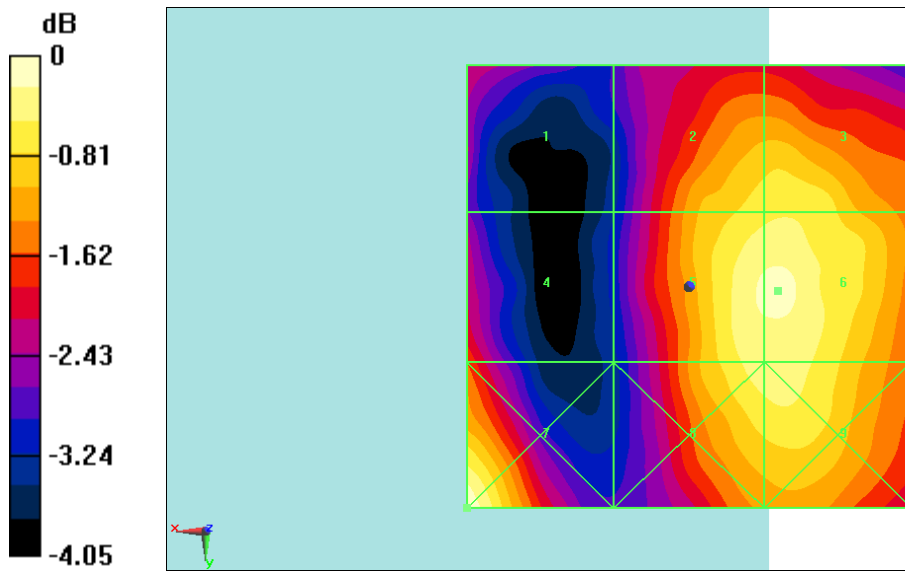

0 dB = 14.27 V/m = 23.09 dBV/m

**Fig B.3 HAC RF E-Field LTE Band41 PC2 QPSK**

**HAC RF E-Field LTE Band41 PC3**

Date: 2022-06-24

Electronics: DAE4 Sn1524

Medium: Air

Medium parameters used:  $\sigma = 0$  mho/m,  $\epsilon_r = 1$ ;  $\rho = 1000$  kg/m<sup>3</sup>

Ambient Temperature: 22.0°C

Communication System: LTE Band41; Frequency: 2636.5 MHz; Duty Cycle: 1:1.58

Probe: EF3DV3 - SN4062

E Scan - ER3DV6 - 2011: 15 mm from Probe Center to the Device

2/Hearing Aid Compatibility Test (101x101x1): Interpolated grid:

dx=0.5000 mm, dy=0.5000 mm

Device Reference Point: 0, 0, -6.3 mm

Reference Value = 15.44 V/m; Power Drift = 0.11 dB

Applied MIF = -3.43 dB

RF audio interference level = 20.24 dBV/m

Emission category: **M4**

MIF scaled E-field

Grid 1 <b>M4</b> 18.67 dBV/m	Grid 2 <b>M4</b> 19.68 dBV/m	Grid 3 <b>M4</b> 19.69 dBV/m
Grid 4 <b>M4</b> 18.89 dBV/m	Grid 5 <b>M4</b> 20.2 dBV/m	Grid 6 <b>M4</b> 20.24 dBV/m
Grid 7 <b>M4</b> 20.35 dBV/m	Grid 8 <b>M4</b> 19.85 dBV/m	Grid 9 <b>M4</b> 19.84 dBV/m

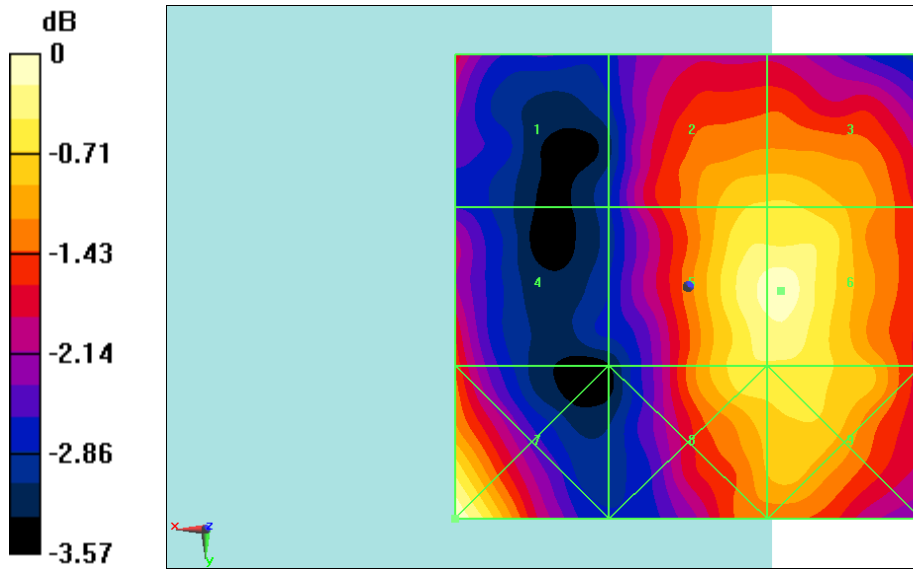

0 dB = 10.41 V/m = 20.35 dBV/m

**Fig B.4 HAC RF E-Field LTE Band41 PC3**



## ANNEX C SYSTEM VALIDATION RESULT

### E SCAN of Dipole 835 MHz

Date: 2022-05-30

Electronics: DAE4 Sn1524

Medium: Air

Medium parameters used:  $\sigma = 0$  mho/m,  $\epsilon_r = 1$ ;  $\rho = 1000$  kg/m<sup>3</sup>

Communication System: CW; Frequency: 835 MHz; Duty Cycle: 1:1

Probe: EF3DV3 – SN4062

**E Scan - measurement distance from the probe sensor center to CD835 = 15mm/Hearing Aid Compatibility Test at 15mm distance (41x361x1):** Interpolated

grid: dx=0.5000 mm, dy=0.5000 mm

Device Reference Point: 0, 0, -6.3 mm

Reference Value = 129.6 V/m; Power Drift = 0.10 dB

Applied MIF = 0.00 dB

RF audio interference level = 40.84 dBV/m

Emission category: **M3**

MIF scaled E-field

Grid 1 <b>M3</b> 40.76 dBV/m	Grid 2 <b>M3</b> 40.84 dBV/m	Grid 3 <b>M3</b> 40.64 dBV/m
Grid 4 <b>M4</b> 36.27 dBV/m	Grid 5 <b>M4</b> 36.4 dBV/m	Grid 6 <b>M4</b> 36.3 dBV/m
Grid 7 <b>M3</b> 40.7 dBV/m	Grid 8 <b>M3</b> 40.88 dBV/m	Grid 9 <b>M3</b> 40.73 dBV/m

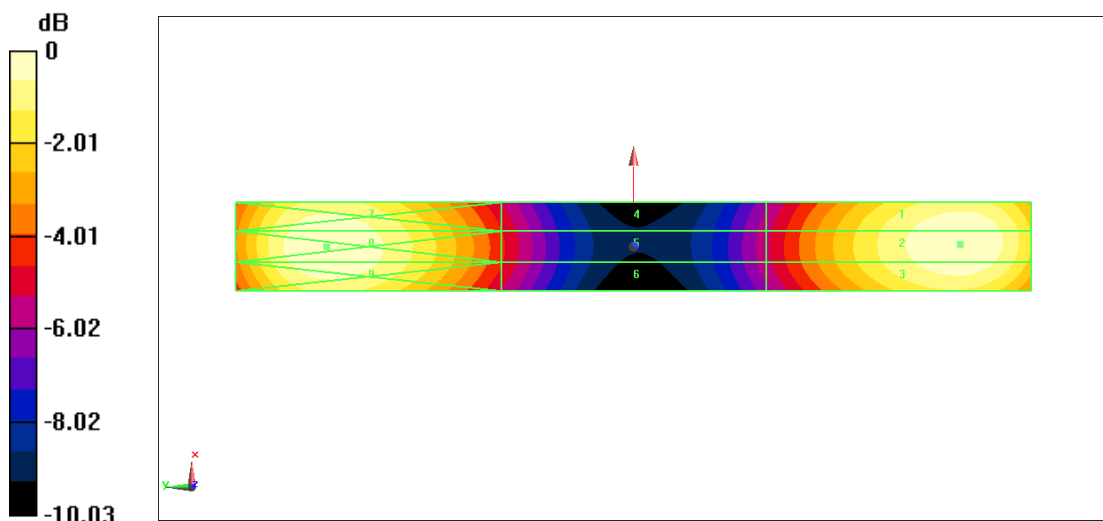

$$0 \text{ dB} = 110.7 \text{ V/m} = 40.88 \text{ dBV/m}$$

**E SCAN of Dipole 1800 MHz**

**Date: 2022-05-30**

Electronics: DAE4 Sn1524

Medium: Air

Medium parameters used:  $\sigma = 0$  mho/m,  $\epsilon_r = 1$ ;  $\rho = 1000$  kg/m<sup>3</sup>

Communication System: CW; Frequency: 1880 MHz; Duty Cycle: 1:1

Probe: EF3DV3 – SN4062

**E Scan - measurement distance from the probe sensor center to CD1880 = 15mm**

**2/Hearing Aid Compatibility Test at 15mm distance (41x181x1):** Interpolated grid:

dx=0.5000 mm, dy=0.5000 mm

Device Reference Point: 0, 0, -6.3 mm

Reference Value = 123.1 V/m; Power Drift = 0.02 dB

Applied MIF = 0.00 dB

RF audio interference level = 38.60 dBV/m

**Emission category: M2**

MIF scaled E-field

Grid 1 <b>M2</b> <b>38.82 dBV/m</b>	Grid 2 <b>M2</b> <b>38.88 dBV/m</b>	Grid 3 <b>M2</b> <b>38.68 dBV/m</b>
Grid 4 <b>M2</b> <b>36.74 dBV/m</b>	Grid 5 <b>M2</b> <b>36.81 dBV/m</b>	Grid 6 <b>M2</b> <b>36.72 dBV/m</b>
Grid 7 <b>M2</b> <b>38.49 dBV/m</b>	Grid 8 <b>M2</b> <b>38.6 dBV/m</b>	Grid 9 <b>M2</b> <b>38.44 dBV/m</b>

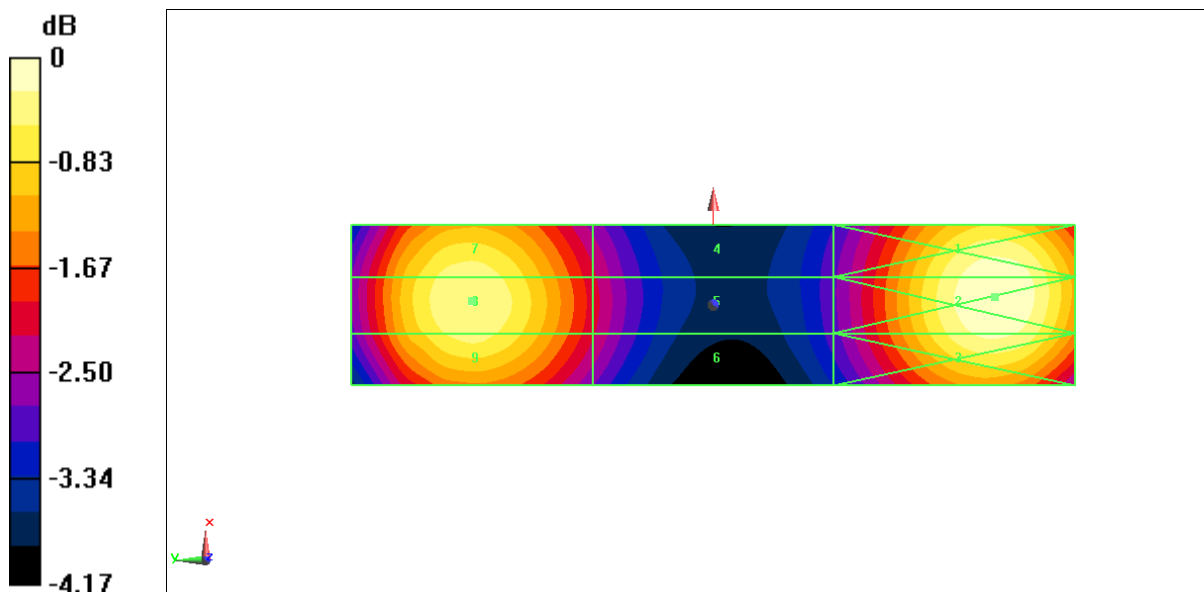

$$0 \text{ dB} = 87.88 \text{ V/m} = 38.88 \text{ dBV/m}$$

**E SCAN of Dipole 2600 MHz**
**Date: 2022-06-24**

Electronics: DAE4 Sn1524

Medium: Air

 Medium parameters used:  $\sigma = 0$  mho/m,  $\epsilon_r = 1$ ;  $\rho = 1000$  kg/m<sup>3</sup>

Communication System: CW; Frequency: 2600 MHz; Duty Cycle: 1:1

Probe: EF3DV3 - SN4062

**E Scan - measurement distance from the probe sensor center to CD2600 = 15mm/Hearing Aid Compatibility Test at 15mm distance (41x141x1):** Interpolated grid: dx=0.5000 mm, dy=0.5000 mm

Device Reference Point: 0, 0, -6.3 mm

Reference Value = 62.15 V/m; Power Drift = -0.10 dB

Applied MIF = 0.00 dB

RF audio interference level = 38.72 dBV/m

**Emission category: M2**

MIF scaled E-field

Grid 1 <b>M2</b> <b>38.79 dBV/m</b>	Grid 2 <b>M2</b> <b>38.89 dBV/m</b>	Grid 3 <b>M2</b> <b>38.72 dBV/m</b>
Grid 4 <b>M2</b> <b>38.13 dBV/m</b>	Grid 5 <b>M2</b> <b>38.17 dBV/m</b>	Grid 6 <b>M2</b> <b>38.02 dBV/m</b>
Grid 7 <b>M2</b> <b>38.6 dBV/m</b>	Grid 8 <b>M2</b> <b>38.72 dBV/m</b>	Grid 9 <b>M2</b> <b>38.48 dBV/m</b>

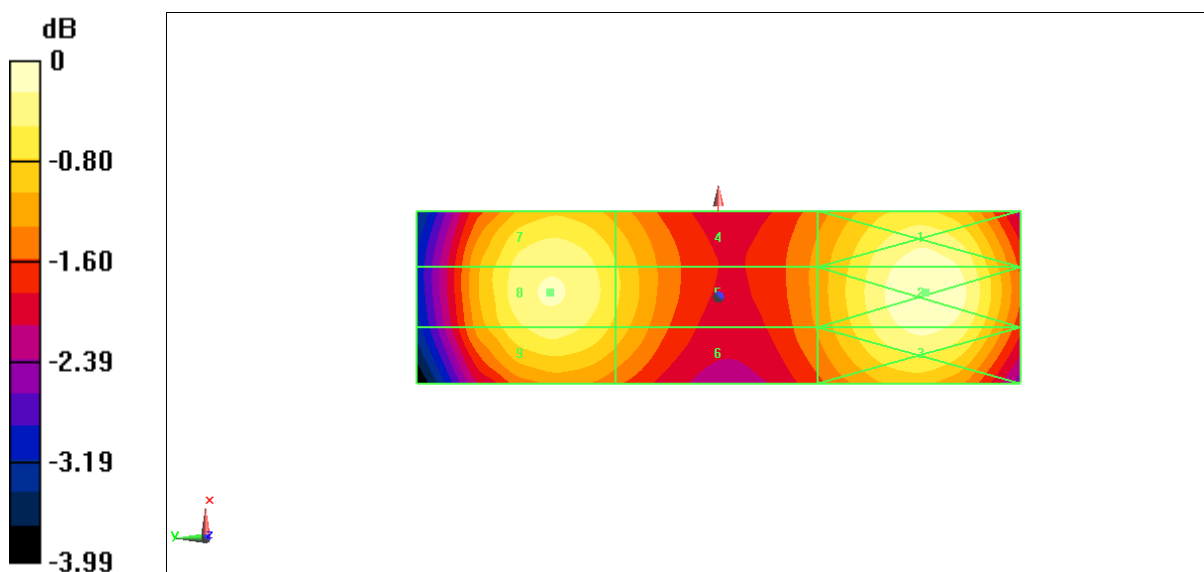

0 dB = 88.05 V/m = 38.89 dBV/m

## ANNEX D PROBE CALIBRATION CERTIFICATE

**Calibration Laboratory of  
Schmid & Partner  
Engineering AG**  
 Zeughausstrasse 43, 8004 Zurich, Switzerland



**S** Schweizerischer Kalibrierdienst  
**C** Service suisse d'étalonnage  
**S** Servizio svizzero di taratura  
**S** Swiss Calibration Service

Accredited by the Swiss Accreditation Service (SAS)  
 The Swiss Accreditation Service is one of the signatories to the EA  
 Multilateral Agreement for the recognition of calibration certificates

Accreditation No.: **SCS 0108**

Client **Auden**

Certificate No: **EF3-4062\_Dec21**

### CALIBRATION CERTIFICATE

Object **EF3DV3- SN:4062**  
 Calibration procedure(s) **QA CAL-02.v9, QA CAL-25.v7  
 Calibration procedure for E-field probes optimized for close near field  
 evaluations in air**  
 Calibration date: **December 17, 2021**

This calibration certificate documents the traceability to national standards, which realize the physical units of measurements (SI).  
 The measurements and the uncertainties with confidence probability are given on the following pages and are part of the certificate.

All calibrations have been conducted in the closed laboratory facility: environment temperature ( $22 \pm 3$ )°C and humidity < 70%.

Calibration Equipment used (M&TE critical for calibration)

Primary Standards	ID	Cal Date (Certificate No.)	Scheduled Calibration
Power meter NRP	SN: 104778	09-Apr-21 (No. 217-03291/03292)	Apr-22
Power sensor NRP-Z91	SN: 103244	09-Apr-21 (No. 217-03291)	Apr-22
Power sensor NRP-Z91	SN: 103245	09-Apr-21 (No. 217-03292)	Apr-22
Reference 20 dB Attenuator	SN: CC2552 (20x)	09-Apr-21 (No. 217-03343)	Apr-22
DAE4	SN: 789	23-Dec-20 (No. DAE4-789_Dec20)	Dec-21
Reference Probe ER3DV6	SN: 2328	08-Oct-21 (No. ER3-2328_Oct21)	Oct-22
Secondary Standards	ID	Check Date (in house)	Scheduled Check
Power meter E4419B	SN: GB41293874	06-Apr-16 (in house check Jun-20)	In house check: Jun-22
Power sensor E4412A	SN: MY41498087	06-Apr-16 (in house check Jun-20)	In house check: Jun-22
Power sensor E4412A	SN: 000110210	06-Apr-16 (in house check Jun-20)	In house check: Jun-22
RF generator HP 8648C	SN: US3642U01700	04-Aug-99 (in house check Jun-20)	In house check: Jun-22
Network Analyzer E8358A	SN: US41080477	31-Mar-14 (in house check Oct-20)	In house check: Oct-22

	Name	Function	Signature
Calibrated by:	Jeffrey Katzman	Laboratory Technician	
Approved by:	Niels Kuster	Quality Manager	

Issued: December 21, 2021  
 This calibration certificate shall not be reproduced except in full without written approval of the laboratory.

**Calibration Laboratory of**  
Schmid & Partner  
Engineering AG  
Zeughausstrasse 43, 8004 Zurich, Switzerland



**S** Schweizerischer Kalibrierdienst  
**C** Service suisse d'étalonnage  
**S** Servizio svizzero di taratura  
**S** Swiss Calibration Service

Accredited by the Swiss Accreditation Service (SAS)  
The Swiss Accreditation Service is one of the signatories to the EA  
Multilateral Agreement for the recognition of calibration certificates

Accreditation No.: **SCS 0108**

#### Glossary:

NORM <sub>x,y,z</sub>	sensitivity in free space
DCP	diode compression point
CF	crest factor (1/duty_cycle) of the RF signal
A, B, C, D	modulation dependent linearization parameters
En	incident E-field orientation normal to probe axis
Ep	incident E-field orientation parallel to probe axis
Polarization $\varphi$	$\varphi$ rotation around probe axis
Polarization $\vartheta$	$\vartheta$ rotation around an axis that is in the plane normal to probe axis (at measurement center), i.e., $\vartheta = 0$ is normal to probe axis
Connector Angle	information used in DASYS system to align probe sensor X to the robot coordinate system

#### Calibration is Performed According to the Following Standards:

- IEEE Std 1309-2005, "IEEE Standard for calibration of electromagnetic field sensors and probes, excluding antennas, from 9 kHz to 40 GHz", December 2005
- CTIA Test Plan for Hearing Aid Compatibility, Rev 3.1.1, May 2017

#### Methods Applied and Interpretation of Parameters:

- NORM<sub>x,y,z</sub>**: Assessed for E-field polarization  $\vartheta = 0$  for XY sensors and  $\vartheta = 90$  for Z sensor ( $f \leq 900$  MHz in TEM-cell;  $f > 1800$  MHz: R22 waveguide).
- NORM(f)<sub>x,y,z</sub>** = **NORM<sub>x,y,z</sub>** \* *frequency\_response* (see Frequency Response Chart).
- DCP<sub>x,y,z</sub>**: DCP are numerical linearization parameters assessed based on the data of power sweep with CW signal (no uncertainty required). DCP does not depend on frequency nor media.
- PAR**: PAR is the Peak to Average Ratio that is not calibrated but determined based on the signal characteristics
- A<sub>x,y,z</sub>; B<sub>x,y,z</sub>; C<sub>x,y,z</sub>; D<sub>x,y,z</sub>; VR<sub>x,y,z</sub>**: A, B, C, D are numerical linearization parameters assessed based on the data of power sweep for specific modulation signal. The parameters do not depend on frequency nor media. VR is the maximum calibration range expressed in RMS voltage across the diode.
- Spherical isotropy (3D deviation from isotropy)**: in a locally homogeneous field realized using an open waveguide setup.
- Sensor Offset**: The sensor offset corresponds to the offset of virtual measurement center from the probe tip (on probe axis). No tolerance required.
- Connector Angle**: The angle is assessed using the information gained by determining the **NORM<sub>x</sub>** (no uncertainty required).



EF3DV3 – SN:4062

December 17, 2021

## DASY/EASY - Parameters of Probe: EF3DV3 - SN:4062

### Basic Calibration Parameters

	Sensor X	Sensor Y	Sensor Z	Unc (k=2)
Norm ( $\mu\text{V}/(\text{V}/\text{m})^2$ )	0.71	0.79	1.21	$\pm 10.1\%$
DCP (mV) <sup>B</sup>	97.4	94.5	90.7	

### Calibration results for Frequency Response (30 MHz – 6 GHz)

Frequency MHz	Target E-Field V/m	Measured E-field (En) V/m	Deviation E-normal in %	Measured E-field (Ep) V/m	Deviation E-normal in %	Unc (k=2) %
30	77.1	77.2	0.2%	77.1	-0.1%	$\pm 5.1\%$
100	77.0	78.0	1.2%	77.8	1.1%	$\pm 5.1\%$
450	77.1	77.9	1.0%	77.9	1.0%	$\pm 5.1\%$
600	77.1	77.6	0.6%	77.6	0.6%	$\pm 5.1\%$
750	77.1	77.4	0.4%	77.3	0.3%	$\pm 5.1\%$
1800	143.2	139.3	-2.7%	139.3	-2.7%	$\pm 5.1\%$
2000	135.2	131.5	-2.7%	131.7	-2.6%	$\pm 5.1\%$
2200	127.7	123.5	-3.3%	124.7	-2.4%	$\pm 5.1\%$
2500	125.5	122.3	-2.5%	123.7	-1.4%	$\pm 5.1\%$
3000	79.4	75.7	-4.7%	77.0	-2.9%	$\pm 5.1\%$
3500	255.7	247.1	-3.4%	244.2	-4.5%	$\pm 5.1\%$
3700	249.3	239.0	-4.1%	238.4	-4.4%	$\pm 5.1\%$
5200	50.2	51.4	2.4%	51.0	1.6%	$\pm 5.1\%$
5500	49.6	49.7	0.3%	48.3	-2.7%	$\pm 5.1\%$
5800	48.9	48.8	-0.1%	49.8	1.8%	$\pm 5.1\%$

The reported uncertainty of measurement is stated as the standard uncertainty of measurement multiplied by the coverage factor k=2, which for a normal distribution corresponds to a coverage probability of approximately 95%.

<sup>B</sup> Numerical linearization parameter: uncertainty not required.

<sup>E</sup> Uncertainty is determined using the max. deviation from linear response applying rectangular distribution and is expressed for the square of the field value.

EF3DV3 – SN:4062

December 17, 2021

## DASY/EASY - Parameters of Probe: EF3DV3 - SN:4062

### Calibration Results for Modulation Response

UID	Communication System Name		A dB	B dB $\sqrt{\mu\text{V}}$	C	D dB	VR mV	Max dev.	Max Unc <sup>E</sup> (k=2)
0	CW	X	0.00	0.00	1.00	0.00	155.6	± 3.3 %	± 4.7 %
		Y	0.00	0.00	1.00		123.0		
		Z	0.00	0.00	1.00		119.2		
10352-AAA	Pulse Waveform (200Hz, 10%)	X	2.71	66.01	9.79	10.00	60.0	± 8.5 %	± 9.6 %
		Y	20.00	90.07	19.68		60.0		
		Z	20.00	90.25	19.95		60.0		
10353-AAA	Pulse Waveform (200Hz, 20%)	X	1.37	63.52	7.72	6.99	80.0	± 5.2 %	± 9.6 %
		Y	20.00	95.38	20.87		80.0		
		Z	20.00	98.51	22.53		80.0		
10354-AAA	Pulse Waveform (200Hz, 40%)	X	0.78	63.02	6.40	3.98	95.0	± 4.3 %	± 9.6 %
		Y	20.00	157.48	48.00		95.0		
		Z	0.14	60.00	100.00		95.0		
10355-AAA	Pulse Waveform (200Hz, 60%)	X	0.50	62.44	5.07	2.22	120.0	± 5.2 %	± 9.6 %
		Y	0.08	60.00	100.00		120.0		
		Z	0.10	60.00	100.00		120.0		
10387-AAA	QPSK Waveform, 1 MHz	X	2.27	75.12	18.68	1.00	150.0	± 5.3 %	± 9.6 %
		Y	20.00	114.88	32.92		150.0		
		Z	20.00	132.40	42.41		150.0		
10388-AAA	QPSK Waveform, 10 MHz	X	2.52	72.17	18.18	0.00	150.0	± 4.5 %	± 9.6 %
		Y	4.53	84.25	24.22		150.0		
		Z	20.00	121.88	39.03		150.0		
10396-AAA	64-QAM Waveform, 100 kHz	X	2.31	70.43	19.73	3.01	150.0	± 5.9 %	± 9.6 %
		Y	1.96	69.74	21.59		150.0		
		Z	2.25	77.90	26.64		150.0		
10399-AAA	64-QAM Waveform, 40 MHz	X	3.55	68.25	16.70	0.00	150.0	± 4.6 %	± 9.6 %
		Y	4.01	70.89	18.64		150.0		
		Z	5.94	80.36	24.13		150.0		
10414-AAA	WLAN CCDF, 64-QAM, 40MHz	X	4.73	66.37	16.19	0.00	150.0	± 4.6 %	± 9.6 %
		Y	4.92	67.17	17.11		150.0		
		Z	5.41	69.71	19.32		150.0		

Note: For details on UID parameters see Appendix

The reported uncertainty of measurement is stated as the standard uncertainty of measurement multiplied by the coverage factor k=2, which for a normal distribution corresponds to a coverage probability of approximately 95%.

<sup>B</sup> Numerical linearization parameter: uncertainty not required.

<sup>E</sup> Uncertainty is determined using the max. deviation from linear response applying rectangular distribution and is expressed for the square of the field value.



EF3DV3 – SN:4062

December 17, 2021

**DASY/EASY - Parameters of Probe: EF3DV3 - SN:4062****Sensor Frequency Model Parameters**

	Sensor X	Sensor Y	Sensor Z
Frequency Corr. (LF)	-0.01	-0.01	4.99
Frequency Corr. (HF)	2.82	2.82	2.82

**Sensor Model Parameters**

	C1 fF	C2 fF	$\alpha$ $V^{-1}$	T1 $ms.V^{-2}$	T2 $ms.V^{-1}$	T3 ms	T4 $V^{-2}$	T5 $V^{-1}$	T6
X	32.3	213.66	37.12	6.24	0.02	5.00	0.62	0.03	1.01
Y	34.8	237.23	39.53	4.38	0.05	5.10	0.00	0.00	1.01
Z	35.8	252.40	43.13	3.34	0.36	5.10	0.00	0.00	1.00

**Other Probe Parameters**

Sensor Arrangement	Rectangular
Connector Angle (°)	-118
Mechanical Surface Detection Mode	enabled
Optical Surface Detection Mode	disabled
Probe Overall Length	337 mm
Probe Body Diameter	12 mm
Tip Length	25 mm
Tip Diameter	4 mm
Probe Tip to Sensor X Calibration Point	1.5 mm
Probe Tip to Sensor Y Calibration Point	1.5 mm
Probe Tip to Sensor Z Calibration Point	1.5 mm



EF3DV3 – SN:4062

December 17, 2021

### Receiving Pattern ( $\phi$ ), $\vartheta = 0^\circ$

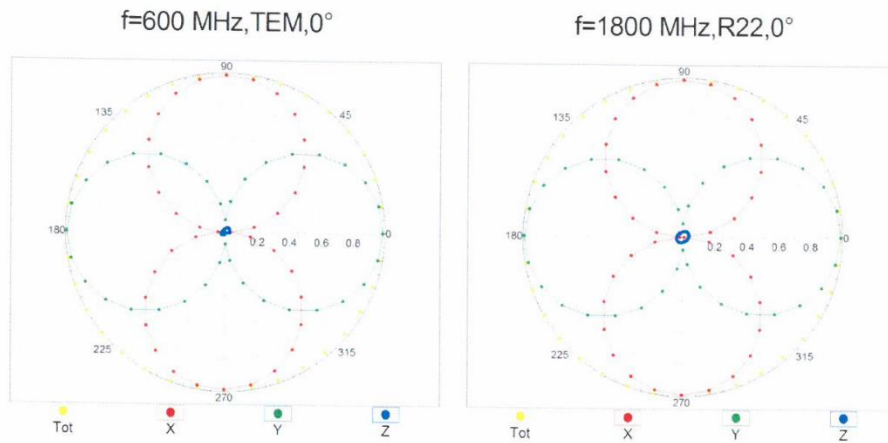

### Receiving Pattern ( $\phi$ ), $\vartheta = 90^\circ$

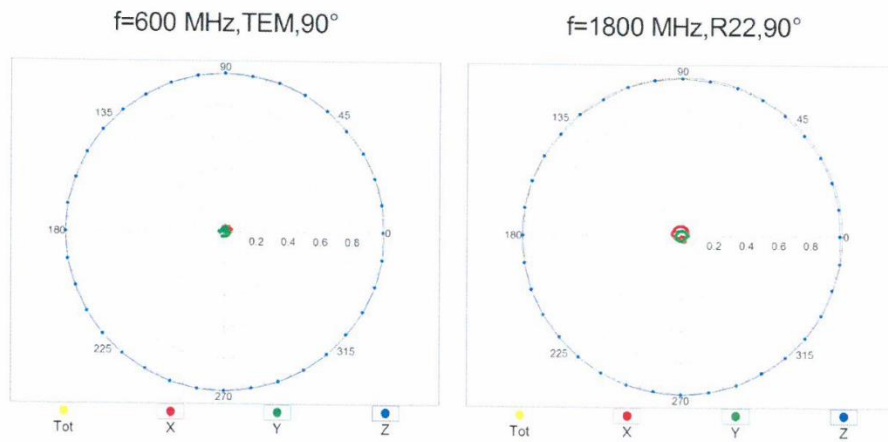

EF3DV3 – SN:4062

December 17, 2021

### Receiving Pattern ( $\phi$ ), $\vartheta = 0^\circ$

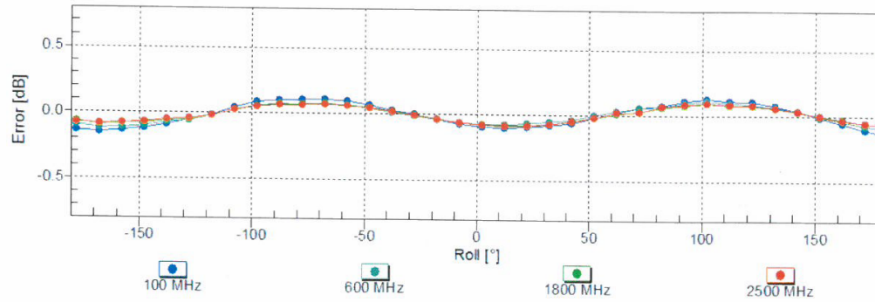

Uncertainty of Axial Isotropy Assessment:  $\pm 0.5\%$  (k=2)

### Receiving Pattern ( $\phi$ ), $\vartheta = 90^\circ$

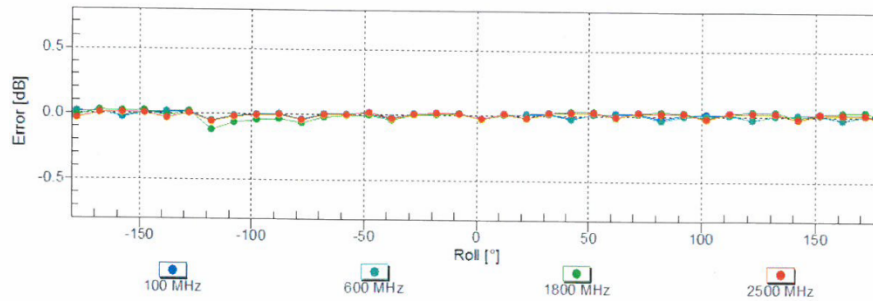

Uncertainty of Axial Isotropy Assessment:  $\pm 0.5\%$  (k=2)

EF3DV3 – SN:4062

December 17, 2021

### Dynamic Range f(E-field) (TEM cell, f = 900 MHz)

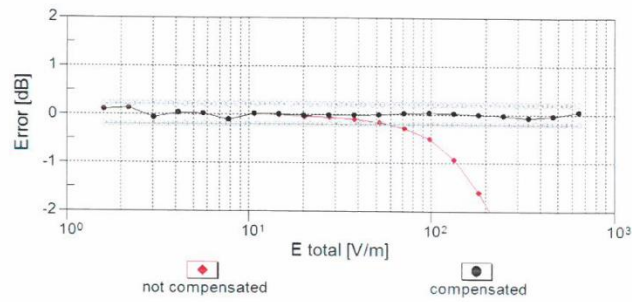
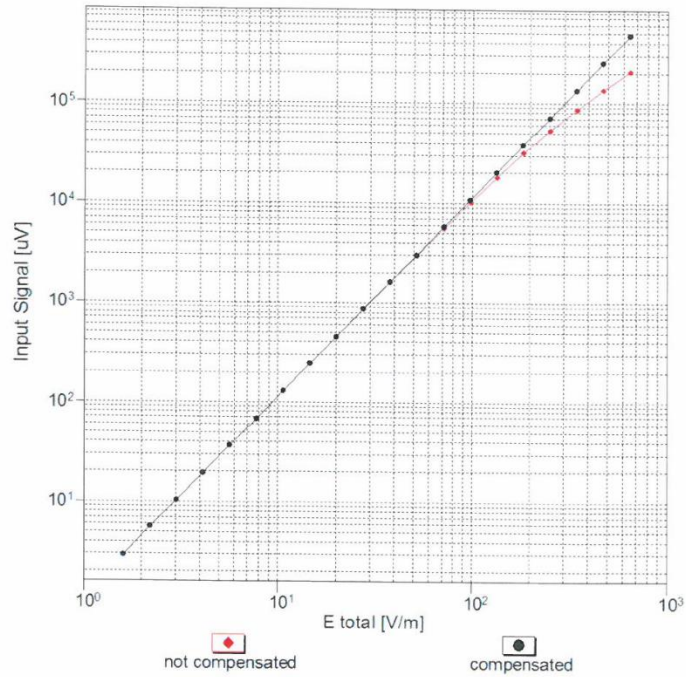

Uncertainty of Linearity Assessment:  $\pm 0.6\%$  (k=2)

EF3DV3 – SN:4062

December 17, 2021

### Deviation from Isotropy in Air Error ( $\phi$ , $\theta$ ), $f = 900$ MHz

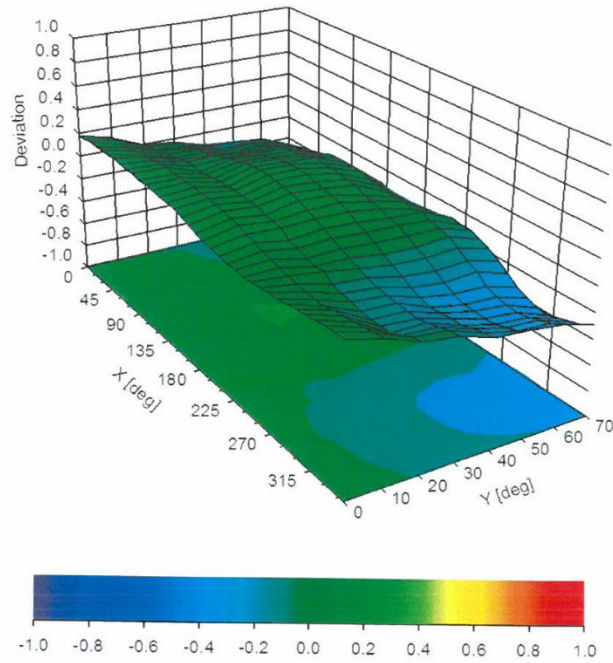

Uncertainty of Spherical Isotropy Assessment:  $\pm 2.6\%$  ( $k=2$ )

EF3DV3 – SN:4062

December 17, 2021

**Appendix: Modulation Calibration Parameters**

UID	Rev	Communication System Name	Group	PAR (dB)	Unc <sup>E</sup> (k=2)
0	-	CW	CW	0.00	± 4.7 %
10010	CAA	SAR Validation (Square, 100ms, 10ms)	Test	10.00	± 9.6 %
10011	CAB	UMTS-FDD (WCDMA)	WCDMA	2.91	± 9.6 %
10012	CAB	IEEE 802.11b WiFi 2.4 GHz (DSSS, 1 Mbps)	WLAN	1.87	± 9.6 %
10013	CAB	IEEE 802.11g WiFi 2.4 GHz (DSSS-OFDM, 6 Mbps)	WLAN	9.46	± 9.6 %
10021	DAC	GSM-FDD (TDMA, GMSK)	GSM	9.39	± 9.6 %
10023	DAC	GPRS-FDD (TDMA, GMSK, TN 0)	GSM	9.57	± 9.6 %
10024	DAC	GPRS-FDD (TDMA, GMSK, TN 0-1)	GSM	6.56	± 9.6 %
10025	DAC	EDGE-FDD (TDMA, 8PSK, TN 0)	GSM	12.62	± 9.6 %
10026	DAC	EDGE-FDD (TDMA, 8PSK, TN 0-1)	GSM	9.55	± 9.6 %
10027	DAC	GPRS-FDD (TDMA, GMSK, TN 0-1-2)	GSM	4.80	± 9.6 %
10028	DAC	GPRS-FDD (TDMA, GMSK, TN 0-1-2-3)	GSM	3.55	± 9.6 %
10029	DAC	EDGE-FDD (TDMA, 8PSK, TN 0-1-2)	GSM	7.78	± 9.6 %
10030	CAA	IEEE 802.15.1 Bluetooth (GFSK, DH1)	Bluetooth	5.30	± 9.6 %
10031	CAA	IEEE 802.15.1 Bluetooth (GFSK, DH3)	Bluetooth	1.87	± 9.6 %
10032	CAA	IEEE 802.15.1 Bluetooth (GFSK, DH5)	Bluetooth	1.16	± 9.6 %
10033	CAA	IEEE 802.15.1 Bluetooth (PI/4-DQPSK, DH1)	Bluetooth	7.74	± 9.6 %
10034	CAA	IEEE 802.15.1 Bluetooth (PI/4-DQPSK, DH3)	Bluetooth	4.53	± 9.6 %
10035	CAA	IEEE 802.15.1 Bluetooth (PI/4-DQPSK, DH5)	Bluetooth	3.83	± 9.6 %
10036	CAA	IEEE 802.15.1 Bluetooth (8-DPSK, DH1)	Bluetooth	8.01	± 9.6 %
10037	CAA	IEEE 802.15.1 Bluetooth (8-DPSK, DH3)	Bluetooth	4.77	± 9.6 %
10038	CAA	IEEE 802.15.1 Bluetooth (8-DPSK, DH5)	Bluetooth	4.10	± 9.6 %
10039	CAB	CDMA2000 (1xRTT, RC1)	CDMA2000	4.57	± 9.6 %
10042	CAB	IS-54 / IS-136 FDD (TDMA/FDM, PI/4-DQPSK, Halfrate)	AMPS	7.78	± 9.6 %
10044	CAA	IS-91/EIA/TIA-553 FDD (FDMA, FM)	AMPS	0.00	± 9.6 %
10048	CAA	DECT (TDD, TDMA/FDM, GFSK, Full Slot, 24)	DECT	13.80	± 9.6 %
10049	CAA	DECT (TDD, TDMA/FDM, GFSK, Double Slot, 12)	DECT	10.79	± 9.6 %
10056	CAA	UMTS-TDD (TD-SCDMA, 1.28 Mcps)	TD-SCDMA	11.01	± 9.6 %
10058	DAC	EDGE-FDD (TDMA, 8PSK, TN 0-1-2-3)	GSM	6.52	± 9.6 %
10059	CAB	IEEE 802.11b WiFi 2.4 GHz (DSSS, 2 Mbps)	WLAN	2.12	± 9.6 %
10060	CAB	IEEE 802.11b WiFi 2.4 GHz (DSSS, 5.5 Mbps)	WLAN	2.83	± 9.6 %
10061	CAB	IEEE 802.11b WiFi 2.4 GHz (DSSS, 11 Mbps)	WLAN	3.60	± 9.6 %
10062	CAD	IEEE 802.11a/h WiFi 5 GHz (OFDM, 6 Mbps)	WLAN	8.68	± 9.6 %
10063	CAD	IEEE 802.11a/h WiFi 5 GHz (OFDM, 9 Mbps)	WLAN	8.63	± 9.6 %
10064	CAD	IEEE 802.11a/h WiFi 5 GHz (OFDM, 12 Mbps)	WLAN	9.09	± 9.6 %
10065	CAD	IEEE 802.11a/h WiFi 5 GHz (OFDM, 18 Mbps)	WLAN	9.00	± 9.6 %
10066	CAD	IEEE 802.11a/h WiFi 5 GHz (OFDM, 24 Mbps)	WLAN	9.38	± 9.6 %
10067	CAD	IEEE 802.11a/h WiFi 5 GHz (OFDM, 36 Mbps)	WLAN	10.12	± 9.6 %
10068	CAD	IEEE 802.11a/h WiFi 5 GHz (OFDM, 48 Mbps)	WLAN	10.24	± 9.6 %
10069	CAD	IEEE 802.11a/h WiFi 5 GHz (OFDM, 54 Mbps)	WLAN	10.56	± 9.6 %
10071	CAB	IEEE 802.11g WiFi 2.4 GHz (DSSS/OFDM, 9 Mbps)	WLAN	9.83	± 9.6 %
10072	CAB	IEEE 802.11g WiFi 2.4 GHz (DSSS/OFDM, 12 Mbps)	WLAN	9.62	± 9.6 %
10073	CAB	IEEE 802.11g WiFi 2.4 GHz (DSSS/OFDM, 18 Mbps)	WLAN	9.94	± 9.6 %
10074	CAB	IEEE 802.11g WiFi 2.4 GHz (DSSS/OFDM, 24 Mbps)	WLAN	10.30	± 9.6 %
10075	CAB	IEEE 802.11g WiFi 2.4 GHz (DSSS/OFDM, 36 Mbps)	WLAN	10.77	± 9.6 %
10076	CAB	IEEE 802.11g WiFi 2.4 GHz (DSSS/OFDM, 48 Mbps)	WLAN	10.94	± 9.6 %
10077	CAB	IEEE 802.11g WiFi 2.4 GHz (DSSS/OFDM, 54 Mbps)	WLAN	11.00	± 9.6 %
10081	CAB	CDMA2000 (1xRTT, RC3)	CDMA2000	3.97	± 9.6 %
10082	CAB	IS-54 / IS-136 FDD (TDMA/FDM, PI/4-DQPSK, Fullrate)	AMPS	4.77	± 9.6 %
10090	DAC	GPRS-FDD (TDMA, GMSK, TN 0-4)	GSM	6.56	± 9.6 %
10097	CAB	UMTS-FDD (HSDPA)	WCDMA	3.98	± 9.6 %
10098	CAB	UMTS-FDD (HSUPA, Subtest 2)	WCDMA	3.98	± 9.6 %
10099	DAC	EDGE-FDD (TDMA, 8PSK, TN 0-4)	GSM	9.55	± 9.6 %





EF3DV3 – SN:4062

December 17, 2021

10100	CAE	LTE-FDD (SC-FDMA, 100% RB, 20 MHz, QPSK)	LTE-FDD	5.67	± 9.6 %
10101	CAE	LTE-FDD (SC-FDMA, 100% RB, 20 MHz, 16-QAM)	LTE-FDD	6.42	± 9.6 %
10102	CAE	LTE-FDD (SC-FDMA, 100% RB, 20 MHz, 64-QAM)	LTE-FDD	6.60	± 9.6 %
10103	CAG	LTE-TDD (SC-FDMA, 100% RB, 20 MHz, QPSK)	LTE-TDD	9.29	± 9.6 %
10104	CAG	LTE-TDD (SC-FDMA, 100% RB, 20 MHz, 16-QAM)	LTE-TDD	9.97	± 9.6 %
10105	CAG	LTE-TDD (SC-FDMA, 100% RB, 20 MHz, 64-QAM)	LTE-TDD	10.01	± 9.6 %
10108	CAG	LTE-FDD (SC-FDMA, 100% RB, 10 MHz, QPSK)	LTE-FDD	5.80	± 9.6 %
10109	CAG	LTE-FDD (SC-FDMA, 100% RB, 10 MHz, 16-QAM)	LTE-FDD	6.43	± 9.6 %
10110	CAG	LTE-FDD (SC-FDMA, 100% RB, 5 MHz, QPSK)	LTE-FDD	5.75	± 9.6 %
10111	CAG	LTE-FDD (SC-FDMA, 100% RB, 5 MHz, 16-QAM)	LTE-FDD	6.44	± 9.6 %
10112	CAG	LTE-FDD (SC-FDMA, 100% RB, 10 MHz, 64-QAM)	LTE-FDD	6.59	± 9.6 %
10113	CAG	LTE-FDD (SC-FDMA, 100% RB, 5 MHz, 64-QAM)	LTE-FDD	6.62	± 9.6 %
10114	CAD	IEEE 802.11n (HT Greenfield, 13.5 Mbps, BPSK)	WLAN	8.10	± 9.6 %
10115	CAD	IEEE 802.11n (HT Greenfield, 81 Mbps, 16-QAM)	WLAN	8.46	± 9.6 %
10116	CAD	IEEE 802.11n (HT Greenfield, 135 Mbps, 64-QAM)	WLAN	8.15	± 9.6 %
10117	CAD	IEEE 802.11n (HT Mixed, 13.5 Mbps, BPSK)	WLAN	8.07	± 9.6 %
10118	CAD	IEEE 802.11n (HT Mixed, 81 Mbps, 16-QAM)	WLAN	8.59	± 9.6 %
10119	CAD	IEEE 802.11n (HT Mixed, 135 Mbps, 64-QAM)	WLAN	8.13	± 9.6 %
10140	CAE	LTE-FDD (SC-FDMA, 100% RB, 15 MHz, 16-QAM)	LTE-FDD	6.49	± 9.6 %
10141	CAE	LTE-FDD (SC-FDMA, 100% RB, 15 MHz, 64-QAM)	LTE-FDD	6.53	± 9.6 %
10142	CAE	LTE-FDD (SC-FDMA, 100% RB, 3 MHz, QPSK)	LTE-FDD	5.73	± 9.6 %
10143	CAE	LTE-FDD (SC-FDMA, 100% RB, 3 MHz, 16-QAM)	LTE-FDD	6.35	± 9.6 %
10144	CAE	LTE-FDD (SC-FDMA, 100% RB, 3 MHz, 64-QAM)	LTE-FDD	6.65	± 9.6 %
10145	CAF	LTE-FDD (SC-FDMA, 100% RB, 1.4 MHz, QPSK)	LTE-FDD	5.76	± 9.6 %
10146	CAF	LTE-FDD (SC-FDMA, 100% RB, 1.4 MHz, 16-QAM)	LTE-FDD	6.41	± 9.6 %
10147	CAF	LTE-FDD (SC-FDMA, 100% RB, 1.4 MHz, 64-QAM)	LTE-FDD	6.72	± 9.6 %
10149	CAE	LTE-FDD (SC-FDMA, 50% RB, 20 MHz, 16-QAM)	LTE-FDD	6.42	± 9.6 %
10150	CAE	LTE-FDD (SC-FDMA, 50% RB, 20 MHz, 64-QAM)	LTE-FDD	6.60	± 9.6 %
10151	CAG	LTE-TDD (SC-FDMA, 50% RB, 20 MHz, QPSK)	LTE-TDD	9.28	± 9.6 %
10152	CAG	LTE-TDD (SC-FDMA, 50% RB, 20 MHz, 16-QAM)	LTE-TDD	9.92	± 9.6 %
10153	CAG	LTE-TDD (SC-FDMA, 50% RB, 20 MHz, 64-QAM)	LTE-TDD	10.05	± 9.6 %
10154	CAG	LTE-FDD (SC-FDMA, 50% RB, 10 MHz, QPSK)	LTE-FDD	5.75	± 9.6 %
10155	CAG	LTE-FDD (SC-FDMA, 50% RB, 10 MHz, 16-QAM)	LTE-FDD	6.43	± 9.6 %
10156	CAG	LTE-FDD (SC-FDMA, 50% RB, 5 MHz, QPSK)	LTE-FDD	5.79	± 9.6 %
10157	CAG	LTE-FDD (SC-FDMA, 50% RB, 5 MHz, 16-QAM)	LTE-FDD	6.49	± 9.6 %
10158	CAG	LTE-FDD (SC-FDMA, 50% RB, 10 MHz, 64-QAM)	LTE-FDD	6.62	± 9.6 %
10159	CAG	LTE-FDD (SC-FDMA, 50% RB, 5 MHz, 64-QAM)	LTE-FDD	6.56	± 9.6 %
10160	CAE	LTE-FDD (SC-FDMA, 50% RB, 15 MHz, QPSK)	LTE-FDD	5.82	± 9.6 %
10161	CAE	LTE-FDD (SC-FDMA, 50% RB, 15 MHz, 16-QAM)	LTE-FDD	6.43	± 9.6 %
10162	CAE	LTE-FDD (SC-FDMA, 50% RB, 15 MHz, 64-QAM)	LTE-FDD	6.58	± 9.6 %
10166	CAF	LTE-FDD (SC-FDMA, 50% RB, 1.4 MHz, QPSK)	LTE-FDD	5.46	± 9.6 %
10167	CAF	LTE-FDD (SC-FDMA, 50% RB, 1.4 MHz, 16-QAM)	LTE-FDD	6.21	± 9.6 %
10168	CAF	LTE-FDD (SC-FDMA, 50% RB, 1.4 MHz, 64-QAM)	LTE-FDD	6.79	± 9.6 %
10169	CAE	LTE-FDD (SC-FDMA, 1 RB, 20 MHz, QPSK)	LTE-FDD	5.73	± 9.6 %
10170	CAE	LTE-FDD (SC-FDMA, 1 RB, 20 MHz, 16-QAM)	LTE-FDD	6.52	± 9.6 %
10171	AAE	LTE-FDD (SC-FDMA, 1 RB, 20 MHz, 64-QAM)	LTE-FDD	6.49	± 9.6 %
10172	CAG	LTE-TDD (SC-FDMA, 1 RB, 20 MHz, QPSK)	LTE-TDD	9.21	± 9.6 %
10173	CAG	LTE-TDD (SC-FDMA, 1 RB, 20 MHz, 16-QAM)	LTE-TDD	9.48	± 9.6 %
10174	CAG	LTE-TDD (SC-FDMA, 1 RB, 20 MHz, 64-QAM)	LTE-TDD	10.25	± 9.6 %
10175	CAG	LTE-FDD (SC-FDMA, 1 RB, 10 MHz, QPSK)	LTE-FDD	5.72	± 9.6 %
10176	CAG	LTE-FDD (SC-FDMA, 1 RB, 10 MHz, 16-QAM)	LTE-FDD	6.52	± 9.6 %
10177	CAI	LTE-FDD (SC-FDMA, 1 RB, 5 MHz, QPSK)	LTE-FDD	5.73	± 9.6 %
10178	CAG	LTE-FDD (SC-FDMA, 1 RB, 5 MHz, 16-QAM)	LTE-FDD	6.52	± 9.6 %
10179	CAG	LTE-FDD (SC-FDMA, 1 RB, 10 MHz, 64-QAM)	LTE-FDD	6.50	± 9.6 %
10180	CAG	LTE-FDD (SC-FDMA, 1 RB, 5 MHz, 64-QAM)	LTE-FDD	6.50	± 9.6 %
10181	CAE	LTE-FDD (SC-FDMA, 1 RB, 15 MHz, QPSK)	LTE-FDD	5.73	± 9.6 %

Certificate No: EF3-4062\_Dec21

Page 11 of 22



EF3DV3 – SN:4062

December 17, 2021

10182	CAE	LTE-FDD (SC-FDMA, 1 RB, 15 MHz, 16-QAM)	LTE-FDD	6.52	± 9.6 %
10183	AAD	LTE-FDD (SC-FDMA, 1 RB, 15 MHz, 64-QAM)	LTE-FDD	6.50	± 9.6 %
10184	CAE	LTE-FDD (SC-FDMA, 1 RB, 3 MHz, QPSK)	LTE-FDD	5.73	± 9.6 %
10185	CAE	LTE-FDD (SC-FDMA, 1 RB, 3 MHz, 16-QAM)	LTE-FDD	6.51	± 9.6 %
10186	AAE	LTE-FDD (SC-FDMA, 1 RB, 3 MHz, 64-QAM)	LTE-FDD	6.50	± 9.6 %
10187	CAF	LTE-FDD (SC-FDMA, 1 RB, 1.4 MHz, QPSK)	LTE-FDD	5.73	± 9.6 %
10188	CAF	LTE-FDD (SC-FDMA, 1 RB, 1.4 MHz, 16-QAM)	LTE-FDD	6.52	± 9.6 %
10189	AAF	LTE-FDD (SC-FDMA, 1 RB, 1.4 MHz, 64-QAM)	LTE-FDD	6.50	± 9.6 %
10193	CAD	IEEE 802.11n (HT Greenfield, 6.5 Mbps, BPSK)	WLAN	8.09	± 9.6 %
10194	CAD	IEEE 802.11n (HT Greenfield, 39 Mbps, 16-QAM)	WLAN	8.12	± 9.6 %
10195	CAD	IEEE 802.11n (HT Greenfield, 65 Mbps, 64-QAM)	WLAN	8.21	± 9.6 %
10196	CAD	IEEE 802.11n (HT Mixed, 6.5 Mbps, BPSK)	WLAN	8.10	± 9.6 %
10197	CAD	IEEE 802.11n (HT Mixed, 39 Mbps, 16-QAM)	WLAN	8.13	± 9.6 %
10198	CAD	IEEE 802.11n (HT Mixed, 65 Mbps, 64-QAM)	WLAN	8.27	± 9.6 %
10219	CAD	IEEE 802.11n (HT Mixed, 7.2 Mbps, BPSK)	WLAN	8.03	± 9.6 %
10220	CAD	IEEE 802.11n (HT Mixed, 43.3 Mbps, 16-QAM)	WLAN	8.13	± 9.6 %
10221	CAD	IEEE 802.11n (HT Mixed, 72.2 Mbps, 64-QAM)	WLAN	8.27	± 9.6 %
10222	CAD	IEEE 802.11n (HT Mixed, 15 Mbps, BPSK)	WLAN	8.06	± 9.6 %
10223	CAD	IEEE 802.11n (HT Mixed, 90 Mbps, 16-QAM)	WLAN	8.48	± 9.6 %
10224	CAD	IEEE 802.11n (HT Mixed, 150 Mbps, 64-QAM)	WLAN	8.08	± 9.6 %
10225	CAB	UMTS-FDD (HSPA+)	WCDMA	5.97	± 9.6 %
10226	CAB	LTE-TDD (SC-FDMA, 1 RB, 1.4 MHz, 16-QAM)	LTE-TDD	9.49	± 9.6 %
10227	CAB	LTE-TDD (SC-FDMA, 1 RB, 1.4 MHz, 64-QAM)	LTE-TDD	10.26	± 9.6 %
10228	CAB	LTE-TDD (SC-FDMA, 1 RB, 1.4 MHz, QPSK)	LTE-TDD	9.22	± 9.6 %
10229	CAD	LTE-TDD (SC-FDMA, 1 RB, 3 MHz, 16-QAM)	LTE-TDD	9.48	± 9.6 %
10230	CAD	LTE-TDD (SC-FDMA, 1 RB, 3 MHz, 64-QAM)	LTE-TDD	10.25	± 9.6 %
10231	CAD	LTE-TDD (SC-FDMA, 1 RB, 3 MHz, QPSK)	LTE-TDD	9.19	± 9.6 %
10232	CAG	LTE-TDD (SC-FDMA, 1 RB, 5 MHz, 16-QAM)	LTE-TDD	9.48	± 9.6 %
10233	CAG	LTE-TDD (SC-FDMA, 1 RB, 5 MHz, 64-QAM)	LTE-TDD	10.25	± 9.6 %
10234	CAG	LTE-TDD (SC-FDMA, 1 RB, 5 MHz, QPSK)	LTE-TDD	9.21	± 9.6 %
10235	CAG	LTE-TDD (SC-FDMA, 1 RB, 10 MHz, 16-QAM)	LTE-TDD	9.48	± 9.6 %
10236	CAG	LTE-TDD (SC-FDMA, 1 RB, 10 MHz, 64-QAM)	LTE-TDD	10.25	± 9.6 %
10237	CAG	LTE-TDD (SC-FDMA, 1 RB, 10 MHz, QPSK)	LTE-TDD	9.21	± 9.6 %
10238	CAF	LTE-TDD (SC-FDMA, 1 RB, 15 MHz, 16-QAM)	LTE-TDD	9.48	± 9.6 %
10239	CAF	LTE-TDD (SC-FDMA, 1 RB, 15 MHz, 64-QAM)	LTE-TDD	10.25	± 9.6 %
10240	CAF	LTE-TDD (SC-FDMA, 1 RB, 15 MHz, QPSK)	LTE-TDD	9.21	± 9.6 %
10241	CAB	LTE-TDD (SC-FDMA, 50% RB, 1.4 MHz, 16-QAM)	LTE-TDD	9.82	± 9.6 %
10242	CAB	LTE-TDD (SC-FDMA, 50% RB, 1.4 MHz, 64-QAM)	LTE-TDD	9.86	± 9.6 %
10243	CAB	LTE-TDD (SC-FDMA, 50% RB, 1.4 MHz, QPSK)	LTE-TDD	9.46	± 9.6 %
10244	CAD	LTE-TDD (SC-FDMA, 50% RB, 3 MHz, 16-QAM)	LTE-TDD	10.06	± 9.6 %
10245	CAD	LTE-TDD (SC-FDMA, 50% RB, 3 MHz, 64-QAM)	LTE-TDD	10.06	± 9.6 %
10246	CAD	LTE-TDD (SC-FDMA, 50% RB, 3 MHz, QPSK)	LTE-TDD	9.30	± 9.6 %
10247	CAG	LTE-TDD (SC-FDMA, 50% RB, 5 MHz, 16-QAM)	LTE-TDD	9.91	± 9.6 %
10248	CAG	LTE-TDD (SC-FDMA, 50% RB, 5 MHz, 64-QAM)	LTE-TDD	10.09	± 9.6 %
10249	CAG	LTE-TDD (SC-FDMA, 50% RB, 5 MHz, QPSK)	LTE-TDD	9.29	± 9.6 %
10250	CAG	LTE-TDD (SC-FDMA, 50% RB, 10 MHz, 16-QAM)	LTE-TDD	9.81	± 9.6 %
10251	CAG	LTE-TDD (SC-FDMA, 50% RB, 10 MHz, 64-QAM)	LTE-TDD	10.17	± 9.6 %
10252	CAG	LTE-TDD (SC-FDMA, 50% RB, 10 MHz, QPSK)	LTE-TDD	9.24	± 9.6 %
10253	CAF	LTE-TDD (SC-FDMA, 50% RB, 15 MHz, 16-QAM)	LTE-TDD	9.90	± 9.6 %
10254	CAF	LTE-TDD (SC-FDMA, 50% RB, 15 MHz, 64-QAM)	LTE-TDD	10.14	± 9.6 %
10255	CAF	LTE-TDD (SC-FDMA, 50% RB, 15 MHz, QPSK)	LTE-TDD	9.20	± 9.6 %
10256	CAB	LTE-TDD (SC-FDMA, 100% RB, 1.4 MHz, 16-QAM)	LTE-TDD	9.96	± 9.6 %
10257	CAB	LTE-TDD (SC-FDMA, 100% RB, 1.4 MHz, 64-QAM)	LTE-TDD	10.08	± 9.6 %
10258	CAB	LTE-TDD (SC-FDMA, 100% RB, 1.4 MHz, QPSK)	LTE-TDD	9.34	± 9.6 %
10259	CAD	LTE-TDD (SC-FDMA, 100% RB, 3 MHz, 16-QAM)	LTE-TDD	9.98	± 9.6 %
10260	CAD	LTE-TDD (SC-FDMA, 100% RB, 3 MHz, 64-QAM)	LTE-TDD	9.97	± 9.6 %

Certificate No: EF3-4062\_Dec21

Page 12 of 22