



TEST REPORT

REPORT NUMBER: B22W00684-SAR

ON

Type of Equipment: GSM/UMTS/LTE Mobile Phone

Type of Designation: mobile phone(touchscreen)

Manufacturer: TCL Communication Ltd.

FCC ID: 2ACCJH166

ACCORDING TO
ANSI C95.1-1992
IEEE 1528-2013

Chongqing Academy of Information and Communication Technology

Month date, year

Jun 9, 2022

Signature



Xiang Luoyong

Director

Note:

The test results in this test report relate only to the devices specified in this report. This report shall not be reproduced except in full without the written approval of Chongqing Academy of Information and Communications Technology.



Report No.:B22W00684-SAR

Revision Version

Report Number	Revision	Date	Memo
B22W00684-SAR	00	2022-06-09	Initial creation of test report

Chongqing Academy of Information and Communication Technology

Address: No. 8,Yuma Road, Chayuan New City, Nan'an District, Chongqing, P. R. China,401336
Tel: 0086-23-88069965 FAX:0086-23-88608777

CONTENTS

1. TEST LABORATORY	5
1.1. TESTING LOCATION	5
1.2. TESTING ENVIRONMENT	5
1.3. PROJECT DATA	5
1.4. SIGNATURE	5
2. STATEMENT OF COMPLIANCE	6
3. CLIENT INFORMATION	8
3.1. APPLICANT INFORMATION	8
3.2. MANUFACTURER INFORMATION	8
4. EQUIPMENT UNDER TEST (EUT) AND ANCILLARY EQUIPMENT (AE)	9
4.1. ABOUT EUT	9
4.2. INTERNAL IDENTIFICATION OF EUT USED DURING THE TEST	10
4.3. INTERNAL IDENTIFICATION OF AE USED DURING THE TEST	10
5. REFERENCE DOCUMENTS	11
5.1. APPLICABLE LIMIT REGULATIONS	11
5.2. APPLICABLE MEASUREMENT STANDARDS	11
6. SPECIFIC ABSORPTION RATE (SAR)	12
6.1. INTRODUCTION	12
6.2. SAR DEFINITION	12
7. SAR MEASUREMENT SETUP	13
7.1. MEASUREMENT SET-UP	13
7.2. DASY5 E-FIELD PROBE SYSTEM	14
7.3. E-FIELD PROBE CALIBRATION	15
7.4. OTHER TEST EQUIPMENT	15
8. POSITION OF THE WIRELESS DEVICE IN RELATION TO THE PHANTOM	19

Chongqing Academy of Information and Communication Technology

Address: No. 8,Yuma Road, Chayuan New City, Nan'an District, Chongqing, P. R. China,401336
Tel: 0086-23-88069965 FAX:0086-23-88608777

8.1. GENERIC DEVICE	19
8.2. DUT SETUP PHOTOS.....	20
9. TISSUE SIMULATING LIQUIDS.....	21
9.1. EQUIVALENT TISSUES.....	21
9.2. DIELECTRIC PERFORMANCE.....	22
10. SYSTEM VALIDATION	25
10.1. SYSTEM VALIDATION.....	25
10.2. SYSTEM SETUP	25
11. MEASUREMENT PROCEDURES	27
11.1. TESTS TO BE PERFORMED.....	27
11.2. MEASUREMENT PROCEDURE	29
11.3. WCDMA MEASUREMENT PROCEDURES FOR SAR.....	30
11.4. SAR MEASUREMENT FOR LTE.....	31
11.5. LUE TOOTH & WI-FI MEASUREMENT PROCEDURES FOR SAR.....	33
11.6. POWER DRIFT.....	33
12. AREA SCAN BASED 1-G SAR.....	34
12.1. REQUIREMENT OF KDB.....	34
12.2. FAST SAR ALGORITHMS.....	34
13. CONDUCTED OUTPUT POWER	35
13.1. MANUFACTURING TOLERANCE	35
13.2. GSM MEASUREMENT RESULT.....	36
13.3. WCDMA RESULT.....	39
13.4. LTE MEASUREMENT RESULT	43
13.5. WIFI AND BT MEASUREMENT RESULT	69
14. SIMULTANEOUS TX SAR CONSIDERATIONS	70
14.1. SIMULTANEOUS TRANSMISSION SAR.....	70



15. SAR TEST RESULT.....	71
15.1. SAR RESULTS.....	71
15.2. SAR MEASUREMENT VARIABILITY	84
16. MEASUREMENT UNCERTAINTY	85
17. MAIN TEST INSTRUMENTS	89
ANNEX A. GRAPH RESULTS	90
ANNEX B. SYSTEM VALIDATION RESULTS	124
ANNEX C. CALIBRATION REPORT.....	133
ANNEX D. EXTENDED CALIBRATION SAR DIPOLE	191
ANNEX E. ACCREDITATION CERTIFICATE	197

1. Test Laboratory

1.1. Testing Location

Company Name:	Chongqing Academy of Information and Communications Technology
Address:	No. 8, Yuma Road, Chayuan New City, Nan'an District, Chongqing, P. R. China
Postal Code:	401336
Telephone:	0086-23-88069965
Fax:	0086-23-88608777

1.2. Testing Environment

Normal Temperature:	18-25°C
Relative Humidity:	30-70%
Ambient noise & Reflection:	< 0.012 W/kg

1.3. Project Data

Testing Start Date:	2022-05-19
Testing End Date:	2022-06-09

1.4. Signature



2022-06-09

Fu Bohao
(Prepared this test report)

Date



2022-06-09

Wang Lili
(Reviewed this test report)

Date



2022-06-09

Xiang Luoyong
Director of the laboratory
(Approved this test report)

Date

Chongqing Academy of Information and Communication Technology

Address: No. 8, Yuma Road, Chayuan New City, Nan'an District, Chongqing, P. R. China, 401336
Tel: 0086-23-88069965 FAX: 0086-23-88608777

2. Statement of Compliance

The maximum results of Specific Absorption Rate (SAR) found during testing for TCL Communication Ltd. GSM/UMTS/LTE mobile phone T501C are as follows:

Table 2.1: Highest Reported SAR (1g)

Technology Band	Head	Hotspot	Body worn
GSM850	0.22	0.67	0.67
GSM1900	0.15	0.43	0.25
WCDMA Band2	0.55	0.59	0.48
WCDMA Band4	0.41	0.65	0.53
WCDMA Band5	0.81	0.78	0.78
LTE Band2	0.43	0.78	0.42
LTE Band5	0.79	0.78	0.78
LTE Band12	0.48	0.55	0.55
LTE Band14	0.71	0.78	0.78
LTE Band30	0.05	1.37	0.76
LTE Band66	0.33	0.55	0.35
WLAN 2.4GHz	0.30	0.14	0.06
BT 2.4GHz	0.06	0.02	0.01

The SAR values found for the Mobile Phone are below the maximum recommended levels of 1.6 W/kg as averaged over any 1g tissue according to the ANSI C95.1-1992.

For body operation, this device has been tested and meets FCC RF exposure guidelines when used with any accessory that contains no metal and which provides a minimum separation distance of 10/15 mm between this device and the body of the user. Use of other accessories may not ensure compliance with FCC RF exposure guidelines.

The EUT battery must be fully charged and checked periodically during the test to ascertain uniform power output.

The measurement together with the test system set-up is described in Chapter 7 of this test report.

A detailed description of the equipment under test can be found in chapter 4 of this test report.

The highest reported SAR value is obtained at the case of (Table 2.1), and the values are:

Head: 0.81 W/kg (1g)

Body: 1.37 W/kg (1g)

Remark:

This device supports both LTE Band4 and Band66. Since the supported frequency span for LTE Band4 falls completely within the supported frequency span for LTE Band66, both LTE bands have the same target power, and both LTE bands share the same transmission path; therefore, SAR was only assessed for LTE Band66.

Table 2.2: The sum of SAR values for Main antenna + WiFi-2.4G (1g)

Position		Main antenna (W/kg)	WiFi-2.4G (W/kg)	Sum (W/kg)
Highest SAR value for Head	Left head, Cheek (WCDMA850)	0.81	0.13	0.94
Highest SAR value for Body	Bottom 10mm (LTE B30)	1.37	/	1.37

Table 2.3: The sum of SAR values for main antenna and BT (1g)

Position		Main antenna (W/kg)	BT (W/kg)	Sum (W/kg)
Maximum reported SAR value for Head	Left head, Cheek (WCDMA850)	0.81	0.03	0.84
Maximum reported SAR value for Body	Bottom 10mm (LTE B30)	1.37	/	1.37

Conclusion:

According to the above tables, the sum of reported SAR values is <math><1.6\text{W/kg}</math>. So the simultaneous transmission SAR with volume scans is not required.

According to the above tables, the highest sum of reported SAR values is 1.37 W/kg (1g). The detail for simultaneous transmission consideration is described in chapter 14.

3. Client Information

3.1. Applicant Information

Company Name:	TCL Communication Ltd.
Address /Post:	5/F, Building 22E, 22 Science Park East Avenue, Hong Kong Science Park, Shatin, NT, Hong Kong
Telephone:	+86 755 3664 5759
Fax:	+86 755 3661 2000-81722
Email:	peter.yang@tcl.com
Contact Person:	Peter yang

3.2. Manufacturer Information

Company Name:	TCL Communication Ltd.
Address /Post:	5/F, Building 22E, 22 Science Park East Avenue, Hong Kong Science Park, Shatin, NT, Hong Kong
Telephone:	+86 755 3664 5759
Fax:	+86 755 3661 2000-81722
Email:	peter.yang@tcl.com
Contact Person:	Peter yang

4. Equipment Under Test (EUT) and Ancillary Equipment (AE)

4.1. About EUT

Description:	GSM/UMTS/LTE Mobile Phone
Model name:	T501C
Operating mode(s):	GSM850/900/1800/1900, WCDMA850/1700/1900 LTE Band 2/4/5/12/14/30/66 BT, Wi-Fi(2.4G)
Tested Tx Frequency:	824 – 849 MHz (GSM 850)
	1850 – 1910 MHz (GSM 1900)
	824 – 849 MHz (WCDMA 850 Band V)
	1712.4 – 1752.6 MHz (WCDMA1700 Band IV)
	1850 – 1910 MHz (WCDMA1900 Band II)
	1850 – 1909.9 MHz (LTE Band 2)
	824 – 848.9 MHz (LTE Band 5)
	699.7 – 715.3 MHz (LTE Band 12)
	788.0–797.9 MHz (LTE Band 14)
	2305.0 –2314.9 MHz (LTE Band 30)
	1710.7 –1779.3 MHz (LTE Band 66)
	2412 – 2462 MHz (Wi-Fi 2.4G)
2400 – 2483.5 MHz (Bluetooth)	
GPRS/EGPRS Multislot Class:	12
Test device Production information:	Production unit
Device type:	Portable device
Antenna type:	Embedded antenna
Hotspot mode:	Support

4.2. Internal Identification of EUT used during the test

EUT ID*	SN or IMEI	HW Version	SW Version	Date of receipt
EUT1	016249000002803	03	ER2D	2022-05-16
EUT2	016249000201207	03	ER2D	2022-05-16

*EUT ID: is used to identify the test sample in the lab internally.

4.3. Internal Identification of AE used during the test

AE ID*	Description	Model	SN	Manufacturer
AE1	Battery	TLi028C7	CAB2880012C7	VEKEN
AE2	Battery	TLi028C1	CAB2880006C1	BYD

*AE ID: is used to identify the test sample in the lab internally.

5. Reference Documents

5.1. Applicable Limit Regulations

ANSI C95.1–1992: IEEE Standard for Safety Levels with Respect to Human Exposure to Radio Frequency Electromagnetic Fields, 3 kHz to 300 GHz.

It specifies the maximum exposure limit of **1.6 W/kg** as averaged over any 1 gram of tissue for portable devices being used within 20 cm of the user in the uncontrolled environment.

5.2. Applicable Measurement Standards

IEEE 1528–2013: Recommended Practice for Determining the Peak Spatial-Average Specific Absorption Rate (SAR) in the Human Body Due to Wireless Communications Devices: Experimental Techniques.

KDB447498 D01: General RF Exposure Guidance v06: Mobile and Portable Devices RF Exposure Procedures and Equipment Authorization Policies.

KDB941225 D06 Hotspot Mode SAR v02r01: SAR Evaluation Procedures for Portable Devices with Wireless Router Capabilities.

KDB941225 D01 SAR test for 3G devices v03r01: SAR Measurement Procedures for 3G Devices

KDB941225 D05 SAR for LTE Devices v02r05: SAR Evaluation Considerations for LTE Devices

KDB248227 D01 802.11 Wi-Fi SAR v02r02: SAR Evaluation Procedures for IEEE 802.11 Wi-Fi Transmitters.

KDB865664 D01 SAR measurement 100 MHz to 6 GHz v01r04: SAR Measurement Requirements for 100 MHz to 6 GHz.

KDB865664 D02 RF Exposure Reporting v01r02: RF Exposure Compliance Reporting and Documentation Considerations.

6. Specific Absorption Rate (SAR)

6.1. Introduction

SAR is related to the rate at which energy is absorbed per unit mass in an object exposed to a radio field. The SAR distribution in a biological body is complicated and is usually carried out by experimental techniques or numerical modeling. The standard recommends limits for two tiers of groups, occupational/controlled and general population/uncontrolled, based on a person's awareness and ability to exercise control over his or her exposure. In general, occupational/controlled exposure limits are higher than the limits for general population/uncontrolled.

6.2. SAR Definition

The SAR definition is the time derivative (rate) of the incremental energy (dW) absorbed by (dissipated in) an incremental mass (dm) contained in a volume element (dv) of a given density (ρ). The equation description is as below:

$$SAR = \frac{d}{dt} \left(\frac{dW}{dm} \right) = \frac{d}{dt} \left(\frac{dW}{\rho dv} \right)$$

SAR is expressed in units of Watts per kilogram (W/kg)

SAR measurement can be either related to the temperature elevation in tissue by

$$SAR = c \left(\frac{\delta T}{\delta t} \right)$$

Where: C is the specific heat capacity, δT is the temperature rise and δt is the exposure duration, or related to the electrical field in the tissue by

$$SAR = \frac{\sigma |E|^2}{\rho}$$

Where: σ is the conductivity of the tissue, ρ is the mass density of tissue and E is the RMS electrical field strength.

However for evaluating SAR of low power transmitter, electrical field measurement is typically applied.

7. SAR MEASUREMENT SETUP

7.1. Measurement Set-up

The DASY5 system for performing compliance tests is illustrated above graphically. This system consists of the following items:

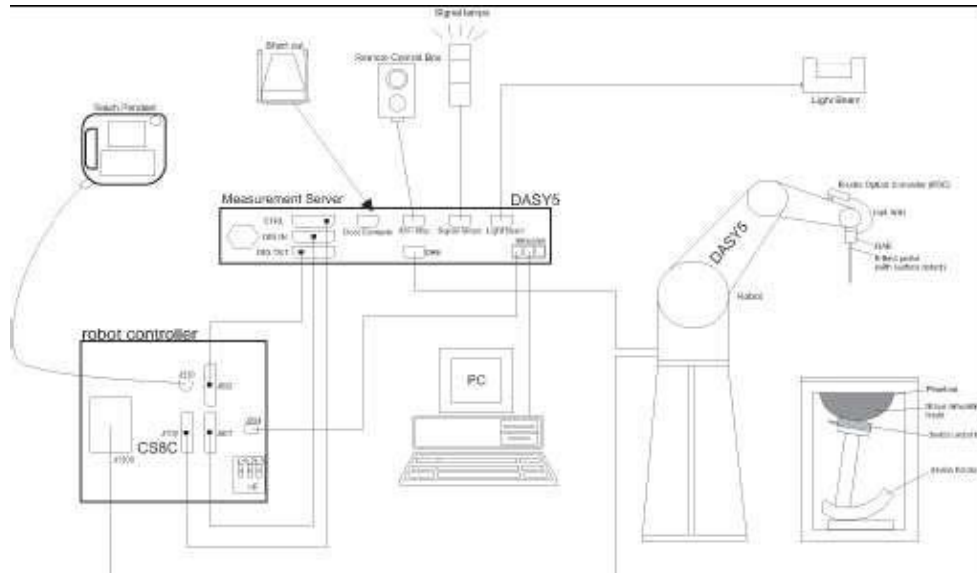

Picture 7-1 SAR Lab Test Measurement Set-up

- A standard high precision 6-axis robot (Stäubli TX=RX family) with controller, teach pendant and software. An arm extension for accommodating the data acquisition electronics (DAE).
- An isotropic field probe optimized and calibrated for the targeted measurement.
- A data acquisition electronics (DAE) which performs the signal amplification, signal multiplexing, AD-conversion, offset measurements, mechanical surface detection, collision detection, etc. The unit is battery powered with standard or rechargeable batteries. The signal is optically transmitted to the EOC.
- The Electro-optical converter (EOC) performs the conversion from optical to electrical signals for the digital communication to the DAE. To use optical surface detection, a special version of the EOC is required. The EOC signal is transmitted to the measurement server.
- The function of the measurement server is to perform the time critical tasks such as signal filtering, control of the robot operation and fast movement interrupts.
- The Light Beam used is for probe alignment. This improves the (absolute) accuracy of the probe positioning.
- A computer running WinXP and the DASY5 software.
- Remote control and teach pendant as well as additional circuitry for robot safety such as warning lamps, etc.
- The phantom, the device holder and other accessories according to the targeted measurement.

7.2. DASY5 E-field Probe System

The SAR measurements were conducted with the dosimetric probe designed in the classical triangular configuration and optimized for dosimetric evaluation. The probe is constructed using the thick film technique; with printed resistive lines on ceramic substrates. The probe is equipped with an optical multifiber line ending at the front of the probe tip. It is connected to the EOC box on the robot arm and provides an automatic detection of the phantom surface. Half of the fibers are connected to a pulsed infrared transmitter, the other half to a synchronized receiver. As the probe approaches the surface, the reflection from the surface produces a coupling from the transmitting to the receiving fibers. This reflection increases first during the approach, reaches maximum and then decreases. If the probe is flatly touching the surface, the coupling is zero. The distance of the coupling maximum to the surface is independent of the surface reflectivity and largely independent of the surface to probe angle. The DASY5 software reads the reflection during a software approach and looks for the maximum using 2nd order curve fitting. The approach is stopped at reaching the maximum.

Probe Specifications:

Model: EX3DV4
Frequency: 650MHz — 6GHz
Calibration: In head and body simulating tissue at
Frequencies from 650 up to 4900MHz
Linearity: ± 0.2 dB

Dynamic Range: 10 mW/kg — 100W/kg

Probe Length: 330 mm

Probe Tip

Length: 20 mm

Body Diameter: 12 mm

Tip Diameter: 2.5mm

Tip-Center: 1 mm

Application: SAR Dosimetry Testing

Compliance tests of mobile phones

Dosimetry in strong gradient fields



Picture 7-2 Near-field Probe



Picture 7-3 E-field Probe

7.3. E-field Probe Calibration

Each E-Probe/Probe Amplifier combination has unique calibration parameters. A TEM cell calibration procedure is conducted to determine the proper amplifier settings to enter in the probe parameters. The amplifier settings are determined for a given frequency by subjecting the probe to a known E-field density (1 mW/cm²) using an RF Signal generator, TEM cell, and RF Power Meter.

The free space E-field from amplified probe outputs is determined in a test chamber. This calibration can be performed in a TEM cell if the frequency is below 1 GHz and in a waveguide or other methodologies above 1 GHz for free space. For the free space calibration, the probe is placed in the volumetric center of the cavity and at the proper orientation with the field. The probe is then rotated 360 degrees until the three channels show the maximum reading. The power density readings equate to 1 mW/cm².

E-field temperature correlation calibration is performed in a flat phantom filled with the appropriate simulated brain tissue. The E-field in the medium correlates with the temperature rise in the dielectric medium. For temperature correlation calibration a RF transparent thermistor-based temperature probe is used in conjunction with the E-field probe.

$$SAR = C \frac{\Delta T}{\Delta t}$$

Where:

Δt = Exposure time (30 seconds),

C = Heat capacity of tissue (brain or muscle),

ΔT = Temperature increase due to RF exposure.

$$SAR = \frac{|E|^2 \cdot \sigma}{\rho}$$

Where:

σ = Simulated tissue conductivity,

ρ = Tissue density (kg/m³).

7.4. Other Test Equipment

7.4.1. Data Acquisition Electronics(DAE)

The data acquisition electronics consist of a highly sensitive electrometer-grade preamplifier with auto-zeroing, a channel and gain-switching multiplexer, a fast 16 bit AD-converter and a command decoder with a control logic unit. Transmission to the measurement server is accomplished through an optical downlink for data and status information, as well as an optical uplink for commands and the clock.

The mechanical probe mounting device includes two different sensor systems for frontal and sideways probe contacts. They are used for mechanical surface detection and probe collision detection.

The input impedance of the DAE is 200 MOhm; the inputs are symmetrical and floating. Common mode rejection is above 80 dB.



Picture7.4.1-1: DAE

7.4.2. Robot

The SPEAG DASY system uses the high precision robots (DASY5: TX90) type from Stäubli SA (France). For the 6-axis controller system, the robot controller version from Stäubli is used. The Stäubli robot series have many features that are important for our application:

- High precision (repeatability 0.02mm)
- High reliability (industrial design)
- Low maintenance costs (virtually maintenance free due to direct drive gears; no belt drives)
- Jerk-free straight movements (brushless synchron motors; no stepper motors)
- Low ELF interference (motor control fields shielded via the closed metallic construction shields)



Picture7.4.2-1: DASY 5

Chongqing Academy of Information and Communication Technology

Address: No. 8, Yuma Road, Chayuan New City, Nan'an District, Chongqing, P. R. China, 401336
Tel: 0086-23-88069965 FAX: 0086-23-88608777

7.4.3. Measurement Server

The Measurement server is based on a PC/104 CPU board with CPU (DASY5: 400 MHz, Intel Celeron), chipdisk (DASY5: 128MB), RAM (DASY5: 128MB). The necessary circuits for communication with the DAE electronic box, as well as the 16 bit AD converter system for optical detection and digital I/O interface are contained on the DASY I/O board, which is directly connected to the PC/104 bus of the CPU board.

The measurement server performs all real-time data evaluation of field measurements and surface detection, controls robot movements and handles safety operation. The PC operating system cannot interfere with these time critical processes. All connections are supervised by a watchdog, and disconnection of any of the cables to the measurement server will automatically disarm the robot and disable all program-controlled robot movements. Furthermore, the measurement server is equipped with an expansion port which is reserved for future applications. Please note that this expansion port does not have a standardized pinout, and therefore only devices provided by SPEAG can be connected. Devices from any other supplier could seriously damage the measurement server.



Picture 7.4.3-1: Server for DASY 5

7.4.4. Device Holder for Phantom

The SAR in the phantom is approximately inversely proportional to the square of the distance between the source and the liquid surface. For a source at 5mm distance, a positioning uncertainty of $\pm 0.5\text{mm}$ would produce a SAR uncertainty of $\pm 20\%$. Accurate device positioning is therefore crucial for accurate and repeatable measurements. The positions in which the devices must be measured are defined by the standards.

The DASY device holder is designed to cope with the different positions given in the standard. It has two scales for device rotation (with respect to the body axis) and device inclination (with respect to the line between the ear reference points). The rotation centers for both scales is the ear reference point (ERP). Thus the device needs no repositioning when changing the angles.

The DASY device holder is constructed of low-loss POM material having the following dielectric parameters:

relative permittivity ≈ 3 and loss tangent ≈ 0.02 . The amount of dielectric material has been reduced in the closest vicinity of the device, since measurements have suggested that the influence of the clamp on the test results could thus be lowered.

<Laptop Extension Kit>

The extension is lightweight and made of POM, acrylic glass and foam. It fits easily on the upper part of the Mounting Device in place of the phone positioner. The extension is fully compatible with the Twin-SAM and ELI phantoms.

**Picture 7.4.4-1: Device Holder****Picture 7.4.4-2: Laptop Extension Kit**

7.4.5. Phantom

The SAM Twin Phantom V4.0 is constructed of a fiberglass shell integrated in a table. The shape of the shell is based on data from an anatomical study designed to represent the 90th percentile of the population. The phantom enables the dissymmetric evaluation of SAR for both left and right handed handset usage, as well as body-worn usage using the flat phantom region. Reference markings on the Phantom allow the complete setup of all predefined phantom positions and measurement grids by manually teaching three points in the robot. The shell phantom has a 2mm shell thickness (except the ear region where shell thickness increases to 6 mm).

Shell Thickness: 2 ± 0.2 mm

Filling Volume: Approx. 25 liters

Dimensions: 810 x 1000 x 500 mm (H x L x W)

Available: Special

**Picture 7.4.5-1: SAM Twin Phantom**

8. Position of the wireless device in relation to the phantom

8.1. Generic device

For a device that can not be categorized as any of the other specific device types, it shall be considered to be a generic device;

The SAR evaluation shall be performed for all surfaces of the DUT that are accessible during intended use, as indicated in Picture 8-1. The separation distance in testing shall correspond to the intended use distance as specified in the user instructions provided by the manufacturer. If the intended use is not specified, all surfaces of the DUT shall be tested directly against the flat phantom.

The surface of the generic device (or the surface of the carry accessory holding the DUT) pointing towards the flat phantom shall be parallel to the surface of the phantom.

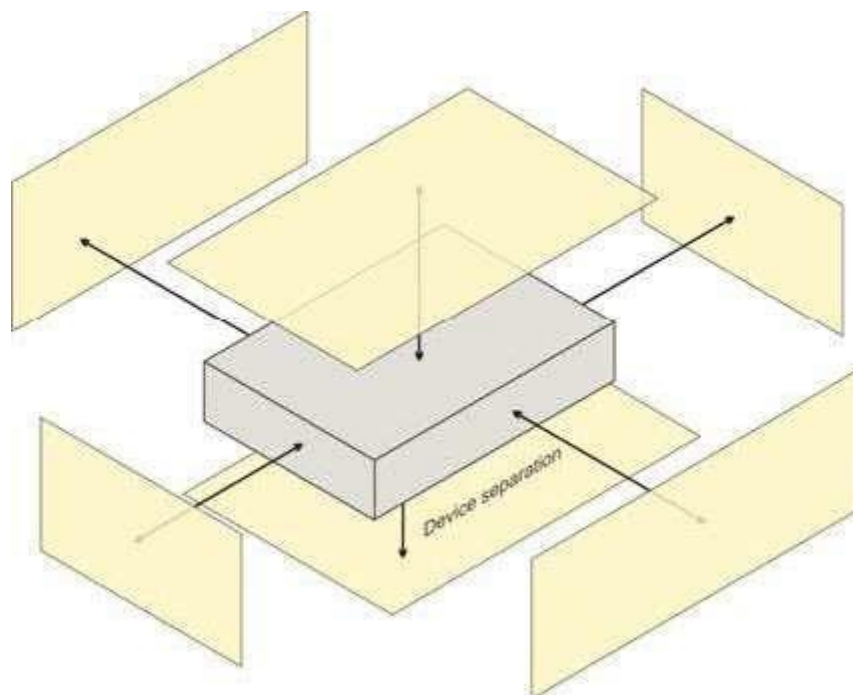

Picture 8.1-1 Test positions for Generic device

8.2. DUT Setup Photo

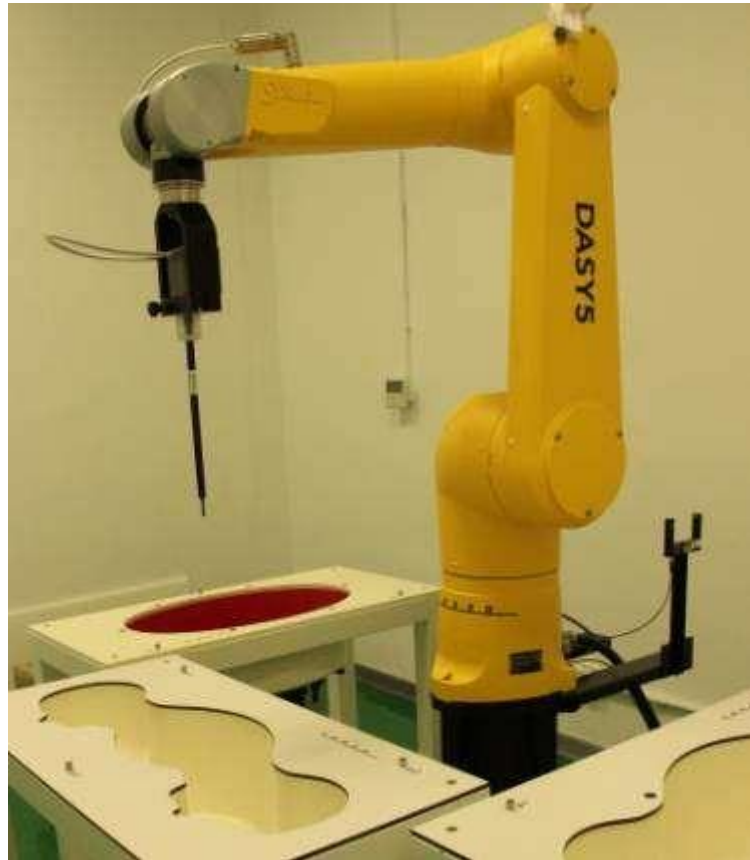

Picture 8.2-1: Specific Absorption Rate Test Layout

9. Tissue Simulating Liquids

9.1. Equivalent Tissues

The liquid used for the frequency range of 800-3000 MHz consisted of water, sugar, salt and Cellulose. The liquid has been previously proven to be suited for worst-case. The Table 9.1-1 and 9.1-2 shows the detail solution. The following tissue formulations are provided for reference only as some of the parameters have not been thoroughly verified. The composition of ingredients may be modified accordingly to achieve the desired target tissue parameters required for routine SAR evaluation.

Table 9.1-1 Composition of the Head Tissue Equivalent Matter

Frequency (MHz)	835	1750	1900	2450
Ingredients (% by weight)				
water	41.45	55.24	54.89	58.79
sugar	56.00	/	/	/
salt	1.45	0.306	0.18	0.06
preventol	0.1	/	/	/
cellulose	1.0	/	/	/
ClycolMonobutyl	/	44.45	44.93	41.15
Dielectric Parameters Target Value	f=850MHz $\epsilon=41.5$ $\sigma=0.91$	f=1750MHz $\epsilon=40.08$ $\sigma=1.37$	f=1950MHz $\epsilon=40.0$ $\sigma=1.40$	f=2450MHz $\epsilon=39.20$ $\sigma=1.80$

Table 9.1-2 Targets for tissue simulating liquid

Frequency (MHz)	Liquid Type	Conductivity (σ)	$\pm 5\%$ Range	Permittivity (ϵ)	$\pm 5\%$ Range
750	Head	0.893	0.849~0.938	41.942	39.840~44.040
835	Head	0.910	0.865~0.956	41.555	39.477~43.632
1750	Head	1.371	1.302~1.440	40.079	38.075~42.083
1900	Head	1.400	1.330~1.470	40.000	38.000~42.000
2450	Head	1.800	1.710~1.890	39.200	37.240~41.160
2300	Head	1.667	1.583~1.750	39.467	37.493~41.440

Chongqing Academy of Information and Communication Technology

Address: No. 8,Yuma Road, Chayuan New City, Nan'an District, Chongqing, P. R. China,401336
Tel: 0086-23-88069965 FAX:0086-23-88608777

9.2. Dielectric Performance

Table 9.2-1: Dielectric Performance of Head Tissue Simulating Liquid

Measurement Value						
Liquid Temperature: 22.5°C						
Type	Frequency (MHz)	Permittivity ϵ	Drift (%)	Conductivity σ	Drift (%)	Test Date
Head	750	42.101	3.79	0.894	1.12	2022-05-30
Head	835	43.156	3.85	0.915	0.55	2022-05-31
Head	835	40.993	-1.35	0.902	-0.88	2022-06-01
Head	1750	41.103	2.56	1.361	-0.73	2022-05-25
Head	1750	41.103	2.56	1.361	-0.73	2022-05-26
Head	1900	39.218	-1.96	1.426	1.86	2022-05-23
Head	1900	39.218	-1.96	1.426	1.86	2022-05-24
Head	2300	39.99	1.33	1.712	2.70	2022-05-27
Head	2450	38.897	-0.77	1.86	3.33	2022-06-02

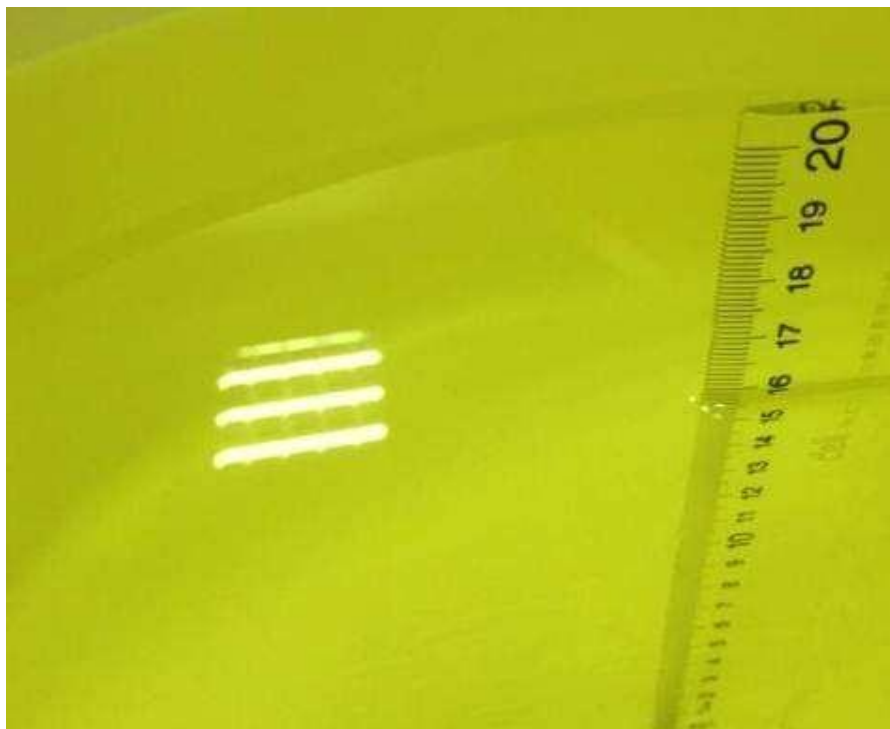

Picture9.2-1:Liquid depth in the Flat Phantom (750 MHz Head)



Picture 9.2-2: Liquid depth in the Flat Phantom (835 MHz Head)

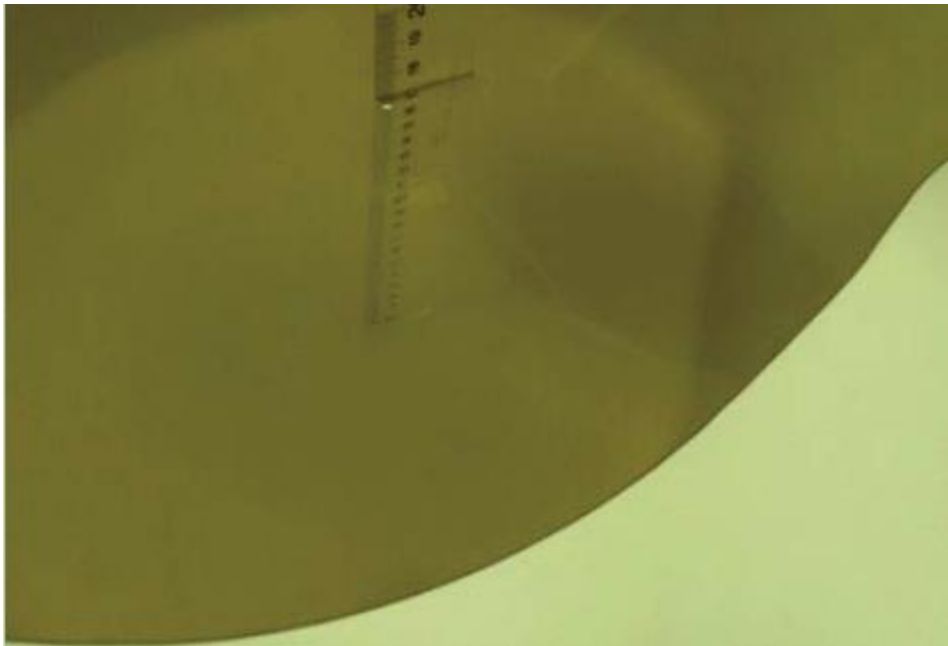

Picture 9.2-3: Liquid depth in the Flat Phantom (1750&1900 MHz Head)

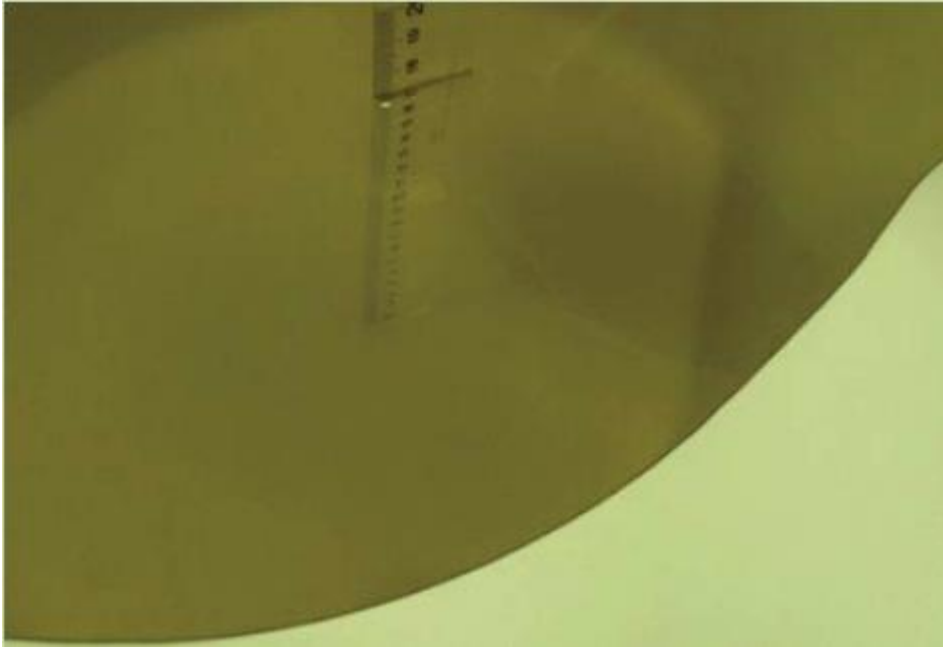

Picture 9.2-4: Liquid depth in the Flat Phantom (2300&2450 MHz Head)

10. System Validation

10.1. System Validation

Each DASY system is equipped with one or more system validation kits. These units, together with the predefined measurement procedures within the DASY software, enable the user to conduct the system performance check and system validation. System validation kit includes a dipole, tripod holder to fix it underneath the flat phantom and a corresponding distance holder.

10.2. System Setup

In the simplified setup for system evaluation, the DUT is replaced by a calibrated dipole and the power source is replaced by a continuous wave that comes from a signal generator. The calibrated dipole must be placed beneath the flat phantom section of the SAM twin phantom with the correct distance holder. The distance holder should touch the phantom surface with a light pressure at the reference marking and be oriented parallel to the long side of the phantom. The equipment setup is shown below:

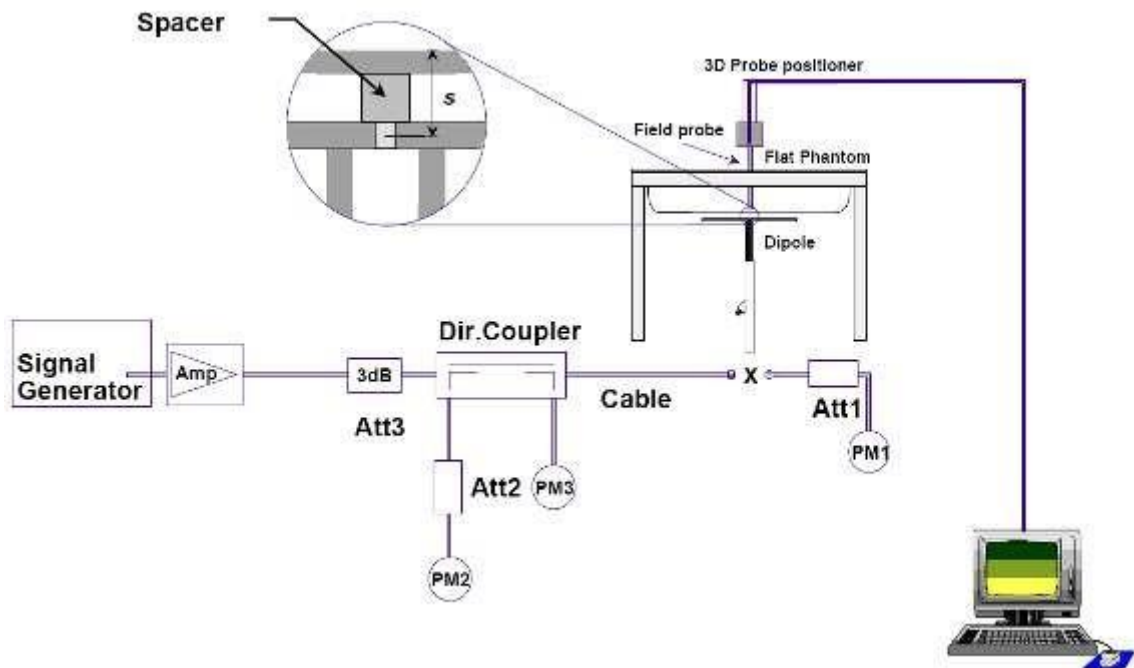

Picture 10-1 System Setup for System Evaluation

The output power on dipole port must be calibrated to 24 dBm (250mW) before dipole is connected. The results are normalized to 1 W input power.



Picture 10.2-1: Photo of Dipole Setup

Table 10.2-1: System Validation of Head

Verification Results							
Input power level: 1W							
Frequency	Target value (W/kg)		Measured value (W/kg)		Deviation		Test date
	1 g Average	10 g Average	1 g Average	10 g Average	1 g Average	10 g Average	
750MHz	2.07	1.37	1.92	1.29	-7.24%	-5.84%	2022-05-30
835MHz	2.40	1.60	2.32	1.52	-3.33%	-5.00%	2022-05-31
835MHz	2.40	1.60	2.39	1.55	-0.42%	-3.13%	2022-06-01
1750MHz	8.96	4.73	8.63	4.73	-3.68%	0.00%	2022-05-25
1750MHz	8.96	4.73	9.13	4.96	1.90%	4.86%	2022-05-26
1900 MHz	9.78	5.04	9.31	4.94	-4.81%	-1.98%	2022-05-23
1900 MHz	9.78	5.04	9.57	5.02	2.15%	0.40%	2022-05-24
2300 MHz	12.3	5.81	12.2	5.81	0.81%	0.00%	2022-05-27
2450 MHz	13.50	6.18	13.6	6.17	0.74%	-0.16%	2022-06-02

11. Measurement Procedures

11.1. Tests to be performed

In order to determine the highest value of the peak spatial-average SAR of a handset, all device positions, configurations and operational modes shall be tested for each frequency band according to steps 1 to 3 below. A flowchart of the test process is shown in Picture 19

Step 1: The tests described in 11.2 shall be performed at the channel that is closest to the centre of the transmit frequency band (f_c) for:

- a) all device positions (cheek and tilt, for both left and right sides of the SAM phantom, as described in Chapter 8),
- b) all configurations for each device position in a), e.g., antenna extended and retracted, and
- c) all operational modes, e.g., analogue and digital, for each device position in a) and configuration in b) in each frequency band.

If more than three frequencies need to be tested according to 11.1 (i.e., $N_c > 3$), then all frequencies,

configurations and modes shall be tested for all of the above test conditions.

Step 2: For the condition providing highest peak spatial-average SAR determined in Step 1, perform all tests described in 11.2 at all other test frequencies, i.e., lowest and highest frequencies. In addition, for all other conditions (device position, configuration and operational mode) where the peak spatial-average SAR value determined in Step 1 is within 3 dB of the applicable SAR limit, it is recommended that all other test frequencies shall be tested as well.

Step 3: Examine all data to determine the highest value of the peak spatial-average SAR found in Steps 1 to 2.

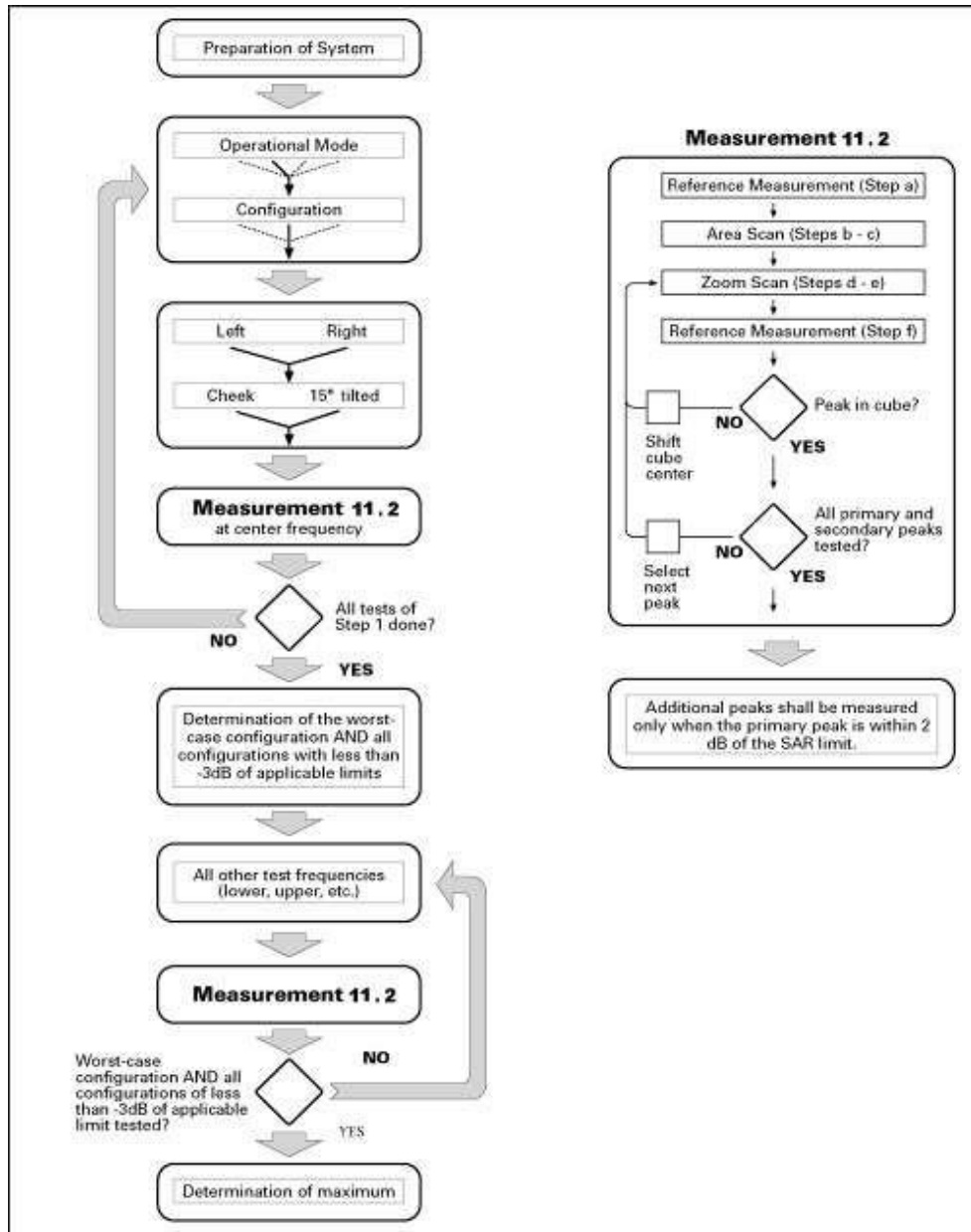

Picture 11.1-1: Block diagram of the tests to be performed

11.2. Measurement procedure

The following procedure shall be performed for each of the test conditions (see Picture 19) described in 11.1:

a) Measure the local SAR at a test point within 8 mm or less in the normal direction from the inner surface of the phantom.

b) Measure the two-dimensional SAR distribution within the phantom (area scan procedure). The boundary of the measurement area shall not be closer than 20 mm from the phantom side walls. The distance between the measurement points should enable the detection of the location of local maximum with an accuracy of better than half the linear dimension of the tissue cube after interpolation. A maximum grid spacing of 20 mm for frequencies below 3 GHz and $(60/f \text{ [GHz]})$ mm for frequencies of 3GHz and greater is recommended. The maximum distance between the geometrical centre of the probe detectors and the inner surface of the phantom shall be 5 mm for frequencies below 3 GHz and $\delta \ln(2)/2$ mm for frequencies of 3 GHz and greater, where δ is the plane wave skin depth and $\ln(x)$ is the natural logarithm. The maximum variation of the sensor-phantom surface shall be ± 1 mm for frequencies below 3 GHz and ± 0.5 mm for frequencies of 3 GHz and greater. At all measurement points the angle of the probe with respect to the line normal to the surface should be less than 5° . If this cannot be achieved for a measurement distance to the phantom inner surface shorter than the probe diameter, additional uncertainty evaluation is needed.

c) From the scanned SAR distribution, identify the position of the maximum SAR value, in addition identify the positions of any local maxima with SAR values within 2 dB of the maximum value that are not within the zoom-scan volume; additional peaks shall be measured only when the primary peak is within 2 dB of the SAR limit. This is consistent with the 2 dB threshold already stated;

d) Measure the three-dimensional SAR distribution at the local maxima locations identified in step c). The horizontal grid step shall be $(24 / f[\text{GHz}])$ mm or less but not more than 8 mm. The minimum zoom size of 30 mm by 30 mm and 30 mm for frequencies below 3 GHz. For higher frequencies, the minimum zoom size of 22 mm by 22 mm and 22 mm. The grid step in the vertical direction shall be $(8-f[\text{GHz}])$ mm or less but not more than 5 mm, if uniform spacing is used. If variable spacing is used in the vertical direction, the maximum spacing between the two closest measured points to the phantom shell shall be $(12 / f[\text{GHz}])$ mm or less but not more than 4 mm, and the spacing between further points shall increase by an incremental factor not exceeding 1.5. When variable spacing is used, extrapolation routines shall be tested with the same spacing as used in measurements. The maximum distance between the geometrical centre of the probe detectors and the inner surface of the phantom shall be 5 mm for frequencies below 3 GHz and $\delta \ln(2)/2$ mm for frequencies of 3 GHz and greater, where δ is the plane wave skin depth and $\ln(x)$ is the natural logarithm. Separate grids shall be centered on each of the local SAR maxima found in step c). Uncertainties due to field distortion between the media boundary and the dielectric enclosure of the probe should also be minimized, which is achieved is the distance between the phantom surface and physical tip

of the probe is larger than probe tip diameter. Other methods may utilize correction procedures for these boundary effects that enable high precision measurements closer than half the probe diameter. For all measurement points, the angle of the probe with respect to the flat phantom surface shall be less than 5°. If this cannot be achieved an additional uncertainty evaluation is needed.

e) Use post processing(e.g. interpolation and extrapolation) procedures to determine the local SAR values at the spatial resolution needed for mass averaging.

11.3. WCDMA Measurement Procedures for SAR

The following procedures are applicable to WCDMA handsets operating under 3GPP Release99, Release 5 and Release 6. The default test configuration is to measure SAR with an established radio link between the DUT and a communication test set using a 12.2kbps RMC (reference measurement channel) configured in Test Loop Mode 1. SAR is selectively confirmed for other physical channel configurations (DPCCH & DPDCHn), HSDPA and HSPA (HSUPA/HSDPA) modes according to output power, exposure conditions and device operating capabilities. Both uplink and downlink should be configured with the same RMC or AMR, when required. SAR for Release 5 HSDPA and Release 6 HSPA are measured using the applicable FRC (fixed reference channel) and E-DCH reference channel configurations. Maximum output power is verified according to applicable versions of 3GPP TS 34.121 and SAR must be measured according to these maximum output conditions. When Maximum Power Reduction (MPR) is not implemented according to Cubic Metric (CM) requirements for Release 6 HSPA, the following procedures do not apply.

For Release 5 HSDPA Data Devices:

Sub-test	β_c	β_d	β_d (SF)	β_c / β_d	β_{hs}	CM/dB
1	2/15	15/15	64	2/15	4/15	0.0
2	12/15	15/15	64	12/15	24/25	1.0
3	15/15	8/15	64	15/8	30/15	1.5
4	15/15	4/15	64	15/4	30/15	1.5

For Release 6 HSPA Data Devices:

Sub-test	β_c	β_d	β_d (SF)	β_c / β_d	β_{hs}	β_{α}	β_{ed}	β_{ed} (SF)	β_{ed} (codes)	CM (dB)	MPR (dB)	AG Index	E-TFCI
1	11/15	15/15	64	11/15	22/15	209/225	1039/225	4	1	1.5	1.5	20	75
2	6/15	15/15	64	6/15	12/15	12/15	12/15	4	1	1.5	1.5	12	67
3	15/15	9/15	64	15/9	30/15	30/15	$\beta_{ed1}:47/15$ $\beta_{ed2}:47/15$	4	2	1.5	1.5	15	92
4	2/15	15/15	64	2/15	4/15	4/15	56/75	4	1	1.5	1.5	17	71
5	15/15	15/15	64	15/15	24/15	30/15	134/15	4	1	1.5	1.5	21	81

Rel.8 DC-HSDPA (Cat 24)

SAR test exclusion for Rel.8 DC-HSDPA must satisfy the SAR test exclusion requirements of Rel.5 HSDPA. SAR test exclusion for DC-HSDPA devices is determined by power measurements according to the H-Set 12, Fixed Reference Channel (FRC) configuration in Table C.8.1.12 of 3GPP TS 34.121-1. A primary and a secondary serving HS-DSCH Cell are required to perform the power measurement and for the results to qualify for SAR test exclusion.

11.4. SAR Measurement for LTE

SAR tests for LTE are performed with a base station simulator, Rohde & Schwarz CMW500. Closed loop power control was used so the UE transmits with maximum output power during SAR testing.

All powers were measured with the CMW 500.

It is performed for conducted power and SAR based on the KDB941225 D05.

SAR is evaluated separately according to the following procedures for the different test positions in each exposure condition – head, body, body-worn accessories and other use conditions. The procedures in the following subsections are applied separately to test each LTE frequency band.

1) QPSK with 1 RB allocation

Start with the largest channel bandwidth and measure SAR for QPSK with 1 RB allocation, using the RB offset and required test channel combination with the highest maximum output power among RB offsets at the upper edge, middle and lower edge of each required test channel. When the reported SAR is ≤ 0.8 W/kg, testing of the remaining RB offset configurations and required test channels is not required for 1 RB allocation; otherwise, SAR is required for the remaining required test channels and only for the RB offset configuration with the highest output power for that channel. When the reported SAR of a required test channel is > 1.45 W/kg, SAR is required for all three RB offset configurations for that required test channel.

2) QPSK with 50% RB allocation

The procedures required for 1 RB allocation in 1) are applied to measure the SAR for QPSK with 50% RB allocation.

3) QPSK with 100% RB allocation

For QPSK with 100% RB allocation, SAR is not required when the highest maximum output power for 100 % RB allocation is less than the highest maximum output power in 50% and 1 RB allocations and the highest reported SAR for 1 RB and 50% RB allocation in 1) and 2) are ≤ 0.8 W/kg. Otherwise, SAR is measured for the highest output power channel; and if the reported SAR is > 1.45 W/kg, the remaining required test channels must also be tested.

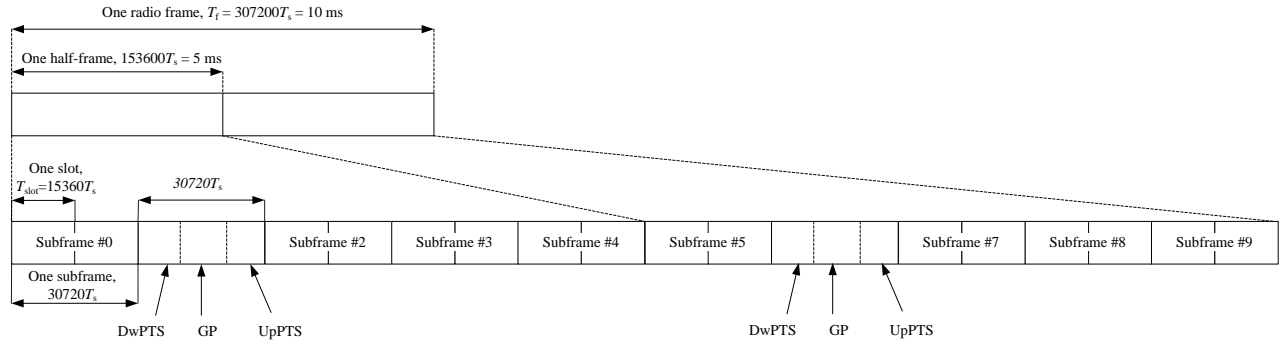

Figure 11.4-1: Frame structure type 2 (for 5 ms switch-point periodicity)

Table 11.4-1: Configuration of special subframe (lengths of DwPTS/GP/UpPTS)

Special subframe configuration	Normal cyclic prefix in downlink				Extended cyclic prefix in downlink		
	DwPTS	UpPTS		DwPTS	UpPTS		
		Normal cyclic prefix in uplink	Extended cyclic prefix in uplink		Normal cyclic prefix in uplink	Extended cyclic prefix in uplink	
0	$6592 \cdot T_s$	$2192 \cdot T_s$	$2560 \cdot T_s$	$7680 \cdot T_s$	$2192 \cdot T_s$	$2560 \cdot T_s$	
1	$19760 \cdot T_s$			$20480 \cdot T_s$			
2	$21952 \cdot T_s$			$23040 \cdot T_s$			
3	$24144 \cdot T_s$			$25600 \cdot T_s$			
4	$26336 \cdot T_s$	$4384 \cdot T_s$	$5120 \cdot T_s$	$7680 \cdot T_s$	$4384 \cdot T_s$	$5120 \cdot T_s$	
5	$6592 \cdot T_s$			$20480 \cdot T_s$			
6	$19760 \cdot T_s$			$23040 \cdot T_s$			
7	$21952 \cdot T_s$			$12800 \cdot T_s$			
8	$24144 \cdot T_s$			-			
9	$13168 \cdot T_s$	-	-	-	-	-	

Table 11.4-2: Uplink-downlink configurations

Uplink-downlink configuration	Downlink-to-Uplink Switch-point periodicity	Subframe number										
		0	1	2	3	4	5	6	7	8	9	
0	5 ms	D	S	U	U	U	D	S	U	U	U	
1	5 ms	D	S	U	U	D	D	S	U	U	D	
2	5 ms	D	S	U	D	D	D	S	U	D	D	
3	10 ms	D	S	U	U	U	D	D	D	D	D	
4	10 ms	D	S	U	U	D	D	D	D	D	D	
5	10 ms	D	S	U	D	D	D	D	D	D	D	
6	5 ms	D	S	U	U	U	D	S	U	U	D	

Duty factor is calculated by:

$$\begin{aligned}
 \text{Duty factor} &= \text{uplink frame} \cdot 6 + \text{UpPTS} \cdot 2 / \text{one frame length} \\
 &= (30720 \cdot T_s \cdot 6 + 5120 \cdot T_s \cdot 2) / 307200 \cdot T_s \\
 &= 0.633
 \end{aligned}$$

11.5 Bluetooth & Wi-Fi Measurement Procedures For SAR

Normal network operating configurations are not suitable for measuring the SAR of 802.11 transmitters in general. Unpredictable fluctuations in network traffic and antenna diversity conditions can introduce undesirable variations in SAR results. The SAR for these devices should be measured using chipset based test mode software to ensure that the results are consistent and reliable.

Chipset based test mode software is hardware dependent and generally varies among manufacturers. The device operating parameters established in a test mode for SAR measurements must be identical to those programmed in production units, including output power levels, amplifier gain settings and other RF performance tuning parameters. The test frequencies should correspond to actual channel frequencies defined for domestic use. SAR for devices with switched diversity should be measured with only one antenna transmitting at a time during each SAR measurement, according to a fixed modulation and data rate. The same data pattern should be used for all measurements.

11.6 Power Drift

To control the output power stability during the SAR test, DASY5 system calculates the power drift by measuring the E-field at the same location at the beginning and at the end of the measurement for each test position. These drift values can be found in Section 15 labeled as: (Power Drift [dB]). This ensures that the power drift during one measurement is within 5%.

12 Area Scan Based 1-g SAR

12.1 Requirement of KDB

According to the KDB447498D01v05, when the implementation is based on the specific polynomial algorithm as presented at the 29th Bioelectromagnetics Society meeting (2007) and the estimated 1-g SAR is ≤ 1.2 W/kg, a zoom scan measurement is not required provided it is also not needed for any other purpose; for example, if the peak SAR location required for simultaneous transmission SAR test exclusion can be determined accurately by the SAR system or manually to discriminate between distinctive peak and scattered noisy SAR distributions from area scans.

There must not be any warning or alert messages due to various measurement concerns identified by the SAR system; for example, noise in measurements, peaks too close to scan boundary, peaks are too sharp, spatial resolution and uncertainty issues etc. The SAR system verification must also demonstrate that the area scan estimated 1-g SAR is within 3% of the zoom scan 1-g SAR (See Annex A). When all the SAR results for each exposure condition in a frequency band and wireless mode are based on estimated 1-g SAR, the 1-g SAR for the highest SAR configuration must be determined by a zoom scan.

12.2 Fast SAR Algorithms

The approach is based on the area scan measurement applying a frequency dependent attenuation parameter. This attenuation parameter was empirically determined by analyzing a large number of phones. The MOTOROLA FAST SAR was developed and validated by the MOTOROLA Research Group in Ft. Lauderdale.

In the initial study, an approximation algorithm based on Linear fit was developed. The accuracy of the algorithm has been demonstrated across a broad frequency range (136-2450 MHz) and for both 1-g and 10-g averaged SAR using a sample of 264 SAR measurements from 55 wireless handsets. For the sample size studied, the root-mean-squared errors of the algorithm are 1.2% and 5.8% for 1-g and 10-g averaged SAR, respectively. The paper describing the algorithm in detail is expected to be published in August 2004 within the Special Issue of Transactions on MTT.

In the second step, the same research group optimized the fitting algorithm to an Polynomial fit where the frequency validity was extended to cover the range 30-6000 MHz. Details of this study can be found in the BEMS 2007 Proceedings.

Both algorithms are implemented in DASY software.

Chongqing Academy of Information and Communication Technology

Address: No. 8, Yuma Road, Chayuan New City, Nan'an District, Chongqing, P. R. China, 401336
Tel: 0086-23-88069965 FAX: 0086-23-88608777

13 Conducted Output Power

13.1 Manufacturing Tolerance

Table13.1-1: Summary of Receiver detection mechanism

Antenna	Receiver on (head scenario)	Receiver off + Hotspot off (Body scenario)	Receiver off + Hotspot on (Hotspot scenario)
Main Antenna	Power Level A1	Power Level B1	Power Level C1

13.2 GSM Measurement Result

Table 13.2-1: The conducted power measurement results-GSM850 Power Level A1/B1/C1

GSM 850 Speech (GMSK)	Measured timeslot-averaged output power (dBm)			Tune up	calculation	Source-based time-averaged output power (dBm)		
	251	190	128			251	190	128
1 Txslot	33.05	33.14	33.1	33.3	/	/	/	/
GSM 850 GPRS (GMSK)	Measured timeslot-averaged output power (dBm)				calculation	Source-based time-averaged output power (dBm)		
	128	190	251			128	190	251
1 Txslot	33.11	33.15	33.04	33.3	-9.03	24.08	24.12	24.01
2 Txslots	29.82	29.86	29.75	30.5	-6.02	23.8	23.84	23.73
3 Txslots	28.92	28.95	28.85	29.5	-4.26	24.66	24.69	24.59
4 Txslots	27.84	27.9	27.82	28.0	-3.01	24.83	24.89	24.81
GSM 850 EGPRS (GMSK)	Measured timeslot-averaged output power (dBm)				calculation	Source-based time-averaged output power (dBm)		
	128	190	251			128	190	251
1 Txslot	33.09	33.12	33.03	33.3	-9.03	24.06	24.09	24
2 Txslots	29.8	29.84	29.75	30.5	-6.02	23.78	23.82	23.73
3 Txslots	28.89	28.93	28.83	29.5	-4.26	24.63	24.67	24.57
4 Txslots	27.84	27.89	27.81	28.0	-3.01	24.83	24.88	24.8
GSM 850 EGPRS (8PSK)	Measured timeslot-averaged output power (dBm)				calculation	Source-based time-averaged output power (dBm)		
	128	190	251			251	190	128
1 Txslot	27.93	27.74	27.9	28.0	-9.03	18.9	18.71	18.87
2 Txslots	24	23.85	24.04	24.5	-6.02	17.98	17.83	18.02
3Txslots	22.93	22.86	22.91	23.5	-4.26	18.67	18.6	18.65
4 Txslots	21.81	21.76	21.84	22.5	-3.01	18.8	18.75	18.83

NOTES:

1) Division Factors

To average the power, the division factor is as follows:

1TX-slot = 1 transmit time slot out of 8 time slots=> conducted power divided by (8/1) => -9.03dB

2TX-slots = 2 transmit time slots out of 8 time slots=> conducted power divided by (8/2) => -6.02dB

3TX-slots = 3 transmit time slots out of 8 time slots=> conducted power divided by (8/3) => -4.26dB

4TX-slots = 4 transmit time slots out of 8 time slots=> conducted power divided by (8/4) => -3.01dB

According to the conducted power as above, the body measurements are performed with 4TX slots for GSM850.

Table 13.2-2: The conducted power measurement results-GSM1900 Power Level B1/C1

PCS1900 Speech (GMSK)	Measured timeslot-averaged output power (dBm)			Tune up	calculation	Source-based time-averaged output power (dBm)		
	512	661	810			512	661	810
1 Txslot	27.27	27.35	27.54	28.5	/	/	/	/
PCS1900 GPRS (GMSK)	Measured timeslot-averaged output power (dBm)			Tune up	calculation	Source-based time-averaged output power (dBm)		
	512	661	810			512	661	810
1 Txslot	27.19	27.34	27.51	28.5	-9.03	18.16	18.31	18.48
2 Txslots	25.21	25.37	25.56	26	-6.02	19.19	19.35	19.54
3 Txslots	24.1	24.28	24.46	25	-4.26	19.84	20.02	20.2
4 Txslots	23.16	23.31	23.51	24	-3.01	20.15	20.3	20.5
PCS1900 EGPRS (GMSK)	Measured timeslot-averaged output power (dBm)				calculation	Source-based time-averaged output power (dBm)		
	512	661	810			512	661	810
1 Txslot	27.21	27.34	27.5	28.5	-9.03	18.18	18.31	18.47
2 Txslots	25.22	25.37	25.56	26	-6.02	19.2	19.35	19.54
3Txslots	24.11	24.27	24.45	25	-4.26	19.85	20.01	20.19
4 Txslots	23.16	23.29	23.49	24	-3.01	20.15	20.28	20.48
PCS1900 EGPRS (8PSK)	Measured timeslot-averaged output power (dBm)				calculation	Source-based time-averaged output power (dBm)		
	512	661	810			512	661	810
1 Txslot	23.42	23.24	23.22	24	-9.03	14.39	14.21	14.19
2 Txslots	21.42	21.08	21.22	21.5	-6.02	15.4	15.06	15.2
3Txslots	20.36	20.13	20.23	20.5	-4.26	16.1	15.87	15.97
4 Txslots	19.23	19.09	19.17	19.5	-3.01	16.22	16.08	16.16

NOTES:

1) Division Factors

To average the power, the division factor is as follows:

1TX-slot = 1 transmit time slot out of 8 time slots=> conducted power divided by (8/1) => -9.03dB

2TX-slots = 2 transmit time slots out of 8 time slots=> conducted power divided by (8/2) => -6.02dB

3TX-slots = 3 transmit time slots out of 8 time slots=> conducted power divided by (8/3) => -4.26dB

4TX-slots = 4 transmit time slots out of 8 time slots=> conducted power divided by (8/4) => -3.01Db

According to the conducted power as above, the body measurements are performed with 4TX slots for GSM1900.

Table 13.2-3: The conducted power measurement results-GSM1900 Power Level A1

PCS1900 Speech (GMSK)	Measured timeslot-averaged output power (dBm)			Tune up	calculation	Source-based time-averaged output power (dBm)		
	512	661	810			512	661	810
1 Txslot	29.86	29.94	30.03	31	/	/	/	/
PCS1900 GPRS (GMSK)	Measured timeslot-averaged output power (dBm)				calculation	Source-based time-averaged output power (dBm)		
	512	661	810			512	661	810
1 Txslot	29.9	29.95	30.07	31	-9.03	20.87	20.92	21.04
2 Txslots	27.05	27.14	27.35	28	-6.02	21.03	21.12	21.33
3 Txslots	26.04	26.13	26.34	27	-4.26	21.78	21.87	22.08
4 Txslots	25	25.1	25.33	25.5	-3.01	21.99	22.09	22.32
PCS1900 EGPRS (GMSK)	Measured timeslot-averaged output power (dBm)				calculation	Source-based time-averaged output power (dBm)		
	512	661	810			512	661	810
1 Txslot	29.9	30.06	30.09	31	-9.03	20.87	21.03	21.06
2 Txslots	27.03	27.23	27.35	28	-6.02	21.01	21.21	21.33
3Txslots	26.01	26.21	26.35	27	-4.26	21.75	21.95	22.09
4 Txslots	24.98	25.15	25.33	25.5	-3.01	21.97	22.14	22.32
PCS1900 EGPRS (8PSK)	Measured timeslot-averaged output power (dBm)				calculation	Source-based time-averaged output power (dBm)		
	512	661	810			512	661	810
1 Txslot	26.32	26.01	26.13	26.5	-9.03	17.29	16.98	17.1
2 Txslots	23.07	22.86	22.97	23.5	-6.02	17.05	16.84	16.95
3Txslots	21.86	21.72	21.92	22.5	-4.26	17.6	17.46	17.66
4 Txslots	20.79	20.55	20.91	21.5	-3.01	17.78	17.54	17.9

NOTES:

1) Division Factors

To average the power, the division factor is as follows:

1TX-slot = 1 transmit time slot out of 8 time slots=> conducted power divided by (8/1) => -9.03dB

2TX-slots = 2 transmit time slots out of 8 time slots=> conducted power divided by (8/2) => -6.02dB

3TX-slots = 3 transmit time slots out of 8 time slots=> conducted power divided by (8/3) => -4.26dB

4TX-slots = 4 transmit time slots out of 8 time slots=> conducted power divided by (8/4) => -3.01dB

According to the conducted power as above, the body measurements are performed with 4TX slots for GSM1900.

13.3 WCDMA Measurement Result

Table 13.3-1: The conducted Power for WCDMA 1900-Power Level A1

WCDMA1900	Sub test	FDDII result (dBm)			Tune up
		9538/9938	9400/9800	9262/9662	
		(1907.6MHz)	(1880MHz)	(1852.4MHz)	
	/	23.92	23.85	23.82	25.0
HSUPA	1	21.15	21.43	21.75	22.5
	2	21.17	21.10	21.76	22.5
	3	20.15	20.12	21.81	22.0
	4	21.37	21.45	21.86	22.5
	5	21.62	21.13	21.77	22.5
HSPA+		21.21	21.08	21.26	22.5
DC-HSDPA	1	21.44	21.15	21.26	23.0
	2	20.75	20.85	20.87	21.5
	3	20.03	20.13	20.14	20.5
	4	21.20	21.05	21.23	22.5

Table 13.3-2: The conducted Power for WCDMA 1900-Power Level B1

WCDMA1900	Sub test	FDDII result (dBm)			Tune up
		9538/9938	9400/9800	9262/9662	
		(1907.6MHz)	(1880MHz)	(1852.4MHz)	
	/	21.73	21.61	21.63	23.0
HSUPA	1	19.05	19.10	19.01	19.5
	2	18.92	18.72	18.75	19.5
	3	18.26	19.65	17.96	19.9
	4	19.27	19.42	19.12	19.5
	5	19.06	19.68	18.96	20.5
HSPA+	/	19.13	19.05	19.33	20.5
DC-HSDPA	1	19.22	19.06	19.08	20.0
	2	18.38	19.28	18.46	20.0
	3	18.26	18.05	18.22	19.0
	4	19.14	18.98	19.22	20.0

Table 13.3-3: The conducted Power for WCDMA 1900-Power Level C1

WCDMA1900	Sub test	FDDII result (dBm)			Tune up
		9538/9938	9400/9800	9262/9662	
		(1907.6MHz)	(1880MHz)	(1852.4MHz)	
	/	20.72	20.62	20.65	22.0
HSUPA	1	18.11	17.90	18.05	18.5
	2	17.79	17.71	17.74	18.5
	3	17.02	17.11	17.05	18
	4	18.12	18.13	18.15	18.5
	5	17.92	17.91	18.01	18.5
HSPA+	/	18.21	18.06	18.15	19.5
DC-HSDPA	1	18.22	18.16	18.01	20.0
	2	17.68	17.59	17.65	19.0
	3	16.96	16.94	16.76	18.0
	4	18.23	17.96	18.01	19.5

Table 13.3-4: The conducted Power for WCDMA 1700-Power Level A1

WCDMA1700	Sub test	FDDII result (dBm)			Tune up
		1513/1738	1412/1637	1312/1537	
		(1752.6MHz)	(1732.4MHz)	(1712.4MHz)	
	/	23.89	23.86	23.85	25.0
HSUPA	1	21.22	21.33	21.25	22.5
	2	20.89	20.56	20.79	21.5
	3	20.35	20.23	20.13	21.5
	4	21.32	21.28	21.27	22.0
	5	21.29	21.31	21.42	22.0
HSPA+	/	21.21	21.37	21.38	22.5
DC-HSDPA	1	21.20	21.15	21.23	21.5
	2	20.65	21.15	20.45	21.5
	3	20.24	20.15	20.25	21.5
	4	21.23	21.32	21.33	22.0

Table 13.3-5: The conducted Power for WCDMA1700-Power Level B1

WCDMA1700	Sub test	FDDIV result (dBm)			Tune up
		1513/1738	1412/1637	1312/1537	
		(1752.6MHz)	(1732.4MHz)	(1712.4MHz)	
	/	22.41	22.43	22.48	22.0
HSUPA	1	19.25	19.01	19.17	19.5
	2	18.85	18.97	19.02	19.5
	3	18.04	18.13	18.24	19.5
	4	19.11	19.12	19.37	19.5
	5	18.91	19.02	19.12	19.5
HSPA+	/	19.18	19.22	19.41	20.5
DC-HSDPA	1	19.15	19.22	19.24	20.0
	2	18.16	18.70	18.45	20.0
	3	17.89	17.91	17.98	18.0
	4	19.15	19.18	19.36	20.5

Table 13.3-6: The conducted Power for WCDMA 1700-Power Level C1

WCDMA1700	Sub test	FDDIV result (dBm)			Tune up
		1513/1738	1412/1637	1312/1537	
		(1752.6MHz)	(1732.4MHz)	(1712.4MHz)	
	/	20.75	20.74	20.86	22.0
HSUPA	1	17.93	18.14	18.10	18.5
	2	17.87	17.80	18.13	18.5
	3	17.09	17.19	17.15	18.5
	4	18.01	18.13	18.30	18.5
	5	17.90	18.13	18.04	18.5
HSPA+		18.15	18.11	18.31	19.5
DC-HSDPA	1	18.22	18.14	18.24	19.0
	2	18.21	17.27	17.67	19.0
	3	16.96	17.05	17.24	18.0
	4	18.11	18.07	18.19	19.0

Table 13.3-7: The conducted Power for WCDMA850-Power Level B1/C1

WCDMA850	Sub test	FDDV result (dBm)			Tune up
		4233/4458	4183/4408	4132/4357	
		(846.6MHz)	(836.6MHz)	(826.4MHz)	
	/	24.72	24.67	24.66	25.0
HSUPA	1	22.40	22.03	22.88	23.5
	2	21.67	21.79	21.79	22.5
	3	21.02	20.97	21.10	22.0
	4	22.05	22.23	22.35	22.5
	5	22.15	22.11	22.08	22.5
HSPA+		21.54	21.80	22.15	23.0
DC-HSDPA	1	21.79	22.09	22.23	23.5
	2	21.52	21.55	21.51	22.5
	3	21.03	21.05	20.89	22.0
	4	21.53	21.79	22.10	22.5

Table 13.3-8: The conducted Power for WCDMA850-Power Level A1

WCDMA850	Sub test	FDDV result (dBm)			Tune up
		4233/4458	4183/4408	4132/4357	
		(846.6MHz)	(836.6MHz)	(826.4MHz)	
	/	22.64	22.61	22.65	23.0
HSUPA	1	20.03	20.10	19.78	21.0
	2	19.81	19.82	19.95	20.5
	3	18.91	18.86	18.94	19.5
	4	20.10	20.07	20.11	21.0
	5	19.78	19.82	20.19	21.0
HSPA+	/	20.02	20.06	20.04	21.0
DC-HSDPA	1	19.91	20.01	20.03	21.0
	2	20.05	19.72	19.37	21.0
	3	18.93	18.81	18.92	20.0
	4	19.96	20.02	20.00	21.0

13.4 LTE Measurement Result

Maximum Target Power for Production Unit – Power Level A1/B1/C1

Band	Tune up (dBm)		
	Receiver on (head scenario)	Receiver off + Hotspot off (Body scenario)	Receiver off + Hotspot on (Hotspot scenario)
	Level A1	Level B1	Level C1
Band 2	25	24	23
Band 5	23	25	25
Band 12	23	25	25
Band 14	23	25	25
Band 30	25	23	21.5
Band 66	25	23	22

LTE band2 power level A1					
BANDWIDTH	Number of RBs	Frequency	QPSK	16QAM	64QAM
1.4MHz	1RB-High (5)	1909.3 (19193)	24.15	23.20	21.88
		1880 (18900)	23.99	22.73	22.12
		1850.7 (18607)	23.88	22.60	21.74
	1RB-Middle (3)	1909.3 (19193)	24.50	23.60	22.43
		1880 (18900)	24.35	23.00	22.60
		1850.7 (18607)	24.35	23.10	22.10
	1RB-Low (0)	1909.3 (19193)	24.10	23.50	22.19
		1880 (18900)	24.05	22.85	22.39
		1850.7 (18607)	24.11	22.87	21.94
	3RB-High (3)	1909.3 (19193)	24.20	23.24	21.92
		1880 (18900)	24.19	23.22	21.98
		1850.7 (18607)	24.04	23.22	21.82
	3RB-Middle (1)	1909.3 (19193)	24.30	23.50	21.83
		1880 (18900)	24.23	23.31	21.99
		1850.7 (18607)	24.20	23.39	21.90
	3RB-Low (0)	1909.3 (19193)	24.30	23.50	21.79
		1880 (18900)	24.14	23.22	21.93
		1850.7 (18607)	24.13	23.32	21.83
6RB (0)	1909.3 (19193)	23.28	22.13	21.23	
	1880 (18900)	23.17	22.30	20.97	
	1850.7 (18607)	23.16	22.34	20.93	
3MHz	1RB-High (14)	1908.5 (19185)	24.05	22.84	22.35
		1880 (18900)	23.96	23.31	21.81
		1851.5 (18615)	24.06	22.78	21.61
	1RB-Middle (7)	1908.5 (19185)	24.40	23.27	22.76
		1880 (18900)	24.35	23.71	22.26
		1851.5 (18615)	24.37	23.17	22.08
	1RB-Low (0)	1908.5 (19185)	24.22	23.12	22.51

Chongqing Academy of Information and Communication Technology

Address: No. 8,Yuma Road, Chayuan New City, Nan'an District, Chongqing, P. R. China,401336
 Tel: 0086-23-88069965 FAX:0086-23-88608777

	8RB-High (7)	1880 (18900)	24.15	23.48	21.98	
		1851.5 (18615)	24.22	23.00	21.80	
		1908.5 (19185)	23.28	22.25	21.06	
	8RB-Middle (4)	1880 (18900)	23.15	22.27	20.91	
		1851.5 (18615)	23.22	22.17	20.93	
		1908.5 (19185)	23.36	22.37	21.13	
	8RB-Low (0)	1880 (18900)	23.25	22.35	21.02	
		1851.5 (18615)	23.28	22.25	21.04	
		1908.5 (19185)	23.32	22.32	21.11	
	15RB (0)	1880 (18900)	23.21	22.38	20.96	
		1851.5 (18615)	23.24	22.18	20.96	
		1908.5 (19185)	23.28	22.31	20.96	
	5MHz	1RB-High (24)	1907.5 (19175)	23.85	22.80	22.30
			1880 (18900)	23.87	22.88	21.81
			1852.5 (18625)	23.88	23.44	21.88
1RB-Middle (12)		1907.5 (19175)	24.40	23.28	22.87	
		1880 (18900)	24.48	23.42	22.48	
		1852.5 (18625)	24.42	24.00	22.54	
1RB-Low (0)		1907.5 (19175)	24.08	23.11	22.42	
		1880 (18900)	24.15	23.10	22.07	
		1852.5 (18625)	24.07	23.66	22.11	
12RB-High (13)		1907.5 (19175)	23.27	22.33	21.12	
		1880 (18900)	23.20	22.22	20.89	
		1852.5 (18625)	23.27	22.35	20.94	
12RB-Middle (6)		1907.5 (19175)	23.38	22.43	21.21	
		1880 (18900)	23.27	22.28	20.98	
		1852.5 (18625)	23.30	22.38	20.96	
12RB-Low (0)		1907.5 (19175)	23.28	22.31	21.14	
		1880 (18900)	23.22	22.25	20.95	
		1852.5 (18625)	23.25	22.29	20.91	
25RB (0)		1907.5 (19175)	23.26	22.27	21.06	
		1880 (18900)	23.22	22.24	20.91	
		1852.5 (18625)	23.22	22.32	20.87	
10MHz		1RB-High (49)	1905 (19150)	23.88	22.86	21.71
			1880 (18900)	23.85	23.31	22.23
			1855 (18650)	24.00	22.70	21.81
	1RB-Middle (24)	1905 (19150)	24.44	23.24	22.08	
		1880 (18900)	24.30	23.70	22.66	
		1855 (18650)	24.41	23.05	22.22	
	1RB-Low (0)	1905 (19150)	24.20	23.08	21.87	
		1880 (18900)	24.11	23.45	22.46	
		1855 (18650)	24.14	22.90	21.96	

Chongqing Academy of Information and Communication Technology

Address: No. 8,Yuma Road, Chayuan New City, Nan'an District, Chongqing, P. R. China,401336
 Tel: 0086-23-88069965 FAX:0086-23-88608777

	25RB-High (25)	1905 (19150)	23.32	22.39	21.19	
		1880 (18900)	23.24	22.32	20.97	
		1855 (18650)	23.31	22.41	21.07	
	25RB-Middle (12)	1905 (19150)	23.35	22.41	21.20	
		1880 (18900)	23.24	22.31	21.02	
		1855 (18650)	23.30	22.40	20.98	
	25RB-Low (0)	1905 (19150)	23.37	22.45	21.34	
		1880 (18900)	23.29	22.35	21.03	
		1855 (18650)	23.20	22.33	20.98	
	50RB (0)	1905 (19150)	23.36	22.40	21.13	
		1880 (18900)	23.22	22.27	20.98	
		1855 (18650)	23.28	22.32	21.03	
15MHz	1RB-High (74)	1902.5 (19125)	24.00	22.66	22.20	
		1880 (18900)	23.82	22.83	21.54	
		1857.5 (18675)	23.88	23.19	21.56	
	1RB-Middle (37)	1902.5 (19125)	24.49	23.28	22.77	
		1880 (18900)	24.33	23.32	22.15	
		1857.5 (18675)	24.38	23.66	22.14	
	1RB-Low (0)	1902.5 (19125)	24.19	23.07	22.39	
		1880 (18900)	24.04	22.93	21.81	
		1857.5 (18675)	24.11	23.48	21.77	
	36RB-High (38)	1902.5 (19125)	23.39	22.32	21.15	
		1880 (18900)	23.27	22.25	21.01	
		1857.5 (18675)	23.37	22.34	21.14	
	36RB-Middle (19)	1902.5 (19125)	23.47	22.41	21.21	
		1880 (18900)	23.34	22.30	21.03	
		1857.5 (18675)	23.36	22.36	21.10	
	36RB-Low (0)	1902.5 (19125)	23.43	22.33	21.18	
		1880 (18900)	23.33	22.31	21.10	
		1857.5 (18675)	23.28	22.27	21.05	
	75RB (0)	1902.5 (19125)	23.47	22.35	21.12	
		1880 (18900)	23.25	22.26	21.05	
		1857.5 (18675)	23.31	22.33	21.11	
	20MHz	1RB-High (99)	1900 (19100)	23.87	23.50	22.22
			1880 (18900)	23.83	23.06	21.44
			1860 (18700)	23.80	23.02	21.80
1RB-Middle (50)		1900 (19100)	24.44	23.95	22.65	
		1880 (18900)	24.35	23.62	21.91	
		1860 (18700)	24.41	23.55	22.39	
1RB-Low (0)		1900 (19100)	24.03	23.62	22.30	
		1880 (18900)	24.02	23.25	21.57	
		1860 (18700)	24.11	23.30	22.08	
50RB-High (50)		1900 (19100)	23.13	22.22	20.93	
	1880 (18900)	23.16	22.15	20.89		

Chongqing Academy of Information and Communication Technology

Address: No. 8,Yuma Road, Chayuan New City, Nan'an District, Chongqing, P. R. China,401336
Tel: 0086-23-88069965 FAX:0086-23-88608777

	50RB-Middle (25)	1860 (18700)	23.27	22.28	21.13
		1900 (19100)	23.28	22.40	21.04
		1880 (18900)	23.22	22.26	20.95
		1860 (18700)	23.23	22.22	21.06
	50RB-Low (0)	1900 (19100)	23.22	22.30	21.03
		1880 (18900)	23.25	22.33	20.99
		1860 (18700)	23.12	22.12	20.97
	100RB (0)	1900 (19100)	23.28	22.28	21.00
		1880 (18900)	23.21	22.19	20.99
		1860 (18700)	23.22	22.23	21.01

LTE band30 power level A1						
BANDWIDTH	Number of RBs	Frequency	QPSK	16QAM	64QAM	
5MHz	1RB-High (24)	2312.5 (27735)	23.53	23.02	21.90	
		2310 (27710)	23.40	22.42	21.50	
		2307.5 (27685)	23.68	22.59	21.36	
	1RB-Middle (12)	2312.5 (27735)	24.03	23.55	22.21	
		2310 (27710)	24.04	23.03	22.09	
		2307.5 (27685)	24.23	23.13	21.87	
	1RB-Low (0)	2312.5 (27735)	23.76	23.27	22.01	
		2310 (27710)	23.70	22.73	21.76	
		2307.5 (27685)	23.92	22.84	21.44	
	12RB-High (13)	2312.5 (27735)	22.91	21.94	20.74	
		2310 (27710)	22.87	21.90	20.57	
		2307.5 (27685)	22.91	21.93	20.68	
	12RB-Middle (6)	2312.5 (27735)	22.94	22.00	20.77	
		2310 (27710)	22.95	22.00	20.66	
		2307.5 (27685)	23.00	22.00	20.75	
	12RB-Low (0)	2312.5 (27735)	22.91	21.95	20.73	
		2310 (27710)	22.88	21.90	20.62	
		2307.5 (27685)	22.95	21.94	20.66	
	25RB (0)	2312.5 (27735)	22.87	21.96	20.58	
		2310 (27710)	22.87	21.85	20.58	
		2307.5 (27685)	22.95	21.92	20.80	
	10MHz	1RB-High (49)	2310 (27710)	23.73	22.34	21.28
		1RB-Middle (24)	2310 (27710)	24.04	22.74	21.72
		1RB-Low (0)	2310 (27710)	23.89	22.60	21.48
25RB-High (25)		2310 (27710)	22.92	22.00	20.76	
25RB-Middle (12)		2310 (27710)	22.98	22.06	20.77	
25RB-Low (0)		2310 (27710)	22.95	22.04	20.81	
50RB (0)		2310 (27710)	22.97	21.99	20.68	

LTE band66 power level A1					
BANDWIDTH	Number of RBs	Frequency	QPSK	16QAM	64QAM
1.4MHz	1RB-High (5)	1779.3(132665)	24.37	23.53	21.56
		1745.0(132322)	24.16	22.80	22.01
		1710.7(131979)	24.14	23.44	22.05
	1RB-Middle (3)	1779.3(132665)	24.40	23.72	22.06
		1745.0(132322)	24.55	23.35	22.31
		1710.7(131979)	24.56	23.85	22.45
	1RB-Low (0)	1779.3(132665)	24.18	23.49	21.75
		1745.0(132322)	24.38	23.09	22.08
		1710.7(131979)	24.35	23.63	22.18
	3RB-High (3)	1779.3(132665)	24.30	23.53	22.11
		1745.0(132322)	24.28	23.40	22.15
		1710.7(131979)	24.44	23.66	22.33
	3RB-Middle (1)	1779.3(132665)	24.42	23.57	22.14
		1745.0(132322)	24.45	23.56	22.16
		1710.7(131979)	24.56	23.72	22.45
	3RB-Low (0)	1779.3(132665)	24.36	23.52	22.09
		1745.0(132322)	24.36	23.47	22.11
		1710.7(131979)	24.50	23.66	22.43
6RB (0)	1779.3(132665)	23.35	22.25	21.28	
	1745.0(132322)	23.43	22.58	21.18	
	1710.7(131979)	23.47	22.34	21.15	
3MHz	1RB-High (14)	1778.5(132657)	24.00	22.78	21.09
		1745.0(132322)	24.09	23.35	22.10
		1711.5(131987)	24.23	22.92	21.83
	1RB-Middle (7)	1778.5(132657)	24.38	23.27	21.15
		1745.0(132322)	24.50	23.82	22.45
		1711.5(131987)	24.55	23.31	22.10
	1RB-Low (0)	1778.5(132657)	24.17	23.11	21.23
		1745.0(132322)	24.32	23.53	22.25
		1711.5(131987)	24.35	23.08	21.95
	8RB-High (7)	1778.5(132657)	23.27	22.23	21.16
		1745.0(132322)	23.33	22.39	21.12
		1711.5(131987)	23.41	22.36	21.28
	8RB-Middle (4)	1778.5(132657)	23.36	22.35	21.82
		1745.0(132322)	23.42	22.48	21.19
		1711.5(131987)	23.50	22.42	21.22
	8RB-Low (0)	1778.5(132657)	23.30	22.31	21.74
		1745.0(132322)	23.36	22.45	21.12
		1711.5(131987)	23.43	22.35	21.16
15RB (0)	1778.5(132657)	23.26	22.28	21.91	
	1745.0(132322)	23.30	22.31	21.08	

Chongqing Academy of Information and Communication Technology

Address: No. 8,Yuma Road, Chayuan New City, Nan'an District, Chongqing, P. R. China,401336
 Tel: 0086-23-88069965 FAX:0086-23-88608777

		1711.5(131987)	23.38	22.36	21.32	
5MHz	1RB-High (24)	1777.5(132647)	23.74	22.73	21.71	
		1745.0(132322)	23.97	22.93	22.19	
		1712.5(131997)	24.01	23.56	21.95	
		1777.5(132647)	24.37	23.30	22.42	
	1RB-Middle (12)	1745.0(132322)	24.64	23.56	22.65	
		1712.5(131997)	24.60	23.91	22.48	
		1777.5(132647)	24.00	23.02	22.09	
	1RB-Low (0)	1745.0(132322)	24.25	23.15	22.34	
		1712.5(131997)	24.23	23.72	22.11	
		1777.5(132647)	23.23	22.28	21.00	
	12RB-High (13)	1745.0(132322)	23.35	22.33	21.15	
		1712.5(131997)	23.43	22.51	21.20	
		1777.5(132647)	23.34	22.40	21.11	
	12RB-Middle (6)	1745.0(132322)	23.38	22.41	21.21	
		1712.5(131997)	23.49	22.53	21.21	
		1777.5(132647)	23.28	22.34	21.12	
	12RB-Low (0)	1745.0(132322)	23.32	22.33	21.13	
		1712.5(131997)	23.36	22.47	21.15	
		1777.5(132647)	23.24	22.25	21.08	
	25RB (0)	1745.0(132322)	23.31	22.29	21.15	
		1712.5(131997)	23.36	22.46	21.11	
		1775.0(132622)	23.85	22.65	21.77	
	10MHz	1RB-High (49)	1745.0(132322)	24.06	22.83	22.05
			1715.0(132022)	24.02	23.42	22.13
1775.0(132622)			24.33	23.06	22.25	
1RB-Middle (24)		1745.0(132322)	24.45	23.33	22.42	
		1715.0(132022)	24.50	23.85	22.56	
		1775.0(132622)	24.16	22.87	22.04	
1RB-Low (0)		1745.0(132322)	24.24	23.15	22.18	
		1715.0(132022)	24.31	23.54	22.18	
		1775.0(132622)	23.23	22.34	21.12	
25RB-High (25)		1745.0(132322)	23.38	22.46	21.25	
		1715.0(132022)	23.42	22.46	21.25	
		1775.0(132622)	23.33	22.43	21.16	
25RB-Middle (12)		1745.0(132322)	23.37	22.45	21.23	
		1715.0(132022)	23.46	22.54	21.23	
		1775.0(132622)	23.33	22.43	21.23	
25RB-Low (0)		1745.0(132322)	23.32	22.43	21.11	
		1715.0(132022)	23.41	22.46	21.25	
		1775.0(132622)	23.33	22.36	21.07	
50RB (0)		1745.0(132322)	23.34	22.33	21.18	
		1715.0(132022)	23.44	22.44	21.20	
		1772.5(132597)	24.01	22.56	21.49	
15MHz		1RB-High (74)				

Chongqing Academy of Information and Communication Technology

Address: No. 8,Yuma Road, Chayuan New City, Nan'an District, Chongqing, P. R. China,401336
Tel: 0086-23-88069965 FAX:0086-23-88608777

	1RB-Middle (37)	1745.0(132322)	23.92	22.84	22.45	
		1717.5(132047)	23.99	23.30	22.57	
		1772.5(132597)	24.44	23.22	22.05	
	1RB-Low (0)	1745.0(132322)	24.44	23.42	22.87	
		1717.5(132047)	24.54	23.85	22.90	
		1772.5(132597)	24.22	23.04	21.78	
	36RB-High (38)	1745.0(132322)	24.21	23.10	22.53	
		1717.5(132047)	24.29	23.56	21.16	
		1772.5(132597)	23.30	22.30	21.15	
	36RB-Middle (19)	1745.0(132322)	23.46	22.41	21.25	
		1717.5(132047)	23.48	22.43	21.19	
		1772.5(132597)	23.35	22.33	21.19	
	36RB-Low (0)	1745.0(132322)	23.46	22.38	21.14	
		1717.5(132047)	23.52	22.50	21.83	
		1772.5(132597)	23.38	22.31	21.16	
	75RB (0)	1745.0(132322)	23.41	22.38	21.16	
		1717.5(132047)	23.45	22.42	21.23	
		1772.5(132597)	23.38	22.37	21.11	
	20MHz	1RB-High (99)	1745.0(132322)	23.41	22.37	21.22
			1717.5(132047)	23.49	22.45	21.34
1770.0(133572)			23.69	22.94	22.24	
1RB-Middle (50)		1745.0(132322)	23.85	23.42	21.75	
		1720.0(132072)	24.00	23.25	21.83	
		1770.0(133572)	24.52	23.45	22.83	
1RB-Low (0)		1745.0(132322)	24.55	23.95	22.39	
		1720.0(132072)	24.60	23.81	22.52	
		1770.0(133572)	24.19	23.23	22.41	
50RB-High (50)		1745.0(132322)	24.18	23.72	22.12	
		1720.0(132072)	24.18	23.40	22.11	
		1770.0(133572)	23.17	22.15	21.12	
50RB-Middle (25)		1745.0(132322)	23.32	22.40	21.17	
		1720.0(132072)	23.36	22.38	21.19	
		1770.0(133572)	23.23	22.27	21.05	
50RB-Low (0)		1745.0(132322)	23.32	22.34	21.16	
		1720.0(132072)	23.40	22.42	21.26	
		1770.0(133572)	23.31	22.25	21.11	
100RB (0)		1745.0(132322)	23.24	22.28	21.12	
		1720.0(132072)	23.41	22.46	21.25	
	1770.0(133572)	23.25	22.25	21.03		
		1745.0(132322)	23.27	22.28	21.13	
		1720.0(132072)	23.37	22.37	21.18	

LTE band2 power level B1					
BANDWIDTH	Number of RBs	Frequency	QPSK	16QAM	64QAM
1.4MHz	1RB-High (5)	1909.3 (19193)	22.80	23.05	22.18
		1880 (18900)	22.81	22.55	22.04
		1850.7 (18607)	22.68	22.34	22.01
	1RB-Middle (3)	1909.3 (19193)	23.22	23.52	22.52
		1880 (18900)	23.12	22.84	22.05
		1850.7 (18607)	23.14	22.95	22.33
	1RB-Low (0)	1909.3 (19193)	22.98	23.32	22.18
		1880 (18900)	22.85	22.61	22.00
		1850.7 (18607)	22.91	22.72	22.05
	3RB-High (3)	1909.3 (19193)	23.11	22.99	21.98
		1880 (18900)	23.03	22.71	22.00
		1850.7 (18607)	22.86	22.74	21.97
	3RB-Middle (1)	1909.3 (19193)	23.21	22.98	21.99
		1880 (18900)	23.08	22.86	21.98
		1850.7 (18607)	23.05	22.90	21.99
	3RB-Low (0)	1909.3 (19193)	23.12	22.99	21.94
		1880 (18900)	22.98	22.89	21.88
		1850.7 (18607)	23.02	22.97	21.88
	6RB (0)	1909.3 (19193)	23.12	22.05	21.15
		1880 (18900)	22.98	22.12	21.29
		1850.7 (18607)	23.01	22.19	21.13
3MHz	1RB-High (14)	1908.5 (19185)	22.86	22.65	22.15
		1880 (18900)	22.71	23.11	22.01
		1851.5 (18615)	22.80	22.53	22.30
	1RB-Middle (7)	1908.5 (19185)	23.22	23.13	22.49
		1880 (18900)	23.10	23.48	22.04
		1851.5 (18615)	23.16	22.98	22.28
	1RB-Low (0)	1908.5 (19185)	22.96	22.93	22.25
		1880 (18900)	22.93	23.28	22.00
		1851.5 (18615)	22.98	22.75	22.12
	8RB-High (7)	1908.5 (19185)	23.07	22.09	21.11
		1880 (18900)	22.96	22.05	21.07
		1851.5 (18615)	23.00	22.03	21.06
	8RB-Middle (4)	1908.5 (19185)	23.18	22.21	21.26
		1880 (18900)	23.04	22.14	21.14
		1851.5 (18615)	23.11	22.04	21.04
	8RB-Low (0)	1908.5 (19185)	23.12	22.16	21.16
		1880 (18900)	23.01	22.10	21.07
		1851.5 (18615)	23.06	22.01	21.06
	15RB (0)	1908.5 (19185)	23.10	22.12	21.12
		1880 (18900)	22.97	22.08	21.06
		1851.5 (18615)	23.00	22.01	21.03

Chongqing Academy of Information and Communication Technology

Address: No. 8,Yuma Road, Chayuan New City, Nan'an District, Chongqing, P. R. China,401336
 Tel: 0086-23-88069965 FAX:0086-23-88608777

5MHz	1RB-High (24)	1907.5 (19175)	22.84	22.78	22.06
		1880 (18900)	22.68	23.11	22.18
		1852.5 (18625)	22.52	22.60	22.01
	1RB-Middle (12)	1907.5 (19175)	23.43	23.31	22.50
		1880 (18900)	23.22	23.71	22.61
		1852.5 (18625)	23.19	23.20	22.31
	1RB-Low (0)	1907.5 (19175)	23.05	22.97	22.16
		1880 (18900)	22.85	23.31	22.26
		1852.5 (18625)	22.84	22.90	22.06
	12RB-High (13)	1907.5 (19175)	23.10	22.12	21.11
		1880 (18900)	22.98	22.06	21.06
		1852.5 (18625)	23.10	22.13	21.05
	12RB-Middle (6)	1907.5 (19175)	23.22	22.25	21.23
		1880 (18900)	23.07	22.14	21.16
		1852.5 (18625)	23.12	22.17	21.10
	12RB-Low (0)	1907.5 (19175)	23.11	22.18	21.12
		1880 (18900)	23.01	22.07	21.08
		1852.5 (18625)	23.03	22.11	21.03
25RB (0)	1907.5 (19175)	23.13	22.11	21.18	
	1880 (18900)	23.02	22.10	21.06	
	1852.5 (18625)	23.03	22.04	21.02	
10MHz	1RB-High (49)	1905 (19150)	22.89	22.68	22.02
		1880 (18900)	22.63	23.10	22.03
		1855 (18650)	22.84	22.51	22.06
	1RB-Middle (24)	1905 (19150)	23.24	23.11	22.15
		1880 (18900)	23.11	23.47	22.25
		1855 (18650)	23.15	22.89	22.36
	1RB-Low (0)	1905 (19150)	22.97	22.88	22.04
		1880 (18900)	22.89	23.19	22.01
		1855 (18650)	22.91	22.70	22.16
	25RB-High (25)	1905 (19150)	23.15	22.24	21.20
		1880 (18900)	23.04	22.11	21.13
		1855 (18650)	23.16	22.24	21.16
	25RB-Middle (12)	1905 (19150)	23.20	22.27	21.28
		1880 (18900)	23.07	22.13	21.16
		1855 (18650)	23.11	22.22	21.13
	25RB-Low (0)	1905 (19150)	23.21	22.29	21.26
		1880 (18900)	23.09	22.13	21.18
		1855 (18650)	23.01	22.16	21.07
50RB (0)	1905 (19150)	23.14	22.16	21.18	
	1880 (18900)	23.06	22.09	21.08	
	1855 (18650)	23.12	22.15	21.11	
15MHz	1RB-High (74)	1902.5 (19125)	22.79	22.72	22.01
		1880 (18900)	22.61	22.96	22.38

Chongqing Academy of Information and Communication Technology

Address: No. 8,Yuma Road, Chayuan New City, Nan'an District, Chongqing, P. R. China,401336
Tel: 0086-23-88069965 FAX:0086-23-88608777

	1RB-Middle (37)	1857.5 (18675)	22.69	22.42	22.04
		1902.5 (19125)	23.24	23.13	22.09
		1880 (18900)	23.16	23.50	22.77
		1857.5 (18675)	23.20	23.22	22.42
	1RB-Low (0)	1902.5 (19125)	22.91	22.85	22.02
		1880 (18900)	22.83	23.19	22.41
		1857.5 (18675)	22.91	22.94	22.02
	36RB-High (38)	1902.5 (19125)	23.27	22.17	21.21
		1880 (18900)	23.10	22.06	21.01
		1857.5 (18675)	23.19	22.11	21.18
	36RB-Middle (19)	1902.5 (19125)	23.31	22.22	21.23
		1880 (18900)	23.12	22.06	21.08
		1857.5 (18675)	23.12	22.06	21.13
	36RB-Low (0)	1902.5 (19125)	23.27	22.19	21.21
		1880 (18900)	23.13	22.10	21.06
		1857.5 (18675)	23.15	22.02	21.06
	75RB (0)	1902.5 (19125)	23.27	22.24	21.19
		1880 (18900)	23.12	22.11	21.11
1857.5 (18675)		23.12	22.06	21.06	
20MHz	1RB-High (99)	1900 (19100)	22.80	23.19	22.40
		1880 (18900)	22.66	22.87	22.00
		1860 (18700)	22.60	22.84	22.01
	1RB-Middle (50)	1900 (19100)	23.32	23.67	22.93
		1880 (18900)	23.22	23.48	22.40
		1860 (18700)	23.23	23.44	22.30
	1RB-Low (0)	1900 (19100)	22.89	23.27	22.45
		1880 (18900)	22.84	23.09	22.06
		1860 (18700)	22.87	23.14	22.01
	50RB-High (50)	1900 (19100)	23.08	22.09	21.10
		1880 (18900)	22.99	22.01	21.00
		1860 (18700)	23.18	22.12	21.04
	50RB-Middle (25)	1900 (19100)	23.14	22.17	21.10
		1880 (18900)	23.07	22.07	21.07
		1860 (18700)	23.14	22.11	21.06
	50RB-Low (0)	1900 (19100)	23.17	22.18	21.09
		1880 (18900)	23.09	22.09	21.06
		1860 (18700)	22.98	22.05	21.02
	100RB (0)	1900 (19100)	23.16	22.16	21.07
		1880 (18900)	23.08	22.07	21.06
		1860 (18700)	23.12	22.07	21.04

LTE band5 power level B1/C1					
BANDWIDTH	Number of RBs	Frequency	QPSK	16QAM	64QAM
1.4MHz	1RB-High (5)	848.3 (20643)	24.20	23.45	22.60
		836.5 (20525)	24.26	23.02	22.38
		824.7 (20407)	24.19	22.88	22.74
	1RB-Middle (3)	848.3 (20643)	24.55	23.85	22.98
		836.5 (20525)	24.58	23.31	22.63
		824.7 (20407)	24.60	23.40	22.85
	1RB-Low (0)	848.3 (20643)	24.33	23.60	22.80
		836.5 (20525)	24.34	23.06	22.45
		824.7 (20407)	24.38	23.14	22.53
	3RB-High (3)	848.3 (20643)	24.40	23.61	22.60
		836.5 (20525)	24.44	23.45	22.53
		824.7 (20407)	24.33	23.48	22.63
	3RB-Middle (1)	848.3 (20643)	24.52	23.68	22.72
		836.5 (20525)	24.50	23.56	22.60
		824.7 (20407)	24.46	23.60	22.48
	3RB-Low (0)	848.3 (20643)	24.46	23.65	22.71
		836.5 (20525)	24.41	23.47	22.67
		824.7 (20407)	24.39	23.53	22.51
	6RB (0)	848.3 (20643)	23.48	22.32	21.92
		836.5 (20525)	23.45	22.57	21.85
		824.7 (20407)	23.44	22.60	21.89
3MHz	1RB-High (14)	847.5 (20635)	24.25	23.55	22.73
		836.5 (20525)	24.28	22.98	22.67
		825.5 (20415)	24.35	23.11	22.48
	1RB-Middle (7)	847.5 (20635)	24.61	23.90	22.98
		836.5 (20525)	24.66	23.37	22.78
		825.5 (20415)	24.62	23.57	22.73
	1RB-Low (0)	847.5 (20635)	24.44	23.71	22.85
		836.5 (20525)	24.45	23.22	22.55
		825.5 (20415)	24.36	23.32	22.47
	8RB-High (7)	847.5 (20635)	23.48	22.54	21.86
		836.5 (20525)	23.48	22.42	21.85
		825.5 (20415)	23.48	22.48	21.81
	8RB-Middle (4)	847.5 (20635)	23.54	22.62	21.97
		836.5 (20525)	23.55	22.51	21.92
		825.5 (20415)	23.57	22.57	21.91
	8RB-Low (0)	847.5 (20635)	23.51	22.58	21.94
		836.5 (20525)	23.54	22.44	21.90
		825.5 (20415)	23.53	22.53	21.83
	15RB (0)	847.5 (20635)	23.47	22.49	21.83
		836.5 (20525)	23.46	22.42	21.86
		825.5 (20415)	23.51	22.52	21.80

Chongqing Academy of Information and Communication Technology

Address: No. 8,Yuma Road, Chayuan New City, Nan'an District, Chongqing, P. R. China,401336
 Tel: 0086-23-88069965 FAX:0086-23-88608777

5MHz	1RB-High (24)	846.5 (20625)	24.00	23.01	22.80
		836.5 (20525)	24.15	23.11	22.45
		826.5 (20425)	24.11	23.72	22.50
	1RB-Middle (12)	846.5 (20625)	24.79	23.69	22.90
		836.5 (20525)	24.78	23.66	22.60
		826.5 (20425)	24.67	24.00	22.93
	1RB-Low (0)	846.5 (20625)	24.28	23.31	22.82
		836.5 (20525)	24.46	23.36	22.57
		826.5 (20425)	24.28	23.84	22.58
	12RB-High (13)	846.5 (20625)	23.48	22.54	21.93
		836.5 (20525)	23.46	22.48	21.83
		826.5 (20425)	23.48	22.56	21.85
	12RB-Middle (6)	846.5 (20625)	23.56	22.65	21.95
		836.5 (20525)	23.56	22.56	21.92
		826.5 (20425)	23.57	22.66	21.93
	12RB-Low (0)	846.5 (20625)	23.57	22.62	21.97
		836.5 (20525)	23.47	22.52	21.86
		826.5 (20425)	23.51	22.57	21.84
25RB (0)	846.5 (20625)	23.54	22.54	21.87	
	836.5 (20525)	23.46	22.47	21.95	
	826.5 (20425)	23.48	22.60	21.94	
10MHz	1RB-High (49)	844 (20600)	24.18	22.92	22.86
		836.5 (20525)	24.28	23.07	22.66
		829 (20450)	24.20	23.60	22.61
	1RB-Middle (24)	844 (20600)	24.84	23.34	22.91
		836.5 (20525)	24.58	23.50	22.89
		829 (20450)	24.61	23.96	22.83
	1RB-Low (0)	844 (20600)	24.39	23.11	22.84
		836.5 (20525)	24.46	23.40	22.78
		829 (20450)	24.38	23.68	22.60
	25RB-High (25)	844 (20600)	23.49	22.61	21.89
		836.5 (20525)	23.55	22.63	21.84
		829 (20450)	23.56	22.62	21.95
	25RB-Middle (12)	844 (20600)	23.54	22.67	21.90
		836.5 (20525)	23.54	22.64	21.85
		829 (20450)	23.57	22.65	21.94
	25RB-Low (0)	844 (20600)	23.58	22.65	21.94
		836.5 (20525)	23.52	22.63	21.89
		829 (20450)	23.59	22.65	21.94
50RB (0)	844 (20600)	23.51	22.59	21.85	
	836.5 (20525)	23.43	22.54	21.88	
	829 (20450)	23.58	22.60	21.80	

Chongqing Academy of Information and Communication Technology

Address: No. 8,Yuma Road, Chayuan New City, Nan'an District, Chongqing, P. R. China,401336
Tel: 0086-23-88069965 FAX:0086-23-88608777

LTE band12 power level B1/C1					
BANDWIDTH	Number of RBs	Frequency	QPSK	16QAM	64QAM
1.4MHz	1RB-High (5)	715.3	24.27	23.37	22.47
		707.5	24.32	23.03	22.23
		699.7	24.27	22.91	22.31
	1RB-Middle (3)	715.3	24.69	23.81	22.89
		707.5	24.61	23.35	22.53
		699.7	24.60	23.43	22.79
	1RB-Low (0)	715.3	24.43	23.61	22.53
		707.5	24.39	23.15	22.41
		699.7	24.48	23.20	22.42
	3RB-High (3)	715.3	24.40	23.59	22.32
		707.5	24.48	23.51	22.36
		699.7	24.35	23.46	22.29
	3RB-Middle (1)	715.3	24.54	23.64	22.45
		707.5	24.54	23.63	22.45
		699.7	24.51	23.63	22.35
	3RB-Low (0)	715.3	24.47	23.61	22.31
		707.5	24.47	23.54	22.38
		699.7	24.44	23.53	22.31
	6RB (0)	715.3	23.56	22.41	21.39
		707.5	23.54	22.69	21.42
		699.7	23.53	22.72	21.54
3MHz	1RB-High (14)	714.5	24.34	22.91	22.51
		707.5	24.32	23.08	22.30
		700.5	24.30	23.57	22.10
	1RB-Middle (7)	714.5	24.64	23.33	22.78
		707.5	24.61	23.53	22.67
		700.5	24.67	23.91	22.50
	1RB-Low (0)	714.5	24.48	23.15	22.63
		707.5	24.43	23.38	22.38
		700.5	24.48	23.71	22.13
	8RB-High (7)	714.5	23.48	22.45	21.34
		707.5	23.50	22.55	21.40
		700.5	23.48	22.57	21.45
	8RB-Middle (4)	714.5	23.59	22.54	21.51
		707.5	23.58	22.66	21.50
		700.5	23.58	22.68	21.58
	8RB-Low (0)	714.5	23.53	22.49	21.47
		707.5	23.52	22.60	21.48
		700.5	23.56	22.65	21.53
	15RB (0)	714.5	23.46	22.46	21.30
		707.5	23.49	22.59	21.49
		700.5	23.48	22.53	21.49

Chongqing Academy of Information and Communication Technology

Address: No. 8,Yuma Road, Chayuan New City, Nan'an District, Chongqing, P. R. China,401336
 Tel: 0086-23-88069965 FAX:0086-23-88608777

5MHz	1RB-High (24)	713.5	23.99	22.95	22.05	
		707.5	24.14	23.11	22.63	
		701.5	24.15	23.70	22.31	
	1RB-Middle (12)	713.5	24.60	23.53	22.64	
		707.5	24.81	23.69	22.89	
		701.5	24.72	24.00	22.69	
	1RB-Low (0)	713.5	24.24	23.24	22.18	
		707.5	24.45	23.37	22.78	
		701.5	24.36	23.81	22.23	
	12RB-High (13)	713.5	23.44	22.51	21.43	
		707.5	23.52	22.60	21.58	
		701.5	23.49	22.57	21.45	
	12RB-Middle (6)	713.5	23.56	22.65	21.54	
		707.5	23.57	22.67	21.62	
		701.5	23.58	22.68	21.53	
	12RB-Low (0)	713.5	23.48	22.53	21.44	
		707.5	23.51	22.60	21.50	
		701.5	23.55	22.65	21.51	
	25RB (0)	713.5	23.44	22.49	21.57	
		707.5	23.53	22.59	21.46	
		701.5	23.49	22.66	21.46	
	10MHz	1RB-High (49)	711	24.28	22.84	22.65
			707.5	24.24	23.00	22.20
			704	24.14	23.55	22.13
1RB-Middle (24)		711	24.59	23.33	22.83	
		707.5	24.62	23.54	22.63	
		704	24.64	23.93	22.64	
1RB-Low (0)		711	24.38	23.14	22.65	
		707.5	24.41	23.26	22.40	
		704	24.43	23.63	22.31	
25RB-High (25)		711	23.54	22.62	21.45	
		707.5	23.65	22.75	21.67	
		704	23.56	22.65	21.76	
25RB-Middle (12)		711	23.53	22.66	21.59	
		707.5	23.58	22.72	21.52	
		704	23.58	22.65	21.71	
25RB-Low (0)		711	23.45	22.62	21.44	
		707.5	23.60	22.71	21.54	
		704	23.61	22.72	21.77	
50RB (0)		711	23.48	22.60	21.41	
		707.5	23.62	22.67	21.56	
		704	23.58	22.62	21.65	

Chongqing Academy of Information and Communication Technology

Address: No. 8,Yuma Road, Chayuan New City, Nan'an District, Chongqing, P. R. China,401336
 Tel: 0086-23-88069965 FAX:0086-23-88608777

LTE band14 power level B1/C1					
BANDWIDTH	Number of RBs	Frequency	QPSK	16QAM	64QAM
5MHz	1RB-High (24)	795.5 (23355)	23.98	22.90	21.98
		793 (23330)	23.87	23.45	22.18
		790.5 (23305)	23.78	22.79	22.05
	1RB-Middle (12)	795.5 (23355)	24.46	23.48	22.56
		793 (23330)	24.46	24.00	22.71
		790.5 (23305)	24.42	23.41	22.61
	1RB-Low (0)	795.5 (23355)	24.25	23.15	22.05
		793 (23330)	24.11	23.64	22.28
		790.5 (23305)	24.09	23.13	22.16
	12RB-High (13)	795.5 (23355)	23.25	22.30	21.16
		793 (23330)	23.30	22.37	21.26
		790.5 (23305)	23.25	22.45	21.19
	12RB-Middle (6)	795.5 (23355)	23.34	22.43	21.26
		793 (23330)	23.35	22.46	21.24
		790.5 (23305)	23.38	22.45	21.24
	12RB-Low (0)	795.5 (23355)	23.30	22.35	21.11
		793 (23330)	23.31	22.43	21.16
		790.5 (23305)	23.26	22.37	21.20
	25RB (0)	795.5 (23355)	23.31	22.35	21.08
		793 (23330)	23.28	22.33	21.05
		790.5 (23305)	23.26	22.32	21.19
10MHz	1RB-High (49)	793 (23330)	24.06	22.73	22.06
	1RB-Middle (24)	793 (23330)	24.53	23.17	22.35
	1RB-Low (0)	793 (23330)	24.28	23.00	22.09
	25RB-High (25)	793 (23330)	23.30	22.46	21.15
	25RB-Middle (12)	793 (23330)	23.38	22.54	21.16
	25RB-Low (0)	793 (23330)	23.30	22.45	21.09
	50RB (0)	793 (23330)	23.28	22.38	21.10

LTE band30 power level B1					
BANDWIDTH	Number of RBs	Frequency	QPSK	16QAM	64QAM
5MHz	1RB-High (24)	2312.5 (27735)	21.61	21.63	21.69
		2310 (27710)	21.55	22.03	22.03
		2307.5 (27685)	21.44	21.47	21.69
	1RB-Middle (12)	2312.5 (27735)	22.22	22.14	22.30
		2310 (27710)	22.08	22.57	22.48
		2307.5 (27685)	22.10	22.08	22.23
	1RB-Low (0)	2312.5 (27735)	21.88	21.82	21.98
		2310 (27710)	21.86	22.34	22.16
		2307.5 (27685)	21.72	21.79	21.93
	12RB-High (13)	2312.5 (27735)	22.00	21.90	21.02
		2310 (27710)	21.92	21.95	21.07
		2307.5 (27685)	21.90	22.00	21.08
	12RB-Middle (6)	2312.5 (27735)	21.99	22.03	21.02
		2310 (27710)	22.01	22.06	21.10
		2307.5 (27685)	22.03	22.06	21.10
	12RB-Low (0)	2312.5 (27735)	21.94	21.94	21.01
		2310 (27710)	21.95	21.99	21.04
		2307.5 (27685)	21.94	21.97	21.08
	25RB (0)	2312.5 (27735)	21.95	21.93	21.03
		2310 (27710)	21.94	22.00	21.06
		2307.5 (27685)	21.92	21.90	21.04
10MHz	1RB-High (49)	2310 (27710)	21.73	21.41	21.72
	1RB-Middle (24)	2310 (27710)	22.00	21.78	22.13
	1RB-Low (0)	2310 (27710)	21.81	21.56	21.90
	25RB-High (25)	2310 (27710)	21.97	21.95	21.06
	25RB-Middle (12)	2310 (27710)	21.98	21.99	21.05
	25RB-Low (0)	2310 (27710)	21.86	21.97	21.07
	50RB (0)	2310 (27710)	21.95	21.98	21.03

LTE band66 power level B1					
BANDWIDTH	Number of RBs	Frequency	QPSK	16QAM	64QAM
1.4MHz	1RB-High (5)	1779.3(132665)	21.22	21.00	21.62
		1745.0(132322)	21.33	21.64	21.80
		1710.7(131979)	21.51	21.27	21.90
	1RB-Middle (3)	1779.3(132665)	21.70	21.52	22.11
		1745.0(132322)	21.71	22.10	22.14
		1710.7(131979)	21.82	21.60	22.31
	1RB-Low (0)	1779.3(132665)	21.51	21.29	21.87
		1745.0(132322)	21.53	21.88	21.83
		1710.7(131979)	21.59	21.37	22.02
	3RB-High (3)	1779.3(132665)	21.41	21.61	21.84
		1745.0(132322)	21.62	21.90	22.01
		1710.7(131979)	21.77	21.75	22.18
	3RB-Middle (1)	1779.3(132665)	21.62	21.76	22.04
		1745.0(132322)	21.77	21.96	22.21
		1710.7(131979)	21.81	21.88	22.21
	3RB-Low (0)	1779.3(132665)	21.53	21.70	21.95
		1745.0(132322)	21.70	21.91	22.11
		1710.7(131979)	21.72	21.80	22.18
	6RB (0)	1779.3(132665)	21.58	21.73	21.35
		1745.0(132322)	21.65	21.50	21.24
		1710.7(131979)	21.75	21.88	21.21
3MHz	1RB-High (14)	1778.5(132657)	21.59	21.88	21.76
		1745.0(132322)	21.84	21.95	21.97
		1711.5(131987)	22.07	22.09	22.29
	1RB-Middle (7)	1778.5(132657)	22.22	22.38	22.09
		1745.0(132322)	22.33	22.45	22.41
		1711.5(131987)	22.51	22.54	22.58
	1RB-Low (0)	1778.5(132657)	21.96	22.04	21.85
		1745.0(132322)	22.01	22.19	22.23
		1711.5(131987)	22.21	22.29	22.38
	8RB-High (7)	1778.5(132657)	22.03	22.07	21.14
		1745.0(132322)	22.12	22.13	21.11
		1711.5(131987)	22.18	22.13	21.22
	8RB-Middle (4)	1778.5(132657)	22.12	22.15	21.22
		1745.0(132322)	22.21	22.24	21.18
		1711.5(131987)	22.23	22.21	21.30
	8RB-Low (0)	1778.5(132657)	22.06	22.14	21.19
		1745.0(132322)	22.15	22.19	21.11
		1711.5(131987)	22.22	22.16	21.25
	15RB (0)	1778.5(132657)	22.00	21.95	21.13
		1745.0(132322)	22.11	22.09	21.13
		1711.5(131987)	22.12	22.15	21.20

Chongqing Academy of Information and Communication Technology

Address: No. 8,Yuma Road, Chayuan New City, Nan'an District, Chongqing, P. R. China,401336
 Tel: 0086-23-88069965 FAX:0086-23-88608777

5MHz	1RB-High (24)	1777.5(132647)	21.61	22.09	21.77
		1745.0(132322)	21.59	21.62	22.03
		1712.5(131997)	21.84	21.82	21.93
	1RB-Middle (12)	1777.5(132647)	22.23	22.70	22.48
		1745.0(132322)	22.27	22.29	22.69
		1712.5(131997)	22.48	22.40	22.55
	1RB-Low (0)	1777.5(132647)	21.86	22.31	22.16
		1745.0(132322)	21.90	21.99	22.37
		1712.5(131997)	22.12	22.03	22.15
	12RB-High (13)	1777.5(132647)	22.03	22.06	21.04
		1745.0(132322)	22.12	22.15	21.22
		1712.5(131997)	22.19	22.22	21.25
	12RB-Middle (6)	1777.5(132647)	22.14	22.18	21.07
		1745.0(132322)	22.20	22.21	21.26
		1712.5(131997)	22.22	22.25	21.26
	12RB-Low (0)	1777.5(132647)	22.05	22.13	21.08
		1745.0(132322)	22.09	22.14	21.20
		1712.5(131997)	22.16	22.18	21.19
25RB (0)	1777.5(132647)	22.03	22.11	21.09	
	1745.0(132322)	22.11	22.07	21.17	
	1712.5(131997)	22.18	22.15	21.16	
10MHz	1RB-High (49)	1775.0(132622)	21.62	22.09	21.67
		1745.0(132322)	21.68	22.12	21.89
		1715.0(132022)	21.89	21.63	22.20
	1RB-Middle (24)	1775.0(132622)	22.10	22.45	22.10
		1745.0(132322)	22.13	22.55	22.36
		1715.0(132022)	22.23	22.02	22.52
	1RB-Low (0)	1775.0(132622)	21.95	22.27	21.85
		1745.0(132322)	21.98	22.33	22.15
		1715.0(132022)	22.06	21.82	22.28
	25RB-High (25)	1775.0(132622)	22.06	22.10	21.19
		1745.0(132322)	22.11	22.18	21.31
		1715.0(132022)	22.16	22.24	21.28
	25RB-Middle (12)	1775.0(132622)	22.11	22.15	21.23
		1745.0(132322)	22.14	22.15	21.31
		1715.0(132022)	22.23	22.35	21.31
	25RB-Low (0)	1775.0(132622)	22.14	22.16	21.29
		1745.0(132322)	22.08	22.19	21.26
		1715.0(132022)	22.10	22.26	21.24
50RB (0)	1775.0(132622)	22.08	22.12	21.21	
	1745.0(132322)	22.13	22.10	21.21	
	1715.0(132022)	22.19	22.20	21.29	
15MHz	1RB-High (74)	1772.5(132597)	21.82	21.44	21.52
		1745.0(132322)	21.63	21.66	21.94

Chongqing Academy of Information and Communication Technology

Address: No. 8,Yuma Road, Chayuan New City, Nan'an District, Chongqing, P. R. China,401336
Tel: 0086-23-88069965 FAX:0086-23-88608777

	1RB-Middle (37)	1717.5(132047)	21.81	22.12	21.72	
		1772.5(132597)	22.31	22.26	22.11	
		1745.0(132322)	22.21	22.20	22.55	
		1717.5(132047)	22.39	22.67	22.12	
	1RB-Low (0)	1772.5(132597)	21.95	22.00	21.86	
		1745.0(132322)	21.85	21.93	22.20	
		1717.5(132047)	22.06	22.35	21.93	
	36RB-High (38)	1772.5(132597)	22.12	22.02	21.17	
		1745.0(132322)	22.25	22.21	21.23	
		1717.5(132047)	22.32	22.25	21.33	
	36RB-Middle (19)	1772.5(132597)	22.21	22.18	21.21	
		1745.0(132322)	22.24	22.21	21.25	
		1717.5(132047)	22.28	22.28	21.32	
	36RB-Low (0)	1772.5(132597)	22.14	22.12	21.23	
		1745.0(132322)	22.16	22.10	21.23	
		1717.5(132047)	22.25	22.25	21.27	
	75RB (0)	1772.5(132597)	22.12	22.10	21.19	
		1745.0(132322)	22.20	22.15	21.15	
		1717.5(132047)	22.25	22.23	21.22	
	20MHz	1RB-High (99)	1770.0(133572)	21.56	21.83	21.95
			1745.0(132322)	21.79	22.28	21.78
			1720.0(132072)	21.78	22.08	21.91
		1RB-Middle (50)	1770.0(133572)	22.20	22.46	22.27
			1745.0(132322)	22.33	22.81	22.53
			1720.0(132072)	22.34	22.64	22.52
		1RB-Low (0)	1770.0(133572)	21.89	22.11	22.26
			1745.0(132322)	21.97	22.46	22.13
1720.0(132072)			22.01	22.26	22.13	
50RB-High (50)		1770.0(133572)	21.97	21.91	21.06	
		1745.0(132322)	22.13	22.15	21.16	
		1720.0(132072)	22.20	22.19	21.28	
50RB-Middle (25)		1770.0(133572)	22.09	22.04	21.11	
		1745.0(132322)	22.16	22.18	21.17	
		1720.0(132072)	22.27	22.26	21.26	
50RB-Low (0)		1770.0(133572)	22.13	22.08	21.12	
		1745.0(132322)	22.10	22.12	21.12	
		1720.0(132072)	22.24	22.23	21.26	
100RB (0)		1770.0(133572)	22.02	22.01	21.07	
		1745.0(132322)	22.11	22.14	21.18	
		1720.0(132072)	22.23	22.22	21.25	

Chongqing Academy of Information and Communication Technology

Address: No. 8,Yuma Road, Chayuan New City, Nan'an District, Chongqing, P. R. China,401336
 Tel: 0086-23-88069965 FAX:0086-23-88608777

LTE band2 power level C1					
BANDWIDTH	Number of RBs	Frequency	QPSK	16QAM	64QAM
1.4MHz	1RB-High (5)	1909.3 (19193)	21.85	22.18	22.04
		1880 (18900)	21.86	21.61	21.58
		1850.7 (18607)	21.75	21.48	21.95
	1RB-Middle (3)	1909.3 (19193)	22.28	22.61	22.48
		1880 (18900)	22.18	21.93	22.04
		1850.7 (18607)	22.16	22.04	22.28
	1RB-Low (0)	1909.3 (19193)	22.06	22.38	22.19
		1880 (18900)	21.90	21.71	21.79
		1850.7 (18607)	21.95	21.78	22.07
	3RB-High (3)	1909.3 (19193)	22.18	22.39	22.32
		1880 (18900)	22.08	22.10	22.12
		1850.7 (18607)	21.94	22.14	22.06
	3RB-Middle (1)	1909.3 (19193)	22.29	22.48	22.46
		1880 (18900)	22.08	22.24	22.19
		1850.7 (18607)	22.09	22.31	22.17
	3RB-Low (0)	1909.3 (19193)	22.22	22.42	22.39
		1880 (18900)	22.03	22.15	22.09
		1850.7 (18607)	22.05	22.25	22.00
	6RB (0)	1909.3 (19193)	22.18	22.03	22.07
		1880 (18900)	22.02	22.18	21.30
		1850.7 (18607)	22.06	22.04	21.15
3MHz	1RB-High (14)	1908.5 (19185)	21.91	22.29	22.19
		1880 (18900)	21.82	21.54	21.69
		1851.5 (18615)	21.77	21.63	21.87
	1RB-Middle (7)	1908.5 (19185)	22.30	22.65	22.53
		1880 (18900)	22.19	22.00	22.06
		1851.5 (18615)	22.11	22.15	22.34
	1RB-Low (0)	1908.5 (19185)	22.08	22.40	22.28
		1880 (18900)	21.98	21.78	21.78
		1851.5 (18615)	21.89	21.95	22.15
	8RB-High (7)	1908.5 (19185)	22.14	22.21	21.16
		1880 (18900)	22.01	21.98	21.06
		1851.5 (18615)	22.05	22.04	21.06
	8RB-Middle (4)	1908.5 (19185)	22.22	22.32	21.28
		1880 (18900)	22.08	22.06	21.13
		1851.5 (18615)	22.09	22.14	21.08
	8RB-Low (0)	1908.5 (19185)	22.19	22.27	21.21
		1880 (18900)	22.01	22.01	21.11
		1851.5 (18615)	22.06	22.09	21.06
15RB (0)	1908.5 (19185)	22.15	22.13	21.16	
	1880 (18900)	22.02	22.00	21.08	

Chongqing Academy of Information and Communication Technology

Address: No. 8,Yuma Road, Chayuan New City, Nan'an District, Chongqing, P. R. China,401336
 Tel: 0086-23-88069965 FAX:0086-23-88608777

		1851.5 (18615)	22.04	22.07	21.08	
5MHz	1RB-High (24)	1907.5 (19175)	21.88	22.37	21.89	
		1880 (18900)	21.52	21.60	21.95	
		1852.5 (18625)	21.71	21.72	21.82	
	1RB-Middle (12)	1907.5 (19175)	22.42	22.88	22.52	
		1880 (18900)	22.16	22.19	22.60	
		1852.5 (18625)	22.30	22.26	22.36	
	1RB-Low (0)	1907.5 (19175)	21.93	22.41	22.18	
		1880 (18900)	21.81	21.87	22.28	
		1852.5 (18625)	21.98	21.93	22.05	
	12RB-High (13)	1907.5 (19175)	22.14	22.17	21.10	
		1880 (18900)	21.99	22.04	21.06	
		1852.5 (18625)	22.04	22.08	21.06	
	12RB-Middle (6)	1907.5 (19175)	22.24	22.32	21.20	
		1880 (18900)	22.10	22.16	21.13	
		1852.5 (18625)	22.12	22.14	21.10	
	12RB-Low (0)	1907.5 (19175)	22.16	22.19	21.12	
		1880 (18900)	22.01	22.10	21.11	
		1852.5 (18625)	22.04	22.07	21.06	
	25RB (0)	1907.5 (19175)	22.15	22.20	21.15	
		1880 (18900)	22.01	22.05	21.08	
		1852.5 (18625)	22.05	22.08	21.02	
	10MHz	1RB-High (49)	1905 (19150)	21.78	22.21	22.01
			1880 (18900)	21.78	21.49	22.01
			1855 (18650)	21.75	21.60	21.85
1RB-Middle (24)		1905 (19150)	22.19	22.58	22.40	
		1880 (18900)	22.15	21.94	22.41	
		1855 (18650)	22.10	22.10	22.28	
1RB-Low (0)		1905 (19150)	22.01	22.31	22.13	
		1880 (18900)	21.89	21.66	22.11	
		1855 (18650)	21.88	21.90	21.80	
25RB-High (25)		1905 (19150)	22.18	22.17	21.31	
		1880 (18900)	22.01	22.14	21.09	
		1855 (18650)	22.12	22.24	21.26	
25RB-Middle (12)		1905 (19150)	22.18	22.20	21.36	
		1880 (18900)	22.01	22.15	21.11	
		1855 (18650)	22.09	22.15	21.19	
25RB-Low (0)		1905 (19150)	22.23	22.26	21.32	
		1880 (18900)	22.06	22.12	21.13	
		1855 (18650)	22.06	22.10	21.13	
50RB (0)		1905 (19150)	22.16	22.17	21.14	
		1880 (18900)	22.05	22.07	21.08	
		1855 (18650)	22.11	22.10	21.15	
15MHz		1RB-High (74)	1902.5 (19125)	21.74	21.75	22.01

Chongqing Academy of Information and Communication Technology

Address: No. 8,Yuma Road, Chayuan New City, Nan'an District, Chongqing, P. R. China,401336
 Tel: 0086-23-88069965 FAX:0086-23-88608777

	1RB-Middle (37)	1880 (18900)	21.59	21.95	21.51	
		1857.5 (18675)	21.62	21.43	22.08	
		1902.5 (19125)	22.19	22.16	22.51	
	1RB-Low (0)	1880 (18900)	22.13	22.54	22.06	
		1857.5 (18675)	22.23	22.27	22.45	
		1902.5 (19125)	21.89	21.85	22.14	
	36RB-High (38)	1880 (18900)	21.85	22.18	21.71	
		1857.5 (18675)	21.92	22.01	22.23	
		1902.5 (19125)	22.19	22.18	21.21	
	36RB-Middle (19)	1880 (18900)	22.05	22.05	21.06	
		1857.5 (18675)	22.15	22.13	21.15	
		1902.5 (19125)	22.25	22.20	21.25	
	36RB-Low (0)	1880 (18900)	22.05	22.04	21.06	
		1857.5 (18675)	22.09	22.08	21.11	
		1902.5 (19125)	22.23	22.18	21.24	
	75RB (0)	1880 (18900)	22.10	22.03	21.11	
		1857.5 (18675)	22.05	22.00	21.04	
		1902.5 (19125)	22.18	22.21	21.16	
	20MHz	1RB-High (99)	1880 (18900)	22.09	22.07	21.10
			1857.5 (18675)	22.05	22.04	21.14
			1900 (19100)	21.78	22.21	21.98
1RB-Middle (50)		1880 (18900)	21.66	21.92	22.11	
		1860 (18700)	21.57	21.88	21.70	
		1900 (19100)	22.31	22.75	22.51	
1RB-Low (0)		1880 (18900)	22.21	22.51	22.68	
		1860 (18700)	22.26	22.45	22.34	
		1900 (19100)	21.87	22.35	22.15	
50RB-High (50)		1880 (18900)	21.83	22.12	22.17	
		1860 (18700)	21.90	22.16	22.03	
		1900 (19100)	22.09	22.14	21.13	
50RB-Middle (25)		1880 (18900)	21.99	22.01	21.09	
		1860 (18700)	22.11	22.13	21.16	
		1900 (19100)	22.16	22.19	21.23	
50RB-Low (0)		1880 (18900)	22.04	22.08	21.02	
		1860 (18700)	22.15	22.09	21.11	
		1900 (19100)	22.19	22.17	21.21	
100RB (0)		1880 (18900)	22.08	22.08	21.06	
		1860 (18700)	21.95	21.93	21.03	
		1900 (19100)	22.14	22.14	21.16	
		1880 (18900)	22.05	22.09	21.06	
		1860 (18700)	22.11	22.10	21.07	
		1900 (19100)	22.14	22.14	21.16	

LTE band30 power level C1					
BANDWIDTH	Number of RBs	Frequency	QPSK	16QAM	64QAM
5MHz	1RB-High (24)	2312.5 (27735)	20.62	20.61	20.81
		2310 (27710)	20.56	21.04	21.00
		2307.5 (27685)	20.42	20.48	20.68
	1RB-Middle (12)	2312.5 (27735)	21.16	21.11	21.32
		2310 (27710)	21.06	21.49	21.45
		2307.5 (27685)	21.05	21.07	21.23
	1RB-Low (0)	2312.5 (27735)	20.86	20.81	21.06
		2310 (27710)	20.72	21.21	21.15
		2307.5 (27685)	20.74	20.78	21.12
	12RB-High (13)	2312.5 (27735)	20.91	20.92	21.02
		2310 (27710)	20.87	20.96	20.93
		2307.5 (27685)	20.88	20.92	21.09
	12RB-Middle (6)	2312.5 (27735)	21.05	21.02	21.11
		2310 (27710)	20.99	21.04	21.12
		2307.5 (27685)	21.01	21.06	21.06
	12RB-Low (0)	2312.5 (27735)	20.88	20.93	21.01
		2310 (27710)	20.91	20.99	21.06
		2307.5 (27685)	20.92	20.95	21.03
	25RB (0)	2312.5 (27735)	20.90	20.91	21.08
		2310 (27710)	20.93	20.98	21.03
		2307.5 (27685)	20.90	20.90	21.01
10MHz	1RB-High (49)	2310 (27710)	20.73	20.45	21.00
	1RB-Middle (24)	2310 (27710)	20.99	20.80	21.46
	1RB-Low (0)	2310 (27710)	20.83	20.62	21.09
	25RB-High (25)	2310 (27710)	20.83	20.96	21.02
	25RB-Middle (12)	2310 (27710)	20.83	20.99	21.03
	25RB-Low (0)	2310 (27710)	20.88	20.89	21.06
	50RB (0)	2310 (27710)	20.85	20.88	21.01

LTE band66 power level C1					
BANDWIDTH	Number of RBs	Frequency	QPSK	16QAM	64QAM
1.4MHz	1RB-High (5)	1779.3(132665)	20.30	20.06	20.58
		1745.0(132322)	20.36	20.72	20.84
		1710.7(131979)	20.53	20.35	20.90
	1RB-Middle (3)	1779.3(132665)	20.72	20.59	20.60
		1745.0(132322)	20.73	21.14	21.19
		1710.7(131979)	20.82	20.63	21.31
	1RB-Low (0)	1779.3(132665)	20.53	20.34	20.80
		1745.0(132322)	20.55	20.92	21.02
		1710.7(131979)	20.59	20.41	21.07
	3RB-High (3)	1779.3(132665)	20.48	20.65	20.89
		1745.0(132322)	20.66	20.95	21.11
		1710.7(131979)	20.78	20.80	21.20
	3RB-Middle (1)	1779.3(132665)	20.64	20.80	21.09
		1745.0(132322)	20.78	21.02	21.22
		1710.7(131979)	20.83	20.92	21.15
	3RB-Low (0)	1779.3(132665)	20.57	20.70	21.01
		1745.0(132322)	20.71	20.96	21.13
		1710.7(131979)	20.72	20.82	21.18
6RB (0)	1779.3(132665)	20.61	20.77	21.07	
	1745.0(132322)	20.66	20.57	21.11	
	1710.7(131979)	20.66	20.90	21.11	
3MHz	1RB-High (14)	1778.5(132657)	20.75	21.16	20.73
		1745.0(132322)	20.91	20.71	20.95
		1711.5(131987)	20.93	21.32	21.23
	1RB-Middle (7)	1778.5(132657)	21.16	21.54	21.09
		1745.0(132322)	21.17	21.18	21.42
		1711.5(131987)	21.32	21.69	21.53
	1RB-Low (0)	1778.5(132657)	20.99	21.31	20.84
		1745.0(132322)	20.96	20.98	21.23
		1711.5(131987)	21.10	21.44	21.33
	8RB-High (7)	1778.5(132657)	21.00	21.08	21.10
		1745.0(132322)	21.06	21.09	21.07
		1711.5(131987)	21.11	21.21	21.20
	8RB-Middle (4)	1778.5(132657)	21.09	21.16	21.23
		1745.0(132322)	21.13	21.22	21.12
		1711.5(131987)	21.27	21.32	21.28
	8RB-Low (0)	1778.5(132657)	20.99	21.15	21.12
		1745.0(132322)	21.09	21.14	21.05
		1711.5(131987)	21.16	21.30	21.27
15RB (0)	1778.5(132657)	20.98	21.02	21.11	
	1745.0(132322)	21.12	21.10	21.10	

Chongqing Academy of Information and Communication Technology

Address: No. 8,Yuma Road, Chayuan New City, Nan'an District, Chongqing, P. R. China,401336
 Tel: 0086-23-88069965 FAX:0086-23-88608777

		1711.5(131987)	21.11	21.15	21.24	
5MHz	1RB-High (24)	1777.5(132647)	20.66	21.11	20.73	
		1745.0(132322)	20.52	20.61	21.00	
		1712.5(131997)	20.79	20.84	20.91	
		1777.5(132647)	21.18	21.61	21.45	
	1RB-Middle (12)	1745.0(132322)	21.23	21.28	21.70	
		1712.5(131997)	21.45	21.41	21.54	
		1777.5(132647)	20.82	21.22	21.11	
	1RB-Low (0)	1745.0(132322)	20.91	20.95	21.33	
		1712.5(131997)	21.05	21.05	21.14	
		1777.5(132647)	21.02	21.12	21.01	
	12RB-High (13)	1745.0(132322)	21.09	21.18	21.15	
		1712.5(131997)	21.16	21.21	21.19	
		1777.5(132647)	21.09	21.15	21.08	
	12RB-Middle (6)	1745.0(132322)	21.18	21.21	21.22	
		1712.5(131997)	21.22	21.25	21.22	
		1777.5(132647)	21.03	21.13	21.05	
	12RB-Low (0)	1745.0(132322)	21.07	21.09	21.15	
		1712.5(131997)	21.15	21.20	21.17	
		1777.5(132647)	21.03	21.08	21.09	
	25RB (0)	1745.0(132322)	21.09	21.05	21.13	
		1712.5(131997)	21.16	21.18	21.13	
		1775.0(132622)	20.71	20.46	20.66	
	10MHz	1RB-High (49)	1745.0(132322)	20.73	20.63	20.87
			1715.0(132022)	20.74	21.18	21.13
1775.0(132622)			21.10	20.91	21.14	
1RB-Middle (24)		1745.0(132322)	21.18	21.09	21.40	
		1715.0(132022)	21.28	21.61	21.56	
		1775.0(132622)	20.91	20.73	20.80	
1RB-Low (0)		1745.0(132322)	20.96	20.96	21.14	
		1715.0(132022)	21.06	21.37	21.22	
		1775.0(132622)	21.01	21.14	21.15	
25RB-High (25)		1745.0(132322)	21.12	21.24	21.26	
		1715.0(132022)	21.17	21.25	21.23	
		1775.0(132622)	21.09	21.14	21.20	
25RB-Middle (12)		1745.0(132322)	21.18	21.27	21.26	
		1715.0(132022)	21.21	21.28	21.28	
		1775.0(132622)	21.11	21.21	21.22	
25RB-Low (0)		1745.0(132322)	21.14	21.12	21.22	
		1715.0(132022)	21.17	21.23	21.25	
		1775.0(132622)	21.11	21.13	21.15	
50RB (0)		1745.0(132322)	21.09	21.13	21.13	
		1715.0(132022)	21.18	21.24	21.22	
		1772.5(132597)	20.62	20.63	20.51	
15MHz		1RB-High (74)				

Chongqing Academy of Information and Communication Technology

Address: No. 8,Yuma Road, Chayuan New City, Nan'an District, Chongqing, P. R. China,401336
Tel: 0086-23-88069965 FAX:0086-23-88608777

		1745.0(132322)	20.66	21.02	21.11
		1717.5(132047)	20.78	20.70	21.03
	1RB-Middle (37)	1772.5(132597)	21.13	21.18	21.05
		1745.0(132322)	21.24	21.66	21.70
		1717.5(132047)	21.36	21.40	21.60
	1RB-Low (0)	1772.5(132597)	20.89	20.87	20.80
		1745.0(132322)	20.88	21.33	21.28
		1717.5(132047)	21.02	21.06	21.26
	36RB-High (38)	1772.5(132597)	21.11	21.08	21.13
		1745.0(132322)	21.19	21.21	21.19
		1717.5(132047)	21.34	21.22	21.23
	36RB-Middle (19)	1772.5(132597)	21.15	21.22	21.14
		1745.0(132322)	21.21	21.17	21.13
		1717.5(132047)	21.28	21.25	21.30
	36RB-Low (0)	1772.5(132597)	21.16	21.19	21.22
		1745.0(132322)	21.18	21.10	21.26
		1717.5(132047)	21.23	21.18	21.22
	75RB (0)	1772.5(132597)	21.12	21.14	21.17
		1745.0(132322)	21.15	21.16	21.21
		1717.5(132047)	21.22	21.21	21.18
20MHz	1RB-High (99)	1770.0(133572)	20.59	20.85	20.66
		1745.0(132322)	20.74	21.22	21.12
		1720.0(132072)	20.78	21.06	20.83
	1RB-Middle (50)	1770.0(133572)	21.26	21.44	21.39
		1745.0(132322)	21.33	21.81	21.70
		1720.0(132072)	21.34	21.66	21.53
	1RB-Low (0)	1770.0(133572)	20.93	21.15	21.03
		1745.0(132322)	21.09	21.56	21.51
		1720.0(132072)	20.99	21.31	21.13
	50RB-High (50)	1770.0(133572)	20.98	20.97	21.06
		1745.0(132322)	21.13	21.19	21.11
		1720.0(132072)	21.22	21.24	21.22
	50RB-Middle (25)	1770.0(133572)	21.13	21.08	21.08
		1745.0(132322)	21.16	21.20	21.16
		1720.0(132072)	21.28	21.25	21.25
	50RB-Low (0)	1770.0(133572)	21.16	21.13	21.16
		1745.0(132322)	21.10	21.13	21.10
		1720.0(132072)	21.21	21.23	21.21
	100RB (0)	1770.0(133572)	21.06	21.08	21.05
		1745.0(132322)	21.15	21.12	21.15
1720.0(132072)		21.22	21.21	21.19	

13.5 Wi-Fi and BT Measurement Result

The maximum output power of BT antenna is **10.52dBm**.

The maximum tune up of BT antenna is **11.0dBm**.

The average conducted power for Wi-Fi 2.4G is as following-Normal power:

802.11b(dBm)	
Channel\data rate	1Mbps
11(2462MHz)	18.81
6(2437MHz)	18.92
1(2412MHz)	18.49
Tune up	19.50
802.11g(dBm)	
Channel\data rate	6Mbps
11(2462MHz)	16.31
6(2437MHz)	16.52
1(2412MHz)	16.24
Tune up	17.00
802.11n(dBm)-20MHz	
Channel\data rate	MCS0
11(2462MHz)	16.55
6(2437MHz)	16.51
1(2412MHz)	16.36
Tune up	17.00
802.11n(dBm)-40MHz	
Channel\data rate	MCS0
9(2452MHz)	16.18
6(2437MHz)	16.33
3(2422MHz)	16.19
Tune up	17.00

14.Simultaneous TX SAR Considerations

14.1 Simultaneous transmission SAR

Table 14.1-1: The sum of SAR values for Main antenna + WiFi-2.4G (1g)

	Position	Main antenna	WiFi-2.4G	Sum
Highest SAR value for Head	Left head, Cheek (WCDNA 850)	0.81	0.13	0.94
Highest SAR value for Body	Bottom 10mm (LTE B30)	1.37	/	1.37
Highest SAR value for Body	Rear 15mm (LTE B30)	0.76	0.06	0.82

Table 14.1-2: The sum of SAR values for main antenna and+BT (1g)

	Position	Main antenna	BT	Sum
Maximum reported SAR value for Head	Left head, Cheek (WCDMA850)	0.81	0.03	0.84
Maximum reported SAR value for Body	Bottom 10mm (LTE B30)	1.37	/	1.37
Maximum reported SAR value for Body	Rear 15mm (LTE B30)	0.76	0.01	0.77

Conclusion:

According to the above tables, the sum of reported SAR values is <math>< 1.6\text{W/kg}</math>. So the simultaneous transmission SAR with volume scans is not required.

15.SAR Test Result

15.1. SAR Result

Table 15.1-1: SAR Values(GSM 850MHz-Head)

Frequency		Mode (number of timeslots)	Test Position	Distance (mm)	Conducted Power (dBm)	Max. tune-up Power (dBm)	Measured SAR(1g) (W/kg)	Reported SAR(1g) (W/kg)	Power Drift (dB)
MHz	Ch.								
836.6	190	Speech	Cheek Left	0	33.14	33.30	0.209	0.22	-0.12
836.6	190	Speech	Tilt Left	0	33.14	33.30	0.11	0.11	-0.09
836.6	190	Speech	Cheek Right	0	33.14	33.30	0.183	0.18	0.19
836.6	190	Speech	Tilt Right	0	33.14	33.30	0.118	0.12	0.10
824.2	128	Speech	Cheek Left	0	33.10	33.30	0.085	0.09	0.13
848.8	251	Speech	Cheek Left	0	33.05	33.30	0.091	0.10	0.17

Note: This max SAR value zoom scan graph is Fig A.1

Table 15.1-2: SAR Values(GSM 850MHz-Body)

Frequency		Mode (number of timeslots)	Test Position	Distance (mm)	Conducted Power (dBm)	Max. tune-up Power (dBm)	Measured SAR(1g) (W/kg)	Reported SAR(1g) (W/kg)	Power Drift (dB)
MHz	Ch.								
836.6	190	GPRS 4TX	Front	10	27.90	28	0.237	0.24	-0.03
836.6	190	GPRS 4TX	Rear	10	27.90	28	0.611	0.63	0.02
836.6	190	GPRS 4TX	Left	10	27.90	28	0.205	0.21	-0.06
836.6	190	GPRS 4TX	Right	10	27.90	28	0.076	0.08	0.10
836.6	190	GPRS 4TX	Bottom	10	27.90	28	0.13	0.13	0.05
824.2	128	GPRS 4TX	Rear	10	27.84	28	0.645	0.67	0.12
848.8	251	GPRS 4TX	Rear	10	27.82	28	0.533	0.56	0.12
824.2	128	EGPRS 4TX(GMSK)	Rear	10	27.84	28	0.479	0.50	-0.06

Note: This max SAR value zoom scan graph is Fig A.2

Table 15.1-3: SAR Values(GSM 1900MHz-Head)

Frequency		Mode (number of timeslots)	Test Position	Distance (mm)	Conducted Power (dBm)	Max. tune- up Power (dBm)	Measured SAR(1g) (W/kg)	Reported SAR(1g) (W/kg)	Power Drift (dB)
MHz	Ch.								
1880	661	Speech	Cheek Left	0	29.94	31	0.074	0.09	0.16
1880	661	Speech	Tilt Left	0	29.94	31	0.037	0.05	-0.13
1880	661	Speech	Cheek Right	0	29.94	31	0.109	0.14	0.11
1880	661	Speech	Tilt Right	0	29.94	31	0.048	0.06	-0.13
1909.8	810	Speech	Cheek Right	0	30.03	31	0.114	0.14	0.17
1850.2	512	Speech	Cheek Right	0	29.86	31	0.116	0.15	0.14

Note: This max SAR value zoom scan graph is Fig A.3

Table 15.1-4: SAR Values(GSM 1900MHz-Body Worn)

Frequency		Mode (number of timeslots)	Test Position	Distance (mm)	Conducted Power (dBm)	Max. tune- up Power (dBm)	Measured SAR(1g) (W/kg)	Reported SAR(1g) (W/kg)	Power Drift (dB)
MHz	Ch.								
1880	661	GPRS 4TX	Front	15	23.31	24	0.136	0.16	-0.11
1880	661	GPRS 4TX	Rear	15	23.31	24	0.199	0.23	0.12
1909.8	810	GPRS 4TX	Rear	15	23.51	24	0.200	0.22	0.13
1850.2	512	GPRS 4TX	Rear	15	23.16	24	0.204	0.25	0.15
1850.2	512	EGPRS 4TX (GMSK)	Rear	15	23.16	24	0.189	0.23	0.06

Note: This max SAR value zoom scan graph is Fig A.5

Table 15.1-5: SAR Values(GSM 1900MHz-Body-Hotspot)

Frequency		Mode (number of timeslots)	Test Position	Distance (mm)	Conducted Power (dBm)	Max. tune- up Power (dBm)	Measured SAR(1g) (W/kg)	Reported SAR(1g) (W/kg)	Power Drift (dB)
MHz	Ch.								
1880	661	GPRS 4TX	Front	10	22.24	23	0.183	0.22	0.18
1880	661	GPRS 4TX	Rear	10	22.24	23	0.363	0.43	0.18
1880	661	GPRS 4TX	Left	10	22.24	23	0.078	0.09	0.08
1880	661	GPRS 4TX	Right	10	22.24	23	0.137	0.16	0.11
1880	661	GPRS 4TX	Bottom	10	22.24	23	0.267	0.32	0.16
1909.8	810	GPRS 4TX	Rear	10	22.47	23	0.198	0.22	0.05
1850.2	512	GPRS 4TX	Rear	10	22.18	23	0.231	0.28	0.13
1880	661	EGPRS 4TX (GMSK)	Rear	10	22.20	23	0.335	0.40	0.11

Note: This max SAR value zoom scan graph is Fig A.4

Chongqing Academy of Information and Communication Technology

Address: No. 8,Yuma Road, Chayuan New City, Nan'an District, Chongqing, P. R. China,401336
 Tel: 0086-23-88069965 FAX:0086-23-88608777

Table 15.1-6: SAR Values(WCDMA1900-Head)

Frequency		Mode (number of timeslots)	Test Position	Distance (mm)	Conducted Power (dBm)	Max. tune-up Power (dBm)	Measured SAR(1g) (W/kg)	Reported SAR(1g) (W/kg)	Power Drift (dB)
MHz	Ch.								
1880	9400	RMC12.2K	Cheek Left	0	23.85	25	0.360	0.47	0.14
1880	9400	RMC12.2K	Tilt Left	0	23.85	25	0.018	0.02	0.19
1880	9400	RMC12.2K	Cheek Right	0	23.85	25	0.423	0.55	0.08
1880	9400	RMC12.2K	Tilt Right	0	23.85	25	0.124	0.16	0.14
1852.4	9262	RMC12.2K	Cheek Right	0	23.82	25	0.364	0.48	0.09
1907.6	9538	RMC12.2K	Cheek Right	0	23.92	25	0.370	0.47	0.15

Note: This max SAR value zoom scan graph is Fig A.6

Table 15.1-7: SAR Values(WCDMA 1900-Body Worn)

Frequency		Mode (number of timeslots)	Test Position	Distance (mm)	Conducted Power (dBm)	Max. tune-up Power (dBm)	Measured SAR(1g) (W/kg)	Reported SAR(1g) (W/kg)	Power Drift (dB)
MHz	Ch.								
1880	9400	RMC12.2K	Front	15	21.61	23	0.253	0.35	0.13
1880	9400	RMC12.2K	Rear	15	21.61	23	0.352	0.48	0.16
1852.4	9262	RMC12.2K	Rear	15	21.63	23	0.350	0.48	0.15
1907.6	9538	RMC12.2K	Rear	15	21.73	23	0.337	0.45	0.13

Note: This max SAR value zoom scan graph is Fig A.8

Table 15.1-8: SAR Values(WCDMA 1900-Body-Hotspot)

Frequency		Mode (number of timeslots)	Test Position	Distance (mm)	Conducted Power (dBm)	Max. tune-up Power (dBm)	Measured SAR(1g) (W/kg)	Reported SAR(1g) (W/kg)	Power Drift (dB)
MHz	Ch.								
1880	9400	RMC12.2K	Front	10	20.62	22	0.288	0.40	-0.05
1880	9400	RMC12.2K	Rear	10	20.62	22	0.429	0.59	-0.01
1880	9400	RMC12.2K	Left	10	20.62	22	0.103	0.14	-0.01
1880	9400	RMC12.2K	Right	10	20.62	22	0.199	0.27	0.05
1880	9400	RMC12.2K	Bottom	10	20.62	22	0.345	0.47	-0.05
1852.4	9262	RMC12.2K	Rear	10	20.65	22	0.307	0.42	0.04
1907.6	9538	RMC12.2K	Rear	10	20.72	22	0.276	0.37	0.03

Note: This max SAR value zoom scan graph is Fig A.7

Chongqing Academy of Information and Communication Technology

Address: No. 8,Yuma Road, Chayuan New City, Nan'an District, Chongqing, P. R. China,401336
 Tel: 0086-23-88069965 FAX:0086-23-88608777

Table 15.1-9: SAR Values(WCDMA 1700—Head)

Frequency		Mode (number of timeslots)	Test Position	Distance (mm)	Conducted Power (dBm)	Max. tune- up Power (dBm)	Measured SAR(1g) (W/kg)	Reported SAR(1g) (W/kg)	Power Drift (dB)
MHz	Ch.								
1732.4	1412	RMC12.2K	Cheek Left	0	23.86	25	0.276	0.36	0.14
1732.4	1412	RMC12.2K	Tilt Left	0	23.86	25	0.111	0.14	-0.11
1732.4	1412	RMC12.2K	Cheek Right	0	23.86	25	0.288	0.37	0.10
1732.4	1412	RMC12.2K	Tilt Right	0	23.86	25	0.116	0.15	0.04
1752.6	1513	RMC12.2K	Cheek Right	0	23.89	25	0.315	0.41	-0.01
1712.4	1312	RMC12.2K	Cheek Right	0	23.85	25	0.250	0.33	0.05

Note: This max SAR value zoom scan graph is Fig A.9

Table 15.1-10: SAR Values(WCDMA1700-Body-Worn)

Frequency		Mode (number of timeslots)	Test Position	Distance (mm)	Conducted Power (dBm)	Max. tune- up Power (dBm)	Measured SAR(1g) (W/kg)	Reported SAR(1g) (W/kg)	Power Drift (dB)
MHz	Ch.								
1732.4	1412	RMC12.2K	Front	15	21.73	23	0.281	0.38	0.01
1732.4	1412	RMC12.2K	Rear	15	21.73	23	0.399	0.53	-0.01
1712.4	1312	RMC12.2K	Rear	15	21.84	23	0.405	0.53	-0.00
1752.6	1513	RMC12.2K	Rear	15	21.75	23	0.395	0.53	-0.01

Note: This max SAR value zoom scan graph is Fig A.11

Table 15.1-11: SAR Values(WCDMA 1700-Body-Hotspot)

Frequency		Mode (number of timeslots)	Test Position	Distance (mm)	Conducted Power (dBm)	Max. tune- up Power (dBm)	Measured SAR(1g) (W/kg)	Reported SAR(1g) (W/kg)	Power Drift (dB)
MHz	Ch.								
1732.4	1412	RMC12.2K	Front	10	20.74	22	0.280	0.37	-0.08
1732.4	1412	RMC12.2K	Rear	10	20.74	22	0.427	0.57	0.05
1732.4	1412	RMC12.2K	Left	10	20.74	22	0.063	0.08	-0.01
1732.4	1412	RMC12.2K	Right	10	20.74	22	0.153	0.20	0.12
1732.4	1412	RMC12.2K	Bottom	10	20.74	22	0.305	0.41	-0.08
1712.4	1312	RMC12.2K	Rear	10	20.86	22	0.483	0.63	0.00
1752.6	1513	RMC12.2K	Rear	10	20.75	22	0.487	0.65	-0.02

Note: This max SAR value zoom scan graph is Fig A.10

Table 15.1-12: SAR Values(WCDMA 850—Head)

Frequency		Mode (number of timeslots)	Test Position	Distance (mm)	Conducted Power (dBm)	Max. tune- up Power (dBm)	Measured SAR(1g) (W/kg)	Reported SAR(1g) (W/kg)	Power Drift (dB)
MHz	Ch.								
836.6	4183	RMC12.2K	Cheek Left	0	22.61	23	0.688	0.75	0.06
836.6	4183	RMC12.2K	Tilt Left	0	22.61	23	0.485	0.53	0.04
836.6	4183	RMC12.2K	Cheek Right	0	22.61	23	0.431	0.47	0.01
836.6	4183	RMC12.2K	Tilt Right	0	22.61	23	0.313	0.34	-0.03
846.6	4233	RMC12.2K	Cheek Left	0	22.64	23	0.589	0.64	0.04
826.4	4132	RMC12.2K	Cheek Left	0	22.65	23	0.751	0.81	0.06
826.4	4132	RMC12.2K	Cheek Left	0	22.65	23	0.611	0.66	-0.02

Note1: This max SAR value zoom scan graph is Fig A.12

Note2: The battery for TLi028C1 reported SAR is 0.66 W/kg when in WCDMA850 left cheek position

Table 15.1-13: SAR Values(WCDMA 850-Body-Hotspot)

Frequency		Mode (number of timeslots)	Test Position	Distance (mm)	Conducted Power (dBm)	Max. tune- up Power (dBm)	Measured SAR(1g) (W/kg)	Reported SAR(1g) (W/kg)	Power Drift (dB)
MHz	Ch.								
836.6	4183	RMC12.2K	Front	10	24.67	25	0.416	0.45	0.09
836.6	4183	RMC12.2K	Rear	10	24.67	25	0.694	0.75	0.04
836.6	4183	RMC12.2K	Left	10	24.67	25	0.508	0.55	-0.04
836.6	4183	RMC12.2K	Right	10	24.67	25	0.722	0.78	0.17
836.6	4183	RMC12.2K	Top	10	24.67	25	0.316	0.34	0.03
846.6	4233	RMC12.2K	Right	10	24.72	25	0.721	0.77	0.05
826.4	4132	RMC12.2K	Right	10	24.66	25	0.663	0.72	-0.08

Note1: This max SAR value zoom scan graph is Fig A.13

Table 15.1-14: SAR Values(LTE Band2—Head)

Frequency		Mode (number of timeslots)	Test Position	Distance (mm)	Conducted Power (dBm)	Max. tune-up Power (dBm)	Measured SAR(1g) (W/kg)	Reported SAR(1g) (W/kg)	Power Drift (dB)
MHz	Ch.								
1900	19100	20M_QPSK_1@Mid	Cheek Left	0	24.44	25	0.379	0.43	0.00
1900	19100	20M_QPSK_1@Mid	Tilt Left	0	24.44	25	0.199	0.23	-0.14
1900	19100	20M_QPSK_1@Mid	Cheek Right	0	24.44	25	0.297	0.34	0.16
1900	19100	20M_QPSK_1@Mid	Tilt Right	0	24.44	25	0.136	0.15	0.11
1900	19100	20M_QPSK_50@Mid	Cheek Left	0	23.28	24	0.303	0.36	0.07
1900	19100	20M_QPSK_50@Mid	Tilt Left	0	23.28	24	0.148	0.17	0.18
1900	19100	20M_QPSK_50@Mid	Cheek Right	0	23.28	24	0.327	0.39	-0.06
1900	19100	20M_QPSK_50@Mid	Tilt Right	0	23.28	24	0.099	0.12	0.17

Note1: This max SAR value zoom scan graph is Fig A.14

Table 15.1-15: SAR Values(LTE Band2-Body-Worn)

Frequency		Mode (number of timeslots)	Test Position	Distance (mm)	Conducted Power (dBm)	Max. tune-up Power (dBm)	Measured SAR(1g) (W/kg)	Reported SAR(1g) (W/kg)	Power Drift (dB)
MHz	Ch.								
1900	19100	20M_QPSK_1@Mid	Front	15	23.32	24	0.261	0.31	0.14
1900	19100	20M_QPSK_1@Mid	Rear	15	23.32	24	0.321	0.38	0.11
1900	19100	20M_QPSK_50@Mid	Front	15	23.18	24	0.244	0.29	0.01
1900	19100	20M_QPSK_50@Mid	Rear	15	23.18	24	0.349	0.42	0.01

Note1: This max SAR value zoom scan graph is Fig A.16

Table 15.1-16: SAR Values(LTE Band2-Body-Hotspot)

Frequency		Mode (number of timeslots)	Test Position	Distance (mm)	Conducted Power (dBm)	Max. tune-up Power (dBm)	Measured SAR(1g) (W/kg)	Reported SAR(1g) (W/kg)	Power Drift (dB)
MHz	Ch.								
1900	19100	20M_QPSK_1@Mid	Front	10	22.31	23	0.335	0.39	0.04
1900	19100	20M_QPSK_1@Mid	Rear	10	22.31	23	0.667	0.78	0.01
1900	19100	20M_QPSK_1@Mid	Left	10	22.31	23	0.138	0.16	-0.16
1900	19100	20M_QPSK_1@Mid	Right	10	22.31	23	0.224	0.26	-0.02
1900	19100	20M_QPSK_1@Mid	Bottom	10	22.31	23	0.446	0.52	0.06
1900	19100	20M_QPSK_50@Mid	Front	10	22.19	23	0.338	0.41	0.12
1900	19100	20M_QPSK_50@Mid	Rear	10	22.19	23	0.600	0.72	0.01

1900	19100	20M_QPSK_50@Mid	Left	10	22.19	23	0.147	0.18	-0.02
1900	19100	20M_QPSK_50@Mid	Right	10	22.19	23	0.222	0.27	0.06
1900	19100	20M_QPSK_50@Mid	Bottom	10	22.19	23	0.435	0.52	0.07

Note1: This max SAR value zoom scan graph is Fig A.15

Table 15.1-17: SAR Values(LTE Band5—Head)

Frequency		Mode (number of timeslots)	Test Position	Distance (mm)	Conducted Power (dBm)	Max. tune-up Power (dBm)	Measured SAR(1g) (W/kg)	Reported SAR(1g) (W/kg)	Power Drift (dB)
MHz	Ch.								
829	20450	10M_QPSK_1@Mid	Cheek Left	0	22.85	23	0.746	0.77	0.10
829	20450	10M_QPSK_1@Mid	Tilt Left	0	22.85	23	0.403	0.42	0.05
829	20450	10M_QPSK_1@Mid	Cheek Right	0	22.85	23	0.435	0.45	0.02
829	20450	10M_QPSK_1@Mid	Tilt Right	0	22.85	23	0.287	0.30	0.04
836.5	20525	10M_QPSK_25@High	Cheek Left	0	22.86	23	0.767	0.79	-0.03
836.5	20525	10M_QPSK_25@High	Tilt Left	0	22.86	23	0.554	0.57	0.01
836.5	20525	10M_QPSK_25@High	Cheek Right	0	22.86	23	0.427	0.44	0.01
836.5	20525	10M_QPSK_25@High	Tilt Right	0	22.86	23	0.305	0.31	0.09

Note1: This max SAR value zoom scan graph is Fig A.17

Table 15.1-18: SAR Values(LTE Band5-Body-Hotspot)

Frequency		Mode (number of timeslots)	Test Position	Distance (mm)	Conducted Power (dBm)	Max. tune-up Power (dBm)	Measured SAR(1g) (W/kg)	Reported SAR(1g) (W/kg)	Power Drift (dB)
MHz	Ch.								
844	20600	10M_QPSK_1@Mid	Front	10	24.84	25	0.290	0.30	-0.03
844	20600	10M_QPSK_1@Mid	Rear	10	24.84	25	0.662	0.69	-0.10
844	20600	10M_QPSK_1@Mid	Left	10	24.84	25	0.556	0.58	0.00
844	20600	10M_QPSK_1@Mid	Right	10	24.84	25	0.754	0.78	0.01
844	20600	10M_QPSK_1@Mid	Top	10	24.84	25	0.454	0.47	0.00
829	20450	10M_QPSK_25@Low	Front	10	23.59	24	0.263	0.29	0.02
829	20450	10M_QPSK_25@Low	Rear	10	23.59	24	0.454	0.50	0.02
829	20450	10M_QPSK_25@Low	Left	10	23.59	24	0.393	0.43	-0.03
829	20450	10M_QPSK_25@Low	Right	10	23.59	24	0.558	0.61	0.00
829	20450	10M_QPSK_25@Low	Top	10	23.59	24	0.279	0.31	0.04

Note1: This max SAR value zoom scan graph is Fig A.18

Table 15.1-19: SAR Values(LTE Band12—Head)

Frequency		Mode (number of timeslots)	Test Position	Distance (mm)	Conducted Power (dBm)	Max. tune-up Power (dBm)	Measured SAR(1g) (W/kg)	Reported SAR(1g) (W/kg)	Power Drift (dB)
MHz	Ch.								
704	23060	10M_QPSK_1@Mid	Cheek Left	0	22.82	23	0.456	0.48	-0.03
704	23060	10M_QPSK_1@Mid	Tilt Left	0	22.82	23	0.313	0.33	0.01
704	23060	10M_QPSK_1@Mid	Cheek Right	0	22.82	23	0.337	0.35	-0.08
704	23060	10M_QPSK_1@Mid	Tilt Right	0	22.82	23	0.110	0.11	0.10
707.5	23095	10M_QPSK_25@High	Cheek Left	0	22.9	23	0.392	0.40	0.01
707.5	23095	10M_QPSK_25@High	Tilt Left	0	22.9	23	0.331	0.34	0.04
707.5	23095	10M_QPSK_25@High	Cheek Right	0	22.9	23	0.346	0.35	0.07
707.5	23095	10M_QPSK_25@High	Tilt Right	0	22.9	23	0.107	0.11	0.13

Note1: This max SAR value zoom scan graph is Fig A.19

Table 15.1-20: SAR Values(LTE Band12-Body-Hotspot)

Frequency		Mode (number of timeslots)	Test Position	Distance (mm)	Conducted Power (dBm)	Max. tune-up Power (dBm)	Measured SAR(1g) (W/kg)	Reported SAR(1g) (W/kg)	Power Drift (dB)
MHz	Ch.								
704	23060	10M_QPSK_1@Mid	Front	10	24.64	25	0.208	0.23	-0.08
704	23060	10M_QPSK_1@Mid	Rear	10	24.64	25	0.505	0.55	0.00
704	23060	10M_QPSK_1@Mid	Left	10	24.64	25	0.275	0.30	-0.06
704	23060	10M_QPSK_1@Mid	Right	10	24.64	25	0.474	0.51	-0.01
704	23060	10M_QPSK_1@Mid	Top	10	24.64	25	0.144	0.16	-0.01
707.5	23095	10M_QPSK_25@High	Front	10	23.65	24	0.228	0.25	0.04
707.5	23095	10M_QPSK_25@High	Rear	10	23.65	24	0.397	0.43	0.01
707.5	23095	10M_QPSK_25@High	Left	10	23.65	24	0.227	0.25	0.03
707.5	23095	10M_QPSK_25@High	Right	10	23.65	24	0.388	0.42	-0.03
707.5	23095	10M_QPSK_25@High	Top	10	23.65	24	0.118	0.13	0.04

Note1: This max SAR value zoom scan graph is Fig A.20

Table 15.1-21: SAR Values(LTE Band14—Head)

Frequency		Mode (number of timeslots)	Test Position	Distance (mm)	Conducted Power (dBm)	Max. tune-up Power (dBm)	Measured SAR(1g) (W/kg)	Reported SAR(1g) (W/kg)	Power Drift (dB)
MHz	Ch.								
793	23330	10M_QPSK_1@Mid	Cheek Left	0	22.13	23	0.582	0.71	-0.15
793	23330	10M_QPSK_1@Mid	Tilt Left	0	22.13	23	0.388	0.47	0.02
793	23330	10M_QPSK_1@Mid	Cheek Right	0	22.13	23	0.302	0.37	0.06
793	23330	10M_QPSK_1@Mid	Tilt Right	0	22.13	23	0.216	0.26	0.07
793	23330	10M_QPSK_25@Mid	Cheek Left	0	22.07	23	0.506	0.63	0.02
793	23330	10M_QPSK_25@Mid	Tilt Left	0	22.07	23	0.298	0.37	0.05
793	23330	10M_QPSK_25@Mid	Cheek Right	0	22.07	23	0.277	0.34	0.06
793	23330	10M_QPSK_25@Mid	Tilt Right	0	22.07	23	0.224	0.28	0.03

Note1: This max SAR value zoom scan graph is Fig A.21

Table 15.1-22: SAR Values(LTE Band14-Body-Hotspot)

Frequency		Mode (number of timeslots)	Test Position	Distance (mm)	Conducted Power (dBm)	Max. tune-up Power (dBm)	Measured SAR(1g) (W/kg)	Reported SAR(1g) (W/kg)	Power Drift (dB)
MHz	Ch.								
793	23330	10M_QPSK_1@Mid	Front	10	24.53	25	0.458	0.51	0.04
793	23330	10M_QPSK_1@Mid	Rear	10	24.53	25	0.465	0.52	0.00
793	23330	10M_QPSK_1@Mid	Left	10	24.53	25	0.404	0.45	-0.04
793	23330	10M_QPSK_1@Mid	Right	10	24.53	25	0.698	0.78	-0.02
793	23330	10M_QPSK_1@Mid	Top	10	24.53	25	0.251	0.28	0.04
793	23330	10M_QPSK_25@Mid	Front	10	23.38	24	0.346	0.40	0.05
793	23330	10M_QPSK_25@Mid	Rear	10	23.38	24	0.500	0.58	0.04
793	23330	10M_QPSK_25@Mid	Left	10	23.38	24	0.323	0.37	-0.05
793	23330	10M_QPSK_25@Mid	Right	10	23.38	24	0.538	0.62	0.00
793	23330	10M_QPSK_25@Mid	Top	10	23.38	24	0.188	0.22	0.12

Note1: This max SAR value zoom scan graph is Fig A.22

Table 15.1-23: SAR Values(LTE Band30—Head)

Frequency		Mode (number of timeslots)	Test Position	Distance (mm)	Conducted Power (dBm)	Max. tune-up Power (dBm)	Measured SAR(1g) (W/kg)	Reported SAR(1g) (W/kg)	Power Drift (dB)
MHz	Ch.								
2310	27710	10M_QPSK_1@Mid	Cheek Left	0	24.04	25	0.019	0.02	0.07
2310	27710	10M_QPSK_1@Mid	Tilt Left	0	24.04	25	0.017	0.02	0.18
2310	27710	10M_QPSK_1@Mid	Cheek Right	0	24.04	25	0.035	0.04	-0.01

Chongqing Academy of Information and Communication Technology

Address: No. 8,Yuma Road, Chayuan New City, Nan'an District, Chongqing, P. R. China,401336
Tel: 0086-23-88069965 FAX:0086-23-88608777

2310	27710	10M_QPSK_1@Mid	Tilt Right	0	24.04	25	0.024	0.03	0.04
2310	27710	10M_QPSK_25@Mid	Cheek Left	0	22.98	24	0.015	0.02	0.01
2310	27710	10M_QPSK_25@Mid	Tilt Left	0	22.98	24	0.021	0.03	0.05
2310	27710	10M_QPSK_25@Mid	Cheek Right	0	22.98	24	0.040	0.05	0.08
2310	27710	10M_QPSK_25@Mid	Tilt Right	0	22.98	24	0.011	0.01	0.01

Note1: This max SAR value zoom scan graph is Fig A.23

Table 15.1-24: SAR Values(LTE Band30-Body Worn)

Frequency		Mode (number of timeslots)	Test Position	Distance (mm)	Conducted Power (dBm)	Max. tune-up Power (dBm)	Measured SAR(1g) (W/kg)	Reported SAR(1g) (W/kg)	Power Drift (dB)
MHz	Ch.								
2310	27710	10M_QPSK_1@Mid	Front	15	22.00	23	0.236	0.30	0.06
2310	27710	10M_QPSK_1@Mid	Rear	15	22.00	23	0.605	0.76	0.02
2310	27710	10M_QPSK_25@Low	Front	15	21.98	23	0.254	0.32	0.07
2310	27710	10M_QPSK_25@Low	Rear	15	21.98	23	0.577	0.73	0.03

Note1: This max SAR value zoom scan graph is Fig A.25

Table 15.1-25: SAR Values(LTE Band30-Body-Hotspot)

Frequency		Mode (number of timeslots)	Test Position	Distance (mm)	Conducted Power (dBm)	Max. tune-up Power (dBm)	Measured SAR(1g) (W/kg)	Reported SAR(1g) (W/kg)	Power Drift (dB)
MHz	Ch.								
2310	27710	10M_QPSK_1@Mid	Front	10	20.99	21.5	0.313	0.35	0.08
2310	27710	10M_QPSK_1@Mid	Rear	10	20.99	21.5	0.835	0.94	0.02
2310	27710	10M_QPSK_1@Low	Rear	10	20.83	21.5	0.767	0.89	0.09
2310	27710	10M_QPSK_1@High	Rear	10	20.73	21.5	0.857	1.02	0.06
2310	27710	10M_QPSK_50@0	Rear	10	20.85	21.5	0.831	0.97	0.02
2310	27710	10M_QPSK_1@Mid	Left	10	20.99	21.5	0.024	0.03	0.07
2310	27710	10M_QPSK_1@Mid	Right	10	20.99	21.5	0.055	0.06	0.05
2310	27710	10M_QPSK_1@Mid	Bottom	10	20.99	21.5	1.05	1.18	-0.16
2310	27710	10M_QPSK_1@High	Bottom	10	20.73	21.5	1.14	1.36	-0.02
2310	27710	10M_QPSK_1@Low	Bottom	10	20.83	21.5	1.02	1.19	-0.15
2310	27710	10M_QPSK_50@0	Bottom	10	20.85	21.5	1.11	1.29	0.04
2310	27710	10M_QPSK_25@Low	Front	10	20.88	21.5	0.327	0.38	0.15
2310	27710	10M_QPSK_25@Low	Rear	10	20.88	21.5	0.711	0.82	0.11
2310	27710	10M_QPSK_25@High	Rear	10	20.83	21.5	0.857	1.00	0.03
2310	27710	10M_QPSK_25@Mid	Rear	10	20.83	21.5	0.844	0.98	0.09

Chongqing Academy of Information and Communication Technology

Address: No. 8,Yuma Road, Chayuan New City, Nan'an District, Chongqing, P. R. China,401336
Tel: 0086-23-88069965 FAX:0086-23-88608777

2310	27710	10M_QPSK_25@Low	Left	10	20.88	21.5	0.025	0.03	0.09
2310	27710	10M_QPSK_25@Low	Right	10	20.88	21.5	0.053	0.06	0.03
2310	27710	10M_QPSK_25@Low	Bottom	10	20.88	21.5	1.04	1.20	-0.12
2310	27710	10M_QPSK_25@High	Bottom	10	20.83	21.5	1.17	1.37	-0.06
2310	27710	10M_QPSK_25@Mid	Bottom	10	20.83	21.5	1.09	1.27	0.16
2310	27710	10M_QPSK_25@High	Bottom	10	20.83	21.5	0.963	1.12	-0.19

Note1: This max SAR value zoom scan graph is Fig A.24

Note2: The battery for TLi028C1 reported SAR is 1.12 W/kg when in LTE band30 bottom position

Table 15.1-26: SAR Values(LTE Band 66—Head)

Frequency		Mode (number of timeslots)	Test Position	Distance (mm)	Conducted Power (dBm)	Max. tune-up Power (dBm)	Measured SAR(1g) (W/kg)	Reported SAR(1g) (W/kg)	Power Drift (dB)
MHz	Ch.								
1720	132072	20M_QPSK_1@Mid	Cheek Left	0	24.60	25	0.297	0.33	0.04
1720	132072	20M_QPSK_1@Mid	Tilt Left	0	24.60	25	0.136	0.15	0.15
1720	132072	20M_QPSK_1@Mid	Cheek Right	0	24.60	25	0.302	0.33	0.18
1720	132072	20M_QPSK_1@Mid	Tilt Right	0	24.60	25	0.133	0.15	0.18
1720	132072	20M_QPSK_50@Low	Cheek Left	0	23.41	24	0.199	0.23	0.03
1720	132072	20M_QPSK_50@Low	Tilt Left	0	23.41	24	0.099	0.11	0.07
1720	132072	20M_QPSK_50@Low	Cheek Right	0	23.41	24	0.264	0.30	0.14
1720	132072	20M_QPSK_50@Low	Tilt Right	0	23.41	24	0.098	0.11	0.11

Note1: This max SAR value zoom scan graph is Fig A.26

Table 15.1-27: SAR Values(LTE Band 66-Body-Worn)

Frequency		Mode (number of timeslots)	Test Position	Distance (mm)	Conducted Power (dBm)	Max. tune-up Power (dBm)	Measured SAR(1g) (W/kg)	Reported SAR(1g) (W/kg)	Power Drift (dB)
MHz	Ch.								
1720	132072	20M_QPSK_1@Mid	Front	15	22.34	23	0.260	0.30	0.03
1720	132072	20M_QPSK_1@Mid	Rear	15	22.34	23	0.290	0.34	0.13
1720	132072	20M_QPSK_50@Mid	Front	15	22.27	23	0.242	0.29	0.10
1720	132072	20M_QPSK_50@Mid	Rear	15	22.27	23	0.298	0.35	0.01

Note1: This max SAR value zoom scan graph is Fig A.28

Table 15.1-28: SAR Values(LTE Band 66-Body-Hotspot)

Chongqing Academy of Information and Communication Technology

Address: No. 8,Yuma Road, Chayuan New City, Nan'an District, Chongqing, P. R. China,401336
Tel: 0086-23-88069965 FAX:0086-23-88608777

Frequency		Mode (number of timeslots)	Test Position	Distance (mm)	Conducted Power (dBm)	Max. tune-up Power (dBm)	Measured SAR(1g) (W/kg)	Reported SAR(1g) (W/kg)	Power Drift (dB)
MHz	Ch.								
1720	132072	20M_QPSK_1@Mid	Front	10	21.34	22	0.299	0.35	0.03
1720	132072	20M_QPSK_1@Mid	Rear	10	21.34	22	0.472	0.55	-0.03
1720	132072	20M_QPSK_1@Mid	Left	10	21.34	22	0.059	0.07	-0.03
1720	132072	20M_QPSK_1@Mid	Right	10	21.34	22	0.140	0.16	0.12
1720	132072	20M_QPSK_1@Mid	Bottom	10	21.34	22	0.298	0.35	0.01
1720	132072	20M_QPSK_50@Mid	Front	10	21.28	22	0.290	0.34	0.11
1720	132072	20M_QPSK_50@Mid	Rear	10	21.28	22	0.456	0.54	-0.05
1720	132072	20M_QPSK_50@Mid	Left	10	21.28	22	0.059	0.07	0.02
1720	132072	20M_QPSK_50@Mid	Right	10	21.28	22	0.137	0.16	0.17
1720	132072	20M_QPSK_50@Mid	Bottom	10	21.28	22	0.289	0.34	0.09

Note1: This max SAR value zoom scan graph is Fig A.27

Table 15.1-29: SAR Values(WLAN—Head)-802.11b

Frequency		Test Position	Distance (mm)	Conducte d Power (dBm)	Max. tune-up Power (dBm)	Duty Cycle	Measured SAR(1g) (W/kg)	Reporte d SAR(1g) (W/kg)	Powe r Drift (dB)
MHz	Ch.								
2437	6	Cheek Left	0	18.92	19.50	99.0%	0.115	0.13	0.01
2437	6	Tilt Left	0	18.92	19.50	99.0%	0.108	0.12	0.04
2437	6	Cheek Right	0	18.92	19.50	99.0%	0.261	0.30	0.09
2437	6	Tilt Right	0	18.92	19.50	99.0%	0.168	0.19	0.09

Note1: This max SAR value zoom scan graph is Fig A.32

Table 15.1-30: SAR Values(WLAN—Body)-802.11b

Frequency		Test Position	Distance (mm)	Conducte d Power (dBm)	Max. tune-up Power (dBm)	Duty Cycle	Measured SAR(1g) (W/kg)	Reporte d SAR(1g) (W/kg)	Powe r Drift (dB)
MHz	Ch.								
2437	6	Front	10	18.92	19.50	99.0%	0.059	0.07	0.19
2437	6	Rear	10	18.92	19.50	99.0%	0.118	0.14	0.09
2437	6	Left	10	18.92	19.50	99.0%	0.069	0.08	-0.04
2437	6	Top	10	18.92	19.50	99.0%	0.060	0.07	0.02

Chongqing Academy of Information and Communication Technology

Address: No. 8,Yuma Road, Chayuan New City, Nan'an District, Chongqing, P. R. China,401336
Tel: 0086-23-88069965 FAX:0086-23-88608777

2437	6	Front	15	18.92	19.50	99.0%	0.031	0.04	0.06
2437	6	Rear	15	18.92	19.50	99.0%	0.048	0.06	0.04

Note1: This max SAR value zoom scan graph is Fig A.33 when the distance is 10mm

Note2: This max SAR value zoom scan graph is Fig A.34 when the distance is 15mm

Table 15.1-31: SAR Values(BT-Head)

Frequency		Mode (number of timeslots)	Test Position	Distance (mm)	Conducted Power (dBm)	Max. tune-up Power (dBm)	Measured SAR(1g) (W/kg)	Reported SAR(1g) (W/kg)	Power Drift (dB)
MHz	Ch.								
2480	78	GFSK	Cheek Right	0	10.52	11	0.050	0.06	-0.10
2480	78	GFSK	Tilt Right	0	10.52	11	0.034	0.04	0.05
2480	78	GFSK	Cheek Left	0	10.52	11	0.029	0.03	0.05
2480	78	GFSK	Tilt Left	0	10.52	11	0.021	0.02	-0.14

Table 15.1-32: SAR Values(BT-Body)

Frequency		Mode (number of timeslots)	Test Position	Distance (mm)	Conducted Power (dBm)	Max. tune-up Power (dBm)	Measured SAR(1g) (W/kg)	Reported SAR(1g) (W/kg)	Power Drift (dB)
MHz	Ch.								
2480	78	GFSK	Front	10	10.52	11	0.009	0.01	0.03
2480	78	GFSK	Rear	10	10.52	11	0.019	0.02	-0.06
2480	78	GFSK	Left	10	10.52	11	0.012	0.01	-0.08
2480	78	GFSK	Top	10	10.52	11	0.014	0.02	0.07
2480	78	GFSK	Front	15	10.52	11	0.007	0.01	0.11
2480	78	GFSK	Rear	15	10.52	11	0.010	0.01	0.03

15.2. SAR Measurement Variability

SAR measurement variability must be assessed for each frequency band, which is determined by the SAR probe calibration point and tissue-equivalent medium used for the device measurements. When both head and body tissue-equivalent media are required for SAR measurements in a frequency band, the variability measurement procedures should be applied to the tissue medium with the highest measured SAR, using the highest measured SAR configuration for that tissue-equivalent medium.

The following procedures are applied to determine if repeated measurements are required.

- 1) Repeated measurement is not required when the original highest measured SAR is < 0.80 W/kg; steps 2) through 4) do not apply.
- 2) When the original highest measured SAR is ≥ 0.80 W/kg, repeat that measurement once.
- 3) Perform a second repeated measurement only if the ratio of largest to smallest SAR for the original and first repeated measurements is > 1.20 or when the original or repeated measurement is ≥ 1.45 W/kg (~ 10% from the 1-g SAR limit).
- 4) Perform a third repeated measurement only if the original, first or second repeated measurement is ≥ 1.5 W/kg and the ratio of largest to smallest SAR for the original, first and second repeated measurements is > 1.20 .

Table 15.2-1 SAR Measurement Variability for Body (1g)

Frequency		Mode/band	Test Position	Distance (mm)	Original measured SAR (W/kg)	First Repeated measured SAR (W/kg)	The Ratio
MHz	Ch.						
2310	27710	10M_QPSK_1@Mid	Rear	10	0.835	0.825	1.01
2310	27710	10M_QPSK_1@High	Rear	10	0.857	0.842	1.02
2310	27710	10M_QPSK_50RB	Rear	10	0.831	0.829	1.0
2310	27710	10M_QPSK_1@Mid	Bottom	10	1.05	1.01	1.04
2310	27710	10M_QPSK_1@High	Bottom	10	1.14	0.989	1.01
2310	27710	10M_QPSK_1@Low	Bottom	10	1.02	0.908	1.12
2310	27710	10M_QPSK_50RB	Bottom	10	1.11	1.08	1.03
2310	27710	10M_QPSK_25@High	Rear	10	0.857	0.839	1.02
2310	27710	10M_QPSK_25@Middle	Rear	10	0.844	0.837	1.0
2310	27710	10M_QPSK_25@Low	Bottom	10	1.04	0.976	1.06
2310	27710	10M_QPSK_25@High	Bottom	10	1.17	1.09	1.07
2310	27710	10M_QPSK_25@Middle	Bottom	10	1.09	0.968	1.13

Chongqing Academy of Information and Communication Technology

Address: No. 8, Yuma Road, Chayuan New City, Nan'an District, Chongqing, P. R. China, 401336
 Tel: 0086-23-88069965 FAX: 0086-23-88608777

16. Measurement Uncertainty

Measurement Uncertainty for Normal SAR Tests (300MHz~3GHz)

No.	Error Description	Type	Uncertainty value	Probably Distribution	Div.	(Ci) 1g	(Ci) 10g	Std. Unc. (1g)	Std. Unc. (10g)	Degree of freedom
Measurement system										
1	Probe calibration	B	6.0	N	1	1	1	6.0	6.0	∞
2	Isotropy	B	4.7	R	$\sqrt{3}$	0.7	0.7	1.9	1.9	∞
3	Boundary effect	B	1.0	R	$\sqrt{3}$	1	1	0.6	0.6	∞
4	Linearity	B	4.7	R	$\sqrt{3}$	1	1	2.7	2.7	∞
5	Detection limit	B	1.0	N	1	1	1	0.6	0.6	∞
6	Readout electronics	B	0.3	R	$\sqrt{3}$	1	1	0.3	0.3	∞
7	Response time	B	0.8	R	$\sqrt{3}$	1	1	0.5	0.5	∞
8	Integration time	B	2.6	R	$\sqrt{3}$	1	1	1.5	1.5	∞
9	RF ambient conditions-noise	B	0	R	$\sqrt{3}$	1	1	0	0	∞
10	RF ambient conditions-reflection	B	0	R	$\sqrt{3}$	1	1	0	0	∞
11	Probe positioned mech. restrictions	B	0.4	R	$\sqrt{3}$	1	1	0.2	0.2	∞
12	Probe positioning with respect to phantom shell	B	2.9	R	$\sqrt{3}$	1	1	1.7	1.7	∞
13	Post-processing	B	1.0	R	$\sqrt{3}$	1	1	0.6	0.6	∞
Test sample related										
14	Test sample positioning	A	3.3	N	1	1	1	3.3	3.3	71
15	Device holder uncertainty	A	3.4	N	1	1	1	3.4	3.4	5
16	Drift of output power	B	5.0	R	$\sqrt{3}$	1	1	2.9	2.9	∞
Phantom and set-up										
17	Phantom uncertainty	B	4.0	R	$\sqrt{3}$	1	1	2.3	2.3	∞
18	Liquid conductivity (target)	B	5.0	R	$\sqrt{3}$	0.64	0.43	1.8	1.2	∞
19	Liquid conductivity (meas.)	A	2.06	N	1	0.64	0.43	1.32	0.89	43
20	Liquid permittivity (target)	B	5.0	R	$\sqrt{3}$	0.6	0.49	1.7	1.4	∞
21	Liquid permittivity (meas.)	A	1.6	N	1	0.6	0.49	1.0	0.8	521
Combined standard uncertainty		$u_c = \sqrt{\sum_{i=1}^{21} c_i^2 u_i^2}$						9.55	9.43	257
Expanded uncertainty (confidence interval of 95 %)		$u_e = 2u_c$						19.1	18.9	

Chongqing Academy of Information and Communication Technology

 Address: No. 8,Yuma Road, Chayuan New City, Nan'an District, Chongqing, P. R. China,401336
 Tel: 0086-23-88069965 FAX:0086-23-88608777

Measurement Uncertainty for Normal SAR Tests (3~6GHz)

No.	Error Description	Type	Uncertainty value	Probably Distribution	Div.	(Ci) 1g	(Ci) 10g	Std. Unc. (1g)	Std. Unc. (10g)	Degree of freedom
Measurement system										
1	Probe calibration	B	6.55	N	1	1	1	6.55	6.55	∞
2	Isotropy	B	4.7	R	$\sqrt{3}$	0.7	0.7	1.9	1.9	∞
3	Boundary effect	B	2.0	R	$\sqrt{3}$	1	1	1.2	1.2	∞
4	Linearity	B	4.7	R	$\sqrt{3}$	1	1	2.7	2.7	∞
5	Detection limit	B	1.0	R	$\sqrt{3}$	1	1	0.6	0.6	∞
6	Readout electronics	B	0.3	R	$\sqrt{3}$	1	1	0.3	0.3	∞
7	Response time	B	0.8	R	$\sqrt{3}$	1	1	0.5	0.5	∞
8	Integration time	B	2.6	R	$\sqrt{3}$	1	1	1.5	1.5	∞
9	RF ambient conditions-noise	B	0	R	$\sqrt{3}$	1	1	0	0	∞
10	RFambient conditions-reflection	B	0	R	$\sqrt{3}$	1	1	0	0	∞
11	Probe positioned mech. restrictions	B	0.8	R	$\sqrt{3}$	1	1	0.5	0.5	∞
12	Probe positioning with respect to phantom shell	B	6.7	R	$\sqrt{3}$	1	1	3.9	3.9	∞
13	Post-processing	B	4.0	R	$\sqrt{3}$	1	1	2.3	2.3	∞
Test sample related										
14	Test sample positioning	A	3.3	N	1	1	1	3.3	3.3	71
15	Device holder uncertainty	A	3.4	N	1	1	1	3.4	3.4	5
16	Drift of output power	B	5.0	R	$\sqrt{3}$	1	1	2.9	2.9	∞
Phantom and set-up										
17	Phantom uncertainty	B	4.0	R	$\sqrt{3}$	1	1	2.3	2.3	∞
18	Liquid conductivity (target)	B	5.0	R	$\sqrt{3}$	0.64	0.43	1.8	1.2	∞
19	Liquid conductivity (meas.)	A	2.06	N	1	0.64	0.43	1.32	0.89	43
20	Liquid permittivity (target)	B	5.0	R	$\sqrt{3}$	0.6	0.49	1.7	1.4	∞
21	Liquid permittivity (meas.)	A	1.6	N	1	0.6	0.49	1.0	0.8	521
Combined standard uncertainty		$u_c = \sqrt{\sum_{i=1}^{21} c_i^2 u_i^2}$						10.7	10.6	257
Expanded uncertainty (confidence interval of 95 %)		$u_e = 2u_c$						21.4	21.1	

Chongqing Academy of Information and Communication Technology

 Address: No. 8,Yuma Road, Chayuan New City, Nan'an District, Chongqing, P. R. China,401336
 Tel: 0086-23-88069965 FAX:0086-23-88608777

Measurement Uncertainty for Fast SAR Tests (300MHz~3GHz)

No.	Error Description	Type	Uncertainty value	Probably Distribution	Div.	(Ci) 1g	(Ci) 10g	Std. Unc. (1g)	Std. Unc. (10g)	Degree of freedom
Measurement system										
1	Probe calibration	B	6.0	N	1	1	1	6.0	6.0	∞
2	Isotropy	B	4.7	R	$\sqrt{3}$	0.7	0.7	1.9	1.9	∞
3	Boundary effect	B	1.0	R	$\sqrt{3}$	1	1	0.6	0.6	∞
4	Linearity	B	4.7	R	$\sqrt{3}$	1	1	2.7	2.7	∞
5	Detection limit	B	1.0	R	$\sqrt{3}$	1	1	0.6	0.6	∞
6	Readout electronics	B	0.3	R	$\sqrt{3}$	1	1	0.3	0.3	∞
7	Response time	B	0.8	R	$\sqrt{3}$	1	1	0.5	0.5	∞
8	Integration time	B	2.6	R	$\sqrt{3}$	1	1	1.5	1.5	∞
9	RF ambient conditions-noise	B	0	R	$\sqrt{3}$	1	1	0	0	∞
10	RFambient conditions-reflection	B	0	R	$\sqrt{3}$	1	1	0	0	∞
11	Probe positioned mech. Restrictions	B	0.4	R	$\sqrt{3}$	1	1	0.2	0.2	∞
12	Probe positioning with respect to phantom shell	B	2.9	R	$\sqrt{3}$	1	1	1.7	1.7	∞
13	Post-processing	B	1.0	R	$\sqrt{3}$	1	1	0.6	0.6	∞
14	Fast SAR z-Approximation	B	7.0	R	$\sqrt{3}$	1	1	4.0	4.0	∞
Test sample related										
15	Test sample positioning	A	3.3	N	1	1	1	3.3	3.3	71
16	Device holder uncertainty	A	3.4	N	1	1	1	3.4	3.4	5
17	Drift of output power	B	5.0	R	$\sqrt{3}$	1	1	2.9	2.9	∞
Phantom and set-up										
18	Phantom uncertainty	B	4.0	R	$\sqrt{3}$	1	1	2.3	2.3	∞
19	Liquid conductivity (target)	B	5.0	R	$\sqrt{3}$	0.64	0.43	1.8	1.2	∞
20	Liquid conductivity (meas.)	A	2.06	N	1	0.64	0.43	1.32	0.89	43
21	Liquid permittivity (target)	B	5.0	R	$\sqrt{3}$	0.6	0.49	1.7	1.4	∞
22	Liquid permittivity (meas.)	A	1.6	N	1	0.6	0.49	1.0	0.8	521
Combined standard uncertainty		$u_c = \sqrt{\sum_{i=1}^{22} c_i^2 u_i^2}$						10.4	10.3	257
Expanded uncertainty (confidence interval of 95 %)		$u_e = 2u_c$						20.8	20.6	

Chongqing Academy of Information and Communication Technology

 Address: No. 8,Yuma Road, Chayuan New City, Nan'an District, Chongqing, P. R. China,401336
 Tel: 0086-23-88069965 FAX:0086-23-88608777

Measurement Uncertainty for Fast SAR Tests (3~6GHz)

No	Error Description	Type	Uncertainty value	Probability Distribution	Div.	(Ci) 1g	(Ci) 10g	Std. Unc. (1g)	Std. Unc. (10g)	Degree of freedom
Measurement system										
1	Probe calibration	B	6.55	N	1	1	1	6.55	6.55	∞
2	Isotropy	B	4.7	R	$\sqrt{3}$	0.7	0.7	1.9	1.9	∞
3	Boundary effect	B	2.0	R	$\sqrt{3}$	1	1	1.2	1.2	∞
4	Linearity	B	4.7	R	$\sqrt{3}$	1	1	2.7	2.7	∞
5	Detection limit	B	1.0	R	$\sqrt{3}$	1	1	0.6	0.6	∞
6	Readout electronics	B	0.3	R	$\sqrt{3}$	1	1	0.3	0.3	∞
7	Response time	B	0.8	R	$\sqrt{3}$	1	1	0.5	0.5	∞
8	Integration time	B	2.6	R	$\sqrt{3}$	1	1	1.5	1.5	∞
9	RF ambient conditions-noise	B	0	R	$\sqrt{3}$	1	1	0	0	∞
10	RF ambient conditions-reflection	B	0	R	$\sqrt{3}$	1	1	0	0	∞
11	Probe positioned mech. Restrictions	B	0.8	R	$\sqrt{3}$	1	1	0.5	0.5	∞
12	Probe positioning with respect to phantom shell	B	6.7	R	$\sqrt{3}$	1	1	3.9	3.9	∞
13	Post-processing	B	1.0	R	$\sqrt{3}$	1	1	0.6	0.6	∞
14	Fast SAR z-Approximation	B	14.0	R	$\sqrt{3}$	1	1	8.1	8.1	∞
Test sample related										
15	Test sample positioning	A	3.3	N	1	1	1	3.3	3.3	71
16	Device holder uncertainty	A	3.4	N	1	1	1	3.4	3.4	5
17	Drift of output power	B	5.0	R	$\sqrt{3}$	1	1	2.9	2.9	∞
Phantom and set-up										
18	Phantom uncertainty	B	4.0	R	$\sqrt{3}$	1	1	2.3	2.3	∞
19	Liquid conductivity (target)	B	5.0	R	$\sqrt{3}$	0.64	0.43	1.8	1.2	∞
20	Liquid conductivity (meas.)	A	2.06	N	1	0.64	0.43	1.32	0.89	43
21	Liquid permittivity (target)	B	5.0	R	$\sqrt{3}$	0.6	0.49	1.7	1.4	∞
22	Liquid permittivity (meas.)	A	1.6	N	1	0.6	0.49	1.0	0.8	521
Combined standard uncertainty		$u_c = \sqrt{\sum_{i=1}^{22} c_i^2 u_i^2}$						13.5	13.4	257
Expanded uncertainty (confidence interval of 95 %)		$u_e = 2u_c$						27.0	26.8	

Chongqing Academy of Information and Communication Technology

 Address: No. 8,Yuma Road, Chayuan New City, Nan'an District, Chongqing, P. R. China,401336
 Tel: 0086-23-88069965 FAX:0086-23-88608777

17.MAIN TEST INSTRUMENTS

Table 17-1: List of Main Instruments

No.	Name	Type	Serial Number	Software version	Hardware version	Calibration Date	Valid Period
01	Probe	EX3DV4	7401	--	--	2021-06-07	2022-06-06
02	DAE	DAE4	797	--	--	2022-05-17	2023-05-16
03	Power Meter	N1914A	MY50 001660	--	--	2021-06-12	2022-06-11
04	Radio Communication Analyzer	CMW500	164483	--	--	2022-05-12	2023-05-11
05	Signal Generator	N5181A	MY50 143363	--	--	2021-06-12	2022-06-11
06	Power Sensor	E8481H	MY51 020011	--	--	2021-06-25	2022-06-25
07	Power Amplifier	ZHL	QA120 2003			2022-05-12	2023-05-11
08	Network Analyzer	E5071C	MY46 212462	A. 10. 0x	8. 0	2021-06-12	2022-06-11
09	D750V3	Dipole	1037	--	--	2021-04-17	2023-04-16
10	D835V2	Dipole	4d135	--	--	2020-10-16	2022-10-15
11	D1750V2	Dipole	1063	--	--	2020-10-15	2022-10-14
12	D1900V2	Dipole	5d153	--	--	2020-10-14	2022-10-13
13	D2300V2	Dipole	1025	--	--	2020-10-14	2022-10-13
14	D2450V2	Dipole	886	--	--	2020-10-13	2022-10-12

Chongqing Academy of Information and Communication Technology

 Address: No. 8,Yuma Road, Chayuan New City, Nan'an District, Chongqing, P. R. China,401336
 Tel: 0086-23-88069965 FAX:0086-23-88608777

ANNEX A. GRAPH RESULTS

GSM 850 Cheek Left

Date/Time: 2022/5/31

Electronics: DAE4 Sn797

Medium: Head 835MHz

Medium parameters used: $f = 837$ MHz; $\sigma = 0.908$ S/m; $\epsilon_r = 41.99$; $\rho = 1000$ kg/m³

Ambient Temperature: 22.5°C Liquid Temperature: 22.0°C

Communication System: Generic GSM(850); Frequency: 836.6 MHz; Duty Cycle: 1:8.30042

Probe: EX3DV4 - SN7401ConvF(10.17, 10.17, 10.17)

Area Scan (8x14x1):

Measurement grid: dx=15mm, dy=15mm

Maximum value of SAR (measured) = 0.210 W/kg

Zoom Scan (5x5x7)/Cube 0:

Measurement grid: dx=8mm, dy=8mm, dz=5mm

Reference Value = 4.367 V/m; Power Drift = -0.12 dB

Peak SAR (extrapolated) = 0.217 W/kg

SAR(1 g) = 0.209 W/kg; SAR(10 g) = 0.192 W/kg

Maximum value of SAR (measured) = 0.211 W/kg

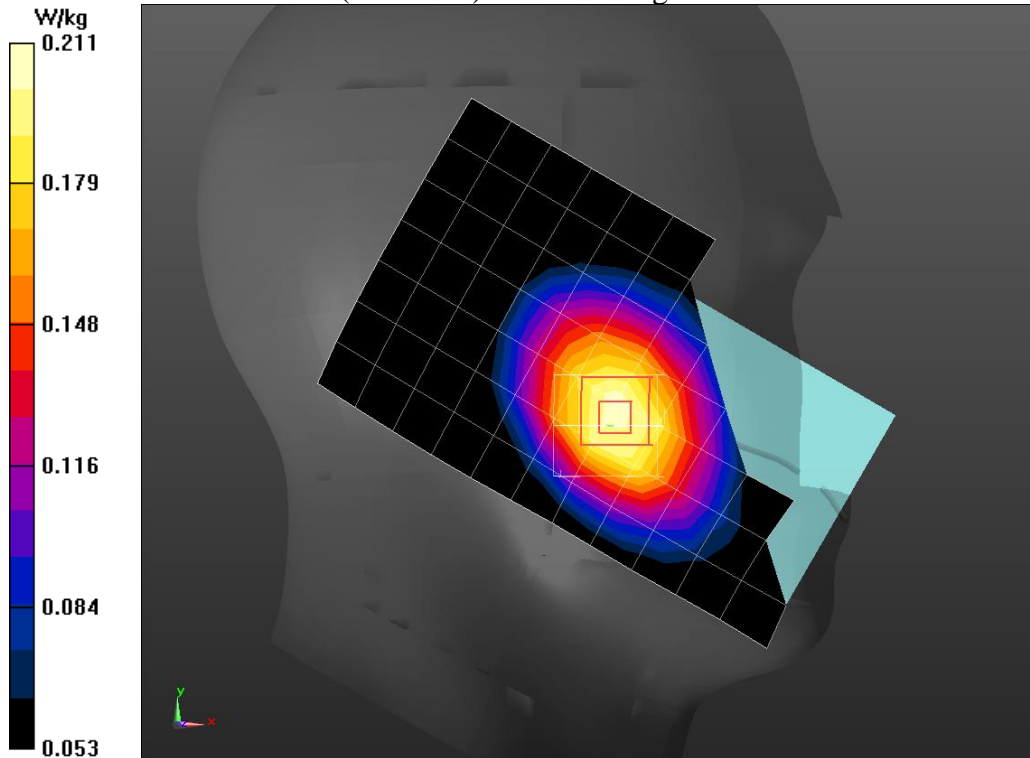

Fig A.1

GSM850 Body Rear 10mm_Hotspot

Date/Time: 2022/5/31

Electronics: DAE4 Sn797

Medium: Head 835MHz

Medium parameters used (interpolated): $f = 824.2$ MHz; $\sigma = 0.883$ S/m; $\epsilon_r = 41.836$; $\rho = 1000$ kg/m³

Ambient Temperature: 22.5°C Liquid Temperature: 22.0°C

Communication System: Generic GSM (0); Frequency: 824.2 MHz; Duty Cycle: 1:2

Probe: EX3DV4 - SN7401ConvF(10.17, 10.17, 10.17)

Area Scan (9x14x1):

Measurement grid: dx=15mm, dy=15mm

Maximum value of SAR (measured) = 0.555 W/kg

Zoom Scan (5x5x7)/Cube 0:

Measurement grid: dx=8mm, dy=8mm, dz=5mm

Reference Value = 16.40 V/m; Power Drift = 0.12 dB

Peak SAR (extrapolated) = 1.08 W/kg

SAR(1 g) = 0.645 W/kg; SAR(10 g) = 0.382 W/kg

Maximum value of SAR (measured) = 0.710 W/kg

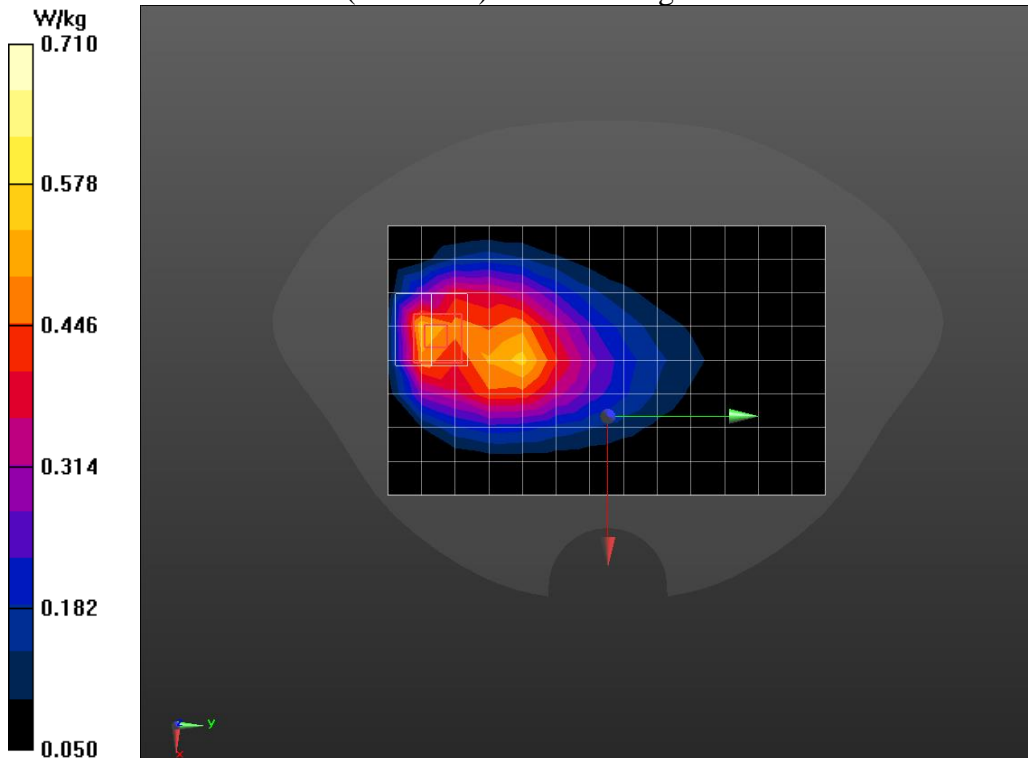

Fig A.2

GSM1900 Cheek Right

Date/Time: 2022/5/24

Electronics: DAE4 Sn797

Medium: Head 1900MHz

Medium parameters used (interpolated): $f = 1850.2$ MHz; $\sigma = 1.379$ S/m; $\epsilon_r = 39.465$; $\rho = 1000$ kg/m³

Ambient Temperature: 22.5°C Liquid Temperature: 22.0°C

Communication System: E/GPRS1900 (0); Frequency: 1850.2 MHz; Duty Cycle: 1:8.30042

Probe: EX3DV4 - SN7401ConvF(8.35, 8.35, 8.35)

Area Scan (8x14x1):

Measurement grid: dx=15mm, dy=15mm

Maximum value of SAR (measured) = 0.123 W/kg

Zoom Scan (5x5x7)/Cube 0:

Measurement grid: dx=8mm, dy=8mm, dz=5mm

Reference Value = 3.555 V/m; Power Drift = 0.14 dB

Peak SAR (extrapolated) = 0.192 W/kg

SAR(1 g) = 0.116 W/kg; SAR(10 g) = 0.074 W/kg

Maximum value of SAR (measured) = 0.125 W/kg

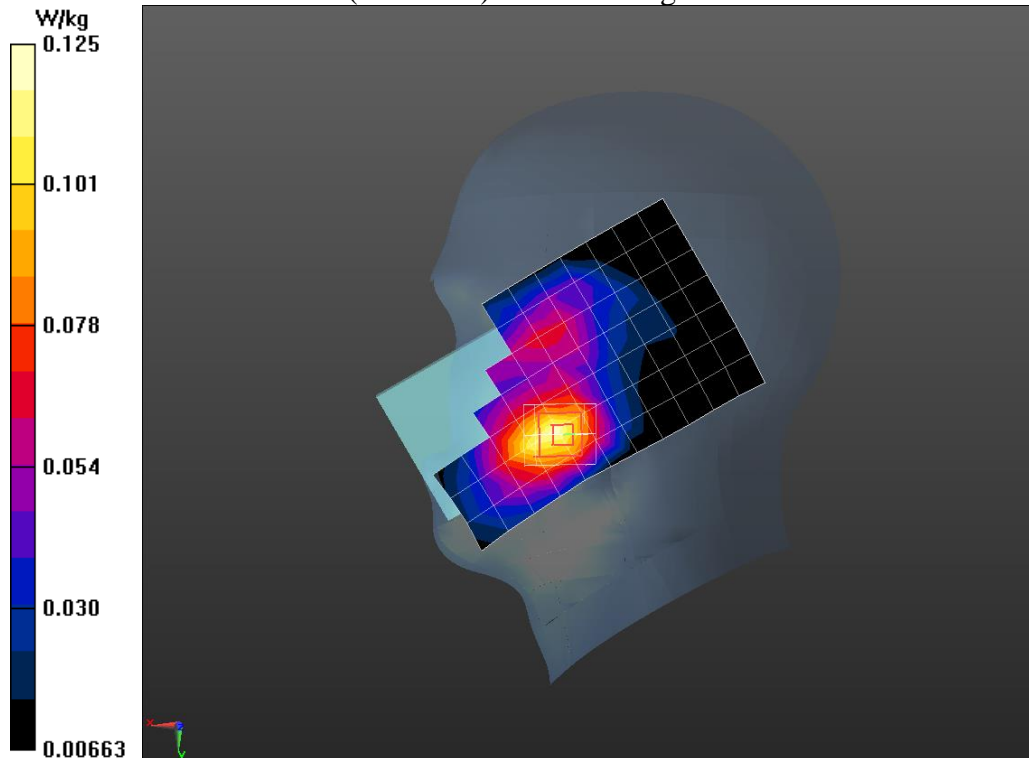

Fig A.3

GSM1900 Body Rear 10mm Hotspot

Date/Time: 2022/5/24

Electronics: DAE4 Sn797

Medium: Head 1900MHz

Medium parameters used: $f = 1880$ MHz; $\sigma = 1.406$ S/m; $\epsilon_r = 39.288$; $\rho = 1000$ kg/m³

Ambient Temperature: 22.5°C Liquid Temperature: 22.0°C

Communication System: E/GPRS1900 (0); Frequency: 1880 MHz; Duty Cycle: 1:2

Probe: EX3DV4 - SN7401ConvF(8.35, 8.35, 8.35)

Area Scan (9x14x1):

Measurement grid: $dx=15$ mm, $dy=15$ mm

Maximum value of SAR (measured) = 0.363 W/kg

Zoom Scan (5x5x7)/Cube 0:

Measurement grid: $dx=8$ mm, $dy=8$ mm, $dz=5$ mm

Reference Value = 4.101 V/m; Power Drift = 0.18 dB

Peak SAR (extrapolated) = 0.734 W/kg

SAR(1 g) = 0.363 W/kg; SAR(10 g) = 0.199 W/kg

Maximum value of SAR (measured) = 0.408 W/kg

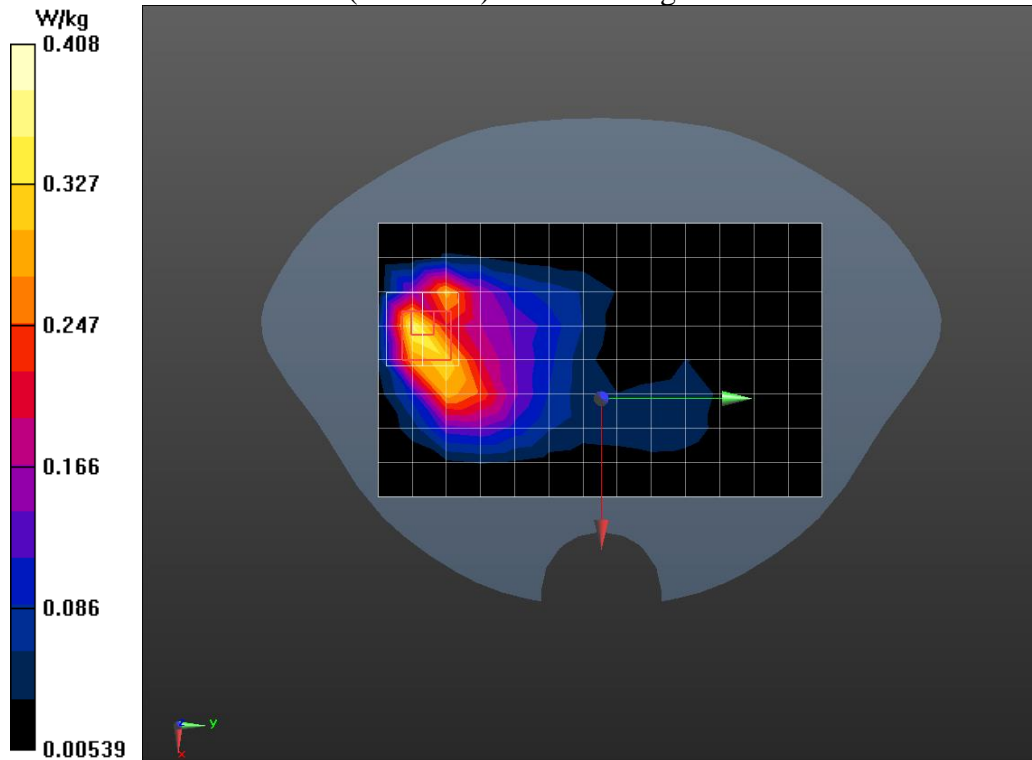

Fig A.4

GSM1900 Body Rear 15mm

Date/Time: 2022/5/24

Electronics: DAE4 Sn797

Medium: Head 1900MHz

Medium parameters used (interpolated): $f = 1850.2$ MHz; $\sigma = 1.379$ S/m; $\epsilon_r = 39.465$; $\rho = 1000$ kg/m³

Ambient Temperature: 22.5°C Liquid Temperature: 22.0°C

Communication System: E/GPRS1900 (0); Frequency: 1850.2 MHz; Duty Cycle: 1:2

Probe: EX3DV4 - SN7401ConvF(8.35, 8.35, 8.35)

Area Scan (9x14x1): Measurement grid: dx=15mm, dy=15mm

Maximum value of SAR (measured) = 0.217 W/kg

Zoom Scan (5x5x7)/Cube 0: Measurement grid: dx=8mm, dy=8mm, dz=5mm

Reference Value = 4.282 V/m; Power Drift = 0.15 dB

Peak SAR (extrapolated) = 0.350 W/kg

SAR(1 g) = 0.204 W/kg; SAR(10 g) = 0.123 W/kg

Maximum value of SAR (measured) = 0.229 W/kg

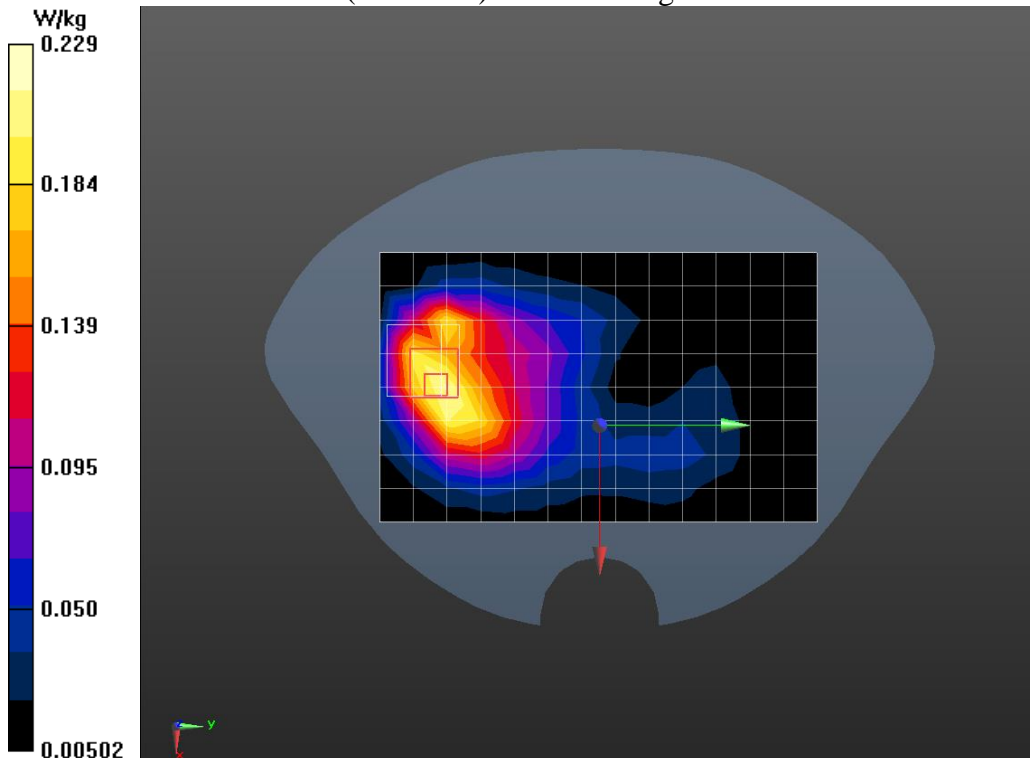

Fig A.5

WCDMA1900 Cheek Right

Date/Time: 2022/5/23

Electronics: DAE4 Sn797

Medium: Head 1900MHz

Medium parameters used: $f = 1880$ MHz; $\sigma = 1.406$ S/m; $\epsilon_r = 39.288$; $\rho = 1000$ kg/m³

Ambient Temperature: 22.5°C Liquid Temperature: 22.0°C

Communication System: WCDMA (0); Frequency: 1880 MHz; Duty Cycle: 1:1

Probe: EX3DV4 - SN7401ConvF(8.35, 8.35, 8.35)

Area Scan (8x14x1):

Measurement grid: $dx=15$ mm, $dy=15$ mm

Maximum value of SAR (measured) = 0.439 W/kg

Zoom Scan (5x5x7)/Cube 0:

Measurement grid: $dx=8$ mm, $dy=8$ mm, $dz=5$ mm

Reference Value = 6.666 V/m; Power Drift = 0.08 dB

Peak SAR (extrapolated) = 0.722 W/kg

SAR(1 g) = 0.423 W/kg; SAR(10 g) = 0.250 W/kg

Maximum value of SAR (measured) = 0.460 W/kg

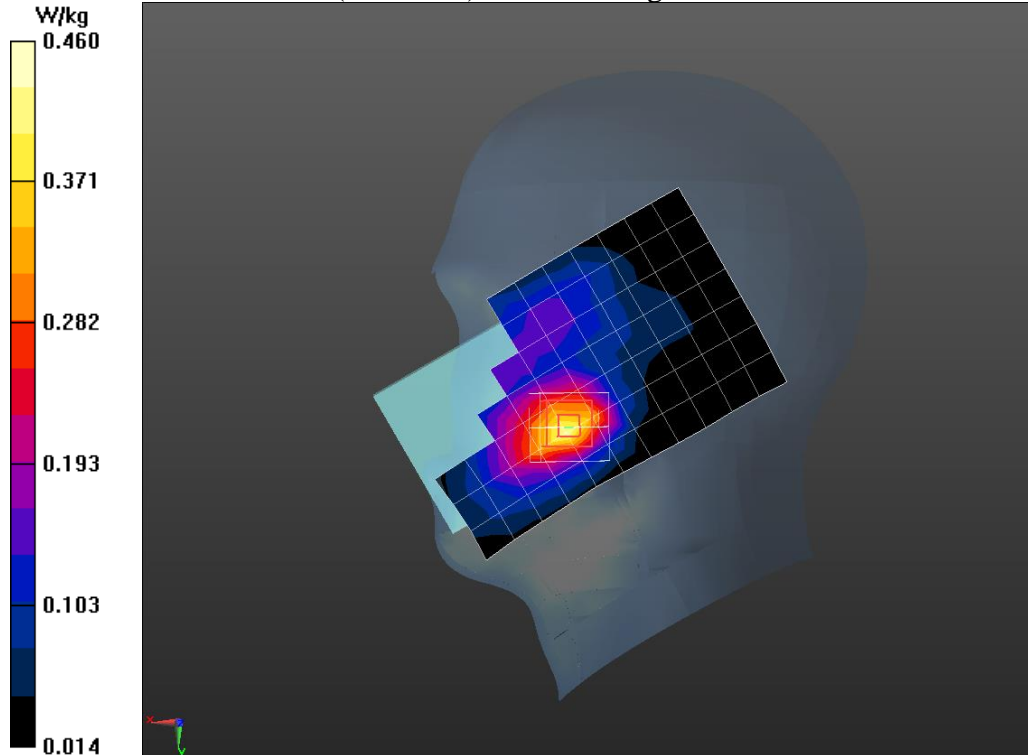

Fig A.6

WCDMA 1900 Body Rear 10mm Hotspot

Date/Time: 2022/5/23

Electronics: DAE4 Sn797

Medium: Head1900MHz

Medium parameters used: $f = 1880$ MHz; $\sigma = 1.406$ S/m; $\epsilon_r = 39.288$; $\rho = 1000$ kg/m³

Ambient Temperature: 22.5°C Liquid Temperature: 22.0°C

Communication System: WCDMA (0); Frequency: 1880 MHz; Duty Cycle: 1:1

Probe: EX3DV4 - SN7401ConvF(8.35, 8.35, 8.35)

Area Scan (9x14x1):

Measurement grid: $dx=15$ mm, $dy=15$ mm

Maximum value of SAR (measured) = 0.445 W/kg

Zoom Scan (5x5x7)/Cube 0:

Measurement grid: $dx=8$ mm, $dy=8$ mm, $dz=5$ mm

Reference Value = 14.52 V/m; Power Drift = -0.01 dB

Peak SAR (extrapolated) = 0.802 W/kg

SAR(1 g) = 0.429 W/kg; SAR(10 g) = 0.241 W/kg

Maximum value of SAR (measured) = 0.470 W/kg

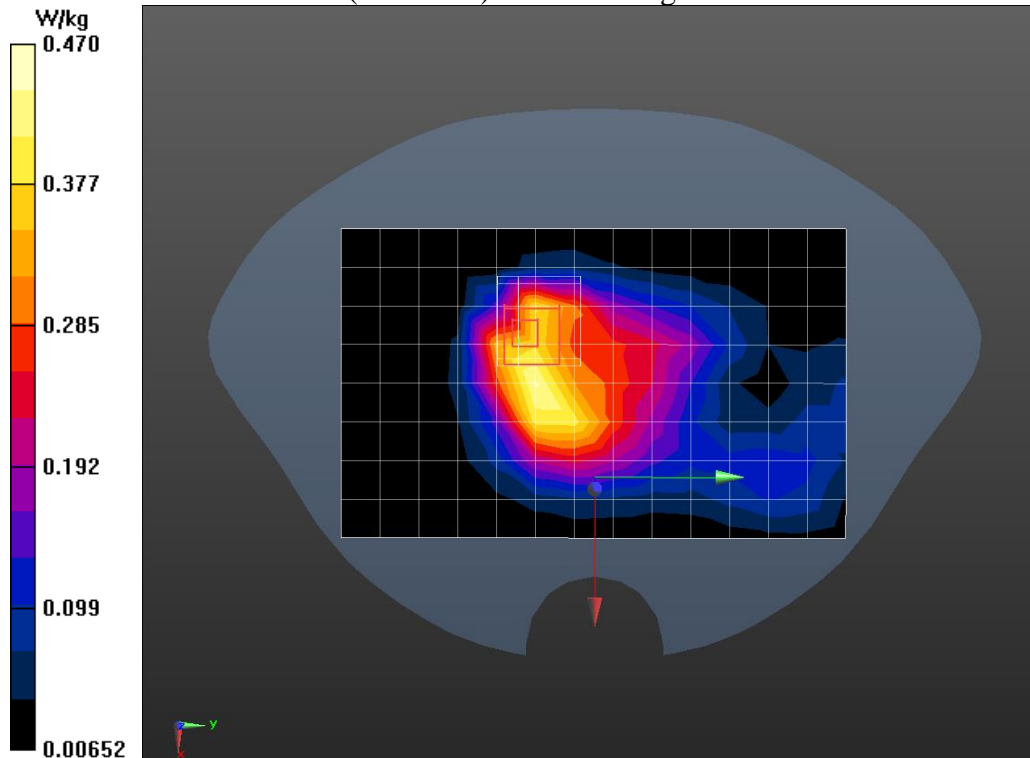

Fig A.7

WCDMA1900 Body Rear 15mm

Date/Time: 2022/5/24

Electronics: DAE4 Sn797

Medium: Head 1900MHz

Medium parameters used: $f = 1880$ MHz; $\sigma = 1.406$ S/m; $\epsilon_r = 39.288$; $\rho = 1000$ kg/m³

Ambient Temperature: 22.5°C Liquid Temperature: 22.0°C

Communication System: WCDMA (0); Frequency: 1880 MHz; Duty Cycle: 1:1

Probe: EX3DV4 - SN7401ConvF(8.35, 8.35, 8.35)

Area Scan (9x14x1):

Measurement grid: dx=15mm, dy=15mm

Maximum value of SAR (measured) = 0.367 W/kg

Zoom Scan (5x5x7)/Cube 0:

Measurement grid: dx=8mm, dy=8mm, dz=5mm

Reference Value = 5.848 V/m; Power Drift = 0.16 dB

Peak SAR (extrapolated) = 0.543 W/kg

SAR(1 g) = 0.352 W/kg; SAR(10 g) = 0.221 W/kg

Maximum value of SAR (measured) = 0.382 W/kg

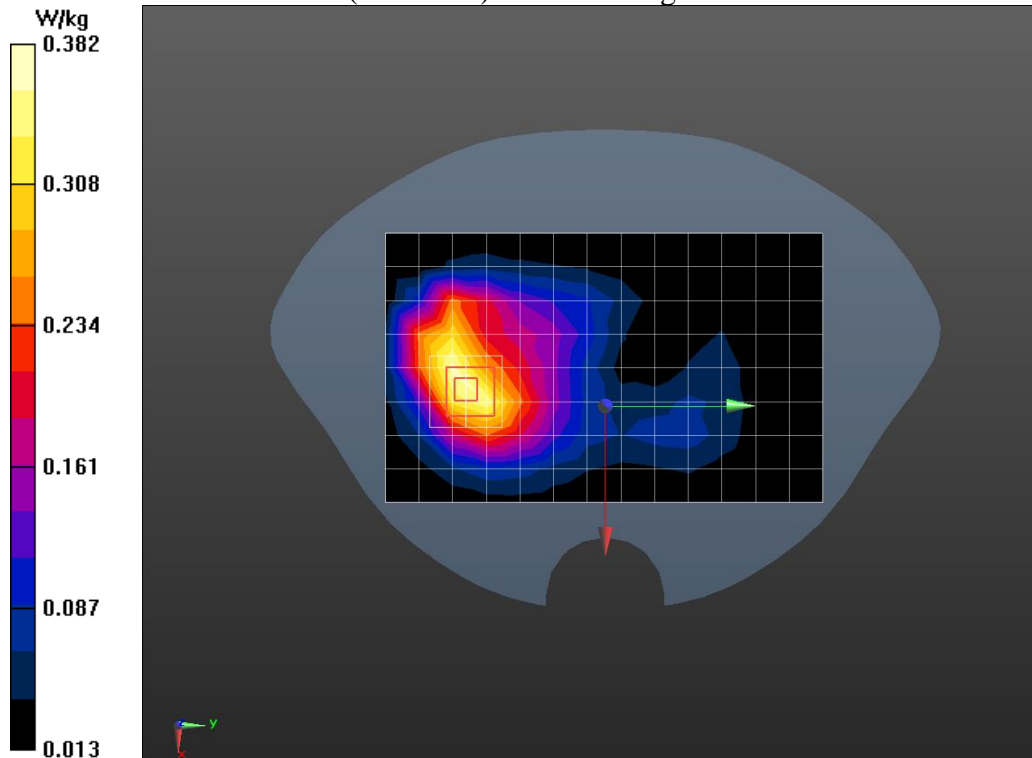

Fig A.8

WCDMA1700 Cheek Right

Date/Time: 2022/5/25

Electronics: DAE4 Sn797

Medium: Head 1750MHz

Medium parameters used: $f = 1753$ MHz; $\sigma = 1.365$ S/m; $\epsilon_r = 41.126$; $\rho = 1000$ kg/m³

Ambient Temperature: 22.5°C Liquid Temperature: 22.0°C

Communication System: WCDMA (0); Frequency: 1752.6 MHz; Duty Cycle: 1:1

Probe: EX3DV4 - SN7401ConvF(8.62, 8.62, 8.62)

Area Scan (8x14x1):

Measurement grid: $dx=15$ mm, $dy=15$ mm

Maximum value of SAR (measured) = 0.327 W/kg

Zoom Scan (5x5x7)/Cube 0:

Measurement grid: $dx=8$ mm, $dy=8$ mm, $dz=5$ mm

Reference Value = 5.623 V/m; Power Drift = -0.01 dB

Peak SAR (extrapolated) = 0.521 W/kg

SAR(1 g) = 0.315 W/kg; SAR(10 g) = 0.197 W/kg

Maximum value of SAR (measured) = 0.341 W/kg

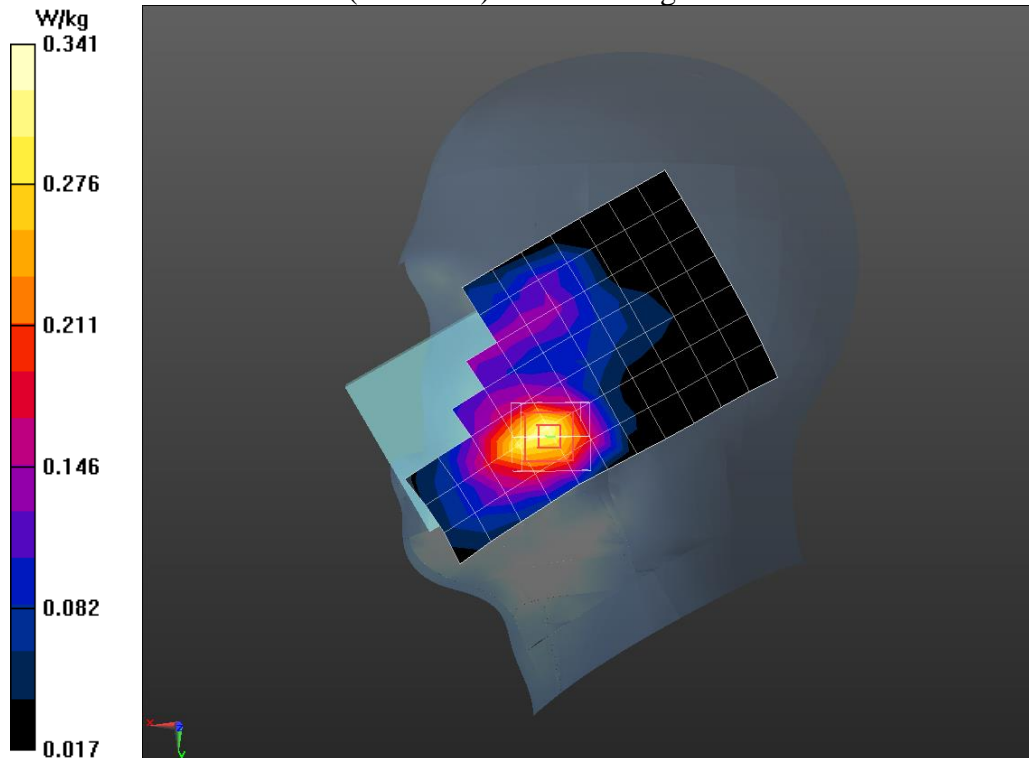

Fig A.9