

ANNEX A Graph Results

GSM850 Head

Date/Time: 3/12/2022

Electronics: DAE4 Sn1525

Medium: H700-6000M

Medium parameters used (interpolated): $f = 836.6$ MHz; $\sigma = 0.862$ S/m; $\epsilon_r = 45.695$; $\rho = 1000$ kg/m³

Ambient Temperature: 23.3°C Liquid Temperature: 22.5°C

Communication System: UID 0, GSM 850 Glass 12 (0) Frequency: 836.6 MHz Duty Cycle: 1:1.99986

Probe: EX3DV4 - SN7517 ConvF(9.7, 9.7, 9.7); Calibrated: 1/19/2022

Area Scan (81x141x1): Interpolated grid: dx=1.500 mm, dy=1.500 mm

Maximum value of SAR (interpolated) = 0.173 W/kg

Zoom Scan (5x5x7)/Cube 0: Measurement grid: dx=8mm, dy=8mm, dz=5mm

Reference Value = 5.115 V/m; Power Drift = 0.10 dB

Peak SAR (extrapolated) = 0.195 W/kg

SAR(1 g) = 0.145 W/kg; SAR(10 g) = 0.112 W/kg

Maximum value of SAR (measured) = 0.173 W/kg

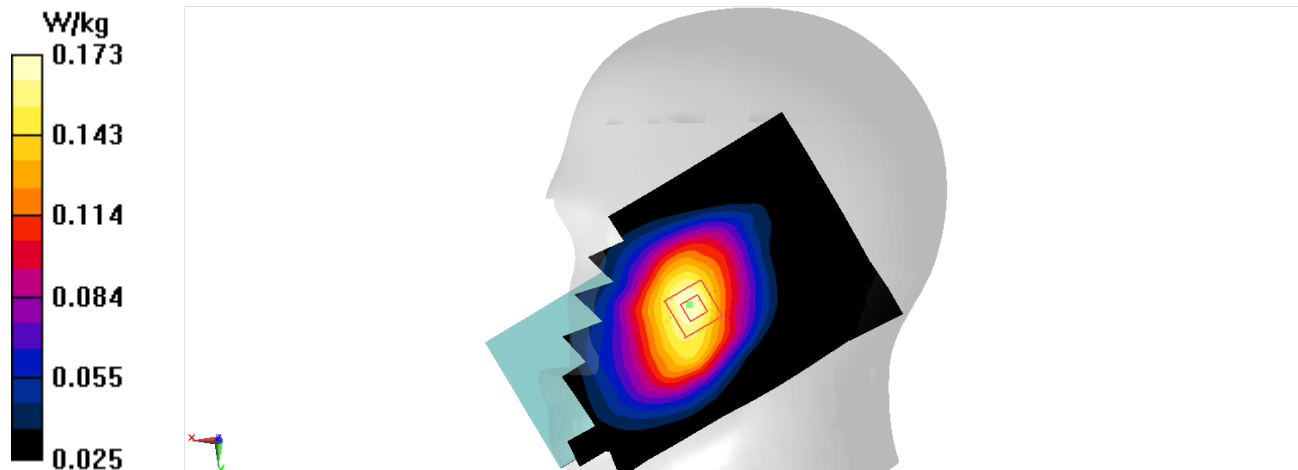

GSM1900 Head

Date/Time: 3/18/2022

Electronics: DAE4 Sn1525

Medium: H700-6000M

Medium parameters used: $f = 1880 \text{ MHz}$; $\sigma = 1.451 \text{ S/m}$; $\epsilon_r = 42.936$; $\rho = 1000 \text{ kg/m}^3$

Ambient Temperature: 23.3°C Liquid Temperature: 22.5°C

Communication System: UID 0, GSM 1900 GPRS12 (0) Frequency: 1880 MHz Duty Cycle: 1:1.99986

Probe: EX3DV4 - SN7517 ConvF(7.74, 7.74, 7.74); Calibrated: 1/19/2022

Area Scan (81x141x1): Interpolated grid: $dx=1.500 \text{ mm}$, $dy=1.500 \text{ mm}$

Maximum value of SAR (interpolated) = 0.285 W/kg

Zoom Scan (5x5x7)/Cube 0: Measurement grid: $dx=8\text{mm}$, $dy=8\text{mm}$, $dz=5\text{mm}$

Reference Value = 3.092 V/m ; Power Drift = -0.16 dB

Peak SAR (extrapolated) = 0.324 W/kg

SAR(1 g) = 0.211 W/kg ; SAR(10 g) = 0.133 W/kg

Maximum value of SAR (measured) = 0.278 W/kg

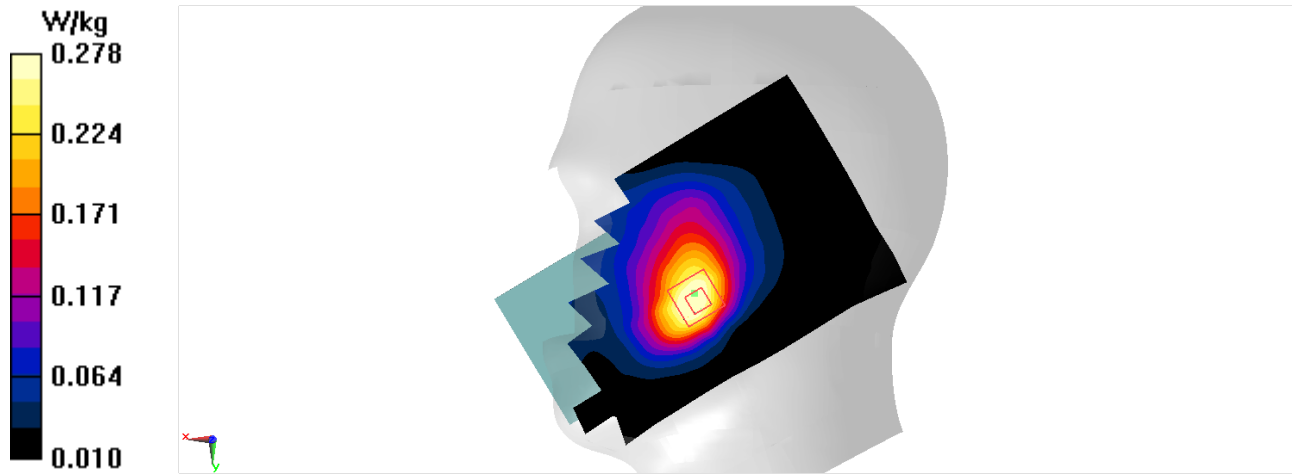

WCDMA1900 Head

Date/Time: 3/18/2022

Electronics: DAE4 Sn1525

Medium: H700-6000M

Medium parameters used: $f = 1880$ MHz; $\sigma = 1.451$ S/m; $\epsilon_r = 42.936$; $\rho = 1000$ kg/m³

Ambient Temperature: 23.3°C Liquid Temperature: 22.5°C

Communication System: UID 0, WCDMA 1900 (0) Frequency: 1880 MHz Duty Cycle: 1:1

Probe: EX3DV4 - SN7517 ConvF(7.74, 7.74, 7.74); Calibrated: 1/19/2022

Left/Cheek/Area Scan (81x141x1): Interpolated grid: dx=1.500 mm, dy=1.500 mm

Maximum value of SAR (interpolated) = 0.243 W/kg

Left/Cheek/Zoom Scan (6x6x7)/Cube 0: Measurement grid: dx=8mm, dy=8mm, dz=5mm

Reference Value = 1.999 V/m; Power Drift = 0.08 dB

Peak SAR (extrapolated) = 0.282 W/kg

SAR(1 g) = 0.175 W/kg; SAR(10 g) = 0.115 W/kg

Maximum value of SAR (measured) = 0.244 W/kg

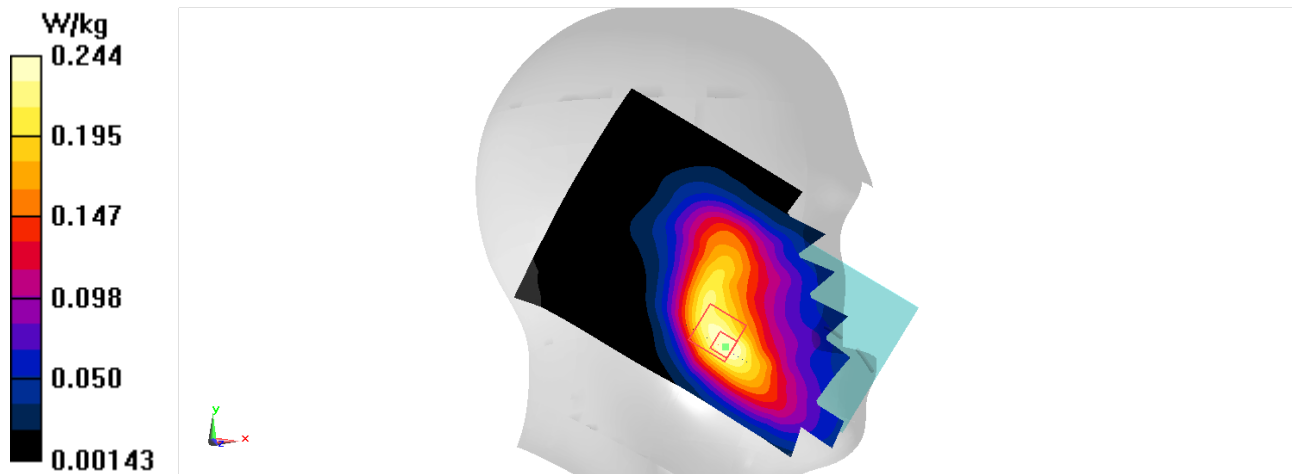

WCDMA1700 Head

Date/Time: 3/23/2022

Electronics: DAE4 Sn1525

Medium: H700-6000M

Medium parameters used (interpolated): $f = 1732.6$ MHz; $\sigma = 1.367$ S/m; $\epsilon_r = 43.079$; $\rho = 1000$ kg/m³

Ambient Temperature: 23.3°C Liquid Temperature: 22.5°C

Communication System: UID 0, WCDMA 1700 Band4 (0) Frequency: 1732.6 MHz Duty Cycle: 1:1

Probe: EX3DV4 - SN7517 ConvF(8.1, 8.1, 8.1); Calibrated: 1/19/2022

Area Scan (81x141x1): Interpolated grid: dx=1.500 mm, dy=1.500 mm

Maximum value of SAR (interpolated) = 0.181 W/kg

Zoom Scan (6x6x7)/Cube 0: Measurement grid: dx=8mm, dy=8mm, dz=5mm

Reference Value = 3.478 V/m; Power Drift = 0.04 dB

Peak SAR (extrapolated) = 0.210 W/kg

SAR(1 g) = 0.140 W/kg; SAR(10 g) = 0.094 W/kg

Maximum value of SAR (measured) = 0.181 W/kg

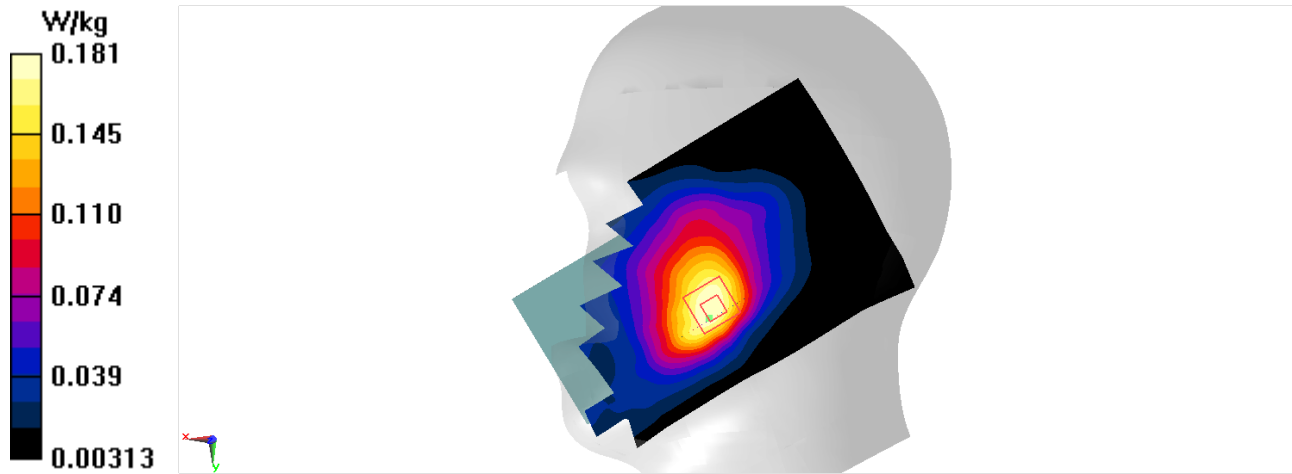

WCDMA850 Head

Date/Time: 3/12/2022

Electronics: DAE4 Sn1525

Medium: H700-6000M

Medium parameters used (interpolated): $f = 826.4$ MHz; $\sigma = 0.857$ S/m; $\epsilon_r = 45.731$; $\rho = 1000$ kg/m³

Ambient Temperature: 23.3°C Liquid Temperature: 22.5°C

Communication System: UID 0, WCDMA 850 (0) Frequency: 826.4 MHz Duty Cycle: 1:1

Probe: EX3DV4 - SN7517 ConvF(9.7, 9.7, 9.7); Calibrated: 1/19/2022

Area Scan (81x141x1): Interpolated grid: dx=1.500 mm, dy=1.500 mm

Maximum value of SAR (interpolated) = 0.579 W/kg

Zoom Scan (5x5x7)/Cube 0: Measurement grid: dx=8mm, dy=8mm, dz=5mm

Reference Value = 21.73 V/m; Power Drift = 0.05 dB

Peak SAR (extrapolated) = 0.659 W/kg

SAR(1 g) = 0.390 W/kg; SAR(10 g) = 0.262 W/kg

Maximum value of SAR (measured) = 0.523 W/kg

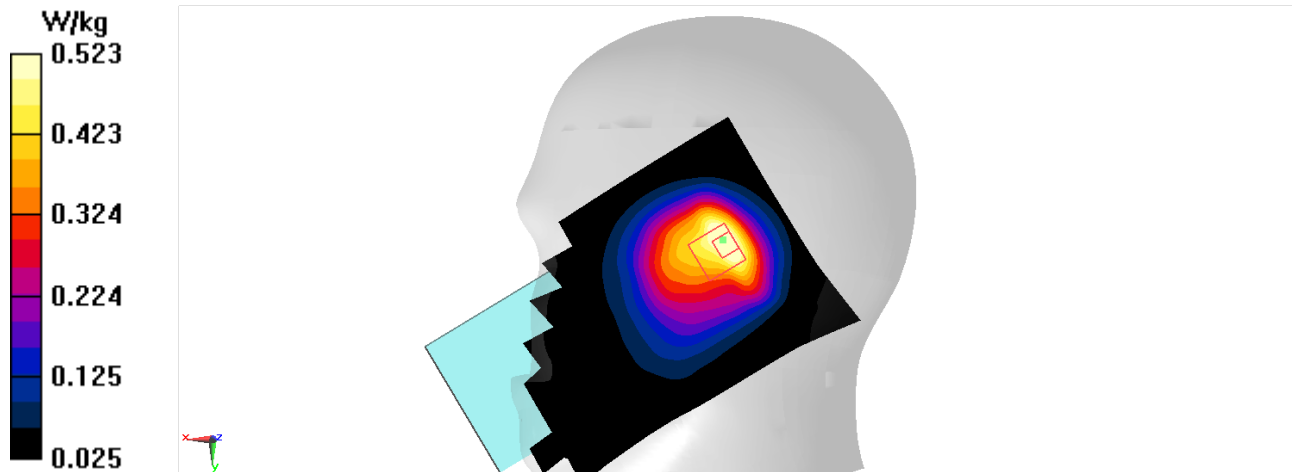

LTE Band2 Head

Date/Time: 3/18/2022

Electronics: DAE4 Sn1525

Medium: H700-6000M

Medium parameters used: $f = 1900$ MHz; $\sigma = 1.465$ S/m; $\epsilon_r = 42.903$; $\rho = 1000$ kg/m³

Ambient Temperature: 23.3°C Liquid Temperature: 22.5°C

Communication System: UID 0, LTE Band2(20MB) (0) Frequency: 1900 MHz Duty Cycle: 1:1

Probe: EX3DV4 - SN7517 ConvF(7.74, 7.74, 7.74); Calibrated: 1/19/2022

Area Scan (81x141x1): Interpolated grid: dx=1.500 mm, dy=1.500 mm

Maximum value of SAR (interpolated) = 0.303 W/kg

Zoom Scan (6x6x7)/Cube 0: Measurement grid: dx=8mm, dy=8mm, dz=5mm

Reference Value = 3.258 V/m; Power Drift = 0.09 dB

Peak SAR (extrapolated) = 0.342 W/kg

SAR(1 g) = 0.209 W/kg; SAR(10 g) = 0.135 W/kg

Maximum value of SAR (measured) = 0.293 W/kg

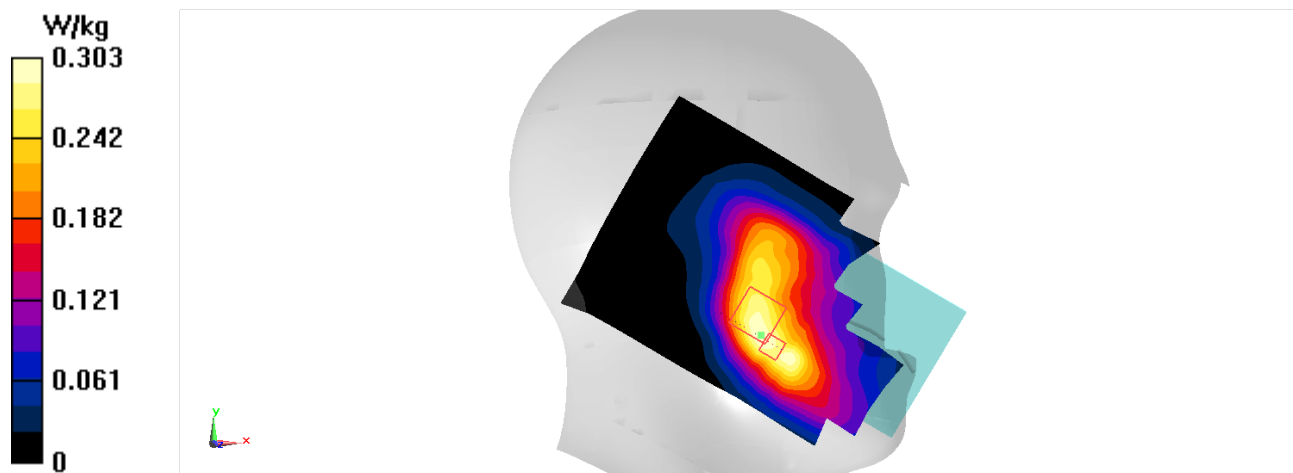

LTE Band7 Head

Date/Time: 3/20/2022

Electronics: DAE4 Sn1525

Medium: H700-6000M

Medium parameters used: $f = 2510$ MHz; $\sigma = 1.973$ S/m; $\epsilon_r = 41.55$; $\rho = 1000$ kg/m³

Ambient Temperature: 23.3°C Liquid Temperature: 22.5°C

Communication System: UID 0, LTE Band7-20M (0) Frequency: 2510 MHz Duty Cycle: 1:1

Probe: EX3DV4 - SN7517 ConvF(7.16, 7.16, 7.16); Calibrated: 1/19/2022

Area Scan (101x171x1): Interpolated grid: dx=1.200 mm, dy=1.200 mm

Maximum value of SAR (interpolated) = 0.222 W/kg

Zoom Scan (7x7x7)/Cube 0: Measurement grid: dx=5mm, dy=5mm, dz=5mm

Reference Value = 3.444 V/m; Power Drift = 0.04 dB

Peak SAR (extrapolated) = 0.239 W/kg

SAR(1 g) = 0.132 W/kg; SAR(10 g) = 0.070 W/kg

Maximum value of SAR (measured) = 0.193 W/kg

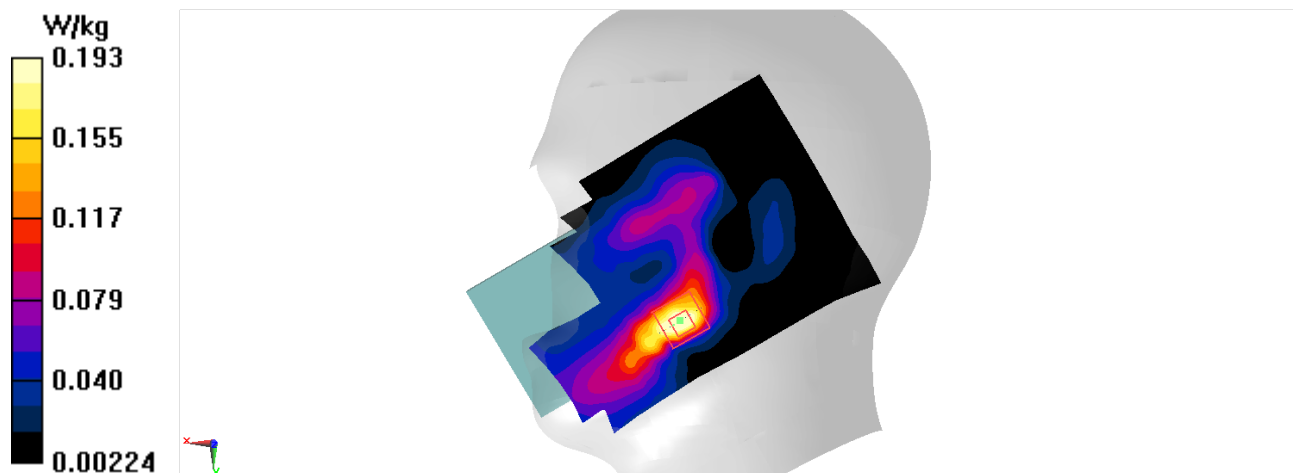

LTE Band12 Head

Date/Time: 3/15/2022

Electronics: DAE4 Sn1525

Medium: H700-6000M

Medium parameters used (interpolated): $f = 711 \text{ MHz}$; $\sigma = 0.805 \text{ S/m}$; $\epsilon_r = 46.088$; $\rho = 1000 \text{ kg/m}^3$

Ambient Temperature: 23.3°C Liquid Temperature: 22.5°C

Communication System: UID 0, LTE Band12 (0) Frequency: 711 MHz Duty Cycle: 1:1

Probe: EX3DV4 - SN7517 ConvF(9.7, 9.7, 9.7); Calibrated: 1/19/2022

Area Scan (81x141x1): Interpolated grid: $dx=1.500 \text{ mm}$, $dy=1.500 \text{ mm}$

Maximum value of SAR (interpolated) = 0.605 W/kg

Zoom Scan (7x8x7)/Cube 0: Measurement grid: $dx=8\text{mm}$, $dy=8\text{mm}$, $dz=5\text{mm}$

Reference Value = 20.31 V/m ; Power Drift = -0.08 dB

Peak SAR (extrapolated) = 0.810 W/kg

SAR(1 g) = 0.360 W/kg ; SAR(10 g) = 0.271 W/kg

Maximum value of SAR (measured) = 0.573 W/kg

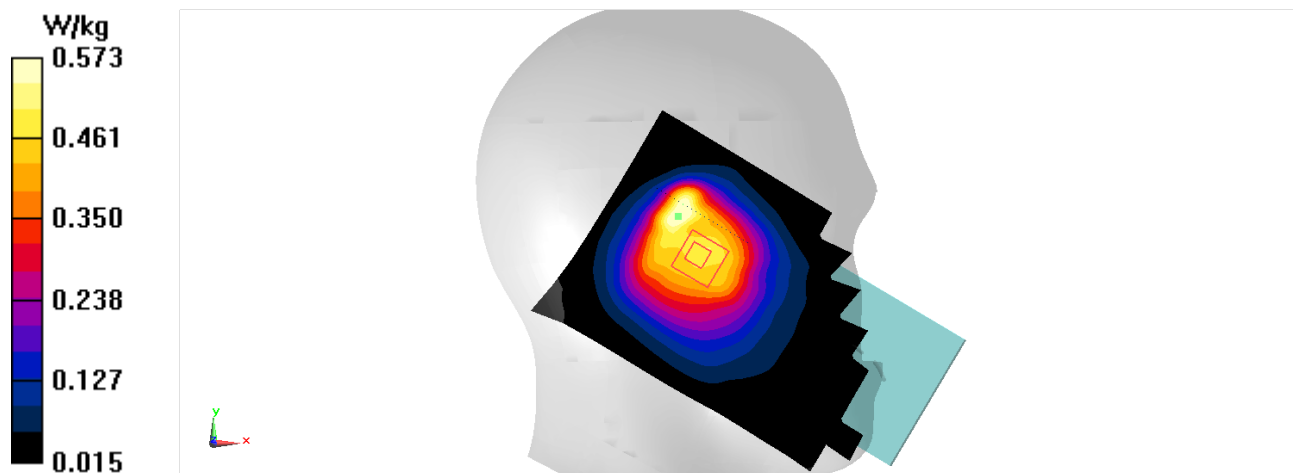

LTE Band13 Head

Date/Time: 3/15/2022

Electronics: DAE4 Sn1525

Medium: H700-6000M

Medium parameters used (interpolated): $f = 782 \text{ MHz}$; $\sigma = 0.836 \text{ S/m}$; $\epsilon_r = 45.894$; $\rho = 1000 \text{ kg/m}^3$

Ambient Temperature: 23.3°C Liquid Temperature: 22.5°C

Communication System: UID 0, LTE Band13 (0) Frequency: 782 MHz Duty Cycle: 1:1

Probe: EX3DV4 - SN7517 ConvF(9.7, 9.7, 9.7); Calibrated: 1/19/2022

Area Scan (81x141x1): Interpolated grid: $dx=1.500 \text{ mm}$, $dy=1.500 \text{ mm}$

Maximum value of SAR (interpolated) = 0.593 W/kg

Zoom Scan (7x8x7)/Cube 0: Measurement grid: $dx=8\text{mm}$, $dy=8\text{mm}$, $dz=5\text{mm}$

Reference Value = 19.85 V/m ; Power Drift = -0.17 dB

Peak SAR (extrapolated) = 0.662 W/kg

SAR(1 g) = 0.338 W/kg ; SAR(10 g) = 0.250 W/kg

Maximum value of SAR (measured) = 0.488 W/kg

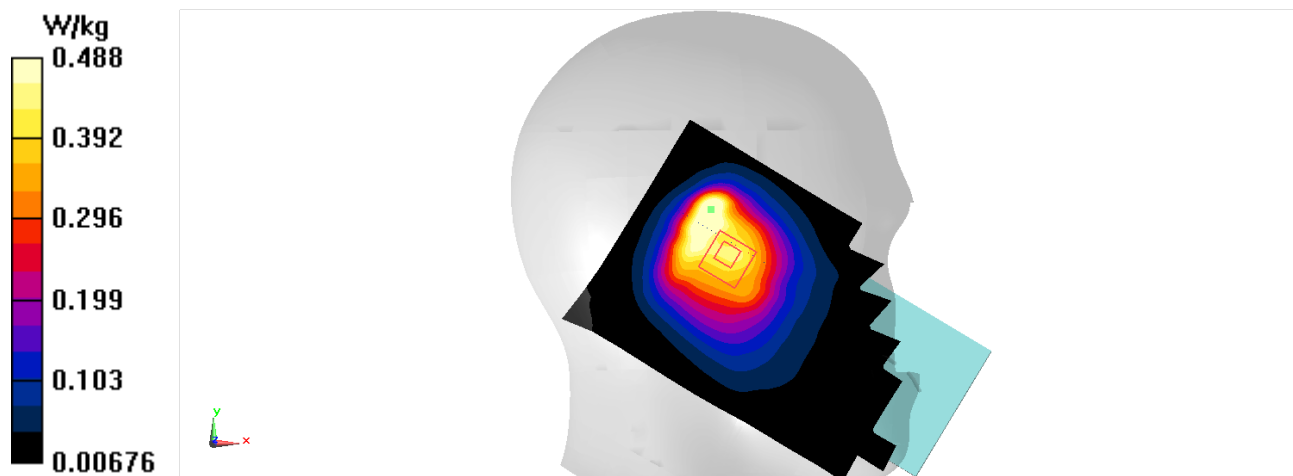

LTE Band26 Head

Date/Time: 3/12/2022

Electronics: DAE4 Sn1525

Medium: H700-6000M

Medium parameters used (interpolated): $f = 841.5$ MHz; $\sigma = 0.864$ S/m; $\epsilon_r = 45.678$; $\rho = 1000$ kg/m³

Ambient Temperature: 23.3°C Liquid Temperature: 22.5°C

Communication System: UID 0, LTE Band26 (0) Frequency: 841.5 MHz Duty Cycle: 1:1

Probe: EX3DV4 - SN7517 ConvF(9.7, 9.7, 9.7); Calibrated: 1/19/2022

Area Scan (81x141x1): Interpolated grid: dx=1.500 mm, dy=1.500 mm

Maximum value of SAR (interpolated) = 1.15 W/kg

Zoom Scan (7x8x7)/Cube 0: Measurement grid: dx=8mm, dy=8mm, dz=5mm

Reference Value = 25.89 V/m; Power Drift = 0.05 dB

Peak SAR (extrapolated) = 1.33 W/kg

SAR(1 g) = 0.672 W/kg; SAR(10 g) = 0.495 W/kg

Maximum value of SAR (measured) = 0.965 W/kg

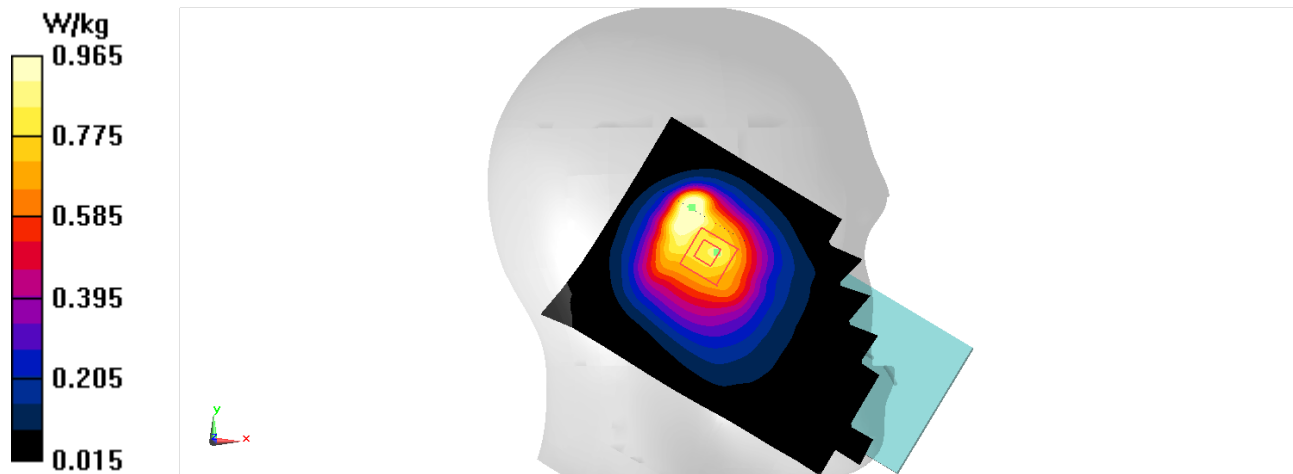

LTE Band38 Head

Date/Time: 3/20/2022

Electronics: DAE4 Sn1525

Medium: H700-6000M

Medium parameters used: $f = 2595$ MHz; $\sigma = 2.049$ S/m; $\epsilon_r = 41.414$; $\rho = 1000$ kg/m³

Ambient Temperature: 23.3°C Liquid Temperature: 22.5°C

Communication System: UID 0, LTE Band38 20M (0) Frequency: 2595 MHz Duty Cycle: 1:1.5787

Probe: EX3DV4 - SN7517 ConvF(6.97, 6.97, 6.97); Calibrated: 1/19/2022

Area Scan (101x171x1): Interpolated grid: dx=1.200 mm, dy=1.200 mm

Maximum value of SAR (interpolated) = 0.154 W/kg

Zoom Scan (7x7x7)/Cube 0: Measurement grid: dx=5mm, dy=5mm, dz=5mm

Reference Value = 2.372 V/m; Power Drift = 0.07 dB

Peak SAR (extrapolated) = 0.187 W/kg

SAR(1 g) = 0.098 W/kg; SAR(10 g) = 0.050 W/kg

Maximum value of SAR (measured) = 0.151 W/kg

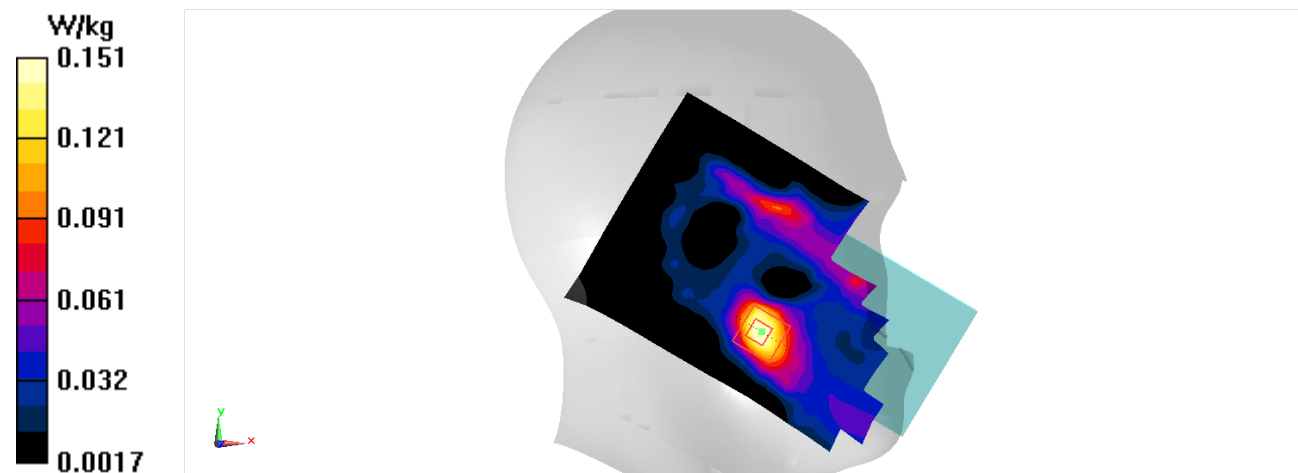

LTE Band66 Head

Date/Time: 3/23/2022

Electronics: DAE4 Sn1525

Medium: H700-6000M

Medium parameters used: $f = 1745$ MHz; $\sigma = 1.374$ S/m; $\epsilon_r = 43.066$; $\rho = 1000$ kg/m³

Ambient Temperature: 23.3°C Liquid Temperature: 22.5°C

Communication System: UID 0, LTE Band66 (0) Frequency: 1745 MHz Duty Cycle: 1:1

Probe: EX3DV4 - SN7517 ConvF(8.1, 8.1, 8.1); Calibrated: 1/19/2022

Area Scan (81x141x1): Interpolated grid: dx=1.500 mm, dy=1.500 mm

Maximum value of SAR (interpolated) = 0.170 W/kg

Zoom Scan (6x6x7)/Cube 0: Measurement grid: dx=8mm, dy=8mm, dz=5mm

Reference Value = 2.549 V/m; Power Drift = 0.05 dB

Peak SAR (extrapolated) = 0.186 W/kg

SAR(1 g) = 0.124 W/kg; SAR(10 g) = 0.086 W/kg

Maximum value of SAR (measured) = 0.163 W/kg

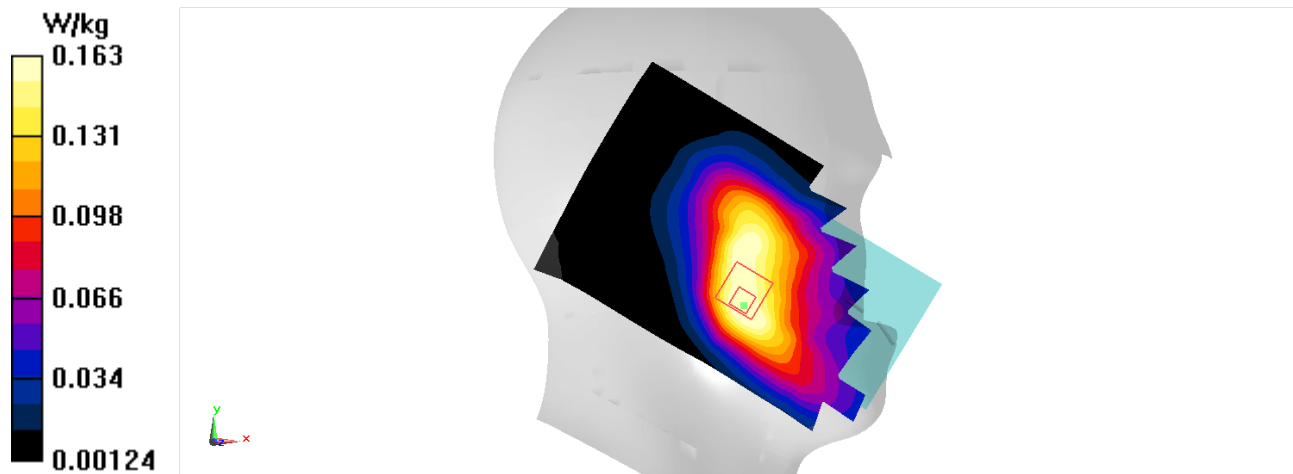

GSM850 Body

Date/Time: 3/12/2022

Electronics: DAE4 Sn1525

Medium: H700-6000M

Medium parameters used (interpolated): $f = 848.8$ MHz; $\sigma = 0.868$ S/m; $\epsilon_r = 45.653$; $\rho = 1000$ kg/m³

Ambient Temperature: 23.3°C Liquid Temperature: 22.5°C

Communication System: UID 0, GSM 850 Glass 12 (0) Frequency: 848.8 MHz Duty Cycle: 1:1.99986

Probe: EX3DV4 - SN7517 ConvF(9.7, 9.7, 9.7); Calibrated: 1/19/2022

Area Scan (81x141x1): Interpolated grid: dx=1.500 mm, dy=1.500 mm

Maximum value of SAR (interpolated) = 0.291 W/kg

Zoom Scan (5x5x7)/Cube 0: Measurement grid: dx=8mm, dy=8mm, dz=5mm

Reference Value = 16.32 V/m; Power Drift = -0.16 dB

Peak SAR (extrapolated) = 0.331 W/kg

SAR(1 g) = 0.199 W/kg; SAR(10 g) = 0.124 W/kg

Maximum value of SAR (measured) = 0.273 W/kg

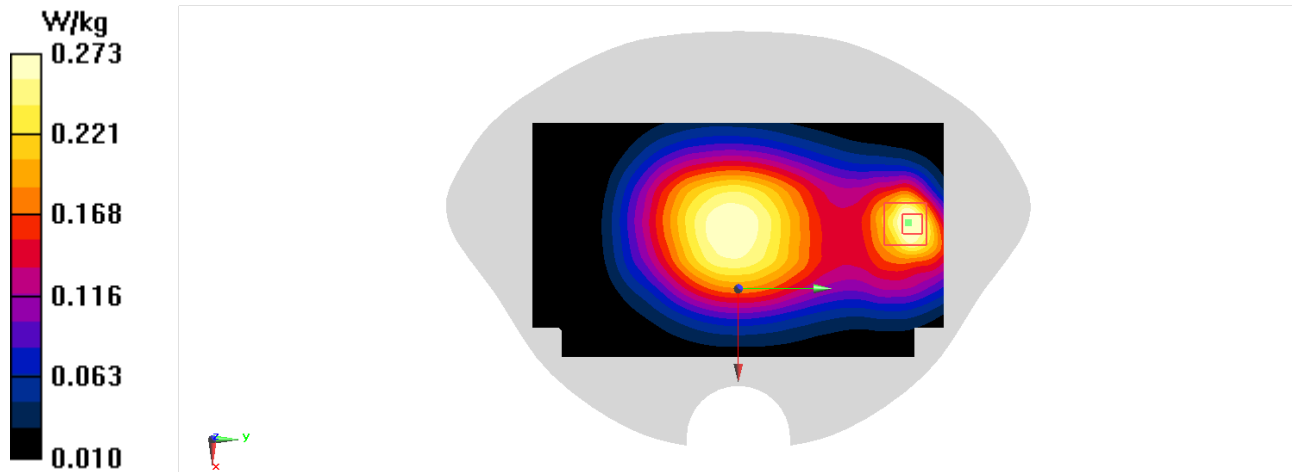

GSM1900 Body

Date/Time: 3/18/2022

Electronics: DAE4 Sn1525

Medium: H700-6000M

Medium parameters used: $f = 1880 \text{ MHz}$; $\sigma = 1.451 \text{ S/m}$; $\epsilon_r = 42.936$; $\rho = 1000 \text{ kg/m}^3$

Ambient Temperature: 23.3°C Liquid Temperature: 22.5°C

Communication System: UID 0, GSM 1900 GPRS12 (0) Frequency: 1880 MHz Duty Cycle: 1:1.99986

Probe: EX3DV4 - SN7517 ConvF(7.74, 7.74, 7.74); Calibrated: 1/19/2022

Area Scan (81x141x1): Interpolated grid: $dx=1.500 \text{ mm}$, $dy=1.500 \text{ mm}$

Maximum value of SAR (interpolated) = 0.947 W/kg

Zoom Scan (5x5x7)/Cube 0: Measurement grid: $dx=8\text{mm}$, $dy=8\text{mm}$, $dz=5\text{mm}$

Reference Value = 19.51 V/m ; Power Drift = -0.17 dB

Peak SAR (extrapolated) = 1.09 W/kg

SAR(1 g) = 0.607 W/kg ; SAR(10 g) = 0.321 W/kg

Maximum value of SAR (measured) = 0.894 W/kg

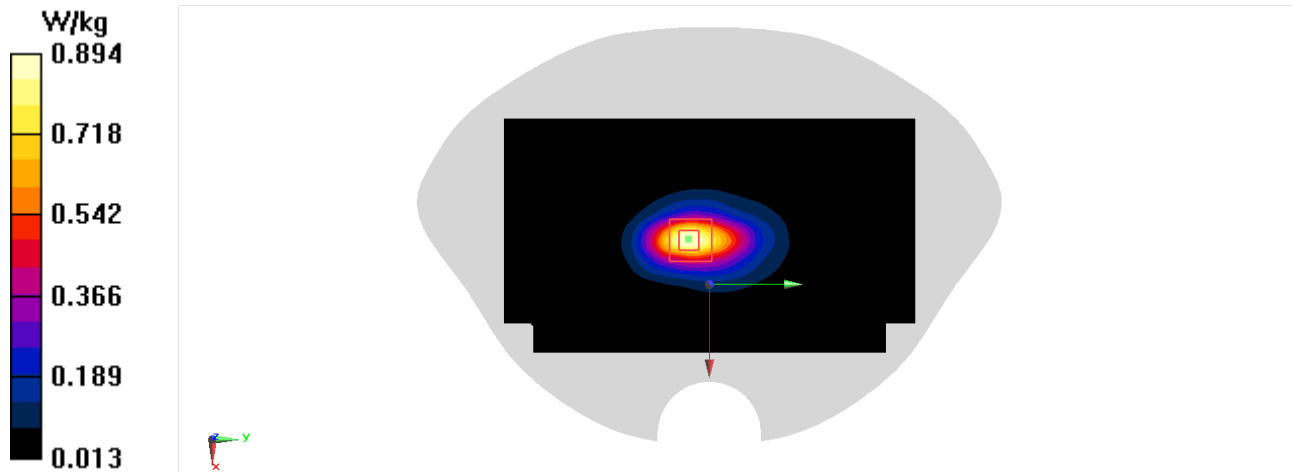

WCDMA1900 Body

Date/Time: 3/18/2022

Electronics: DAE4 Sn1525

Medium: H700-6000M

Medium parameters used (interpolated): $f = 1852.4 \text{ MHz}$; $\sigma = 1.433 \text{ S/m}$; $\epsilon_r = 42.972$; $\rho = 1000 \text{ kg/m}^3$

Ambient Temperature: 23.3°C Liquid Temperature: 22.5°C

Communication System: UID 0, WCDMA 1900 (0) Frequency: 1852.4 MHz Duty Cycle: 1:1

Probe: EX3DV4 - SN7517 ConvF(7.74, 7.74, 7.74); Calibrated: 1/19/2022

Area Scan (81x141x1): Interpolated grid: $dx=1.500 \text{ mm}$, $dy=1.500 \text{ mm}$

Maximum value of SAR (interpolated) = 1.26 W/kg

Zoom Scan (5x5x7)/Cube 0: Measurement grid: $dx=8\text{mm}$, $dy=8\text{mm}$, $dz=5\text{mm}$

Reference Value = 20.62 V/m ; Power Drift = -0.06 dB

Peak SAR (extrapolated) = 1.49 W/kg

SAR(1 g) = 0.811 W/kg ; SAR(10 g) = 0.429 W/kg

Maximum value of SAR (measured) = 1.20 W/kg

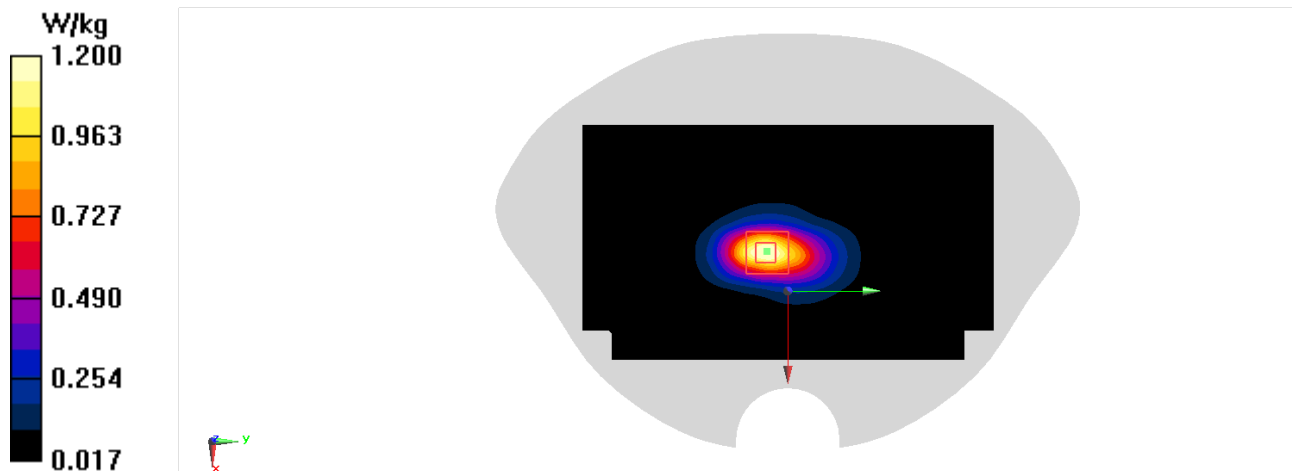

WCDMA1700 Body

Date/Time: 3/23/2022

Electronics: DAE4 Sn1525

Medium: H700-6000M

Medium parameters used (interpolated): $f = 1712.4$ MHz; $\sigma = 1.356$ S/m; $\epsilon_r = 43.105$; $\rho = 1000$ kg/m³

Ambient Temperature: 23.3°C Liquid Temperature: 22.5°C

Communication System: UID 0, WCDMA 1700 Band4 (0) Frequency: 1712.4 MHz Duty Cycle: 1:1

Probe: EX3DV4 - SN7517 ConvF(8.1, 8.1, 8.1); Calibrated: 1/19/2022

Area Scan (81x141x1): Interpolated grid: dx=1.500 mm, dy=1.500 mm

Maximum value of SAR (interpolated) = 1.35 W/kg

Body/Bottom 10mm 3.22 FUCE/Zoom Scan (5x5x7)/Cube 0: Measurement grid: dx=8mm, dy=8mm, dz=5mm

Reference Value = 22.14 V/m; Power Drift = -0.04 dB

Peak SAR (extrapolated) = 1.59 W/kg

SAR(1 g) = 0.861 W/kg; SAR(10 g) = 0.454 W/kg

Maximum value of SAR (measured) = 1.30 W/kg

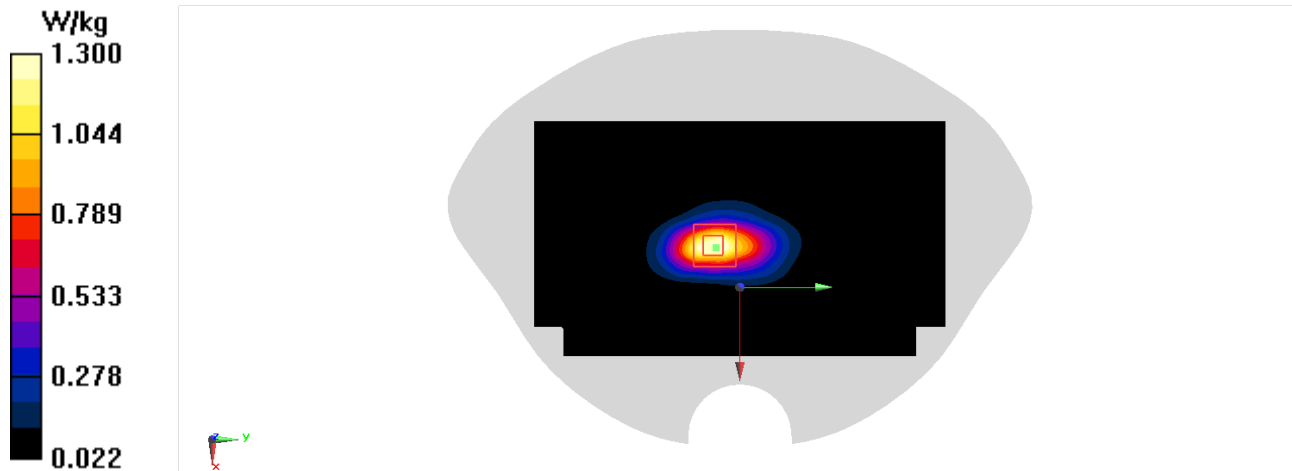

WCDMA850 Body

Date/Time: 3/12/2022

Electronics: DAE4 Sn1525

Medium: H700-6000M

Medium parameters used (interpolated): $f = 836.6$ MHz; $\sigma = 0.862$ S/m; $\epsilon_r = 45.695$; $\rho = 1000$ kg/m³

Ambient Temperature: 23.3°C Liquid Temperature: 22.5°C

Communication System: UID 0, WCDMA 850 (0) Frequency: 836.6 MHz Duty Cycle: 1:1

Probe: EX3DV4 - SN7517 ConvF(9.7, 9.7, 9.7); Calibrated: 1/19/2022

Area Scan (81x141x1): Interpolated grid: dx=1.500 mm, dy=1.500 mm

Maximum value of SAR (interpolated) = 0.226 W/kg

Zoom Scan (5x5x7)/Cube 0: Measurement grid: dx=8mm, dy=8mm, dz=5mm

Reference Value = 13.50 V/m; Power Drift = 0.07 dB

Peak SAR (extrapolated) = 0.250 W/kg

SAR(1 g) = 0.184 W/kg; SAR(10 g) = 0.140 W/kg

Maximum value of SAR (measured) = 0.225 W/kg

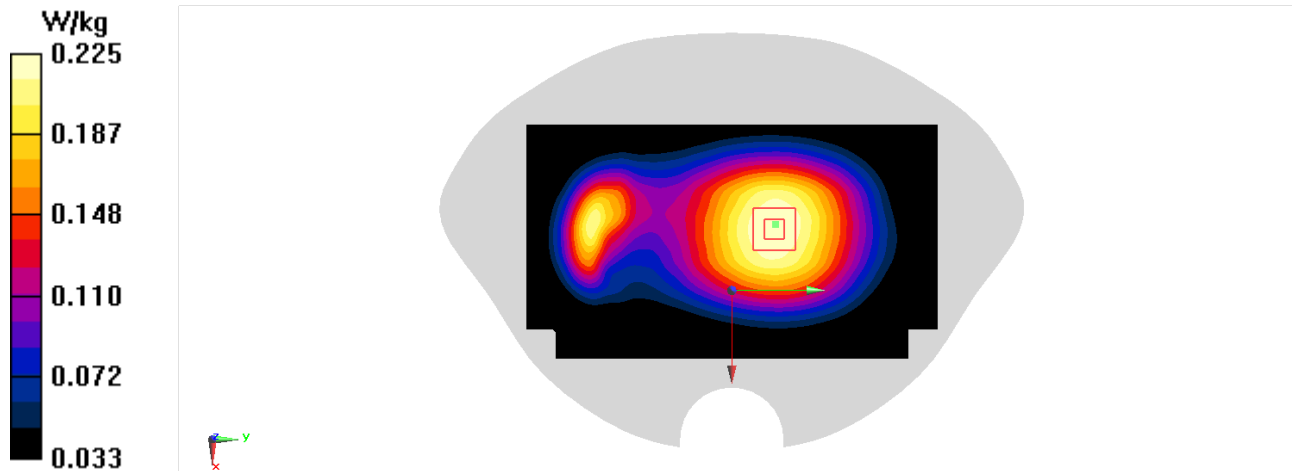

LTE Band2 Body

Date/Time: 3/18/2022

Electronics: DAE4 Sn1525

Medium: H700-6000M

Medium parameters used: $f = 1900$ MHz; $\sigma = 1.465$ S/m; $\epsilon_r = 42.903$; $\rho = 1000$ kg/m³

Ambient Temperature: 23.3°C Liquid Temperature: 22.5°C

Communication System: UID 0, LTE Band2(20MB) (0) Frequency: 1900 MHz Duty Cycle: 1:1

Probe: EX3DV4 - SN7517 ConvF(7.74, 7.74, 7.74); Calibrated: 1/19/2022

Area Scan (81x141x1): Interpolated grid: dx=1.500 mm, dy=1.500 mm

Maximum value of SAR (interpolated) = 1.56 W/kg

Zoom Scan (5x5x7)/Cube 0: Measurement grid: dx=8mm, dy=8mm, dz=5mm

Reference Value = 13.06 V/m; Power Drift = 0.08 dB

Peak SAR (extrapolated) = 1.79 W/kg

SAR(1 g) = 0.979 W/kg; SAR(10 g) = 0.513 W/kg

Maximum value of SAR (measured) = 1.48 W/kg

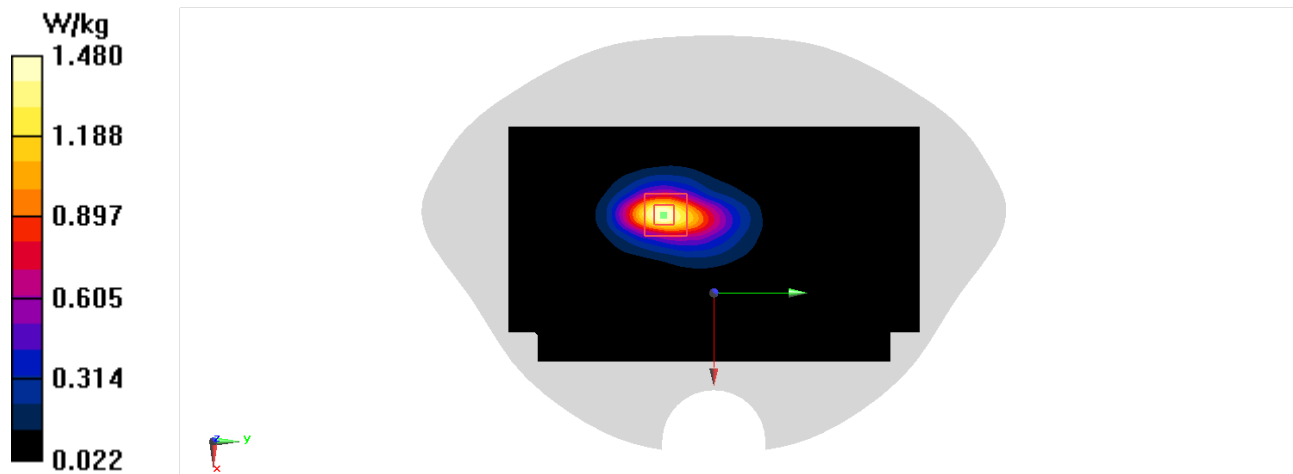

LTE Band7 Body

Date/Time: 3/20/2022

Electronics: DAE4 Sn1525

Medium: H700-6000M

Medium parameters used: $f = 2510$ MHz; $\sigma = 1.973$ S/m; $\epsilon_r = 41.55$; $\rho = 1000$ kg/m³

Ambient Temperature: 23.3°C Liquid Temperature: 22.5°C

Communication System: UID 0, LTE Band7-20M (0) Frequency: 2510 MHz Duty Cycle: 1:1

Probe: EX3DV4 - SN7517 ConvF(7.16, 7.16, 7.16); Calibrated: 1/19/2022

Area Scan (101x171x1): Interpolated grid: dx=1.200 mm, dy=1.200 mm

Maximum value of SAR (interpolated) = 1.18 W/kg

Zoom Scan (7x7x7)/Cube 0: Measurement grid: dx=5mm, dy=5mm, dz=5mm

Reference Value = 16.33 V/m; Power Drift = 0.08 dB

Peak SAR (extrapolated) = 1.59 W/kg

SAR(1 g) = 0.729 W/kg; SAR(10 g) = 0.319 W/kg

Maximum value of SAR (measured) = 1.24 W/kg

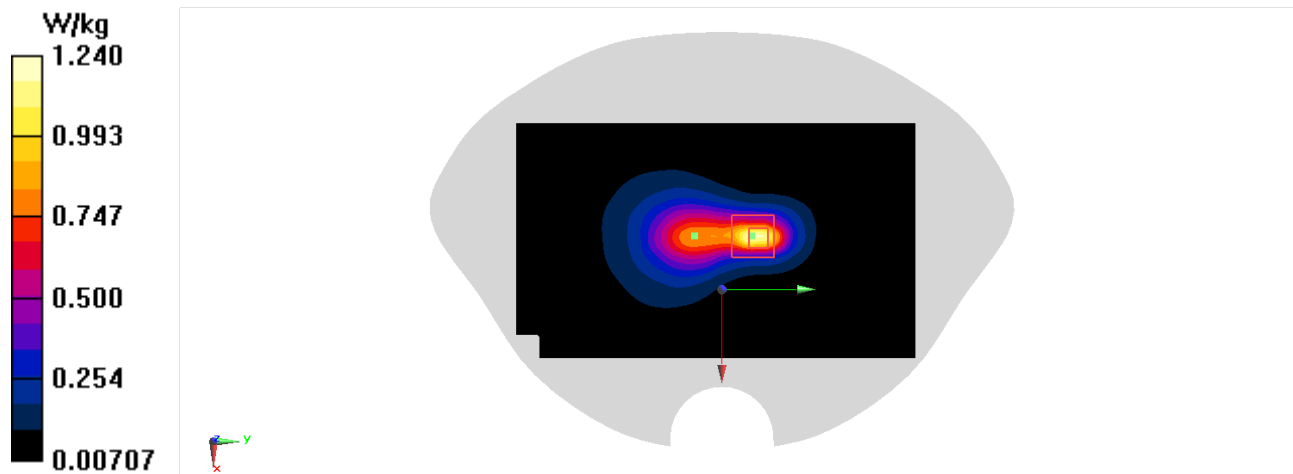

LTE Band12 Body

Date/Time: 3/15/2022

Electronics: DAE4 Sn1525

Medium: H700-6000M

Medium parameters used (interpolated): $f = 711 \text{ MHz}$; $\sigma = 0.805 \text{ S/m}$; $\epsilon_r = 46.089$; $\rho = 1000 \text{ kg/m}^3$

Ambient Temperature: 23.3°C Liquid Temperature: 22.5°C

Communication System: UID 0, LTE Band12 (0) Frequency: 711 MHz Duty Cycle: 1:1

Probe: EX3DV4 - SN7517 ConvF(9.7, 9.7, 9.7); Calibrated: 1/19/2022

Area Scan (81x141x1): Interpolated grid: $dx=1.500 \text{ mm}$, $dy=1.500 \text{ mm}$

Maximum value of SAR (interpolated) = 0.158 W/kg

Zoom Scan (5x5x7)/Cube 0: Measurement grid: $dx=8\text{mm}$, $dy=8\text{mm}$, $dz=5\text{mm}$

Reference Value = 12.05 V/m ; Power Drift = 0.09 dB

Peak SAR (extrapolated) = 0.184 W/kg

SAR(1 g) = 0.121 W/kg ; SAR(10 g) = 0.085 W/kg

Maximum value of SAR (measured) = 0.158 W/kg

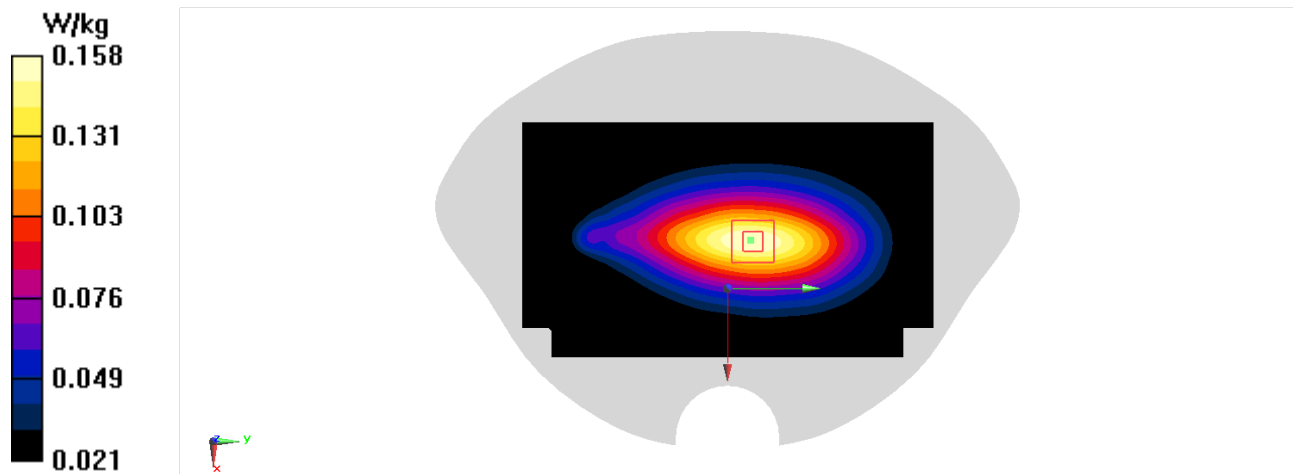

LTE Band13 Body

Date/Time: 3/15/2022

Electronics: DAE4 Sn1525

Medium: H700-6000M

Medium parameters used (interpolated): $f = 782 \text{ MHz}$; $\sigma = 0.836 \text{ S/m}$; $\epsilon_r = 45.894$; $\rho = 1000 \text{ kg/m}^3$

Ambient Temperature: 23.3°C Liquid Temperature: 22.5°C

Communication System: UID 0, LTE Band13 (0) Frequency: 782 MHz Duty Cycle: 1:1

Probe: EX3DV4 - SN7517 ConvF(9.7, 9.7, 9.7); Calibrated: 1/19/2022

Area Scan (81x141x1): Interpolated grid: $dx=1.500 \text{ mm}$, $dy=1.500 \text{ mm}$

Maximum value of SAR (interpolated) = 0.135 W/kg

Zoom Scan (6x6x7)/Cube 0: Measurement grid: $dx=8\text{mm}$, $dy=8\text{mm}$, $dz=5\text{mm}$

Reference Value = 10.74 V/m ; Power Drift = -0.08 dB

Peak SAR (extrapolated) = 0.145 W/kg

SAR(1 g) = 0.107 W/kg ; SAR(10 g) = 0.083 W/kg

Maximum value of SAR (measured) = 0.130 W/kg

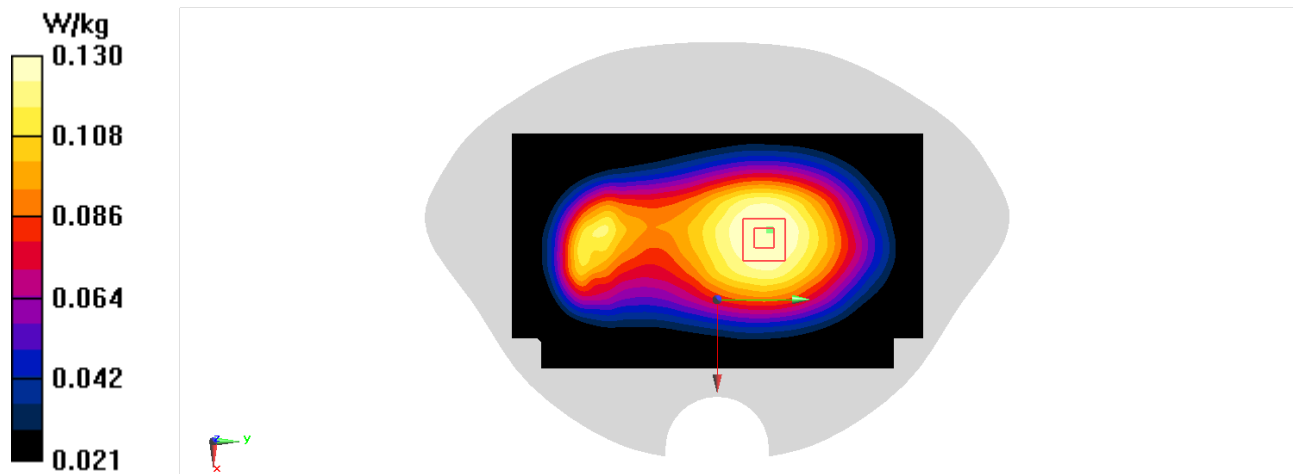

LTE Band26 Body

Date/Time: 3/12/2022

Electronics: DAE4 Sn1525

Medium: H700-6000M

Medium parameters used (interpolated): $f = 841.5$ MHz; $\sigma = 0.864$ S/m; $\epsilon_r = 45.678$; $\rho = 1000$ kg/m³

Ambient Temperature: 23.3°C Liquid Temperature: 22.5°C

Communication System: UID 0, LTE Band26 (0) Frequency: 841.5 MHz Duty Cycle: 1:1

Probe: EX3DV4 - SN7517 ConvF(9.7, 9.7, 9.7); Calibrated: 1/19/2022

Area Scan (81x141x1): Interpolated grid: dx=1.500 mm, dy=1.500 mm

Maximum value of SAR (interpolated) = 0.313 W/kg

Zoom Scan (6x6x7)/Cube 0: Measurement grid: dx=8mm, dy=8mm, dz=5mm

Reference Value = 16.38 V/m; Power Drift = -0.05 dB

Peak SAR (extrapolated) = 0.343 W/kg

SAR(1 g) = 0.253 W/kg; SAR(10 g) = 0.194 W/kg

Maximum value of SAR (measured) = 0.309 W/kg

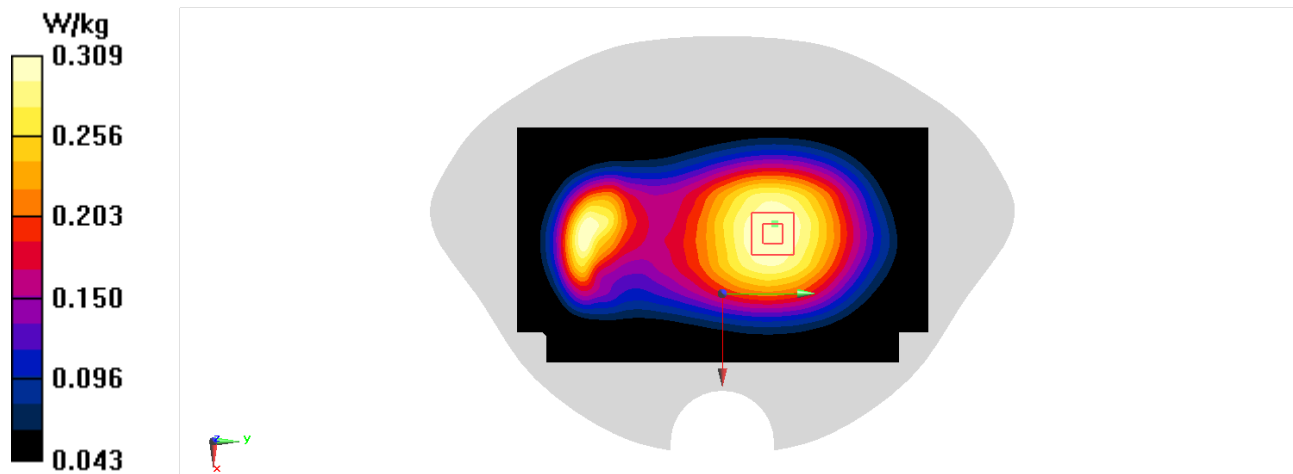

LTE Band38 Body

Date/Time: 3/20/2022

Electronics: DAE4 Sn1525

Medium: H700-6000M

Medium parameters used: $f = 2595$ MHz; $\sigma = 2.049$ S/m; $\epsilon_r = 41.414$; $\rho = 1000$ kg/m³

Ambient Temperature: 23.3°C Liquid Temperature: 22.5°C

Communication System: UID 0, LTE Band38 20M (0) Frequency: 2595 MHz Duty Cycle: 1:1.5787

Probe: EX3DV4 - SN7517 ConvF(6.97, 6.97, 6.97); Calibrated: 1/19/2022

Area Scan (101x171x1): Interpolated grid: dx=1.200 mm, dy=1.200 mm

Maximum value of SAR (interpolated) = 0.969 W/kg

Zoom Scan (7x7x7)/Cube 0: Measurement grid: dx=5mm, dy=5mm, dz=5mm

Reference Value = 3.030 V/m; Power Drift = 0.03 dB

Peak SAR (extrapolated) = 1.23 W/kg

SAR(1 g) = 0.598 W/kg; SAR(10 g) = 0.276 W/kg

Maximum value of SAR (measured) = 0.976 W/kg

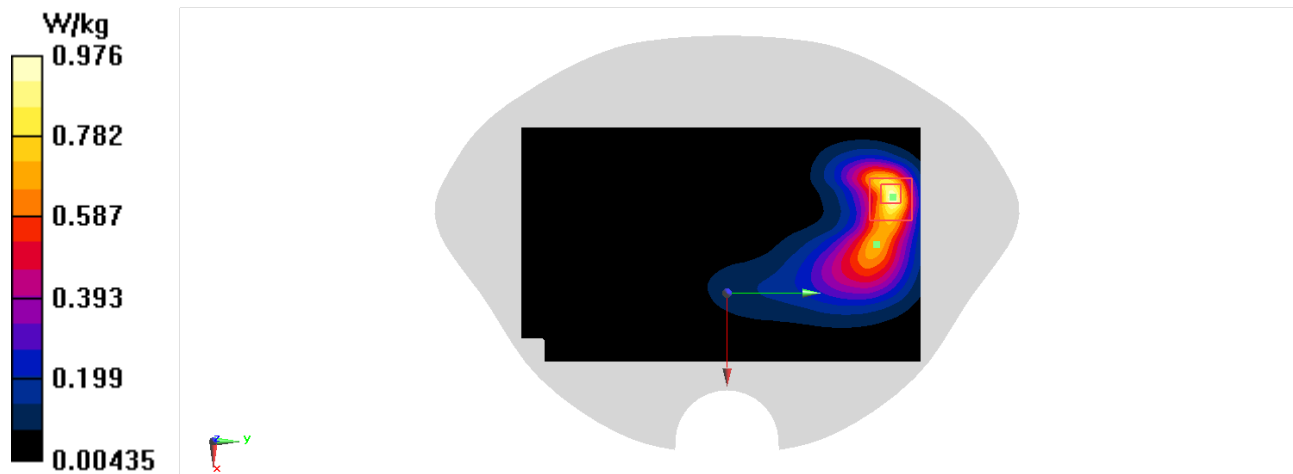

LTE Band66 Body

Date/Time: 3/23/2022

Electronics: DAE4 Sn1525

Medium: H700-6000M

Medium parameters used: $f = 1720 \text{ MHz}$; $\sigma = 1.36 \text{ S/m}$; $\epsilon_r = 43.094$; $\rho = 1000 \text{ kg/m}^3$

Ambient Temperature: 23.3°C Liquid Temperature: 22.5°C

Communication System: UID 0, LTE Band66 (0) Frequency: 1720 MHz Duty Cycle: 1:1

Probe: EX3DV4 - SN7517 ConvF(8.1, 8.1, 8.1); Calibrated: 1/19/2022

Area Scan (81x141x1): Interpolated grid: $dx=1.500 \text{ mm}$, $dy=1.500 \text{ mm}$

Maximum value of SAR (interpolated) = 1.43 W/kg

Zoom Scan (5x5x7)/Cube 0: Measurement grid: $dx=8\text{mm}$, $dy=8\text{mm}$, $dz=5\text{mm}$

Reference Value = 21.75 V/m ; Power Drift = 0.07 dB

Peak SAR (extrapolated) = 1.68 W/kg

SAR(1 g) = 0.907 W/kg ; SAR(10 g) = 0.476 W/kg

Maximum value of SAR (measured) = 1.34 W/kg

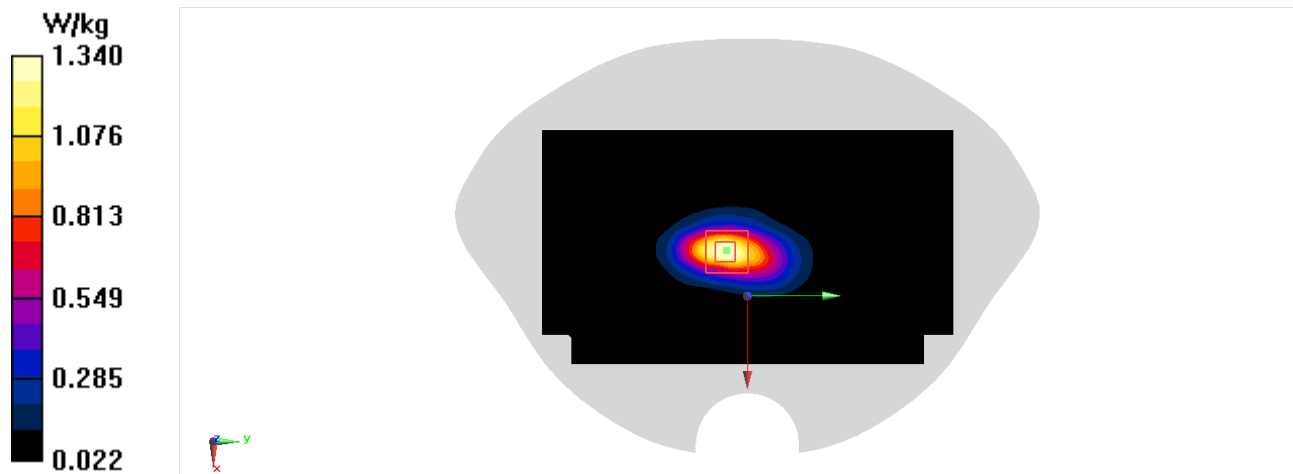

WCDMA1900 Body

Date/Time: 3/18/2022

Electronics: DAE4 Sn1525

Medium: H700-6000M

Medium parameters used (interpolated): $f = 1852.4$ MHz; $\sigma = 1.433$ S/m; $\epsilon_r = 42.972$; $\rho = 1000$ kg/m³

Ambient Temperature: 23.3°C Liquid Temperature: 22.5°C

Communication System: UID 0, WCDMA 1900 (0) Frequency: 1852.4 MHz Duty Cycle: 1:1

Probe: EX3DV4 - SN7517 ConvF(7.74, 7.74, 7.74); Calibrated: 1/19/2022

Area Scan (81x141x1): Interpolated grid: dx=1.500 mm, dy=1.500 mm

Maximum value of SAR (interpolated) = 0.456 W/kg

Zoom Scan (5x5x7)/Cube 0: Measurement grid: dx=8mm, dy=8mm, dz=5mm

Reference Value = 6.764 V/m; Power Drift = 0.05 dB

Peak SAR (extrapolated) = 0.572 W/kg

SAR(1 g) = 0.331 W/kg; SAR(10 g) = 0.188 W/kg

Maximum value of SAR (measured) = 0.480 W/kg

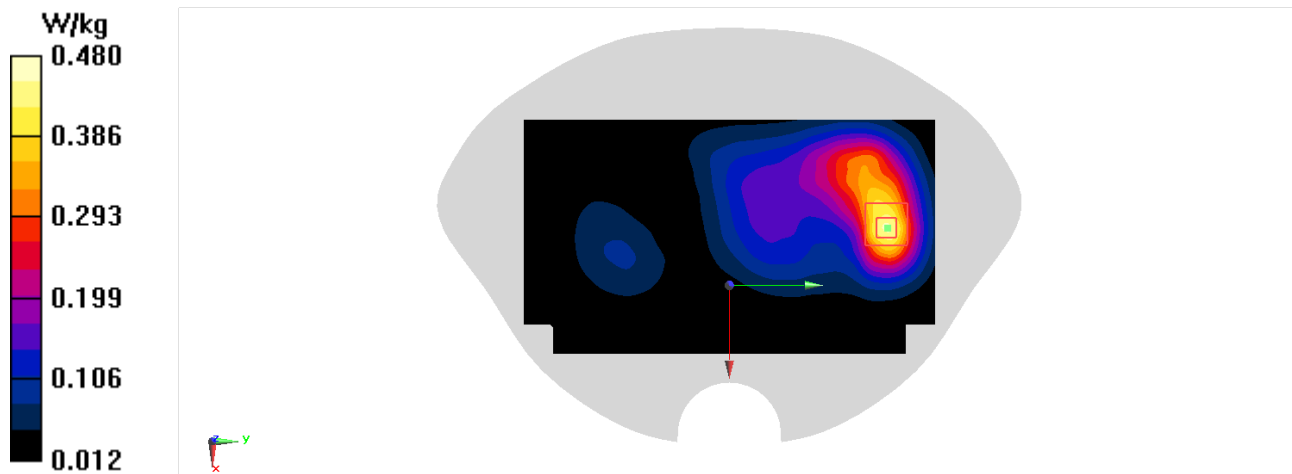

WCDMA1700 Body

Date/Time: 3/23/2022

Electronics: DAE4 Sn1525

Medium: H700-6000M

Medium parameters used (interpolated): $f = 1712.4$ MHz; $\sigma = 1.356$ S/m; $\epsilon_r = 43.105$; $\rho = 1000$ kg/m³

Ambient Temperature: 23.3°C Liquid Temperature: 22.5°C

Communication System: UID 0, WCDMA 1700 Band4 (0) Frequency: 1712.4 MHz Duty Cycle: 1:1

Probe: EX3DV4 - SN7517 ConvF(8.1, 8.1, 8.1); Calibrated: 1/19/2022

Area Scan (81x141x1): Interpolated grid: dx=1.500 mm, dy=1.500 mm

Maximum value of SAR (interpolated) = 1.07 W/kg

Zoom Scan (5x5x7)/Cube 0: Measurement grid: dx=8mm, dy=8mm, dz=5mm

Reference Value = 3.355 V/m; Power Drift = 0.06 dB

Peak SAR (extrapolated) = 1.23 W/kg

SAR(1 g) = 0.703 W/kg; SAR(10 g) = 0.386 W/kg

Maximum value of SAR (measured) = 1.02 W/kg

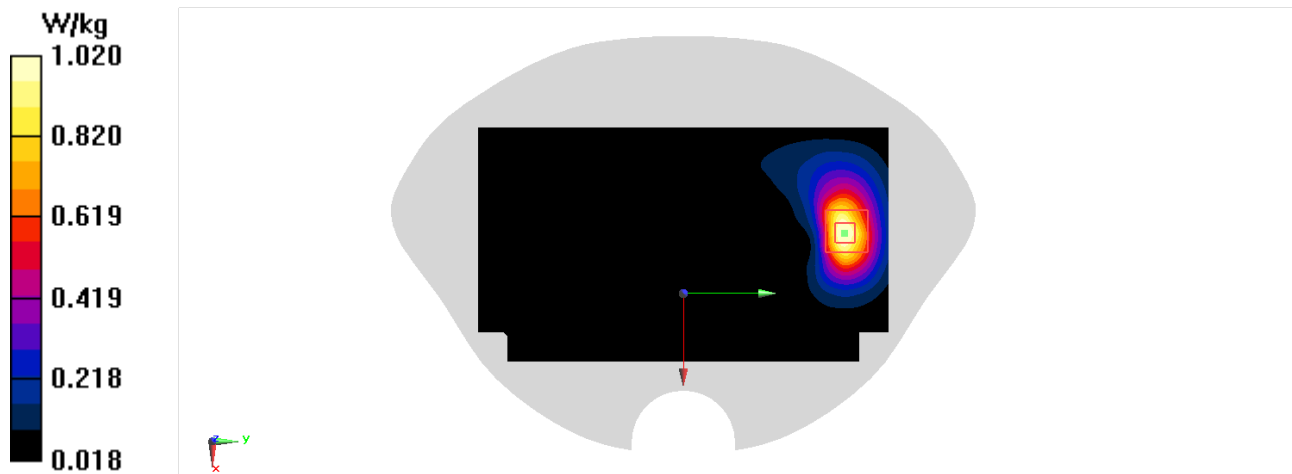

LTE Band2 Body

Date/Time: 3/18/2022

Electronics: DAE4 Sn1525

Medium: H700-6000M

Medium parameters used: $f = 1900$ MHz; $\sigma = 1.465$ S/m; $\epsilon_r = 42.903$; $\rho = 1000$ kg/m³

Ambient Temperature: 23.3°C Liquid Temperature: 22.5°C

Communication System: UID 0, LTE Band2(20MB) (0) Frequency: 1900 MHz Duty Cycle: 1:1

Probe: EX3DV4 - SN7517 ConvF(7.74, 7.74, 7.74); Calibrated: 1/19/2022

Area Scan (81x141x1): Interpolated grid: dx=1.500 mm, dy=1.500 mm

Maximum value of SAR (interpolated) = 0.540 W/kg

Zoom Scan (5x5x7)/Cube 0: Measurement grid: dx=8mm, dy=8mm, dz=5mm

Reference Value = 6.671 V/m; Power Drift = 0.10 dB

Peak SAR (extrapolated) = 0.665 W/kg

SAR(1 g) = 0.381 W/kg; SAR(10 g) = 0.214 W/kg

Maximum value of SAR (measured) = 0.558 W/kg

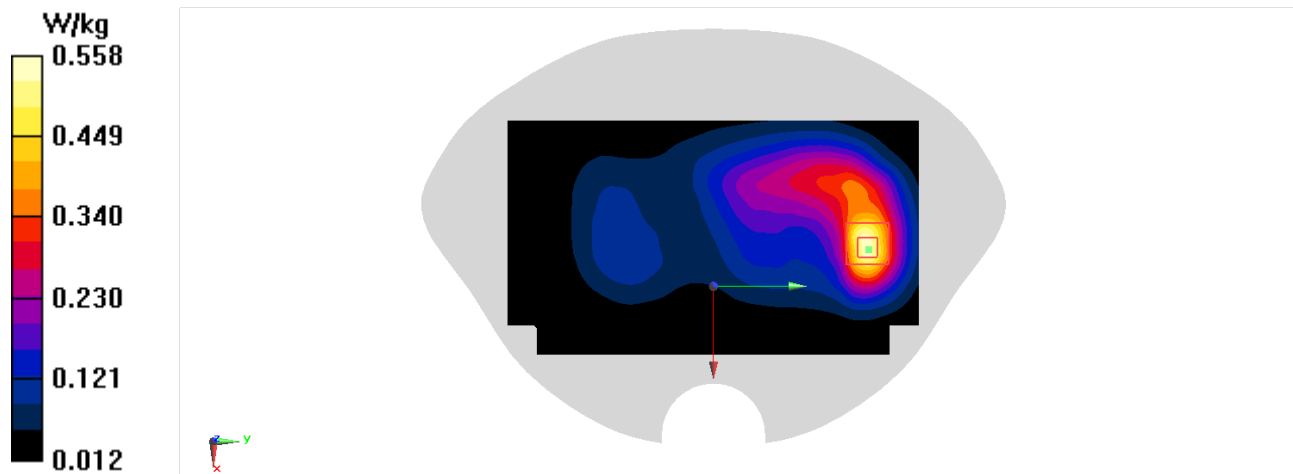

LTE Band7 Body

Date/Time: 3/20/2022

Electronics: DAE4 Sn1525

Medium: H700-6000M

Medium parameters used: $f = 2510$ MHz; $\sigma = 1.973$ S/m; $\epsilon_r = 41.55$; $\rho = 1000$ kg/m³

Ambient Temperature: 23.3°C Liquid Temperature: 22.5°C

Communication System: UID 0, LTE Band7-20M (0) Frequency: 2510 MHz Duty Cycle: 1:1

Probe: EX3DV4 - SN7517 ConvF(7.16, 7.16, 7.16); Calibrated: 1/19/2022

Area Scan (101x171x1): Interpolated grid: dx=1.200 mm, dy=1.200 mm

Maximum value of SAR (interpolated) = 0.499 W/kg

Zoom Scan (7x7x7)/Cube 0: Measurement grid: dx=5mm, dy=5mm, dz=5mm

Reference Value = 4.965 V/m; Power Drift = -0.03 dB

Peak SAR (extrapolated) = 0.636 W/kg

SAR(1 g) = 0.328 W/kg; SAR(10 g) = 0.167 W/kg

Maximum value of SAR (measured) = 0.521 W/kg

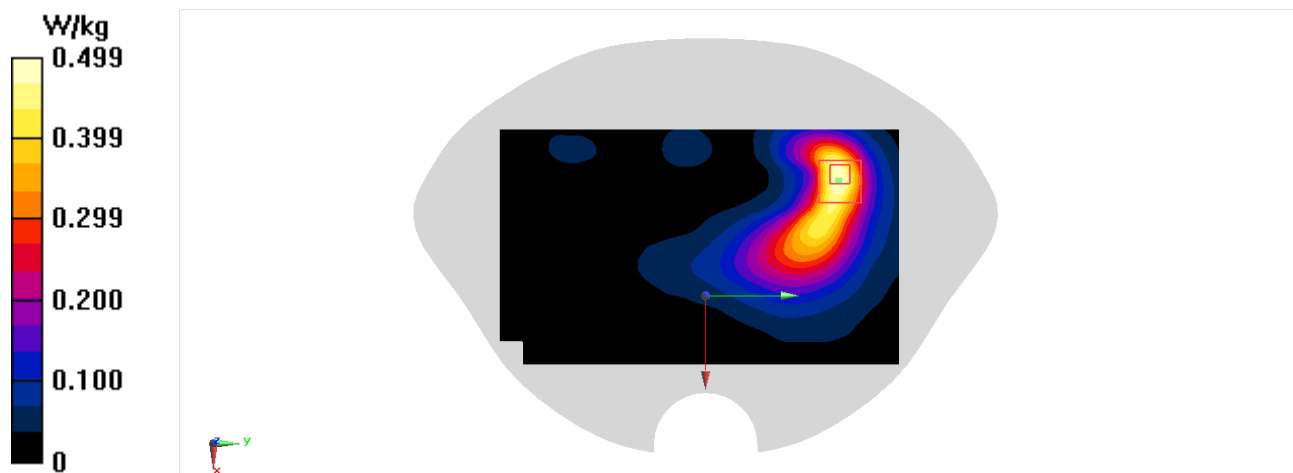

LTE Band38 Body

Date/Time: 3/20/2022

Electronics: DAE4 Sn1525

Medium: H700-6000M

Medium parameters used: $f = 2595 \text{ MHz}$; $\sigma = 2.049 \text{ S/m}$; $\epsilon_r = 41.414$; $\rho = 1000 \text{ kg/m}^3$

Ambient Temperature: 23.3°C Liquid Temperature: 22.5°C

Communication System: UID 0, LTE Band38 20M (0) Frequency: 2595 MHz Duty Cycle: 1:1.5787

Probe: EX3DV4 - SN7517 ConvF(6.97, 6.97, 6.97); Calibrated: 1/19/2022

Area Scan (101x171x1): Interpolated grid: $dx=1.200 \text{ mm}$, $dy=1.200 \text{ mm}$

Maximum value of SAR (interpolated) = 0.361 W/kg

Zoom Scan (8x7x7)/Cube 0: Measurement grid: $dx=5\text{mm}$, $dy=5\text{mm}$, $dz=5\text{mm}$

Reference Value = 1.774 V/m ; Power Drift = 0.06 dB

Peak SAR (extrapolated) = 0.454 W/kg

SAR(1 g) = 0.233 W/kg ; SAR(10 g) = 0.118 W/kg

Maximum value of SAR (measured) = 0.370 W/kg

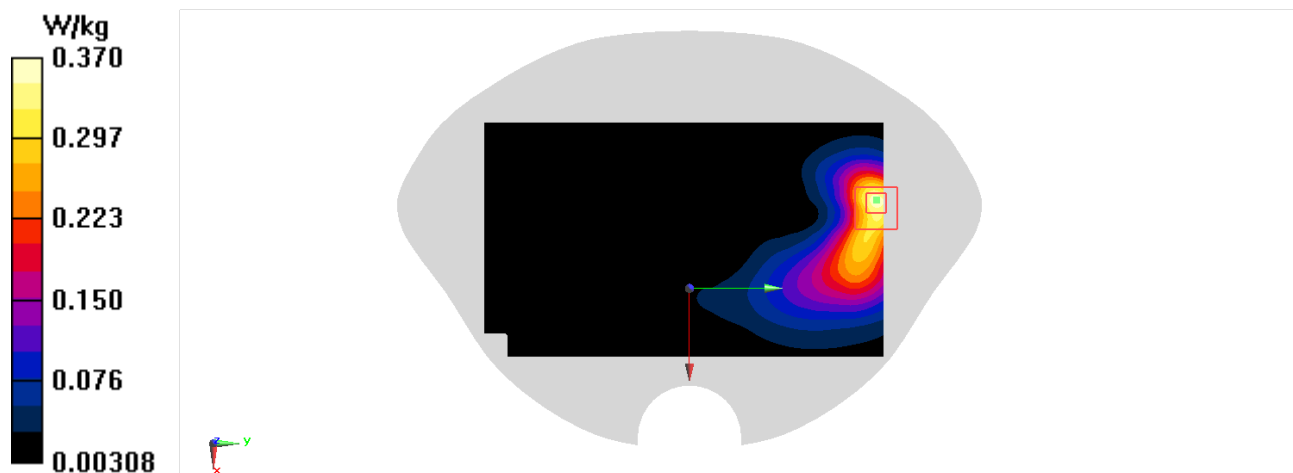

LTE Band66 Body

Date/Time: 3/23/2022

Electronics: DAE4 Sn1525

Medium: H700-6000M

Medium parameters used: $f = 1745 \text{ MHz}$; $\sigma = 1.374 \text{ S/m}$; $\epsilon_r = 43.066$; $\rho = 1000 \text{ kg/m}^3$

Ambient Temperature: 23.3°C Liquid Temperature: 22.5°C

Communication System: UID 0, LTE Band66 (0) Frequency: 1745 MHz Duty Cycle: 1:1

Probe: EX3DV4 - SN7517 ConvF(8.1, 8.1, 8.1); Calibrated: 1/19/2022

Area Scan (81x141x1): Interpolated grid: $dx=1.500 \text{ mm}$, $dy=1.500 \text{ mm}$

Maximum value of SAR (interpolated) = 0.991 W/kg

Zoom Scan (5x5x7)/Cube 0: Measurement grid: $dx=8\text{mm}$, $dy=8\text{mm}$, $dz=5\text{mm}$

Reference Value = 5.841 V/m ; Power Drift = 0.07 dB

Peak SAR (extrapolated) = 1.16 W/kg

SAR(1 g) = 0.660 W/kg ; SAR(10 g) = 0.365 W/kg

Maximum value of SAR (measured) = 0.971 W/kg

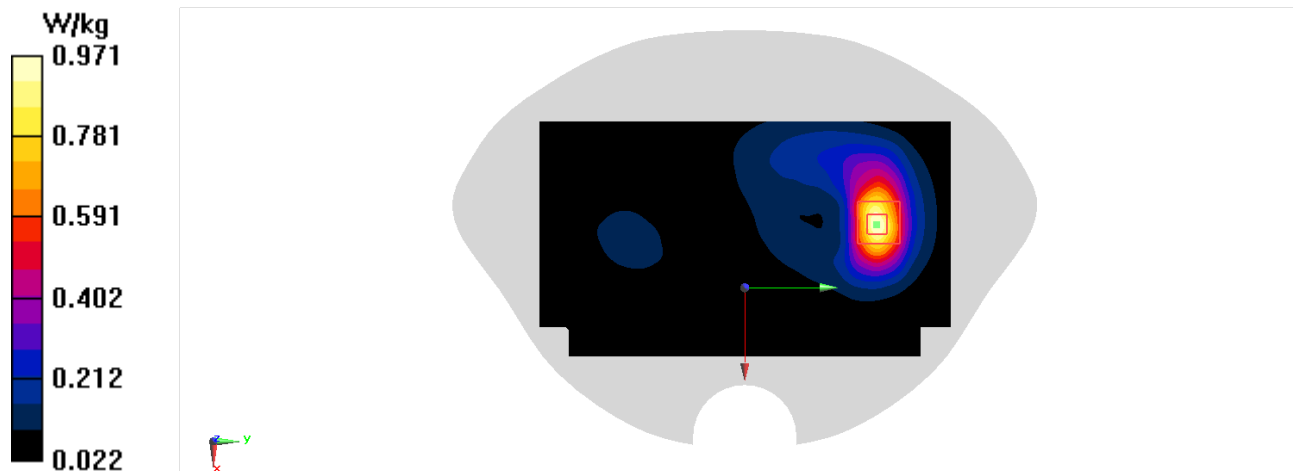

WLAN 2.4G Head

Date/Time: 3/19/2022

Electronics: DAE4 Sn1525

Medium: H700-6000M

Medium parameters used (interpolated): $f = 2437 \text{ MHz}$; $\sigma = 1.905 \text{ S/m}$; $\epsilon_r = 41.74$; $\rho = 1000 \text{ kg/m}^3$

Ambient Temperature: 23.3°C Liquid Temperature: 22.5°C

Communication System: UID 0, Wlan 2450 (0) Frequency: 2437 MHz Duty Cycle: 1:1

Probe: EX3DV4 - SN7517 ConvF(7.16, 7.16, 7.16); Calibrated: 1/19/2022

Area Scan (91x171x1): Interpolated grid: $dx=1.200 \text{ mm}$, $dy=1.200 \text{ mm}$

Maximum value of SAR (interpolated) = 0.235 W/kg

Zoom Scan (8x8x7)/Cube 0: Measurement grid: $dx=5\text{mm}$, $dy=5\text{mm}$, $dz=5\text{mm}$

Reference Value = 5.480 V/m ; Power Drift = 0.07 dB

Peak SAR (extrapolated) = 0.287 W/kg

SAR(1 g) = 0.144 W/kg ; SAR(10 g) = 0.070 W/kg

Maximum value of SAR (measured) = 0.228 W/kg

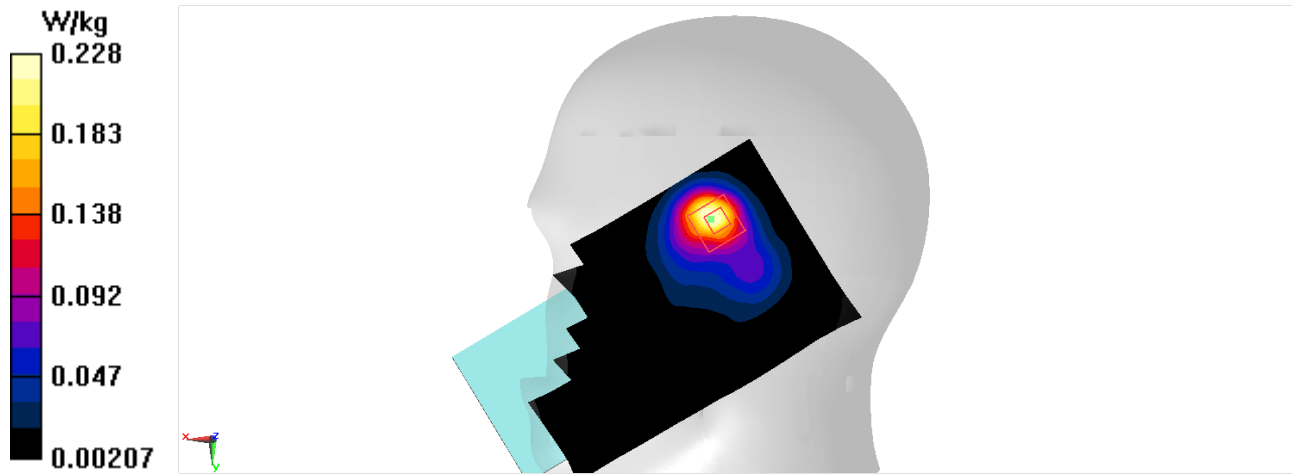

WLAN 2.4G Body

Date/Time: 3/19/2022

Electronics: DAE4 Sn1525

Medium: H700-6000M

Medium parameters used (interpolated): $f = 2437$ MHz; $\sigma = 1.905$ S/m; $\epsilon_r = 41.74$; $\rho = 1000$ kg/m³

Ambient Temperature: 23.3°C Liquid Temperature: 22.5°C

Communication System: UID 0, Wlan 2450 (0) Frequency: 2437 MHz Duty Cycle: 1:1

Probe: EX3DV4 - SN7517 ConvF(7.16, 7.16, 7.16); Calibrated: 1/19/2022

Area Scan (101x171x1): Interpolated grid: dx=1.200 mm, dy=1.200 mm

Maximum value of SAR (interpolated) = 0.142 W/kg

Zoom Scan (7x7x7)/Cube 0: Measurement grid: dx=5mm, dy=5mm, dz=5mm

Reference Value = 3.719 V/m; Power Drift = 0.10 dB

Peak SAR (extrapolated) = 0.167 W/kg

SAR(1 g) = 0.083 W/kg; SAR(10 g) = 0.033 W/kg

Maximum value of SAR (measured) = 0.134 W/kg

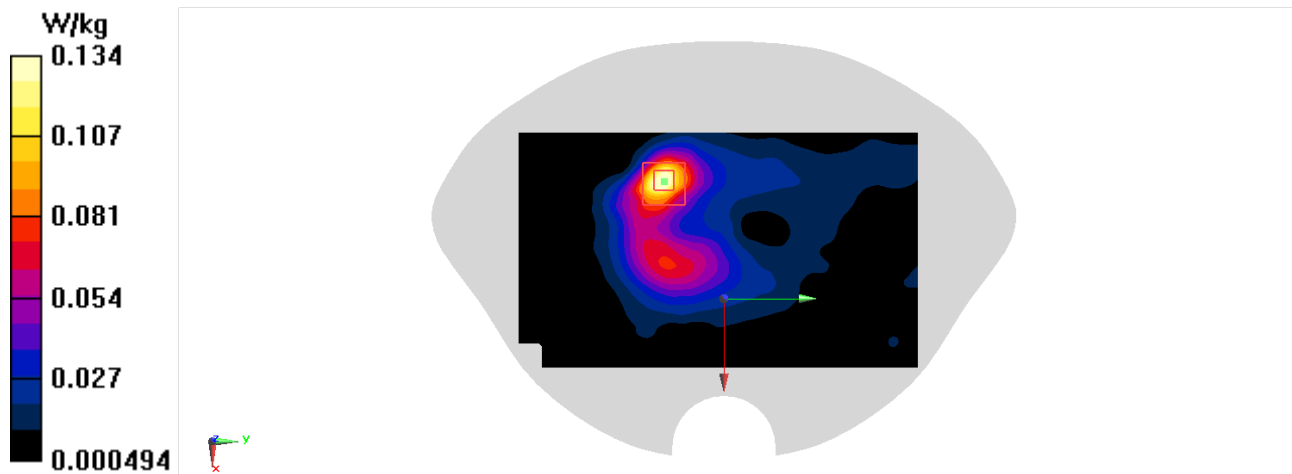

BT Head

Date/Time: 3/19/2022

Electronics: DAE4 Sn1525

Medium: H700-6000M

Medium parameters used (interpolated): $f = 2402$ MHz; $\sigma = 1.874$ S/m; $\epsilon_r = 41.843$; $\rho = 1000$ kg/m³

Ambient Temperature: 23.3°C Liquid Temperature: 22.5°C

Communication System: UID 0, Bluetooth (0) Frequency: 2402 MHz Duty Cycle: 1:1

Probe: EX3DV4 - SN7517 ConvF(7.16, 7.16, 7.16); Calibrated: 1/19/2022

Area Scan (101x171x1): Interpolated grid: dx=1.200 mm, dy=1.200 mm

Maximum value of SAR (interpolated) = 0.0292 W/kg

Zoom Scan (8x8x7)/Cube 0: Measurement grid: dx=5mm, dy=5mm, dz=5mm

Reference Value = 2.448 V/m; Power Drift = -0.03 dB

Peak SAR (extrapolated) = 0.0260 W/kg

SAR(1 g) = 0.012 W/kg; SAR(10 g) = 0.0053 W/kg

Maximum value of SAR (measured) = 0.0205 W/kg

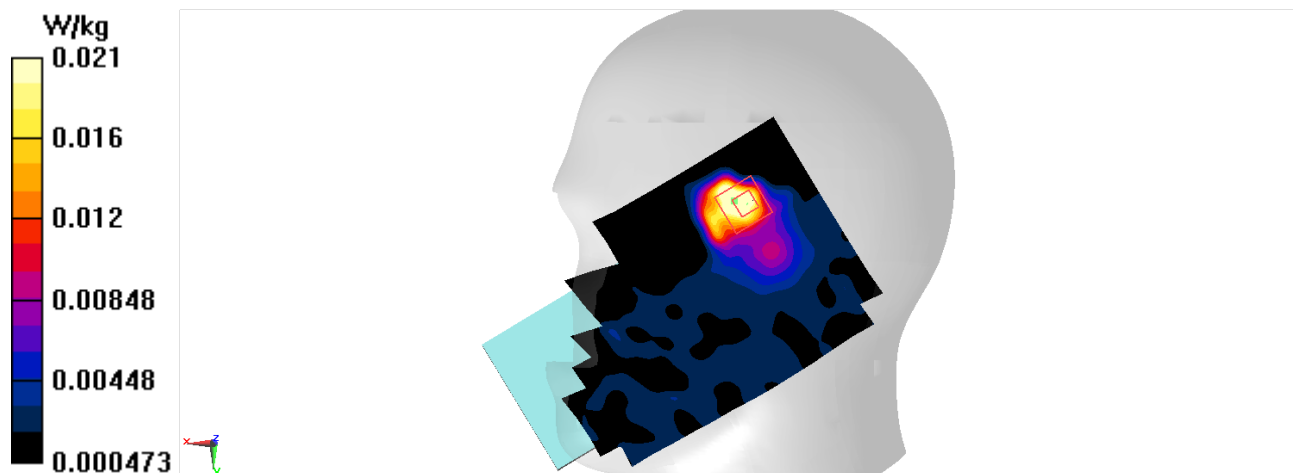

ANNEX B System Verification Results

SystemPerformanceCheck-D750-1017

Date/Time: 3/15/2022

Electronics: DAE4 Sn1525

Medium: H700-6000M

Medium parameters used: $f = 750 \text{ MHz}$; $\sigma = 0.822 \text{ S/m}$; $\epsilon_r = 46.028$; $\rho = 1000 \text{ kg/m}^3$

Ambient Temperature: 23.3°C Liquid Temperature: 22.5°C

Communication System: UID 0, CW (0) Frequency: 750 MHz Duty Cycle: 1:1

Probe: EX3DV4 - SN7517 ConvF(9.7, 9.7, 9.7); Calibrated: 1/19/2022

System Performance Check at Frequencies below 1 GHz/d=15mm, Pin=250 mW, dist=2.0mm (EX-Probe)/Area Scan (61x141x1): Interpolated grid: $dx=1.500 \text{ mm}$, $dy=1.500 \text{ mm}$
Maximum value of SAR (interpolated) = 2.51 W/kg

System Performance Check at Frequencies below 1 GHz/d=15mm, Pin=250 mW, dist=2.0mm (EX-Probe)/Zoom Scan (7x7x7) (7x7x7)/Cube 0: Measurement grid: $dx=5\text{mm}$, $dy=5\text{mm}$, $dz=5\text{mm}$
Reference Value = 54.65 V/m; Power Drift = -0.12 dB
Peak SAR (extrapolated) = 3.02 W/kg
SAR(1 g) = 2 W/kg; SAR(10 g) = 1.33 W/kg
Maximum value of SAR (measured) = 2.53 W/kg

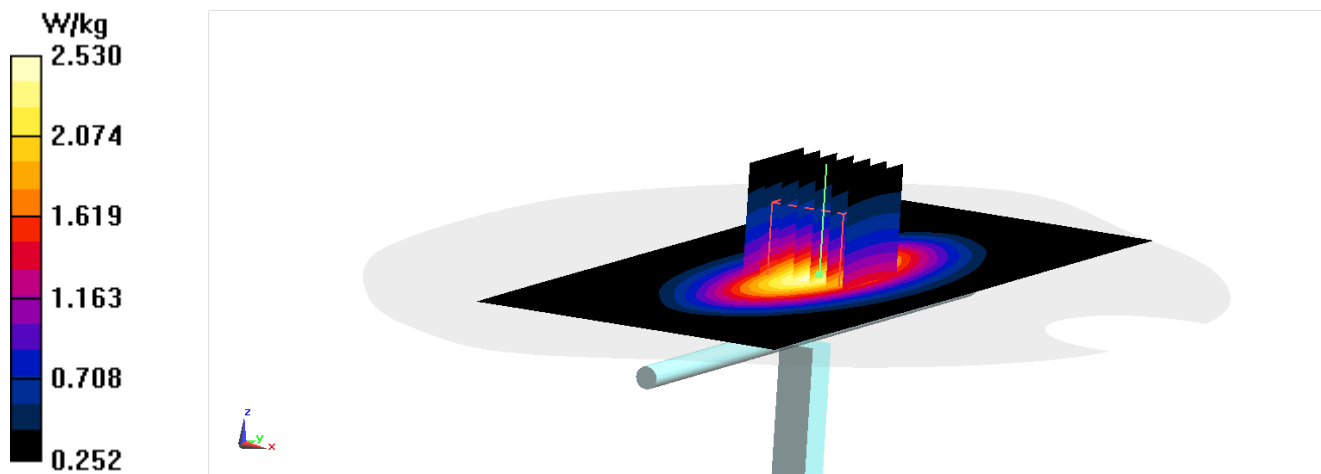

B.1

SystemPerformanceCheck-D835_4d069

Date/Time: 3/12/2022

Electronics: DAE4 Sn1525

Medium: H700-6000M

Medium parameters used: $f = 835 \text{ MHz}$; $\sigma = 0.861 \text{ S/m}$; $\epsilon_r = 45.601$; $\rho = 1000 \text{ kg/m}^3$

Ambient Temperature: 23.3°C Liquid Temperature: 22.5°C

Communication System: UID 0, CW (0) Frequency: 835 MHz Duty Cycle: 1:1

Probe: EX3DV4 - SN7517 ConvF(9.7, 9.7, 9.7); Calibrated: 1/19/2022

System Performance Check at Frequencies below 1 GHz/d=15mm, Pin=250 mW, dist=2.0mm

(EX-Probe)/Area Scan (61x121x1): Interpolated grid: dx=1.500 mm, dy=1.500 mm

Maximum value of SAR (interpolated) = 3.12 W/kg

System Performance Check at Frequencies below 1 GHz/d=15mm, Pin=250 mW, dist=2.0mm

(EX-Probe)/Zoom Scan (7x7x7) (7x7x7)/Cube 0: Measurement grid: dx=5mm, dy=5mm, dz=5mm

Reference Value = 60.33 V/m; Power Drift = 0.10 dB

Peak SAR (extrapolated) = 4.06 W/kg

SAR(1 g) = 2.45 W/kg; SAR(10 g) = 1.52 W/kg

Maximum value of SAR (measured) = 3.27 W/kg

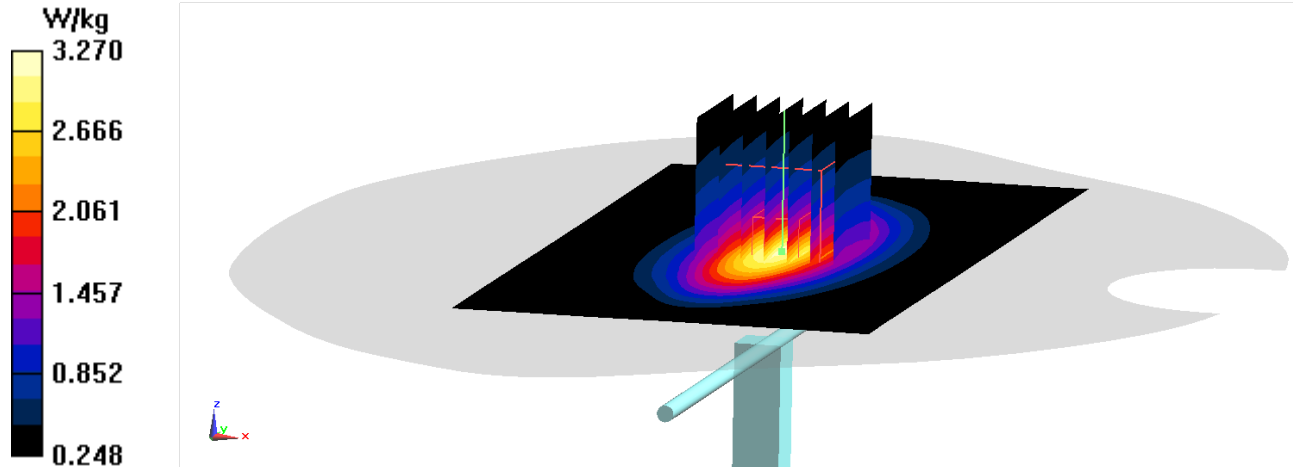

SystemPerformanceCheck-D1750_1003

Date/Time: 3/23/2022

Electronics: DAE4 Sn1525

Medium: H700-6000M

Medium parameters used: $f = 1750$ MHz; $\sigma = 1.377$ S/m; $\epsilon_r = 43.061$; $\rho = 1000$ kg/m³

Ambient Temperature: 23.3°C Liquid Temperature: 22.5°C

Communication System: UID 0, CW Frequency: 1750 MHz Duty Cycle: 1:1

Probe: EX3DV4 - SN7517 ConvF(8.1, 8.1, 8.1); Calibrated: 1/19/2022

System Performance Check at Frequencies above 1 GHz/d=10mm, Pin=250 mW, dist=2.0mm

(EX-Probe)/Area Scan (61x81x1): Interpolated grid: dx=1.500 mm, dy=1.500 mm

Maximum value of SAR (interpolated) = 12.3 W/kg

System Performance Check at Frequencies above 1 GHz/d=10mm, Pin=250 mW, dist=2.0mm

(EX-Probe)/Zoom Scan (7x7x7) (7x7x7)/Cube 0: Measurement grid: dx=5mm, dy=5mm, dz=5mm

Reference Value = 92.79 V/m; Power Drift = -0.19 dB

Peak SAR (extrapolated) = 14.8 W/kg

SAR(1 g) = 8.65 W/kg; SAR(10 g) = 4.74 W/kg

Maximum value of SAR (measured) = 11.9 W/kg

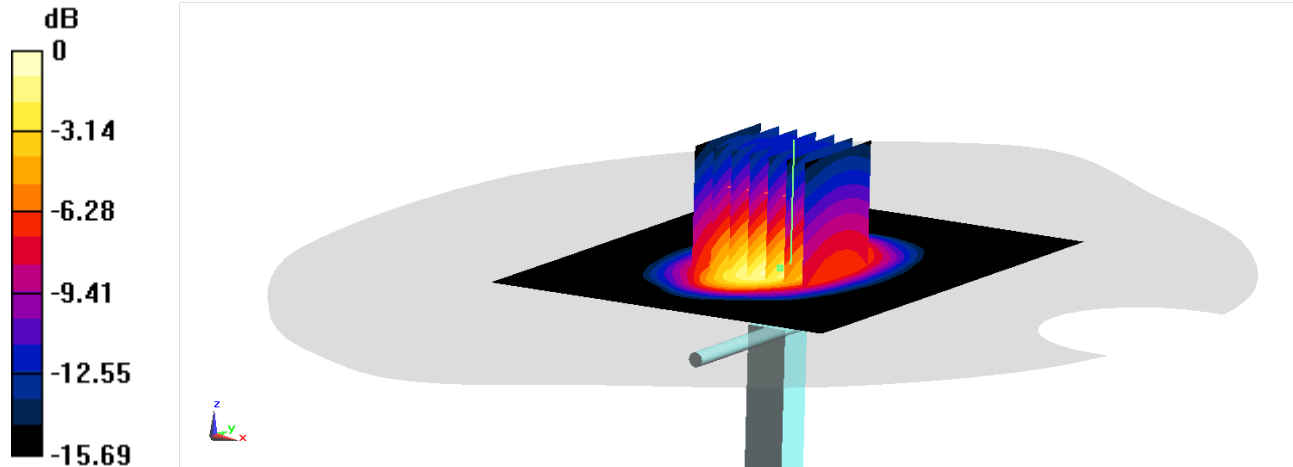

0 dB = 12.3 W/kg = 10.90 dBW/kg

1900MHz Validation For Head_Ref_Dipole SN5d101

Date/Time: 3/18/2022

Electronics: DAE4 Sn1525

Medium: H700-6000M

Medium parameters used: $f = 1900$ MHz; $\sigma = 1.465$ S/m; $\epsilon_r = 42.903$; $\rho = 1000$ kg/m³

Ambient Temperature: 23.3°C Liquid Temperature: 22.5°C

Communication System: UID 0, CW (0) Frequency: 1900 MHz Duty Cycle: 1:1

Probe: EX3DV4 - SN7517 ConvF(7.74, 7.74, 7.74); Calibrated: 1/19/2022

Configuration/d=10mm, Pin=250 mW, dist=2.0mm (EX-Probe)/Area Scan (61x61x1): Interpolated grid: dx=1.500 mm, dy=1.500 mm
Maximum value of SAR (interpolated) = 12.9 W/kg

Configuration/d=10mm, Pin=250 mW, dist=2.0mm (EX-Probe)/Zoom Scan (7x7x7) (5x5x7)/Cube 0: Measurement grid: dx=8mm, dy=8mm, dz=5mm
Reference Value = 91.67 V/m; Power Drift = 0.19 dB
Peak SAR (extrapolated) = 16.7 W/kg
SAR(1 g) = 9.27 W/kg; SAR(10 g) = 4.84 W/kg
Maximum value of SAR (measured) = 13.2 W/kg

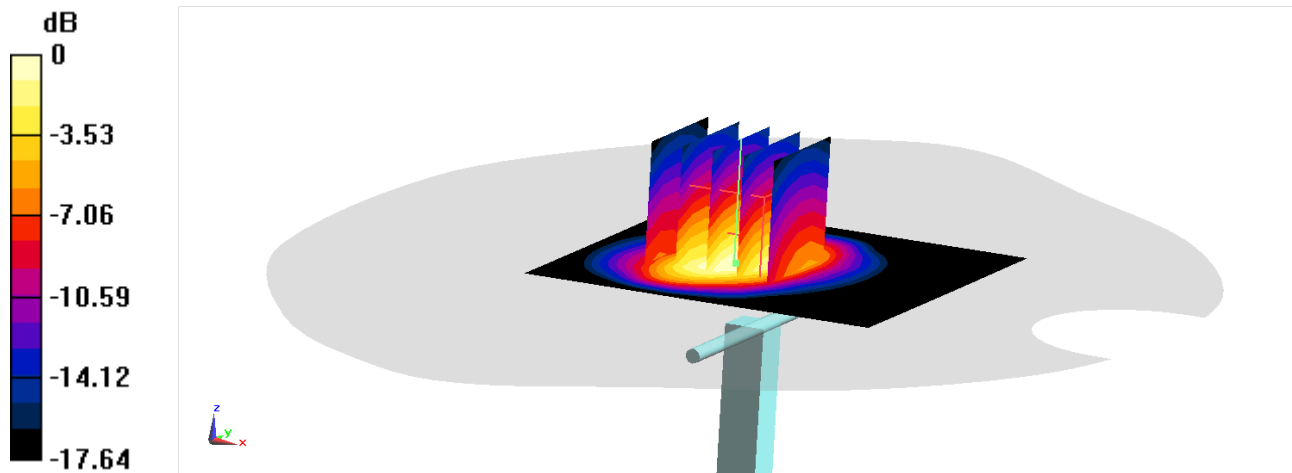

0 dB = 12.9 W/kg = 11.11 dBW/kg

SystemPerformanceCheck-D2450_853

Date/Time: 3/19/2022

Electronics: DAE4 Sn1525

Medium: H700-6000M

Medium parameters used: $f = 2450$ MHz; $\sigma = 1.918$ S/m; $\epsilon_r = 41.701$; $\rho = 1000$ kg/m³

Ambient Temperature: 23.3°C Liquid Temperature: 22.5°C

Communication System: UID 0, CW (0) Frequency: 2450 MHz Duty Cycle: 1:1

Probe: EX3DV4 - SN7517 ConvF(7.16, 7.16, 7.16); Calibrated: 1/19/2022

System Performance Check at Frequencies above 1 GHz/d=10mm, Pin=250mW, dist=2.0mm

(EX-Probe)/Area Scan (61x71x1): Interpolated grid: dx=1.200 mm, dy=1.200 mm

Maximum value of SAR (interpolated) = 21.0 W/kg

System Performance Check at Frequencies above 1 GHz/d=10mm, Pin=250mW, dist=2.0mm

(EX-Probe)/Zoom Scan (7x7x7) (7x7x7)/Cube 0: Measurement grid: dx=5mm, dy=5mm, dz=5mm

Reference Value = 102.9 V/m; Power Drift = -0.03 dB

Peak SAR (extrapolated) = 25.8 W/kg

SAR(1 g) = 12.8 W/kg; SAR(10 g) = 6 W/kg

Maximum value of SAR (measured) = 19.4 W/kg

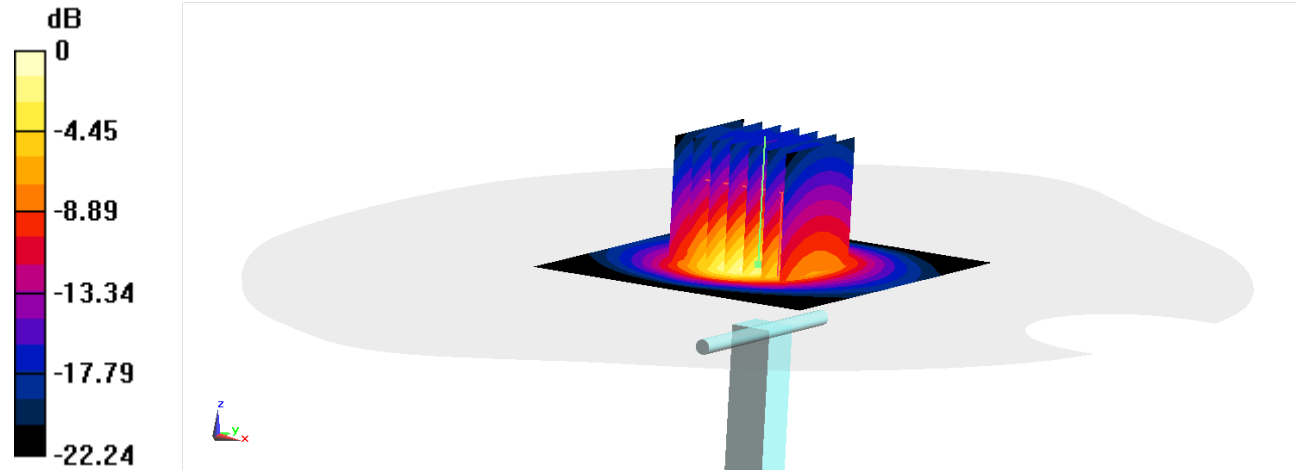

0 dB = 21.0 W/kg = 13.22 dBW/kg

SystemPerformanceCheck-D2600_1012

Date/Time: 3/20/2022

Electronics: DAE4 Sn1525

Medium: H700-6000M

Medium parameters used: $f = 2600$ MHz; $\sigma = 2.053$ S/m; $\epsilon_r = 41.409$; $\rho = 1000$ kg/m³

Ambient Temperature: 23.3°C Liquid Temperature: 22.5°C

Communication System: UID 0, CW (0) Frequency: 2600 MHz Duty Cycle: 1:1

Probe: EX3DV4 - SN7517 ConvF(6.97, 6.97, 6.97); Calibrated: 1/19/2022

System Performance Check at Frequencies above 1 GHz/d=10mm, Pin=250 mW, dist=2.0mm

(EX-Probe)/Area Scan (81x91x1): Interpolated grid: dx=1.200 mm, dy=1.200 mm

Maximum value of SAR (interpolated) = 22.8 W/kg

System Performance Check at Frequencies above 1 GHz/d=10mm, Pin=250 mW, dist=2.0mm

(EX-Probe)/Zoom Scan (7x7x7) (7x7x7)/Cube 0: Measurement grid: dx=5mm, dy=5mm, dz=5mm

Reference Value = 101.8 V/m; Power Drift = -0.08 dB

Peak SAR (extrapolated) = 29.2 W/kg

SAR(1 g) = 14 W/kg; SAR(10 g) = 6.36 W/kg

Maximum value of SAR (measured) = 21.5 W/kg

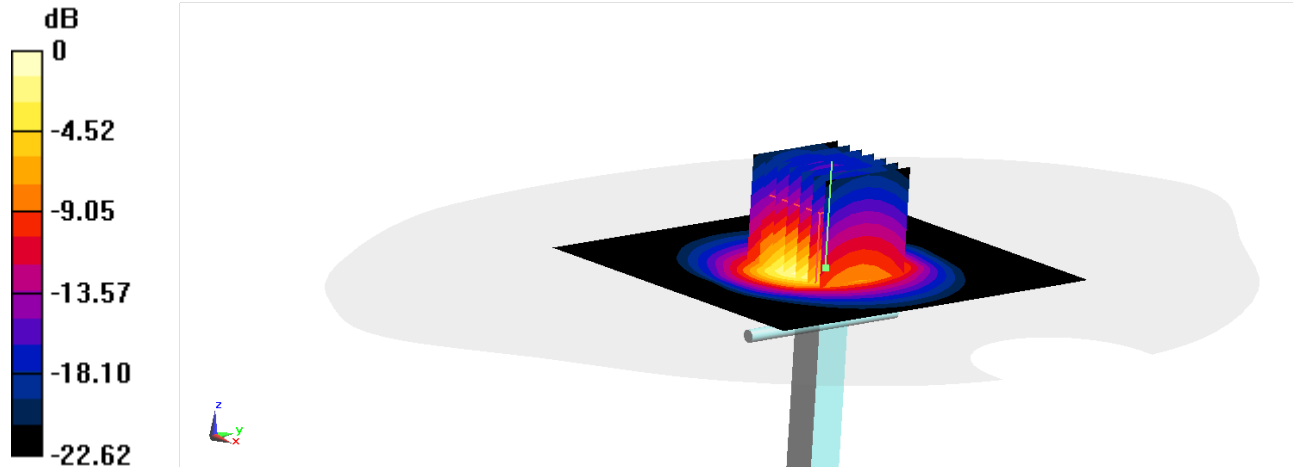

0 dB = 22.8 W/kg = 13.58 dBW/kg

ANNEX C SAR Measurement Setup

C.1 Measurement Set-up

The Dasy5 or DASY6 system for performing compliance tests is illustrated above graphically. This system consists of the following items:

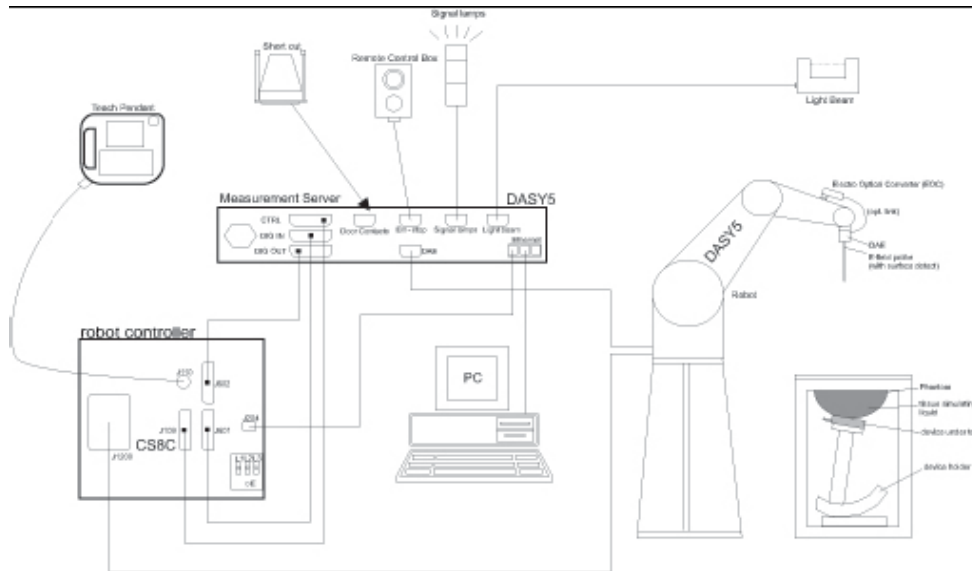

Picture C.1 SAR Lab Test Measurement Set-up

- A standard high precision 6-axis robot (StäubliTX=RX family) with controller, teach pendant and software. An arm extension for accommodating the data acquisition electronics (DAE).
- An isotropic field probe optimized and calibrated for the targeted measurement.
- A data acquisition electronics (DAE) which performs the signal amplification, signal multiplexing, AD-conversion, offset measurements, mechanical surface detection, collision detection, etc. The unit is battery powered with standard or rechargeable batteries. The signal is optically transmitted to the EOC.
- The Electro-optical converter (EOC) performs the conversion from optical to electrical signals for the digital communication to the DAE. To use optical surface detection, a special version of the EOC is required. The EOC signal is transmitted to the measurement server.
- The function of the measurement server is to perform the time critical tasks such as signal filtering, control of the robot operation and fast movement interrupts.
- The Light Beam used is for probe alignment. This improves the (absolute) accuracy of the probe positioning.
- A computer running WinXP and the DASY5 or DASY6 software.
- Remote control and teach pendant as well as additional circuitry for robot safety such as
- warning lamps, etc.
- The phantom, the device holder and other accessories according to the targeted measurement.

C.2 Dasy5 E-field Probe System

The SAR measurements were conducted with the dosimetric probe designed in the classical triangular configuration and optimized for dosimetric evaluation. The probe is constructed using the thick film technique; with printed resistive lines on ceramic substrates. The probe is equipped with an optical multifiber line ending at the front of the probe tip. It is connected to the EOC box on the robot arm and provides an automatic detection of the phantom surface. Half of the fibers are connected to a pulsed infrared transmitter, the other half to a synchronized receiver. As the probe approaches the surface, the reflection from the surface produces a coupling from the transmitting to the receiving fibers. This reflection increases first during the approach, reaches maximum and then decreases. If the probe is flatly touching the surface, the coupling is zero. The distance of the coupling maximum to the surface is independent of the surface reflectivity and largely independent of the surface to probe angle. The DASY5 or DASY6 software reads the reflection during a software approach and looks for the maximum using 2nd order curve fitting. The approach is stopped at reaching the maximum.

Probe Specifications:

Model:	ES3DV3, EX3DV4
Frequency	10MHz — 6.0GHz(EX3DV4)
Range:	10MHz — 4GHz(ES3DV3)
Calibration:	In head and body simulating tissue at Frequencies from 835 up to 5800MHz
Linearity:	± 0.2 dB(30 MHz to 6 GHz) for EX3DV4 ± 0.2 dB(30 MHz to 4 GHz) for ES3DV3
DynamicRange:	10 mW/kg — 100W/kg
Probe Length:	330 mm
Probe Tip	
Length:	20 mm
Body Diameter:	12 mm
Tip Diameter:	2.5 mm (3.9 mm for ES3DV3)
Tip-Center:	1 mm (2.0mm for ES3DV3)
Application:	SAR Dosimetry Testing Compliance tests of mobile phones Dosimetry in strong gradient fields



Picture C.2 Near-field Probe



Picture C.3 E-field Probe

C.3 E-field Probe Calibration

Each E-Probe/Probe Amplifier combination has unique calibration parameters. A TEM cell calibration procedure is conducted to determine the proper amplifier settings to enter in the probe parameters. The amplifier settings are determined for a given frequency by subjecting the probe to a known E-field density (1 mW/cm²) using an RF Signal generator, TEM cell, and RF Power Meter.

The free space E-field from amplified probe outputs is determined in a test chamber. This calibration can be performed in a TEM cell if the frequency is below 1 GHz and in a waveguide or other methodologies above 1 GHz for free space. For the free space calibration, the probe is placed

©Copyright. All rights reserved by CTTL.

in the volumetric center of the cavity and at the proper orientation with the field. The probe is then rotated 360 degrees until the three channels show the maximum reading. The power density readings equates to 1 mW/cm².

E-field temperature correlation calibration is performed in a flat phantom filled with the appropriate simulated brain tissue. The E-field in the medium correlates with the temperature rise in the dielectric medium. For temperature correlation calibration a RF transparent thermistor-based temperature probe is used in conjunction with the E-field probe.

$$SAR = C \frac{\Delta T}{\Delta t}$$

Where:

Δt = Exposure time (30 seconds),

C = Heat capacity of tissue (brain or muscle),

ΔT = Temperature increase due to RF exposure.

$$SAR = \frac{|E|^2 \cdot \sigma}{\rho}$$

Where:

σ = Simulated tissue conductivity,

ρ = Tissue density (kg/m³).

C.4 Other Test Equipment

C.4.1 Data Acquisition Electronics(DAE)

The data acquisition electronics consist of a highly sensitive electrometer-grade preamplifier with auto-zeroing, a channel and gain-switching multiplexer, a fast 16 bit AD-converter and a command decoder with a control logic unit. Transmission to the measurement server is accomplished through an optical downlink for data and status information, as well as an optical uplink for commands and the clock.

The mechanical probe mounting device includes two different sensor systems for frontal and sideways probe contacts. They are used for mechanical surface detection and probe collision detection.

The input impedance of the DAE is 200 MOhm; the inputs are symmetrical and floating. Common mode rejection is above 80 dB.



PictureC.4: DAE

C.4.2 Robot

The SPEAG DASY system uses the high precision robots (DASY5: RX160L) type from Stäubli SA (France). For the 6-axis controller system, the robot controller version from Stäubli is used. The Stäubli robot series have many features that are important for our application:

- High precision (repeatability 0.02mm)
- High reliability (industrial design)
- Low maintenance costs (virtually maintenance free due to direct drive gears; no belt drives)
- Jerk-free straight movements (brushless synchron motors; no stepper motors)
- Low ELF interference (motor control fields shielded via the closed metallic construction shields)



Picture C.5 DASY 5

C.4.3 Measurement Server

The Measurement server is based on a PC/104 CPU board with CPU (DASY5: 400 MHz, Intel Celeron), chipdisk (DASY5: 128MB), RAM (DASY5: 128MB). The necessary circuits for communication with the DAE electronic box, as well as the 16 bit AD converter system for optical detection and digital I/O interface are contained on the DASY I/O board, which is directly connected to the PC/104 bus of the CPU board.

The measurement server performs all real-time data evaluation of field measurements and surface detection, controls robot movements and handles safety operation. The PC operating system cannot interfere with these time critical processes. All connections are supervised by a watchdog, and disconnection of any of the cables to the measurement server will automatically disarm the robot and disable all program-controlled robot movements. Furthermore, the measurement server is equipped with an expansion port which is reserved for future applications. Please note that this expansion port does not have a standardized pinout, and therefore only devices provided by SPEAG can be connected. Devices from any other supplier could seriously damage the measurement server.



Picture C.6 Server for DASY 5

C.4.4 Device Holder for Phantom

The SAR in the phantom is approximately inversely proportional to the square of the distance between the source and the liquid surface. For a source at 5mm distance, a positioning uncertainty of ± 0.5 mm would produce a SAR uncertainty of $\pm 20\%$. Accurate device positioning is therefore crucial for accurate and repeatable measurements. The positions in which the devices must be measured are defined by the standards.

The DASY device holder is designed to cope with the different positions given in the standard. It has two scales for device rotation (with respect to the body axis) and device inclination (with respect to the line between the ear reference points). The rotation centers for both scales are the ear reference point (ERP). Thus the device needs no repositioning when changing the angles.

The DASY device holder is constructed of low-loss POM material having the following dielectric parameters: relative permittivity $\epsilon = 3$ and loss tangent $\delta = 0.02$. The amount of dielectric material has been reduced in the closest vicinity of the device, since measurements have suggested that the influence of the clamp on the test results could thus be lowered.

<Laptop Extension Kit>

The extension is lightweight and made of POM, acrylic glass and foam. It fits easily on the upper part of the Mounting Device in place of the phone positioner. The extension is fully compatible with the Twin-SAM and ELI phantoms.



Picture C7-1: Device Holder

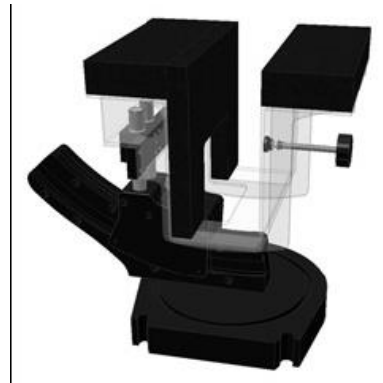

Picture C.7-2: Laptop Extension Kit

C.4.5 Phantom

The SAM Twin Phantom V4.0 is constructed of a fiberglass shell integrated in a table. The shape of the shell is based on data from an anatomical study designed to

Represent the 90th percentile of the population. The phantom enables the dissymmetric evaluation of SAR for both left and right handed handset usage, as well as body-worn usage using the flat phantom region. Reference markings on the Phantom allow the complete setup of all predefined phantom positions and measurement grids by manually teaching three points in the robot. The shell phantom has a 2mm shell thickness (except the ear region where shell thickness increases to 6 mm).

Shell Thickness: 2 ± 0.2 mm

Filling Volume: Approx. 25 liters

Dimensions: 810 x 1000 x 500 mm (H x L x W)

Available: Special

©Copyright. All rights reserved by CTTL.



Picture C.8: SAM Twin Phantom

ANNEX D Position of the wireless device in relation to the phantom

D.1 General considerations

This standard specifies two handset test positions against the head phantom – the “cheek” position and the “tilt” position.

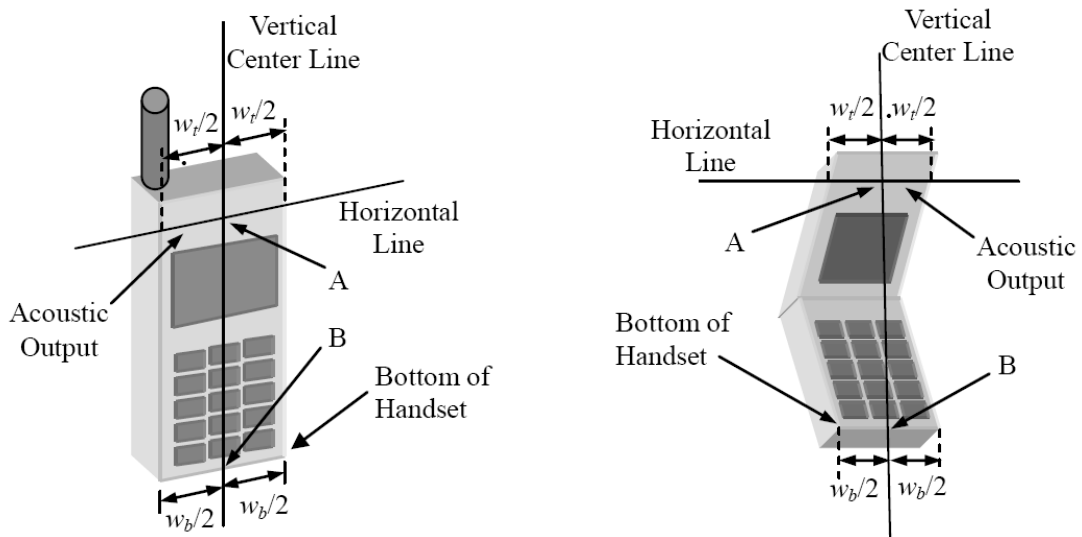

- w_t Width of the handset at the level of the acoustic
- w_b Width of the bottom of the handset
- A Midpoint of the width w_t of the handset at the level of the acoustic output
- B Midpoint of the width w_b of the bottom of the handset

Picture D.1-a Typical “fixed” case handset Picture D.1-b Typical “clam-shell” case handset

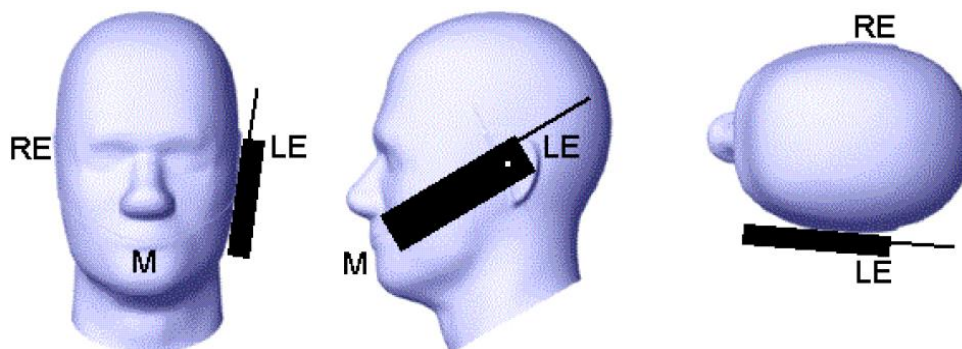

Picture D.2 Cheek position of the wireless device on the left side of SAM

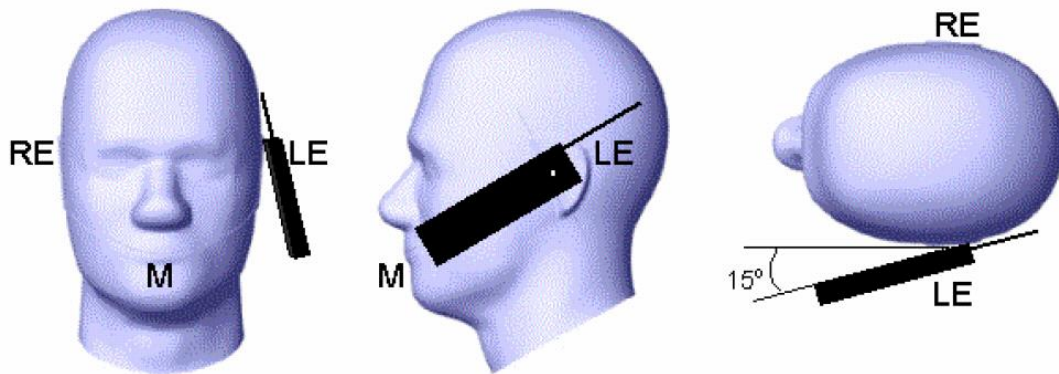

Picture D.3 Tilt position of the wireless device on the left side of SAM

D.2 Body-worn device

A typical example of a body-worn device is a mobile phone, wireless enabled PDA or other battery operated wireless device with the ability to transmit while mounted on a person's body using a carry accessory approved by the wireless device manufacturer.

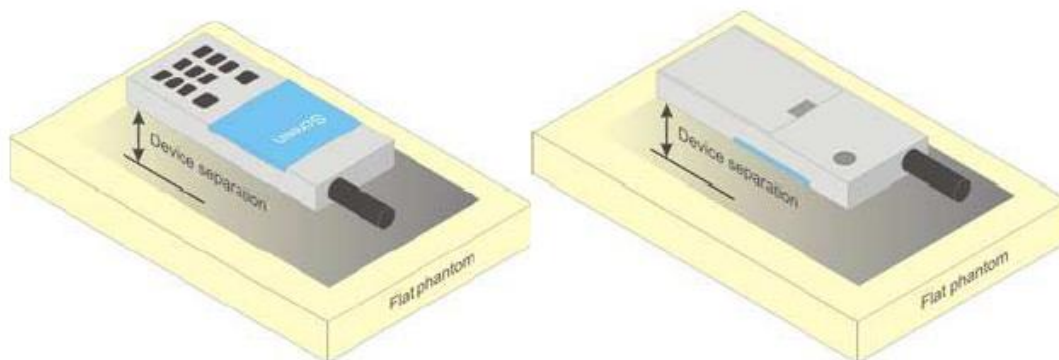

Picture D.4 Test positions for body-worn devices

D.3 Desktop device

A typical example of a desktop device is a wireless enabled desktop computer placed on a table or desk when used.

The DUT shall be positioned at the distance and in the orientation to the phantom that corresponds to the intended use as specified by the manufacturer in the user instructions. For devices that employ an external antenna with variable positions, tests shall be performed for all antenna positions specified. Picture 8.5 show positions for desktop device SAR tests. If the intended use is not specified, the device shall be tested directly against the flat phantom.

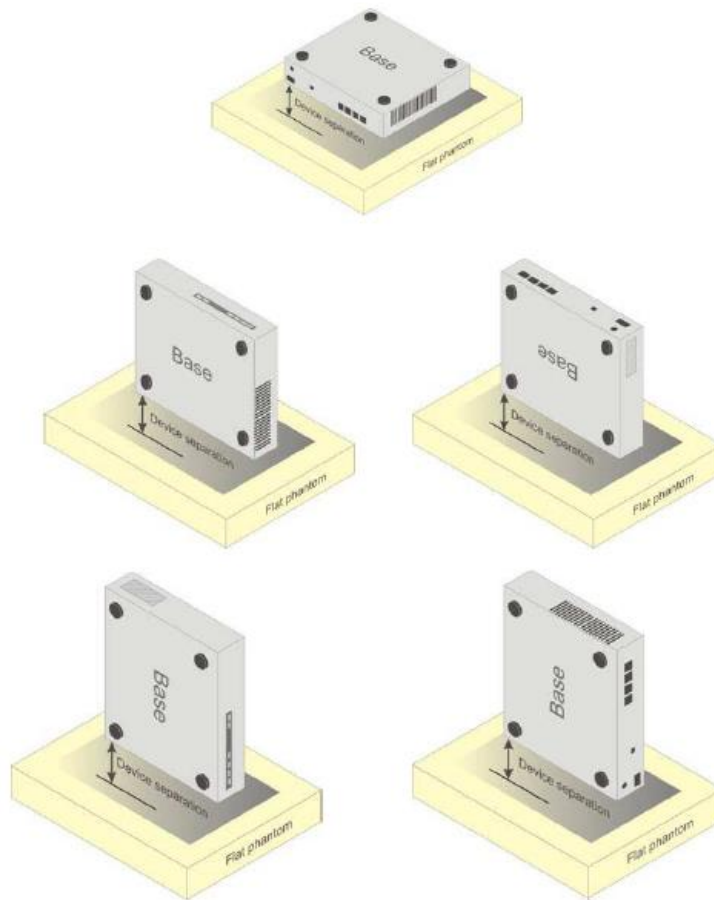

Picture D.5 Test positions for desktop devices

D.4 DUT Setup Photos

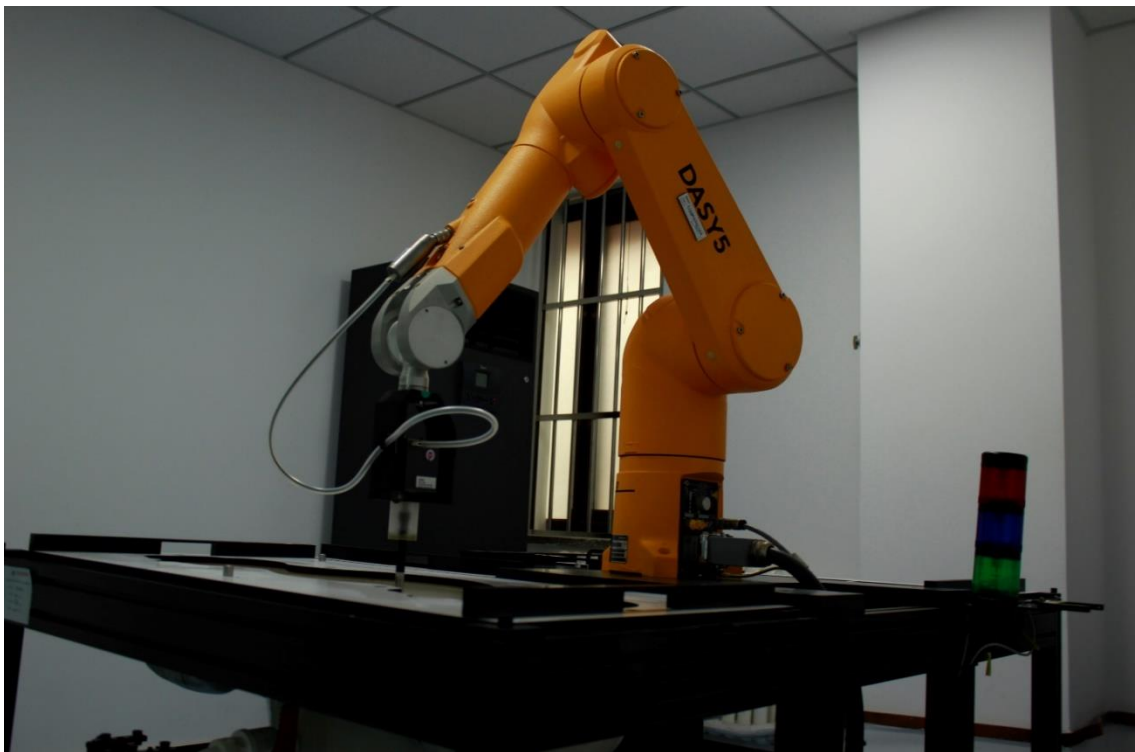

Picture D.6

ANNEX E Equivalent Media Recipes

The liquid used for the frequency range of 800-3000 MHz consisted of water, sugar, salt, preventol, glycol monobutyl and Cellulose. The liquid has been previously proven to be suited for worst-case. The Table E.1 shows the detail solution. It's satisfying the latest tissue dielectric parameters requirements proposed by the IEEE 1528 and IEC 62209.

TableE.1: Composition of the Tissue Equivalent Matter

Frequency (MHz)	835Head	835Body	1900 Head	1900 Body	2450 Head	2450 Body	5800 Head	5800 Body
Ingredients (% by weight)								
Water	41.45	52.5	55.242	69.91	58.79	72.60	65.53	65.53
Sugar	56.0	45.0	\	\	\	\	\	\
Salt	1.45	1.4	0.306	0.13	0.06	0.18	\	\
Preventol	0.1	0.1	\	\	\	\	\	\
Cellulose	1.0	1.0	\	\	\	\	\	\
Glycol Monobutyl	\	\	44.452	29.96	41.15	27.22	\	\
Diethylenglycol monohexylether	\	\	\	\	\	\	17.24	17.24
Triton X-100	\	\	\	\	\	\	17.24	17.24
Dielectric Parameters Target Value	$\epsilon=41.5$ $\sigma=0.90$	$\epsilon=55.2$ $\sigma=0.97$	$\epsilon=40.0$ $\sigma=1.40$	$\epsilon=53.3$ $\sigma=1.52$	$\epsilon=39.2$ $\sigma=1.80$	$\epsilon=52.7$ $\sigma=1.95$	$\epsilon=35.3$ $\sigma=5.27$	$\epsilon=48.2$ $\sigma=6.00$

Note: There are a little adjustment respectively for 750, 1750, 2600, 5200, 5300 and 5600 based on the recipe of closest frequency in table E.1.

ANNEX F System Validation

The SAR system must be validated against its performance specifications before it is deployed. When SAR probes, system components or software are changed, upgraded or recalibrated, these must be validated with the SAR system(s) that operates with such components.

Table F.1: System Validation for 7517

Probe SN.	Liquid name	Validation date	Frequency point	Status (OK or Not)
7517	Head 750MHz	February.7,2022	750 MHz	OK
7517	Head 900MHz	February.7,2022	900 MHz	OK
7517	Head 1750MHz	February.7,2022	1750 MHz	OK
7517	Head 1900MHz	February.8,2022	1900 MHz	OK
7517	Head 2300MHz	February.8,2022	2300 MHz	OK
7517	Head 2450MHz	February.8,2022	2450 MHz	OK
7517	Head 2600MHz	February.8,2022	2600 MHz	OK
7517	Head 3300MHz	February.9,2022	3300 MHz	OK
7517	Head 3500MHz	February.9,2022	3500 MHz	OK
7517	Head 3700MHz	February.9,2022	3700 MHz	OK
7517	Head 5250MHz	February.10,2022	5250 MHz	OK
7517	Head 5600MHz	February.10,2022	5600 MHz	OK
7517	Head 5750MHz	February.10,2022	5750 MHz	OK



ANNEX G Probe Calibration Certificate

Probe 7517 Calibration Certificate



Add: No.52 HuaYuanBei Road, Haidian District, Beijing, 100191, China
 Tel: +86-10-62304633-2512 Fax: +86-10-62304633-2504
 E-mail: cttl@chinattl.com Http://www.chinattl.cn

Client **CTTL**

Certificate No: **Z21-60558**

CALIBRATION CERTIFICATE

Object **EX3DV4 - SN : 7517**

Calibration Procedure(s) **FF-Z11-004-02
Calibration Procedures for Dosimetric E-field Probes**

Calibration date: **January 19, 2022**

This calibration Certificate documents the traceability to national standards, which realize the physical units of measurements(SI). The measurements and the uncertainties with confidence probability are given on the following pages and are part of the certificate.

All calibrations have been conducted in the closed laboratory facility: environment temperature(22±3)°C and humidity<70%.

Calibration Equipment used (M&TE critical for calibration)

Primary Standards	ID #	Cal Date(Calibrated by, Certificate No.)	Scheduled Calibration
Power Meter NRP2	101919	15-Jun-21(CTTL, No.J21X04466)	Jun-22
Power sensor NRP-Z91	101547	15-Jun-21(CTTL, No.J21X04466)	Jun-22
Power sensor NRP-Z91	101548	15-Jun-21(CTTL, No.J21X04466)	Jun-22
Reference 10dBAttenuator	18N50W-10dB	10-Feb-20(CTTL, No.J20X00525)	Feb-22
Reference 20dBAttenuator	18N50W-20dB	10-Feb-20(CTTL, No.J20X00526)	Feb-22
Reference Probe EX3DV4	SN 3617	27-Jan-21(SPEAG, No.EX3-3617_Jan21)	Jan-22
DAE4	SN 1555	20-Aug-21(SPEAG, No.DAE4-1555_Aug21/2)	Aug-22
Secondary Standards	ID #	Cal Date(Calibrated by, Certificate No.)	Scheduled Calibration
SignalGenerator MG3700A	6201052605	16-Jun-21(CTTL, No.J21X04467)	Jun-22
Network Analyzer E5071C	MY46110673	14-Jan-22 (CTTL, No.J22X00406)	Jan -23

	Name	Function	Signature
Calibrated by:	Yu Zongying	SAR Test Engineer	
Reviewed by:	Lin Hao	SAR Test Engineer	
Approved by:	Qi Dianyuan	SAR Project Leader	

Issued: January 21, 2022

This calibration certificate shall not be reproduced except in full without written approval of the laboratory.

Certificate No: Z21-60558

Page 1 of 10



In Collaboration with
s p e a g
CALIBRATION LABORATORY



Add: No.52 HuaYuanBei Road, Haidian District, Beijing, 100191, China
Tel: +86-10-62304633-2512 Fax: +86-10-62304633-2504
E-mail: ctl@chinattl.com [Http://www.chinattl.cn](http://www.chinattl.cn)

Glossary:

TSL	tissue simulating liquid
NORM _{x,y,z}	sensitivity in free space
ConvF	sensitivity in TSL / NORM _{x,y,z}
DCP	diode compression point
CF	crest factor (1/duty_cycle) of the RF signal
A,B,C,D	modulation dependent linearization parameters
Polarization Φ	Φ rotation around probe axis
Polarization θ	θ rotation around an axis that is in the plane normal to probe axis (at measurement center), i $\theta=0$ is normal to probe axis

Connector Angle information used in DASY system to align probe sensor X to the robot coordinate system

Calibration is Performed According to the Following Standards:

- IEEE Std 1528-2013, "IEEE Recommended Practice for Determining the Peak Spatial-Averaged Specific Absorption Rate (SAR) in the Human Head from Wireless Communications Devices: Measurement Techniques", June 2013
- IEC 62209-1, "Measurement procedure for the assessment of Specific Absorption Rate (SAR) from hand-held and body-mounted devices used next to the ear (frequency range of 300 MHz to 6 GHz)", July 2016
- IEC 62209-2, "Procedure to determine the Specific Absorption Rate (SAR) for wireless communication devices used in close proximity to the human body (frequency range of 30 MHz to 6 GHz)", March 2010
- KDB 865664, "SAR Measurement Requirements for 100 MHz to 6 GHz"

Methods Applied and Interpretation of Parameters:

- NORM_{x,y,z}:** Assessed for E-field polarization $\theta=0$ ($f \leq 900\text{MHz}$ in TEM-cell; $f > 1800\text{MHz}$: waveguide). NORM_{x,y,z} are only intermediate values, i.e., the uncertainties of NORM_{x,y,z} does not effect the E^2 -field uncertainty inside TSL (see below ConvF).
- NORM(f)_{x,y,z} = NORM_{x,y,z} * frequency_response** (see Frequency Response Chart). This linearization is implemented in DASY4 software versions later than 4.2. The uncertainty of the frequency response is included in the stated uncertainty of ConvF.
- DCP_{x,y,z}:** DCP are numerical linearization parameters assessed based on the data of power sweep (no uncertainty required). DCP does not depend on frequency nor media.
- PAR:** PAR is the Peak to Average Ratio that is not calibrated but determined based on the signal characteristics.
- A_{x,y,z}; B_{x,y,z}; C_{x,y,z}; VR_{x,y,z}:** A,B,C are numerical linearization parameters assessed based on the data of power sweep for specific modulation signal. The parameters do not depend on frequency nor media. VR is the maximum calibration range expressed in RMS voltage across the diode.
- ConvF and Boundary Effect Parameters:** Assessed in flat phantom using E-field (or Temperature Transfer Standard for $f \leq 800\text{MHz}$) and inside waveguide using analytical field distributions based on power measurements for $f > 800\text{MHz}$. The same setups are used for assessment of the parameters applied for boundary compensation (alpha, depth) of which typical uncertainty valued are given. These parameters are used in DASY4 software to improve probe accuracy close to the boundary. The sensitivity in TSL corresponds to NORM_{x,y,z} * ConvF whereby the uncertainty corresponds to that given for ConvF. A frequency dependent ConvF is used in DASY version 4.4 and higher which allows extending the validity from $\pm 50\text{MHz}$ to $\pm 100\text{MHz}$.
- Spherical isotropy (3D deviation from isotropy):** in a field of low gradients realized using a flat phantom exposed by a patch antenna.
- Sensor Offset:** The sensor offset corresponds to the offset of virtual measurement center from the probe tip (on probe axis). No tolerance required.
- Connector Angle:** The angle is assessed using the information gained by determining the NORM_x (no uncertainty required).

Certificate No:Z21-60558

Page 2 of 10



Add: No.52 HuaYuanBei Road, Haidian District, Beijing, 100191, China
 Tel: +86-10-62304633-2512 Fax: +86-10-62304633-2504
 E-mail: cttl@chinattl.com [Http://www.chinattl.cn](http://www.chinattl.cn)

DASY/EASY – Parameters of Probe: EX3DV4 – SN:7517

Basic Calibration Parameters

	Sensor X	Sensor Y	Sensor Z	Unc (k=2)
Norm($\mu\text{V}/(\text{V}/\text{m})^2$) ^A	0.49	0.51	0.55	$\pm 10.0\%$
DCP(mV) ^B	101.9	101.5	100.9	

Modulation Calibration Parameters

UID	Communication System Name		A dB	B dB/ μV	C	D dB	VR mV	Unc ^E (k=2)
0	CW	X	0.0	0.0	1.0	0.00	168.0	$\pm 3.0\%$
		Y	0.0	0.0	1.0		172.3	
		Z	0.0	0.0	1.0		178.0	

The reported uncertainty of measurement is stated as the standard uncertainty of Measurement multiplied by the coverage factor $k=2$, which for a normal distribution Corresponds to a coverage probability of approximately 95%.

^A The uncertainties of Norm X, Y, Z do not affect the E²-field uncertainty inside TSL (see Page 4 and Page 5).

^B Numerical linearization parameter: uncertainty not required.

^E Uncertainty is determined using the max. deviation from linear response applying rectangular distribution and is expressed for the square of the field value.

DASY/EASY – Parameters of Probe: EX3DV4 – SN:7517

Calibration Parameter Determined in Head Tissue Simulating Media

f [MHz] ^C	Relative Permittivity ^F	Conductivity (S/m) ^F	ConvF X	ConvF Y	ConvF Z	Alpha ^G	Depth ^G (mm)	Unct. (k=2)
750	41.9	0.89	9.70	9.70	9.70	0.15	1.32	±12.1%
900	41.5	0.97	9.30	9.30	9.30	0.21	1.19	±12.1%
1450	40.5	1.20	8.40	8.40	8.40	0.18	1.06	±12.1%
1640	40.3	1.29	8.20	8.20	8.20	0.30	0.90	±12.1%
1750	40.1	1.37	8.10	8.10	8.10	0.25	0.93	±12.1%
1900	40.0	1.40	7.74	7.74	7.74	0.30	0.90	±12.1%
2100	39.8	1.49	7.64	7.64	7.64	0.24	1.09	±12.1%
2300	39.5	1.67	7.44	7.44	7.44	0.64	0.68	±12.1%
2450	39.2	1.80	7.16	7.16	7.16	0.43	0.91	±12.1%
2600	39.0	1.96	6.97	6.97	6.97	0.57	0.77	±12.1%
3300	38.2	2.71	6.85	6.85	6.85	0.45	0.92	±13.3%
3500	37.9	2.91	6.60	6.60	6.60	0.40	1.03	±13.3%
3700	37.7	3.12	6.34	6.34	6.34	0.41	1.03	±13.3%
3900	37.5	3.32	6.25	6.25	6.25	0.35	1.35	±13.3%
4100	37.2	3.53	6.34	6.34	6.34	0.40	1.15	±13.3%
4200	37.1	3.63	6.26	6.26	6.26	0.35	1.35	±13.3%
4400	36.9	3.84	6.15	6.15	6.15	0.35	1.35	±13.3%
4600	36.7	4.04	6.05	6.05	6.05	0.50	1.13	±13.3%
4800	36.4	4.25	6.01	6.01	6.01	0.50	1.13	±13.3%
4950	36.3	4.40	5.74	5.74	5.74	0.45	1.25	±13.3%
5250	35.9	4.71	5.30	5.30	5.30	0.50	1.25	±13.3%
5600	35.5	5.07	4.70	4.70	4.70	0.55	1.20	±13.3%
5750	35.4	5.22	4.75	4.75	4.75	0.55	1.20	±13.3%

^C Frequency validity above 300 MHz of ±100MHz only applies for DASY v4.4 and higher (Page 2), else it is restricted to ±50MHz. The uncertainty is the RSS of ConvF uncertainty at calibration frequency and the uncertainty for the indicated frequency band. Frequency validity below 300 MHz is ± 10, 25, 40, 50 and 70 MHz for ConvF assessments at 30, 64, 128, 150 and 220 MHz respectively. Above 5 GHz frequency validity can be extended to ± 110 MHz.

^F At frequency below 3 GHz, the validity of tissue parameters (ϵ and σ) can be relaxed to ±10% if liquid compensation formula is applied to measured SAR values. At frequencies above 3 GHz, the validity of tissue parameters (ϵ and σ) is restricted to ±5%. The uncertainty is the RSS of the ConvF uncertainty for indicated target tissue parameters.

^G Alpha/Depth are determined during calibration. SPEAG warrants that the remaining deviation due to the boundary effect after compensation is always less than ± 1% for frequencies below 3 GHz and below ± 2% for the frequencies between 3-6 GHz at any distance larger than half the probe tip diameter from the boundary.



Add: No.52 HuaYuanBei Road, Haidian District, Beijing, 100191, China
 Tel: +86-10-62304633-2512 Fax: +86-10-62304633-2504
 E-mail: cttl@chinattl.com [Http://www.chinattl.cn](http://www.chinattl.cn)

DASY/EASY – Parameters of Probe: EX3DV4 – SN:7517

Calibration Parameter Determined in Body Tissue Simulating Media

f [MHz] ^C	Relative Permittivity ^F	Conductivity (S/m) ^F	ConvF X	ConvF Y	ConvF Z	Alpha ^G	Depth ^G (mm)	Unct. (k=2)
750	55.5	0.96	9.65	9.65	9.65	0.40	0.85	±12.1%
900	55.0	1.05	9.20	9.20	9.20	0.24	1.18	±12.1%
1450	54.0	1.30	8.20	8.20	8.20	0.14	1.34	±12.1%
1640	53.8	1.40	8.05	8.05	8.05	0.25	1.08	±12.1%
1750	53.4	1.49	7.85	7.85	7.85	0.32	0.98	±12.1%
1900	53.3	1.52	7.58	7.58	7.58	0.24	1.13	±12.1%
2100	53.2	1.62	7.47	7.47	7.47	0.25	1.19	±12.1%
2300	52.9	1.81	7.35	7.35	7.35	0.44	0.93	±12.1%
2450	52.7	1.95	7.21	7.21	7.21	0.50	0.84	±12.1%
2600	52.5	2.16	7.02	7.02	7.02	0.68	0.70	±12.1%
3300	51.6	3.08	6.25	6.25	6.25	0.43	1.11	±13.3%
3500	51.3	3.31	6.06	6.06	6.06	0.40	1.25	±13.3%
3700	51.0	3.55	5.99	5.99	5.99	0.40	1.25	±13.3%
3900	51.2	3.78	5.95	5.95	5.95	0.40	1.30	±13.3%
4100	50.5	4.01	5.90	5.90	5.90	0.40	1.30	±13.3%
4200	50.4	4.13	5.80	5.80	5.80	0.45	1.30	±13.3%
4400	50.1	4.37	5.70	5.70	5.70	0.45	1.30	±13.3%
4600	49.8	4.60	5.58	5.58	5.58	0.50	1.25	±13.3%
4800	49.6	4.83	5.41	5.41	5.41	0.50	1.45	±13.3%
4950	49.4	5.01	5.12	5.12	5.12	0.50	1.55	±13.3%
5250	48.9	5.36	4.70	4.70	4.70	0.50	1.55	±13.3%
5600	48.5	5.77	4.10	4.10	4.10	0.55	1.50	±13.3%
5750	48.3	5.94	4.15	4.15	4.15	0.50	1.60	±13.3%

^C Frequency validity above 300 MHz of ±100MHz only applies for DASY v4.4 and higher (Page 2), else it is restricted to ±50MHz. The uncertainty is the RSS of ConvF uncertainty at calibration frequency and the uncertainty for the indicated frequency band. Frequency validity below 300 MHz is ± 10, 25, 40, 50 and 70 MHz for ConvF assessments at 30, 64, 128, 150 and 220 MHz respectively. Above 5 GHz frequency validity can be extended to ± 110 MHz.

^F At frequency below 3 GHz, the validity of tissue parameters (ϵ and σ) can be relaxed to ±10% if liquid compensation formula is applied to measured SAR values. At frequencies above 3 GHz, the validity of tissue parameters (ϵ and σ) is restricted to ±5%. The uncertainty is the RSS of the ConvF uncertainty for indicated target tissue parameters.

^G Alpha/Depth are determined during calibration. SPEAG warrants that the remaining deviation due to the boundary effect after compensation is always less than ± 1% for frequencies below 3 GHz and below ± 2% for the frequencies between 3-6 GHz at any distance larger than half the probe tip diameter from the boundary.



Add: No.52 HuaYuanBei Road, Haidian District, Beijing, 100191, China
Tel: +86-10-62304633-2512 Fax: +86-10-62304633-2504
E-mail: ctl@chinattl.com [Http://www.chinattl.cn](http://www.chinattl.cn)

Frequency Response of E-Field (TEM-Cell: ifi110 EXX, Waveguide: R22)

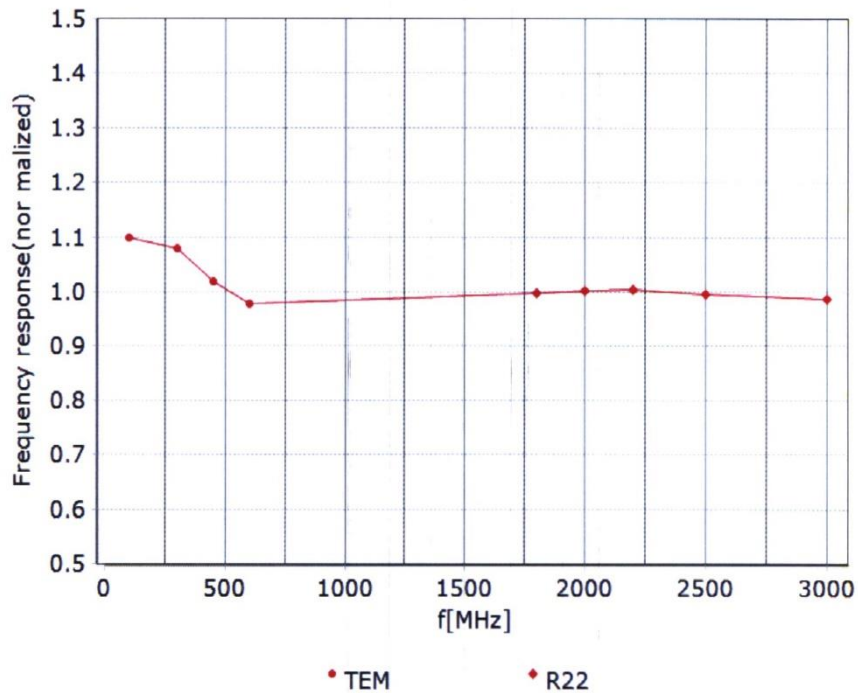

Uncertainty of Frequency Response of E-field: $\pm 7.4\%$ ($k=2$)



Add: No.52 HuaYuanBei Road, Haidian District, Beijing, 100191, China
Tel: +86-10-62304633-2512 Fax: +86-10-62304633-2504
E-mail: ctl@chinattl.com [Http://www.chinattl.cn](http://www.chinattl.cn)

Receiving Pattern (Φ), $\theta=0^\circ$

f=600 MHz, TEM

f=1800 MHz, R22

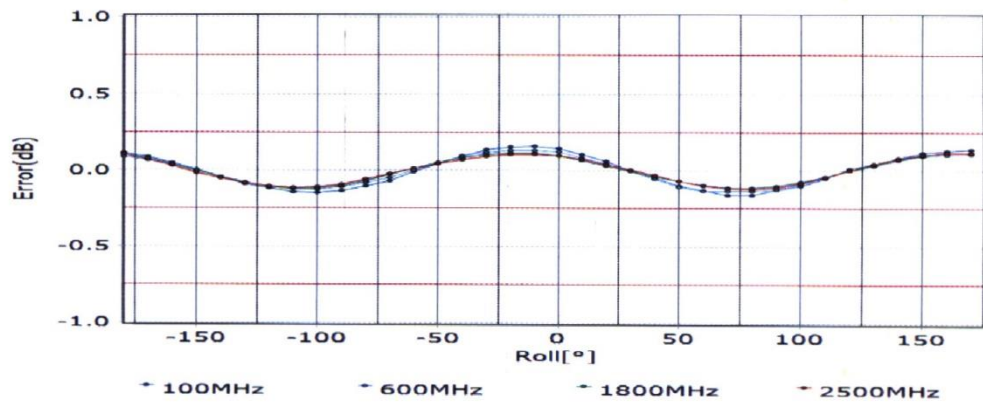
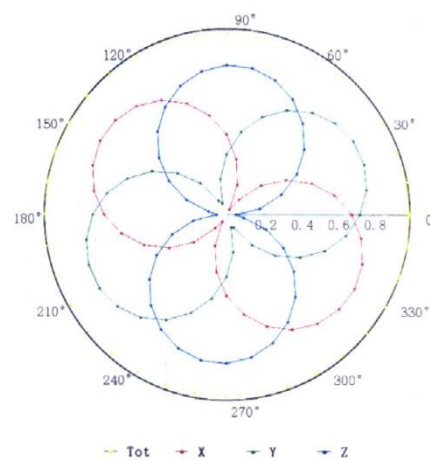
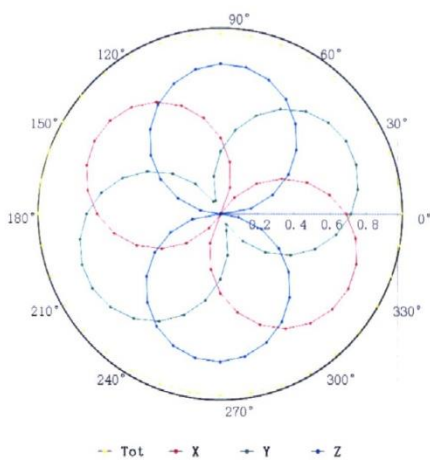

Uncertainty of Axial Isotropy Assessment: $\pm 1.2\%$ ($k=2$)

Add: No.52 HuaYuanBei Road, Haidian District, Beijing, 100191, China
 Tel: +86-10-62304633-2512 Fax: +86-10-62304633-2504
 E-mail: cttl@chinattl.com [Http://www.chinattl.cn](http://www.chinattl.cn)

Dynamic Range f(SAR_{head}) (TEM cell, f = 900 MHz)

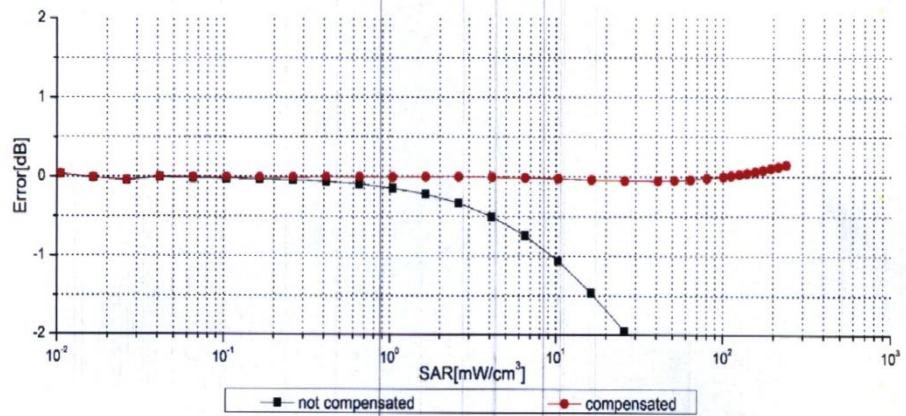
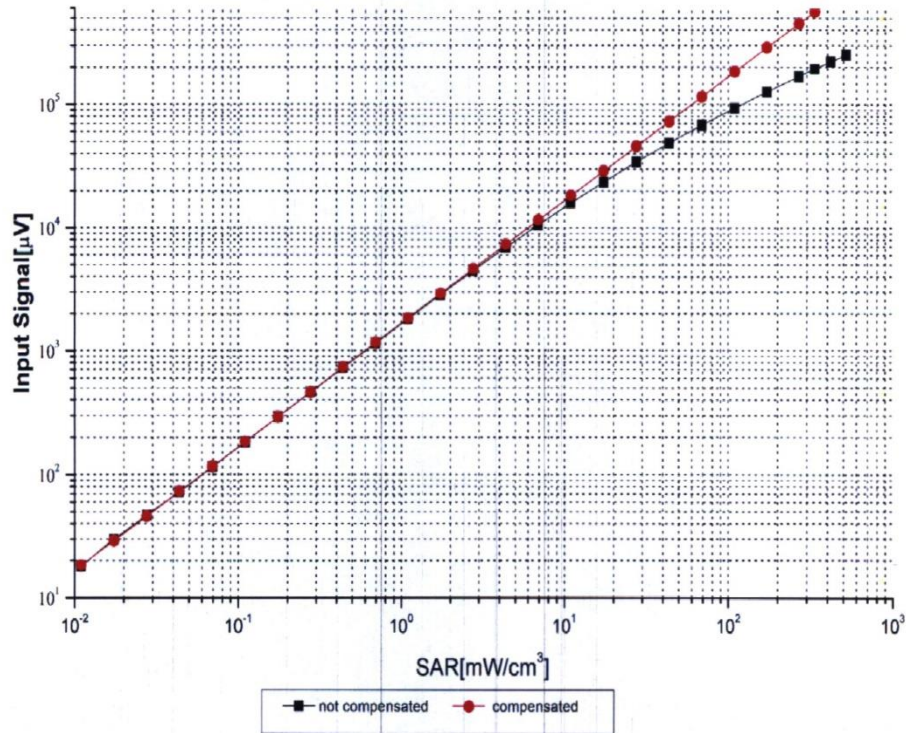

Uncertainty of Linearity Assessment: $\pm 0.9\%$ ($k=2$)

Add: No.52 HuaYuanBei Road, Haidian District, Beijing, 100191, China
 Tel: +86-10-62304633-2512 Fax: +86-10-62304633-2504
 E-mail: ctl@chinattl.com [Http://www.chinattl.cn](http://www.chinattl.cn)

Conversion Factor Assessment

f=750 MHz,WGLS R9(H_convF)

f=1750 MHz,WGLS R22(H_convF)

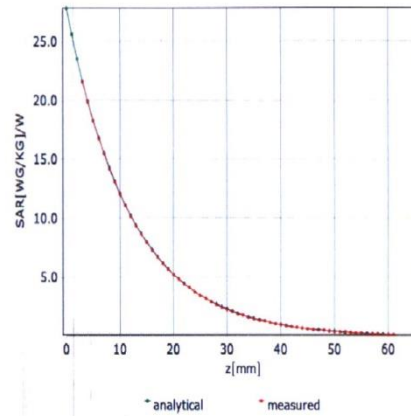
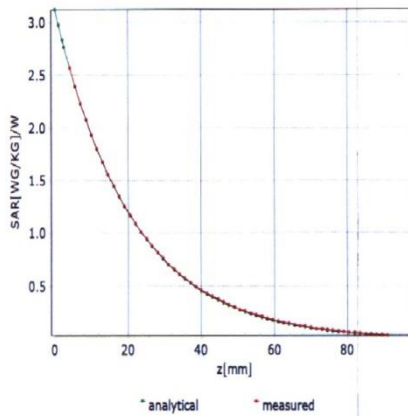

Deviation from Isotropy in Liquid

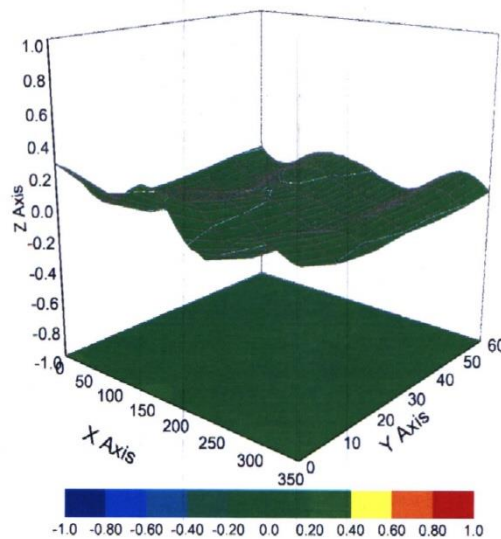

Uncertainty of Spherical Isotropy Assessment: $\pm 3.2\%$ ($k=2$)



Add: No.52 HuaYuanBei Road, Haidian District, Beijing, 100191, China
Tel: +86-10-62304633-2512 Fax: +86-10-62304633-2504
E-mail: cttl@chinattl.com [Http://www.chinattl.cn](http://www.chinattl.cn)

DASY/EASY – Parameters of Probe: EX3DV4 – SN:7517

Other Probe Parameters

Sensor Arrangement	Triangular
Connector Angle (°)	15.7
Mechanical Surface Detection Mode	enabled
Optical Surface Detection Mode	disable
Probe Overall Length	337mm
Probe Body Diameter	10mm
Tip Length	9mm
Tip Diameter	2.5mm
Probe Tip to Sensor X Calibration Point	1mm
Probe Tip to Sensor Y Calibration Point	1mm
Probe Tip to Sensor Z Calibration Point	1mm
Recommended Measurement Distance from Surface	1.4mm



ANNEX H Dipole Calibration Certificate

750 MHz Dipole Calibration Certificate

**Calibration Laboratory of
Schmid & Partner
Engineering AG**
Zeughausstrasse 43, 8004 Zurich, Switzerland



S Schweizerischer Kalibrierdienst
C Service suisse d'étalonnage
S Servizio svizzero di taratura
S Swiss Calibration Service

Accredited by the Swiss Accreditation Service (SAS)
The Swiss Accreditation Service is one of the signatories to the EA
Multilateral Agreement for the recognition of calibration certificates

Accreditation No.: **SCS 0108**

Client **CTTL (Auden)**

Certificate No: **D750V3-1017_Jul21**

CALIBRATION CERTIFICATE																																																											
Object	D750V3 - SN:1017																																																										
Calibration procedure(s)	QA CAL-05.v11 Calibration Procedure for SAR Validation Sources between 0.7-3 GHz																																																										
Calibration date:	July 12, 2021																																																										
<p>This calibration certificate documents the traceability to national standards, which realize the physical units of measurements (SI). The measurements and the uncertainties with confidence probability are given on the following pages and are part of the certificate.</p> <p>All calibrations have been conducted in the closed laboratory facility: environment temperature (22 ± 3)°C and humidity < 70%.</p> <p>Calibration Equipment used (M&TE critical for calibration)</p> <table border="1"> <thead> <tr> <th>Primary Standards</th> <th>ID #</th> <th>Cal Date (Certificate No.)</th> <th>Scheduled Calibration</th> </tr> </thead> <tbody> <tr> <td>Power meter NRP</td> <td>SN: 104778</td> <td>09-Apr-21 (No. 217-03291/03292)</td> <td>Apr-22</td> </tr> <tr> <td>Power sensor NRP-Z91</td> <td>SN: 103244</td> <td>09-Apr-21 (No. 217-03291)</td> <td>Apr-22</td> </tr> <tr> <td>Power sensor NRP-Z91</td> <td>SN: 103245</td> <td>09-Apr-21 (No. 217-03292)</td> <td>Apr-22</td> </tr> <tr> <td>Reference 20 dB Attenuator</td> <td>SN: BH9394 (20k)</td> <td>09-Apr-21 (No. 217-03343)</td> <td>Apr-22</td> </tr> <tr> <td>Type-N mismatch combination</td> <td>SN: 310982 / 06327</td> <td>09-Apr-21 (No. 217-03344)</td> <td>Apr-22</td> </tr> <tr> <td>Reference Probe EX3DV4</td> <td>SN: 7349</td> <td>28-Dec-20 (No. EX3-7349_Dec20)</td> <td>Dec-21</td> </tr> <tr> <td>DAE4</td> <td>SN: 601</td> <td>02-Nov-20 (No. DAE4-601_Nov20)</td> <td>Nov-21</td> </tr> </tbody> </table> <table border="1"> <thead> <tr> <th>Secondary Standards</th> <th>ID #</th> <th>Check Date (in house)</th> <th>Scheduled Check</th> </tr> </thead> <tbody> <tr> <td>Power meter E4419B</td> <td>SN: GB39512475</td> <td>30-Oct-14 (in house check Oct-20)</td> <td>In house check: Oct-22</td> </tr> <tr> <td>Power sensor HP 8481A</td> <td>SN: US37292783</td> <td>07-Oct-15 (in house check Oct-20)</td> <td>In house check: Oct-22</td> </tr> <tr> <td>Power sensor HP 8481A</td> <td>SN: MY41092317</td> <td>07-Oct-15 (in house check Oct-20)</td> <td>In house check: Oct-22</td> </tr> <tr> <td>RF generator R&S SMT-06</td> <td>SN: 100972</td> <td>15-Jun-15 (in house check Oct-20)</td> <td>In house check: Oct-22</td> </tr> <tr> <td>Network Analyzer Agilent E8358A</td> <td>SN: US41080477</td> <td>31-Mar-14 (in house check Oct-20)</td> <td>In house check: Oct-21</td> </tr> </tbody> </table>				Primary Standards	ID #	Cal Date (Certificate No.)	Scheduled Calibration	Power meter NRP	SN: 104778	09-Apr-21 (No. 217-03291/03292)	Apr-22	Power sensor NRP-Z91	SN: 103244	09-Apr-21 (No. 217-03291)	Apr-22	Power sensor NRP-Z91	SN: 103245	09-Apr-21 (No. 217-03292)	Apr-22	Reference 20 dB Attenuator	SN: BH9394 (20k)	09-Apr-21 (No. 217-03343)	Apr-22	Type-N mismatch combination	SN: 310982 / 06327	09-Apr-21 (No. 217-03344)	Apr-22	Reference Probe EX3DV4	SN: 7349	28-Dec-20 (No. EX3-7349_Dec20)	Dec-21	DAE4	SN: 601	02-Nov-20 (No. DAE4-601_Nov20)	Nov-21	Secondary Standards	ID #	Check Date (in house)	Scheduled Check	Power meter E4419B	SN: GB39512475	30-Oct-14 (in house check Oct-20)	In house check: Oct-22	Power sensor HP 8481A	SN: US37292783	07-Oct-15 (in house check Oct-20)	In house check: Oct-22	Power sensor HP 8481A	SN: MY41092317	07-Oct-15 (in house check Oct-20)	In house check: Oct-22	RF generator R&S SMT-06	SN: 100972	15-Jun-15 (in house check Oct-20)	In house check: Oct-22	Network Analyzer Agilent E8358A	SN: US41080477	31-Mar-14 (in house check Oct-20)	In house check: Oct-21
Primary Standards	ID #	Cal Date (Certificate No.)	Scheduled Calibration																																																								
Power meter NRP	SN: 104778	09-Apr-21 (No. 217-03291/03292)	Apr-22																																																								
Power sensor NRP-Z91	SN: 103244	09-Apr-21 (No. 217-03291)	Apr-22																																																								
Power sensor NRP-Z91	SN: 103245	09-Apr-21 (No. 217-03292)	Apr-22																																																								
Reference 20 dB Attenuator	SN: BH9394 (20k)	09-Apr-21 (No. 217-03343)	Apr-22																																																								
Type-N mismatch combination	SN: 310982 / 06327	09-Apr-21 (No. 217-03344)	Apr-22																																																								
Reference Probe EX3DV4	SN: 7349	28-Dec-20 (No. EX3-7349_Dec20)	Dec-21																																																								
DAE4	SN: 601	02-Nov-20 (No. DAE4-601_Nov20)	Nov-21																																																								
Secondary Standards	ID #	Check Date (in house)	Scheduled Check																																																								
Power meter E4419B	SN: GB39512475	30-Oct-14 (in house check Oct-20)	In house check: Oct-22																																																								
Power sensor HP 8481A	SN: US37292783	07-Oct-15 (in house check Oct-20)	In house check: Oct-22																																																								
Power sensor HP 8481A	SN: MY41092317	07-Oct-15 (in house check Oct-20)	In house check: Oct-22																																																								
RF generator R&S SMT-06	SN: 100972	15-Jun-15 (in house check Oct-20)	In house check: Oct-22																																																								
Network Analyzer Agilent E8358A	SN: US41080477	31-Mar-14 (in house check Oct-20)	In house check: Oct-21																																																								
Calibrated by:	Name Jeffrey Katzman	Function Laboratory Technician	Signature 																																																								
Approved by:	Katja Pokovic	Technical Manager																																																									
This calibration certificate shall not be reproduced except in full without written approval of the laboratory.			Issued: July 15, 2021																																																								