



HAC RF TEST REPORT

No. I22Z60016-SEM02

For

TCL Communication Ltd.

GSM/UMTS/LTE Mobile phone

Model name: 4188S

With

Hardware Version: 04

Software Version: RDS5

FCC ID: 2ACCJH162

Results Summary: M Category = M3

Issued Date: 2022-03-02

Note:

The test results in this test report relate only to the devices specified in this report. This report shall not be reproduced except in full without the written approval of CTTL.

Test Laboratory:

CTTL, Telecommunication Technology Labs, CAICT

No. 51, Xueyuan Road, Haidian District, Beijing, P. R. China 100191.

Tel:+86(0)10-62304633-2512, Fax:+86(0)10-62304633-2504

Email: ctl_terminals@caict.ac.cn, website: www.caict.ac.cn



No.I22Z60016-SEM02

REPORT HISTORY

| Report Number | Revision | Issue Date | Description |
|----------------------|-----------------|-------------------|---------------------------------|
| I22Z60016-SEM02 | Rev.0 | 2022-03-02 | Initial creation of test report |

TABLE OF CONTENT

| | |
|--|-----------|
| 1 TEST LABORATORY | 5 |
| 1.1 TESTING LOCATION | 5 |
| 1.2 TESTING ENVIRONMENT..... | 5 |
| 1.3 PROJECT DATA | 5 |
| 1.4 SIGNATURE..... | 5 |
| 2 CLIENT INFORMATION | 6 |
| 2.1 APPLICANT INFORMATION | 6 |
| 2.2 MANUFACTURER INFORMATION | 6 |
| 3 EQUIPMENT UNDER TEST (EUT) AND ANCILLARY EQUIPMENT (AE) | 7 |
| 3.1 ABOUT EUT | 7 |
| 3.2 INTERNAL IDENTIFICATION OF EUT USED DURING THE TEST | 7 |
| 3.3 INTERNAL IDENTIFICATION OF AE USED DURING THE TEST | 7 |
| 3.4 AIR INTERFACES / BANDS INDICATING OPERATING MODES | 8 |
| 4 MAXIMUM OUTPUT POWER | 9 |
| 5 REFERENCE DOCUMENTS..... | 11 |
| 5.1 REFERENCE DOCUMENTS FOR TESTING | 11 |
| 6 OPERATIONAL CONDITIONS DURING TEST | 12 |
| 6.1 HAC MEASUREMENT SET-UP..... | 12 |
| 6.2 PROBE SPECIFICATION | 13 |
| 6.3 TEST ARCH PHANTOM & PHONE POSITIONER | 14 |
| 6.4 ROBOTIC SYSTEM SPECIFICATIONS | 14 |
| 7 EUT ARRANGEMENT | 15 |
| 7.1 WD RF EMISSION MEASUREMENTS REFERENCE AND PLANE | 15 |
| 8 SYSTEM VALIDATION | 16 |
| 8.1 VALIDATION PROCEDURE | 16 |
| 8.2 VALIDATION RESULT | 16 |
| 9 EVALUATION OF MIF | 17 |
| 9.1 INTRODUCTION..... | 17 |
| 9.2 MIF MEASUREMENT WITH THE AIA | 18 |
| 9.3 TEST EQUIPMENT FOR THE MIF MEASUREMENT | 18 |
| 9.4 TEST SIGNAL VALIDATION..... | 18 |
| 9.5 DUT MIF RESULTS..... | 19 |
| 10 EVALUATION FOR LOW-POWER EXEMPTION | 20 |
| 10.1 PRODUCT TESTING THRESHOLD | 20 |
| 10.2 CONDUCTED POWER..... | 20 |
| 10.3 CONCLUSION | 21 |



11 RF TEST PROCEDURES..... 22

12 MEASUREMENT RESULTS (E-FIELD)..... 23

13 ANSIC 63.19-2011 LIMITS 23

14 MEASUREMENT UNCERTAINTY 24

15 MAIN TEST INSTRUMENTS..... 25

16 CONCLUSION 25

ANNEX A TEST LAYOUT 26

ANNEX B TEST PLOTS 27

ANNEX C SYSTEM VALIDATION RESULT..... 33

ANNEX D PROBE CALIBRATION CERTIFICATE 36

ANNEX E DIPOLE CALIBRATION CERTIFICATE..... 58

1 Test Laboratory

1.1 Testing Location

| | |
|--------------|---|
| CompanyName: | CTTL(Shouxiang) |
| Address: | No. 51 Shouxiang Science Building, Xueyuan Road, Haidian District, Beijing, P. R. China100191 |

1.2 Testing Environment

| | |
|---|----------------|
| Temperature: | 18°C~25°C, |
| Relative humidity: | 30%~ 70% |
| Ground system resistance: | < 0.5 Ω |
| Ambient noise is checked and found very low and in compliance with requirement of standards. Reflection of surrounding objects is minimized and in compliance with requirement of standards. | |

1.3 Project Data

| | |
|---------------------|------------------|
| Project Leader: | Qi Dianyuan |
| Test Engineer: | Lin Xiaojun |
| Testing Start Date: | January 29 2022 |
| Testing End Date: | February 27 2022 |

1.4 Signature



Lin Xiaojun
(Prepared this test report)



Qi Dianyuan
(Reviewed this test report)



Lu Bingsong
Deputy Director of the laboratory
(Approved this test report)



2 Client Information

2.1 Applicant Information

| | |
|-----------------|---|
| Company Name: | TCL Communication Ltd. |
| Address/Post: | 5/F, Building 22E, 22 Science Park East Avenue, Hong Kong Science Park, Shatin, NT, Hong Kong |
| Contact Person: | Peter yang |
| Contact Email: | peter.yang@tcl.com |
| Telephone: | +86 755 3664 5759 |
| Fax: | +86 755 3661 2000-81722 |

2.2 Manufacturer Information

| | |
|-----------------|---|
| Company Name: | TCL Communication Ltd. |
| Address/Post: | 5/F, Building 22E, 22 Science Park East Avenue, Hong Kong Science Park, Shatin, NT, Hong Kong |
| Contact Person: | Peter yang |
| Contact Email: | peter.yang@tcl.com |
| Telephone: | +86 755 3664 5759 |
| Fax | +86 755 3661 2000-81722 |

3 Equipment Under Test (EUT) and Ancillary Equipment (AE)

3.1 About EUT

| | |
|--------------------|---|
| Description: | GSM/UMTS/LTE Mobile phone |
| Model name: | 4188S |
| Operating mode(s): | GSM850/GSM900/GSM1800/GSM1900,WCDMA850/900/1700/1900/2100,LTE Band 2/3/4/5/7/12/13/66, BT, Wi-Fi 2.4G |

3.2 Internal Identification of EUT used during the test

| EUT ID* | IMEI | HW Version | SW Version |
|---------|-----------------|------------|------------|
| EUT1 | 356806500015813 | 04 | RDS5 |
| EUT2 | 356806500015839 | 04 | RDS5 |

*EUT ID: is used to identify the test sample in the lab internally.

Note: It is performed to test HAC with the EUT1-2

3.3 Internal Identification of AE used during the test

| AE ID* | Description | Model | SN | Manufacturer |
|--------|-------------|--------------|----|--------------|
| AE1 | Battery | CAB2880029C7 | \ | VEKEN |

*AE ID: is used to identify the test sample in the lab internally.

3.4 Air Interfaces / Bands Indicating Operating Modes

| Air-interface | Band(MHz) | Type | C63.19/tested | Simultaneous Transmissions | Name of Voice Service |
|---------------|---------------------|------|-------------------|----------------------------|-----------------------|
| GSM | 850 | VO | Yes | BT, WLAN | CMRS Voice |
| | 1900 | | | | |
| GPRS/EDGE | 850 | DT | Yes | | Google duo |
| | 1900 | | | | |
| WCDMA (UMTS) | 850 | VO | NO ⁽¹⁾ | BT, WLAN | CMRS Voice |
| | 1700 | | | | |
| | 1900 | DT | NO ⁽¹⁾ | | Google duo |
| LTE FDD | Band 2/5/7/12/13/66 | V/D | NO ⁽¹⁾ | BT, WLAN | VoLTE, Google duo |
| BT | 2450 | DT | NA | GSM,WCDMA ,LTE | NA |
| WLAN | 2450 | V/D | Yes | GSM,WCDMA ,LTE | VoWiFi, Google duo |

NA: Not Applicable VO: Voice Only V/D: CMRS and IP Voice Service over Digital Transport

DT: Digital Transport

* HAC Rating was not based on concurrent voice and data modes, Non current mode was found to represent worst case rating for both M and T rating

Note1 = The air interface is exempted from testing by low power exemption that its average antenna input power plus its MIF is ≤ 17 dBm, and is rated as M4.

Note2= The device have similar frequency in some LTE bands: 4/66, since the supported frequency spans for the smaller LTE bands are completely cover by the larger LTE bands, therefore, only larger LTE bands were required to be tested for hearing-aid compliance.

4 Maximum Output Power

| | | | |
|--------------------------|-------------------------------------|-------------------------------------|-------------------------------------|
| GSM 850MHz | Conducted Power (dBm) | | |
| | Channel 251(848.8MHz) | Channel 190(836.6MHz) | Channel 128(824.2MHz) |
| Voice | 32.8 | 32.8 | 32.8 |
| EDGE | 26 | 26 | 26 |
| GSM 1900MHz | Conducted Power(dBm) | | |
| | Channel 810(1909.8MHz) | Channel 661(1880MHz) | Channel 512(1850.2MHz) |
| Voice | 30.6 | 30.6 | 30.6 |
| EDGE | 26.3 | 26.3 | 26.3 |
| WCDMA 850MHz | Conducted Power (dBm) | | |
| | Channel 4233(846.6MHz) | Channel 4182(836.4MHz) | Channel 4132(826.4MHz) |
| RMC | 24 | 24 | 24 |
| HSPA | 23 | 23 | 23 |
| WCDMA 1700MHz | Conducted Power (dBm) | | |
| | Channel 1513 (1752.6MHz) | Channel 1412 (1732.4MHz) | Channel 1312 (1712.4MHz) |
| RMC | 24.5 | 24.5 | 24.5 |
| HSPA | 23.5 | 23.5 | 23.5 |
| WCDMA 1900MHz | Conducted Power (dBm) | | |
| | Channel 9538 (1907.6MHz) | Channel 9400 (1880MHz) | Channel 9262(1852.4MHz) |
| RMC | 25 | 25 | 25 |
| HSPA | 23.5 | 23.5 | 23.5 |
| LTE Band2 | Conducted Power (dBm) | | |
| | Channel 19100(1900MHz) | Channel 18900(1880MHz) | Channel18700(1860MHz) |
| QPSK | 25.5 | 25.5 | 25.5 |
| LTE Band5 | Conducted Power (dBm) | | |
| | Channel 20450(829MHz) | Channel 20525(836.5MHz) | Channel20600(844MHz) |
| QPSK | 25.5 | 25.5 | 25.5 |
| LTE Band7 | Conducted Power (dBm) | | |
| | Channel 20850(2510MHz) | Channel 21100(2535MHz) | Channel21350(2560MHz) |
| QPSK | 25 | 25 | 25 |
| LTE Band12 | Conducted Power (dBm) | | |
| | Channel 23130(711MHz) | Channel 23095(707.5MHz) | Channel23060(704MHz) |
| QPSK | 25.5 | 25.5 | 25.5 |
| LTE Band13 | Conducted Power (dBm) | | |
| | Channel 23230(782MHz) | | |
| QPSK | 25.5 | | |
| LTE Band66 | Conducted Power (dBm) | | |
| | Channel 132572(1770MHz) | Channel 132322(1745MHz) | Channel 133072(1720MHz) |
| QPSK | 25.5 | 25.5 | 25.5 |



| 2.4GHz 802.11g | Conducted Power (dBm) | | |
|-------------------|-----------------------|---------------------|---------------------|
| | Channel 11 (2462MHz) | Channel 6 (2437MHz) | Channel 1 (2412MHz) |
| | 18 | 18 | 18 |

5 Reference Documents

5.1 Reference Documents for testing

The following document listed in this section is referred for testing.

| Reference | Title | Version |
|-------------------|--|--------------|
| ANSI C63.19-2011 | American National Standard for Methods of Measurement of Compatibility between Wireless Communication Devices and Hearing Aids | 2011 Edition |
| FCC 47 CFR §20.19 | Hearing Aid Compatible Mobile Headsets | 2015 Edition |
| KDB 285076 D01 | Equipment Authorization Guidance for Hearing Aid Compatibility | v05r01 |

6 OPERATIONAL CONDITIONS DURING TEST

6.1 HAC MEASUREMENT SET-UP

These measurements are performed using the DASY5 NEO automated dosimetric assessment system. It is made by Schmid & Partner Engineering AG (SPEAG) in Zurich, Switzerland. It consists of high precision robotics system (Stäubli), robot controller, Intel Core2 computer, near-field probe, probe alignment sensor. The robot is a six-axis industrial robot performing precise movements. A cell controller system contains the power supply, robot controller, teach pendant (Joystick), and remote control, is used to drive the robot motors. The PC consists of the HP Intel Core2 1.86 GHz computer with Windows XP system and HAC Measurement Software DASY5 NEO, A/D interface card, monitor, mouse, and keyboard. The Stäubli Robot is connected to the cell controller to allow software manipulation of the robot. A data acquisition electronic (DAE) circuit performs the signal amplification, signal multiplexing, AD-conversion, offset measurements, mechanical surface detection, collision detection, etc. is connected to the Electro-optical coupler (EOC). The EOC performs the conversion from the optical into digital electric signal of the DAE and transfers data to the PC plug-in card.

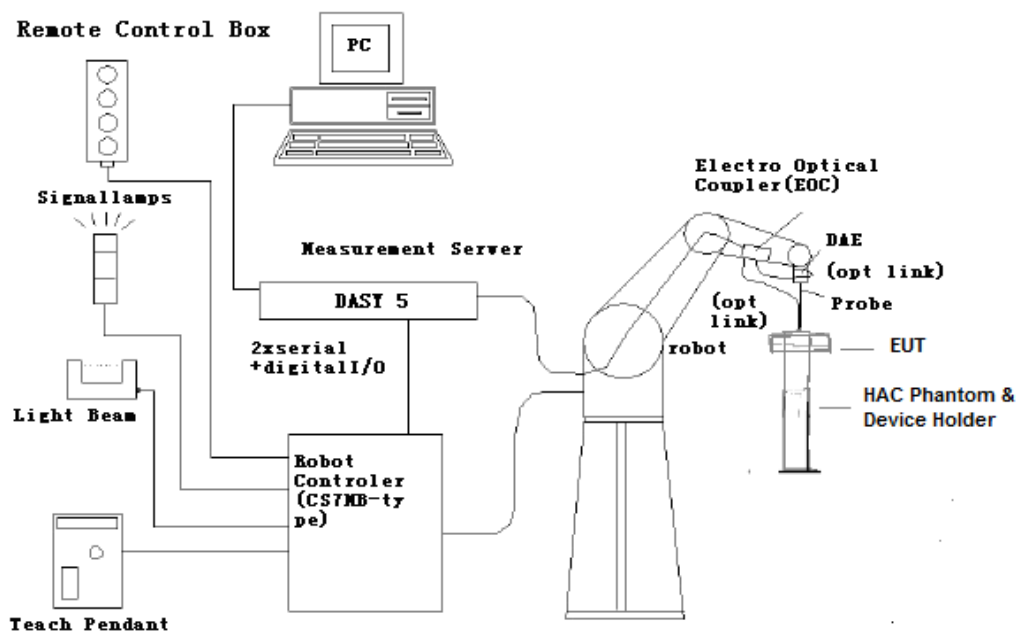

Fig. 1 HAC Test Measurement Set-up

The DAE4 consists of a highly sensitive electrometer-grade preamplifier with auto-zeroing, a channel and gain-switching multiplexer, a fast 16 bit AD-converter and a command decoder and control logic unit. Transmission to the PC-card is accomplished through an optical downlink for data and status information and an optical uplink for commands and clock lines. The mechanical probe mounting device includes two different sensor systems for frontal and sidewise probe contacts. They are also used for mechanical surface detection and probe collision detection. The robot uses its own controller with a built in VME-bus computer.

6.2 Probe Specification

E-Field Probe Description

| | |
|---------------|--|
| Construction | <p>One dipole parallel, two dipoles normal to probe axis</p> <p>Built-in shielding against static charges</p> <p>PEEK enclosure material</p> |
| Calibration | <p>In air from 100 MHz to 3.0 GHz (absolute accuracy $\pm 6.0\%$, $k=2$)</p> |
| Frequency | <p>40 MHz to > 6 GHz (can be extended to < 20 MHz)</p> <p>Linearity: ± 0.2 dB (100 MHz to 3 GHz)</p> |
| Directivity | <p>± 0.2 dB in air (rotation around probe axis)</p> <p>± 0.4 dB in air (rotation normal to probe axis)</p> |
| Dynamic Range | <p>2 V/m to > 1000 V/m; Linearity: ± 0.2 dB</p> |
| Dimensions | <p>Overall length: 330 mm (Tip: 16 mm)</p> <p>Tip diameter: 8 mm (Body: 12 mm)</p> <p>Distance from probe tip to dipole centers: 2.5 mm</p> |
| Application | <p>General near-field measurements up to 6 GHz</p> <p>Field component measurements</p> <p>Fast automatic scanning in phantoms</p> |



[ER3DV6]

6.3 Test Arch Phantom & Phone Positioner

The Test Arch phantom should be positioned horizontally on a stable surface. Reference markings on the Phantom allow the complete setup of all predefined phantom positions and measurement grids by manually teaching three points in the robot. It enables easy and well defined positioning of the phone and validation dipoles as well as simple teaching of the robot (Dimensions: 370 x 370 x 370 mm).

The Phone Positioner supports accurate and reliable positioning of any phone with effect on near field $< \pm 0.5$ dB.

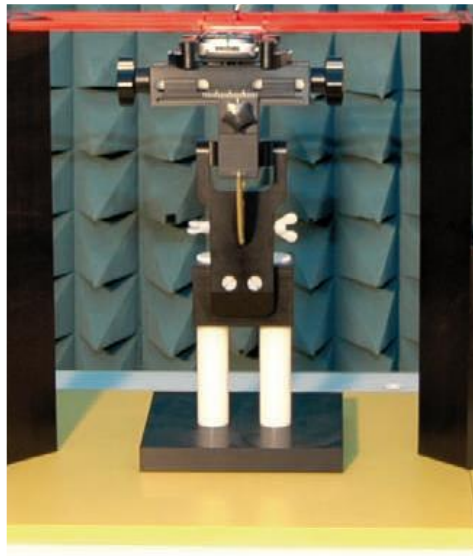

Fig. 2 HAC Phantom & Device Holder

6.4 Robotic System Specifications

Specifications

Positioner: Stäubli Unimation Corp. Robot Model: RX160L

Repeatability: ± 0.02 mm

No. of Axis: 6

Data Acquisition Electronic (DAE) System

Cell Controller

Processor: Intel Core2

Clock Speed: 1.86GHz

Operating System: Windows XP

Data Converter

Features: Signal Amplifier, multiplexer, A/D converter, and control logic

Software: DASY5 software

Connecting Lines: Optical downlink for data and status info.

Optical uplink for commands and clock

7 EUT ARRANGEMENT

7.1 WD RF Emission Measurements Reference and Plane

Figure 4 illustrates the references and reference plane that shall be used in the WD emissions measurement.

- The grid is 5 cm by 5 cm area that is divided into 9 evenly sized blocks or sub-grids.
- The grid is centered on the audio frequency output transducer of the WD (speaker or T-coil).
- The grid is located by reference to a reference plane. This reference plane is the planar area that contains the highest point in the area of the WD that normally rests against the user's ear
- The measurement plane is located parallel to the reference plane and 15 mm from it, out from the phone. The grid is located in the measurement plane.

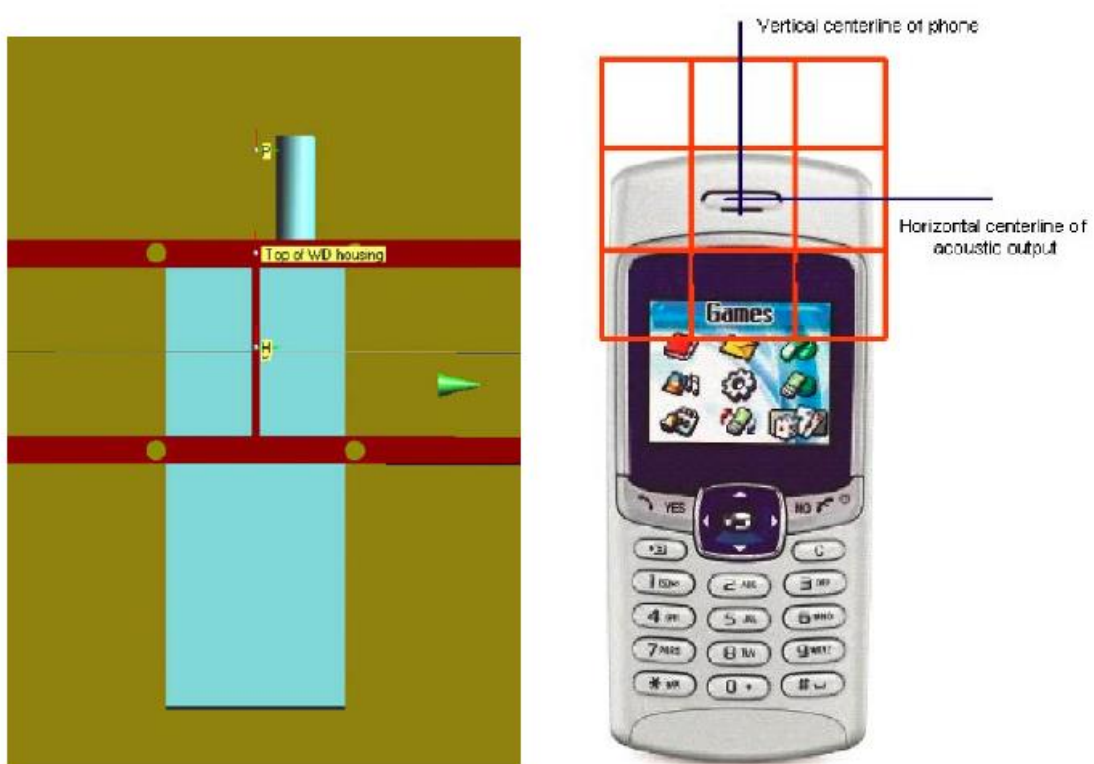

Fig. 3 WD reference and plane for RF emission measurements

8 SYSTEM VALIDATION

8.1 Validation Procedure

Place a dipole antenna meeting the requirements given in ANSI C63.19 in the position normally occupied by the WD. The dipole antenna serves as a known source for an electrical output. Position the E-field probes so that:

- The probes and their cables are parallel to the coaxial feed of the dipole antenna
- The probe cables and the coaxial feed of the dipole antenna approach the measurement area from opposite directions
- The center point of the probe element(s) are 15 mm from the closest surface of the dipole elements.

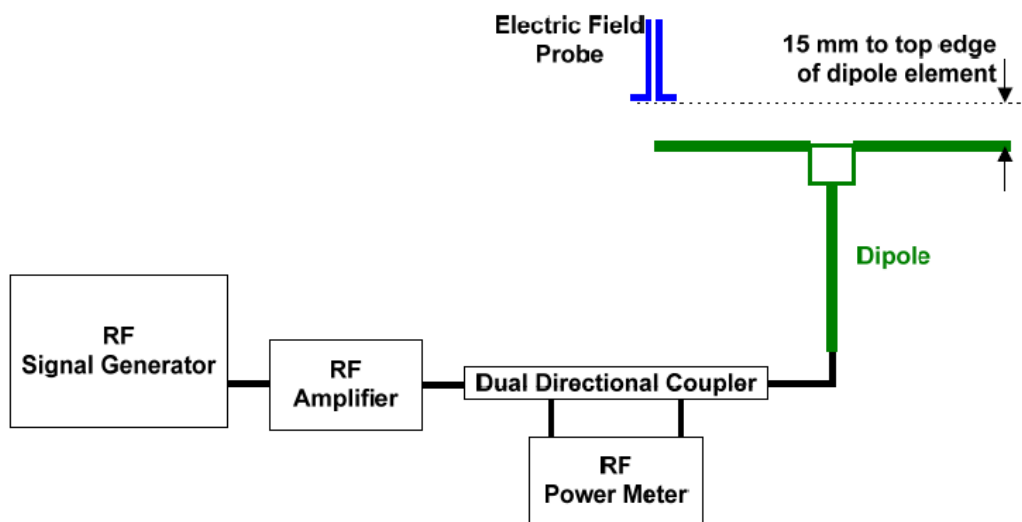

Fig. 4 Dipole Validation Setup

8.2 Validation Result

| E-Field Scan | | | | | | |
|--------------|-----------------|------------------|------------------------------------|----------------------------------|----------------------------|------------------------|
| Mode | Frequency (MHz) | Input Power (mW) | Measured ¹ Value(dBV/m) | Target ² Value(dBV/m) | Deviation ³ (%) | Limit ⁴ (%) |
| CW | 835 | 100 | 40.76 | 41.00 | -2.73 | ± 25 |
| CW | 1880 | 100 | 38.68 | 38.80 | -1.37 | ± 25 |
| CW | 2450 | 100 | 38.31 | 38.64 | -3.73 | ± 25 |

Notes:

1. Please refer to the attachment for detailed measurement data and plot.
2. Target value is provided by SPEAD in the calibration certificate of specific dipoles.
3. Deviation (%) = $100 * (\text{Measured value minus Target value}) / \text{Target value}$.
4. ANSI C63.19 requires values within $\pm 25\%$ are acceptable, of which 12% is deviation and 13% is measurement uncertainty. Values independently validated for the dipole actually used in the measurements should be used, when available.

9 Evaluation of MIF

9.1 Introduction

The MIF (Modulation Interference Factor) is used to classify E-field emission to determine Hearing Aid Compatibility (HAC). It scales the power-averaged signal to the RF audio interference level and is characteristic to a modulation scheme. The HAC standard preferred "indirect" measurement method is based on average field measurement with separate scaling by the MIF. With an Audio Interference Analyzer (AIA) designed by SPEAG specifically for the MIF measurement, these values have been verified by practical measurements on an RF signal modulated with each of the waveforms. The resulting deviations from the simulated values are within the requirements of the HAC standard.

The AIA (Audio Interference Analyzer) is an USB powered electronic sensor to evaluate signals in the frequency range 698MHz - 6 GHz. It contains RMS detector and audio frequency circuits for sampling of the RF envelope.

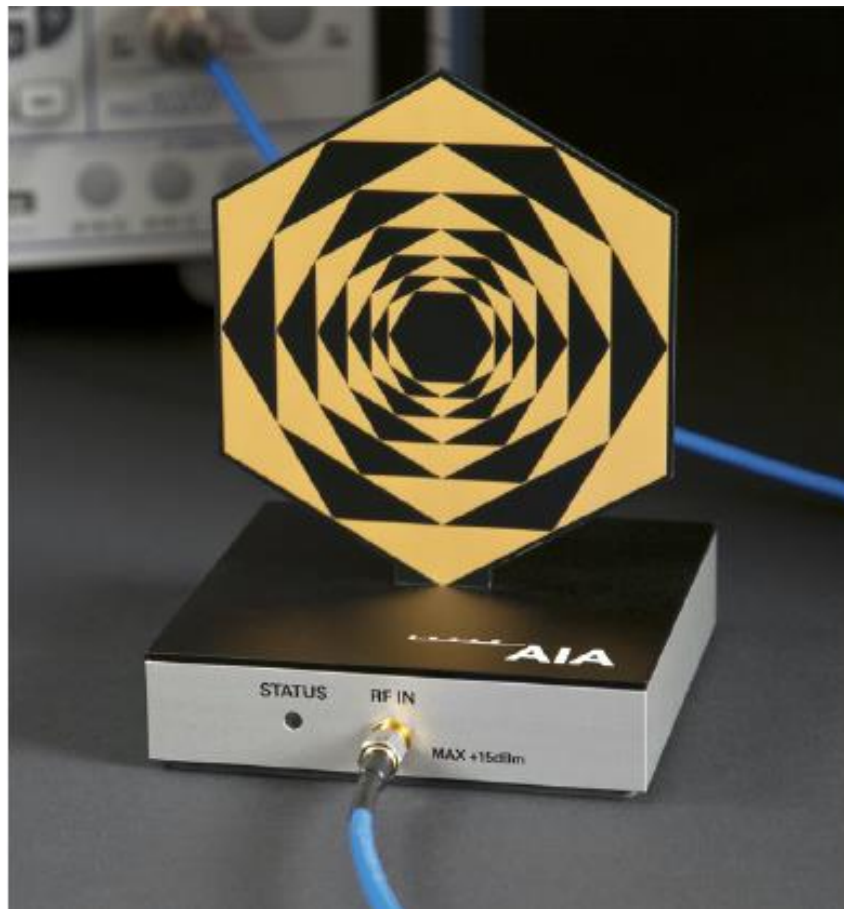

Fig. 5 AIA Front View

9.2 MIF measurement with the AIA

The MIF is measured with the AIA as follows:

1. Connect the AIA via USB to the DASY5 PC and verify the configuration settings.
2. Couple the RF signal to be evaluated to an AIA via cable or antenna.
3. Generate a MIF measurement job for the unknown signal and select the measurement port and timing settings.
4. Document the results via the post processor in a report.

9.3 Test equipment for the MIF measurement

| No. | Name | Type | Serial Number | Manufacturer |
|-----|------------------|---------------|---------------|--------------|
| 01 | Signal Generator | E4483C | MY49071430 | Anritsu |
| 02 | AIA | SE UMS 170 CB | 1029 | SPEAG |
| 03 | BTS | CMW500 | 166370 | R&S |

9.4 Test signal validation

The signal generator (E4438C) is used to generate a 1GHz signal with different modulation in the below table based on the ANSI C63.19-2011. The measured MIF with AIA are compared with the target values given in ANSI C63.19-2011 table D.3, D.4 and D5.

| Pulse modulation | Target MIF | Measured MIF | Deviation |
|--|------------|--------------|-----------|
| 0.5ms pulse, 1000Hz repetition rate | -0.9 dB | -0.9 dB | 0 dB |
| 1ms pulse, 100Hz repetition rate | +3.9 dB | +3.7 dB | 0.2 dB |
| 0.1ms pulse, 100Hz repetition rate | +10.1 dB | +10.0 dB | 0.1 dB |
| 10ms pulse, 10Hz repetition rate | +1.6 dB | +1.7 dB | 0.1 dB |
| Sine-wave modulation | Target MIF | Measured MIF | Deviation |
| 1 kHz, 80% AM | -1.2 dB | -1.3 dB | 0.1 dB |
| 1 kHz, 10% AM | -9.1 dB | -9.0 dB | 0.1 dB |
| 1 kHz, 1% AM | -19.1 dB | -18.9 dB | 0.2 dB |
| 100 Hz, 10% AM | -16.1 dB | -16.0 dB | 0.1 dB |
| 10 kHz, 10% AM | -21.5 dB | -21.6 dB | 0.1 dB |
| Transmission protocol | Target MIF | Measured MIF | Deviation |
| GSM; full-rate version 2; speech codec/handset low | +3.5 dB | +3.47 dB | 0.03 dB |
| WCDMA; speech; speech codec low; AMR 12.2 kb/s | -20.0 dB | -19.8 dB | 0.2 dB |
| CDMA; speech; SO3; RC3; full frame rate; 8kEVRC | -19.0 dB | -19.1 dB | 0.1 dB |
| CDMA; speech; SO3; RC1; 1/8 th frame rate; 8kEVRC | +3.3 dB | +3.44 dB | 0.14 dB |

9.5 DUT MIF results

Based on the KDB285076D01v05, the handset can also use the MIF values predetermined by the test equipment manufacturer. MIF values applied in this test report were provided by the HAC equipment provider of SPEAG, and the worst values for all air interface are listed below to be determine the Low-power Exemption.

| Typical MIF levels in ANSI C63.19-2011 | |
|---|--------------------------------|
| Transmission protocol | Modulation interference factor |
| GSM-FDD (TDMA, GMSK) | +3.63 dB |
| EDGE-FDD (TDMA, 8PSK, TN 0-1-2-3) | -1.82dB |
| UMTS-FDD(WCDMA, AMR) | -25.43dB |
| UMTS-FDD (HSPA) | -20.75dB |
| LTE-FDD (SC-FDMA, 1RB, 20MHz, QPSK) | -15.63 dB |
| LTE-FDD (SC-FDMA, 1RB, 20MHz, 16QAM) | -9.76 dB |
| LTE-FDD (SC-FDMA, 1RB, 20MHz, 64QAM) | -9.93 dB |
| IEEE 802.11b WiFi 2.4 GHz (DSSS, 1 Mbps) | -5.90 dB |
| IEEE 802.11b WiFi 2.4 GHz (DSSS, 2 Mbps) | -5.17 dB |
| IEEE 802.11b WiFi 2.4 GHz (DSSS, 5.5 Mbps) | -3.37 dB |
| IEEE 802.11b WiFi 2.4 GHz (DSSS, 11 Mbps) | -2.02 dB |
| IEEE 802.11g WiFi 2.4 GHz (DSSS-OFDM, 6 Mbps) | -0.36dB |
| IEEE 802.11n (HT Greenfield, 6.5 Mbps, BPSK) | -15.80 dB |

10 Evaluation for low-power exemption

10.1 Product testing threshold

There are two methods for exempting an RF air interface technology from testing. The first method requires evaluation of the MIF for the worst-case operating mode. An RF air interface technology of a device is exempt from testing when its average antenna input power plus its MIF is ≤ 17 dBm for any of its operating modes. The second method does not require determination of the MIF. The RF emissions testing exemption shall be applied to an RF air interface technology in a device whose peak antenna input power, averaged over intervals $\leq 50 \mu s$, is ≤ 23 dBm. An RF air interface technology that is exempted from testing by either method shall be rated as M4.

The first method is used to be exempt from testing for the RF air interface technology in this report.

10.2 Conducted power

| Band | Average power (dBm) | MIF (dB) | Sum (dBm) | C63.19 Tested |
|-------------------|---------------------|----------|-----------|---------------|
| GSM 850 - Voice | 32.8 | 3.63 | 36.43 | Yes |
| GSM 850 - EDGE | 26 | -1.82 | 24.18 | Yes* |
| GSM 1900 - Voice | 30.6 | 3.63 | 34.23 | Yes |
| GSM 1900 - EDGE | 26.3 | -1.82 | 24.48 | Yes* |
| WCDMA 850 - RMC | 24 | -25.43 | -1.43 | No |
| WCDMA 850 - HSPA | 23 | -20.75 | 2.25 | No |
| WCDMA 1700 - RMC | 24.5 | -25.43 | -0.93 | No |
| WCDMA 1700 - HSPA | 23.5 | -20.75 | 2.75 | No |
| WCDMA 1900 - RMC | 25 | -25.43 | -0.43 | No |
| WCDMA 1900 - HSPA | 23.5 | -20.75 | 2.75 | No |
| LTE Band 2 QPSK | 25.5 | -15.63 | 9.87 | No |
| LTE Band 5 QPSK | 25.5 | -15.63 | 9.87 | No |
| LTE Band 7 QPSK | 25 | -15.63 | 9.37 | No |
| LTE Band 12 QPSK | 25.5 | -15.63 | 9.87 | No |
| LTE Band 13 QPSK | 25.5 | -15.63 | 9.87 | No |
| LTE Band 66 QPSK | 25.5 | -15.63 | 9.87 | No |
| LTE Band 2 16QAM | 24.5 | -9.76 | 14.74 | No |
| LTE Band 5 16QAM | 24.5 | -9.76 | 14.74 | No |
| LTE Band 7 16QAM | 24 | -9.76 | 14.24 | No |
| LTE Band 12 16QAM | 24.5 | -9.76 | 14.74 | No |
| LTE Band 13 16QAM | 24.5 | -9.76 | 14.74 | No |
| LTE Band 66 16QAM | 24.5 | -9.76 | 14.74 | No |
| LTE Band 71 16QAM | 24.5 | -9.76 | 14.74 | No |
| WiFi-2.4G | 18 | -0.36 | 17.64 | Yes |

*Note: For GSM bands, EDGE modes were not evaluated as Voice modes were found to be the worst-case modes for the GSM air interface.



10.3 Conclusion

According to the above table, the sums of average power and MIF for WCDMA and LTE FDD are less than 17dBm. So it is measured for GSM WiFi2.4G bands. The WCDMA and LTE FDD are exempt from testing and rated as M4.

11 RF TEST PROCEDURES

The evaluation was performed with the following procedure:

- 1) Confirm proper operation of the field probe, probe measurement system and other instrumentation and the positioning system.
- 2) Position the WD in its intended test position. The gauge block can simplify this positioning.
- 3) Configure the WD normal operation for maximum rated RF output power, at the desired channel and other operating parameters (e.g., test mode), as intended for the test.
- 4) The center sub-grid shall be centered on the center of the T-Coil mode axial measurement point or the acoustic output, as appropriate. Locate the field probe at the initial test position in the 50 mm by 50 mm grid, which is contained in the measurement plane. If the field alignment method is used, align the probe for maximum field reception.
- 5) Record the reading.
- 6) Scan the entire 50 mm by 50 mm region in equally spaced increments and record the reading at each measurement point. The distance between measurement points shall be sufficient to assure the identification of the maximum reading.
- 7) Identify the five contiguous sub-grids around the center sub-grid whose maximum reading is the lowest of all available choices. This eliminates the three sub-grids with the maximum readings. Thus, the six areas to be used to determine the WD's highest emissions are identified.
- 8) Identify the maximum field reading within the non-excluded sub-grids identified in Step 7)
- 9) Evaluate the MIF and add to the maximum steady-state rms field-strength reading to obtain the RF audio interference level..
- 10) Compare this RF audio interference level with the categories and record the resulting WD category rating.

12 Measurement Results (E-Field)

| Frequency | | Measured Value(dBV/m) | Power Drift (dB) | Category |
|---------------------|---------|-----------------------|------------------|-------------------------|
| MHz | Channel | | | |
| GSM 850 | | | | |
| 848.8 | 251 | 34.01 | -0.01 | M4 (see Fig B.1) |
| 836.6 | 190 | 33.35 | -0.03 | M4 |
| 824.2 | 128 | 31.95 | 0.00 | M4 |
| GSM 1900 | | | | |
| 1909.8 | 810 | 31.25 | -0.01 | M3 (see Fig B.2) |
| 1880 | 661 | 30.06 | 0.05 | M3 |
| 1850.2 | 512 | 30.16 | -0.03 | M3 |
| WiFi2.4G 11g | | | | |
| 2462 | 11 | 19.96 | -0.06 | M4 |
| 2437 | 6 | 20.65 | 0.11 | M4 (see Fig B.5) |
| 2412 | 1 | 19.93 | 0.01 | M4 |

13 ANSIC 63.19-2011 LIMITS

WD RF audio interference level categories in logarithmic units

| Emission categories | < 960 MHz | E-field emissions |
|---------------------|-----------|-------------------|
| Category M1 | 50 to 55 | dB (V/m) |
| Category M2 | 45 to 50 | dB (V/m) |
| Category M3 | 40 to 45 | dB (V/m) |
| Category M4 | < 40 | dB (V/m) |
| Emission categories | > 960 MHz | E-field emissions |
| Category M1 | 40 to 45 | dB (V/m) |
| Category M2 | 35 to 40 | dB (V/m) |
| Category M3 | 30 to 35 | dB (V/m) |
| Category M4 | < 30 | dB (V/m) |

14 MEASUREMENT UNCERTAINTY

| No. | Error source | Type | Uncertainty Value(%) | Prob. Dist. | k | c _i E | Standard Uncertainty (%) u_i ; (%)E | Degree of freedom V_{eff} or ν_i |
|----------------------------|--------------------------------|------|----------------------|-------------|------------|------------------|---------------------------------------|--|
| Measurement System | | | | | | | | |
| 1 | Probe Calibration | B | 5. | N | 1 | 1 | 5.1 | ∞ |
| 2 | Axial Isotropy | B | 4.7 | R | $\sqrt{3}$ | 1 | 2.7 | ∞ |
| 3 | Sensor Displacement | B | 16.5 | R | $\sqrt{3}$ | 1 | 9.5 | ∞ |
| 4 | Boundary Effects | B | 2.4 | R | $\sqrt{3}$ | 1 | 1.4 | ∞ |
| 5 | Linearity | B | 4.7 | R | $\sqrt{3}$ | 1 | 2.7 | ∞ |
| 6 | Scaling to Peak Envelope Power | B | 2.0 | R | $\sqrt{3}$ | 1 | 1.2 | ∞ |
| 7 | System Detection Limit | B | 1.0 | R | $\sqrt{3}$ | 1 | 0.6 | ∞ |
| 8 | Readout Electronics | B | 0.3 | N | 1 | 1 | 0.3 | ∞ |
| 9 | Response Time | B | 0.8 | R | $\sqrt{3}$ | 1 | 0.5 | ∞ |
| 10 | Integration Time | B | 2.6 | R | $\sqrt{3}$ | 1 | 1.5 | ∞ |
| 11 | RF Ambient Conditions | B | 3.0 | R | $\sqrt{3}$ | 1 | 1.7 | ∞ |
| 12 | RF Reflections | B | 12.0 | R | $\sqrt{3}$ | 1 | 6.9 | ∞ |
| 13 | Probe Positioner | B | 1.2 | R | $\sqrt{3}$ | 1 | 0.7 | ∞ |
| 14 | Probe Positioning | A | 4.7 | R | $\sqrt{3}$ | 1 | 2.7 | ∞ |
| 15 | Extra. And Interpolation | B | 1.0 | R | $\sqrt{3}$ | 1 | 0.6 | ∞ |
| Test Sample Related | | | | | | | | |
| 16 | Device Positioning Vertical | B | 4.7 | R | $\sqrt{3}$ | 1 | 2.7 | ∞ |
| 17 | Device Positioning Lateral | B | 1.0 | R | $\sqrt{3}$ | 1 | 0.6 | ∞ |
| 18 | Device Holder and Phantom | B | 2.4 | R | $\sqrt{3}$ | 1 | 1.4 | ∞ |
| 19 | Power Drift | B | 5.0 | R | $\sqrt{3}$ | 1 | 2.9 | ∞ |

| | | | | | | | | |
|---|-------------------|--------------|-----|---|------------|---|------|----------|
| 20 | AIA measurement | B | 12 | R | $\sqrt{3}$ | 1 | 6.9 | ∞ |
| Phantom and Setup related | | | | | | | | |
| 21 | Phantom Thickness | B | 2.4 | R | $\sqrt{3}$ | 1 | 1.4 | ∞ |
| Combined standard uncertainty(%) | | | | | | | 16.2 | |
| Expanded uncertainty (confidence interval of 95 %) | | $u_e = 2u_c$ | | N | k=2 | | 32.4 | |

15 MAIN TEST INSTRUMENTS

Table 1: List of Main Instruments

| No. | Name | Type | Serial Number | Calibration Date | Valid Period |
|-----|------------------|---------------|---------------|--------------------------|--------------|
| 01 | Signal Generator | E4438C | MY49070393 | May 14, 2021 | One Year |
| 02 | Power meter | NRP2 | 106276 | May 11, 2021 | One year |
| 03 | Power sensor | NRP6A | 101369 | | |
| 04 | Amplifier | 60S1G4 | 0331848 | No Calibration Requested | |
| 05 | E-Field Probe | EF3DV3 | 4060 | May 21, 2021 | One year |
| 06 | DAE | SPEAG DAE4 | 1524 | October 08, 2021 | One year |
| 07 | HAC Dipole | CD835V3 | 1023 | August 24, 2021 | One year |
| 08 | HAC Dipole | CD1880V3 | 1018 | August 24, 2021 | One year |
| 09 | HAC Dipole | CD2450V3 | 1021 | August 24, 2021 | One year |
| 10 | BTS | CMW500 | 166370 | June 25,2021 | One year |
| 11 | AIA | SE UMS 170 CB | 1029 | No Calibration Requested | |

16 CONCLUSION

The HAC measurement indicates that the EUT complies with the HAC limits of the ANSIC63.19-2011. The total M-rating is **M3**.

END OF REPORT BODY

ANNEX A TEST LAYOUT

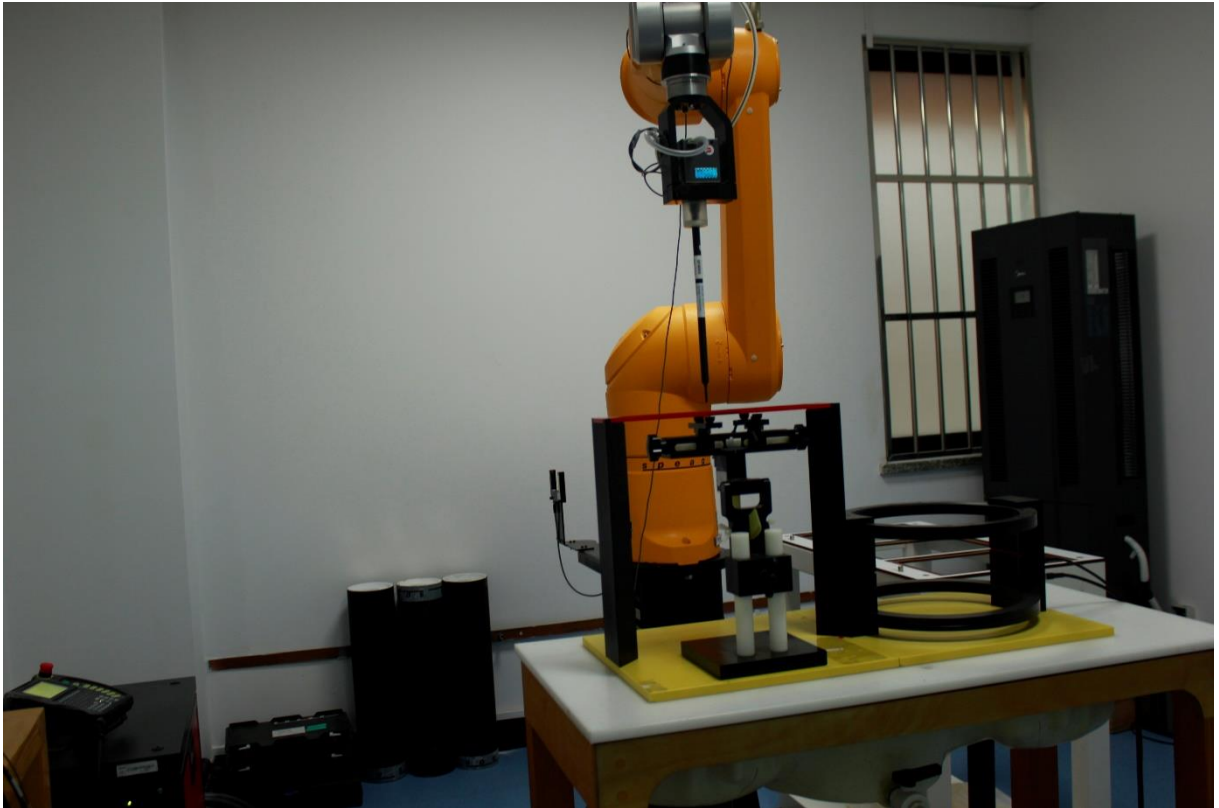

Picture A1:HAC RF System Layout

ANNEX B TEST PLOTS

HAC RF E-Field GSM 850 High

Date: 2022-01-30

Electronics: DAE4 Sn1524

Medium: Air

Medium parameters used: $\sigma = 0$ mho/m, $\epsilon_r = 1$; $\rho = 1000$ kg/m³

Ambient Temperature: 22.0°C

Communication System: GSM 850; Frequency: 848.8 MHz; Duty Cycle: 1:8.3

Probe: EF3DV3 - SN4060;ConvF(1, 1, 1)

E Scan - ER3DV6 - 2011: 15 mm from Probe Center to the Device

3/Hearing Aid Compatibility Test (101x101x1): Interpolated grid:

dx=0.5000 mm, dy=0.5000 mm

Device Reference Point: 0, 0, -6.3 mm

Reference Value = 41.07 V/m; Power Drift = -0.01 dB

Applied MIF = 3.50 dB

RF audio interference level = 34.01 dBV/m

Emission category: M4

MIF scaled E-field

| | | |
|--------------------------|--------------------------|--------------------------|
| Grid 1 M4 33.71 dBV/m | Grid 2 M4 33.92 dBV/m | Grid 3 M4 32.92 dBV/m |
| Grid 4 M4 33.83 dBV/m | Grid 5 M4 34.01 dBV/m | Grid 6 M4 32.95 dBV/m |
| Grid 7 M4 33.81 dBV/m | Grid 8 M4 33.96 dBV/m | Grid 9 M4 32.93 dBV/m |

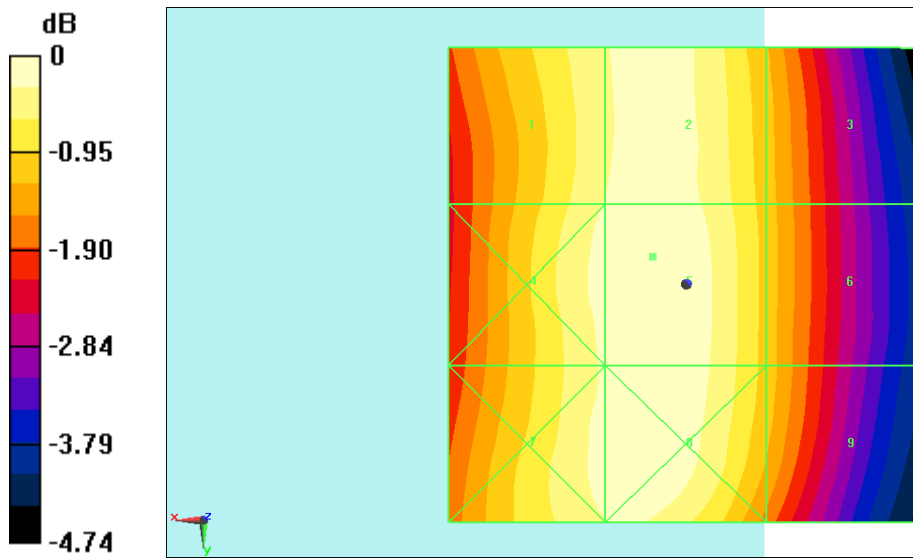

0 dB = 50.16 V/m = 34.01 dBV/m

Fig B.1 HAC RF E-Field GSM 850 High

HAC RF E-Field GSM 1900 High

Date: 2022-01-29

Electronics: DAE4 Sn1524

Medium: Air

Medium parameters used: $\sigma = 0$ mho/m, $\epsilon_r = 1$; $\rho = 1000$ kg/m³

Ambient Temperature: 22.0°C

Communication System: PCS 1900; Frequency: 1909.8 MHz; Duty Cycle: 1:8.3

Probe: EF3DV3 - SN4060;ConvF(1, 1, 1)

E Scan - ER3DV6 - 2011: 15 mm from Probe Center to the Device 2

2/Hearing Aid Compatibility Test (101x101x1): Interpolated grid:

dx=0.5000 mm, dy=0.5000 mm

Device Reference Point: 0, 0, -6.3 mm

Reference Value = 26.54 V/m; Power Drift = -0.01 dB

Applied MIF = 3.34 dB

RF audio interference level = 31.25 dBV/m

Emission category: M3

MIF scaled E-field

| | | |
|--------------------------|--------------------------|--------------------------|
| Grid 1 M3 31.51 dBV/m | Grid 2 M3 32.51 dBV/m | Grid 3 M3 31.7 dBV/m |
| Grid 4 M4 29.83 dBV/m | Grid 5 M3 31.25 dBV/m | Grid 6 M3 30.86 dBV/m |
| Grid 7 M4 29.68 dBV/m | Grid 8 M4 29.65 dBV/m | Grid 9 M4 28.76 dBV/m |

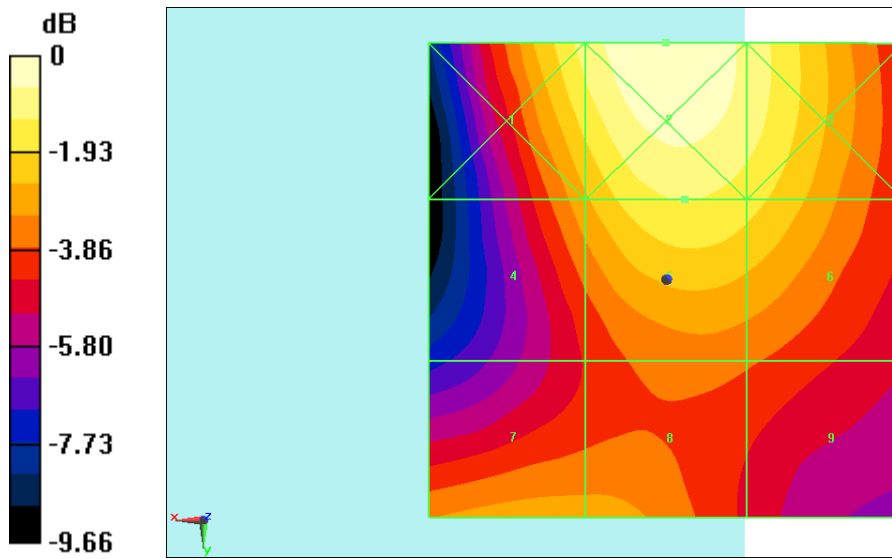

$0 \text{ dB} = 42.21 \text{ V/m} = 32.51 \text{ dBV/m}$

Fig B.2 HAC RF E-Field GSM 1900 High

HAC RF E-Field WiFi2.4G 11g

Date: 2022-02-27

Electronics: DAE4 Sn1524

Medium: Air

Medium parameters used: $\sigma = 0$ mho/m, $\epsilon_r = 1$; $\rho = 1000$ kg/m³

Ambient Temperature: 22.0°C

Communication System: WiFi2.4G; Frequency: 2437 MHz; Duty Cycle: 1:1

Probe: EF3DV3 - SN4060;ConvF(1, 1, 1)

E Scan - ER3DV6 - 2011: 15 mm from Probe Center to the

Device/Hearing Aid Compatibility Test (101x101x1): Interpolated

grid: dx=0.5000 mm, dy=0.5000 mm

Device Reference Point: 0, 0, -6.3 mm

Reference Value = 26.78 V/m; Power Drift = 0.11 dB

Applied MIF = -7.05 dB

RF audio interference level = 20.65 dBV/m

Emission category: M4

MIF scaled E-field

| | | |
|--------------------------|--------------------------|--------------------------|
| Grid 1 M4 22.61 dBV/m | Grid 2 M4 22.06 dBV/m | Grid 3 M4 19.83 dBV/m |
| Grid 4 M4 20.58 dBV/m | Grid 5 M4 20.65 dBV/m | Grid 6 M4 19.71 dBV/m |
| Grid 7 M4 18.04 dBV/m | Grid 8 M4 18.15 dBV/m | Grid 9 M4 17.8 dBV/m |

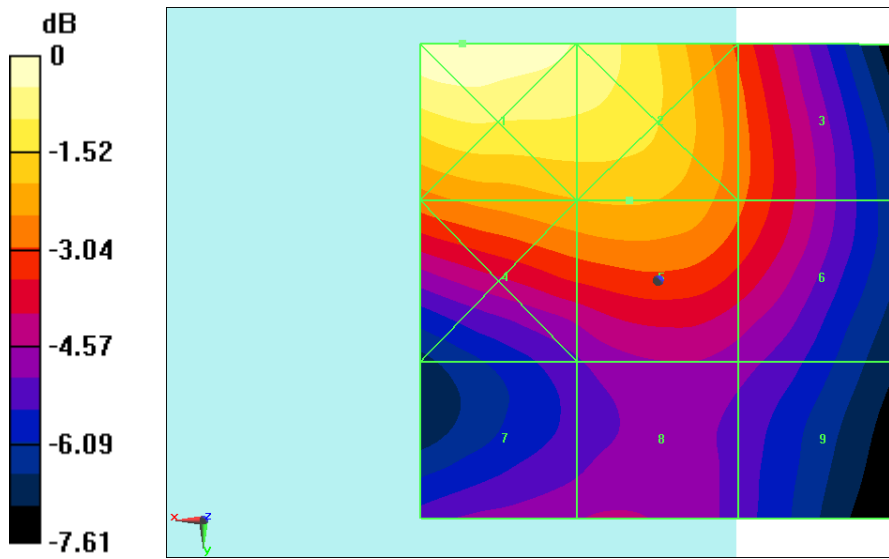

0 dB = 13.51 V/m = 22.61 dBV/m

Fig B.3 HAC RF E-Field WiFi2.4G 11g

ANNEX C SYSTEM VALIDATION RESULT

E SCAN of Dipole 835 MHz

Date: 2021-01-30

Electronics: DAE4 Sn1524

Medium: Air

Medium parameters used: $\sigma = 0$ mho/m, $\epsilon_r = 1$; $\rho = 1000$ kg/m³

Communication System: CW; Frequency: 835 MHz; Duty Cycle: 1:1

Probe: EF3DV3 - SN4060; ConvF(1, 1, 1)

E Scan - measurement distance from the probe sensor center to CD835 = 15mm/Hearing Aid Compatibility Test at 15mm distance (41x361x1): Interpolated

grid: dx=0.5000 mm, dy=0.5000 mm

Device Reference Point: 0, 0, -6.3 mm

Reference Value = 130.5 V/m; Power Drift = 0.01 dB

Applied MIF = 0.00 dB

RF audio interference level = 40.76 dBV/m

Emission category: **M3**

MIF scaled E-field

| | | |
|--|--|--|
| Grid 1 M3 41.02 dBV/m | Grid 2 M3 41.03 dBV/m | Grid 3 M3 40.58 dBV/m |
| Grid 4 M4 36.43 dBV/m | Grid 5 M4 36.46 dBV/m | Grid 6 M4 36.23 dBV/m |
| Grid 7 M3 40.67 dBV/m | Grid 8 M3 40.76 dBV/m | Grid 9 M3 40.54 dBV/m |

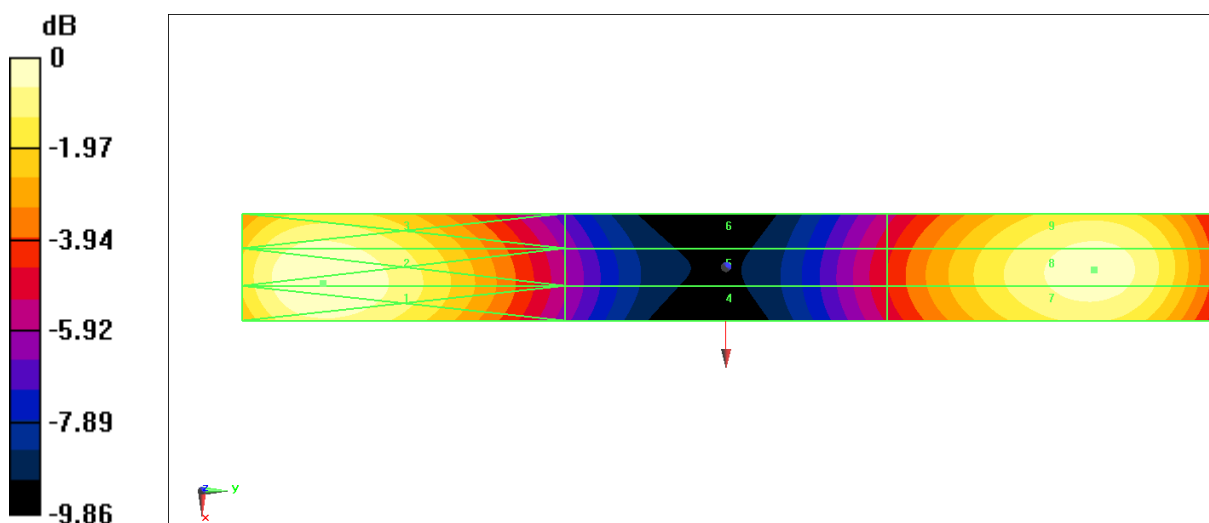

$$0 \text{ dB} = 112.6 \text{ V/m} = 41.03 \text{ dBV/m}$$

E SCAN of Dipole 1880MHz

Date: 2022-01-29

Electronics: DAE4 Sn1524

Medium: Air

Medium parameters used: $\sigma = 0$ mho/m, $\epsilon_r = 1$; $\rho = 1000$ kg/m³

Communication System: CW; Frequency: 1880 MHz; Duty Cycle: 1:1

Probe: EF3DV3 - SN4060;ConvF(1, 1, 1)

**E Scan - measurement distance from the probe sensor center to CD1880 = 15mm
2/Hearing Aid Compatibility Test at 15mm distance (41x181x1):** Interpolated grid:
dx=0.5000 mm, dy=0.5000 mm

Device Reference Point: 0, 0, -6.3 mm

Reference Value = 121.3 V/m; Power Drift = 0.01 dB

Applied MIF = 0.00 dB

RF audio interference level = 38.68 dBV/m

Emission category: M2

MIF scaled E-field

| | | |
|--|--|--|
| Grid 1 M2 39.32 dBV/m | Grid 2 M2 39.32 dBV/m | Grid 3 M2 38.84 dBV/m |
| Grid 4 M2 37 dBV/m | Grid 5 M2 37.03 dBV/m | Grid 6 M2 36.92 dBV/m |
| Grid 7 M2 38.57 dBV/m | Grid 8 M2 38.68 dBV/m | Grid 9 M2 38.51 dBV/m |

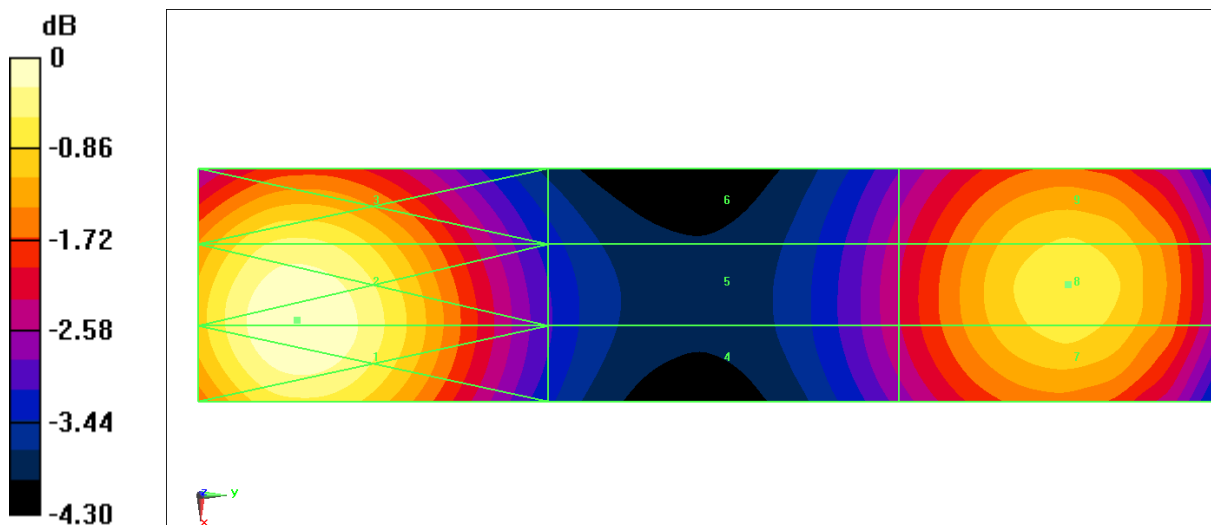

0 dB = 92.49 V/m = 39.32 dBV/m

E SCAN of Dipole 2450 MHz
Date: 2022-02-27

Electronics: DAE4 Sn1524

Medium: Air

 Medium parameters used: $\sigma = 0$ mho/m, $\epsilon_r = 1$; $\rho = 1000$ kg/m³

Communication System: CW; Frequency: 2450 MHz; Duty Cycle: 1:1

Probe: EF3DV3 - SN4060;ConvF(1, 1, 1)

E Scan - measurement distance from the probe sensor center to CD2450 = 15mm/Hearing Aid Compatibility Test at 15mm distance (41x181x1): Interpolated grid: dx=0.5000 mm, dy=0.5000 mm

Device Reference Point: 0, 0, -6.3 mm

Reference Value = 68.38 V/m; Power Drift = 0.03 dB

Applied MIF = 0.00 dB

RF audio interference level = 38.92 dBV/m

Emission category: M2

MIF scaled E-field

| | | |
|--|--|--|
| Grid 1 M2 39.08 dBV/m | Grid 2 M2 39.1 dBV/m | Grid 3 M2 38.74 dBV/m |
| Grid 4 M2 38.51 dBV/m | Grid 5 M2 38.54 dBV/m | Grid 6 M2 38.36 dBV/m |
| Grid 7 M2 38.85 dBV/m | Grid 8 M2 38.92 dBV/m | Grid 9 M2 38.71 dBV/m |

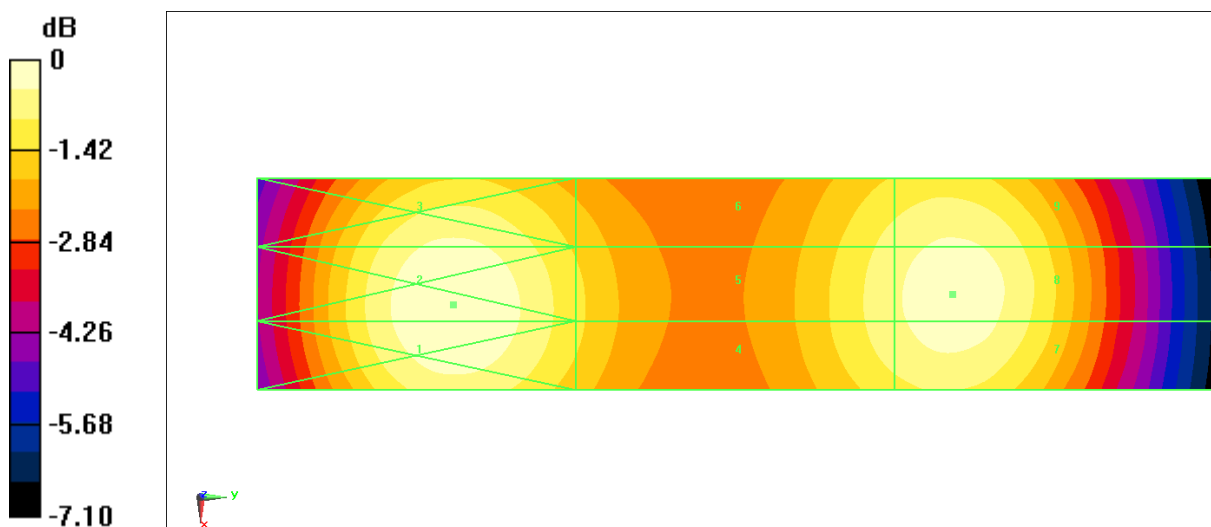
 $0 \text{ dB} = 90.12 \text{ V/m} = 39.10 \text{ dBV/m}$

ANNEX D PROBE CALIBRATION CERTIFICATE

Calibration Laboratory of
Schmid & Partner
Engineering AG
 Zeughausstrasse 43, 8004 Zurich, Switzerland



S Schweizerischer Kalibrierdienst
C Service suisse d'étalonnage
S Servizio svizzero di taratura
S Swiss Calibration Service

Accredited by the Swiss Accreditation Service (SAS)
 The Swiss Accreditation Service is one of the signatories to the EA
 Multilateral Agreement for the recognition of calibration certificates

Accreditation No.: SCS 0108

Client **CTTL-BJ (Auden)**

Certificate No: **EF3-4060_May21**

CALIBRATION CERTIFICATE

Object **EF3DV3- SN:4060**

Calibration procedure(s) **QA CAL-02.v9, QA CAL-25.v7**
 Calibration procedure for E-field probes optimized for close near field
 evaluations in air

Calibration date: **May 21, 2021**

This calibration certificate documents the traceability to national standards, which realize the physical units of measurements (SI).
 The measurements and the uncertainties with confidence probability are given on the following pages and are part of the certificate.

All calibrations have been conducted in the closed laboratory facility: environment temperature (22 ± 3)°C and humidity < 70%.

Calibration Equipment used (M&TE critical for calibration)

| Primary Standards | ID | Cal Date (Certificate No.) | Scheduled Calibration |
|----------------------------|------------------|-----------------------------------|------------------------|
| Power meter NRP | SN: 104778 | 09-Apr-21 (No. 217-03291/03292) | Apr-22 |
| Power sensor NRP-Z91 | SN: 103244 | 09-Apr-21 (No. 217-03291) | Apr-22 |
| Power sensor NRP-Z91 | SN: 103245 | 09-Apr-21 (No. 217-03292) | Apr-22 |
| Reference 20 dB Attenuator | SN: CC2552 (20x) | 09-Apr-21 (No. 217-03343) | Apr-22 |
| DAE4 | SN: 789 | 23-Dec-20 (No. DAE4-789_Dec20) | Dec-21 |
| Reference Probe ER3DV6 | SN: 2328 | 05-Oct-20 (No. ER3-2328_Oct20) | Oct-21 |
| Secondary Standards | ID | Check Date (in house) | Scheduled Check |
| Power meter E4419B | SN: GB41293874 | 06-Apr-16 (in house check Jun-20) | In house check: Jun-22 |
| Power sensor E4412A | SN: MY41498087 | 06-Apr-16 (in house check Jun-20) | In house check: Jun-22 |
| Power sensor E4412A | SN: 000110210 | 06-Apr-16 (in house check Jun-20) | In house check: Jun-22 |
| RF generator HP 8648C | SN: US3642U01700 | 04-Aug-99 (in house check Jun-20) | In house check: Jun-22 |
| Network Analyzer E8358A | SN: US41080477 | 31-Mar-14 (in house check Oct-20) | In house check: Oct-21 |

| | Name | Function | Signature |
|----------------|-----------------|-----------------------|-----------|
| Calibrated by: | Jeffrey Katzman | Laboratory Technician | |
| Approved by: | Katja Pokovic | Technical Manager | |

Issued: May 21, 2021

This calibration certificate shall not be reproduced except in full without written approval of the laboratory.

Calibration Laboratory of
Schmid & Partner
Engineering AG
 Zeughausstrasse 43, 8004 Zurich, Switzerland



S Schweizerischer Kalibrierdienst
C Service suisse d'étalonnage
S Servizio svizzero di taratura
S Swiss Calibration Service

Accredited by the Swiss Accreditation Service (SAS)
The Swiss Accreditation Service is one of the signatories to the EA
Multilateral Agreement for the recognition of calibration certificates

Accreditation No.: **SCS 0108**

Glossary:

| | |
|-----------------------|---|
| NORM _{x,y,z} | sensitivity in free space |
| DCP | diode compression point |
| CF | crest factor (1/duty_cycle) of the RF signal |
| A, B, C, D | modulation dependent linearization parameters |
| E _n | incident E-field orientation normal to probe axis |
| E _p | incident E-field orientation parallel to probe axis |
| Polarization φ | φ rotation around probe axis |
| Polarization θ | θ rotation around an axis that is in the plane normal to probe axis (at measurement center). i.e., θ = 0 is normal to probe axis |
| Connector Angle | information used in DASY system to align probe sensor X to the robot coordinate system |

Calibration is Performed According to the Following Standards:

- a) IEEE Std 1309-2005, "IEEE Standard for calibration of electromagnetic field sensors and probes, excluding antennas, from 9 kHz to 40 GHz", December 2005
- b) CTIA Test Plan for Hearing Aid Compatibility, Rev 3.1.1, May 2017

Methods Applied and Interpretation of Parameters:

- **NORM_{x,y,z}**: Assessed for E-field polarization θ = 0 for XY sensors and θ = 90 for Z sensor (f ≤ 900 MHz in TEM-cell; f > 1800 MHz: R22 waveguide).
- **NORM(f)_{x,y,z} = NORM_{x,y,z} * frequency_response** (see Frequency Response Chart).
- **DCP_{x,y,z}**: DCP are numerical linearization parameters assessed based on the data of power sweep with CW signal (no uncertainty required). DCP does not depend on frequency nor media.
- **PAR**: PAR is the Peak to Average Ratio that is not calibrated but determined based on the signal characteristics
- **A_{x,y,z}; B_{x,y,z}; C_{x,y,z}; D_{x,y,z}; VR_{x,y,z}**: A, B, C, D are numerical linearization parameters assessed based on the data of power sweep for specific modulation signal. The parameters do not depend on frequency nor media. VR is the maximum calibration range expressed in RMS voltage across the diode.
- **Spherical isotropy (3D deviation from isotropy)**: in a locally homogeneous field realized using an open waveguide setup.
- **Sensor Offset**: The sensor offset corresponds to the offset of virtual measurement center from the probe tip (on probe axis). No tolerance required.
- **Connector Angle**: The angle is assessed using the information gained by determining the **NORM_x** (no uncertainty required).