

SAR TEST REPORT

No. I21Z62543-SEM02

For

TCL Communication Ltd.

GSM/UMTS/LTE Mobile phone

Model name: 5031G, 5131G

With

Hardware Version: 05

Software Version: SVN:01

FCC ID: 2ACCJH160

Issued Date: 2022-2-11

Note:

The test results in this test report relate only to the devices specified in this report. This report shall not be reproduced except in full without the written approval of CTTL.

Test Laboratory:

CTTL, Telecommunication Technology Labs, CAICT

No. 51, Xueyuan Road, Haidian District, Beijing, P. R. China 100191.

Tel:+86(0)10-62304633-2512, Fax:+86(0)10-62304633-2504

Email: ctl_terminals@caict.ac.cn, website: www.caict.ac.cn



REPORT HISTORY

Report Number	Revision	Issue Date	Description
I21Z62543-SEM02	Rev.0	2022-1-26	Initial creation of test report
I21Z62543-SEM02	Rev.0	2022-2-11	Information in Table 2.1 has been updated. The report has been supplemented with VOIP test data. The Medium information has been updated to Head.

TABLE OF CONTENT

1 TEST LABORATORY	5
1.1 TESTING LOCATION.....	5
1.2 TESTING ENVIRONMENT.....	5
1.3 PROJECT DATA	5
1.4 SIGNATURE.....	5
2 STATEMENT OF COMPLIANCE	6
3 CLIENT INFORMATION	8
3.1 APPLICANT INFORMATION.....	8
3.2 MANUFACTURER INFORMATION	8
4 EQUIPMENT UNDER TEST (EUT) AND ANCILLARY EQUIPMENT (AE)	9
4.1 ABOUT EUT.....	9
4.2INTERNAL IDENTIFICATION OF EUT USED DURING THE TEST.....	10
4.3 INTERNAL IDENTIFICATION OF AE USED DURING THE TEST	10
5 TEST METHODOLOGY	11
5.1 APPLICABLE LIMIT REGULATIONS.....	11
5.2 APPLICABLE MEASUREMENT STANDARDS	11
6 SPECIFIC ABSORPTION RATE (SAR).....	12
6.1 INTRODUCTION.....	12
6.2 SAR DEFINITION.....	12
7 TISSUE SIMULATING LIQUIDS	13
7.1 TARGETS FOR TISSUE SIMULATING LIQUID.....	13
7.2 DIELECTRIC PERFORMANCE	13
8 SYSTEM VERIFICATION	16
8.1 SYSTEM SETUP.....	16
8.2 SYSTEM VERIFICATION.....	17
9 MEASUREMENT PROCEDURES	18
9.1 TESTS TO BE PERFORMED	18
9.2 GENERAL MEASUREMENT PROCEDURE.....	19
9.3 WCDMA MEASUREMENT PROCEDURES FOR SAR.....	21
9.4 SAR MEASUREMENT FOR LTE.....	22
9.5 BLUETOOTH & WI-FI MEASUREMENT PROCEDURES FOR SAR	24
9.6 POWER DRIFT.....	24
10 AREA SCAN BASED 1-G SAR.....	25
10.1 REQUIREMENT OF KDB.....	25
10.2 FAST SAR ALGORITHMS	25
11 CONDUCTED OUTPUT POWER.....	26
11.1 GSM MEASUREMENT RESULT	26
11.2 WCDMA MEASUREMENT RESULT	28
11.3 LTE MEASUREMENT RESULT	30
11.4 WI-FI AND BT MEASUREMENT RESULT	49

12 SIMULTANEOUS TX SAR CONSIDERATIONS	52
12.1 TRANSMIT ANTENNA SEPARATION DISTANCES.....	52
12.2 SAR MEASUREMENT POSITIONS.....	52
12.3 STANDALONE SAR TEST EXCLUSION CONSIDERATIONS	53
13 EVALUATION OF SIMULTANEOUS	54
14 SAR TEST RESULT	55
14.1 SAR RESULTS FOR FAST SAR	57
14.2 SAR RESULTS FOR STANDARD PROCEDURE.....	59
14.3 WLAN EVALUATION FOR 2.4G	60
15 SAR MEASUREMENT VARIABILITY	66
16 MEASUREMENT UNCERTAINTY	67
16.1 MEASUREMENT UNCERTAINTY FOR NORMAL SAR TESTS (300MHZ~3GHZ).....	67
16.2 MEASUREMENT UNCERTAINTY FOR NORMAL SAR TESTS (3~6GHZ)	68
16.3 MEASUREMENT UNCERTAINTY FOR FAST SAR TESTS (300MHZ~3GHZ).....	69
16.4 MEASUREMENT UNCERTAINTY FOR FAST SAR TESTS (3~6GHZ)	70
17 MAIN TEST INSTRUMENTS	71
ANNEX A GRAPH RESULTS	71
ANNEX B SYSTEM VERIFICATION RESULTS	102
ANNEX C SAR MEASUREMENT SETUP	111
ANNEX D POSITION OF THE WIRELESS DEVICE IN RELATION TO THE PHANTOM	117
ANNEX E EQUIVALENT MEDIA RECIPES	120
ANNEX F SYSTEM VALIDATION	121
ANNEX G PROBE CALIBRATION CERTIFICATE	122
ANNEX H DIPOLE CALIBRATION CERTIFICATE	131
ANNEX I ACCREDITATION CERTIFICATE	155

1 Test Laboratory

1.1 Testing Location

Company Name:	CTTL(Shouxiang)
Address:	No. 51 Shouxiang Science Building, Xueyuan Road, Haidian District, Beijing, P. R. China100191

1.2 Testing Environment

Temperature:	18°C~25°C,
Relative humidity:	30%~ 70%
Ground system resistance:	< 0.5 Ω
Ambient noise & Reflection:	< 0.012 W/kg

1.3 Project Data

Project Leader:	Qi Dianyuan
Test Engineer:	Lin Xiaojun
Testing Start Date:	January 6, 2022
Testing End Date:	February 10, 2022

1.4 Signature



Lin Xiaojun
(Prepared this test report)

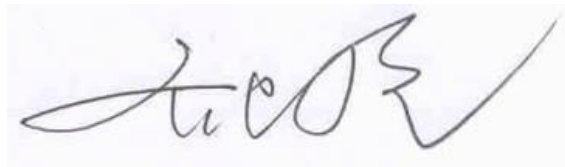

Qi Dianyuan
(Reviewed this test report)

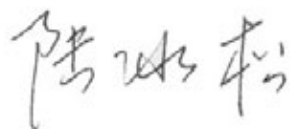

Lu Bingsong
Deputy Director of the laboratory
(Approved this test report)

2 Statement of Compliance

The maximum results of Specific Absorption Rate (SAR) found during testing for TCL Communication Ltd. GSM/UMTS/LTE Mobile phone 5031G, 5131G are as follows:

Table 2.1: Highest Reported SAR (1g)

Mode		Highest Reported SAR (1g)		
		1g SAR Head	1g SAR Hotspot	1g SAR Body-worn
GSM	GSM 850	0.23	0.35	/
	PCS 1900	0.12	1.08	/
WCDMA	UMTS FDD 2	0.23	0.79	0.36
	UMTS FDD 5	0.50	0.67	/
	LTE Band 5	0.39	0.52	/
	LTE Band 7	0.15	0.87	0.48
	LTE Band 41	0.05	0.65	0.37
WLAN 2.4 GHz		0.73	0.98	0.49

The SAR values found for the Mobile Phone are below the maximum recommended levels of 1.6 W/kg as averaged over any 1g tissue according to the ANSI C95.1-1992.

For body operation, this device has been tested and meets FCC RF exposure guidelines when used with any accessory that contains no metal and which provides a minimum separation distance of 10 mm for hotspot and 15mm for body worn between this device and the body of the user. Use of other accessories may not ensure compliance with FCC RF exposure guidelines.

The EUT battery must be fully charged and checked periodically during the test to ascertain uniform power output.

The measurement together with the test system set-up is described in annex C of this test report. A detailed description of the equipment under test can be found in chapter 4 of this test report. The highest reported SAR value is obtained at the case of (**Table 2.1**), and the values are: **1.08W/kg(1g)**.

Table 2.2: The sum of reported SAR values for Main antenna and WiFi2.4G+BT

	Position	Cellular antenna	WiFi	BT	Sum
Highest reported SAR value for Head	Right hand, Cheek (WCDMA850)	0.30	0.35	<0.01	0.65
Maximum reported SAR value for Body	Rear 10mm (GSM1900)	0.92	0.32	<0.01	1.24
	Bottom 10mm (GSM1900)	1.08	/	/	1.08
	Front 15mm (WCDMA1900)	0.22	0.02	0.09	0.33
	Rear 15mm (LTE Band7)	0.48	0.49	<0.01	0.97

Note: WiFi2.4G&BT antenna is located at the top of the device, the distance from the bottom is greater than 25mm, so the test is exempt.

Note1: we have evaluated and chose the highest value of body 10mm and 15mm in the above table.

According to the above tables, the highest sum of reported SAR values is **1.24 W/kg (1g)**. The detail for simultaneous transmission consideration is described in chapter 13.

3 Client Information

3.1 Applicant Information

Company Name:	TCL Communication Ltd.
Address/Post:	5/F, Building 22E, 22 Science Park East Avenue, Hong Kong Science Park, Shatin, NT, Hong Kong
Contact Person:	Peter yang
E-mail:	peter.yang@tcl.com
Telephone:	peter.yang@tcl.com
Fax:	+86 755 3661 2000-8172

3.2 Manufacturer Information

Company Name:	TCL Communication Ltd.
Address/Post:	5/F, Building 22E, 22 Science Park East Avenue, Hong Kong Science Park, Shatin, NT, Hong Kong
Contact Person:	Peter yang
E-mail:	peter.yang@tcl.com
Telephone:	peter.yang@tcl.com
Fax:	+86 755 3661 2000-8172

4 Equipment Under Test (EUT) and Ancillary Equipment (AE)

4.1 About EUT

Description:	GSM/UMTS/LTE Mobile phone
Model name:	5031G, 5131G
Operating mode(s):	GSM850/900/1800/1900, WCDMA850/900/1900/2100,BT,Wi-Fi(2.4G), LTE Band1/3/5/7/8/20/28/38/40/41
Tested Tx Frequency:	824 – 849 MHz (GSM 850)
	1850 – 1910 MHz (GSM 1900)
	824–849 MHz (WCDMA 850 Band V)
	1850–1910 MHz (WCDMA1900 Band II)
	824 – 849 MHz (LTE Band 5)
	2500 – 2570 MHz(LTE Band 7)
	2496 – 2690 MHz (LTE Band 41)
	2412 – 2462 MHz (Wi-Fi 2.4G)
GPRS/EGPRS Multislot Class:	12
GPRS capability Class:	B
Test device Production information:	Production unit
Device type:	Portable device
Antenna type:	Integrated antenna
Hotspot mode:	Support

4.2 Internal Identification of EUT used during the test

EUT ID*	IMEI	HW	SW Version
EUT1	352006940205371 352006940205389	05	SVN:01
EUT2	352006940204770 352006940204788	05	SVN:01
EUT3	352006940204796 352006940204804	05	SVN:01
EUT4	352006940205330 352006940205348	05	SVN:01
EUT5	352006940205199 352006940205207	05	SVN:01
EUT6	352006940000350 352006940000368	05	SVN:01
EUT7	352006940000756 352006940204762	05	SVN:01

*EUT ID: is used to identify the test sample in the lab internally.

Note: It is performed to test SAR with the EUT1-5 and conducted power with the EUT6-7.

4.3 Internal Identification of AE used during the test

AE ID*	Description	Model	SN	Manufacturer
AE1	Battery	TLi028C7	/	VEKEN
AE2	Battery	TLi028C1		BYD
AE3	Headset	CCB0046A10C1		JUWEI
AE4	Headset	CCB0046A10C4		MEIHAO
AE5	Headset	CCB0049A10C1		JUWEI

*AE ID: is used to identify the test sample in the lab internally.

5 TEST METHODOLOGY

5.1 Applicable Limit Regulations

ANSI C95.1–1992:IEEE Standard for Safety Levels with Respect to Human Exposure to Radio Frequency Electromagnetic Fields, 3 kHz to 300 GHz.

It specifies the maximum exposure limit of **1.6 W/kg** as averaged over any 1 gram of tissue for portable devices being used within 20 cm of the user in the uncontrolled environment.

5.2 Applicable Measurement Standards

IEEE 1528–2013: Recommended Practice for Determining the Peak Spatial-Average Specific Absorption Rate (SAR) in the Human Head from Wireless Communications Devices: Measurement Techniques.

KDB447498 D01: General RF Exposure Guidance v06: Mobile and Portable Devices RF Exposure Procedures and Equipment Authorization Policies.

KDB648474 D04 Handset SAR v01r03: SAR Evaluation Considerations for Wireless Handsets.

KDB941225 D01 SAR test for 3G devices v03r01: SAR Measurement Procedures for 3G Devices

KDB941225 D05 SAR for LTE Devices v02r05: SAR Evaluation Considerations for LTE Devices

KDB941225 D06 Hotspot Mode SAR v02r01: SAR Evaluation Procedures for Portable Devices with Wireless Router Capabilities

KDB248227 D01 802.11 Wi-Fi SAR v02r02: SAR GUIDANCE FOR IEEE 802.11 (Wi-Fi) TRANSMITTERS

KDB865664 D01 SAR measurement 100 MHz to 6 GHz v01r04: SAR Measurement Requirements for 100 MHz to 6 GHz.

KDB865664 D02 RF Exposure Reporting v01r02: RF Exposure Compliance Reporting and Documentation Considerations

6 Specific Absorption Rate (SAR)

6.1 Introduction

SAR is related to the rate at which energy is absorbed per unit mass in an object exposed to a radio field. The SAR distribution in a biological body is complicated and is usually carried out by experimental techniques or numerical modeling. The standard recommends limits for two tiers of groups, occupational/controlled and general population/uncontrolled, based on a person's awareness and ability to exercise control over his or her exposure. In general, occupational/controlled exposure limits are higher than the limits for general population/uncontrolled.

6.2 SAR Definition

The SAR definition is the time derivative (rate) of the incremental energy (dW) absorbed by (dissipated in) an incremental mass (dm) contained in a volume element (dv) of a given density (ρ). The equation description is as below:

$$SAR = \frac{d}{dt} \left(\frac{dW}{dm} \right) = \frac{d}{dt} \left(\frac{dW}{\rho dv} \right)$$

SAR is expressed in units of Watts per kilogram (W/kg)

SAR measurement can be either related to the temperature elevation in tissue by

$$SAR = c \left(\frac{\delta T}{\delta t} \right)$$

Where: C is the specific heat capacity, δT is the temperature rise and δt is the exposure duration, or related to the electrical field in the tissue by

$$SAR = \frac{\sigma |E|^2}{\rho}$$

Where: σ is the conductivity of the tissue, ρ is the mass density of tissue and E is the RMS electrical field strength.

However for evaluating SAR of low power transmitter, electrical field measurement is typically applied.

7 Tissue Simulating Liquids

7.1 Targets for tissue simulating liquid

Table 7.1: Targets for tissue simulating liquid

Frequency(MHz)	Liquid Type	Conductivity(σ)	$\pm 10\%$ Range	Permittivity(ϵ)	$\pm 10\%$ Range
835	Head	0.90	0.81~0.99	41.5	37.35~45.65
1900	Head	1.40	1.26~1.54	40.0	36~44
2450	Head	1.80	1.62~1.98	39.2	35.28~43.12
2600	Head	1.96	1.76~2.16	39.01	35.11~42.91

7.2 Dielectric Performance

Table 7.2: Dielectric Performance of Tissue Simulating Liquid

Measurement Date (yyyy-mm-dd)	Type	Frequency	Permittivity ϵ	Drift (%)	Conductivity σ (S/m)	Drift (%)
2022/1/6	Head	835 MHz	41.26	-0.58	0.908	0.89
2022/1/7	Head	835 MHz	41.6	0.24	0.901	0.11
2022/1/8	Head	1900 MHz	40.6	1.50	1.41	0.71
2022/1/9	Head	2450 MHz	38.76	-1.12	1.787	-0.72
2022/1/10	Head	2600 MHz	38.86	-0.38	1.943	-0.87
2022/1/11	Head	2600 MHz	39.57	1.44	1.966	0.31
2022/2/10	Head	835 MHz	42.29	1.90	0.889	-1.22
2022/2/10	Head	1900 MHz	40.17	0.43	1.418	1.29

Note: The liquid temperature is 23.0°C

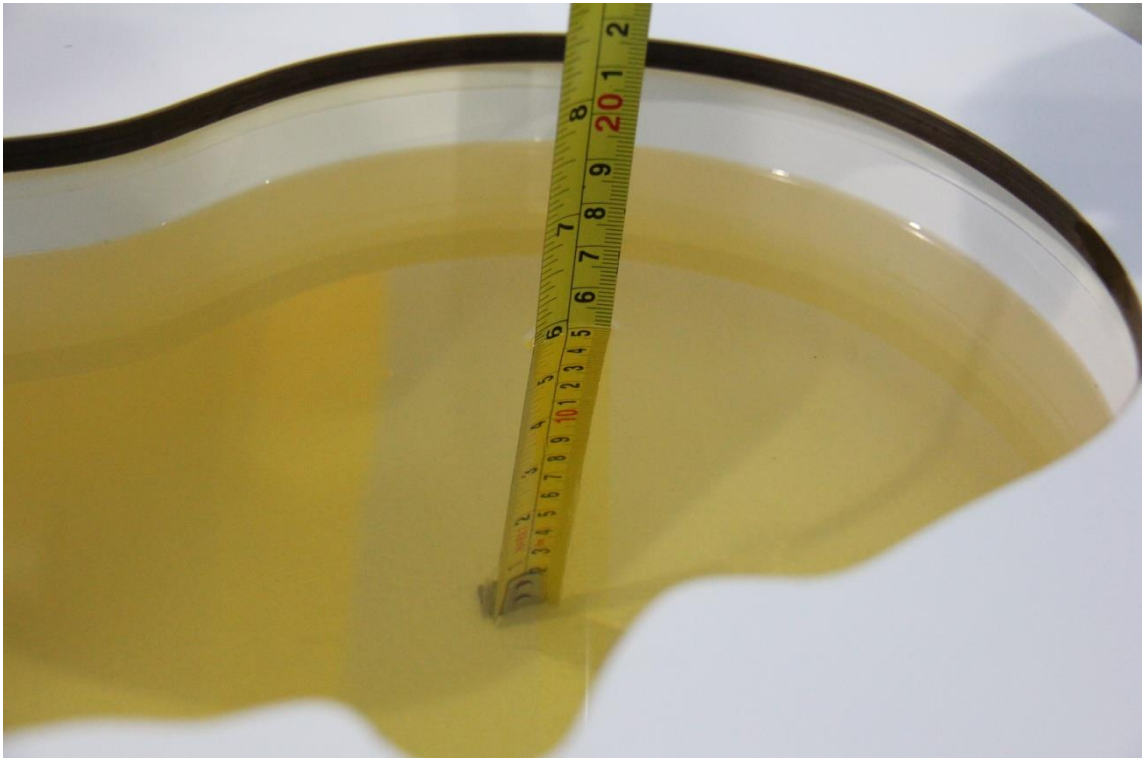

Picture 7-1 Liquid depth in the Head Phantom (835 MHz)

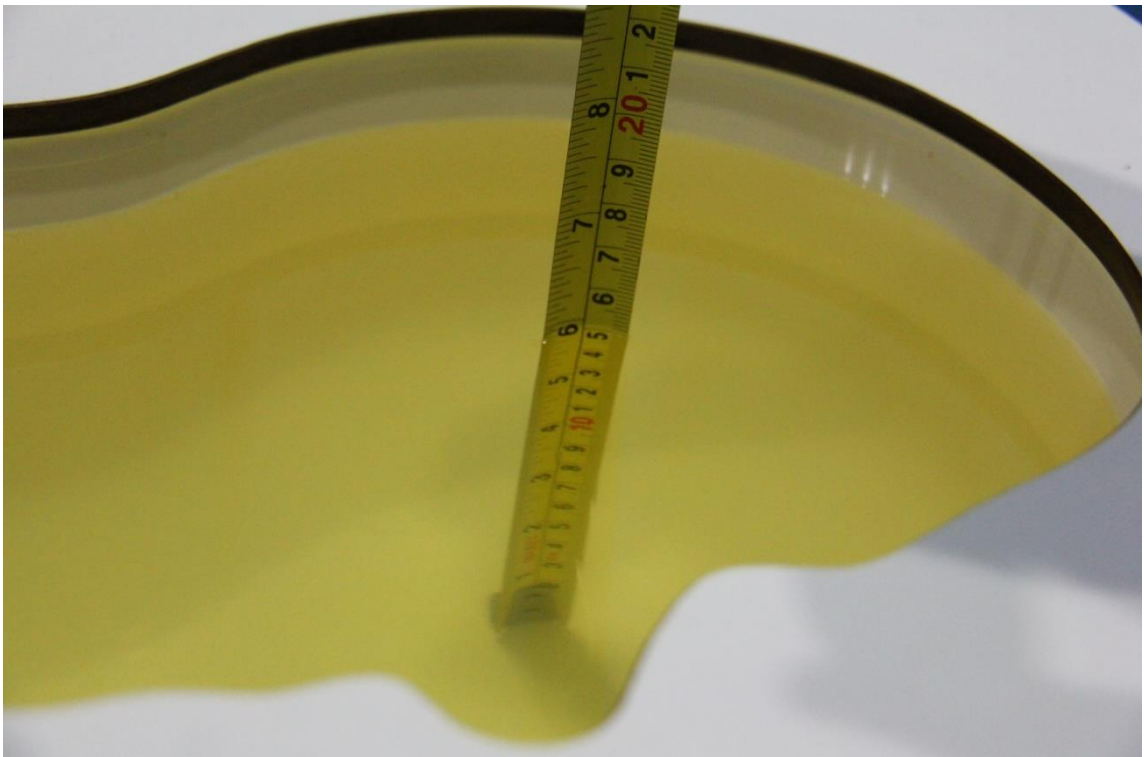

Picture 7-2 Liquid depth in the Head Phantom (1900 MHz)

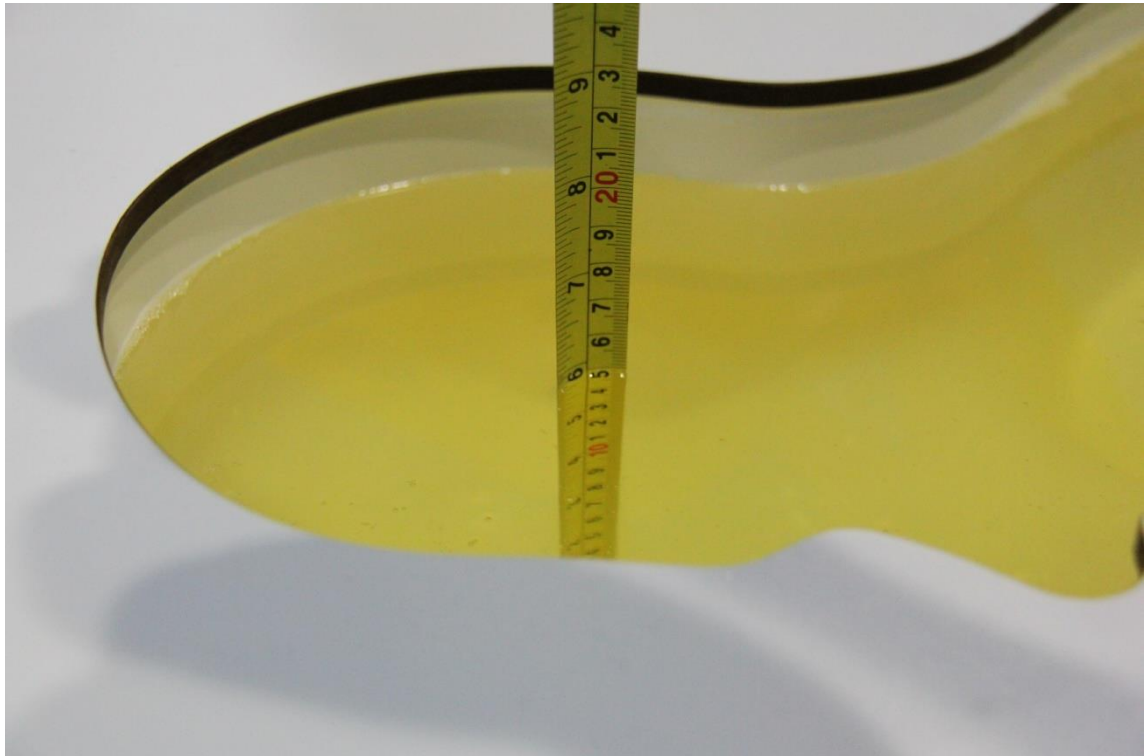

Picture 7-3 Liquid depth in the Head Phantom (2450MHz)



Picture 7-4 Liquid depth in the Head Phantom (2600 MHz)

8 System verification

8.1 System Setup

In the simplified setup for system evaluation, the DUT is replaced by a calibrated dipole and the power source is replaced by a continuous wave that comes from a signal generator. The calibrated dipole must be placed beneath the flat phantom section of the SAM twin phantom with the correct distance holder. The distance holder should touch the phantom surface with a light pressure at the reference marking and be oriented parallel to the long side of the phantom. The equipment setup is shown below:

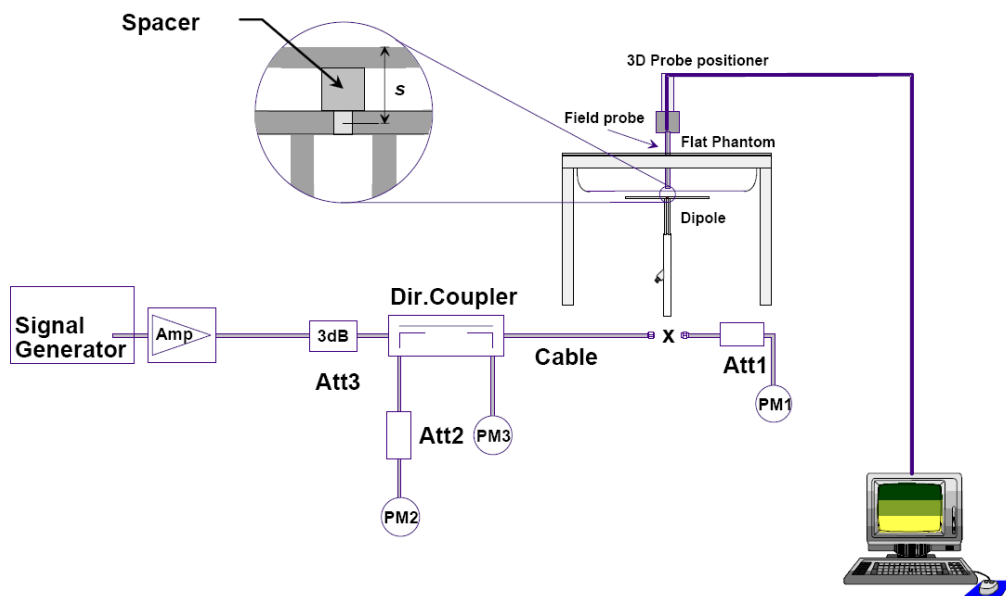

Picture 8.1 System Setup for System Evaluation



Picture 8.2 Photo of Dipole Setup

8.2 System Verification

SAR system verification is required to confirm measurement accuracy, according to the tissue dielectric media, probe calibration points and other system operating parameters required for measuring the SAR of a test device. The system verification must be performed for each frequency band and within the valid range of each probe calibration point required for testing the device.

The system verification results are required that the area scan estimated 1-g SAR is within 3% of the zoom scan 1-g SAR. The details are presented in annex B.

Table 8.1: System Verification of Head

Measurement Date (yyyy-mm-dd)	Frequency	Target value (W/kg)		Measured value(W/kg)		Deviation	
		10 g Average	1 g Average	10 g Average	1 g Average	10 g Average	1 g Average
2022/1/6	835 MHz	6.24	9.63	6.16	9.64	-1.28%	0.10%
2022/1/7	835 MHz	6.24	9.63	6.24	9.72	0.00%	0.93%
2022/1/8	1900 MHz	20.9	40.1	21	39.48	0.48%	-1.55%
2022/1/9	2450 MHz	24.9	53.3	24.68	54.08	-0.88%	1.46%
2022/1/10	2600 MHz	25.5	57.1	25.96	58.16	1.80%	1.86%
2022/1/11	2600 MHz	25.5	57.1	25.64	58	0.55%	1.58%
2022/2/10	835 MHz	6.25	9.60	6.24	9.72	-0.16%	1.25%
2022/2/10	1900 MHz	20.6	39.6	20.44	39.7	-0.78%	0.25%

9 Measurement Procedures

9.1 Tests to be performed

In order to determine the highest value of the peak spatial-average SAR of a handset, all device positions, configurations and operational modes shall be tested for each frequency band according to steps 1 to 3 below. A flowchart of the test process is shown in picture 9.1.

Step 1: The tests described in 9.2 shall be performed at the channel that is closest to the centre of the transmit frequency band (f_c) for:

- a) all device positions (cheek and tilt, for both left and right sides of the SAM phantom, as described in annex D),
- b) all configurations for each device position in a), e.g., antenna extended and retracted, and
- c) all operational modes, e.g., analogue and digital, for each device position in a) and configuration in b) in each frequency band.

If more than three frequencies need to be tested according to 11.1 (i.e., $N_c > 3$), then all frequencies, configurations and modes shall be tested for all of the above test conditions.

Step 2: For the condition providing highest peak spatial-average SAR determined in Step 1, perform all tests described in 9.2 at all other test frequencies, i.e., lowest and highest frequencies. In addition, for all other conditions (device position, configuration and operational mode) where the peak spatial-average SAR value determined in Step 1 is within 3 dB of the applicable SAR limit, it is recommended that all other test frequencies shall be tested as well.

Step 3: Examine all data to determine the highest value of the peak spatial-average SAR found in Steps 1 to 2.

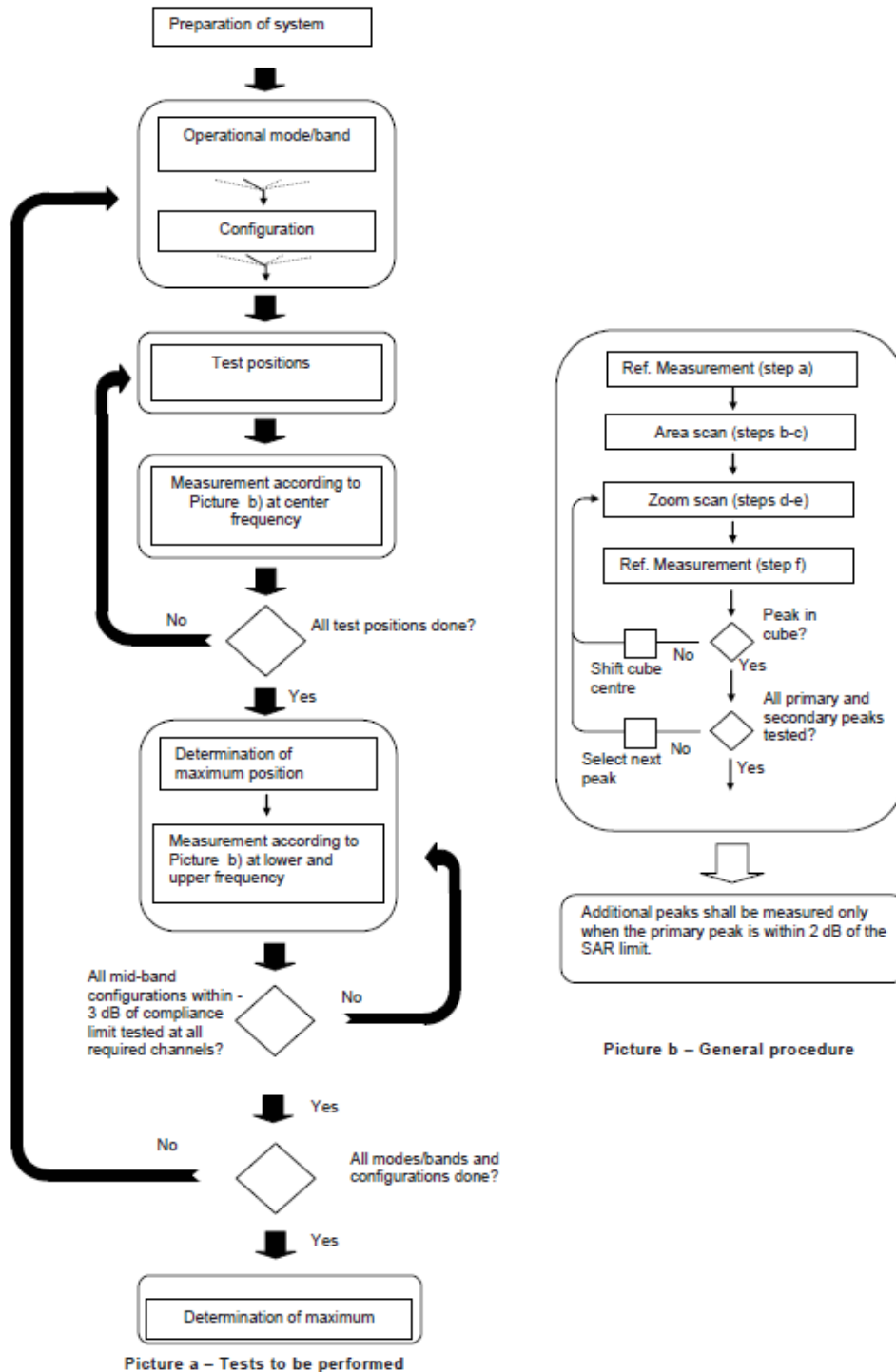

Picture a – Tests to be performed

Picture b – General procedure

Picture 9.1Block diagram of the tests to be performed

9.2 General Measurement Procedure

The area and zoom scan resolutions specified in the table below must be applied to the SAR measurements and fully documented in SAR reports to qualify for TCB approval. Probe boundary effect error compensation is required for measurements with the probe tip closer than half a probe tip diameter to the phantom surface. Both the probe tip diameter and sensor offset distance must satisfy measurement protocols; to ensure probe boundary effect errors are minimized and the

higher fields closest to the phantom surface can be correctly measured and extrapolated to the phantom surface for computing 1-g SAR. Tolerances of the post-processing algorithms must be verified by the test laboratory for the scan resolutions used in the SAR measurements, according to the reference distribution functions specified in IEEE Std 1528-2013. The results should be documented as part of the system validation records and may be requested to support test results when all the measurement parameters in the following table are not satisfied.

		≤ 3 GHz	> 3 GHz
Maximum distance from closest measurement point (geometric center of probe sensors) to phantom surface		5 ± 1 mm	$\frac{1}{2} \cdot \delta \cdot \ln(2) \pm 0.5$ mm
Maximum probe angle from probe axis to phantom surface normal at the measurement location		$30^\circ \pm 1^\circ$	$20^\circ \pm 1^\circ$
Maximum area scan spatial resolution: Δx_{Area} , Δy_{Area}		≤ 2 GHz: ≤ 15 mm 2 – 3 GHz: ≤ 12 mm	3 – 4 GHz: ≤ 12 mm 4 – 6 GHz: ≤ 10 mm
		When the x or y dimension of the test device, in the measurement plane orientation, is smaller than the above, the measurement resolution must be \leq the corresponding x or y dimension of the test device with at least one measurement point on the test device.	
Maximum zoom scan spatial resolution: Δx_{Zoom} , Δy_{Zoom}		≤ 2 GHz: ≤ 8 mm 2 – 3 GHz: ≤ 5 mm*	3 – 4 GHz: ≤ 5 mm* 4 – 6 GHz: ≤ 4 mm*
Maximum zoom scan spatial resolution, normal to phantom surface	uniform grid: $\Delta z_{Zoom}(n)$	≤ 5 mm	3 – 4 GHz: ≤ 4 mm 4 – 5 GHz: ≤ 3 mm 5 – 6 GHz: ≤ 2 mm
	graded grid	$\Delta z_{Zoom}(1)$: between 1 st two points closest to phantom surface	≤ 4 mm
		$\Delta z_{Zoom}(n>1)$: between subsequent points	$\leq 1.5 \cdot \Delta z_{Zoom}(n-1)$
Minimum zoom scan volume	x, y, z	≥ 30 mm	3 – 4 GHz: ≥ 28 mm 4 – 5 GHz: ≥ 25 mm 5 – 6 GHz: ≥ 22 mm
Note: δ is the penetration depth of a plane-wave at normal incidence to the tissue medium; see draft standard IEEE P1528-2011 for details. * When zoom scan is required and the <i>reported</i> SAR from the area scan based 1-g SAR estimation procedures of KDB 447498 is ≤ 1.4 W/kg, ≤ 8 mm, ≤ 7 mm and ≤ 5 mm zoom scan resolution may be applied, respectively, for 2 GHz to 3 GHz, 3 GHz to 4 GHz and 4 GHz to 6 GHz.			

9.3 WCDMA Measurement Procedures for SAR

The following procedures are applicable to WCDMA handsets operating under 3GPP Release99, Release 5 and Release 6. The default test configuration is to measure SAR with an established radio link between the DUT and a communication test set using a 12.2kbps RMC (reference measurement channel) configured in Test Loop Mode 1. SAR is selectively confirmed for other physical channel configurations (DPCCH & DPDCH_n), HSDPA and HSPA (HSUPA/HSDPA) modes according to output power, exposure conditions and device operating capabilities. Both uplink and downlink should be configured with the same RMC or AMR, when required. SAR for Release 5 HSDPA and Release 6 HSPA are measured using the applicable FRC (fixed reference channel) and E-DCH reference channel configurations. Maximum output power is verified according to applicable versions of 3GPP TS 34.121 and SAR must be measured according to these maximum output conditions. When Maximum Power Reduction (MPR) is not implemented according to Cubic Metric (CM) requirements for Release 6 HSPA, the following procedures do not apply.

For Release 5 HSDPA Data Devices:

Sub-test	β_c	β_d	β_d (SF)	β_c / β_d	β_{hs}	CM/dB
1	2/15	15/15	64	2/15	4/15	0.0
2	12/15	15/15	64	12/15	24/25	1.0
3	15/15	8/15	64	15/8	30/15	1.5
4	15/15	4/15	64	15/4	30/15	1.5

For Release 6 HSPA Data Devices

Sub-test	β_c	β_d	β_d (SF)	β_c / β_d	β_{hs}	β_{ec}	β_{ed}	β_{ed} (SF)	β_{ed} (codes)	CM (dB)	MPR (dB)	AG Index	E-TFCI
1	11/15	15/15	64	11/15	22/15	209/225	1039/225	4	1	1.5	1.5	20	75
2	6/15	15/15	64	6/15	12/15	12/15	12/15	4	1	1.5	1.5	12	67
3	15/15	9/15	64	15/9	30/15	30/15	$\beta_{ed1}:47/15$ $\beta_{ed2}:47/15$	4	2	1.5	1.5	15	92
4	2/15	15/15	64	2/15	4/15	4/15	56/75	4	1	1.5	1.5	17	71
5	15/15	15/15	64	15/15	24/15	30/15	134/15	4	1	1.5	1.5	21	81

Rel.8 DC-HSDPA (Cat 24)

SAR test exclusion for Rel.8 DC-HSDPA must satisfy the SAR test exclusion requirements of Rel.5 HSDPA. SAR test exclusion for DC-HSDPA devices is determined by power measurements according to the H-Set 12, Fixed Reference Channel (FRC) configuration in Table C.8.1.12 of 3GPP TS 34.121-1. A primary and a secondary serving HS-DSCH Cell are required to perform the power measurement and for the results to qualify for SAR test exclusion.

9.4 SAR Measurement for LTE

SAR tests for LTE are performed with a base station simulator, Rohde & Schwarz CMW500. Closed loop power control was used so the UE transmits with maximum output power during SAR testing. All powers were measured with the CMW 500.

It is performed for conducted power and SAR based on the KDB941225 D05.

SAR is evaluated separately according to the following procedures for the different test positions in each exposure condition – head, body, body-worn accessories and other use conditions. The procedures in the following subsections are applied separately to test each LTE frequency band.

1) QPSK with 1 RB allocation

Start with the largest channel bandwidth and measure SAR for QPSK with 1 RB allocation, using the RB offset and required test channel combination with the highest maximum output power among RB offsets at the upper edge, middle and lower edge of each required test channel. When the reported SAR is ≤ 0.8 W/kg, testing of the remaining RB offset configurations and required test channels is not required for 1 RB allocation; otherwise, SAR is required for the remaining required test channels and only for the RB offset configuration with the highest output power for that channel. When the reported SAR of a required test channel is > 1.45 W/kg, SAR is required for all three RB offset configurations for that required test channel.

2) QPSK with 50% RB allocation

The procedures required for 1 RB allocation in 1) are applied to measure the SAR for QPSK with 50% RB allocation.

3) QPSK with 100% RB allocation

For QPSK with 100% RB allocation, SAR is not required when the highest maximum output power for 100 % RB allocation is less than the highest maximum output power in 50% and 1 RB allocations and the highest reported SAR for 1 RB and 50% RB allocation in 1) and 2) are ≤ 0.8 W/kg. Otherwise, SAR is measured for the highest output power channel; and if the reported SAR is > 1.45 W/kg, the remaining required test channels must also be tested.

TDD test:

TDD testing is performed using guidance from FCC KDB 941225 D05 v02r05 and the SAR test guidance provided in April 2013 TCB works hop notes. TDD is tested at the highest duty factor using UL-DL configuration 0 with special subframe configuration 6 and applying the FDD LTE procedures in KDB 941225 D05 v02r05. SAR testing is performed using the extended cyclic prefix listed in 3GPP TS 36.211.

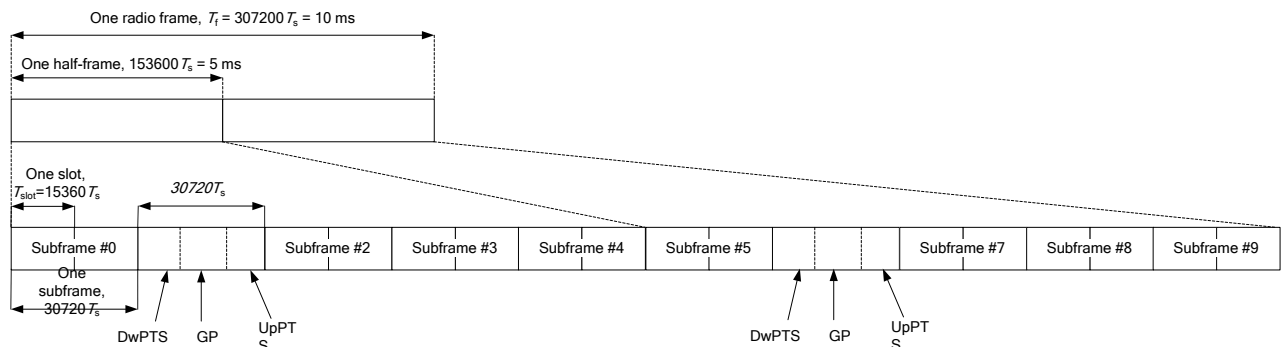

Figure 9.2: Frame structure type 2 (for 5 ms switch-point periodicity)

Table 9.1: Configuration of special subframe (lengths of DwPTS/GP/UpPTS)

Special subframe configuration	Normal cyclic prefix in downlink			Extended cyclic prefix in downlink		
	DwPTS	UpPTS		DwPTS	UpPTS	
		Normal cyclic prefix in uplink	Extended cyclic prefix in uplink		Normal cyclic prefix in uplink	Extended cyclic prefix in uplink
0	$6592 \cdot T_s$	$2192 \cdot T_s$	$2560 \cdot T_s$	$7680 \cdot T_s$	$2192 \cdot T_s$	$2560 \cdot T_s$
1	$19760 \cdot T_s$			$20480 \cdot T_s$		
2	$21952 \cdot T_s$			$23040 \cdot T_s$		
3	$24144 \cdot T_s$			$25600 \cdot T_s$		
4	$26336 \cdot T_s$			$7680 \cdot T_s$		
5	$6592 \cdot T_s$	$4384 \cdot T_s$	$5120 \cdot T_s$	$20480 \cdot T_s$	$4384 \cdot T_s$	$5120 \cdot T_s$
6	$19760 \cdot T_s$			$23040 \cdot T_s$		
7	$21952 \cdot T_s$			$12800 \cdot T_s$		
8	$24144 \cdot T_s$			-		
9	$13168 \cdot T_s$			-		

Table 9.2: Uplink-downlink configurations

Uplink-downlink configuration	Downlink-to-Uplink Switch-point periodicity	Subframe number									
		0	1	2	3	4	5	6	7	8	9
0	5 ms	D	S	U	U	U	D	S	U	U	U
1	5 ms	D	S	U	U	D	D	S	U	U	D
2	5 ms	D	S	U	D	D	D	S	U	D	D
3	10 ms	D	S	U	U	U	D	D	D	D	D
4	10 ms	D	S	U	U	D	D	D	D	D	D
5	10 ms	D	S	U	D	D	D	D	D	D	D
6	5 ms	D	S	U	U	U	D	S	U	U	D

Duty factor is calculated by:

Duty factor = uplink frame*6+UpPTS*2/one frame length

$$= (30720 \cdot T_s * 6 + 5120 \cdot T_s * 2) / 307200 \cdot T_s$$

$$= 0.633$$

According to the KDB 447498 D01, SAR should be evaluated at more than 3 frequencies for devices supporting transmit bands wider than 100MHz. Oct.2014 FCC-TCB conference notes (Dec. 2014 rev.) specifies the 5 test channels to use for 3GPP band 41 SAR evaluation.

9.5 Bluetooth & Wi-Fi Measurement Procedures for SAR

Normal network operating configurations are not suitable for measuring the SAR of 802.11 transmitters in general. Unpredictable fluctuations in network traffic and antenna diversity conditions can introduce undesirable variations in SAR results. The SAR for these devices should be measured using chipset based test mode software to ensure that the results are consistent and reliable.

Chipset based test mode software is hardware dependent and generally varies among manufacturers. The device operating parameters established in a test mode for SAR measurements must be identical to those programmed in production units, including output power levels, amplifier gain settings and other RF performance tuning parameters. The test frequencies should correspond to actual channel frequencies defined for domestic use. SAR for devices with switched diversity should be measured with only one antenna transmitting at a time during each SAR measurement, according to a fixed modulation and data rate. The same data pattern should be used for all measurements.

9.6 Power Drift

To control the output power stability during the SAR test, DASY5 system calculates the power drift by measuring the E-field at the same location at the beginning and at the end of the measurement for each test position. These drift values can be found in section 14 labeled as: (Power Drift [dB]). This ensures that the power drift during one measurement is within 5%.

10 Area Scan Based 1-g SAR

10.1 Requirement of KDB

According to the KDB447498 D01 v06, when the implementation is based the specific polynomial fit algorithm as presented at the 29th Bioelectromagnetics Society meeting (2007) and the estimated 1-gSAR is ≤ 1.2 W/kg, a zoom scan measurement is not required provided it is also not needed for any other purpose; for example, if the peak SAR location required for simultaneous transmission SAR test exclusion can be determined accurately by the SAR system or manually to discriminate between distinctive peaks and scattered noisy SAR distributions from area scans.

There must not be any warning or alert messages due to various measurement concerns identified by the SAR system; for example, noise in measurements, peaks too close to scan boundary, peaks are too sharp, spatial resolution and uncertainty issues etc. The SAR system verification must also demonstrate that the area scan estimated 1-g SAR is within 3% of the zoom scan 1-g SAR (See Annex B). When all the SAR results for each exposure condition in a frequency band and wireless mode are based on estimated 1-g SAR, the 1-g SAR for the highest SAR configuration must be determined by a zoom scan.

10.2 Fast SAR Algorithms

The approach is based on the area scan measurement applying a frequency dependent attenuation parameter. This attenuation parameter was empirically determined by analyzing a large number of phones. The MOTOROLA FAST SAR was developed and validated by the MOTOROLA Research Group in Ft. Lauderdale.

In the initial study, an approximation algorithm based on Linear fit was developed. The accuracy of the algorithm has been demonstrated across a broad frequency range (136-2450 MHz) and for both 1- and 10-g averaged SAR using a sample of 264 SAR measurements from 55 wireless handsets. For the sample size studied, the root-mean-squared errors of the algorithm are 1.2% and 5.8% for 1- and 10-g averaged SAR, respectively. The paper describing the algorithm in detail is expected to be published in August 2004 within the Special Issue of Transactions on MTT.

In the second step, the same research group optimized the fitting algorithm to an Polynomial fit whereby the frequency validity was extended to cover the range 30-6000MHz. Details of this study can be found in the BEMS 2007 Proceedings.

Both algorithms are implemented in DASY software.

11 Conducted Output Power

Table1: Summary of Receiver detection mechanism

Antenna	Receiver ON/Hotspot OFF (Head scenario)	Receiver OFF +Hotspot OFF (Body scenario)	Receiver OFF +Hotspot ON (Body scenario)
Standalone	DSI0	DSI1	DSI2

11.1 GSM Measurement result

Table 11.1-1: The conducted power measurement results for GSM, GPRS and EGPRS-
DSI0/1/2

GSM 850 Speech (GMSK)	Measured Power (dBm)			Tune up	calculation	Averaged Power (dBm)		
	251	190	128			251	190	128
1 Txslot	31.73	31.71	31.69	33	/	/	/	/
GSM 850 GPRS (GMSK)	Measured Power (dBm)				calculation	Averaged Power (dBm)		
	251	190	128			251	190	128
1 Txslot	31.77	31.74	31.68	33	-9.03	22.74	22.71	22.65
2 Txslots	29.60	29.59	29.54	30.5	-6.02	23.58	23.57	23.52
3Txslots	27.48	27.55	27.62	28.5	-4.26	23.22	23.29	23.36
4 Txslots	26.30	26.38	26.46	27.5	-3.01	23.29	23.37	23.45
GSM 850 EGPRS (GMSK)	Measured Power (dBm)				calculation	Averaged Power (dBm)		
	251	190	128			251	190	128
1 Txslot	31.74	31.71	31.67	33	-9.03	22.71	22.68	22.64
2 Txslots	29.58	29.57	29.54	30.5	-6.02	23.56	23.55	23.52
3Txslots	27.46	27.53	27.61	28.5	-4.26	23.20	23.27	23.35
4 Txslots	26.29	26.36	26.45	27.5	-3.01	23.28	23.35	23.44
GSM 850 EGPRS (8PSK)	Measured Power (dBm)				calculation	Averaged Power (dBm)		
	251	190	128			251	190	128
1 Txslot	25.76	25.51	25.64	26.5	-9.03	16.73	16.48	16.61
2 Txslots	22.64	22.58	23.47	23.5	-6.02	16.62	16.56	17.45
3Txslots	20.60	21.69	20.88	22	-4.26	16.34	17.43	16.62
4 Txslots	19.41	19.68	19.61	20.5	-3.01	16.40	16.67	16.60

NOTES:

1) Division Factors

To average the power, the division factor is as follows:

1TX-slot = 1 transmit time slot out of 8 time slots=> conducted power divided by (8/1) => -9.03dB

2TX-slots = 2 transmit time slots out of 8 time slots=> conducted power divided by (8/2) => -6.02dB

3TX-slots = 3 transmit time slots out of 8 time slots=> conducted power divided by (8/3) => -4.26dB

4TX-slots = 4 transmit time slots out of 8 time slots=> conducted power divided by (8/4) => -3.01dB

According to the conducted power as above, the body measurements are performed with 2Txslots for GSM850

Table 11.1-2: The conducted power measurement results for GSM, GPRS and EGPRS
DSI0/1/2

PCS1900 Speech (GMSK)	Measured Power (dBm)			Tune up	calculation	Averaged Power (dBm)		
	810	661	512			810	661	512
1 Txslot	29.07	29.40	29.41	30.3	/	/	/	/
PCS1900 GPRS (GMSK)	Measured Power (dBm)				calculation	Averaged Power (dBm)		
	810	661	512			810	661	512
1 Txslot	29.29	29.57	29.56	30.3	-9.03	20.26	20.54	20.53
2 Txslots	27.03	27.41	27.46	28	-6.02	21.01	21.39	21.44
3Txslots	25.22	25.49	25.56	26	-4.26	20.96	21.23	21.30
4 Txslots	24.00	24.30	24.31	25	-3.01	20.99	21.29	21.30
PCS1900 EGPRS (GMSK)	Measured Power (dBm)				calculation	Averaged Power (dBm)		
	810	661	512			810	661	512
1 Txslot	29.15	29.46	29.44	30.3	-9.03	20.12	20.43	20.41
2 Txslots	26.89	27.30	27.31	28	-6.02	20.87	21.28	21.29
3Txslots	25.10	25.38	25.43	26	-4.26	20.84	21.12	21.17
4 Txslots	23.60	24.20	24.20	25	-3.01	20.59	21.19	21.19
PCS1900 EGPRS (8PSK)	Measured Power (dBm)				calculation	Averaged Power (dBm)		
	810	661	512			810	661	512
1 Txslot	24.67	25.13	25.24	26	-9.03	15.64	16.10	16.21
2 Txslots	22.16	22.72	22.73	23.5	-6.02	16.14	16.70	16.71
3Txslots	19.97	20.42	20.50	21	-4.26	15.71	16.16	16.24
4 Txslots	18.68	19.15	19.29	20	-3.01	15.67	16.14	16.28

NOTES:

1) Division Factors

To average the power, the division factor is as follows:

1TX-slot = 1 transmit time slot out of 8 time slots=> conducted power divided by (8/1) => -9.03dB

2TX-slots = 2 transmit time slots out of 8 time slots=> conducted power divided by (8/2) => -6.02dB

3TX-slots = 3 transmit time slots out of 8 time slots=> conducted power divided by (8/3) => -4.26dB

4TX-slots = 4 transmit time slots out of 8 time slots=> conducted power divided by (8/4) => -3.01dB

According to the conducted power as above, the body measurements are performed with 2Txslots for GSM1900.

11.2 WCDMA Measurement result
Table 11.2-1: The conducted Power for WCDMA DSI0/1/2

Item	band	FDDV result			
	ARFCN	4233 (846.6MHz)	4182 (836.4MHz)	4132 (826.4MHz)	Tune up
WCDMA	\	22.87	22.75	22.90	24
HSUPA	1	20.2	20.25	20.32	21
	2	20.03	20.05	20.01	21
	3	20.78	20.81	20.85	22
	4	19.36	19.35	19.43	20
	5	20.77	20.80	20.83	22
HSPA+		21.29	21.34	21.44	22
DC-HSDPA	1	21.75	21.78	21.81	23
	2	21.76	21.79	21.80	23
	3	21.25	21.28	21.30	23
	4	21.26	21.28	21.29	23

Table 11.2-3: The conducted Power for WCDMA DSI0

Item	band	FDDII result			
	ARFCN	9538 (1907.6MHz)	9400 (1880MHz)	9262 (1852.4MHz)	
WCDMA	\	22.69	22.68	22.76	24
HSUPA	1	19.67	20.08	20.12	22
	2	20.05	20.02	20.07	22
	3	20.64	20.69	20.73	22
	4	20.01	20.01	20.02	22
	5	20.64	20.68	20.72	21
HSPA+		21.27	21.35	21.41	23
DC-HSDPA	1	21.65	21.68	21.75	22
	2	21.66	21.69	21.73	22
	3	21.15	21.20	21.22	22
	4	21.16	21.19	21.21	22

Table 11.2-4: The conducted Power for WCDMA DSI1

Item	band	FDDII result			
	ARFCN	9538 (1907.6MHz)	9400 (1880MHz)	9262 (1852.4MHz)	
WCDMA	\	20.14	20.18	20.28	21
HSUPA	1	17.39	17.49	17.55	18.5
	2	17.01	17.16	17.17	18.5
	3	18.01	18.05	18.14	19
	4	16.51	16.56	16.64	18
	5	18.01	18.05	18.15	19
HSPA+		18.53	18.56	18.62	20
	1	19.05	19.08	19.15	20

DC-HSDPA	2	19.04	19.07	19.16	20
	3	18.55	18.58	18.68	20
	4	18.54	18.57	18.67	20

Table 11.2-5: The conducted Power for WCDMA DSII2

Item	band	FDDII result			
	ARFCN	9538 (1907.6MHz)	9400 (1880MHz)	9262 (1852.4MHz)	
WCDMA	\	18.08	18.25	18.18	19
HSUPA	1	16.41	16.50	16.59	17
	2	16	16.09	16.18	17
	3	17.03	17.14	17.23	18
	4	15.53	15.64	15.72	16.5
	5	17	17.12	17.20	18
HSPA+		17.51	17.72	17.78	19
DC-HSDPA	1	18.06	18.15	18.16	20
	2	18.05	18.12	18.17	20
	3	17.56	17.60	17.65	18.5
	4	17.57	17.62	17.67	18.5

11.3 LTE Measurement result

Table 11.3-1: Maximum Power Reduction (MPR) for LTE-Normal Power

Modulation	Channel bandwidth / Transmission bandwidth configuration [RB]						MPR (dB)
	1.4	3	5	10	15	20	
	MHz	MHz	MHz	MHz	MHz	MHz	
QPSK	> 5	> 4	> 8	> 12	> 16	> 18	1
16 QAM	≤ 5	≤ 4	≤ 8	≤ 12	≤ 16	≤ 18	1
16 QAM	> 5	> 4	> 8	> 12	> 16	> 18	2

Table 11.3-2: Maximum Power Reduction (MPR) for LTE- Low Power

Modulation	Channel bandwidth / Transmission bandwidth configuration [RB]						MPR (dB)
	1.4	3	5	10	15	20	
	MHz	MHz	MHz	MHz	MHz	MHz	
QPSK	> 5	> 4	> 8	> 12	> 16	> 18	0
16 QAM	≤ 5	≤ 4	≤ 8	≤ 12	≤ 16	≤ 18	0
16 QAM	> 5	> 4	> 8	> 12	> 16	> 18	0

Table 11.3-3: The tune up for LTE

Mode/Band	DSI0	DSI1	DSI2
FDD Band 5	24	24	24
FDD Band 7	24	18	17.5
FDD Band 41	24	20.5	20

Band 5 DSI0/1/2

Bandwidth (MHz)	RB allocation	Frequency (MHz)	QPSK	16QAM
	RB offset (Start RB)		Actual output power (dBm)	Actual output power (dBm)
1.4 MHz	1RB High (5)	848.3	23.00	21.83
		836.5	22.82	22.05
		824.7	22.69	22.23
	1RB Middle (3)	848.3	23.17	21.96
		836.5	22.86	21.83
		824.7	22.74	22.28
	1RB Low (0)	848.3	22.99	21.82
		836.5	22.60	21.90
		824.7	22.65	22.07
	3RB High (3)	848.3	23.10	21.70
		836.5	22.67	21.75
		824.7	22.66	21.75
	3RB Middle (1)	848.3	23.21	21.75
		836.5	22.79	21.98
		824.7	22.72	21.73
	3RB Low (0)	848.3	22.97	21.71
		836.5	22.63	21.69

	6RB (0)	824.7	22.66	21.73	
		848.3	22.06	20.89	
		836.5	21.81	21.20	
		824.7	21.66	21.02	
3 MHz	1RB High (14)	847.5	23.06	22.07	
		836.5	23.07	22.37	
		825.5	22.83	22.35	
	1RB Middle (7)	847.5	23.20	22.03	
		836.5	23.12	22.34	
		825.5	22.87	22.38	
	1RB Low (0)	847.5	23.08	21.96	
		836.5	22.92	21.98	
		825.5	22.67	22.25	
	8RB High (7)	847.5	22.16	20.71	
		836.5	22.06	21.19	
		825.5	21.88	21.06	
	8RB Middle (4)	847.5	22.21	21.01	
		836.5	22.04	21.18	
		825.5	21.82	21.13	
	8RB Low (0)	847.5	22.10	21.03	
		836.5	22.08	21.14	
		825.5	21.71	21.12	
	15RB (0)	847.5	22.15	21.13	
		836.5	22.10	21.15	
		825.5	21.80	21.12	
	5 MHz	1RB High (24)	846.5	22.61	21.90
			836.5	22.54	22.25
			826.5	22.59	22.18
1RB Middle (12)		846.5	22.79	22.16	
		836.5	22.84	22.38	
		826.5	22.78	22.62	
1RB Low (0)		846.5	22.62	21.79	
		836.5	22.51	21.90	
		826.5	22.50	21.99	
12RB High (13)		846.5	21.75	20.90	
		836.5	21.62	21.09	
		826.5	21.67	20.99	
12RB Middle (6)		846.5	21.76	21.14	
		836.5	21.75	21.12	
		826.5	21.75	21.07	
12RB Low (0)		846.5	21.84	21.06	
		836.5	21.78	21.11	
		826.5	21.63	21.08	
25RB (0)		846.5	21.70	21.15	
		836.5	21.81	21.15	
		826.5	21.82	21.04	
10 MHz		1RB High (49)	844.0	22.97	22.18
			836.5	22.92	22.19
			829.0	22.95	22.27
	1RB	844.0	23.09	22.35	

	Middle (24)	836.5	23.06	22.26
		829.0	23.10	22.35
		844.0	22.96	22.20
	1RB Low (0)	836.5	23.02	22.28
		829.0	22.98	22.23
		844.0	22.03	21.06
	25RB High (25)	836.5	22.11	21.07
		829.0	22.10	21.08
		844.0	22.10	21.12
	25RB Middle (12)	836.5	22.07	21.07
		829.0	22.08	21.09
		844.0	22.10	21.11
	25RB Low (0)	836.5	22.05	21.05
		829.0	22.06	21.07
		844.0	22.07	21.08
50RB (0)	836.5	22.06	21.04	
	829.0	22.04	21.07	

Band7 DS10

BANDWIDTH	Number of RBs	Frequency	QPSK	16QAM
5MHz	1RB-High (24)	2567.5 (21425)	23.12	21.93
		2535 (21100)	23.02	22.51
		2502.5 (20775)	23.09	22.46
	1RB-Middle (12)	2567.5 (21425)	23.34	22.30
		2535 (21100)	23.33	22.77
		2502.5 (20775)	23.32	22.74
	1RB-Low (0)	2567.5 (21425)	22.84	22.11
		2535 (21100)	23.03	22.49
		2502.5 (20775)	23.06	22.37
	12RB-High (13)	2567.5 (21425)	21.83	20.88
		2535 (21100)	22.20	21.32
		2502.5 (20775)	22.22	21.29
	12RB-Middle (6)	2567.5 (21425)	21.98	21.01
		2535 (21100)	22.23	21.34
		2502.5 (20775)	22.30	21.35
	12RB-Low (0)	2567.5 (21425)	21.86	20.93
		2535 (21100)	22.18	21.25
		2502.5 (20775)	22.27	21.32
	25RB (0)	2567.5 (21425)	21.85	20.93
		2535 (21100)	22.18	21.28
		2502.5 (20775)	22.23	21.31
	1RB-High (49)	2565 (21400)	23.24	22.08
		2535 (21100)	23.06	22.37
		2505 (20800)	23.16	22.63

10MHz	1RB-Middle (24)	2565 (21400)	23.38	22.31	
		2535 (21100)	23.21	22.56	
		2505 (20800)	23.24	22.66	
	1RB-Low (0)	2565 (21400)	22.93	22.37	
		2535 (21100)	23.14	22.61	
		2505 (20800)	23.15	22.60	
	25RB-High (25)	2565 (21400)	21.97	20.98	
		2535 (21100)	22.21	21.33	
		2505 (20800)	22.28	21.37	
	25RB-Middle (12)	2565 (21400)	21.91	20.98	
		2535 (21100)	22.19	21.31	
		2505 (20800)	22.27	21.35	
	25RB-Low (0)	2565 (21400)	21.97	21.00	
		2535 (21100)	22.20	21.30	
		2505 (20800)	22.32	21.39	
	50RB (0)	2565 (21400)	21.94	20.99	
		2535 (21100)	22.20	21.27	
		2505 (20800)	22.31	21.36	
15MHz	1RB-High (74)	2562.5 (21375)	22.67	21.98	
		2535 (21100)	22.97	22.34	
		2507.5 (20825)	23.10	22.47	
	1RB-Middle (37)	2562.5 (21375)	22.85	22.24	
		2535 (21100)	23.13	22.59	
		2507.5 (20825)	23.20	22.70	
	1RB-Low (0)	2562.5 (21375)	22.93	22.38	
		2535 (21100)	23.06	22.51	
		2507.5 (20825)	23.08	22.45	
	36RB-High (38)	2562.5 (21375)	21.93	20.97	
		2535 (21100)	22.18	21.24	
		2507.5 (20825)	22.29	21.34	
	36RB-Middle (19)	2562.5 (21375)	21.94	20.99	
		2535 (21100)	22.16	21.23	
		2507.5 (20825)	22.26	21.31	
	36RB-Low (0)	2562.5 (21375)	21.98	21.04	
		2535 (21100)	22.18	21.27	
		2507.5 (20825)	22.30	21.35	
	75RB (0)	2562.5 (21375)	21.94	21.03	
		2535 (21100)	22.15	21.22	
		2507.5 (20825)	22.27	21.34	
		1RB-High (99)	2560 (21350)	22.80	22.17
			2535 (21100)	22.93	22.39
			2510 (20850)	22.99	22.50
		2560 (21350)	23.15	22.67	

20MHz	1RB-Middle (50)	2535 (21100)	23.26	22.68
		2510 (20850)	23.32	22.89
	1RB-Low (0)	2560 (21350)	22.95	22.34
		2535 (21100)	23.03	22.43
		2510 (20850)	23.00	22.33
	50RB-High (50)	2560 (21350)	22.21	21.26
		2535 (21100)	22.27	21.36
		2510 (20850)	22.31	21.37
	50RB-Middle (25)	2560 (21350)	22.18	21.25
		2535 (21100)	22.27	21.34
		2510 (20850)	22.32	21.38
	50RB-Low (0)	2560 (21350)	22.23	21.31
		2535 (21100)	22.23	21.32
		2510 (20850)	22.33	21.40
	100RB (0)	2560 (21350)	22.24	21.31
2535 (21100)		22.27	21.36	
2510 (20850)		22.33	21.40	

Band7 DS11

BANDWIDTH	Number of RBs	Frequency	QPSK	16QAM
5MHz	1RB-High (24)	2567.5 (21425)	16.20	16.33
		2535 (21100)	16.47	16.64
		2502.5 (20775)	16.61	16.76
	1RB-Middle (12)	2567.5 (21425)	16.40	16.60
		2535 (21100)	16.73	16.76
		2502.5 (20775)	16.83	16.85
	1RB-Low (0)	2567.5 (21425)	16.18	16.24
		2535 (21100)	16.49	16.48
		2502.5 (20775)	16.61	16.64
	12RB-High (13)	2567.5 (21425)	16.28	15.99
		2535 (21100)	16.62	16.38
		2502.5 (20775)	16.72	16.46
	12RB-Middle (6)	2567.5 (21425)	16.37	16.13
		2535 (21100)	16.67	16.40
		2502.5 (20775)	16.78	16.54
	12RB-Low (0)	2567.5 (21425)	16.31	16.03
		2535 (21100)	16.59	16.31
		2502.5 (20775)	16.74	16.48
25RB (0)	2567.5 (21425)	16.31	16.07	
	2535 (21100)	16.63	16.38	
	2502.5 (20775)	16.75	16.52	

10MHz	1RB-High (49)	2565 (21400)	16.29	16.42	
		2535 (21100)	16.53	16.57	
		2505 (20800)	16.71	16.83	
	1RB-Middle (24)	2565 (21400)	16.41	16.54	
		2535 (21100)	16.68	16.68	
		2505 (20800)	16.84	16.82	
	1RB-Low (0)	2565 (21400)	16.41	16.56	
		2535 (21100)	16.58	16.69	
		2505 (20800)	16.69	16.75	
	25RB-High (25)	2565 (21400)	16.37	16.10	
		2535 (21100)	16.63	16.40	
		2505 (20800)	16.77	16.53	
	25RB-Middle (12)	2565 (21400)	16.34	16.12	
		2535 (21100)	16.63	16.39	
		2505 (20800)	16.77	16.51	
	25RB-Low (0)	2565 (21400)	16.39	16.12	
		2535 (21100)	16.65	16.38	
		2505 (20800)	16.83	16.56	
	50RB (0)	2565 (21400)	16.36	16.11	
		2535 (21100)	16.62	16.40	
		2505 (20800)	16.79	16.53	
	15MHz	1RB-High (74)	2562.5 (21375)	16.20	16.27
			2535 (21100)	16.47	16.56
			2507.5 (20825)	16.65	16.72
1RB-Middle (37)		2562.5 (21375)	16.35	16.46	
		2535 (21100)	16.59	16.69	
		2507.5 (20825)	16.72	16.79	
1RB-Low (0)		2562.5 (21375)	16.39	16.36	
		2535 (21100)	16.56	16.70	
		2507.5 (20825)	16.61	16.59	
36RB-High (38)		2562.5 (21375)	16.36	16.04	
		2535 (21100)	16.61	16.35	
		2507.5 (20825)	16.78	16.49	
36RB-Middle (19)		2562.5 (21375)	16.38	16.09	
		2535 (21100)	16.62	16.35	
		2507.5 (20825)	16.78	16.49	
36RB-Low (0)		2562.5 (21375)	16.43	16.15	
		2535 (21100)	16.64	16.35	
		2507.5 (20825)	16.80	16.49	
75RB (0)		2562.5 (21375)	16.36	16.10	
		2535 (21100)	16.60	16.34	
		2507.5 (20825)	16.80	16.52	
			2560 (21350)	16.09	16.17

20MHz	1RB-High (99)	2535 (21100)	16.28	16.23
		2510 (20850)	16.44	16.57
	1RB-Middle (50)	2560 (21350)	16.57	16.53
		2535 (21100)	16.72	16.81
		2510 (20850)	16.82	16.70
	1RB-Low (0)	2560 (21350)	16.26	16.33
		2535 (21100)	16.41	16.44
		2510 (20850)	16.45	16.57
	50RB-High (50)	2560 (21350)	16.46	16.23
		2535 (21100)	16.63	16.38
		2510 (20850)	16.83	16.55
	50RB-Middle (25)	2560 (21350)	16.48	16.20
		2535 (21100)	16.65	16.39
		2510 (20850)	16.79	16.52
	50RB-Low (0)	2560 (21350)	16.58	16.28
		2535 (21100)	16.62	16.37
		2510 (20850)	16.85	16.60
	100RB (0)	2560 (21350)	16.52	16.24
2535 (21100)		16.61	16.38	
2510 (20850)		16.84	16.56	

Band7 DS12

BANDWIDTH	Number of RBs	Frequency	QPSK	16QAM
5MHz	1RB-High (24)	2567.5 (21425)	16.17	16.58
		2535 (21100)	16.44	16.77
		2502.5 (20775)	16.61	16.85
	1RB-Middle (12)	2567.5 (21425)	16.47	16.69
		2535 (21100)	16.72	17.02
		2502.5 (20775)	16.81	17.22
	1RB-Low (0)	2567.5 (21425)	16.17	16.54
		2535 (21100)	16.45	16.83
		2502.5 (20775)	16.58	16.85
	12RB-High (13)	2567.5 (21425)	16.27	16.28
		2535 (21100)	16.64	16.61
		2502.5 (20775)	16.72	16.70
	12RB-Middle (6)	2567.5 (21425)	16.38	16.38
		2535 (21100)	16.66	16.67
		2502.5 (20775)	16.78	16.80
	12RB-Low (0)	2567.5 (21425)	16.29	16.29
		2535 (21100)	16.57	16.61
		2502.5 (20775)	16.73	16.71

	25RB (0)	2567.5 (21425)	16.30	16.30	
		2535 (21100)	16.60	16.64	
		2502.5 (20775)	16.74	16.76	
10MHz	1RB-High (49)	2565 (21400)	16.26	16.66	
		2535 (21100)	16.50	16.89	
		2505 (20800)	16.70	17.04	
	1RB-Middle (24)	2565 (21400)	16.38	16.74	
		2535 (21100)	16.66	17.09	
		2505 (20800)	16.77	17.01	
	1RB-Low (0)	2565 (21400)	16.37	16.67	
		2535 (21100)	16.65	16.88	
		2505 (20800)	16.70	17.07	
	25RB-High (25)	2565 (21400)	16.34	16.34	
		2535 (21100)	16.60	16.65	
		2505 (20800)	16.75	16.78	
	25RB-Middle (12)	2565 (21400)	16.34	16.36	
		2535 (21100)	16.63	16.65	
		2505 (20800)	16.77	16.78	
	25RB-Low (0)	2565 (21400)	16.34	16.38	
		2535 (21100)	16.64	16.66	
		2505 (20800)	16.79	16.81	
	50RB (0)	2565 (21400)	16.35	16.35	
		2535 (21100)	16.61	16.60	
		2505 (20800)	16.80	16.80	
	15MHz	1RB-High (74)	2562.5 (21375)	16.18	16.58
			2535 (21100)	16.41	16.78
			2507.5 (20825)	16.61	17.00
1RB-Middle (37)		2562.5 (21375)	16.31	16.62	
		2535 (21100)	16.59	16.89	
		2507.5 (20825)	16.68	17.02	
1RB-Low (0)		2562.5 (21375)	16.37	16.75	
		2535 (21100)	16.54	16.82	
		2507.5 (20825)	16.61	16.86	
36RB-High (38)		2562.5 (21375)	16.30	16.29	
		2535 (21100)	16.59	16.57	
		2507.5 (20825)	16.79	16.72	
36RB-Middle (19)		2562.5 (21375)	16.37	16.33	
		2535 (21100)	16.63	16.58	
		2507.5 (20825)	16.77	16.34	
36RB-Low (0)		2562.5 (21375)	16.41	16.39	
		2535 (21100)	16.62	16.61	
		2507.5 (20825)	16.78	16.76	
		2562.5 (21375)	16.33	16.35	

	75RB (0)	2535 (21100)	16.57	16.59
		2507.5 (20825)	16.76	16.75
20MHz	1RB-High (99)	2560 (21350)	16.09	16.30
		2535 (21100)	16.22	16.43
		2510 (20850)	16.42	16.81
	1RB-Middle (50)	2560 (21350)	16.51	16.83
		2535 (21100)	16.70	17.05
		2510 (20850)	16.84	17.07
	1RB-Low (0)	2560 (21350)	16.23	16.53
		2535 (21100)	16.43	16.80
		2510 (20850)	16.48	16.77
	50RB-High (50)	2560 (21350)	16.43	16.45
		2535 (21100)	16.64	16.63
		2510 (20850)	16.81	16.82
	50RB-Middle (25)	2560 (21350)	16.46	16.47
		2535 (21100)	16.62	16.64
		2510 (20850)	16.80	16.78
	50RB-Low (0)	2560 (21350)	16.74	16.53
		2535 (21100)	16.64	16.63
		2510 (20850)	16.84	16.83
	100RB (0)	2560 (21350)	16.49	16.49
		2535 (21100)	16.61	16.62
		2510 (20850)	16.82	16.82

Band41 DS10

BANDWIDTH	Number of RBs	Frequency	QPSK	16QAM
5MHz	1RB-High (24)	2687.5 (41565)	23.52	22.62
		2640.3(41093)	23.11	22.21
		2593 (40620)	22.88	22.06
		2545.8(40148)	22.51	21.65
		2498.5 (39675)	22.78	21.91
	1RB-Middle (12)	2687.5 (41565)	23.70	22.79
		2640.3(41093)	23.30	22.47
		2593 (40620)	23.12	22.32
		2545.8(40148)	22.73	21.88
		2498.5 (39675)	22.98	22.16
	1RB-Low (0)	2687.5 (41565)	23.50	22.58
		2640.3(41093)	23.11	22.22
		2593 (40620)	22.90	22.06
		2545.8(40148)	22.59	21.73
		2498.5 (39675)	22.66	21.74

	12RB-High (13)	2687.5 (41565)	22.63	21.61
		2640.3(41093)	22.19	21.16
		2593 (40620)	22.01	20.98
		2545.8(40148)	21.59	20.51
		2498.5 (39675)	21.90	20.81
	12RB-Middle (6)	2687.5 (41565)	22.75	21.65
		2640.3(41093)	22.25	21.22
		2593 (40620)	22.03	20.99
		2545.8(40148)	21.68	20.62
		2498.5 (39675)	21.99	20.90
	12RB-Low (0)	2687.5 (41565)	22.72	21.63
		2640.3(41093)	22.21	21.17
		2593 (40620)	22.00	20.93
		2545.8(40148)	21.61	20.53
		2498.5 (39675)	21.90	20.82
	25RB (0)	2687.5 (41565)	22.64	21.68
		2640.3(41093)	22.23	21.23
		2593 (40620)	22.02	21.06
		2545.8(40148)	21.63	20.60
		2498.5 (39675)	21.91	20.90
10MHz	1RB-High (49)	2685 (41540)	23.60	22.68
		2639(41080)	23.17	22.25
		2593 (40620)	22.93	22.10
		2547(40160)	22.55	21.72
		2501 (39700)	22.85	21.97
	1RB-Middle (24)	2685 (41540)	23.69	22.77
		2639(41080)	23.30	22.41
		2593 (40620)	23.03	22.24
		2547(40160)	22.74	21.90
		2501 (39700)	22.91	22.01
	1RB-Low (0)	2685 (41540)	23.54	22.64
		2639(41080)	23.17	22.33
		2593 (40620)	22.94	22.10
		2547(40160)	22.66	21.80
		2501 (39700)	22.86	22.00
	25RB-High (25)	2685 (41540)	22.59	21.65
		2639(41080)	22.23	21.27
		2593 (40620)	22.05	21.07
		2547(40160)	21.60	20.58
		2501 (39700)	21.85	20.85
	25RB-Middle (12)	2685 (41540)	22.69	21.72
		2639(41080)	22.22	21.28
		2593 (40620)	22.04	21.07

		2547(40160)	21.69	20.67	
		2501 (39700)	21.96	20.96	
	25RB-Low (0)	2685 (41540)	22.69	21.76	
		2639(41080)	22.23	21.26	
		2593 (40620)	22.03	21.03	
		2547(40160)	21.66	20.70	
		2501 (39700)	21.96	20.96	
	50RB (0)	2685 (41540)	22.61	21.72	
		2639(41080)	22.20	21.30	
		2593 (40620)	22.02	21.09	
		2547(40160)	21.64	20.64	
		2501 (39700)	21.89	20.94	
	15MHz	1RB-High (74)	2682.5 (41515)	23.45	22.56
			2637.8(41068)	23.03	22.15
2593 (40620)			22.82	22.00	
2548.3(40173)			22.44	21.60	
2503.5 (39725)			22.70	21.87	
1RB-Middle (37)		2682.5 (41515)	23.54	22.64	
		2637.8(41068)	23.16	22.30	
		2593 (40620)	22.95	22.10	
		2548.3(40173)	22.62	21.76	
		2503.5 (39725)	22.83	22.01	
1RB-Low (0)		2682.5 (41515)	23.39	22.45	
		2637.8(41068)	23.08	22.23	
		2593 (40620)	22.84	22.01	
		2548.3(40173)	22.54	21.73	
		2503.5 (39725)	22.72	21.88	
36RB-High (38)		2682.5 (41515)	22.57	21.57	
		2637.8(41068)	22.20	21.18	
		2593 (40620)	22.01	20.96	
		2548.3(40173)	21.58	20.53	
		2503.5 (39725)	21.83	20.80	
36RB-Middle (19)		2682.5 (41515)	22.60	21.58	
		2637.8(41068)	22.21	21.19	
		2593 (40620)	22.02	20.97	
		2548.3(40173)	21.65	20.63	
		2503.5 (39725)	21.92	20.92	
36RB-Low (0)		2682.5 (41515)	22.59	21.57	
		2637.8(41068)	22.22	21.17	
		2593 (40620)	21.97	20.94	
		2548.3(40173)	21.66	20.61	
		2503.5 (39725)	21.96	20.91	
75RB (0)	2682.5 (41515)	22.57	21.63		

		2637.8(41068)	22.18	21.22
		2593 (40620)	22.03	21.05
		2548.3(40173)	21.62	20.59
		2503.5 (39725)	21.86	20.88
20MHz	1RB-High (99)	2680 (41490)	23.44	22.69
		2636.5(41055)	23.01	22.24
		2593 (40620)	22.85	22.16
		2549.5(40185)	22.48	21.78
		2506 (39750)	22.66	21.98
	1RB-Middle (50)	2680 (41490)	23.69	22.91
		2636.5(41055)	23.39	22.65
		2593 (40620)	23.19	22.50
		2549.5(40185)	22.77	22.07
		2506 (39750)	22.99	22.36
	1RB-Low (0)	2680 (41490)	23.37	22.56
		2636.5(41055)	23.07	22.36
		2593 (40620)	22.86	22.14
		2549.5(40185)	22.62	21.87
		2506 (39750)	22.76	22.03
	50RB-High (50)	2680 (41490)	22.63	21.72
		2636.5(41055)	22.35	21.44
		2593 (40620)	22.19	21.27
		2549.5(40185)	21.73	20.78
		2506 (39750)	21.99	21.06
	50RB-Middle (25)	2680 (41490)	22.75	21.84
		2636.5(41055)	22.39	21.48
		2593 (40620)	22.18	21.25
		2549.5(40185)	21.82	20.86
		2506 (39750)	22.10	21.15
	50RB-Low (0)	2680 (41490)	22.69	21.77
		2636.5(41055)	22.37	21.39
		2593 (40620)	22.10	21.20
		2549.5(40185)	21.84	20.88
		2506 (39750)	22.16	21.20
100RB (0)	2680 (41490)	22.70	21.77	
	2636.5(41055)	22.34	21.43	
	2593 (40620)	22.16	21.23	
	2549.5(40185)	21.77	20.79	
	2506 (39750)	22.06	21.08	

Band41 DS11

BANDWIDTH	Number of RBs	Frequency	QPSK	16QAM
-----------	---------------	-----------	------	-------

5MHz	1RB-High (24)	2687.5 (41565)	19.58	19.66
		2640.3(41093)	19.07	19.18
		2593 (40620)	18.89	19.00
		2545.8(40148)	18.53	18.61
		2498.5 (39675)	18.86	18.93
	1RB-Middle (12)	2687.5 (41565)	19.75	19.84
		2640.3(41093)	19.38	19.42
		2593 (40620)	19.17	19.18
		2545.8(40148)	18.76	18.82
		2498.5 (39675)	19.04	19.09
	1RB-Low (0)	2687.5 (41565)	19.51	19.64
		2640.3(41093)	19.12	19.20
		2593 (40620)	18.90	18.99
		2545.8(40148)	18.58	18.71
		2498.5 (39675)	18.86	18.93
	12RB-High (13)	2687.5 (41565)	19.60	19.59
		2640.3(41093)	19.16	19.13
		2593 (40620)	18.91	18.92
		2545.8(40148)	18.60	18.60
		2498.5 (39675)	18.94	18.87
	12RB-Middle (6)	2687.5 (41565)	19.68	19.64
		2640.3(41093)	19.25	19.19
		2593 (40620)	18.95	18.97
		2545.8(40148)	18.68	18.59
		2498.5 (39675)	18.98	18.90
12RB-Low (0)	2687.5 (41565)	19.64	19.64	
	2640.3(41093)	19.23	19.17	
	2593 (40620)	18.95	18.91	
	2545.8(40148)	18.63	18.57	
	2498.5 (39675)	18.91	18.89	
25RB (0)	2687.5 (41565)	19.60	19.67	
	2640.3(41093)	19.20	19.22	
	2593 (40620)	18.95	18.99	
	2545.8(40148)	18.61	18.62	
	2498.5 (39675)	18.92	18.89	
10MHz	1RB-High (49)	2685 (41540)	19.42	19.70
		2639(41080)	19.14	19.25
		2593 (40620)	18.95	19.07
		2547(40160)	18.58	18.66
		2501 (39700)	18.91	18.92
	1RB-Middle (24)	2685 (41540)	19.71	19.83
		2639(41080)	19.12	19.40
		2593 (40620)	18.97	19.17

		2547(40160)	18.75	18.81
		2501 (39700)	19.05	19.14
	1RB-Low (0)	2685 (41540)	19.56	19.66
		2639(41080)	19.17	19.28
		2593 (40620)	18.94	19.06
		2547(40160)	18.67	18.75
		2501 (39700)	18.92	18.99
	25RB-High (25)	2685 (41540)	19.57	19.64
		2639(41080)	19.17	19.19
		2593 (40620)	18.96	18.98
		2547(40160)	18.56	18.61
		2501 (39700)	18.86	18.81
	25RB-Middle (12)	2685 (41540)	19.67	19.70
		2639(41080)	19.27	19.25
		2593 (40620)	19.01	19.04
		2547(40160)	18.65	18.65
		2501 (39700)	18.90	18.91
	25RB-Low (0)	2685 (41540)	19.64	19.70
		2639(41080)	19.19	19.18
		2593 (40620)	18.98	18.95
		2547(40160)	18.69	18.63
		2501 (39700)	18.95	18.94
	50RB (0)	2685 (41540)	19.60	19.70
		2639(41080)	19.16	19.21
		2593 (40620)	18.94	18.97
2547(40160)		18.57	18.57	
2501 (39700)		18.84	18.87	
15MHz	1RB-High (74)	2682.5 (41515)	19.33	19.61
		2637.8(41068)	19.05	19.14
		2593 (40620)	18.86	18.96
		2548.3(40173)	18.49	18.59
		2503.5 (39725)	18.78	18.83
	1RB-Middle (37)	2682.5 (41515)	19.58	19.67
		2637.8(41068)	19.21	19.30
		2593 (40620)	18.92	19.08
		2548.3(40173)	18.63	18.72
		2503.5 (39725)	18.94	19.02
	1RB-Low (0)	2682.5 (41515)	19.40	19.39
		2637.8(41068)	19.11	19.20
		2593 (40620)	18.87	18.96
		2548.3(40173)	18.60	18.67
		2503.5 (39725)	18.85	18.90
	36RB-High (38)	2682.5 (41515)	19.54	19.56

		2637.8(41068)	19.18	19.13
		2593 (40620)	18.98	18.91
		2548.3(40173)	18.56	18.52
		2503.5 (39725)	18.88	18.81
	36RB-Middle (19)	2682.5 (41515)	19.59	19.56
		2637.8(41068)	19.20	19.16
		2593 (40620)	18.94	18.95
		2548.3(40173)	18.64	18.58
		2503.5 (39725)	18.97	18.90
	36RB-Low (0)	2682.5 (41515)	19.56	19.45
		2637.8(41068)	19.18	19.13
		2593 (40620)	18.96	18.89
		2548.3(40173)	18.68	18.62
		2503.5 (39725)	18.96	18.90
	75RB (0)	2682.5 (41515)	19.57	19.62
		2637.8(41068)	19.18	19.17
		2593 (40620)	18.95	18.94
		2548.3(40173)	18.56	18.56
		2503.5 (39725)	18.83	18.55
	20MHz	1RB-High (99)	2680 (41490)	19.58
2636.5(41055)			19.09	18.96
2593 (40620)			18.97	18.82
2549.5(40185)			18.55	18.39
2506 (39750)			18.80	18.65
1RB-Middle (50)		2680 (41490)	19.90	19.74
		2636.5(41055)	19.53	19.37
		2593 (40620)	19.33	19.19
		2549.5(40185)	18.95	18.75
		2506 (39750)	19.24	19.08
1RB-Low (0)		2680 (41490)	19.48	19.33
		2636.5(41055)	19.19	19.06
		2593 (40620)	18.93	18.80
		2549.5(40185)	18.70	18.51
		2506 (39750)	18.91	18.74
50RB-High (50)		2680 (41490)	19.72	19.55
		2636.5(41055)	19.39	19.19
		2593 (40620)	19.23	19.00
		2549.5(40185)	18.72	18.50
		2506 (39750)	19.02	18.79
50RB-Middle (25)		2680 (41490)	19.82	19.62
		2636.5(41055)	19.44	19.21
		2593 (40620)	19.22	18.99
		2549.5(40185)	18.86	18.59

	50RB-Low (0)	2506 (39750)	19.14	18.89
		2680 (41490)	19.83	19.58
		2636.5(41055)	19.41	19.18
		2593 (40620)	19.17	18.95
		2549.5(40185)	18.85	18.58
	100RB (0)	2506 (39750)	19.18	18.97
		2680 (41490)	19.87	19.66
		2636.5(41055)	19.46	19.26
		2593 (40620)	19.26	19.03
		2549.5(40185)	18.86	18.63
		2506 (39750)	19.20	18.93

Band41 DS12

BANDWIDTH	Number of RBs	Frequency	QPSK	16QAM
5MHz	1RB-High (24)	2687.5 (41565)	19.35	19.78
		2640.3(41093)	19.18	19.31
		2593 (40620)	19.03	19.14
		2545.8(40148)	18.66	18.74
		2498.5 (39675)	18.94	19.04
	1RB-Middle (12)	2687.5 (41565)	19.88	19.97
		2640.3(41093)	19.47	19.54
		2593 (40620)	19.28	19.30
		2545.8(40148)	18.87	18.92
		2498.5 (39675)	19.15	19.21
	1RB-Low (0)	2687.5 (41565)	19.62	19.77
		2640.3(41093)	19.22	19.34
		2593 (40620)	19.01	19.11
		2545.8(40148)	18.71	18.79
		2498.5 (39675)	18.98	19.04
	12RB-High (13)	2687.5 (41565)	19.69	19.72
		2640.3(41093)	19.28	19.24
		2593 (40620)	19.09	19.04
		2545.8(40148)	18.72	18.67
		2498.5 (39675)	19.01	18.93
	12RB-Middle (6)	2687.5 (41565)	19.79	19.76
		2640.3(41093)	19.36	19.30
		2593 (40620)	19.10	19.09
		2545.8(40148)	18.79	18.71
2498.5 (39675)		19.11	19.02	
12RB-Low (0)	2687.5 (41565)	19.78	19.74	
	2640.3(41093)	19.34	19.24	
	2593 (40620)	19.09	19.05	

		2545.8(40148)	18.76	18.64
		2498.5 (39675)	19.05	18.95
	25RB (0)	2687.5 (41565)	19.75	19.80
		2640.3(41093)	19.31	19.34
		2593 (40620)	19.11	19.14
		2545.8(40148)	18.74	18.73
		2498.5 (39675)	19.04	19.02
10MHz	1RB-High (49)	2685 (41540)	19.56	19.83
		2639(41080)	19.28	19.39
		2593 (40620)	19.07	19.19
		2547(40160)	18.73	18.77
		2501 (39700)	18.99	19.10
	1RB-Middle (24)	2685 (41540)	19.84	19.95
		2639(41080)	19.28	19.54
		2593 (40620)	19.04	19.32
		2547(40160)	18.89	18.94
		2501 (39700)	19.18	19.24
	1RB-Low (0)	2685 (41540)	19.68	19.78
		2639(41080)	19.30	19.41
		2593 (40620)	19.06	19.19
		2547(40160)	18.79	18.90
		2501 (39700)	19.04	19.12
	25RB-High (25)	2685 (41540)	19.68	19.73
		2639(41080)	19.34	19.33
		2593 (40620)	19.10	19.12
		2547(40160)	18.73	18.67
		2501 (39700)	18.95	18.93
	25RB-Middle (12)	2685 (41540)	19.76	19.82
		2639(41080)	19.40	19.39
		2593 (40620)	19.15	19.19
		2547(40160)	18.81	18.78
2501 (39700)		19.08	19.08	
25RB-Low (0)	2685 (41540)	19.77	19.85	
	2639(41080)	19.31	19.34	
	2593 (40620)	19.11	19.11	
	2547(40160)	18.79	18.75	
	2501 (39700)	19.09	19.07	
50RB (0)	2685 (41540)	19.71	19.84	
	2639(41080)	19.30	19.34	
	2593 (40620)	19.06	19.09	
	2547(40160)	18.70	18.71	
	2501 (39700)	18.95	18.98	
15MHz	1RB-High (74)	2682.5 (41515)	19.62	19.72

		2637.8(41068)	19.17	19.27
		2593 (40620)	18.98	19.10
		2548.3(40173)	18.62	18.72
		2503.5 (39725)	18.86	18.96
	1RB-Middle (37)	2682.5 (41515)	19.69	19.78
		2637.8(41068)	19.27	19.45
		2593 (40620)	19.08	19.22
		2548.3(40173)	18.78	18.85
	1RB-Low (0)	2503.5 (39725)	19.06	19.12
		2682.5 (41515)	19.53	19.51
		2637.8(41068)	19.23	19.34
		2593 (40620)	18.97	19.10
	36RB-High (38)	2548.3(40173)	18.72	18.78
		2503.5 (39725)	18.92	18.98
		2682.5 (41515)	19.67	19.68
		2637.8(41068)	19.26	19.25
	36RB-Middle (19)	2593 (40620)	19.00	19.03
		2548.3(40173)	18.72	18.64
		2503.5 (39725)	19.01	18.90
		2682.5 (41515)	19.69	19.68
36RB-Low (0)	2637.8(41068)	19.33	19.28	
	2593 (40620)	19.04	19.07	
	2548.3(40173)	18.76	18.75	
	2503.5 (39725)	19.10	19.02	
75RB (0)	2682.5 (41515)	19.68	19.56	
	2637.8(41068)	19.30	19.27	
	2593 (40620)	19.07	19.02	
	2548.3(40173)	18.82	18.73	
20MHz	1RB-High (99)	2503.5 (39725)	19.06	19.02
		2682.5 (41515)	19.69	19.73
		2637.8(41068)	19.27	19.31
		2593 (40620)	19.03	19.03
		2548.3(40173)	18.71	18.71
	1RB-Middle (50)	2503.5 (39725)	18.99	19.01
		2680 (41490)	19.60	19.72
		2636.5(41055)	19.11	19.22
		2593 (40620)	18.96	19.10
		2549.5(40185)	18.58	18.67
		2506 (39750)	18.81	18.91
		2680 (41490)	19.91	19.99
		2636.5(41055)	19.53	19.64
		2593 (40620)	19.31	19.43
		2549.5(40185)	18.98	19.03

		2506 (39750)	19.26	19.34
	1RB-Low (0)	2680 (41490)	19.48	19.59
		2636.5(41055)	19.19	19.33
		2593 (40620)	18.94	19.04
		2549.5(40185)	18.71	18.78
		2506 (39750)	18.97	19.00
		50RB-High (50)	2680 (41490)	19.74
	2636.5(41055)		19.41	19.47
	2593 (40620)		19.23	19.26
	2549.5(40185)		18.73	18.78
	2506 (39750)		19.05	18.97
	50RB-Middle (25)	2680 (41490)	19.83	19.88
		2636.5(41055)	19.44	19.47
		2593 (40620)	19.24	19.26
		2549.5(40185)	18.86	18.87
		2506 (39750)	19.16	19.16
	50RB-Low (0)	2680 (41490)	19.81	19.84
		2636.5(41055)	19.40	19.43
		2593 (40620)	19.19	19.21
		2549.5(40185)	18.85	18.87
2506 (39750)		19.19	19.21	
100RB (0)	2680 (41490)	19.83	19.90	
	2636.5(41055)	19.46	19.51	
	2593 (40620)	19.29	19.31	
	2549.5(40185)	18.86	18.87	
	2506 (39750)	19.18	19.18	

11.4 Wi-Fi and BT Measurement result

The maximum output power of BT is 9.13dBm.

The maximum tune up of BT is 9.8dBm.

The conducted output power for WLAN 2.4 GHz (Standalone for body) power is as following

802.11b	Channel\data rate	1Mbps
WLAN2450	11(2462MHz)	19.03
	6(2437(MHz)	19.12
	1(2412MHz)	18.60
	tuneup	20.00
802.11g	Channel\data rate	6Mbps
WLAN2450	11(2462MHz)	17.79
	6(2437(MHz)	17.69
	1(2412MHz)	17.35
	tuneup	18.50
802.11n-20MHz	Channel\data rate	MCS0
WLAN2450	11(2462MHz)	16.53
	6(2437(MHz)	16.66
	1(2412MHz)	16.36
	tuneup	17.50
802.11n-40MHz	Channel\data rate	MCS0
WLAN2450	9(2452MHz)	16.99
	6(2437MHz)	16.84
	3(2422MHz)	16.74
	tuneup	17.50

The conducted output power for WLAN 2.4 GHz (Standalone for head) power is as following

802.11b	Channel\data rate	1Mbps
WLAN2450	11(2462MHz)	16.12
	6(2437(MHz)	16.22
	1(2412MHz)	15.56
	tuneup	17.00
802.11g	Channel\data rate	6Mbps
WLAN2450	11(2462MHz)	14.80
	6(2437(MHz)	14.56
	1(2412MHz)	14.31
	tuneup	15.50
802.11n-20MHz	Channel\data rate	MCS0

WLAN2450	11(2462MHz)	13.73
	6(2437(MHz)	13.66
	1(2412MHz)	13.33
	tuneup	14.50
802.11n-40MHz	Channel\data rate	MCS0
WLAN2450	9(2452MHz)	13.82
	6(2437MHz)	13.85
	3(2422MHz)	13.72
	tuneup	14.50

The conducted output power for WLAN 2.4 GHz (Simultaneous for head) power is as following

802.11b	Channel\data rate	1Mbps
WLAN2450	11(2462MHz)	14.08
	6(2437(MHz)	14.23
	1(2412MHz)	13.66
	tuneup	15.00
802.11g	Channel\data rate	6Mbps
WLAN2450	11(2462MHz)	12.61
	6(2437(MHz)	12.80
	1(2412MHz)	12.42
	tuneup	13.50
802.11n-20MHz	Channel\data rate	MCS0
WLAN2450	11(2462MHz)	11.79
	6(2437(MHz)	11.56
	1(2412MHz)	11.37
	tuneup	13.50
802.11n-40MHz	Channel\data rate	MCS0
WLAN2450	9(2452MHz)	11.90
	6(2437MHz)	11.92
	3(2422MHz)	11.81
	tuneup	13.50

The conducted output power for WLAN 2.4 GHz (Simultaneous for body) power is as following

802.11b	Channel\data rate	1Mbps
WLAN2450	11(2462MHz)	13.18
	6(2437(MHz)	13.21
	1(2412MHz)	12.77
	tuneup	14.00
802.11g	Channel\data rate	6Mbps
WLAN2450	11(2462MHz)	11.73
	6(2437(MHz)	11.75
	1(2412MHz)	11.46

	tuneup	12.50
802.11n-20MHz	Channel\data rate	MCS0
WLAN2450	11(2462MHz)	10.64
	6(2437(MHz)	10.57
	1(2412MHz)	10.19
	tuneup	12.50
802.11n-40MHz	Channel\data rate	MCS0
WLAN2450	9(2452MHz)	11.02
	6(2437MHz)	11.03
	3(2422MHz)	10.88
	tuneup	12.50

12 Simultaneous TX SAR Considerations

12.1 Transmit Antenna Separation Distances

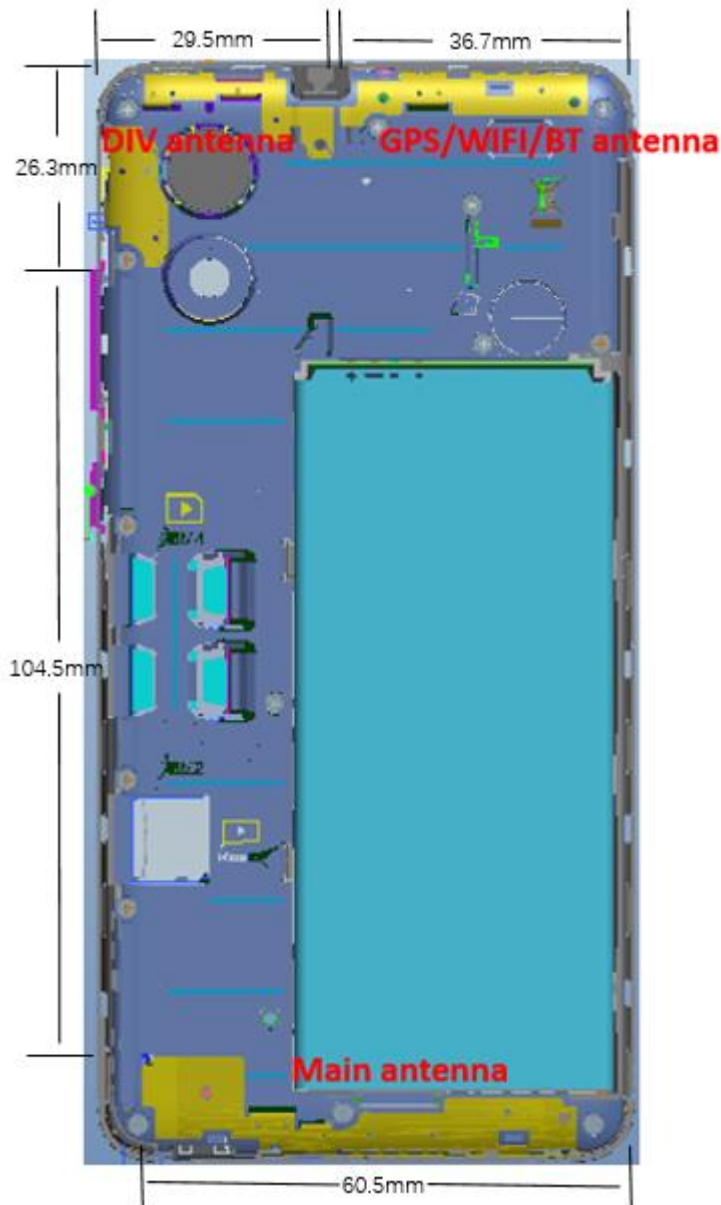

Picture 12.1 Antenna Locations

12.2 SAR Measurement Positions

According to the KDB941225 D06 Hot Spot SAR v01, the edges with less than 2.5 cm distance to the antennas need to be tested for SAR.

SAR measurement positions						
Mode	Front	Rear	Left edge	Right edge	Top edge	Bottom edge
Main antenna	Yes	Yes	Yes	Yes	No	Yes
WIFI/BT antenna	Yes	Yes	No	Yes	Yes	No

12.3 Standalone SAR Test Exclusion Considerations

Standalone 1-g head or body SAR evaluation by measurement or numerical simulation is not required when the corresponding SAR Exclusion Threshold condition, listed below, is satisfied. The 1-g SAR test exclusion threshold for 100 MHz to 6 GHz at test separation distances ≤ 50 mm are determined by:

$[(\text{max. power of channel, including tune-up tolerance, mW}) / (\text{min. test separation distance, mm})] \cdot [\sqrt{f(\text{GHz})}] \leq 3.0$ for 1-g SAR, where

- $f(\text{GHz})$ is the RF channel transmit frequency in GHz
- Power and distance are rounded to the nearest mW and mm before calculation
- The result is rounded to one decimal place for comparison

Table 12.1: Standalone SAR test exclusion considerations

Band/Mode	F(GHz)	Position	SAR test exclusion threshold(mW)	RF output power		SAR test exclusion
				dBm	mW	
Bluetooth	2.441	Head	9.60	9.8	9.5	YES
		Body	19.20	9.8	9.5	YES
2.4GHz WLAN	2.45	Head	9.58	14	25	No
		Body	19.17	13	20	No

13 Evaluation of Simultaneous

Table 13.1: The sum of reported SAR values for Main antenna and WiFi2.4G+BT

	Position	Cellular antenna	WiFi	BT	Sum
Highest reported SAR value for Head	Right hand, Cheek (WCDMA850)	0.30	0.35	<0.01	0.65
Maximum reported SAR value for Body	Rear 10mm (GSM1900)	0.92	0.32	<0.01	1.24
	Bottom 10mm (GSM1900)	1.08	/	<0.01	1.08
	Front 15mm (WCDMA1900)	0.22	0.02	0.09	0.33
	Rear 15mm (LTE Band7)	0.48	0.49	<0.01	0.97

When standalone SAR test exclusion applies to an antenna that transmits simultaneously with other antennas, the standalone SAR must be estimated according to following to determine simultaneous transmission SAR test exclusion:

(max. power of channel, including tune-up tolerance, mW)/(min. test separation distance,mm)]·[√f(GHz)/x] W/kg for test separation distances ≤ 50 mm;
 where x = 7.5 for 1-g SAR.

When the minimum test separation distance is < 5 mm, a distance of 5 mm is applied to determine SAR test exclusion

Conclusion:

According to the above tables, the sum of reported SAR values is<1.6W/kg. So the simultaneous transmission SAR with volume scans is not required.

14 SAR Test Result

It is determined by user manual for the distance between the EUT and the phantom bottom. The distance is 10 mm or 15mm and just applied to the condition of body worn accessory.

It is performed for all SAR measurements with area scan based 1-g SAR estimation (Fast SAR). A zoom scan measurement is added when the estimated 1-gSAR is the highest measured SAR in each exposure configuration, wireless mode and frequency band combination or more than 1.2W/kg.

The calculated SAR is obtained by the following formula:

$$\text{Reported SAR} = \text{Measured SAR} \times 10^{(P_{\text{Target}} - P_{\text{Measured}})/10}$$

Where P_{Target} is the power of manufacturing upper limit;

P_{Measured} is the measured power in chapter 11.

Table 14.1: Duty Cycle

Mode	Duty Cycle
GPRS&EGPRS for GSM850/GSM1900	1:4
LTE B41	1:1.58
WCDMA<E FDD	1:1

We'll perform the head measurement in all bands with the primary battery and SIM card depending on the evaluation of multi-batteries and multi-SIM cards and retest on highest value point with other batteries and SIM cards. Then, repeat the measurement in the Body test.

Table 14.2: The evaluation of multi-batteries for Head Test

Frequency		Side	Test Position	Battery Type	SAR(1g) (W/kg)	Power Drift(dB)
MHz	Ch.					
848.8	251	Left	Cheek	B1	0.256	0.15
848.8	251	Left	Cheek	B2	0.181	0.14

Note: According to the values in the above table, the battery of **B1** is the primary battery.

We'll perform the head measurement with this battery and retest on highest value point with others.

Table 14.3: The evaluation of multi-batteries for Body Test

Frequency		Test Position	Spacing (mm)	Battery Type	SAR(1g) (W/kg)	Power Drift(dB)
MHz	Ch.					
1850.2	512	Bottom	10	B1	0.947	-0.07
1850.2	512	Bottom	10	B2	0.941	-0.09

Note: According to the values in the above table, the battery of **B1** is the primary battery.

We'll perform the body measurement with this battery and retest on highest value point with others.

Table 14.4: The evaluation of multi-SIM cards for Head Test

Frequency		Side	Test Position	SIM	SAR(1g) (W/kg)	Power Drift(dB)
MHz	Ch.					
1852.4	9262	Right	Cheek	SIM1	0.174	-0.01
1852.4	9262	Right	Cheek	SIM2	0.168	-0.02

Note: According to the values in the above table, the **SIM2** is the primary SIM card.

We'll perform the head measurement with the SIM2 and retest on highest value point with others.

Table 14.5: The evaluation of multi-SIM cards for Body Test

Frequency		Test Position	Spacing (mm)	SIM	SAR(1g) (W/kg)	Power Drift(dB)
MHz	Ch.					
1907.6	9538	Bottom	10	SIM1	0.637	-0.19
1907.6	9538	Bottom	10	SIM2	0.632	0.06

Note: According to the values in the above table, the **SIM2** is the primary SIM card.

We'll perform the body measurement with the SIM2 and retest on highest value point with others.

Note:

B1: TLi028C7 of VEKEN

B2: TLi028C1 of BYD

S1: SIM1

S2: SIM2

14.1 SAR results for Fast SAR

Frequency Band	Channel Number	Frequency (MHz)	Mode/RB	Test setup	Distance	Figure No./Note	EUT Measured Power (dBm)	Tune up (dBm)	Measured SAR 1g (W/kg)	Calculated SAR 1g (W/kg)	Measured SAR 10g (W/kg)	Calculated SAR 10g (W/kg)	Power Drift
GSM850	251	848.8	GPRS(2TX)	Left Cheek	0mm	Fig.A1	29.60	30.50	0.190	0.23	0.144	0.18	0.15
GSM850	190	836.6	GPRS(2TX)	Left Cheek	0mm	\	29.59	30.50	0.138	0.17	0.105	0.13	0.03
GSM850	128	824.2	GPRS(2TX)	Left Cheek	0mm	\	29.54	30.50	0.124	0.15	0.094	0.12	0.19
GSM850	190	836.6	GPRS(2TX)	Left Tilt	0mm	\	29.59	30.50	0.091	0.11	0.074	0.09	0.06
GSM850	190	836.6	GPRS(2TX)	Right Cheek	0mm	\	29.59	30.50	0.095	0.12	0.078	0.10	-0.18
GSM850	190	836.6	GPRS(2TX)	Right Tilt	0mm	\	29.59	30.50	0.078	0.10	0.063	0.08	-0.17
GSM850	251	848.8	EGPRS(2TX)	Left Cheek	0mm	\	29.58	30.50	0.181	0.22	0.139	0.17	0.15
GSM850	190	836.6	GPRS(2TX)	Left Cheek	0mm	S2	29.59	30.50	0.177	0.22	0.140	0.17	-0.08
GSM850	190	836.6	GPRS(2TX)	Left Cheek	0mm	B2	29.59	30.50	0.182	0.22	0.141	0.17	0.14
GSM850	190	836.6	GPRS(2TX)	Front	10mm	\	29.59	30.50	0.099	0.12	0.074	0.09	0.04
GSM850	251	848.8	GPRS(2TX)	Rear	10mm	Fig.A2	29.60	30.50	0.286	0.35	0.156	0.19	0.09
GSM850	190	836.6	GPRS(2TX)	Rear	10mm	\	29.59	30.50	0.247	0.30	0.134	0.17	-0.12
GSM850	128	824.2	GPRS(2TX)	Rear	10mm	\	29.54	30.50	0.218	0.27	0.150	0.19	0.01
GSM850	190	836.6	GPRS(2TX)	Left Edge	10mm	\	29.59	30.50	0.160	0.20	0.111	0.14	0.09
GSM850	190	836.6	GPRS(2TX)	Right Edge	10mm	\	29.59	30.50	0.093	0.11	0.064	0.08	-0.10
GSM850	190	836.6	GPRS(2TX)	Bottom Edge	10mm	\	29.59	30.50	0.107	0.13	0.059	0.07	0.13
GSM850	190	836.6	GPRS(2TX)	Rear	10mm	\	29.59	30.50	0.000	0.00	0.000	0.00	0.18
GSM850	128	824.2	EGPRS(2TX)	Rear	10mm	\	29.54	30.50	0.211	0.26	0.153	0.19	0.06
GSM850	251	848.8	GPRS(2TX)	Rear	10mm	S2	29.60	30.50	0.279	0.34	0.149	0.18	0.19
GSM850	251	848.8	GPRS(2TX)	Rear	10mm	B2	29.60	30.50	0.282	0.35	0.148	0.18	-0.17
GSM1900	661	1880	GPRS(2TX)	Left Cheek	0mm	\	27.41	28	0.066	0.08	0.044	0.05	-0.18
GSM1900	661	1880	GPRS(2TX)	Left Tilt	0mm	\	27.41	28	0.036	0.04	0.025	0.03	-0.19
GSM1900	810	1909.8	GPRS(2TX)	Right Cheek	0mm	\	27.03	28	0.075	0.09	0.049	0.06	0.04
GSM1900	661	1880	GPRS(2TX)	Right Cheek	0mm	\	27.41	28	0.087	0.10	0.056	0.06	-0.05
GSM1900	512	1850.2	GPRS(2TX)	Right Cheek	0mm	Fig.A3	27.46	28	0.110	0.12	0.071	0.08	-0.04
GSM1900	661	1880	GPRS(2TX)	Right Tilt	0mm	\	27.41	28	0.037	0.04	0.024	0.03	0.08
GSM1900	512	1850.2	EGPRS(2TX)	Right Cheek	0mm	\	27.31	28	0.098	0.11	0.064	0.07	0.11
GSM1900	512	1850.2	GPRS(2TX)	Right Cheek	0mm	S2	27.46	28	0.101	0.11	0.063	0.07	-0.15
GSM1900	512	1850.2	GPRS(2TX)	Right Cheek	0mm	B2	27.46	28	0.102	0.12	0.065	0.07	-0.15
GSM1900	661	1880	GPRS(2TX)	Front	10mm	\	27.41	28	0.382	0.44	0.216	0.25	0.12
GSM1900	661	1880	GPRS(2TX)	Rear	10mm	\	27.41	28	0.804	0.92	0.433	0.50	-0.09
GSM1900	661	1880	GPRS(2TX)	Left Edge	10mm	\	27.41	28	0.114	0.13	0.067	0.08	0.14
GSM1900	661	1880	GPRS(2TX)	Right Edge	10mm	\	27.41	28	0.092	0.11	0.057	0.07	-0.06
GSM1900	661	1880	GPRS(2TX)	Bottom Edge	10mm	\	27.41	28	0.842	0.97	0.439	0.50	0.05
GSM1900	512	1850.2	GPRS(2TX)	Bottom Edge	10mm	Fig.A4	27.46	28	0.950	1.08	0.503	0.57	-0.03
GSM1900	810	1909.8	GPRS(2TX)	Bottom Edge	10mm	\	27.03	28	0.716	0.89	0.376	0.47	0.02
GSM1900	512	1850.2	EGPRS(2TX)	Bottom Edge	10mm	\	27.31	28	0.911	1.07	0.475	0.56	0.01
GSM1900	512	1850.2	GPRS(2TX)	Bottom Edge	10mm	S2	27.46	28	0.933	1.06	0.480	0.54	0.02
GSM1900	512	1850.2	GPRS(2TX)	Bottom Edge	10mm	B2	27.46	28	0.941	1.07	0.486	0.55	-0.09
WCDMA1900	9400	1880	RMC	Left Cheek	0mm	\	22.68	24.00	0.144	0.20	0.093	0.13	-0.10
WCDMA1900	9400	1880	RMC	Left Tilt	0mm	\	22.68	24.00	0.058	0.08	0.039	0.05	0.09
WCDMA1900	9538	1907.6	RMC	Right Cheek	0mm	\	22.69	24.00	0.153	0.21	0.097	0.13	0.04
WCDMA1900	9400	1880	RMC	Right Cheek	0mm	\	22.68	24.00	0.161	0.22	0.103	0.14	-0.16
WCDMA1900	9262	1852.4	RMC	Right Cheek	0mm	Fig.A5	22.76	24.00	0.174	0.23	0.112	0.15	-0.01
WCDMA1900	9400	1880	RMC	Right Tilt	0mm	\	22.68	24.00	0.084	0.11	0.054	0.07	-0.11
WCDMA1900	9262	1852.4	RMC	Right Cheek	0mm	S2	22.76	24.00	0.168	0.22	0.106	0.14	-0.02
WCDMA1900	9262	1852.4	RMC	Right Cheek	0mm	B2	22.76	24.00	0.170	0.23	0.108	0.14	-0.01
WCDMA1900	9400	1880	RMC	Front	10mm	\	18.25	19	0.264	0.31	0.157	0.19	-0.15
WCDMA1900	9400	1880	RMC	Rear	10mm	\	18.25	19	0.536	0.64	0.303	0.36	0.05
WCDMA1900	9400	1880	RMC	Left Edge	10mm	\	18.25	19	0.090	0.11	0.055	0.07	0.18
WCDMA1900	9400	1880	RMC	Right Edge	10mm	\	18.25	19	0.069	0.08	0.044	0.05	0.18
WCDMA1900	9400	1880	RMC	Bottom Edge	10mm	\	18.25	19	0.600	0.71	0.320	0.38	-0.09
WCDMA1900	9262	1852	RMC	Bottom Edge	10mm	\	18.18	19	0.610	0.74	0.325	0.39	-0.08
WCDMA1900	9538	1907.6	RMC	Bottom Edge	10mm	Fig.A6	18.08	19	0.637	0.79	0.338	0.42	-0.19
WCDMA1900	9538	1907.6	RMC	Bottom Edge	10mm	S2	18.08	19	0.632	0.78	0.334	0.41	0.06
WCDMA1900	9538	1907.6	RMC	Bottom Edge	10mm	B2	18.08	19	0.633	0.78	0.334	0.41	-0.07
WCDMA1900	9400	1880	RMC	Front	15mm	\	20.18	21	0.160	0.19	0.096	0.12	-0.09
WCDMA1900	9400	1880	RMC	Rear	15mm	\	20.18	21	0.284	0.34	0.161	0.19	-0.02
WCDMA1900	9262	1852	RMC	Rear	15mm	Fig.A7	20.28	21	0.306	0.36	0.174	0.21	-0.10
WCDMA1900	9538	1907.6	RMC	Rear	15mm	\	20.14	21	0.270	0.33	0.155	0.19	-0.12
WCDMA1900	9262	1852	RMC	Rear	15mm	S2	20.28	21	0.298	0.35	0.171	0.20	0.16
WCDMA1900	9262	1852	RMC	Rear	15mm	B2	20.28	21	0.302	0.36	0.170	0.20	0.14
WCDMA 850	4183	836.6	RMC	Left Cheek	0mm	\	22.75	24	0.341	0.45	0.253	0.34	-0.13
WCDMA 850	4233	846.6	RMC	Left Cheek	0mm	Fig.A8	22.87	24	0.385	0.50	0.285	0.37	-0.19
WCDMA 850	4132	826.4	RMC	Left Cheek	0mm	\	22.90	24	0.293	0.38	0.217	0.28	0.04
WCDMA 850	4183	836.6	RMC	Left Tilt	0mm	\	22.75	24	0.226	0.30	0.181	0.24	0.04
WCDMA 850	4183	836.6	RMC	Right Cheek	0mm	\	22.75	24	0.228	0.30	0.182	0.24	0.12
WCDMA 850	4183	836.6	RMC	Right Tilt	0mm	\	22.75	24	0.211	0.28	0.169	0.23	0.14
WCDMA 850	4233	846.6	RMC	Left Cheek	0mm	S2	22.87	24	0.370	0.48	0.276	0.36	0.12
WCDMA 850	4233	846.6	RMC	Left Cheek	0mm	B2	22.87	24	0.372	0.48	0.269	0.35	-0.01
WCDMA 850	4183	836.6	RMC	Front	10mm	\	22.75	24	0.308	0.41	0.229	0.31	0.15
WCDMA 850	4233	846.6	RMC	Rear	10mm	Fig.A9	22.87	24	0.517	0.67	0.386	0.50	0.15
WCDMA 850	4183	836.6	RMC	Rear	10mm	\	22.75	24	0.492	0.66	0.363	0.48	0.11
WCDMA 850	4132	826.4	RMC	Rear	10mm	\	22.90	24	0.462	0.60	0.344	0.44	-0.10
WCDMA 850	4183	836.6	RMC	Left Edge	10mm	\	22.75	24	0.334	0.45	0.239	0.32	-0.12
WCDMA 850	4183	836.6	RMC	Right Edge	10mm	\	22.75	24	0.222	0.30	0.151	0.20	0.08
WCDMA 850	4183	836.6	RMC	Bottom Edge	10mm	\	22.75	24	0.201	0.27	0.114	0.15	0.17
WCDMA 850	4233	846.6	RMC	Rear	10mm	S2	22.87	24	0.500	0.65	0.380	0.49	0.07
WCDMA 850	4233	846.6	RMC	Rear	10mm	B2	22.87	24	0.496	0.64	0.376	0.49	0.19

RF Exposure Conditions	Frequency Band	Channel Number	Frequency (MHz)	Mode/RB	Test setup	Distance	Figure No./Note	EUT Measured Power (dBm)	Tune up (dBm)	Measured SAR 1g (W/kg)	Calculated SAR 1g (W/kg)	Measured SAR 10g (W/kg)	Calculated SAR 10g (W/kg)	Power Drift
Head	LTE Band5	20450	829	1RB-Middle	Left Cheek	0mm	Fig.A10	23.10	24.00	0.316	0.39	0.233	0.29	0.04
Head	LTE Band5	20450	829	1RB-Middle	Left Tilt	0mm	\	23.10	24.00	0.217	0.27	0.171	0.21	0.15
Head	LTE Band5	20450	829	1RB-Middle	Right Cheek	0mm	\	23.10	24.00	0.231	0.28	0.183	0.23	0.17
Head	LTE Band5	20450	829	1RB-Middle	Right Tilt	0mm	\	23.10	24.00	0.216	0.27	0.171	0.21	0.01
Head	LTE Band5	20525	836.5	25RB-High	Left Cheek	0mm	\	22.11	23.00	0.261	0.32	0.191	0.23	-0.03
Head	LTE Band5	20525	836.5	25RB-High	Left Tilt	0mm	\	22.11	23.00	0.184	0.23	0.145	0.18	-0.07
Head	LTE Band5	20525	836.5	25RB-High	Right Cheek	0mm	\	22.11	23.00	0.192	0.24	0.152	0.19	0.13
Head	LTE Band5	20525	836.5	25RB-High	Right Tilt	0mm	\	22.11	23.00	0.180	0.22	0.143	0.18	-0.01
Head	LTE Band5	20450	829	1RB-Middle	Left Cheek	0mm	S2	23.10	24.00	0.281	0.35	0.201	0.25	0.17
Head	LTE Band5	20450	829	1RB-Middle	Left Cheek	0mm	B2	23.10	24.00	0.292	0.36	0.193	0.24	-0.14
Body	LTE Band5	20450	829	1RB-Middle	Front	10mm	\	23.10	24.00	0.259	0.32	0.197	0.24	0.07
Body	LTE Band5	20450	829	1RB-Middle	Rear	10mm	Fig.A11	23.10	24.00	0.421	0.52	0.318	0.39	0.15
Body	LTE Band5	20450	829	1RB-Middle	Left Edge	10mm	\	23.10	24.00	0.315	0.39	0.221	0.27	-0.08
Body	LTE Band5	20450	829	1RB-Middle	Right Edge	10mm	\	23.10	24.00	0.185	0.23	0.130	0.16	-0.04
Body	LTE Band5	20450	829	1RB-Middle	Bottom Edge	10mm	\	23.10	24.00	0.162	0.20	0.093	0.11	-0.11
Body	LTE Band5	20525	836.5	25RB-High	Front	10mm	\	22.11	23.00	0.208	0.26	0.159	0.20	-0.17
Body	LTE Band5	20525	836.5	25RB-High	Rear	10mm	\	22.11	23.00	0.347	0.43	0.260	0.32	0.04
Body	LTE Band5	20525	836.5	25RB-High	Left Edge	10mm	\	22.11	23.00	0.250	0.31	0.175	0.21	-0.03
Body	LTE Band5	20525	836.5	25RB-High	Right Edge	10mm	\	22.11	23.00	0.148	0.18	0.102	0.13	-0.11
Body	LTE Band5	20525	836.5	25RB-High	Bottom Edge	10mm	\	22.11	23.00	0.153	0.19	0.082	0.10	-0.16
Body	LTE Band5	20450	829	1RB-Middle	Rear	10mm	S2	23.10	24.00	0.413	0.51	0.285	0.35	-0.01
Body	LTE Band5	20450	829	1RB-Middle	Rear	10mm	B2	23.10	24.00	0.409	0.50	0.301	0.37	-0.19
Head	LTE Band7	20850	2510	1RB-Middle	Left Cheek	0mm	Fig.A12	23.32	24.00	0.124	0.15	0.061	0.07	0.19
Head	LTE Band7	20850	2510	1RB-Middle	Left Tilt	0mm	\	23.32	24.00	0.049	0.06	0.025	0.03	-0.10
Head	LTE Band7	20850	2510	1RB-Middle	Right Cheek	0mm	\	23.32	24.00	0.121	0.14	0.055	0.06	0.18
Head	LTE Band7	20850	2510	1RB-Middle	Right Tilt	0mm	\	23.32	24.00	0.076	0.09	0.039	0.05	0.00
Head	LTE Band7	20850	2510	50RB-Low	Left Cheek	0mm	\	22.33	23.00	0.098	0.11	0.049	0.06	0.09
Head	LTE Band7	20850	2510	50RB-Low	Left Tilt	0mm	\	22.33	23.00	0.000	0.00	0.000	0.00	-0.05
Head	LTE Band7	20850	2510	50RB-Low	Right Cheek	0mm	\	22.33	23.00	0.094	0.11	0.053	0.06	0.16
Head	LTE Band7	20850	2510	50RB-Low	Right Tilt	0mm	\	22.33	23.00	0.057	0.07	0.030	0.03	-0.04
Head	LTE Band7	20850	2510	1RB-Middle	Left Cheek	0mm	S2	23.32	24.00	0.118	0.14	0.050	0.06	-0.14
Head	LTE Band7	20850	2510	1RB-Middle	Left Cheek	0mm	B2	23.32	24.00	0.121	0.14	0.054	0.06	0.17
Body	LTE Band7	20850	2510	1RB-Middle	Front	10mm	\	16.84	17.50	0.221	0.26	0.113	0.13	-0.14
Body	LTE Band7	20850	2510	1RB-Middle	Rear	10mm	\	16.84	17.50	0.653	0.76	0.320	0.37	-0.02
Body	LTE Band7	20850	2510	1RB-Middle	Left Edge	10mm	\	16.84	17.50	0.028	0.03	0.018	0.02	-0.03
Body	LTE Band7	20850	2510	1RB-Middle	Right Edge	10mm	\	16.84	17.50	0.026	0.03	0.017	0.02	-0.08
Body	LTE Band7	20850	2510	1RB-Middle	Bottom Edge	10mm	Fig.A13	16.84	17.50	0.749	0.87	0.363	0.42	0.09
Body	LTE Band7	21100	2535	1RB-Middle	Bottom Edge	10mm	\	16.70	17.50	0.679	0.82	0.332	0.40	-0.06
Body	LTE Band7	21350	2560	1RB-Middle	Bottom Edge	10mm	\	16.51	17.50	0.647	0.81	0.315	0.40	0.19
Body	LTE Band7	20850	2510	25RB-Low	Front	10mm	\	16.84	17.50	0.206	0.24	0.109	0.13	-0.16
Body	LTE Band7	20850	2510	25RB-Low	Rear	10mm	\	16.84	17.50	0.612	0.71	0.303	0.35	0.00
Body	LTE Band7	20850	2510	25RB-Low	Left Edge	10mm	\	16.84	17.50	0.031	0.04	0.019	0.02	-0.14
Body	LTE Band7	20850	2510	25RB-Low	Right Edge	10mm	\	16.84	17.50	0.027	0.03	0.017	0.02	0.07
Body	LTE Band7	20850	2510	25RB-Low	Bottom Edge	10mm	\	16.84	17.50	0.698	0.81	0.341	0.40	0.00
Body	LTE Band7	21100	2535	25RB-Low	Bottom Edge	10mm	\	16.64	17.50	0.653	0.80	0.320	0.39	0.16
Body	LTE Band7	21350	2560	25RB-Low	Bottom Edge	10mm	\	16.55	17.50	0.619	0.77	0.305	0.38	0.14
Body	LTE Band7	20850	2510	1RB-Middle	Bottom Edge	10mm	S2	16.84	17.50	0.740	0.86	0.350	0.41	-0.10
Body	LTE Band7	20850	2510	1RB-Middle	Bottom Edge	10mm	B2	16.84	17.50	0.737	0.86	0.361	0.42	0.01
Body	LTE Band7	20850	2510	1RB-Middle	Front	15mm	\	16.82	18.00	0.134	0.18	0.073	0.10	0.03
Body	LTE Band7	20850	2510	1RB-Middle	Rear	15mm	Fig.A14	16.82	18.00	0.366	0.48	0.190	0.25	-0.17
Body	LTE Band7	20850	2510	25RB-Low	Front	15mm	\	16.85	18.00	0.130	0.17	0.070	0.09	0.06
Body	LTE Band7	20850	2510	25RB-Low	Rear	15mm	\	16.85	18.00	0.350	0.46	0.181	0.24	-0.14
Body	LTE Band7	20850	2510	1RB-Middle	Rear	15mm	S2	16.82	18.00	0.350	0.46	0.181	0.24	0.08
Body	LTE Band7	20850	2510	1RB-Middle	Rear	15mm	B2	16.82	18.00	0.362	0.48	0.176	0.23	-0.10
Head	LTE Band41	41490	2680	1RB-Middle	Left Cheek	0mm	\	23.69	24.00	0.029	0.03	0.025	0.03	0.15
Head	LTE Band41	41490	2680	1RB-Middle	Left Tilt	0mm	\	23.69	24.00	0.000	0.00	0.000	0.00	0.09
Head	LTE Band41	41490	2680	1RB-Middle	Right Cheek	0mm	Fig.A15	23.69	24.00	0.043	0.05	0.022	0.02	0.08
Head	LTE Band41	41490	2680	1RB-Middle	Right Tilt	0mm	\	23.69	24.00	0.000	0.00	0.000	0.00	-0.19
Head	LTE Band41	41490	2680	50RB-Middle	Left Cheek	0mm	\	22.75	23.00	0.022	0.02	0.019	0.02	-0.05
Head	LTE Band41	41490	2680	50RB-Middle	Left Tilt	0mm	\	22.75	23.00	0.000	0.00	0.000	0.00	0.07
Head	LTE Band41	41490	2680	50RB-Middle	Right Cheek	0mm	\	22.75	23.00	0.024	0.02	0.020	0.02	-0.08
Head	LTE Band41	41490	2680	50RB-Middle	Right Tilt	0mm	\	22.75	23.00	0.000	0.00	0.000	0.00	0.14
Head	LTE Band41	41490	2680	1RB-Middle	Right Cheek	0mm	S2	23.69	24.00	0.038	0.04	0.020	0.02	0.18
Head	LTE Band41	41490	2680	1RB-Middle	Right Cheek	0mm	B2	23.69	24.00	0.040	0.04	0.019	0.02	0.12
Body	LTE Band41	41490	2680	1RB-Middle	Front	10mm	\	19.91	20.00	0.188	0.19	0.093	0.10	0.02
Body	LTE Band41	41490	2680	1RB-Middle	Rear	10mm	\	19.91	20.00	0.502	0.51	0.230	0.23	0.05
Body	LTE Band41	41490	2680	1RB-Middle	Left Edge	10mm	\	19.91	20.00	0.028	0.03	0.017	0.02	0.19
Body	LTE Band41	41490	2680	1RB-Middle	Right Edge	10mm	\	19.91	20.00	0.020	0.02	0.012	0.01	0.15
Body	LTE Band41	41490	2680	1RB-Middle	Bottom Edge	10mm	Fig.A16	19.91	20.00	0.640	0.65	0.301	0.31	-0.01
Body	LTE Band41	41490	2680	50RB-Middle	Front	10mm	\	19.83	20.00	0.138	0.14	0.068	0.07	-0.12
Body	LTE Band41	41490	2680	50RB-Middle	Rear	10mm	\	19.83	20.00	0.384	0.40	0.176	0.18	0.12
Body	LTE Band41	41490	2680	50RB-Middle	Left Edge	10mm	\	19.83	20.00	0.023	0.02	0.014	0.01	0.08
Body	LTE Band41	41490	2680	50RB-Middle	Right Edge	10mm	\	19.83	20.00	0.018	0.02	0.007	0.01	0.15
Body	LTE Band41	41490	2680	50RB-Middle	Bottom Edge	10mm	\	19.83	20.00	0.498	0.52	0.231	0.24	0.15
Body	LTE Band41	41490	2680	1RB-Middle	Bottom Edge	10mm	S2	19.91	20.00	0.619	0.63	0.288	0.29	0.05
Body	LTE Band41	41490	2680	1RB-Middle	Bottom Edge	10mm	B2	19.91	20.00	0.622	0.64	0.290	0.30	0.13
Body	LTE Band41	41490	2680	1RB-Middle	Front	15mm	\	19.90	20.50	0.135	0.15	0.071	0.08	0.09
Body	LTE Band41	41490	2680	1RB-Middle	Rear	15mm	Fig.A17	19.90	20.50	0.323	0.37	0.163	0.19	-0.09
Body	LTE Band41	41490	2680	50RB-Low	Front	15mm	\	19.83	20.50	0.095	0.11	0.050	0.06	-0.06
Body	LTE Band41	41490	2680	50RB-Low	Rear	15mm	\	19.83	20.50	0.233	0.27	0.117	0.14	-0.11
Body	LTE Band41	41490	2680	1RB-Middle	Rear	15mm	S2	19.90	20.50	0.309	0.35	0.157	0.18	-0.15
Body	LTE Band41	41490	2680	1RB-Middle	Rear	15mm	B2	19.90	20.50	0.315	0.36	0.160	0.18	0.03

RF Exposure Conditions	Frequency Band	Channel Number	Mode/RB	Test setup	Distance	EUT Measured Power (dBm)	Tune up (dBm)	Measured SAR 1g (W/kg)	Calculated SAR 1g (W/kg)	Measured SAR 10g (W/kg)	Calculated SAR 10g (W/kg)	Power Drift
Head	BT	38	GFSK	Left Cheek	0mm	9.13	9.80	<0.01	<0.01	<0.01	<0.01	\
Head	BT	38	GFSK	Left Tilt	0mm	9.13	9.80	<0.01	<0.01	<0.01	<0.01	\
Head	BT	38	GFSK	Right Cheek	0mm	9.13	9.80	<0.01	<0.01	<0.01	<0.01	\
Head	BT	38	GFSK	Right Tilt	0mm	9.13	9.80	<0.01	<0.01	<0.01	<0.01	\
Body	BT	38	GFSK	Front	10mm	9.13	9.80	<0.01	<0.01	<0.01	<0.01	\
Body	BT	38	GFSK	Rear	10mm	9.13	9.80	<0.01	<0.01	<0.01	<0.01	\
Body	BT	38	GFSK	Left Edge	10mm	9.13	9.80	<0.01	<0.01	<0.01	<0.01	\
Body	BT	38	GFSK	Right Edge	10mm	9.13	9.80	<0.01	<0.01	<0.01	<0.01	\
Body	BT	38	GFSK	Top Edge	10mm	9.13	9.80	<0.01	<0.01	<0.01	<0.01	\

14.2 SAR results for Standard procedure

There is zoom scan measurement to be added for the highest measured SAR in each exposure configuration/band.

Frequency Band	Channel Number	Frequency (MHz)	Mode/RB	Test setup	Distance	Figure No./Note	EUT Measured Power (dBm)	Tune up (dBm)	Measured SAR 1g (W/kg)	Calculated SAR 1g (W/kg)	Measured SAR 10g (W/kg)	Calculated SAR 10g (W/kg)	Power Drift
GSM850	251	848.8	GPRS(2TX)	Left Cheek	0mm	Fig.A1	29.60	30.50	0.190	0.23	0.144	0.18	0.15
GSM850	251	848.8	GPRS(2TX)	Rear	10mm	Fig.A2	29.60	30.50	0.286	0.35	0.156	0.19	0.09
GSM1900	512	1850.2	GPRS(2TX)	Right Cheek	0mm	Fig.A3	27.46	28	0.110	0.12	0.071	0.08	-0.04
GSM1900	512	1850.2	GPRS(2TX)	Bottom Edge	10mm	Fig.A4	27.46	28	0.950	1.08	0.503	0.57	-0.03
WCDMA1900	9262	1852.4	RMC	Right Cheek	0mm	Fig.A5	22.76	24.00	0.174	0.23	0.112	0.15	-0.01
WCDMA1900	9538	1907.6	RMC	Bottom Edge	10mm	Fig.A6	18.08	19	0.637	0.79	0.338	0.42	-0.19
WCDMA 850	4233	846.6	RMC	Left Cheek	0mm	Fig.A8	22.87	24	0.385	0.50	0.285	0.37	-0.19
WCDMA 850	4233	846.6	RMC	Rear	10mm	Fig.A9	22.87	24	0.517	0.67	0.386	0.50	0.15
LTE Band5	20450	829	1RB-Middle	Left Cheek	0mm	Fig.A10	23.10	24.00	0.316	0.39	0.233	0.29	0.04
LTE Band5	20450	829	1RB-Middle	Rear	10mm	Fig.A11	23.10	24.00	0.421	0.52	0.318	0.39	0.15
LTE Band7	20850	2510	1RB-Middle	Left Cheek	0mm	Fig.A12	23.32	24.00	0.124	0.15	0.061	0.07	0.19
LTE Band7	20850	2510	1RB-Middle	Bottom Edge	10mm	Fig.A13	16.84	17.50	0.749	0.87	0.363	0.42	0.09
LTE Band7	20850	2510	1RB-Middle	Rear	15mm	Fig.A14	16.82	18.00	0.366	0.48	0.190	0.25	-0.17
LTE Band41	41490	2680	1RB-Middle	Right Cheek	0mm	Fig.A15	23.69	24.00	0.043	0.05	0.022	0.02	0.08
LTE Band41	41490	2680	1RB-Middle	Bottom Edge	10mm	Fig.A16	19.91	20.00	0.640	0.65	0.301	0.31	-0.01
LTE Band41	41490	2680	1RB-Middle	Rear	15mm	Fig.A17	19.90	20.50	0.323	0.37	0.163	0.19	-0.09

14.3 WLAN Evaluation for 2.4G

According to the KDB248227 D01, SAR is measured for 2.4GHz 802.11b DSSS using the initial test position procedure.

Head Evaluation WLAN 2.4 GHz (Standalone)

Table 14.3-1: SAR Values (WLAN - Head)– 802.11b (Fast SAR)

Frequency		Side	Test Position	Figure No./ Note	Conducted Power (dBm)	Max. tune-up Power (dBm)	Measured SAR(1g) (W/kg)	Reported SAR(1g)(W/kg)	Measured SAR(10g) (W/kg)	Reported SAR(10g)(W/kg)	Power Drift (dB)
MHz	Ch.										
2437	6	Left	Cheek	/	16.22	17.00	0.361	0.43	0.180	0.22	0.15
2437	6	Left	Tilt	/	16.22	17.00	0.441	0.53	0.219	0.26	-0.14
2437	6	Right	Cheek	/	16.22	17.00	0.470	0.56	0.230	0.28	0.17
2437	6	Right	Tilt	/	16.22	17.00	0.581	0.70	0.287	0.34	-0.01
2437	6	Right	Tilt	S2	16.22	17.00	0.566	0.68	0.227	0.27	0.15
2437	6	Right	Tilt	B2	16.22	17.00	0.559	0.67	0.221	0.26	-0.12

As shown above table, the initial test position for head is “Right Tilt”. So the head SAR of WLAN is presented as below:

Table 14.3-2: SAR Values (WLAN - Head)– 802.11b (Full SAR)

Frequency		Side	Test Position	Figure No./ Note	Conducted Power (dBm)	Max. tune-up Power (dBm)	Measured SAR(1g) (W/kg)	Reported SAR(1g)(W/kg)	Measured SAR(10g) (W/kg)	Reported SAR(10g)(W/kg)	Power Drift (dB)
MHz	Ch.										
2437	6	Right	Tilt	Fig.18	16.22	17.00	0.611	0.73	0.290	0.35	0.10
2437	6	Right	Cheek	/	16.22	17.00	0.481	0.58	0.242	0.29	0.11

Note1: When the reported SAR of the initial test position is > 0.4 W/kg, SAR is repeated for the 802.11 transmission mode configuration tested in the initial test position using subsequent highest estimated 1-g SAR conditions determined by area scans, on the highest maximum output power channel, until the reported SAR is ≤ 0.8 W/kg.
 Note2: For all positions/configurations tested using the initial test position and subsequent test positions, when the reported SAR is > 0.8 W/kg, SAR is measured for these test positions/configurations on the subsequent next highest measured output power channel until the reported SAR is ≤ 1.2 W/kg or all required channels are tested.

According to the KDB248227 D01, The reported SAR must be scaled to 100% transmission duty factor to determine compliance at the maximum tune-up tolerance limit. The scaled reported SAR is presented as below.

Table 14.3-3: SAR Values (WLAN - Head) – 802.11b (Scaled Reported SAR)

Frequency		Side	Test Position	Actual duty factor	maximum duty factor	Reported SAR (1g)(W/kg)	Scaled reported SAR (1g)(W/kg)
MHz	Ch.						

2437	6	Right	Tilt	100%	100%	0.73	0.73
------	---	-------	------	------	------	-------------	-------------

SAR is not required for OFDM because the 802.11b adjusted SAR ≤ 1.2 W/kg.

Body Evaluation WLAN 2.4 GHz (Standalone)

Table 14.3-4: SAR Values (WLAN - Body)– 802.11b (Fast SAR)

Frequency		Test Position	Figure No./ Note	Conducted Power (dBm)	Max. tune-up Power (dBm)	Measured SAR(1g) (W/kg)	Reported SAR(1g)(W/kg)	Measured SAR(10g) (W/kg)	Reported SAR(10g)(W/kg)	Power Drift (dB)
MHz	Ch.									
2437	6	Front	/	19.12	20.00	0.245	0.30	0.130	0.16	-0.08
2437	6	Rear	/	19.12	20.00	0.751	0.92	0.357	0.44	0.11
2437	6	Right	/	19.12	20.00	0.049	0.06	0.028	0.03	-0.03
2437	6	Top Edge	/	19.12	20.00	0.697	0.85	0.342	0.42	0.01
2437	6	Rear	S2	19.12	20.00	0.741	0.91	0.351	0.43	0.11
2437	6	Rear	B2	19.12	20.00	0.746	0.91	0.352	0.43	-0.02

Note1: The distance between the EUT and the phantom bottom is 10mm.

As shown above table, the initial test position for body is “Rear”. So the body SAR of WLAN is presented as below:

Table 14.3-5: SAR Values (WLAN - Body)– 802.11b (Full SAR)

Frequency		Test Position	Figure No./ Note	Conducted Power (dBm)	Max. tune-up Power (dBm)	Measured SAR(1g) (W/kg)	Reported SAR(1g)(W/kg)	Measured SAR(10g) (W/kg)	Reported SAR(10g)(W/kg)	Power Drift (dB)
MHz	Ch.									
2437	6	Rear	Fig.19	19.12	20.00	0.720	0.88	0.359	0.44	-0.11
2437	6	Top Edge	/	19.12	20.00	0.699	0.86	0.351	0.43	-0.01
2437	6	Front	/	19.12	20.00	0.251	0.31	0.140	0.17	0.07
2462	11	Rear	/	19.03	20.00	0.781	0.98	0.370	0.46	0.02
2462	11	Top Edge	/	19.03	20.00	0.769	0.96	0.367	0.46	-0.09

Note1: When the reported SAR of the initial test position is > 0.4 W/kg, SAR is repeated for the 802.11 transmission mode configuration tested in the initial test position using subsequent highest estimated 1-g SAR conditions determined by area scans, on the highest maximum output power channel, until the reported SAR is ≤ 0.8 W/kg.

Note2: For all positions/configurations tested using the initial test position and subsequent test positions, when the reported SAR is > 0.8 W/kg, SAR is measured for these test positions/configurations on the subsequent next highest measured output power channel until the reported SAR is ≤ 1.2 W/kg or all required channels are tested.

According to the KDB248227 D01, The reported SAR must be scaled to 100% transmission duty factor to determine compliance at the maximum tune-up tolerance limit. The scaled reported SAR is presented as below.

Table 14.3-6: SAR Values (WLAN - Body) – 802.11b (Scaled Reported SAR)

Frequency		Test Position	Actual duty factor	maximum duty factor	Reported SAR (1g)(W/kg)	Scaled reported SAR (1g)(W/kg)
MHz	Ch.					
2437	6	Rear	100%	100%	0.98	0.98

SAR is not required for OFDM because the 802.11b adjusted SAR \leq 1.2 W/kg.

Head Evaluation WLAN 2.4 GHz (Simultaneous transmit)

Table 14.3-7: SAR Values (WLAN - Head)– 802.11b (Fast SAR)-

Frequency		Side	Test Position	Figure No./ Note	Conducted Power (dBm)	Max. tune-up Power (dBm)	Measured SAR(1g) (W/kg)	Reported SAR(1g)(W/kg)	Measured SAR(10g) (W/kg)	Reported SAR(10g)(W/kg)	Power Drift (dB)
MHz	Ch.										
2437	6	Left	Cheek	/	14.23	15.00	0.223	0.27	0.063	0.08	-0.19
2437	6	Left	Tilt	/	14.23	15.00	0.273	0.33	0.077	0.09	-0.09
2437	6	Right	Cheek	/	14.23	15.00	0.291	0.35	0.081	0.10	-0.19
2437	6	Right	Tilt	/	14.23	15.00	0.360	0.43	0.101	0.12	-0.17
2437	6	Right	Tilt	S2	14.23	15.00	0.346	0.41	0.097	0.12	-0.17
2437	6	Right	Tilt	B2	14.23	15.00	0.351	0.42	0.098	0.12	0.08

As shown above table, the initial test position for head is “Right Tilt”. So the head SAR of WLAN is presented as below:

Table 14.3-8: SAR Values (WLAN - Head)– 802.11b (Full SAR)

Frequency		Side	Test Position	Figure No./ Note	Conducted Power (dBm)	Max. tune-up Power (dBm)	Measured SAR(1g) (W/kg)	Reported SAR(1g)(W/kg)	Measured SAR(10g) (W/kg)	Reported SAR(10g)(W/kg)	Power Drift (dB)
MHz	Ch.										
2437	6	Right	Tilt	Fig.20	14.23	15.00	0.438	0.52	0.186	0.22	-0.05
2437	6	Right	Cheek	/	14.23	15.00	0.310	0.37	0.083	0.10	0.11

Note1: When the reported SAR of the initial test position is > 0.4 W/kg, SAR is repeated for the 802.11 transmission mode configuration tested in the initial test position using subsequent highest estimated 1-g SAR conditions determined by area scans, on the highest maximum output power channel, until the reported SAR is \leq 0.8 W/kg.

Note2: For all positions/configurations tested using the initial test position and subsequent test positions, when the reported SAR is > 0.8 W/kg, SAR is measured for these test positions/configurations on the subsequent next highest measured output power channel until the reported SAR is \leq 1.2 W/kg or all required channels are tested.

According to the KDB248227 D01, The reported SAR must be scaled to 100% transmission duty factor to determine compliance at the maximum tune-up tolerance limit. The scaled reported SAR is presented as below.

Table 14.3-9: SAR Values (WLAN - Head) – 802.11b (Scaled Reported SAR)

Frequency		Side	Test Position	Actual duty factor	maximum duty factor	Reported SAR (1g)(W/kg)	Scaled reported SAR (1g)(W/kg)
MHz	Ch.						
2437	6	Right	Tilt	100%	100%	0.52	0.52

SAR is not required for OFDM because the 802.11b adjusted SAR \leq 1.2 W/kg.

Body Evaluation WLAN 2.4 GHz (Simultaneous transmit)
Table 14.3-10: SAR Values (WLAN - Body)– 802.11b (Fast SAR)

Frequency		Test Position	Figure No./ Note	Conducted Power (dBm)	Max. tune-up Power (dBm)	Measured SAR(1g) (W/kg)	Reported SAR(1g)(W/kg)	Measured SAR(10g) (W/kg)	Reported SAR(10g)(W/kg)	Power Drift (dB)
MHz	Ch.									
2437	6	Front	/	13.21	14.00	0.081	0.10	0.044	0.05	0.02
2437	6	Rear	/	13.21	14.00	0.249	0.30	0.121	0.14	-0.01
2437	6	Right Edge	/	13.21	14.00	0.016	0.02	0.009	0.01	-0.02
2437	6	Top Edge	/	13.21	14.00	0.231	0.28	0.116	0.14	0.13
2437	6	Front	S2	13.21	14.00	0.229	0.27	0.110	0.13	0.00
2437	6	Rear	B2	13.21	14.00	0.235	0.28	0.109	0.13	0.11

Note1: The distance between the EUT and the phantom bottom is 10mm.

As shown above table, the initial test position for body is “Rear”. So the body SAR of WLAN is presented as below:

Table 14.3-11: SAR Values (WLAN - Body)– 802.11b (Full SAR)

Frequency		Test Position	Figure No./ Note	Conducted Power (dBm)	Max. tune-up Power (dBm)	Measured SAR(1g) (W/kg)	Reported SAR(1g)(W/kg)	Measured SAR(10g) (W/kg)	Reported SAR(10g) (W/kg)	Power Drift (dB)
MHz	Ch.									
2437	6	Rear	Fig.21	13.21	14.00	0.264	0.32	0.127	0.15	0.16

Note1: When the reported SAR of the initial test position is > 0.4 W/kg, SAR is repeated for the 802.11 transmission mode configuration tested in the initial test position using subsequent highest estimated 1-g SAR conditions determined by area scans, on the highest maximum output power channel, until the reported SAR is ≤ 0.8 W/kg.

Note2: For all positions/configurations tested using the initial test position and subsequent test positions, when the reported SAR is > 0.8 W/kg, SAR is measured for these test positions/configurations on the subsequent next highest measured output power channel until the reported SAR is ≤ 1.2 W/kg or all required channels are tested.

According to the KDB248227 D01, The reported SAR must be scaled to 100% transmission duty factor to determine compliance at the maximum tune-up tolerance limit. The scaled reported SAR is presented as below.

Table 14.3-12: SAR Values (WLAN - Body) – 802.11b (Scaled Reported SAR)

Frequency		Test Position	Actual duty factor	maximum duty factor	Reported SAR (1g)(W/kg)	Scaled reported SAR (1g)(W/kg)
MHz	Ch.					
2437	6	Rear	100%	100%	0.32	0.32

SAR is not required for OFDM because the 802.11b adjusted SAR ≤ 1.2 W/kg.

Body Evaluation WLAN 2.4 GHz (Simultaneous transmit)
Table 14.3-13: SAR Values (WLAN - Body)– 802.11b (Fast SAR)

Frequency		Test Position	Figure No./ Note	Conducted Power (dBm)	Max. tune-up Power (dBm)	Measured SAR(1g) (W/kg)	Reported SAR(1g)(W/kg)	Measured SAR(10g) (W/kg)	Reported SAR(10g) (W/kg)	Power Drift (dB)
MHz	Ch.									
2437	6	Front	15mm	14.23	15.00	0.149	0.18	0.130	0.16	0.10
2437	6	Rear	15mm	14.23	15.00	0.403	0.48	0.170	0.20	0.14

Note1: The distance between the EUT and the phantom bottom is 15mm.

As shown above table, the initial test position for body is “Rear”. So the body SAR of WLAN is presented as below:

Table 14.3-14: SAR Values (WLAN - Body)– 802.11b (Full SAR)

Frequency		Test Position	Figure No./ Note	Conducted Power (dBm)	Max. tune-up Power (dBm)	Measured SAR(1g) (W/kg)	Reported SAR(1g)(W/kg)	Measured SAR(10g) (W/kg)	Reported SAR(10g) (W/kg)	Power Drift (dB)
MHz	Ch.									
2437	6	Rear	Fig.22	14.23	15.00	0.411	0.49	0.179	0.21	-0.09
2437	6	Front	/	14.23	15.00	0.153	0.18	0.137	0.16	-0.14

Note1: When the reported SAR of the initial test position is > 0.4 W/kg, SAR is repeated for the 802.11 transmission mode configuration tested in the initial test position using subsequent highest estimated 1-g SAR conditions determined by area scans, on the highest maximum output power channel, until the reported SAR is ≤ 0.8 W/kg.

Note2: For all positions/configurations tested using the initial test position and subsequent test positions, when the reported SAR is > 0.8 W/kg, SAR is measured for these test positions/configurations on the subsequent next highest measured output power channel until the reported SAR is ≤ 1.2 W/kg or all required channels are tested.

According to the KDB248227 D01, The reported SAR must be scaled to 100% transmission duty factor to determine compliance at the maximum tune-up tolerance limit. The scaled reported SAR is presented as below.

Table 14.3-15: SAR Values (WLAN - Body) – 802.11b (Scaled Reported SAR)

Frequency		Test Position	Actual duty factor	maximum duty factor	Reported SAR (1g)(W/kg)	Scaled reported SAR (1g)(W/kg)
MHz	Ch.					
2437	6	Rear	100%	100%	0.49	0.49

SAR is not required for OFDM because the 802.11b adjusted SAR ≤ 1.2 W/kg.

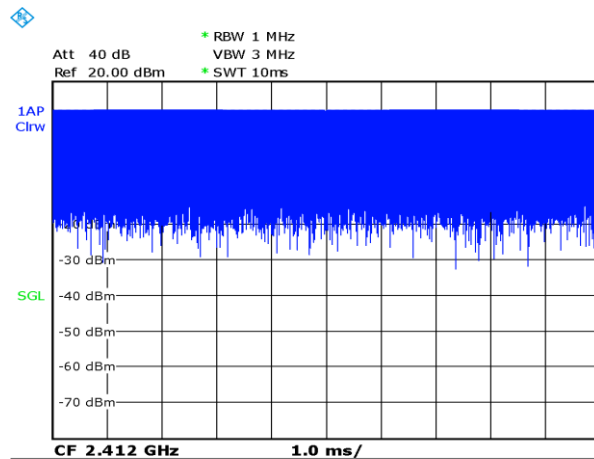

Picture 14.1 Duty factor plot for head

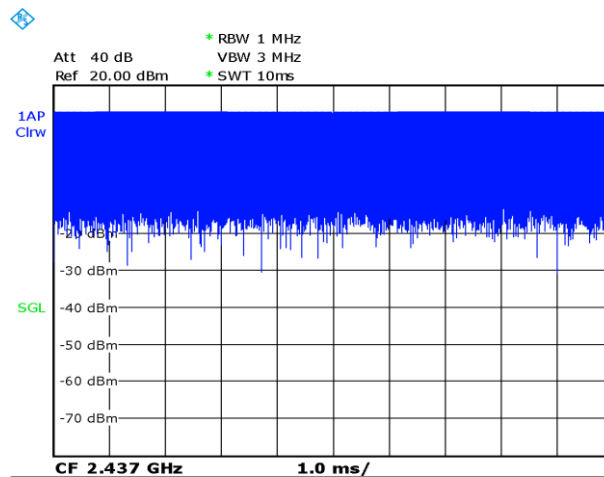

Picture 14.2 Duty factor plot for head

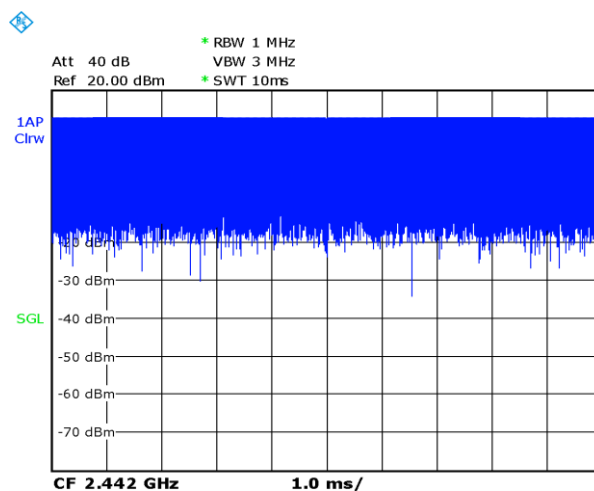

Picture 14.3 Duty factor plot for body

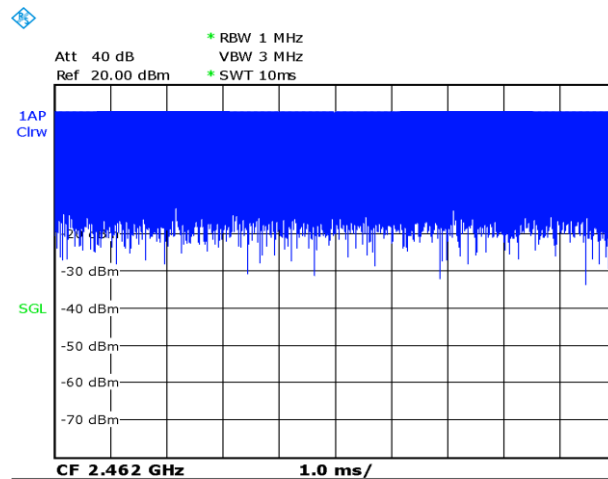

Picture 14.4 Duty factor plot for body

15 SAR Measurement Variability

SAR measurement variability must be assessed for each frequency band, which is determined by the SAR probe calibration point and tissue-equivalent medium used for the device measurements. When both head and body tissue-equivalent media are required for SAR measurements in a frequency band, the variability measurement procedures should be applied to the tissue medium with the highest measured SAR, using the highest measured SAR configuration for that tissue-equivalent medium.

The following procedures are applied to determine if repeated measurements are required.

- 1) Repeated measurement is not required when the original highest measured SAR is < 0.80 W/kg; steps 2) through 4) do not apply.
- 2) When the original highest measured SAR is ≥ 0.80 W/kg, repeat that measurement once.
- 3) Perform a second repeated measurement only if the ratio of largest to smallest SAR for the original and first repeated measurements is > 1.20 or when the original or repeated measurement is ≥ 1.45 W/kg ($\sim 10\%$ from the 1-g SAR limit).
- 4) Perform a third repeated measurement only if the original, first or second repeated measurement is ≥ 1.5 W/kg and the ratio of largest to smallest SAR for the original, first and second repeated measurements is > 1.20 .

Table 15.1: SAR Measurement Variability for Body GSM1900 (1g)

Frequency		Test Position	Original SAR (W/kg)	First Repeated SAR (W/kg)	The Ratio	Second Repeated SAR (W/kg)
Ch.	MHz					
661	1880	Rear	0.804	0.800	1.01	/
661	1880	Bottom Edge	0.842	0.829	1.02	/
512	1850.2	Bottom Edge	0.950	0.942	1.01	/

16 Measurement Uncertainty

16.1 Measurement Uncertainty for Normal SAR Tests (300MHz~3GHz)

No.	Error Description	Type	Uncertainty value	Probably Distribution	Div.	(Ci) 1g	(Ci) 10g	Std. Unc. (1g)	Std. Unc. (10g)	Degree of freedom
Measurement system										
1	Probe calibration	B	6.0	N	1	1	1	6.0	6.0	∞
2	Isotropy	B	4.7	R	$\sqrt{3}$	0.7	0.7	1.9	1.9	∞
3	Boundary effect	B	1.0	R	$\sqrt{3}$	1	1	0.6	0.6	∞
4	Linearity	B	4.7	R	$\sqrt{3}$	1	1	2.7	2.7	∞
5	Detection limit	B	1.0	N	1	1	1	0.6	0.6	∞
6	Readout electronics	B	0.3	R	$\sqrt{3}$	1	1	0.3	0.3	∞
7	Response time	B	0.8	R	$\sqrt{3}$	1	1	0.5	0.5	∞
8	Integration time	B	2.6	R	$\sqrt{3}$	1	1	1.5	1.5	∞
9	RF ambient conditions-noise	B	0	R	$\sqrt{3}$	1	1	0	0	∞
10	RF ambient conditions-reflection	B	0	R	$\sqrt{3}$	1	1	0	0	∞
11	Probe positioned mech. restrictions	B	0.4	R	$\sqrt{3}$	1	1	0.2	0.2	∞
12	Probe positioning with respect to phantom shell	B	2.9	R	$\sqrt{3}$	1	1	1.7	1.7	∞
13	Post-processing	B	1.0	R	$\sqrt{3}$	1	1	0.6	0.6	∞
Test sample related										
14	Test sample positioning	A	3.3	N	1	1	1	3.3	3.3	71
15	Device holder uncertainty	A	3.4	N	1	1	1	3.4	3.4	5
16	Drift of output power	B	5.0	R	$\sqrt{3}$	1	1	2.9	2.9	∞
Phantom and set-up										
17	Phantom uncertainty	B	4.0	R	$\sqrt{3}$	1	1	2.3	2.3	∞
18	Liquid conductivity (target)	B	5.0	R	$\sqrt{3}$	0.64	0.43	1.8	1.2	∞
19	Liquid conductivity (meas.)	A	2.06	N	1	0.64	0.43	1.32	0.89	43
20	Liquid permittivity (target)	B	5.0	R	$\sqrt{3}$	0.6	0.49	1.7	1.4	∞
21	Liquid permittivity (meas.)	A	1.6	N	1	0.6	0.49	1.0	0.8	521

Combined standard uncertainty	$u_c = \sqrt{\sum_{i=1}^{21} c_i^2 u_i^2}$						9.55	9.43	257
Expanded uncertainty (confidence interval of 95 %)	$u_e = 2u_c$						19.1	18.9	

16.2 Measurement Uncertainty for Normal SAR Tests (3~6GHz)

No.	Error Description	Type	Uncertainty value	Probably Distribution	Div.	(Ci) 1g	(Ci) 10g	Std. Unc. (1g)	Std. Unc. (10g)	Degree of freedom
Measurement system										
1	Probe calibration	B	6.55	N	1	1	1	6.55	6.55	∞
2	Isotropy	B	4.7	R	$\sqrt{3}$	0.7	0.7	1.9	1.9	∞
3	Boundary effect	B	2.0	R	$\sqrt{3}$	1	1	1.2	1.2	∞
4	Linearity	B	4.7	R	$\sqrt{3}$	1	1	2.7	2.7	∞
5	Detection limit	B	1.0	R	$\sqrt{3}$	1	1	0.6	0.6	∞
6	Readout electronics	B	0.3	R	$\sqrt{3}$	1	1	0.3	0.3	∞
7	Response time	B	0.8	R	$\sqrt{3}$	1	1	0.5	0.5	∞
8	Integration time	B	2.6	R	$\sqrt{3}$	1	1	1.5	1.5	∞
9	RF ambient conditions-noise	B	0	R	$\sqrt{3}$	1	1	0	0	∞
10	RFambient conditions-reflection	B	0	R	$\sqrt{3}$	1	1	0	0	∞
11	Probe positioned mech. restrictions	B	0.8	R	$\sqrt{3}$	1	1	0.5	0.5	∞
12	Probe positioning with respect to phantom shell	B	6.7	R	$\sqrt{3}$	1	1	3.9	3.9	∞
13	Post-processing	B	4.0	R	$\sqrt{3}$	1	1	2.3	2.3	∞
Test sample related										
14	Test sample positioning	A	3.3	N	1	1	1	3.3	3.3	71
15	Device holder uncertainty	A	3.4	N	1	1	1	3.4	3.4	5
16	Drift of output power	B	5.0	R	$\sqrt{3}$	1	1	2.9	2.9	∞
Phantom and set-up										
17	Phantom uncertainty	B	4.0	R	$\sqrt{3}$	1	1	2.3	2.3	∞
18	Liquid conductivity (target)	B	5.0	R	$\sqrt{3}$	0.64	0.43	1.8	1.2	∞
19	Liquid conductivity (meas.)	A	2.06	N	1	0.64	0.43	1.32	0.89	43
20	Liquid permittivity (target)	B	5.0	R	$\sqrt{3}$	0.6	0.49	1.7	1.4	∞

21	Liquid permittivity (meas.)	A	1.6	N	1	0.6	0.49	1.0	0.8	521
Combined standard uncertainty		$u_c = \sqrt{\sum_{i=1}^{21} c_i^2 u_i^2}$						10.7	10.6	257
Expanded uncertainty (confidence interval of 95 %)		$u_e = 2u_c$						21.4	21.1	

16.3 Measurement Uncertainty for Fast SAR Tests (300MHz~3GHz)

No.	Error Description	Type	Uncertainty value	Probably Distribution	Div.	(Ci) 1g	(Ci) 10g	Std. Unc. (1g)	Std. Unc. (10g)	Degree of freedom
Measurement system										
1	Probe calibration	B	6.0	N	1	1	1	6.0	6.0	∞
2	Isotropy	B	4.7	R	$\sqrt{3}$	0.7	0.7	1.9	1.9	∞
3	Boundary effect	B	1.0	R	$\sqrt{3}$	1	1	0.6	0.6	∞
4	Linearity	B	4.7	R	$\sqrt{3}$	1	1	2.7	2.7	∞
5	Detection limit	B	1.0	R	$\sqrt{3}$	1	1	0.6	0.6	∞
6	Readout electronics	B	0.3	R	$\sqrt{3}$	1	1	0.3	0.3	∞
7	Response time	B	0.8	R	$\sqrt{3}$	1	1	0.5	0.5	∞
8	Integration time	B	2.6	R	$\sqrt{3}$	1	1	1.5	1.5	∞
9	RF ambient conditions-noise	B	0	R	$\sqrt{3}$	1	1	0	0	∞
10	RFambient conditions-reflection	B	0	R	$\sqrt{3}$	1	1	0	0	∞
11	Probe positioned mech. Restrictions	B	0.4	R	$\sqrt{3}$	1	1	0.2	0.2	∞
12	Probe positioning with respect to phantom shell	B	2.9	R	$\sqrt{3}$	1	1	1.7	1.7	∞
13	Post-processing	B	1.0	R	$\sqrt{3}$	1	1	0.6	0.6	∞
14	Fast SAR z-Approximation	B	7.0	R	$\sqrt{3}$	1	1	4.0	4.0	∞
Test sample related										
15	Test sample positioning	A	3.3	N	1	1	1	3.3	3.3	71
16	Device holder uncertainty	A	3.4	N	1	1	1	3.4	3.4	5
17	Drift of output power	B	5.0	R	$\sqrt{3}$	1	1	2.9	2.9	∞
Phantom and set-up										
18	Phantom uncertainty	B	4.0	R	$\sqrt{3}$	1	1	2.3	2.3	∞
19	Liquid conductivity (target)	B	5.0	R	$\sqrt{3}$	0.64	0.43	1.8	1.2	∞

20	Liquid conductivity (meas.)	A	2.06	N	1	0.64	0.43	1.32	0.89	43
21	Liquid permittivity (target)	B	5.0	R	$\sqrt{3}$	0.6	0.49	1.7	1.4	∞
22	Liquid permittivity (meas.)	A	1.6	N	1	0.6	0.49	1.0	0.8	521
Combined standard uncertainty		$u_c = \sqrt{\sum_{i=1}^{22} c_i^2 u_i^2}$						10.4	10.3	257
Expanded uncertainty (confidence interval of 95 %)		$u_e = 2u_c$						20.8	20.6	

16.4 Measurement Uncertainty for Fast SAR Tests (3~6GHz)

No.	Error Description	Type	Uncertainty value	Probably Distribution	Div.	(Ci) 1g	(Ci) 10g	Std. Unc. (1g)	Std. Unc. (10g)	Degree of freedom
Measurement system										
1	Probe calibration	B	6.55	N	1	1	1	6.55	6.55	∞
2	Isotropy	B	4.7	R	$\sqrt{3}$	0.7	0.7	1.9	1.9	∞
3	Boundary effect	B	2.0	R	$\sqrt{3}$	1	1	1.2	1.2	∞
4	Linearity	B	4.7	R	$\sqrt{3}$	1	1	2.7	2.7	∞
5	Detection limit	B	1.0	R	$\sqrt{3}$	1	1	0.6	0.6	∞
6	Readout electronics	B	0.3	R	$\sqrt{3}$	1	1	0.3	0.3	∞
7	Response time	B	0.8	R	$\sqrt{3}$	1	1	0.5	0.5	∞
8	Integration time	B	2.6	R	$\sqrt{3}$	1	1	1.5	1.5	∞
9	RF ambient conditions-noise	B	0	R	$\sqrt{3}$	1	1	0	0	∞
10	RFambient conditions-reflection	B	0	R	$\sqrt{3}$	1	1	0	0	∞
11	Probe positioned mech. Restrictions	B	0.8	R	$\sqrt{3}$	1	1	0.5	0.5	∞
12	Probe positioning with respect to phantom shell	B	6.7	R	$\sqrt{3}$	1	1	3.9	3.9	∞
13	Post-processing	B	1.0	R	$\sqrt{3}$	1	1	0.6	0.6	∞
14	Fast SAR z-Approximation	B	14.0	R	$\sqrt{3}$	1	1	8.1	8.1	∞
Test sample related										
15	Test sample positioning	A	3.3	N	1	1	1	3.3	3.3	71
16	Device holder uncertainty	A	3.4	N	1	1	1	3.4	3.4	5

17	Drift of output power	B	5.0	R	$\sqrt{3}$	1	1	2.9	2.9	∞
Phantom and set-up										
18	Phantom uncertainty	B	4.0	R	$\sqrt{3}$	1	1	2.3	2.3	∞
19	Liquid conductivity (target)	B	5.0	R	$\sqrt{3}$	0.64	0.43	1.8	1.2	∞
20	Liquid conductivity (meas.)	A	2.06	N	1	0.64	0.43	1.32	0.89	43
21	Liquid permittivity (target)	B	5.0	R	$\sqrt{3}$	0.6	0.49	1.7	1.4	∞
22	Liquid permittivity (meas.)	A	1.6	N	1	0.6	0.49	1.0	0.8	521
Combined standard uncertainty		$u_c = \sqrt{\sum_{i=1}^{22} c_i^2 u_i^2}$						13.5	13.4	257
Expanded uncertainty (confidence interval of 95 %)		$u_e = 2u_c$						27.0	26.8	

17 MAIN TEST INSTRUMENTS

Table 17.1: List of Main Instruments

No.	Name	Type	Serial Number	Calibration Date	Valid Period
01	Network analyzer	E5071C	MY46110673	January 14, 2021	One year
02	Power meter	NRP2	106277	September 23, 2021	One year
03	Power sensor	NRP8S	104291		
04	Signal Generator	E4438C	MY49071430	February 1, 2021	One Year
05	Amplifier	60S1G4	0331848	No Calibration Requested	
06	BTS	CMW500	159890	January 25 2021	One year
07	BTS	CMW500	159889	January 13 2021	One year
08	E-field Probe	SPEAG EX3DV4	7517	February 03, 2021	One year
09	DAE	SPEAG DAE4	1525	September 1, 2021	One year
10	Dipole Validation Kit	SPEAG D835V2	4d069	July 12,,2021	One year
11	Dipole Validation Kit	SPEAG D1900V2	5d101	July 15,2021	One year
12	Dipole Validation Kit	SPEAG D2450V2	853	July 26,2021	One year
13	Dipole Validation Kit	SPEAG D2600V2	1012	July 26,2021	One year

END OF REPORT BODY

ANNEX A Graph Results

GSM850_CH128 Right Touch GPRS(2TX)

Date: 2/10/2022

Electronics: DAE4 Sn1525

Medium: head 835 MHz

Medium parameters used: $f = 848.8$; $\sigma = 0.879$ mho/m; $\epsilon_r = 42.3$; $\rho = 1000$ kg/m³

Ambient Temperature: 22.5°C, Liquid Temperature: 22.3°C

Communication System: GSM850 848.8 Duty Cycle: 1:4

Probe: EX3DV4 – SN7517 ConvF(9.40,9.40,9.40)

Area Scan (71x121x1): Interpolated grid: $dx=1.500$ mm, $dy=1.500$ mm

Maximum value of SAR (interpolated) = 0.166 W/kg

Zoom Scan (7x7x7)/Cube 0: Measurement grid: $dx=8$ mm, $dy=8$ mm, $dz=5$ mm

Reference Value = 3.604 V/m; Power Drift = 0.15 dB

Peak SAR (extrapolated) = 0.246 W/kg

SAR(1 g) = 0.190 W/kg; SAR(10 g) = 0.144 W/kg

Maximum value of SAR (measured) = 0.226 W/kg

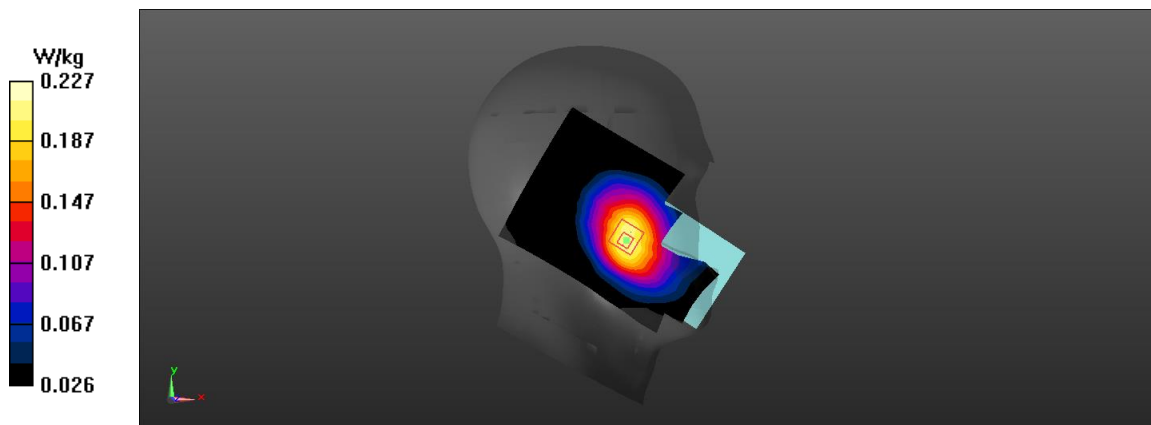

Fig A.1

GSM850_CH251 Rear GPRS 10mm 2TX

Date: 1/6/2022

Electronics: DAE4 Sn1525

Medium: head 835 MHz

Medium parameters used: $f = 848.8$ MHz; $\sigma = 0.905$ mho/m; $\epsilon_r = 41.37$; $\rho = 1000$ kg/m³

Ambient Temperature: 22.5°C, Liquid Temperature: 22.3°C

Communication System: GSM850 848.8 Duty Cycle: 1:4

Probe: EX3DV4 – SN7517 ConvF(9.40,9.40,9.40)

Area Scan (91x141x1): Interpolated grid: dx=1.500 mm, dy=1.500 mm

Maximum value of SAR (interpolated) = 0.431 W/kg

Zoom Scan (7x7x7)/Cube 0: Measurement grid: dx=8mm, dy=8mm, dz=5mm

Reference Value = 17.2 V/m; Power Drift = 0.09 dB

Peak SAR (extrapolated) = 0.552 W/kg

SAR(1 g) = 0.286 W/kg; SAR(10 g) = 0.156 W/kg

Maximum value of SAR (measured) = 0.443 W/kg

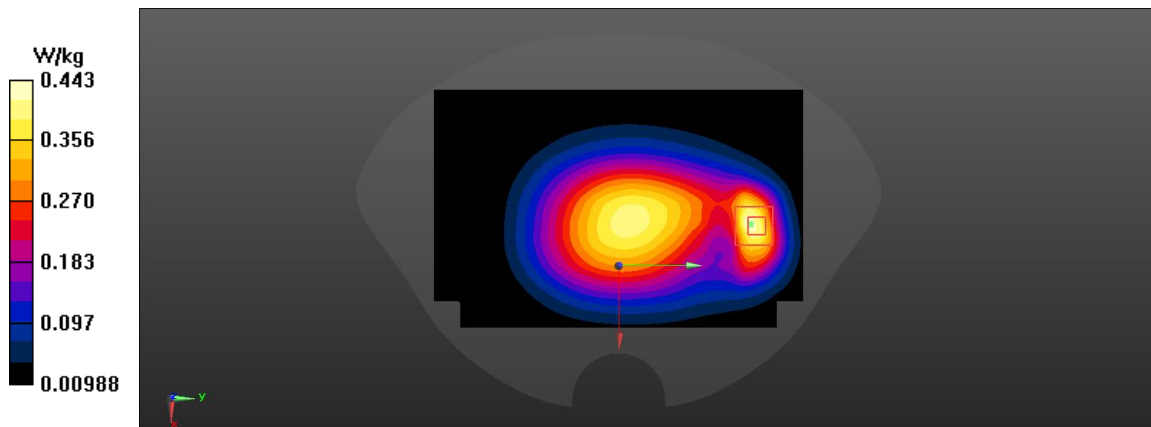

Fig A.2

PCS1900_CH512 Right Cheek GPRS(2TX)

Date: 2/10/2022

Electronics: DAE4 Sn1525

Medium: head 1900 MHz

Medium parameters used: $f = 1850.2$; $\sigma = 1.399$ mho/m; $\epsilon_r = 40.19$; $\rho = 1000$ kg/m³

Ambient Temperature: 22.5°C, Liquid Temperature: 22.3°C

Communication System: PCS1900 1850.2 Duty Cycle: 1:4

Probe: EX3DV4 – SN7584 ConvF(7.81,7.81,7.81)

Area Scan (71x121x1): Interpolated grid: dx=1.500 mm, dy=1.500 mm

Maximum value of SAR (interpolated) = 0.142 W/kg

Zoom Scan (7x7x7)/Cube 0: Measurement grid: dx=8mm, dy=8mm, dz=5mm

Reference Value = 2.069 V/m; Power Drift = -0.04 dB

Peak SAR (extrapolated) = 0.162 W/kg

SAR(1 g) = 0.11 W/kg; SAR(10 g) = 0.071 W/kg

Maximum value of SAR (measured) = 0.118 W/kg

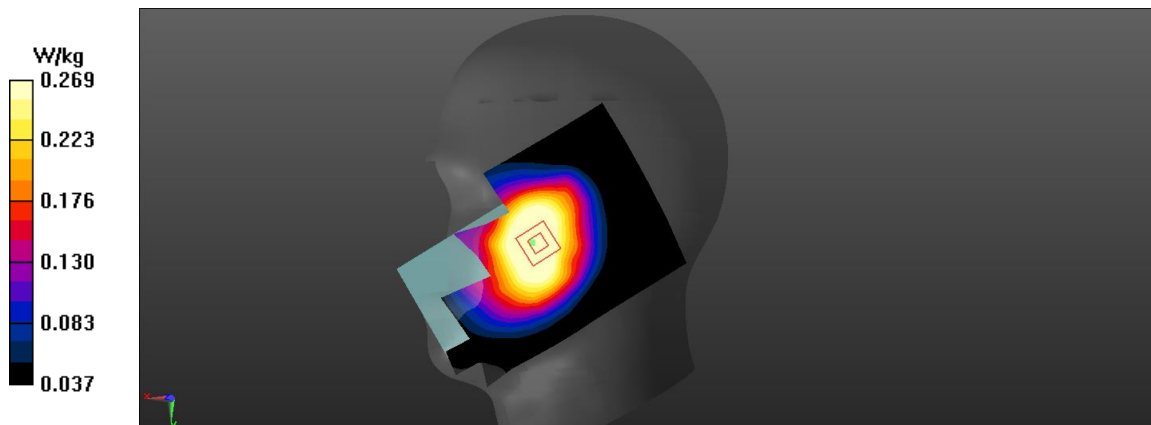
**Fig A.3**

PCS1900_CH512 Bottom Edge GPRS 10mm 2TX

Date: 1/8/2022

Electronics: DAE4 Sn1525

Medium: head 1900 MHz

Medium parameters used: $f = 1850.2$ MHz; $\sigma = 1.376$ mho/m; $\epsilon_r = 39.93$; $\rho = 1000$ kg/m³

Ambient Temperature: 22.5°C, Liquid Temperature: 22.3°C

Communication System: PCS1900 1850.2 Duty Cycle: 1:4

Probe: EX3DV4 – SN7517 ConvF(7.81,7.81,7.81)

Area Scan (71x121x1): Interpolated grid: dx=1.500 mm, dy=1.500 mm

Maximum value of SAR (interpolated) = 1.47 W/kg

Zoom Scan (7x7x7)/Cube 0: Measurement grid: dx=8mm, dy=8mm, dz=5mm

Reference Value =26.82 V/m; Power Drift = -0.03 dB

Peak SAR (extrapolated) = 1.75 W/kg

SAR(1 g) = 0.95 W/kg; SAR(10 g) = 0.503 W/kg

Maximum value of SAR (measured) = 1.44 W/kg

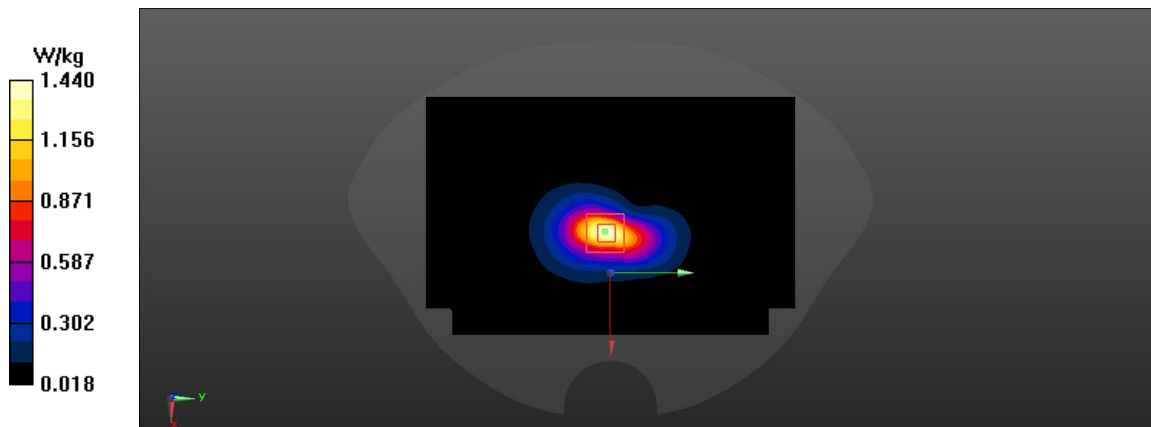
**Fig A.4**

WCDMA1900-BII_CH9262 Right Cheek

Date: 1/8/2022

Electronics: DAE4 Sn1525

Medium: head 1900 MHz

Medium parameters used: $f = 1852.4$ MHz; $\sigma = 1.364$ mho/m; $\epsilon_r = 40.66$; $\rho = 1000$ kg/m³

Ambient Temperature: 22.5°C, Liquid Temperature: 22.3°C

Communication System: WCDMA1900-BII 1852.4 Duty Cycle: 1:1

Probe: EX3DV4 – SN7517 ConvF(7.81,7.81,7.81)

Area Scan (71x121x1): Interpolated grid: dx=1.500 mm, dy=1.500 mm

Maximum value of SAR (interpolated) = 0.244 W/kg

Zoom Scan (7x7x7)/Cube 0: Measurement grid: dx=8mm, dy=8mm, dz=5mm

Reference Value = 2.973 V/m; Power Drift = -0.01 dB

Peak SAR (extrapolated) = 0.264 W/kg

SAR(1 g) = 0.174 W/kg; SAR(10 g) = 0.112 W/kg

Maximum value of SAR (measured) = 0.186 W/kg

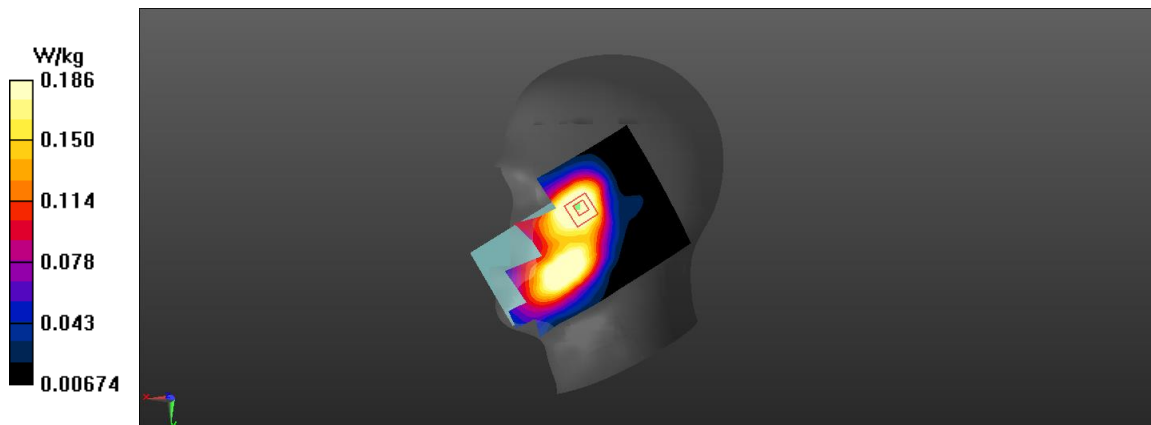
**Fig A.5**

WCDMA1900-BII_CH9538 Bottom Edge 10mm

Date: 1/8/2022

Electronics: DAE4 Sn1525

Medium: head 1900 MHz

Medium parameters used: $f = 1907.6$ MHz; $\sigma = 1.431$ mho/m; $\epsilon_r = 39.86$; $\rho = 1000$ kg/m³

Ambient Temperature: 22.5°C, Liquid Temperature: 22.3°C

Communication System: WCDMA1900-BII 1907.6 Duty Cycle: 1:1

Probe: EX3DV4 – SN7517 ConvF(7.81,7.81,7.81)

Area Scan (91x141x1): Interpolated grid: dx=1.500 mm, dy=1.500 mm

Maximum value of SAR (interpolated) = 0.952 W/kg

Zoom Scan (5x5x7)/Cube 0: Measurement grid: dx=8mm, dy=8mm, dz=5mm

Reference Value = 12.31 V/m; Power Drift = -0.19 dB

Peak SAR (extrapolated) = 1.17 W/kg

SAR(1 g) = 0.637 W/kg; SAR(10 g) = 0.338 W/kg

Maximum value of SAR (measured) = 0.976 W/kg

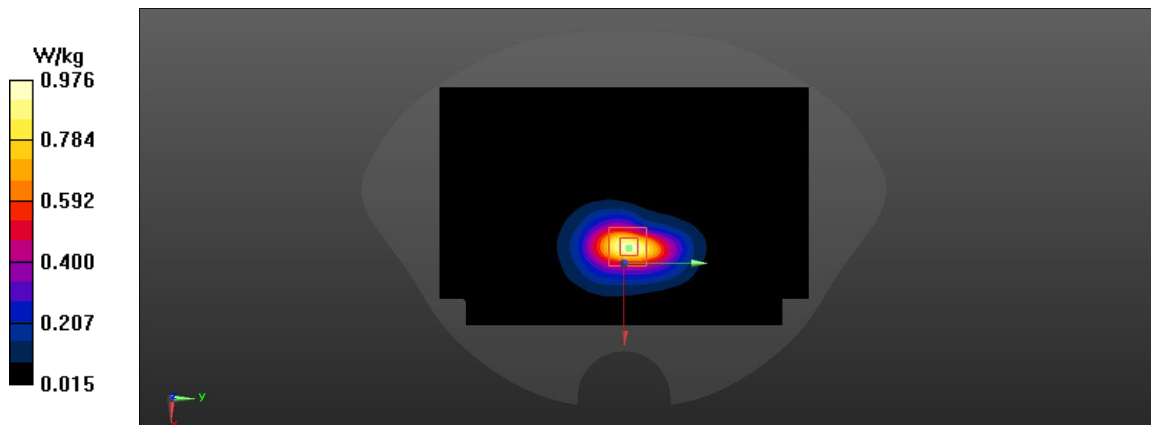

Fig A.6

WCDMA1900-BII_CH9262 Rear 15mm

Date: 1/8/2022

Electronics: DAE4 Sn1525

Medium: head 1900 MHz

Medium parameters used: $f = 1852$ MHz; $\sigma = 1.377$ mho/m; $\epsilon_r = 39.93$; $\rho = 1000$ kg/m³

Ambient Temperature: 22.5°C, Liquid Temperature: 22.3°C

Communication System: WCDMA1900-BII 1852 Duty Cycle: 1:1

Probe: EX3DV4 – SN7517 ConvF(7.81,7.81,7.81)

Area Scan (91x141x1): Interpolated grid: dx=1.500 mm, dy=1.500 mm

Maximum value of SAR (interpolated) = 0.46 W/kg

Zoom Scan (5x5x7)/Cube 0: Measurement grid: dx=8mm, dy=8mm, dz=5mm

Reference Value = 5.986 V/m; Power Drift = -0.1 dB

Peak SAR (extrapolated) = 0.543 W/kg

SAR(1 g) = 0.306 W/kg; SAR(10 g) = 0.174 W/kg

Maximum value of SAR (measured) = 0.454 W/kg

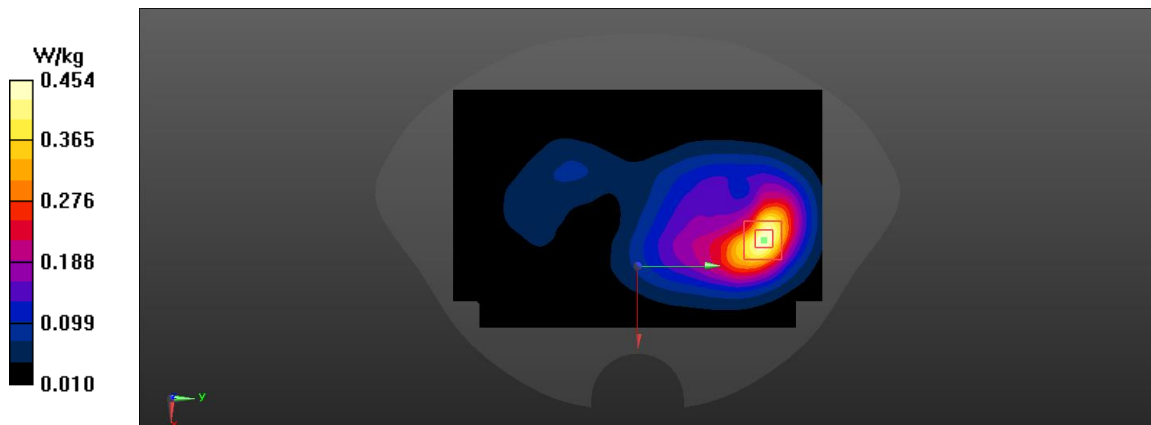
**Fig A.7**

WCDMA850-BV_CH4233 Left Cheek

Date: 1/6/2022

Electronics: DAE4 Sn1525

Medium: head 835 MHz

Medium parameters used: $f = 846.6$ MHz; $\sigma = 0.919$ mho/m; $\epsilon_r = 41.25$; $\rho = 1000$ kg/m³

Ambient Temperature: 22.5°C, Liquid Temperature: 22.3°C

Communication System: WCDMA850-BV 846.6 Duty Cycle: 1:1

Probe: EX3DV4 – SN7517 ConvF(9.40,9.40,9.40)

Area Scan (81x141x1): Interpolated grid: dx=1.500 mm, dy=1.500 mm

Maximum value of SAR (interpolated) = 0.448 W/kg

Zoom Scan (7x7x7)/Cube 0: Measurement grid: dx=8mm, dy=8mm, dz=5mm

Reference Value = 4.491 V/m; Power Drift = -0.19 dB

Peak SAR (extrapolated) = 0.517 W/kg

SAR(1 g) = 0.385 W/kg; SAR(10 g) = 0.285 W/kg

Maximum value of SAR (measured) = 0.469 W/kg

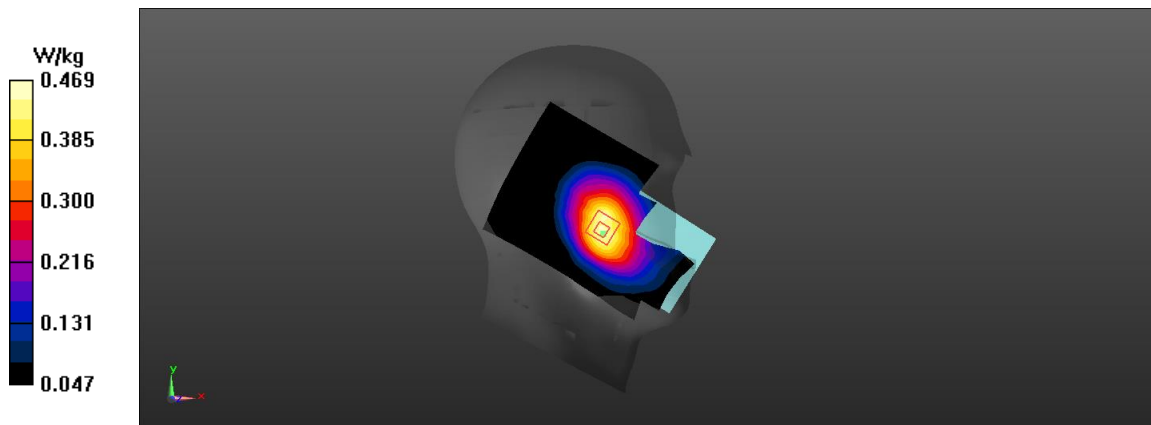
**Fig A.8**

WCDMA850-BV_CH4233 Rear 10mm

Date: 1/6/2022

Electronics: DAE4 Sn1525

Medium: head 835 MHz

Medium parameters used: $f = 846.6$ MHz; $\sigma = 0.903$ mho/m; $\epsilon_r = 41.38$; $\rho = 1000$ kg/m³

Ambient Temperature: 22.5°C, Liquid Temperature: 22.3°C

Communication System: WCDMA850-BV 846.6 Duty Cycle: 1:1

Probe: EX3DV4 – SN7517 ConvF(9.40,9.40,9.40)

Area Scan (71x121x1): Interpolated grid: dx=1.500 mm, dy=1.500 mm

Maximum value of SAR (interpolated) = 0.627 W/kg

Zoom Scan (7x7x7)/Cube 0: Measurement grid: dx=8mm, dy=8mm, dz=5mm

Reference Value = 23.48 V/m; Power Drift = 0.15 dB

Peak SAR (extrapolated) = 0.678 W/kg

SAR(1 g) = 0.517 W/kg; SAR(10 g) = 0.386 W/kg

Maximum value of SAR (measured) = 0.623 W/kg

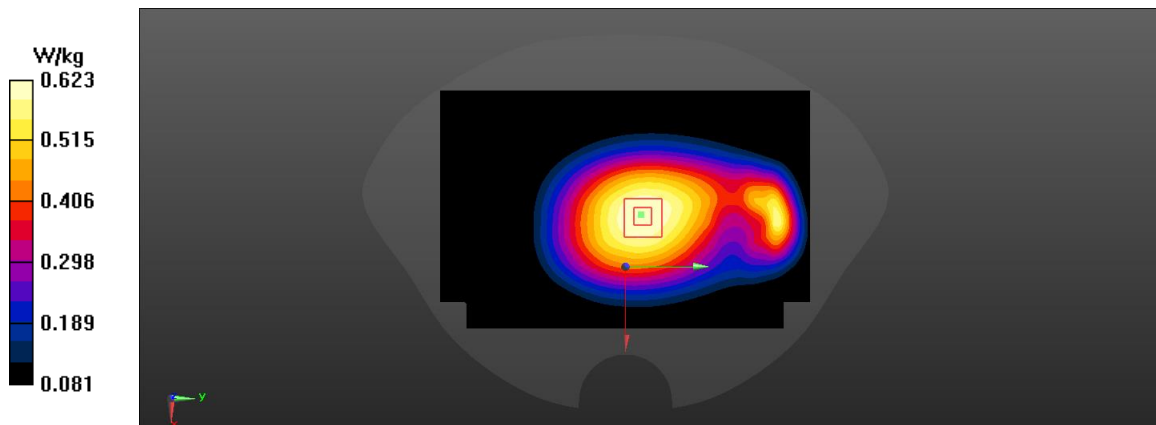
**Fig A.9**

LTE850-FDD5_CH20450 1RB-Middle Left Cheek

Date: 1/6/2022

Electronics: DAE4 Sn1525

Medium: head 835 MHz

Medium parameters used: $f = 829$ MHz; $\sigma = 0.902$ mho/m; $\epsilon_r = 41.27$; $\rho = 1000$ kg/m³

Ambient Temperature: 22.5°C, Liquid Temperature: 22.3°C

Communication System: LTE850-FDD5 829 MHz Duty Cycle: 1:1

Probe: EX3DV4 – SN7517 ConvF(9.40,9.40,9.40)

Area Scan (71x121x1): Interpolated grid: dx=1.500 mm, dy=1.500 mm

Maximum value of SAR (interpolated) = 0.372 W/kg

Zoom Scan (7x7x7)/Cube 0: Measurement grid: dx=8mm, dy=8mm, dz=5mm

Reference Value = 3.637 V/m; Power Drift = 0.04 dB

Peak SAR (extrapolated) = 0.43 W/kg

SAR(1 g) = 0.316 W/kg; SAR(10 g) = 0.233 W/kg

Maximum value of SAR (measured) = 0.391 W/kg

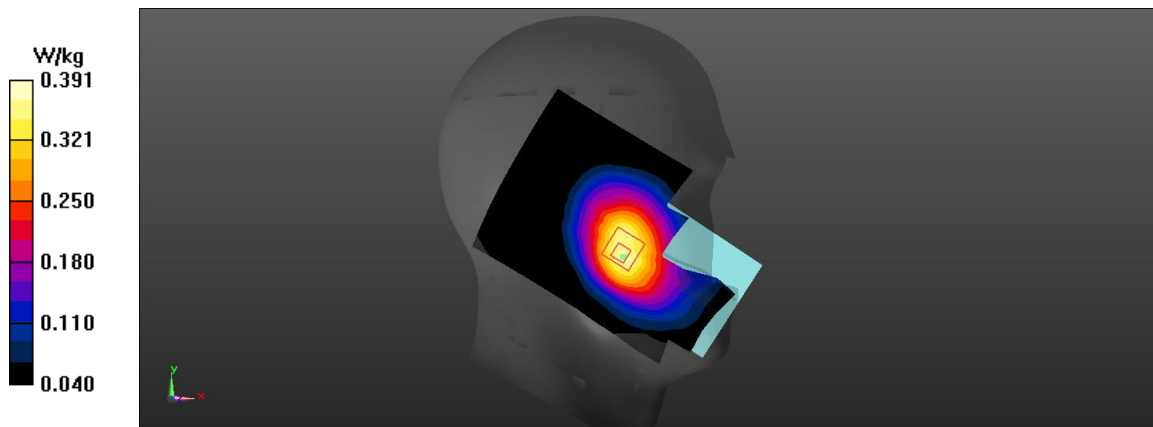

Fig A.10

LTE850-FDD5_CH20450 1RB-Middle Rear 10mm

Date: 1/6/2022

Electronics: DAE4 Sn1525

Medium: head 835 MHz

Medium parameters used: $f = 829$ MHz; $\sigma = 0.886$ mho/m; $\epsilon_r = 41.4$; $\rho = 1000$ kg/m³

Ambient Temperature: 22.5°C, Liquid Temperature: 22.3°C

Communication System: LTE850-FDD5 829 MHz Duty Cycle: 1:1

Probe: EX3DV4 – SN7517 ConvF(9.40,9.40,9.40)

Area Scan (71x121x1): Interpolated grid: dx=1.500 mm, dy=1.500 mm

Maximum value of SAR (interpolated) = 0.537 W/kg

Zoom Scan (7x7x7)/Cube 0: Measurement grid: dx=8mm, dy=8mm, dz=5mm

Reference Value = 21.33 V/m; Power Drift = 0.15 dB

Peak SAR (extrapolated) = 0.577 W/kg

SAR(1 g) = 0.421 W/kg; SAR(10 g) = 0.318 W/kg

Maximum value of SAR (measured) = 0.528 W/kg

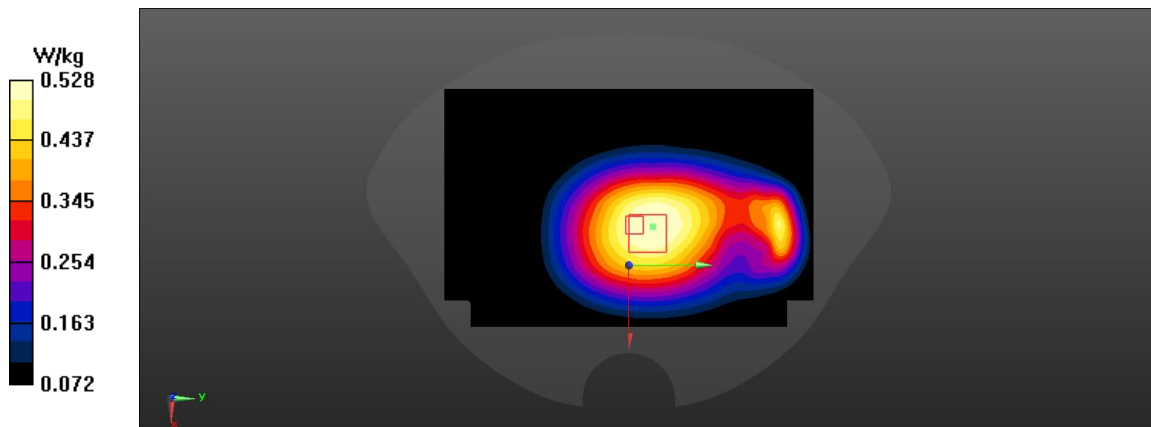

Fig A.11

LTE2500-FDD7_CH20850 1RB-Middle Left Cheek

Date: 1/10/2022

Electronics: DAE4 Sn1525

Medium: head 2600 MHz

Medium parameters used: $f = 2510$ MHz; $\sigma = 1.858$ mho/m; $\epsilon_r = 38.97$; $\rho = 1000$ kg/m³

Ambient Temperature: 22.5°C, Liquid Temperature: 22.3°C

Communication System: LTE2500-FDD7 2510 MHz Duty Cycle: 1:1

Probe: EX3DV4 – SN7517 ConvF(7.10,7.10,7.10)

Area Scan (71x121x1): Interpolated grid: dx=1.200 mm, dy=1.200 mm

Maximum value of SAR (interpolated) = 0.192 W/kg

Zoom Scan (7x7x7)/Cube 0: Measurement grid: dx=5mm, dy=5mm, dz=5mm

Reference Value = 0.886 V/m; Power Drift = 0.19 dB

Peak SAR (extrapolated) = 0.265 W/kg

SAR(1 g) = 0.124 W/kg; SAR(10 g) = 0.061 W/kg

Maximum value of SAR (measured) = 0.211 W/kg

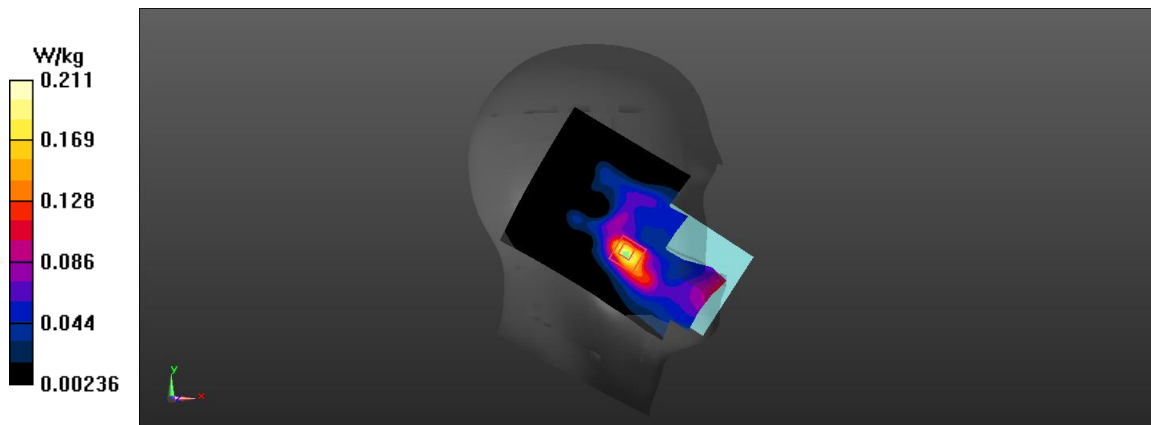

Fig A.12

LTE2500-FDD7_CH20850 1RB-Middle Bottom Edge 10mm

Date: 1/10/2022

Electronics: DAE4 Sn1525

Medium: head 2600 MHz

Medium parameters used: $f = 2510$ MHz; $\sigma = 1.89$ mho/m; $\epsilon_r = 39.61$; $\rho = 1000$ kg/m³

Ambient Temperature: 22.5°C, Liquid Temperature: 22.3°C

Communication System: LTE2500-FDD7 2510 MHz Duty Cycle: 1:1

Probe: EX3DV4 – SN7517 ConvF(7.10,7.10,7.10)

Area Scan (71x121x1): Interpolated grid: dx=1.200 mm, dy=1.200 mm

Maximum value of SAR (interpolated) = 1.24 W/kg

Zoom Scan (7x7x7)/Cube 0: Measurement grid: dx=5mm, dy=5mm, dz=5mm

Reference Value = 20.99 V/m; Power Drift = 0.09 dB

Peak SAR (extrapolated) = 1.49 W/kg

SAR(1 g) = 0.74909149874 W/kg; SAR(10 g) = 0.363 W/kg

Maximum value of SAR (measured) = 1.21 W/kg

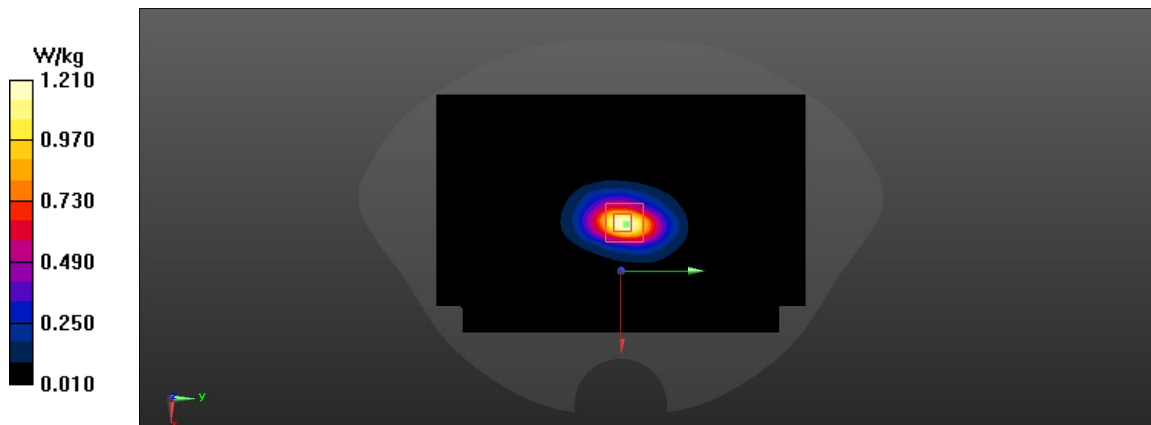

Fig A.13

LTE2500-FDD7_CH20850 1RB-Middle Rear 15mm

Date: 1/10/2022

Electronics: DAE4 Sn1525

Medium: head 2600 MHz

Medium parameters used: $f = 2510$ MHz; $\sigma = 1.89$ mho/m; $\epsilon_r = 39.61$; $\rho = 1000$ kg/m³

Ambient Temperature: 22.5°C, Liquid Temperature: 22.3°C

Communication System: LTE2500-FDD7 2510 MHz Duty Cycle: 1:1

Probe: EX3DV4 – SN7517 ConvF(7.10,7.10,7.10)

Area Scan (71x121x1): Interpolated grid: dx=1.200 mm, dy=1.200 mm

Maximum value of SAR (interpolated) = 0.546 W/kg

Zoom Scan (7x7x7)/Cube 0: Measurement grid: dx=5mm, dy=5mm, dz=5mm

Reference Value = 1.408 V/m; Power Drift = -0.17 dB

Peak SAR (extrapolated) = 0.666 W/kg

SAR(1 g) = 0.366 W/kg; SAR(10 g) = 0.19 W/kg

Maximum value of SAR (measured) = 0.556 W/kg

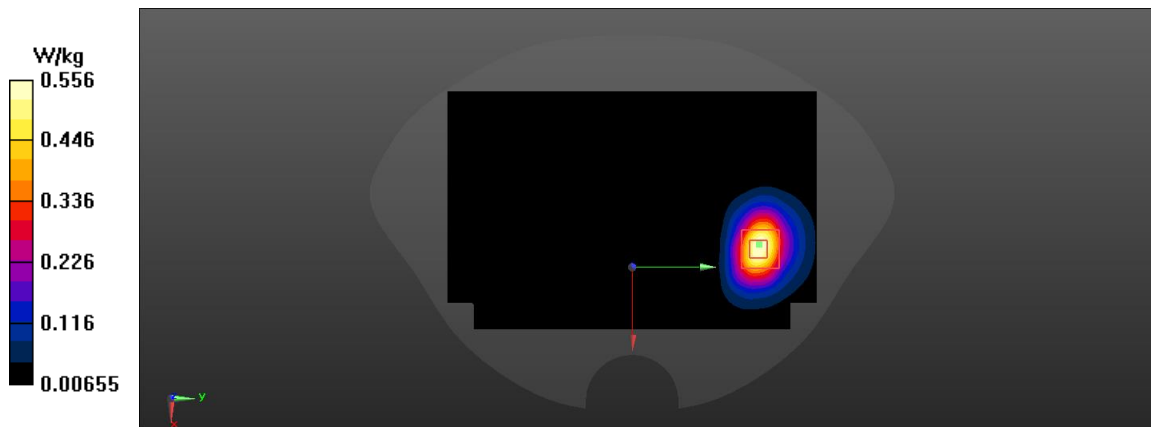

Fig A.14

LTE2600-TDD41_CH41490 1RB-Middle Right Cheek

Date: 1/10/2022

Electronics: DAE4 Sn1525

Medium: head 2600 MHz

Medium parameters used: $f = 2510$ MHz; $\sigma = 1.858$ mho/m; $\epsilon_r = 38.97$; $\rho = 1000$ kg/m³

Ambient Temperature: 22.5°C, Liquid Temperature: 22.3°C

Communication System: LTE2600-TDD41 2510 MHz Duty Cycle: 1:1.58

Probe: EX3DV4 – SN7517 ConvF(7.10,7.10,7.10)

Area Scan (81x131x1): Interpolated grid: dx=1.200 mm, dy=1.200 mm

Maximum value of SAR (interpolated) = 0.0757 W/kg

Zoom Scan (5x5x7)/Cube 0: Measurement grid: dx=5mm, dy=5mm, dz=5mm

Reference Value = 1.226 V/m; Power Drift = 0.08 dB

Peak SAR (extrapolated) = 0.079 W/kg

SAR(1 g) = 0.043 W/kg; SAR(10 g) = 0.022 W/kg

Maximum value of SAR (measured) = 0.0487s W/kg

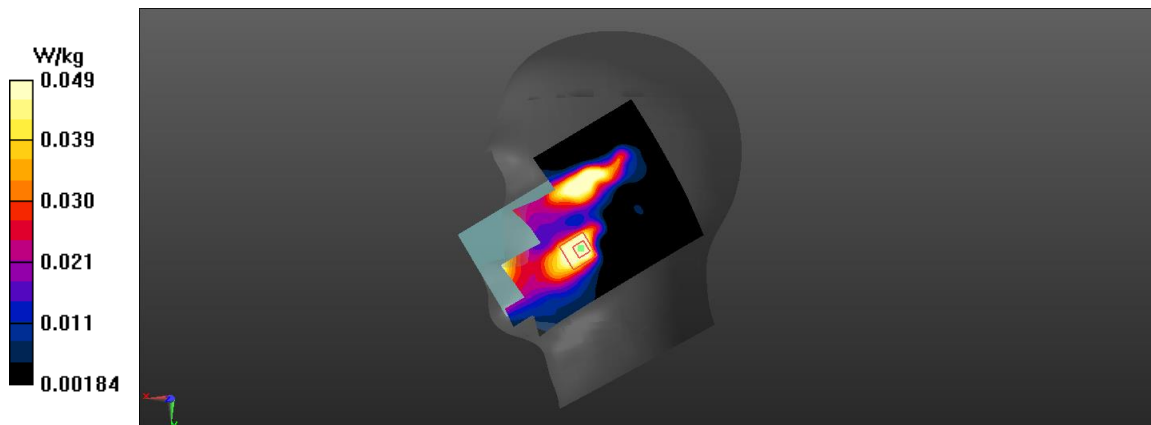

Fig A.15

LTE2600-TDD41_CH41490 1RB-Middle Bottom Edge 10mm

Date: 1/10/2022

Electronics: DAE4 Sn1525

Medium: head 2600 MHz

Medium parameters used: $f = 2510$ MHz; $\sigma = 1.89$ mho/m; $\epsilon_r = 39.61$; $\rho = 1000$ kg/m³

Ambient Temperature: 22.5°C, Liquid Temperature: 22.3°C

Communication System: LTE2600-TDD41 2510 MHz Duty Cycle: 1:1.58

Probe: EX3DV4 – SN7517 ConvF(7.10,7.10,7.10)

Area Scan (91x141x1): Interpolated grid: dx=1.200 mm, dy=1.200 mm

Maximum value of SAR (interpolated) = 1.11 W/kg

Zoom Scan (7x7x7)/Cube 0: Measurement grid: dx=5mm, dy=5mm, dz=5mm

Reference Value = 17.59 V/m; Power Drift = -0.01 dB

Peak SAR (extrapolated) = 1.3 W/kg

SAR(1 g) = 0.64 W/kg; SAR(10 g) = 0.301 W/kg

Maximum value of SAR (measured) = 1.06 W/kg

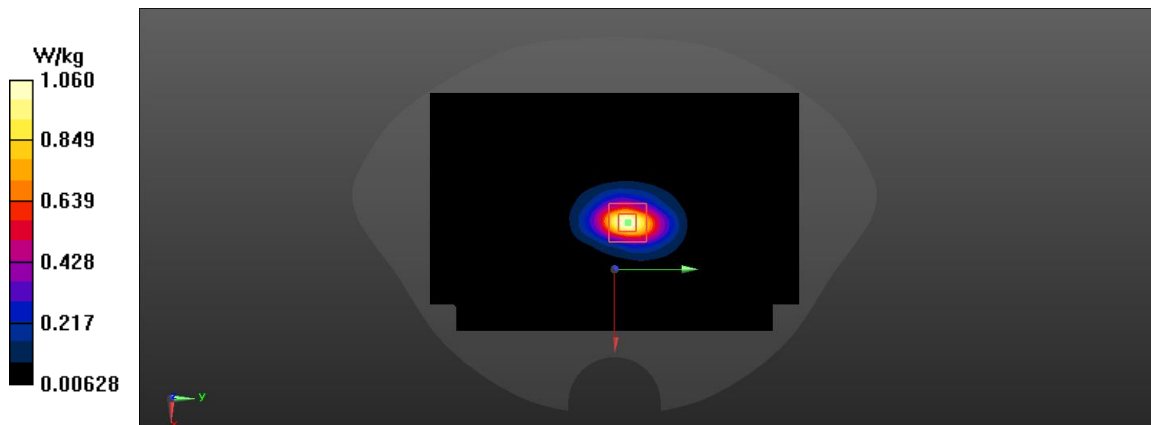

Fig A.16

LTE2600-TDD41_CH41490 1RB-Middle Rear 15mm

Date: 1/10/2022

Electronics: DAE4 Sn1525

Medium: head 2600 MHz

Medium parameters used: $f = 2510$ MHz; $\sigma = 1.89$ mho/m; $\epsilon_r = 39.61$; $\rho = 1000$ kg/m³

Ambient Temperature: 22.5°C, Liquid Temperature: 22.3°C

Communication System: LTE2600-TDD41 2510 MHz Duty Cycle: 1:1.58

Probe: EX3DV4 – SN7517 ConvF(7.10,7.10,7.10)

Area Scan (71x121x1): Interpolated grid: dx=1.200 mm, dy=1.200 mm

Maximum value of SAR (interpolated) = 0.506 W/kg

Zoom Scan (7x7x7)/Cube 0: Measurement grid: dx=5mm, dy=5mm, dz=5mm

Reference Value = 0.615 V/m; Power Drift = -0.09 dB

Peak SAR (extrapolated) = 0.615 W/kg

SAR(1 g) = 0.323 W/kg; SAR(10 g) = 0.163 W/kg

Maximum value of SAR (measured) = 0.506 W/kg

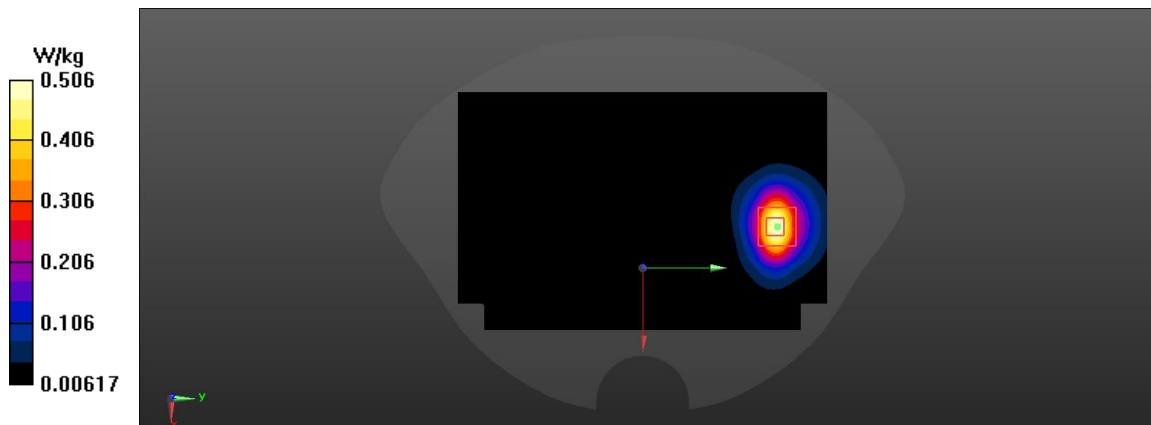

Fig A.17

WLAN2450_CH1 802.11b 1M Right Tilt

Date: 1/9/2022

Electronics: DAE4 Sn1525

Medium: head 2450 MHz

Medium parameters used: $f = 2437$ MHz; $\sigma = 1.751$ mho/m; $\epsilon_r = 38.81$; $\rho = 1000$ kg/m³

Ambient Temperature: 22.5°C, Liquid Temperature: 22.3°C

Communication System: WLAN2450 2427 Duty Cycle: 1:1

Probe: EX3DV4 – SN7517 ConvF(7.34,7.34,7.34)

Area Scan (71x121x1): Interpolated grid: dx=1.200 mm, dy=1.200 mm

Maximum value of SAR (interpolated) = 1.01 W/kg

Zoom Scan (7x7x7)/Cube 0: Measurement grid: dx=5mm, dy=5mm, dz=5mm

Reference Value = 10.72 V/m; Power Drift = 0.10 dB

Peak SAR (extrapolated) = 1.64 W/kg

SAR(1 g) = 0.611 W/kg; SAR(10 g) = 0.290W/kg

Maximum value of SAR (measured) = 0.712W/kg

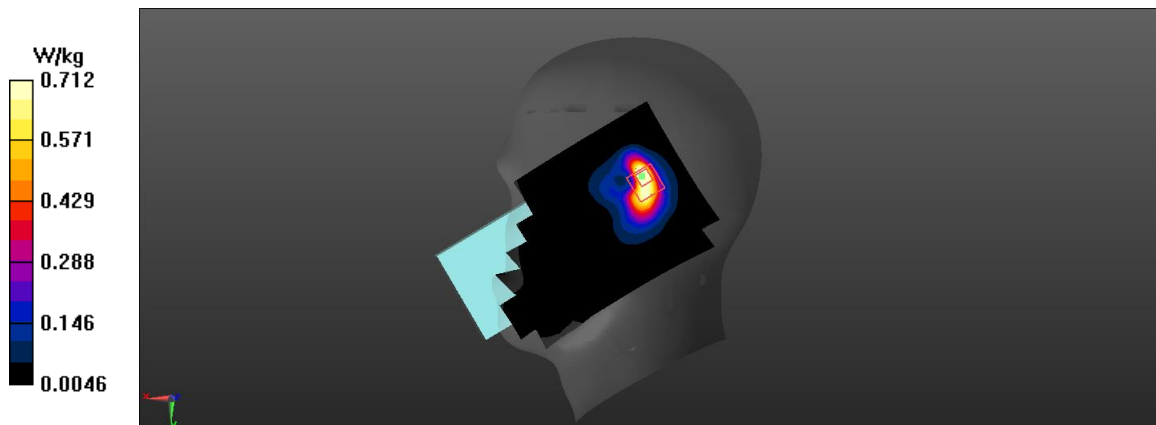

Fig A.18

WLAN2450_CH11 802.11b 1M Rear 10mm

Date: 1/9/2022

Electronics: DAE4 Sn1525

Medium: head 2450 MHz

Medium parameters used: $f = 2437$ MHz; $\sigma = 1.83$ mho/m; $\epsilon_r = 39.11$; $\rho = 1000$ kg/m³

Ambient Temperature: 22.5°C, Liquid Temperature: 22.3°C

Communication System: WLAN2450 2437 Duty Cycle: 1:1

Probe: EX3DV4 – SN7517 ConvF(7.34,7.34,7.34)

Area Scan (71x121x1): Interpolated grid: dx=1.200 mm, dy=1.200 mm

Maximum value of SAR (interpolated) = 1.28 W/kg

Zoom Scan (7x7x7)/Cube 0: Measurement grid: dx=5mm, dy=5mm, dz=5mm

Reference Value = 1.704 V/m; Power Drift = 0.18 dB

Peak SAR (extrapolated) = 1.61 W/kg

SAR(1 g) = 0.797 W/kg; SAR(10 g) = 0.376 W/kg

Maximum value of SAR (measured) = 1.31 W/kg

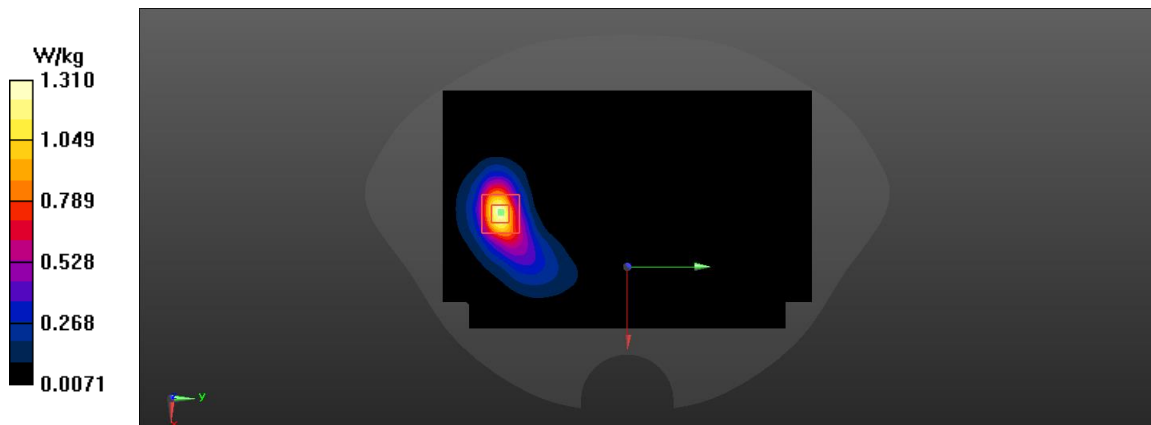

Fig A.19

WLAN2450_CH6 802.11b 1M Right Tilt

Date: 1/9/2022

Electronics: DAE4 Sn1525

Medium: head 2450 MHz

Medium parameters used: $f = 2437$ MHz; $\sigma = 1.775$ mho/m; $\epsilon_r = 38.78$; $\rho = 1000$ kg/m³

Ambient Temperature: 22.5°C, Liquid Temperature: 22.3°C

Communication System: WLAN2450 2437 Duty Cycle: 1:1

Probe: EX3DV4 – SN7517 ConvF(7.34,7.34,7.34)

Area Scan (71x121x1): Interpolated grid: dx=1.200 mm, dy=1.200 mm

Maximum value of SAR (interpolated) = 0.686 W/kg

Zoom Scan (7x7x7)/Cube 0: Measurement grid: dx=5mm, dy=5mm, dz=5mm

Reference Value = 9.674 V/m; Power Drift = -0.05 dB

Peak SAR (extrapolated) = 1.02 W/kg

SAR(1 g) = 0.438 W/kg; SAR(10 g) = 0.186 W/kg

Maximum value of SAR (measured) = 0.442 W/kg

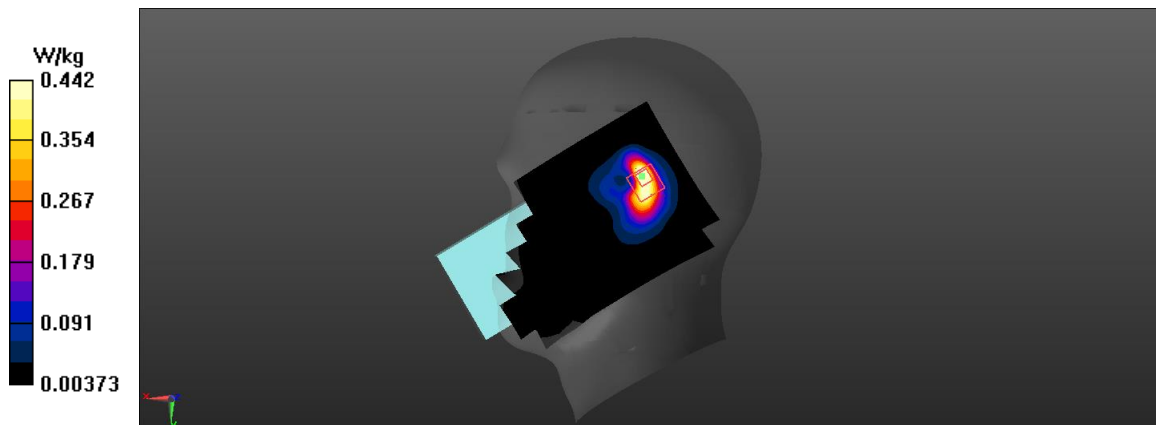

Fig A.20

WLAN2450_CH6 802.11b 1M Rear 10mm

Date: 1/9/2022

Electronics: DAE4 Sn1525

Medium: head 2450 MHz

Medium parameters used: $f = 2437$ MHz; $\sigma = 1.807$ mho/m; $\epsilon_r = 39.14$; $\rho = 1000$ kg/m³

Ambient Temperature: 22.5°C, Liquid Temperature: 22.3°C

Communication System: WLAN2450 2437 Duty Cycle: 1:1

Probe: EX3DV4 – SN7517 ConvF(7.34,7.34,7.34)

Area Scan (71x121x1): Interpolated grid: dx=1.200 mm, dy=1.200 mm

Maximum value of SAR (interpolated) = 0.442 W/kg

Zoom Scan (7x7x7)/Cube 0: Measurement grid: dx=5mm, dy=5mm, dz=5mm

Reference Value = 0.568 V/m; Power Drift = 0.16 dB

Peak SAR (extrapolated) = 0.521 W/kg

SAR(1 g) = 0.264 W/kg; SAR(10 g) = 0.127 W/kg

Maximum value of SAR (measured) = 0.426 W/kg

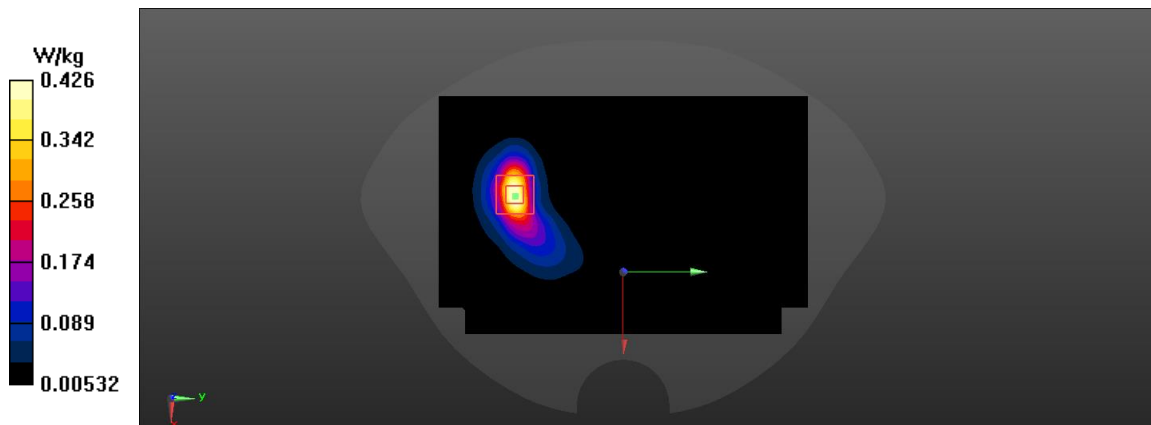

Fig A.21

WLAN2450_CH6 802.11b 1M Rear 15mm

Date: 1/9/2022

Electronics: DAE4 Sn1525

Medium: head 2450 MHz

Medium parameters used: $f = 2437$ MHz; $\sigma = 1.857$ mho/m; $\epsilon_r = 37.979$; $\rho = 1000$ kg/m³

Ambient Temperature: 22.5°C, Liquid Temperature: 22.3°C

Communication System: WLAN2450 2437 Duty Cycle: 1:1

Probe: EX3DV4 – SN7517 ConvF(7.34,7.34,7.34)

Area Scan (71x121x1): Interpolated grid: dx=1.200 mm, dy=1.200 mm

Maximum value of SAR (interpolated) = 0.437 W/kg

Zoom Scan (7x7x7)/Cube 0: Measurement grid: dx=5mm, dy=5mm, dz=5mm

Reference Value = 0.477 V/m; Power Drift = -0.09 dB

Peak SAR (extrapolated) = 0.521 W/kg

SAR(1 g) = 0.411 W/kg; SAR(10 g) = 0.170 W/kg

Maximum value of SAR (measured) = 0.526 W/kg

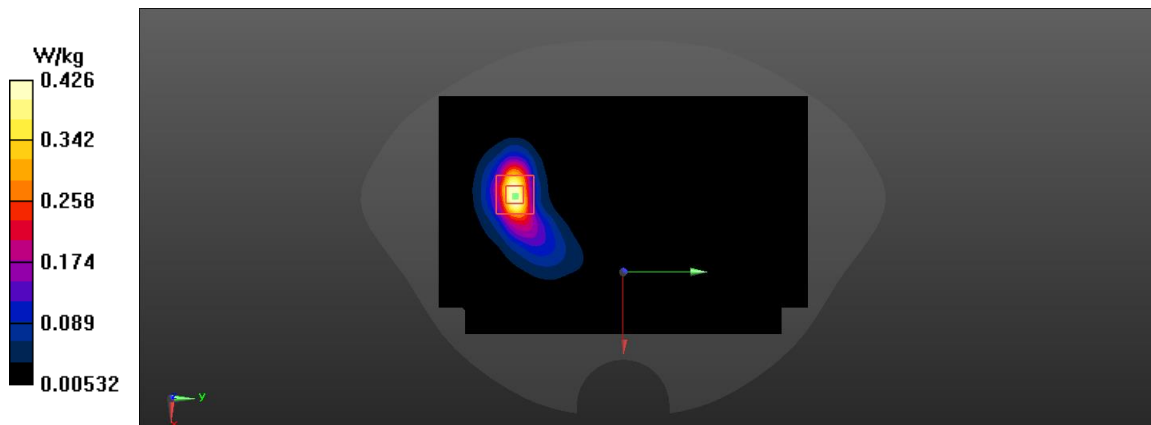

Fig A.21

Fig. 1-1 Z-Scan at power reference point (850 MHz)

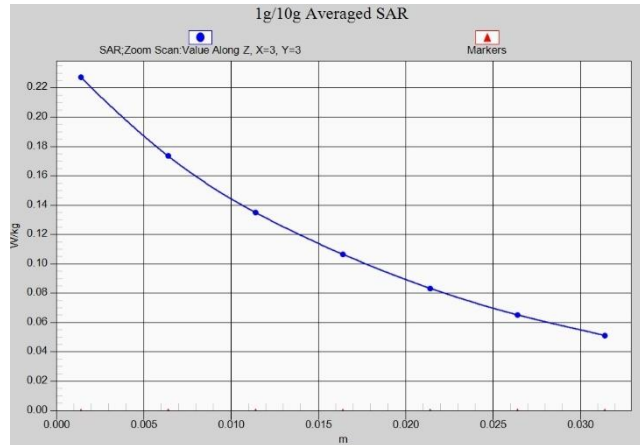

Fig. 1-2 Z-Scan at power reference point (850 MHz)

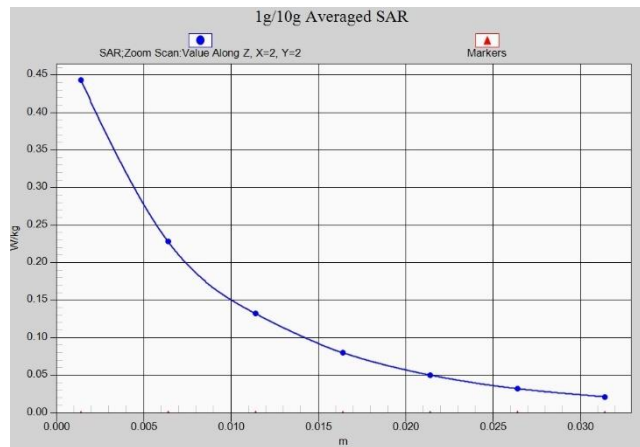

Fig. 1-3 Z-Scan at power reference point (1900 MHz)

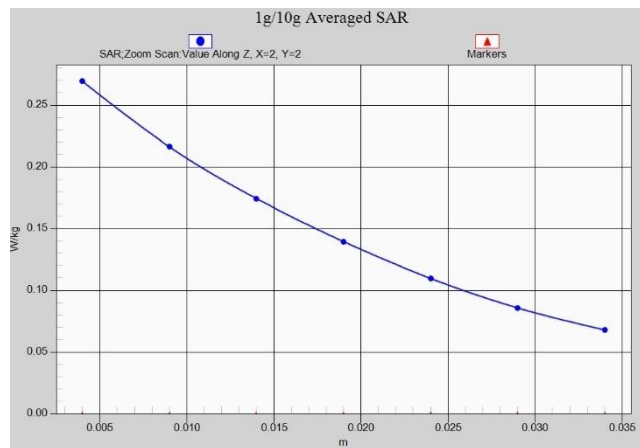

Fig. 1-4 Z-Scan at power reference point (1900 MHz)

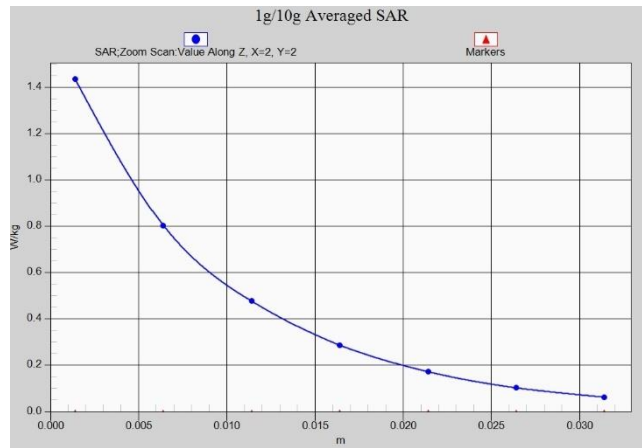

Fig. 1-5 Z-Scan at power reference point (WCDMA850)

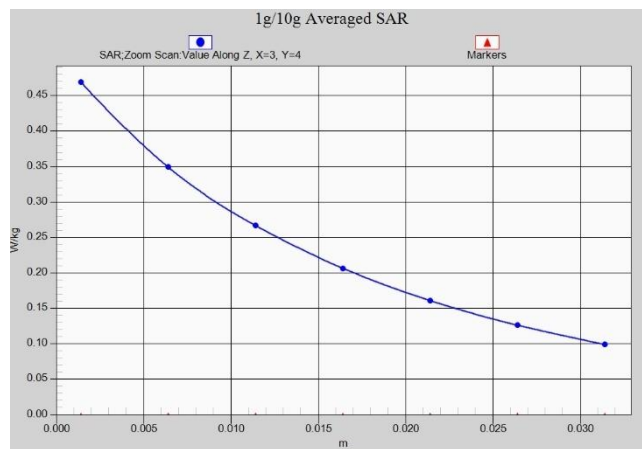

Fig. 1-6 Z-Scan at power reference point (WCDMA850)

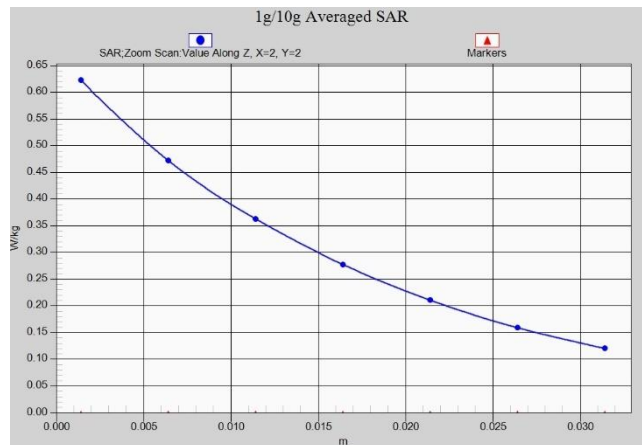

Fig. 1-7 Z-Scan at power reference point (WCDMA1700)

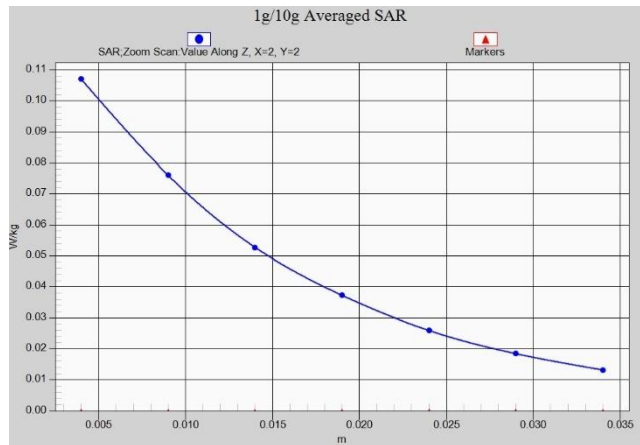

Fig. 1-8 Z-Scan at power reference point (WCDMA1900)

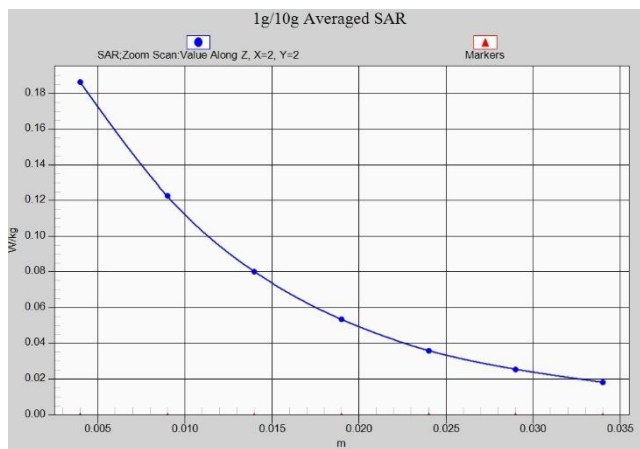

Fig. 1-9 Z-Scan at power reference point (WCDMA1900)

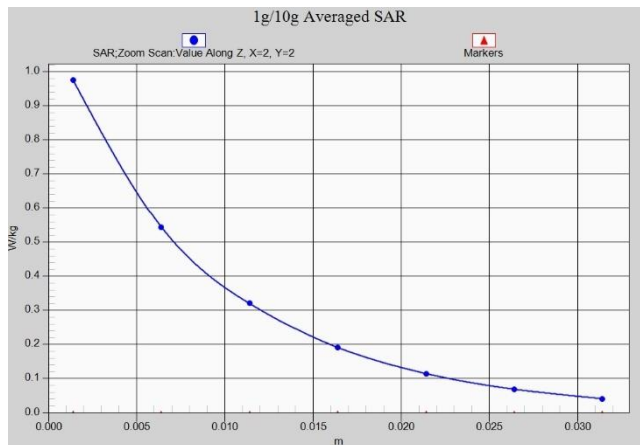

Fig. 1-10 Z-Scan at power reference point (WCDMA1900)

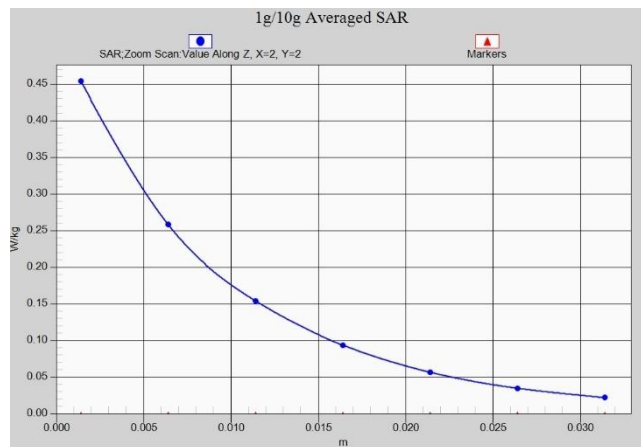

Fig. 1-11 Z-Scan at power reference point (LTE Band5)

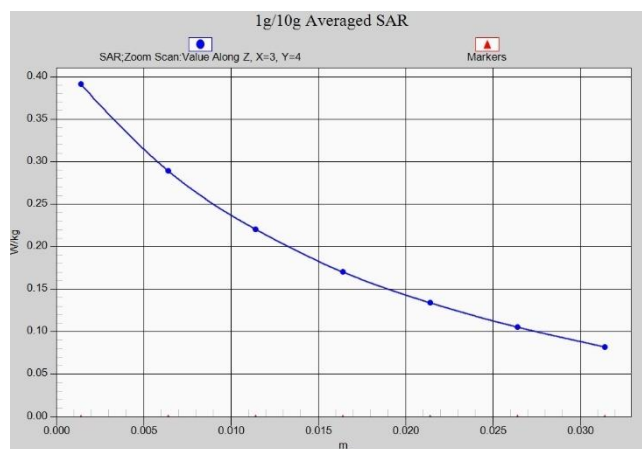

Fig. 1-12 Z-Scan at power reference point (LTE Band5)

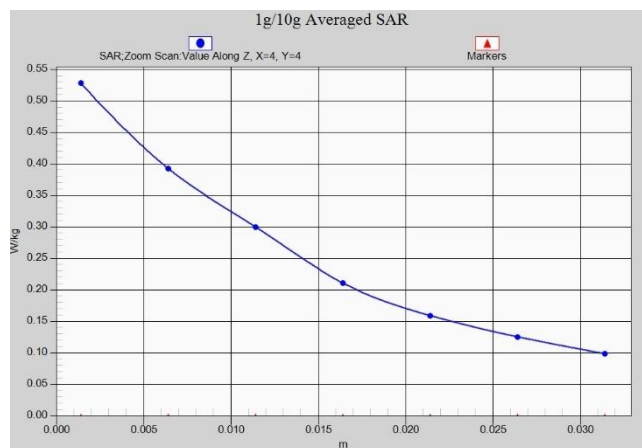

Fig. 1-13 Z-Scan at power reference point (LTE Band7)

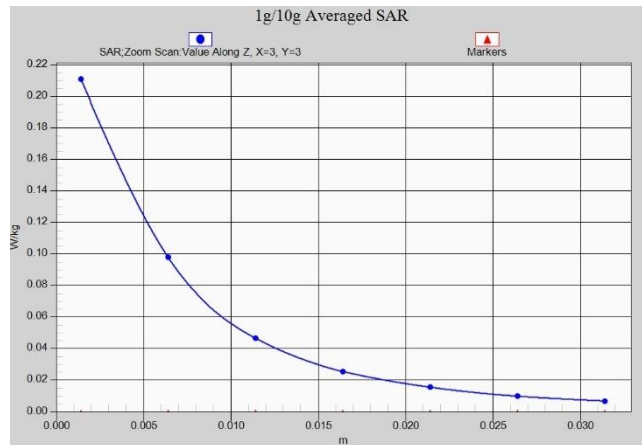

Fig. 1-14 Z-Scan at power reference point (LTE Band7)

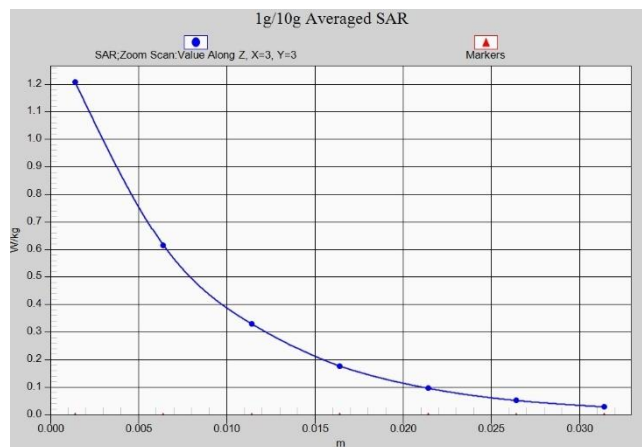

Fig. 1-15 Z-Scan at power reference point (LTE Band7)

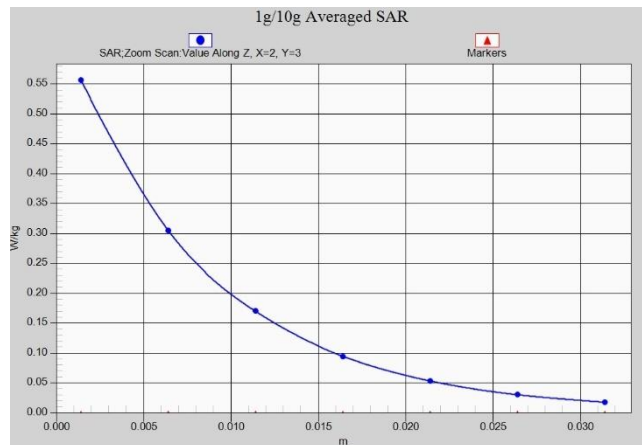

Fig. 1-16 Z-Scan at power reference point (LTE Band41)