



HAC RF TEST REPORT

No. I22Z60193-SEM02

For

TCL Communication Ltd.

GSM/UMTS/LTE /NR Mobile phone

Model Name: T767W

With

Hardware Version: 03

Software Version: BKS3

FCC ID: 2ACCJH155

Results Summary: M Category = M3

Issued Date: 2022-03-04

Note:

The test results in this test report relate only to the devices specified in this report. This report shall not be reproduced except in full without the written approval of CTTL.

Test Laboratory:

CTTL, Telecommunication Technology Labs, CAICT

No. 51, Xueyuan Road, Haidian District, Beijing, P. R. China 100191.

Tel:+86(0)10-62304633-2512, Fax:+86(0)10-62304633-2504

Email: ctl_terminals@caict.ac.cn, website: www.caict.ac.cn



No.I22Z60193-SEM02

REPORT HISTORY

Report Number	Revision	Issue Date	Description
I22Z60193-SEM02	Rev.0	2022-03-04	Initial creation of test report

TABLE OF CONTENT

1 TEST LABORATORY	5
1.1 TESTING LOCATION	5
1.2 TESTING ENVIRONMENT.....	5
1.3 PROJECT DATA	5
1.4 SIGNATURE.....	5
2 CLIENT INFORMATION	6
2.1 APPLICANT INFORMATION	6
2.2 MANUFACTURER INFORMATION	6
3 EQUIPMENT UNDER TEST (EUT) AND ANCILLARY EQUIPMENT (AE)	7
3.1 ABOUT EUT	7
3.2 INTERNAL IDENTIFICATION OF EUT USED DURING THE TEST	7
3.3 INTERNAL IDENTIFICATION OF AE USED DURING THE TEST	7
3.4 AIR INTERFACES / BANDS INDICATING OPERATING MODES	8
4 MAXIMUM OUTPUT POWER.	9
5 REFERENCE DOCUMENTS.....	12
5.1 REFERENCE DOCUMENTS FOR TESTING	12
6 OPERATIONAL CONDITIONS DURING TEST	13
6.1 HAC MEASUREMENT SET-UP.....	13
6.2 PROBE SPECIFICATION	14
6.3 TEST ARCH PHANTOM &PHONE POSITIONER	15
6.4 ROBOTIC SYSTEM SPECIFICATIONS	15
7 EUT ARRANGEMENT	16
7.1 WD RF EMISSION MEASUREMENTS REFERENCE AND PLANE	16
8 SYSTEM VALIDATION	17
8.1 VALIDATION PROCEDURE	17
8.2 VALIDATION RESULT	17
9 EVALUATION OF MIF	18
9.1 INTRODUCTION.....	18
9.2 MIF MEASUREMENT WITH THE AIA	19
9.3 TEST EQUIPMENT FOR THE MIF MEASUREMENT	19
9.4 DUT MIF RESULTS.....	19
10 EVALUATION FOR LOW-POWER EXEMPTION	21
10.1 PRODUCT TESTING THRESHOLD	21
10.2 CONDUCTED POWER.....	21
10.3 CONCLUSION	22
11 RF TEST PROCEDURES.....	23



12 MEASUREMENT RESULTS (E-FIELD)..... 24

13 ANSIC 63.19-2011 LIMITS 25

14 MEASUREMENT UNCERTAINTY 26

15 MAIN TEST INSTRUMENTS..... 27

16 CONCLUSION 27

ANNEX A TEST LAYOUT 28

ANNEX B TEST PLOTS 29

ANNEX C SYSTEM VALIDATION RESULT..... 39

ANNEX D PROBE CALIBRATION CERTIFICATE 43

ANNEX E DIPOLE CALIBRATION CERTIFICATE..... 65

1 Test Laboratory

1.1 Testing Location

CompanyName:	CTTL(Shouxiang)
Address:	No. 51 Shouxiang Science Building, Xueyuan Road, Haidian District, Beijing, P. R. China100191

1.2 Testing Environment

Temperature:	18°C~25°C,
Relative humidity:	30%~ 70%
Ground system resistance:	< 0.5 Ω
Ambient noise is checked and found very low and in compliance with requirement of standards. Reflection of surrounding objects is minimized and in compliance with requirement of standards.	

1.3 Project Data

Project Leader:	Qi Dianyuan
Test Engineer:	Lin Xiaojun
Testing Start Date:	October 17, 2021
Testing End Date:	October 29, 2021

1.4 Signature



Lin Xiaojun
(Prepared this test report)

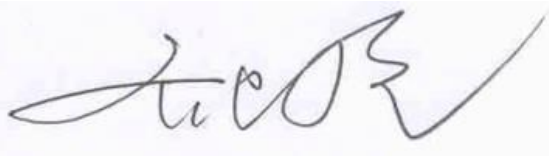

Qi Dianyuan
(Reviewed this test report)



Lu Bingsong
Deputy Director of the laboratory
(Approved this test report)



2 Client Information

2.1 Applicant Information

Company Name:	TCL Communication Ltd.
Address/Post:	5/F, Building 22E, 22 Science Park East Avenue, Hong Kong Science Park, Shatin, NT, Hong Kong
Contact Person:	Peter yang
Contact Email:	peter.yang@tcl.com
Telephone:	+86 755 3664 5759
Fax	+86 755 3661 2000-81722

2.2 Manufacturer Information

Company Name:	TCL Communication Ltd.
Address/Post:	5/F, Building 22E, 22 Science Park East Avenue, Hong Kong Science Park, Shatin, NT, Hong Kong
Contact Person:	Peter yang
Contact Email:	peter.yang@tcl.com
Telephone:	+86 755 3664 5759
Fax	+86 755 3661 2000-81722

3 Equipment Under Test (EUT) and Ancillary Equipment (AE)

This EUT is a variant product and the report of original sample is No.I21Z61774-SEM02. we share all bands results of original sample.

3.1 About EUT

Description:	GSM/UMTS/LTE /NR Mobile phone
Model name:	T767W
Operating mode(s):	GSM850/900/1800/1900, WCDMA B1/B2/B4/B5/B8, 5G NR n2/n5/n25/n41/n66/n70/n71/n77, BT, Wi-Fi, LTE Band 1/2/3/4/5/7/8/12/13/20/25/26/28/38/39/40/41/66/71

3.2 Internal Identification of EUT used during the test

EUT ID*	IMEI	HW Version	SW Version
EUT1	016062000005811	03	BKS3
EUT2	016062000205411	03	BKS3
EUT3	016062000204703	03	BKS3
EUT4	016062000204695	03	BKS3
EUT5	016168000201514	03	BKS3

*EUT ID: is used to identify the test sample in the lab internally.

Note: It is performed to test HAC with the EUT1-5

3.3 Internal Identification of AE used during the test

AE ID*	Description	Model	SN	Manufacturer
AE1	Battery	TLp043E7	\	VEKEN
AE2	Battery	TLp043E1	\	BYD

*AE ID: is used to identify the test sample in the lab internally.

3.4 Air Interfaces / Bands Indicating Operating Modes

Air-interface	Band(MHz)	Type	C63.19/tested	Simultaneous Transmissions	Name of Voice Service
GSM	850	VO	Yes	BT, WLAN	CMRS Voice
	1900				
GPRS/EDGE	850	DT	Yes		Google duo
	1900				
WCDMA (UMTS)	850	VO	NO ⁽¹⁾	BT, WLAN	CMRS Voice
	1700				
	1900	DT	NO ⁽¹⁾		Google duo
LTE TDD	Band41	V/D	Yes	BT, WLAN	VoLTE, Google duo
LTE FDD	Band2/5/7/12/13/25/26/66/71	V/D	NO ⁽¹⁾	BT, WLAN	VoLTE, Google duo
NR	n2/n5/n25/n41/n66/n70/n71/n77	V/D	NO ⁽¹⁾	BT, WLAN	VoNR, Google duo
BT	2450	DT	NA	GSM,WCDMA ,LTE,NR	NA
WLAN	2450	V/D	Yes	GSM,WCDMA ,LTE,NR	VoWiFi, Google duo
WLAN	5G	V/D	NO ⁽¹⁾	GSM,WCDMA ,LTE,NR	VoWiFi, Google duo

NA: Not Applicable VO: Voice Only V/D: CMRS and IP Voice Service over Digital Transport
DT: Digital Transport

* HAC Rating was not based on concurrent voice and data modes, Non current mode was found to represent worst case rating for both M and T rating

Note1 = The air interface is exempted from testing by low power exemption that its average antenna input power plus its MIF is ≤ 17 dBm, and is rated as M4.

Note2= The device have similar frequency in some LTE bands : 4/66,38/41 since the supported frequency spans for the smaller LTE bands are completely cover by the larger LTE bands, therefore, only larger LTE bands were required to be tested for hearing-aid compliance.

4 Maximum Output Power.

GSM 850MHz	Conducted Power (dBm)		
	Channel 251(848.8MHz)	Channel 190(836.6MHz)	Channel 128(824.2MHz)
Voice	32.8	32.8	32.8
EDGE	28	28	28
GSM 1900MHz	Conducted Power(dBm)		
	Channel 810(1909.8MHz)	Channel 661(1880MHz)	Channel512(1850.2MHz)
Voice	29.5	29.5	29.5
EDGE	28.7	28.7	28.7
WCDMA 850MHz	Conducted Power (dBm)		
	Channel 4233(846.6MHz)	Channel 4182(836.4MHz)	Channel 4132(826.4MHz)
RMC	24	24	24
HSPA	22.7	22.7	22.7
WCDMA 1700MHz	Conducted Power (dBm)		
	Channel1513(1752.6MHz)	Channel1412(1732.4MHz)	Channel1312(1712.4MHz)
RMC	22	22	22
HSPA	21	21	21
WCDMA 1900MHz	Conducted Power (dBm)		
	Channel 9538(1907.6MHz)	Channel 9400(1880MHz)	Channel 9262(1852.4MHz)
RMC	22.5	22.5	22.5
HSPA	21.5	21.5	21.5
LTE Band2 QPSK	Conducted Power (dBm)		
	Channel 19100(1900MHz)	Channel 18900(1880MHz)	Channel18700(1860MHz)
	22.5	22.5	22.5
LTE Band5 QPSK	Conducted Power (dBm)		
	Channel 20600(844MHz)	Channel 20525(836.5MHz)	Channel20450(829MHz)
	24.5	24.5	24.5
LTE Band7 QPSK	Conducted Power (dBm)		
	Channel 21350(2560MHz)	Channel 21100(2535MHz)	Channel20850(2510MHz)
	20.8	20.8	20.8
LTE Band12 QPSK	Conducted Power (dBm)		
	Channel 23130(711MHz)	Channel 23095(707.5MHz)	Channel23060(704MHz)
	24.5	24.5	24.5
LTE Band13 QPSK	Conducted Power (dBm)		
	Channel 23230(782MHz)		
	24.5		
LTE Band25 QPSK	Conducted Power (dBm)		
	Channel 26590(1905MHz)	Channel 26365(1882.5MHz)	Channel26140(1860MHz)
	22.5	22.5	22.5
LTE Band26 QPSK	Conducted Power (dBm)		
	Channel 26965(841.5MHz)	Channel 26865(831.5MHz)	Channel26775(822.5MHz)

	24.5	24.5	24.5
LTE Band41 QPSK PC2	Conducted Power (dBm)		
	Channel 41490(2680MHz)	Channel 40620(2593MHz)	Channel 39750(2506MHz)
	24.6	24.6	24.6
LTE Band41 QPSK PC3	Conducted Power (dBm)		
	Channel 41490(2680MHz)	Channel 40620(2593MHz)	Channel 39750(2506MHz)
	22	22	22
LTE Band66 QPSK	Conducted Power (dBm)		
	Channel 132572(1770MHz)	Channel 132322(1745MHz)	Channel 132072(1720MHz)
	22.5	22.5	22.5
LTE Band71 QPSK	Conducted Power (dBm)		
	Channel 133372(688MHz)	Channel 133322(683MHz)	Channel 133222(673MHz)
	24.5	24.5	24.5
2.4GHz 802.11b	Conducted Power (dBm)		
	Channel 11 (2462MHz)	Channel 6 (2437MHz)	Channel 1 (2412MHz)
	21.5	21.5	21.5
5GHz 802.11a	Tune up (dBm)		
	Channel 60 (5300MHz)	Channel 124 (5620MHz)	Channel 157 (5785MHz)
	20	20	20
5G NR N25	Conducted Power (dBm)		
	Channel381000 (1905MHz)	Channel376500(1882.5MHz)	Channel372000(1860MHz)
	22.5	22.5	22.5
5G NR N41	Conducted Power (dBm)		
	Channel 528000(2640MHz)	Channel518598(2593MHz)	Channel 509202(2546MHz)
	23	23	23
5G NR N66	Conducted Power (dBm)		
	Channel354000 (1770MHz)	Channel 136100 (680.5MHz)	Channel354000 (1770MHz)
	22.5	22.5	22.5
5G NR N71	Conducted Power (dBm)		
	Channel662000 (3930MHz)	Channel 654800 (3822MHz)	Channel650000 (3750MHz)
	23.5	23.5	23.5
5G NR N77	Conducted Power (dBm)		
	Channel662000 (3930MHz)	Channel 654800 (3822MHz)	Channel650000 (3750MHz)
	26.5	26.5	26.5
5G NR N2	Conducted Power (dBm)		
	Channel 381500 (1907.5MHz)	Channel 376000 (1880MHz)	Channel 370500 (1852.5MHz)
	22.8	22.8	22.8
5G NR N5	Conducted Power (dBm)		
	Channel 169300 (846.5MHz)	Channel 167300 (836.5MHz)	Channel 165300 (826.5MHz)
	24.2	24.2	24.2



5G NR N70	Conducted Power (dBm)		
	Channel 341500 (1707.5MHz)	Channel 340500 (1702.5MHz)	Channel 339500 (1697.5MHz)
	22.8	22.8	22.8

5 Reference Documents

5.1 Reference Documents for testing

The following document listed in this section is referred for testing.

Reference	Title	Version
ANSI C63.19-2011	American National Standard for Methods of Measurement of Compatibility between Wireless Communication Devices and Hearing Aids	2011 Edition
FCC 47 CFR §20.19	Hearing Aid Compatible Mobile Headsets	2015 Edition
KDB 285076 D01	Equipment Authorization Guidance for Hearing Aid Compatibility	v05r01

6 OPERATIONAL CONDITIONS DURING TEST

6.1 HAC MEASUREMENT SET-UP

These measurements are performed using the DASY5 NEO automated dosimetric assessment system. It is made by Schmid & Partner Engineering AG (SPEAG) in Zurich, Switzerland. It consists of high precision robotics system (Stäubli), robot controller, Intel Core2 computer, near-field probe, probe alignment sensor. The robot is a six-axis industrial robot performing precise movements. A cell controller system contains the power supply, robot controller, teach pendant (Joystick), and remote control, is used to drive the robot motors. The PC consists of the HP Intel Core2 1.86 GHz computer with Windows XP system and HAC Measurement Software DASY5 NEO, A/D interface card, monitor, mouse, and keyboard. The Stäubli Robot is connected to the cell controller to allow software manipulation of the robot. A data acquisition electronic (DAE) circuit performs the signal amplification, signal multiplexing, AD-conversion, offset measurements, mechanical surface detection, collision detection, etc. is connected to the Electro-optical coupler (EOC). The EOC performs the conversion from the optical into digital electric signal of the DAE and transfers data to the PC plug-in card.

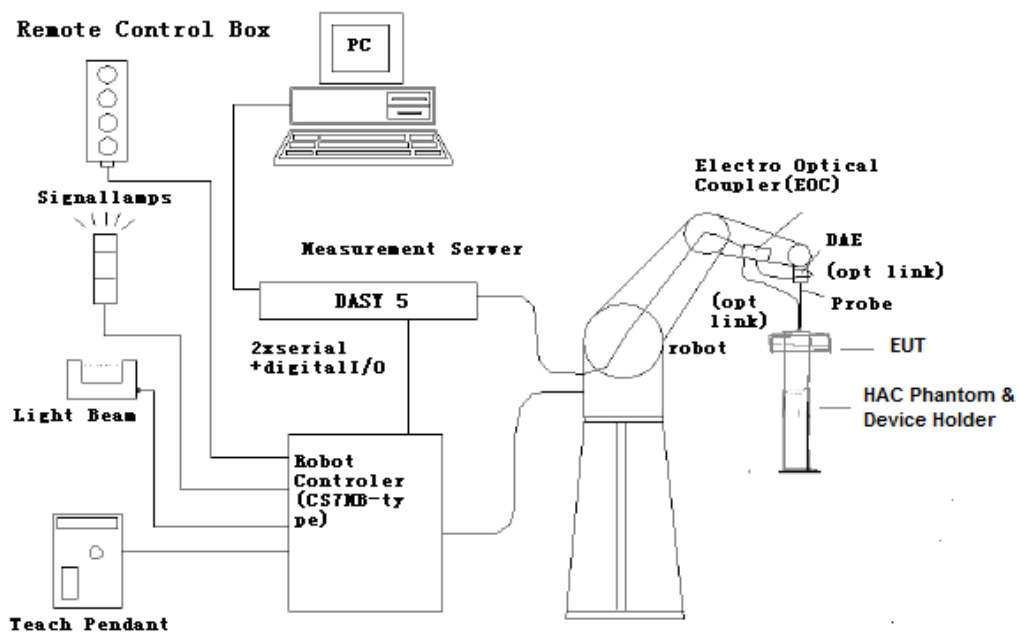

Fig. 1 HAC Test Measurement Set-up

The DAE4 consists of a highly sensitive electrometer-grade preamplifier with auto-zeroing, a channel and gain-switching multiplexer, a fast 16 bit AD-converter and a command decoder and control logic unit. Transmission to the PC-card is accomplished through an optical downlink for data and status information and an optical uplink for commands and clock lines. The mechanical probe mounting device includes two different sensor systems for frontal and sidewise probe contacts. They are also used for mechanical surface detection and probe collision detection. The robot uses its own controller with a built in VME-bus computer.

6.2 Probe Specification

E-Field Probe Description

Construction	<p>One dipole parallel, two dipoles normal to probe axis</p> <p>Built-in shielding against static charges</p> <p>PEEK enclosure material</p>
Calibration	<p>In air from 100 MHz to 3.0 GHz (absolute accuracy $\pm 6.0\%$, $k=2$)</p>
Frequency	<p>40 MHz to > 6 GHz (can be extended to < 20 MHz)</p> <p>Linearity: ± 0.2 dB (100 MHz to 3 GHz)</p>
Directivity	<p>± 0.2 dB in air (rotation around probe axis)</p> <p>± 0.4 dB in air (rotation normal to probe axis)</p>
Dynamic Range	<p>2 V/m to > 1000 V/m; Linearity: ± 0.2 dB</p>
Dimensions	<p>Overall length: 330 mm (Tip: 16 mm)</p> <p>Tip diameter: 8 mm (Body: 12 mm)</p> <p>Distance from probe tip to dipole centers: 2.5 mm</p>
Application	<p>General near-field measurements up to 6 GHz</p> <p>Field component measurements</p> <p>Fast automatic scanning in phantoms</p>



[ER3DV6]

6.3 Test Arch Phantom & Phone Positioner

The Test Arch phantom should be positioned horizontally on a stable surface. Reference markings on the Phantom allow the complete setup of all predefined phantom positions and measurement grids by manually teaching three points in the robot. It enables easy and well defined positioning of the phone and validation dipoles as well as simple teaching of the robot (Dimensions: 370 x 370 x 370 mm).

The Phone Positioner supports accurate and reliable positioning of any phone with effect on near field $< \pm 0.5$ dB.

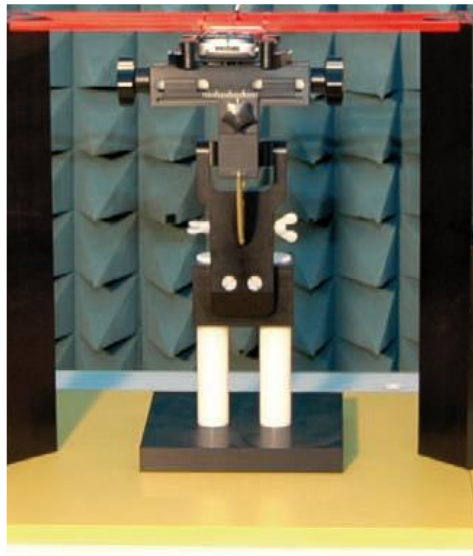

Fig. 2 HAC Phantom & Device Holder

6.4 Robotic System Specifications

Specifications

Positioner: Stäubli Unimation Corp. Robot Model: RX160L

Repeatability: ± 0.02 mm

No. of Axis: 6

Data Acquisition Electronic (DAE) System

Cell Controller

Processor: Intel Core2

Clock Speed: 1.86GHz

Operating System: Windows XP

Data Converter

Features: Signal Amplifier, multiplexer, A/D converter, and control logic

Software: DASY5 software

Connecting Lines: Optical downlink for data and status info.

Optical uplink for commands and clock

7 EUT ARRANGEMENT

7.1 WD RF Emission Measurements Reference and Plane

Figure 4 illustrates the references and reference plane that shall be used in the WD emissions measurement.

- The grid is 5 cm by 5 cm area that is divided into 9 evenly sized blocks or sub-grids.
- The grid is centered on the audio frequency output transducer of the WD (speaker or T-coil).
- The grid is located by reference to a reference plane. This reference plane is the planar area that contains the highest point in the area of the WD that normally rests against the user's ear
- The measurement plane is located parallel to the reference plane and 15 mm from it, out from the phone. The grid is located in the measurement plane.

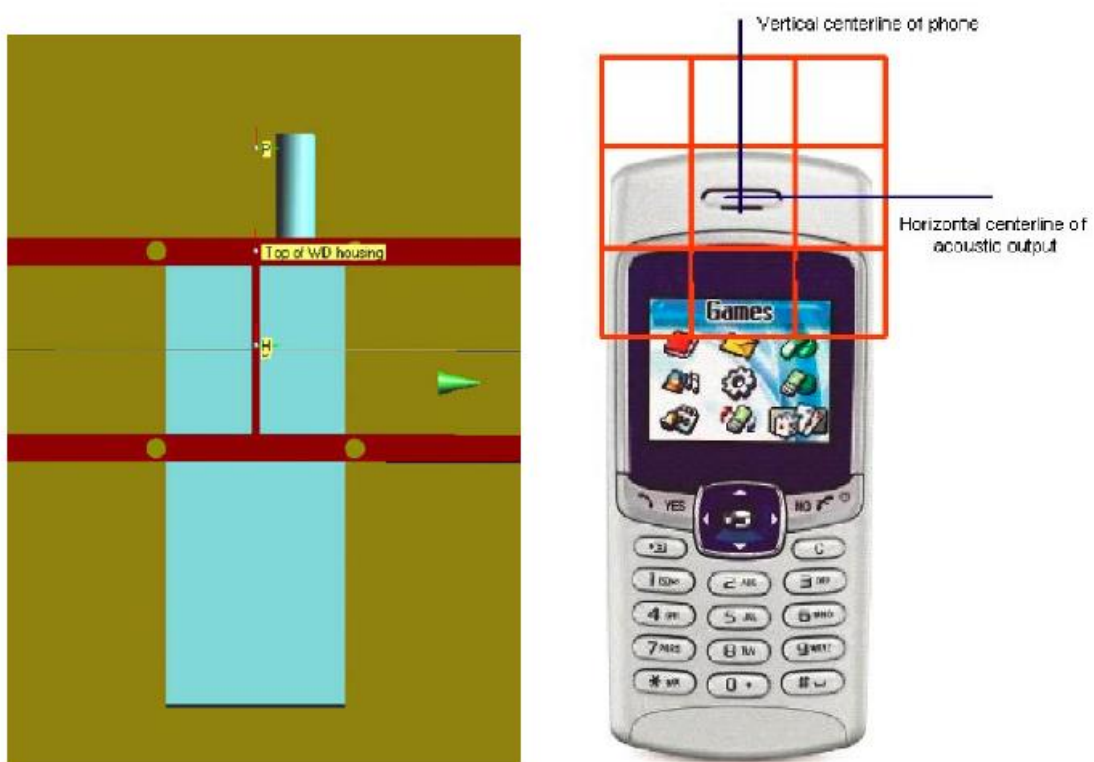

Fig. 3 WD reference and plane for RF emission measurements

8 SYSTEM VALIDATION

8.1 Validation Procedure

Place a dipole antenna meeting the requirements given in ANSI C63.19 in the position normally occupied by the WD. The dipole antenna serves as a known source for an electrical output. Position the E-field probes so that:

- The probes and their cables are parallel to the coaxial feed of the dipole antenna
- The probe cables and the coaxial feed of the dipole antenna approach the measurement area from opposite directions
- The center point of the probe element(s) are 15 mm from the closest surface of the dipole elements.

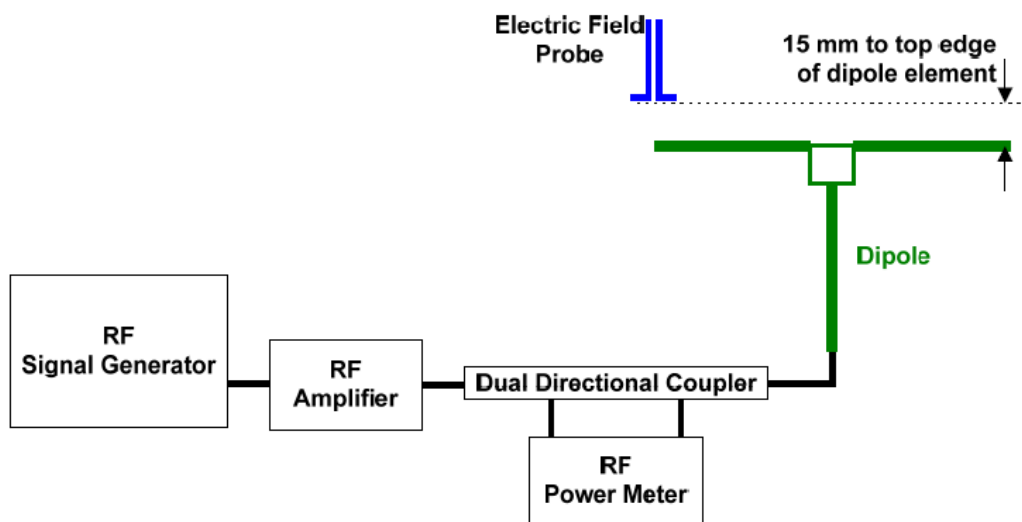

Fig. 4 Dipole Validation Setup

8.2 Validation Result

E-Field Scan						
Mode	Frequency (MHz)	Input Power (mW)	Measured ¹ Value(dBV/m)	Target ² Value(dBV/m)	Deviation ³ (%)	Limit ⁴ (%)
CW	835	100	40.63	41.00	-4.17	± 25
CW	1880	100	39.01	38.80	2.45	± 25
CW	2450	100	38.64	38.68	-0.46	± 25
CW	2600	100	38.80	38.64	1.86	± 25

Notes:

1. Please refer to the attachment for detailed measurement data and plot.
2. Target value is provided by SPEAD in the calibration certificate of specific dipoles.
3. Deviation (%) = $100 * (\text{Measured value minus Target value})$ divided by Target value.
4. ANSI C63.19 requires values within $\pm 25\%$ are acceptable, of which 12% is deviation and 13% is measurement uncertainty. Values independently validated for the dipole actually used in the measurements should be used, when available.

9 Evaluation of MIF

9.1 Introduction

The MIF (Modulation Interference Factor) is used to classify E-field emission to determine Hearing Aid Compatibility (HAC). It scales the power-averaged signal to the RF audio interference level and is characteristic to a modulation scheme. The HAC standard preferred "indirect" measurement method is based on average field measurement with separate scaling by the MIF. With an Audio Interference Analyzer (AIA) designed by SPEAG specifically for the MIF measurement, these values have been verified by practical measurements on an RF signal modulated with each of the waveforms. The resulting deviations from the simulated values are within the requirements of the HAC standard.

The AIA (Audio Interference Analyzer) is an USB powered electronic sensor to evaluate signals in the frequency range 698MHz - 6 GHz. It contains RMS detector and audio frequency circuits for sampling of the RF envelope.

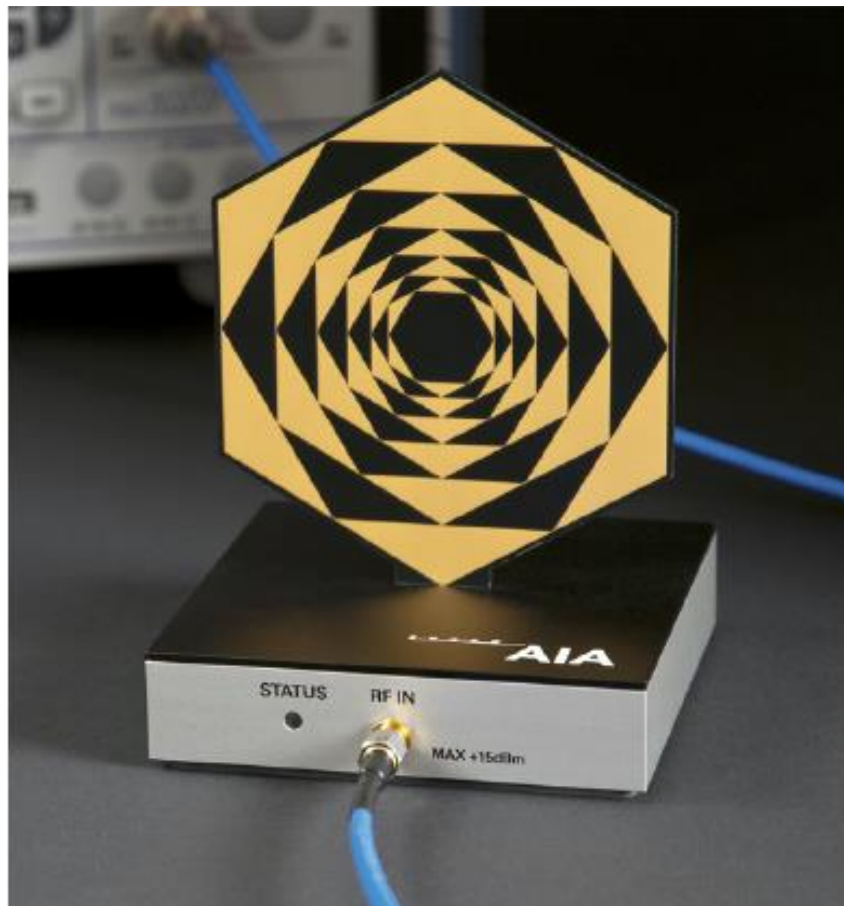

Fig. 5 AIA Front View

9.2 MIF measurement with the AIA

The MIF is measured with the AIA as follows:

1. Connect the AIA via USB to the DASY5 PC and verify the configuration settings.
2. Couple the RF signal to be evaluated to an AIA via cable or antenna.
3. Generate a MIF measurement job for the unknown signal and select the measurement port and timing settings.
4. Document the results via the post processor in a report.

9.3 Test equipment for the MIF measurement

No.	Name	Type	Serial Number	Manufacturer
01	Signal Generator	E4438C	MY49071430	Agilent
02	AIA	SE UMS 170 CB	1029	SPEAG
03	BTS	CMW500	166370	R&S

9.4 DUT MIF results

Based on the KDB285076D01v05, the handset can also use the MIF values predetermined by the test equipment manufacturer. MIF values applied in this test report were provided by the HAC equipment provider of SPEAG, and the worst values for all air interface are listed below to be determine the Low-power Exemption.

Typical MIF levels in ANSI C63.19-2011	
Transmission protocol	Modulation interference factor
GSM-FDD (TDMA, GMSK)	+3.63 dB
EDGE-FDD (TDMA, 8PSK, TN 0-1-2-3)	-1.82dB
UMTS-FDD(WCDMA, AMR)	-25.43dB
UMTS-FDD (HSPA)	-20.75dB
LTE-FDD (SC-FDMA, 1RB, 20MHz, QPSK)	-15.63 dB
LTE-FDD (SC-FDMA, 1RB, 20MHz, 16QAM)	-9.76 dB
LTE-FDD (SC-FDMA, 1RB, 20MHz, 64QAM)	-9.93 dB
LTE-TDD (SC-FDMA, 1RB, 20MHz, QPSK)	-1.62 dB
LTE-TDD (SC-FDMA, 1RB, 20MHz, 16QAM)	-1.44 dB
LTE-TDD (SC-FDMA, 1RB, 20MHz, 64QAM)	-1.54 dB
LTE-TDD(SC-FDMA,1RB,20MHz,QPSK,UL Subframe=2,3,4,7,8,9)	-3.41 dB
LTE-TDD(SC-FDMA,1RB,20MHz,16QAM,UL Subframe=2,3,4,7,8,9)	-3.17 dB
LTE-TDD(SC-FDMA,1RB,20MHz,64QAM,UL Subframe=2,3,4,7,8,9)	-3.31 dB
IEEE 802.11b WiFi 2.4 GHz (DSSS, 1 Mbps)	-5.90 dB
IEEE 802.11b WiFi 2.4 GHz (DSSS, 2 Mbps)	-5.17 dB
IEEE 802.11b WiFi 2.4 GHz (DSSS, 5.5 Mbps)	-3.37 dB
IEEE 802.11b WiFi 2.4 GHz (DSSS, 11 Mbps)	-2.02 dB

IEEE 802.11g WiFi 2.4 GHz (DSSS-OFDM, 6 Mbps)	-0.36dB
IEEE 802.11n (HT Greenfield, 6.5 Mbps, BPSK)	-15.80 dB
IEEE 802.11a/h WiFi 5 GHz (OFDM, 6 Mbps)	-5.82 dB
IEEE 802.11ac WiFi (20MHz, MCS0, 99pc duty cycle)	-12.23dB
5G NR (DFT-s-OFDM, 1 RB, 20 MHz, QPSK, 15 kHz)	-15.06dB
5G NR (CP-OFDM, 1 RB, 5 MHz, QPSK, 15 kHz)	-12.18dB
5G NR (CP-OFDM, 1 RB, 10 MHz, QPSK, 15 kHz)	-12.26dB
5G NR (CP-OFDM, 1 RB, 15 MHz, QPSK, 15 kHz)	-12.08dB
5G NR (CP-OFDM, 1 RB, 20 MHz, QPSK, 15 kHz)	-12.20dB
5G NR (CP-OFDM, 1 RB, 5 MHz, QPSK, 30 kHz)	-14.39dB
5G NR (CP-OFDM, 1 RB, 10 MHz, QPSK, 30 kHz)	-14.47dB
5G NR (CP-OFDM, 1 RB, 15 MHz, QPSK, 30 kHz)	-14.33dB
5G NR (CP-OFDM, 1 RB, 20 MHz, QPSK, 30 kHz)	-14.46dB
5G NR (CP-OFDM, 1 RB, 25 MHz, QPSK, 30 kHz)	-14.35dB
5G NR (CP-OFDM, 1 RB, 30 MHz, QPSK, 30 kHz)	-14.32dB
5G NR (CP-OFDM, 1 RB, 40 MHz, QPSK, 30 kHz)	-14.32dB
5G NR (CP-OFDM, 1 RB, 50 MHz, QPSK, 30 kHz)	-14.55dB
5G NR (CP-OFDM, 1 RB, 60 MHz, QPSK, 30 kHz)	-14.45dB
5G NR (CP-OFDM, 1 RB, 80 MHz, QPSK, 30 kHz)	-14.47dB
5G NR (CP-OFDM, 1 RB, 90 MHz, QPSK, 30 kHz)	-14.43dB
5G NR (CP-OFDM, 1 RB, 100 MHz, QPSK, 30 kHz)	-14.38dB
5G NR (DFT-s-OFDM, 1 RB, 5 MHz, QPSK, 15 kHz)	-15.06dB
5G NR (DFT-s-OFDM, 1 RB, 10 MHz, QPSK, 15 kHz)	-15.06dB
5G NR (DFT-s-OFDM, 1 RB, 15 MHz, QPSK, 15 kHz)	-15.06dB
5G NR (DFT-s-OFDM, 1 RB, 20 MHz, QPSK, 15 kHz)	-15.06dB

10 Evaluation for low-power exemption

10.1 Product testing threshold

There are two methods for exempting an RF air interface technology from testing. The first method requires evaluation of the MIF for the worst-case operating mode. An RF air interface technology of a device is exempt from testing when its average antenna input power plus its MIF is ≤ 17 dBm for any of its operating modes. The second method does not require determination of the MIF. The RF emissions testing exemption shall be applied to an RF air interface technology in a device whose peak antenna input power, averaged over intervals $\leq 50 \mu s$, is ≤ 23 dBm. An RF air interface technology that is exempted from testing by either method shall be rated as M4.

The first method is used to be exempt from testing for the RF air interface technology in this report.

10.2 Conducted power

Band	Average power (dBm)	MIF (dB)	Sum (dBm)	C63.19 Tested
GSM 850 - Voice	32.8	3.63	36.43	Yes
GSM 850 - EDGE	28	-1.82	26.18	Yes*
GSM 1900 - Voice	29.5	3.63	33.13	Yes
GSM 1900 - EDGE	28.7	-1.82	26.88	Yes*
WCDMA 850 - RMC	24	-25.43	-1.43	No
WCDMA 850 - HSPA	22.7	-20.75	1.95	No
WCDMA 1700 - RMC	22	-25.43	-3.43	No
WCDMA 1700 - HSPA	21	-20.75	0.25	No
WCDMA 1900 - RMC	22.5	-25.43	-2.93	No
WCDMA 1900 - HSPA	21.5	-20.75	0.75	No
LTE Band 2 QPSK	22.5	-15.63	6.87	No
LTE Band 5 QPSK	24.5	-15.63	8.87	No
LTE Band 7 QPSK	20.8	-15.63	5.17	No
LTE Band 12 QPSK	24.5	-15.63	8.87	No
LTE Band 13 QPSK	24.5	-15.63	8.87	No
LTE Band 25 QPSK	22.5	-15.63	6.87	No
LTE Band 26 QPSK	24.5	-15.63	8.87	No
LTE Band 66 QPSK	22.5	-15.63	6.87	No
LTE Band 71 QPSK	24.5	-15.63	8.87	No
LTE Band 41 QPSK PC2	24.6	-3.41	21.19	Yes
LTE Band 41 QPSK PC3	22	-3.41	18.59	Yes
NR n2	22.8	-12.08	10.72	No
NR n5	24.2	-12.08	12.12	No
NR n70	22.8	-12.08	10.72	No
NR n25	22.5	-12.08	10.42	No

NR n66	22.5	-12.08	10.42	No
NR n71	23.5	-12.08	11.42	No
NR n41	23	-12.08	10.92	No
NR n77	26.5	-12.08	14.42	No
WiFi-2.4G	21.5	-2.02	19.48	Yes
WiFi-5G	20	-5.82	14.18	No

*Note: For GSM bands, EDGE modes were not evaluated as Voice modes were found to be the worst-case modes for the GSM air interface.

10.3 Conclusion

According to the above table, the sums of average power and MIF for WCDMA, LTE FDD WiFi 5G and NR are less than 17dBm. So it is measured for GSM LTE TDD bands and WiFi 2.4G. The WCDMA, LTE FDD WiFi 5G and NR are exempt from testing and rated as M4.

11 RF TEST PROCEDURES

The evaluation was performed with the following procedure:

- 1) Confirm proper operation of the field probe, probe measurement system and other instrumentation and the positioning system.
- 2) Position the WD in its intended test position. The gauge block can simplify this positioning.
- 3) Configure the WD normal operation for maximum rated RF output power, at the desired channel and other operating parameters (e.g., test mode), as intended for the test.
- 4) The center sub-grid shall be centered on the center of the T-Coil mode axial measurement point or the acoustic output, as appropriate. Locate the field probe at the initial test position in the 50 mm by 50 mm grid, which is contained in the measurement plane. If the field alignment method is used, align the probe for maximum field reception.
- 5) Record the reading.
- 6) Scan the entire 50 mm by 50 mm region in equally spaced increments and record the reading at each measurement point. The distance between measurement points shall be sufficient to assure the identification of the maximum reading.
- 7) Identify the five contiguous sub-grids around the center sub-grid whose maximum reading is the lowest of all available choices. This eliminates the three sub-grids with the maximum readings. Thus, the six areas to be used to determine the WD's highest emissions are identified.
- 8) Identify the maximum field reading within the non-excluded sub-grids identified in Step 7)
- 9) Evaluate the MIF and add to the maximum steady-state rms field-strength reading to obtain the RF audio interference level..
- 10) Compare this RF audio interference level with the categories and record the resulting WD category rating.

12 Measurement Results (E-Field)

Frequency		Measured Value(dBV/m)	Power Drift (dB)	Category
MHz	Channel			
GSM 850				
848.8	251	38.5	-0.03	M4
836.6	190	39.60	-0.04	M4
824.2	128	40.19	-0.05	M3 (see Fig B.1)
GSM 1900				
1909.8	810	29.70	0.07	M4
1880	661	31.05	-0.16	M3(see Fig B.2)
1850.2	512	30.97	-0.04	M3
LTE Band 41 QPSK Power Class 2				
2680	41490	25.05	-0.40	M4
2636.5	41055	28.60	-0.17	M4
2593	40620	28.65	0.00	M4
2549.5	40185	28.06	0.05	M4
2506	39750	26.52	0.01	M4
LTE Band 41 16QAM Power Class 2				
2680	41490	28.29	-0.07	M4
2636.5	41055	29.13	0.04	M4
2593	40620	29.47	0.02	M4(see Fig B.3)
2549.5	40185	28.25	-0.01	M4
2506	39750	26.83	0.01	M4
LTE Band 41 64QAM Power Class 2				
2680	41490	27.05	0.06	M4
2636.5	41055	27.78	-0.04	M4
2593	40620	28.01	-0.01	M4
2549.5	40185	27.49	-0.02	M4
2506	39750	25.64	-0.02	M4
LTE Band 41 QPSK Power Class 3				
2680	41490	23.58	0.09	M4
2636.5	41055	24.85	0.00	M4
2593	40620	25.16	0.01	M4
2549.5	40185	25.23	0.03	M4(see Fig B.4)
2506	39750	24.51	0.03	M4
LTE Band 41 16QAM Power Class 3				
2680	41490	23.42	-0.15	M4
2636.5	41055	24.12	-0.06	M4
2593	40620	24.25	-0.32	M4
2549.5	40185	24.32	0.06	M4
2506	39750	23.41	-0.10	M4
LTE Band 41 64QAM Power Class 3				

2680	41490	21.70	0.07	M4
2636.5	41055	22.91	-0.03	M4
2593	40620	23.41	0.04	M4
2549.5	40185	23.28	0.02	M4
2506	39750	22.45	0.03	M4
WiFi2.4G 11b				
2462	11	19.08	0.02	M4
2437	6	21.02	-0.04	M4
2412	1	23.55	-0.07	M4(see Fig B.5)

Note: For LTE Band 41, UL-DL Configuration 1 was used to evaluate Power Class 2 and UL-DL Configuration 1 was used to evaluate Power Class 3.

13 ANSIC 63.19-2011 LIMITS

WD RF audio interference level categories in logarithmic units

Emission categories	< 960 MHz	E-field emissions
Category M1	50 to 55	dB (V/m)
Category M2	45 to 50	dB (V/m)
Category M3	40 to 45	dB (V/m)
Category M4	< 40	dB (V/m)
Emission categories	> 960 MHz	E-field emissions
Category M1	40 to 45	dB (V/m)
Category M2	35 to 40	dB (V/m)
Category M3	30 to 35	dB (V/m)
Category M4	< 30	dB (V/m)

14 MEASUREMENT UNCERTAINTY

No.	Error source	Type	Uncertainty Value(%)	Prob. Dist.	k	c _i E	Standard Uncertainty (%) u_i ; (%)E	Degree of freedom V_{eff} or ν_i
Measurement System								
1	Probe Calibration	B	5.	N	1	1	5.1	∞
2	Axial Isotropy	B	4.7	R	$\sqrt{3}$	1	2.7	∞
3	Sensor Displacement	B	16.5	R	$\sqrt{3}$	1	9.5	∞
4	Boundary Effects	B	2.4	R	$\sqrt{3}$	1	1.4	∞
5	Linearity	B	4.7	R	$\sqrt{3}$	1	2.7	∞
6	Scaling to Peak Envelope Power	B	2.0	R	$\sqrt{3}$	1	1.2	∞
7	System Detection Limit	B	1.0	R	$\sqrt{3}$	1	0.6	∞
8	Readout Electronics	B	0.3	N	1	1	0.3	∞
9	Response Time	B	0.8	R	$\sqrt{3}$	1	0.5	∞
10	Integration Time	B	2.6	R	$\sqrt{3}$	1	1.5	∞
11	RF Ambient Conditions	B	3.0	R	$\sqrt{3}$	1	1.7	∞
12	RF Reflections	B	12.0	R	$\sqrt{3}$	1	6.9	∞
13	Probe Positioner	B	1.2	R	$\sqrt{3}$	1	0.7	∞
14	Probe Positioning	A	4.7	R	$\sqrt{3}$	1	2.7	∞
15	Extra. And Interpolation	B	1.0	R	$\sqrt{3}$	1	0.6	∞
Test Sample Related								
16	Device Positioning Vertical	B	4.7	R	$\sqrt{3}$	1	2.7	∞
17	Device Positioning Lateral	B	1.0	R	$\sqrt{3}$	1	0.6	∞
18	Device Holder and Phantom	B	2.4	R	$\sqrt{3}$	1	1.4	∞
19	Power Drift	B	5.0	R	$\sqrt{3}$	1	2.9	∞

20	AIA measurement	B	12	R	$\sqrt{3}$	1	6.9	∞
Phantom and Setup related								
21	Phantom Thickness	B	2.4	R	$\sqrt{3}$	1	1.4	∞
Combined standard uncertainty(%)							16.2	
Expanded uncertainty (confidence interval of 95 %)		$u_e = 2u_c$		N	k=2		32.4	

15 MAIN TEST INSTRUMENTS

Table 1: List of Main Instruments

No.	Name	Type	Serial Number	Calibration Date	Valid Period
01	Signal Generator	E4483C	MY49071430	February 01, 2021	One Year
02	Power meter	NRP2	106276	May 11, 2021	One year
03	Power sensor	NRP6A	101369		
04	Amplifier	60S1G4	0331848	No Calibration Requested	
05	E-Field Probe	EF3DV3	4060	May 21, 2021	One year
06	DAE	SPEAG DAE4	1524	October 08, 2021	One year
07	HAC Dipole	CD835V3	1023	August 24, 2021	One year
08	HAC Dipole	CD1880V3	1018	August 24, 2021	One year
09	HAC Dipole	CD2450V3	1021	August 24, 2021	One year
10	HAC Dipole	CD2600V3	1017	August 24, 2021	One year
11	BTS	CMW500	166370	June 25,2021	One year
12	AIA	SE UMS 170 CB	1029	No Calibration Requested	

16 CONCLUSION

The HAC measurement indicates that the EUT complies with the HAC limits of the ANSIC63.19-2011. The total M-rating is **M3**.

END OF REPORT BODY

ANNEX A TEST LAYOUT

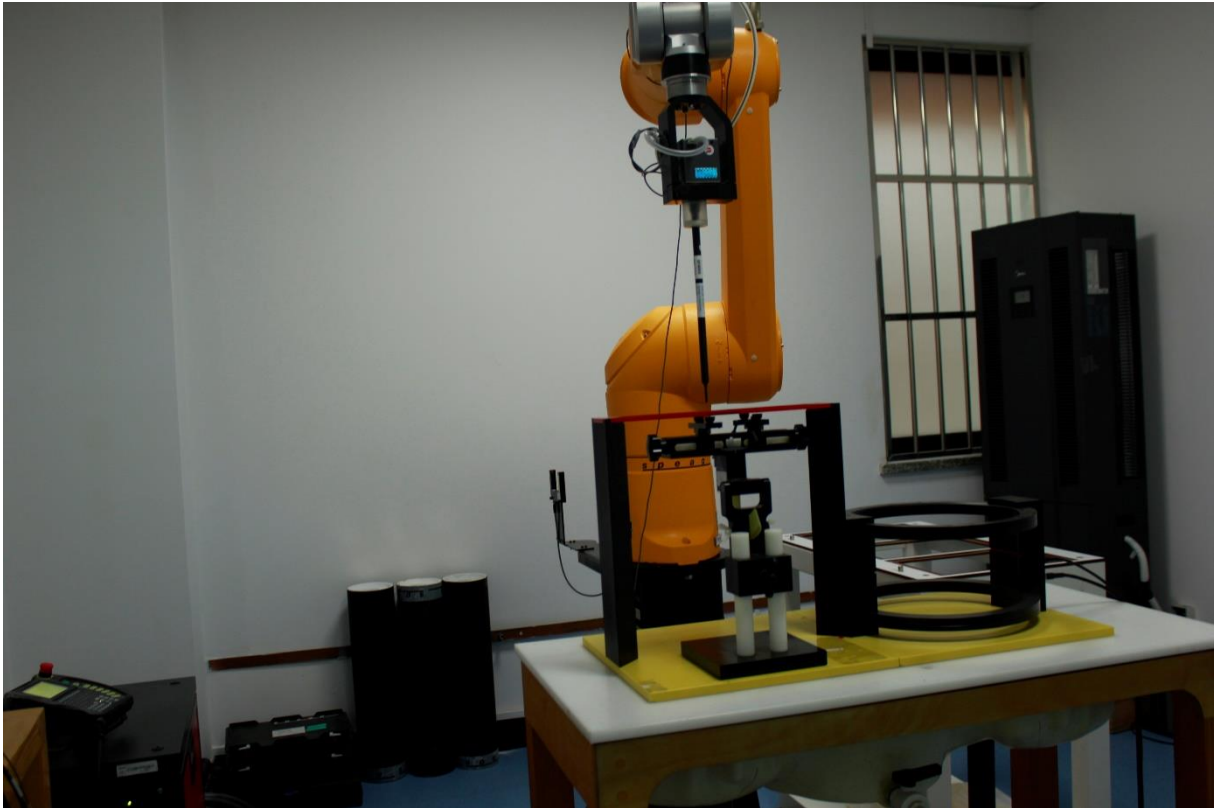

Picture A1:HAC RF System Layout

ANNEX B TEST PLOTS

HAC RF E-Field GSM 850 Low

Date: 2021-10-17

Electronics: DAE4 Sn1524

Medium: Air

Medium parameters used: $\sigma = 0$ mho/m, $\epsilon_r = 1$; $\rho = 1000$ kg/m³

Ambient Temperature: 22.0°C

Communication System: GSM 850; Frequency: 824.2 MHz; Duty Cycle: 1:8.3

Probe: EF3DV3 - SN4060;ConvF(1, 1, 1)

E Scan – ER3DV6 – 2011: 15 mm from Probe Center to the Device/Hearing

Aid Compatibility Test (101x101x1): Interpolated grid: dx=0.5000 mm,

dy=0.5000 mm

Device Reference Point: 0, 0, -6.3 mm

Reference Value = 80.41 V/m; Power Drift = -0.05 dB

Applied MIF = 3.48 dB

RF audio interference level = 40.19 dBV/m

Emission category: **M3**

MIF scaled E-field

Grid 1 M4 37.69 dBV/m	Grid 2 M4 37.72 dBV/m	Grid 3 M4 35.14 dBV/m
Grid 4 M3 40.06 dBV/m	Grid 5 M3 40.19 dBV/m	Grid 6 M4 37.26 dBV/m
Grid 7 M3 41.7 dBV/m	Grid 8 M3 41.77 dBV/m	Grid 9 M4 38.5 dBV/m

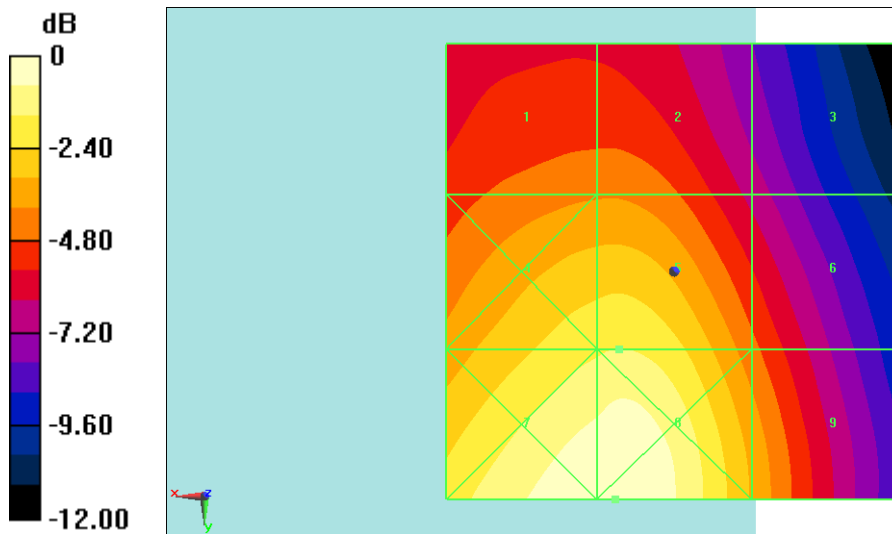

0 dB = 122.6 V/m = 41.77 dBV/m

Fig B.1 HAC RF E-Field GSM 850 Low

HAC RF E-Field GSM 1900 Middle

Date: 2021-10-17

Electronics: DAE4 Sn1524

Medium: Air

Medium parameters used: $\sigma = 0$ mho/m, $\epsilon_r = 1$; $\rho = 1000$ kg/m³

Ambient Temperature: 22.0°C

Communication System: PCS 1900; Frequency: 1880 MHz; Duty Cycle: 1:8.3

Probe: EF3DV3 - SN4060;ConvF(1, 1, 1)

E Scan - ER3DV6 - 2011: 15 mm from Probe Center to the Device 2 2

2/Hearing Aid Compatibility Test (101x101x1): Interpolated grid:

dx=0.5000 mm, dy=0.5000 mm

Device Reference Point: 0, 0, -6.3 mm

Reference Value = 21.52 V/m; Power Drift = -0.16 dB

Applied MIF = 3.47 dB

RF audio interference level = 31.05 dBV/m

Emission category: M3

MIF scaled E-field

Grid 1 M3 31.73 dBV/m	Grid 2 M3 31.47 dBV/m	Grid 3 M4 29.63 dBV/m
Grid 4 M4 29.79 dBV/m	Grid 5 M4 29.5 dBV/m	Grid 6 M4 28.31 dBV/m
Grid 7 M3 31.05 dBV/m	Grid 8 M3 30.75 dBV/m	Grid 9 M4 28.35 dBV/m

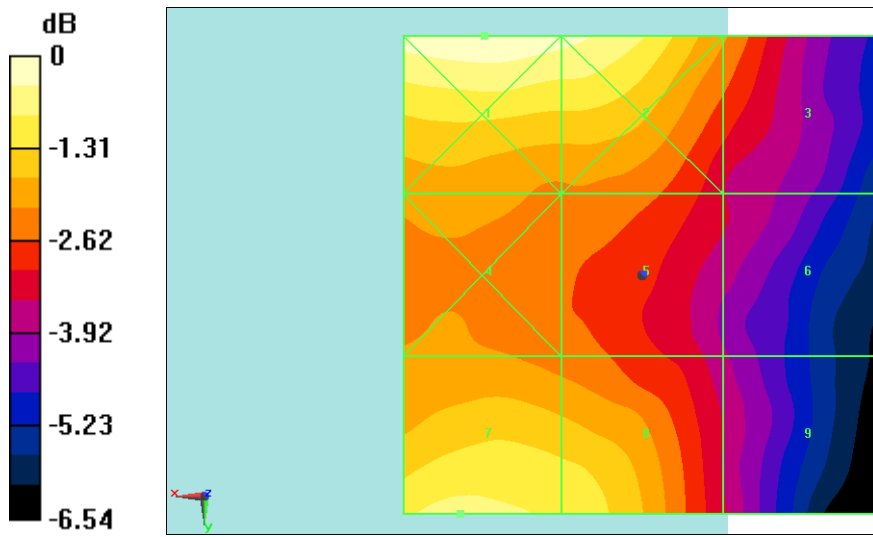

0 dB = 38.59 V/m = 31.73 dBV/m

Fig B.2 HAC RF E-Field GSM 1900 Middle

HAC RF E-Field LTE Band41 PC2 16QAM CH40620
Date: 2021-10-21

Electronics: DAE4 Sn1524

Medium: Air

 Medium parameters used: $\sigma = 0$ mho/m, $\epsilon_r = 1$; $\rho = 1000$ kg/m³

Ambient Temperature: 22.0°C

Communication System: LTE Band41; Frequency: 2593 MHz; Duty Cycle: 1:1.58

Probe: EF3DV3 - SN4060;ConvF(1, 1, 1)

E Scan - ER3DV6 - 2011: 15 mm from Probe Center to the Device

3/Hearing Aid Compatibility Test (101x101x1): Interpolated grid:

dx=0.5000 mm, dy=0.5000 mm

Device Reference Point: 0, 0, -6.3 mm

Reference Value = 42.67 V/m; Power Drift = 0.02 dB

Applied MIF = -1.52 dB

RF audio interference level = 29.47 dBV/m

Emission category: M4

MIF scaled E-field

Grid 1 M4 25.54 dBV/m	Grid 2 M4 27.86 dBV/m	Grid 3 M4 27.76 dBV/m
Grid 4 M4 28.24 dBV/m	Grid 5 M4 29.47 dBV/m	Grid 6 M4 28.58 dBV/m
Grid 7 M4 29.31 dBV/m	Grid 8 M4 29.57 dBV/m	Grid 9 M4 28.6 dBV/m

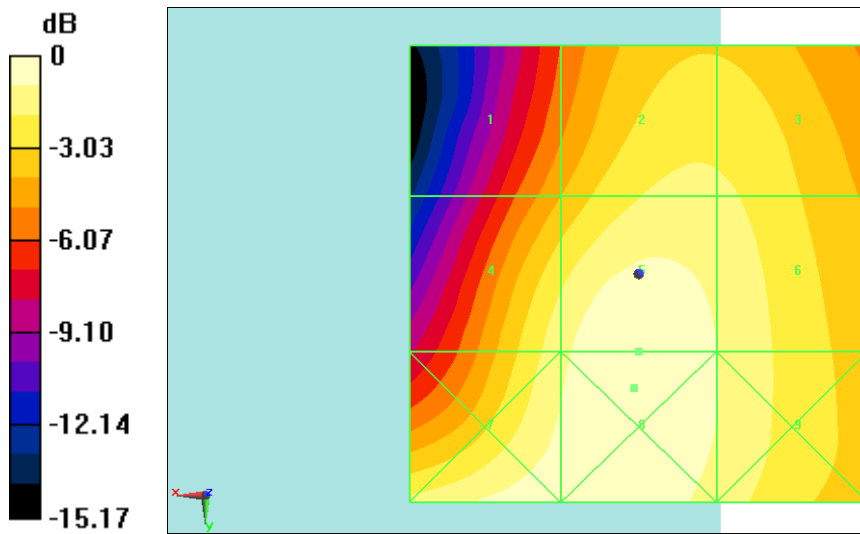

0 dB = 30.09 V/m = 29.57 dBV/m

Fig B.3 HAC RF E-Field LTE Band41 PC2 16QAM CH40620

HAC RF E-Field LTE Band41 PC3 QPSK CH40185
Date: 2021-10-21

Electronics: DAE4 Sn1524

Medium: Air

 Medium parameters used: $\sigma = 0$ mho/m, $\epsilon_r = 1$; $\rho = 1000$ kg/m³

Ambient Temperature: 22.0°C

Communication System: LTE Band41; Frequency: 2549.5 MHz; Duty Cycle: 1:1.58

Probe: EF3DV3 - SN4060;ConvF(1, 1, 1)

E Scan - ER3DV6 - 2011: 15 mm from Probe Center to the Device 3

3/Hearing Aid Compatibility Test (101x101x1): Interpolated grid:

 $dx=0.5000$ mm, $dy=0.5000$ mm

Device Reference Point: 0, 0, -6.3 mm

Reference Value = 32.34 V/m; Power Drift = 0.03 dB

Applied MIF = -3.79 dB

RF audio interference level = 25.23 dBV/m

Emission category: M4

MIF scaled E-field

Grid 1 M4 21.21 dBV/m	Grid 2 M4 22.79 dBV/m	Grid 3 M4 22.48 dBV/m
Grid 4 M4 24.67 dBV/m	Grid 5 M4 25.23 dBV/m	Grid 6 M4 22.94 dBV/m
Grid 7 M4 27.56 dBV/m	Grid 8 M4 26.01 dBV/m	Grid 9 M4 22.87 dBV/m

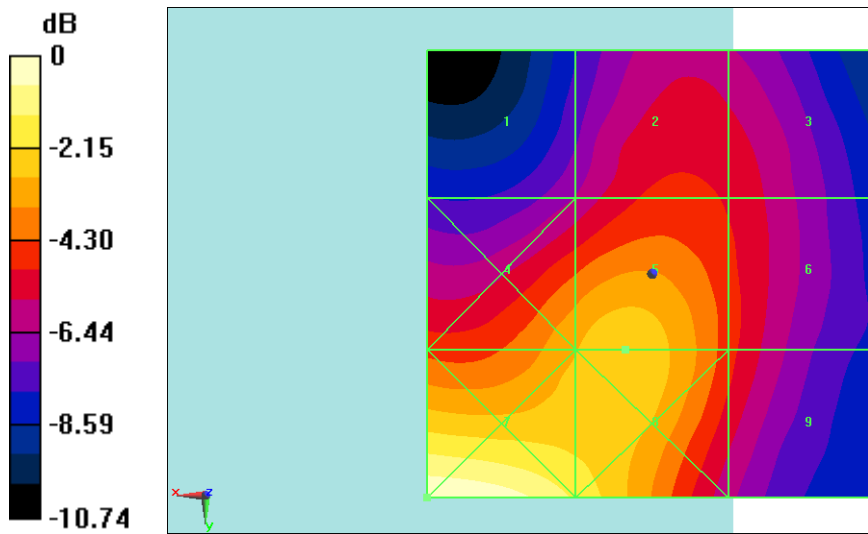

0 dB = 23.88 V/m = 27.56 dBV/m

Fig B.4 HAC RF E-Field LTE Band41 PC3 QPSK CH40185

HAC RF E-Field WiFi2.4G CH1**Date: 2021-10-29**

Electronics: DAE4 Sn1524

Medium: Air

Medium parameters used: $\sigma = 0$ mho/m, $\epsilon_r = 1$; $\rho = 1000$ kg/m³

Ambient Temperature: 22.0°C

Communication System: WiFi2.4G; Frequency: 2412 MHz; Duty Cycle: 1:1

Probe: EF3DV3 - SN4060;ConvF(1, 1, 1)

E Scan - ER3DV6 - 2011: 15 mm from Probe Center to the Device

2/Hearing Aid Compatibility Test (101x101x1): Interpolated grid:

dx=0.5000 mm, dy=0.5000 mm

Device Reference Point: 0, 0, -6.3 mm

Reference Value = 31.37 V/m; Power Drift = -0.07 dB

Applied MIF = -5.64 dB

RF audio interference level = 23.55 dBV/m

Emission category: **M4**

MIF scaled E-field

Grid 1 M4 23.48 dBV/m	Grid 2 M4 23.8 dBV/m	Grid 3 M4 23.32 dBV/m
Grid 4 M4 23.22 dBV/m	Grid 5 M4 23.55 dBV/m	Grid 6 M4 23.13 dBV/m
Grid 7 M4 20.95 dBV/m	Grid 8 M4 20.96 dBV/m	Grid 9 M4 20.69 dBV/m

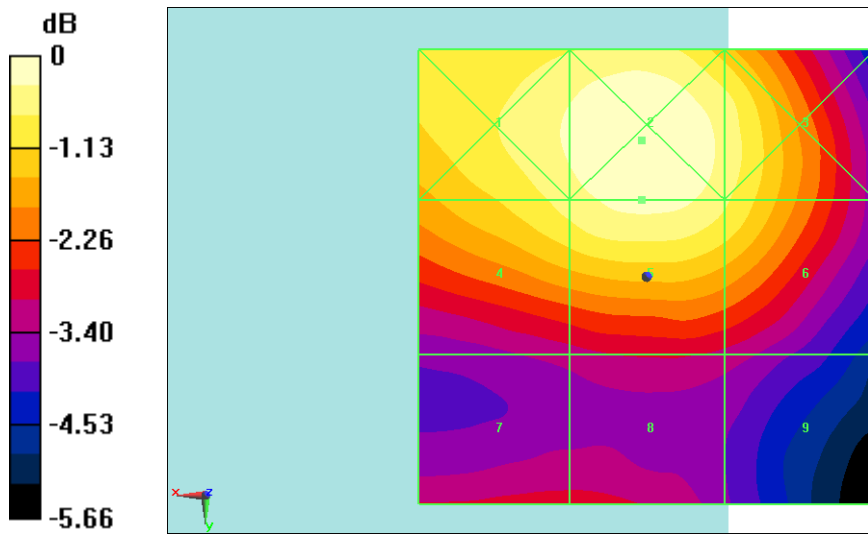

0 dB = 15.49 V/m = 23.80 dBV/m

Fig B.5 HAC RF E-Field WiFi2.4G 11b

ANNEX C SYSTEM VALIDATION RESULT

E SCAN of Dipole 835 MHz

Date: 2021-10-17

Electronics: DAE4 Sn1524

Medium: Air

Medium parameters used: $\sigma = 0$ mho/m, $\epsilon_r = 1$; $\rho = 1000$ kg/m³

Communication System: CW; Frequency: 835 MHz; Duty Cycle: 1:1

Probe: EF3DV3 - SN4060;ConvF(1, 1, 1)

E Scan - measurement distance from the probe sensor center to CD835 = 15mm/Hearing Aid Compatibility Test at 15mm distance (41x361x1): Interpolated grid: dx=0.5000 mm, dy=0.5000 mm

Device Reference Point: 0, 0, -6.3 mm

Reference Value = 128.4 V/m; Power Drift = 0.01 dB

Applied MIF = 0.00 dB

RF audio interference level = 40.63 dBV/m

Emission category: M3

MIF scaled E-field

Grid 1 M3 41.51 dBV/m	Grid 2 M3 41.51 dBV/m	Grid 3 M3 40.83 dBV/m
Grid 4 M4 36.29 dBV/m	Grid 5 M4 36.32 dBV/m	Grid 6 M4 36.11 dBV/m
Grid 7 M3 40.51 dBV/m	Grid 8 M3 40.63 dBV/m	Grid 9 M3 40.47 dBV/m

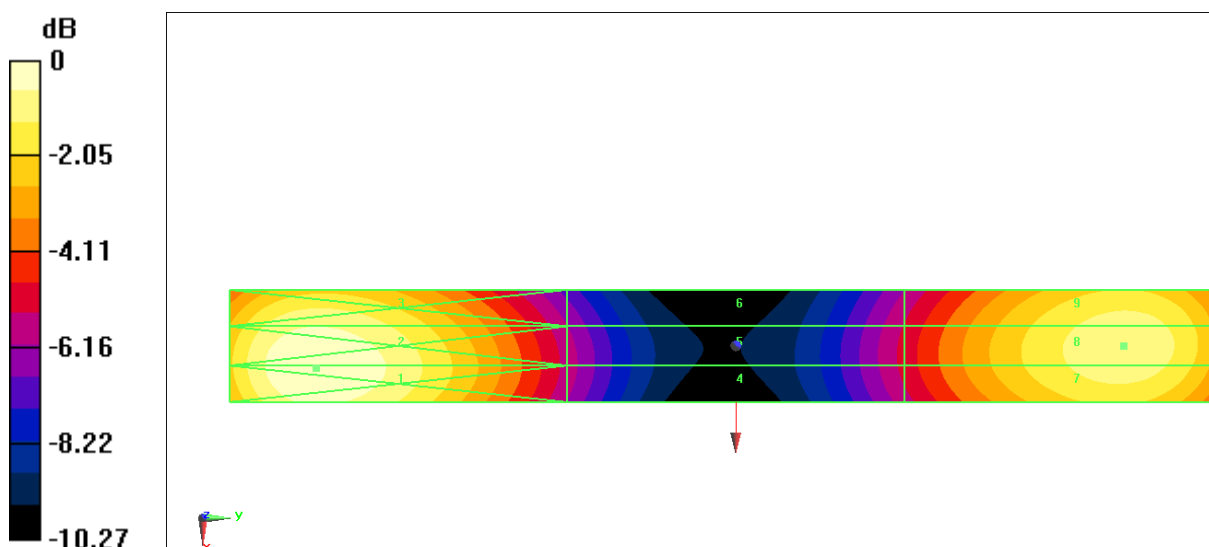

0 dB = 119.0 V/m = 41.51 dBV/m

E SCAN of Dipole 1880MHz
Date: 2021-10-17

Electronics: DAE4 Sn1524

Medium: Air

 Medium parameters used: $\sigma = 0$ mho/m, $\epsilon_r = 1$; $\rho = 1000$ kg/m³

Communication System: CW; Frequency: 1880 MHz; Duty Cycle: 1:1

Probe: EF3DV3 - SN4060;ConvF(1, 1, 1)

**E Scan - measurement distance from the probe sensor center to CD1880 = 15mm
 2/Hearing Aid Compatibility Test at 15mm distance (41x181x1):** Interpolated grid:

dx=0.5000 mm, dy=0.5000 mm

Device Reference Point: 0, 0, -6.3 mm

Reference Value = 133.2 V/m; Power Drift = 0.01 dB

Applied MIF = 0.00 dB

RF audio interference level = 39.01 dBV/m

Emission category: M2

MIF scaled E-field

Grid 1 M2 39.56 dBV/m	Grid 2 M2 39.55 dBV/m	Grid 3 M2 38.92 dBV/m
Grid 4 M2 37.06 dBV/m	Grid 5 M2 37.11 dBV/m	Grid 6 M2 37.03 dBV/m
Grid 7 M2 38.87 dBV/m	Grid 8 M2 39.01 dBV/m	Grid 9 M2 38.86 dBV/m

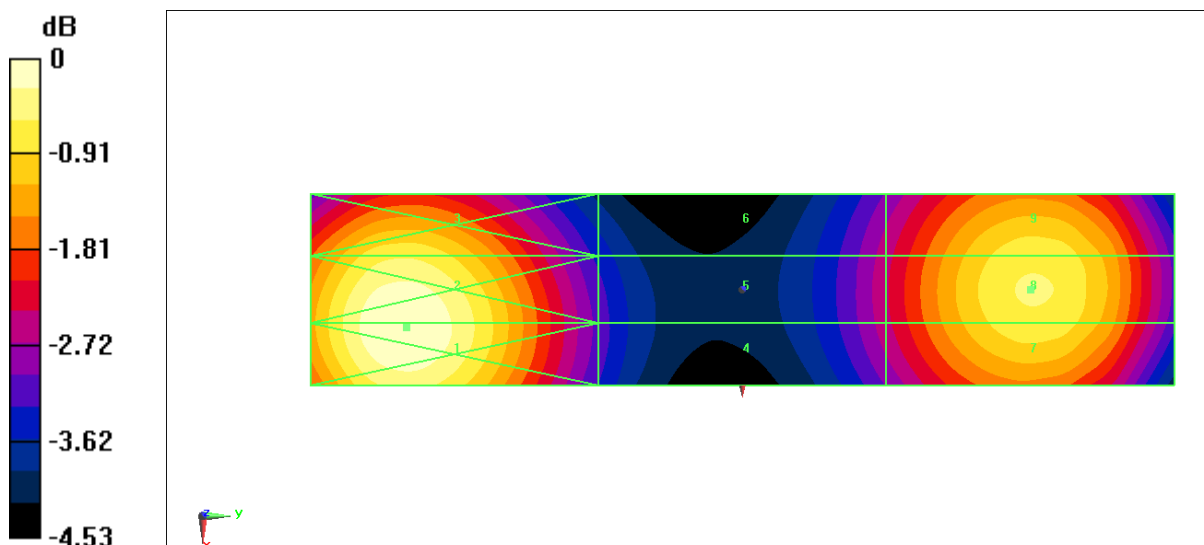

0 dB = 95.03 V/m = 39.56 dBV/m

E SCAN of Dipole 2450 MHz
Date: 2021-10-29

Electronics: DAE4 Sn1524

Medium: Air

 Medium parameters used: $\sigma = 0$ mho/m, $\epsilon_r = 1$; $\rho = 1000$ kg/m³

Communication System: CW; Frequency: 2450 MHz; Duty Cycle: 1:1

Probe: EF3DV3 - SN4060;ConvF(1, 1, 1)

E Scan - measurement distance from the probe sensor center to CD2450 = 15mm/Hearing Aid Compatibility Test at 15mm distance (41x181x1): Interpolated grid: dx=0.5000 mm, dy=0.5000 mm

Device Reference Point: 0, 0, -6.3 mm

Reference Value = 69.45 V/m; Power Drift = 0.01 dB

Applied MIF = 0.00 dB

RF audio interference level = 38.64 dBV/m

Emission category: M2

MIF scaled E-field

Grid 1 M2 38.75 dBV/m	Grid 2 M2 38.77 dBV/m	Grid 3 M2 38.36 dBV/m
Grid 4 M2 38.14 dBV/m	Grid 5 M2 38.18 dBV/m	Grid 6 M2 38.02 dBV/m
Grid 7 M2 38.57 dBV/m	Grid 8 M2 38.64 dBV/m	Grid 9 M2 38.44 dBV/m

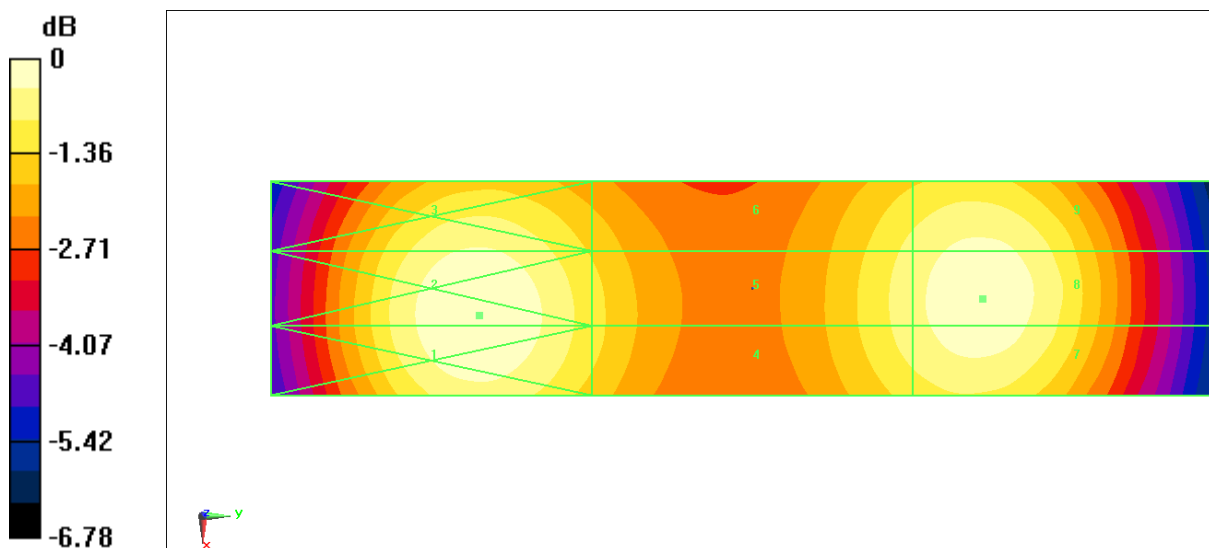

0 dB = 86.75 V/m = 38.77 dBV/m

E SCAN of Dipole 2600 MHz
Date: 2021-10-21

Electronics: DAE4 Sn1524

Medium: Air

 Medium parameters used: $\sigma = 0$ mho/m, $\epsilon_r = 1$; $\rho = 1000$ kg/m³

Communication System: CW; Frequency: 2600 MHz; Duty Cycle: 1:1

Probe: EF3DV3 - SN4060;ConvF(1, 1, 1)

Dipole E-Field measurement (E-field scan for ANSI C63.19-2007 & -2011 compliance)/E Scan - measurement distance from the probe sensor center to CD2600 = 15mm/Hearing Aid Compatibility Test at 15mm distance (41x141x1): Interpolated grid: dx=0.5000 mm, dy=0.5000 mm

Device Reference Point: 0, 0, -6.3 mm

Reference Value = 64.26 V/m; Power Drift = 0.01 dB

Applied MIF = 0.00 dB

RF audio interference level = 38.80 dBV/m

Emission category: M2

MIF scaled E-field

Grid 1 M2 38.95 dBV/m	Grid 2 M2 38.96 dBV/m	Grid 3 M2 38.59 dBV/m
Grid 4 M2 38.15 dBV/m	Grid 5 M2 38.18 dBV/m	Grid 6 M2 38.03 dBV/m
Grid 7 M2 38.72 dBV/m	Grid 8 M2 38.8 dBV/m	Grid 9 M2 38.58 dBV/m

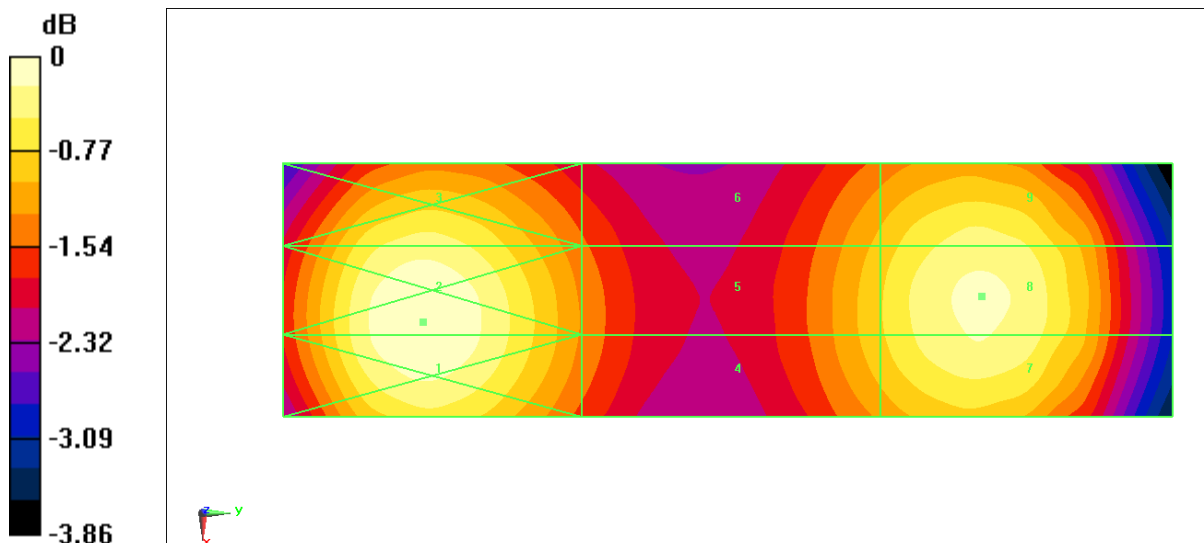

0 dB = 88.75 V/m = 38.96 dBV/m

ANNEX D PROBE CALIBRATION CERTIFICATE

Calibration Laboratory of
Schmid & Partner
Engineering AG
 Zeughausstrasse 43, 8004 Zurich, Switzerland



S Schweizerischer Kalibrierdienst
C Service suisse d'étalonnage
S Servizio svizzero di taratura
S Swiss Calibration Service

Accredited by the Swiss Accreditation Service (SAS)
 The Swiss Accreditation Service is one of the signatories to the EA
 Multilateral Agreement for the recognition of calibration certificates

Accreditation No.: SCS 0108

Client **CTTL-BJ (Auden)**

Certificate No: **EF3-4060_May21**

CALIBRATION CERTIFICATE

Object **EF3DV3- SN:4060**

Calibration procedure(s) **QA CAL-02.v9, QA CAL-25.v7**
 Calibration procedure for E-field probes optimized for close near field
 evaluations in air

Calibration date: **May 21, 2021**

This calibration certificate documents the traceability to national standards, which realize the physical units of measurements (SI).
 The measurements and the uncertainties with confidence probability are given on the following pages and are part of the certificate.

All calibrations have been conducted in the closed laboratory facility: environment temperature (22 ± 3)°C and humidity < 70%.

Calibration Equipment used (M&TE critical for calibration)

Primary Standards	ID	Cal Date (Certificate No.)	Scheduled Calibration
Power meter NRP	SN: 104778	09-Apr-21 (No. 217-03291/03292)	Apr-22
Power sensor NRP-Z91	SN: 103244	09-Apr-21 (No. 217-03291)	Apr-22
Power sensor NRP-Z91	SN: 103245	09-Apr-21 (No. 217-03292)	Apr-22
Reference 20 dB Attenuator	SN: CC2552 (20x)	09-Apr-21 (No. 217-03343)	Apr-22
DAE4	SN: 789	23-Dec-20 (No. DAE4-789_Dec20)	Dec-21
Reference Probe ER3DV6	SN: 2328	05-Oct-20 (No. ER3-2328_Oct20)	Oct-21
Secondary Standards	ID	Check Date (in house)	Scheduled Check
Power meter E4419B	SN: GB41293874	06-Apr-16 (in house check Jun-20)	In house check: Jun-22
Power sensor E4412A	SN: MY41498087	06-Apr-16 (in house check Jun-20)	In house check: Jun-22
Power sensor E4412A	SN: 000110210	06-Apr-16 (in house check Jun-20)	In house check: Jun-22
RF generator HP 8648C	SN: US3642U01700	04-Aug-99 (in house check Jun-20)	In house check: Jun-22
Network Analyzer E8358A	SN: US41080477	31-Mar-14 (in house check Oct-20)	In house check: Oct-21

	Name	Function	Signature
Calibrated by:	Jeffrey Katzman	Laboratory Technician	
Approved by:	Katja Pokovic	Technical Manager	

Issued: May 21, 2021

This calibration certificate shall not be reproduced except in full without written approval of the laboratory.