



SAR TEST REPORT

No. I22Z60193-SEM01

For

TCL Communication Ltd.

GSM/UMTS/LTE /NR Mobile phone

Model name: T767W

With

Hardware Version: 03

Software Version: BKS3

FCC ID: 2ACCJH155

Issued Date: 2022-3-2

Note:

The test results in this test report relate only to the devices specified in this report. This report shall not be reproduced except in full without the written approval of CTTL.

Test Laboratory:

CTTL, Telecommunication Technology Labs, CAICT

No. 52, Huayuan North Road, Haidian District, Beijing, P. R. China 100191.

Tel:+86(0)10-62304633-2512,Fax:+86(0)10-62304633-2504

Email: ctl_terminals@caict.ac.cn, website: www.caict.ac.cn



REPORT HISTORY

Report Number	Revision	Issue Date	Description
I22Z60193-SEM01	Rev.0	2022-3-2	Initial creation of test report

TABLE OF CONTENT

1 TEST LABORATORY	5
1.1 TESTING LOCATION	5
1.2 TESTING ENVIRONMENT.....	5
1.3 PROJECT DATA	5
1.4 SIGNATURE.....	5
2 STATEMENT OF COMPLIANCE	6
3 CLIENT INFORMATION	9
3.1 APPLICANT INFORMATION	9
3.2 MANUFACTURER INFORMATION	9
4 EQUIPMENT UNDER TEST (EUT) AND ANCILLARY EQUIPMENT (AE).....	10
4.1 ABOUT EUT	10
4.2 INTERNAL IDENTIFICATION OF EUT USED DURING THE TEST.....	11
4.3 INTERNAL IDENTIFICATION OF AE USED DURING THE TEST	11
5 TEST METHODOLOGY	12
5.1 APPLICABLE LIMIT REGULATIONS	12
5.2 APPLICABLE MEASUREMENT STANDARDS.....	12
6 SPECIFIC ABSORPTION RATE (SAR).....	13
6.1 INTRODUCTION.....	13
6.2 SAR DEFINITION.....	13
7 TISSUE SIMULATING LIQUIDS	14
7.1 TARGETS FOR TISSUE SIMULATING LIQUID	14
7.2 DIELECTRIC PERFORMANCE	14
8 SYSTEM VERIFICATION	19
8.1 SYSTEM SETUP.....	19
8.2 SYSTEM VERIFICATION.....	20
9 MEASUREMENT PROCEDURES	21
9.1 TESTS TO BE PERFORMED	21
9.2 GENERAL MEASUREMENT PROCEDURE.....	22
9.3 WCDMA MEASUREMENT PROCEDURES FOR SAR	24
9.4 SAR MEASUREMENT FOR LTE.....	25
9.5 BLUETOOTH & WI-FI MEASUREMENT PROCEDURES FOR SAR	27
9.6 SAR MEASUREMENT FOR ENDC	27
9.7 POWER DRIFT.....	27
10 AREA SCAN BASED 1-G SAR.....	28
10.1 REQUIREMENT OF KDB.....	28
10.2 FAST SAR ALGORITHMS	28
11 CONDUCTED OUTPUT POWER.....	29
11.1 GSM MEASUREMENT RESULT	29
11.2 WCDMA MEASUREMENT RESULT.....	32
11.3 LTE MEASUREMENT RESULT	35

11.4 Wi-Fi AND BT MEASUREMENT RESULT	93
11.5 NR 5G MEASUREMENT RESULT	98
12 SIMULTANEOUS TX SAR CONSIDERATIONS.....	109
12.1 TRANSMIT ANTENNA SEPARATION DISTANCES	109
12.2 SAR MEASUREMENT POSITIONS	110
12.3 STANDALONE SAR TEST EXCLUSION CONSIDERATIONS	110
13 EVALUATION OF SIMULTANEOUS.....	111
14 SAR TEST RESULT	113
14.1 SAR RESULTS FOR FAST SAR.....	114
14.2 SAR RESULTS FOR STANDARD PROCEDURE	128
14.3 WLAN EVALUATION FOR 2.4G	135
14.4 WLAN EVALUATION FOR 5G.....	140
14.5 SAR RESULTS FOR FAST BT	148
14.6 SAR RESULTS FOR SUB6G.....	149
14.7 SAR EVALUATION FOR PHABLET	164
15 SAR MEASUREMENT VARIABILITY.....	166
16 MEASUREMENT UNCERTAINTY	168
16.1 MEASUREMENT UNCERTAINTY FOR NORMAL SAR TESTS (300MHZ~3GHZ)	168
16.2 MEASUREMENT UNCERTAINTY FOR NORMAL SAR TESTS (3~6GHZ)	169
16.3 MEASUREMENT UNCERTAINTY FOR FAST SAR TESTS (300MHZ~3GHZ)	170
16.4 MEASUREMENT UNCERTAINTY FOR FAST SAR TESTS (3~6GHZ).....	171
17 MAIN TEST INSTRUMENTS.....	173
ANNEX A GRAPH RESULTS.....	174
ANNEX B SYSTEM VERIFICATION RESULTS	250
ANNEX C SAR MEASUREMENT SETUP	267
ANNEX D POSITION OF THE WIRELESS DEVICE IN RELATION TO THE PHANTOM	273
ANNEX E EQUIVALENT MEDIA RECIPES	276
ANNEX F SYSTEM VALIDATION	277
ANNEX G PROBE CALIBRATION CERTIFICATE.....	278
ANNEX H DIPOLE CALIBRATION CERTIFICATE	287
ANNEX I NEWLY ADD BANDS AND ENDC.....	352
ANNEX J ACCREDITATION CERTIFICATE.....	387

1 Test Laboratory

1.1 Testing Location

Company Name:	CTTL(Shouxiang)
Address:	No. 51 Shouxiang Science Building, Xueyuan Road, Haidian District, Beijing, P. R. China100191

1.2 Testing Environment

Temperature:	18°C~25°C,
Relative humidity:	30%~ 70%
Ground system resistance:	< 0.5 Ω
Ambient noise & Reflection:	< 0.012 W/kg

1.3 Project Data

Project Leader:	Qi Dianyuan
Test Engineer:	Lin Xiaojun
Testing Start Date:	February 18, 2022
Testing End Date:	February 20, 2022

1.4 Signature



Lin Xiaojun
(Prepared this test report)

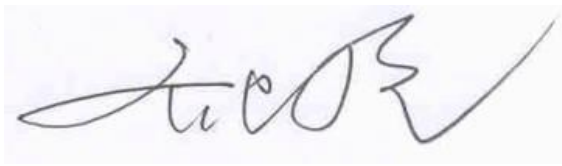

Qi Dianyuan
(Reviewed this test report)

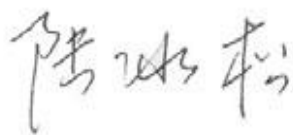

Lu Bingsong
Deputy Director of the laboratory
(Approved this test report)

2 Statement of Compliance

This EUT is a variant product and the report of original sample is No.I21Z61774-SEM01. We do full test for newly add bands 5G NR n2(SA&NSA)/n5(SA&NSA)/n70(SA). It shares the results of original sample for other bands. The results of newly add bands and ENDC are presented in the annex I.

The maximum results of Specific Absorption Rate (SAR) found during testing for TCL Communication Ltd. GSM/UMTS/LTE /NR Mobile phone T767W are as follows:

Table 2.1: Highest Reported SAR (1g)

Mode		Antenna	Highest Reported SAR (1g)			
			1g SAR Head	1g SAR Hotspot 10mm	1g SAR Body-worn 15mm	Product Specific 10-g SAR 0mm
GSM	GSM 850	ANT2	0.69	0.28	/	/
	PCS 1900	ANT4	1.01	0.54	/	/
WCDMA	UMTS FDD 2	ANT4	1.01	0.73	0.41	/
	UMTS FDD 4	ANT4	1.09	0.68	0.44	/
	UMTS FDD 5	ANT2	0.73	0.36	/	/
LTE	LTE Band 2	ANT6	0.09	0.15	/	/
	LTE Band 7	ANT5	0.85	0.92	/	/
	LTE Band 12	ANT2	0.51	0.39	/	/
	LTE Band 13	ANT2	0.60	0.35	/	/
	LTE Band 25	ANT4	0.92	0.94	0.23	/
	LTE Band 26	ANT2	0.88	0.43	/	/
	LTE Band 41-PC2	ANT5	1.03	1.14	0.45	2.76
	LTE Band 41-PC3	ANT5	0.71	0.89	0.37	/
	LTE Band 66	ANT4	0.90	0.90	0.46	/
	LTE Band 66	ANT6	0.13	0.12	/	/
NR	LTE Band 71	ANT2	0.49	0.32	/	/
	N2(SA/NSA)	ANT4	0.62	0.43	0.35	/
	N5(SA)	ANT2	0.86	0.35	0.28	/
	N5(NSA)	ANT2	0.36	0.35	0.28	/
	N25(SA&NSA)	ANT4	0.49	0.51	0.26	/
	N41(SA)	ANT5	0.18	0.23	0.45	/
	N41(NSA)	ANT5	0.18	0.23	0.68	/
	N66(SA&NSA)	ANT4	0.48	0.47	0.34	/
	n70(SA)	ANT4	0.79	0.56	0.37	/
	n71(SA)	ANT2	0.34	0.17	/	/
	n71(NSA)	ANT2	0.19	0.17	/	/
N77H(SA/NSA)	ANT1	0.14	0.36	/	/	
N77L(SA/NSA)	ANT1	0.09	0.46	/	/	
WLAN 2.4 GHz		ANT3	0.73	0.49	/	/
WLAN 5 GHz			0.49	0.57	/	/
BT			0.02	0.01	/	/

The SAR values found for the Mobile Phone are below the maximum recommended levels of 1.6 W/kg as averaged over any 1g tissue according to the ANSI C95.1-1992.

For body operation, this device has been tested and meets FCC RF exposure guidelines when used with any accessory that contains no metal and which provides a minimum separation distance of 10 mm for hotspot and 15mm for body worn between this device and the body of the user. Use of other accessories may not ensure compliance with FCC RF exposure guidelines.

The EUT battery must be fully charged and checked periodically during the test to ascertain uniform power output.

The measurement together with the test system set-up is described in annex C of this test report. A detailed description of the equipment under test can be found in chapter 4 of this test report. The highest reported SAR value is obtained at the case of **(Table 2.1)**, and the values are: **1.14 W/kg(1g)**.

Table 2.2: The sum of reported SAR values for Main antenna and WiFi-5G+BT

	Position	Cellular antenna	WiFi	BT	Sum
Highest reported SAR value for Head	Right hand, Cheek (WCDMA1700)	1.09	0.22	0.02	1.33
Maximum reported SAR value for Body	Rear 10mm (LTE Band66)	0.90	0.29	0.01	1.20

Note1: we have evaluated and chose the highest value of body 10mm and 15mm in the above table.

Table 2.3: The sum of reported SAR values for Main antenna and WiFi-2.4G+BT

	Band	Cellular antenna	WiFi	BT	Sum
Highest reported SAR value for Head	Right hand, Cheek (WCDMA1700)	1.09	0.15	0.02	1.26
Maximum reported SAR value for Body	Right 10mm (LTE Band 41-PC2)	1.14	/	/	1.14

Note1: we have evaluated and chose the highest value of body 10mm and 15mm in the above table.

According to the above tables, the highest sum of reported SAR values is **1.33 W/kg (1g)**. The detail for simultaneous transmission consideration is described in chapter 13.

According to the KDB648474 D04, the UMPC mini-tablet procedures must also be applied to test the SAR of all surfaces and edges with an antenna located at ≤ 25 mm from that surface or edge, in direct contact with a flat phantom, for 10-g extremity SAR according to the body-equivalent tissue dielectric parameters in KDB Publication 865664 D01 to address interactive hand use exposure conditions. When hotspot mode applies, 10-g extremity SAR is required only for the surfaces and edges with hotspot mode 1-g reported SAR > 1.2 W/kg

Table 2.4: The sum of SAR values for 10g extremity SAR

	Position	Main antenna	WiFi-2.4G	BT	Sum	Limited
10-g extremity SAR (Separation Distance 0mm)	Right (LTE Band41 PC2)	2.76	/	/	2.76	4.0

Table 2.5: The sum of SAR values for 10g extremity SAR

	Position	Main antenna	WiFi-5G	BT	Sum	Limited
10-g extremity SAR (Separation Distance 0mm)	Right (LTE Band41 PC2)	2.76	/	/	2.76	4.0

3 Client Information

3.1 Applicant Information

Company Name:	TCL Communication Ltd.
Address/Post:	5/F, Building 22E, 22 Science Park East Avenue, Hong Kong Science Park, Shatin, NT, Hong Kong
Contact Person:	Peter yang
Contact Email:	peter.yang@tcl.com
Telephone:	+86 755 3664 5759
Fax:	+86 755 3661 2000-81722

3.2 Manufacturer Information

Company Name:	TCL Communication Ltd.
Address/Post:	5/F, Building 22E, 22 Science Park East Avenue, Hong Kong Science Park, Shatin, NT, Hong Kong
Contact Person:	Peter yang
Contact Email:	peter.yang@tcl.com
Telephone:	+86 755 3664 5759
Fax:	+86 755 3661 2000-81722

4 Equipment Under Test (EUT) and Ancillary Equipment (AE)

4.1 About EUT

Description:	GSM/UMTS/LTE /NR Mobile phone
Model name:	T767W
Operating mode(s):	GSM850/900/1800/1900, WCDMA850/900/1700/1900/2100, BT, Wi-Fi (2.4G/5G), 5G n2/n5/n25/n66/n41/n70/ n71/n77, LTE Band 1/2/3/4/5/7/8/12/13/20/25/26/28/38/39/40/41/66/71
Tested Tx Frequency:	824 – 849 MHz (GSM 850)
	1850 – 1910 MHz (GSM 1900)
	824–849 MHz (WCDMA 850 Band V)
	1710 – 1755 MHz (WCDMA 1700 Band IV)
	1850–1910 MHz (WCDMA1900 Band II)
	1850 – 1910 MHz(LTE Band 2)
	1710 – 1755 MHz (LTE Band 4)
	824 – 849 MHz (LTE Band 5)
	2500 – 2570 MHz(LTE Band 7)
	699 – 716 MHz (LTE Band 12)
	779.5 –784.5 MHz (LTE Band 13)
	1850.7 – 1914.3 MHz (LTE Band 25)
	814 – 849 MHz (LTE Band 26)
	2570 – 2620 MHz (LTE Band 38)
	2496 – 2690 MHz (LTE Band 41)
	1710 – 1780 MHz (LTE Band 66)
	665.5 – 695.5 MHz (LTE Band 71)
	2412 – 2462 MHz (Wi-Fi 2.4G)
	5150-5825 MHz (Wi-Fi 5G)
	1850 – 1910 MHz(n2)
824 – 849 MHz(n5)	
1852.5 – 1912.5 MHz (n25)	
2506.02 – 2679.99 MHz (n41)	
1712.5 – 1777.5 MHz (n66)	
1695 – 1710 MHz (n70)	
665.5 – 695.5 MHz (n71)	
3450 – 3550 MHz (n77L)	
3700 – 3980 MHz (n77H)	
GPRS/EGPRS Multislot Class:	12
GPRS capability Class:	B
Test device Production information:	Production unit
Device type:	Portable device
Antenna type:	Integrated antenna
Hotspot mode:	Support

Note: The n77 frequency is divided into two parts. The first part of the frequency range is 3700-3900MHz, represented by n77H, and the second part of the frequency range is 3450-3550 MHz, represented by n77L.

4.2 Internal Identification of EUT used during the test

EUT ID*	IMEI	HW	SW Version
EUT1	016168000201530	03	BKS3
EUT2	016168000201662	03	BKS3
EUT3	016168000201548	03	BKS3

*EUT ID: is used to identify the test sample in the lab internally.

Note: It is performed to test SAR with the EUT1-2 and conducted power with the EUT3.

4.3 Internal Identification of AE used during the test

AE ID*	Description	Model	SN	Manufacturer
AE1	Battery	TLp043E7	/	VEKEN
AE2	Battery	TLp043E1	/	BYD

*AE ID: is used to identify the test sample in the lab internally.

5 TEST METHODOLOGY

5.1 Applicable Limit Regulations

ANSI C95.1–1992:IEEE Standard for Safety Levels with Respect to Human Exposure to Radio Frequency Electromagnetic Fields, 3 kHz to 300 GHz.

It specifies the maximum exposure limit of **1.6 W/kg** as averaged over any 1 gram of tissue for portable devices being used within 20 cm of the user in the uncontrolled environment.

5.2 Applicable Measurement Standards

IEEE 1528–2013: Recommended Practice for Determining the Peak Spatial-Average Specific Absorption Rate (SAR) in the Human Head from Wireless Communications Devices: Measurement Techniques.

KDB447498 D01: General RF Exposure Guidance v06: Mobile and Portable Devices RF Exposure Procedures and Equipment Authorization Policies.

KDB648474 D04 Handset SAR v01r03: SAR Evaluation Considerations for Wireless Handsets.

KDB941225 D01 SAR test for 3G devices v03r01: SAR Measurement Procedures for 3G Devices

KDB941225 D05 SAR for LTE Devices v02r05: SAR Evaluation Considerations for LTE Devices

KDB941225 D06 Hotspot Mode SAR v02r01: SAR Evaluation Procedures for Portable Devices with Wireless Router Capabilities

KDB248227 D01 802.11 Wi-Fi SAR v02r02: SAR GUIDANCE FOR IEEE 802.11 (Wi-Fi) TRANSMITTERS

KDB865664 D01 SAR measurement 100 MHz to 6 GHz v01r04: SAR Measurement Requirements for 100 MHz to 6 GHz.

KDB865664 D02 RF Exposure Reporting v01r02: RF Exposure Compliance Reporting and Documentation Considerations

TCB Workshop Nov 2019: RF Exposure Policy Updates (5G NR NSA Sub 6G SAR)

6 Specific Absorption Rate (SAR)

6.1 Introduction

SAR is related to the rate at which energy is absorbed per unit mass in an object exposed to a radio field. The SAR distribution in a biological body is complicated and is usually carried out by experimental techniques or numerical modeling. The standard recommends limits for two tiers of groups, occupational/controlled and general population/uncontrolled, based on a person's awareness and ability to exercise control over his or her exposure. In general, occupational/controlled exposure limits are higher than the limits for general population/uncontrolled.

6.2 SAR Definition

The SAR definition is the time derivative (rate) of the incremental energy (dW) absorbed by (dissipated in) an incremental mass (dm) contained in a volume element (dv) of a given density (ρ). The equation description is as below:

$$SAR = \frac{d}{dt} \left(\frac{dW}{dm} \right) = \frac{d}{dt} \left(\frac{dW}{\rho dv} \right)$$

SAR is expressed in units of Watts per kilogram (W/kg)

SAR measurement can be either related to the temperature elevation in tissue by

$$SAR = c \left(\frac{\delta T}{\delta t} \right)$$

Where: C is the specific heat capacity, δT is the temperature rise and δt is the exposure duration, or related to the electrical field in the tissue by

$$SAR = \frac{\sigma |E|^2}{\rho}$$

Where: σ is the conductivity of the tissue, ρ is the mass density of tissue and E is the RMS electrical field strength.

However for evaluating SAR of low power transmitter, electrical field measurement is typically applied.

7 Tissue Simulating Liquids

7.1 Targets for tissue simulating liquid

Table 7.1: Targets for tissue simulating liquid

Frequency(MHz)	Liquid Type	Conductivity(σ)	$\pm 10\%$ Range	Permittivity(ϵ)	$\pm 10\%$ Range
750	Head	0.89	0.80~0.98	41.94	37.75~46.13
835	Head	0.90	0.81~0.99	41.5	37.35~45.65
1750	Head	1.40	1.26~1.54	40.0	36~44
1900	Head	1.40	1.26~1.54	40.0	36~44
2450	Head	1.80	1.62~1.98	39.2	35.28~43.12
2600	Head	1.96	1.76~2.16	39.01	35.11~42.91

Table 7.2: Targets for tissue simulating liquid

Frequency(MHz)	Liquid Type	Conductivity(σ)	$\pm 5\%$ Range	Permittivity(ϵ)	$\pm 5\%$ Range
3700	Head	3.12	2.96~3.28	37.70	35.82~39.59
3900	Head	3.32	3.15~3.49	37.47	35.6~39.34
5250	Head	4.71	4.47~4.95	35.93	34.13~37.73
5600	Head	5.07	4.82~5.32	35.53	33.8~37.3
5750	Head	5.22	4.96~5.48	35.36	33.59~37.13

7.2 Dielectric Performance

Table 7.3: Dielectric Performance of Tissue Simulating Liquid

Measurement Date (yyyy-mm-dd)	Type	Frequency	Permittivity ϵ	Drift (%)	Conductivity σ (S/m)	Drift (%)
2021-10-1	Head	750 MHz	44.5	6.10	0.879	-1.24
2021-10-24	Head	750 MHz	45.73	9.04	0.875	-1.69
2021-10-19	Head	835 MHz	43.98	5.98	0.904	0.44
2021-10-15	Head	1750 MHz	43.35	8.16	1.388	1.31
2021-10-22	Head	1750 MHz	43.35	8.16	1.388	1.31
2021-10-13	Head	1900 MHz	41.88	4.70	1.514	8.14
2021-10-20	Head	1900 MHz	43.09	7.73	1.482	5.86
2021-10-27	Head	2450 MHz	40.27	2.73	1.921	6.72
2021-10-30	Head	2600 MHz	39.94	2.38	2.041	4.13
2021-10-28	Head	2600 MHz	40.59	4.05	1.998	1.94
2021-11-3	Head	3500 MHz	38.84	2.40	2.963	1.82
2021-11-3	Head	3900 MHz	38.02	1.47	3.358	1.14
2021-10-23	Head	5250 MHz	34.79	-3.17	4.668	-0.89
2021-10-25	Head	5600 MHz	34.17	-3.83	5.043	-0.53
2021-10-26	Head	5750 MHz	33.86	-4.24	5.211	-0.17
2021-11-22	Head	2600 MHz	40.35	3.44	1.976	0.82

Note: The liquid temperature is 22.0°C

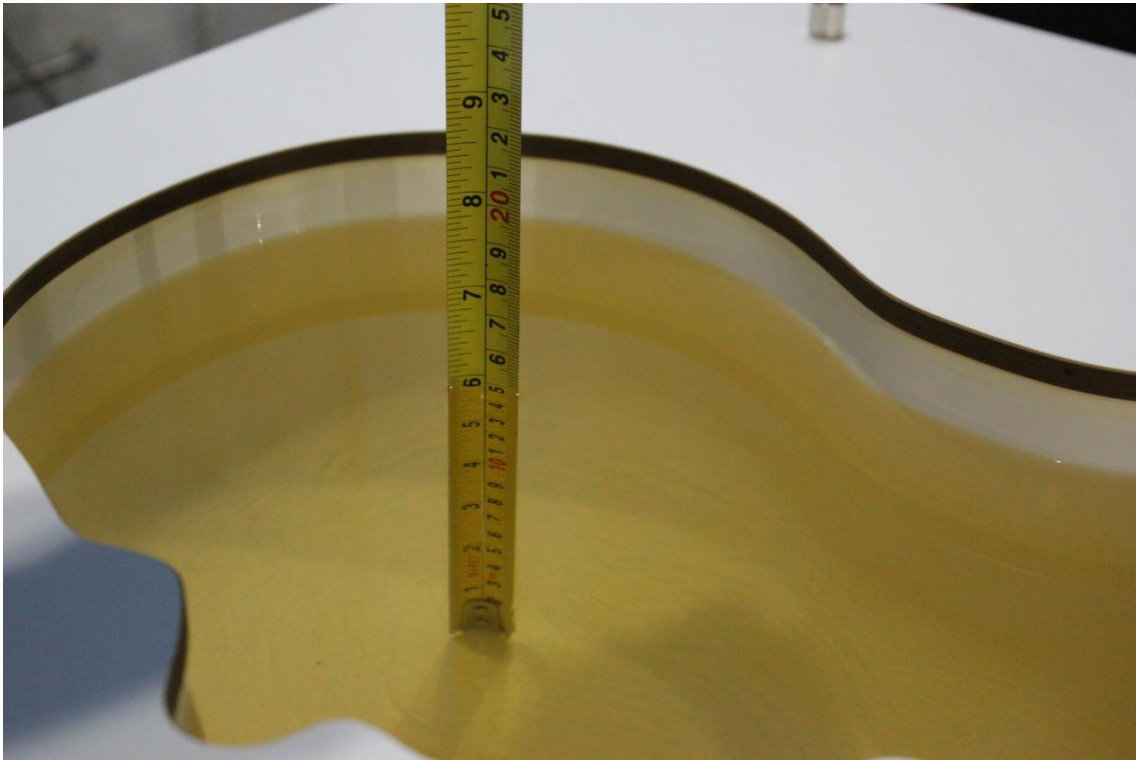

Picture 7-1 Liquid depth in the Head Phantom (750MHz)

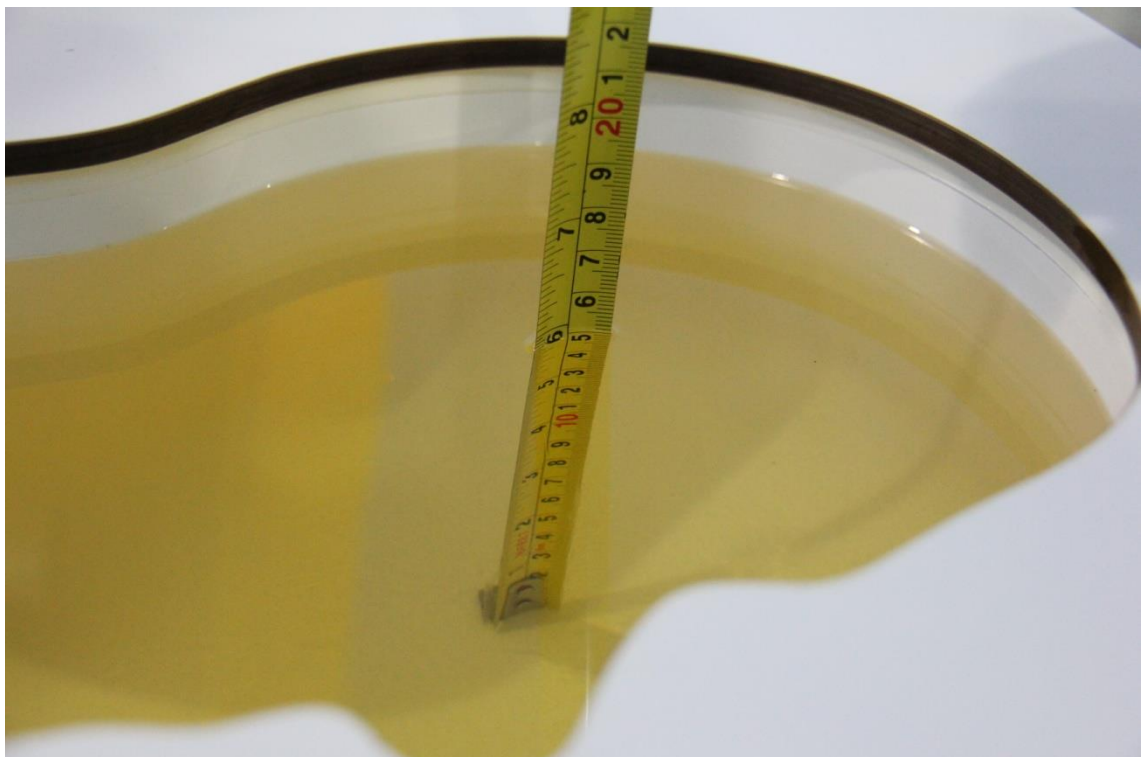

Picture 7-2 Liquid depth in the Head Phantom (835 MHz)



Picture 7-3 Liquid depth in the Head Phantom (1750 MHz)

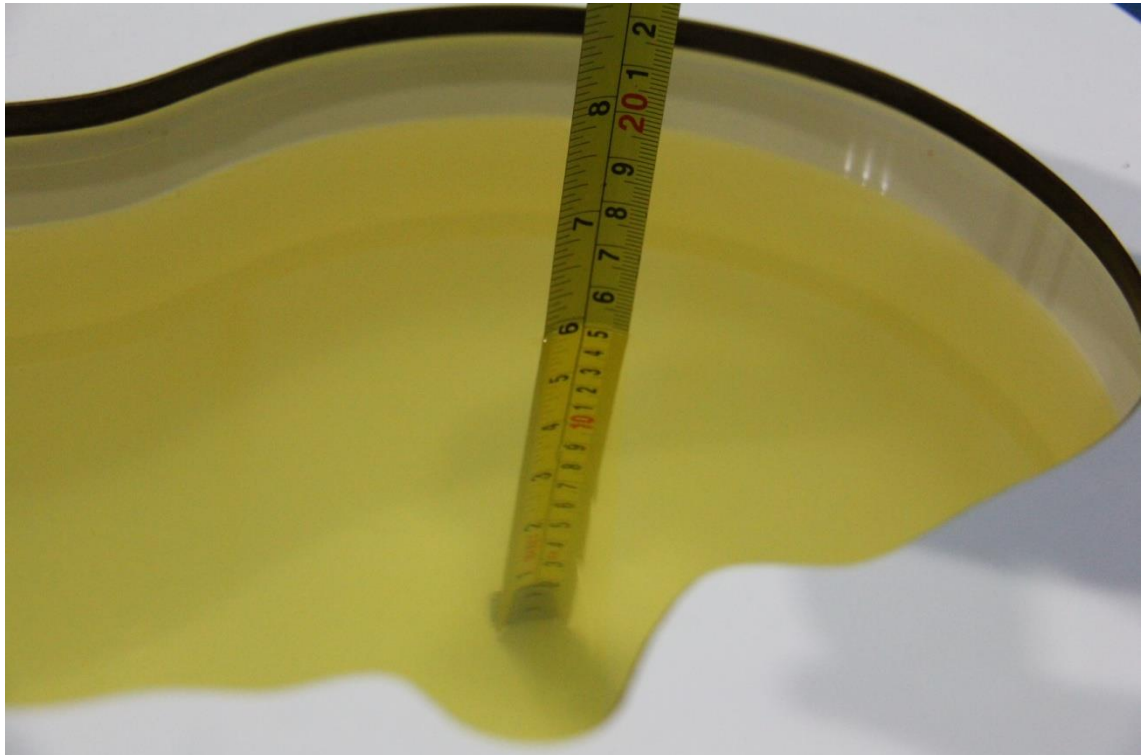

Picture 7-4 Liquid depth in the Head Phantom (1900 MHz)

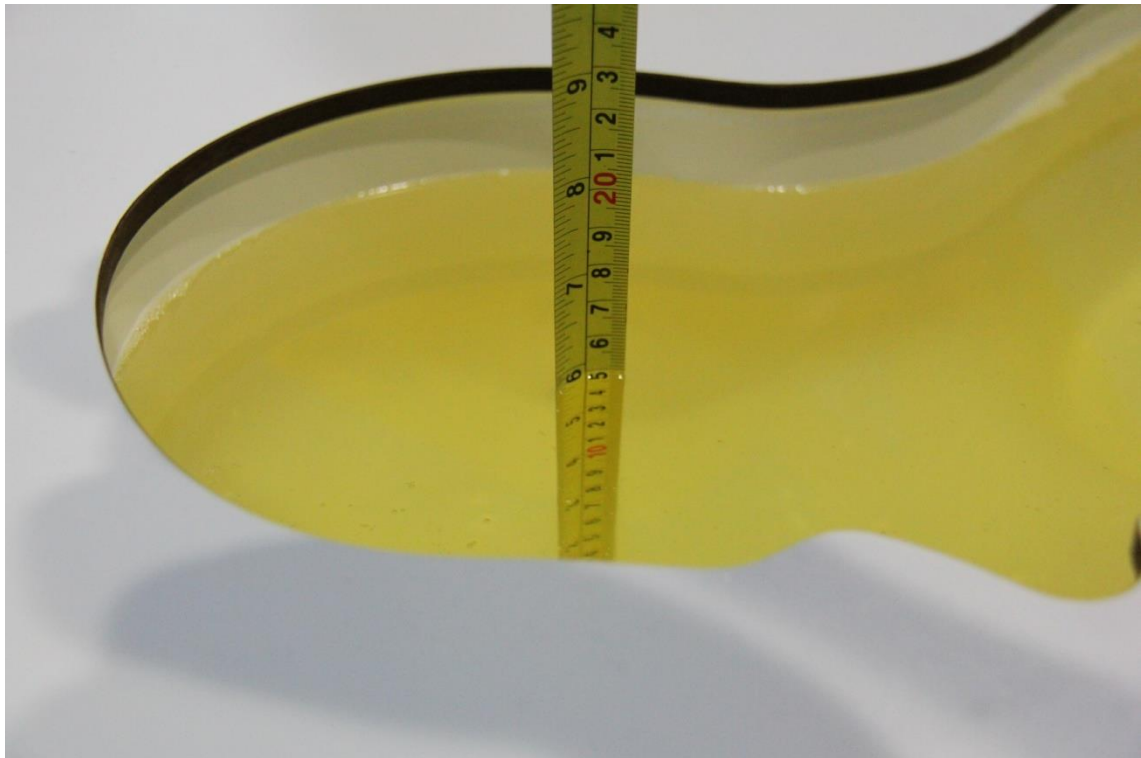

Picture 7-5 Liquid depth in the Head Phantom (2450MHz)



Picture 7-6 Liquid depth in the Head Phantom (2600 MHz)



Picture 7-7 Liquid depth in the Head Phantom (5GHz)



Picture 7-8 Liquid depth in the Head Phantom (3500-3900 MHz)

8 System verification

8.1 System Setup

In the simplified setup for system evaluation, the DUT is replaced by a calibrated dipole and the power source is replaced by a continuous wave that comes from a signal generator. The calibrated dipole must be placed beneath the flat phantom section of the SAM twin phantom with the correct distance holder. The distance holder should touch the phantom surface with a light pressure at the reference marking and be oriented parallel to the long side of the phantom. The equipment setup is shown below:

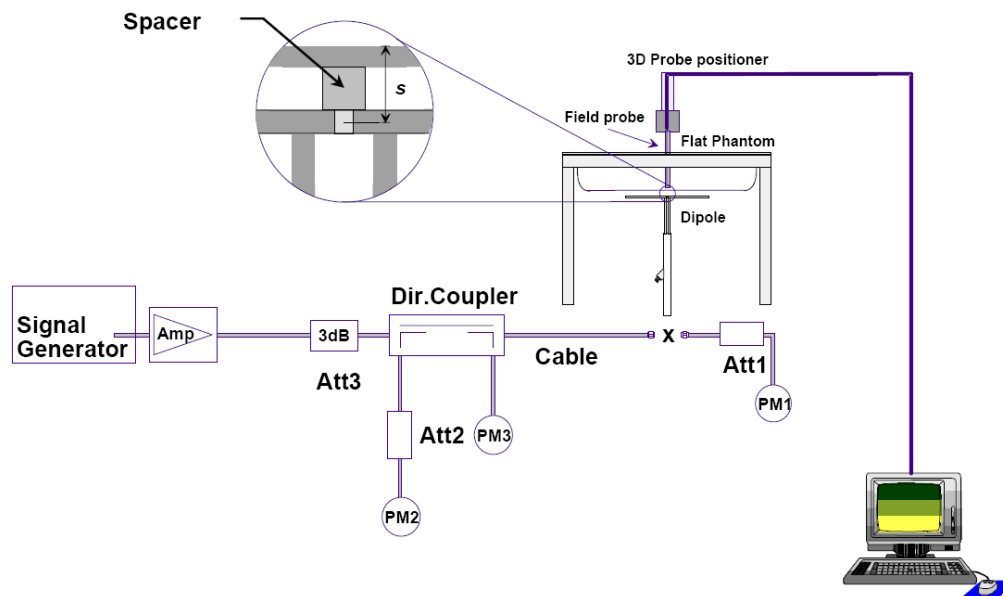

Picture 8.1 System Setup for System Evaluation



Picture 8.2 Photo of Dipole Setup

8.2 System Verification

SAR system verification is required to confirm measurement accuracy, according to the tissue dielectric media, probe calibration points and other system operating parameters required for measuring the SAR of a test device. The system verification must be performed for each frequency band and within the valid range of each probe calibration point required for testing the device.

The system verification results are required that the area scan estimated 1-g SAR is within 3% of the zoom scan 1-g SAR. The details are presented in annex B.

Table 8.1: System Verification of Head

Measurement Date (yyyy-mm-dd)	Frequency	Target value (W/kg)		Measured value(W/kg)		Deviation	
		10 g Average	1 g Average	10 g Average	1 g Average	10 g Average	1 g Average
2021-10-1	750 MHz	5.65	8.68	5.76	8.64	1.95%	-0.46%
2021-10-24	750 MHz	5.65	8.68	6.00	9.04	6.19%	4.15%
2021-10-19	835 MHz	6.24	9.63	6.48	9.80	3.85%	1.77%
2021-10-15	1750 MHz	19.4	36.9	21.0	39.8	8.04%	7.75%
2021-10-22	1750 MHz	19.4	36.9	19.0	35.8	-1.86%	-2.98%
2021-10-13	1900 MHz	20.9	40.1	22.5	43.6	7.56%	8.73%
2021-10-20	1900 MHz	20.9	40.1	22.0	42.8	5.45%	6.73%
2021-10-27	2450 MHz	24.9	53.3	25.9	56.4	3.94%	5.82%
2021-10-30	2600 MHz	25.5	57.1	26.4	59.6	3.37%	4.38%
2021-10-28	2600 MHz	25.5	57.1	24.3	54.8	-4.78%	-4.03%
2021-11-3	3500 MHz	25.2	67.3	26.8	72.8	6.35%	8.17%
2021-11-3	3900 MHz	24.1	69.3	22.3	63.6	-7.55%	-8.23%
2021-10-23	5250 MHz	22.7	79.5	21.7	75.6	-4.41%	-4.91%
2021-10-25	5600 MHz	23.7	83.8	22.0	76.9	-7.17%	-8.23%
2021-10-26	5750 MHz	22.7	81.0	21.2	74.1	-6.61%	-8.52%
2021-11-22	2600 MHz	25.5	57.1	23.9	53.6	-6.35%	-6.13%

9 Measurement Procedures

9.1 Tests to be performed

In order to determine the highest value of the peak spatial-average SAR of a handset, all device positions, configurations and operational modes shall be tested for each frequency band according to steps 1 to 3 below. A flowchart of the test process is shown in picture 9.1.

Step 1: The tests described in 9.2 shall be performed at the channel that is closest to the centre of the transmit frequency band (f_c) for:

- a) all device positions (cheek and tilt, for both left and right sides of the SAM phantom, as described in annex D),
- b) all configurations for each device position in a), e.g., antenna extended and retracted, and
- c) all operational modes, e.g., analogue and digital, for each device position in a) and configuration in b) in each frequency band.

If more than three frequencies need to be tested according to 11.1 (i.e., $N_c > 3$), then all frequencies, configurations and modes shall be tested for all of the above test conditions.

Step 2: For the condition providing highest peak spatial-average SAR determined in Step 1, perform all tests described in 9.2 at all other test frequencies, i.e., lowest and highest frequencies. In addition, for all other conditions (device position, configuration and operational mode) where the peak spatial-average SAR value determined in Step 1 is within 3 dB of the applicable SAR limit, it is recommended that all other test frequencies shall be tested as well.

Step 3: Examine all data to determine the highest value of the peak spatial-average SAR found in Steps 1 to 2.

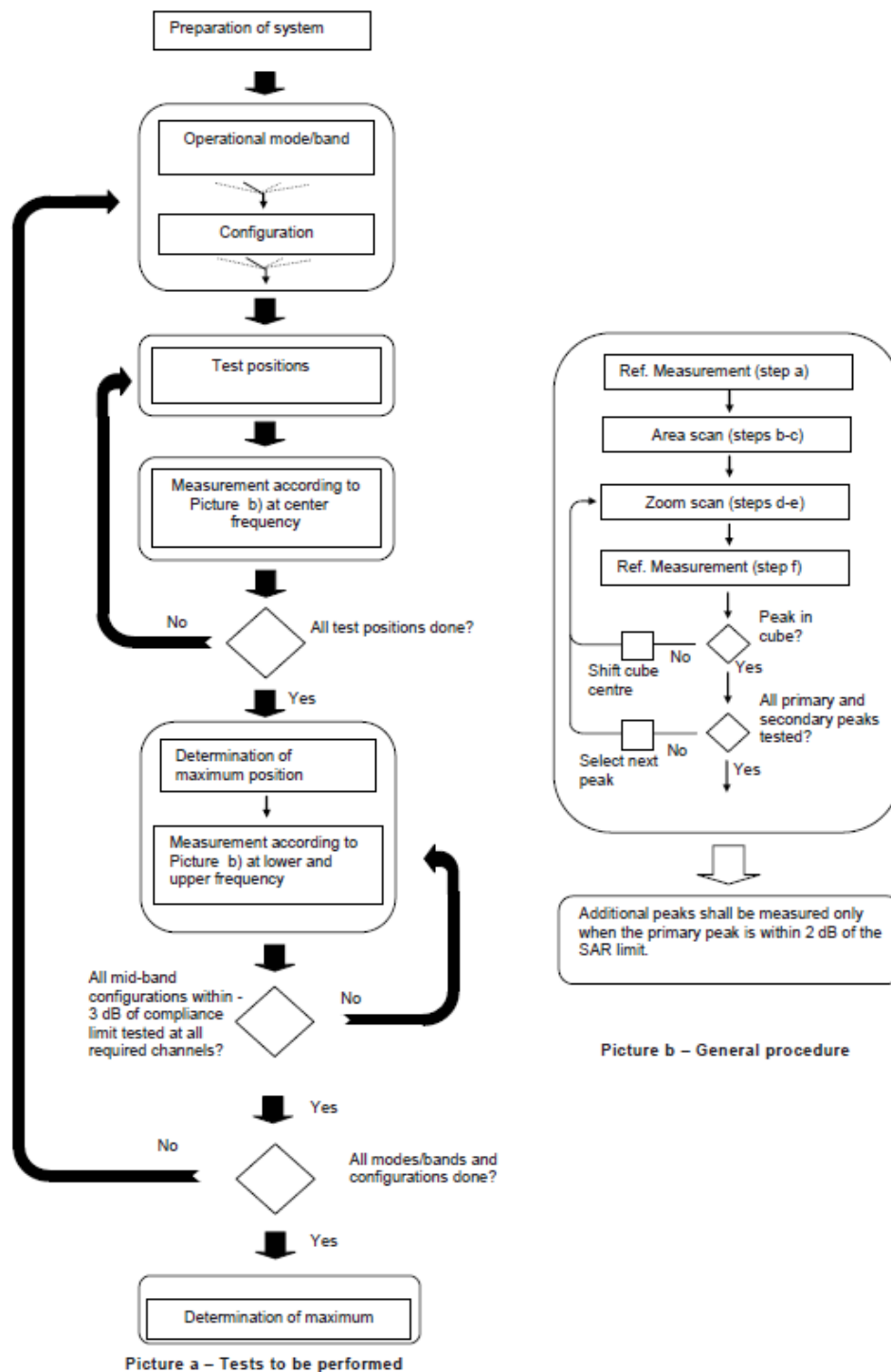

Picture 9.1 Block diagram of the tests to be performed

9.2 General Measurement Procedure

The area and zoom scan resolutions specified in the table below must be applied to the SAR measurements and fully documented in SAR reports to qualify for TCB approval. Probe boundary effect error compensation is required for measurements with the probe tip closer than half a probe tip diameter to the phantom surface. Both the probe tip diameter and sensor offset distance must satisfy measurement protocols; to ensure probe boundary effect errors are minimized and the

higher fields closest to the phantom surface can be correctly measured and extrapolated to the phantom surface for computing 1-g SAR. Tolerances of the post-processing algorithms must be verified by the test laboratory for the scan resolutions used in the SAR measurements, according to the reference distribution functions specified in IEEE Std 1528-2013. The results should be documented as part of the system validation records and may be requested to support test results when all the measurement parameters in the following table are not satisfied.

		≤ 3 GHz	> 3 GHz	
Maximum distance from closest measurement point (geometric center of probe sensors) to phantom surface		5 ± 1 mm	$\frac{1}{2} \cdot \delta \cdot \ln(2) \pm 0.5$ mm	
Maximum probe angle from probe axis to phantom surface normal at the measurement location		$30^\circ \pm 1^\circ$	$20^\circ \pm 1^\circ$	
Maximum area scan spatial resolution: Δx_{Area} , Δy_{Area}		≤ 2 GHz: ≤ 15 mm 2 – 3 GHz: ≤ 12 mm	3 – 4 GHz: ≤ 12 mm 4 – 6 GHz: ≤ 10 mm	
		When the x or y dimension of the test device, in the measurement plane orientation, is smaller than the above, the measurement resolution must be \leq the corresponding x or y dimension of the test device with at least one measurement point on the test device.		
Maximum zoom scan spatial resolution: Δx_{Zoom} , Δy_{Zoom}		≤ 2 GHz: ≤ 8 mm 2 – 3 GHz: ≤ 5 mm*	3 – 4 GHz: ≤ 5 mm* 4 – 6 GHz: ≤ 4 mm*	
Maximum zoom scan spatial resolution, normal to phantom surface	uniform grid: $\Delta z_{Zoom}(n)$	≤ 5 mm	3 – 4 GHz: ≤ 4 mm 4 – 5 GHz: ≤ 3 mm 5 – 6 GHz: ≤ 2 mm	
	graded grid	$\Delta z_{Zoom}(1)$: between 1 st two points closest to phantom surface	≤ 4 mm	3 – 4 GHz: ≤ 3 mm 4 – 5 GHz: ≤ 2.5 mm 5 – 6 GHz: ≤ 2 mm
		$\Delta z_{Zoom}(n>1)$: between subsequent points	$\leq 1.5 \cdot \Delta z_{Zoom}(n-1)$	
Minimum zoom scan volume	x, y, z	≥ 30 mm	3 – 4 GHz: ≥ 28 mm 4 – 5 GHz: ≥ 25 mm 5 – 6 GHz: ≥ 22 mm	
Note: δ is the penetration depth of a plane-wave at normal incidence to the tissue medium; see draft standard IEEE P1528-2011 for details. * When zoom scan is required and the <i>reported</i> SAR from the area scan based 1-g SAR estimation procedures of KDB 447498 is ≤ 1.4 W/kg, ≤ 8 mm, ≤ 7 mm and ≤ 5 mm zoom scan resolution may be applied, respectively, for 2 GHz to 3 GHz, 3 GHz to 4 GHz and 4 GHz to 6 GHz.				

9.3 WCDMA Measurement Procedures for SAR

The following procedures are applicable to WCDMA handsets operating under 3GPP Release99, Release 5 and Release 6. The default test configuration is to measure SAR with an established radio link between the DUT and a communication test set using a 12.2kbps RMC (reference measurement channel) configured in Test Loop Mode 1. SAR is selectively confirmed for other physical channel configurations (DPCCH & DPDCH_n), HSDPA and HSPA (HSUPA/HSDPA) modes according to output power, exposure conditions and device operating capabilities. Both uplink and downlink should be configured with the same RMC or AMR, when required. SAR for Release 5 HSDPA and Release 6 HSPA are measured using the applicable FRC (fixed reference channel) and E-DCH reference channel configurations. Maximum output power is verified according to applicable versions of 3GPP TS 34.121 and SAR must be measured according to these maximum output conditions. When Maximum Power Reduction (MPR) is not implemented according to Cubic Metric (CM) requirements for Release 6 HSPA, the following procedures do not apply.

For Release 5 HSDPA Data Devices:

Sub-test	β_c	β_d	β_d (SF)	β_c/β_d	β_{hs}	CM/dB
1	2/15	15/15	64	2/15	4/15	0.0
2	12/15	15/15	64	12/15	24/25	1.0
3	15/15	8/15	64	15/8	30/15	1.5
4	15/15	4/15	64	15/4	30/15	1.5

For Release 6 HSPA Data Devices

Sub-test	β_c	β_d	β_d (SF)	β_c/β_d	β_{hs}	β_{ec}	β_{ed}	β_{ed} (SF)	β_{ed} (codes)	CM (dB)	MPR (dB)	AG Index	E-TFCI
1	11/15	15/15	64	11/15	22/15	209/225	1039/225	4	1	1.5	1.5	20	75
2	6/15	15/15	64	6/15	12/15	12/15	12/15	4	1	1.5	1.5	12	67
3	15/15	9/15	64	15/9	30/15	30/15	$\beta_{ed1}:47/15$ $\beta_{ed2}:47/15$	4	2	1.5	1.5	15	92
4	2/15	15/15	64	2/15	4/15	4/15	56/75	4	1	1.5	1.5	17	71
5	15/15	15/15	64	15/15	24/15	30/15	134/15	4	1	1.5	1.5	21	81

Rel.8 DC-HSDPA (Cat 24)

SAR test exclusion for Rel.8 DC-HSDPA must satisfy the SAR test exclusion requirements of Rel.5 HSDPA. SAR test exclusion for DC-HSDPA devices is determined by power measurements according to the H-Set 12, Fixed Reference Channel (FRC) configuration in Table C.8.1.12 of 3GPP TS 34.121-1. A primary and a secondary serving HS-DSCH Cell are required to perform the power measurement and for the results to qualify for SAR test exclusion.

9.4 SAR Measurement for LTE

SAR tests for LTE are performed with a base station simulator, Rohde & Schwarz CMW500. Closed loop power control was used so the UE transmits with maximum output power during SAR testing. All powers were measured with the CMW 500.

It is performed for conducted power and SAR based on the KDB941225 D05.

SAR is evaluated separately according to the following procedures for the different test positions in each exposure condition – head, body, body-worn accessories and other use conditions. The procedures in the following subsections are applied separately to test each LTE frequency band.

1) QPSK with 1 RB allocation

Start with the largest channel bandwidth and measure SAR for QPSK with 1 RB allocation, using the RB offset and required test channel combination with the highest maximum output power among RB offsets at the upper edge, middle and lower edge of each required test channel. When the reported SAR is ≤ 0.8 W/kg, testing of the remaining RB offset configurations and required test channels is not required for 1 RB allocation; otherwise, SAR is required for the remaining required test channels and only for the RB offset configuration with the highest output power for that channel. When the reported SAR of a required test channel is > 1.45 W/kg, SAR is required for all three RB offset configurations for that required test channel.

2) QPSK with 50% RB allocation

The procedures required for 1 RB allocation in 1) are applied to measure the SAR for QPSK with 50% RB allocation.

3) QPSK with 100% RB allocation

For QPSK with 100% RB allocation, SAR is not required when the highest maximum output power for 100 % RB allocation is less than the highest maximum output power in 50% and 1 RB allocations and the highest reported SAR for 1 RB and 50% RB allocation in 1) and 2) are ≤ 0.8 W/kg. Otherwise, SAR is measured for the highest output power channel; and if the reported SAR is > 1.45 W/kg, the remaining required test channels must also be tested.

TDD test:

TDD testing is performed using guidance from FCC KDB 941225 D05 v02r05 and the SAR test guidance provided in April 2013 TCB works hop notes. TDD is tested at the highest duty factor using UL-DL configuration 0 with special subframe configuration 6 and applying the FDD LTE procedures in KDB 941225 D05 v02r05. SAR testing is performed using the extended cyclic prefix listed in 3GPP TS 36.211.

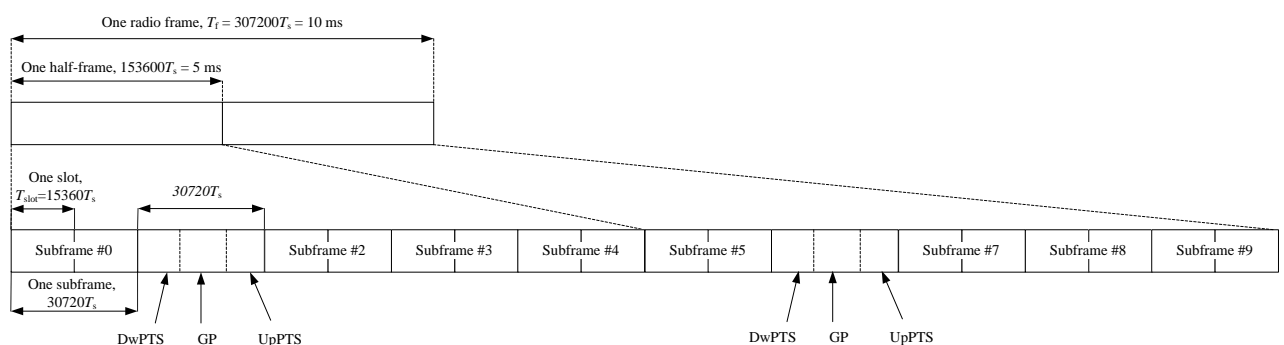

Figure 9.2: Frame structure type 2 (for 5 ms switch-point periodicity)

Table 9.1: Configuration of special subframe (lengths of DwPTS/GP/UpPTS)

Special subframe configuration	Normal cyclic prefix in downlink			Extended cyclic prefix in downlink		
	DwPTS	UpPTS		DwPTS	UpPTS	
		Normal cyclic prefix in uplink	Extended cyclic prefix in uplink		Normal cyclic prefix in uplink	Extended cyclic prefix in uplink
0	$6592 \cdot T_s$	$2192 \cdot T_s$	$2560 \cdot T_s$	$7680 \cdot T_s$	$2192 \cdot T_s$	$2560 \cdot T_s$
1	$19760 \cdot T_s$			$20480 \cdot T_s$		
2	$21952 \cdot T_s$			$23040 \cdot T_s$		
3	$24144 \cdot T_s$			$25600 \cdot T_s$		
4	$26336 \cdot T_s$	$4384 \cdot T_s$	$5120 \cdot T_s$	$7680 \cdot T_s$	$4384 \cdot T_s$	$5120 \cdot T_s$
5	$6592 \cdot T_s$			$20480 \cdot T_s$		
6	$19760 \cdot T_s$			$23040 \cdot T_s$		
7	$21952 \cdot T_s$			$12800 \cdot T_s$		
8	$24144 \cdot T_s$			-		
9	$13168 \cdot T_s$	-	-	-	-	-

Table 9.2: Uplink-downlink configurations

Uplink-downlink configuration	Downlink-to-Uplink Switch-point periodicity	Subframe number										
		0	1	2	3	4	5	6	7	8	9	
0	5 ms	D	S	U	U	U	D	S	U	U	U	
1	5 ms	D	S	U	U	D	D	S	U	U	D	
2	5 ms	D	S	U	D	D	D	S	U	D	D	
3	10 ms	D	S	U	U	U	D	D	D	D	D	
4	10 ms	D	S	U	U	D	D	D	D	D	D	
5	10 ms	D	S	U	D	D	D	D	D	D	D	
6	5 ms	D	S	U	U	U	D	S	U	U	D	

Duty factor is calculated by:

$$\begin{aligned}
 \text{Duty factor} &= \text{uplink frame} \cdot 6 + \text{UpPTS} \cdot 2 / \text{one frame length} \\
 &= (30720 \cdot T_s \cdot 6 + 5120 \cdot T_s \cdot 2) / 307200 \cdot T_s \\
 &= 0.633
 \end{aligned}$$

According to the KDB 447498 D01, SAR should be evaluated at more than 3 frequencies for devices supporting transmit bands wider than 100MHz. Oct.2014 FCC-TCB conference notes (Dec. 2014 rev.) specifies the 5 test channels to use for 3GPP band 41 SAR evaluation.

9.5 Bluetooth & Wi-Fi Measurement Procedures for SAR

Normal network operating configurations are not suitable for measuring the SAR of 802.11 transmitters in general. Unpredictable fluctuations in network traffic and antenna diversity conditions can introduce undesirable variations in SAR results. The SAR for these devices should be measured using chipset based test mode software to ensure that the results are consistent and reliable.

Chipset based test mode software is hardware dependent and generally varies among manufacturers. The device operating parameters established in a test mode for SAR measurements must be identical to those programmed in production units, including output power levels, amplifier gain settings and other RF performance tuning parameters. The test frequencies should correspond to actual channel frequencies defined for domestic use. SAR for devices with switched diversity should be measured with only one antenna transmitting at a time during each SAR measurement, according to a fixed modulation and data rate. The same data pattern should be used for all measurements.

9.6 SAR Measurement for ENDC

1. Test LTE SAR with single uplink at maximum power following LTE SAR test procedure.
2. Test conducted power of 5G NR sub-carrier under EN-DC at maximum power (FDD and TDD)[1] and change the different parameters to find the worst-case configuration, see detail procedure as attached.

[1] For TDD band (n41), PC2 mode is only tested, because the duty cycle of both PC2 and PC3 are the same and PC2 has higher power than PC3.

3. Test SAR in worst case configuration for 5G NR in single uplink (test mode).
4. If the single uplink 1g SAR values for 5G NR and LTE are both less than 0.8W/kg and the algebraic summation of the 1g SAR values are less than 1.45W/kg, no additional measurements need to be performed.

9.7 Power Drift

To control the output power stability during the SAR test, DASY5 system calculates the power drift by measuring the E-field at the same location at the beginning and at the end of the measurement for each test position. These drift values can be found in section14 labeled as: (Power Drift [dB]). This ensures that the power drift during one measurement is within 5%.

10 Area Scan Based 1-g SAR

10.1 Requirement of KDB

According to the KDB447498 D01 v06, when the implementation is based the specific polynomial fit algorithm as presented at the 29th Bioelectromagnetics Society meeting (2007) and the estimated 1-gSAR is ≤ 1.2 W/kg, a zoom scan measurement is not required provided it is also not needed for any other purpose; for example, if the peak SAR location required for simultaneous transmission SAR test exclusion can be determined accurately by the SAR system or manually to discriminate between distinctive peaks and scattered noisy SAR distributions from area scans.

There must not be any warning or alert messages due to various measurement concerns identified by the SAR system; for example, noise in measurements, peaks too close to scan boundary, peaks are too sharp, spatial resolution and uncertainty issues etc. The SAR system verification must also demonstrate that the area scan estimated 1-g SAR is within 3% of the zoom scan 1-g SAR (See Annex B). When all the SAR results for each exposure condition in a frequency band and wireless mode are based on estimated 1-g SAR, the 1-g SAR for the highest SAR configuration must be determined by a zoom scan.

10.2 Fast SAR Algorithms

The approach is based on the area scan measurement applying a frequency dependent attenuation parameter. This attenuation parameter was empirically determined by analyzing a large number of phones. The MOTOROLA FAST SAR was developed and validated by the MOTOROLA Research Group in Ft. Lauderdale.

In the initial study, an approximation algorithm based on Linear fit was developed. The accuracy of the algorithm has been demonstrated across a broad frequency range (136-2450 MHz) and for both 1- and 10-g averaged SAR using a sample of 264 SAR measurements from 55 wireless handsets. For the sample size studied, the root-mean-squared errors of the algorithm are 1.2% and 5.8% for 1- and 10-g averaged SAR, respectively. The paper describing the algorithm in detail is expected to be published in August 2004 within the Special Issue of Transactions on MTT.

In the second step, the same research group optimized the fitting algorithm to an Polynomial fit whereby the frequency validity was extended to cover the range 30-6000MHz. Details of this study can be found in the BEMS 2007 Proceedings.

Both algorithms are implemented in DASY software.

11 Conducted Output Power

Table1: Summary of Receiver detection mechanism

Antenna	Receiver on (head scenario)	Receiver off + Hotspot on (Body/other scenario)	Receiver off + Hotspot off (Body/other scenario)
Standalone	DSI3	DSI2	DSI1
UL CA/ENDC	DSI6	DSI5	DSI4

11.1 GSM Measurement result

During the process of testing, the EUT was controlled via Agilent Digital Radio Communication tester (E5515C) to ensure the maximum power transmission and proper modulation. This result contains conducted output power for the EUT. In all cases, the measured peak output power should be greater and within 5% than EMI measurement.

Table 11.1-1: The conducted power measurement results for GSM, GPRS and EGPRS-
DSI1/2/3

GSM 850 Speech (GMSK)	Measured Power (dBm)			Tune up	calculation	Averaged Power (dBm)		
	251	190	128			251	190	128
1 Txslot	31.41	31.45	31.39	32.80	/	/	/	/
GSM 850 GPRS (GMSK)	Measured Power (dBm)				calculation	Averaged Power (dBm)		
	251	190	128			251	190	128
1 Txslot	31.31	31.37	31.30	32.80	-9.03	22.28	22.34	22.27
2 Txslots	30.53	30.59	30.53	31.50	-6.02	24.51	24.57	24.51
3Txslots	28.76	28.81	28.78	29.00	-4.26	24.50	24.55	24.52
4 Txslots	27.69	27.73	27.69	28.00	-3.01	24.68	24.72	24.68
GSM 850 EGPRS (GMSK)	Measured Power (dBm)				calculation	Averaged Power (dBm)		
	251	190	128			251	190	128
1 Txslot	31.25	31.30	31.23	32.80	-9.03	22.22	22.27	22.20
2 Txslots	30.46	30.52	30.45	31.50	-6.02	24.44	24.50	24.43
3Txslots	28.69	28.74	28.70	29.00	-4.26	24.43	24.48	24.44
4 Txslots	27.61	27.66	27.60	28.00	-3.01	24.60	24.65	24.59
GSM 850 EGPRS (8PSK)	Measured Power (dBm)				calculation	Averaged Power (dBm)		
	251	190	128			251	190	128
1 Txslot	26.05	25.93	25.89	27.50	-9.03	17.02	16.90	16.86
2 Txslots	24.74	24.69	25.47	26.50	-6.02	18.72	18.67	19.45
3Txslots	22.58	23.62	22.75	24.50	-4.26	18.32	19.36	18.49
4 Txslots	22.34	21.62	21.36	23.00	-3.01	19.33	18.61	18.35

NOTES:

1) Division Factors

To average the power, the division factor is as follows:

1TX-slot = 1 transmit time slot out of 8 time slots=> conducted power divided by (8/1) => -9.03dB

2TX-slots = 2 transmit time slots out of 8 time slots=> conducted power divided by (8/2) => -6.02dB

3TX-slots = 3 transmit time slots out of 8 time slots=> conducted power divided by (8/3) => -4.26dB

4TX-slots = 4 transmit time slots out of 8 time slots=> conducted power divided by (8/4) => -3.01dB

According to the conducted power as above, the body measurements are performed with 4Txslots for GSM850

Table 11.1-2: The conducted power measurement results for GSM, GPRS and EGPRS DSI3

PCS1900 Speech (GMSK)	Measured Power (dBm)			Tune up	calculation	Averaged Power (dBm)		
	810	661	512			810	661	512
1 Txslot	28.68	29.15	28.45	29.50	/	/	/	/
PCS1900 GPRS (GMSK)	Measured Power (dBm)				calculation	Averaged Power (dBm)		
	810	661	512			810	661	512
1 Txslot	28.63	29.09	28.40	29.50	-9.03	19.60	20.06	19.37
2 Txslots	27.51	27.97	27.30	28.70	-6.02	21.49	21.95	21.28
3Txslots	25.46	25.92	25.26	26.50	-4.26	21.20	21.66	21.00
4 Txslots	24.48	24.94	24.26	25.50	-3.01	21.47	21.93	21.25
PCS1900 EGPRS (GMSK)	Measured Power (dBm)				calculation	Averaged Power (dBm)		
	810	661	512			810	661	512
1 Txslot	28.58	29.05	28.36	29.50	-9.03	19.55	20.02	19.33
2 Txslots	27.47	27.94	27.26	28.70	-6.02	21.45	21.92	21.24
3Txslots	25.43	25.89	25.21	26.50	-4.26	21.17	21.63	20.95
4 Txslots	24.44	24.92	24.22	25.50	-3.01	21.43	21.91	21.21
PCS1900 EGPRS (8PSK)	Measured Power (dBm)				calculation	Averaged Power (dBm)		
	810	661	512			810	661	512
1 Txslot	25.78	26.20	25.27	27.00	-9.03	16.75	17.17	16.24
2 Txslots	24.00	24.21	23.16	24.50	-6.02	17.98	18.19	17.14
3Txslots	21.47	21.92	20.62	22.00	-4.26	17.21	17.66	16.36
4 Txslots	19.85	20.63	19.18	20.80	-3.01	16.84	17.62	16.17

NOTES:

1) Division Factors

To average the power, the division factor is as follows:

1TX-slot = 1 transmit time slot out of 8 time slots=> conducted power divided by (8/1) => -9.03dB

2TX-slots = 2 transmit time slots out of 8 time slots=> conducted power divided by (8/2) => -6.02dB

3TX-slots = 3 transmit time slots out of 8 time slots=> conducted power divided by (8/3) => -4.26dB

4TX-slots = 4 transmit time slots out of 8 time slots=> conducted power divided by (8/4) => -3.01dB

According to the conducted power as above, the body measurements are performed with 2Txslots for GSM1900.

Table 11.1-3: The conducted power measurement results for GSM, GPRS and EGPRS DSI1/2

PCS1900 GPRS (GMSK)	Measured Power (dBm)				calculation	Averaged Power (dBm)		
	810	661	512			810	661	512
1 Txslot	28.46	28.74	28.20	29.50	-9.03	19.43	19.71	19.17
2 Txslots	26.64	26.90	26.40	27.50	-6.02	20.62	20.88	20.38
3Txslots	24.59	24.87	24.37	25.50	-4.26	20.33	20.61	20.11
4 Txslots	23.67	23.95	23.44	24.50	-3.01	20.66	20.94	20.43
PCS1900 EGPRS (GMSK)	Measured Power (dBm)				calculation	Averaged Power (dBm)		
	810	661	512			810	661	512
1 Txslot	28.42	28.73	28.17	29.50	-9.03	19.39	19.70	19.14
2 Txslots	26.60	26.89	26.37	27.50	-6.02	20.58	20.87	20.35
3Txslots	24.56	24.86	24.34	25.50	-4.26	20.30	20.60	20.08
4 Txslots	23.64	23.94	23.42	24.50	-3.01	20.63	20.93	20.41
PCS1900 EGPRS (8PSK)	Measured Power (dBm)				calculation	Averaged Power (dBm)		
	810	661	512			810	661	512
1 Txslot	25.39	25.61	24.76	26.00	-9.03	16.36	16.58	15.73
2 Txslots	24.10	24.41	23.62	25.00	-6.02	18.08	18.39	17.60
3Txslots	22.79	23.17	22.41	23.50	-4.26	18.53	18.91	18.15
4 Txslots	21.44	21.88	20.80	22.00	-3.01	18.43	18.87	17.79

NOTES:

1) Division Factors

To average the power, the division factor is as follows:

1TX-slot = 1 transmit time slot out of 8 time slots=> conducted power divided by (8/1) => -9.03dB

2TX-slots = 2 transmit time slots out of 8 time slots=> conducted power divided by (8/2) => -6.02dB

3TX-slots = 3 transmit time slots out of 8 time slots=> conducted power divided by (8/3) => -4.26dB

4TX-slots = 4 transmit time slots out of 8 time slots=> conducted power divided by (8/4) => -3.01dB

According to the conducted power as above, the body measurements are performed with 4Txslots for GSM1900.

11.2 WCDMA Measurement result

Table 11.2-1: The conducted Power for WCDMA DSI1/2/3

Item	band	FDDV result			
	ARFCN	4132 (826.4MHz)	4182 (836.4MHz)	4233 (846.6MHz)	Tune up
WCDMA	\	23.15	23.25	23.14	24.00
HSUPA	1	20.77	20.75	20.76	22.70
	2	20.21	20.32	20.20	21.00
	3	20.22	20.33	20.20	21.00
	4	19.73	19.82	19.71	20.50
	5	21.2	21.31	21.18	22.00
HSPA+		21.67	21.76	21.88	22.50
DC-HSDPA	1	22.25	22.36	22.28	22.70
	2	22.2	22.34	22.26	22.70
	3	21.77	21.87	21.79	22.00
	4	21.78	21.86	21.80	22.00

Table 11.2-2: The conducted Power for WCDMA DSI3

Item	band	FDDIV result			
	ARFCN	1312 (1712.4MHz)	1412 (1732.4MHz)	1513 (1752.6MHz)	
WCDMA	\	21.04	21.22	21.35	22.00
HSUPA	1	19.66	19.96	20.03	20.50
	2	18.18	18.46	18.54	19.00
	3	18.21	18.48	18.56	19.00
	4	18.02	18.02	18.11	19.00
	5	19.62	19.85	19.95	20.50
HSPA+		19.76	20.00	20.09	20.50
DC-HSDPA	1	20.18	20.54	20.59	21.00
	2	20.02	20.48	20.54	21.00
	3	19.7	20.07	20.12	21.00
	4	19.68	20.03	20.10	21.00
Item	band	FDDII result			
	ARFCN	9262 (1852.4MHz)	9400 (1880MHz)	9538 (1907.6MHz)	
WCDMA	\	21.56	21.96	21.41	22.50
HSUPA	1	19.76	19.68	19.52	20.50
	2	18.87	19.18	18.61	20.00
	3	19.63	20.06	19.65	20.50
	4	18.58	18.69	18.63	19.00
	5	19.57	20.01	19.60	20.50
HSPA+		20.06	20.52	20.10	21.00
DC-HSDPA	1	20.8	21.06	20.50	21.50
	2	20.79	21.05	20.48	21.50
	3	20.33	20.58	20.00	21.00
	4	20.35	20.60	20.02	21.00

Table 11.2-3: The conducted Power for WCDMA DS12

Item	band	FDDIV result			
	ARFCN	1312 (1712.4MHz)	1412 (1732.4MHz)	1513 (1752.6MHz)	
WCDMA	\	20.41	20.56	20.09	21.00
HSUPA	1	18.1	18.28	17.80	18.70
	2	17.71	17.78	17.29	18.50
	3	18.47	18.66	18.33	19.00
	4	17.12	17.29	16.81	18.00
	5	18.41	18.61	18.28	19.00
HSPA+		18.9	19.12	18.78	19.50
DC-HSDPA	1	19.64	19.66	19.18	20.50
	2	19.63	19.65	19.16	20.00
	3	19.17	19.18	18.68	20.00
	4	19.19	19.20	18.70	20.00
Item	band	FDDII result			
	ARFCN	9262 (1852.4MHz)	9400 (1880MHz)	9538 (1907.6MHz)	
WCDMA	\	19.83	20.08	20.06	20.50
HSUPA	1	17.45	17.82	17.74	18.50
	2	16.97	17.32	17.25	18.00
	3	17	17.34	17.27	18.00
	4	16.51	16.88	16.82	17.50
	5	17.91	18.31	18.23	19.00
HSPA+		18.55	18.86	18.80	19.50
DC-HSDPA	1	18.97	19.40	19.30	20.00
	2	18.81	19.34	19.25	20.00
	3	18.49	18.93	18.83	19.50
	4	18.47	18.89	18.81	19.50

Table 11.2-3: The conducted Power for WCDMA DSI1

Item	band	FDDIV result			
	ARFCN	1312 (1712.4MHz)	1412 (1732.4MHz)	1513 (1752.6MHz)	
WCDMA	\	20.98	21.11	21.03	21.50
HSUPA	1	18.6	18.85	18.71	19.50
	2	18.12	18.35	18.22	19.00
	3	18.15	18.37	18.24	19.00
	4	17.66	17.91	17.79	18.50
	5	19.06	19.34	19.20	20.00
HSPA+		19.7	19.89	19.77	20.50
DC-HSDPA	1	20.12	20.43	20.27	21.00
	2	19.96	20.37	20.22	21.00
	3	19.64	19.96	19.80	20.50
	4	19.62	19.92	19.78	20.50
Item	band	FDDII result			
	ARFCN	9262 (1852.4MHz)	9400 (1880MHz)	9538 (1907.6MHz)	
WCDMA	\	21.20	21.38	20.98	22.00
HSUPA	1	18.9	19.10	18.69	19.70
	2	18.51	18.60	18.18	19.00
	3	19.27	19.48	19.22	20.00
	4	17.92	18.11	17.70	18.50
	5	19.21	19.43	19.17	19.70
HSPA+		19.7	19.94	19.67	20.50
DC-HSDPA	1	20.44	20.48	20.07	21.00
	2	20.43	20.47	20.05	21.00
	3	19.97	20.00	19.57	21.00
	4	19.99	20.02	19.59	21.00

11.3 LTE Measurement result

Table 11.3-1: Maximum Power Reduction (MPR) for LTE- DSI1/2/3

Modulation	Channel bandwidth / Transmission bandwidth configuration [RB]						MPR (dB)
	1.4 MHz	3 MHz	5 MHz	10 MHz	15 MHz	20 MHz	
QPSK	> 5	> 4	> 8	> 12	> 16	> 18	1
16 QAM	≤ 5	≤ 4	≤ 8	≤ 12	≤ 16	≤ 18	1
16 QAM	> 5	> 4	> 8	> 12	> 16	> 18	2
64 QAM	≤ 5	≤ 4	≤ 8	≤ 12	≤ 16	≤ 18	2
64 QAM	> 5	> 4	> 8	> 12	> 16	> 18	3

Table 11.3-2: The tune up for LTE- DSI1/2/3

Band	Tune up
LTE Band 7	20.8
LTE Band 13	24.5
LTE Band 26	24.5
LTE Band 71	24.5

Table 11.3-3: Maximum Power Reduction (MPR) for LTE- DSI1/3

Modulation	Channel bandwidth / Transmission bandwidth configuration [RB]						MPR (dB)
	1.4 MHz	3 MHz	5 MHz	10 MHz	15 MHz	20 MHz	
QPSK	> 5	> 4	> 8	> 12	> 16	> 18	1
16 QAM	≤ 5	≤ 4	≤ 8	≤ 12	≤ 16	≤ 18	1
16 QAM	> 5	> 4	> 8	> 12	> 16	> 18	2
64 QAM	≤ 5	≤ 4	≤ 8	≤ 12	≤ 16	≤ 18	2
64 QAM	> 5	> 4	> 8	> 12	> 16	> 18	3

Table 11.3-4: The tune up for LTE- DSI1/3

Band	Tune up
LTE Band 25	22.5
LTE Band 41 PC2	24.6
LTE Band 41 PC3	22
LTE Band 66	22.5

Table 11.3-5: Maximum Power Reduction (MPR) for LTE- DS12

Modulation	Channel bandwidth / Transmission bandwidth configuration [RB]						MPR (dB)
	1.4	3	5	10	15	20	
	MHz	MHz	MHz	MHz	MHz	MHz	
QPSK	> 5	> 4	> 8	> 12	> 16	> 18	0
16 QAM	≤ 5	≤ 4	≤ 8	≤ 12	≤ 16	≤ 18	0
16 QAM	> 5	> 4	> 8	> 12	> 16	> 18	0
64 QAM	≤ 5	≤ 4	≤ 8	≤ 12	≤ 16	≤ 18	0
64 QAM	> 5	> 4	> 8	> 12	> 16	> 18	0

Table 11.3-6: The tune up for LTE- DS12

Band	Tune up
LTE Band 25	21.5
LTE Band 66	21.5

Table 11.3-7: Maximum Power Reduction (MPR) for LTE- DS12

Modulation	Channel bandwidth / Transmission bandwidth configuration [RB]						MPR (dB)
	1.4	3	5	10	15	20	
	MHz	MHz	MHz	MHz	MHz	MHz	
QPSK	> 5	> 4	> 8	> 12	> 16	> 18	1
16 QAM	≤ 5	≤ 4	≤ 8	≤ 12	≤ 16	≤ 18	1
16 QAM	> 5	> 4	> 8	> 12	> 16	> 18	2
64 QAM	≤ 5	≤ 4	≤ 8	≤ 12	≤ 16	≤ 18	2
64 QAM	> 5	> 4	> 8	> 12	> 16	> 18	3

Table 11.3-8: The tune up for LTE- DS12

Band	Tune up
LTE Band 41 PC2	24.3
LTE Band 41 PC3	21.3

Table 11.3-9: Maximum Power Reduction (MPR) for LTE- DS16

Modulation	Channel bandwidth / Transmission bandwidth configuration [RB]						MPR (dB)
	1.4	3	5	10	15	20	
	MHz	MHz	MHz	MHz	MHz	MHz	
QPSK	> 5	> 4	> 8	> 12	> 16	> 18	1
16 QAM	≤ 5	≤ 4	≤ 8	≤ 12	≤ 16	≤ 18	1
16 QAM	> 5	> 4	> 8	> 12	> 16	> 18	2
64 QAM	≤ 5	≤ 4	≤ 8	≤ 12	≤ 16	≤ 18	2
64 QAM	> 5	> 4	> 8	> 12	> 16	> 18	3

Table 11.3-10: The tune up for LTE- DS16

Band	Tune up
LTE Band 2(ANT6)	20.5
LTE Band 66(ANT6)	20.5

Table 11.3-11: Maximum Power Reduction (MPR) for LTE- DSI5

Modulation	Channel bandwidth / Transmission bandwidth configuration [RB]						MPR (dB)
	1.4 MHz	3 MHz	5 MHz	10 MHz	15 MHz	20 MHz	
QPSK	> 5	> 4	> 8	> 12	> 16	> 18	1
16 QAM	≤ 5	≤ 4	≤ 8	≤ 12	≤ 16	≤ 18	1
16 QAM	> 5	> 4	> 8	> 12	> 16	> 18	2
64 QAM	≤ 5	≤ 4	≤ 8	≤ 12	≤ 16	≤ 18	2
64 QAM	> 5	> 4	> 8	> 12	> 16	> 18	3

Table 11.3-12: The tune up for LTE- DSI5

Band	Tune up
LTE Band 2(ANT6)	20.5
LTE Band 66(ANT6)	20.5

Table 11.3-13: Maximum Power Reduction (MPR) for LTE- DSI4/5/6

Modulation	Channel bandwidth / Transmission bandwidth configuration [RB]						MPR (dB)
	1.4 MHz	3 MHz	5 MHz	10 MHz	15 MHz	20 MHz	
QPSK	> 5	> 4	> 8	> 12	> 16	> 18	1
16 QAM	≤ 5	≤ 4	≤ 8	≤ 12	≤ 16	≤ 18	1
16 QAM	> 5	> 4	> 8	> 12	> 16	> 18	2
64 QAM	≤ 5	≤ 4	≤ 8	≤ 12	≤ 16	≤ 18	2
64 QAM	> 5	> 4	> 8	> 12	> 16	> 18	3

Table 11.3-14: The tune up for LTE- DSI4/5/6

Band	Tune up
LTE Band 2(ANT4)	19.5
LTE Band 66(ANT4)	19.5

Table 11.3-15: Maximum Power Reduction (MPR) for LTE- DS14/6

Modulation	Channel bandwidth / Transmission bandwidth configuration [RB]						MPR (dB)
	1.4 MHz	3 MHz	5 MHz	10 MHz	15 MHz	20 MHz	
QPSK	> 5	> 4	> 8	> 12	> 16	> 18	1
16 QAM	≤ 5	≤ 4	≤ 8	≤ 12	≤ 16	≤ 18	1
16 QAM	> 5	> 4	> 8	> 12	> 16	> 18	2
64 QAM	≤ 5	≤ 4	≤ 8	≤ 12	≤ 16	≤ 18	2
64 QAM	> 5	> 4	> 8	> 12	> 16	> 18	3

Table 11.3-14: The tune up for LTE- DS14/6

Band	Tune up
LTE Band 12	20

Table 11.3-1: Maximum Power Reduction (MPR) for LTE- DS11/2/3/5

Modulation	Channel bandwidth / Transmission bandwidth configuration [RB]						MPR (dB)
	1.4 MHz	3 MHz	5 MHz	10 MHz	15 MHz	20 MHz	
QPSK	> 5	> 4	> 8	> 12	> 16	> 18	1
16 QAM	≤ 5	≤ 4	≤ 8	≤ 12	≤ 16	≤ 18	1
16 QAM	> 5	> 4	> 8	> 12	> 16	> 18	2
64 QAM	≤ 5	≤ 4	≤ 8	≤ 12	≤ 16	≤ 18	2
64 QAM	> 5	> 4	> 8	> 12	> 16	> 18	3

Table 11.3-2: The tune up for LTE- DS11/2/3/5

Band	Tune up
LTE Band 12	24.5

DSI1/2/3

Band 7					
Bandwidth (MHz)	RB allocation	Frequency (MHz)	QPSK	16QAM	64QAM
	RB offset (Start RB)		Actual output power (dBm)	Actual output power (dBm)	Actual output power (dBm)
5 MHz	1RB High (24)	2567.5	20.08	19.59	18.44
		2535	20.01	19.53	18.37
		2502.5	18.99	18.23	17.09
	1RB Middle (12)	2567.5	20.15	19.56	18.43
		2535	20.07	19.38	18.31
		2502.5	18.96	18.19	17.19
	1RB Low (0)	2567.5	20.19	19.60	18.50
		2535	19.85	19.33	18.10
		2502.5	18.97	18.24	17.18
	12RB High (13)	2567.5	19.23	18.28	17.29
		2535	19.17	18.11	17.12
		2502.5	18.02	16.95	15.98
	12RB Middle (6)	2567.5	19.30	18.31	17.29
		2535	19.12	18.12	17.10
		2502.5	17.96	16.90	15.93
	12RB Low (0)	2567.5	19.37	18.37	17.34
		2535	19.07	18.06	17.02
		2502.5	17.99	16.92	15.98
	25RB (0)	2567.5	19.34	18.34	17.32
		2535	19.16	18.14	17.10
		2502.5	17.99	16.98	15.92
10 MHz	1RB High (49)	2565	20.04	19.45	18.35
		2535	20.07	19.53	18.38
		2505	19.08	18.42	17.21
	1RB Middle (24)	2565	20.21	19.42	18.50
		2535	20.03	19.44	18.26
		2505	18.97	18.16	17.16
	1RB Low (0)	2565	20.29	19.42	18.41
		2535	19.79	19.19	18.13
		2505	18.95	18.19	17.11
	25RB High (25)	2565	19.30	18.30	17.31
		2535	19.19	18.21	17.17
		2505	18.11	17.13	16.12
	25RB Middle (12)	2565	19.39	18.36	17.38
		2535	19.12	18.11	17.08
		2505	17.98	17.02	15.95
	25RB Low (0)	2565	19.48	18.49	17.47
		2535	19.08	18.11	17.06
		2505	17.96	16.94	15.96
50RB (0)	2565	19.40	18.41	17.39	
	2535	19.18	18.17	17.12	

		2505	18.02	17.04	16.00
15 MHz	1RB High (74)	2562.5	19.98	19.50	18.30
		2535	20.10	19.57	18.40
		2507.5	19.21	18.37	17.38
	1RB Middle (37)	2562.5	20.22	19.43	18.52
		2535	19.93	19.36	18.21
		2507.5	19.04	18.34	17.14
	1RB Low (0)	2562.5	20.27	19.47	18.52
		2535	19.62	18.98	17.87
		2507.5	18.90	18.10	17.04
	36RB High (38)	2562.5	19.30	18.31	17.29
		2535	19.23	18.23	17.23
		2507.5	18.17	17.15	16.19
	36RB Middle (19)	2562.5	19.41	18.41	17.39
		2535	19.05	18.06	17.04
		2507.5	18.02	17.01	15.99
	36RB Low (0)	2562.5	19.46	18.51	17.47
		2535	19.03	18.04	16.98
		2507.5	17.92	16.97	15.95
	75RB (0)	2562.5	19.40	18.37	17.35
		2535	19.14	18.15	17.09
		2507.5	18.11	17.05	16.04
20 MHz	1RB High (99)	2560	20.02	19.36	18.36
		2535	20.10	19.53	18.40
		2510	19.37	18.54	17.40
	1RB Middle (50)	2560	20.28	19.42	18.57
		2535	19.97	19.45	18.27
		2510	19.11	18.32	17.26
	1RB Low (0)	2560	20.25	19.47	18.53
		2535	19.49	18.96	17.74
		2510	18.85	18.07	16.99
	50RB High (50)	2560	19.33	18.33	17.27
		2535	19.37	18.33	17.29
		2510	18.40	17.34	16.33
	50RB Middle (25)	2560	19.48	18.45	17.44
		2535	19.15	18.13	17.10
		2510	18.16	17.09	16.09
	50RB Low (0)	2560	19.53	18.58	17.53
		2535	19.04	18.01	17.03
		2510	18.01	16.98	15.98
	100RB (0)	2560	19.46	18.42	17.38
		2535	19.25	18.23	17.11
		2510	18.18	17.12	16.10

Band 13					
Bandwidth (MHz)	RB allocation	Frequency (MHz)	QPSK	16QAM	64QAM
	RB offset (Start RB)		Actual output power (dBm)	Actual output power (dBm)	Actual output power (dBm)
5 MHz	1RB High (24)	784.5	23.41	22.63	21.46
		782	23.39	22.60	21.48
		779.5	23.39	22.59	21.48
	1RB Middle (12)	784.5	23.41	22.65	21.50
		782	23.45	22.62	21.56
		779.5	23.41	22.57	21.48
	1RB Low (0)	784.5	23.44	22.65	21.49
		782	23.48	22.71	21.57
		779.5	23.34	22.53	21.42
	12RB High (13)	784.5	22.35	21.33	20.34
		782	22.36	21.33	20.36
		779.5	22.43	21.39	20.45
	12RB Middle (6)	784.5	22.41	21.35	20.36
		782	22.34	21.36	20.34
		779.5	22.35	21.38	20.33
	12RB Low (0)	784.5	22.39	21.39	20.38
		782	22.24	21.19	20.22
		779.5	22.35	21.35	20.34
	25RB (0)	784.5	22.41	21.39	20.37
		782	22.29	21.31	20.28
		779.5	22.43	21.38	20.38
10 MHz	1RB High (49)	782	23.35	22.52	21.40
	1RB Middle (24)	782	23.45	22.55	21.50
	1RB Low (0)	782	23.37	22.45	21.43
	25RB High (25)	782	22.38	21.35	20.30
	25RB Middle (12)	782	22.32	21.36	20.32
	25RB Low (0)	782	22.21	21.20	20.19
	50RB (0)	782	22.31	21.30	20.26

Band 26						
Bandwidth (MHz)	RB allocation	Frequency (MHz)	QPSK	16QAM	64QAM	
	RB offset (Start RB)		Actual output power (dBm)	Actual output power (dBm)	Actual output power (dBm)	
1.4 MHz	1RB High (5)	848.3	23.92	23.11	21.99	
		831.5	23.83	23.00	21.99	
		814.7	23.63	22.81	21.78	
	1RB Middle (3)	848.3	23.94	23.14	22.05	
		831.5	23.87	23.06	21.94	
		814.7	23.62	22.85	21.79	
	1RB Low (0)	848.3	23.91	23.15	22.00	
		831.5	23.83	22.96	21.96	
		814.7	23.63	22.76	21.76	
	3RB High (3)	848.3	23.97	22.96	21.99	
		831.5	23.83	22.79	21.92	
		814.7	23.70	22.70	21.76	
	3RB Middle (1)	848.3	23.94	23.02	21.98	
		831.5	23.85	22.78	21.82	
		814.7	23.69	22.68	21.73	
	3RB Low (0)	848.3	23.95	22.96	21.98	
		831.5	23.83	22.89	21.86	
		814.7	23.68	22.77	21.70	
	6RB (0)	848.3	23.01	22.01	20.87	
		831.5	22.82	21.87	20.74	
		814.7	22.68	21.70	20.52	
	3 MHz	1RB High (14)	847.5	23.99	23.08	22.03
			831.5	23.83	22.99	21.89
			815.5	23.80	22.85	21.83
		1RB Middle (7)	847.5	23.98	23.10	22.08
			831.5	23.89	23.04	21.90
			815.5	23.84	22.94	21.87
1RB Low (0)		847.5	23.92	23.03	21.94	
		831.5	23.83	22.85	21.87	
		815.5	23.74	22.94	21.87	
8RB High (7)		847.5	22.92	21.94	20.88	
		831.5	22.78	21.83	20.82	
		815.5	22.79	21.82	20.80	
8RB Middle (4)		847.5	22.94	21.96	20.92	
		831.5	22.83	21.84	20.77	
		815.5	22.78	21.86	20.84	
8RB Low (0)		847.5	22.93	21.96	20.94	
		831.5	22.76	21.83	20.77	
		815.5	22.74	21.84	20.77	
15RB (0)		847.5	22.91	21.97	20.89	
		831.5	22.75	21.84	20.76	
		815.5	22.73	21.80	20.77	
5 MHz		1RB High (24)	846.5	24.02	23.13	22.03
			831.5	23.91	23.01	21.96

	1RB Middle (12)	816.5	23.79	22.91	21.79	
		846.5	23.98	23.08	22.03	
		831.5	23.91	23.02	21.98	
		816.5	23.76	22.80	21.77	
		1RB Low (0)	846.5	23.93	23.00	22.02
			831.5	23.84	22.97	21.88
			816.5	23.73	22.83	21.76
		12RB High (13)	846.5	22.88	21.84	20.84
			831.5	22.82	21.82	20.79
	816.5		22.71	21.72	20.69	
	12RB Middle (6)	846.5	22.94	21.94	20.95	
		831.5	22.86	21.80	20.84	
		816.5	22.74	21.71	20.71	
	12RB Low (0)	846.5	23.10	22.07	21.06	
		831.5	22.86	21.87	20.83	
		816.5	22.69	21.72	20.68	
	25RB (0)	846.5	23.00	21.99	20.97	
		831.5	22.84	21.83	20.82	
		816.5	22.71	21.71	20.66	
	10 MHz	1RB High (49)	844	23.97	23.02	22.02
			831.5	23.86	22.98	21.91
			820	23.75	22.89	21.86
		1RB Middle (24)	844	24.00	23.04	21.99
			831.5	23.90	23.00	21.96
			820	23.81	22.97	21.96
		1RB Low (0)	844	23.89	23.02	21.96
			831.5	23.82	22.86	21.84
820			23.74	22.89	21.80	
25RB High (25)		844	22.75	21.74	20.69	
		831.5	22.84	21.84	20.80	
		820	22.81	21.86	20.81	
25RB Middle (12)		844	22.94	21.95	20.89	
		831.5	22.83	21.86	20.84	
		820	22.78	21.80	20.77	
25RB Low (0)		844	22.91	21.95	20.86	
		831.5	22.86	21.88	20.81	
		820	22.69	21.72	20.70	
50RB (0)		844	22.83	21.84	20.79	
		831.5	22.84	21.83	20.80	
		820	22.75	21.73	20.70	
15 MHz		1RB High (74)	841.5	23.85	23.09	21.93
			831.5	23.77	22.94	21.95
			822.5	23.72	22.82	21.83
		1RB Middle (37)	841.5	23.86	23.04	21.94
			831.5	23.85	22.98	21.94
			822.5	23.74	22.90	21.78
	1RB Low (0)	841.5	23.82	23.02	21.89	
		831.5	23.74	22.97	21.82	



		822.5	23.68	22.77	21.76
	36RB High (38)	841.5	22.74	21.74	20.75
		831.5	22.83	21.82	20.79
		822.5	22.77	21.75	20.70
	36RB Middle (19)	841.5	22.84	21.86	20.81
		831.5	22.75	21.79	20.79
		822.5	22.73	21.75	20.70
	36RB Low (0)	841.5	22.81	21.84	20.82
		831.5	22.77	21.79	20.77
		822.5	22.66	21.61	20.66
	75RB (0)	841.5	22.75	21.77	20.71
		831.5	22.76	21.81	20.78
		822.5	22.70	21.73	20.67

Band 71						
Bandwidth (MHz)	RB allocation	Frequency (MHz)	QPSK	16QAM	64QAM	
	RB offset (Start RB)		Actual output power (dBm)	Actual output power (dBm)	Actual output power (dBm)	
5 MHz	1RB High (24)	695.5	23.46	22.78	21.63	
		680.5	23.85	23.02	21.88	
		665.5	23.97	23.05	22.01	
	1RB Middle (12)	695.5	23.58	22.86	21.72	
		680.5	23.91	23.13	21.97	
		665.5	24.01	23.16	22.08	
	1RB Low (0)	695.5	23.65	22.85	21.80	
		680.5	23.90	23.10	21.93	
		665.5	24.06	23.17	22.09	
	12RB High (13)	695.5	22.43	21.45	20.48	
		680.5	22.77	21.81	20.81	
		665.5	22.97	21.94	20.97	
	12RB Middle (6)	695.5	22.52	21.53	20.52	
		680.5	22.81	21.81	20.77	
		665.5	22.96	21.91	20.92	
	12RB Low (0)	695.5	22.60	21.58	20.57	
		680.5	22.81	21.80	20.85	
		665.5	22.87	21.78	20.82	
	25RB (0)	695.5	22.55	21.54	20.49	
		680.5	22.83	21.83	20.79	
		665.5	22.94	21.96	20.93	
	10 MHz	1RB High (49)	693	23.45	22.69	21.53
			680.5	23.79	22.92	21.90
			668	23.92	23.13	21.96
1RB Middle (24)		693	23.65	23.01	21.74	
		680.5	23.86	23.07	22.00	
		668	24.05	23.27	22.10	
1RB Low (0)		693	23.79	23.07	21.84	
		680.5	23.93	23.09	21.98	
		668	24.05	23.21	22.14	
25RB High (25)		693	22.52	21.56	20.49	
		680.5	22.79	21.85	20.81	
		668	22.92	21.96	20.88	
25RB Middle (12)		693	22.55	21.59	20.59	
		680.5	22.80	21.78	20.80	
		668	22.92	21.90	20.91	
25RB Low (0)		693	22.61	21.66	20.65	
		680.5	22.87	21.83	20.82	
		668	22.79	21.80	20.76	
50RB (0)		693	22.60	21.58	20.58	
		680.5	22.84	21.82	20.83	
		668	22.87	21.86	20.82	
15 MHz		1RB High (74)	690.5	23.41	22.63	21.59
			680.5	23.68	22.93	21.82

	1RB Middle (37)	670.5	23.82	23.07	21.87	
		690.5	23.65	22.96	21.79	
		680.5	23.88	23.08	22.03	
	1RB Low (0)	670.5	23.97	23.07	22.05	
		690.5	23.81	23.13	21.87	
		680.5	23.92	23.12	22.02	
	36RB High (38)	670.5	24.01	23.26	22.11	
		690.5	22.54	21.52	20.55	
		680.5	22.75	21.77	20.74	
	36RB Middle (19)	670.5	22.86	21.86	20.83	
		690.5	22.67	21.64	20.62	
		680.5	22.79	21.79	20.78	
	36RB Low (0)	670.5	22.93	21.90	20.89	
		690.5	22.71	21.70	20.69	
		680.5	22.89	21.86	20.85	
	75RB (0)	670.5	22.79	21.80	20.77	
		690.5	22.64	21.59	20.61	
		680.5	22.81	21.78	20.76	
	20 MHz	1RB High (99)	670.5	22.82	21.81	20.77
			688	23.46	22.66	21.52
			683	23.57	22.82	21.62
		1RB Middle (50)	673	23.74	22.88	21.79
			688	23.81	23.04	21.84
			683	23.88	23.05	21.96
1RB Low (0)		673	23.97	23.09	22.00	
		688	23.87	23.12	21.91	
		683	24.00	23.07	21.95	
50RB High (50)		673	24.01	23.21	21.98	
		688	22.55	21.51	20.52	
		683	22.64	21.63	20.62	
50RB Middle (25)		673	22.87	21.83	20.82	
		688	22.78	21.70	20.66	
		683	22.79	21.74	20.75	
50RB Low (0)		673	22.95	21.89	20.88	
		688	22.82	21.74	20.69	
		683	22.85	21.87	20.83	
100RB (0)		673	22.86	21.82	20.72	
		688	22.68	21.60	20.61	
		683	22.78	21.72	20.70	
			673	22.85	21.77	20.77

DS11/3

Band 25						
Bandwidth (MHz)	RB allocation	Frequency (MHz)	QPSK	16QAM	64QAM	
	RB offset (Start RB)		Actual output power (dBm)	Actual output power (dBm)	Actual output power (dBm)	
1.4 MHz	1RB High (5)	1914.3	21.34	20.77	19.67	
		1882.5	21.90	21.40	20.26	
		1850.7	21.30	20.83	19.70	
	1RB Middle (3)	1914.3	21.40	20.66	19.68	
		1882.5	21.90	21.37	20.29	
		1850.7	21.35	20.79	19.55	
	1RB Low (0)	1914.3	21.36	20.80	19.58	
		1882.5	21.90	21.23	20.15	
		1850.7	21.31	20.64	19.61	
	3RB High (3)	1914.3	21.38	20.50	19.57	
		1882.5	21.91	21.00	20.10	
		1850.7	21.37	20.43	19.58	
	3RB Middle (1)	1914.3	21.38	20.50	19.60	
		1882.5	21.91	21.06	20.19	
		1850.7	21.32	20.36	19.57	
	3RB Low (0)	1914.3	21.37	20.54	19.58	
		1882.5	21.93	21.13	20.17	
		1850.7	21.32	20.52	19.62	
	6RB (0)	1914.3	20.53	19.59	18.44	
		1882.5	21.10	20.12	19.03	
		1850.7	20.53	19.60	18.40	
	3 MHz	1RB High (14)	1913.5	21.37	20.67	19.60
			1882.5	21.84	21.31	20.16
			1851.5	21.42	20.78	19.74
1RB Middle (7)		1913.5	21.39	20.78	19.73	
		1882.5	21.90	21.42	20.20	
		1851.5	21.39	20.84	19.68	
1RB Low (0)		1913.5	21.30	20.69	19.63	
		1882.5	21.89	21.39	20.17	
		1851.5	21.28	20.66	19.61	
8RB High (7)		1913.5	20.49	19.59	18.53	
		1882.5	20.96	20.11	19.01	
		1851.5	20.56	19.63	18.52	
8RB Middle (4)		1913.5	20.52	19.60	18.49	
		1882.5	21.06	20.11	19.03	
		1851.5	20.51	19.58	18.50	
8RB Low (0)		1913.5	20.52	19.56	18.52	
		1882.5	21.10	20.12	19.08	
		1851.5	20.54	19.50	18.54	
15RB (0)		1913.5	20.50	19.54	18.46	
		1882.5	21.03	20.04	19.02	
		1851.5	20.52	19.54	18.51	
5 MHz		1RB	1912.5	21.40	20.80	19.72

	High (24)	1882.5	21.87	21.33	20.11
		1852.5	21.49	20.84	19.82
	1RB Middle (12)	1912.5	21.41	20.81	19.69
		1882.5	21.99	21.40	20.18
		1852.5	21.45	20.91	19.70
	1RB Low (0)	1912.5	21.37	20.84	19.65
		1882.5	21.93	21.35	20.28
		1852.5	21.29	20.70	19.69
	12RB High (13)	1912.5	20.48	19.47	18.48
		1882.5	21.02	20.04	19.04
		1852.5	20.59	19.57	18.53
	12RB Middle (6)	1912.5	20.54	19.52	18.54
		1882.5	21.12	20.09	19.07
		1852.5	20.57	19.53	18.53
	12RB Low (0)	1912.5	20.61	19.56	18.60
		1882.5	21.13	20.13	19.16
		1852.5	20.56	19.47	18.48
	25RB (0)	1912.5	20.56	19.55	18.52
		1882.5	21.13	20.13	19.07
		1852.5	20.58	19.60	18.51
10 MHz	1RB High (49)	1910	21.35	20.79	19.63
		1882.5	21.78	21.28	20.14
		1855	21.50	21.01	19.75
	1RB Middle (24)	1910	21.38	20.79	19.63
		1882.5	21.97	21.34	20.29
		1855	21.47	20.96	19.78
	1RB Low (0)	1910	21.41	20.89	19.65
		1882.5	21.93	21.37	20.29
		1855	21.32	20.78	19.63
	25RB High (25)	1910	20.47	19.39	18.41
		1882.5	21.09	20.09	19.06
		1855	20.70	19.71	18.67
	25RB Middle (12)	1910	20.56	19.53	18.52
		1882.5	21.05	20.09	19.08
		1855	20.62	19.63	18.61
	25RB Low (0)	1910	20.63	19.62	18.56
		1882.5	21.11	20.17	19.12
		1855	20.55	19.57	18.53
	50RB (0)	1910	20.53	19.54	18.53
		1882.5	21.10	20.08	19.05
1855		20.66	19.62	18.60	
15 MHz	1RB High (74)	1907.5	21.30	20.78	19.58
		1882.5	21.68	21.07	20.00
		1857.5	21.47	20.91	19.82
	1RB Middle (37)	1907.5	21.43	20.84	19.69
		1882.5	21.93	21.43	20.20
		1857.5	21.51	21.01	19.85
	1RB	1907.5	21.62	21.03	19.97

	Low (0)	1882.5	21.82	21.27	20.16
		1857.5	21.28	20.78	19.61
	36RB High (38)	1907.5	20.40	19.44	18.48
		1882.5	20.96	20.02	18.99
		1857.5	20.68	19.70	18.70
	36RB Middle (19)	1907.5	20.54	19.59	18.60
		1882.5	20.99	20.03	19.02
		1857.5	20.66	19.64	18.64
	36RB Low (0)	1907.5	20.72	19.67	18.67
		1882.5	21.04	20.02	19.07
		1857.5	20.55	19.56	18.55
	75RB (0)	1907.5	20.62	19.61	18.53
		1882.5	21.08	20.03	19.00
		1857.5	20.67	19.65	18.60
	20 MHz	1RB High (99)	1905	21.83	21.22
1882.5			22.04	21.48	20.27
1860			21.94	21.16	19.99
1RB Middle (50)		1905	21.95	21.30	20.28
		1882.5	22.18	21.41	20.49
		1860	21.90	21.18	20.01
1RB Low (0)		1905	22.06	21.38	20.39
		1882.5	22.14	21.38	20.22
		1860	21.75	20.97	19.87
50RB High (50)		1905	20.97	19.94	18.94
		1882.5	21.38	20.36	19.33
		1860	20.90	19.89	18.90
50RB Middle (25)		1905	21.11	20.13	19.06
		1882.5	21.29	20.27	19.30
		1860	20.90	19.87	18.89
50RB Low (0)		1905	21.36	20.35	19.31
		1882.5	21.30	20.31	19.30
		1860	20.82	19.79	18.76
100RB (0)		1905	21.19	20.15	19.13
		1882.5	21.32	20.29	19.32
		1860	20.84	19.81	18.81

Band 41-PC2					
Bandwidth (MHz)	RB allocation	Frequency (MHz)	QPSK	16QAM	64QAM
	RB offset (Start RB)		Actual output power (dBm)	Actual output power (dBm)	Actual output power (dBm)
5 MHz	1RB High (24)	2687.5	23.78	22.98	21.73
		2640.3	23.62	22.82	21.53
		2593	23.56	22.74	21.47
		2545.8	24.50	23.35	22.39
		2498.5	23.18	22.34	21.09
	1RB Middle (12)	2687.5	23.78	22.95	21.69
		2640.3	23.69	22.90	21.63
		2593	23.65	22.78	21.53
		2545.8	24.50	23.43	22.40
		2498.5	23.19	22.37	21.10
	1RB Low (0)	2687.5	23.73	22.90	21.67
		2640.3	23.73	22.90	21.66
		2593	23.63	22.79	21.54
		2545.8	24.42	23.56	22.31
		2498.5	23.13	22.29	21.05
	12RB High (13)	2687.5	22.73	21.75	20.78
		2640.3	22.59	21.59	20.60
		2593	22.46	21.46	20.51
		2545.8	23.43	22.40	21.46
		2498.5	22.10	21.10	20.13
	12RB Middle (6)	2687.5	22.70	21.72	20.75
		2640.3	22.62	21.63	20.65
		2593	22.51	21.53	20.56
		2545.8	23.42	22.40	21.44
		2498.5	22.09	21.09	20.13
	12RB Low (0)	2687.5	22.71	21.74	20.76
		2640.3	22.65	21.69	20.72
		2593	22.54	21.54	20.60
		2545.8	23.39	22.40	21.43
		2498.5	22.07	21.08	20.12
	25RB (0)	2687.5	22.75	21.79	20.81
		2640.3	22.65	21.67	20.66
		2593	22.49	21.51	20.55
		2545.8	23.42	22.46	21.45
		2498.5	22.12	21.15	20.15
	10 MHz	1RB High (49)	2685	23.75	22.96
2639			23.56	22.79	21.48
2593			23.51	22.73	21.42

		2547	24.52	23.45	22.39
		2501	23.16	22.36	21.09
	1RB Middle (24)	2685	23.71	22.91	21.63
		2639	23.71	22.98	21.66
		2593	23.58	22.81	21.51
		2547	24.48	23.44	22.39
		2501	23.18	22.40	21.09
		1RB Low (0)	2685	23.62	22.81
	2639		23.73	22.92	21.66
	2593		23.68	22.87	21.59
	2547		24.37	23.54	22.27
	2501		23.09	22.28	21.01
	25RB High (25)	2685	22.71	21.74	20.78
		2639	22.58	21.61	20.66
		2593	22.46	21.48	20.51
		2547	23.45	22.49	21.53
		2501	22.14	21.18	20.22
	25RB Middle (12)	2685	22.68	21.73	20.75
		2639	22.66	21.68	20.69
		2593	22.51	21.53	20.58
		2547	23.45	22.45	21.50
		2501	22.11	21.14	20.18
	25RB Low (0)	2685	22.63	21.67	20.70
		2639	22.64	21.69	20.70
		2593	22.56	21.59	20.65
		2547	23.36	22.39	21.43
		2501	22.05	21.08	20.10
	50RB (0)	2685	22.71	21.74	20.70
		2639	22.68	21.66	20.61
		2593	22.52	21.55	20.49
2547		23.43	22.45	21.40	
2501		22.10	21.13	20.09	
15 MHz	1RB High (74)	2682.5	23.64	22.86	21.58
		2637.8	23.43	22.68	21.41
		2593	23.43	22.65	21.40
		2548.3	24.37	23.56	22.31
		2503.5	23.16	22.38	21.10
	1RB Middle (37)	2682.5	23.61	22.83	21.58
		2637.8	23.66	22.90	21.61
		2593	23.52	22.74	21.48
		2548.3	24.45	23.43	22.41

	1RB Low (0)	2503.5	23.15	22.36	21.09
		2682.5	23.45	22.69	21.43
		2637.8	23.68	22.90	21.66
		2593	23.66	22.91	21.65
		2548.3	24.29	23.49	22.22
		2503.5	23.56	22.21	21.65
	36RB High (38)	2682.5	22.62	21.63	20.64
		2637.8	22.55	21.55	20.56
		2593	22.40	21.39	20.42
		2548.3	23.39	22.42	21.42
		2503.5	22.15	21.15	20.15
	36RB Middle (19)	2682.5	22.56	21.58	20.58
		2637.8	22.58	21.59	20.60
		2593	22.45	21.47	20.47
		2548.3	23.39	22.38	21.39
		2503.5	22.10	21.08	20.11
	36RB Low (0)	2682.5	22.52	21.53	20.55
		2637.8	22.64	21.64	20.63
		2593	22.57	21.55	20.57
		2548.3	23.33	22.34	21.35
		2503.5	22.01	21.02	20.01
	75RB (0)	2682.5	22.61	21.66	20.63
		2637.8	22.57	21.59	20.59
		2593	22.50	21.53	20.50
		2548.3	23.39	22.43	21.42
2503.5		22.11	21.12	20.07	
20 MHz	1RB High (99)	2680	23.61	22.83	21.57
		2636.5	23.78	22.99	21.73
		2593	23.46	22.69	21.40
		2549.5	24.25	23.48	22.20
		2506	23.38	22.60	21.32
	1RB Middle (50)	2680	23.75	22.96	21.69
		2636.5	23.98	23.21	21.94
		2593	23.65	22.85	21.62
		2549.5	24.40	23.41	22.31
		2506	23.33	22.53	21.26
	1RB Low (0)	2680	23.74	22.95	21.69
		2636.5	23.89	23.10	21.85
		2593	23.78	23.02	21.75
		2549.5	24.20	23.39	22.12
		2506	23.14	22.35	21.09

	50RB High (50)	2680	22.72	21.77	20.74
		2636.5	22.86	21.91	20.86
		2593	22.58	21.62	20.72
		2549.5	23.33	22.36	21.30
		2506	22.41	21.45	20.57
	50RB Middle (25)	2680	22.73	21.78	20.75
		2636.5	22.94	21.96	20.96
		2593	22.59	21.65	20.75
		2549.5	23.37	22.40	21.36
		2506	22.29	21.31	20.44
	50RB Low (0)	2680	22.80	21.86	20.81
		2636.5	22.90	21.95	20.92
		2593	22.73	21.76	20.76
		2549.5	23.30	22.32	21.29
		2506	22.18	21.21	20.33
	100RB (0)	2680	22.75	21.79	20.77
		2636.5	22.90	21.92	20.87
		2593	22.65	21.65	20.76
		2549.5	23.32	22.35	21.31
		2506	22.28	21.30	20.45

Band 41-PC3					
Bandwidth (MHz)	RB allocation	Frequency (MHz)	QPSK	16QAM	64QAM
	RB offset (Start RB)		Actual output power (dBm)	Actual output power (dBm)	Actual output power (dBm)
5 MHz	1RB High (24)	2687.5	20.81	19.89	18.60
		2640.3	20.59	19.67	18.37
		2593	20.54	19.57	18.31
		2545.8	21.45	20.49	19.23
		2498.5	20.17	19.42	18.12
	1RB Middle (12)	2687.5	20.85	19.83	18.57
		2640.3	20.70	19.73	18.44
		2593	20.60	19.61	18.34
		2545.8	21.48	20.49	19.23
		2498.5	20.21	19.38	18.14
	1RB Low (0)	2687.5	20.77	19.79	18.55
		2640.3	20.71	19.73	18.47
		2593	20.59	19.65	18.41
		2545.8	21.39	20.43	19.14
		2498.5	20.14	19.34	18.09
	12RB High (13)	2687.5	19.75	18.86	17.93
		2640.3	19.58	18.68	17.72
		2593	19.44	18.54	17.63
		2545.8	20.41	19.49	18.58
		2498.5	19.28	18.21	17.26
	12RB Middle (6)	2687.5	19.74	18.83	17.91
		2640.3	19.57	18.68	17.75
		2593	19.48	18.58	17.66
		2545.8	20.37	19.49	18.54
		2498.5	19.27	18.22	17.26
	12RB Low (0)	2687.5	19.75	18.86	17.93
		2640.3	19.67	18.73	17.80
		2593	19.52	18.64	17.71
		2545.8	20.36	19.49	18.66
		2498.5	19.26	18.20	17.24
25RB (0)	2687.5	19.81	18.97	17.98	
	2640.3	19.61	18.78	17.79	
	2593	19.49	18.64	17.66	
	2545.8	20.42	19.58	18.61	
	2498.5	19.30	18.30	17.31	
10 MHz	1RB High (49)	2685	20.76	19.84	18.58
		2639	20.54	19.59	18.35
		2593	20.49	19.52	18.28

		2547	21.48	20.53	19.28
		2501	20.17	19.39	18.15
	1RB Middle (24)	2685	20.71	19.83	18.50
		2639	20.67	19.75	18.46
		2593	20.56	19.64	18.36
		2547	21.44	20.52	19.21
		2501	20.17	19.44	18.13
		1RB Low (0)	2685	20.61	19.69
	2639		20.71	19.79	18.51
	2593		20.65	19.72	18.54
	2547		21.34	20.40	19.12
	2501		20.08	19.32	18.18
	25RB High (25)	2685	19.74	18.90	17.95
		2639	19.58	18.75	17.78
		2593	19.45	18.62	17.65
		2547	20.44	19.62	18.64
		2501	19.34	18.34	17.38
	25RB Middle (12)	2685	19.71	18.87	17.92
		2639	19.61	18.80	17.83
		2593	19.51	18.67	17.70
		2547	20.42	19.59	18.62
		2501	19.31	18.30	17.34
	25RB Low (0)	2685	19.65	18.83	17.86
		2639	19.62	18.80	17.85
		2593	19.55	18.71	17.74
		2547	20.35	19.52	18.56
		2501	19.25	18.25	17.26
	50RB (0)	2685	19.74	18.93	17.88
		2639	19.64	18.83	17.80
		2593	19.50	18.72	17.68
2547		20.40	19.58	18.55	
2501		19.29	18.32	17.26	
15 MHz	1RB High (74)	2682.5	20.64	19.76	18.48
		2637.8	20.43	19.51	18.25
		2593	20.40	19.49	18.21
		2548.3	21.36	20.43	19.19
		2503.5	20.17	19.46	18.17
	1RB Middle (37)	2682.5	20.64	19.73	18.46
		2637.8	20.67	19.74	18.45
		2593	20.52	19.59	18.33
		2548.3	21.42	20.50	19.23

	1RB Low (0)	2503.5	20.15	19.41	18.16
		2682.5	20.46	19.56	18.29
		2637.8	20.67	19.75	18.47
		2593	20.64	19.74	18.48
		2548.3	21.28	20.35	19.08
		2503.5	20.00	19.26	18.12
	36RB High (38)	2682.5	19.66	18.82	17.82
		2637.8	19.54	18.70	17.70
		2593	19.42	18.54	17.54
		2548.3	20.41	19.54	18.52
		2503.5	19.35	18.32	17.31
	36RB Middle (19)	2682.5	19.62	18.76	17.75
		2637.8	19.60	18.71	17.73
		2593	19.47	18.60	17.60
		2548.3	20.39	19.52	18.51
		2503.5	19.29	18.26	17.25
	36RB Low (0)	2682.5	19.55	18.69	17.68
		2637.8	19.64	18.78	17.82
		2593	19.56	18.69	17.72
		2548.3	20.33	19.45	18.45
		2503.5	19.20	18.18	17.17
	75RB (0)	2682.5	19.66	18.82	17.81
		2637.8	19.58	18.76	17.74
		2593	19.51	18.66	17.65
		2548.3	20.41	19.56	18.56
2503.5		19.29	18.28	17.26	
20 MHz	1RB High (99)	2680	20.62	19.91	18.47
		2636.5	20.73	19.98	18.54
		2593	20.64	19.70	18.28
		2549.5	21.24	20.45	19.03
		2506	20.52	19.59	18.17
	1RB Middle (50)	2680	20.78	20.00	18.55
		2636.5	20.98	20.18	18.75
		2593	20.76	19.82	18.39
		2549.5	21.37	20.41	19.13
		2506	20.48	19.54	18.08
	1RB Low (0)	2680	20.77	19.97	18.54
		2636.5	20.89	20.09	18.68
		2593	20.80	20.01	18.58
		2549.5	21.18	20.41	18.97
		2506	20.33	19.40	18.05

	50RB High (50)	2680	19.93	18.94	17.92
		2636.5	20.04	19.04	18.02
		2593	19.70	18.76	17.70
		2549.5	20.49	19.50	18.48
		2506	19.64	18.62	17.58
	50RB Middle (25)	2680	19.93	18.93	17.91
		2636.5	20.11	19.13	18.11
		2593	19.77	18.79	17.73
		2549.5	19.51	19.22	18.50
		2506	19.47	18.48	17.43
	50RB Low (0)	2680	19.99	19.02	18.00
		2636.5	20.09	19.09	18.06
		2593	19.87	18.91	17.89
		2549.5	20.45	19.48	18.45
		2506	19.34	18.38	17.34
	100RB (0)	2680	19.96	18.96	17.94
		2636.5	20.06	19.08	18.05
		2593	19.82	18.80	17.77
		2549.5	20.44	19.48	18.48
		2506	19.49	18.48	17.45

Band 66					
Bandwidth (MHz)	RB allocation	Frequency (MHz)	QPSK	16QAM	64QAM
	RB offset (Start RB)		Actual output power (dBm)	Actual output power (dBm)	Actual output power (dBm)
1.4 MHz	1RB High (5)	1779.3	21.78	21.21	20.12
		1745	21.88	21.17	20.05
		1710.7	22.17	21.42	20.31
	1RB Middle (3)	1779.3	21.81	21.31	20.08
		1745	21.92	21.19	19.99
		1710.7	22.23	21.14	20.30
	1RB Low (0)	1779.3	21.78	21.24	20.11
		1745	21.90	21.08	20.01
		1710.7	22.20	21.18	20.30
	3RB High (3)	1779.3	21.82	20.94	20.02
		1745	21.90	20.91	19.92
		1710.7	22.23	21.24	20.32
	3RB Middle (1)	1779.3	21.82	20.98	20.07
		1745	21.92	20.84	19.97
		1710.7	22.25	21.18	20.28
	3RB Low (0)	1779.3	21.82	21.02	20.05
		1745	21.91	20.95	19.95
		1710.7	22.23	21.25	20.32
	6RB (0)	1779.3	21.00	20.07	18.89
		1745	20.90	19.97	18.83
		1710.7	21.23	20.28	19.15
3 MHz	1RB High (14)	1778.5	21.80	21.17	20.10
		1745	21.93	21.18	19.95
		1711.5	22.23	21.50	20.34
	1RB Middle (7)	1778.5	21.89	21.17	20.07
		1745	21.94	21.16	20.06
		1711.5	22.20	21.34	20.41
	1RB Low (0)	1778.5	21.81	21.29	20.10
		1745	21.92	21.17	20.07
		1711.5	22.22	21.46	20.35
	8RB High (7)	1778.5	20.96	20.04	18.98
		1745	20.88	19.90	18.86
		1711.5	21.22	20.28	19.24
	8RB Middle (4)	1778.5	20.97	20.02	18.95
		1745	20.84	19.95	18.88
		1711.5	21.22	20.26	19.20
	8RB Low (0)	1778.5	20.95	20.04	18.94
		1745	20.91	19.97	18.87
		1711.5	21.21	20.27	19.26
	15RB (0)	1778.5	20.96	20.02	18.95
		1745	20.89	19.92	18.94
		1711.5	21.24	20.23	19.22
5 MHz	1RB High (24)	1777.5	21.87	21.23	20.11
		1745	21.93	21.07	20.06

	1RB Middle (12)	1712.5	22.24	21.48	20.32	
		1777.5	21.82	21.28	20.11	
		1745	21.93	21.23	20.14	
	1RB Low (0)	1712.5	22.29	21.48	20.36	
		1777.5	21.80	21.31	20.05	
		1745	21.97	21.23	20.07	
	12RB High (13)	1712.5	22.21	21.45	20.35	
		1777.5	20.97	19.91	18.96	
		1745	20.86	19.85	18.84	
	12RB Middle (6)	1712.5	21.18	20.22	19.22	
		1777.5	20.98	19.96	18.93	
		1745	20.90	19.92	18.91	
	12RB Low (0)	1712.5	21.25	20.23	19.25	
		1777.5	21.05	19.95	19.04	
		1745	20.98	19.91	18.96	
	25RB (0)	1712.5	21.27	20.29	19.25	
		1777.5	20.98	20.02	18.97	
		1745	20.92	19.92	18.89	
	10 MHz	1RB High (49)	1712.5	21.24	20.28	19.20
			1777.5	20.98	20.02	18.97
			1745	20.92	19.92	18.89
1RB Middle (24)		1775	21.78	21.16	20.08	
		1745	21.90	21.19	19.98	
		1715	22.22	21.44	20.31	
1RB Low (0)		1775	21.78	21.21	20.17	
		1745	21.92	21.22	20.00	
		1715	22.25	21.00	20.37	
25RB High (25)		1775	21.92	21.10	20.07	
		1745	21.94	21.25	20.04	
		1715	22.22	21.23	20.37	
25RB Middle (12)		1775	20.96	19.99	18.94	
		1745	20.87	19.87	18.87	
		1715	21.25	20.23	19.22	
25RB Low (0)		1775	21.00	20.03	18.99	
		1745	20.91	19.90	18.87	
		1715	21.27	20.23	19.24	
50RB (0)		1775	21.01	20.02	18.94	
		1745	20.97	20.00	18.96	
		1715	21.28	20.31	19.31	
15 MHz	1RB High (74)	1775	21.01	20.01	18.98	
		1745	20.96	19.96	18.92	
		1715	21.26	20.32	19.29	
	1RB Middle (37)	1772.5	21.75	21.25	20.05	
		1745	21.84	21.16	19.89	
		1717.5	22.00	21.34	20.29	
	1RB Low (0)	1772.5	21.79	21.27	20.09	
		1745	21.93	21.23	20.02	
		1717.5	22.22	21.23	20.40	
	1RB Low (0)	1772.5	21.83	21.03	19.99	
		1745	21.91	21.09	20.07	

	36RB High (38)	1717.5	22.15	21.33	20.38	
		1772.5	20.96	19.96	18.94	
		1745	20.84	19.85	18.81	
	36RB Middle (19)	1717.5	21.26	20.28	19.28	
		1772.5	20.91	19.95	18.94	
		1745	20.89	19.92	18.92	
	36RB Low (0)	1717.5	21.18	20.23	19.18	
		1772.5	20.90	19.91	18.90	
		1745	20.99	19.90	18.92	
	75RB (0)	1717.5	21.22	20.21	19.23	
		1772.5	20.89	19.94	18.89	
		1745	20.95	19.93	18.88	
	20 MHz	1RB High (99)	1717.5	21.28	20.27	19.24
			1770	21.75	20.96	19.96
			1745	21.67	20.99	19.89
1RB Middle (50)		1720	21.87	21.14	19.97	
		1770	21.85	21.00	19.99	
		1745	21.94	21.02	19.95	
1RB Low (0)		1720	21.96	21.29	20.20	
		1770	21.69	20.88	19.81	
		1745	21.81	21.07	20.04	
50RB High (50)		1720	21.81	21.12	19.89	
		1770	20.70	19.74	18.72	
		1745	20.62	19.62	18.62	
50RB Middle (25)		1720	20.87	20.05	19.02	
		1770	20.85	19.82	18.82	
		1745	20.81	19.83	18.81	
50RB Low (0)		1720	20.98	19.96	18.95	
		1770	20.66	19.57	18.56	
		1745	20.84	19.83	18.82	
100RB (0)		1720	20.97	19.99	18.94	
		1770	20.65	19.61	18.63	
		1745	20.72	19.70	18.69	
			1720	21.04	20.01	18.96

DSI2

Band 25						
Bandwidth (MHz)	RB allocation	Frequency (MHz)	QPSK	16QAM	64QAM	
	RB offset (Start RB)		Actual output power (dBm)	Actual output power (dBm)	Actual output power (dBm)	
1.4 MHz	1RB High (5)	1914.3	20.77	20.93	20.95	
		1882.5	20.97	21.27	21.12	
		1850.7	20.83	21.18	21.02	
	1RB Middle (3)	1914.3	20.77	20.96	20.98	
		1882.5	21.02	21.15	21.22	
		1850.7	20.85	21.20	21.03	
	1RB Low (0)	1914.3	20.78	20.97	20.90	
		1882.5	20.97	21.24	21.14	
		1850.7	20.84	21.21	20.99	
	3RB High (3)	1914.3	20.82	20.78	20.87	
		1882.5	20.97	20.90	21.08	
		1850.7	20.87	20.88	21.32	
	3RB Middle (1)	1914.3	20.78	20.74	20.87	
		1882.5	20.95	20.95	21.04	
		1850.7	20.87	20.85	21.45	
	3RB Low (0)	1914.3	20.76	20.81	20.87	
		1882.5	20.93	20.96	21.10	
		1850.7	20.85	20.81	21.44	
	6RB (0)	1914.3	20.81	20.80	20.75	
		1882.5	20.98	21.06	20.96	
		1850.7	20.90	20.96	20.88	
	3 MHz	1RB High (14)	1913.5	20.76	21.02	21.01
			1882.5	20.93	21.30	21.17
			1851.5	20.87	21.17	21.10
1RB Middle (7)		1913.5	20.83	21.02	21.01	
		1882.5	21.02	21.28	21.20	
		1851.5	20.89	21.09	20.98	
1RB Low (0)		1913.5	20.76	21.03	20.98	
		1882.5	20.98	21.23	21.14	
		1851.5	20.82	21.20	21.06	
8RB High (7)		1913.5	20.72	20.81	20.82	
		1882.5	20.92	20.99	20.94	
		1851.5	20.90	20.95	20.94	
8RB Middle (4)		1913.5	20.80	20.88	20.81	
		1882.5	20.94	21.01	20.99	
		1851.5	20.86	20.91	20.93	
8RB Low (0)		1913.5	20.78	20.89	20.85	
		1882.5	20.97	21.00	20.98	
		1851.5	20.81	20.93	20.89	
15RB (0)		1913.5	20.75	20.81	20.80	
		1882.5	20.93	20.95	20.96	
		1851.5	20.86	20.90	20.90	
5 MHz		1RB	1912.5	20.81	21.02	20.97

	High (24)	1882.5	20.95	21.18	21.17
		1852.5	20.90	21.17	21.10
	1RB Middle (12)	1912.5	20.89	21.07	20.98
		1882.5	21.07	21.40	21.16
		1852.5	20.90	21.23	21.10
	1RB Low (0)	1912.5	20.82	21.12	21.00
		1882.5	21.01	21.37	21.21
		1852.5	20.88	21.22	21.03
	12RB High (13)	1912.5	20.72	20.71	20.75
		1882.5	20.97	21.00	21.03
		1852.5	20.88	20.87	20.90
	12RB Middle (6)	1912.5	20.79	20.77	20.85
		1882.5	20.98	20.97	21.00
		1852.5	20.90	20.90	20.92
	12RB Low (0)	1912.5	20.81	20.82	20.86
		1882.5	21.02	21.01	21.05
		1852.5	20.85	20.91	20.89
	25RB (0)	1912.5	20.80	20.85	20.81
		1882.5	20.99	21.04	21.06
		1852.5	20.93	20.94	20.95
10 MHz	1RB High (49)	1910	20.82	20.98	20.93
		1882.5	20.95	21.32	21.12
		1855	20.87	21.12	21.06
	1RB Middle (24)	1910	20.83	21.10	20.98
		1882.5	21.05	21.28	21.20
		1855	20.95	21.16	21.01
	1RB Low (0)	1910	20.88	21.19	20.98
		1882.5	20.95	21.29	21.11
		1855	20.90	21.13	21.08
	25RB High (25)	1910	20.75	20.76	20.74
		1882.5	21.05	21.08	21.06
		1855	20.97	20.96	20.99
	25RB Middle (12)	1910	20.78	20.83	20.80
		1882.5	20.92	20.99	21.02
		1855	20.91	20.93	20.94
	25RB Low (0)	1910	20.83	20.84	20.84
		1882.5	20.99	21.00	20.98
		1855	20.86	20.87	20.85
	50RB (0)	1910	20.75	20.76	20.78
		1882.5	21.03	20.98	21.02
1855		20.93	20.93	20.94	
15 MHz	1RB High (74)	1907.5	20.72	21.03	20.86
		1882.5	20.81	21.04	21.00
		1857.5	20.79	21.04	20.89
	1RB Middle (37)	1907.5	20.80	21.14	20.96
		1882.5	20.96	21.26	21.09
		1857.5	20.89	21.19	21.04
1RB	1907.5	20.84	21.19	21.02	

	Low (0)	1882.5	20.88	21.14	20.94
		1857.5	20.82	21.04	20.95
	36RB High (38)	1907.5	20.74	20.77	20.78
		1882.5	20.95	21.00	20.98
		1857.5	20.85	20.84	20.87
	36RB Middle (19)	1907.5	20.75	20.77	20.83
		1882.5	20.94	20.93	20.99
		1857.5	20.83	20.90	20.86
	36RB Low (0)	1907.5	20.84	20.90	20.89
		1882.5	20.91	20.98	20.96
		1857.5	20.83	20.85	20.88
	75RB (0)	1907.5	20.81	20.81	20.83
		1882.5	20.93	20.96	20.92
		1857.5	20.86	20.89	20.89
	20 MHz	1RB High (99)	1905	20.88	21.02
1882.5			21.03	21.30	21.15
1860			20.68	21.05	21.04
1RB Middle (50)		1905	21.08	21.27	21.12
		1882.5	21.16	21.46	21.26
		1860	20.89	20.92	20.94
1RB Low (0)		1905	21.11	21.33	21.19
		1882.5	21.00	21.16	21.19
		1860	20.63	20.83	20.81
50RB High (50)		1905	20.89	20.89	20.90
		1882.5	21.19	21.16	21.20
		1860	20.77	20.80	20.80
50RB Middle (25)		1905	21.05	21.12	21.12
		1882.5	21.18	21.19	21.18
		1860	20.73	20.76	20.75
50RB Low (0)		1905	21.20	21.24	21.23
		1882.5	21.10	21.16	21.15
		1860	20.66	20.70	20.69
100RB (0)		1905	21.01	21.01	21.03
		1882.5	21.13	21.13	21.13
		1860	20.70	20.72	20.72

Band 41-PC2					
Bandwidth (MHz)	RB allocation	Frequency (MHz)	QPSK	16QAM	64QAM
	RB offset (Start RB)		Actual output power (dBm)	Actual output power (dBm)	Actual output power (dBm)
5 MHz	1RB High (24)	2687.5	23.56	22.75	21.48
		2640.3	23.73	22.92	21.64
		2593	23.48	22.67	21.36
		2545.8	24.16	23.23	22.07
		2498.5	23.13	22.32	21.03
	1RB Middle (12)	2687.5	23.62	22.76	21.53
		2640.3	23.82	22.97	21.70
		2593	23.53	22.70	21.42
		2545.8	24.19	23.30	22.10
		2498.5	23.16	22.30	21.07
	1RB Low (0)	2687.5	23.56	22.72	21.50
		2640.3	23.76	22.94	21.70
		2593	23.53	22.73	21.44
		2545.8	24.12	23.27	22.05
		2498.5	23.09	22.26	21.00
	12RB High (13)	2687.5	22.51	21.52	20.57
		2640.3	22.66	21.66	20.70
		2593	22.37	21.37	20.51
		2545.8	23.09	22.10	21.14
		2498.5	22.06	21.06	20.25
	12RB Middle (6)	2687.5	22.52	21.51	20.57
		2640.3	22.68	21.69	20.72
		2593	22.43	21.42	20.59
		2545.8	23.12	22.13	21.14
		2498.5	22.04	21.04	20.23
	12RB Low (0)	2687.5	22.53	21.55	20.59
		2640.3	22.72	21.70	20.74
		2593	22.44	21.46	20.63
		2545.8	23.11	22.11	21.13
		2498.5	22.03	21.03	20.23
	25RB (0)	2687.5	22.54	21.56	20.60
		2640.3	22.72	21.72	20.74
		2593	22.42	21.43	20.57
		2545.8	23.11	22.12	21.12
		2498.5	22.06	21.08	20.24
	10 MHz	1RB High (49)	2685	23.49	22.72
2639			23.66	22.90	21.63
2593			23.41	22.62	21.31

		2547	24.19	23.17	22.10
		2501	23.09	22.32	21.03
	1RB Middle (24)	2685	23.57	22.79	21.52
		2639	23.74	23.00	21.69
		2593	23.48	22.74	21.42
		2547	24.19	23.19	22.12
		2501	23.11	22.34	21.06
		1RB Low (0)	2685	23.55	22.78
	2639		23.79	22.99	21.71
	2593		23.57	22.78	21.50
	2547		24.10	23.30	22.03
	2501		23.05	22.24	20.98
	25RB High (25)	2685	22.53	21.57	20.62
		2639	22.68	21.71	20.74
		2593	22.36	21.40	20.51
		2547	23.14	22.16	21.19
		2501	22.08	21.11	20.32
	25RB Middle (12)	2685	22.52	21.57	20.62
		2639	22.71	21.74	20.79
		2593	22.42	21.44	20.74
		2547	23.12	22.14	21.19
		2501	22.04	21.09	20.29
	25RB Low (0)	2685	22.51	21.56	20.61
		2639	22.70	21.74	20.80
		2593	22.46	21.49	20.66
		2547	23.10	22.14	21.15
		2501	21.98	21.02	20.23
	50RB (0)	2685	22.57	21.60	20.58
		2639	22.73	21.75	20.74
		2593	22.43	21.44	20.63
2547		23.13	22.15	21.12	
2501		22.07	21.10	20.23	
15 MHz	1RB High (74)	2682.5	23.38	22.63	21.38
		2637.8	23.56	22.80	21.54
		2593	23.29	22.53	21.26
		2548.3	24.03	23.26	22.01
		2503.5	23.04	22.26	21.01
	1RB Middle (37)	2682.5	23.49	22.72	21.44
		2637.8	23.75	22.95	21.69
		2593	23.42	22.64	21.39
		2548.3	24.11	23.12	22.09

		2503.5	23.08	22.30	21.03
	1RB Low (0)	2682.5	23.45	22.71	21.46
		2637.8	23.66	22.93	21.64
		2593	23.50	22.76	21.50
		2548.3	23.99	23.20	21.93
		2503.5	22.93	22.16	20.91
	36RB High (38)	2682.5	22.42	21.46	20.47
		2637.8	22.63	21.62	20.64
		2593	22.27	21.26	20.44
		2548.3	23.10	22.09	21.10
		2503.5	22.04	21.06	20.22
	36RB Middle (19)	2682.5	22.42	21.43	20.44
		2637.8	22.68	21.66	20.67
		2593	22.35	21.33	20.47
		2548.3	23.07	22.07	21.09
		2503.5	21.98	20.98	20.15
	36RB Low (0)	2682.5	22.47	21.48	20.51
		2637.8	22.67	21.67	20.70
		2593	22.42	21.40	20.57
		2548.3	23.01	22.04	21.06
2503.5		21.94	20.96	20.11	
75RB (0)	2682.5	22.48	21.51	20.51	
	2637.8	22.68	21.68	20.69	
	2593	22.36	21.36	20.56	
	2548.3	23.12	22.11	21.09	
	2503.5	22.01	21.03	20.19	
20 MHz	1RB High (99)	2680	22.92	23.05	22.81
		2636.5	22.97	23.15	22.88
		2593	22.77	22.97	22.69
		2549.5	23.62	23.80	23.56
		2506	22.70	22.90	22.62
	1RB Middle (50)	2680	22.92	23.06	22.79
		2636.5	23.19	23.38	23.11
		2593	22.92	23.11	22.84
		2549.5	23.80	23.95	23.70
		2506	22.56	22.71	22.45
	1RB Low (0)	2680	22.83	22.99	22.73
		2636.5	23.07	23.31	23.05
		2593	23.06	23.27	23.01
		2549.5	23.58	23.77	23.21
		2506	22.35	22.51	23.21

	50RB High (50)	2680	22.97	22.97	22.95
		2636.5	23.11	23.13	23.09
		2593	22.86	22.89	22.86
		2549.5	23.77	23.78	23.74
		2506	22.66	22.69	22.66
	50RB Middle (25)	2680	22.95	22.94	22.94
		2636.5	23.18	23.19	23.17
		2593	22.90	22.93	22.93
		2549.5	23.76	23.79	23.80
		2506	22.55	22.53	22.53
	50RB Low (0)	2680	22.94	22.95	22.93
		2636.5	23.13	23.16	23.13
		2593	22.99	23.01	23.01
		2549.5	23.70	23.73	23.72
		2506	22.37	22.40	22.38
	100RB (0)	2680	22.97	22.95	22.95
		2636.5	23.13	23.13	23.11
		2593	22.90	22.94	22.95
		2549.5	23.69	23.74	23.73
		2506	22.55	22.55	22.56

Band 41-PC3					
Bandwidth (MHz)	RB allocation	Frequency (MHz)	QPSK	16QAM	64QAM
	RB offset (Start RB)		Actual output power (dBm)	Actual output power (dBm)	Actual output power (dBm)
5 MHz	1RB High (24)	2687.5	20.58	19.86	18.39
		2640.3	20.71	19.95	18.51
		2593	20.61	19.69	18.23
		2545.8	21.19	20.12	18.96
		2498.5	20.31	19.41	17.93
	1RB Middle (12)	2687.5	20.63	19.84	18.40
		2640.3	20.78	19.96	18.52
		2593	20.64	19.68	18.25
		2545.8	21.21	20.14	18.92
		2498.5	20.33	19.37	17.95
	1RB Low (0)	2687.5	20.59	19.85	18.40
		2640.3	20.76	19.98	18.57
		2593	20.69	19.73	18.32
		2545.8	21.02	20.12	18.92
		2498.5	20.29	19.36	17.93
	12RB High (13)	2687.5	19.70	18.67	17.75
		2640.3	19.83	18.78	17.83
		2593	19.52	18.46	17.53
		2545.8	20.25	19.21	18.27
		2498.5	19.25	18.22	17.24
	12RB Middle (6)	2687.5	19.72	18.67	17.74
		2640.3	19.83	18.78	17.85
		2593	19.56	18.49	17.56
		2545.8	20.26	19.22	18.28
		2498.5	19.22	18.17	17.15
	12RB Low (0)	2687.5	19.73	18.69	17.75
		2640.3	19.88	18.81	17.87
		2593	19.60	18.54	17.60
		2545.8	20.22	19.20	18.29
		2498.5	19.25	18.17	17.15
	25RB (0)	2687.5	19.74	18.76	17.79
		2640.3	19.87	18.88	17.89
		2593	19.55	18.56	17.59
		2545.8	20.26	19.27	18.29
		2498.5	19.26	18.28	17.19
	10 MHz	1RB High (49)	2685	20.47	19.77
2639			20.64	19.87	18.45
2593			20.51	19.61	18.21

		2547	21.16	20.14	18.95
		2501	20.26	19.37	17.90
	1RB Middle (24)	2685	20.54	19.81	18.38
		2639	20.69	19.95	18.53
		2593	20.56	19.68	18.25
		2547	21.14	20.24	18.93
		2501	20.27	19.35	17.89
		1RB Low (0)	2685	20.53	19.82
	2639		20.72	19.99	18.58
	2593		20.55	19.76	18.34
	2547		21.07	20.13	18.89
	2501		20.22	19.32	17.86
	25RB High (25)	2685	19.67	18.73	17.77
		2639	19.81	18.83	17.87
		2593	19.49	18.50	17.54
		2547	20.27	19.29	17.93
		2501	19.20	18.26	17.31
	25RB Middle (12)	2685	19.68	18.73	17.77
		2639	19.83	18.87	17.91
		2593	19.57	18.58	17.63
		2547	20.25	19.26	18.11
		2501	19.24	18.24	17.29
	25RB Low (0)	2685	19.67	18.71	17.74
		2639	19.88	18.89	17.93
		2593	19.57	18.63	17.68
		2547	20.22	19.25	18.30
		2501	19.17	18.18	17.23
	50RB (0)	2685	19.73	18.77	17.74
		2639	19.86	18.92	17.89
		2593	19.55	18.61	17.55
2547		20.27	19.30	18.28	
2501		19.26	18.27	17.25	
15 MHz	1RB High (74)	2682.5	20.48	19.75	18.31
		2637.8	20.59	19.84	18.43
		2593	20.45	19.58	18.16
		2548.3	21.07	20.25	18.87
		2503.5	20.25	19.37	17.91
	1RB Middle (37)	2682.5	20.56	19.83	18.37
		2637.8	20.73	20.00	18.55
		2593	20.60	19.69	18.27
		2548.3	21.15	20.15	18.98

	1RB Low (0)	2503.5	20.28	19.39	17.93
		2682.5	20.54	19.79	18.37
		2637.8	20.73	19.97	18.55
		2593	20.55	19.79	18.38
		2548.3	21.03	20.25	18.84
		2503.5	20.17	19.28	17.83
	36RB High (38)	2682.5	19.70	18.68	17.67
		2637.8	19.86	18.81	17.84
		2593	19.51	18.47	17.48
		2548.3	20.30	19.27	18.27
		2503.5	19.25	18.26	17.26
	36RB Middle (19)	2682.5	19.68	18.66	17.64
		2637.8	19.87	18.83	17.85
		2593	19.55	18.52	17.54
		2548.3	20.24	19.23	18.28
		2503.5	19.22	18.19	17.20
	36RB Low (0)	2682.5	19.69	18.70	17.70
		2637.8	19.86	18.87	17.90
		2593	19.61	18.63	17.65
		2548.3	20.19	19.21	18.24
		2503.5	19.18	18.16	17.18
	75RB (0)	2682.5	19.72	18.71	17.70
		2637.8	19.88	18.91	17.90
		2593	19.57	18.57	17.57
		2548.3	20.13	19.12	18.29
2503.5		19.30	18.26	17.26	
20 MHz	1RB High (99)	2680	19.91	20.00	19.56
		2636.5	19.91	20.01	19.58
		2593	19.73	19.83	19.39
		2549.5	20.60	20.68	20.24
		2506	19.71	19.80	19.35
	1RB Middle (50)	2680	19.92	19.96	19.54
		2636.5	20.15	20.22	19.81
		2593	19.90	19.94	19.52
		2549.5	20.75	20.82	20.40
		2506	19.54	19.60	20.11
	1RB Low (0)	2680	19.82	19.88	19.46
		2636.5	20.05	20.17	19.72
		2593	20.02	20.11	19.69
		2549.5	20.58	20.66	20.22
		2506	19.31	19.43	19.62

	50RB High (50)	2680	19.97	20.00	19.98
		2636.5	20.07	20.11	20.09
		2593	19.85	19.87	19.85
		2549.5	20.73	20.74	20.73
		2506	19.68	19.72	19.69
	50RB Middle (25)	2680	19.95	19.96	19.95
		2636.5	20.16	20.21	20.15
		2593	19.90	19.92	19.90
		2549.5	20.77	20.80	20.77
		2506	19.54	19.57	19.54
	50RB Low (0)	2680	19.90	19.95	19.94
		2636.5	20.12	20.17	20.14
		2593	19.97	20.01	19.99
		2549.5	20.65	20.71	20.71
		2506	19.37	19.43	19.38
	100RB (0)	2680	19.94	19.99	19.97
		2636.5	20.08	20.14	20.11
		2593	19.88	19.95	19.90
		2549.5	20.68	20.73	20.71
		2506	19.55	19.55	19.55

Band 66					
Bandwidth (MHz)	RB allocation	Frequency (MHz)	QPSK	16QAM	64QAM
	RB offset (Start RB)		Actual output power (dBm)	Actual output power (dBm)	Actual output power (dBm)
1.4 MHz	1RB High (5)	1779.3	20.87	21.17	21.01
		1745	20.81	21.06	20.97
		1710.7	20.97	21.22	21.17
	1RB Middle (3)	1779.3	20.89	21.24	21.03
		1745	20.82	21.08	20.95
		1710.7	21.00	21.39	21.19
	1RB Low (0)	1779.3	20.86	21.11	21.12
		1745	20.80	21.07	20.97
		1710.7	20.99	21.22	21.18
	3RB High (3)	1779.3	20.92	20.89	20.99
		1745	20.80	20.85	20.95
		1710.7	21.07	20.99	21.14
	3RB Middle (1)	1779.3	20.89	20.96	21.02
		1745	20.85	20.82	20.97
		1710.7	21.04	21.04	21.14
	3RB Low (0)	1779.3	20.92	20.94	20.98
		1745	20.85	20.85	20.90
		1710.7	21.04	21.10	21.15
	6RB (0)	1779.3	20.94	21.04	20.91
		1745	20.88	20.96	20.82
		1710.7	21.03	21.13	21.04
3 MHz	1RB High (14)	1778.5	20.86	21.12	21.06
		1745	20.79	21.15	21.00
		1711.5	20.99	21.37	21.11
	1RB Middle (7)	1778.5	20.93	21.20	21.09
		1745	20.85	21.11	20.96
		1711.5	20.99	21.39	21.31
	1RB Low (0)	1778.5	20.90	21.23	21.05
		1745	20.86	21.17	20.94
		1711.5	21.00	21.27	21.11
	8RB High (7)	1778.5	20.87	20.98	20.95
		1745	20.78	20.84	20.84
		1711.5	21.03	21.13	21.08
	8RB Middle (4)	1778.5	20.92	21.00	20.95
		1745	20.81	20.90	20.88
		1711.5	21.03	21.08	21.05
	8RB Low (0)	1778.5	20.94	20.99	20.99
		1745	20.84	20.88	20.89
		1711.5	21.05	21.11	21.08
	15RB (0)	1778.5	20.90	20.95	20.92
		1745	20.81	20.83	20.81
		1711.5	21.01	21.08	21.03
5 MHz	1RB High (24)	1777.5	20.92	21.12	21.12
		1745	20.84	21.15	21.01

	1RB Middle (12)	1712.5	21.03	21.27	21.13
		1777.5	20.95	21.24	21.07
		1745	20.88	21.03	21.00
	1RB Low (0)	1712.5	21.03	21.46	21.21
		1777.5	20.91	21.18	21.07
		1745	20.88	21.11	21.03
	12RB High (13)	1712.5	21.05	21.23	21.22
		1777.5	20.89	20.90	20.89
		1745	20.79	20.77	20.82
	12RB Middle (6)	1712.5	21.00	21.00	21.03
		1777.5	20.91	20.92	20.99
		1745	20.88	20.89	20.91
	12RB Low (0)	1712.5	21.04	21.03	21.08
		1777.5	21.02	21.05	21.03
		1745	20.94	20.95	21.01
	25RB (0)	1712.5	21.11	21.07	21.10
		1777.5	20.97	20.95	20.99
		1745	20.82	20.89	20.86
10 MHz	1RB High (49)	1712.5	21.06	21.09	21.06
		1777.5	20.97	20.95	20.99
		1745	20.82	20.89	20.86
	1RB Middle (24)	1775	20.90	21.09	21.04
		1745	20.80	21.04	21.04
		1715	21.04	21.21	21.23
	1RB Low (0)	1775	20.91	21.11	21.06
		1745	20.85	21.06	21.05
		1715	21.02	21.36	21.14
	25RB High (25)	1775	20.92	21.16	21.00
		1745	20.86	21.07	20.97
		1715	21.04	21.26	21.19
	25RB Middle (12)	1775	20.89	20.91	20.91
		1745	20.81	20.81	20.79
		1715	21.05	21.05	21.05
	25RB Low (0)	1775	20.89	20.95	20.95
		1745	20.89	20.89	20.86
		1715	21.06	21.09	21.05
50RB (0)	1775	20.98	21.01	20.97	
	1745	20.90	20.91	20.91	
	1715	21.05	21.10	21.09	
15 MHz	1RB High (74)	1775	20.92	20.99	21.00
		1745	20.85	20.87	20.90
		1715	21.08	21.10	21.06
	1RB Middle (37)	1772.5	20.82	21.14	21.10
		1745	20.72	21.04	20.98
		1717.5	20.96	21.30	21.16
	1RB Low (0)	1772.5	20.92	21.11	21.08
		1745	20.81	21.18	21.00
		1717.5	21.01	21.27	21.23
	1RB Low (0)	1772.5	20.79	21.02	20.96
		1745	20.81	21.14	21.01

	36RB High (38)	1717.5	20.96	21.30	21.16	
		1772.5	20.83	20.90	20.89	
		1745	20.70	20.75	20.73	
	36RB Middle (19)	1717.5	21.06	21.10	21.08	
		1772.5	20.94	20.91	20.92	
		1745	20.84	20.83	20.91	
	36RB Low (0)	1717.5	21.02	21.04	21.09	
		1772.5	20.88	20.88	20.89	
		1745	20.89	20.86	20.90	
	75RB (0)	1717.5	20.99	21.05	21.04	
		1772.5	20.85	20.88	20.90	
		1745	20.77	20.78	20.84	
	20 MHz	1RB High (99)	1717.5	21.06	21.08	21.07
			1770	20.72	20.85	20.87
			1745	20.61	20.96	20.82
1RB Middle (50)		1720	20.81	21.03	20.94	
		1770	20.78	21.02	20.90	
		1745	20.76	21.03	20.89	
1RB Low (0)		1720	20.97	21.28	21.14	
		1770	20.62	20.86	20.75	
		1745	20.76	20.99	20.88	
50RB High (50)		1720	20.89	21.21	21.09	
		1770	20.70	20.67	20.70	
		1745	20.59	20.61	20.61	
50RB Middle (25)		1720	21.11	21.10	21.10	
		1770	20.77	20.83	20.79	
		1745	20.81	20.80	20.80	
50RB Low (0)		1720	21.05	21.06	21.05	
		1770	20.59	20.58	20.53	
		1745	20.80	20.84	20.84	
100RB (0)		1720	21.00	21.08	21.02	
		1770	20.66	20.62	20.66	
		1745	20.69	20.68	20.68	
			1720	21.07	21.08	21.08

DS15/6

Band 2(ANT6)					
Bandwidth (MHz)	RB allocation	Frequency (MHz)	QPSK	16QAM	64QAM
	RB offset (Start RB)		Actual output power (dBm)	Actual output power (dBm)	Actual output power (dBm)
1.4 MHz	1RB High (5)	1909.3	19.32	18.37	17.29
		1880	19.88	19.00	17.88
		1850.7	19.28	18.43	17.32
	1RB Middle (3)	1909.3	19.38	18.26	17.30
		1880	19.88	18.97	17.91
		1850.7	19.33	18.39	17.17
	1RB Low (0)	1909.3	19.34	18.40	17.20
		1880	19.88	18.83	17.77
		1850.7	19.29	18.24	17.23
	3RB High (3)	1909.3	19.36	18.10	17.19
		1880	19.89	18.60	17.72
		1850.7	19.35	18.03	17.20
	3RB Middle (1)	1909.3	19.36	18.10	17.22
		1880	19.89	18.66	17.81
		1850.7	19.30	17.96	17.19
	3RB Low (0)	1909.3	19.35	18.14	17.20
		1880	19.91	18.73	17.79
		1850.7	19.30	18.12	17.24
	6RB (0)	1909.3	18.51	17.19	16.06
		1880	19.08	17.72	16.65
		1850.7	18.51	17.20	16.02
3 MHz	1RB High (14)	1908.5	19.35	18.27	17.22
		1880	19.82	18.91	17.78
		1851.5	19.40	18.38	17.36
	1RB Middle (7)	1908.5	19.37	18.38	17.35
		1880	19.88	19.02	17.82
		1851.5	19.37	18.44	17.30
	1RB Low (0)	1908.5	19.28	18.29	17.25
		1880	19.87	18.99	17.79
		1851.5	19.26	18.26	17.23
	8RB High (7)	1908.5	18.47	17.19	16.15
		1880	18.94	17.71	16.63
		1851.5	18.54	17.23	16.14
	8RB Middle (4)	1908.5	18.50	17.20	16.11
		1880	19.04	17.71	16.65
		1851.5	18.49	17.18	16.12
	8RB Low (0)	1908.5	18.50	17.16	16.14
		1880	19.08	17.72	16.70
		1851.5	18.52	17.10	16.16
	15RB (0)	1908.5	18.48	17.14	16.08
		1880	19.01	17.64	16.64
		1851.5	18.50	17.14	16.13

5 MHz	1RB High (24)	1907.5	19.38	18.40	17.34	
		1880	19.85	18.93	17.73	
		1852.5	19.47	18.44	17.44	
	1RB Middle (12)	1907.5	19.39	18.41	17.31	
		1880	19.97	19.00	17.80	
		1852.5	19.43	18.51	17.32	
	1RB Low (0)	1907.5	19.35	18.44	17.27	
		1880	19.91	18.95	17.90	
		1852.5	19.27	18.30	17.31	
	12RB High (13)	1907.5	18.46	17.07	16.10	
		1880	19.00	17.64	16.66	
		1852.5	18.57	17.17	16.15	
	12RB Middle (6)	1907.5	18.52	17.12	16.16	
		1880	19.10	17.69	16.69	
		1852.5	18.55	17.13	16.15	
	12RB Low (0)	1907.5	18.59	17.16	16.22	
		1880	19.11	17.73	16.78	
		1852.5	18.54	17.07	16.10	
	25RB (0)	1907.5	18.54	17.15	16.14	
		1880	19.11	17.73	16.69	
		1852.5	18.56	17.20	16.13	
	10 MHz	1RB High (49)	1905	19.33	18.39	17.25
			1880	19.76	18.88	17.76
			1855	19.48	18.61	17.37
1RB Middle (24)		1905	19.36	18.39	17.25	
		1880	19.95	18.94	17.91	
		1855	19.45	18.56	17.40	
1RB Low (0)		1905	19.39	18.49	17.27	
		1880	19.91	18.97	17.91	
		1855	19.30	18.38	17.25	
25RB High (25)		1905	18.45	16.99	16.03	
		1880	19.07	17.69	16.68	
		1855	18.68	17.31	16.29	
25RB Middle (12)		1905	18.54	17.13	16.14	
		1880	19.03	17.69	16.70	
		1855	18.60	17.23	16.23	
25RB Low (0)		1905	18.61	17.22	16.18	
		1880	19.09	17.77	16.74	
		1855	18.53	17.17	16.15	
50RB (0)		1905	18.51	17.14	16.15	
		1880	19.08	17.68	16.67	
		1855	18.64	17.22	16.22	
15 MHz		1RB High (74)	1902.5	19.28	18.38	17.20
			1880	19.66	18.67	17.62
			1857.5	19.45	18.51	17.44
	1RB Middle (37)	1902.5	19.41	18.44	17.31	
		1880	19.91	19.03	17.82	
		1857.5	19.49	18.61	17.47	

	1RB Low (0)	1902.5	19.60	18.63	17.59
		1880	19.80	18.87	17.78
		1857.5	19.26	18.38	17.23
	36RB High (38)	1902.5	18.38	17.04	16.10
		1880	18.94	17.62	16.61
		1857.5	18.66	17.30	16.32
	36RB Middle (19)	1902.5	18.52	17.19	16.22
		1880	18.97	17.63	16.64
		1857.5	18.64	17.24	16.26
	36RB Low (0)	1902.5	18.70	17.27	16.29
		1880	19.02	17.62	16.69
		1857.5	18.53	17.16	16.17
75RB (0)	1902.5	18.60	17.21	16.15	
	1880	19.06	17.63	16.62	
	1857.5	18.65	17.25	16.22	
20 MHz	1RB High (99)	1900	19.81	18.82	17.71
		1880	19.74	18.71	17.63
		1860	19.56	18.64	17.66
	1RB Middle (50)	1900	19.97	18.98	17.86
		1880	19.86	18.84	17.67
		1860	19.48	18.74	17.88
	1RB Low (0)	1900	19.77	18.79	17.65
		1880	19.57	18.78	17.76
		1860	19.28	18.56	17.67
	50RB High (50)	1900	18.88	17.85	17.01
		1880	18.93	17.67	17.02
		1860	18.36	17.66	17.01
	50RB Middle (25)	1900	18.91	17.88	17.02
		1880	18.77	17.87	17.11
		1860	18.43	17.76	17.08
	50RB Low (0)	1900	19.05	18.04	17.17
		1880	18.71	17.88	17.03
		1860	18.32	17.76	17.11
	100RB (0)	1900	18.94	17.97	17.07
		1880	18.78	17.85	17.09
		1860	18.33	17.74	17.03

DSI5/6

Band 66(ANT6)					
Bandwidth (MHz)	RB allocation	Frequency (MHz)	QPSK	16QAM	64QAM
	RB offset (Start RB)		Actual output power (dBm)	Actual output power (dBm)	Actual output power (dBm)
1.4 MHz	1RB High (5)	1779.3	19.65	18.85	17.91
		1745	19.75	18.81	17.84
		1710.7	20.04	19.06	18.10
	1RB Middle (3)	1779.3	19.68	18.95	17.87
		1745	19.79	18.83	17.78
		1710.7	20.10	18.78	18.09
	1RB Low (0)	1779.3	19.65	18.88	17.90
		1745	19.77	18.72	17.80
		1710.7	20.07	18.82	18.09
	3RB High (3)	1779.3	19.69	18.58	17.81
		1745	19.77	18.55	17.71
		1710.7	20.10	18.88	18.11
	3RB Middle (1)	1779.3	19.69	18.62	17.86
		1745	19.79	18.48	17.76
		1710.7	20.12	18.82	18.07
	3RB Low (0)	1779.3	19.69	18.66	17.84
		1745	19.78	18.59	17.74
		1710.7	20.10	18.89	18.11
	6RB (0)	1779.3	18.87	17.71	16.68
		1745	18.77	17.61	16.62
		1710.7	19.10	17.92	16.94
3 MHz	1RB High (14)	1778.5	19.67	18.81	17.89
		1745	19.80	18.82	17.74
		1711.5	20.10	19.14	18.13
	1RB Middle (7)	1778.5	19.76	18.81	17.86
		1745	19.81	18.80	17.85
		1711.5	20.07	18.98	18.20
	1RB Low (0)	1778.5	19.68	18.93	17.89
		1745	19.79	18.81	17.86
		1711.5	20.09	19.10	18.14
	8RB High (7)	1778.5	18.83	17.68	16.77
		1745	18.75	17.54	16.65
		1711.5	19.09	17.92	17.03
	8RB Middle (4)	1778.5	18.84	17.66	16.74
		1745	18.71	17.59	16.67
		1711.5	19.09	17.90	16.99
	8RB Low (0)	1778.5	18.82	17.68	16.73
		1745	18.78	17.61	16.66
		1711.5	19.08	17.91	17.05
	15RB (0)	1778.5	18.83	17.66	16.74
		1745	18.76	17.56	16.73
		1711.5	19.11	17.87	17.01
5 MHz	1RB	1777.5	19.74	18.87	17.90

	High (24)	1745	19.80	18.71	17.85
		1712.5	20.11	19.12	18.11
	1RB Middle (12)	1777.5	19.69	18.92	17.90
		1745	19.80	18.87	17.93
		1712.5	20.16	19.12	18.15
	1RB Low (0)	1777.5	19.67	18.95	17.84
		1745	19.84	18.87	17.86
		1712.5	20.08	19.09	18.14
	12RB High (13)	1777.5	18.84	17.55	16.75
		1745	18.73	17.49	16.63
		1712.5	19.05	17.86	17.01
	12RB Middle (6)	1777.5	18.85	17.60	16.72
		1745	18.77	17.56	16.70
		1712.5	19.12	17.87	17.04
	12RB Low (0)	1777.5	18.92	17.59	16.83
		1745	18.85	17.55	16.75
		1712.5	19.14	17.93	17.04
	25RB (0)	1777.5	18.85	17.66	16.76
		1745	18.79	17.56	16.68
		1712.5	19.11	17.92	16.99
10 MHz	1RB High (49)	1775	19.65	18.80	17.87
		1745	19.77	18.83	17.77
		1715	20.09	19.08	18.10
	1RB Middle (24)	1775	19.65	18.85	17.96
		1745	19.79	18.86	17.79
		1715	20.12	18.64	18.16
	1RB Low (0)	1775	19.79	18.74	17.86
		1745	19.81	18.89	17.83
		1715	20.09	18.87	18.16
	25RB High (25)	1775	18.83	17.63	16.73
		1745	18.74	17.51	16.66
		1715	19.12	17.87	17.01
	25RB Middle (12)	1775	18.87	17.67	16.78
		1745	18.78	17.54	16.66
		1715	19.14	17.87	17.03
	25RB Low (0)	1775	18.88	17.66	16.73
		1745	18.84	17.64	16.75
		1715	19.15	17.95	17.10
	50RB (0)	1775	18.88	17.65	16.77
		1745	18.83	17.60	16.71
1715		19.13	17.96	17.08	
15 MHz	1RB High (74)	1772.5	19.62	18.89	17.84
		1745	19.71	18.80	17.68
		1717.5	19.87	18.98	18.08
	1RB Middle (37)	1772.5	19.66	18.91	17.88
		1745	19.80	18.87	17.81
		1717.5	20.09	18.87	18.19
1RB	1772.5	19.70	18.67	17.78	

	Low (0)	1745	19.78	18.73	17.86
		1717.5	20.02	18.97	18.17
	36RB High (38)	1772.5	18.83	17.60	16.73
		1745	18.71	17.49	16.60
		1717.5	19.13	17.92	17.07
	36RB Middle (19)	1772.5	18.78	17.59	16.73
		1745	18.76	17.56	16.71
		1717.5	19.05	17.87	16.97
	36RB Low (0)	1772.5	18.77	17.55	16.69
		1745	18.86	17.54	16.71
		1717.5	19.09	17.85	17.02
	75RB (0)	1772.5	18.76	17.58	16.68
		1745	18.82	17.57	16.67
		1717.5	19.15	17.91	17.03
	20 MHz	1RB High (99)	1770	19.62	18.60
1745			19.63	18.61	17.76
1720			19.59	18.57	17.72
1RB Middle (50)		1770	19.76	18.74	17.89
		1745	19.73	18.71	17.86
		1720	19.62	18.60	17.75
1RB Low (0)		1770	19.57	18.55	17.70
		1745	19.58	18.56	17.71
		1720	19.41	18.39	17.54
50RB High (50)		1770	18.78	17.76	16.91
		1745	18.81	17.79	16.94
		1720	18.46	17.44	16.59
50RB Middle (25)		1770	18.74	17.72	16.87
		1745	18.68	17.65	16.80
		1720	18.55	17.53	16.68
50RB Low (0)		1770	18.89	17.87	17.02
		1745	18.65	17.61	16.77
		1720	18.43	17.41	16.56
100RB (0)		1770	18.82	17.80	16.95
		1745	18.70	17.68	16.83
		1720	18.46	17.44	16.59

DSI4/5/6

Band 2(ANT4)					
Bandwidth (MHz)	RB allocation	Frequency (MHz)	QPSK	16QAM	64QAM
	RB offset (Start RB)		Actual output power (dBm)	Actual output power (dBm)	Actual output power (dBm)
1.4 MHz	1RB High (5)	1909.3	18.84	17.68	16.52
		1880	18.88	18.05	17.04
		1850.7	18.32	17.70	16.51
	1RB Middle (3)	1909.3	18.87	17.61	16.48
		1880	18.90	18.27	17.02
		1850.7	18.33	17.73	16.45
	1RB Low (0)	1909.3	18.90	17.52	16.42
		1880	18.86	18.21	17.07
		1850.7	18.26	17.48	16.46
	3RB High (3)	1909.3	18.91	17.29	16.37
		1880	18.89	17.90	16.91
		1850.7	18.38	17.37	16.41
	3RB Middle (1)	1909.3	18.86	17.28	16.41
		1880	18.86	17.94	16.96
		1850.7	18.36	17.31	16.41
	3RB Low (0)	1909.3	18.90	17.34	16.43
		1880	18.86	17.89	16.99
		1850.7	18.33	17.31	16.36
	6RB (0)	1909.3	17.86	16.37	15.21
		1880	17.85	16.92	15.76
		1850.7	17.31	16.40	15.28
3 MHz	1RB High (14)	1908.5	18.86	17.64	16.42
		1880	18.86	18.10	17.00
		1851.5	18.36	17.57	16.59
	1RB Middle (7)	1908.5	18.90	17.56	16.49
		1880	18.85	18.16	17.03
		1851.5	18.33	17.54	16.46
	1RB Low (0)	1908.5	18.89	17.64	16.54
		1880	18.84	18.30	17.03
		1851.5	18.29	17.53	16.47
	8RB High (7)	1908.5	17.80	16.35	15.34
		1880	17.81	16.89	15.84
		1851.5	17.33	16.44	15.37
	8RB Middle (4)	1908.5	17.83	16.35	15.28
		1880	17.85	16.91	15.84
		1851.5	17.36	16.46	15.40
	8RB Low (0)	1908.5	17.86	16.38	15.35
		1880	17.87	16.91	15.88
		1851.5	17.28	16.39	15.33
	15RB (0)	1908.5	17.83	16.30	15.28
		1880	17.84	16.88	15.85
		1851.5	17.32	16.33	15.28

5 MHz	1RB High (24)	1907.5	18.93	17.63	16.59
		1880	18.94	18.21	17.08
		1852.5	18.51	17.71	16.70
	1RB Middle (12)	1907.5	18.95	17.71	16.51
		1880	18.95	18.16	17.11
		1852.5	18.43	17.59	16.59
	1RB Low (0)	1907.5	19.00	17.71	16.56
		1880	18.99	18.29	17.05
		1852.5	18.43	17.61	16.57
	12RB High (13)	1907.5	17.94	16.33	15.32
		1880	17.93	16.91	15.87
		1852.5	17.46	16.43	15.41
	12RB Middle (6)	1907.5	17.89	16.33	15.35
		1880	17.89	16.82	15.81
		1852.5	17.38	16.39	15.34
	12RB Low (0)	1907.5	17.93	16.39	15.33
		1880	17.96	16.91	15.88
		1852.5	17.37	16.35	15.36
25RB (0)	1907.5	17.95	16.41	15.37	
	1880	17.98	16.96	15.92	
	1852.5	17.36	16.37	15.36	
10 MHz	1RB High (49)	1905	18.97	17.59	16.54
		1880	18.90	18.17	17.11
		1855	18.54	17.77	16.63
	1RB Middle (24)	1905	18.90	17.73	16.63
		1880	18.99	18.16	17.06
		1855	18.48	17.83	16.60
	1RB Low (0)	1905	18.92	17.89	16.78
		1880	18.93	18.17	16.99
		1855	18.40	17.66	16.57
	25RB High (25)	1905	17.94	16.45	15.39
		1880	17.94	16.99	15.91
		1855	17.51	16.53	15.47
	25RB Middle (12)	1905	17.93	16.50	15.45
		1880	17.91	16.91	15.89
		1855	17.47	16.46	15.43
	25RB Low (0)	1905	17.92	16.63	15.57
		1880	17.94	16.96	15.86
		1855	17.37	16.40	15.36
50RB (0)	1905	17.92	16.53	15.50	
	1880	17.96	16.93	15.90	
	1855	17.43	16.41	15.43	
15 MHz	1RB High (74)	1902.5	18.80	17.50	16.41
		1880	18.79	18.00	16.88
		1857.5	18.54	17.89	16.60
	1RB Middle (37)	1902.5	19.01	17.85	16.80
		1880	19.00	18.21	17.13
		1857.5	18.52	17.89	16.72

	1RB Low (0)	1902.5	18.81	17.97	16.80
		1880	18.86	18.18	16.95
		1857.5	18.33	17.70	16.39
	36RB High (38)	1902.5	17.95	16.44	15.45
		1880	17.94	16.93	15.92
		1857.5	17.52	16.55	15.51
	36RB Middle (19)	1902.5	17.92	16.57	15.56
		1880	17.92	16.90	15.93
		1857.5	17.51	16.50	15.50
	36RB Low (0)	1902.5	17.94	16.72	15.69
		1880	17.91	16.93	15.90
		1857.5	17.37	16.38	15.32
75RB (0)	1902.5	17.93	16.61	15.58	
	1880	17.97	16.91	15.86	
	1857.5	17.51	16.45	15.44	
20 MHz	1RB High (99)	1900	18.50	17.71	16.44
		1880	18.83	18.03	16.79
		1860	18.81	18.02	16.82
	1RB Middle (50)	1900	18.84	18.08	16.92
		1880	19.10	18.43	17.08
		1860	18.66	17.84	16.63
	1RB Low (0)	1900	18.79	17.99	16.78
		1880	18.95	18.12	17.07
		1860	18.46	17.58	16.58
	50RB High (50)	1900	17.60	16.53	15.49
		1880	18.11	17.04	15.98
		1860	17.74	16.68	15.61
	50RB Middle (25)	1900	17.84	16.77	15.70
		1880	18.10	16.98	15.92
		1860	17.68	16.62	15.56
	50RB Low (0)	1900	17.90	16.84	15.76
		1880	18.09	17.01	15.97
		1860	17.48	16.43	15.32
	100RB (0)	1900	17.76	16.64	15.58
		1880	18.10	16.98	15.94
		1860	17.56	16.55	15.48

Band 66					
Bandwidth (MHz)	RB allocation	Frequency (MHz)	QPSK	16QAM	64QAM
	RB offset (Start RB)		Actual output power (dBm)	Actual output power (dBm)	Actual output power (dBm)
1.4 MHz	1RB High (5)	1779.3	18.86	18.15	16.95
		1745	18.74	18.14	16.83
		1710.7	19.06	18.38	17.14
	1RB Middle (3)	1779.3	18.80	18.02	16.95
		1745	18.78	17.95	16.86
		1710.7	19.06	18.32	17.16
	1RB Low (0)	1779.3	18.83	18.06	16.94
		1745	18.77	18.01	16.90
		1710.7	19.07	18.38	17.17
	3RB High (3)	1779.3	18.89	17.93	16.95
		1745	18.77	17.77	16.86
		1710.7	19.11	18.12	17.08
	3RB Middle (1)	1779.3	18.88	17.87	16.93
		1745	18.75	17.77	16.80
		1710.7	19.11	18.03	17.18
	3RB Low (0)	1779.3	18.86	17.86	16.98
		1745	18.78	17.73	16.89
		1710.7	19.09	18.03	17.11
	6RB (0)	1779.3	17.89	16.91	15.74
		1745	17.73	16.77	15.80
		1710.7	18.05	17.10	16.10
3 MHz	1RB High (14)	1778.5	18.82	18.08	16.95
		1745	18.76	18.05	16.93
		1711.5	19.06	18.38	17.18
	1RB Middle (7)	1778.5	18.82	18.10	17.04
		1745	18.72	18.05	16.93
		1711.5	19.09	18.39	17.18
	1RB Low (0)	1778.5	18.80	17.97	16.96
		1745	18.78	17.99	16.87
		1711.5	19.07	18.20	17.22
	8RB High (7)	1778.5	17.85	16.91	15.81
		1745	17.69	16.74	15.78
		1711.5	18.02	17.10	16.15
	8RB Middle (4)	1778.5	17.87	16.93	15.79
		1745	17.72	16.76	15.87
		1711.5	18.02	17.10	16.13
	8RB Low (0)	1778.5	17.84	16.87	15.80
		1745	17.72	16.80	15.85
		1711.5	18.06	17.15	16.14
	15RB (0)	1778.5	17.87	16.83	15.84
		1745	17.73	16.72	15.79
		1711.5	18.05	17.06	16.10
5 MHz	1RB High (24)	1777.5	18.92	18.12	17.01
		1745	18.86	18.10	16.98

	1RB Middle (12)	1712.5	19.12	18.28	17.32	
		1777.5	18.85	18.01	17.00	
		1745	18.89	18.10	16.95	
	1RB Low (0)	1712.5	19.14	18.28	17.19	
		1777.5	18.88	18.16	17.02	
		1745	18.85	18.09	17.08	
	12RB High (13)	1712.5	19.16	18.39	17.25	
		1777.5	17.84	16.82	15.85	
		1745	17.67	16.66	15.78	
	12RB Middle (6)	1712.5	18.06	17.03	16.10	
		1777.5	17.83	16.80	15.82	
		1745	17.73	16.75	15.85	
	12RB Low (0)	1712.5	18.10	17.08	16.17	
		1777.5	17.92	16.87	15.92	
		1745	17.83	16.78	15.92	
	25RB (0)	1712.5	18.13	17.08	16.20	
		1777.5	17.90	16.84	15.86	
		1745	17.77	16.74	15.84	
	10 MHz	1RB High (49)	1712.5	18.10	17.11	16.21
			1777.5	17.90	16.84	15.86
			1745	17.77	16.74	15.84
1RB Middle (24)		1775	18.92	18.11	16.96	
		1745	18.87	18.18	16.92	
		1715	19.15	18.40	17.24	
1RB Low (0)		1775	18.84	18.10	17.04	
		1745	18.82	18.09	16.93	
		1715	19.06	18.25	17.25	
25RB High (25)		1775	18.84	18.03	16.90	
		1745	18.82	18.09	17.05	
		1715	19.15	18.41	17.21	
25RB Middle (12)		1775	17.78	16.80	15.78	
		1745	17.68	16.68	15.76	
		1715	18.10	17.09	16.16	
25RB Low (0)		1775	17.89	16.88	15.81	
		1745	17.78	16.75	15.88	
		1715	18.08	17.09	16.17	
50RB (0)		1775	17.91	16.84	15.82	
		1745	17.88	16.92	15.93	
		1715	18.14	17.19	16.23	
15 MHz	1RB High (74)	1775	17.88	16.82	15.79	
		1745	17.78	16.80	15.88	
		1715	18.15	17.14	16.24	
	1RB Middle (37)	1772.5	18.79	18.08	17.02	
		1745	18.68	17.96	16.86	
		1717.5	19.02	18.22	17.23	
	1RB Low (0)	1772.5	18.84	18.08	16.94	
		1745	18.78	18.05	16.91	
		1717.5	19.07	18.41	17.22	
		1RB Low (0)	1772.5	18.74	17.96	16.90
			1745	18.78	18.14	16.90

	36RB High (38)	1717.5	19.02	18.22	17.16	
		1772.5	17.78	16.81	15.74	
		1745	17.67	16.67	15.79	
	36RB Middle (19)	1717.5	18.13	17.10	16.10	
		1772.5	17.81	16.83	15.77	
		1745	17.78	16.75	15.88	
	36RB Low (0)	1717.5	18.09	17.06	16.17	
		1772.5	17.73	16.77	15.84	
		1745	17.82	16.80	15.92	
	75RB (0)	1717.5	18.11	17.10	16.22	
		1772.5	17.75	16.74	15.69	
		1745	17.76	16.75	15.83	
	20 MHz	1RB High (99)	1717.5	18.12	17.13	16.14
			1770	18.75	18.10	16.94
			1745	18.74	17.88	16.92
1RB Middle (50)		1720	18.96	18.26	17.12	
		1770	18.81	17.98	16.91	
		1745	18.76	18.04	16.89	
1RB Low (0)		1720	19.10	18.39	17.23	
		1770	18.61	17.95	16.68	
		1745	18.81	18.14	16.95	
50RB High (50)		1720	19.00	18.27	17.09	
		1770	17.71	16.66	15.69	
		1745	17.59	16.59	15.69	
50RB Middle (25)		1720	18.19	17.14	16.22	
		1770	17.81	16.79	15.87	
		1745	17.82	16.83	15.92	
50RB Low (0)		1720	18.14	17.11	16.16	
		1770	17.53	16.52	15.60	
		1745	17.82	16.80	15.87	
100RB (0)		1720	18.18	17.19	16.29	
		1770	17.60	16.61	15.69	
		1745	17.70	16.69	15.77	
			1720	18.16	17.11	16.22

DS11/2/3/5

Band 12						
Bandwidth (MHz)	RB allocation	Frequency (MHz)	QPSK	16QAM	64QAM	
	RB offset (Start RB)		Actual output power (dBm)	Actual output power (dBm)	Actual output power (dBm)	
1.4 MHz	1RB High (5)	715.3	23.25	22.43	21.37	
		707.5	23.53	22.75	21.65	
		699.7	23.76	23.00	21.89	
	1RB Middle (3)	715.3	23.24	22.52	21.38	
		707.5	23.60	22.76	21.73	
		699.7	23.82	23.06	21.95	
	1RB Low (0)	715.3	23.23	22.51	21.40	
		707.5	23.58	22.82	21.78	
		699.7	23.75	23.13	21.86	
	3RB High (3)	715.3	23.26	22.19	21.34	
		707.5	23.53	22.42	21.59	
		699.7	23.82	22.78	21.90	
	3RB Middle (1)	715.3	23.24	22.28	21.33	
		707.5	23.57	22.54	21.66	
		699.7	23.84	22.79	21.93	
	3RB Low (0)	715.3	23.26	22.25	21.30	
		707.5	23.56	22.57	21.64	
		699.7	23.82	22.76	21.90	
	6RB (0)	715.3	22.22	21.29	20.12	
		707.5	22.56	21.65	20.47	
		699.7	22.80	21.85	20.74	
	3 MHz	1RB High (14)	714.5	23.24	22.55	21.38
			707.5	23.52	22.71	21.66
			700.5	23.74	22.91	21.86
		1RB Middle (7)	714.5	23.25	22.57	21.38
			707.5	23.59	22.92	21.66
			700.5	23.80	22.93	21.97
1RB Low (0)		714.5	23.38	22.70	21.51	
		707.5	23.62	22.90	21.64	
		700.5	23.82	23.10	21.96	
8RB High (7)		714.5	22.23	21.28	20.20	
		707.5	22.45	21.60	20.50	
		700.5	22.74	21.82	20.78	
8RB Middle (4)		714.5	22.24	21.28	20.21	
		707.5	22.55	21.61	20.50	
		700.5	22.75	21.82	20.76	
8RB Low (0)		714.5	22.24	21.32	20.25	
		707.5	22.54	21.60	20.55	
		700.5	22.77	21.84	20.79	
15RB (0)		714.5	22.24	21.26	20.22	
		707.5	22.50	21.56	20.44	
		700.5	22.78	21.80	20.70	

5 MHz	1RB High (24)	713.5	23.22	22.46	21.28	
		707.5	23.46	22.77	21.53	
		701.5	23.67	22.80	21.64	
	1RB Middle (12)	713.5	23.42	22.56	21.56	
		707.5	23.60	22.78	21.73	
		701.5	23.78	23.03	21.82	
	1RB Low (0)	713.5	23.42	22.60	21.54	
		707.5	23.62	22.78	21.66	
		701.5	23.85	23.07	21.94	
	12RB High (13)	713.5	22.20	21.20	20.19	
		707.5	22.41	21.41	20.37	
		701.5	22.71	21.65	20.69	
	12RB Middle (6)	713.5	22.30	21.32	20.33	
		707.5	22.58	21.55	20.54	
		701.5	22.74	21.72	20.67	
	12RB Low (0)	713.5	22.31	21.37	20.33	
		707.5	22.67	21.61	20.66	
		701.5	22.71	21.72	20.64	
	25RB (0)	713.5	22.31	21.30	20.26	
		707.5	22.53	21.56	20.54	
		701.5	22.71	21.73	20.68	
	10 MHz	1RB High (49)	711	23.20	22.39	21.35
			707.5	23.37	22.64	21.43
			704	23.52	22.83	21.56
1RB Middle (24)		711	23.52	22.82	21.66	
		707.5	23.59	22.90	21.72	
		704	23.72	22.93	21.77	
1RB Low (0)		711	23.62	22.85	21.69	
		707.5	23.72	22.94	21.80	
		704	23.87	23.21	22.03	
25RB High (25)		711	22.35	21.42	20.34	
		707.5	22.44	21.45	20.44	
		704	22.49	21.47	20.41	
25RB Middle (12)		711	22.41	21.43	20.38	
		707.5	22.56	21.54	20.53	
		704	22.69	21.64	20.61	
25RB Low (0)		711	22.58	21.55	20.58	
		707.5	22.62	21.74	20.69	
		704	22.59	21.55	20.57	
50RB (0)		711	22.52	21.45	20.44	
		707.5	22.63	21.61	20.58	
		704	22.54	21.55	20.55	

DSI4/6

Band 12						
Bandwidth (MHz)	RB allocation RB offset (Start RB)	Frequency (MHz)	QPSK	16QAM	64QAM	
			Actual output power (dBm)	Actual output power (dBm)	Actual output power (dBm)	
1.4 MHz	1RB High (5)	715.3	18.55	18.09	16.93	
		707.5	18.86	18.45	17.23	
		699.7	19.10	18.52	17.35	
	1RB Middle (3)	715.3	18.58	18.08	16.90	
		707.5	18.89	18.47	17.21	
		699.7	19.17	18.55	17.56	
	1RB Low (0)	715.3	18.60	18.13	16.93	
		707.5	18.91	18.48	17.30	
		699.7	19.13	18.71	17.40	
	3RB High (3)	715.3	18.61	17.71	16.86	
		707.5	18.90	18.01	17.13	
		699.7	19.15	18.30	17.37	
	3RB Middle (1)	715.3	18.61	17.79	16.88	
		707.5	18.92	18.08	17.21	
		699.7	19.13	18.25	17.39	
	3RB Low (0)	715.3	18.61	17.74	16.83	
		707.5	18.92	18.00	17.19	
		699.7	19.17	18.29	17.44	
	6RB (0)	715.3	17.74	16.83	15.71	
		707.5	18.07	17.19	15.97	
		699.7	18.29	17.33	16.22	
	3 MHz	1RB High (14)	714.5	18.57	18.13	16.94
			707.5	18.86	18.38	17.18
			700.5	19.03	18.57	17.31
		1RB Middle (7)	714.5	18.54	18.17	16.94
			707.5	18.90	18.30	17.26
			700.5	19.11	18.65	17.36
1RB Low (0)		714.5	18.69	18.28	17.04	
		707.5	18.91	18.38	17.22	
		700.5	19.10	18.62	17.53	
8RB High (7)		714.5	17.71	16.78	15.72	
		707.5	17.99	17.05	16.01	
		700.5	18.24	17.33	16.25	
8RB Middle (4)		714.5	17.73	16.81	15.74	
		707.5	18.05	17.08	16.02	
		700.5	18.25	17.31	16.29	
8RB Low (0)		714.5	17.77	16.81	15.81	
		707.5	18.03	17.07	16.05	
		700.5	18.20	17.30	16.25	
15RB (0)		714.5	17.75	16.76	15.74	
		707.5	18.00	17.02	16.00	
		700.5	18.22	17.27	16.23	

5 MHz	1RB High (24)	713.5	18.69	18.01	16.96
		707.5	18.86	18.22	17.18
		701.5	19.07	18.41	17.24
	1RB Middle (12)	713.5	18.74	18.21	17.10
		707.5	18.94	18.37	17.19
		701.5	19.06	18.52	17.33
	1RB Low (0)	713.5	18.81	18.20	17.07
		707.5	19.06	18.34	17.29
		701.5	19.23	18.76	17.57
	12RB High (13)	713.5	17.71	16.77	15.77
		707.5	17.93	16.95	15.93
		701.5	18.21	17.19	16.20
	12RB Middle (6)	713.5	17.82	16.86	15.87
		707.5	18.05	17.05	16.06
		701.5	18.22	17.17	16.15
	12RB Low (0)	713.5	17.82	16.85	15.85
		707.5	18.15	17.11	16.16
		701.5	18.18	17.14	16.20
	25RB (0)	713.5	17.79	16.78	15.79
		707.5	18.05	17.06	16.04
		701.5	18.23	17.20	16.19
10 MHz	1RB High (49)	711	18.61	18.15	17.00
		707.5	18.84	18.30	16.98
		704	18.87	18.51	17.22
	1RB Middle (24)	711	18.89	18.52	17.29
		707.5	18.92	18.48	17.27
		704	19.04	18.46	17.30
	1RB Low (0)	711	18.97	18.46	17.26
		707.5	19.11	18.47	17.34
		704	19.22	18.65	17.51
	25RB High (25)	711	17.92	16.93	15.90
		707.5	18.01	17.04	16.02
		704	17.94	16.93	15.93
	25RB Middle (12)	711	17.93	16.96	15.93
		707.5	18.10	17.06	16.06
		704	18.18	17.19	16.15
	25RB Low (0)	711	18.11	17.13	16.08
		707.5	18.08	17.31	16.29
		704	18.13	17.09	16.09
	50RB (0)	711	18.02	17.01	15.98
		707.5	18.17	17.17	16.12
		704	18.09	17.04	16.05

Uplink maximum output power is measured with downlink carrier aggregation active, using the channel with highest measured maximum output power when downlink carrier aggregation is inactive. SAR test is not required since maximum output power when downlink carrier aggregation active is not more than ¼ dB higher than the maximum output power measured when downlink carrier aggregation inactive.

UL LTE CA Class	LTE B41 PC2									
	PCC				SCC				Power	
	PCC Bandwidth	channel	RB	RB OFFSET	SCC Bandwidth	channel	RB	RB OFFSET	tune up	conducted power (dBm)
CA 41C	20M	39750	1	99	5M	39867	1	0	24.6	23.46
CA 41C	20M	39750	1	99	20M	39948	1	0	24.6	23.57
CA 41C	20M	39750	1	99	15M	39921	1	0	24.6	23.56
CA 41C	20M	39750	1	99	10M	39894	1	0	24.6	23.54
CA 41C	15M	39725	1	74	10M	39845	1	0	24.6	23.52
CA 41C	20M	41490	1	0	20M	41292	1	99	24.6	23.67
CA 41C	20M	41490	1	0	15M	41319	1	74	24.6	23.71
CA 41C	20M	41490	1	0	10M	41346	1	49	24.6	23.65
CA 41C	20M	41490	1	0	5M	41373	1	24	24.6	23.62
CA 41C	15M	41515	1	0	15M	41365	1	74	24.6	23.84
CA 41C	15M	41515	1	0	10M	41395	1	49	24.6	23.8

UL LTE CA Class	LTE B41 PC3									
	PCC				SCC				Power	
	PCC Bandwidth	channel	RB	RB OFFSET	SCC Bandwidth	channel	RB	RB OFFSET	tune up	conducted power (dBm)
CA 41C	20M	39750	1	99	5M	39867	1	0	22	20.55
CA 41C	20M	39750	1	99	20M	39948	1	0	22	20.63
CA 41C	20M	39750	1	99	15M	39921	1	0	22	20.71
CA 41C	20M	39750	1	99	10M	39894	1	0	22	20.6
CA 41C	15M	39725	1	74	10M	39845	1	0	22	20.47
CA 41C	20M	41490	1	0	20M	41292	1	99	22	20.72
CA 41C	20M	41490	1	0	15M	41319	1	74	22	20.8
CA 41C	20M	41490	1	0	10M	41346	1	49	22	20.67
CA 41C	20M	41490	1	0	5M	41373	1	24	22	20.6
CA 41C	15M	41515	1	0	15M	41365	1	74	22	20.88
CA 41C	15M	41515	1	0	10M	41395	1	49	22	20.74

UL LTE CA Class	LTE B41 PC2									
	PCC				SCC				Power	
	PCC Bandwidth	channel	RB	RB OFFSET	SCC Bandwidth	channel	RB	RB OFFSET	tune up	conducted power (dBm)
CA 41C	20M	39750	1	99	5M	39867	1	0	24.3	22.34
CA 41C	20M	39750	1	99	20M	39948	1	0	24.3	22.4
CA 41C	20M	39750	1	99	15M	39921	1	0	24.3	22.35
CA 41C	20M	39750	1	99	10M	39894	1	0	24.3	22.21
CA 41C	15M	39725	1	74	10M	39845	1	0	24.3	22.22
CA 41C	20M	41490	1	0	20M	41292	1	99	24.3	22.38
CA 41C	20M	41490	1	0	15M	41319	1	74	24.3	22.52
CA 41C	20M	41490	1	0	10M	41346	1	49	24.3	22.36
CA 41C	20M	41490	1	0	5M	41373	1	24	24.3	22.34
CA 41C	15M	41515	1	0	15M	41365	1	74	24.3	22.55
CA 41C	15M	41515	1	0	10M	41395	1	49	24.3	22.55

UL LTE CA Class	LTE B41 PC3									
	PCC				SCC				Power	
	PCC Bandwidth	channel	RB	RB OFFSET	SCC Bandwidth	channel	RB	RB OFFSET	tune up	conducted power (dBm)
CA 41C	20M	39750	1	99	5M	39867	1	0	21.3	19.37
CA 41C	20M	39750	1	99	20M	39948	1	0	21.3	19.49
CA 41C	20M	39750	1	99	15M	39921	1	0	21.3	19.53
CA 41C	20M	39750	1	99	10M	39894	1	0	21.3	19.40
CA 41C	15M	39725	1	74	10M	39845	1	0	21.3	19.40
CA 41C	20M	41490	1	0	20M	41292	1	99	21.3	19.56
CA 41C	20M	41490	1	0	15M	41319	1	74	21.3	19.68
CA 41C	20M	41490	1	0	10M	41346	1	49	21.3	19.54
CA 41C	20M	41490	1	0	5M	41373	1	24	21.3	19.51
CA 41C	15M	41515	1	0	15M	41365	1	74	21.3	19.76
CA 41C	15M	41515	1	0	10M	41395	1	49	21.3	19.66

The conducted power measurement results of downlink LTE CA Conduced Power are as below (DS1/3):

DL LTE CA Class	PCC								SCC			Power	
	PCC Band	PCC Band width (MHz)	PCC UL RB size	PCC UL RB offset	PCC DL RB size	PCC DL RB offset	PCC UL Channel	PCC DL Channel	SCC Band	SCC Band width (MHz)	SCC DL Channel	Rel 8 LTETx Power (dBm)	Rel 10 DL LTE CA Tx Power (dBm)
66A-66A	66	5	1	12	25	0	131997	66461	66	20	67036	22.29	21.92
66C	66	20	1	50	100	0	132072	66536	66	20	66734	21.96	21.90
66A-2A	66	5	1	12	25	0	131997	66461	2	20	900	22.29	21.92
66A-5A	66	5	1	12	25	0	131997	66461	5	10	2525	22.29	21.90
66A-12A	66	5	1	12	25	0	131997	66461	12	10	5095	22.29	21.98
12A-66A	12	10	1	0	50	0	23060	704	66	20	66786	23.87	23.21
41C-PC2	41	20	1	99	100	0	39750	39750	41	20	39948	23.38	23.11
41A-41A-PC2	41	20	1	99	100	0	39750	39750	41	20	41490	23.38	21.93
41C-PC3	41	20	1	99	100	0	39750	39750	41	20	39948	20.52	20.05
41A-41A-PC3	41	20	1	99	100	0	39750	39750	41	20	41490	20.52	20.03
25A-25A	25	20	1	99	100	0	26140	8140	25	20	8590	21.94	21.87
25A-26A	25	20	1	50	100	0	26365	8365	26	10	8865	22.18	21.87
25A-41A	25	20	1	50	100	0	26365	8365	41	20	40620	22.18	21.89
26A-25A	26	5	1	24	25	0	27015	9015	25	20	8365	24.02	23.47

The conducted power measurement results of downlink LTE CA Conduced Power are as below (DS2):

DL LTE CA Class	PCC								SCC			Power	
	PCC Band	PCC Band width (MHz)	PCC UL RB size	PCC UL RB offset	PCC DL RB size	PCC DL RB offset	PCC UL Channel	PCC DL Channel	SCC Band	SCC Band width (MHz)	SCC DL Channel	Rel 8 LTETx Power (dBm)	Rel 10 DL LTE CA Tx Power (dBm)
66A-66A	66	5	50	50	100	0	132072	66536	66	20	67236	21.11	20.89
66C	66	20	50	50	100	0	132072	66536	66	20	66734	21.11	20.91
66A-2A	66	20	50	50	100	0	132072	66536	2	20	900	21.11	20.89
66A-5A	66	20	50	50	100	0	132072	66536	5	10	2525	21.11	20.90
66A-12A	66	20	50	50	100	0	132072	66536	12	10	5095	21.11	20.74
41C-PC2	41	20	1	99	100	0	39750	39750	41	20	39948	22.70	22.61
41A-41A-PC2	41	20	1	99	100	0	39750	39750	41	20	41490	22.70	22.52
41C-PC3	41	20	1	99	100	0	39750	39750	41	20	39948	19.71	19.52
41A-41A-PC3	41	20	1	99	100	0	39750	39750	41	20	41490	19.71	19.34
25A-25A	25	20	50	0	100	0	26590	8590	25	20	8140	21.2	20.86
25A-26A	25	20	50	0	100	0	26590	8590	26	10	8865	21.2	20.91
25A-41A	25	20	50	0	100	0	26590	8590	41	20	40620	21.2	21.03

11.4 Wi-Fi and BT Measurement result

The maximum output power of BT is 7.90dBm.

The maximum tune up of BT is 9dBm.

Table2: Summary of Receiver detection mechanism

Antenna	Receiver on (head scenario)	Receiver off + Hotspot on (Body/other scenario)	Receiver off + Hotspot off (Body/other scenario)
Standalone	DSI0		
Simultaneous transmit	DSI3	DSI2	DSI1

The average conducted power for Wi-Fi is as following:

The conducted output power for WiFi 2.4G power is as following- DSI0

802.11b	Channel\data	1Mbps
WLAN2450	11(2462MHz)	20.51
	6(2437(MHz)	19.77
	1(2412MHz)	21.21
	Tune up	21.50
802.11g	Channel\data	6Mbps
WLAN2450	11(2462MHz)	19.59
	6(2437(MHz)	18.94
	1(2412MHz)	20.11
	Tune up	20.50
802.11n-20MHz	Channel\data	MCS0
WLAN2450	11(2462MHz)	18.64
	6(2437(MHz)	18.08
	1(2412MHz)	19.14
	Tune up	19.50
802.11n-40MHz	Channel\data	MCS0
WLAN2450	9(2452MHz)	15.51
	6(2437MHz)	16.21
	3(2422MHz)	16.66
	Tune up	17.50

The conducted output power for WiFi 2.4G power is as following- **DSI3**

802.11b	Channel\data	1Mbps
WLAN2450	11(2462MHz)	13.98
	6(2437(MHz)	13.23
	1(2412MHz)	14.42
	Tune up	14.50
802.11g	Channel\data	6Mbps
WLAN2450	11(2462MHz)	12.99
	6(2437(MHz)	12.39
	1(2412MHz)	13.42
	Tune up	13.50
802.11n-20MHz	Channel\data	MCS0
WLAN2450	11(2462MHz)	12.89
	6(2437(MHz)	12.31
	1(2412MHz)	13.42
	Tune up	13.50
802.11n-40MHz	Channel\data	MCS0
WLAN2450	9(2452MHz)	11.18
	6(2437MHz)	11.75
	3(2422MHz)	12.18
	Tune up	12.50

The conducted output power for WiFi 2.4G power is as following- **DSI1/2**

802.11b	Channel\data	1Mbps
WLAN2450	11(2462MHz)	14.86
	6(2437(MHz)	14.17
	1(2412MHz)	15.45
	Tune up	15.50
802.11g	Channel\data	6Mbps
WLAN2450	11(2462MHz)	13.82
	6(2437(MHz)	13.45
	1(2412MHz)	14.41
	Tune up	14.50
802.11n-20MHz	Channel\data	MCS0
WLAN2450	11(2462MHz)	13.81
	6(2437(MHz)	13.33
	1(2412MHz)	14.25
	Tune up	14.50
802.11n-40MHz	Channel\data	MCS0
WLAN2450	9(2452MHz)	12.03
	6(2437MHz)	12.71
	3(2422MHz)	13.03
	Tune up	13.50

The conducted output power for WiFi 5G power is as following- DSI0

802.11a(dBm)	
Channel\data rate	6Mbps
36(5180 MHz)	18.52
40(5200 MHz)	18.72
44(5220 MHz)	18.97
48(5240 MHz)	19.01
52(5260 MHz)	19.48
56(5280 MHz)	19.35
60(5300 MHz)	19.28
64(5320 MHz)	19.18
100(5500 MHz)	18.67
104(5520 MHz)	18.72
108(5540 MHz)	18.82
112(5560 MHz)	19.02
116(5580 MHz)	18.74
120(5600 MHz)	18.83
124(5620 MHz)	19.01
128(5640 MHz)	18.84
132(5660 MHz)	19.14
136(5680 MHz)	18.96
140(5700 MHz)	18.88
144(5720 MHz)	18.87
149(5745 MHz)	19.02
153(5765 MHz)	19.28
157(5785 MHz)	19.60
161(5805 MHz)	19.69
165(5825 MHz)	19.67
Tune up	20

The conducted output power for WiFi 5G power is as following- DSI3

802.11a(dBm)	
Channel\data rate	6Mbps
36(5180 MHz)	13.35
40(5200 MHz)	13.51
44(5220 MHz)	13.76
48(5240 MHz)	13.72
52(5260 MHz)	14.15
56(5280 MHz)	13.86
60(5300 MHz)	13.85
64(5320 MHz)	13.36
100(5500 MHz)	13.11
104(5520 MHz)	13.09
108(5540 MHz)	13.29
112(5560 MHz)	13.42
116(5580 MHz)	13.27
120(5600 MHz)	13.46
124(5620 MHz)	13.45
128(5640 MHz)	13.26
132(5660 MHz)	13.68
136(5680 MHz)	13.43
140(5700 MHz)	13.27
144(5720 MHz)	13.34
149(5745 MHz)	13.39
153(5765 MHz)	13.51
157(5785 MHz)	13.96
161(5805 MHz)	13.92
165(5825 MHz)	14.11
Tune up	15.00

The conducted output power for WiFi 5G power is as following- DSI1/2

802.11a(dBm)	
Channel\data rate	6Mbps
36(5180 MHz)	12.65
40(5200 MHz)	12.77
44(5220 MHz)	12.89
48(5240 MHz)	12.82
52(5260 MHz)	13.25
56(5280 MHz)	13.11
60(5300 MHz)	12.86
64(5320 MHz)	12.66
100(5500 MHz)	12.29
104(5520 MHz)	12.35
108(5540 MHz)	12.44
112(5560 MHz)	12.66
116(5580 MHz)	12.42
120(5600 MHz)	12.58
124(5620 MHz)	12.67
128(5640 MHz)	12.53
132(5660 MHz)	12.87
136(5680 MHz)	12.67
140(5700 MHz)	12.53
144(5720 MHz)	12.46
149(5745 MHz)	12.45
153(5765 MHz)	12.72
157(5785 MHz)	12.97
161(5805 MHz)	13.19
165(5825 MHz)	13.09
Tune up	14.00

11.5 NR 5G Measurement result

Table1: Summary of Receiver detection mechanism

Antenna	Receiver on (head scenario)	Receiver off + Hotspot on (Body/other scenario)	Receiver off + Hotspot off (Body/other scenario)
SA	DSI3	DSI2	DSI1
NSA	DSI6	DSI5	DSI4

Table 11.5-1: Maximum Power Reduction (MPR) for NR DSI2/3/5/6

Modulation		MPR (dB)		
		Edge RB allocations	Outer RB allocations	Inner RB allocations
DFT-s-OFDM	Pi/2 BPSK	0	0	0
	QPSK	0	0	0
	16 QAM	0	0	0
	64 QAM	0	0	0
	256 QAM	0	0	0
CP-OFDM	QPSK	0	0	0
	16 QAM	0	0	0
	64 QAM	0	0	0
	256 QAM	0	0	0

Table 11.5-2: Maximum Target Power for Production Unit – DSI2/3/5/6

No.	Test Freq Description	5G-n25						Tune up	Power Results (dBm)	
		SCS (kHz)	NR BW (MHz)	Modulation	RB allocation	NR Test Freq. (MHz)	NR Test CH.			
1	High	15	5	DFT-s-OFDM QPSK	Inner_Full	12@6	1912.5	382500	20	18.70
2	Middle	15	5	DFT-s-OFDM QPSK	Inner_Full	12@6	1882.5	376500	20	18.92
3	Low	15	5	DFT-s-OFDM QPSK	Inner_Full	12@6	1852.5	370500	20	18.61
4	High	15	20	DFT-s-OFDM QPSK	Inner_Full	50@25	1905	381000	20	18.79
5	Middle	15	20	DFT-s-OFDM QPSK	Inner_Full	50@25	1882.5	376500	20	18.86
6	Low	15	20	DFT-s-OFDM QPSK	Inner_Full	50@25	1860	372000	20	18.64
According to the table above, the maximum power configuration is selected as the default test configuration										
No.	Test Freq Description	5G-n25						Tune up	Power Results (dBm)	
		SCS (kHz)	NR BW (MHz)	Modulation	RB allocation	NR Test Freq. (MHz)	NR Test CH.			
1	Middle	15	5	DFT-s-OFDM Pi/2 BPSK1	Inner_Full	12@6	1882.5	376500	20	18.84
2	Middle	15	5	DFT-s-OFDM 16QAM	Inner_Full	12@6	1882.5	376500	20	19.03
3	Middle	15	5	DFT-s-OFDM 64QAM	Inner_Full	12@6	1882.5	376500	20	19.01
4	Middle	15	5	DFT-s-OFDM 256QAM	Inner_Full	12@6	1882.5	376500	20	19.02
5	Middle	15	5	CP-OFDM QPSK	Inner_Full	12@6	1882.5	376500	20	19.14
6	Middle	15	5	CP-OFDM 16QAM	Inner_Full	12@6	1882.5	376500	20	19.24
7	Middle	15	5	CP-OFDM 64QAM	Inner_Full	12@6	1882.5	376500	20	19.23
8	Middle	15	5	CP-OFDM 256QAM	Inner_Full	12@6	1882.5	376500	20	18.02
9	Middle	15	5	CP-OFDM 16QAM	Edge_Full_Right	2@23	1882.5	376500	20	18.90
10	Middle	15	5	CP-OFDM 16QAM	Edge_Full_Left	2@0	1882.5	376500	20	18.99
11	Middle	15	5	CP-OFDM 16QAM	Inner_1RB_Right	1@23	1882.5	376500	20	19.43
12	Middle	15	5	CP-OFDM 16QAM	Inner_1RB_Left	1@1	1882.5	376500	20	19.47
13	Middle	15	5	CP-OFDM 16QAM	Outer_Full	25@0	1882.5	376500	20	19.21
14	Middle	15	5	CP-OFDM 16QAM	Edge_1RB_Right	1@24	1882.5	376500	20	19.37
15	Middle	15	5	CP-OFDM 16QAM	Edge_1RB_Left	1@0	1882.5	376500	20	19.45
16	default	15	10	CP-OFDM 16QAM	Inner_Full	25@12	1882.5	376500	20	19.06
17	default	15	15	CP-OFDM 16QAM	Inner_Full	36@18	1882.5	376500	20	19.17

No.	Test Freq Description	5G-n66							Tune up	Power Results (dBm)
		SCS (kHz)	NR BW (MHz)	Modulation	RB allocation		NR Test Freq. (MHz)	NR Test CH.		
1	High	15	5	DFT-s-OFDM QPSK	Inner_Full (12@6)	12@6	1777.5	355500	19.5	18.12
2	Middle	15	5	DFT-s-OFDM QPSK	Inner_Full (12@6)	12@6	1745	349000	19.5	17.94
3	Low	15	5	DFT-s-OFDM QPSK	Inner_Full (12@6)	12@6	1712.5	342500	19.5	18.04
4	High	15	20	DFT-s-OFDM QPSK	Inner_Full (50@25)	50@25	1770	354000	19.5	17.97
5	Middle	15	20	DFT-s-OFDM QPSK	Inner_Full (50@25)	50@25	1745	349000	19.5	17.96
6	Low	15	20	DFT-s-OFDM QPSK	Inner_Full (50@25)	50@25	1720	344000	19.5	17.99

According to the table above, the maximum power configuration is selected as the default test configuration

No.	Test Freq Description	5G-n66							Tune up	Power Results (dBm)
		SCS (kHz)	NR BW (MHz)	Modulation	RB allocation		NR Test Freq. (MHz)	NR Test CH.		
1	Low	15	5	DFT-s-OFDM Pi/2 BPSK1	Inner_Full (12@6)	12@6	1777.5	355500	19.5	18.08
2	Low	15	5	DFT-s-OFDM 16QAM	Inner_Full (12@6)	12@6	1777.5	355500	19.5	18.23
3	Low	15	5	DFT-s-OFDM 64QAM	Inner_Full (12@6)	12@6	1777.5	355500	19.5	18.21
4	Low	15	5	DFT-s-OFDM 256QAM	Inner_Full (12@6)	12@6	1777.5	355500	19.5	18.24
5	Low	15	5	CP-OFDM QPSK	Inner_Full (12@6)	12@6	1777.5	355500	19.5	18.36
6	Low	15	5	CP-OFDM 16QAM	Inner_Full (12@6)	12@6	1777.5	355500	19.5	18.44
7	Low	15	5	CP-OFDM 64QAM	Inner_Full (12@6)	12@6	1777.5	355500	19.5	18.37
8	Low	15	5	CP-OFDM 256QAM	Inner_Full (12@6)	12@6	1777.5	355500	19.5	17.53
9	Low	15	5	CP-OFDM 16QAM	Edge_Full_Right (2@23)	(2@23)	1777.5	355500	19.5	18.14
10	Low	15	5	CP-OFDM 16QAM	Edge_Full_Left(2@0)	(2@0)	1777.5	355500	19.5	18.22
11	Low	15	5	CP-OFDM 16QAM	Inner_1RB_Right (1@23)	(1@23)	1777.5	355500	19.5	18.56
12	Low	15	5	CP-OFDM 16QAM	Inner_1RB_Left (1@1)	(1@1)	1777.5	355500	19.5	18.63
13	Low	15	5	CP-OFDM 16QAM	Outer_Full (25@0)	(25@0)	1777.5	355500	19.5	18.41
14	Low	15	5	CP-OFDM 16QAM	Edge_1RB_Right (1@24)	1@24	1777.5	355500	19.5	18.61
15	Low	15	5	CP-OFDM 16QAM	Edge_1RB_Left (1@0)	1@0	1777.5	355500	19.5	18.57
16	Low	15	10	CP-OFDM 16QAM	Inner_Full (25@12)	25@12	1745	349000	19.5	18.05
17	Low	15	15	CP-OFDM 16QAM	Inner_Full (36@18)	36@18	1745	349000	19.5	18.23

Table 11.5-3: Maximum Power Reduction (MPR) for NR DSI1/4

Modulation		MPR (dB)		
		Edge RB allocations	Outer RB allocations	Inner RB allocations
DFT-s-OFDM	Pi/2 BPSK	$\leq 3.5^1$	$\leq 1.2^2$	$\leq 0.2^4$
		0	0	0
	QPSK	0		0
	16 QAM	0		0
	64 QAM	0		
	256 QAM	1.5		
CP-OFDM	QPSK	0		0
	16 QAM	0		0
	64 QAM	0.5		
	256 QAM	3.5		

Table 11.5-4: Maximum Target Power for Production Unit –DS11/4

No.	Test Freq Description	5G-n25							Tune up	Power Results (dBm)
		SCS (kHz)	NR BW (MHz)	Modulation	RB allocation		NR Test Freq. (MHz)	NR Test CH.		
1	High	15	5	DFT-s-OFDM QPSK	Inner_Full	12@6	1912.5	382500	22.5	21.73
2	Middle	15	5	DFT-s-OFDM QPSK	Inner_Full	12@6	1882.5	376500	22.5	21.95
3	Low	15	5	DFT-s-OFDM QPSK	Inner_Full	12@6	1852.5	370500	22.5	21.63
4	High	15	20	DFT-s-OFDM QPSK	Inner_Full	50@25	1905	381000	22.5	21.79
5	Middle	15	20	DFT-s-OFDM QPSK	Inner_Full	50@25	1882.5	376500	22.5	21.88
6	Low	15	20	DFT-s-OFDM QPSK	Inner_Full	50@25	1860	372000	22.5	21.63

According to the table above, the maximum power configuration is selected as the default test configuration

No.	Test Freq Description	5G-n25							Tune up	Power Results (dBm)
		SCS (kHz)	NR BW (MHz)	Modulation	RB allocation		NR Test Freq. (MHz)	NR Test CH.		
1	Middle	15	5	DFT-s-OFDM PI/2 BPSK1	Inner_Full	12@6	1882.5	376500	22.5	21.85
2	Middle	15	5	DFT-s-OFDM 16QAM	Inner_Full	12@6	1882.5	376500	22.5	22.13
3	Middle	15	5	DFT-s-OFDM 64QAM	Inner_Full	12@6	1882.5	376500	22.5	21.00
4	Middle	15	5	DFT-s-OFDM 256QAM	Inner_Full	12@6	1882.5	376500	21	19.03
5	Middle	15	5	CP-OFDM QPSK	Inner_Full	12@6	1882.5	376500	22.5	22.39
6	Middle	15	5	CP-OFDM 16QAM	Inner_Full	12@6	1882.5	376500	22.5	21.91
7	Middle	15	5	CP-OFDM 64QAM	Inner_Full	12@6	1882.5	376500	22	20.32
8	Middle	15	5	CP-OFDM 256QAM	Inner_Full	12@6	1882.5	376500	19	17.04
9	Middle	15	5	CP-OFDM QPSK	Edge_Full_Right	2@23	1882.5	376500	22.5	20.73
10	Middle	15	5	CP-OFDM QPSK	Edge_Full_Left	2@0	1882.5	376500	22.5	20.82
11	Middle	15	5	CP-OFDM QPSK	Inner_1RB_Right	1@23	1882.5	376500	22.5	22.25
12	Middle	15	5	CP-OFDM QPSK	Inner_1RB_Left	1@1	1882.5	376500	22.5	22.25
13	Middle	15	5	CP-OFDM QPSK	Outer_Full	25@0	1882.5	376500	22.5	20.82
14	Middle	15	5	CP-OFDM QPSK	Edge_1RB_Right	1@24	1882.5	376500	22.5	20.65
15	Middle	15	5	CP-OFDM QPSK	Edge_1RB_Left	1@0	1882.5	376500	22.5	20.75
16	default	15	10	CP-OFDM QPSK	Inner_Full	25@12	1882.5	376500	22.5	22.23
17	default	15	15	CP-OFDM QPSK	Inner_Full	36@18	1882.5	376500	22.5	22.31

No.	Test Freq Description	5G-n66							Tune up	Power Results (dBm)
		SCS (kHz)	NR BW (MHz)	Modulation	RB allocation		NR Test Freq. (MHz)	NR Test CH.		
1	High	15	5	DFT-s-OFDM QPSK	Inner_Full (12@6)	12@6	1777.5	355500	22.5	21.17
2	Middle	15	5	DFT-s-OFDM QPSK	Inner_Full (12@6)	12@6	1745	349000	22.5	21.14
3	Low	15	5	DFT-s-OFDM QPSK	Inner_Full (12@6)	12@6	1712.5	342500	22.5	21.21
4	High	15	20	DFT-s-OFDM QPSK	Inner_Full (50@25)	50@25	1770	354000	22.5	21.15
5	Middle	15	20	DFT-s-OFDM QPSK	Inner_Full (50@25)	50@25	1745	349000	22.5	21.12
6	Low	15	20	DFT-s-OFDM QPSK	Inner_Full (50@25)	50@25	1720	344000	22.5	21.14

According to the table above, the maximum power configuration is selected as the default test configuration

No.	Test Freq Description	5G-n66							Tune up	Power Results (dBm)
		SCS (kHz)	NR BW (MHz)	Modulation	RB allocation		NR Test Freq. (MHz)	NR Test CH.		
1	Low	15	5	DFT-s-OFDM PI/2 BPSK1	Inner_Full (12@6)	12@6	1712.5	342500	22.5	21.12
2	Low	15	5	DFT-s-OFDM 16QAM	Inner_Full (12@6)	12@6	1712.5	342500	22.5	21.31
3	Low	15	5	DFT-s-OFDM 64QAM	Inner_Full (12@6)	12@6	1712.5	342500	22.5	20.75
4	Low	15	5	DFT-s-OFDM 256QAM	Inner_Full (12@6)	12@6	1712.5	342500	21	19.02
5	Low	15	5	CP-OFDM QPSK	Inner_Full (12@6)	12@6	1712.5	342500	22.5	21.53
6	Low	15	5	CP-OFDM 16QAM	Inner_Full (12@6)	12@6	1712.5	342500	22.5	21.65
7	Low	15	5	CP-OFDM 64QAM	Inner_Full (12@6)	12@6	1712.5	342500	22	20.11
8	Low	15	5	CP-OFDM 256QAM	Inner_Full (12@6)	12@6	1712.5	342500	19	17.02
9	Low	15	5	CP-OFDM 16QAM	Edge_Full_Right (2@23)	(2@23)	1712.5	342500	22.5	20.66
10	Low	15	5	CP-OFDM 16QAM	Edge_Full_Left (2@0)	(2@0)	1712.5	342500	22.5	20.74
11	Low	15	5	CP-OFDM 16QAM	Inner_1RB_Right (1@23)	(1@23)	1712.5	342500	22.5	21.79
12	Low	15	5	CP-OFDM 16QAM	Inner_1RB_Left (1@1)	(1@1)	1712.5	342500	22.5	21.94
13	Low	15	5	CP-OFDM 16QAM	Outer_Full (25@0)	(25@0)	1712.5	342500	22.5	20.52
14	Low	15	5	CP-OFDM 16QAM	Edge_1RB_Right (1@24)	1@24	1712.5	342500	22.5	20.66
15	Low	15	5	CP-OFDM 16QAM	Edge_1RB_Left (1@0)	1@0	1712.5	342500	22.5	20.75
16	Low	15	10	CP-OFDM 16QAM	Inner_Full (25@12)	25@12	1745	349000	22.5	21.39
17	Low	15	15	CP-OFDM 16QAM	Inner_Full (36@18)	36@18	1745	349000	22.5	21.55

Table 11.5-5: Maximum Power Reduction (MPR) for NR DSI3

Modulation		MPR (dB)		
		Edge RB allocations	Outer RB allocations	Inner RB allocations
DFT-s-OFDM	Pi/2 BPSK	$\leq 3.5^{\dagger}$	$\leq 1.2^{\dagger}$	$\leq 0.2^{\dagger}$
		0	0	0
	QPSK	0		0
	16 QAM	0		0
	64 QAM	0		
	256 QAM	1.5		
CP-OFDM	QPSK	0		0
	16 QAM	0		0
	64 QAM	0.5		
	256 QAM	3.5		

**Table 11.5-6: Maximum Target Power for Production Unit –DSI3/DSI6
N77H**

No.	Test Freq Description	5G-n77							Tune up	Power Results (dBm)
		SCS (kHz)	NR BW (MHz)	Modulation	RB allocation		NR Test Freq. (MHz)	NR Test CH.		
1	High	30	20	DFT-s-OFDM QPSK	Inner_Full	25@12	3969.990	664666	26.5	24.76
2	Middle-1	30	20	DFT-s-OFDM QPSK	Inner_Full	25@12	3918.000	661200	26.5	24.81
3	Middle-2	30	20	DFT-s-OFDM QPSK	Inner_Full	25@12	3866.000	657733	26.5	25.27
4	Middle-3	30	20	DFT-s-OFDM QPSK	Inner_Full	25@12	3814.000	654267	26.5	25.60
5	Middle-5	30	20	DFT-s-OFDM QPSK	Inner_Full	25@12	3762.000	650800	26.5	25.12
6	Low	30	20	DFT-s-OFDM QPSK	Inner_Full	25@12	3710.010	647334	26.5	24.56
7	High	30	100	DFT-s-OFDM QPSK	Inner_Full	135@67	3930.000	662000	26.5	24.83
8	Middle-1	30	100	DFT-s-OFDM QPSK	Inner_Full	135@67	3894.000	659600	26.5	25.58
9	Middle-2	30	100	DFT-s-OFDM QPSK	Inner_Full	135@67	3858.000	657200	26.5	25.51
10	Middle-3	30	100	DFT-s-OFDM QPSK	Inner_Full	135@67	3822.000	654800	26.5	25.76
11	Middle-4	30	100	DFT-s-OFDM QPSK	Inner_Full	135@67	3786.000	652400	26.5	25.52
12	Low	30	100	DFT-s-OFDM QPSK	Inner_Full	135@67	3750.000	650000	26.5	25.11

According to the table above, the maximum power configuration is selected as the default test configuration

No.	Test Freq Description	5G-n77							Tune up	Power Results (dBm)
		SCS (kHz)	NR BW (MHz)	Modulation	RB allocation		NR Test Freq. (MHz)	NR Test CH.		
1	Middle-3	30	100	DFT-s-OFDM Pi/2 BPSK1	Inner_Full	135@67	3822.000	654800	26.5	25.73
2	Middle-3	30	100	DFT-s-OFDM 16QAM	Inner_Full	135@67	3822.000	654800	26.5	25.74
3	Middle-3	30	100	DFT-s-OFDM 64QAM	Inner_Full	135@67	3822.000	654800	26.5	25.24
4	Middle-3	30	100	DFT-s-OFDM 256QAM	Inner_Full	135@67	3822.000	654800	25	23.18
5	Middle-3	30	100	CP-OFDM QPSK	Inner_Full	135@67	3822.000	654800	26.5	25.95
6	Middle-3	30	100	CP-OFDM 16QAM	Inner_Full	135@67	3822.000	654800	26.5	26.04
7	Middle-3	30	100	CP-OFDM 64QAM	Inner_Full	135@67	3822.000	654800	26	24.46
8	Middle-3	30	100	CP-OFDM 256QAM	Inner_Full	135@67	3822.000	654800	23	21.39
9	Middle-3	30	100	CP-OFDM 16QAM	Edge_Full_Right	2@271	3822.000	654800	26.5	24.59
10	Middle-3	30	100	CP-OFDM 16QAM	Edge_Full_Left	2@0	3822.000	654800	26.5	24.51
11	Middle-3	30	100	CP-OFDM 16QAM	Inner_1RB_Right	1@271	3822.000	654800	26.5	24.98
12	Middle-3	30	100	CP-OFDM 16QAM	Inner_1RB_Left	1@1	3822.000	654800	26.5	24.87
13	Middle-3	30	100	CP-OFDM 16QAM	Outer_Full	270@0	3822.000	654800	26.5	24.72
14	Middle-3	30	100	CP-OFDM 16QAM	Edge_1RB_Left	1@0	3822.000	654800	26.5	24.76
15	Middle-3	30	100	CP-OFDM 16QAM	Edge_1RB_Right	1@272	3822.000	654800	26.5	24.85
16	Middle-1	30	40	CP-OFDM 16QAM	Inner_Full	50@25	3918.000	661200	26.5	25.01
17	Middle-1	30	50	CP-OFDM 16QAM	Inner_Full	64@32	3918.000	661200	26.5	24.87
18	Middle-1	30	60	CP-OFDM 16QAM	Inner_Full	81@40	3918.000	661200	26.5	24.86
19	Middle-1	30	80	CP-OFDM 16QAM	Inner_Full	108@54	3918.000	661200	26.5	24.91
20	Middle-1	30	90	CP-OFDM 16QAM	Inner_Full	120@60	3918.000	661200	26.5	25.14

N77L

No.	Test Freq Description	5G-n77							Tune up	Power Results (dBm) n77
		SCS (kHz)	NR BW (MHz)	Modulation	RB allocation		NR Test Freq. (MHz)	NR Test CH.		
1	High	30	20	DFT-s-OFDM QPSK	Inner_Full	25@12	3540	636000	26.50	24.52
2	Middle	30	20	DFT-s-OFDM QPSK	Inner_Full	25@12	3500.01	633334	26.50	24.72
6	Low	30	20	DFT-s-OFDM QPSK	Inner_Full	25@12	3460.02	630668	26.50	24.78
7	High	30	100	DFT-s-OFDM QPSK	Inner_Full	135@67	3499.98	633332	26.50	24.79
8	Middle	30	100	DFT-s-OFDM QPSK	Inner_Full	135@67	3500.01	633334	26.50	24.82

According to the table above, the maximum power configuration is selected as the default test configuration

No.	Test Freq Description	5G-n77							Tune up	Power Results (dBm) n77
		SCS (kHz)	NR BW (MHz)	Modulation	RB allocation		NR Test Freq. (MHz)	NR Test CH.		
1	Middle	30	100	DFT-s-OFDM Pi/2 BPSK1	Inner_Full	135@67	3500.01	633334	26.50	24.73
2	Middle	30	100	DFT-s-OFDM 16QAM	Inner_Full	135@67	3500.01	633334	26.50	24.67
3	Middle	30	100	DFT-s-OFDM 64QAM	Inner_Full	135@67	3500.01	633334	26.50	24.52
4	Middle	30	100	DFT-s-OFDM 256QAM	Inner_Full	135@67	3500.01	633334	25.00	23.06
5	Middle	30	100	CP-OFDM QPSK	Inner_Full	135@67	3500.01	633334	26.50	24.75
6	Middle	30	100	CP-OFDM 16QAM	Inner_Full	135@67	3500.01	633334	26.50	24.77
7	Middle	30	100	CP-OFDM 64QAM	Inner_Full	135@67	3500.01	633334	26.00	24.01
8	Middle	30	100	CP-OFDM 256QAM	Inner_Full	135@67	3500.01	633334	23.00	21.13
1	Middle	30	100	DFT-s-OFDM QPSK	Edge_1RB_Right	2@271	3500.01	633334	26.50	24.56
6	Middle	30	100	DFT-s-OFDM QPSK	Edge_1RB_Left	2@0	3500.01	633334	26.50	24.59
9	Middle	30	100	DFT-s-OFDM QPSK	Edge_Full_Right	1@271	3500.01	633334	26.50	24.50
10	Middle	30	100	DFT-s-OFDM QPSK	Edge_Full_Left	1@1	3500.01	633334	26.50	24.62
11	Middle	30	100	DFT-s-OFDM QPSK	Inner_1RB_Right	270@0	3500.01	633334	26.50	24.58
12	Middle	30	100	DFT-s-OFDM QPSK	Inner_1RB_Left	1@0	3500.01	633334	26.50	24.61
13	Middle	30	100	DFT-s-OFDM QPSK	Outer_Full	1@272	3500.01	633334	26.50	24.70
18	Middle-5	30	40	DFT-s-OFDM QPSK	Inner_Full	50@25	3500.01	633334	26.50	24.58
19	Middle-5	30	50	DFT-s-OFDM QPSK	Inner_Full	64@32	3500.01	633334	26.50	24.8
20	Middle-5	30	60	DFT-s-OFDM QPSK	Inner_Full	81@40	3500.01	633334	26.50	24.67
22	Middle-5	30	80	DFT-s-OFDM QPSK	Inner_Full	108@54	3500.01	633334	26.50	24.6
23	Middle-5	30	90	DFT-s-OFDM QPSK	Inner_Full	120@60	3500.01	633334	26.50	24.56

Table 11.5-7: Maximum Power Reduction (MPR) for NR DS11/2/4/5

Modulation		MPR (dB)		
		Edge RB allocations	Outer RB allocations	Inner RB allocations
DFT-s-OFDM	Pi/2 BPSK	0	0	0
	QPSK	0	0	0
	16 QAM	0	0	0
	64 QAM	0	0	0
	256 QAM	0	0	0
CP-OFDM	QPSK	0	0	0
	16 QAM	0	0	0
	64 QAM	0	0	0
	256 QAM	0	0	0

N77H

Table 11.5-8: Maximum Target Power for Production Unit – DS11/2/4/5

No.	Test Freq Description	5G-n77							Tune up	Power Results (dBm)
		SCS (kHz)	NR BW (MHz)	Modulation	RB allocation	NR Test Freq. (MHz)	NR Test CH.	n77		
1	High	30	20	DFT-s-OFDM QPSK	Inner_Full	25@12	3969.990	664666	22.5	21.64
2	Middle-1	30	20	DFT-s-OFDM QPSK	Inner_Full	25@12	3918.000	661200	22.5	21.32
3	Middle-2	30	20	DFT-s-OFDM QPSK	Inner_Full	25@12	3866.000	657733	22.5	20.91
4	Middle-3	30	20	DFT-s-OFDM QPSK	Inner_Full	25@12	3814.000	654267	22.5	21.17
5	Middle-5	30	20	DFT-s-OFDM QPSK	Inner_Full	25@12	3762.000	650800	22.5	20.75
6	Low	30	20	DFT-s-OFDM QPSK	Inner_Full	25@12	3710.010	647334	22.5	20.51
7	High	30	100	DFT-s-OFDM QPSK	Inner_Full	135@67	3930.000	662000	22.5	21.47
8	Middle-1	30	100	DFT-s-OFDM QPSK	Inner_Full	135@67	3894.000	659600	22.5	21.17
9	Middle-2	30	100	DFT-s-OFDM QPSK	Inner_Full	135@67	3858.000	657200	22.5	21.02
10	Middle-3	30	100	DFT-s-OFDM QPSK	Inner_Full	135@67	3822.000	654800	22.5	21.15
11	Middle-4	30	100	DFT-s-OFDM QPSK	Inner_Full	135@67	3786.000	652400	22.5	20.98
12	Low	30	100	DFT-s-OFDM QPSK	Inner_Full	135@67	3750.000	650000	22.5	20.71

According to the table above, the maximum power configuration is selected as the default test configuration

No.	Test Freq Description	5G-n77							Tune up	Power Results (dBm)
		SCS (kHz)	NR BW (MHz)	Modulation	RB allocation	NR Test Freq. (MHz)	NR Test CH.	n77		
1	High	30	20	DFT-s-OFDM PI/2 BPSK1	Inner_Full	25@12	3969.990	664666	22.5	21.51
2	High	30	20	DFT-s-OFDM 16QAM	Inner_Full	25@12	3969.990	664666	22.5	21.71
3	High	30	20	DFT-s-OFDM 64QAM	Inner_Full	25@12	3969.990	664666	22.5	21.69
4	High	30	20	DFT-s-OFDM 256QAM	Inner_Full	25@12	3969.990	664666	22.5	21.74
5	High	30	20	CP-OFDM QPSK	Inner_Full	25@12	3969.990	664666	22.5	21.95
6	High	30	20	CP-OFDM 16QAM	Inner_Full	25@12	3969.990	664666	22.5	22.02
7	High	30	20	CP-OFDM 64QAM	Inner_Full	25@12	3969.990	664666	22.5	22.01
8	High	30	20	CP-OFDM 256QAM	Inner_Full	25@12	3969.990	664666	22.5	21.67
9	High	30	20	CP-OFDM 16QAM	Edge_Full_Right	2@49	3969.990	664666	22.5	21.78
10	High	30	20	CP-OFDM 16QAM	Edge_Full_Left	2@0	3969.990	664666	22.5	21.71
11	High	30	20	CP-OFDM 16QAM	Inner_1RB_Right	1@49	3969.990	664666	22.5	21.91
12	High	30	20	CP-OFDM 16QAM	Inner_1RB_Left	1@1	3969.990	664666	22.5	22.01
13	High	30	20	CP-OFDM 16QAM	Outer_Full	50@0	3969.990	664666	22.5	21.91
14	High	30	20	CP-OFDM 16QAM	Edge_1RB_Left	1@0	3969.990	664666	22.5	21.92
15	High	30	20	CP-OFDM 16QAM	Edge_1RB_Right	1@50	3969.990	664666	22.5	21.93
16	High	30	40	CP-OFDM 16QAM	Inner_Full	50@25	3918.000	661200	22.5	21.57
17	High	30	50	CP-OFDM 16QAM	Inner_Full	64@32	3918.000	661200	22.5	21.65
18	High	30	60	CP-OFDM 16QAM	Inner_Full	81@40	3918.000	661200	22.5	21.68
19	High	30	80	CP-OFDM 16QAM	Inner_Full	108@54	3918.000	661200	22.5	21.64
20	High	30	90	CP-OFDM 16QAM	Inner_Full	120@60	3918.000	661200	22.5	21.61

N77L

No.	Test Freq Description	5G-n77							Tune up	Power Results (dBm)
		SCS (kHz)	NR BW (MHz)	Modulation	RB allocation	NR Test Freq. (MHz)	NR Test CH.	n77		
1	High	30	20	DFT-s-OFDM QPSK	Inner_Full	25@12	3540	636000	22.50	20.52
2	Middle	30	20	DFT-s-OFDM QPSK	Inner_Full	25@12	3500.01	633334	22.50	20.72
6	Low	30	20	DFT-s-OFDM QPSK	Inner_Full	25@12	3460.02	630668	22.50	20.80
7	High	30	100	DFT-s-OFDM QPSK	Inner_Full	135@67	3499.98	633332	22.50	20.69
8	Middle	30	100	DFT-s-OFDM QPSK	Inner_Full	135@67	3500.01	633334	22.50	20.77

According to the table above, the maximum power configuration is selected as the default test configuration

No.	Test Freq Description	5G-n77							Tune up	Power Results (dBm)
		SCS (kHz)	NR BW (MHz)	Modulation	RB allocation	NR Test Freq. (MHz)	NR Test CH.	n77		
1	Middle	30	20	DFT-s-OFDM PI/2 BPSK1	Inner_Full	25@12	3500.01	633334	22.50	20.72
2	Middle	30	20	DFT-s-OFDM 16QAM	Inner_Full	25@12	3500.01	633334	22.50	20.75
3	Middle	30	20	DFT-s-OFDM 64QAM	Inner_Full	25@12	3500.01	633334	22.50	20.71
4	Middle	30	20	DFT-s-OFDM 256QAM	Inner_Full	25@12	3500.01	633334	22.50	20.78
5	Middle	30	20	CP-OFDM QPSK	Inner_Full	25@12	3500.01	633334	22.50	20.73
6	Middle	30	20	CP-OFDM 16QAM	Inner_Full	25@12	3500.01	633334	22.50	20.79
7	Middle	30	20	CP-OFDM 64QAM	Inner_Full	25@12	3500.01	633334	22.50	20.68
8	Middle	30	20	CP-OFDM 256QAM	Inner_Full	25@12	3500.01	633334	22.50	20.52
1	Middle	30	20	DFT-s-OFDM QPSK	Edge_1RB_Right	1@50	3500.01	633334	22.50	20.68
6	Middle	30	20	DFT-s-OFDM QPSK	Edge_1RB_Left	1@0	3500.01	633334	22.50	20.61
9	Middle	30	20	DFT-s-OFDM QPSK	Edge_Full_Right	2@49	3500.01	633334	22.50	20.55
10	Middle	30	20	DFT-s-OFDM QPSK	Edge_Full_Left	2@0	3500.01	633334	22.50	20.70
11	Middle	30	20	DFT-s-OFDM QPSK	Inner_1RB_Right	1@49	3500.01	633334	22.50	20.53
12	Middle	30	20	DFT-s-OFDM QPSK	Inner_1RB_Left	1@1	3500.01	633334	22.50	20.64
13	Middle	30	20	DFT-s-OFDM QPSK	Outer_Full	50@0	3500.01	633334	22.50	20.74
18	Middle-5	30	40	DFT-s-OFDM QPSK	Inner_Full	50@25	3500.01	633334	22.50	20.54
19	Middle-5	30	50	DFT-s-OFDM QPSK	Inner_Full	64@32	3500.01	633334	22.50	20.69
20	Middle-5	30	60	DFT-s-OFDM QPSK	Inner_Full	81@40	3500.01	633334	22.50	20.62
22	Middle-5	30	80	DFT-s-OFDM QPSK	Inner_Full	108@54	3500.01	633334	22.50	20.56
23	Middle-5	30	90	DFT-s-OFDM QPSK	Inner_Full	120@60	3500.01	633334	22.50	20.55

Table 11.5-9: Maximum Power Reduction (MPR) for NR DSI6

Modulation		MPR (dB)		
		Edge RB allocations	Outer RB allocations	Inner RB allocations
DFT-s-OFDM	Pi/2 BPSK	0	0	0
	QPSK	0		0
	16 QAM	0		0
	64 QAM	0		
	256 QAM	0		
CP-OFDM	QPSK	0		0
	16 QAM	0		0
	64 QAM	0		
	256 QAM	0		

Table 11.5-10: Maximum Target Power for Production Unit – DSI6

No.	Test Freq Description	5G-n71							Tune up	Power Results (dBm)
		SCS (kHz)	NR BW (MHz)	Modulation	RB allocation		NR Test Freq. (MHz)	NR Test CH.		
1	High	15	5	DFT-s-OFDM QPSK	Inner_Full (12@6)	12@6	695.5	139100	21	19.51
2	Middle	15	5	DFT-s-OFDM QPSK	Inner_Full (12@6)	12@6	680.5	136100	21	19.63
3	Low	15	5	DFT-s-OFDM QPSK	Inner_Full (12@6)	12@6	665.5	133100	21	19.87
4	High	15	20	DFT-s-OFDM QPSK	Inner_Full (50@25)	50@25	688	137600	21	19.59
5	Middle	15	20	DFT-s-OFDM QPSK	Inner_Full (50@25)	50@25	680.5	136100	21	19.67
6	Low	15	20	DFT-s-OFDM QPSK	Inner_Full (50@25)	50@25	673	134600	21	19.74

According to the table above, the maximum power configuration is selected as the default test configuration

No.	Test Freq Description	5G-n71							Tune up	Power Results (dBm)
		SCS (kHz)	NR BW (MHz)	Modulation	RB allocation		NR Test Freq. (MHz)	NR Test CH.		
1	default	15	5	DFT-s-OFDM Pi/2 BPSK1	Inner_Full (12@6)	12@6	665.5	133100	21	19.76
2	default	15	5	DFT-s-OFDM 16QAM	Inner_Full (12@6)	12@6	665.5	133100	21	20.09
3	default	15	5	DFT-s-OFDM 64QAM	Inner_Full (12@6)	12@6	665.5	133100	21	20.07
4	default	15	5	DFT-s-OFDM 256QAM	Inner_Full (12@6)	12@6	665.5	133100	21	19.57
5	default	15	5	CP-OFDM QPSK	Inner_Full (12@6)	12@6	665.5	133100	21	20.35
6	default	15	5	CP-OFDM 16QAM	Inner_Full (12@6)	12@6	665.5	133100	21	20.42
7	default	15	5	CP-OFDM 64QAM	Inner_Full (12@6)	12@6	665.5	133100	21	20.45
8	default	15	5	CP-OFDM 256QAM	Inner_Full (12@6)	12@6	665.5	133100	21	19.02
9	default	15	5	CP-OFDM 64QAM	Edge_Full_Right	2@23	665.5	133100	21	20.47
10	default	15	5	CP-OFDM 64QAM	Edge_Full_Left	2@0	665.5	133100	21	20.65
11	default	15	5	CP-OFDM 64QAM	Inner_1RB_Right	1@23	665.5	133100	21	20.32
12	default	15	5	CP-OFDM 64QAM	Inner_1RB_Left	1@1	665.5	133100	21	20.52
13	default	15	5	CP-OFDM 64QAM	Outer_Full	25@0	665.5	133100	21	20.17
14	default	15	5	CP-OFDM 64QAM	Edge_1RB_Right (1@24)	1@24	665.5	133100	21	20.34
15	default	15	5	CP-OFDM 64QAM	Edge_1RB_Left (1@0)	1@0	665.5	133100	21	20.52
16	default	15	10	CP-OFDM 64QAM	Inner_Full	25@12	680.5	136100	21	19.81
17	default	15	15	CP-OFDM 64QAM	Inner_Full	36@18	680.5	136100	21	20.07

Table 11.5-11: Maximum Power Reduction (MPR) for NR DS11/2/3/4/5

Modulation		MPR (dB)		
		Edge RB allocations	Outer RB allocations	Inner RB allocations
DFT-s-OFDM	Pi/2 BPSK	$\leq 3.5^{\dagger}$	$\leq 1.2^{\dagger}$	$\leq 0.2^{\dagger}$
		0	0	0
	QPSK	0		0
	16 QAM	0		0
	64 QAM	0		
CP-OFDM	256 QAM	1.5		
	QPSK	0		0
	16 QAM	0		0
	64 QAM	0.5		
	256 QAM	3.5		

Table 11.5-12: Maximum Target Power for Production Unit –DS11/2/3/4/5

No.	Test Freq Description	5G-n71							Tune up	Power Results (dBm)
		SCS (kHz)	NR BW (MHz)	Modulation	RB allocation		NR Test Freq. (MHz)	NR Test CH.		
1	High	15	5	DFT-s-OFDM QPSK	Inner_Full (12@6)	12@6	695.5	139100	23.5	21.71
2	Middle	15	5	DFT-s-OFDM QPSK	Inner_Full (12@6)	12@6	680.5	136100	23.5	21.84
3	Low	15	5	DFT-s-OFDM QPSK	Inner_Full (12@6)	12@6	665.5	133100	23.5	22.05
4	High	15	20	DFT-s-OFDM QPSK	Inner_Full (50@25)	50@25	688	137600	23.5	21.81
5	Middle	15	20	DFT-s-OFDM QPSK	Inner_Full (50@25)	50@25	680.5	136100	23.5	21.87
6	Low	15	20	DFT-s-OFDM QPSK	Inner_Full (50@25)	50@25	673	134600	23.5	21.91

According to the table above, the maximum power configuration is selected as the default test configuration

No.	Test Freq Description	5G-n71							Tune up	Power Results (dBm)
		SCS (kHz)	NR BW (MHz)	Modulation	RB allocation		NR Test Freq. (MHz)	NR Test CH.		
1	default	15	5	DFT-s-OFDM Pi/2 BPSK1	Inner_Full (12@6)	12@6	665.5	133100	23.5	21.85
2	default	15	5	DFT-s-OFDM 16QAM	Inner_Full (12@6)	12@6	665.5	133100	23.5	22.31
3	default	15	5	DFT-s-OFDM 64QAM	Inner_Full (12@6)	12@6	665.5	133100	23.5	21.75
4	default	15	5	DFT-s-OFDM 256QAM	Inner_Full (12@6)	12@6	665.5	133100	22	20.11
5	default	15	5	CP-OFDM QPSK	Inner_Full (12@6)	12@6	665.5	133100	23.5	22.73
6	default	15	5	CP-OFDM 16QAM	Inner_Full (12@6)	12@6	665.5	133100	23.5	22.76
7	default	15	5	CP-OFDM 64QAM	Inner_Full (12@6)	12@6	665.5	133100	23	21.07
8	default	15	5	CP-OFDM 256QAM	Inner_Full (12@6)	12@6	665.5	133100	20	18.09
9	default	15	5	CP-OFDM 16QAM	Edge_Full_Right	2@23	665.5	133100	23.5	21.53
10	default	15	5	CP-OFDM 16QAM	Edge_Full_Left	2@0	665.5	133100	23.5	21.66
11	default	15	5	CP-OFDM 16QAM	Inner_1RB_Right	1@23	665.5	133100	23.5	22.81
12	default	15	5	CP-OFDM 16QAM	Inner_1RB_Left	1@1	665.5	133100	23.5	23.04
13	default	15	5	CP-OFDM 16QAM	Outer_Full	25@0	665.5	133100	23.5	21.59
14	default	15	5	CP-OFDM 16QAM	Edge_1RB_Right (1@24)	1@24	665.5	133100	23.5	21.65
15	default	15	5	CP-OFDM 16QAM	Edge_1RB_Left (1@0)	1@0	665.5	133100	23.5	21.83
16	default	15	10	CP-OFDM 16QAM	Inner_Full	25@12	680.5	136100	23.5	22.37
17	default	15	15	CP-OFDM 16QAM	Inner_Full	36@18	680.5	136100	23.5	22.56

Table 11.5-13: Maximum Power Reduction (MPR) for NR DS12/3/5/6

Modulation		MPR (dB)		
		Edge RB allocations	Outer RB allocations	Inner RB allocations
DFT-s-OFDM	Pi/2 BPSK	0	0	0
	QPSK	0		0
	16 QAM	0		0
	64 QAM	0		
	256 QAM	0		
CP-OFDM	QPSK	0		0
	16 QAM	0		0
	64 QAM	0		
	256 QAM	0		

Table 11.5-14: Maximum Target Power for Production Unit –DS12/3/5/6

No.	Test Freq Description	5G-n41							Tune up	Power Results (dBm)
		SCS (kHz)	NR BW (MHz)	Modulation	RB allocation		NR Test Freq. (MHz)	NR Test CH.		
1	High	30	20	DFT-s-OFDM QPSK	Inner_Full (25@12)	25@12	2679.99	535998	18	16.67
2	Middle-1	30	20	DFT-s-OFDM QPSK	Inner_Full (25@12)	25@12	2636.49	527298	18	16.87
3	Middle-2	30	20	DFT-s-OFDM QPSK	Inner_Full (25@12)	25@12	2592.99	518598	18	16.64
4	Middle-3	30	20	DFT-s-OFDM QPSK	Inner_Full (25@12)	25@12	2549.51	509902	18	17.59
5	Low	30	20	DFT-s-OFDM QPSK	Inner_Full (25@12)	25@12	2506.02	501204	18	16.28
6	High	30	100	DFT-s-OFDM QPSK	Inner_Full (135@67)	135@67	2640	528000	18	16.73
7	Middle	30	100	DFT-s-OFDM QPSK	Inner_Full (135@67)	135@67	2616.51	523302	18	16.71
8	Middle	30	100	DFT-s-OFDM QPSK	Inner_Full (135@67)	135@67	2592.99	518598	18	16.80
9	Middle	30	100	DFT-s-OFDM QPSK	Inner_Full (135@67)	135@67	2569.5	513900	18	17.26
10	Low	30	100	DFT-s-OFDM QPSK	Inner_Full (135@67)	135@67	2546.01	509202	18	17.32

According to the table above, the maximum power configuration is selected as the default test configuration

No.	Test Freq Description	5G-n41							Tune up	Power Results (dBm)
		SCS (kHz)	NR BW (MHz)	Modulation	RB allocation		NR Test Freq. (MHz)	NR Test CH.		
1	Middle-3	30	20	DFT-s-OFDM Pi/2 BPSK1	Inner_Full (25@12)	25@12	2549.51	509902	18	17.58
2	Middle-3	30	20	DFT-s-OFDM 16QAM	Inner_Full (25@12)	25@12	2549.51	509902	18	17.52
3	Middle-3	30	20	DFT-s-OFDM 64QAM	Inner_Full (25@12)	25@12	2549.51	509902	18	17.58
4	Middle-3	30	20	DFT-s-OFDM 256QAM	Inner_Full (25@12)	25@12	2549.51	509902	18	17.63
5	Middle-3	30	20	CP-OFDM QPSK	Inner_Full (25@12)	25@12	2549.51	509902	18	17.59
6	Middle-3	30	20	CP-OFDM 16QAM	Inner_Full (25@12)	25@12	2549.51	509902	18	17.66
7	Middle-3	30	20	CP-OFDM 64QAM	Inner_Full (25@12)	25@12	2549.51	509902	18	17.56
8	Middle-3	30	20	CP-OFDM 256QAM	Inner_Full (25@12)	25@12	2549.51	509902	18	17.61
9	Middle-3	30	20	CP-OFDM 16QAM	Edge_Full_Right	2@49	2549.51	509902	18	17.36
10	Middle-3	30	20	CP-OFDM 16QAM	Edge_Full_Left	2@0	2549.51	509902	18	17.23
11	Middle-3	30	20	CP-OFDM 16QAM	Inner_1RB_Right	1@49	2549.51	509902	18	17.64
12	Middle-3	30	20	CP-OFDM 16QAM	Inner_1RB_Left	1@1	2549.51	509902	18	17.58
13	Middle-3	30	20	CP-OFDM 16QAM	Outer_Full	50@0	2549.51	509902	18	17.51
14	Middle-3	30	20	CP-OFDM 16QAM	Edge_1RB_Right (1@50)	1@50	2549.51	509902	18	17.64
15	Middle-3	30	20	CP-OFDM 16QAM	Edge_1RB_Left (1@0)	1@0	2549.51	509902	18	17.54
16	Middle-1	30	40	CP-OFDM 16QAM	Inner_Full	50@25	2569.5	513900	18	17.46
17	Middle-1	30	50	CP-OFDM 16QAM	Inner_Full	64@32	2569.5	513900	18	17.54
18	Middle-1	30	60	CP-OFDM 16QAM	Inner_Full	81@40	2569.5	513900	18	17.50
19	Middle-1	30	80	CP-OFDM 16QAM	Inner_Full	108@54	2569.5	513900	18	17.47
20	Middle-1	30	90	CP-OFDM 16QAM	Inner_Full	120@60	2569.5	513900	18	17.43

Table 11.5-15: Maximum Power Reduction (MPR) for NR DSI1/4

Modulation		MPR (dB)		
		Edge RB allocations	Outer RB allocations	Inner RB allocations
DFT-s-OFDM	Pi/2 BPSK	0	0	0
	QPSK	0		0
	16 QAM	0		0
	64 QAM	0		
	256 QAM	0		
CP-OFDM	QPSK	0		0
	16 QAM	0		0
	64 QAM	0		
	256 QAM	1		

Table 11.5-16: Maximum Target Power for Production Unit –DSI4

No.	Test Freq Description	5G-n41							Tune up	Power Results (dBm)
		SCS (kHz)	NR BW (MHz)	Modulation	RB allocation		NR Test Freq. (MHz)	NR Test CH.		
1	High	30	20	DFT-s-OFDM QPSK	Inner_Full (25@12)	25@12	2679.99	535998	23	21.47
2	Middle-1	30	20	DFT-s-OFDM QPSK	Inner_Full (25@12)	25@12	2636.49	527298	23	21.74
3	Middle-2	30	20	DFT-s-OFDM QPSK	Inner_Full (25@12)	25@12	2592.99	518598	23	21.48
4	Middle-3	30	20	DFT-s-OFDM QPSK	Inner_Full (25@12)	25@12	2549.51	509902	23	22.44
5	Low	30	20	DFT-s-OFDM QPSK	Inner_Full (25@12)	25@12	2506.02	501204	23	21.02
6	High	30	100	DFT-s-OFDM QPSK	Inner_Full (135@67)	135@67	2640	528000	23	21.56
7	Middle	30	100	DFT-s-OFDM QPSK	Inner_Full (135@67)	135@67	2616.51	523302	23	21.53
8	Middle	30	100	DFT-s-OFDM QPSK	Inner_Full (135@67)	135@67	2592.99	518598	23	21.71
9	Middle	30	100	DFT-s-OFDM QPSK	Inner_Full (135@67)	135@67	2569.5	513900	23	22.18
10	Low	30	100	DFT-s-OFDM QPSK	Inner_Full (135@67)	135@67	2546.01	509202	23	22.25

According to the table above, the maximum power configuration is selected as the default test configuration

No.	Test Freq Description	5G-n41							Tune up	Power Results (dBm)
		SCS (kHz)	NR BW (MHz)	Modulation	RB allocation		NR Test Freq. (MHz)	NR Test CH.		
1	Middle-3	30	20	DFT-s-OFDM Pi/2 BPSK1	Inner_Full (25@12)	25@12	2549.51	509902	23	22.27
2	Middle-3	30	20	DFT-s-OFDM 16QAM	Inner_Full (25@12)	25@12	2549.51	509902	23	22.66
3	Middle-3	30	20	DFT-s-OFDM 64QAM	Inner_Full (25@12)	25@12	2549.51	509902	23	22.65
4	Middle-3	30	20	DFT-s-OFDM 256QAM	Inner_Full (25@12)	25@12	2549.51	509902	23	22.69
5	Middle-3	30	20	CP-OFDM QPSK	Inner_Full (25@12)	25@12	2549.51	509902	23	22.94
6	Middle-3	30	20	CP-OFDM 16QAM	Inner_Full (25@12)	25@12	2549.51	509902	23	22.99
7	Middle-3	30	20	CP-OFDM 64QAM	Inner_Full (25@12)	25@12	2549.51	509902	23	22.93
8	Middle-3	30	20	CP-OFDM 256QAM	Inner_Full (25@12)	25@12	2549.51	509902	22	21.25
9	Middle-3	30	20	CP-OFDM 16QAM	Edge_Full_Right	2@49	2549.51	509902	23	22.69
10	Middle-3	30	20	CP-OFDM 16QAM	Edge_Full_Left	2@0	2549.51	509902	23	22.51
11	Middle-3	30	20	CP-OFDM 16QAM	Inner_1RB_Right	1@49	2549.51	509902	23	22.93
12	Middle-3	30	20	CP-OFDM 16QAM	Inner_1RB_Left	1@1	2549.51	509902	23	22.85
13	Middle-3	30	20	CP-OFDM 16QAM	Outer_Full	50@0	2549.51	509902	23	22.83
14	Middle-3	30	20	CP-OFDM 16QAM	Edge_1RB_Right (1@50)	1@50	2549.51	509902	23	22.94
15	Middle-3	30	20	CP-OFDM 16QAM	Edge_1RB_Left (1@0)	1@0	2549.51	509902	23	22.81
16	Middle-3	30	40	CP-OFDM 16QAM	Inner_Full	50@25	2569.5	513900	23	22.61
17	Middle-3	30	50	CP-OFDM 16QAM	Inner_Full	64@32	2569.5	513900	23	22.67
18	Middle-3	30	60	CP-OFDM 16QAM	Inner_Full	81@40	2569.5	513900	23	22.64
19	Middle-3	30	80	CP-OFDM 16QAM	Inner_Full	108@54	2569.5	513900	23	22.62
20	Middle-3	30	90	CP-OFDM 16QAM	Inner_Full	120@60	2569.5	513900	23	22.65

Table 11.5-17: Maximum Target Power for Production Unit –DSI1

No.	Test Freq Description	5G-n41							Tune up	Power Results (dBm)
		SCS (kHz)	NR BW (MHz)	Modulation	RB allocation		NR Test Freq. (MHz)	NR Test CH.		
1	High	30	20	DFT-s-OFDM QPSK	Inner_Full (25@12)	25@12	2679.99	535998	24.5	23.55
2	Middle-1	30	20	DFT-s-OFDM QPSK	Inner_Full (25@12)	25@12	2636.49	527298	24.5	23.83
3	Middle-2	30	20	DFT-s-OFDM QPSK	Inner_Full (25@12)	25@12	2592.99	518598	24.5	23.61
4	Middle-3	30	20	DFT-s-OFDM QPSK	Inner_Full (25@12)	25@12	2549.51	509902	24.5	24.49
5	Low	30	20	DFT-s-OFDM QPSK	Inner_Full (25@12)	25@12	2506.02	501204	24.5	23.12
6	High	30	100	DFT-s-OFDM QPSK	Inner_Full (135@67)	135@67	2640	528000	24.5	23.68
7	Middle	30	100	DFT-s-OFDM QPSK	Inner_Full (135@67)	135@67	2616.51	523302	24.5	23.67
8	Middle	30	100	DFT-s-OFDM QPSK	Inner_Full (135@67)	135@67	2592.99	518598	24.5	23.76
9	Middle	30	100	DFT-s-OFDM QPSK	Inner_Full (135@67)	135@67	2569.5	513900	24.5	24.22
10	Low	30	100	DFT-s-OFDM QPSK	Inner_Full (135@67)	135@67	2546.01	509202	24.5	24.28

According to the table above, the maximum power configuration is selected as the default test configuration

No.	Test Freq Description	5G-n41							Tune up	Power Results (dBm)
		SCS (kHz)	NR BW (MHz)	Modulation	RB allocation		NR Test Freq. (MHz)	NR Test CH.		
1	Middle-3	30	20	DFT-s-OFDM PI/2 BPSK1	Inner_Full (25@12)	25@12	2549.51	509902	24.5	24.45
2	Middle-3	30	20	DFT-s-OFDM 16QAM	Inner_Full (25@12)	25@12	2549.51	509902	24.5	24.46
3	Middle-3	30	20	DFT-s-OFDM 64QAM	Inner_Full (25@12)	25@12	2549.51	509902	24.5	24.41
4	Middle-3	30	20	DFT-s-OFDM 256QAM	Inner_Full (25@12)	25@12	2549.51	509902	24.5	23.54
5	Middle-3	30	20	CP-OFDM QPSK	Inner_Full (25@12)	25@12	2549.51	509902	24.5	24.39
6	Middle-3	30	20	CP-OFDM 16QAM	Inner_Full (25@12)	25@12	2549.51	509902	24.5	24.41
7	Middle-3	30	20	CP-OFDM 64QAM	Inner_Full (25@12)	25@12	2549.51	509902	24.5	24.33
8	Middle-3	30	20	CP-OFDM 256QAM	Inner_Full (25@12)	25@12	2549.51	509902	23.5	21.57
9	Middle-3	30	20	DFT-s-OFDM QPSK	Edge_Full_Right	2@49	2549.51	509902	24.5	24.32
10	Middle-3	30	20	DFT-s-OFDM QPSK	Edge_Full_Left	2@0	2549.51	509902	24.5	24.12
11	Middle-3	30	20	DFT-s-OFDM QPSK	Inner_1RB_Right	1@49	2549.51	509902	24.5	24.48
12	Middle-3	30	20	DFT-s-OFDM QPSK	Inner_1RB_Left	1@1	2549.51	509902	24.5	24.46
13	Middle-3	30	20	DFT-s-OFDM QPSK	Outer_Full	50@0	2549.51	509902	24.5	24.33
14	Middle-3	30	20	DFT-s-OFDM QPSK	Edge_1RB_Right (1@50)	1@50	2549.51	509902	24.5	24.34
15	Middle-3	30	20	DFT-s-OFDM QPSK	Edge_1RB_Left (1@0)	1@0	2549.51	509902	24.5	24.37
16	Middle-3	30	40	DFT-s-OFDM QPSK	Inner_Full	50@25	2569.5	513900	24.5	24.29
17	Middle-3	30	50	DFT-s-OFDM QPSK	Inner_Full	64@32	2569.5	513900	24.5	24.32
18	Middle-3	30	60	DFT-s-OFDM QPSK	Inner_Full	81@40	2569.5	513900	24.5	24.21
19	Middle-3	30	80	DFT-s-OFDM QPSK	Inner_Full	108@54	2569.5	513900	24.5	24.31
20	Middle-3	30	90	DFT-s-OFDM QPSK	Inner_Full	120@60	2569.5	513900	24.5	24.18

12 Simultaneous TX SAR Considerations

12.1 Transmit Antenna Separation Distances

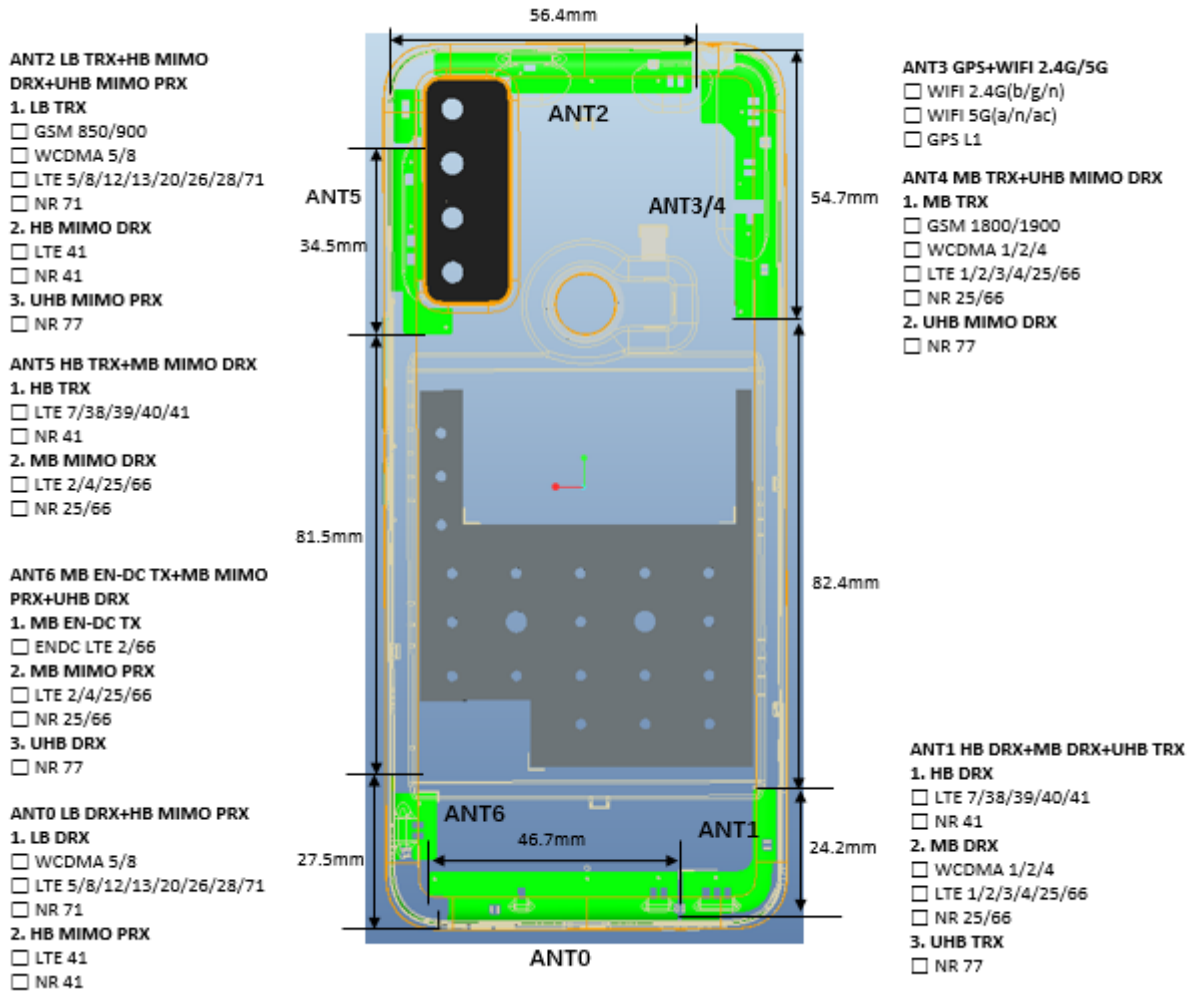

Antenna	Type	Brand	Description
0	FPC	HT	LB DRX+ HB MIMO PRX antenna
1	FPC	HT	MB&HB DRX+UHB TRX antenna
2	FPC	HT	LB TRX+HB MIMO DRX+UHB MIMO PRX antenna
3	FPC	HT	WiFi2.4G +Bluetooth + WiFi 5G +GPS antenna
4	FPC	HT	MB TRX+ UHB MIMO DRX antenna
5	FPC	HT	HB TRX+MB MIMO DRX antenna
6	FPC	HT	MB EN-DC TX+MB MIMO PRX+UHB DRX antenna

Picture 12.1 Antenna Locations

12.2 SAR Measurement Positions

According to the KDB941225 D06 Hot Spot SAR v01, the edges with less than 2.5 cm distance to the antennas need to be tested for SAR.

SAR measurement positions						
Mode	Front	Rear	Left edge	Right edge	Top edge	Bottom edge
ANT1	Yes	Yes	Yes	No	No	Yes
ANT2	Yes	Yes	Yes	Yes	Yes	No
ANT3	Yes	Yes	Yes	No	Yes	No
ANT4	Yes	Yes	Yes	No	Yes	No
ANT6	Yes	Yes	No	Yes	No	Yes

12.3 Standalone SAR Test Exclusion Considerations

Standalone 1-g head or body SAR evaluation by measurement or numerical simulation is not required when the corresponding SAR Exclusion Threshold condition, listed below, is satisfied. The 1-g SAR test exclusion threshold for 100 MHz to 6 GHz at test separation distances ≤ 50 mm are determined by:

$[(\text{max. power of channel, including tune-up tolerance, mW}) / (\text{min. test separation distance, mm})] \cdot [\sqrt{f(\text{GHz})}] \leq 3.0$ for 1-g SAR, where

- $f(\text{GHz})$ is the RF channel transmit frequency in GHz
- Power and distance are rounded to the nearest mW and mm before calculation
- The result is rounded to one decimal place for comparison

Table 12.1: Standalone SAR test exclusion considerations

Band/Mode	F(GHz)	Position	SAR test exclusion threshold(mW)	RF output power		SAR test exclusion
				dBm	mW	
Bluetooth	2.441	Head	9.60	9	7.94	No
		Body	19.20	9	7.94	No
2.4GHz WLAN	2.45	Head	9.58	21.5	141.25	No
		Body	19.17	21.5	141.25	No
5GHz WLAN	5.2	Head	6.58	20	100.00	No
		Body	13.16	20	100.00	No
	5.3	Head	6.52	20	100.00	No
		Body	13.03	20	100.00	No
	5.6	Head	6.34	20	100.00	No
		Body	12.68	20	100.00	No
	5.8	Head	6.23	20	100.00	No
		Body	12.46	20	100.00	No

13 Evaluation of Simultaneous

Table 13.1: The sum of reported SAR values for Main antenna and WiFi-5G+BT

	Position	Cellular antenna	WiFi	BT	Sum
Highest reported SAR value for Head	Right hand, Cheek (WCDMA1700)	1.09	0.22	0.02	1.33
Maximum reported SAR value for Body	Rear 10mm (LTE Band66)	0.90	0.29	0.01	1.20

Note1: we have evaluated and chose the highest value of WiFi 2.4G and 5G in the above table.

Table 13.2: The sum of reported SAR values for Main antenna and WiFi-2.4G

	Band	Cellular antenna	WiFi	BT	Sum
Highest reported SAR value for Head	Right hand, Cheek (WCDMA1700)	1.09	0.15	0.02	1.26
Maximum reported SAR value for Body	Right 10mm (LTE Band 41-PC2)	1.14	/	/	1.14

	LTE	NR	Position	Reported SAR 1g(W/kg)
ENDC	LTE Band 2(ANT6)	N25	Head	0.58
	LTE Band 12(ANT2)	N25	Head	0.65
	LTE Band 66(ANT6)	N25	Head	0.62
	LTE Band 2(ANT6)	N66	Head	0.57
	LTE Band 12(ANT2)	N66	Head	0.64
	LTE Band 2(ANT6)	N71	Head	0.25
	LTE Band 66(ANT6)	N71	Head	0.29
	LTE Band 2(ANT6)	N41	Head	0.24
	LTE Band 66(ANT6)	N41	Head	0.24

	LTE	NR	Position	Reported SAR 1g(W/kg)
ENDC	LTE Band 2(ANT6)	N25	Body 10mm	0.56
	LTE Band 12(ANT2)	N25	Body 10mm	0.70
	LTE Band 66(ANT6)	N25	Body 10mm	0.52
	LTE Band 2(ANT6)	N66	Body 10mm	0.58
	LTE Band 12(ANT2)	N66	Body 10mm	0.58
	LTE Band 2(ANT6)	N71	Body 10mm	0.32
	LTE Band 66(ANT6)	N71	Body 10mm	0.28
	LTE Band 2(ANT6)	N41	Body 10mm	0.34
	LTE Band 66(ANT6)	N41	Body 10mm	0.34

	LTE	NR	Position	Reported SAR 1g(W/kg)
ENDC	LTE Band 2(ANT6)	N25	Body 15mm	0.41
	LTE Band 12(ANT2)	N25	Body 15mm	0.55
	LTE Band 66(ANT6)	N25	Body 15mm	0.37
	LTE Band 2(ANT6)	N66	Body 15mm	0.49
	LTE Band 12(ANT2)	N66	Body 15mm	0.49
	LTE Band 2(ANT6)	N41	Body 15mm	0.83
	LTE Band 66(ANT6)	N41	Body 15mm	0.79

	LTE	LTE	Position	Reported SAR 1g(W/kg)
ULCA	LTE Band 2(ANT6)	LTE Band 66(ANT4)	Head	0.80
	LTE Band 12(ANT2)	LTE Band 66(ANT4)	Head	0.87
	LTE Band 2(ANT4)	LTE Band 12(ANT2)	Head	0.75

	LTE	LTE	Position	Reported SAR 1g(W/kg)
ULCA	LTE Band 2(ANT6)	LTE Band 66(ANT4)	Body 10mm	0.53
	LTE Band 12(ANT2)	LTE Band 66(ANT4)	Body 10mm	0.67
	LTE Band 2(ANT4)	LTE Band 12(ANT2)	Body 10mm	0.65

Conclusion:

According to the above tables, the sum of reported SAR values is 1.6W/kg. So the simultaneous transmission SAR with volume scans is not required.

14 SAR Test Result

It is determined by user manual for the distance between the EUT and the phantom bottom. The distance is 10 mm or 15mm and just applied to the condition of body worn accessory.

It is performed for all SAR measurements with area scan based 1-g SAR estimation (Fast SAR). A zoom scan measurement is added when the estimated 1-gSAR is the highest measured SAR in each exposure configuration, wireless mode and frequency band combination or more than 1.2W/kg.

The calculated SAR is obtained by the following formula:

$$\text{Reported SAR} = \text{Measured SAR} \times 10^{(P_{\text{Target}} - P_{\text{Measured}})/10}$$

Where P_{Target} is the power of manufacturing upper limit;

P_{Measured} is the measured power in chapter 11.

Table 14.1: Duty Cycle

Mode	Duty Cycle
Speech for GSM850/1900	1:2
Speech for GSM1900	1:4
GPRS&EGPRS for GSM850/1900	1:2
WCDMA<E FDD	1:1
LTE B41 PC3	1:1.58
LTE B41 PC2	1:2.309

Note:

The **B1** is the battery of TLp043E7 by VEKEN

The **B2** is the battery of TLp043E1 by BYD

14.1 SAR results for Fast SAR

Table 14.1-1: SAR Values (GSM 850 MHz Band - Head)

Frequency		Side	Test Position	Figure No./Note	Conducted Power (dBm)	Max. tune-up Power (dBm)	Measured SAR(10g) (W/kg)	Reported SAR(10g) (W/kg)	Measured SAR(1g) (W/kg)	Reported SAR(1g) (W/kg)	Power Drift (dB)
Ch.	MHz										
190	836.6	Left	Touch	/	27.73	28.00	0.305	0.32	0.498	0.53	0.16
251	848.8	Left	Tilt	/	27.69	28.00	0.234	0.25	0.459	0.49	-0.07
190	836.6	Left	Tilt	/	27.73	28.00	0.301	0.32	0.611	0.65	0.18
128	824.2	Left	Tilt	Fig.1	27.69	28.00	0.310	0.33	0.638	0.69	0.06
190	836.6	Right	Touch	/	27.73	28.00	0.261	0.28	0.497	0.53	-0.09
190	836.6	Right	Tilt	/	27.73	28.00	0.219	0.23	0.429	0.46	-0.15

Table 14.1-2: SAR Values (GSM 850 MHz Band - Body)

Frequency		Mode (number of timeslots)	Test Position	Figure No./Note	Conducted Power (dBm)	Max. tune-up Power (dBm)	Measured SAR(10g) (W/kg)	Reported SAR(10g) (W/kg)	Measured SAR(1g) (W/kg)	Reported SAR(1g) (W/kg)	Power Drift (dB)
Ch.	MHz										
190	836.6	GPRS (4)	Front	/	27.73	28.00	0.109	0.12	0.188	0.20	0.13
190	836.6	GPRS (4)	Rear	/	27.73	28.00	0.127	0.14	0.217	0.23	0.05
190	836.6	GPRS (4)	Left	/	27.73	28.00	0.074	0.08	0.114	0.12	0.17
190	836.6	GPRS (4)	Right	/	27.73	28.00	0.135	0.14	0.255	0.27	0.06
251	848.8	GPRS (4)	Top	/	27.69	28.00	0.127	0.14	0.243	0.26	0.18
190	836.6	GPRS (4)	Top	Fig.2	27.73	28.00	0.139	0.15	0.264	0.28	0.14
128	824.2	GPRS (4)	Top	/	27.69	28.00	0.142	0.15	0.168	0.18	0.17
190	836.6	EGPRS (4)	Top	/	27.66	28.00	0.121	0.13	0.239	0.26	0.03

Note: The distance between the EUT and the phantom bottom is 10mm.

Table 14.1-3: SAR Values (GSM 1900 MHz Band - Head)

Frequency		Side	Test Position	Figure No./Note	Conducted Power (dBm)	Max. tune-up Power (dBm)	Measured SAR(10g) (W/kg)	Reported SAR(10g) (W/kg)	Measured SAR(1g) (W/kg)	Reported SAR(1g) (W/kg)	Power Drift (dB)
Ch.	MHz										
661	1880	Left	Touch	/	27.97	28.70	0.161	0.19	0.299	0.35	-0.10
661	1880	Left	Tilt	/	27.97	28.70	0.061	0.07	0.099	0.12	0.17
810	1909.8	Right	Touch	/	27.51	28.70	0.323	0.42	0.680	0.89	-0.15
661	1880	Right	Touch	/	27.97	28.70	0.343	0.41	0.645	0.76	0.06
512	1850.2	Right	Touch	Fig.3	27.30	28.70	0.348	0.48	0.730	1.01	0.10
661	1880	Right	Tilt	/	27.97	28.70	0.080	0.09	0.140	0.17	0.01

Table 14.1-4: SAR Values (GSM 1900 MHz Band - Body)

Frequency		Mode (number of timeslots)	Test Position	Figure No./ Note	Conducted Power (dBm)	Max. tune-up Power (dBm)	Measured SAR(10g) (W/kg)	Reported SAR(10g) (W/kg)	Measured SAR(1g) (W/kg)	Reported SAR(1g) (W/kg)	Power Drift (dB)
Ch.	MHz										
661	1880	GPRS (4)	Front	/	23.95	24.50	0.033	0.04	0.087	0.10	-0.16
661	1880	GPRS (4)	Rear	/	23.95	24.50	0.177	0.20	0.345	0.39	-0.17
810	1909.8	GPRS (4)	Left	/	23.95	24.50	0.193	0.22	0.411	0.47	-0.09
661	1880	GPRS (4)	Left	Fig.4	23.67	24.50	0.221	0.27	0.445	0.54	0.09
512	1850.2	GPRS (4)	Left	/	23.44	24.50	0.188	0.24	0.402	0.51	0.01
661	1880	GPRS (4)	Top	/	23.95	24.50	0.024	0.03	0.043	0.05	-0.15
661	1880	EGPRS (4)	Left	/	23.94	24.50	0.211	0.24	0.423	0.48	-0.08

Note: The distance between the EUT and the phantom bottom is 10mm.

Table 14.1-5: SAR Values (WCDMA 850 MHz Band - Head)

Frequency		Side	Test Position	Figure No./Note	Conducted Power (dBm)	Max. tune-up Power (dBm)	Measured SAR(10g) (W/kg)	Reported SAR(10g) (W/kg)	Measured SAR(1g) (W/kg)	Reported SAR(1g) (W/kg)	Power Drift (dB)
Ch.	MHz										
4182	836.4	Left	Touch	/	23.25	24.00	0.360	0.43	0.522	0.62	0.06
4233	846.6	Left	Tilt	/	23.15	24.00	0.293	0.36	0.480	0.58	-0.15
4182	836.4	Left	Tilt	/	23.25	24.00	0.351	0.42	0.574	0.68	0.01
4132	826.4	Left	Tilt	Fig.5	23.14	24.00	0.360	0.44	0.601	0.73	-0.09
4182	836.4	Right	Touch	/	23.25	24.00	0.275	0.33	0.428	0.51	-0.09
4182	836.4	Right	Tilt	/	23.25	24.00	0.290	0.34	0.443	0.53	-0.04

Table 14.1-6: SAR Values (WCDMA 850 MHz Band - Body)

Frequency		Test Position	Figure No./ Note	Conducted Power (dBm)	Max. tune-up Power (dBm)	Measured SAR(10g) (W/kg)	Reported SAR(10g) (W/kg)	Measured SAR(1g) (W/kg)	Reported SAR(1g) (W/kg)	Power Drift (dB)
Ch.	MHz									
4182	836.4	Front	/	23.25	24.00	0.117	0.14	0.199	0.24	0.13
4233	846.6	Rear	/	23.15	24.00	0.164	0.20	0.272	0.33	0.05
4182	836.4	Rear	/	23.25	24.00	0.176	0.21	0.286	0.34	0.11
4132	826.4	Rear	Fig.6	23.14	24.00	0.180	0.22	0.293	0.36	0.05
4182	836.4	Left	/	23.25	24.00	0.072	0.09	0.110	0.13	0.03
4182	836.4	Right	/	23.25	24.00	0.147	0.17	0.223	0.27	-0.16
4182	836.4	Top	/	23.25	24.00	0.060	0.07	0.101	0.12	0.04

Note: The distance between the EUT and the phantom bottom is 10mm.

Table 14.1-7: SAR Values (WCDMA 1700 MHz Band - Head)

Frequency		Side	Test Position	Figure No./Note	Conducted Power (dBm)	Max. tune-up Power (dBm)	Measured SAR(10g) (W/kg)	Reported SAR(10g) (W/kg)	Measured SAR(1g) (W/kg)	Reported SAR(1g) (W/kg)	Power Drift (dB)
Ch.	MHz										
1412	1732.4	Left	Touch	/	21.22	22.00	0.226	0.27	0.448	0.54	-0.17
1412	1732.4	Left	Tilt	/	21.22	22.00	0.091	0.11	0.145	0.17	0.16
1513	1752.6	Right	Touch	/	21.04	22.00	0.415	0.52	0.869	1.08	0.05
1412	1732.4	Right	Touch	Fig.7	21.22	22.00	0.427	0.51	0.912	1.09	0.05
1312	1712.4	Right	Touch	/	21.35	22.00	0.418	0.49	0.889	1.03	-0.12
1412	1732.4	Right	Tilt	/	21.22	22.00	0.140	0.17	0.276	0.33	0.06
1412	1732.4	Right	Touch	B2	21.22	22.00	0.339	0.41	0.756	0.90	0.17

Table 14.1-8: SAR Values (WCDMA 1700 MHz Band - Body)

Frequency		Test Position	Figure No./Note	Conducted Power (dBm)	Max. tune-up Power (dBm)	Measured SAR(10g) (W/kg)	Reported SAR(10g) (W/kg)	Measured SAR(1g) (W/kg)	Reported SAR(1g) (W/kg)	Power Drift (dB)
Ch.	MHz									
1412	1732.4	Front	/	20.08	20.50	0.093	0.10	0.159	0.18	0.19
1513	1752.6	Rear	Fig.8	19.83	20.50	0.305	0.36	0.579	0.68	0.15
1412	1732.4	Rear	/	20.08	20.50	0.283	0.31	0.532	0.59	-0.12
1312	1712.4	Rear	/	20.06	20.50	0.270	0.30	0.499	0.55	-0.13
1412	1732.4	Left	/	20.08	20.50	0.272	0.30	0.520	0.57	0.18
1412	1732.4	Top	/	20.08	20.50	0.043	0.05	0.069	0.08	-0.13

Note1: The distance between the EUT and the phantom bottom is 10mm.

Table 14.1-9: SAR Values (WCDMA 1700 MHz Band - Body)

Frequency		Test Position	Figure No./Note	Conducted Power (dBm)	Max. tune-up Power (dBm)	Measured SAR(10g) (W/kg)	Reported SAR(10g) (W/kg)	Measured SAR(1g) (W/kg)	Reported SAR(1g) (W/kg)	Power Drift (dB)
Ch.	MHz									
1412	1732.4	Front	/	21.11	21.5	0.076	0.08	0.129	0.14	0.07
1513	1752.6	Rear	Fig.9	20.98	21.5	0.212	0.24	0.386	0.44	-0.04
1412	1732.4	Rear	/	21.11	21.5	0.211	0.23	0.372	0.41	0.12
1312	1712.4	Rear	/	21.03	21.5	0.196	0.22	0.308	0.34	-0.03

Note1: The distance between the EUT and the phantom bottom is 15mm.

Table 14.1-10: SAR Values (WCDMA 1900 MHz Band - Head)

Frequency		Side	Test Position	Figure No./ Note	Conducted Power (dBm)	Max. tune-up Power (dBm)	Measured SAR(10g) (W/kg)	Reported SAR(10g) (W/kg)	Measured SAR(1g) (W/kg)	Reported SAR(1g) (W/kg)	Power Drift (dB)
Ch.	MHz										
9400	1880	Left	Touch	/	21.96	22.50	0.241	0.27	0.457	0.52	0.01
9400	1880	Left	Tilt	/	21.96	22.50	0.071	0.08	0.124	0.14	-0.11
9538	1907.6	Right	Touch	/	21.56	22.50	0.377	0.47	0.733	0.91	-0.18
9400	1880	Right	Touch	Fig.10	21.96	22.50	0.410	0.46	0.896	1.01	-0.17
9262	1852.4	Right	Touch	/	21.41	22.50	0.367	0.47	0.780	1.00	-0.04
9400	1880	Right	Tilt	/	21.96	22.50	0.097	0.11	0.181	0.20	-0.01

Table 14.1-11: SAR Values (WCDMA 1900 MHz Band - Body)

Frequency		Test Position	Figure No./ Note	Conducted Power (dBm)	Max. tune-up Power (dBm)	Measured SAR(10g) (W/kg)	Reported SAR(10g) (W/kg)	Measured SAR(1g) (W/kg)	Reported SAR(1g) (W/kg)	Power Drift (dB)
Ch.	MHz									
9400	1880	Front	/	20.56	21.00	0.087	0.10	0.157	0.17	-0.19
9400	1880	Rear	/	20.56	21.00	0.272	0.30	0.527	0.58	0.01
9538	1907.6	Left	/	20.56	21.00	0.303	0.34	0.613	0.68	-0.06
9400	1880	Left	Fig.11	20.41	21.00	0.311	0.36	0.636	0.73	0.07
9262	1852.4	Left	/	20.09	21.00	0.282	0.35	0.570	0.70	0.10
9400	1880	Top	/	20.56	21.00	0.037	0.04	0.065	0.07	-0.05

Note1: The distance between the EUT and the phantom bottom is 10mm.

Table 14.1-12: SAR Values (WCDMA 1900 MHz Band - Body)

Frequency		Test Position	Figure No./ Note	Conducted Power (dBm)	Max. tune-up Power (dBm)	Measured SAR(10g) (W/kg)	Reported SAR(10g) (W/kg)	Measured SAR(1g) (W/kg)	Reported SAR(1g) (W/kg)	Power Drift (dB)
Ch.	MHz									
9400	1880	Front	/	21.38	22.00	0.069	0.08	0.126	0.15	0.12
9538	1907.6	Rear	Fig.12	21.10	22.00	0.186	0.23	0.336	0.41	-0.12
9400	1880	Rear		21.38	22.00	0.171	0.20	0.320	0.37	-0.17
9262	1852.4	Rear		20.98	22.00	0.091	0.12	0.260	0.33	-0.08

Note1: The distance between the EUT and the phantom bottom is 15mm.

Table 14.1-13: SAR Values (LTE Band7 - Head)

Frequency		Mode	Side	Test Position	Figure No./ Note	Conducted Power (dBm)	Max. tune-up Power (dBm)	Measured SAR(10g) (W/kg)	Reported SAR(10g) (W/kg)	Measured SAR(1g) (W/kg)	Reported SAR(1g) (W/kg)	Power Drift (dB)
Ch.	MHz											
21350	2560	1RB_Mid	Left	Touch	/	20.28	20.80	0.289	0.33	0.747	0.84	-0.11
21000	2535	1RB_High	Left	Touch	/	20.10	20.80	0.232	0.27	0.621	0.73	-0.03
20850	2510	1RB_High	Left	Touch	Fig.13	19.37	20.80	0.232	0.32	0.612	0.85	0.18
21350	2560	1RB_Mid	Left	Tilt	/	20.28	20.80	0.044	0.05	0.117	0.13	-0.15
21350	2560	1RB_Mid	Right	Touch	/	20.28	20.80	0.089	0.10	0.189	0.21	-0.05
21350	2560	1RB_Mid	Right	Tilt	/	20.28	20.80	0.022	0.02	0.046	0.05	0.04
21350	2560	50RB_Low	Left	Touch	/	19.53	19.80	0.195	0.21	0.558	0.59	0.06
21350	2560	50RB_Low	Left	Tilt	/	19.53	19.80	0.035	0.04	0.092	0.10	-0.09
21350	2560	50RB_Low	Right	Touch	/	19.53	19.80	0.102	0.11	0.244	0.26	-0.17
21350	2560	50RB_Low	Right	Tilt	/	19.53	19.80	0.018	0.02	0.049	0.05	-0.13
21350	2560	100RB	Left	Touch		19.46	19.80	0.186	0.20	0.531	0.57	0.19

Note1: The LTE mode is QPSK_20MHz.

Table 14.1-14: SAR Values (LTE Band7 - Body)

Frequency		Mode	Test Position	Figure No./ Note	Conducted Power (dBm)	Max. tune-up Power (dBm)	Measured SAR(10g) (W/kg)	Reported SAR(10g) (W/kg)	Measured SAR(1g) (W/kg)	Reported SAR(1g) (W/kg)	Power Drift (dB)
Ch.	MHz										
21350	2560	1RB_Mid	Front	/	20.10	20.80	0.080	0.09	0.168	0.20	0.06
21350	2560	1RB_Mid	Rear	/	20.10	20.80	0.231	0.27	0.505	0.59	0.18
21350	2560	1RB_Mid	Right	Fig.14	20.28	20.80	0.353	0.40	0.815	0.92	0.05
21000	2535	1RB_High	Right	/	20.10	20.80	0.283	0.33	0.678	0.80	0.04
20850	2510	1RB_High	Right	/	19.37	20.80	0.271	0.38	0.619	0.86	0.05
21350	2560	1RB_Mid	Top	/	20.10	20.80	0.027	0.03	0.054	0.06	0.11
21350	2560	50RB_Low	Front	/	19.53	19.80	0.065	0.07	0.136	0.14	-0.07
21350	2560	50RB_Low	Rear	/	19.53	19.80	0.183	0.19	0.395	0.42	-0.13
21350	2560	50RB_Low	Right	/	19.53	19.80	0.268	0.29	0.611	0.65	-0.07
21350	2560	50RB_Low	Top	/	19.53	19.80	0.021	0.02	0.049	0.05	-0.18
21350	2560	100RB	Right	/	19.46	19.80	0.332	0.36	0.783	0.85	-0.12

Note1: The distance between the EUT and the phantom bottom is 10mm.

Note2: The LTE mode is QPSK_20MHz.

Table 14.1-15: SAR Values (LTE Band12 - Head)

Frequency		Mode	Side	Test Position	Figure No./ Note	Conducted Power (dBm)	Max. tune-up Power (dBm)	Measured SAR(10g) (W/kg)	Reported SAR(10g) (W/kg)	Measured SAR(1g) (W/kg)	Reported SAR(1g) (W/kg)	Power Drift (dB)
Ch.	MHz											
23060	704	1RB_Low	Left	Touch	Fig.15	23.87	24.50	0.326	0.38	0.442	0.51	-0.16
23060	704	1RB_Low	Left	Tilt	/	23.87	24.50	0.288	0.33	0.425	0.49	0.00
23060	704	1RB_Low	Right	Touch	/	23.87	24.50	0.248	0.29	0.306	0.35	-0.01
23060	704	1RB_Low	Right	Tilt	/	23.87	24.50	0.207	0.24	0.281	0.32	-0.16
23060	704	25RB_Mid	Left	Touch	/	22.69	23.50	0.250	0.30	0.319	0.38	-0.08
23060	704	25RB_Mid	Left	Tilt	/	22.69	23.50	0.239	0.29	0.342	0.41	-0.18
23060	704	25RB_Mid	Right	Touch	/	22.69	23.50	0.159	0.19	0.205	0.25	-0.02
23060	704	25RB_Mid	Right	Tilt	/	22.69	23.50	0.151	0.18	0.212	0.26	-0.02

Note1: The LTE mode is QPSK_10MHz.

Table 14.1-16 SAR Values (LTE Band12- Body)

Frequency		Mode	Test Position	Figure No./ Note	Conducted Power (dBm)	Max. tune-up Power (dBm)	Measured SAR(10g) (W/kg)	Reported SAR(10g) (W/kg)	Measured SAR(1g) (W/kg)	Reported SAR(1g) (W/kg)	Power Drift (dB)
Ch.	MHz										
Ambient Temperature: 22.9°C Liquid Temperature: 22.5°C											
23060	704	1RB_Low	Front	/	23.87	24.50	0.150	0.17	0.206	0.24	0.04
23060	704	1RB_Low	Rear	/	23.87	24.50	0.181	0.21	0.252	0.29	0.18
23060	704	1RB_Low	Left	/	23.87	24.50	0.112	0.13	0.167	0.19	-0.17
23060	704	1RB_Low	Right	Fig.16	23.87	24.50	0.239	0.28	0.341	0.39	-0.09
23060	704	1RB_Low	Top	/	23.87	24.50	0.108	0.12	0.208	0.24	-0.06
23060	704	25RB_Mid	Front	/	22.69	23.50	0.117	0.14	0.161	0.19	-0.19
23060	704	25RB_Mid	Rear	/	22.69	23.50	0.141	0.17	0.193	0.23	0.19
23060	704	25RB_Mid	Left	/	22.69	23.50	0.092	0.11	0.138	0.17	0.03
23060	704	25RB_Mid	Right	/	22.69	23.50	0.203	0.24	0.304	0.37	-0.17
23060	704	25RB_Mid	Top	/	22.69	23.50	0.085	0.10	0.164	0.20	0.06

Note1: The distance between the EUT and the phantom bottom is 10mm.

Note2: The LTE mode is QPSK_10MHz.

Note3: The data is used for ENDC and UL CA

Table 14.1-17: SAR Values (LTE Band13 - Head)

Frequency		Mode	Side	Test Position	Figure No.	Conducted Power (dBm)	Max. tune-up Power (dBm)	Measured SAR(10g) (W/kg)	Reported SAR(10g) (W/kg)	Measured SAR(1g) (W/kg)	Reported SAR(1g) (W/kg)	Power Drift (dB)
Ch.	MHz											
23230	782	1RB_Mid	Left	Touch	Fig.17	23.45	24.50	0.249	0.32	0.469	0.60	-0.12
23230	782	1RB_Mid	Left	Tilt	/	23.45	24.50	0.244	0.31	0.442	0.56	-0.16
23230	782	1RB_Mid	Right	Touch	/	23.45	24.50	0.225	0.29	0.436	0.56	-0.19
23230	782	1RB_Mid	Right	Tilt	/	23.45	24.50	0.228	0.29	0.422	0.54	0.09
23230	782	25RB_High	Left	Touch	/	22.38	23.50	0.223	0.29	0.387	0.50	-0.15
23230	782	25RB_High	Left	Tilt	/	22.38	23.50	0.210	0.27	0.400	0.52	-0.08
23230	782	25RB_High	Right	Touch	/	22.38	23.50	0.180	0.23	0.352	0.46	0.07
23230	782	25RB_High	Right	Tilt	/	22.38	23.50	0.182	0.24	0.333	0.43	0.05

Note1: The LTE mode is QPSK_10MHz.

Table 14.1-18: SAR Values (LTE Band13 - Body)

Frequency		Mode	Test Position	Figure No.	Conducted Power (dBm)	Max. tune-up Power (dBm)	Measured SAR(10g) (W/kg)	Reported SAR(10g) (W/kg)	Measured SAR(1g) (W/kg)	Reported SAR(1g) (W/kg)	Power Drift (dB)
Ch.	MHz										
23230	782	1RB_Mid	Front	/	23.45	24.50	0.111	0.14	0.189	0.24	0.04
23230	782	1RB_Mid	Rear	/	23.45	24.50	0.153	0.19	0.255	0.32	0.12
23230	782	1RB_Mid	Left	/	23.45	24.50	0.067	0.09	0.096	0.12	-0.17
23230	782	1RB_Mid	Right	/	23.45	24.50	0.174	0.22	0.253	0.32	0.19
23230	782	1RB_Mid	Top	Fig.18	23.45	24.50	0.141	0.18	0.272	0.35	-0.06
23230	782	25RB_High	Front	/	22.38	23.50	0.088	0.11	0.146	0.19	-0.12
23230	782	25RB_High	Rear	/	22.38	23.50	0.118	0.15	0.194	0.25	0.15
23230	782	25RB_High	Left	/	22.38	23.50	0.051	0.07	0.074	0.10	-0.07
23230	782	25RB_High	Right	/	22.38	23.50	0.135	0.17	0.196	0.25	-0.04
23230	782	25RB_High	Top	/	22.38	23.50	0.112	0.14	0.217	0.28	0.05

Note1: The distance between the EUT and the phantom bottom is 10mm.

Note2: The LTE mode is QPSK_10MHz.

Table 14.1-19: SAR Values (LTE Band25 - Head)

Frequency		Mode	Side	Test Position	Figure No./ Note	Conducted Power (dBm)	Max. tune-up Power (dBm)	Measured SAR(10g) (W/kg)	Reported SAR(10g) (W/kg)	Measured SAR(1g) (W/kg)	Reported SAR(1g) (W/kg)	Power Drift (dB)
Ch.	MHz											
26365	1882.5	1RB_Mid	Left	Touch	/	22.18	22.50	0.272	0.29	0.623	0.67	-0.10
26365	1882.5	1RB_Mid	Left	Tilt	/	22.18	22.50	0.083	0.09	0.153	0.16	0.09
26590	1905	1RB_Low	Right	Touch	/	22.06	22.50	0.359	0.40	0.783	0.87	0.19
26365	1882.5	1RB_Mid	Right	Touch	Fig.19	22.18	22.50	0.401	0.43	0.853	0.92	0.05
26140	1860	1RB_High	Right	Touch	/	21.94	22.50	0.374	0.43	0.812	0.92	-0.06
26365	1882.5	1RB_Mid	Right	Tilt	/	22.18	22.50	0.119	0.13	0.238	0.26	-0.11
26365	1882.5	50RB_High	Left	Touch	/	21.38	21.50	0.157	0.16	0.320	0.33	-0.16
26365	1882.5	50RB_High	Left	Tilt	/	21.38	21.50	0.078	0.08	0.150	0.15	0.07
26365	1882.5	50RB_High	Right	Touch	/	21.38	21.50	0.326	0.34	0.728	0.75	-0.09
26365	1882.5	50RB_High	Right	Tilt	/	21.38	21.50	0.093	0.10	0.184	0.19	0.06
26365	1882.5	100RB	Right	Touch	/	21.32	21.50	0.311	0.32	0.709	0.74	0.18

Note1: The LTE mode is QPSK_20MHz.

Table 14.1-20: SAR Values (LTE Band25 - Body)

Frequency		Mode	Test Position	Figure No./ Note	Conducted Power (dBm)	Max. tune-up Power (dBm)	Measured SAR(10g) (W/kg)	Reported SAR(10g) (W/kg)	Measured SAR(1g) (W/kg)	Reported SAR(1g) (W/kg)	Power Drift (dB)
Ch.	MHz										
26365	1882.5	1RB_Mid	Front	/	21.16	21.50	0.139	0.15	0.276	0.30	-0.14
26365	1882.5	1RB_Mid	Rear	/	21.16	21.50	0.275	0.30	0.532	0.58	0.15
26590	1905	1RB_Mid	Left	Fig.20	21.08	21.50	0.417	0.46	0.857	0.94	0.08
26365	1882.5	1RB_Mid	Left	/	21.16	21.50	0.391	0.42	0.804	0.87	-0.13
26140	1860	1RB_Mid	Left	/	20.89	21.50	0.364	0.42	0.728	0.84	-0.11
26365	1882.5	1RB_Mid	Top	/	21.16	21.50	0.043	0.05	0.075	0.08	0.04
26590	1905	50RB_Low	Front	/	21.20	21.50	0.134	0.14	0.241	0.26	-0.1
26590	1905	50RB_Low	Rear	/	21.20	21.50	0.322	0.35	0.612	0.66	0.06
26590	1905	50RB_Low	Left	/	21.20	21.50	0.357	0.38	0.710	0.76	0.06
26590	1905	50RB_Low	Top	/	21.20	21.50	0.048	0.05	0.083	0.09	-0.02
26365	1882.5	100RB	Left	/	21.13	21.50	0.403	0.44	0.721	0.79	0.07

Note1: The distance between the EUT and the phantom bottom is 10mm.

Note2: The LTE mode is QPSK_20MHz.

Table 14.1-21: SAR Values (LTE Band25 - Body)

Frequency		Mode	Test Position	Figure No./ Note	Conducted Power (dBm)	Max. tune-up Power (dBm)	Measured SAR(10g) (W/kg)	Reported SAR(10g) (W/kg)	Measured SAR(1g) (W/kg)	Reported SAR(1g) (W/kg)	Power Drift (dB)
Ch.	MHz										
26365	1882.5	1RB_Mid	Front	/	22.18	22.50	0.041	0.04	0.080	0.09	-0.19
26365	1882.5	1RB_Mid	Rear	/	22.18	22.50	0.114	0.12	0.212	0.23	0.16
26365	1882.5	50RB_High	Front	/	21.38	21.50	0.041	0.04	0.068	0.07	0.17
26365	1882.5	50RB_High	Rear	Fig.21	21.38	21.50	0.122	0.13	0.224	0.23	0.00

Note1: The distance between the EUT and the phantom bottom is 15mm.

Note2: The LTE mode is QPSK_20MHz.

Table 14.1-22: SAR Values (LTE Band26 - Head)

Frequency		Mode	Side	Test Position	Figure No.	Conducted Power (dBm)	Max. tune-up Power (dBm)	Measured SAR(10g) (W/kg)	Reported SAR(10g) (W/kg)	Measured SAR(1g) (W/kg)	Reported SAR(1g) (W/kg)	Power Drift (dB)
Ch.	MHz											
26965	841.5	1RB_Mid	Left	Touch	/	23.86	24.50	0.371	0.43	0.632	0.73	-0.02
26965	841.5	1RB_Mid	Left	Tilt	/	23.86	24.50	0.366	0.42	0.706	0.82	-0.02
26865	831.5	1RB_Mid	Left	Tilt	/	23.85	24.50	0.382	0.44	0.732	0.85	-0.14
26775	822.5	1RB_Mid	Left	Tilt	Fig.22	23.74	24.50	0.385	0.46	0.739	0.88	-0.02
26965	841.5	1RB_Mid	Right	Touch	/	23.86	24.50	0.358	0.41	0.600	0.70	0.02
26965	841.5	1RB_Mid	Right	Tilt	/	23.86	24.50	0.303	0.35	0.545	0.63	0.04
26965	841.5	36RB_Mid	Left	Touch	/	22.84	23.50	0.274	0.32	0.453	0.53	-0.15
26965	841.5	36RB_Mid	Left	Tilt	/	22.84	23.50	0.261	0.30	0.485	0.56	-0.14
26965	841.5	36RB_Mid	Right	Touch	/	22.84	23.50	0.249	0.29	0.416	0.48	-0.13
26965	841.5	36RB_Mid	Right	Tilt	/	22.84	23.50	0.224	0.26	0.419	0.49	-0.19
26865	831.5	75RB	Left	Tilt	/	22.76	23.50	0.267	0.32	0.502	0.60	0.11

Note1: The LTE mode is QPSK_15MHz.

Table 14.1-23: SAR Values (LTE Band26 - Body)

Frequency		Mode	Test Position	Figure No.	Conducted Power (dBm)	Max. tune-up Power (dBm)	Measured SAR(10g) (W/kg)	Reported SAR(10g) (W/kg)	Measured SAR(1g) (W/kg)	Reported SAR(1g) (W/kg)	Power Drift (dB)
Ch.	MHz										
26965	841.5	1RB_Mid	Front	/	23.86	24.50	0.160	0.19	0.274	0.32	0.05
26965	841.5	1RB_Mid	Rear	/	23.86	24.50	0.207	0.24	0.348	0.40	0.09
26965	841.5	1RB_Mid	Left	/	23.86	24.50	0.088	0.10	0.133	0.15	0.12
26965	841.5	1RB_Mid	Right	/	23.86	24.50	0.183	0.21	0.278	0.32	-0.13
26965	841.5	1RB_Mid	Top	Fig.23	23.86	24.50	0.197	0.23	0.372	0.43	-0.10
26965	841.5	36RB_Mid	Front	/	22.84	23.50	0.127	0.15	0.218	0.25	0.05
26965	841.5	36RB_Mid	Rear	/	22.84	23.50	0.170	0.20	0.278	0.32	-0.04

26965	841.5	36RB_Mid	Left	/	22.84	23.50	0.072	0.08	0.110	0.13	0.16
26965	841.5	36RB_Mid	Right	/	22.84	23.50	0.149	0.17	0.225	0.26	0.04
26965	841.5	36RB_Mid	Top	/	22.84	23.50	0.154	0.18	0.301	0.35	-0.16

Note1: The distance between the EUT and the phantom bottom is 10mm.

Note2: The LTE mode is QPSK_15MHz.

Table 14.1-24: SAR Values (LTE Band41 PC2- Head)

Frequency		Mode	Side	Test Position	Figure No.	Conducted Power (dBm)	tune-up Power (dBm)	Measured SAR(10g) (W/kg)	Reported SAR(10g) (W/kg)	Measured SAR(1g) (W/kg)	Reported SAR(1g) (W/kg)	Power Drift (dB)
Ch.	MHz											
41490	2680	1RB_Mid	Left	Touch	/	23.75	24.60	0.253	0.31	0.662	0.81	-0.10
41055	2636.5	1RB_Mid	Left	Touch	/	23.98	24.60	0.284	0.33	0.741	0.85	0.03
40620	2593	1RB_Low	Left	Touch	/	23.78	24.60	0.264	0.32	0.682	0.82	0.06
40185	2549.5	1RB_Mid	Left	Touch	/	24.40	24.60	0.311	0.33	0.795	0.83	0.02
39750	2506	1RB_High	Left	Touch	Fig.24	23.33	24.60	0.292	0.39	0.768	1.03	0.12
40185	2549.5	1RB_Mid	Left	Tilt	/	24.40	24.60	0.066	0.07	0.128	0.13	0.08
40185	2549.5	1RB_Mid	Right	Touch	/	24.40	24.60	0.183	0.19	0.403	0.42	-0.13
40185	2549.5	1RB_Mid	Right	Tilt	/	24.40	24.60	0.032	0.03	0.079	0.08	-0.09
40185	2549.5	50RB_Mid	Left	Touch	/	23.37	23.60	0.255	0.27	0.586	0.62	0.04
40185	2549.5	50RB_Mid	Left	Tilt	/	23.37	23.60	0.050	0.05	0.097	0.10	0.05
40185	2549.5	50RB_Mid	Right	Touch	/	23.37	23.60	0.156	0.16	0.341	0.36	0.06
40185	2549.5	50RB_Mid	Right	Tilt	/	23.37	23.60	0.030	0.03	0.053	0.06	0.01
40185	2549.5	100RB	Left	Touch	/	23.32	23.60	0.272	0.29	0.598	0.64	-0.17
41515	2682.5	1RB_Low	Left	Touch	ULCA	23.84	24.60	0.201	0.24	0.512	0.61	0.03

Note1: The LTE mode is QPSK_20MHz.

Table 14.1-25: SAR Values (LTE Band41 PC2- Body)

Frequency		Mode	Test Position	Figure No.	Conducted Power (dBm)	tune-up Power (dBm)	Measured SAR(10g) (W/kg)	Reported SAR(10g) (W/kg)	Measured SAR(1g) (W/kg)	Reported SAR(1g) (W/kg)	Power Drift (dB)
Ch.	MHz										
40185	2549.5	1RB_Mid	Front	/	23.80	24.30	0.060	0.07	0.139	0.16	0.05
40185	2549.5	1RB_Mid	Rear	/	23.80	24.30	0.131	0.15	0.323	0.36	0.13
41490	2680	1RB_Mid	Right	/	22.92	24.30	0.322	0.44	0.740	1.02	0.19
41055	2636.5	1RB_Mid	Right	/	23.19	24.30	0.363	0.47	0.838	1.08	-0.1
40620	2593	1RB_Low	Right	/	23.06	24.30	0.322	0.43	0.744	0.99	0.11
40185	2549.5	1RB_Mid	Right	/	23.80	24.30	0.250	0.28	0.746	0.84	0.04
39750	2506	1RB_High	Right	/	22.70	24.30	0.232	0.34	0.590	0.85	-0.09
40185	2549.5	1RB_Mid	Top	/	23.80	24.30	0.026	0.03	0.051	0.06	0.09
40185	2549.5	50RB_High	Front	/	23.77	24.30	0.109	0.12	0.195	0.22	0.08
40185	2549.5	50RB_High	Rear	/	23.77	24.30	0.252	0.28	0.535	0.60	0.08
41490	2680	50RB_High	Right	/	22.97	24.30	0.348	0.47	0.793	1.08	-0.08
41055	2636.5	50RB_Mid	Right	/	23.18	24.30	0.362	0.47	0.835	1.08	0.02

40620	2593	50RB_Low	Right	/	22.99	24.30	0.347	0.47	0.794	1.07	-0.01
40185	2549.5	50RB_High	Right	Fig.25	23.77	24.30	0.425	0.48	1.01	1.14	0.09
39750	2506	50RB_High	Right	/	22.66	24.30	0.241	0.35	0.549	0.80	0.13
40185	2549.5	50RB_Mid	Top	/	23.77	24.30	0.018	0.02	0.048	0.05	-0.13
40185	2549.5	100RB	Right	/	23.80	24.30	0.341	0.38	0.788	0.88	-0.13
41515	2682.5	1RB_Low	Right	ULCA	22.55	24.30	0.316	0.47	0.567	0.85	0.02
40185	2549.5	50RB_High	Right	B2	23.77	24.30	0.327	0.37	0.73	0.83	0.15

Note1: The distance between the EUT and the phantom bottom is 10mm.

Note2: The LTE mode is QPSK_20MHz.

Table 14.1-26: SAR Values (LTE Band41 PC2- Body)

Frequency		Mode	Test Position	Figure No.	Conducted Power (dBm)	tune-up Power (dBm)	Measured SAR(10g) (W/kg)	Reported SAR(10g) (W/kg)	Measured SAR(1g) (W/kg)	Reported SAR(1g) (W/kg)	Power Drift (dB)
Ch.	MHz										
40185	2549.5	1RB_Mid	Front	/	24.40	24.60	0.070	0.07	0.137	0.14	-0.06
40185	2549.5	1RB_Mid	Rear	Fig.26	24.40	24.60	0.207	0.22	0.428	0.45	-0.15
40185	2549.5	50RB_Mid	Front	/	23.37	23.60	0.047	0.05	0.099	0.10	-0.13
40185	2549.5	50RB_Mid	Rear	/	23.37	23.60	0.149	0.16	0.300	0.32	0.09
41515	2682.5	1RB_Low	Rear	ULCA	23.84	24.60	0.147	0.18	0.296	0.35	0.07

Note1: The distance between the EUT and the phantom bottom is 10mm.

Note2: The LTE mode is QPSK_20MHz.

Table 14.1-27: SAR Values (LTE Band41 PC3- Head)

Frequency		Mode	Side	Test Position	Figure No.	Conducted Power (dBm)	tune-up Power (dBm)	Measured SAR(10g) (W/kg)	Reported SAR(10g) (W/kg)	Measured SAR(1g) (W/kg)	Reported SAR(1g) (W/kg)	Power Drift (dB)
Ch.	MHz											
40185	2549.5	1RB_Mid	Left	Touch	Fig.27	21.37	22.00	0.240	0.28	0.616	0.71	0.06
40185	2549.5	1RB_Mid	Left	Tilt	/	21.37	22.00	0.053	0.06	0.106	0.12	-0.12
40185	2549.5	1RB_Mid	Right	Touch	/	21.37	22.00	0.144	0.17	0.315	0.36	0.02
40185	2549.5	1RB_Mid	Right	Tilt	/	21.37	22.00	0.025	0.03	0.060	0.07	-0.02
40185	2549.5	50RB_High	Left	Touch	/	20.49	21.00	0.195	0.22	0.442	0.50	-0.06
40185	2549.5	50RB_High	Left	Tilt	/	20.49	21.00	0.035	0.04	0.073	0.08	-0.19
40185	2549.5	50RB_High	Right	Touch	/	20.49	21.00	0.295	0.33	0.203	0.23	0.07
40185	2549.5	50RB_High	Right	Tilt	/	20.49	21.00	0.022	0.02	0.040	0.04	0.04
41515	2682.5	1RB_Low	Left	Touch	ULCA	20.88	22.00	0.211	0.27	0.542	0.70	0.05

Note1: The LTE mode is QPSK_20MHz.

Table 14.1-28: SAR Values (LTE Band41 PC3- Body)

Frequency		Mode	Test Position	Figure No.	Ambient Temperature: 22.9 °C		Liquid Temperature: 22.5 °C		Measured SAR(1g) (W/kg)	Reported SAR(1g) (W/kg)	Power Drift (dB)
Ch.	MHz				Conducted Power (dBm)	tune-up Power (dBm)	Measured SAR(10g) (W/kg)	Reported SAR(10g) (W/kg)			
40185	2549.5	1RB_Mid	Front	/	20.75	21.30	0.076	0.09	0.168	0.19	0.05
40185	2549.5	1RB_Mid	Rear	/	20.75	21.30	0.145	0.16	0.344	0.39	-0.08
41490	2680	1RB_Mid	Right	/	19.92	21.30	0.260	0.36	0.601	0.83	-0.04
41055	2636.5	1RB_Mid	Right	/	20.15	21.30	0.227	0.30	0.641	0.84	0.12
40620	2593	1RB_Low	Right	/	20.02	21.30	0.249	0.33	0.581	0.78	0.03
40185	2549.5	1RB_Mid	Right	/	20.75	21.30	0.318	0.36	0.760	0.86	-0.12
39750	2506	1RB_High	Right	/	19.71	21.30	0.176	0.25	0.407	0.59	0.08
40185	2549.5	1RB_Mid	Top	/	20.75	21.30	0.022	0.02	0.056	0.06	-0.05
40185	2549.5	50RB_Mid	Front	/	20.77	21.30	0.074	0.08	0.162	0.18	-0.02
40185	2549.5	50RB_Mid	Rear	/	20.77	21.30	0.231	0.26	0.628	0.71	-0.03
41490	2680	50RB_High	Right	/	19.97	21.30	0.265	0.36	0.614	0.83	0.13
41055	2636.5	50RB_Mid	Right	/	20.16	21.30	0.279	0.36	0.645	0.84	0.18
40620	2593	50RB_Low	Right	/	19.97	21.30	0.257	0.35	0.596	0.81	-0.03
40185	2549.5	50RB_Mid	Right	Fig.28	20.77	21.30	0.329	0.37	0.789	0.89	0.08
39750	2506	50RB_High	Right	/	19.68	21.30	0.177	0.26	0.407	0.59	0.13
40185	2549.5	50RB_Mid	Top	/	20.77	21.30	0.020	0.02	0.044	0.05	0.05
40185	2549.5	100RB	Right	/	20.68	21.30	0.260	0.30	0.602	0.69	0.19
41515	2682.5	1RB_Low	Right	ULCA	19.76	21.30	0.272	0.39	0.613	0.87	0.06

Note1: The distance between the EUT and the phantom bottom is 10mm.

Note2: The LTE mode is QPSK_20MHz.

Table 14.1-29: SAR Values (LTE Band41 PC3- Body)

Frequency		Mode	Test Position	Figure No.	Ambient Temperature: 22.9 °C		Liquid Temperature: 22.5 °C		Measured SAR(1g) (W/kg)	Reported SAR(1g) (W/kg)	Power Drift (dB)
Ch.	MHz				Conducted Power (dBm)	tune-up Power (dBm)	Measured SAR(10g) (W/kg)	Reported SAR(10g) (W/kg)			
40185	2549.5	1RB_Mid	Front	/	21.37	22.00	0.052	0.06	0.098	0.11	0.18
40185	2549.5	1RB_Mid	Rear	Fig.29	21.37	22.00	0.153	0.18	0.317	0.37	-0.09
40185	2549.5	50RB_High	Front	/	20.49	21.00	0.041	0.05	0.075	0.08	0.15
40185	2549.5	50RB_High	Rear	/	20.49	21.00	0.125	0.14	0.259	0.29	-0.02
41515	2682.5	1RB_Low	Rear	ULCA	20.88	22.00	0.127	0.16	0.261	0.34	0.08

Note1: The distance between the EUT and the phantom bottom is 15mm.

Note2: The LTE mode is QPSK_20MHz.

Table 14.1-30: SAR Values (LTE Band66 - Head)

Frequency		Mode	Side	Test Position	Figure No.	Conducted Power (dBm)	Max. tune-up Power (dBm)	Measured SAR(10g) (W/kg)	Reported SAR(10g) (W/kg)	Measured SAR(1g) (W/kg)	Reported SAR(1g) (W/kg)	Power Drift (dB)
Ch.	MHz											
132322	1745	1RB_Mid	Left	Touch	/	21.96	22.50	0.287	0.32	0.604	0.68	0.02
132322	1745	1RB_Mid	Left	Tilt	/	21.96	22.50	0.135	0.15	0.250	0.28	-0.05
132570	1770	1RB_Mid	Right	Touch	/	21.85	22.50	0.353	0.41	0.764	0.89	-0.08
132322	1745	1RB_Mid	Right	Touch	/	21.94	22.50	0.362	0.41	0.791	0.90	-0.15
132072	1720	1RB_Mid	Right	Touch	Fig.30	21.96	22.50	0.380	0.43	0.793	0.90	0.08
132322	1745	1RB_Mid	Right	Tilt	/	21.96	22.50	0.119	0.13	0.228	0.26	-0.16
132072	1720	50RB_Mid	Left	Touch	/	20.98	21.50	0.223	0.25	0.481	0.54	-0.09
132072	1720	50RB_Mid	Left	Tilt	/	20.98	21.50	0.082	0.09	0.149	0.17	0.02
132072	1720	50RB_Mid	Right	Touch	/	20.98	21.50	0.238	0.27	0.518	0.58	-0.08
132072	1720	50RB_Mid	Right	Tilt	/	20.98	21.50	0.094	0.11	0.180	0.20	-0.07
132322	1745	100RB	Right	Touch	/	20.72	21.50	0.381	0.46	0.533	0.64	0.03

Note1: The LTE mode is QPSK_20MHz.

Table 14.1-31: SAR Values (LTE Band66 - Body)

Frequency		Mode	Test Position	Figure No.	Conducted Power (dBm)	Max. tune-up Power (dBm)	Measured SAR(10g) (W/kg)	Reported SAR(10g) (W/kg)	Measured SAR(1g) (W/kg)	Reported SAR(1g) (W/kg)	Power Drift (dB)
Ch.	MHz										
132072	1720	1RB_Mid	Front	/	20.97	21.50	0.268	0.30	0.460	0.52	0.02
132570	1770	1RB_Mid	Rear	/	20.78	21.50	0.309	0.36	0.620	0.73	-0.18
132322	1745	1RB_Mid	Rear	/	20.76	21.50	0.303	0.36	0.577	0.68	0.02
132072	1720	1RB_Mid	Rear	/	20.97	21.50	0.388	0.44	0.711	0.80	0.16
132072	1720	1RB_Mid	Left	/	20.97	21.50	0.310	0.35	0.618	0.70	0.11
132072	1720	1RB_Mid	Top	/	20.97	21.50	0.075	0.08	0.127	0.14	0.17
132072	1720	50RB_High	Front	/	21.11	21.50	0.324	0.35	0.685	0.75	0.06
132570	1770	50RB_Mid	Rear	/	20.77	21.50	0.288	0.34	0.659	0.78	0.07
132322	1745	50RB_Mid	Rear	/	20.81	21.50	0.322	0.38	0.646	0.76	-0.12
132072	1720	50RB_High	Rear	Fig.31	21.11	21.50	0.431	0.47	0.822	0.90	0.19
132072	1720	50RB_High	Left	/	21.11	21.50	0.299	0.33	0.611	0.67	0.02
132072	1720	50RB_High	Top	/	21.11	21.50	0.075	0.08	0.123	0.13	0.09
132072	1720	100RB	Rear	/	21.07	21.50	0.304	0.34	0.602	0.66	-0.08

Note1: The distance between the EUT and the phantom bottom is 10mm

Note2: The LTE mode is QPSK_20MHz.

Table 14.1-32: SAR Values (LTE Band66 - Body)

Frequency		Mode	Test Position	Figure No.	Conducted Power (dBm)	Max. tune-up Power (dBm)	Measured SAR(10g) (W/kg)	Reported SAR(10g) (W/kg)	Measured SAR(1g) (W/kg)	Reported SAR(1g) (W/kg)	Power Drift (dB)
Ch.	MHz										
132072	1720	1RB_Mid	Front	/	21.96	22.50	0.092	0.10	0.163	0.18	-0.01
132072	1720	1RB_Mid	Rear	Fig.32	21.96	22.50	0.230	0.26	0.408	0.46	-0.11
132072	1720	50RB_High	Front	/	20.98	21.50	0.071	0.08	0.124	0.14	0.11
132072	1720	50RB_High	Rear	/	20.98	21.50	0.207	0.23	0.382	0.43	0.06

Note1: The distance between the EUT and the phantom bottom is 15mm

Note2: The LTE mode is QPSK_20MHz.

Table 14.1-33: SAR Values (LTE Band71 - Head)

Frequency		Mode	Side	Test Position	Figure No.	Conducted Power (dBm)	Max. tune-up Power (dBm)	Measured SAR(10g) (W/kg)	Reported SAR(10g) (W/kg)	Measured SAR(1g) (W/kg)	Reported SAR(1g) (W/kg)	Power Drift (dB)
Ch.	MHz											
133222	673	1RB_Mid	Left	Touch	/	24.01	24.50	0.240	0.27	0.427	0.48	-0.05
133222	673	1RB_Mid	Left	Tilt	Fig.33	24.01	24.50	0.226	0.25	0.439	0.49	0.01
133222	673	1RB_Mid	Right	Touch	/	24.01	24.50	0.266	0.30	0.366	0.41	0.04
133222	673	1RB_Mid	Right	Tilt	/	24.01	24.50	0.179	0.20	0.312	0.35	-0.17
133322	683	50RB_Mid	Left	Touch	/	22.95	23.50	0.230	0.26	0.383	0.43	-0.07
133322	683	50RB_Mid	Left	Tilt	/	22.95	23.50	0.202	0.23	0.390	0.44	-0.07
133322	683	50RB_Mid	Right	Touch	/	22.95	23.50	0.166	0.19	0.264	0.30	0.04
133322	683	50RB_Mid	Right	Tilt	/	22.95	23.50	0.153	0.17	0.270	0.31	-0.03

Note1: The LTE mode is QPSK_20MHz.

Table 14.1-34: SAR Values (LTE Band71 - Body)

Frequency		Mode	Test Position	Figure No.	Conducted Power (dBm)	Max. tune-up Power (dBm)	Measured SAR(10g) (W/kg)	Reported SAR(10g) (W/kg)	Measured SAR(1g) (W/kg)	Reported SAR(1g) (W/kg)	Power Drift (dB)
Ch.	MHz										
133222	673	1RB_Mid	Front	/	24.01	24.50	0.150	0.17	0.207	0.23	-0.16
133222	673	1RB_Mid	Rear	/	24.01	24.50	0.187	0.21	0.265	0.30	0.14
133222	673	1RB_Mid	Left	/	24.01	24.50	0.121	0.14	0.182	0.20	-0.02
133222	673	1RB_Mid	Right	Fig.34	24.01	24.50	0.201	0.23	0.286	0.32	-0.15
133222	673	1RB_Mid	Top	/	24.01	24.50	0.086	0.10	0.167	0.19	-0.17
133322	683	50RB_Mid	Front	/	22.95	23.50	0.127	0.14	0.175	0.20	0.12
133322	683	50RB_Mid	Rear	/	22.95	23.50	0.156	0.18	0.213	0.24	-0.13
133322	683	50RB_Mid	Left	/	22.95	23.50	0.102	0.12	0.154	0.17	0.09
133322	683	50RB_Mid	Right	/	22.95	23.50	0.185	0.21	0.272	0.31	-0.19
133322	683	50RB_Mid	Top	/	22.95	23.50	0.071	0.08	0.144	0.16	-0.05

Note1: The distance between the EUT and the phantom bottom is 10mm

Note2: The LTE mode is QPSK_20MHz.

14.2 SAR results for Standard procedure

There is zoom scan measurement to be added for the highest measured SAR in each exposure configuration/band.

Table 14.2-1: SAR Values (GSM 850 MHz Band - Head)

Frequency		Side	Test Position	Figure No./Note	Conducted Power (dBm)	Max. tune-up Power (dBm)	Measured SAR(10g) (W/kg)	Reported SAR(10g) (W/kg)	Measured SAR(1g) (W/kg)	Reported SAR(1g) (W/kg)	Power Drift (dB)
Ch.	MHz										
128	824.2	Left	Tilt	Fig.1	27.69	28.00	0.310	0.33	0.638	0.69	0.06

Table 14.2-2: SAR Values (GSM 850 MHz Band - Body)

Frequency		Mode (number of timeslots)	Test Position	Figure No./Note	Conducted Power (dBm)	Max. tune-up Power (dBm)	Measured SAR(10g) (W/kg)	Reported SAR(10g) (W/kg)	Measured SAR(1g) (W/kg)	Reported SAR(1g) (W/kg)	Power Drift (dB)
Ch.	MHz										
190	836.6	GPRS (4)	Top	Fig.2	27.73	28.00	0.139	0.15	0.264	0.28	0.14

Note: The distance between the EUT and the phantom bottom is 10mm.

Table 14.2-3: SAR Values (GSM 1900 MHz Band - Head)

Frequency		Side	Test Position	Figure No./Note	Conducted Power (dBm)	Max. tune-up Power (dBm)	Measured SAR(10g) (W/kg)	Reported SAR(10g) (W/kg)	Measured SAR(1g) (W/kg)	Reported SAR(1g) (W/kg)	Power Drift (dB)
Ch.	MHz										
512	1850.2	Right	Touch	Fig.3	27.30	28.70	0.348	0.48	0.730	1.01	0.10

Table 14.2-4: SAR Values (GSM 1900 MHz Band - Body)

Frequency		Mode (number of timeslots)	Test Position	Figure No./Note	Conducted Power (dBm)	Max. tune-up Power (dBm)	Measured SAR(10g) (W/kg)	Reported SAR(10g) (W/kg)	Measured SAR(1g) (W/kg)	Reported SAR(1g) (W/kg)	Power Drift (dB)
Ch.	MHz										
661	1880	GPRS (4)	Left	Fig.4	23.67	24.50	0.221	0.27	0.445	0.54	0.09

Note: The distance between the EUT and the phantom bottom is 10mm.

Table 14.2-5: SAR Values (WCDMA 850 MHz Band - Head)

Frequency		Side	Test Position	Figure No./Note	Conducted Power (dBm)	Max. tune-up Power (dBm)	Measured SAR(10g) (W/kg)	Reported SAR(10g) (W/kg)	Measured SAR(1g) (W/kg)	Reported SAR(1g) (W/kg)	Power Drift (dB)
Ch.	MHz										
4132	826.4	Left	Tilt	Fig.5	23.14	24.00	0.360	0.44	0.601	0.73	-0.09

Table 14.2-6: SAR Values (WCDMA 850 MHz Band - Body)

Frequency		Test Position	Figure No./Note	Conducted Power (dBm)	Max. tune-up Power (dBm)	Measured SAR(10g) (W/kg)	Reported SAR(10g) (W/kg)	Measured SAR(1g) (W/kg)	Reported SAR(1g) (W/kg)	Power Drift (dB)
Ch.	MHz									
4132	826.4	Rear	Fig.6	23.14	24.00	0.180	0.22	0.293	0.36	0.05

Note: The distance between the EUT and the phantom bottom is 10mm.

Table 14.2-7: SAR Values (WCDMA 1700 MHz Band - Head)

Frequency		Side	Test Position	Figure No./Note	Conducted Power (dBm)	Max. tune-up Power (dBm)	Measured SAR(10g) (W/kg)	Reported SAR(10g) (W/kg)	Measured SAR(1g) (W/kg)	Reported SAR(1g) (W/kg)	Power Drift (dB)
Ch.	MHz										
1412	1732.4	Right	Touch	Fig.7	21.22	22.00	0.427	0.51	0.912	1.09	0.05

Table 14.2-8: SAR Values (WCDMA 1700 MHz Band - Body)

Frequency		Test Position	Figure No./Note	Conducted Power (dBm)	Max. tune-up Power (dBm)	Measured SAR(10g) (W/kg)	Reported SAR(10g) (W/kg)	Measured SAR(1g) (W/kg)	Reported SAR(1g) (W/kg)	Power Drift (dB)
Ch.	MHz									
1513	1752.6	Rear	Fig.8	19.83	20.50	0.305	0.36	0.579	0.68	0.15

Note1: The distance between the EUT and the phantom bottom is 10mm.

Table 14.2-9: SAR Values (WCDMA 1700 MHz Band - Body)

Frequency		Test Position	Figure No./Note	Conducted Power (dBm)	Max. tune-up Power (dBm)	Measured SAR(10g) (W/kg)	Reported SAR(10g) (W/kg)	Measured SAR(1g) (W/kg)	Reported SAR(1g) (W/kg)	Power Drift (dB)
Ch.	MHz									
1513	1752.6	Rear	Fig.9	20.98	21.5	0.212	0.24	0.386	0.44	-0.04

Note1: The distance between the EUT and the phantom bottom is 15mm.

Table 14.2-10: SAR Values (WCDMA 1900 MHz Band - Head)

Frequency		Side	Test Position	Figure No./Note	Conducted Power (dBm)	Max. tune-up Power (dBm)	Measured SAR(10g) (W/kg)	Reported SAR(10g) (W/kg)	Measured SAR(1g) (W/kg)	Reported SAR(1g) (W/kg)	Power Drift (dB)
Ch.	MHz										
9400	1880	Right	Touch	Fig.10	21.96	22.50	0.410	0.46	0.896	1.01	-0.17

Table 14.2-11: SAR Values (WCDMA 1900 MHz Band - Body)

Frequency		Test Position	Figure No./Note	Conducted Power (dBm)	Max. tune-up Power (dBm)	Measured SAR(10g) (W/kg)	Reported SAR(10g) (W/kg)	Measured SAR(1g) (W/kg)	Reported SAR(1g) (W/kg)	Power Drift (dB)
Ch.	MHz									
9400	1880	Left	Fig.11	20.41	21.00	0.311	0.36	0.636	0.73	0.07

Note1: The distance between the EUT and the phantom bottom is 10mm.

Table 14.2-12: SAR Values (WCDMA 1900 MHz Band - Body)

Frequency		Test Position	Figure No./Note	Conducted Power (dBm)	Max. tune-up Power (dBm)	Measured SAR(10g) (W/kg)	Reported SAR(10g) (W/kg)	Measured SAR(1g) (W/kg)	Reported SAR(1g) (W/kg)	Power Drift (dB)
Ch.	MHz									
9538	1907.6	Rear	Fig.12	21.10	22.00	0.186	0.23	0.336	0.41	-0.12

Note1: The distance between the EUT and the phantom bottom is 15mm.

Table 14.2-13: SAR Values (LTE Band7 - Head)

Frequency		Mode	Side	Test Position	Figure No./ Note	Conducted Power (dBm)	Max. tune-up Power (dBm)	Measured SAR(10g) (W/kg)	Reported SAR(10g) (W/kg)	Measured SAR(1g) (W/kg)	Reported SAR(1g) (W/kg)	Power Drift (dB)
Ch.	MHz											
20850	2510	1RB_High	Left	Touch	Fig.13	19.37	20.80	0.232	0.32	0.612	0.85	0.18

Note1: The LTE mode is QPSK_20MHz.

Table 14.2-14: SAR Values (LTE Band7 - Body)

Frequency		Mode	Test Position	Figure No./ Note	Conducted Power (dBm)	Max. tune-up Power (dBm)	Measured SAR(10g) (W/kg)	Reported SAR(10g) (W/kg)	Measured SAR(1g) (W/kg)	Reported SAR(1g) (W/kg)	Power Drift (dB)
Ch.	MHz										
21350	2560	1RB_Mid	Right	Fig.14	20.28	20.80	0.353	0.40	0.815	0.92	0.05

Note1: The distance between the EUT and the phantom bottom is 10mm.

Note2: The LTE mode is QPSK_20MHz.

Table 14.2-15: SAR Values (LTE Band12 - Head)

Frequency		Mode	Side	Test Position	Figure No./ Note	Conducted Power (dBm)	Max. tune-up Power (dBm)	Measured SAR(10g) (W/kg)	Reported SAR(10g) (W/kg)	Measured SAR(1g) (W/kg)	Reported SAR(1g) (W/kg)	Power Drift (dB)
Ch.	MHz											
23060	704	1RB_Low	Left	Touch	Fig.15	23.87	24.50	0.326	0.38	0.442	0.51	-0.16

Note1: The LTE mode is QPSK_10MHz.

Table 14.2-16 SAR Values (LTE Band12- Body)

Ambient Temperature: 22.9°C Liquid Temperature: 22.5°C											
Frequency		Mode	Test Position	Figure No./ Note	Conducted Power (dBm)	Max. tune-up Power (dBm)	Measured SAR(10g) (W/kg)	Reported SAR(10g) (W/kg)	Measured SAR(1g) (W/kg)	Reported SAR(1g) (W/kg)	Power Drift (dB)
Ch.	MHz										
23060	704	1RB_Low	Right	Fig.16	23.87	24.50	0.239	0.28	0.341	0.39	-0.09

Note1: The distance between the EUT and the phantom bottom is 10mm.

Note2: The LTE mode is QPSK_10MHz.

Table 14.2-17: SAR Values (LTE Band13 - Head)

Frequency		Mode	Side	Test Position	Figure No.	Conducted Power (dBm)	Max. tune-up Power (dBm)	Measured SAR(10g) (W/kg)	Reported SAR(10g) (W/kg)	Measured SAR(1g) (W/kg)	Reported SAR(1g) (W/kg)	Power Drift (dB)
Ch.	MHz											
23230	782	1RB_Mid	Left	Touch	Fig.17	23.45	24.50	0.249	0.32	0.469	0.60	-0.12

Note1: The LTE mode is QPSK_10MHz.

Table 14.2-18: SAR Values (LTE Band13 - Body)

Frequency		Mode	Test Position	Figure No.	Conducted Power (dBm)	Max. tune-up Power (dBm)	Measured SAR(10g) (W/kg)	Reported SAR(10g) (W/kg)	Measured SAR(1g) (W/kg)	Reported SAR(1g) (W/kg)	Power Drift (dB)
Ch.	MHz										
23230	782	1RB_Mid	Top	Fig.18	23.45	24.50	0.141	0.18	0.272	0.35	-0.06

Note1: The distance between the EUT and the phantom bottom is 10mm.

Note2: The LTE mode is QPSK_10MHz.

Table 14.2-19: SAR Values (LTE Band25 - Head)

Frequency		Mode	Side	Test Position	Figure No./ Note	Conducted Power (dBm)	Max. tune-up Power (dBm)	Measured SAR(10g) (W/kg)	Reported SAR(10g) (W/kg)	Measured SAR(1g) (W/kg)	Reported SAR(1g) (W/kg)	Power Drift (dB)
Ch.	MHz											
26365	1882.5	1RB_Mid	Right	Touch	Fig.19	22.18	22.50	0.401	0.43	0.853	0.92	0.05

Note1: The LTE mode is QPSK_20MHz.

Table 14.2-20: SAR Values (LTE Band25 - Body)

Frequency		Mode	Test Position	Figure No./ Note	Conducted Power (dBm)	Max. tune-up Power (dBm)	Measured SAR(10g) (W/kg)	Reported SAR(10g) (W/kg)	Measured SAR(1g) (W/kg)	Reported SAR(1g) (W/kg)	Power Drift (dB)
Ch.	MHz										
26590	1905	1RB_Mid	Left	Fig.20	21.08	21.50	0.417	0.46	0.857	0.94	0.08

Note1: The distance between the EUT and the phantom bottom is 10mm.

Note2: The LTE mode is QPSK_20MHz.

Table 14.2-21: SAR Values (LTE Band25 - Body)

Frequency		Mode	Test Position	Figure No./ Note	Conducted Power (dBm)	Max. tune-up Power (dBm)	Measured SAR(10g) (W/kg)	Reported SAR(10g) (W/kg)	Measured SAR(1g) (W/kg)	Reported SAR(1g) (W/kg)	Power Drift (dB)
Ch.	MHz										
26365	1882.5	50RB_High	Rear	Fig.21	21.38	21.50	0.122	0.13	0.224	0.23	0.00

Note1: The distance between the EUT and the phantom bottom is 15mm.

Note2: The LTE mode is QPSK_20MHz.

Table 14.2-22: SAR Values (LTE Band26 - Head)

Frequency		Mode	Side	Test Position	Figure No.	Conducted Power (dBm)	Max. tune-up Power (dBm)	Measured SAR(10g) (W/kg)	Reported SAR(10g) (W/kg)	Measured SAR(1g) (W/kg)	Reported SAR(1g) (W/kg)	Power Drift (dB)
Ch.	MHz											

26775	822.5	1RB_Mid	Left	Tilt	Fig.22	23.74	24.50	0.385	0.46	0.739	0.88	-0.02
-------	-------	---------	------	------	--------	-------	-------	-------	-------------	-------	-------------	-------

Note1: The LTE mode is QPSK_15MHz.

Table 14.2-23: SAR Values (LTE Band26 - Body)

Frequency		Mode	Test Position	Figure No.	Conducted Power (dBm)	Max. tune-up Power (dBm)	Measured SAR(10g) (W/kg)	Reported SAR(10g) (W/kg)	Measured SAR(1g) (W/kg)	Reported SAR(1g) (W/kg)	Power Drift (dB)
Ch.	MHz										
26965	841.5	1RB_Mid	Top	Fig.23	23.86	24.50	0.197	0.23	0.372	0.43	-0.10

Note1: The distance between the EUT and the phantom bottom is 10mm.

Note2: The LTE mode is QPSK_15MHz.

Table 14.2-24: SAR Values (LTE Band41 PC2- Head)

Frequency		Mode	Side	Test Position	Figure No.	Conducted Power (dBm)	tune-up Power (dBm)	Measured SAR(10g) (W/kg)	Reported SAR(10g) (W/kg)	Measured SAR(1g) (W/kg)	Reported SAR(1g) (W/kg)	Power Drift (dB)
Ch.	MHz											
39750	2506	1RB_High	Left	Touch	Fig.24	23.33	24.60	0.292	0.39	0.768	1.03	0.12

Note1: The LTE mode is QPSK_20MHz.

Table 14.2-25: SAR Values (LTE Band41 PC2- Body)

Frequency		Mode	Test Position	Figure No.	Conducted Power (dBm)	tune-up Power (dBm)	Measured SAR(10g) (W/kg)	Reported SAR(10g) (W/kg)	Measured SAR(1g) (W/kg)	Reported SAR(1g) (W/kg)	Power Drift (dB)
Ch.	MHz										
40185	2549.5	50RB_High	Right	Fig.25	23.77	24.30	0.425	0.48	1.01	1.14	0.09

Note1: The distance between the EUT and the phantom bottom is 10mm.

Note2: The LTE mode is QPSK_20MHz.

Table 14.2-26: SAR Values (LTE Band41 PC2- Body)

Frequency		Mode	Test Position	Figure No.	Conducted Power (dBm)	tune-up Power (dBm)	Measured SAR(10g) (W/kg)	Reported SAR(10g) (W/kg)	Measured SAR(1g) (W/kg)	Reported SAR(1g) (W/kg)	Power Drift (dB)
Ch.	MHz										
40185	2549.5	1RB_Mid	Rear	Fig.26	24.40	24.60	0.207	0.22	0.428	0.45	-0.15

Note1: The distance between the EUT and the phantom bottom is 10mm.

Note2: The LTE mode is QPSK_20MHz.

Table 14.2-27: SAR Values (LTE Band41 PC3- Head)

Frequency		Mode	Side	Test Position	Figure No.	Conducted Power (dBm)	tune-up Power (dBm)	Measured SAR(10g) (W/kg)	Reported SAR(10g) (W/kg)	Measured SAR(1g) (W/kg)	Reported SAR(1g) (W/kg)	Power Drift (dB)
Ch.	MHz											
40185	2549.5	1RB_Mid	Left	Touch	Fig.27	21.37	22.00	0.240	0.28	0.616	0.71	0.06

Note1: The LTE mode is QPSK_20MHz.

Table 14.2-28: SAR Values (LTE Band41 PC3- Body)

Frequency		Mode	Test Position	Figure No.	Conducted Power (dBm)	tune-up Power (dBm)	Measured SAR(10g) (W/kg)	Reported SAR(10g) (W/kg)	Measured SAR(1g) (W/kg)	Reported SAR(1g) (W/kg)	Power Drift (dB)
Ch.	MHz										
40185	2549.5	50RB_Mid	Right	Fig.28	20.77	21.30	0.329	0.37	0.789	0.89	0.08

Note1: The distance between the EUT and the phantom bottom is 10mm.

Note2: The LTE mode is QPSK_20MHz.

Table 14.2-29: SAR Values (LTE Band41 PC3- Body)

Frequency		Mode	Test Position	Figure No.	Conducted Power (dBm)	tune-up Power (dBm)	Measured SAR(10g) (W/kg)	Reported SAR(10g) (W/kg)	Measured SAR(1g) (W/kg)	Reported SAR(1g) (W/kg)	Power Drift (dB)
Ch.	MHz										
40185	2549.5	1RB_Mid	Rear	Fig.29	21.37	22.00	0.153	0.18	0.317	0.37	-0.09

Note1: The distance between the EUT and the phantom bottom is 15mm.

Note2: The LTE mode is QPSK_20MHz.

Table 14.2-30: SAR Values (LTE Band66 - Head)

Frequency		Mode	Side	Test Position	Figure No.	Conducted Power (dBm)	Max. tune-up Power (dBm)	Measured SAR(10g) (W/kg)	Reported SAR(10g) (W/kg)	Measured SAR(1g) (W/kg)	Reported SAR(1g) (W/kg)	Power Drift (dB)
Ch.	MHz											
132072	1720	1RB_Mid	Right	Touch	Fig.30	21.96	22.50	0.380	0.43	0.793	0.90	0.08

Note1: The LTE mode is QPSK_20MHz.

Table 14.2-31: SAR Values (LTE Band66 - Body)

Frequency		Mode	Test Position	Figure No.	Conducted Power (dBm)	Max. tune-up Power (dBm)	Measured SAR(10g) (W/kg)	Reported SAR(10g) (W/kg)	Measured SAR(1g) (W/kg)	Reported SAR(1g) (W/kg)	Power Drift (dB)
Ch.	MHz										
132072	1720	50RB_High	Rear	Fig.31	21.11	21.50	0.431	0.47	0.822	0.90	0.19

Note1: The distance between the EUT and the phantom bottom is 10mm

Note2: The LTE mode is QPSK_20MHz.

Table 14.2-32: SAR Values (LTE Band66 - Body)

Frequency		Mode	Test Position	Figure No.	Conducted Power (dBm)	Max. tune-up Power (dBm)	Measured SAR(10g) (W/kg)	Reported SAR(10g) (W/kg)	Measured SAR(1g) (W/kg)	Reported SAR(1g) (W/kg)	Power Drift (dB)
Ch.	MHz										
132072	1720	1RB_Mid	Rear	Fig.32	21.96	22.50	0.230	0.26	0.408	0.46	-0.11

Note1: The distance between the EUT and the phantom bottom is 15mm

Note2: The LTE mode is QPSK_20MHz.

Table 14.2-33: SAR Values (LTE Band71 - Head)

Frequency		Mode	Side	Test Position	Figure No.	Conducted Power (dBm)	Max. tune-up Power (dBm)	Measured SAR(10g) (W/kg)	Reported SAR(10g) (W/kg)	Measured SAR(1g) (W/kg)	Reported SAR(1g) (W/kg)	Power Drift (dB)
Ch.	MHz											
133222	673	1RB_Mid	Left	Tilt	Fig.33	24.01	24.50	0.226	0.25	0.439	0.49	0.01

Note1: The LTE mode is QPSK_20MHz.

Table 14.2-34: SAR Values (LTE Band71 - Body)

Frequency		Mode	Test Position	Figure No.	Conducted Power (dBm)	Max. tune-up Power (dBm)	Measured SAR(10g) (W/kg)	Reported SAR(10g) (W/kg)	Measured SAR(1g) (W/kg)	Reported SAR(1g) (W/kg)	Power Drift (dB)
Ch.	MHz										
133222	673	1RB_Mid	Right	Fig.34	24.01	24.50	0.201	0.23	0.286	0.32	-0.15

Note1: The distance between the EUT and the phantom bottom is 10mm

Note2: The LTE mode is QPSK_20MHz.

14.3 WLAN Evaluation for 2.4G

According to the KDB248227 D01, SAR is measured for 2.4GHz 802.11b DSSS using the initial test position procedure.

Head Evaluation-Standalone

Table 14.3-1: SAR Values (WLAN - Head)– 802.11b (Fast SAR)

Frequency		Side	Test Position	Figure No./ Note	Conducted Power (dBm)	Max. tune-up Power (dBm)	Ambient Temperature: 22.9°C		Liquid Temperature: 22.5°C		Power Drift (dB)
MHz	Ch.						Measured SAR(10g) (W/kg)	Reported SAR(10g) (W/kg)	Measured SAR(1g) (W/kg)	Reported SAR(1g)(W/kg)	
2412	1	Left	Touch	/	21.21	21.50	0.255	0.27	0.431	0.46	0.13
2412	1	Left	Tilt	/	21.21	21.50	0.285	0.30	0.534	0.57	-0.03
2412	1	Right	Touch	/	21.21	21.50	0.367	0.39	0.746	0.80	0.00
2412	1	Right	Tilt	/	21.21	21.50	0.398	0.43	0.785	0.84	0.11

As shown above table, the initial test position for head is “Right Tilt”. So the head SAR of WLAN is presented as below:

Table 14.3-2: SAR Values (WLAN - Head)– 802.11b (Full SAR)

Frequency		Side	Test Position	Figure No./ Note	Conducted Power (dBm)	Max. tune-up Power (dBm)	Ambient Temperature: 22.9°C		Liquid Temperature: 22.5°C		Power Drift (dB)
MHz	Ch.						Measured SAR(10g) (W/kg)	Reported SAR(10g) (W/kg)	Measured SAR(1g) (W/kg)	Reported SAR(1g)(W/kg)	
2412	1	Right	Touch	/	21.21	21.50	0.320	0.34	0.636	0.68	0.00
2412	1	Right	Tilt	Fig.35	21.21	21.50	0.356	0.38	0.682	0.73	0.11

Note1: When the reported SAR of the initial test position is > 0.4 W/kg, SAR is repeated for the 802.11 transmission mode configuration tested in the initial test position using subsequent highest estimated 1-g SAR conditions determined by area scans, on the highest maximum output power channel, until the reported SAR is \leq 0.8 W/kg.

Note2: For all positions/configurations tested using the initial test position and subsequent test positions, when the reported SAR is > 0.8 W/kg, SAR is measured for these test positions/configurations on the subsequent next highest measured output power channel until the reported SAR is \leq 1.2 W/kg or all required channels are tested.

According to the KDB248227 D01, The reported SAR must be scaled to 100% transmission duty factor to determine compliance at the maximum tune-up tolerance limit. The scaled reported SAR is presented as below.

Table 14.3-3: SAR Values (WLAN - Head) – 802.11b (Scaled Reported SAR)

Frequency		Side	Test Position	Ambient Temperature: 22.9°C		Liquid Temperature: 22.5°C	
MHz	Ch.			Actual duty factor	maximum duty factor	Reported SAR (1g)(W/kg)	Scaled reported SAR (1g)(W/kg)
2412	1	Right	Tilt	100%	100%	0.73	0.73

SAR is not required for OFDM because the 802.11b adjusted SAR \leq 1.2 W/kg.

Head Evaluation- Simultaneous transmit
Table 14.3-4: SAR Values (WLAN - Head)– 802.11b (Fast SAR)

Frequency		Side	Test Position	Figure No./ Note	Ambient Temperature: 22.9 °C		Liquid Temperature: 22.5 °C				
MHz	Ch.				Conducted Power (dBm)	Max. tune-up Power (dBm)	Measured SAR(10g) (W/kg)	Reported SAR(10g) (W/kg)	Measured SAR(1g) (W/kg)	Reported SAR(1g)(W/kg)	Power Drift (dB)
2412	1	Left	Touch	/	14.42	14.50	0.059	0.06	0.099	0.10	-0.05
2412	1	Left	Tilt	/	14.42	14.50	0.067	0.07	0.130	0.13	0.12
2412	1	Right	Touch	/	14.42	14.50	0.077	0.08	0.155	0.16	0.05
2412	1	Right	Tilt	/	14.42	14.50	0.083	0.08	0.168	0.17	0.08

As shown above table, the initial test position for head is “Right Tilt”. So the head SAR of WLAN is presented as below:

Table 14.3-5: SAR Values (WLAN - Head)– 802.11b (Full SAR)

Frequency		Side	Test Position	Figure No./ Note	Ambient Temperature: 22.9 °C		Liquid Temperature: 22.5 °C				
MHz	Ch.				Conducted Power (dBm)	Max. tune-up Power (dBm)	Measured SAR(10g) (W/kg)	Reported SAR(10g) (W/kg)	Measured SAR(1g) (W/kg)	Reported SAR(1g)(W/kg)	Power Drift (dB)
2412	1	Right	Touch	/	14.42	14.50	0.073	0.07	0.145	0.15	0.05
2412	1	Right	Tilt	/	14.42	14.50	0.075	0.08	0.144	0.15	0.08

Note1: When the reported SAR of the initial test position is > 0.4 W/kg, SAR is repeated for the 802.11 transmission mode configuration tested in the initial test position using subsequent highest estimated 1-g SAR conditions determined by area scans, on the highest maximum output power channel, until the reported SAR is \leq 0.8 W/kg.

Note2: For all positions/configurations tested using the initial test position and subsequent test positions, when the reported SAR is > 0.8 W/kg, SAR is measured for these test positions/configurations on the subsequent next highest measured output power channel until the reported SAR is \leq 1.2 W/kg or all required channels are tested.

According to the KDB248227 D01, The reported SAR must be scaled to 100% transmission duty factor to determine compliance at the maximum tune-up tolerance limit. The scaled reported SAR is presented as below.

Table 14.3-6: SAR Values (WLAN - Head) – 802.11b (Scaled Reported SAR)

Frequency		Side	Test Position	Ambient Temperature: 22.9 °C		Liquid Temperature: 22.5 °C	
MHz	Ch.			Actual duty factor	maximum duty factor	Reported SAR (1g)(W/kg)	Scaled reported SAR (1g)(W/kg)
2412	1	Right	Touch	100%	100%	0.15	0.15

SAR is not required for OFDM because the 802.11b adjusted SAR \leq 1.2 W/kg.

Body Evaluation- Standalone
Table 14.3-7: SAR Values (WLAN - Body)– 802.11b (Fast SAR)

Frequency		Test Position	Figure No./ Note	Conducted Power (dBm)	Max. tune-up Power (dBm)	Ambient Temperature: 22.9 °C		Liquid Temperature: 22.5 °C		Power Drift (dB)
MHz	Ch.					Measured SAR(10g) (W/kg)	Reported SAR(10g) (W/kg)	Measured SAR(1g) (W/kg)	Reported SAR(1g)(W/kg)	
2412	1	Front	/	21.21	21.50	0.113	0.12	0.205	0.22	0.08
2412	1	Rear	/	21.21	21.50	0.245	0.26	0.482	0.52	-0.04
2412	1	Left	/	21.21	21.50	0.163	0.17	0.327	0.35	0.18
2412	1	Top	/	21.21	21.50	0.149	0.16	0.307	0.33	0.02

As shown above table, the initial test position for body is “Rear ”. So the body SAR of WLAN is presented as below:

Table 14.3-8: SAR Values (WLAN - Body)– 802.11b (Full SAR)

Frequency		Test Position	Figure No./ Note	Conducted Power (dBm)	Max. tune-up Power (dBm)	Ambient Temperature: 22.9 °C		Liquid Temperature: 22.5 °C		Power Drift (dB)
MHz	Ch.					Measured SAR(10g) (W/kg)	Reported SAR(10g) (W/kg)	Measured SAR(1g) (W/kg)	Reported SAR(1g)(W/kg)	
2412	1	Rear	Fig.36	21.21	21.50	0.228	0.24	0.461	0.49	-0.04

Note1: When the reported SAR of the initial test position is > 0.4 W/kg, SAR is repeated for the 802.11 transmission mode configuration tested in the initial test position using subsequent highest estimated 1-g SAR conditions determined by area scans, on the highest maximum output power channel, until the reported SAR is \leq 0.8 W/kg.

Note2: For all positions/configurations tested using the initial test position and subsequent test positions, when the reported SAR is > 0.8 W/kg, SAR is measured for these test positions/configurations on the subsequent next highest measured output power channel until the reported SAR is \leq 1.2 W/kg or all required channels are tested.

According to the KDB248227 D01, The reported SAR must be scaled to 100% transmission duty factor to determine compliance at the maximum tune-up tolerance limit. The scaled reported SAR is presented as below.

Table 14.3-9: SAR Values (WLAN - Body) – 802.11b (Scaled Reported SAR)

Frequency		Test Position	Ambient Temperature: 22.9 °C		Liquid Temperature: 22.5 °C	
MHz	Ch.		Actual duty factor	maximum duty factor	Reported SAR (1g)(W/kg)	Scaled reported SAR (1g)(W/kg)
2412	1	Rear	100%	100%	0.49	0.49

SAR is not required for OFDM because the 802.11b adjusted SAR \leq 1.2 W/kg.

Body Evaluation- Simultaneous transmit
Table 14.3-10: SAR Values (WLAN - Body)– 802.11b (Fast SAR)

Frequency		Test Position	Figure No./ Note	Conducted Power (dBm)	Max. tune-up Power (dBm)	Ambient Temperature: 22.9 °C		Liquid Temperature: 22.5 °C		Power Drift (dB)
MHz	Ch.					Measured SAR(10g) (W/kg)	Reported SAR(10g) (W/kg)	Measured SAR(1g) (W/kg)	Reported SAR(1g)(W/kg)	
2412	1	Front	/	15.45	15.50	0.035	0.04	0.066	0.07	-0.09
2412	1	Rear	/	15.45	15.50	0.067	0.07	0.139	0.14	0.05
2412	1	Left	/	15.45	15.50	0.050	0.05	0.107	0.11	0.07
2412	1	Top	/	15.45	15.50	0.057	0.06	0.110	0.11	0.12

As shown above table, the initial test position for body is “Rear ”. So the body SAR of WLAN is presented as below:

Table 14.3-11: SAR Values (WLAN - Body)– 802.11b (Full SAR)

Frequency		Test Position	Figure No./ Note	Conducted Power (dBm)	Max. tune-up Power (dBm)	Ambient Temperature: 22.9 °C		Liquid Temperature: 22.5 °C		Power Drift (dB)
MHz	Ch.					Measured SAR(10g) (W/kg)	Reported SAR(10g) (W/kg)	Measured SAR(1g) (W/kg)	Reported SAR(1g)(W/kg)	
2412	1	Rear	/	15.45	15.50	0.062	0.06	0.129	0.13	0.05

Note1: When the reported SAR of the initial test position is > 0.4 W/kg, SAR is repeated for the 802.11 transmission mode configuration tested in the initial test position using subsequent highest estimated 1-g SAR conditions determined by area scans, on the highest maximum output power channel, until the reported SAR is \leq 0.8 W/kg.

Note2: For all positions/configurations tested using the initial test position and subsequent test positions, when the reported SAR is > 0.8 W/kg, SAR is measured for these test positions/configurations on the subsequent next highest measured output power channel until the reported SAR is \leq 1.2 W/kg or all required channels are tested.

According to the KDB248227 D01, The reported SAR must be scaled to 100% transmission duty factor to determine compliance at the maximum tune-up tolerance limit. The scaled reported SAR is presented as below.

Table 14.3-12: SAR Values (WLAN - Body) – 802.11b (Scaled Reported SAR)

Frequency		Test Position	Ambient Temperature: 22.9 °C		Liquid Temperature: 22.5 °C	
MHz	Ch.		Actual duty factor	maximum duty factor	Reported SAR (1g)(W/kg)	Scaled reported SAR (1g)(W/kg)
2412	1	Rear	100%	100%	0.13	0.13

SAR is not required for OFDM because the 802.11b adjusted SAR \leq 1.2 W/kg.

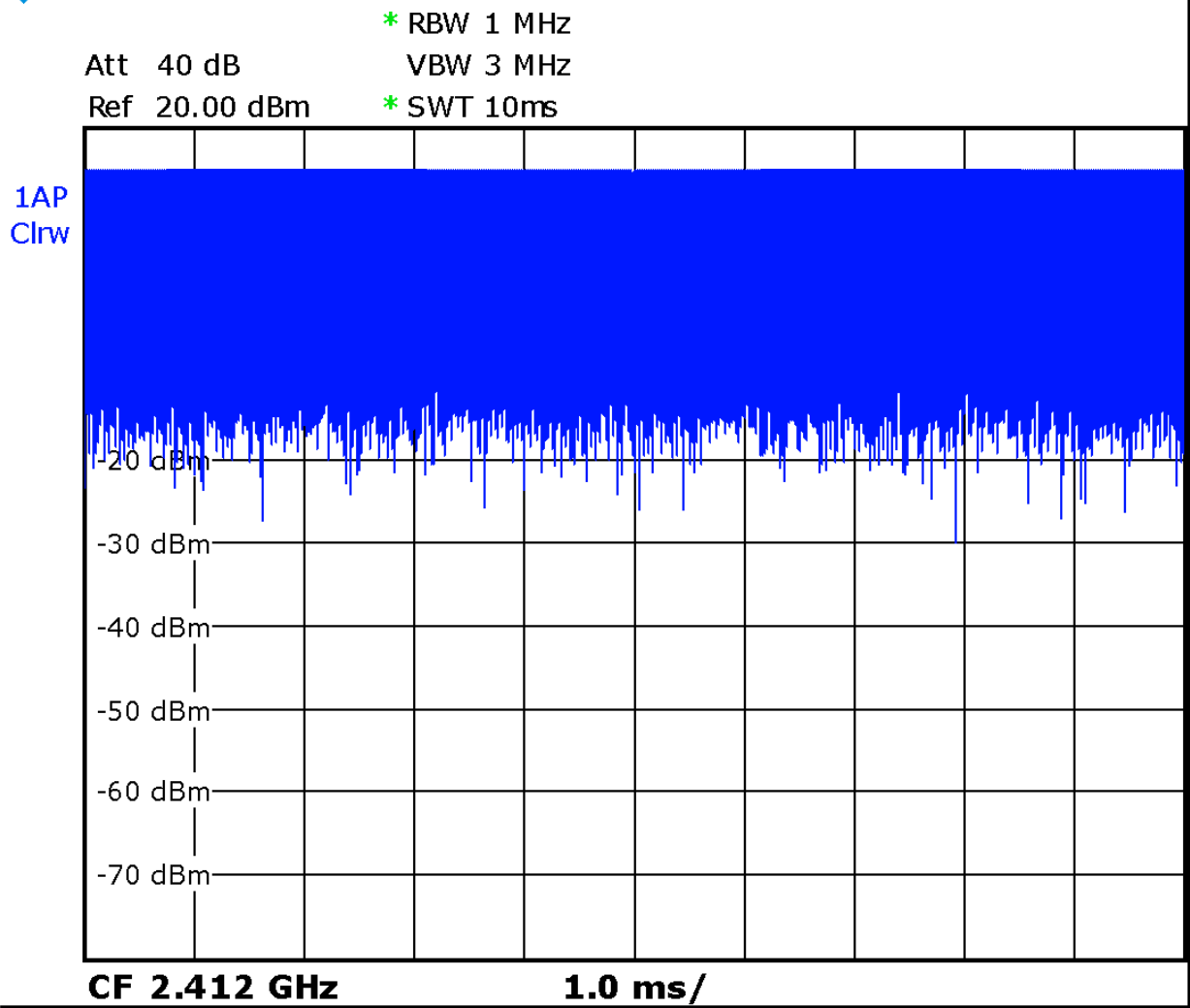

Picture 14.1 Duty factor plot for head

14.4 WLAN Evaluation For 5G

Table 14.4-1: OFDM mode specified maximum output power of WLAN antenna

802.11 mode	a	g	n		ac			
Ch. BW(MHz)	20	20	20	40	20	40	80	160
U-NII-1	X		X	X	X	X	X	
U-NII-2A	X		X	X	X	X	X	
U-NII-2C	X		X	X	X	X	X	
U-NII-3	X		X	X	X	X	X	
§ 15.247 (5.8 GHz)								

X: maximum(conducted) output power(mW), including tolerance, specified for production units

Table 14.4-2: Maximum output power specified of WLAN antenna - Standalone

802.11 mode	a	g	n		ac			
Ch. BW(MHz)	20	20	20	40	20	40	80	160
U-NII-1	100		89	89	89	89	89	
U-NII-2A	100		89	89	89	89	89	
U-NII-2C	100		89	89	89	89	89	
U-NII-3	100		89	89	89	89	89	
§ 15.247 (5.8 GHz)								

- The maximum output power specified for production units is the same for all channels, modulations and data rates in each channel bandwidth configuration of the 802.11a/g/n/ac modes.
- The **blue highlighted** cells represent highest output configurations in each standalone or aggregated frequency band, with tune-up tolerance included.

Table 14.4-3: Maximum output power specified of WLAN antenna for Head - Simultaneous transmit

802.11 mode	a	g	n		ac			
Ch. BW(MHz)	20	20	20	40	20	40	80	160
U-NII-1	32		25	25	25	25	25	
U-NII-2A	32		25	25	25	25	25	
U-NII-2C	32		25	25	25	25	25	
U-NII-3	32		25	25	25	25	25	
§ 15.247 (5.8 GHz)								

- The maximum output power specified for production units is the same for all channels, modulations and data rates in each channel bandwidth configuration of the 802.11a/g/n/ac modes.
- The **blue highlighted** cells represent highest output configurations in each standalone or aggregated frequency band, with tune-up tolerance included.

Table 14.4-4: Maximum output power specified of WLAN antenna for Body - Simultaneous transmit

802.11 mode	a	g	n		ac			
Ch. BW(MHz)	20	20	20	40	20	40	80	160
U-NII-1	25		20	20	20	20	20	
U-NII-2A	25		20	20	20	20	20	
U-NII-2C	25		20	20	20	20	20	
U-NII-3	25		20	20	20	20	20	
§ 15.247 (5.8 GHz)								

- The maximum output power specified for production units is the same for all channels, modulations and data rates in each channel bandwidth configuration of the 802.11a/g/n/ac modes.
- The **blue highlighted** cells represent highest output configurations in each standalone or aggregated frequency band, with tune-up tolerance included.

Table 14.4-5: Maximum output power measured of WLAN antenna, for the applicable OFDM configurations according to the default power measurement procedures for selection initial test configurations - Standalone

802.11 mode	a	n		ac		
BW(MHz)	20	20	40	20	40	80
U-NII-1	36/40/44/ 48 71/74/79/80	36/40/44/48 Lower power	38/46 Lower power	36/40/44/48 Lower power	38/46 Lower power	42 Lower power
U-NII-2A	52 /56/60/64 89/86/85/83	52/56/60/64 Lower power	54/62 Lower power	52/56/60/64 Lower power	54/62 Lower power	58 Lower power
U-NII-2C	100/104/108/112 116/120/124/128 132 /136/140/144 74/74/76/80/75/7 6/80/77/ 82 /79/77/ 77/	100/104/108/112 116/132/136/140 Lower power	102/110/134 Lower power	100/104/108/112 116/132/136/140 Lower power	102/110/134 Lower power	106/122/138 Lower power
U-NII-3	149/153/157/ 161 / 165 80/85/91/ 93 /93	149/153/157/161 /165 Lower power	151/159 Lower power	149/153/157/161 /165 Lower power	151/159 Lower power	155 Lower power

- The **bold numbers** is the maximum output measured power (mW).
- Channels with measured maximum power within 0.25dB are considered to have the same measured output. Channels selected for initial test configuration are **highlighted in yellow**.

Table 14.4-6: Maximum output power measured of WLAN antenna, for the applicable OFDM configurations according to the default power measurement procedures for selection initial test configurations - Head Simultaneous transmit

802.11 mode	a	n		ac		
BW(MHz)	20	20	40	20	40	80
U-NII-1	36/40/44/48 22/22/24/24	36/40/44/48 Lower power	38/46 Lower power	36/40/44/48 Lower power	38/46 Lower power	42 Lower power
U-NII-2A	52/56/60/64 26/24/24/22	52/56/60/64 Lower power	54/62 Lower power	52/56/60/64 Lower power	54/62 Lower power	58 Lower power
U-NII-2C	100/104/108/112 116/120/124/128 132/136/140/144 20/20/21/22/21/2 2/22/21/23/22/21/ 22	100/104/108/112 116/132/136/140 Lower power	102/110/134 Lower power	100/104/108/112 116/132/136/140 Lower power	102/110/134 Lower power	106/122/138 Lower power
U-NII-3	149/153/157/161/ 165 22/22/25/25/26	149/153/157/161 /165 Lower power	151/159 Lower power	149/153/157/161 /165 Lower power	151/159 Lower power	155 Lower power

- The **bold numbers** is the maximum output measured power (mW).
- Channels with measured maximum power within 0.25dB are considered to have the same measured output. Channels selected for initial test configuration are **highlighted in yellow**.

Table 14.4-7: Maximum output power measured of WLAN antenna, for the applicable OFDM configurations according to the default power measurement procedures for selection initial test configurations – Body Simultaneous transmit

802.11 mode	a	n		ac		
BW(MHz)	20	20	40	20	40	80
U-NII-1	36/40/44/48 18/19/19/19	36/40/44/48 Lower power	38/46 Lower power	36/40/44/48 Lower power	38/46 Lower power	42 Lower power
U-NII-2A	52/56/60/64 21/20/19/18	52/56/60/64 Lower power	54/62 Lower power	52/56/60/64 Lower power	54/62 Lower power	58 Lower power
U-NII-2C	100/104/108/112 116/120/124/128 132/136/140/144 17/17/18/18/17/18/18/18/ 19/18/18/18	100/104/108/112 116/132/136/140 Lower power	102/110/134 Lower power	100/104/108 /112 116/132/136/ 140 Lower power	102/110/134 Lower power	106 Lower power
U-NII-3	149/153/157/161/165 18/19/20/21/20	149/153/157/16 1/165 Lower power	151/159 Lower power	149/153/157 /161/165 Lower power	151/159 Lower power	155 Lower power

- The **bold numbers** is the maximum output measured power (mW).
- Channels with measured maximum power within 0.25dB are considered to have the same measured output.

Channels selected for initial test configuration are highlighted in yellow.

Table 14.4-8: Reported SAR of initial test configuration for Head - Standalone

802.11 mode	a	n		ac		
		20	40	20	40	80
U-NII-1	36/40/44/48 UNII-2A exclusion applied	36/40/44/48	38/46	36/40/44/48	38/46	42
U-NII-2A	52/56/60/64 0.38	52/56/60/64	54/62	52/56/60/64	54/62	58
U-NII-2C	100/104/108/112/ 116/120/124/128/ 132/136/140/144 0.49	100/104/108/112 116/132/136/140	102/110/118/ 126/134	100/104/108/112 116/132/136/140	102/110 /134	106/122/138
U-NII-3	149/153/157/161 /165 0.18	149/153/157/161 /165	151/159	149/153/157/161 /165	151/159	155

Highest measured output power channel tested initially are in yellow highlight.

The tune up of UNII-1 is less than UNII-2A. SAR is measured for UNII-2A band first. Adjusted SAR of UNII-2A band is ≤ 1.2 W/kg. SAR is not required for UNII-1 band.

Table 14.4-9: Reported SAR of initial test configuration for Body - Standalone

802.11 mode	a	n		ac		
		20	40	20	40	80
U-NII-1	36/40/44/48 UNII-2A exclusion applied	36/40/44/48	38/46	36/40/44/48	38/46	42
U-NII-2A	52/56/60/64 0.45	52/56/60/64	54/62	52/56/60/64	54/62	58
U-NII-2C	100/104/108/112/ 116/120/124/128/ 132/136/140/144 0.57	100/104/108/112 116/132/136/140	102/110/118/ 126/134	100/104/108/112 116/132/136/140	102/110 /134	106/122/138
U-NII-3	149/153/157/161 /165 0.28	149/153/157/161 /165	151/159	149/153/157/161 /165	151/159	155

Highest measured output power channel tested initially are in yellow highlight.

The tune up of UNII-1 is less than UNII-2A. SAR is measured for UNII-2A band first. Adjusted SAR of UNII-2A band is ≤ 1.2 W/kg. SAR is not required for UNII-1 band.

Table 14.4-10: Reported SAR of initial test configuration for - Head Simultaneous transmit

802.11 mode	a	n		ac		
BW(MHz)	20	20	40	20	40	80
U-NII-1	36/40/44/48 UNII-2A exclusion applied	36/40/44/48	38/46	36/40/44/48	38/46	42
U-NII-2A	52/56/60/64 0.15	52/56/60/64	54/62	52/56/60/64	54/62	58
U-NII-2C	100/104/108/112/ 116/120/124/128/ 132/136/140/144 0.22	100/104/108/112 116/132/136/140	102/110/118/ 126/134	100/104/108/112 116/132/136/140	102/110 /134	106/122/138
U-NII-3	149/153/157/161 /165 0.08	149/153/157/161 /165	151/159	149/153/157/161 /165	151/159	155

Highest measured output power channel tested initially are in **yellow highlight**.

The tune up of UNII-1 is less than UNII-2A. SAR is measured for UNII-2A band first. Adjusted SAR of UNII-2A band is ≤ 1.2 W/kg. SAR is not required for UNII-1 band.

Table 14.4-11: Reported SAR of initial test configuration for - Body Simultaneous transmit

802.11 mode	a	n		ac		
BW(MHz)	20	20	40	20	40	80
U-NII-1	36/40/44/48 UNII-2A exclusion applied	36/40/44/48	38/46	36/40/44/48	38/46	42
U-NII-2A	52/56/60/64 0.15	52/56/60/64	54/62	52/56/60/64	54/62	58
U-NII-2C	100/104/108/112/ 116/120/124/128/ 132/136/140/144 0.29	100/104/108/112 116/132/136/140	102/110/118/ 126/134	100/104/108/112 116/132/136/140	102/110 /134	106/122/138
U-NII-3	149/153/157/161 /165 0.12	149/153/157/161 /165	151/159	149/153/157/161 /165	151/159	155

Highest measured output power channel tested initially are in **yellow highlight**.

The tune up of UNII-1 is less than UNII-2A. SAR is measured for UNII-2A band first. Adjusted SAR of UNII-2A band is ≤ 1.2 W/kg. SAR is not required for UNII-1 band.

Table 14.4-12: SAR Values (WLAN – Head standalone)

Frequency		Side	Test Position	Figure No.	Conducted Power (dBm)	Max. tune-up Power (dBm)	Measured SAR(10g) (W/kg)	Reported SAR(10g) (W/kg)	Measured SAR(1g) (W/kg)	Reported SAR(1g) (W/kg)	Power Drift (dB)
MHz	Ch.										
5260	52	Left	Touch	/	19.48	20.00	0.070	0.08	0.188	0.21	-0.12
5260	52	Left	Tilt	/	19.48	20.00	0.078	0.09	0.228	0.26	0.03
5260	52	Right	Touch	/	19.48	20.00	0.100	0.11	0.341	0.38	0.15
5260	52	Right	Tilt	/	19.48	20.00	0.104	0.12	0.321	0.36	-0.04
5660	132	Left	Touch	/	19.14	20.00	0.081	0.10	0.235	0.29	0.07
5660	132	Left	Tilt	/	19.14	20.00	0.080	0.10	0.246	0.30	-0.09
5660	132	Right	Touch	Fig.37	19.14	20.00	0.116	0.14	0.405	0.49	0.06
5660	132	Right	Tilt	/	19.14	20.00	0.110	0.13	0.346	0.42	-0.12
5805	161	Left	Touch	/	19.69	20.00	0.030	0.03	0.085	0.09	-0.12
5805	161	Left	Tilt	/	19.69	20.00	0.033	0.04	0.093	0.10	-0.14
5805	161	Right	Touch	/	19.69	20.00	0.050	0.05	0.172	0.18	0.15
5805	161	Right	Tilt	/	19.69	20.00	0.038	0.04	0.125	0.13	0.02

Table 14.4-13: SAR Values (WLAN – Body standalone)

Frequency		Test Position	Figure No.	Conducted Power (dBm)	Max. tune-up Power (dBm)	Measured SAR(10g) (W/kg)	Reported SAR(10g) (W/kg)	Measured SAR(1g) (W/kg)	Reported SAR(1g) (W/kg)	Power Drift (dB)
MHz	Ch.									
5260	52	Front	/	19.48	20.00	0.021	0.02	0.060	0.07	-0.16
5260	52	Rear	/	19.48	20.00	0.119	0.13	0.401	0.45	0.00
5260	52	Left		19.48	20.00	0.082	0.09	0.230	0.26	0.06
5260	52	Top	/	19.48	20.00	0.052	0.06	0.144	0.16	0.03
5660	132	Front	/	19.14	20.00	0.031	0.04	0.094	0.11	0.01
5660	132	Rear	Fig.38	19.14	20.00	0.142	0.17	0.471	0.57	0.00
5660	132	Left		19.14	20.00	0.094	0.11	0.272	0.33	0.14
5660	132	Top	/	19.14	20.00	0.061	0.07	0.159	0.19	-0.05
5805	161	Front	/	19.69	20.00	0.018	0.02	0.054	0.06	-0.09
5805	161	Rear	/	19.69	20.00	0.081	0.09	0.257	0.28	-0.08
5805	161	Left		19.69	20.00	0.052	0.06	0.154	0.17	-0.16
5805	161	Top	/	19.69	20.00	0.037	0.04	0.096	0.10	-0.14

Note1: The distance between the EUT and the phantom bottom is 10mm.

Table 14.4-14: SAR Values (WLAN – Head Simultaneous transmit)

Frequency		Side	Test Position	Figure No.	Conducted Power (dBm)	Max. tune-up Power (dBm)	Measured SAR(10g) (W/kg)	Reported SAR(10g) (W/kg)	Measured SAR(1g) (W/kg)	Reported SAR(1g) (W/kg)	Power Drift (dB)
MHz	Ch.										
5260	52	Left	Touch	/	14.15	15.00	0.024	0.03	0.065	0.08	0.11
5260	52	Left	Tilt	/	14.15	15.00	0.033	0.04	0.096	0.12	-0.05
5260	52	Right	Touch	/	14.15	15.00	0.031	0.04	0.095	0.12	0.08
5260	52	Right	Tilt	/	14.15	15.00	0.039	0.05	0.122	0.15	0.15
5660	132	Left	Touch	/	13.68	15.00	0.022	0.03	0.064	0.09	0.03
5660	132	Left	Tilt	/	13.68	15.00	0.022	0.03	0.063	0.09	0.18
5660	132	Right	Touch	/	13.68	15.00	0.043	0.06	0.162	0.22	0.07
5660	132	Right	Tilt	/	13.68	15.00	0.041	0.06	0.140	0.19	0.12
5825	165	Left	Touch	/	14.11	15.00	0.009	0.01	0.040	0.05	0.14
5825	165	Left	Tilt	/	14.11	15.00	0.014	0.02	0.067	0.08	-0.12
5825	165	Right	Touch	/	14.11	15.00	0.017	0.02	0.058	0.07	-0.11
5825	165	Right	Tilt	/	14.11	15.00	0.018	0.02	0.060	0.07	0.02

Table 14.4-15: SAR Values (WLAN – Body Simultaneous transmit)

Frequency		Test Position	Figure No.	Conducted Power (dBm)	Max. tune-up Power (dBm)	Measured SAR(10g) (W/kg)	Reported SAR(10g) (W/kg)	Measured SAR(1g) (W/kg)	Reported SAR(1g) (W/kg)	Power Drift (dB)
MHz	Ch.									
5260	52	Front	/	13.25	14.00	0.007	0.01	0.038	0.05	-0.17
5260	52	Rear	/	13.25	14.00	0.034	0.04	0.124	0.15	-0.08
5260	52	Left		13.25	14.00	0.020	0.02	0.064	0.08	-0.11
5260	52	Top	/	13.25	14.00	0.017	0.02	0.054	0.06	0.00
5660	132	Front	/	12.87	14.00	0.011	0.01	0.059	0.08	-0.03
5660	132	Rear	/	12.87	14.00	0.063	0.08	0.226	0.29	0.10
5660	132	Left		12.87	14.00	0.038	0.05	0.132	0.17	-0.17
5660	132	Top	/	12.87	14.00	0.029	0.04	0.086	0.11	0.16
5805	161	Front	/	13.19	14.00	0.007	0.01	0.041	0.05	0.09
5805	161	Rear	/	13.19	14.00	0.027	0.03	0.103	0.12	-0.06
5805	161	Left		13.19	14.00	0.021	0.03	0.069	0.08	0.13
5805	161	Top	/	13.19	14.00	0.011	0.01	0.059	0.07	-0.13

Note1: The distance between the EUT and the phantom bottom is 10mm.

According to the KDB248227 D01, The reported SAR must be scaled to 100% transmission duty factor to determine compliance at the maximum tune-up tolerance limit. The scaled reported SAR is presented as below.

Table 14.4-16: SAR Values (WLAN - Head standalone) - Scaled Reported SAR

Frequency		Side	Test Position	Actual duty factor	maximum duty factor	Reported SAR (1g) (W/kg)	Scaled reported SAR (1g) (W/kg)
MHz	Ch.						
5660	132	Right	Touch	100%	100%	0.49	0.49

Table 14.4-17: SAR Values (WLAN – Body standalone) – Scaled Reported SAR

Frequency		Test Position	D (mm)	Actual duty factor	maximum duty factor	Reported SAR (1g) (W/kg)	Scaled reported SAR (1g) (W/kg)
MHz	Ch.						
5660	132	Rear	10	100%	100%	0.57	0.57

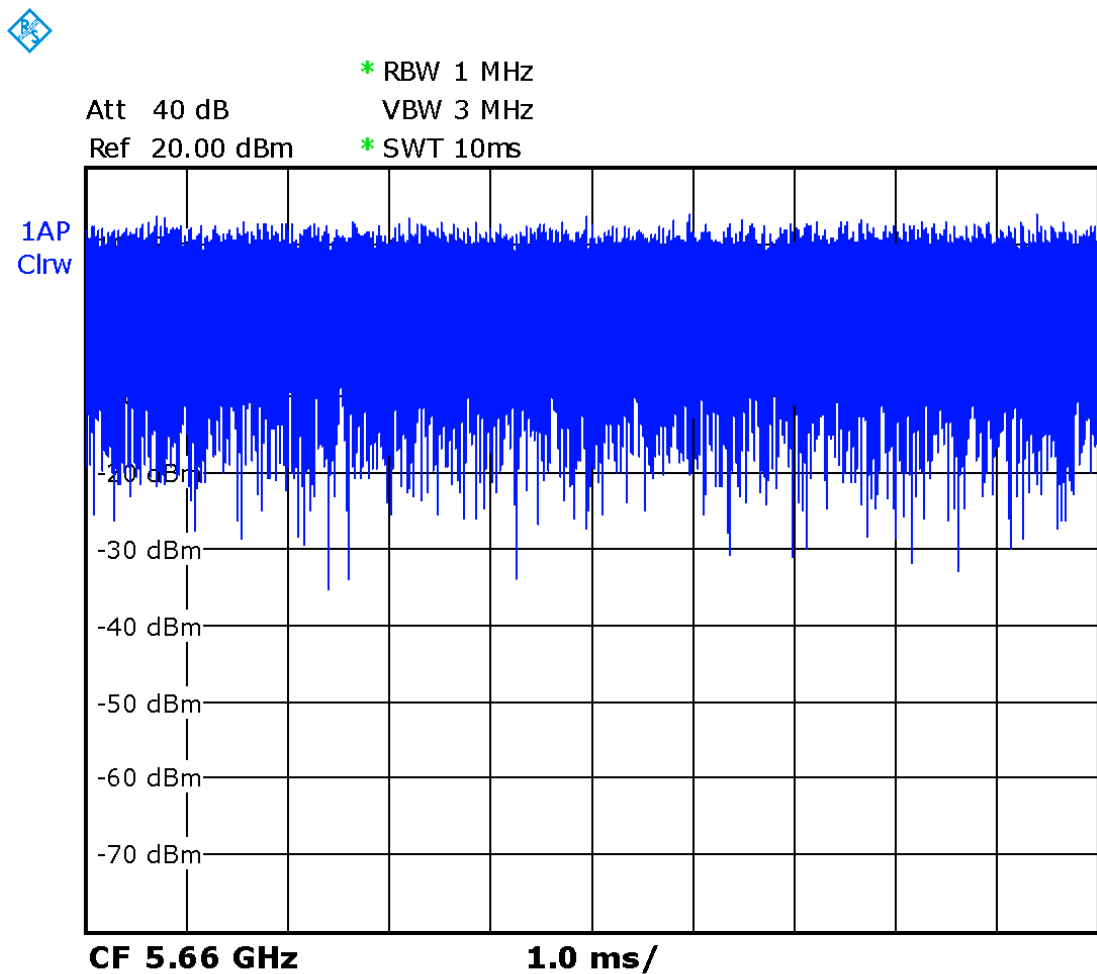

Picture 14.3 The plot of duty factor for Head

14.5 SAR results for Fast BT

Table 14.5-1: SAR Values (Bluetooth - Head)

Frequency		Side	Test Position	Figure No.	Conducted Power (dBm)	Max. tune-up Power (dBm)	Measured SAR(10g) (W/kg)	Reported SAR(10g) (W/kg)	Measured SAR(1g) (W/kg)	Reported SAR(1g) (W/kg)	Power Drift (dB)
Ch.	MHz										
78	2480	Left	Touch	/	7.90	9.00	<0.01	<0.01	<0.01	<0.01	/
78	2480	Left	Tilt	/	7.90	9.00	<0.01	<0.01	<0.01	<0.01	/
78	2480	Right	Touch	Fig.39	7.90	9.00	0.005	0.01	0.012	0.02	0.19
78	2480	Right	Tilt	/	7.90	9.00	<0.01	<0.01	<0.01	<0.01	/

Table 14.5-1: SAR Values (Bluetooth - Body)

Frequency		Test Position	Figure No.	Conducted Power (dBm)	Max. tune-up Power (dBm)	Measured SAR(10g) (W/kg)	Reported SAR(10g) (W/kg)	Measured SAR(1g) (W/kg)	Reported SAR(1g) (W/kg)	Power Drift (dB)
Ch	MHz									
Ambient Temperature: 22.2 °C Liquid Temperature: 22 °C										
78	2480	Front	/	7.90	9.00	<0.01	<0.01	<0.01	<0.01	/
78	2480	Rear	Fig.40	7.90	9.00	0.004	0.01	0.011	0.01	0.18
78	2480	Left	/	7.90	9.00	<0.01	<0.01	<0.01	<0.01	/
78	2480	Top	/	7.90	9.00	<0.01	<0.01	<0.01	<0.01	/

Note1: The distance between the EUT and the phantom bottom is 10mm

14.6 SAR results for SUB6G

Table 14.6-1: SAR Values (NR5G n25-Head)

Frequency		Side	Test Position	Figure No./Note	Conducted Power (dBm)	Max. tune-up Power (dBm)	Measured SAR(10g) (W/kg)	Reported SAR(10g) (W/kg)	Measured SAR(1g) (W/kg)	Reported SAR(1g) (W/kg)	Power Drift (dB)
Ch.	MHz										
376500	1882.5	Left	Cheek	/	19.47	20.00	0.114	0.13	0.228	0.26	0.16
376500	1882.5	Left	Tilt	/	19.47	20.00	0.043	0.05	0.072	0.08	0.18
376500	1882.5	Right	Cheek	Fig.41	19.47	20.00	0.201	0.23	0.434	0.49	0.13
376500	1882.5	Right	Tilt	/	19.47	20.00	0.050	0.06	0.090	0.10	0.05
376500	1882.5	Left	Cheek	DFT-s-OFDM	19.03	20.00	0.175	0.22	0.338	0.42	0.18

Table 14.6-2: SAR Values (NR5G n25-Body)

Frequency		Test Position	Figure No./Note	Conducted Power (dBm)	Max. tune-up Power (dBm)	Measured SAR(10g) (W/kg)	Reported SAR(10g) (W/kg)	Measured SAR(1g) (W/kg)	Reported SAR(1g) (W/kg)	Power Drift (dB)
Ch.	MHz									
376500	1882.5	Front	/	19.47	20.00	0.064	0.07	0.114	0.13	0.12
376500	1882.5	Rear	/	19.47	20.00	0.178	0.20	0.367	0.41	-0.13
376500	1882.5	Left	Fig.42	19.47	20.00	0.222	0.25	0.448	0.51	0.18
376500	1882.5	Top	/	19.47	20.00	<0.01	<0.01	<0.01	<0.01	/
376500	1882.5	Left	DFT-s-OFDM	19.03	20.00	0.203	0.25	0.411	0.51	0.12

Note: The distance between the EUT and the phantom bottom is 10mm

Table 14.6-3: SAR Values (NR5G n25-Body)

Frequency		Test Position	Figure No./Note	Conducted Power (dBm)	Max. tune-up Power (dBm)	Measured SAR(10g) (W/kg)	Reported SAR(10g) (W/kg)	Measured SAR(1g) (W/kg)	Reported SAR(1g) (W/kg)	Power Drift (dB)
Ch.	MHz									
376500	1882.5	Front	/	22.39	22.50	0.053	0.05	0.090	0.09	-0.03
376500	1882.5	Rear	Fig.43	22.39	22.50	0.142	0.15	0.258	0.26	0.16
376500	1882.5	Rear	DFT-s-OFDM	22.13	22.50	0.121	0.13	0.223	0.24	-0.06

Note: The distance between the EUT and the phantom bottom is 15mm

Table 14.6-4: SAR Values (NR5G n66-Head)

Frequency		Side	Test Position	Figure No./Note	Conducted Power (dBm)	Max. tune-up Power (dBm)	Measured SAR(10g) (W/kg)	Reported SAR(10g) (W/kg)	Measured SAR(1g) (W/kg)	Reported SAR(1g) (W/kg)	Power Drift (dB)
Ch.	MHz										
355500	1777.5	Left	Cheek	/	18.63	20.00	0.080	0.11	0.155	0.21	0.05
355500	1777.5	Left	Tilt	/	18.63	20.00	0.035	0.05	0.058	0.08	-0.13
355500	1777.5	Right	Cheek	Fig.44	18.63	20.00	0.165	0.23	0.353	0.48	0.18
355500	1777.5	Right	Tilt	/	18.63	20.00	0.046	0.06	0.085	0.12	0.09
355500	1777.5	Left	Cheek	DFT-s-OFDM	18.24	20.00	0.154	0.23	0.321	0.48	-0.14

Table 14.6-5: SAR Values (NR5G n66-Body)

Frequency		Test Position	Figure No./Note	Conducted Power (dBm)	Max. tune-up Power (dBm)	Measured SAR(10g) (W/kg)	Reported SAR(10g)(W/kg)	Measured SAR(1g) (W/kg)	Reported SAR(1g) (W/kg)	Power Drift (dB)
Ch.	MHz									
355500	1777.5	Front	/	18.63	20.00	0.059	0.08	0.109	0.15	-0.02
355500	1777.5	Rear		18.63	20.00	0.161	0.22	0.311	0.43	0.15
355500	1777.5	Left	Fig.45	18.63	20.00	0.169	0.23	0.343	0.47	0.09
355500	1777.5	Top	/	18.63	20.00	<0.01	<0.01	<0.01	<0.01	
355500	1777.5	Left	DFT-s-OFDM	18.24	20.00	0.154	0.23	0.311	0.47	-0.16

Note: The distance between the EUT and the phantom bottom is 10mm

Table 14.6-6: SAR Values (NR5G n66-Body)

Frequency		Test Position	Figure No./Note	Conducted Power (dBm)	Max. tune-up Power (dBm)	Measured SAR(10g) (W/kg)	Reported SAR(10g)(W/kg)	Measured SAR(1g) (W/kg)	Reported SAR(1g) (W/kg)	Power Drift (dB)
Ch.	MHz									
342500	1712.5	Front	/	21.94	22.50	0.066	0.08	0.110	0.13	-0.04
342500	1712.5	Rear	Fig.46	21.94	22.50	0.172	0.20	0.299	0.34	0.05
342500	1712.5	Rear	DFT-s-OFDM	21.31	22.50	0.151	0.20	0.245	0.32	-0.90

Note: The distance between the EUT and the phantom bottom is 15mm

Table 14.6-7: SAR Values (NR5G n71-Head)

Frequency		Side	Test Position	Figure No./Note	Conducted Power (dBm)	Max. tune-up Power (dBm)	Measured SAR(10g) (W/kg)	Reported SAR(10g) (W/kg)	Measured SAR(1g) (W/kg)	Reported SAR(1g) (W/kg)	Power Drift (dB)
Ch.	MHz										
133100	665.5	Left	Cheek	/	23.04	23.50	0.144	0.16	0.287	0.32	-0.18
133100	665.5	Left	Tilt	Fig.47	23.04	23.50	0.155	0.17	0.302	0.34	0.11
133100	665.5	Right	Cheek	/	23.04	23.50	0.131	0.15	0.254	0.28	0.01
133100	665.5	Right	Tilt	/	23.04	23.50	0.132	0.15	0.231	0.26	-0.03
133100	665.5	Right	Cheek	DFT-s-OFDM	22.31	23.50	0.132	0.17	0.262	0.34	-0.06

Note: The data is used for SA.

Table 14.6-8: SAR Values (NR5G n71-Head)

Frequency		Side	Test Position	Figure No./Note	Conducted Power (dBm)	Max. tune-up Power (dBm)	Measured SAR(10g) (W/kg)	Reported SAR(10g) (W/kg)	Measured SAR(1g) (W/kg)	Reported SAR(1g) (W/kg)	Power Drift (dB)
Ch.	MHz										
133100	665.5	Left	Cheek	/	20.65	21.00	0.089	0.10	0.172	0.19	-0.12
133100	665.5	Left	Tilt	Fig.48	20.65	21.00	0.092	0.10	0.176	0.19	0.13
133100	665.5	Right	Cheek	/	20.65	21.00	0.091	0.10	0.147	0.16	0.11
133100	665.5	Right	Tilt	/	20.65	21.00	0.071	0.08	0.124	0.13	0.15
133100	665.5	Right	Cheek	DFT-s-OFDM	20.09	21.00	0.084	0.10	0.157	0.19	-0.16

Note: The data is used for NSA.

Table 14.6-9: SAR Values (NR5G n71-Body)

Frequency		Test Position	Figure No./Note	Conducted Power (dBm)	Max. tune-up Power (dBm)	Measured SAR(10g) (W/kg)	Reported SAR(10g) (W/kg)	Measured SAR(1g) (W/kg)	Reported SAR(1g) (W/kg)	Power Drift (dB)
Ch.	MHz									
133100	665.5	Front	/	23.04	23.50	0.097	0.11	0.128	0.14	-0.13
133100	665.5	Rear	Fig.49	23.04	23.50	0.111	0.12	0.149	0.17	0.13
133100	665.5	Left	/	23.04	23.50	0.042	0.05	0.062	0.07	0.07
133100	665.5	Right	/	23.04	23.50	0.095	0.11	0.137	0.15	0.16
133100	665.5	Top	/	23.04	23.50	0.056	0.06	0.103	0.11	0.12
133100	665.5	Rear	DFT-s-OFDM	22.31	23.50	0.094	0.12	0.132	0.17	-0.07

Note: The distance between the EUT and the phantom bottom is 10mm

Note1: The data is used for SA and NSA.

Table 14.6-10: SAR Values (NR5G n41-Head)

Frequency		Side	Test Position	Figure No./Note	Conducted Power (dBm)	Max. tune-up Power (dBm)	Measured SAR(10g) (W/kg)	Reported SAR(10g) (W/kg)	Measured SAR(1g) (W/kg)	Reported SAR(1g) (W/kg)	Power Drift (dB)
Ch.	MHz										
509902	2549.51	Left	Cheek	Fig.50	17.94	18.00	0.057	0.06	0.146	0.15	0.17
513900	2569.5	Left	Tilt	/	17.94	18.00	0.017	0.02	0.051	0.05	0.03
513900	2569.5	Right	Cheek	/	17.94	18.00	0.022	0.02	0.052	0.05	0.13
513900	2569.5	Right	Tilt	/	17.94	18.00	0.013	0.01	0.045	0.05	0.19
513900	2569.5	Left	Cheek	DFT-s-OFDM	17.92	18.00	0.051	0.05	0.124	0.13	0.14

Table 14.6-11: SAR Values (NR5G n41-Body)

Frequency		Test Position	Figure No./Note	Conducted Power (dBm)	Max. tune-up Power (dBm)	Measured SAR(10g) (W/kg)	Reported SAR(10g)(W/kg)	Measured SAR(1g) (W/kg)	Reported SAR(1g) (W/kg)	Power Drift (dB)
Ch.	MHz									
509902	2549.51	Front	/	17.94	18.00	0.041	0.04	0.087	0.09	-0.04
509902	2549.51	Rear	/	17.94	18.00	0.082	0.08	0.185	0.19	-0.17
509902	2549.51	Right	Fig.51	17.94	18.00	0.084	0.09	0.191	0.19	0.16
509902	2549.51	Top	/	17.94	18.00	0.014	0.01	0.031	0.03	0.05
509902	2549.51	Right	DFT-s-OFDM	17.92	18.00	0.081	0.08	0.184	0.19	0.03

Note: The distance between the EUT and the phantom bottom is 10mm

Table 14.6-12: SAR Values (NR5G n41-Body)

Frequency		Test Position	Figure No./Note	Conducted Power (dBm)	Max. tune-up Power (dBm)	Measured SAR(10g) (W/kg)	Reported SAR(10g)(W/kg)	Measured SAR(1g) (W/kg)	Reported SAR(1g) (W/kg)	Power Drift (dB)
Ch.	MHz									
509902	2549.51	Front	/	22.99	23.00	0.083	0.08	0.164	0.16	0.05
509902	2549.51	Rear	Fig.52	22.99	23.00	0.275	0.28	0.573	0.57	0.09
509902	2549.51	Rear	DFT-s-OFDM	22.69	23.00	0.241	0.26	0.534	0.57	-0.04

Note: The distance between the EUT and the phantom bottom is 15mm

Note1: The data is used for NSA.

Table 14.6-13: SAR Values (NR5G n41-Body)

Frequency		Test Position	Figure No./ Note	Conducted Power (dBm)	Max. tune-up Power (dBm)	Measured SAR(10g) (W/kg)	Reported SAR(10g)(W/kg)	Measured SAR(1g) (W/kg)	Reported SAR(1g) (W/kg)	Power Drift (dB)
Ch.	MHz									
509902	2549.51	Front	/	24.49	24.50	0.106	0.11	0.199	0.20	-0.13
509902	2549.51	Rear	Fig.53	24.49	24.50	0.186	0.19	0.380	0.38	-0.12
509902	2549.51	Rear	CP-OFDM	24.41	24.50	0.174	0.18	0.362	0.37	0.08

Note: The distance between the EUT and the phantom bottom is 15mm

Note1: The data is used for SA.

Table 14.6-14: SAR Values (NR5G n41 - Head) - Scaled Reported SAR

Frequency		Side	Test Position	Actual duty factor	maximum duty factor	Reported SAR (1g) (W/kg)	Scaled reported SAR (1g) (W/kg)
MHz	Ch.						
509902	2549.51	Left	Cheek	42.1%	50%	0.15	0.18

Table 14.6-15: SAR Values (NR5G n41- Body) – Scaled Reported SAR

Frequency		Test Position	D (mm)	Actual duty factor	maximum duty factor	Reported SAR (1g) (W/kg)	Scaled reported SAR (1g) (W/kg)
MHz	Ch.						
509902	2549.51	Right	10	42.1%	50%	0.19	0.23

Table 14.6-16: SAR Values (NR5G n41- Body) – Scaled Reported SAR(NSA)

Frequency		Test Position	D (mm)	Actual duty factor	maximum duty factor	Reported SAR (1g) (W/kg)	Scaled reported SAR (1g) (W/kg)
MHz	Ch.						
509902	2549.51	Rear	15	42.1%	50%	0.57	0.68

Table 14.6-17: SAR Values (NR5G n41- Body) – Scaled Reported SAR(SA)

Frequency		Test Position	D (mm)	Actual duty factor	maximum duty factor	Reported SAR (1g) (W/kg)	Scaled reported SAR (1g) (W/kg)
MHz	Ch.						
509902	2549.51	Rear	15	42.1%	50%	0.38	0.45

Table 14.6-18: SAR Values (NR5G n77H-Head)

Frequency		Side	Test Position	Figure No./Note	Conducted Power (dBm)	Max. tune-up Power (dBm)	Measured SAR(10g) (W/kg)	Reported SAR(10g) (W/kg)	Measured SAR(1g) (W/kg)	Reported SAR(1g) (W/kg)	Power Drift (dB)
Ch.	MHz										
654800	3822	Left	Cheek	Fig.54	26.04	26.50	0.049	0.05	0.110	0.12	0.10
654800	3822	Left	Tilt	/	26.04	26.50	0.037	0.04	0.097	0.11	0.04
654800	3822	Right	Cheek	/	26.04	26.50	0.043	0.05	0.103	0.11	-0.17
654800	3822	Right	Tilt	/	26.04	26.50	0.037	0.04	0.100	0.11	-0.09
654800	3822	Right	Cheek	DFT-s-OFDM	25.76	26.50	0.032	0.04	0.089	0.11	0.18

Note1: The data is used for SA and NSA.

Table 14.6-19: SAR Values (NR5G n77H -Body)

Frequency		Test Position	Figure No./ Note	Conducted Power (dBm)	Max. tune-up Power (dBm)	Measured SAR(10g) (W/kg)	Report ed SAR(10g)(W/kg)	Measure d SAR(1g) (W/kg)	Reporte d SAR(1g) (W/kg)	Power Drift (dB)
Ch.	MHz									
664666	3969.99	Front	/	22.02	22.50	0.034	0.04	0.088	0.10	-0.18
664666	3969.99	Rear	/	22.02	22.50	0.090	0.10	0.250	0.28	0.09
664666	3969.99	Left	/	22.02	22.50	0.015	0.02	0.054	0.06	-0.01
664666	3969.99	Right		22.02	22.50	0.016	0.02	0.062	0.07	0.05
664666	3969.99	Bottom	Fig.55	22.02	22.50	0.099	0.11	0.285	0.32	0.07
664666	3969.99	Top	DFT-s-OFDM	21.74	22.50	0.091	0.11	0.265	0.32	-0.13

Note1: The distance between the EUT and the phantom bottom is 10mm

Note2: The data is used for SA and NSA.

Table 14.6-20 SAR Values (NR5G n77H - Head) - Scaled Reported SAR

Frequency		Side	Test Position	Actual duty factor	maximum duty factor	Reported SAR (1g) (W/kg)	Scaled reported SAR (1g) (W/kg)
MHz	Ch.						
654800	3822	Right	Cheek	44%	50%	0.12	0.14

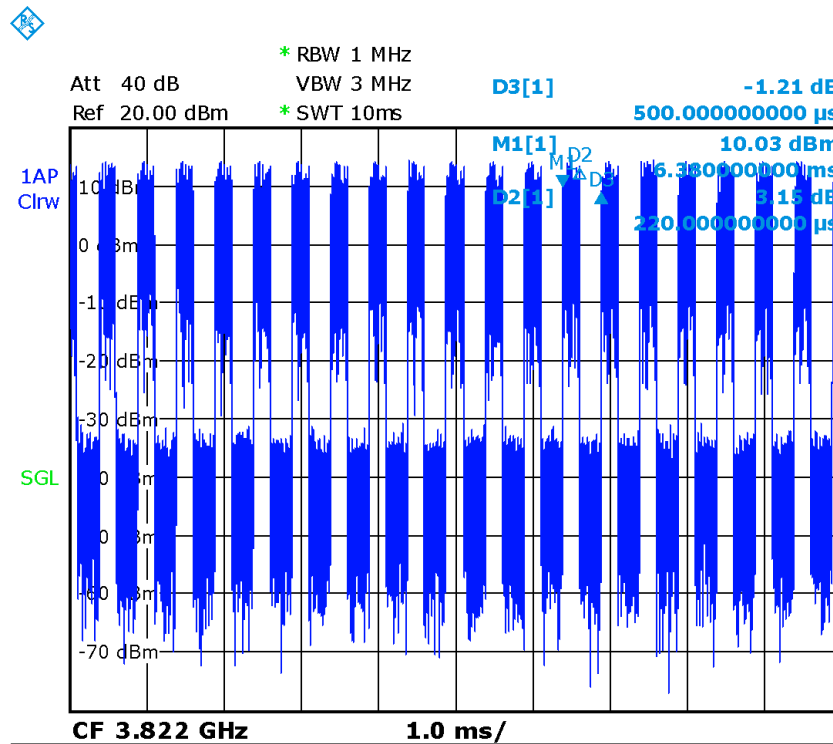
Table 14.6-21: SAR Values (NR5G n77H- Body) – Scaled Reported SAR

Frequency		Test Position	D (mm)	Actual duty factor	maximum duty factor	Reported SAR (1g) (W/kg)	Scaled reported SAR (1g) (W/kg)
MHz	Ch.						
664666	3969.99	Bottom	10	44%	50%	0.32	0.36

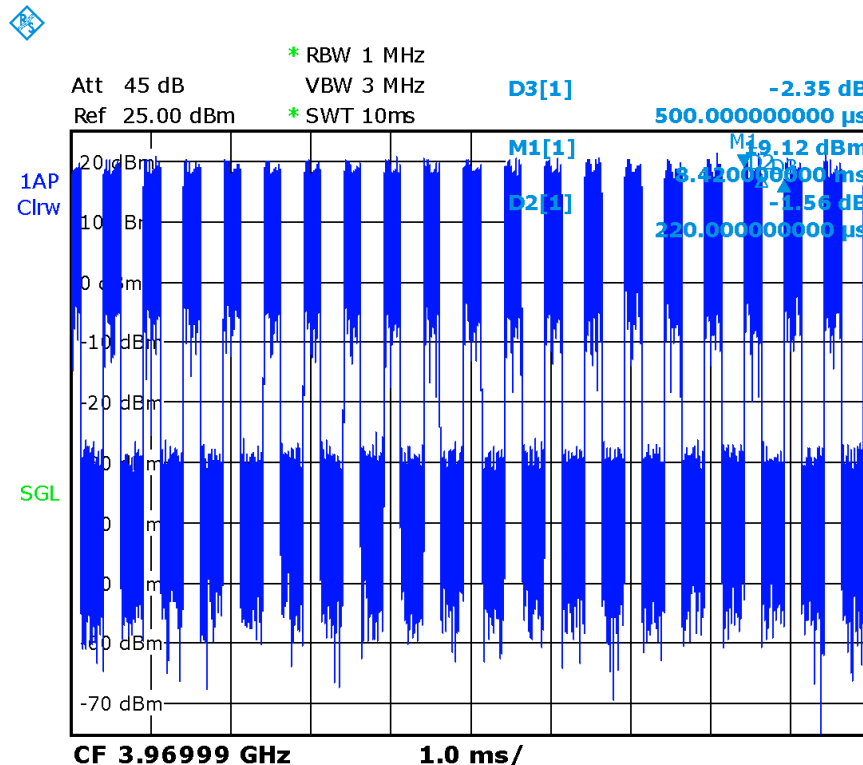

Table 14.6-22: SAR Values (NR5G n77L-Head)

Frequency		Side	Test Position	Figure No./Note	Conducted Power (dBm)	Max. tune-up Power (dBm)	Measured SAR(10g) (W/kg)	Reported SAR(10g) (W/kg)	Measured SAR(1g) (W/kg)	Reported SAR(1g) (W/kg)	Power Drift (dB)
Ch.	MHz										
633334	3500.01	Left	Cheek	Fig.56	24.82	26.50	0.015	0.02	0.048	0.07	0.13
633334	3500.01	Left	Tilt	/	24.82	26.50	0.008	0.01	0.024	0.04	0.04
633334	3500.01	Right	Cheek	/	24.82	26.50	0.010	0.01	0.031	0.05	-0.03
633334	3500.01	Right	Tilt	/	24.82	26.50	0.012	0.02	0.040	0.06	0.12
633334	3500.01	Right	Cheek	DFT-s-OFDM	24.77	26.50	0.014	0.02	0.044	0.07	-0.04

Note1: The data is used for SA and NSA.

Table 14.6-23: SAR Values (NR5G n77L-Body)

Frequency		Test Position	Figure No./ Note	Conducted Power (dBm)	Max. tune-up Power (dBm)	Measured SAR(10g) (W/kg)	Report ed SAR(10g)(W/kg)	Measure d SAR(1g) (W/kg)	Reporte d SAR(1g) (W/kg)	Power Drift (dB)
Ch.	MHz									
630668	3460.02	Front	/	20.80	22.50	0.040	0.06	0.083	0.12	0.12
630668	3460.02	Rear	Fig.57	20.80	22.50	0.105	0.16	0.273	0.40	0.04
630668	3460.02	Left	/	20.80	22.50	0.037	0.05	0.087	0.13	0.09
630668	3460.02	Right	/	20.80	22.50	<0.01	<0.01	<0.01	<0.01	/
630668	3460.02	Bottom	/	20.80	22.50	0.071	0.11	0.183	0.27	-0.01
630668	3460.02	Top	CP-OFDM	20.79	22.50	0.108	0.16	0.270	0.40	-0.05

Note1: The distance between the EUT and the phantom bottom is 10mm

Note2: The data is used for SA and NSA.

Table 14.6-24 SAR Values (NR5G n77L - Head) - Scaled Reported SAR

Frequency		Side	Test Position	Actual duty factor	maximum duty factor	Reported SAR (1g) (W/kg)	Scaled reported SAR (1g) (W/kg)
MHz	Ch.						
633334	3500.01	Left	Cheek	40%	50%	0.07	0.09

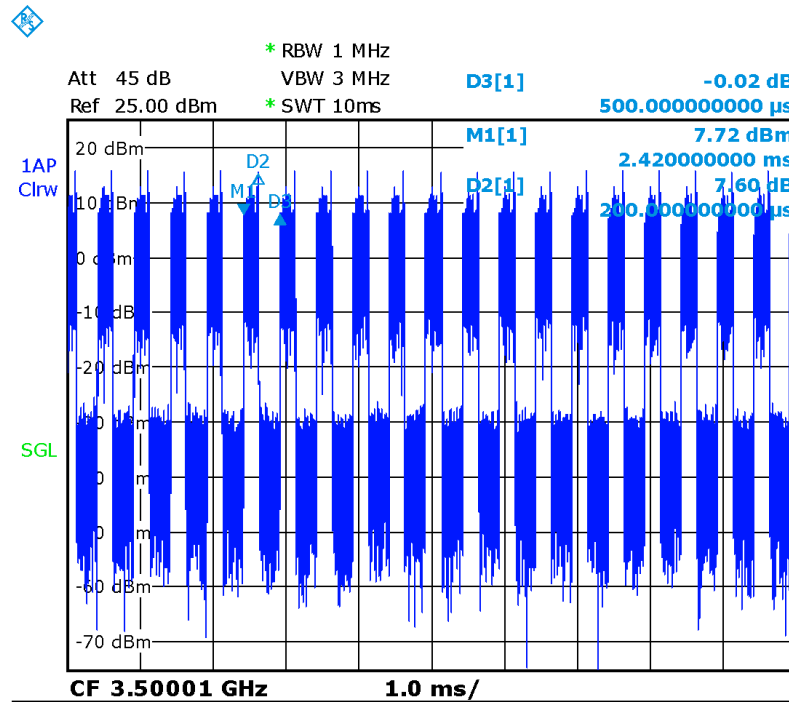

Table 14.6-25: SAR Values (NR5G n77L- Body) – Scaled Reported SAR

Frequency		Test Position	D (mm)	Actual duty factor	maximum duty factor	Reported SAR (1g) (W/kg)	Scaled reported SAR (1g) (W/kg)
MHz	Ch.						
630668	3460.02	Rear	10	44%	50%	0.40	0.46

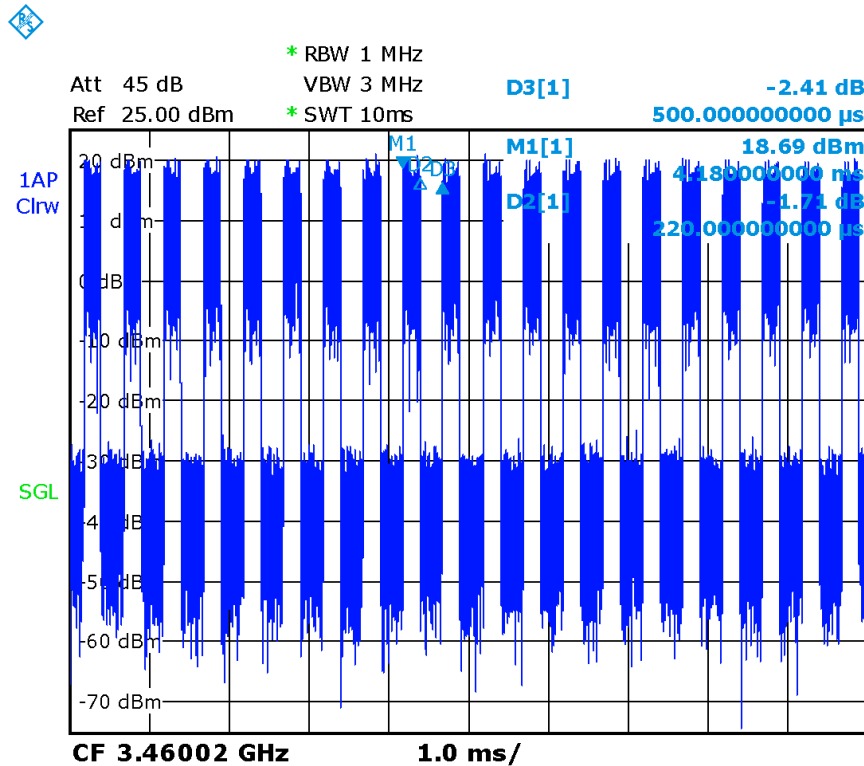

Table 14.6-26: SAR Values (LTE Band2 – Head ANT6)

Frequency		Mode	Side	Test Position	Figure No./ Note	Conducted Power (dBm)	Max. tune-up Power (dBm)	Measured SAR(10g) (W/kg)	Reported SAR(10g) (W/kg)	Measured SAR(1g) (W/kg)	Reported SAR(1g) (W/kg)	Power Drift (dB)
Ch.	MHz											
19100	1900	1RB_Mid	Left	Touch	/	19.97	20.5	0.033	0.04	0.052	0.06	0.12
19100	1900	1RB_Mid	Left	Tilt	/	19.97	20.5	0.026	0.03	0.043	0.05	-0.11
19100	1900	1RB_Mid	Right	Touch	/	19.97	20.5	0.048	0.05	0.077	0.09	-0.12
19100	1900	1RB_Mid	Right	Tilt	/	19.97	20.5	0.021	0.02	0.034	0.04	0.03
18900	1880	50RB_Low	Left	Touch	/	19.05	19.5	0.021	0.02	0.043	0.05	0.09
18900	1880	50RB_Low	Left	Tilt	/	19.05	19.5	0.019	0.02	0.041	0.05	0.15
18900	1880	50RB_Low	Right	Touch	/	19.05	19.5	0.041	0.05	0.065	0.07	-0.12
18900	1880	50RB_Low	Right	Tilt	/	19.05	19.5	0.021	0.02	0.034	0.04	0.16

Note1: The LTE mode is QPSK_20MHz.

Note2: The data is used for ENDC and UL CA

Table 14.6-27: SAR Values (LTE Band2 – Body ANT6)

Frequency		Mode	Test Position	Figure No./ Note	Conducted Power (dBm)	Max. tune-up Power (dBm)	Measured SAR(10g) (W/kg)	Reported SAR(10g) (W/kg)	Measured SAR(1g) (W/kg)	Reported SAR(1g) (W/kg)	Power Drift (dB)
Ch.	MHz										
19100	1900	1RB_Mid	Front	/	19.97	20.5	0.045	0.05	0.086	0.10	-0.05
19100	1900	1RB_Mid	Rear	/	19.97	20.5	0.067	0.08	0.132	0.15	0.14
19100	1900	1RB_Mid	Right	/	19.97	20.5	0.05	0.06	0.099	0.11	-0.14
19100	1900	1RB_Mid	Bottom	/	19.97	20.5	0.038	0.04	0.074	0.08	0.07
19100	1900	50RB_Low	Front	/	19.05	19.5	0.036	0.04	0.069	0.08	0.13
19100	1900	50RB_Low	Rear	/	19.05	19.5	0.059	0.07	0.116	0.13	-0.16
19100	1900	50RB_Low	Right	/	19.05	19.5	0.043	0.05	0.087	0.10	-0.09
19100	1900	50RB_Low	Top	/	19.05	19.5	0.036	0.04	0.068	0.08	-0.06

Note1: The distance between the EUT and the phantom bottom is 10mm.

Note2: The LTE mode is QPSK_20MHz.

Note3: The data is used for ENDC and UL CA

Table 14.6-28: SAR Values (LTE Band66 – Head ANT6)

Frequency		Mode	Side	Test Position	Figure No./ Note	Conducted Power (dBm)	Max. tune-up Power (dBm)	Measured SAR(10g) (W/kg)	Reported SAR(10g) (W/kg)	Measured SAR(1g) (W/kg)	Reported SAR(1g) (W/kg)	Power Drift (dB)
Ch.	MHz											
132572	1770	1RB_Mid	Left	Touch	/	19.76	20.5	0.036	0.04	0.053	0.06	-0.02
132572	1770	1RB_Mid	Left	Tilt	/	19.76	20.5	0.026	0.03	0.04	0.05	0.15
132572	1770	1RB_Mid	Right	Touch	/	19.76	20.5	0.072	0.09	0.113	0.13	0.04
132572	1770	1RB_Mid	Right	Tilt	/	19.76	20.5	0.026	0.03	0.041	0.05	-0.15
132572	1770	50RB_Low	Left	Touch	/	18.89	19.5	0.029	0.03	0.042	0.05	0.04
132572	1770	50RB_Low	Left	Tilt	/	18.89	19.5	0.022	0.03	0.035	0.04	0.09
132572	1770	50RB_Low	Right	Touch	/	18.89	19.5	0.059	0.07	0.091	0.10	-0.15
132572	1770	50RB_Low	Right	Tilt	/	18.89	19.5	0.022	0.03	0.035	0.04	0.14

Note1: The LTE mode is QPSK_20MHz.

Note2: The data is used for ENDC and UL CA

Table 14.6-29: SAR Values (LTE Band66 – Body ANT6)

Frequency		Mode	Test Position	Figure No./ Note	Conducted Power (dBm)	Max. tune-up Power (dBm)	Measured SAR(10g) (W/kg)	Reported SAR(10g) (W/kg)	Measured SAR(1g) (W/kg)	Reported SAR(1g) (W/kg)	Power Drift (dB)
Ch.	MHz										
132072	1720	1RB_Mid	Front	/	19.76	20.5	0.052	0.06	0.083	0.10	0.09
132072	1720	1RB_Mid	Rear	/	19.76	20.5	0.055	0.07	0.095	0.11	0.02
132072	1720	1RB_Mid	Right	/	19.76	20.5	0.053	0.06	0.095	0.11	-0.19
132072	1720	1RB_Mid	Bottom	/	19.76	20.5	0.057	0.07	0.098	0.12	-0.06
132072	1720	50RB_Low	Front	/	18.89	19.5	0.041	0.05	0.063	0.07	0.16
132072	1720	50RB_Low	Rear	/	18.89	19.5	0.051	0.06	0.086	0.10	-0.13
132072	1720	50RB_Low	Right	/	18.89	19.5	0.052	0.06	0.087	0.10	0.18
132072	1720	50RB_Low	Bottom	/	18.89	19.5	0.049	0.06	0.083	0.10	-0.05

Note1: The distance between the EUT and the phantom bottom is 10mm.

Note2: The LTE mode is QPSK_20MHz.

Note3: The data is used for ENDC and UL CA

Table 14.6-30: SAR Values (LTE Band12 – Head)

Frequency		Mode	Side	Test Position	Figure No./ Note	Conducted Power (dBm)	Max. tune-up Power (dBm)	Measured SAR(10g) (W/kg)	Reported SAR(10g) (W/kg)	Measured SAR(1g) (W/kg)	Reported SAR(1g) (W/kg)	Power Drift (dB)
Ch.	MHz											
23060	704	1RB_Low	Left	Touch	/	19.22	20.00	0.077	0.09	0.156	0.19	0.08
23060	704	1RB_Low	Left	Tilt	/	19.22	20.00	0.083	0.10	0.159	0.19	0.160
23060	704	1RB_Low	Right	Touch	/	19.22	20.00	0.078	0.09	0.13	0.16	-0.06
23060	704	1RB_Low	Right	Tilt	/	19.22	20.00	0.063	0.08	0.108	0.13	-0.13
23060	704	25RB_Mid	Left	Touch	/	18.18	19.00	0.068	0.08	0.112	0.14	0.15
23060	704	25RB_Mid	Left	Tilt	/	18.18	19.00	0.067	0.08	0.13	0.16	0.03
23060	704	25RB_Mid	Right	Touch	/	18.18	19.00	0.059	0.07	0.104	0.13	0.11
23060	704	25RB_Mid	Right	Tilt	/	18.18	19.00	0.046	0.06	0.079	0.10	-0.18

Note1: The LTE mode is QPSK_10MHz.

Note2: The data is used for ENDC and UL CA

Table 14.6-31: SAR Values (LTE Band2 – Head ANT4)

Frequency		Mode	Side	Test Position	Figure No./ Note	Conducted Power (dBm)	Max. tune-up Power (dBm)	Measured SAR(10g) (W/kg)	Reported SAR(10g) (W/kg)	Measured SAR(1g) (W/kg)	Reported SAR(1g) (W/kg)	Power Drift (dB)
Ch.	MHz											
18900	1880	1RB_Mid	Left	Touch	/	19.1	19.5	0.183	0.20	0.412	0.45	-0.01
18900	1880	1RB_Mid	Left	Tilt	/	19.1	19.5	0.059	0.06	0.108	0.12	0.04
18900	1880	1RB_Mid	Right	Touch	/	19.1	19.5	0.245	0.27	0.534	0.59	0.080
18900	1880	1RB_Mid	Right	Tilt	/	19.1	19.5	0.075	0.08	0.152	0.17	-0.10
18900	1880	50RB_High	Left	Touch	/	18.11	18.5	0.17	0.19	0.374	0.41	0.07
18900	1880	50RB_High	Left	Tilt	/	18.11	18.5	0.059	0.06	0.11	0.12	-0.18
18900	1880	50RB_High	Right	Touch	/	18.11	18.5	0.19	0.21	0.414	0.45	-0.04
18900	1880	50RB_High	Right	Tilt	/	18.11	18.5	0.062	0.07	0.127	0.14	-0.18

Note1: The LTE mode is QPSK_20MHz.

Note2: The data is used for UL CA

Table 14.6-32: SAR Values (LTE Band2 – Body ANT4)

Frequency		Mode	Test Position	Figure No./ Note	Conducted Power (dBm)	Max. tune-up Power (dBm)	Measured SAR(10g) (W/kg)	Reported SAR(10g) (W/kg)	Measured SAR(1g) (W/kg)	Reported SAR(1g) (W/kg)	Power Drift (dB)
Ch.	MHz										
18900	1880	1RB_Mid	Front	/	19.1	19.5	0.076	0.08	0.149	0.16	-0.16
18900	1880	1RB_Mid	Rear	/	19.1	19.5	0.165	0.18	0.329	0.36	0.11
18900	1880	1RB_Mid	Left	/	19.1	19.5	0.192	0.21	0.385	0.42	0.090
18900	1880	1RB_Mid	Top	/	19.1	19.5	<0.01	<0.01	<0.01	<0.01	/
18900	1880	50RB_High	Front	/	18.11	18.5	0.062	0.07	0.116	0.13	-0.17
18900	1880	50RB_High	Rear	/	18.11	18.5	0.135	0.15	0.272	0.30	0.07
18900	1880	50RB_High	Left	/	18.11	18.5	0.159	0.17	0.319	0.35	0.05
18900	1880	50RB_High	Top	/	18.11	18.5	<0.01	<0.01	<0.01	<0.01	/

Note1: The distance between the EUT and the phantom bottom is 10mm.

Note2: The LTE mode is QPSK_20MHz.

Note3: The data is used for UL CA

Table 14.6-33: SAR Values (LTE Band66 – Head ANT4)

Frequency		Mode	Side	Test Position	Figure No./ Note	Conducted Power (dBm)	Max. tune-up Power (dBm)	Measured SAR(10g) (W/kg)	Reported SAR(10g) (W/kg)	Measured SAR(1g) (W/kg)	Reported SAR(1g) (W/kg)	Power Drift (dB)
Ch.	MHz											
132072	1720	1RB_Mid	Left	Touch	/	19.1	19.5	0.179	0.20	0.354	0.39	0.03
132072	1720	1RB_Mid	Left	Tilt	/	19.1	19.5	0.077	0.08	0.135	0.15	0.16
132072	1720	1RB_Mid	Right	Touch	/	19.1	19.5	0.301	0.33	0.647	0.71	0.110
132072	1720	1RB_Mid	Right	Tilt	/	19.1	19.5	0.098	0.11	0.187	0.21	-0.08
132072	1720	50RB_High	Left	Touch	/	18.19	18.5	0.149	0.16	0.298	0.32	0.14
132072	1720	50RB_High	Left	Tilt	/	18.19	18.5	0.057	0.06	0.103	0.11	-0.15
132072	1720	50RB_High	Right	Touch	/	18.19	18.5	0.249	0.27	0.527	0.57	0.18
132072	1720	50RB_High	Right	Tilt	/	18.19	18.5	0.075	0.08	0.144	0.15	-0.13

Note1: The LTE mode is QPSK_20MHz.

Note2: The data is used for UL CA

Table 14.6-34: SAR Values (LTE Band66 – Body ANT4)

Frequency		Mode	Test Position	Figure No./ Note	Conducted Power (dBm)	Max. tune-up Power (dBm)	Measured SAR(10g) (W/kg)	Reported SAR(10g) (W/kg)	Measured SAR(1g) (W/kg)	Reported SAR(1g) (W/kg)	Power Drift (dB)
Ch.	MHz										
132072	1720	1RB_Mid	Front	/	19.1	19.5	0.101	0.11	0.203	0.22	-0.19
132072	1720	1RB_Mid	Rear	/	19.1	19.5	0.162	0.18	0.343	0.38	0.14
132072	1720	1RB_Mid	Left	/	19.1	19.5	0.183	0.20	0.37	0.41	0.10
132072	1720	1RB_Mid	Top	/	19.1	19.5	<0.01	<0.01	<0.01	<0.01	/
132072	1720	50RB_High	Front	/	18.19	18.5	0.06	0.06	0.125	0.13	0.18
132072	1720	50RB_High	Rear	/	18.19	18.5	0.13	0.14	0.28	0.30	-0.09
132072	1720	50RB_High	Left	/	18.19	18.5	0.13	0.14	0.281	0.30	0.11
132072	1720	50RB_High	Top	/	18.19	18.5	<0.01	<0.01	<0.01	<0.01	/

Note1: The distance between the EUT and the phantom bottom is 10mm.

Note2: The LTE mode is QPSK_20MHz.

Note3: The data is used for UL CA

14.7 SAR Evaluation for Phablet

According to the KDB648474 D04, for smart phones, with a display diagonal dimension > 15.0 cm or an overall diagonal dimension > 16.0 cm, that can provide similar mobile web access and multimedia support found in mini-tablets or UMPC mini-tablets and support voice calls next to the ear, unless it is confirmed otherwise through KDB inquiries, the following phablet procedures should be applied to evaluate SAR compliance for each applicable wireless modes and frequency band. Devices marketed as phablets, regardless of form factors and operating characteristics must be tested as a phablet to determine SAR compliance.

1. The normally required head and body-worn accessory SAR test procedures for handsets, including hotspot mode, must be applied.
2. The UMPC mini-tablet procedures must also be applied to test the SAR of all surfaces and edges with an antenna located at ≤ 25 mm from that surface or edge, in direct contact with a flat phantom, for 10-g extremity SAR according to the body-equivalent tissue dielectric parameters in KDB Publication 865664 D01 to address interactive hand use exposure conditions. When hotspot mode applies, 10-g extremity SAR is required only for the surfaces and edges with hotspot mode 1-g reported SAR > 1.2 W/kg; however, when power reduction applies to hotspot mode the measured SAR must be scaled to the maximum output power, including tolerance, allowed for phablet modes to compare with the 1.2 W/kg SAR test reduction threshold. The normal tablet procedures in KDB Publication 616217 are required when the overall diagonal dimension of the device is > 20.0 cm. Hotspot mode SAR is not required when normal tablet procedures are applied. Extremity 10-g SAR is also not required for the front (top) surface of larger form factor full size tablets. The more conservative normal tablet SAR results can be used to support phablet mode 10-g extremity SAR.
3. The simultaneous transmission operating configurations applicable to voice and data transmissions for both phone and mini-tablet modes must be taken into consideration separately for 1-g and 10-g SAR to determine the simultaneous transmission SAR test exclusion and measurement requirements for the relevant wireless modes and exposure conditions

For the device of this project, the overall diagonal dimension is 179.84 cm (> 16.0 cm), so this device is a phone as “phablet”.

Table 14.4-1: 10g extremity SAR determination

Frequency			Position	Conducted Power (dBm)	Hotspot off tune-up Power (dBm)	Measured SAR(1g) (W/kg)	Adjusted SAR(1g)(W/kg)
Band	Ch.	MHz					
LTE Band41 PC2	40185	2549.5	Right	23.77	24.60	1.01	1.22

According to the above table, the 10g extremity SAR is required for the LTE Band41 PC2.

Table 14.4-2: SAR Values for 10g extremity SAR

Frequency			Mode/ Figure No.	Conducted Power (dBm)	Max. tune-up Power (dBm)	Measured SAR(10g) (W/kg)	Reported SAR(10g) (W/kg)	Power Drift (dB)	Limited (W/kg)
Ambient Temperature: 22.9 °C	Liquid Temperature: 22.5 °C	Band							
LTE Band41 PC2	41490	2680	Right	23.75	24.60	2.11	2.57	-0.12	4.0
LTE Band41 PC2	41055	2636.5	Right	23.98	24.60	2.01	2.32	0.03	
LTE Band41 PC2	40620	2593	Right	23.78	24.60	2.13	2.57	0.17	
LTE Band41 PC2	40185	2549.5	Right	24.40	24.60	2.64	2.76	0.01	
LTE Band41 PC2	39750	2506	Right	23.33	24.60	1.98	2.65	-0.06	

Note1: The distance between the EUT and the phantom bottom is 0mm.

Table 14.4-3: The sum of SAR values for 10g extremity SAR

	Position	Main antenna	WiFi-2.4G	BT	Sum	Limited
10-g extremity SAR (Separation Distance 0mm)	Right (LTE Band41 PC2)	2.76	/	/	2.76	4.0

Table 14.4-4: The sum of SAR values for 10g extremity SAR

	Position	Main antenna	WiFi-5G	BT	Sum	Limited
10-g extremity SAR (Separation Distance 0mm)	Right (LTE Band41 PC2)	2.76	/	/	2.76	4.0

15 SAR Measurement Variability

SAR measurement variability must be assessed for each frequency band, which is determined by the SAR probe calibration point and tissue-equivalent medium used for the device measurements. When both head and body tissue-equivalent media are required for SAR measurements in a frequency band, the variability measurement procedures should be applied to the tissue medium with the highest measured SAR, using the highest measured SAR configuration for that tissue-equivalent medium.

The following procedures are applied to determine if repeated measurements are required.

- 1) Repeated measurement is not required when the original highest measured SAR is < 0.80 W/kg; steps 2) through 4) do not apply.
- 2) When the original highest measured SAR is ≥ 0.80 W/kg, repeat that measurement once.
- 3) Perform a second repeated measurement only if the ratio of largest to smallest SAR for the original and first repeated measurements is > 1.20 or when the original or repeated measurement is ≥ 1.45 W/kg ($\sim 10\%$ from the 1-g SAR limit).
- 4) Perform a third repeated measurement only if the original, first or second repeated measurement is ≥ 1.5 W/kg and the ratio of largest to smallest SAR for the original, first and second repeated measurements is > 1.20 .

Table 15.1: SAR Measurement Variability for Head W1700 (1g)

Frequency		Side	Test Position	Original SAR (W/kg)	First Repeated SAR (W/kg)	The Ratio	Second Repeated SAR (W/kg)
Ch.	MHz						
1412	1732.4	Right	Cheek	0.912	0.899	1.01	/

Table 15.2: SAR Measurement Variability for Head W1900 (1g)

Frequency		Side	Test Position	Original SAR (W/kg)	First Repeated SAR (W/kg)	The Ratio	Second Repeated SAR (W/kg)
Ch.	MHz						
9400	1880	Right	Cheek	0.896	0.871	1.03	/

Table 15.3: SAR Measurement Variability for Body LTE B7 (1g)

Frequency		Mode	Test Position	Spacing (mm)	Original SAR (W/kg)	First Repeated SAR (W/kg)	The Ratio	Second Repeated SAR (W/kg)
Ch.	MHz							
21350	2560	1RB_Mid	Right	10	0.815	0.802	1.02	/

Table 15.4: SAR Measurement Variability for Head LTE B25 (1g)

Frequency		Mode	Side	Test Position	Original SAR (W/kg)	First Repeated SAR (W/kg)	The Ratio	Second Repeated SAR (W/kg)
Ch.	MHz							
26365	1882.5	1RB_Mid	Right	Cheek	0.853	0.822	1.04	/

Table 15.5: SAR Measurement Variability for Body LTE B25 (1g)

Frequency		Mode	Test Position	Spacing (mm)	Original SAR (W/kg)	First Repeated SAR (W/kg)	The Ratio	Second Repeated SAR (W/kg)
Ch.	MHz							
26590	1905	1RB_Mid	Left	10	0.857	0.837	1.02	/

Table 15.6: SAR Measurement Variability for Body LTE B41 PC2 (1g)

Frequency		Mode	Test Position	Spacing (mm)	Original SAR (W/kg)	First Repeated SAR (W/kg)	The Ratio	Second Repeated SAR (W/kg)
Ch.	MHz							
40185	2549.5	50RB_High	Right	10	1.01	0.992	1.02	/

Table 15.7: SAR Measurement Variability for Body LTE B66 (1g)

Frequency		Mode	Test Position	Spacing (mm)	Original SAR (W/kg)	First Repeated SAR (W/kg)	The Ratio	Second Repeated SAR (W/kg)
Ch.	MHz							
132072	1720	1RB_Mid	Rear	10	0.822	0.805	1.02	/

16 Measurement Uncertainty

16.1 Measurement Uncertainty for Normal SAR Tests (300MHz~3GHz)

No.	Error Description	Type	Uncertainty value	Probably Distribution	Div.	(Ci) 1g	(Ci) 10g	Std. Unc. (1g)	Std. Unc. (10g)	Degree of freedom
Measurement system										
1	Probe calibration	B	6.0	N	1	1	1	6.0	6.0	∞
2	Isotropy	B	4.7	R	$\sqrt{3}$	0.7	0.7	1.9	1.9	∞
3	Boundary effect	B	1.0	R	$\sqrt{3}$	1	1	0.6	0.6	∞
4	Linearity	B	4.7	R	$\sqrt{3}$	1	1	2.7	2.7	∞
5	Detection limit	B	1.0	N	1	1	1	0.6	0.6	∞
6	Readout electronics	B	0.3	R	$\sqrt{3}$	1	1	0.3	0.3	∞
7	Response time	B	0.8	R	$\sqrt{3}$	1	1	0.5	0.5	∞
8	Integration time	B	2.6	R	$\sqrt{3}$	1	1	1.5	1.5	∞
9	RF ambient conditions-noise	B	0	R	$\sqrt{3}$	1	1	0	0	∞
10	RF ambient conditions-reflection	B	0	R	$\sqrt{3}$	1	1	0	0	∞
11	Probe positioned mech. restrictions	B	0.4	R	$\sqrt{3}$	1	1	0.2	0.2	∞
12	Probe positioning with respect to phantom shell	B	2.9	R	$\sqrt{3}$	1	1	1.7	1.7	∞
13	Post-processing	B	1.0	R	$\sqrt{3}$	1	1	0.6	0.6	∞
Test sample related										
14	Test sample positioning	A	3.3	N	1	1	1	3.3	3.3	71
15	Device holder uncertainty	A	3.4	N	1	1	1	3.4	3.4	5
16	Drift of output power	B	5.0	R	$\sqrt{3}$	1	1	2.9	2.9	∞
Phantom and set-up										
17	Phantom uncertainty	B	4.0	R	$\sqrt{3}$	1	1	2.3	2.3	∞
18	Liquid conductivity (target)	B	5.0	R	$\sqrt{3}$	0.64	0.43	1.8	1.2	∞
19	Liquid conductivity (meas.)	A	2.06	N	1	0.64	0.43	1.32	0.89	43
20	Liquid permittivity (target)	B	5.0	R	$\sqrt{3}$	0.6	0.49	1.7	1.4	∞
21	Liquid permittivity (meas.)	A	1.6	N	1	0.6	0.49	1.0	0.8	521

Combined standard uncertainty	$u_c = \sqrt{\sum_{i=1}^{21} c_i^2 u_i^2}$							9.55	9.43	257
Expanded uncertainty (confidence interval of 95 %)	$u_e = 2u_c$							19.1	18.9	

16.2 Measurement Uncertainty for Normal SAR Tests (3~6GHz)

No.	Error Description	Type	Uncertainty value	Probably Distribution	Div.	(Ci) 1g	(Ci) 10g	Std. Unc. (1g)	Std. Unc. (10g)	Degree of freedom
Measurement system										
1	Probe calibration	B	6.55	N	1	1	1	6.55	6.55	∞
2	Isotropy	B	4.7	R	$\sqrt{3}$	0.7	0.7	1.9	1.9	∞
3	Boundary effect	B	2.0	R	$\sqrt{3}$	1	1	1.2	1.2	∞
4	Linearity	B	4.7	R	$\sqrt{3}$	1	1	2.7	2.7	∞
5	Detection limit	B	1.0	R	$\sqrt{3}$	1	1	0.6	0.6	∞
6	Readout electronics	B	0.3	R	$\sqrt{3}$	1	1	0.3	0.3	∞
7	Response time	B	0.8	R	$\sqrt{3}$	1	1	0.5	0.5	∞
8	Integration time	B	2.6	R	$\sqrt{3}$	1	1	1.5	1.5	∞
9	RF ambient conditions-noise	B	0	R	$\sqrt{3}$	1	1	0	0	∞
10	RFambient conditions-reflection	B	0	R	$\sqrt{3}$	1	1	0	0	∞
11	Probe positioned mech. restrictions	B	0.8	R	$\sqrt{3}$	1	1	0.5	0.5	∞
12	Probe positioning with respect to phantom shell	B	6.7	R	$\sqrt{3}$	1	1	3.9	3.9	∞
13	Post-processing	B	4.0	R	$\sqrt{3}$	1	1	2.3	2.3	∞
Test sample related										
14	Test sample positioning	A	3.3	N	1	1	1	3.3	3.3	71
15	Device holder uncertainty	A	3.4	N	1	1	1	3.4	3.4	5
16	Drift of output power	B	5.0	R	$\sqrt{3}$	1	1	2.9	2.9	∞
Phantom and set-up										
17	Phantom uncertainty	B	4.0	R	$\sqrt{3}$	1	1	2.3	2.3	∞
18	Liquid conductivity (target)	B	5.0	R	$\sqrt{3}$	0.64	0.43	1.8	1.2	∞
19	Liquid conductivity (meas.)	A	2.06	N	1	0.64	0.43	1.32	0.89	43
20	Liquid permittivity	B	5.0	R	$\sqrt{3}$	0.6	0.49	1.7	1.4	∞

	(target)									
21	Liquid permittivity (meas.)	A	1.6	N	1	0.6	0.49	1.0	0.8	521
Combined standard uncertainty		$u_c = \sqrt{\sum_{i=1}^{21} c_i^2 u_i^2}$						10.7	10.6	257
Expanded uncertainty (confidence interval of 95 %)		$u_e = 2u_c$						21.4	21.1	

16.3 Measurement Uncertainty for Fast SAR Tests (300MHz~3GHz)

No.	Error Description	Type	Uncertainty value	Probably Distribution	Div.	(Ci) 1g	(Ci) 10g	Std. Unc. (1g)	Std. Unc. (10g)	Degree of freedom
Measurement system										
1	Probe calibration	B	6.0	N	1	1	1	6.0	6.0	∞
2	Isotropy	B	4.7	R	$\sqrt{3}$	0.7	0.7	1.9	1.9	∞
3	Boundary effect	B	1.0	R	$\sqrt{3}$	1	1	0.6	0.6	∞
4	Linearity	B	4.7	R	$\sqrt{3}$	1	1	2.7	2.7	∞
5	Detection limit	B	1.0	R	$\sqrt{3}$	1	1	0.6	0.6	∞
6	Readout electronics	B	0.3	R	$\sqrt{3}$	1	1	0.3	0.3	∞
7	Response time	B	0.8	R	$\sqrt{3}$	1	1	0.5	0.5	∞
8	Integration time	B	2.6	R	$\sqrt{3}$	1	1	1.5	1.5	∞
9	RF ambient conditions-noise	B	0	R	$\sqrt{3}$	1	1	0	0	∞
10	RF ambient conditions-reflection	B	0	R	$\sqrt{3}$	1	1	0	0	∞
11	Probe positioned mech. Restrictions	B	0.4	R	$\sqrt{3}$	1	1	0.2	0.2	∞
12	Probe positioning with respect to phantom shell	B	2.9	R	$\sqrt{3}$	1	1	1.7	1.7	∞
13	Post-processing	B	1.0	R	$\sqrt{3}$	1	1	0.6	0.6	∞
14	Fast SAR z-Approximation	B	7.0	R	$\sqrt{3}$	1	1	4.0	4.0	∞
Test sample related										
15	Test sample positioning	A	3.3	N	1	1	1	3.3	3.3	71
16	Device holder uncertainty	A	3.4	N	1	1	1	3.4	3.4	5
17	Drift of output power	B	5.0	R	$\sqrt{3}$	1	1	2.9	2.9	∞
Phantom and set-up										
18	Phantom uncertainty	B	4.0	R	$\sqrt{3}$	1	1	2.3	2.3	∞

19	Liquid conductivity (target)	B	5.0	R	$\sqrt{3}$	0.64	0.43	1.8	1.2	∞
20	Liquid conductivity (meas.)	A	2.06	N	1	0.64	0.43	1.32	0.89	43
21	Liquid permittivity (target)	B	5.0	R	$\sqrt{3}$	0.6	0.49	1.7	1.4	∞
22	Liquid permittivity (meas.)	A	1.6	N	1	0.6	0.49	1.0	0.8	521
Combined standard uncertainty		$u_c = \sqrt{\sum_{i=1}^{22} c_i^2 u_i^2}$						10.4	10.3	257
Expanded uncertainty (confidence interval of 95 %)		$u_e = 2u_c$						20.8	20.6	

16.4 Measurement Uncertainty for Fast SAR Tests (3~6GHz)

No.	Error Description	Type	Uncertainty value	Probably Distribution	Div.	(Ci) 1g	(Ci) 10g	Std. Unc. (1g)	Std. Unc. (10g)	Degree of freedom
Measurement system										
1	Probe calibration	B	6.55	N	1	1	1	6.55	6.55	∞
2	Isotropy	B	4.7	R	$\sqrt{3}$	0.7	0.7	1.9	1.9	∞
3	Boundary effect	B	2.0	R	$\sqrt{3}$	1	1	1.2	1.2	∞
4	Linearity	B	4.7	R	$\sqrt{3}$	1	1	2.7	2.7	∞
5	Detection limit	B	1.0	R	$\sqrt{3}$	1	1	0.6	0.6	∞
6	Readout electronics	B	0.3	R	$\sqrt{3}$	1	1	0.3	0.3	∞
7	Response time	B	0.8	R	$\sqrt{3}$	1	1	0.5	0.5	∞
8	Integration time	B	2.6	R	$\sqrt{3}$	1	1	1.5	1.5	∞
9	RF ambient conditions-noise	B	0	R	$\sqrt{3}$	1	1	0	0	∞
10	RFambient conditions-reflection	B	0	R	$\sqrt{3}$	1	1	0	0	∞
11	Probe positioned mech. Restrictions	B	0.8	R	$\sqrt{3}$	1	1	0.5	0.5	∞
12	Probe positioning with respect to phantom shell	B	6.7	R	$\sqrt{3}$	1	1	3.9	3.9	∞
13	Post-processing	B	1.0	R	$\sqrt{3}$	1	1	0.6	0.6	∞
14	Fast SAR z-Approximation	B	14.0	R	$\sqrt{3}$	1	1	8.1	8.1	∞
Test sample related										
15	Test sample positioning	A	3.3	N	1	1	1	3.3	3.3	71

16	Device holder uncertainty	A	3.4	N	1	1	1	3.4	3.4	5
17	Drift of output power	B	5.0	R	$\sqrt{3}$	1	1	2.9	2.9	∞
Phantom and set-up										
18	Phantom uncertainty	B	4.0	R	$\sqrt{3}$	1	1	2.3	2.3	∞
19	Liquid conductivity (target)	B	5.0	R	$\sqrt{3}$	0.64	0.43	1.8	1.2	∞
20	Liquid conductivity (meas.)	A	2.06	N	1	0.64	0.43	1.32	0.89	43
21	Liquid permittivity (target)	B	5.0	R	$\sqrt{3}$	0.6	0.49	1.7	1.4	∞
22	Liquid permittivity (meas.)	A	1.6	N	1	0.6	0.49	1.0	0.8	521
Combined standard uncertainty		$u_c' = \sqrt{\sum_{i=1}^{22} c_i^2 u_i^2}$						13.5	13.4	257
Expanded uncertainty (confidence interval of 95 %)		$u_e = 2u_c$						27.0	26.8	

17 MAIN TEST INSTRUMENTS

Table 17.1: List of Main Instruments

No.	Name	Type	Serial Number	Calibration Date	Valid Period
01	Network analyzer	E5071C	MY46110673	January 14, 2021	One year
02	Power meter	NRP2	106277	September 23, 2021	One year
03	Power sensor	NRP8S	104291		
04	Signal Generator	E4438C	MY49071430	February 1, 2021	One Year
05	Amplifier	60S1G4	0331848	No Calibration Requested	
06	BTS	CMW500	159890	January 25 2021	One year
07	BTS	CMW500	159889	January 13 2021	One year
08	E-field Probe	SPEAG EX3DV4	7600	November 30, 2020	One year
09	DAE	SPEAG DAE4	1525	September 1, 2021	One year
10	E-field Probe	SPEAG EX3DV4	7517	February 03, 2021	One year
11	E-field Probe	SPEAG EX3DV4	7548	June 25, 2021	One year
12	DAE	SPEAG DAE4	1331	September 1, 2021	One year
13	Dipole Validation Kit	SPEAG D750V3	1017	July 12,2021	One year
14	Dipole Validation Kit	SPEAG D835V2	4d069	July 12,,2021	One year
15	Dipole Validation Kit	SPEAG D1750V2	1003	July 12,,2021	One year
16	Dipole Validation Kit	SPEAG D1900V2	5d101	July 15,2021	One year
17	Dipole Validation Kit	SPEAG D2450V2	853	July 26,2021	One year
18	Dipole Validation Kit	SPEAG D2600V2	1012	July 26,2021	One year
19	Dipole Validation Kit	SPEAG D3500V2	1016	June 21,2021	One year
20	Dipole Validation Kit	SPEAG D3900V2	1024	June 21,2021	One year
21	Dipole Validation Kit	SPEAG D5GHzV2	1060	June 22,2021	One year

END OF REPORT BODY

ANNEX A Graph Results

GSM850_Head

Date: 10/19/2021

Electronics: DAE4 Sn1525

Medium: H835

Medium parameters used: $f = 825$ MHz; $\sigma = 0.899$ S/m; $\epsilon_r = 44$; $\rho = 1000$ kg/m³

Ambient Temperature: 23.1°C Liquid Temperature: 22.1°C

Communication System: GSM850 4TX Frequency: 824.2 MHz Duty Cycle: 1:1.99986

Probe: EX3DV4 - SN7600 ConvF(10.88, 10.88, 10.88)

Area Scan (81x141x1): Interpolated grid: dx=1.500 mm, dy=1.500 mm

Maximum value of SAR (interpolated) = 1.36 W/kg

Zoom Scan (6x6x7)/Cube 0: Measurement grid: dx=8mm, dy=8mm, dz=5mm

Reference Value = 22.97 V/m; Power Drift = 0.06 dB

Peak SAR (extrapolated) = 2.03 W/kg

SAR(1 g) = 0.638 W/kg; SAR(10 g) = 0.310 W/kg

Maximum value of SAR (measured) = 1.33 W/kg

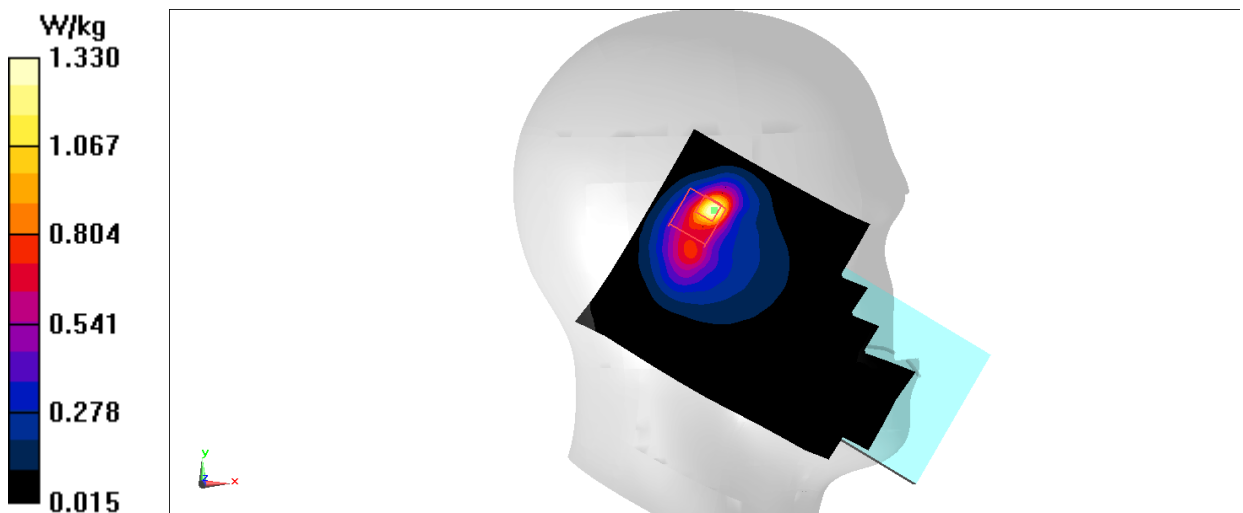

Fig A.1

GSM850_Body

Date: 10/19/2021

Electronics: DAE4 Sn1525

Medium: H835

Medium parameters used (interpolated): $f = 836.6$ MHz; $\sigma = 0.904$ S/m; $\epsilon_r = 43.978$; $\rho = 1000$ kg/m³

Ambient Temperature: 23.1oC Liquid Temperature: 22.1oC

Communication System: GSM850 4TX Frequency: 836.6 MHz Duty Cycle: 1:1.99986

Probe: EX3DV4 - SN7600 ConvF(10.88, 10.88, 10.88)

Area Scan (41x141x1): Interpolated grid: dx=1.500 mm, dy=1.500 mm

Maximum value of SAR (interpolated) = 0.614 W/kg

Zoom Scan (5x5x7)/Cube 0: Measurement grid: dx=8mm, dy=8mm, dz=5mm

Reference Value = 15.23 V/m; Power Drift = 0.14 dB

Peak SAR (extrapolated) = 0.563 W/kg

SAR(1 g) = 0.264 W/kg; SAR(10 g) = 0.139 W/kg

Maximum value of SAR (measured) = 0.431 W/kg

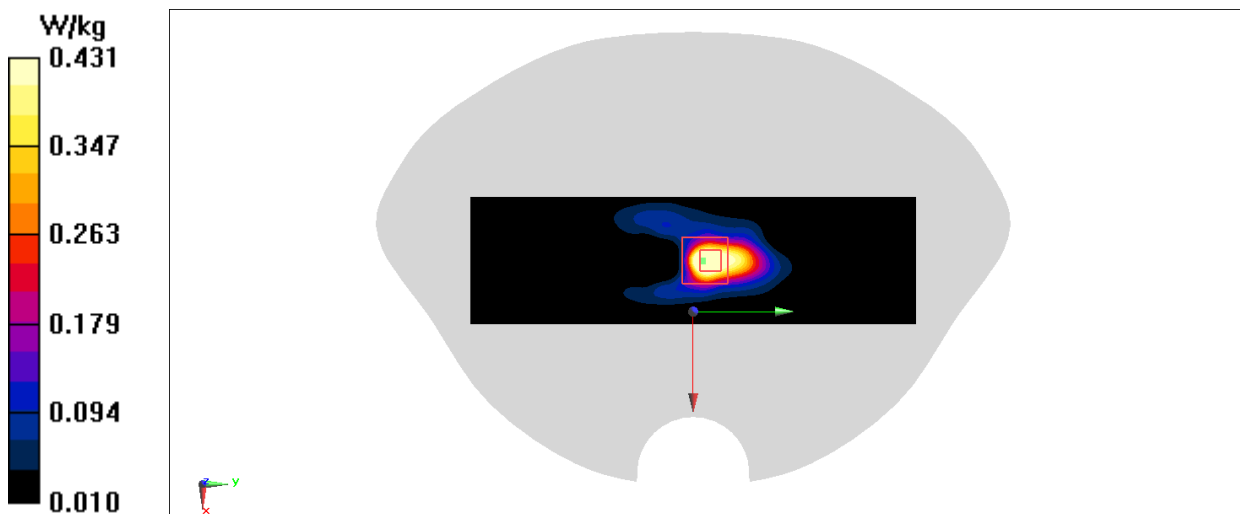

Fig A.2

PCS1900_Head

Date: 10/13/2021

Electronics: DAE4 Sn1525

Medium: H1900

Medium parameters used (interpolated): $f = 1850.2$ MHz; $\sigma = 1.486$ S/m; $\epsilon_r = 41.94$; $\rho = 1000$ kg/m³

Ambient Temperature: 23.3oC Liquid Temperature: 22.3oC

Communication System: GSM1900 2TX Frequency: 1850.2 MHz Duty Cycle: 1:4.00037

Probe: EX3DV4 - SN7600 ConvF(8.7, 8.7, 8.7)

Area Scan (81x141x1): Interpolated grid: dx=1.500 mm, dy=1.500 mm

Maximum value of SAR (interpolated) = 1.22 W/kg

Zoom Scan (5x5x7)/Cube 0: Measurement grid: dx=8mm, dy=8mm, dz=5mm

Reference Value = 8.455 V/m; Power Drift = 0.10 dB

Peak SAR (extrapolated) = 1.51 W/kg

SAR(1 g) = 0.730 W/kg; SAR(10 g) = 0.348 W/kg

Maximum value of SAR (measured) = 1.28 W/kg

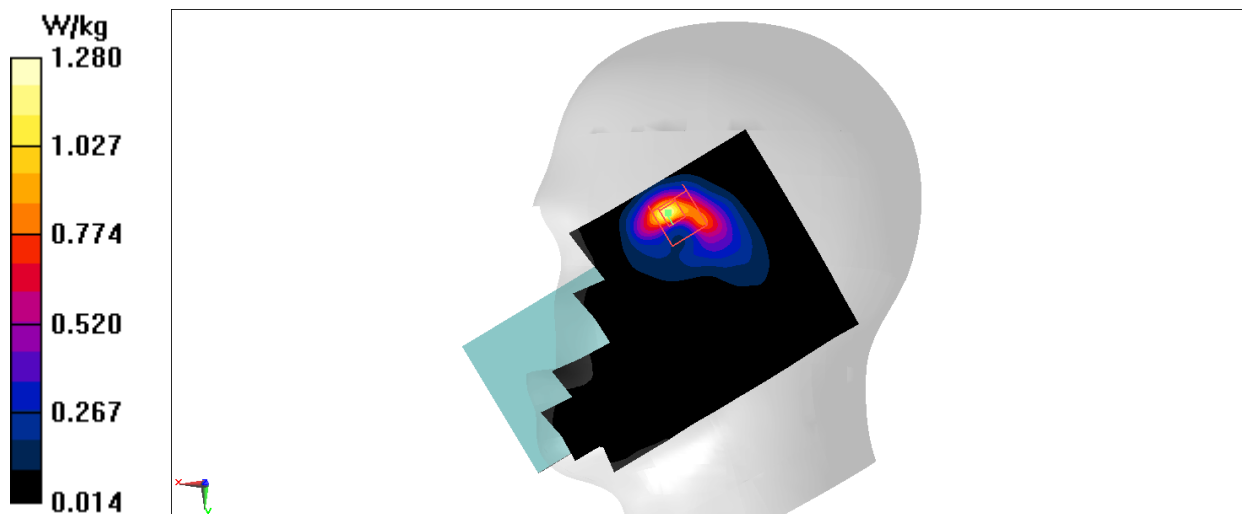

Fig A.3

PCS1900_Body

Date: 10/13/2021

Electronics: DAE4 Sn1525

Medium: H1900

Medium parameters used: $f = 1880$ MHz; $\sigma = 1.503$ S/m; $\epsilon_r = 41.89$; $\rho = 1000$ kg/m³

Ambient Temperature: 23.3oC Liquid Temperature: 22.3oC

Communication System: GSM1900 4TX Frequency: 1880 MHz Duty Cycle: 1:1.99986

Probe: EX3DV4 - SN7600 ConvF(8.7, 8.7, 8.7)

Area Scan (41x141x1): Interpolated grid: dx=1.500 mm, dy=1.500 mm

Maximum value of SAR (interpolated) = 0.659 W/kg

Zoom Scan (5x5x7)/Cube 0: Measurement grid: dx=8mm, dy=8mm, dz=5mm

Reference Value = 8.183 V/m; Power Drift = 0.09 dB

Peak SAR (extrapolated) = 0.846 W/kg

SAR(1 g) = 0.445 W/kg; SAR(10 g) = 0.221 W/kg

Maximum value of SAR (measured) = 0.705 W/kg

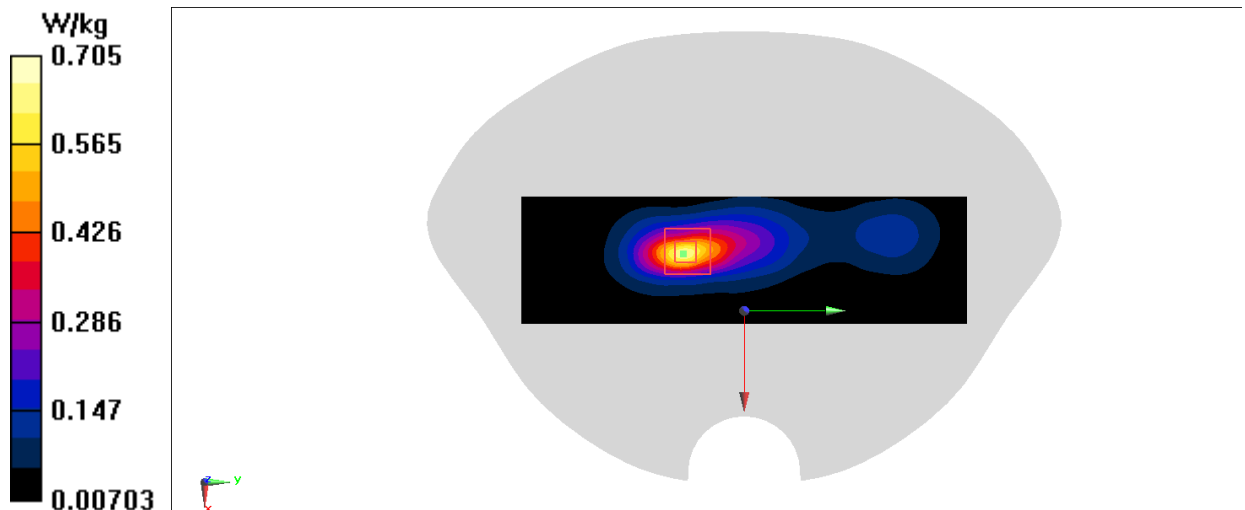
**Fig A.4**

WCDMA1900-BII_Head

Date: 10/13/2021

Electronics: DAE4 Sn1525

Medium: H1900

Medium parameters used: $f = 1880$ MHz; $\sigma = 1.503$ S/m; $\epsilon_r = 41.89$; $\rho = 1000$ kg/m³

Ambient Temperature: 23.3oC Liquid Temperature: 22.3oC

Communication System: WCDMA 1900 Frequency: 1880 MHz Duty Cycle: 1:1

Probe: EX3DV4 - SN7600 ConvF(8.7, 8.7, 8.7)

Area Scan (81x141x1): Interpolated grid: dx=1.500 mm, dy=1.500 mm

Maximum value of SAR (interpolated) = 1.52 W/kg

Zoom Scan (5x5x7)/Cube 0: Measurement grid: dx=8mm, dy=8mm, dz=5mm

Reference Value = 8.538 V/m; Power Drift = -0.17 dB

Peak SAR (extrapolated) = 1.84 W/kg

SAR(1 g) = 0.896 W/kg; SAR(10 g) = 0.410 W/kg

Maximum value of SAR (measured) = 1.56 W/kg

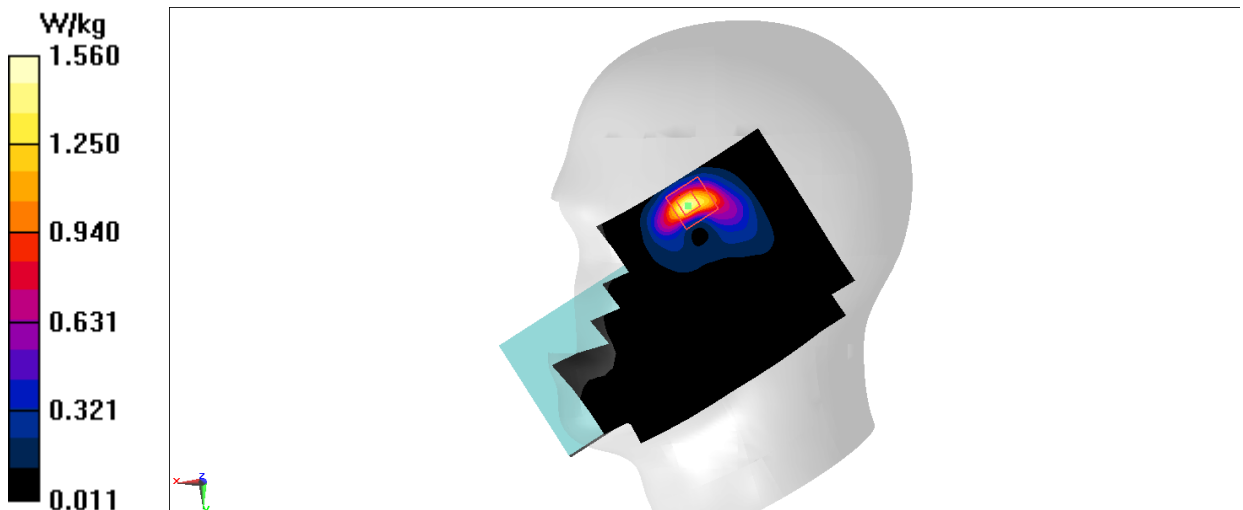
**Fig A.5**

WCDMA1900-BII_Body

Date: 10/13/2021

Electronics: DAE4 Sn1525

Medium: H1900

Medium parameters used: $f = 1880$ MHz; $\sigma = 1.503$ S/m; $\epsilon_r = 41.89$; $\rho = 1000$ kg/m³

Ambient Temperature: 23.3oC Liquid Temperature: 22.3oC

Communication System: WCDMA 1900 Frequency: 1880 MHz Duty Cycle: 1:1

Probe: EX3DV4 - SN7600 ConvF(8.7, 8.7, 8.7)

Area Scan (41x141x1): Interpolated grid: dx=1.500 mm, dy=1.500 mm

Maximum value of SAR (interpolated) = 0.961 W/kg

Zoom Scan (5x5x7)/Cube 0: Measurement grid: dx=8mm, dy=8mm, dz=5mm

Reference Value = 8.554 V/m; Power Drift = 0.07 dB

Peak SAR (extrapolated) = 1.24 W/kg

SAR(1 g) = 0.636 W/kg; SAR(10 g) = 0.311 W/kg

Maximum value of SAR (measured) = 1.01 W/kg

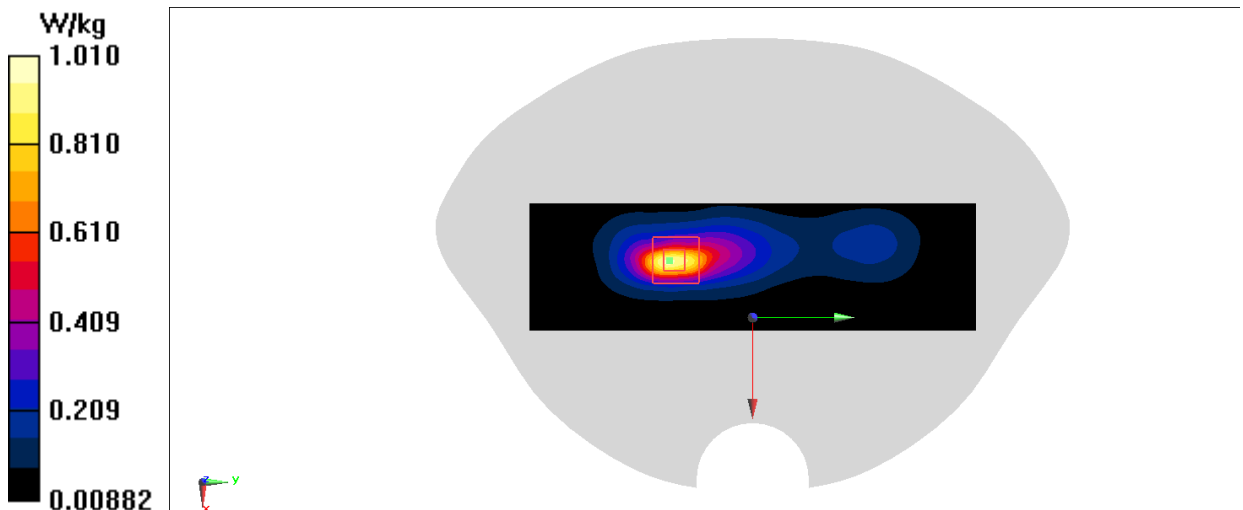

Fig A.6

WCDMA1900-BII_Body

Date: 10/13/2021

Electronics: DAE4 Sn1525

Medium: H1900

Medium parameters used (interpolated): $f = 1907.6$ MHz; $\sigma = 1.518$ S/m; $\epsilon_r = 41.875$; $\rho = 1000$ kg/m³

Ambient Temperature: 23.3oC Liquid Temperature: 22.5oC

Communication System: WCDMA1900(B2) Frequency: 1907.6 MHz Duty Cycle: 1:1

Probe: EX3DV4 - SN7600 ConvF(8.7, 8.7, 8.7)

Area Scan (91x151x1): Interpolated grid: dx=1.500 mm, dy=1.500 mm

Maximum value of SAR (interpolated) = 0.513 W/kg

Zoom Scan (5x5x7)/Cube 0: Measurement grid: dx=8mm, dy=8mm, dz=5mm

Reference Value = 8.146 V/m; Power Drift = -0.12 dB

Peak SAR (extrapolated) = 0.596 W/kg

SAR(1 g) = 0.336 W/kg; SAR(10 g) = 0.186 W/kg

Maximum value of SAR (measured) = 0.484 W/kg

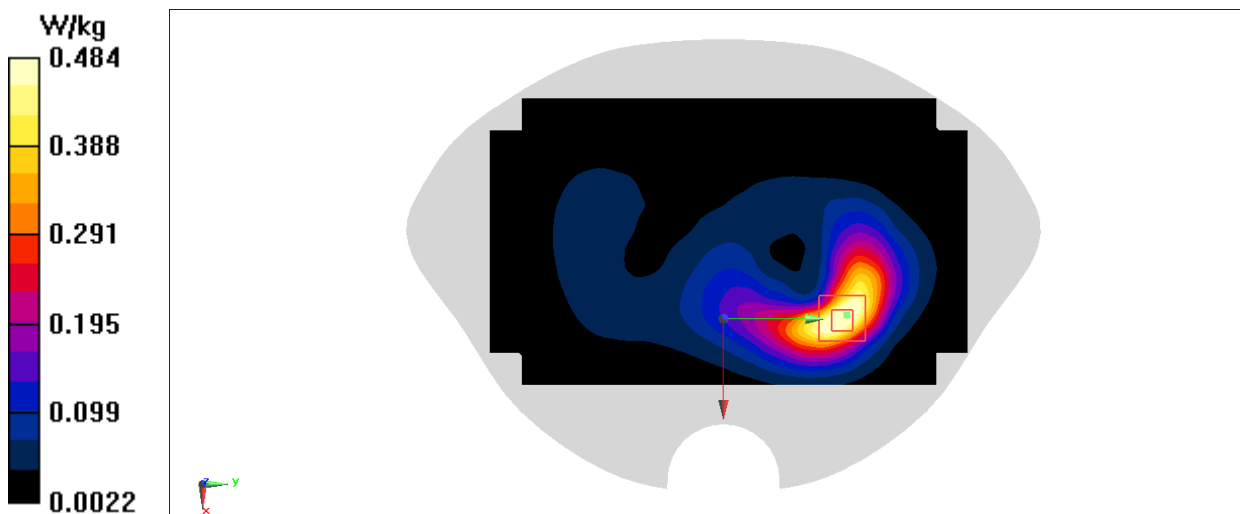
**Fig A.7**

WCDMA1700-BIV_Head

Date: 10/15/2021

Electronics: DAE4 Sn1525

Medium: H1750

Medium parameters used (interpolated): $f = 1732.4$ MHz; $\sigma = 1.377$ S/m; $\epsilon_r = 43.351$; $\rho = 1000$ kg/m³

Ambient Temperature: 22.9oC Liquid Temperature: 22.7oC

Communication System: WCDMA1700(B4) Frequency: 1732.4 MHz Duty Cycle: 1:1

Probe: EX3DV4 - SN7600 ConvF(9.01, 9.01, 9.01)

Area Scan (81x141x1): Interpolated grid: dx=1.500 mm, dy=1.500 mm

Maximum value of SAR (interpolated) = 1.60 W/kg

Zoom Scan (5x6x7)/Cube 0: Measurement grid: dx=8mm, dy=8mm, dz=5mm

Reference Value = 8.527 V/m; Power Drift = 0.05 dB

Peak SAR (extrapolated) = 1.99 W/kg

SAR(1 g) = 0.912 W/kg; SAR(10 g) = 0.427 W/kg

Maximum value of SAR (measured) = 1.51 W/kg

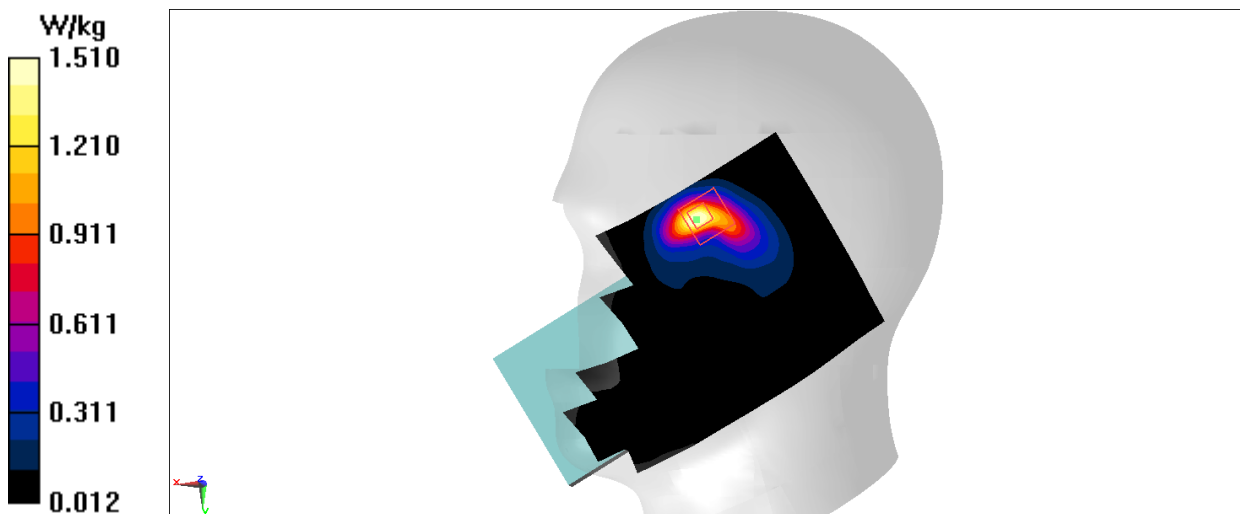
**Fig A.8**

WCDMA1700-BIV_Body

Date: 10/15/2021

Electronics: DAE4 Sn1525

Medium: H1750

Medium parameters used (interpolated): $f = 1732.4$ MHz; $\sigma = 1.377$ S/m; $\epsilon_r = 43.351$; $\rho = 1000$ kg/m³

Ambient Temperature: 22.9oC Liquid Temperature: 22.7oC

Communication System: WCDMA1700(B4) Frequency: 1732.4 MHz Duty Cycle: 1:1

Probe: EX3DV4 - SN7600 ConvF(9.01, 9.01, 9.01)

Area Scan (81x141x1): Interpolated grid: dx=1.500 mm, dy=1.500 mm

Maximum value of SAR (interpolated) = 0.831 W/kg

Zoom Scan (5x5x7)/Cube 0: Measurement grid: dx=8mm, dy=8mm, dz=5mm

Reference Value = 5.863 V/m; Power Drift = 0.15 dB

Peak SAR (extrapolated) = 1.12 W/kg

SAR(1 g) = 0.579 W/kg; SAR(10 g) = 0.305 W/kg

Maximum value of SAR (measured) = 0.881 W/kg

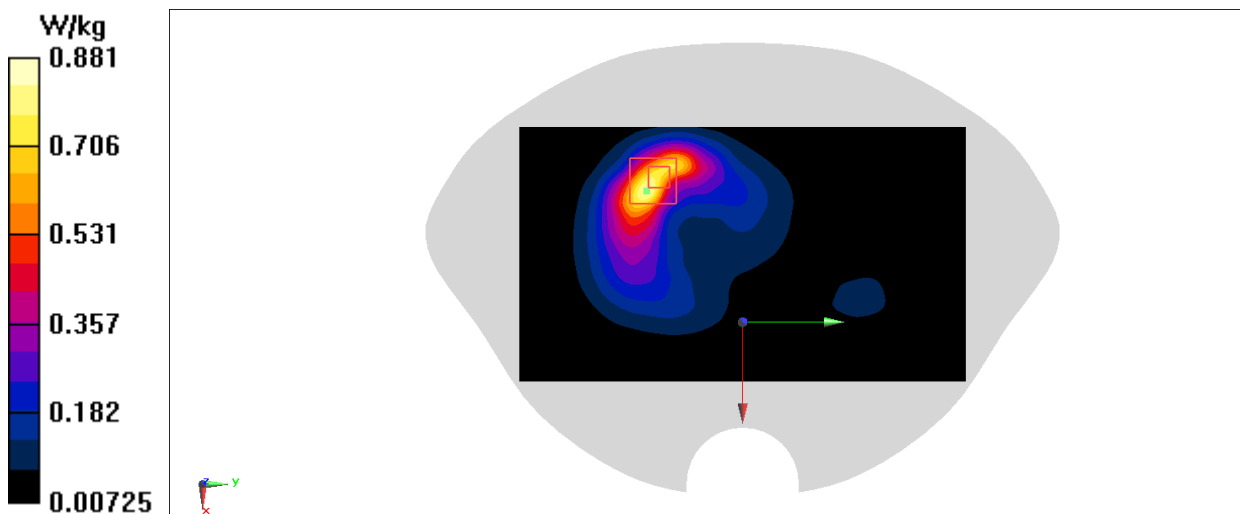
**Fig A.9**

WCDMA1700-BIV_Body

Date: 10/15/2021

Electronics: DAE4 Sn1525

Medium: H1750

Medium parameters used (interpolated): $f = 1752.6$ MHz; $\sigma = 1.391$ S/m; $\epsilon_r = 43.35$; $\rho = 1000$ kg/m³

Ambient Temperature: 22.9oC Liquid Temperature: 22.7oC

Communication System: WCDMA1700(B4) Frequency: 1752.6 MHz Duty Cycle: 1:1

Probe: EX3DV4 - SN7600 ConvF(9.01, 9.01, 9.01)

Area Scan (91x151x1): Interpolated grid: dx=1.500 mm, dy=1.500 mm

Maximum value of SAR (interpolated) = 0.588 W/kg

Zoom Scan (5x5x7)/Cube 0: Measurement grid: dx=8mm, dy=8mm, dz=5mm

Reference Value = 7.588 V/m; Power Drift = -0.04 dB

Peak SAR (extrapolated) = 0.685 W/kg

SAR(1 g) = 0.386 W/kg; SAR(10 g) = 0.212 W/kg

Maximum value of SAR (measured) = 0.539 W/kg

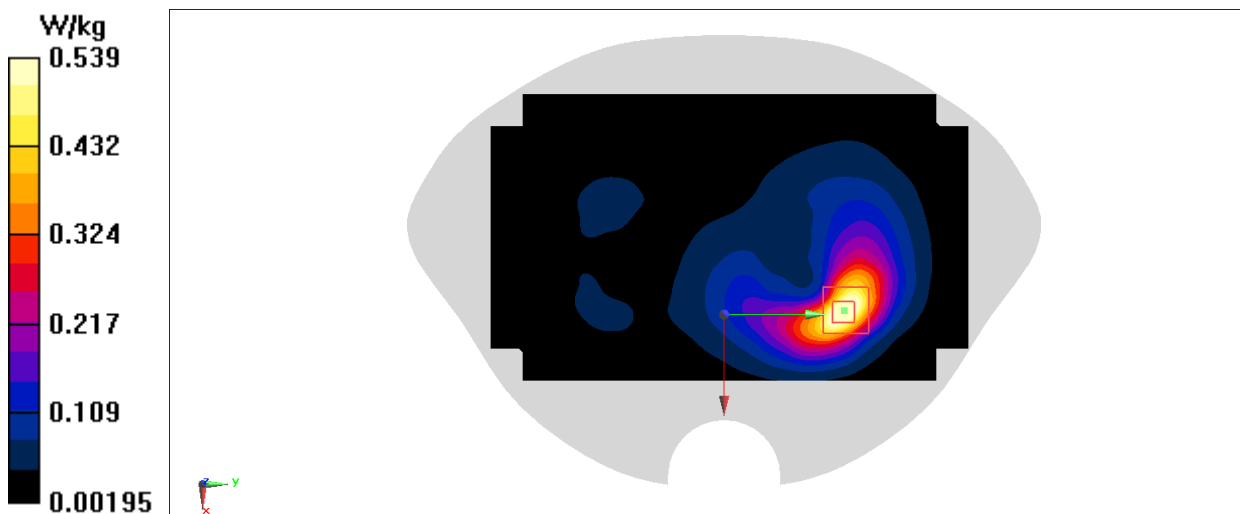
**Fig A.10**

WCDMA850-BV_Head

Date: 10/19/2021

Electronics: DAE4 Sn1525

Medium: H835

Medium parameters used (interpolated): $f = 826.4$ MHz; $\sigma = 0.9$ S/m; $\epsilon_r = 43.996$; $\rho = 1000$ kg/m³

Ambient Temperature: 23.1oC Liquid Temperature: 22.1oC

Communication System: WCDMA850(B5) Frequency: 826.4 MHz Duty Cycle: 1:1

Probe: EX3DV4 - SN7600 ConvF(10.88, 10.88, 10.88)

Area Scan (81x131x1): Interpolated grid: dx=1.500 mm, dy=1.500 mm

Maximum value of SAR (interpolated) = 0.959 W/kg

Zoom Scan (5x5x7)/Cube 0: Measurement grid: dx=8mm, dy=8mm, dz=5mm

Reference Value = 29.08 V/m; Power Drift = -0.09 dB

Peak SAR (extrapolated) = 1.31 W/kg

SAR(1 g) = 0.601 W/kg; SAR(10 g) = 0.360 W/kg

Maximum value of SAR (measured) = 0.982 W/kg

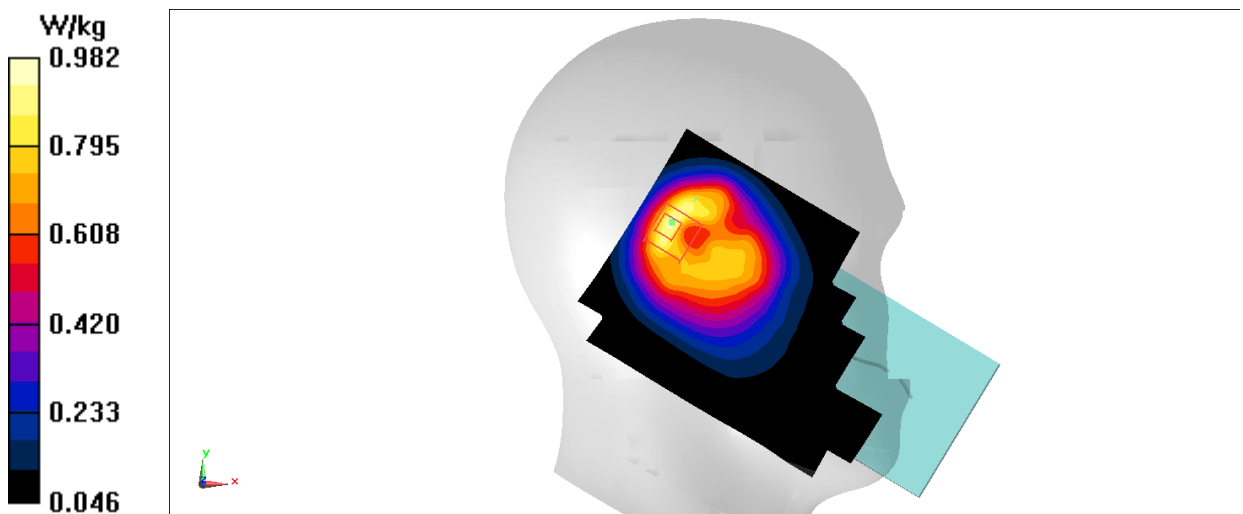

Fig A.11

WCDMA850-BV_Body

Date: 10/19/2021

Electronics: DAE4 Sn1525

Medium: H835

Medium parameters used (interpolated): $f = 826.4$ MHz; $\sigma = 0.9$ S/m; $\epsilon_r = 43.996$; $\rho = 1000$ kg/m³

Ambient Temperature: 23.1oC Liquid Temperature: 22.1oC

Communication System: WCDMA850(B5) Frequency: 826.4 MHz Duty Cycle: 1:1

Probe: EX3DV4 - SN7600 ConvF(10.88, 10.88, 10.88)

Area Scan (41x141x1): Interpolated grid: dx=1.500 mm, dy=1.500 mm

Maximum value of SAR (interpolated) = 0.420 W/kg

Zoom Scan (5x5x7)/Cube 0: Measurement grid: dx=8mm, dy=8mm, dz=5mm

Reference Value = 18.02 V/m; Power Drift = 0.05 dB

Peak SAR (extrapolated) = 0.503 W/kg

SAR(1 g) = 0.293 W/kg; SAR(10 g) = 0.180 W/kg

Maximum value of SAR (measured) = 0.410 W/kg

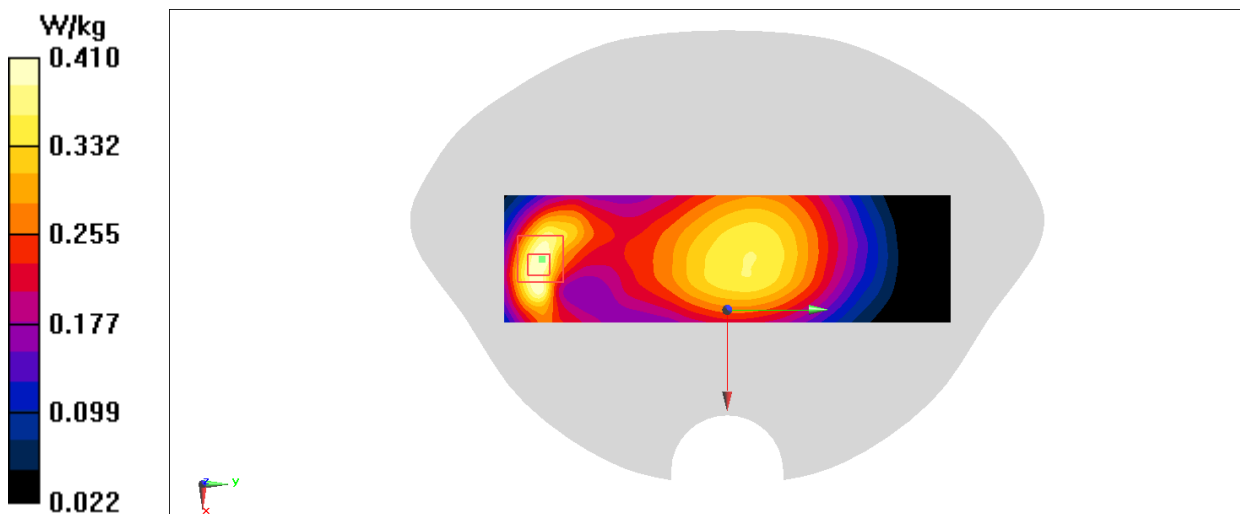
**Fig A.12**

LTE2600-FDD7_Head

Date: 10/30/2021

Electronics: DAE4 Sn1525

Medium: H2600

Medium parameters used: $f = 2510$ MHz; $\sigma = 1.966$ S/m; $\epsilon_r = 40.121$; $\rho = 1000$ kg/m³

Ambient Temperature: 22.6oC Liquid Temperature: 22.5oC

Communication System: LTE Band7 Frequency: 2510 MHz Duty Cycle: 1:1

Probe: EX3DV4 - SN7600 ConvF(7.79, 7.79, 7.79)

Area Scan (101x171x1): Interpolated grid: dx=1.200 mm, dy=1.200 mm

Maximum value of SAR (interpolated) = 0.905 W/kg

Zoom Scan (7x7x7)/Cube 0: Measurement grid: dx=5mm, dy=5mm, dz=5mm

Reference Value = 0.8460 V/m; Power Drift = 0.18 dB

Peak SAR (extrapolated) = 1.60 W/kg

SAR(1 g) = 0.612 W/kg; SAR(10 g) = 0.232 W/kg

Maximum value of SAR (measured) = 1.13 W/kg

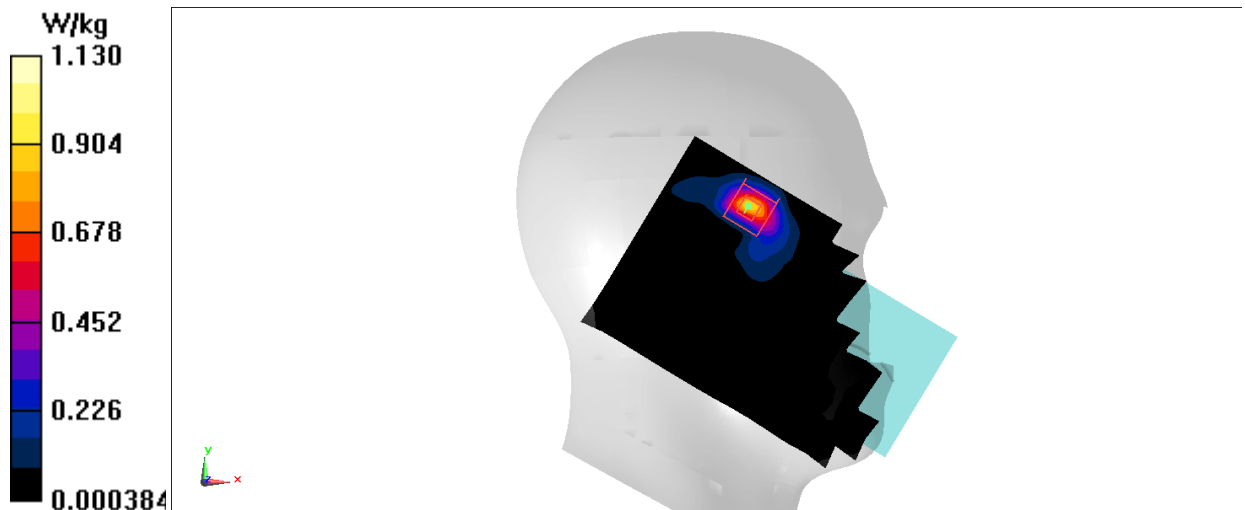
**Fig A.13**

LTE2600-FDD7_Body

Date: 10/30/2021

Electronics: DAE4 Sn1525

Medium: H2600

Medium parameters used: $f = 2560$ MHz; $\sigma = 2.01$ S/m; $\epsilon_r = 40.06$; $\rho = 1000$ kg/m³

Ambient Temperature: 22.6oC Liquid Temperature: 22.5oC

Communication System: LTE Band7 Frequency: 2560 MHz Duty Cycle: 1:1

Probe: EX3DV4 - SN7600 ConvF(7.67, 7.67, 7.67)

Area Scan (51x171x1): Interpolated grid: dx=1.200 mm, dy=1.200 mm

Maximum value of SAR (interpolated) = 1.36 W/kg

Zoom Scan (7x7x7)/Cube 0: Measurement grid: dx=5mm, dy=5mm, dz=5mm

Reference Value = 5.031 V/m; Power Drift = 0.05 dB

Peak SAR (extrapolated) = 1.78 W/kg

SAR(1 g) = 0.815 W/kg; SAR(10 g) = 0.353 W/kg

Maximum value of SAR (measured) = 1.40 W/kg

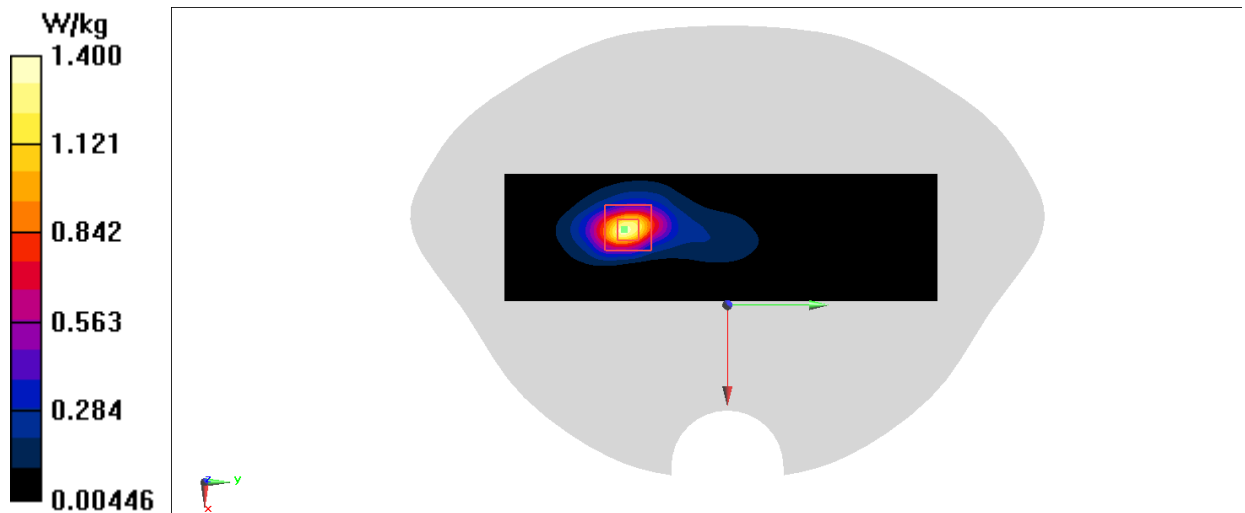
**Fig A.14**

LTE700-FDD12_Head

Date: 10/1/2021

Electronics: DAE4 Sn1525

Medium: H750

Medium parameters used (interpolated): $f = 704 \text{ MHz}$; $\sigma = 0.859 \text{ S/m}$; $\epsilon_r = 44.682$; $\rho = 1000 \text{ kg/m}^3$

Ambient Temperature: 22.8oC Liquid Temperature: 22.3oC

Communication System: LTE Band12 Frequency: 704 MHz Duty Cycle: 1:1

Probe: EX3DV4 - SN7600 ConvF(10.88, 10.88, 10.88)

Area Scan (81x131x1): Interpolated grid: $dx=1.500 \text{ mm}$, $dy=1.500 \text{ mm}$

Maximum value of SAR (interpolated) = 0.576 W/kg

Zoom Scan (8x8x7)/Cube 0: Measurement grid: $dx=8\text{mm}$, $dy=8\text{mm}$, $dz=5\text{mm}$

Reference Value = 25.41 V/m; Power Drift = -0.16 dB

Peak SAR (extrapolated) = 0.725 W/kg

SAR(1 g) = 0.442 W/kg; SAR(10 g) = 0.326 W/kg

Maximum value of SAR (measured) = 0.570 W/kg

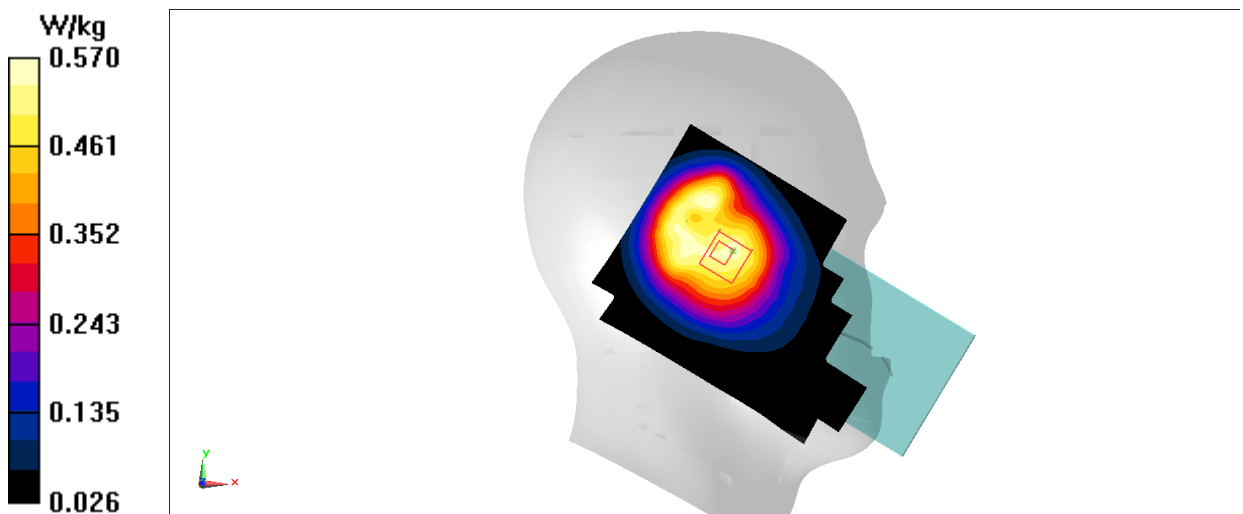
**Fig A.15**

LTE700-FDD12_Body

Date: 10/1/2021

Electronics: DAE4 Sn1525

Medium: H750

Medium parameters used (interpolated): $f = 704$ MHz; $\sigma = 0.859$ S/m; $\epsilon_r = 44.682$; $\rho = 1000$ kg/m³

Ambient Temperature: 22.8oC Liquid Temperature: 22.3oC

Communication System: LTE Band12 Frequency: 704 MHz Duty Cycle: 1:1

Probe: EX3DV4 - SN7600 ConvF(10.88, 10.88, 10.88)

Area Scan (91x151x1): Interpolated grid: dx=1.500 mm, dy=1.500 mm

Maximum value of SAR (interpolated) = 0.455 W/kg

Zoom Scan (5x5x7)/Cube 0: Measurement grid: dx=8mm, dy=8mm, dz=5mm

Reference Value = 21.54 V/m; Power Drift = -0.09 dB

Peak SAR (extrapolated) = 0.516 W/kg

SAR(1 g) = 0.341 W/kg; SAR(10 g) = 0.239 W/kg

Maximum value of SAR (measured) = 0.448 W/kg

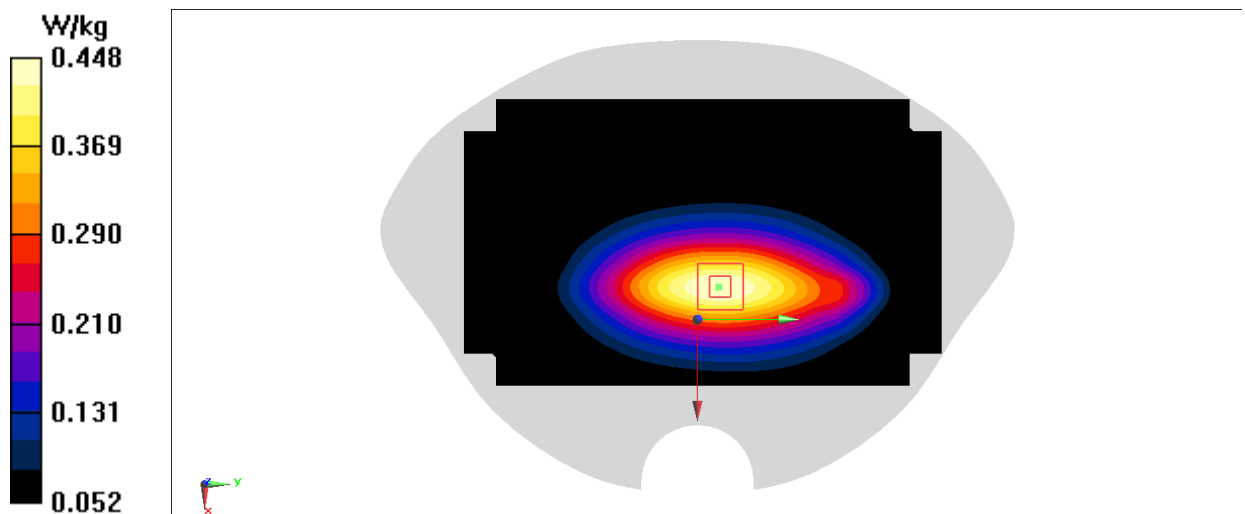
**Fig A.16**

LTE750-FDD13_Head

Date: 10/1/2021

Electronics: DAE4 Sn1525

Medium: H750

Medium parameters used (interpolated): $f = 782$ MHz; $\sigma = 0.893$ S/m; $\epsilon_r = 44.376$; $\rho = 1000$ kg/m³

Ambient Temperature: 22.8oC Liquid Temperature: 22.3oC

Communication System: LTE Band13 Frequency: 782 MHz Duty Cycle: 1:1

Probe: EX3DV4 - SN7600 ConvF(10.88, 10.88, 10.88)

Area Scan (81x131x1): Interpolated grid: dx=1.500 mm, dy=1.500 mm

Maximum value of SAR (interpolated) = 0.739 W/kg

Zoom Scan (7x7x7)/Cube 0: Measurement grid: dx=8mm, dy=8mm, dz=5mm

Reference Value = 16.86 V/m; Power Drift = -0.12 dB

Peak SAR (extrapolated) = 1.01 W/kg

SAR(1 g) = 0.469 W/kg; SAR(10 g) = 0.249 W/kg

Maximum value of SAR (measured) = 0.731 W/kg

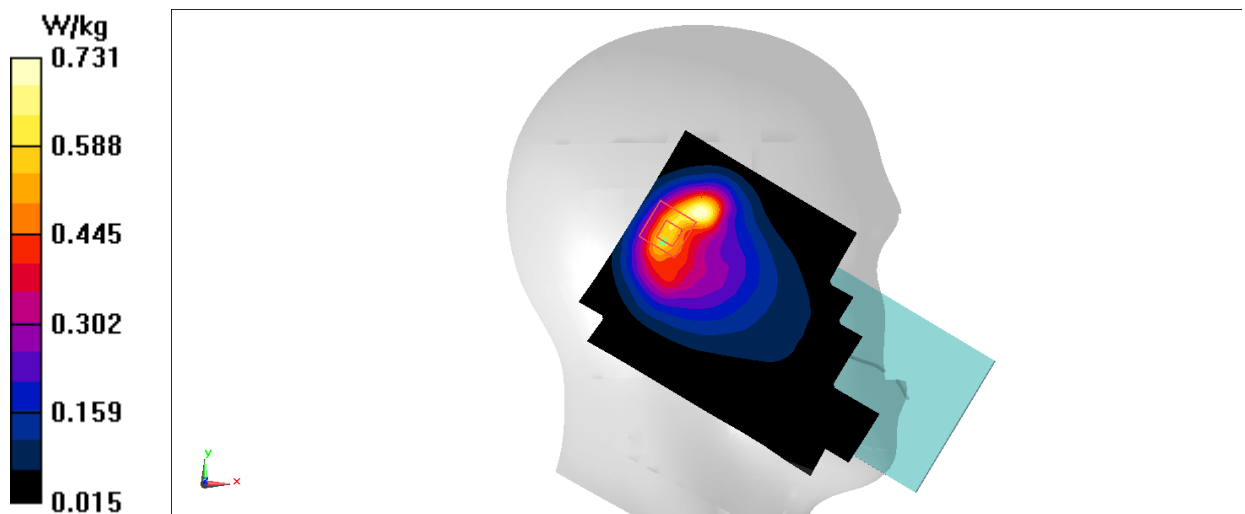

Fig A.17

LTE750-FDD13_Body

Date: 10/1/2021

Electronics: DAE4 Sn1525

Medium: H750

Medium parameters used (interpolated): $f = 782 \text{ MHz}$; $\sigma = 0.893 \text{ S/m}$; $\epsilon_r = 44.376$; $\rho = 1000 \text{ kg/m}^3$

Ambient Temperature: 22.8oC Liquid Temperature: 22.3oC

Communication System: LTE Band13 Frequency: 782 MHz Duty Cycle: 1:1

Probe: EX3DV4 - SN7600 ConvF(10.88, 10.88, 10.88)

Area Scan (91x151x1): Interpolated grid: $dx=1.500 \text{ mm}$, $dy=1.500 \text{ mm}$

Maximum value of SAR (interpolated) = 0.421 W/kg

Zoom Scan (5x5x7)/Cube 0: Measurement grid: $dx=8\text{mm}$, $dy=8\text{mm}$, $dz=5\text{mm}$

Reference Value = 20.84 V/m; Power Drift = -0.06 dB

Peak SAR (extrapolated) = 0.560 W/kg

SAR(1 g) = 0.272 W/kg; SAR(10 g) = 0.141 W/kg

Maximum value of SAR (measured) = 0.420 W/kg

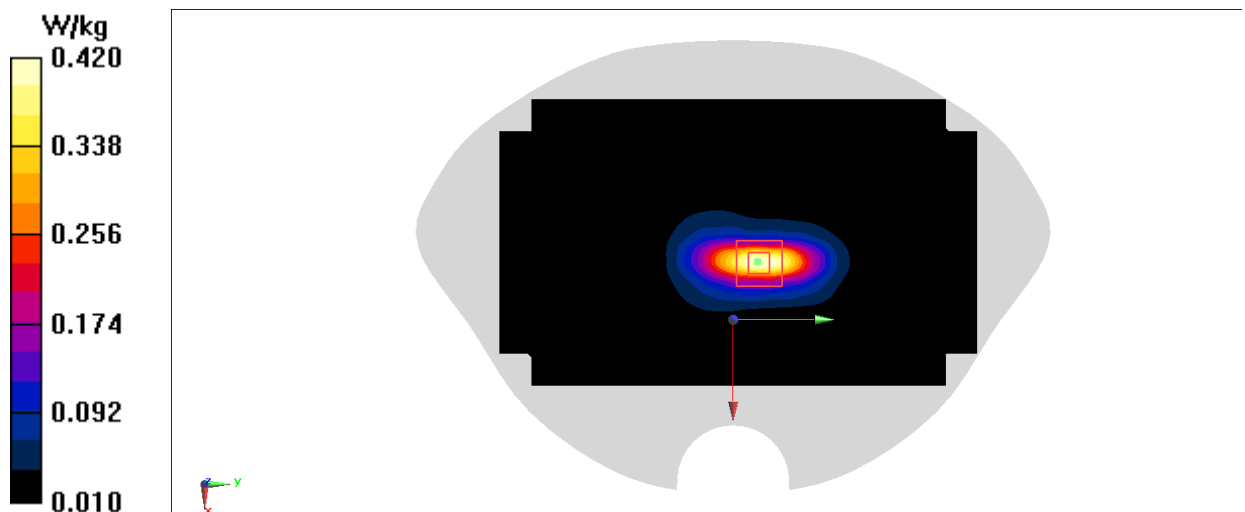
**Fig A.18**

LTE1900-FDD25_Head

Date: 10/13/2021

Electronics: DAE4 Sn1525

Medium: H1900

Medium parameters used (interpolated): $f = 1882.5$ MHz; $\sigma = 1.508$ S/m; $\epsilon_r = 41.89$; $\rho = 1000$ kg/m³

Ambient Temperature: 23.3oC Liquid Temperature: 22.3oC

Communication System: LTE Band25 Frequency: 1882.5 MHz Duty Cycle: 1:1

Probe: EX3DV4 - SN7600 ConvF(8.7, 8.7, 8.7)

Area Scan (81x141x1): Interpolated grid: dx=1.500 mm, dy=1.500 mm

Maximum value of SAR (interpolated) = 1.51 W/kg

Zoom Scan (5x5x7)/Cube 0: Measurement grid: dx=8mm, dy=8mm, dz=5mm

Reference Value = 6.719 V/m; Power Drift = 0.05 dB

Peak SAR (extrapolated) = 1.71 W/kg

SAR(1 g) = 0.853 W/kg; SAR(10 g) = 0.401 W/kg

Maximum value of SAR (measured) = 1.45 W/kg

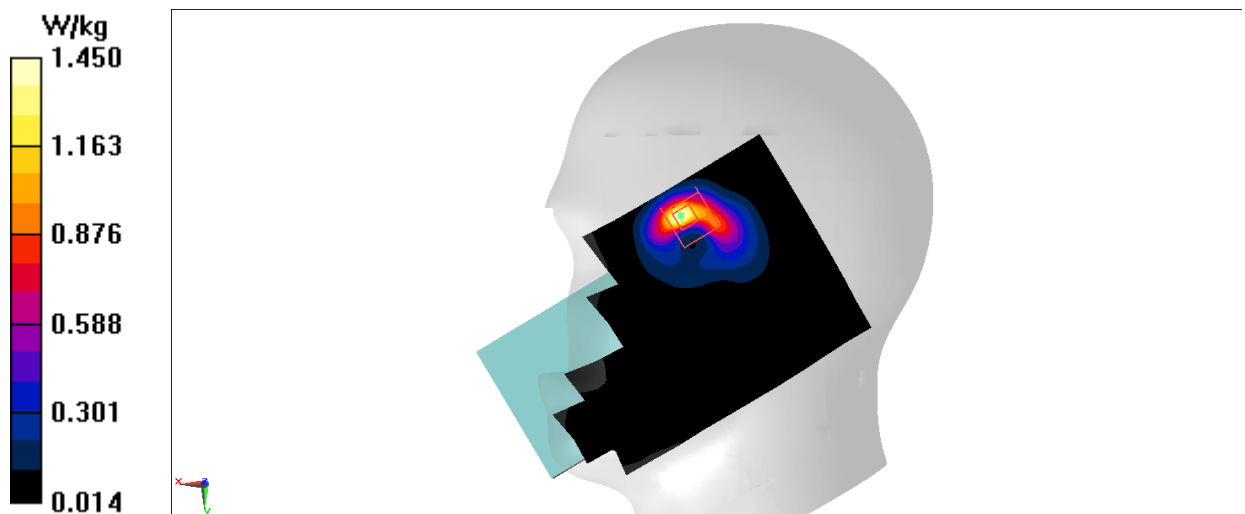

Fig A.19

LTE1900-FDD25_Body

Date: 10/13/2021

Electronics: DAE4 Sn1525

Medium: H1900

Medium parameters used: $f = 1905 \text{ MHz}$; $\sigma = 1.516 \text{ S/m}$; $\epsilon_r = 41.88$; $\rho = 1000 \text{ kg/m}^3$

Ambient Temperature: 23.3oC Liquid Temperature: 22.3oC

Communication System: LTE Band25 Frequency: 1905 MHz Duty Cycle: 1:1

Probe: EX3DV4 - SN7600 ConvF(8.7, 8.7, 8.7)

Area Scan (41x141x1): Interpolated grid: $dx=1.500 \text{ mm}$, $dy=1.500 \text{ mm}$

Maximum value of SAR (interpolated) = 1.19 W/kg

Zoom Scan (5x5x7)/Cube 0: Measurement grid: $dx=8\text{mm}$, $dy=8\text{mm}$, $dz=5\text{mm}$

Reference Value = 7.753 V/m; Power Drift = 0.08 dB

Peak SAR (extrapolated) = 1.65 W/kg

SAR(1 g) = 0.857 W/kg; SAR(10 g) = 0.417 W/kg

Maximum value of SAR (measured) = 1.29 W/kg

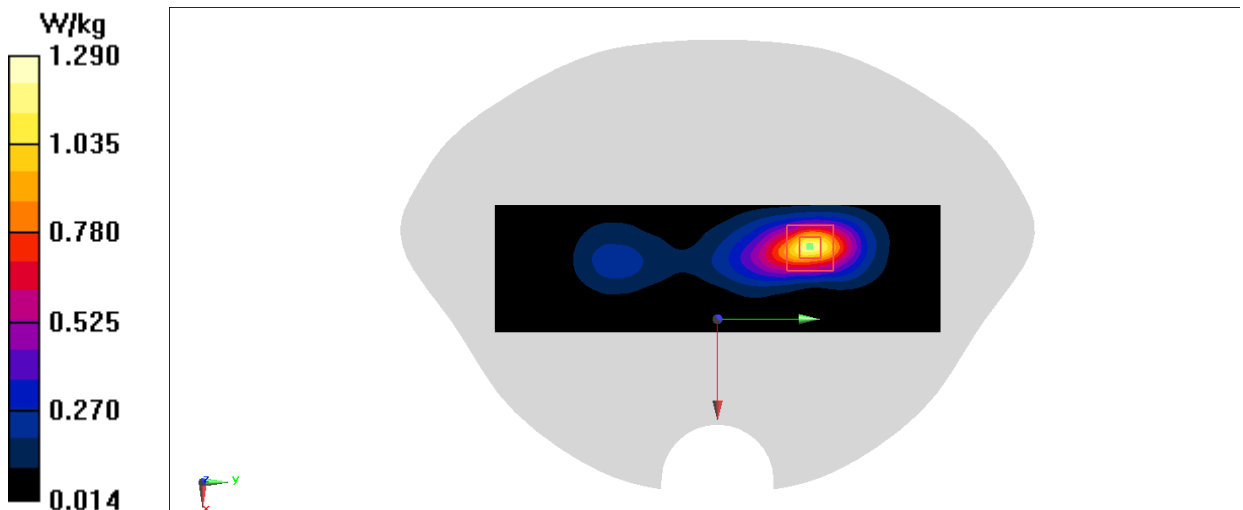
**Fig A.20**

LTE1900-FDD25_Body

Date: 10/13/2021

Electronics: DAE4 Sn1525

Medium: H1900

Medium parameters used (interpolated): $f = 1882.5$ MHz; $\sigma = 1.508$ S/m; $\epsilon_r = 41.89$; $\rho = 1000$ kg/m³

Ambient Temperature: 23.3oC Liquid Temperature: 22.3oC

Communication System: LTE Band25 Frequency: 1882.5 MHz Duty Cycle: 1:1

Probe: EX3DV4 - SN7600 ConvF(8.7, 8.7, 8.7)

Area Scan (91x151x1): Interpolated grid: dx=1.500 mm, dy=1.500 mm

Maximum value of SAR (interpolated) = 0.324 W/kg

Zoom Scan (5x5x7)/Cube 0: Measurement grid: dx=8mm, dy=8mm, dz=5mm

Reference Value = 5.160 V/m; Power Drift = -0.00 dB

Peak SAR (extrapolated) = 0.394 W/kg

SAR(1 g) = 0.224 W/kg; SAR(10 g) = 0.122 W/kg

Maximum value of SAR (measured) = 0.328 W/kg

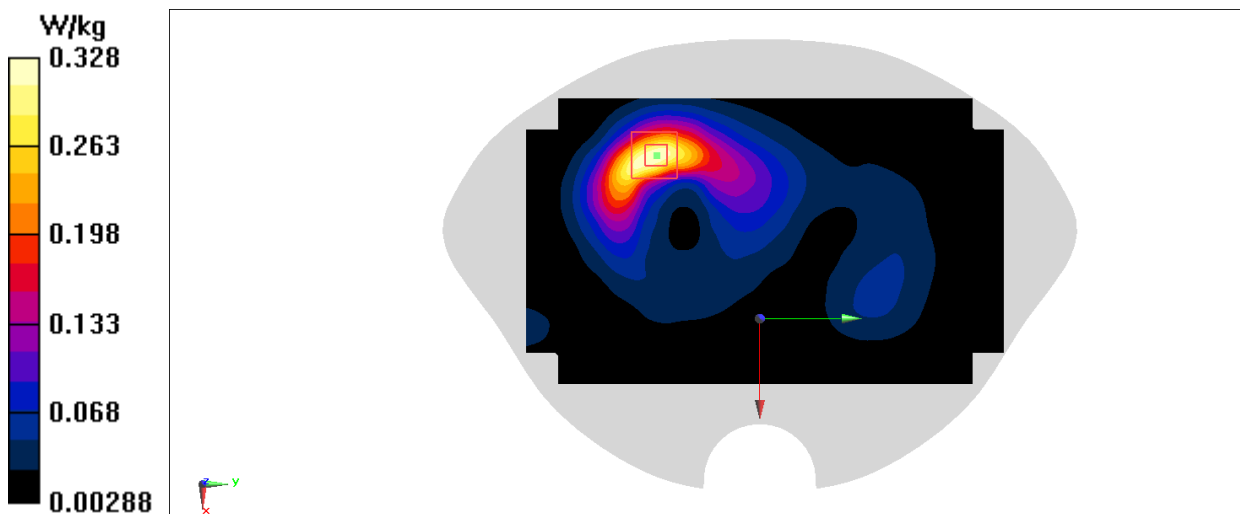

Fig A.21