



SAR TEST REPORT

No. I21Z62136-SEM03

For

TCL Communication Ltd.

GSM/UMTS/LTE Mobile phone

Model name: T602DL

With

Hardware Version: PIO

Software Version: vU48

FCC ID: 2ACCJH152

Issued Date: 2021-12-23

Note:

The test results in this test report relate only to the devices specified in this report. This report shall not be reproduced except in full without the written approval of CTTL.

Test Laboratory:

CTTL, Telecommunication Technology Labs, CAICT

No. 51, Xueyuan Road, Haidian District, Beijing, P. R. China 100191.

Tel:+86(0)10-62304633-2512, Fax:+86(0)10-62304633-2504

Email: ctl_terminals@caict.ac.cn, website: www.caict.ac.cn

**REPORT HISTORY**

Report Number	Revision	Issue Date	Description
I21Z62136-SEM03	Rev.0	2021-12-20	Initial creation of test report
I21Z62136-SEM03	Rev.1	2021-12-23	<p>The file KDB248227 D01 802.11 Wi-Fi SAR V02R02 has been added to section 5.2 of the report.</p> <p>Removed the description of 5GNR EN-DC from section 9.6.</p> <p>Updated the SAR calibrated values for the dipole in table 8.1.</p>

TABLE OF CONTENT

1 TEST LABORATORY	5
1.1 TESTING LOCATION	5
1.2 TESTING ENVIRONMENT.....	5
1.3 PROJECT DATA	5
1.4 SIGNATURE.....	5
2 STATEMENT OF COMPLIANCE	6
3 CLIENT INFORMATION	8
3.1 APPLICANT INFORMATION	8
3.2 MANUFACTURER INFORMATION	8
4 EQUIPMENT UNDER TEST (EUT) AND ANCILLARY EQUIPMENT (AE)	9
4.1 ABOUT EUT	9
4.2 INTERNAL IDENTIFICATION OF EUT USED DURING THE TEST	10
4.3 INTERNAL IDENTIFICATION OF AE USED DURING THE TEST	10
5 TEST METHODOLOGY	11
5.1 APPLICABLE LIMIT REGULATIONS	11
5.2 APPLICABLE MEASUREMENT STANDARDS.....	11
6 SPECIFIC ABSORPTION RATE (SAR)	12
6.1 INTRODUCTION.....	12
6.2 SAR DEFINITION.....	12
7 TISSUE SIMULATING LIQUIDS	13
7.1 TARGETS FOR TISSUE SIMULATING LIQUID	13
7.2 DIELECTRIC PERFORMANCE	13
8 SYSTEM VERIFICATION	17
8.1 SYSTEM SETUP.....	17
8.2 SYSTEM VERIFICATION.....	18
9 MEASUREMENT PROCEDURES	19
9.1 TESTS TO BE PERFORMED	19
9.2 GENERAL MEASUREMENT PROCEDURE.....	20
9.3 WCDMA MEASUREMENT PROCEDURES FOR SAR	22
9.4 SAR MEASUREMENT FOR LTE.....	23
9.5 BLUETOOTH & WI-FI MEASUREMENT PROCEDURES FOR SAR	25
9.6 SAR MEASUREMENT FOR ENDC	25
9.7 POWER DRIFT.....	25
10 AREA SCAN BASED 1-G SAR	26
10.1 REQUIREMENT OF KDB.....	26
10.2 FAST SAR ALGORITHMS	26
11 CONDUCTED OUTPUT POWER	27
11.1 GSM MEASUREMENT RESULT	27
11.2 WCDMA MEASUREMENT RESULT.....	29
11.3 LTE MEASUREMENT RESULT	32

11.4 WI-FI AND BT MEASUREMENT RESULT	87
12 SIMULTANEOUS TX SAR CONSIDERATIONS	88
12.1 TRANSMIT ANTENNA SEPARATION DISTANCES	88
12.2 SAR MEASUREMENT POSITIONS	89
12.3 STANDALONE SAR TEST EXCLUSION CONSIDERATIONS	89
13 EVALUATION OF SIMULTANEOUS	90
14 SAR TEST RESULT	91
14.1 SAR RESULTS FOR FAST SAR	92
14.2 SAR RESULTS FOR STANDARD PROCEDURE	97
14.3 WLAN EVALUATION FOR 2.4G	97
14.4 SAR RESULTS FOR FAST BT	101
14.4 SAR EVALUATION FOR PHABLET	103
15 SAR MEASUREMENT VARIABILITY	105
16 MEASUREMENT UNCERTAINTY	105
16.1 MEASUREMENT UNCERTAINTY FOR NORMAL SAR TESTS (300MHZ~3GHZ)	105
16.2 MEASUREMENT UNCERTAINTY FOR NORMAL SAR TESTS (3~6GHZ)	106
16.3 MEASUREMENT UNCERTAINTY FOR FAST SAR TESTS (300MHZ~3GHZ)	107
16.4 MEASUREMENT UNCERTAINTY FOR FAST SAR TESTS (3~6GHZ)	108
17 MAIN TEST INSTRUMENTS	110
ANNEX A GRAPH RESULTS	111
ANNEX B SYSTEM VERIFICATION RESULTS	157
ANNEX C SAR MEASUREMENT SETUP	169
ANNEX D POSITION OF THE WIRELESS DEVICE IN RELATION TO THE PHANTOM	175
ANNEX E EQUIVALENT MEDIA RECIPES	178
ANNEX F SYSTEM VALIDATION	179
ANNEX G PROBE CALIBRATION CERTIFICATE	180
ANNEX H DIPOLE CALIBRATION CERTIFICATE	189
ANNEX I ACCREDITATION CERTIFICATE	225

1 Test Laboratory

1.1 Testing Location

Company Name:	CTTL(Shouxiang)
Address:	No. 51 Shouxiang Science Building, Xueyuan Road, Haidian District, Beijing, P. R. China100191

1.2 Testing Environment

Temperature:	18°C~25°C,
Relative humidity:	30%~ 70%
Ground system resistance:	< 0.5 Ω
Ambient noise & Reflection:	< 0.012 W/kg

1.3 Project Data

Project Leader:	Qi Dianyuan
Test Engineer:	Lin Xiaojun
Testing Start Date:	November 25, 2021
Testing End Date:	December 8, 2021

1.4 Signature



Lin Xiaojun

(Prepared this test report)

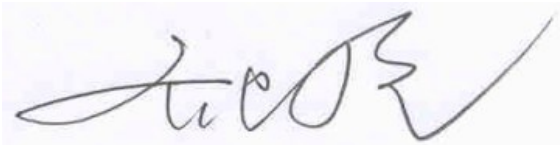

Qi Dianyuan

(Reviewed this test report)

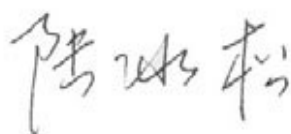

Lu Bingsong

Deputy Director of the laboratory

(Approved this test report)

2 Statement of Compliance

The maximum results of Specific Absorption Rate (SAR) found during testing for TCL Communication Ltd. GSM/UMTS/LTE Mobile phone T602DL are as follows:

Table 2.1: Highest Reported SAR (1g)

Mode		Highest Reported SAR (1g)			
		1g SAR Head	1g SAR Hotspot 10mm	1g SAR Body-worn 15mm	Product Specific 10-g SAR 0mm
GSM	GSM 850	0.27	0.18	/	/
	PCS 1900	0.15	0.60	/	/
WCDMA	UMTS FDD 2	0.33	0.59	0.24	/
	UMTS FDD 4	0.21	1.07	0.44	1.96
	UMTS FDD 5	0.27	0.28	/	/
LTE	LTE Band 12	0.40	0.37	/	/
	LTE Band 13	0.73	0.32	/	/
	LTE Band 25	0.31	0.48	0.32	/
	LTE Band 26	0.46	0.48	/	/
	LTE Band 41-PC3	0.07	0.31	0.18	/
	LTE Band 41-PC2	0.08	0.32	0.26	/
	LTE Band 66	0.19	0.78	0.41	/
	LTE Band 71	0.64	0.54	/	/
WLAN 2.4 GHz		0.58	0.28	0.14	1.40

The SAR values found for the Mobile Phone are below the maximum recommended levels of 1.6 W/kg as averaged over any 1g tissue according to the ANSI C95.1-1992.

For body operation, this device has been tested and meets FCC RF exposure guidelines when used with any accessory that contains no metal and which provides a minimum separation distance of 10 mm for hotspot and 15mm for body worn between this device and the body of the user. Use of other accessories may not ensure compliance with FCC RF exposure guidelines.

The EUT battery must be fully charged and checked periodically during the test to ascertain uniform power output.

The measurement together with the test system set-up is described in annex C of this test report. A detailed description of the equipment under test can be found in chapter 4 of this test report. The highest reported SAR value is obtained at the case of **(Table 2.1)**, and the values are: **1.07 W/kg(1g)**.

Table 2.2: The sum of reported SAR values for Main antenna and WiFi+BT

	Position	Cellular antenna	WiFi	BT	Sum
Highest reported SAR value for Head	Right hand, Cheek (LTE Band71)	0.64	0.58	0.26	1.48
Maximum reported SAR value for Body	Rear 10mm (WCDMA1700)	0.94	0.28	0.13	1.35

Note1: we have evaluated and chose the highest value of body 10mm and 15mm in the above table.

According to the above tables, the highest sum of reported SAR values is **1.48 W/kg (1g)**. The detail for simultaneous transmission consideration is described in chapter 13.

According to the KDB648474 D04, the UMPC mini-tablet procedures must also be applied to test the SAR of all surfaces and edges with an antenna located at ≤ 25 mm from that surface or edge, in direct contact with a flat phantom, for 10-g extremity SAR according to the body-equivalent tissue dielectric parameters in KDB Publication 865664 D01 to address interactive hand use exposure conditions. When hotspot mode applies, 10-g extremity SAR is required only for the surfaces and edges with hotspot mode 1-g reported SAR > 1.2 W/kg

Table 2.3: The sum of SAR values for 10g extremity SAR

	Position	Main antenna	WiFi-2.4G	BT	Sum	Limited
10-g extremity SAR (Separation Distance 0mm)	Bottom Edge (WCDMA1700)	1.96	/	/	1.96	4.0
10-g extremity SAR (Separation Distance 0mm)	Rear (WCDMA1700)	1.92	1.40	/	3.32	4.0

Note: WiFi antenna is located at the top of the device, the distance from the bottom is greater than 25mm, so the test is exempt.

3 Client Information

3.1 Applicant Information

Company Name:	TCL Communication Ltd.
Address/Post:	5/F, Building 22E, 22 Science Park East Avenue, Hong Kong Science Park, Shatin, NT, Hong Kong
Contact Person:	Gong Zhizhou
E-mail:	zhizhou.gong@tcl.com
Telephone:	0086-755-36611722
Fax:	/

3.2 Manufacturer Information

Company Name:	TCL Communication Ltd.
Address/Post:	5/F, Building 22E, 22 Science Park East Avenue, Hong Kong Science Park, Shatin, NT, Hong Kong
Contact Person:	Gong Zhizhou
E-mail:	zhizhou.gong@tcl.com
Telephone:	0086-755-36611722
Fax:	/

4 Equipment Under Test (EUT) and Ancillary Equipment (AE)

4.1 About EUT

Description:	GSM/UMTS/LTE Mobile phone
Model name:	T602DL
Operating mode(s):	GSM850/900/1800/1900, WCDMA850/1700/1900, BT, Wi-Fi 2.4G, LTE Band2/4/5/12/13/25/26/41/66/71
Tested Tx Frequency:	824 – 849 MHz (GSM 850)
	1850 – 1910 MHz (GSM 1900)
	824–849 MHz (WCDMA 850 Band V)
	1710 – 1755 MHz (WCDMA 1700 Band IV)
	1850–1910 MHz (WCDMA1900 Band II)
	699 – 716 MHz (LTE Band 12)
	779.5 –784.5 MHz (LTE Band 13)
	1850.7 – 1914.3 MHz (LTE Band 25)
	814 – 849 MHz (LTE Band 26)
	2496 – 2690 MHz (LTE Band 41)
	1710 – 1780 MHz (LTE Band 66)
	665.5 – 695.5 MHz (LTE Band 71)
	2412 – 2462 MHz (Wi-Fi 2.4G)
GPRS/EGPRS Multislot Class:	12
GPRS capability Class:	B
Test device Production information:	Production unit
Device type:	Portable device
Antenna type:	Integrated antenna
Hotspot mode:	Support

4.2 Internal Identification of EUT used during the test

EUT ID*	IMEI	HW	SW Version
EUT1	016053000010216	PIO	vU48
EUT2	016053000010679	PIO	vU48
EUT3	016053000010687	PIO	vU48
EUT4	016053000010174	PIO	vU48
EUT5	016053000010828	PIO	vU48
EUT6	016053000010836	PIO	vU48

*EUT ID: is used to identify the test sample in the lab internally.

Note: It is performed to test SAR with the EUT1-4 and conducted power with the EUT5-6.

4.3 Internal Identification of AE used during the test

AE ID*	Description	Model	SN	Manufacturer
AE1	Battery	TLi028C7	/	VEKEN
AE2	Battery	TLi028C1	/	BYD

*AE ID: is used to identify the test sample in the lab internally.

5 TEST METHODOLOGY

5.1 Applicable Limit Regulations

ANSI C95.1–1992: IEEE Standard for Safety Levels with Respect to Human Exposure to Radio Frequency Electromagnetic Fields, 3 kHz to 300 GHz.

It specifies the maximum exposure limit of **1.6 W/kg** as averaged over any 1 gram of tissue for portable devices being used within 20 cm of the user in the uncontrolled environment.

5.2 Applicable Measurement Standards

IEEE 1528–2013: Recommended Practice for Determining the Peak Spatial-Average Specific Absorption Rate (SAR) in the Human Head from Wireless Communications Devices: Measurement Techniques.

KDB447498 D01: General RF Exposure Guidance v06: Mobile and Portable Devices RF Exposure Procedures and Equipment Authorization Policies.

KDB648474 D04 Handset SAR v01r03: SAR Evaluation Considerations for Wireless Handsets.

KDB941225 D01 SAR test for 3G devices v03r01: SAR Measurement Procedures for 3G Devices

KDB941225 D05 SAR for LTE Devices v02r05: SAR Evaluation Considerations for LTE Devices

KDB941225 D06 Hotspot Mode SAR v02r01: SAR Evaluation Procedures for Portable Devices with Wireless Router Capabilities

KDB248227 D01 802.11 Wi-Fi SAR v02r02: SAR GUIDANCE FOR IEEE 802.11 (Wi-Fi) TRANSMITTERS

KDB865664 D01 SAR measurement 100 MHz to 6 GHz v01r04: SAR Measurement Requirements for 100 MHz to 6 GHz.

KDB865664 D02 RF Exposure Reporting v01r02: RF Exposure Compliance Reporting and Documentation Considerations

6 Specific Absorption Rate (SAR)

6.1 Introduction

SAR is related to the rate at which energy is absorbed per unit mass in an object exposed to a radio field. The SAR distribution in a biological body is complicated and is usually carried out by experimental techniques or numerical modeling. The standard recommends limits for two tiers of groups, occupational/controlled and general population/uncontrolled, based on a person's awareness and ability to exercise control over his or her exposure. In general, occupational/controlled exposure limits are higher than the limits for general population/uncontrolled.

6.2 SAR Definition

The SAR definition is the time derivative (rate) of the incremental energy (dW) absorbed by (dissipated in) an incremental mass (dm) contained in a volume element (dv) of a given density (ρ). The equation description is as below:

$$SAR = \frac{d}{dt} \left(\frac{dW}{dm} \right) = \frac{d}{dt} \left(\frac{dW}{\rho dv} \right)$$

SAR is expressed in units of Watts per kilogram (W/kg)

SAR measurement can be either related to the temperature elevation in tissue by

$$SAR = c \left(\frac{\delta T}{\delta t} \right)$$

Where: C is the specific heat capacity, δT is the temperature rise and δt is the exposure duration, or related to the electrical field in the tissue by

$$SAR = \frac{\sigma |E|^2}{\rho}$$

Where: σ is the conductivity of the tissue, ρ is the mass density of tissue and E is the RMS electrical field strength.

However for evaluating SAR of low power transmitter, electrical field measurement is typically applied.

7 Tissue Simulating Liquids

7.1 Targets for tissue simulating liquid

Table 7.1: Targets for tissue simulating liquid

Frequency(MHz)	Liquid Type	Conductivity(σ)	$\pm 10\%$ Range	Permittivity(ϵ)	$\pm 10\%$ Range
750	Head	0.89	0.80~0.98	41.94	37.75~46.13
835	Head	0.90	0.81~0.99	41.5	37.35~45.65
1750	Head	1.40	1.26~1.54	40.0	36~44
1900	Head	1.40	1.26~1.54	40.0	36~44
2450	Head	1.80	1.62~1.98	39.2	35.28~43.12
2600	Head	1.96	1.76~2.16	39.01	35.11~42.91

7.2 Dielectric Performance

Table 7.3: Dielectric Performance of Tissue Simulating Liquid

Measurement Date (yyyy-mm-dd)	Type	Frequency	Permittivity ϵ	Drift (%)	Conductivity σ (S/m)	Drift (%)
2021/11/25	Head	750 MHz	42.12	0.43	0.902	1.35
2021/11/26	Head	750 MHz	41.73	-0.50	0.889	-0.11
2021/11/28	Head	835 MHz	41.45	-0.12	0.912	1.33
2021/11/29	Head	835 MHz	41.03	-1.13	0.895	-0.56
2021/12/1	Head	1750 MHz	40.31	0.57	1.356	-1.02
2021/12/2	Head	1750 MHz	40.72	1.60	1.355	-1.09
2021/12/3	Head	1900 MHz	40.18	0.45	1.373	-1.93
2021/12/4	Head	1900 MHz	40.21	0.53	1.415	1.07
2021/12/6	Head	2450 MHz	39.36	0.41	1.787	-0.72
2021/12/7	Head	2600 MHz	38.82	-0.49	1.954	-0.31
2021/12/8	Head	2600 MHz	38.46	-1.41	1.956	-0.20

Note: The liquid temperature is 22.0°C

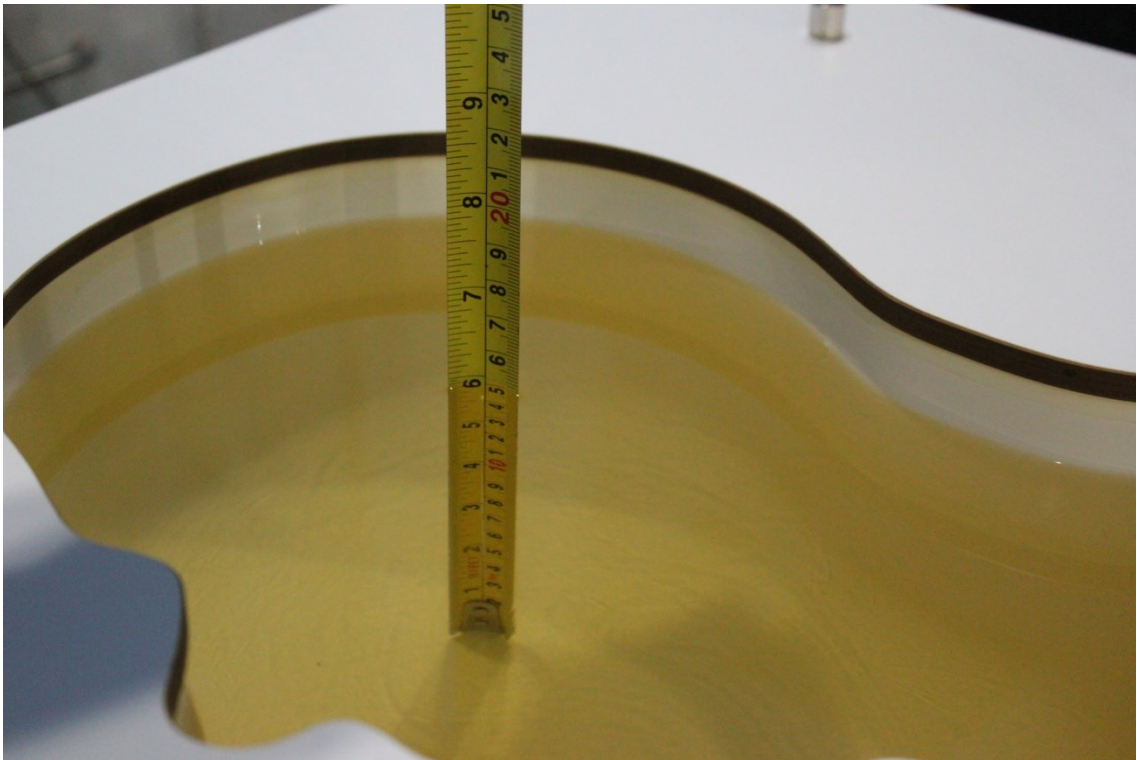

Picture 7-1 Liquid depth in the Head Phantom (750MHz)

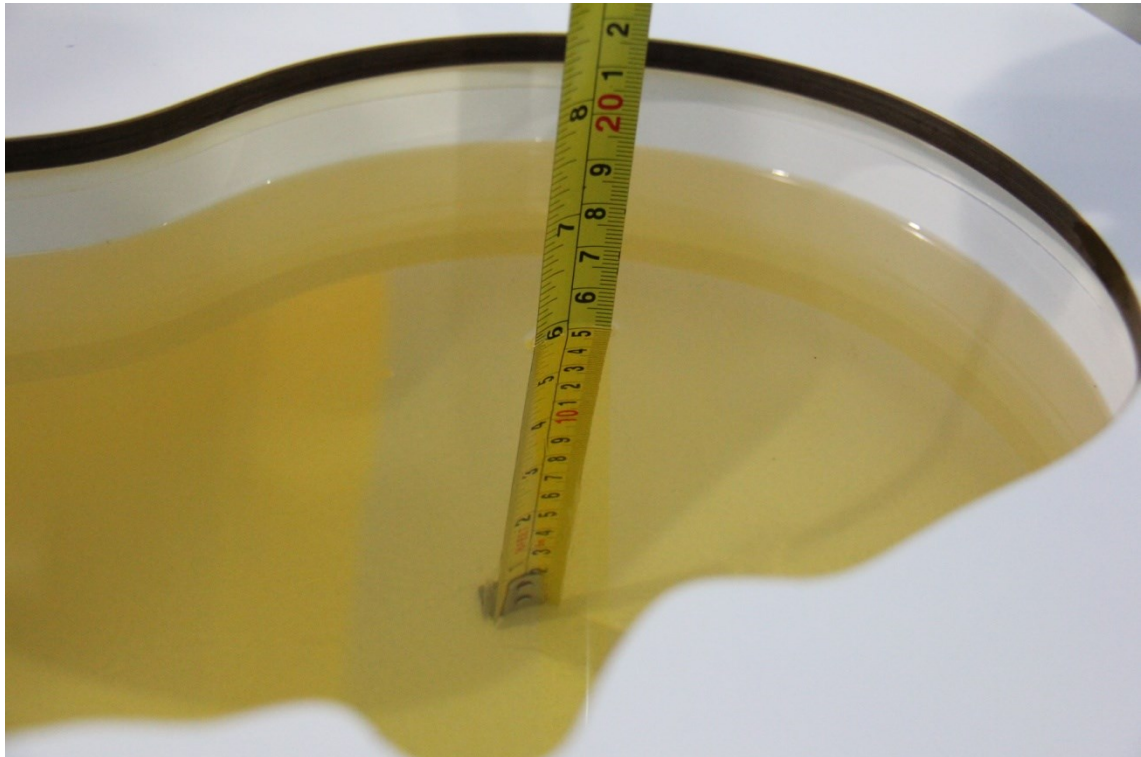

Picture 7-2 Liquid depth in the Head Phantom (835 MHz)



Picture 7-3 Liquid depth in the Head Phantom (1750 MHz)

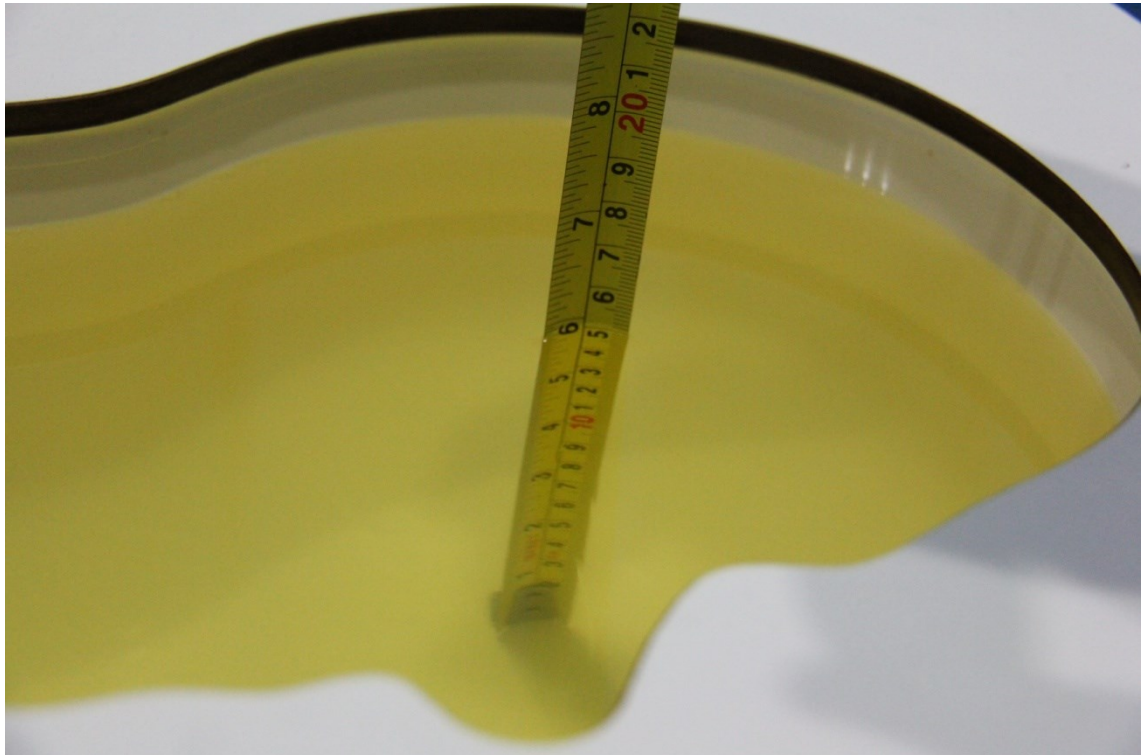

Picture 7-4 Liquid depth in the Head Phantom (1900 MHz)

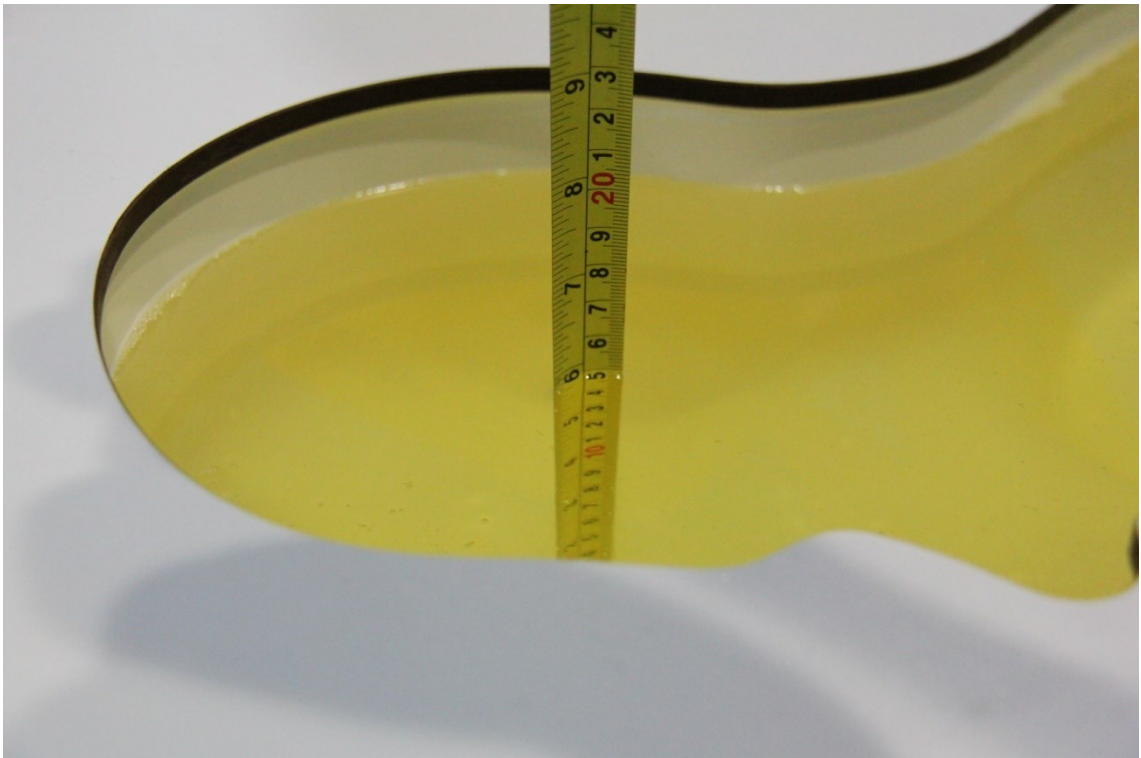

Picture 7-5 Liquid depth in the Head Phantom (2450MHz)

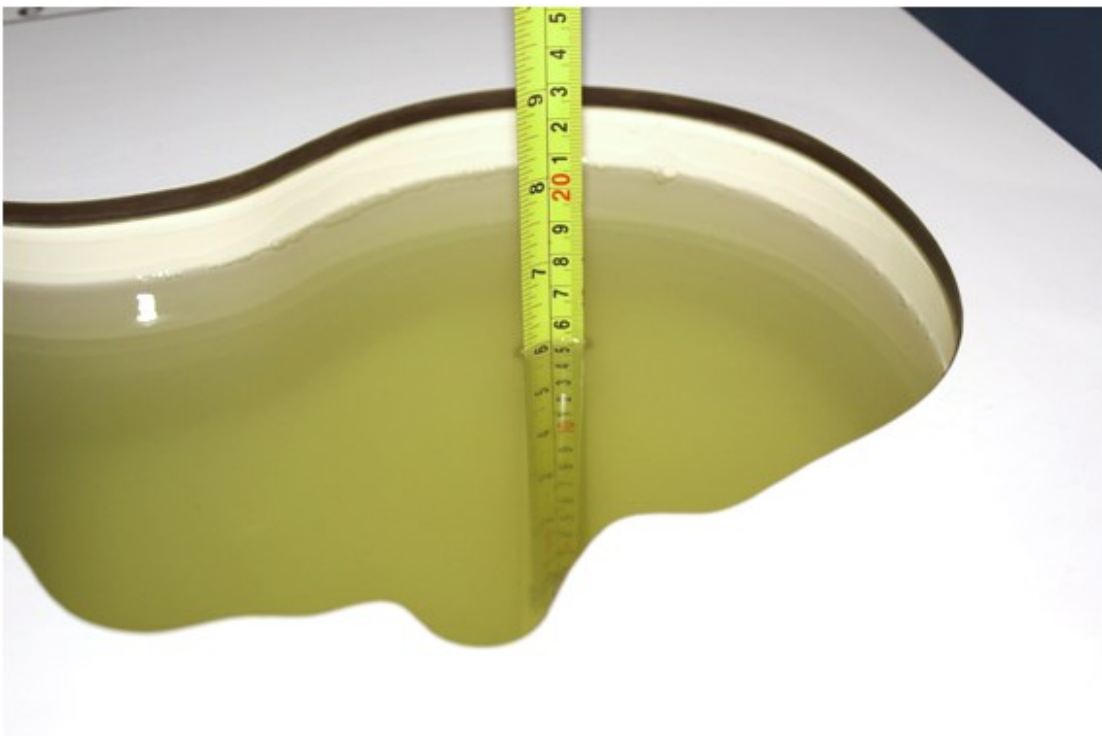

Picture 7-6 Liquid depth in the Head Phantom (2600 MHz)

8 System verification

8.1 System Setup

In the simplified setup for system evaluation, the DUT is replaced by a calibrated dipole and the power source is replaced by a continuous wave that comes from a signal generator. The calibrated dipole must be placed beneath the flat phantom section of the SAM twin phantom with the correct distance holder. The distance holder should touch the phantom surface with a light pressure at the reference marking and be oriented parallel to the long side of the phantom. The equipment setup is shown below:

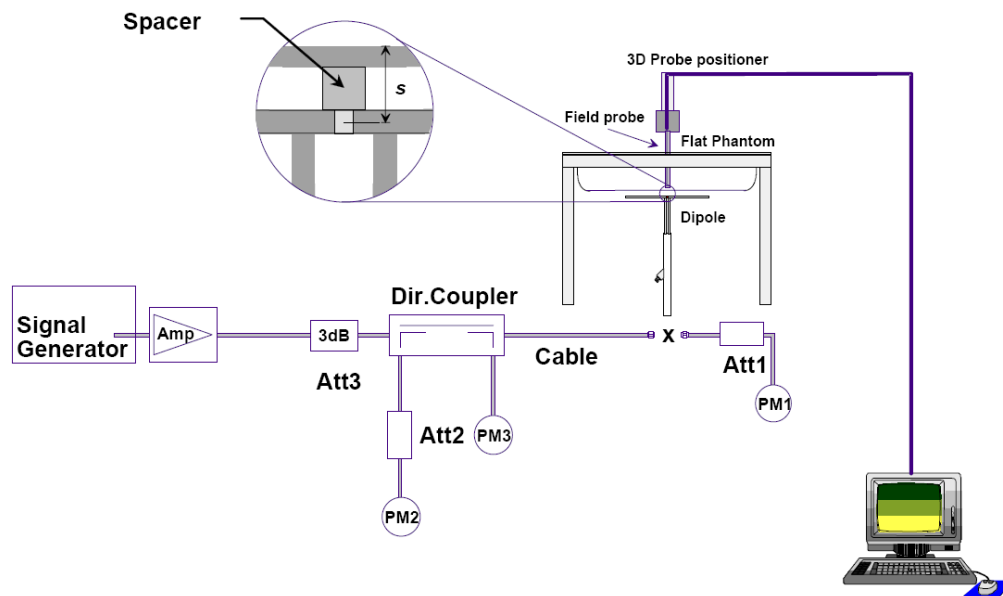

Picture 8.1 System Setup for System Evaluation

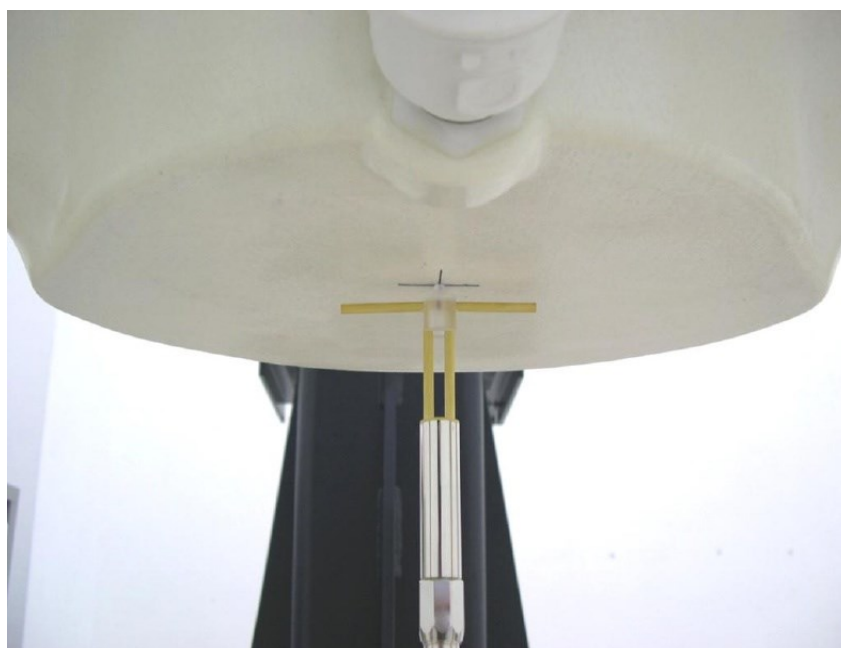

Picture 8.2 Photo of Dipole Setup

8.2 System Verification

SAR system verification is required to confirm measurement accuracy, according to the tissue dielectric media, probe calibration points and other system operating parameters required for measuring the SAR of a test device. The system verification must be performed for each frequency band and within the valid range of each probe calibration point required for testing the device.

The system verification results are required that the area scan estimated 1-g SAR is within 3% of the zoom scan 1-g SAR. The details are presented in annex B.

Table 8.1: System Verification of Head

Measurement Date (yyyy-mm-dd)	Frequency	Target value (W/kg)		Measured value(W/kg)		Deviation	
		10 g Average	1 g Average	10 g Average	1 g Average	10 g Average	1 g Average
2021/11/25	750 MHz	5.65	8.68	5.48	8.48	-3.01%	-2.30%
2021/11/26	750 MHz	5.65	8.68	5.44	8.52	-3.72%	-1.84%
2021/11/28	900 MHz	6.24	9.63	6.12	9.68	-1.92%	0.52%
2021/11/29	900 MHz	6.24	9.63	6.2	9.56	-0.64%	-0.73%
2021/12/1	1750 MHz	19.4	36.9	18.92	36.36	-2.47%	-1.46%
2021/12/2	1750 MHz	19.4	36.9	19.12	36.32	-1.44%	-1.57%
2021/12/3	1900 MHz	20.9	40.1	20.68	39.92	-1.05%	-0.45%
2021/12/4	1900 MHz	20.9	40.1	20.6	39.48	-1.44%	-1.55%
2021/12/6	2450 MHz	24.9	53.3	24.28	52.52	-2.49%	-1.46%
2021/12/7	2600 MHz	25.5	57.1	25.32	57.68	-0.71%	1.02%
2021/12/8	2600 MHz	25.5	57.1	26.24	58.12	2.90%	1.79%

9 Measurement Procedures

9.1 Tests to be performed

In order to determine the highest value of the peak spatial-average SAR of a handset, all device positions, configurations and operational modes shall be tested for each frequency band according to steps 1 to 3 below. A flowchart of the test process is shown in picture 9.1.

Step 1: The tests described in 9.2 shall be performed at the channel that is closest to the centre of the transmit frequency band (f_c) for:

- a) all device positions (cheek and tilt, for both left and right sides of the SAM phantom, as described in annex D),
- b) all configurations for each device position in a), e.g., antenna extended and retracted, and
- c) all operational modes, e.g., analogue and digital, for each device position in a) and configuration in b) in each frequency band.

If more than three frequencies need to be tested according to 11.1 (i.e., $N_c > 3$), then all frequencies, configurations and modes shall be tested for all of the above test conditions.

Step 2: For the condition providing highest peak spatial-average SAR determined in Step 1, perform all tests described in 9.2 at all other test frequencies, i.e., lowest and highest frequencies. In addition, for all other conditions (device position, configuration and operational mode) where the peak spatial-average SAR value determined in Step 1 is within 3 dB of the applicable SAR limit, it is recommended that all other test frequencies shall be tested as well.

Step 3: Examine all data to determine the highest value of the peak spatial-average SAR found in Steps 1 to 2.

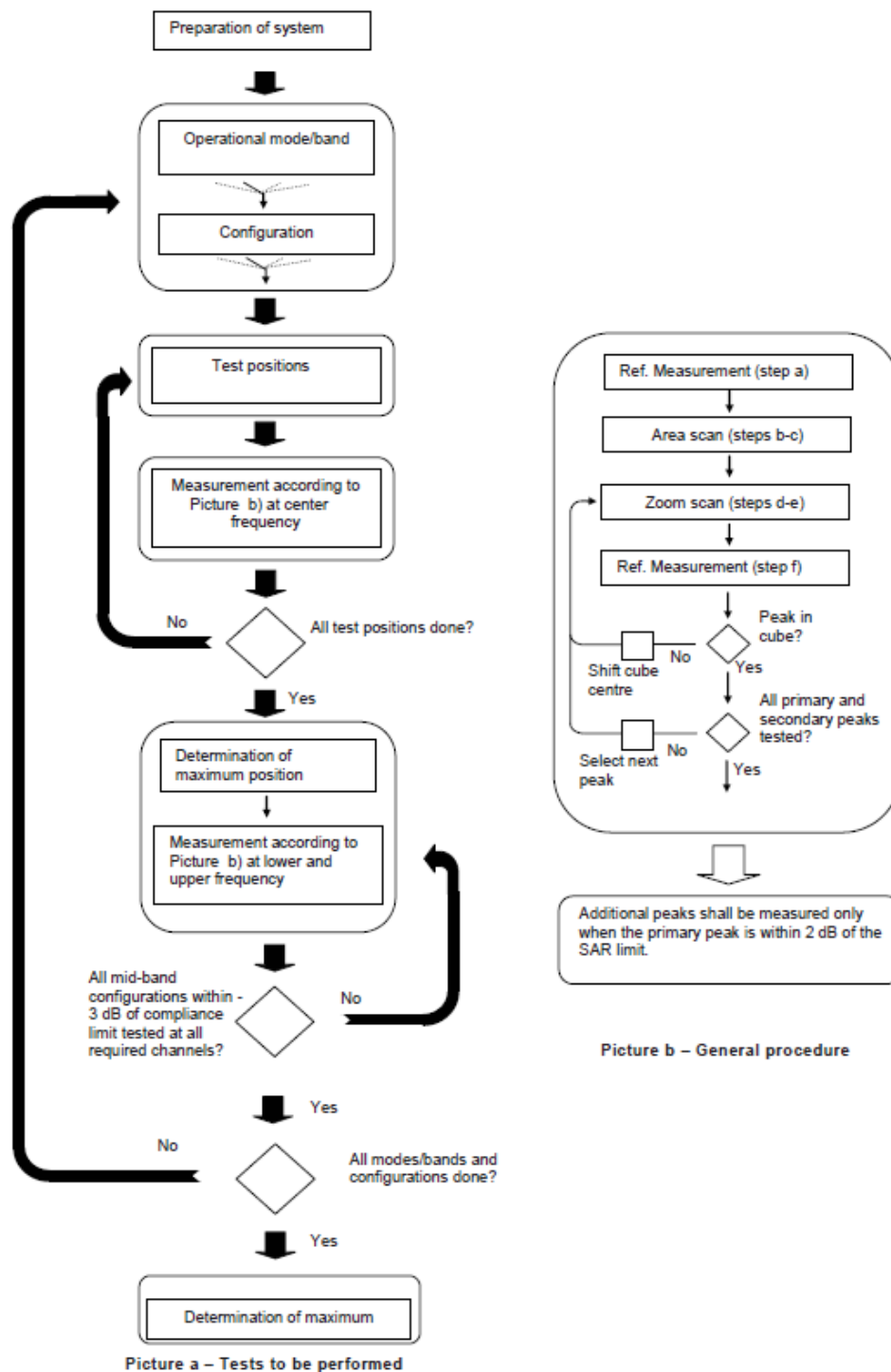

Picture 9.1 Block diagram of the tests to be performed

9.2 General Measurement Procedure

The area and zoom scan resolutions specified in the table below must be applied to the SAR measurements and fully documented in SAR reports to qualify for TCB approval. Probe boundary effect error compensation is required for measurements with the probe tip closer than half a probe tip diameter to the phantom surface. Both the probe tip diameter and sensor offset distance must satisfy measurement protocols; to ensure probe boundary effect errors are minimized and the

higher fields closest to the phantom surface can be correctly measured and extrapolated to the phantom surface for computing 1-g SAR. Tolerances of the post-processing algorithms must be verified by the test laboratory for the scan resolutions used in the SAR measurements, according to the reference distribution functions specified in IEEE Std 1528-2013. The results should be documented as part of the system validation records and may be requested to support test results when all the measurement parameters in the following table are not satisfied.

		≤ 3 GHz	> 3 GHz	
Maximum distance from closest measurement point (geometric center of probe sensors) to phantom surface		5 ± 1 mm	$\frac{1}{2} \cdot \delta \cdot \ln(2) \pm 0.5$ mm	
Maximum probe angle from probe axis to phantom surface normal at the measurement location		$30^\circ \pm 1^\circ$	$20^\circ \pm 1^\circ$	
Maximum area scan spatial resolution: Δx_{Area} , Δy_{Area}		≤ 2 GHz: ≤ 15 mm 2 – 3 GHz: ≤ 12 mm	3 – 4 GHz: ≤ 12 mm 4 – 6 GHz: ≤ 10 mm	
		When the x or y dimension of the test device, in the measurement plane orientation, is smaller than the above, the measurement resolution must be \leq the corresponding x or y dimension of the test device with at least one measurement point on the test device.		
Maximum zoom scan spatial resolution: Δx_{Zoom} , Δy_{Zoom}		≤ 2 GHz: ≤ 8 mm 2 – 3 GHz: ≤ 5 mm*	3 – 4 GHz: ≤ 5 mm* 4 – 6 GHz: ≤ 4 mm*	
Maximum zoom scan spatial resolution, normal to phantom surface	uniform grid: $\Delta z_{Zoom}(n)$	≤ 5 mm	3 – 4 GHz: ≤ 4 mm 4 – 5 GHz: ≤ 3 mm 5 – 6 GHz: ≤ 2 mm	
	graded grid	$\Delta z_{Zoom}(1)$: between 1 st two points closest to phantom surface	≤ 4 mm	3 – 4 GHz: ≤ 3 mm 4 – 5 GHz: ≤ 2.5 mm 5 – 6 GHz: ≤ 2 mm
		$\Delta z_{Zoom}(n>1)$: between subsequent points	$\leq 1.5 \cdot \Delta z_{Zoom}(n-1)$	
Minimum zoom scan volume	x, y, z	≥ 30 mm	3 – 4 GHz: ≥ 28 mm 4 – 5 GHz: ≥ 25 mm 5 – 6 GHz: ≥ 22 mm	
Note: δ is the penetration depth of a plane-wave at normal incidence to the tissue medium; see draft standard IEEE P1528-2011 for details. * When zoom scan is required and the <i>reported</i> SAR from the area scan based 1-g SAR estimation procedures of KDB 447498 is ≤ 1.4 W/kg, ≤ 8 mm, ≤ 7 mm and ≤ 5 mm zoom scan resolution may be applied, respectively, for 2 GHz to 3 GHz, 3 GHz to 4 GHz and 4 GHz to 6 GHz.				

9.3 WCDMA Measurement Procedures for SAR

The following procedures are applicable to WCDMA handsets operating under 3GPP Release99, Release 5 and Release 6. The default test configuration is to measure SAR with an established radio link between the DUT and a communication test set using a 12.2kbps RMC (reference measurement channel) configured in Test Loop Mode 1. SAR is selectively confirmed for other physical channel configurations (DPCCH & DPDCH_n), HSDPA and HSPA (HSUPA/HSDPA) modes according to output power, exposure conditions and device operating capabilities. Both uplink and downlink should be configured with the same RMC or AMR, when required. SAR for Release 5 HSDPA and Release 6 HSPA are measured using the applicable FRC (fixed reference channel) and E-DCH reference channel configurations. Maximum output power is verified according to applicable versions of 3GPP TS 34.121 and SAR must be measured according to these maximum output conditions. When Maximum Power Reduction (MPR) is not implemented according to Cubic Metric (CM) requirements for Release 6 HSPA, the following procedures do not apply.

For Release 5 HSDPA Data Devices:

Sub-test	β_c	β_d	β_d (SF)	β_c / β_d	β_{hs}	CM/dB
1	2/15	15/15	64	2/15	4/15	0.0
2	12/15	15/15	64	12/15	24/25	1.0
3	15/15	8/15	64	15/8	30/15	1.5
4	15/15	4/15	64	15/4	30/15	1.5

For Release 6 HSPA Data Devices

Sub-test	β_c	β_d	β_d (SF)	β_c / β_d	β_{hs}	β_{ec}	β_{ed}	β_{ed} (SF)	β_{ed} (codes)	CM (dB)	MPR (dB)	AG Index	E-TFCI
1	11/15	15/15	64	11/15	22/15	209/225	1039/225	4	1	1.5	1.5	20	75
2	6/15	15/15	64	6/15	12/15	12/15	12/15	4	1	1.5	1.5	12	67
3	15/15	9/15	64	15/9	30/15	30/15	$\beta_{ed1}:47/15$ $\beta_{ed2}:47/15$	4	2	1.5	1.5	15	92
4	2/15	15/15	64	2/15	4/15	4/15	56/75	4	1	1.5	1.5	17	71
5	15/15	15/15	64	15/15	24/15	30/15	134/15	4	1	1.5	1.5	21	81

Rel.8 DC-HSDPA (Cat 24)

SAR test exclusion for Rel.8 DC-HSDPA must satisfy the SAR test exclusion requirements of Rel.5 HSDPA. SAR test exclusion for DC-HSDPA devices is determined by power measurements according to the H-Set 12, Fixed Reference Channel (FRC) configuration in Table C.8.1.12 of 3GPP TS 34.121-1. A primary and a secondary serving HS-DSCH Cell are required to perform the power measurement and for the results to qualify for SAR test exclusion.

9.4 SAR Measurement for LTE

SAR tests for LTE are performed with a base station simulator, Rohde & Schwarz CMW500. Closed loop power control was used so the UE transmits with maximum output power during SAR testing. All powers were measured with the CMW 500.

It is performed for conducted power and SAR based on the KDB941225 D05.

SAR is evaluated separately according to the following procedures for the different test positions in each exposure condition – head, body, body-worn accessories and other use conditions. The procedures in the following subsections are applied separately to test each LTE frequency band.

1) QPSK with 1 RB allocation

Start with the largest channel bandwidth and measure SAR for QPSK with 1 RB allocation, using the RB offset and required test channel combination with the highest maximum output power among RB offsets at the upper edge, middle and lower edge of each required test channel. When the reported SAR is ≤ 0.8 W/kg, testing of the remaining RB offset configurations and required test channels is not required for 1 RB allocation; otherwise, SAR is required for the remaining required test channels and only for the RB offset configuration with the highest output power for that channel. When the reported SAR of a required test channel is > 1.45 W/kg, SAR is required for all three RB offset configurations for that required test channel.

2) QPSK with 50% RB allocation

The procedures required for 1 RB allocation in 1) are applied to measure the SAR for QPSK with 50% RB allocation.

3) QPSK with 100% RB allocation

For QPSK with 100% RB allocation, SAR is not required when the highest maximum output power for 100 % RB allocation is less than the highest maximum output power in 50% and 1 RB allocations and the highest reported SAR for 1 RB and 50% RB allocation in 1) and 2) are ≤ 0.8 W/kg. Otherwise, SAR is measured for the highest output power channel; and if the reported SAR is > 1.45 W/kg, the remaining required test channels must also be tested.

TDD test:

TDD testing is performed using guidance from FCC KDB 941225 D05 v02r05 and the SAR test guidance provided in April 2013 TCB works hop notes. TDD is tested at the highest duty factor using UL-DL configuration 0 with special subframe configuration 6 and applying the FDD LTE procedures in KDB 941225 D05 v02r05. SAR testing is performed using the extended cyclic prefix listed in 3GPP TS 36.211.

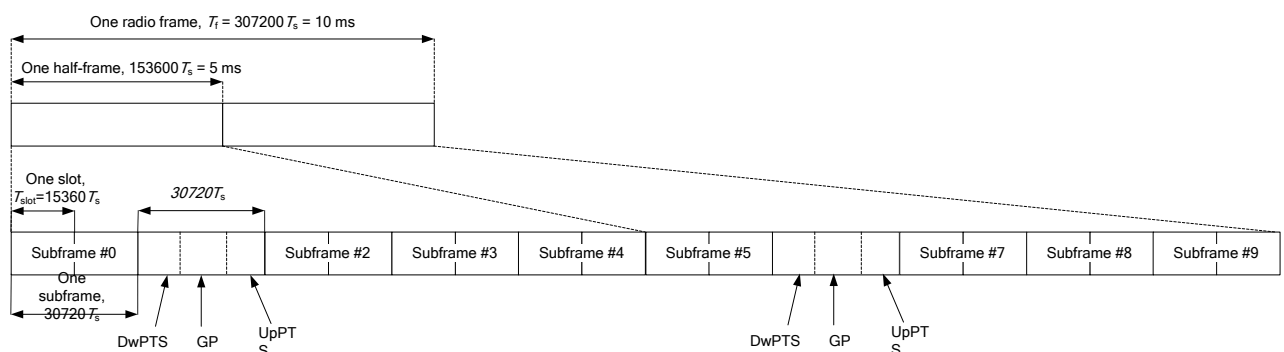

Figure 9.2: Frame structure type 2 (for 5 ms switch-point periodicity)

Table 9.1: Configuration of special subframe (lengths of DwPTS/GP/UpPTS)

Special subframe configuration	Normal cyclic prefix in downlink			Extended cyclic prefix in downlink		
	DwPTS	UpPTS		DwPTS	UpPTS	
		Normal cyclic prefix in uplink	Extended cyclic prefix in uplink		Normal cyclic prefix in uplink	Extended cyclic prefix in uplink
0	$6592 \cdot T_s$	$2192 \cdot T_s$	$2560 \cdot T_s$	$7680 \cdot T_s$	$2192 \cdot T_s$	$2560 \cdot T_s$
1	$19760 \cdot T_s$			$20480 \cdot T_s$		
2	$21952 \cdot T_s$			$23040 \cdot T_s$		
3	$24144 \cdot T_s$			$25600 \cdot T_s$		
4	$26336 \cdot T_s$	$4384 \cdot T_s$	$5120 \cdot T_s$	$7680 \cdot T_s$	$4384 \cdot T_s$	$5120 \cdot T_s$
5	$6592 \cdot T_s$			$20480 \cdot T_s$		
6	$19760 \cdot T_s$			$23040 \cdot T_s$		
7	$21952 \cdot T_s$			$12800 \cdot T_s$		
8	$24144 \cdot T_s$			-		
9	$13168 \cdot T_s$	-	-	-	-	-

Table 9.2: Uplink-downlink configurations

Uplink-downlink configuration	Downlink-to-Uplink Switch-point periodicity	Subframe number										
		0	1	2	3	4	5	6	7	8	9	
0	5 ms	D	S	U	U	U	D	S	U	U	U	
1	5 ms	D	S	U	U	D	D	S	U	U	D	
2	5 ms	D	S	U	D	D	D	S	U	D	D	
3	10 ms	D	S	U	U	U	D	D	D	D	D	
4	10 ms	D	S	U	U	D	D	D	D	D	D	
5	10 ms	D	S	U	D	D	D	D	D	D	D	
6	5 ms	D	S	U	U	U	D	S	U	U	D	

Duty factor is calculated by:

$$\begin{aligned}
 \text{Duty factor} &= \text{uplink frame} \cdot 6 + \text{UpPTS} \cdot 2 / \text{one frame length} \\
 &= (30720 \cdot T_s \cdot 6 + 5120 \cdot T_s \cdot 2) / 307200 \cdot T_s \\
 &= 0.633
 \end{aligned}$$

According to the KDB 447498 D01, SAR should be evaluated at more than 3 frequencies for devices supporting transmit bands wider than 100MHz. Oct.2014 FCC-TCB conference notes (Dec. 2014 rev.) specifies the 5 test channels to use for 3GPP band 41 SAR evaluation.

9.5 Bluetooth & Wi-Fi Measurement Procedures for SAR

Normal network operating configurations are not suitable for measuring the SAR of 802.11 transmitters in general. Unpredictable fluctuations in network traffic and antenna diversity conditions can introduce undesirable variations in SAR results. The SAR for these devices should be measured using chipset based test mode software to ensure that the results are consistent and reliable.

Chipset based test mode software is hardware dependent and generally varies among manufacturers. The device operating parameters established in a test mode for SAR measurements must be identical to those programmed in production units, including output power levels, amplifier gain settings and other RF performance tuning parameters. The test frequencies should correspond to actual channel frequencies defined for domestic use. SAR for devices with switched diversity should be measured with only one antenna transmitting at a time during each SAR measurement, according to a fixed modulation and data rate. The same data pattern should be used for all measurements.

9.6 SAR Measurement for LTE

1. Test LTE SAR with single uplink at maximum power following LTE SAR test procedure.

[1] For TDD band (n41), PC2 mode is only tested, because the duty cycle of both PC2 and PC3 are the same and PC2 has higher power than PC3.

9.7 Power Drift

To control the output power stability during the SAR test, DASY5 system calculates the power drift by measuring the E-field at the same location at the beginning and at the end of the measurement for each test position. These drift values can be found in section 14 labeled as: (Power Drift [dB]). This ensures that the power drift during one measurement is within 5%.

10 Area Scan Based 1-g SAR

10.1 Requirement of KDB

According to the KDB447498 D01 v06, when the implementation is based the specific polynomial fit algorithm as presented at the 29th Bioelectromagnetics Society meeting (2007) and the estimated 1-gSAR is ≤ 1.2 W/kg, a zoom scan measurement is not required provided it is also not needed for any other purpose; for example, if the peak SAR location required for simultaneous transmission SAR test exclusion can be determined accurately by the SAR system or manually to discriminate between distinctive peaks and scattered noisy SAR distributions from area scans.

There must not be any warning or alert messages due to various measurement concerns identified by the SAR system; for example, noise in measurements, peaks too close to scan boundary, peaks are too sharp, spatial resolution and uncertainty issues etc. The SAR system verification must also demonstrate that the area scan estimated 1-g SAR is within 3% of the zoom scan 1-g SAR (See Annex B). When all the SAR results for each exposure condition in a frequency band and wireless mode are based on estimated 1-g SAR, the 1-g SAR for the highest SAR configuration must be determined by a zoom scan.

10.2 Fast SAR Algorithms

The approach is based on the area scan measurement applying a frequency dependent attenuation parameter. This attenuation parameter was empirically determined by analyzing a large number of phones. The MOTOROLA FAST SAR was developed and validated by the MOTOROLA Research Group in Ft. Lauderdale.

In the initial study, an approximation algorithm based on Linear fit was developed. The accuracy of the algorithm has been demonstrated across a broad frequency range (136-2450 MHz) and for both 1- and 10-g averaged SAR using a sample of 264 SAR measurements from 55 wireless handsets. For the sample size studied, the root-mean-squared errors of the algorithm are 1.2% and 5.8% for 1- and 10-g averaged SAR, respectively. The paper describing the algorithm in detail is expected to be published in August 2004 within the Special Issue of Transactions on MTT.

In the second step, the same research group optimized the fitting algorithm to an Polynomial fit whereby the frequency validity was extended to cover the range 30-6000MHz. Details of this study can be found in the BEMS 2007 Proceedings.

Both algorithms are implemented in DASY software.

11 Conducted Output Power

Table1: Summary of Receiver detection mechanism

Antenna	Receiver on (Head scenario)	Receiver off + Hotspot on (Body scenario)	Receiver off + Hotspot off (Body scenario)
Standalone	DSI1/DSI3	DSI2	DSI0

11.1 GSM Measurement result

Table 11.1-1: The conducted power measurement results for GSM, GPRS and EGPRS-
DSI0/1/2/3

GSM 850 Speech (GMSK)	Measured Power (dBm)			Tune up	calculation	Averaged Power (dBm)		
	251	190	128			251	190	128
1 Txslot	31.96	32.05	31.92	33.30	/	/	/	/
GSM 850 GPRS (GMSK)	Measured Power (dBm)				calculation	Averaged Power (dBm)		
	251	190	128			251	190	128
1 Txslot	32.03	32.07	31.93	33.30	-9.03	23.00	23.04	22.90
2 Txslots	28.34	28.51	28.41	30.50	-6.02	22.32	22.49	22.39
3Txslots	27.25	27.50	27.43	28.00	-4.26	22.99	23.24	23.17
4 Txslots	26.01	26.29	26.21	27.00	-3.01	23.00	23.28	23.20
GSM 850 EGPRS (GMSK)	Measured Power (dBm)				calculation	Averaged Power (dBm)		
	251	190	128			251	190	128
1 Txslot	31.91	32.01	31.89	33.30	-9.03	22.88	22.98	22.86
2 Txslots	28.24	28.46	28.37	30.50	-6.02	22.22	22.44	22.35
3Txslots	27.16	27.45	27.39	28.00	-4.26	22.90	23.19	23.13
4 Txslots	25.94	26.24	26.28	27.00	-3.01	22.93	23.23	23.27
GSM 850 EGPRS (8PSK)	Measured Power (dBm)				calculation	Averaged Power (dBm)		
	251	190	128			251	190	128
1 Txslot	25.99	26.09	26.11	26.50	-9.03	16.96	17.06	17.08
2 Txslots	21.94	22.07	22.16	23.50	-6.02	15.92	16.05	16.14
3Txslots	20.82	20.86	21.46	22.50	-4.26	16.56	16.60	17.20
4 Txslots	19.69	19.76	19.97	21.50	-3.01	16.68	16.75	16.96

NOTES:

1) Division Factors

To average the power, the division factor is as follows:

1TX-slot = 1 transmit time slot out of 8 time slots=> conducted power divided by (8/1) => -9.03dB

2TX-slots = 2 transmit time slots out of 8 time slots=> conducted power divided by (8/2) => -6.02dB

3TX-slots = 3 transmit time slots out of 8 time slots=> conducted power divided by (8/3) => -4.26dB

4TX-slots = 4 transmit time slots out of 8 time slots=> conducted power divided by (8/4) => -3.01dB

According to the conducted power as above, the body measurements are performed with 4Txslots for GSM850

Table 11.1-2: The conducted power measurement results for GSM, GPRS and EGPRS
DSIO/1/2/3

PCS1900 Speech (GMSK)	Measured Power (dBm)			Tune up	calculation	Averaged Power (dBm)		
	810	661	512			810	661	512
1 Txslot	30.22	30.25	30.23	31.00	/	/	/	/
PCS1900 GPRS (GMSK)	Measured Power (dBm)				calculation	Averaged Power (dBm)		
	810	661	512			810	661	512
1 Txslot	30.25	30.23	30.20	31.00	-9.03	21.22	21.20	21.17
2 Txslots	26.13	26.12	26.04	27.00	-6.02	20.11	20.10	20.02
3Txslots	24.90	24.99	24.89	25.00	-4.26	20.64	20.73	20.63
4 Txslots	23.95	23.90	23.76	24.00	-3.01	20.94	20.89	20.75
PCS1900 EGPRS (GMSK)	Measured Power (dBm)				calculation	Averaged Power (dBm)		
	810	661	512			810	661	512
1 Txslot	30.20	30.29	30.26	31.00	-9.03	21.17	21.26	21.23
2 Txslots	26.09	26.09	25.99	27.00	-6.02	20.07	20.07	19.97
3Txslots	24.99	24.98	24.83	25.00	-4.26	20.73	20.72	20.57
4 Txslots	23.91	23.89	23.72	24.00	-3.01	20.90	20.88	20.71
PCS1900 EGPRS (8PSK)	Measured Power (dBm)				calculation	Averaged Power (dBm)		
	810	661	512			810	661	512
1 Txslot	25.53	25.73	25.85	26.50	-9.03	16.50	16.70	16.82
2 Txslots	22.10	22.08	22.10	23.50	-6.02	16.08	16.06	16.08
3Txslots	21.07	21.00	20.96	22.50	-4.26	16.81	16.74	16.70
4 Txslots	20.05	19.92	19.86	21.50	-3.01	17.04	16.91	16.85

NOTES:

1) Division Factors

To average the power, the division factor is as follows:

1TX-slot = 1 transmit time slot out of 8 time slots=> conducted power divided by (8/1) => -9.03dB

2TX-slots = 2 transmit time slots out of 8 time slots=> conducted power divided by (8/2) => -6.02dB

3TX-slots = 3 transmit time slots out of 8 time slots=> conducted power divided by (8/3) => -4.26dB

4TX-slots = 4 transmit time slots out of 8 time slots=> conducted power divided by (8/4) => -3.01dB

According to the conducted power as above, the body measurements are performed with 1Txslots for GSM1900.

11.2 WCDMA Measurement result

Table 11.2-1: The conducted Power for WCDMA DS10/2

Item	band	FDDV result			
	ARFCN	4233 (846.6MHz)	4182 (836.4MHz)	4132 (826.4MHz)	Tune up
WCDMA	\	24.25	24.21	24.17	24.50
HSUPA	1	21.29	21.20	21.16	21.50
	2	21.25	21.20	21.17	21.50
	3	21.76	21.72	21.65	22.00
	4	20.79	20.76	20.62	21.50
	5	22.26	22.22	22.16	23.50
HSPA+		22.75	22.79	22.71	23.00
DC-HSDPA	1	23.17	23.23	23.15	23.50
	2	23.16	23.09	22.94	23.50
	3	22.63	22.68	22.61	23.00
	4	22.61	22.66	22.63	23.00

Table 11.2-2: The conducted Power for WCDMA DS11/3

Item	band	FDDIV result			
	ARFCN	1513 (1752.6MHz)	1412 (1732.4MHz)	1312 (1712.4MHz)	
WCDMA	\	24.54	24.59	24.64	25.50
HSUPA	1	21.4	21.46	21.55	23.50
	2	21.38	21.44	21.42	21.50
	3	22.41	22.42	22.42	22.50
	4	20.89	20.92	21.05	21.50
	5	22.37	22.38	22.49	23.50
HSPA+		22.99	22.88	23.08	23.50
DC-HSDPA	1	23.36	23.48	23.60	23.80
	2	23.28	23.36	23.40	23.80
	3	22.83	22.94	23.01	23.50
	4	22.8	22.92	23.01	23.50
Item	band	FDDII result			
	ARFCN	9538 (1907.6MHz)	9400 (1880MHz)	9262 (1852.4MHz)	
WCDMA	\	23.86	23.82	23.77	24.50
HSUPA	1	20.88	20.84	20.80	21.50
	2	20.85	20.80	20.73	21.50
	3	21.84	21.80	21.74	22.00
	4	20.32	20.30	20.23	21.50
	5	21.82	21.75	21.69	23.50
HSPA+		22.34	22.44	22.26	22.50
DC-HSDPA	1	22.87	22.86	22.77	23.00
	2	22.78	22.70	22.66	23.00
	3	22.34	22.31	22.24	23.00
	4	22.34	22.30	22.22	22.50

Item	band	FDDV result			
	ARFCN	4233 (846.6MHz)	4182 (836.4MHz)	4132 (826.4MHz)	Tune up
WCDMA	\	22.12	22.01	22.02	23.00
HSUPA	1	20.54	20.44	20.44	21.50
	2	20.19	20.30	20.08	20.50
	3	21.19	21.08	21.07	20.50
	4	19.50	19.39	19.36	19.50
	5	21.12	21.04	21.04	21.50
HSPA+		21.63	21.51	21.66	22.00
DC-HSDPA	1	22.13	22.12	22.10	22.50
	2	22.14	22.10	22.09	22.50
	3	21.58	21.52	21.48	22.00
	4	21.56	21.50	21.51	22.00

Table 11.2-3: The conducted Power for WCDMA DSI0

Item	band	FDDIV result			
	ARFCN	1513 (1752.6MHz)	1412 (1732.4MHz)	1312 (1712.4MHz)	
WCDMA	\	20.15	20.09	20.09	22.00
HSUPA	1	18.42	18.36	17.98	19.50
	2	18.06	17.99	17.98	18.50
	3	19.08	19.01	18.98	19.50
	4	17.32	17.46	17.45	17.50
	5	19.05	19.00	19.01	19.50
HSPA+		19.72	19.50	19.51	20.50
DC-HSDPA	1	20.10	20.05	20.04	20.50
	2	20.02	19.98	20.02	20.50
	3	19.55	19.50	19.50	20.50
	4	19.54	19.47	19.47	20.00
Item	band	FDDII result			
	ARFCN	9538 (1907.6MHz)	9400 (1880MHz)	9262 (1852.4MHz)	
WCDMA	\	20.04	19.94	19.91	21.50
HSUPA	1	18.42	18.25	18.26	19.50
	2	17.96	17.88	17.90	18.50
	3	18.94	18.89	18.89	19.50
	4	17.46	17.38	17.40	17.50
	5	18.91	18.85	18.88	19.50
HSPA+		19.58	19.36	19.38	20.00
DC-HSDPA	1	19.91	19.93	19.95	20.50
	2	19.84	19.89	19.87	20.50
	3	19.35	19.40	19.39	20.00
	4	19.34	19.37	19.40	20.00

Table 11.2-3: The conducted Power for WCDMA DS12

Item	band	FDDIV result			
	ARFCN	1513 (1752.6MHz)	1412 (1732.4MHz)	1312 (1712.4MHz)	
WCDMA	\	19.16	19.09	19.04	20.00
HSUPA	1	17.66	17.59	17.65	19.50
	2	17.10	17.05	17.06	17.50
	3	17.91	17.81	17.80	18.00
	4	16.63	16.57	16.56	17.50
	5	18.06	18.02	17.98	19.50
HSPA+		18.65	18.58	18.55	19.00
DC-HSDPA	1	19.08	19.05	19.06	19.50
	2	19.08	19.01	19.03	19.50
	3	18.59	18.56	18.54	19.00
	4	18.56	18.51	18.52	19.00
Item	band	FDDII result			
	ARFCN	9538 (1907.6MHz)	9400 (1880MHz)	9262 (1852.4MHz)	
WCDMA	\	19.02	18.94	18.92	20.50
HSUPA	1	17.54	17.58	17.53	19.50
	2	17.02	16.94	16.94	17.50
	3	17.97	17.90	17.93	18.00
	4	16.55	16.44	16.45	17.50
	5	17.95	17.87	17.87	19.50
HSPA+		18.56	18.56	18.42	19.00
DC-HSDPA	1	18.86	18.94	18.93	19.50
	2	18.89	18.90	18.93	19.50
	3	18.40	18.42	18.41	19.00
	4	18.36	18.41	18.39	19.00

11.3 LTE Measurement result

Table 11.3-1: Maximum Power Reduction (MPR) for LTE-Normal Power

Modulation	Channel bandwidth / Transmission bandwidth configuration [RB]						MPR (dB)
	1.4	3	5	10	15	20	
	MHz	MHz	MHz	MHz	MHz	MHz	
QPSK	> 5	> 4	> 8	> 12	> 16	> 18	1
16 QAM	≤ 5	≤ 4	≤ 8	≤ 12	≤ 16	≤ 18	1
16 QAM	> 5	> 4	> 8	> 12	> 16	> 18	2
64 QAM	≤ 5	≤ 4	≤ 8	≤ 12	≤ 16	≤ 18	2
64 QAM	> 5	> 4	> 8	> 12	> 16	> 18	3

Table 11.3-2: Maximum Power Reduction (MPR) for LTE- Low Power

Modulation	Channel bandwidth / Transmission bandwidth configuration [RB]						MPR (dB)
	1.4	3	5	10	15	20	
	MHz	MHz	MHz	MHz	MHz	MHz	
QPSK	> 5	> 4	> 8	> 12	> 16	> 18	0
16 QAM	≤ 5	≤ 4	≤ 8	≤ 12	≤ 16	≤ 18	0
16 QAM	> 5	> 4	> 8	> 12	> 16	> 18	0
64 QAM	≤ 5	≤ 4	≤ 8	≤ 12	≤ 16	≤ 18	0
64 QAM	> 5	> 4	> 8	> 12	> 16	> 18	0

Table 11.3-3: The tune up for LTE– DSI1/3

Band	Tune up
LTE Band 12	23
LTE Band 13	23
LTE Band 25	25
LTE Band 26	23
LTE Band 41 PC3	24
LTE Band 41 PC2	27
LTE Band 66	25
LTE Band 71	23

Table 11.3-5: The tune up for LTE– DSI0/2

Band	Tune up
LTE Band 12	24.5
LTE Band 13	24.5
LTE Band 26	25
LTE Band 71	24.5

Table 11.3-6: The tune up for LTE– DSI0

Band	Tune up
LTE Band 25	21.5

LTE Band 41 PC3	20
LTE Band 41 PC2	23
LTE Band 66	22.5

Table 11.3-7: The tune up for LTE– DSI2

Band	Tune up
LTE Band 25	20.5
LTE Band 41 PC3	19
LTE Band 41 PC2	22
LTE Band 66	21

DSI0/2

		Band 12				
Bandwidth (MHz)	RB allocation	Frequency (MHz)	QPSK	16QAM	64QAM	
	RB offset (Start RB)		Actual output power (dBm)	Actual output power (dBm)	Actual output power (dBm)	
1.4 MHz	1RB High (5)	715.3	24.14	23.48	22.41	
		707.5	24.18	23.49	22.49	
		699.7	24.18	23.56	22.47	
	1RB Middle (3)	715.3	24.22	23.54	22.51	
		707.5	24.28	23.49	22.47	
		699.7	24.27	23.66	22.48	
	1RB Low (0)	715.3	24.14	23.50	22.43	
		707.5	24.15	23.44	22.38	
		699.7	24.18	23.57	22.47	
	3RB High (3)	715.3	24.24	23.26	22.36	
		707.5	24.25	23.27	22.37	
		699.7	24.33	23.32	22.47	
	3RB Middle (1)	715.3	24.31	23.34	22.50	
		707.5	24.33	23.25	22.45	
		699.7	24.36	23.42	22.57	
	3RB Low (0)	715.3	24.27	23.32	22.48	
		707.5	24.25	23.21	22.40	
		699.7	24.30	23.37	22.50	
	6RB (0)	715.3	23.28	22.43	21.35	
		707.5	23.34	22.46	21.40	
		699.7	23.32	22.49	21.40	
	3 MHz	1RB High (14)	714.5	24.20	23.48	22.52
			707.5	24.23	23.51	22.45
			700.5	24.24	23.44	22.49
1RB Middle (7)		714.5	24.22	23.71	22.65	
		707.5	24.20	23.51	22.60	
		700.5	24.23	23.59	22.66	
1RB Low (0)	714.5	24.26	23.50	22.49		
	707.5	24.22	23.55	22.42		

	8RB High (7)	700.5	24.27	23.60	22.52	
		714.5	23.27	22.41	21.42	
		707.5	23.26	22.42	21.43	
		700.5	23.29	22.42	21.43	
	8RB Middle (4)	714.5	23.31	22.47	21.43	
		707.5	23.30	22.46	21.47	
		700.5	23.32	22.46	21.46	
	8RB Low (0)	714.5	23.31	22.45	21.46	
		707.5	23.26	22.35	21.42	
		700.5	23.29	22.45	21.45	
	15RB (0)	714.5	23.29	22.39	21.40	
		707.5	23.32	22.37	21.39	
700.5		23.33	22.39	21.40		
5 MHz	1RB High (24)	713.5	24.09	23.47	22.37	
		707.5	24.16	23.49	22.41	
		701.5	24.14	23.40	22.41	
	1RB Middle (12)	713.5	24.15	23.78	22.63	
		707.5	24.12	23.68	22.67	
		701.5	24.14	23.70	22.64	
	1RB Low (0)	713.5	24.19	23.45	22.42	
		707.5	24.16	23.49	22.44	
		701.5	24.21	23.56	22.45	
	12RB High (13)	713.5	23.26	22.33	21.39	
		707.5	23.33	22.40	21.43	
		701.5	23.27	22.36	21.40	
	12RB Middle (6)	713.5	23.39	22.44	21.47	
		707.5	23.38	22.43	21.46	
		701.5	23.37	22.41	21.49	
	12RB Low (0)	713.5	23.36	22.41	21.47	
		707.5	23.31	22.39	21.41	
		701.5	23.30	22.35	21.40	
	25RB (0)	713.5	23.32	22.42	21.40	
		707.5	23.33	22.42	21.41	
		701.5	23.32	22.39	21.38	
	10 MHz	1RB High (49)	711	24.19	23.45	22.37
			707.5	24.27	23.49	22.37
			704	24.25	23.47	22.44
1RB Middle (24)		711	24.34	23.51	22.52	
		707.5	24.36	23.47	22.40	
		704	24.35	23.53	22.46	
1RB Low (0)		711	24.30	23.50	22.38	
		707.5	24.26	23.36	22.32	
		704	24.34	23.58	22.45	
25RB High (25)		711	23.29	22.29	21.32	
		707.5	23.37	22.35	21.33	
		704	23.36	22.36	21.38	
25RB Middle		711	23.43	22.35	21.35	
		707.5	23.39	22.38	21.37	

	(12)	704	23.38	22.36	21.38
	25RB Low (0)	711	23.42	22.38	21.42
		707.5	23.37	22.35	21.35
		704	23.35	22.33	21.36
	50RB (0)	711	23.37	22.35	21.37
		707.5	23.40	22.37	21.38
		704	23.37	22.35	21.36

DSI1/3

Band 12					
Bandwidth (MHz)	RB allocation RB offset (Start RB)	Frequency (MHz)	QPSK	16QAM	64QAM
			Actual output power (dBm)	Actual output power (dBm)	Actual output power (dBm)
1.4 MHz	1RB High (5)	715.3	21.21	21.24	21.05
		707.5	21.27	21.16	21.14
		699.7	21.34	21.32	21.16
	1RB Middle (3)	715.3	21.34	21.25	21.25
		707.5	21.40	21.29	21.17
		699.7	21.45	21.42	21.32
	1RB Low (0)	715.3	21.24	21.25	21.15
		707.5	21.23	21.16	21.08
		699.7	21.31	21.27	21.16
	3RB High (3)	715.3	21.36	21.05	21.08
		707.5	21.40	21.08	21.09
		699.7	21.47	21.13	21.19
	3RB Middle (1)	715.3	21.39	21.02	21.18
		707.5	21.41	21.02	21.09
		699.7	21.49	21.21	21.27
	3RB Low (0)	715.3	21.34	21.04	21.13
		707.5	21.35	21.04	21.06
		699.7	21.42	21.17	21.21
	6RB (0)	715.3	21.31	21.13	20.07
		707.5	21.39	21.17	20.09
		699.7	21.42	21.24	20.16
3 MHz	1RB High (14)	714.5	21.24	21.23	21.12
		707.5	21.29	21.18	21.20
		700.5	21.36	21.40	21.32
	1RB Middle (7)	714.5	21.47	21.46	21.31
		707.5	21.42	21.40	21.28
		700.5	21.48	21.48	21.31
	1RB Low (0)	714.5	21.29	21.34	21.19
		707.5	21.26	21.23	21.13
		700.5	21.40	21.36	21.21
	8RB High (7)	714.5	21.30	21.05	20.08
		707.5	21.33	21.08	20.13
700.5		21.43	21.16	20.22	

	8RB Middle (4)	714.5	21.36	21.08	20.14	
		707.5	21.37	21.12	20.20	
		700.5	21.46	21.21	20.23	
	8RB Low (0)	714.5	21.35	21.12	20.14	
		707.5	21.34	21.10	20.10	
		700.5	21.39	21.16	20.19	
	15RB (0)	714.5	21.35	21.06	20.05	
		707.5	21.35	21.06	20.11	
		700.5	21.42	21.16	20.17	
5 MHz	1RB High (24)	713.5	21.15	21.12	20.93	
		707.5	21.18	21.14	21.03	
		701.5	21.21	21.08	21.11	
	1RB Middle (12)	713.5	21.47	21.49	21.32	
		707.5	21.44	21.28	21.16	
		701.5	21.55	21.50	21.27	
	1RB Low (0)	713.5	21.20	21.11	21.04	
		707.5	21.20	21.19	21.03	
		701.5	21.27	21.30	21.11	
	12RB High (13)	713.5	21.27	20.96	20.03	
		707.5	21.32	21.00	20.07	
		701.5	21.38	21.06	20.11	
	12RB Middle (6)	713.5	21.41	21.10	20.17	
		707.5	21.39	21.07	20.13	
		701.5	21.47	21.15	20.18	
	12RB Low (0)	713.5	21.40	21.07	20.15	
		707.5	21.37	21.00	20.10	
		701.5	21.38	21.08	20.13	
	25RB (0)	713.5	21.36	21.05	20.08	
		707.5	21.35	21.03	20.09	
		701.5	21.38	21.09	20.11	
	10 MHz	1RB High (49)	711	21.64	21.68	21.50
			707.5	21.69	21.63	21.54
			704	21.70	21.53	21.60
1RB Middle (24)		711	21.85	21.51	21.65	
		707.5	21.92	21.54	21.58	
		704	21.85	21.52	21.67	
1RB Low (0)		711	21.75	21.63	21.47	
		707.5	21.75	21.64	21.57	
		704	21.82	21.61	21.53	
25RB High (25)		711	21.73	21.43	20.45	
		707.5	21.80	21.43	20.49	
		704	21.78	21.44	20.52	
25RB Middle (12)		711	21.81	21.52	20.55	
		707.5	21.81	21.52	20.55	
		704	21.87	21.54	20.57	
25RB Low (0)		711	21.84	21.55	20.59	
		707.5	21.84	21.51	20.57	
		704	21.83	21.57	20.60	

	50RB (0)	711	21.81	21.51	20.53
		707.5	21.81	21.51	20.56
		704	21.82	21.54	20.54

DSI0/2

Band 13					
Bandwidth (MHz)	RB allocation RB offset (Start RB)	Frequency (MHz)	QPSK	16QAM	64QAM
			Actual output power (dBm)	Actual output power (dBm)	Actual output power (dBm)
5 MHz	1RB High (24)	784.5	23.89	23.14	22.03
		782	23.81	23.07	22.00
		779.5	23.91	23.12	22.09
	1RB Middle (12)	784.5	24.07	23.32	22.31
		782	24.17	23.40	22.30
		779.5	24.13	23.32	22.31
	1RB Low (0)	784.5	23.93	23.14	22.10
		782	23.94	23.13	22.12
		779.5	23.86	22.98	21.97
	12RB High (13)	784.5	22.97	21.97	21.00
		782	23.05	22.01	21.03
		779.5	23.10	22.07	21.10
	12RB Middle (6)	784.5	23.06	22.02	21.07
		782	23.11	22.09	21.11
		779.5	23.08	22.06	21.07
	12RB Low (0)	784.5	23.02	21.98	21.02
		782	23.08	22.06	21.07
		779.5	22.90	21.85	20.89
	25RB (0)	784.5	22.97	21.97	20.97
		782	23.07	22.06	21.06
		779.5	23.03	21.97	20.99
10 MHz	1RB High (49)	782	24.06	23.39	22.30
	1RB Middle (24)	782	24.35	23.64	22.53
	1RB Low (0)	782	24.28	23.35	22.38
	25RB High (25)	782	23.28	22.25	21.24
	25RB Middle (12)	782	23.33	22.32	21.34

	25RB Low (0)	782	23.34	22.35	21.34
	50RB (0)	782	23.29	22.29	21.30

DSI1/3

Band 13						
Bandwidth (MHz)	RB allocation RB offset (Start RB)	Frequency (MHz)	QPSK	16QAM	64QAM	
			Actual output power (dBm)	Actual output power (dBm)	Actual output power (dBm)	
5 MHz	1RB High (24)	784.5	21.21	21.52	21.37	
		782	21.18	21.42	21.32	
		779.5	21.25	21.49	21.42	
	1RB Middle (12)	784.5	21.38	21.65	21.52	
		782	21.51	21.78	21.68	
		779.5	21.44	21.64	21.59	
	1RB Low (0)	784.5	21.26	21.48	21.34	
		782	21.29	21.52	21.40	
		779.5	21.15	21.34	21.27	
	12RB High (13)	784.5	21.24	21.24	20.25	
		782	21.32	21.30	20.32	
		779.5	21.37	21.36	20.38	
	12RB Middle (6)	784.5	21.32	21.29	20.34	
		782	21.36	21.38	20.42	
		779.5	21.38	21.31	20.38	
	12RB Low (0)	784.5	21.29	21.29	20.32	
		782	21.35	21.35	20.35	
		779.5	21.20	21.12	20.15	
	25RB (0)	784.5	21.26	21.24	20.26	
		782	21.33	21.36	20.33	
		779.5	21.31	21.27	20.26	
	10 MHz	1RB High (49)	782	21.87	21.91	21.83
		1RB Middle (24)	782	21.98	21.92	21.86
		1RB Low (0)	782	21.87	21.90	21.89
25RB High (25)		782	21.89	21.91	20.90	

	25RB Middle (12)	782	21.94	21.90	20.98
	25RB Low (0)	782	21.93	21.93	20.95
	50RB (0)	782	21.93	21.93	20.93

DS11/3

Band 25					
Bandwidth (MHz)	RB allocation	Frequency (MHz)	QPSK	16QAM	64QAM
	RB offset (Start RB)		Actual output power (dBm)	Actual output power (dBm)	Actual output power (dBm)
1.4 MHz	1RB High (5)	1914.3	23.86	23.15	22.06
		1882.5	23.75	23.05	21.87
		1850.7	23.78	23.02	21.89
	1RB Middle (3)	1914.3	23.96	23.18	22.19
		1882.5	23.78	23.11	21.97
		1850.7	23.87	23.05	22.05
	1RB Low (0)	1914.3	23.87	23.18	22.07
		1882.5	23.73	23.08	22.00
		1850.7	23.79	23.07	21.88
	3RB High (3)	1914.3	23.97	22.95	22.05
		1882.5	23.82	22.80	21.88
		1850.7	23.87	22.88	21.90
	3RB Middle (1)	1914.3	23.99	22.93	22.04
		1882.5	23.82	22.75	21.90
		1850.7	23.92	22.88	21.94
	3RB Low (0)	1914.3	23.96	22.95	22.00
		1882.5	23.82	22.80	21.86
		1850.7	23.84	22.79	21.95
6RB (0)	1914.3	22.99	22.02	20.93	
	1882.5	22.81	21.91	20.78	
	1850.7	22.88	21.94	20.81	
3 MHz	1RB High (14)	1913.5	23.98	23.26	22.22
		1882.5	23.84	23.07	21.99
		1851.5	23.89	23.17	21.98
	1RB Middle (7)	1913.5	24.16	23.39	22.30
		1882.5	24.03	23.27	22.29
		1851.5	24.05	23.21	22.23
	1RB Low (0)	1913.5	23.97	23.28	22.08
		1882.5	23.89	23.10	22.12
		1851.5	23.93	23.18	22.07
8RB High (7)	1913.5	23.04	22.08	21.07	
	1882.5	22.90	21.97	21.01	
	1851.5	22.92	21.96	21.09	

	8RB Middle (4)	1913.5	23.07	22.15	21.10	
		1882.5	22.94	21.99	21.07	
		1851.5	22.96	21.96	21.09	
	8RB Low (0)	1913.5	23.02	22.08	21.04	
		1882.5	22.91	21.98	21.02	
		1851.5	22.93	21.99	21.03	
	15RB (0)	1913.5	23.05	22.07	21.00	
		1882.5	22.91	21.92	21.08	
		1851.5	22.92	21.89	21.08	
5 MHz	1RB High (24)	1912.5	23.89	23.12	22.00	
		1882.5	23.74	23.07	21.95	
		1852.5	23.70	22.98	21.93	
	1RB Middle (12)	1912.5	24.19	23.31	22.38	
		1882.5	24.04	23.37	22.18	
		1852.5	24.07	23.16	22.15	
	1RB Low (0)	1912.5	23.83	23.03	22.04	
		1882.5	23.79	23.05	21.98	
		1852.5	23.79	23.07	21.99	
	12RB High (13)	1912.5	23.01	22.00	21.02	
		1882.5	22.90	21.87	21.09	
		1852.5	22.87	21.84	21.08	
	12RB Middle (6)	1912.5	23.06	22.04	21.07	
		1882.5	22.96	21.93	21.04	
		1852.5	22.96	21.94	21.06	
	12RB Low (0)	1912.5	23.04	22.00	21.02	
		1882.5	22.90	21.89	21.08	
		1852.5	22.92	21.87	21.09	
	25RB (0)	1912.5	23.03	22.01	21.00	
		1882.5	22.93	21.89	21.09	
		1852.5	22.92	21.90	21.07	
	10 MHz	1RB High (49)	1910	23.94	23.21	22.13
			1882.5	23.83	23.10	21.99
			1855	23.81	23.09	22.02
		1RB Middle (24)	1910	24.06	23.30	22.19
			1882.5	23.96	23.27	22.13
			1855	23.95	23.10	22.04
1RB Low (0)		1910	23.95	23.27	22.21	
		1882.5	23.87	23.08	21.99	
		1855	23.87	23.09	22.02	
25RB High (25)		1910	23.02	21.97	21.09	
		1882.5	22.97	21.96	21.05	
		1855	22.88	21.88	21.07	
25RB Middle (12)		1910	23.06	22.05	21.03	
		1882.5	22.95	21.93	21.01	
		1855	22.91	21.90	21.07	
25RB Low (0)		1910	23.10	22.12	21.10	
		1882.5	22.95	21.97	21.02	
		1855	22.95	21.93	21.09	

	50RB (0)	1910	23.07	22.06	21.05
		1882.5	23.01	21.99	21.05
		1855	22.94	21.92	21.01
15 MHz	1RB High (74)	1907.5	23.93	23.28	22.10
		1882.5	23.80	23.06	21.95
		1857.5	23.82	23.12	21.98
	1RB Middle (37)	1907.5	23.97	23.24	22.16
		1882.5	23.85	23.16	22.03
		1857.5	23.84	23.07	22.04
	1RB Low (0)	1907.5	23.88	23.15	22.14
		1882.5	23.82	23.11	22.06
		1857.5	23.86	23.16	22.01
	36RB High (38)	1907.5	22.99	21.98	21.07
		1882.5	22.90	21.92	21.04
		1857.5	22.87	21.84	21.03
	36RB Middle (19)	1907.5	23.05	22.02	21.00
		1882.5	22.97	21.93	21.01
		1857.5	22.91	21.85	21.08
	36RB Low (0)	1907.5	23.02	21.97	21.09
		1882.5	22.91	21.87	21.11
		1857.5	22.91	21.87	21.09
	75RB (0)	1907.5	23.00	21.99	21.08
		1882.5	22.90	21.87	21.06
		1857.5	22.87	21.87	21.04
20 MHz	1RB High (99)	1905	24.10	23.26	22.21
		1882.5	24.00	23.32	22.14
		1860	23.99	23.29	22.15
	1RB Middle (50)	1905	24.28	23.60	22.51
		1882.5	24.10	23.32	22.35
		1860	24.18	23.39	22.28
	1RB Low (0)	1905	24.02	23.23	22.2
		1882.5	24.01	23.32	22.22
		1860	24.04	23.31	22.21
	50RB High (50)	1905	23.08	22.04	21.05
		1882.5	23.08	22.08	21.05
		1860	23.06	22.06	21.02
	50RB Middle (25)	1905	23.22	22.23	21.2
		1882.5	23.17	22.19	21.17
		1860	23.13	22.14	21.1
	50RB Low (0)	1905	23.17	22.17	21.15
		1882.5	23.06	22.05	21.04
		1860	23.15	22.14	21.12
	100RB (0)	1905	23.13	22.10	21.09
		1882.5	23.05	22.05	21.01
		1860	23.10	22.09	21.08

Band 25						
Bandwidth (MHz)	RB allocation	Frequency (MHz)	QPSK	16QAM	64QAM	
	RB offset (Start RB)		Actual output power (dBm)	Actual output power (dBm)	Actual output power (dBm)	
1.4 MHz	1RB High (5)	1914.3	20.67	20.90	20.89	
		1882.5	20.39	20.78	20.61	
		1850.7	20.52	20.92	20.75	
	1RB Middle (3)	1914.3	20.80	21.15	21.00	
		1882.5	20.53	20.89	20.73	
		1850.7	20.73	20.90	20.92	
	1RB Low (0)	1914.3	20.69	20.88	20.92	
		1882.5	20.40	20.70	20.64	
		1850.7	20.59	20.91	20.80	
	3RB High (3)	1914.3	20.82	20.76	20.82	
		1882.5	20.49	20.50	20.67	
		1850.7	20.70	20.66	20.78	
	3RB Middle (1)	1914.3	20.85	20.87	20.96	
		1882.5	20.54	20.60	20.65	
		1850.7	20.76	20.74	20.84	
	3RB Low (0)	1914.3	20.78	20.75	20.91	
		1882.5	20.50	20.55	20.59	
		1850.7	20.67	20.65	20.78	
	6RB (0)	1914.3	20.80	20.90	20.79	
		1882.5	20.49	20.61	20.50	
		1850.7	20.68	20.79	20.66	
	3 MHz	1RB High (14)	1913.5	20.70	21.03	20.84
			1882.5	20.47	20.75	20.66
			1851.5	20.56	20.85	20.81
		1RB Middle (7)	1913.5	20.88	21.18	21.02
			1882.5	20.58	20.92	20.72
			1851.5	20.78	21.08	20.91
1RB Low (0)		1913.5	20.69	21.08	20.90	
		1882.5	20.47	20.89	20.71	
		1851.5	20.61	20.99	20.75	
8RB High (7)		1913.5	20.74	20.82	20.78	
		1882.5	20.51	20.58	20.53	
		1851.5	20.57	20.66	20.61	
8RB Middle (4)		1913.5	20.78	20.83	20.84	
		1882.5	20.52	20.58	20.56	
		1851.5	20.67	20.72	20.69	
8RB Low (0)		1913.5	20.76	20.84	20.80	
		1882.5	20.49	20.60	20.52	
		1851.5	20.65	20.70	20.69	
15RB (0)		1913.5	20.74	20.78	20.75	
		1882.5	20.49	20.49	20.50	
		1851.5	20.61	20.65	20.60	
5 MHz		1RB High (24)	1912.5	20.61	20.87	20.78
			1882.5	20.37	20.74	20.57

	1RB Middle (12)	1852.5	20.45	20.73	20.57	
		1912.5	20.87	21.22	21.01	
		1882.5	20.64	21.01	20.80	
		1852.5	20.75	20.96	20.90	
		1RB Low (0)	1912.5	20.60	20.97	20.76
			1882.5	20.37	20.62	20.62
			1852.5	20.52	20.91	20.66
		12RB High (13)	1912.5	20.74	20.72	20.76
			1882.5	20.51	20.50	20.53
	1852.5		20.60	20.58	20.59	
	12RB Middle (6)	1912.5	20.82	20.81	20.84	
		1882.5	20.52	20.53	20.54	
		1852.5	20.62	20.67	20.64	
	12RB Low (0)	1912.5	20.74	20.74	20.75	
		1882.5	20.48	20.49	20.52	
		1852.5	20.62	20.62	20.66	
	25RB (0)	1912.5	20.77	20.77	20.75	
		1882.5	20.51	20.53	20.53	
		1852.5	20.58	20.61	20.58	
	10 MHz	1RB High (49)	1910	20.73	20.98	20.97
			1882.5	20.49	20.69	20.65
			1855	20.49	20.85	20.70
		1RB Middle (24)	1910	20.84	21.14	20.96
			1882.5	20.57	20.81	20.72
			1855	20.63	21.01	20.86
		1RB Low (0)	1910	20.55	20.83	20.71
			1882.5	20.52	20.85	20.64
1855			20.62	20.86	20.81	
25RB High (25)		1910	20.76	20.77	20.74	
		1882.5	20.54	20.56	20.55	
		1855	20.55	20.59	20.59	
25RB Middle (12)		1910	20.78	20.80	20.76	
		1882.5	20.57	20.60	20.59	
		1855	20.66	20.63	20.63	
25RB Low (0)		1910	20.76	20.78	20.79	
		1882.5	20.55	20.57	20.56	
		1855	20.61	20.63	20.59	
50RB (0)		1910	20.76	20.78	20.76	
		1882.5	20.56	20.55	20.55	
		1855	20.62	20.60	20.60	
15 MHz		1RB High (74)	1907.5	20.68	20.99	20.88
			1882.5	20.45	20.70	20.59
			1857.5	20.45	20.75	20.55
		1RB Middle (37)	1907.5	20.66	20.98	20.76
			1882.5	20.50	20.76	20.73
			1857.5	20.55	20.82	20.77
	1RB Low (0)	1907.5	20.46	20.78	20.69	
1882.5		20.51	20.85	20.73		

	36RB High (38)	1857.5	20.61	20.87	20.82	
		1907.5	20.76	20.71	20.73	
		1882.5	20.54	20.52	20.55	
	36RB Middle (19)	1857.5	20.57	20.53	20.55	
		1907.5	20.74	20.70	20.72	
		1882.5	20.56	20.54	20.57	
	36RB Low (0)	1857.5	20.58	20.57	20.61	
		1907.5	20.62	20.60	20.63	
		1882.5	20.56	20.53	20.54	
	75RB (0)	1857.5	20.63	20.60	20.62	
		1907.5	20.68	20.68	20.64	
		1882.5	20.54	20.54	20.54	
	20 MHz	1RB High (99)	1857.5	20.56	20.55	20.52
			1905	20.96	20.80	20.94
			1882.5	20.73	20.79	20.71
1RB Middle (50)		1860	20.75	20.87	20.79	
		1905	20.91	20.96	20.92	
		1882.5	20.91	20.96	20.91	
1RB Low (0)		1860	20.97	20.82	20.83	
		1905	20.76	20.90	20.75	
		1882.5	20.80	20.86	20.73	
50RB High (50)		1860	20.89	20.95	20.89	
		1905	20.95	20.75	20.77	
		1882.5	20.85	20.68	20.66	
50RB Middle (25)		1860	20.85	20.69	20.67	
		1905	20.91	20.81	20.81	
		1882.5	20.90	20.71	20.70	
50RB Low (0)		1860	20.90	20.71	20.75	
		1905	20.88	20.71	20.69	
		1882.5	20.83	20.60	20.65	
100RB (0)		1860	20.93	20.75	20.75	
		1905	20.93	20.75	20.74	
		1882.5	20.86	20.66	20.64	
			1860	20.86	20.65	20.65

DS12

Band 25					
Bandwidth (MHz)	RB allocation RB offset (Start RB)	Frequency (MHz)	QPSK	16QAM	64QAM
			Actual output power (dBm)	Actual output power (dBm)	Actual output power (dBm)
1.4 MHz	1RB High (5)	1914.3	19.12	19.37	19.27
		1882.5	18.84	19.06	19.05
		1850.7	19.00	19.39	19.18
	1RB Middle (3)	1914.3	19.28	19.64	19.39
		1882.5	18.98	19.25	19.20
		1850.7	19.16	19.55	19.40
	1RB Low (0)	1914.3	19.12	19.51	19.27
		1882.5	18.86	19.17	19.03

	3RB High (3)	1850.7	18.99	19.33	19.30	
		1914.3	19.21	19.28	19.31	
		1882.5	18.97	18.97	19.09	
	3RB Middle (1)	1850.7	19.12	19.18	19.22	
		1914.3	19.30	19.28	19.39	
		1882.5	18.99	19.03	19.11	
	3RB Low (0)	1850.7	19.19	19.22	19.29	
		1914.3	19.25	19.18	19.31	
		1882.5	18.99	18.92	19.03	
	6RB (0)	1850.7	19.12	19.17	19.24	
		1914.3	19.24	19.35	19.24	
		1882.5	18.97	19.02	18.92	
3 MHz	1RB High (14)	1850.7	19.11	19.23	19.09	
		1913.5	19.13	19.48	19.31	
		1882.5	18.90	19.15	19.15	
	1RB Middle (7)	1851.5	18.99	19.36	19.16	
		1913.5	19.12	19.65	19.55	
		1882.5	19.03	19.37	19.27	
	1RB Low (0)	1851.5	19.16	19.56	19.47	
		1913.5	19.13	19.49	19.36	
		1882.5	18.93	19.24	19.16	
	8RB High (7)	1851.5	19.07	19.42	19.23	
		1913.5	19.20	19.23	19.22	
		1882.5	18.96	19.03	18.97	
	8RB Middle (4)	1851.5	19.00	19.12	19.10	
		1913.5	19.19	19.28	19.26	
		1882.5	18.95	19.01	19.00	
	8RB Low (0)	1851.5	19.11	19.19	19.18	
		1913.5	19.18	19.25	19.27	
		1882.5	18.95	19.02	18.97	
	15RB (0)	1851.5	19.08	19.20	19.16	
		1913.5	19.18	19.20	19.19	
		1882.5	18.91	18.99	18.95	
	5 MHz	1RB High (24)	1851.5	19.03	19.07	19.04
			1912.5	19.03	19.27	19.24
			1882.5	18.79	19.12	19.02
1RB Middle (12)		1852.5	18.81	19.24	19.05	
		1912.5	19.26	19.58	19.54	
		1882.5	19.03	19.34	19.30	
1RB Low (0)		1852.5	19.14	19.54	19.35	
		1912.5	19.01	19.23	19.20	
		1882.5	18.80	19.10	18.99	
12RB High (13)		1852.5	18.95	19.23	19.18	
		1912.5	19.14	19.13	19.17	
		1882.5	18.91	18.90	18.93	
12RB Middle (6)		1852.5	19.00	19.01	19.03	
		1912.5	19.23	19.22	19.26	
		1882.5	18.93	18.97	18.97	

	12RB Low (0)	1852.5	19.05	19.04	19.07	
		1912.5	19.17	19.15	19.21	
		1882.5	18.88	18.92	18.97	
		1852.5	19.03	19.05	19.08	
		25RB (0)	1912.5	19.17	19.22	19.19
			1882.5	18.93	18.97	18.98
1852.5	18.99		19.04	19.02		
10 MHz	1RB High (49)	1910	19.03	19.28	19.26	
		1882.5	18.81	19.24	18.98	
		1855	18.88	19.25	19.14	
	1RB Middle (24)	1910	19.15	19.44	19.41	
		1882.5	18.95	19.26	19.17	
		1855	19.01	19.40	19.19	
	1RB Low (0)	1910	18.89	19.20	19.14	
		1882.5	18.89	19.24	19.12	
		1855	18.98	19.32	19.21	
	25RB High (25)	1910	19.11	19.17	19.15	
		1882.5	18.91	18.95	18.94	
		1855	18.94	18.98	19.00	
	25RB Middle (12)	1910	19.14	19.16	19.17	
		1882.5	18.93	18.95	18.98	
		1855	18.99	19.03	19.05	
	25RB Low (0)	1910	19.10	19.14	19.16	
		1882.5	18.94	18.96	18.96	
		1855	18.98	19.02	19.03	
	50RB (0)	1910	19.13	19.17	19.15	
		1882.5	18.91	18.95	18.91	
		1855	18.99	19.02	19.07	
	15 MHz	1RB High (74)	1907.5	19.09	19.37	19.15
			1882.5	18.78	19.13	18.92
			1857.5	18.77	19.05	18.97
		1RB Middle (37)	1907.5	19.01	19.20	19.11
			1882.5	18.84	19.19	19.04
			1857.5	18.90	19.19	19.09
		1RB Low (0)	1907.5	18.81	19.09	18.96
			1882.5	18.87	19.15	19.01
			1857.5	18.94	19.27	19.20
36RB High (38)		1907.5	19.07	19.05	19.10	
		1882.5	18.86	18.85	18.89	
		1857.5	18.89	18.87	18.90	
36RB Middle (19)		1907.5	19.07	19.03	19.05	
		1882.5	18.90	18.89	18.91	
		1857.5	18.93	18.93	18.94	
36RB Low (0)		1907.5	18.97	18.93	18.97	
		1882.5	18.88	18.84	18.93	
		1857.5	18.97	18.94	18.95	
75RB (0)		1907.5	19.02	19.01	18.98	
		1882.5	18.86	18.86	18.87	

20 MHz	1RB High (99)	1857.5	18.91	18.89	18.90	
		1905	19.20	19.37	19.17	
		1882.5	18.95	19.28	19.12	
	1RB Middle (50)	1860	18.96	19.24	19.17	
		1905	19.24	19.54	19.22	
		1882.5	19.08	19.33	19.34	
	1RB Low (0)	1860	19.20	19.53	19.39	
		1905	18.99	19.37	18.95	
		1882.5	18.99	19.36	19.22	
	50RB High (50)	1860	19.12	19.32	19.30	
		1905	19.16	19.17	19.13	
		1882.5	19.03	19.08	19.07	
	50RB Middle (25)	1860	19.05	19.07	19.07	
		1905	19.20	19.23	19.20	
		1882.5	19.09	19.13	19.14	
	50RB Low (0)	1860	19.12	19.13	19.16	
		1905	19.09	19.10	19.06	
		1882.5	19.03	19.06	19.03	
	100RB (0)	1860	19.15	19.15	19.16	
		1905	19.13	19.13	19.11	
		1882.5	19.04	19.05	19.05	
			1860	19.06	19.06	19.05

DSI0/2

Band 26					
Bandwidth (MHz)	RB allocation RB offset (Start RB)	Frequency (MHz)	QPSK	16QAM	64QAM
			Actual output power (dBm)	Actual output power (dBm)	Actual output power (dBm)
1.4 MHz	1RB High (5)	848.3	23.99	23.08	22.11
		831.5	23.91	23.20	22.13
		814.7	23.82	23.15	22.05
	1RB Middle (3)	848.3	24.08	23.29	22.23
		831.5	24.02	23.32	22.19
		814.7	23.98	23.21	22.13
	1RB Low (0)	848.3	23.95	23.15	22.18
		831.5	23.93	23.22	22.17
		814.7	23.83	23.13	22.06
	3RB High (3)	848.3	24.09	23.02	22.15
		831.5	24.01	22.94	22.07
		814.7	23.93	22.96	22.06
	3RB Middle (1)	848.3	24.15	23.07	22.22
		831.5	24.05	23.07	22.12
		814.7	24.01	22.98	22.07
	3RB Low (0)	848.3	24.08	22.90	22.11
		831.5	23.99	22.93	22.09
		814.7	23.96	22.87	22.06
	6RB (0)	848.3	23.12	22.21	21.06
		831.5	23.06	22.13	21.08

		814.7	23.01	22.08	20.94	
3 MHz	1RB High (14)	847.5	24.07	23.17	22.25	
		831.5	23.96	23.22	22.11	
		815.5	23.96	21.06	22.06	
	1RB Middle (7)	847.5	24.16	23.43	22.40	
		831.5	24.20	23.34	22.39	
		815.5	24.19	21.07	22.26	
	1RB Low (0)	847.5	24.02	23.17	22.09	
		831.5	24.01	23.30	22.23	
		815.5	24.02	21.09	22.14	
	8RB High (7)	847.5	23.08	22.12	21.16	
		831.5	23.06	22.15	21.12	
		815.5	23.06	22.12	21.06	
	8RB Middle (4)	847.5	23.15	22.19	21.22	
		831.5	23.11	22.14	21.12	
		815.5	23.08	22.13	21.09	
	8RB Low (0)	847.5	23.08	22.16	21.14	
		831.5	23.07	22.14	21.13	
		815.5	23.08	22.11	21.07	
	15RB (0)	847.5	23.12	22.10	21.11	
		831.5	23.08	22.10	21.10	
		815.5	23.07	22.09	21.01	
	5 MHz	1RB High (24)	846.5	23.95	23.14	22.14
			831.5	23.89	23.11	22.05
			816.5	23.83	23.10	21.99
1RB Middle (12)		846.5	24.15	23.34	22.34	
		831.5	24.17	23.44	22.44	
		816.5	24.05	23.27	22.27	
1RB Low (0)		846.5	23.84	23.07	22.06	
		831.5	23.89	23.15	22.14	
		816.5	23.84	23.14	21.99	
12RB High (13)		846.5	23.04	22.05	21.09	
		831.5	23.06	22.01	21.07	
		816.5	23.01	22.00	21.03	
12RB Middle (6)		846.5	23.11	22.12	21.16	
		831.5	23.12	22.11	21.14	
		816.5	23.06	22.01	21.04	
12RB Low (0)		846.5	23.06	22.05	21.09	
		831.5	23.03	22.00	21.07	
		816.5	22.99	21.94	21.00	
25RB (0)		846.5	23.09	22.09	21.12	
		831.5	23.07	22.07	21.09	
		816.5	23.01	22.05	21.04	
10 MHz		1RB High (49)	844	24.06	23.18	22.20
			831.5	23.94	23.24	22.16
			820	23.93	23.21	22.17
	1RB Middle (24)	844	24.02	23.31	22.26	
		831.5	24.12	23.25	22.30	

	1RB Low (0)	820	24.06	23.31	22.18	
		844	23.95	23.22	22.12	
		831.5	23.95	23.19	22.16	
		820	23.94	23.25	22.16	
		25RB High (25)	844	23.08	22.11	21.11
			831.5	23.14	22.11	21.11
			820	23.07	22.02	21.06
		25RB Middle (12)	844	23.12	22.09	21.08
			831.5	23.14	22.10	21.11
	820		23.09	22.08	21.13	
	25RB Low (0)	844	23.11	22.14	21.13	
		831.5	23.12	22.10	21.11	
		820	23.08	22.07	21.08	
	50RB (0)	844	23.10	22.13	21.13	
		831.5	23.12	22.08	21.14	
		820	23.06	22.07	21.07	
	15 MHz	1RB High (74)	841.5	23.98	23.06	22.16
			831.5	24.02	23.13	22.19
			822.5	24.08	23.19	22.31
		1RB Middle (37)	841.5	24.16	23.40	22.34
			831.5	24.23	23.48	22.42
			822.5	24.12	23.38	22.37
		1RB Low (0)	841.5	24.10	23.27	22.24
			831.5	24.06	23.33	22.23
			822.5	23.95	23.15	22.16
		36RB High (38)	841.5	23.19	22.18	21.21
			831.5	23.20	22.21	21.24
822.5			23.15	22.19	21.21	
36RB Middle (19)		841.5	23.24	22.25	21.26	
		831.5	23.27	22.26	21.28	
		822.5	23.26	22.20	21.23	
36RB Low (0)		841.5	23.20	22.21	21.23	
		831.5	23.20	22.26	21.22	
		822.5	23.16	22.10	21.12	
75RB (0)		841.5	23.21	22.22	21.25	
		831.5	23.20	22.25	21.21	
		822.5	23.21	22.16	21.15	

DSI1/3

Band 26					
Bandwidth (MHz)	RB allocation RB offset (Start RB)	Frequency (MHz)	QPSK	16QAM	64QAM
			Actual output power (dBm)	Actual output power (dBm)	Actual output power (dBm)
1.4 MHz	1RB High (5)	848.3	21.66	21.86	21.78
		831.5	21.57	21.77	21.76
		814.7	21.53	21.72	21.63
	1RB	848.3	21.76	21.98	21.81

	Middle (3)	831.5	21.69	21.96	21.87	
		814.7	21.62	21.81	21.77	
	1RB Low (0)	848.3	21.62	21.90	21.76	
		831.5	21.58	21.79	21.75	
		814.7	21.50	21.82	21.69	
	3RB High (3)	848.3	21.75	21.67	21.75	
		831.5	21.66	21.59	21.69	
		814.7	21.63	21.59	21.66	
	3RB Middle (1)	848.3	21.84	21.73	21.82	
		831.5	21.71	21.64	21.85	
		814.7	21.68	21.62	21.69	
	3RB Low (0)	848.3	21.75	21.72	21.77	
		831.5	21.67	21.66	21.77	
		814.7	21.60	21.55	21.67	
	6RB (0)	848.3	21.78	21.83	20.74	
		831.5	21.67	21.76	20.67	
		814.7	21.59	21.67	20.60	
	3 MHz	1RB High (14)	847.5	21.71	21.87	21.78
			831.5	21.61	21.92	21.75
			815.5	21.58	21.91	21.72
		1RB Middle (7)	847.5	21.86	22.05	21.94
			831.5	21.83	22.10	21.90
			815.5	21.75	22.09	21.82
		1RB Low (0)	847.5	21.63	21.88	21.75
			831.5	21.66	21.96	21.79
			815.5	21.62	21.82	21.80
		8RB High (7)	847.5	21.69	21.70	20.67
			831.5	21.64	21.70	20.67
			815.5	21.62	21.67	20.69
		8RB Middle (4)	847.5	21.74	21.80	20.78
			831.5	21.71	21.71	20.71
			815.5	21.66	21.73	20.71
		8RB Low (0)	847.5	21.69	21.73	20.73
			831.5	21.66	21.71	20.68
			815.5	21.66	21.69	20.69
		15RB (0)	847.5	21.71	21.71	20.70
831.5			21.66	21.65	20.65	
815.5			21.64	21.65	20.68	
5 MHz		1RB High (24)	846.5	21.61	21.81	21.78
			831.5	21.51	21.77	21.70
			816.5	21.50	21.62	21.57
		1RB Middle (12)	846.5	21.83	22.13	21.82
			831.5	21.83	22.11	21.96
			816.5	21.79	21.90	21.78
		1RB Low (0)	846.5	21.49	21.79	21.60
			831.5	21.49	21.81	21.64
			816.5	21.47	21.79	21.64
		12RB	846.5	21.66	21.64	20.69

	High (13)	831.5	21.68	21.62	20.68	
		816.5	21.61	21.57	20.62	
		846.5	21.73	21.72	20.72	
	12RB Middle (6)	831.5	21.74	21.71	20.75	
		816.5	21.66	21.60	20.65	
		846.5	21.67	21.65	20.66	
	12RB Low (0)	831.5	21.64	21.63	20.63	
		816.5	21.58	21.57	20.60	
		846.5	21.71	21.69	20.67	
	25RB (0)	831.5	21.68	21.66	20.68	
		816.5	21.62	21.60	20.61	
		844	21.77	22.02	21.79	
10 MHz	1RB High (49)	831.5	21.64	21.90	21.75	
		820	21.61	21.80	21.77	
		844	21.74	22.08	21.79	
	1RB Middle (24)	831.5	21.84	22.05	21.97	
		820	21.76	22.03	21.87	
		844	21.71	21.91	21.77	
	1RB Low (0)	831.5	21.65	21.84	21.74	
		820	21.65	21.82	21.72	
		844	21.72	21.72	20.73	
	25RB High (25)	831.5	21.77	21.72	20.77	
		820	21.72	21.68	20.64	
		844	21.74	21.69	20.73	
	25RB Middle (12)	831.5	21.75	21.72	20.73	
		820	21.75	21.71	20.73	
		844	21.76	21.75	20.75	
	25RB Low (0)	831.5	21.74	21.70	20.73	
		820	21.70	21.69	20.68	
		844	21.76	21.75	20.75	
	50RB (0)	831.5	21.73	21.71	20.73	
		820	21.71	21.68	20.69	
		841.5	21.90	21.79	21.74	
	15 MHz	1RB High (74)	831.5	21.78	21.75	21.64
			822.5	21.82	21.88	21.71
			841.5	21.91	21.93	21.74
		1RB Middle (37)	831.5	21.97	21.90	21.78
			822.5	21.90	21.96	21.78
			841.5	21.88	21.83	21.75
		1RB Low (0)	831.5	21.84	21.81	21.65
			822.5	21.86	21.80	21.65
			841.5	21.91	21.63	20.65
		36RB High (38)	831.5	21.95	21.63	20.67
			822.5	21.95	21.65	20.65
			841.5	21.94	21.64	20.66
		36RB Middle (19)	831.5	21.96	21.67	20.68
			822.5	21.95	21.67	20.68
			841.5	21.93	21.64	20.70

	Low (0)	831.5	21.95	21.63	20.63
		822.5	21.94	21.63	20.65
	75RB (0)	841.5	21.94	21.65	20.66
		831.5	21.95	21.64	20.65
		822.5	21.93	21.65	20.64

DSI1/3

Band 41-PC3					
Bandwidth (MHz)	RB allocation	Frequency (MHz)	QPSK	16QAM	64QAM
	RB offset (Start RB)		Actual output power (dBm)	Actual output power (dBm)	Actual output power (dBm)
5 MHz	1RB High (24)	2687.5	23.24	22.40	21.01
		2640.3	23.33	22.45	21.03
		2593	23.30	22.37	20.95
		2545.8	22.81	21.82	20.41
		2498.5	22.64	21.70	20.27
	1RB Middle (12)	2687.5	23.52	22.56	21.17
		2640.3	23.59	22.71	21.24
		2593	23.62	22.62	21.27
		2545.8	23.03	22.01	20.66
		2498.5	22.84	21.90	20.45
	1RB Low (0)	2687.5	23.24	22.39	20.99
		2640.3	23.36	22.49	21.07
		2593	23.39	22.43	21.03
		2545.8	22.87	21.91	20.50
		2498.5	22.66	21.74	20.32
	12RB High (13)	2687.5	22.42	21.37	20.45
		2640.3	22.46	21.42	20.47
		2593	22.37	21.33	20.38
		2545.8	21.84	20.77	19.85
		2498.5	21.71	20.64	19.70
	12RB Middle (6)	2687.5	22.46	21.41	20.51
		2640.3	22.55	21.48	20.51
		2593	22.50	21.41	20.50
		2545.8	21.97	20.86	19.94
		2498.5	21.75	20.69	19.73
	12RB Low (0)	2687.5	22.42	21.37	20.43
		2640.3	22.50	21.44	20.48
		2593	22.43	21.37	20.43
		2545.8	21.89	20.82	19.89
		2498.5	21.70	20.64	19.68
	25RB (0)	2687.5	22.45	21.42	20.46
		2640.3	22.50	21.51	20.53

		2593	22.41	21.41	20.43
		2545.8	21.88	20.85	19.90
		2498.5	21.67	20.70	19.74
10 MHz	1RB High (49)	2685	23.33	22.49	21.07
		2639	23.41	22.55	21.09
		2593	23.34	22.40	20.99
		2547	22.78	21.84	20.41
		2501	22.65	21.74	20.30
	1RB Middle (24)	2685	23.37	22.53	21.13
		2639	23.52	22.65	21.32
		2593	23.50	22.57	21.20
		2547	23.01	22.05	20.65
		2501	22.83	21.90	20.46
	1RB Low (0)	2685	23.35	22.45	21.01
		2639	23.53	22.65	21.19
		2593	23.48	22.52	21.11
		2547	22.98	22.02	20.68
		2501	22.72	21.79	20.37
	25RB High (25)	2685	22.44	21.48	20.54
		2639	22.50	21.52	20.57
		2593	22.44	21.46	20.49
		2547	21.89	20.88	19.91
		2501	21.71	20.70	19.73
	25RB Middle (12)	2685	22.47	21.49	20.53
		2639	22.56	21.58	20.62
		2593	22.51	21.49	20.54
		2547	21.94	20.95	19.97
		2501	21.72	20.71	19.74
	25RB Low (0)	2685	22.40	21.44	20.47
		2639	22.56	21.59	20.61
		2593	22.53	21.53	20.54
		2547	21.98	20.98	20.01
		2501	21.73	20.73	19.76
50RB (0)	2685	22.44	21.51	20.49	
	2639	22.54	21.60	20.58	
	2593	22.46	21.51	20.46	
	2547	21.92	20.97	19.94	
	2501	21.71	20.82	19.75	
15 MHz	1RB High (74)	2682.5	23.23	22.42	21.02
		2637.8	23.29	22.42	21.06

		2593	23.27	22.34	20.92
		2548.3	22.75	21.82	20.38
		2503.5	22.54	21.61	20.19
	1RB Middle (37)	2682.5	23.28	22.41	21.02
		2637.8	23.48	22.63	21.20
		2593	23.49	22.50	21.12
		2548.3	22.86	21.92	20.52
		2503.5	22.68	21.76	20.30
	1RB Low (0)	2682.5	23.22	22.30	20.93
		2637.8	23.40	22.52	21.11
		2593	23.43	22.48	21.06
		2548.3	22.91	21.97	20.56
		2503.5	22.66	21.73	20.33
	36RB High (38)	2682.5	22.36	21.34	20.34
		2637.8	22.47	21.41	20.45
		2593	22.39	21.33	20.32
		2548.3	21.84	20.78	19.78
		2503.5	21.59	20.53	20.33
	36RB Middle (19)	2682.5	22.38	21.36	20.35
		2637.8	22.51	21.48	20.48
		2593	22.45	21.38	20.36
		2548.3	21.87	20.81	19.78
		2503.5	21.68	20.61	20.34
	36RB Low (0)	2682.5	22.34	21.27	20.30
		2637.8	22.56	21.50	20.50
		2593	22.48	21.43	20.43
		2548.3	21.90	20.85	19.86
		2503.5	21.67	20.61	20.42
	75RB (0)	2682.5	22.38	21.39	20.41
		2637.8	22.51	21.54	20.52
2593		22.41	21.43	20.41	
2548.3		21.88	20.90	19.87	
2503.5		21.62	20.66	20.38	
20 MHz	1RB High (99)	2680	22.96	22.11	20.71
		2636.5	23.00	22.12	20.71
		2593	22.91	22.02	20.62
		2549.5	22.54	21.60	20.20
		2506	22.39	21.46	20.07
	1RB Middle (50)	2680	23.25	22.27	20.95
		2636.5	23.36	22.47	21.07
		2593	23.30	22.40	21.00
		2549.5	22.75	21.81	20.44

		2506	22.51	21.64	20.23
	1RB Low (0)	2680	23.02	22.07	20.69
		2636.5	23.16	22.18	20.82
		2593	23.15	22.23	20.80
		2549.5	22.70	21.77	20.35
		2506	22.40	21.47	20.08
		2680	22.15	21.25	20.23
	50RB High (50)	2636.5	22.20	21.35	20.30
		2593	22.12	21.18	20.15
		2549.5	21.61	20.68	19.64
		2506	21.37	20.40	19.39
		2680	22.12	21.23	20.16
	50RB Middle (25)	2636.5	22.28	21.43	20.33
		2593	22.21	21.23	20.23
		2549.5	21.65	20.68	19.68
		2506	21.48	20.51	19.49
		2680	22.08	21.18	20.14
	50RB Low (0)	2636.5	22.30	21.36	20.33
		2593	22.21	21.27	20.28
		2549.5	21.68	20.73	19.75
		2506	21.43	20.48	19.46
		2680	22.09	21.16	20.15
	100RB (0)	2636.5	22.29	21.39	20.31
		2593	22.18	21.24	20.21
		2549.5	21.65	20.71	19.69
2506		21.40	20.41	19.39	

DSI0

Band 41-PC3					
Bandwidth (MHz)	RB allocation	Frequency (MHz)	QPSK	16QAM	64QAM
	RB offset (Start RB)		Actual output power (dBm)	Actual output power (dBm)	Actual output power (dBm)
5 MHz	1RB High (24)	2687.5	19.00	19.05	18.63
		2640.3	19.14	19.14	18.72
		2593	19.22	19.23	18.82
		2545.8	18.84	18.89	18.46
		2498.5	18.74	18.73	18.32
	1RB Middle (12)	2687.5	19.20	19.20	18.82
		2640.3	19.37	19.35	19.00
		2593	19.37	19.45	19.05
		2545.8	19.05	19.07	18.66

	1RB Low (0)	2498.5	18.89	18.95	18.54
		2687.5	19.08	19.10	18.64
		2640.3	19.22	19.21	18.83
		2593	19.25	19.28	18.85
		2545.8	18.90	18.93	18.52
		2498.5	18.78	18.79	18.38
	12RB High (13)	2687.5	19.11	18.95	19.05
		2640.3	19.18	19.10	19.17
		2593	19.24	19.16	19.25
		2545.8	18.89	18.82	18.87
		2498.5	18.75	18.68	18.74
	12RB Middle (6)	2687.5	19.13	19.04	19.10
		2640.3	19.23	19.16	19.23
		2593	19.34	19.20	19.30
		2545.8	18.90	18.82	18.92
		2498.5	18.81	18.73	18.79
	12RB Low (0)	2687.5	19.13	18.96	19.05
		2640.3	19.26	19.14	19.26
		2593	19.25	19.18	19.27
		2545.8	18.88	18.78	18.88
2498.5		18.78	18.65	18.73	
25RB (0)	2687.5	19.10	19.06	19.08	
	2640.3	19.20	19.18	19.23	
	2593	19.27	19.23	19.30	
	2545.8	18.88	18.85	18.89	
	2498.5	18.79	18.74	18.79	
10 MHz	1RB High (49)	2685	19.15	19.12	18.67
		2639	19.14	19.21	18.78
		2593	19.33	19.27	18.86
		2547	18.92	18.93	18.52
		2501	18.70	18.76	18.34
	1RB Middle (24)	2685	19.25	19.31	18.85
		2639	19.37	19.39	18.95
		2593	19.44	19.44	19.04
		2547	19.07	19.07	18.66
		2501	18.92	18.95	18.52
	1RB Low (0)	2685	19.19	19.23	18.77
		2639	19.40	19.32	18.92
		2593	19.38	19.41	18.99
		2547	19.03	19.02	18.62
		2501	18.84	18.90	18.47

	25RB High (25)	2685	19.16	19.12	19.13
		2639	19.24	19.17	19.23
		2593	19.34	19.28	19.30
		2547	18.96	18.90	18.90
		2501	18.79	18.77	18.82
	25RB Middle (12)	2685	19.15	19.12	19.16
		2639	19.34	19.28	19.32
		2593	19.37	19.30	19.35
		2547	18.98	18.95	18.97
		2501	18.74	18.76	18.79
	25RB Low (0)	2685	19.21	19.14	19.18
		2639	19.39	19.31	19.34
		2593	19.39	19.33	19.36
		2547	19.03	18.96	18.99
		2501	18.82	18.75	18.79
	50RB (0)	2685	19.17	19.15	19.15
		2639	19.36	19.28	19.28
		2593	19.36	19.34	19.31
		2547	18.92	18.94	18.92
		2501	18.78	18.79	18.76
15 MHz	1RB High (74)	2682.5	18.99	19.01	18.61
		2637.8	19.08	19.08	18.66
		2593	19.18	19.21	18.80
		2548.3	18.85	18.86	18.43
		2503.5	18.58	18.63	18.19
	1RB Middle (37)	2682.5	19.19	19.16	18.78
		2637.8	19.34	19.33	18.92
		2593	19.33	19.34	18.93
		2548.3	18.96	18.99	18.53
		2503.5	18.76	18.80	18.40
	1RB Low (0)	2682.5	19.14	19.10	18.69
		2637.8	19.33	19.33	18.88
		2593	19.29	19.32	18.88
		2548.3	18.98	18.93	18.50
		2503.5	18.80	18.78	18.35
	36RB High (38)	2682.5	19.10	18.97	19.02
		2637.8	19.18	19.08	19.11
		2593	19.26	19.16	19.18
		2548.3	18.89	18.80	18.83
		2503.5	18.69	18.57	18.60
36RB	2682.5	19.13	19.02	19.05	

	Middle (19)	2637.8	19.29	19.20	19.21
		2593	19.35	19.22	19.24
		2548.3	18.98	18.83	18.84
		2503.5	18.76	18.63	18.68
	36RB Low (0)	2682.5	19.12	19.03	19.06
		2637.8	19.38	19.24	19.28
		2593	19.35	19.23	19.25
		2548.3	18.96	18.84	18.86
		2503.5	18.79	18.65	18.68
	75RB (0)	2682.5	19.12	19.06	19.08
		2637.8	19.23	19.21	19.25
		2593	19.34	19.27	19.26
		2548.3	18.91	18.87	18.87
		2503.5	18.74	18.67	18.68
	20 MHz	1RB High (99)	2680	19.03	19.12
2636.5			19.09	19.24	18.8
2593			19.14	19.26	18.85
2549.5			18.83	18.95	18.73
2506			18.60	18.75	18.69
1RB Middle (50)		2680	19.33	19.43	19.07
		2636.5	19.49	19.60	19.2
		2593	19.48	19.62	19.2
		2549.5	19.05	19.19	19.08
		2506	18.83	19.02	19.06
1RB Low (0)		2680	19.18	19.28	18.86
		2636.5	19.39	19.50	19.14
		2593	19.31	19.42	19.02
		2549.5	18.95	19.09	18.97
		2506	18.73	18.94	18.94
50RB High (50)		2680	19.20	19.30	19.27
		2636.5	19.26	19.35	19.33
		2593	19.31	19.41	19.39
		2549.5	18.92	19.07	19.28
		2506	18.63	18.76	19.32
50RB Middle (25)		2680	19.24	19.34	19.32
		2636.5	19.38	19.47	19.45
		2593	19.39	19.48	19.47
		2549.5	18.99	19.08	19.42
	2506	18.75	18.90	19.42	
50RB Low (0)	2680	19.23	19.32	19.32	
	2636.5	19.48	19.58	19.56	

		2593	19.38	19.52	19.46
		2549.5	18.97	19.08	19.4
		2506	18.77	18.89	19.39
	100RB (0)	2680	19.22	19.31	19.29
		2636.5	19.36	19.44	19.45
		2593	19.35	19.43	19.41
		2549.5	18.98	19.06	19.36
		2506	18.70	18.81	19.35

DSI2

Band 41-PC3					
Bandwidth (MHz)	RB allocation	Frequency (MHz)	QPSK	16QAM	64QAM
	RB offset (Start RB)		Actual output power (dBm)	Actual output power (dBm)	Actual output power (dBm)
5 MHz	1RB High (24)	2687.5	18.11	18.11	17.75
		2640.3	18.15	18.21	17.80
		2593	18.23	18.31	17.91
		2545.8	17.87	17.94	17.56
		2498.5	17.72	17.80	17.44
	1RB Middle (12)	2687.5	18.27	18.34	17.93
		2640.3	18.37	18.44	18.11
		2593	18.43	18.49	18.09
		2545.8	18.04	18.11	17.72
		2498.5	17.94	18.01	17.60
	1RB Low (0)	2687.5	18.06	18.15	17.75
		2640.3	18.21	18.32	17.91
		2593	18.28	18.36	17.94
		2545.8	17.91	18.00	17.62
		2498.5	17.77	17.86	17.47
	12RB High (13)	2687.5	18.11	18.07	18.14
		2640.3	18.22	18.18	18.26
		2593	18.27	18.24	18.30
		2545.8	17.93	17.90	17.97
		2498.5	17.74	17.75	17.83
	12RB Middle (6)	2687.5	18.14	18.11	18.18
		2640.3	18.27	18.23	18.31
		2593	18.37	18.30	18.39
		2545.8	17.98	17.92	17.98
		2498.5	17.78	17.80	17.85
	12RB Low (0)	2687.5	18.11	18.07	18.14
		2640.3	18.27	18.22	18.30
		2593	18.32	18.28	18.34

		2545.8	17.92	17.90	17.94
		2498.5	17.77	17.70	17.85
	25RB (0)	2687.5	18.13	18.15	18.19
		2640.3	18.29	18.28	18.31
		2593	18.33	18.33	18.37
		2545.8	17.96	17.95	18.01
		2498.5	17.79	17.80	17.86
10 MHz	1RB High (49)	2685	18.14	18.21	17.81
		2639	18.21	18.29	17.90
		2593	18.32	18.40	17.97
		2547	17.94	18.00	17.61
		2501	17.74	17.83	17.40
	1RB Middle (24)	2685	18.26	18.36	17.99
		2639	18.42	18.45	18.07
		2593	18.47	18.59	18.16
		2547	18.11	18.14	17.76
		2501	17.87	18.01	17.61
	1RB Low (0)	2685	18.17	18.29	17.87
		2639	18.36	18.45	18.02
		2593	18.40	18.48	18.07
		2547	18.05	18.10	17.71
		2501	17.85	17.97	17.54
	25RB High (25)	2685	18.16	18.22	18.24
		2639	18.28	18.30	18.34
		2593	18.34	18.38	18.42
		2547	17.97	18.01	18.05
		2501	17.81	17.81	17.83
	25RB Middle (12)	2685	18.18	18.21	18.27
		2639	18.33	18.35	18.38
		2593	18.37	18.39	18.43
		2547	18.04	18.04	18.08
		2501	17.80	17.83	17.88
	25RB Low (0)	2685	18.25	18.24	18.28
		2639	18.37	18.38	18.41
		2593	18.44	18.43	18.49
		2547	18.06	18.04	18.12
		2501	17.84	17.84	17.90
50RB (0)	2685	18.21	18.27	18.24	
	2639	18.35	18.41	18.37	
	2593	18.42	18.47	18.42	

		2547	18.00	18.06	18.02
		2501	17.81	17.90	17.86
15 MHz	1RB High (74)	2682.5	18.05	18.12	17.71
		2637.8	18.11	18.17	17.76
		2593	18.23	18.28	17.86
		2548.3	17.86	17.95	17.55
		2503.5	17.59	17.72	17.31
	1RB Middle (37)	2682.5	18.22	18.25	17.86
		2637.8	18.30	18.41	17.99
		2593	18.37	18.45	18.03
		2548.3	18.00	18.05	17.65
		2503.5	17.82	17.86	17.46
	1RB Low (0)	2682.5	18.14	18.19	17.82
		2637.8	18.30	18.39	18.00
		2593	18.34	18.41	17.99
		2548.3	17.96	18.06	17.66
		2503.5	17.77	17.86	17.47
	36RB High (38)	2682.5	18.14	18.07	18.10
		2637.8	18.24	18.20	18.22
		2593	18.31	18.26	18.28
		2548.3	17.95	17.86	17.91
		2503.5	17.74	17.65	17.65
	36RB Middle (19)	2682.5	18.20	18.13	18.18
		2637.8	18.30	18.26	18.27
		2593	18.36	18.29	18.32
		2548.3	18.01	17.93	17.99
		2503.5	17.81	17.75	17.74
	36RB Low (0)	2682.5	18.15	18.12	18.15
		2637.8	18.34	18.31	18.33
		2593	18.34	18.32	18.34
2548.3		17.97	17.94	17.96	
2503.5		17.81	17.73	17.79	
75RB (0)	2682.5	18.19	18.22	18.21	
	2637.8	18.30	18.31	18.32	
	2593	18.37	18.39	18.38	
	2548.3	17.97	17.99	18.01	
	2503.5	17.72	17.80	17.79	
20 MHz	1RB High (99)	2680	18.04	18.09	17.69
		2636.5	18.11	18.15	17.74
		2593	18.18	18.22	17.83
		2549.5	17.87	17.93	17.53
		2506	17.67	17.75	17.29

	1RB Middle (50)	2680	18.33	18.38	18.03
		2636.5	18.48	18.56	18.09
		2593	18.49	18.56	18.16
		2549.5	18.12	18.15	17.75
		2506	17.38	17.42	17.35
	1RB Low (0)	2680	18.21	18.21	17.84
		2636.5	18.36	18.43	18.04
		2593	18.33	18.40	17.98
		2549.5	17.97	18.02	17.64
		2506	17.73	17.78	17.5
	50RB High (50)	2680	18.21	18.21	18.2
		2636.5	18.26	18.31	18.27
		2593	18.33	18.35	18.31
		2549.5	17.96	18.01	17.99
		2506	17.71	17.66	17.64
	50RB Middle (25)	2680	18.26	18.28	18.28
		2636.5	18.37	18.39	18.38
		2593	18.41	18.46	18.43
		2549.5	18.03	18.03	18.02
		2506	18.20	18.02	17.83
50RB Low (0)	2680	18.25	18.26	18.26	
	2636.5	18.45	18.50	18.48	
	2593	18.40	18.44	18.41	
	2549.5	18.01	18.05	18.03	
	2506	18.08	18.07	18.06	
100RB (0)	2680	18.24	18.25	18.24	
	2636.5	18.34	18.38	18.37	
	2593	18.35	18.40	18.4	
	2549.5	18.00	18.02	18.01	
	2506	17.68	17.71	17.64	

DSI1/3

Band 41-PC2					
Bandwidth (MHz)	RB allocation	Frequency (MHz)	QPSK	16QAM	64QAM
	RB offset (Start RB)		Actual output power (dBm)	Actual output power (dBm)	Actual output power (dBm)
5 MHz	1RB High (24)	2687.5	26.14	25.33	24.19
		2640.3	26.19	25.37	24.23
		2593	26.13	25.32	24.13
		2545.8	25.58	24.77	23.59
		2498.5	25.51	24.75	23.54

	1RB Middle (12)	2687.5	26.26	25.43	24.28
		2640.3	26.34	25.52	24.35
		2593	26.30	25.48	24.22
		2545.8	25.77	24.91	23.72
		2498.5	25.59	24.79	23.62
	1RB Low (0)	2687.5	26.14	25.32	24.15
		2640.3	26.25	25.42	24.25
		2593	26.18	25.36	24.20
		2545.8	25.68	24.82	23.72
		2498.5	25.56	24.74	23.59
	12RB High (13)	2687.5	25.32	24.34	23.40
		2640.3	25.37	24.37	23.41
		2593	25.29	24.31	23.38
		2545.8	24.76	23.75	22.83
		2498.5	24.64	23.67	22.74
	12RB Middle (6)	2687.5	25.36	24.37	23.41
		2640.3	25.44	24.44	23.45
		2593	25.39	24.40	23.47
		2545.8	24.88	23.84	22.92
		2498.5	24.69	23.69	22.78
12RB Low (0)	2687.5	25.33	24.33	23.42	
	2640.3	25.42	24.41	23.42	
	2593	25.35	24.37	23.44	
	2545.8	24.82	23.78	22.88	
	2498.5	24.59	23.62	22.71	
25RB (0)	2687.5	25.30	24.36	23.42	
	2640.3	25.36	24.43	23.44	
	2593	25.29	24.36	23.40	
	2545.8	24.76	23.81	22.88	
	2498.5	24.61	23.68	22.74	
10 MHz	1RB High (49)	2685	26.23	25.42	24.23
		2639	26.27	25.44	24.26
		2593	26.19	25.37	24.19
		2547	25.63	24.80	23.61
		2501	25.53	24.73	23.51
	1RB Middle (24)	2685	26.33	25.50	24.33
		2639	26.45	25.63	24.46
		2593	26.40	25.57	24.42
		2547	25.84	25.02	23.84
		2501	25.73	24.91	23.71
	1RB	2685	26.17	25.37	24.18

	Low (0)	2639	26.36	25.54	24.37
		2593	26.30	25.48	24.31
		2547	25.80	24.97	23.77
		2501	25.63	24.83	23.62
	25RB High (25)	2685	25.37	24.41	23.38
		2639	25.43	24.46	23.48
		2593	25.35	24.38	23.47
		2547	24.79	23.76	22.90
		2501	24.67	23.70	22.76
	25RB Middle (12)	2685	25.37	24.39	23.45
		2639	25.47	24.50	23.52
		2593	25.43	24.44	23.52
		2547	24.87	23.86	22.94
		2501	24.65	23.71	22.77
	25RB Low (0)	2685	25.31	24.36	23.43
		2639	25.47	24.51	23.61
		2593	25.43	24.44	23.55
		2547	24.88	23.96	22.99
		2501	24.64	23.68	22.76
	50RB (0)	2685	25.39	24.42	23.40
2639		25.48	24.53	23.48	
2593		25.40	24.44	23.45	
2547		24.85	23.89	22.91	
2501		24.67	23.72	22.74	
15 MHz	1RB High (74)	2682.5	26.17	25.33	24.15
		2637.8	26.21	25.37	24.18
		2593	26.13	25.30	24.11
		2548.3	25.64	24.79	23.61
		2503.5	25.42	24.60	23.41
	1RB Middle (37)	2682.5	26.19	25.37	24.19
		2637.8	26.35	25.51	24.36
		2593	26.30	25.47	24.31
		2548.3	25.71	24.87	23.70
		2503.5	25.57	24.77	23.56
	1RB Low (0)	2682.5	26.09	25.26	24.07
		2637.8	26.32	25.48	24.31
		2593	26.29	25.46	24.27
		2548.3	25.74	24.91	23.73
		2503.5	25.63	24.77	23.55
	36RB High (38)	2682.5	25.31	24.26	23.27
		2637.8	25.41	24.36	23.36

		2593	25.30	24.27	23.32	
		2548.3	24.76	23.71	22.78	
		2503.5	24.55	23.52	22.57	
	36RB Middle (19)	2682.5	25.32	24.29	23.28	
		2637.8	25.47	24.42	23.42	
		2593	25.35	24.32	23.37	
		2548.3	24.78	23.76	22.81	
		2503.5	24.61	23.58	22.64	
	36RB Low (0)	2682.5	25.26	24.21	23.28	
		2637.8	25.48	24.45	23.42	
		2593	25.40	24.36	23.44	
		2548.3	24.84	23.80	22.84	
		2503.5	24.62	23.59	22.64	
	75RB (0)	2682.5	25.30	24.32	23.31	
		2637.8	25.43	24.46	23.42	
		2593	25.34	24.33	23.40	
		2548.3	24.81	23.81	22.85	
		2503.5	24.57	23.61	22.62	
	20 MHz	1RB High (99)	2680	26.97	26.14	25.00
			2636.5	26.96	26.17	25.03
2593			26.89	26.05	24.90	
2549.5			26.48	25.64	24.49	
2506			26.36	25.51	24.35	
1RB Middle (50)		2680	26.94	26.26	25.12	
		2636.5	26.97	26.45	25.32	
		2593	26.95	26.38	25.22	
		2549.5	26.66	25.81	24.65	
		2506	26.52	25.67	24.49	
1RB Low (0)		2680	26.96	26.12	24.97	
		2636.5	26.90	26.25	25.10	
		2593	26.98	26.23	25.09	
		2549.5	26.62	25.75	24.62	
		2506	26.42	25.60	24.41	
50RB High (50)		2680	26.22	25.24	24.22	
		2636.5	26.33	25.32	24.30	
		2593	26.22	25.24	24.21	
		2549.5	25.71	24.72	23.67	
		2506	25.48	24.50	23.44	
50RB Middle (25)		2680	26.22	25.24	24.21	
		2636.5	26.44	25.41	24.40	
		2593	26.30	25.30	24.28	

		2549.5	25.74	24.76	23.70
		2506	25.55	24.59	23.53
	50RB Low (0)	2680	26.18	25.20	24.16
		2636.5	26.40	25.38	24.38
		2593	26.30	25.31	24.29
		2549.5	25.82	24.81	23.76
		2506	25.52	24.55	23.52
		2680	26.25	25.22	24.23
	100RB (0)	2636.5	26.42	25.42	24.38
		2593	26.34	25.30	24.28
		2549.5	25.78	24.77	23.74
		2506	25.51	24.53	23.48
		2680	26.25	25.22	24.23

DSI0

Band 41-PC2					
Bandwidth (MHz)	RB allocation	Frequency (MHz)	QPSK	16QAM	64QAM
	RB offset (Start RB)		Actual output power (dBm)	Actual output power (dBm)	Actual output power (dBm)
5 MHz	1RB High (24)	2687.5	21.97	22.19	21.97
		2640.3	22.09	22.32	22.07
		2593	22.21	22.43	22.18
		2545.8	21.85	22.08	21.83
		2498.5	21.73	21.95	21.71
	1RB Middle (12)	2687.5	22.11	22.30	22.04
		2640.3	22.24	22.38	22.09
		2593	22.29	22.54	22.28
		2545.8	21.94	22.13	21.88
		2498.5	21.81	22.04	21.78
	1RB Low (0)	2687.5	22.02	22.25	22.04
		2640.3	22.21	22.42	22.18
		2593	22.25	22.47	22.23
		2545.8	21.88	22.14	21.89
		2498.5	21.76	21.99	21.73
	12RB High (13)	2687.5	22.05	22.08	22.15
		2640.3	22.18	22.23	22.27
		2593	22.33	22.29	22.32
		2545.8	21.89	21.90	21.94
		2498.5	21.78	21.82	21.83
	12RB Middle (6)	2687.5	22.13	22.16	22.20
		2640.3	22.27	22.30	22.33
		2593	22.33	22.35	22.39
		2545.8	21.96	21.96	22.00

	12RB Low (0)	2498.5	21.82	21.86	21.89
		2687.5	22.09	22.14	22.16
		2640.3	22.26	22.31	22.35
		2593	22.28	22.30	22.35
		2545.8	21.91	21.92	21.96
		2498.5	21.75	21.78	21.82
	25RB (0)	2687.5	22.09	22.22	22.18
		2640.3	22.25	22.29	22.33
		2593	22.33	22.33	22.36
		2545.8	21.91	21.94	22.00
10 MHz	1RB High (49)	2685	22.05	22.30	22.04
		2639	22.16	22.39	22.13
		2593	22.25	22.52	22.25
		2547	21.92	22.12	21.86
		2501	21.73	21.94	21.69
	1RB Middle (24)	2685	22.22	22.38	22.11
		2639	22.34	22.51	22.23
		2593	22.45	22.63	22.36
		2547	22.01	22.20	21.94
		2501	21.91	22.12	21.85
	1RB Low (0)	2685	22.15	22.39	22.11
		2639	22.35	22.57	22.32
		2593	22.35	22.51	22.36
		2547	21.99	22.20	21.93
		2501	21.85	22.06	21.79
	25RB High (25)	2685	22.16	22.16	22.23
		2639	22.25	22.21	22.33
		2593	22.32	22.36	22.42
		2547	21.95	21.99	21.97
		2501	21.79	21.84	21.91
25RB Middle (12)	2685	22.16	22.20	22.28	
	2639	22.32	22.36	22.47	
	2593	22.36	22.37	22.44	
	2547	21.99	22.02	22.07	
	2501	21.79	21.85	21.89	
25RB Low (0)	2685	22.17	22.24	22.29	
	2639	22.34	22.36	22.42	
	2593	22.38	22.44	22.49	
	2547	22.00	22.01	22.05	

	50RB (0)	2501	21.80	21.84	21.89
		2685	22.14	22.22	22.21
		2639	22.32	22.38	22.34
		2593	22.36	22.43	22.40
		2547	21.97	22.04	22.01
		2501	21.77	21.84	21.82
15 MHz	1RB High (74)	2682.5	21.93	22.18	21.92
		2637.8	22.01	22.23	21.98
		2593	22.15	22.36	22.10
		2548.3	21.82	22.01	21.75
		2503.5	21.56	21.78	21.52
	1RB Middle (37)	2682.5	22.11	22.35	22.11
		2637.8	22.27	22.49	22.32
		2593	22.32	22.52	22.26
		2548.3	21.91	22.11	21.86
		2503.5	21.77	22.00	21.73
	1RB Low (0)	2682.5	22.06	22.30	22.02
		2637.8	22.26	22.49	22.22
		2593	22.27	22.49	22.24
		2548.3	21.90	22.09	21.84
		2503.5	21.73	21.96	21.70
	36RB High (38)	2682.5	22.07	22.06	22.08
		2637.8	22.18	22.15	22.17
		2593	22.25	22.23	22.25
		2548.3	21.89	21.85	21.87
		2503.5	21.66	21.63	21.64
	36RB Middle (19)	2682.5	22.11	22.09	22.11
		2637.8	22.28	22.25	22.27
		2593	22.30	22.29	22.30
		2548.3	21.91	21.90	21.92
		2503.5	21.71	21.69	21.73
36RB Low (0)	2682.5	22.11	22.09	22.10	
	2637.8	22.33	22.30	22.34	
	2593	22.33	22.30	22.33	
	2548.3	21.92	21.88	21.91	
	2503.5	21.73	21.70	21.74	
75RB (0)	2682.5	22.09	22.13	22.14	
	2637.8	22.26	22.29	22.28	
	2593	22.28	22.32	22.32	
	2548.3	21.90	21.93	21.92	
	2503.5	21.68	21.71	21.71	
20 MHz	1RB	2680	22.02	22.24	21.98

	High (99)	2636.5	22.08	22.29	22.04
		2593	22.18	22.37	22.11
		2549.5	21.87	22.05	21.87
		2506	21.68	21.87	21.62
	1RB Middle (50)	2680	22.27	22.54	22.3
		2636.5	22.47	22.68	22.44
		2593	22.50	22.70	22.45
		2549.5	22.10	22.31	22.05
		2506	21.93	22.13	21.89
	1RB Low (0)	2680	22.18	22.37	22.13
		2636.5	22.41	22.61	22.36
		2593	22.37	22.54	22.27
		2549.5	21.97	22.16	21.9
		2506	21.83	22.07	21.8
	50RB High (50)	2680	22.18	22.21	22.28
		2636.5	22.25	22.29	22.34
		2593	22.30	22.36	22.34
		2549.5	21.98	22.02	22
		2506	21.67	21.74	21.72
	50RB Middle (25)	2680	22.24	22.31	22.29
		2636.5	22.41	22.46	22.43
		2593	22.43	22.48	22.45
		2549.5	22.04	22.10	22.07
		2506	21.83	21.89	21.86
	50RB Low (0)	2680	22.22	22.30	22.27
		2636.5	22.49	22.54	22.52
		2593	22.39	22.47	22.43
		2549.5	22.00	22.06	22.04
2506		21.81	21.88	21.86	
100RB (0)	2680	22.20	22.26	22.26	
	2636.5	22.38	22.41	22.39	
	2593	22.36	22.42	22.41	
	2549.5	22.01	22.06	22.05	
	2506	21.73	21.78	21.79	

DS12

Band 41-PC2					
Bandwidth (MHz)	RB allocation	Frequency (MHz)	QPSK	16QAM	64QAM
	RB offset (Start RB)		Actual output power (dBm)	Actual output power (dBm)	Actual output power (dBm)
5 MHz	1RB	2687.5	21.06	21.31	21.09

	High (24)	2640.3	21.21	21.46	21.19
		2593	21.30	21.53	21.28
		2545.8	20.95	21.15	20.91
		2498.5	20.82	21.04	20.77
	1RB Middle (12)	2687.5	21.18	21.44	21.17
		2640.3	21.33	21.51	21.28
		2593	21.34	21.62	21.36
		2545.8	21.02	21.24	20.99
		2498.5	20.89	21.11	20.85
	1RB Low (0)	2687.5	21.13	21.38	21.16
		2640.3	21.30	21.51	21.28
		2593	21.33	21.56	21.31
		2545.8	21.00	21.20	20.96
		2498.5	20.84	21.08	20.83
	12RB High (13)	2687.5	21.17	21.20	21.24
		2640.3	21.28	21.33	21.36
		2593	21.36	21.36	21.42
		2545.8	20.99	21.01	21.04
		2498.5	20.83	20.85	20.93
	12RB Middle (6)	2687.5	21.20	21.24	21.30
		2640.3	21.36	21.38	21.44
		2593	21.46	21.44	21.46
		2545.8	21.06	21.06	21.10
		2498.5	20.90	20.91	20.95
12RB Low (0)	2687.5	21.19	21.22	21.27	
	2640.3	21.35	21.38	21.43	
	2593	21.38	21.38	21.44	
	2545.8	21.00	21.02	21.04	
	2498.5	20.82	20.82	20.86	
25RB (0)	2687.5	21.19	21.26	21.30	
	2640.3	21.33	21.40	21.42	
	2593	21.37	21.43	21.46	
	2545.8	21.00	21.05	21.07	
	2498.5	20.81	20.89	20.92	
10 MHz	1RB High (49)	2685	21.09	21.44	21.15
		2639	21.30	21.52	21.23
		2593	21.38	21.64	21.34
		2547	21.04	21.24	20.96
		2501	20.81	21.04	20.76
	1RB Middle (24)	2685	21.32	21.58	21.30
		2639	21.48	21.69	21.44

		2593	21.53	21.76	21.48
		2547	21.15	21.36	21.10
		2501	20.99	21.21	20.92
	1RB Low (0)	2685	21.26	21.50	21.24
		2639	21.47	21.69	21.41
		2593	21.45	21.69	21.40
		2547	21.12	21.34	21.05
		2501	20.94	21.17	20.88
	25RB High (25)	2685	21.25	21.37	21.41
		2639	21.36	21.45	21.48
		2593	21.44	21.46	21.52
		2547	21.08	21.09	21.14
		2501	20.89	20.90	20.96
	25RB Middle (12)	2685	21.27	21.32	21.37
		2639	21.43	21.46	21.50
		2593	21.46	21.49	21.53
		2547	21.08	21.11	21.16
		2501	20.88	20.91	20.96
	25RB Low (0)	2685	21.31	21.43	21.48
		2639	21.43	21.47	21.56
		2593	21.51	21.52	21.56
		2547	21.11	21.12	21.18
		2501	20.88	20.91	20.97
	50RB (0)	2685	21.24	21.35	21.34
		2639	21.41	21.49	21.44
2593		21.45	21.52	21.49	
2547		21.07	21.13	21.09	
2501		20.83	20.91	20.87	
15 MHz	1RB High (74)	2682.5	21.17	21.34	21.06
		2637.8	21.20	21.39	21.12
		2593	21.30	21.51	21.23
		2548.3	21.01	21.19	20.92
		2503.5	20.68	20.89	20.63
	1RB Middle (37)	2682.5	21.29	21.47	21.24
		2637.8	21.44	21.63	21.36
		2593	21.47	21.66	21.41
		2548.3	21.05	21.26	21.00
		2503.5	20.86	21.09	20.81
	1RB Low (0)	2682.5	21.27	21.46	21.19
		2637.8	21.40	21.63	21.37
		2593	21.42	21.61	21.36

		2548.3	21.05	21.24	20.98	
		2503.5	20.83	21.06	20.80	
	36RB High (38)	2682.5	21.26	21.20	21.21	
		2637.8	21.32	21.29	21.32	
		2593	21.39	21.35	21.37	
		2548.3	21.01	20.96	20.98	
		2503.5	20.76	20.73	20.75	
		2682.5	21.28	21.24	21.27	
	36RB Middle (19)	2637.8	21.40	21.37	21.40	
		2593	21.42	21.41	21.41	
		2548.3	21.06	21.01	21.03	
		2503.5	20.85	20.81	20.83	
		2682.5	21.25	21.22	21.26	
	36RB Low (0)	2637.8	21.46	21.44	21.46	
		2593	21.46	21.41	21.44	
		2548.3	21.05	21.00	21.01	
		2503.5	20.85	20.81	20.83	
		2682.5	21.25	21.29	21.28	
	75RB (0)	2637.8	21.38	21.40	21.40	
		2593	21.42	21.45	21.43	
		2548.3	21.03	21.05	21.03	
		2503.5	20.79	20.82	20.82	
		20 MHz	1RB High (99)	2680	21.00	21.24
	2636.5			21.05	21.32	21.06
	2593			21.18	21.41	21.14
2549.5	20.88			21.08	20.84	
2506	20.67			20.89	20.48	
1RB Middle (50)	2680		21.30	21.51	21.28	
	2636.5		21.46	21.70	21.43	
	2593		21.47	21.64	21.43	
	2549.5		21.10	21.31	21.05	
	2506		21.21	21.45	21.27	
1RB Low (0)	2680		21.17	21.40	21.17	
	2636.5		21.39	21.61	21.34	
	2593		21.34	21.55	21.31	
	2549.5		20.99	21.18	20.92	
	2506		20.81	21.01	20.6	
50RB High (50)	2680		21.17	21.25	21.24	
	2636.5		21.25	21.34	21.3	
	2593		21.32	21.38	21.36	
	2549.5		20.97	21.02	21	

	50RB Middle (25)	2506	20.85	20.72	20.71
		2680	21.22	21.32	21.3
		2636.5	21.39	21.45	21.44
		2593	21.48	21.47	21.45
		2549.5	21.03	21.08	21.07
		2506	20.89	20.84	20.84
	50RB Low (0)	2680	21.21	21.31	21.28
		2636.5	21.37	21.54	21.53
		2593	21.38	21.45	21.44
		2549.5	21.03	21.09	21.05
		2506	20.88	20.81	20.74
	100RB (0)	2680	21.20	21.28	21.26
		2636.5	21.35	21.40	21.4
		2593	21.37	21.41	21.39
		2549.5	21.02	21.04	21.04
2506		20.87	20.76	20.31	

DSI1/3

Band 66					
BANDWIDTH	Number of RBs	Frequency	QPSK	16QAM	64QAM
1.4MHz	1RB-High (5)	1779.3 (132665)	24.67	23.85	22.82
		1745 (132322)	24.46	23.63	22.52
		1710.7 (131979)	24.58	23.71	22.67
	1RB-Middle (3)	1779.3 (132665)	24.79	23.95	22.88
		1745 (132322)	24.56	23.80	22.62
		1710.7 (131979)	24.71	23.82	22.76
	1RB-Low (0)	1779.3 (132665)	24.66	23.87	22.85
		1745 (132322)	24.42	23.66	22.61
		1710.7 (131979)	24.57	23.68	22.71
	3RB-High (3)	1779.3 (132665)	24.78	23.68	22.79
		1745 (132322)	24.57	23.45	22.52
		1710.7 (131979)	24.68	23.63	22.71
	3RB-Middle (1)	1779.3 (132665)	24.84	23.71	22.91
		1745 (132322)	24.61	23.45	22.66
		1710.7 (131979)	24.79	23.63	22.79
	3RB-Low (0)	1779.3 (132665)	24.79	23.70	22.90
		1745 (132322)	24.55	23.48	22.59
		1710.7 (131979)	24.68	23.54	22.68
	6RB (0)	1779.3 (132665)	23.84	22.89	21.72
		1745 (132322)	23.58	22.63	21.50
		1710.7 (131979)	23.73	22.75	21.66

3MHz	1RB-High (14)	1778.5 (132657)	24.69	23.82	22.85
		1745 (132322)	24.44	23.56	22.49
		1711.5 (131987)	24.55	23.72	22.68
	1RB-Middle (7)	1778.5 (132657)	24.89	23.95	22.93
		1745 (132322)	24.64	23.80	22.75
		1711.5 (131987)	24.72	23.82	22.79
	1RB-Low (0)	1778.5 (132657)	24.66	23.81	22.82
		1745 (132322)	24.47	23.64	22.57
		1711.5 (131987)	24.60	23.68	22.70
	8RB-High (7)	1778.5 (132657)	23.74	22.79	21.74
		1745 (132322)	23.51	22.53	21.51
		1711.5 (131987)	23.58	22.61	21.60
	8RB-Middle (4)	1778.5 (132657)	23.81	22.82	21.80
		1745 (132322)	23.54	22.56	21.49
		1711.5 (131987)	23.64	22.64	21.66
	8RB-Low (0)	1778.5 (132657)	23.77	22.81	21.78
		1745 (132322)	23.50	22.52	21.49
		1711.5 (131987)	23.64	22.64	21.64
	15RB (0)	1778.5 (132657)	23.79	22.76	21.74
		1745 (132322)	23.50	22.46	21.47
		1711.5 (131987)	23.64	22.58	21.56
5MHz	1RB-High (24)	1777.5 (132647)	24.55	23.74	22.72
		1745 (132322)	24.32	23.49	22.43
		1712.5 (131997)	24.43	23.67	22.62
	1RB-Middle (12)	1777.5 (132647)	24.89	24.06	23.01
		1745 (132322)	24.63	23.85	22.72
		1712.5 (131997)	24.75	23.88	22.76
	1RB-Low (0)	1777.5 (132647)	24.55	23.73	22.73
		1745 (132322)	24.35	23.60	22.44
		1712.5 (131997)	24.46	23.60	22.52
	12RB-High (13)	1777.5 (132647)	23.72	22.72	21.72
		1745 (132322)	23.50	22.45	21.47
		1712.5 (131997)	23.60	22.53	21.58
	12RB-Middle (6)	1777.5 (132647)	23.79	22.76	21.76
		1745 (132322)	23.56	22.46	21.55
		1712.5 (131997)	23.66	22.61	21.64
	12RB-Low (0)	1777.5 (132647)	23.75	22.71	21.75
		1745 (132322)	23.49	22.44	21.45
		1712.5 (131997)	23.58	22.53	21.55
	25RB (0)	1777.5 (132647)	23.76	22.72	21.72
		1745 (132322)	23.51	22.49	21.44
		1712.5 (131997)	23.60	22.58	21.56

10MHz	1RB-High (49)	1775 (132622)	24.61	23.77	22.80
		1745 (132322)	24.39	23.46	22.47
		1715 (132022)	24.51	23.74	22.68
	1RB-Middle (24)	1775 (132622)	24.80	23.98	23.01
		1745 (132322)	24.59	23.82	22.72
		1715 (132022)	24.66	23.89	22.79
	1RB-Low (0)	1775 (132622)	24.56	23.69	22.63
		1745 (132322)	24.45	23.68	22.58
		1715 (132022)	24.58	23.69	22.72
	25RB-High (25)	1775 (132622)	23.77	22.75	21.72
		1745 (132322)	23.57	22.50	21.50
		1715 (132022)	23.65	22.62	21.59
	25RB-Middle (12)	1775 (132622)	23.81	22.79	21.76
		1745 (132322)	23.58	22.55	21.51
		1715 (132022)	23.67	22.63	21.61
	25RB-Low (0)	1775 (132622)	23.80	22.78	21.76
		1745 (132322)	23.54	22.50	21.50
		1715 (132022)	23.67	22.61	21.59
	50RB (0)	1775 (132622)	23.79	22.75	21.76
		1745 (132322)	23.57	22.51	21.51
		1715 (132022)	23.68	22.64	21.61
15MHz	1RB-High (74)	1772.5 (132597)	24.63	23.76	22.72
		1745 (132322)	24.31	23.40	22.44
		1717.5 (132047)	24.52	23.83	22.70
	1RB-Middle (37)	1772.5 (132597)	24.63	23.79	22.74
		1745 (132322)	24.47	23.71	22.62
		1717.5 (132047)	24.59	23.72	22.73
	1RB-Low (0)	1772.5 (132597)	24.44	23.62	22.54
		1745 (132322)	24.44	23.73	22.60
		1717.5 (132047)	24.53	23.66	22.65
	36RB-High (38)	1772.5 (132597)	23.74	22.71	21.71
		1745 (132322)	23.54	22.45	21.51
		1717.5 (132047)	23.67	22.59	21.62
	36RB-Middle (19)	1772.5 (132597)	23.76	22.67	21.71
		1745 (132322)	23.55	22.49	21.48
		1717.5 (132047)	23.65	22.59	21.61
	36RB-Low (0)	1772.5 (132597)	23.72	22.65	21.70
		1745 (132322)	23.52	22.46	21.49
		1717.5 (132047)	23.63	22.56	21.59
	75RB (0)	1772.5 (132597)	23.72	22.68	21.69
		1745 (132322)	23.52	22.48	21.46
		1717.5 (132047)	23.64	22.59	21.57

20MHz	1RB-High (99)	1770 (132572)	24.75	24.02	22.92
		1745 (132322)	24.46	23.56	22.53
		1720 (132072)	24.65	23.85	22.91
	1RB-Middle (50)	1770 (132572)	24.88	24.04	23.12
		1745 (132322)	24.75	24.03	22.93
		1720 (132072)	24.90	24.00	23.04
	1RB-Low (0)	1770 (132572)	24.48	23.67	22.64
		1745 (132322)	24.61	23.85	22.84
		1720 (132072)	24.68	23.84	22.83
	50RB-High (50)	1770 (132572)	23.91	22.89	21.89
		1745 (132322)	23.75	22.73	21.73
		1720 (132072)	23.86	22.84	21.80
	50RB-Middle (25)	1770 (132572)	23.97	22.94	21.92
		1745 (132322)	23.78	22.76	21.73
		1720 (132072)	23.90	22.86	21.84
	50RB-Low (0)	1770 (132572)	23.89	22.85	21.85
		1745 (132322)	23.72	22.69	21.70
		1720 (132072)	23.93	22.91	21.86
	100RB (0)	1770 (132572)	23.88	22.81	21.83
		1745 (132322)	23.73	22.69	21.66
		1720 (132072)	23.87	22.82	21.80

DS10

Band 66					
BANDWIDTH	Number of RBs	Frequency	QPSK	16QAM	64QAM
1.4MHz	1RB-High (5)	1779.3 (132665)	21.81	21.80	21.73
		1745 (132322)	21.88	21.72	21.69
		1710.7 (131979)	21.82	21.67	21.67
	1RB-Middle (3)	1779.3 (132665)	21.98	21.68	21.66
		1745 (132322)	21.97	21.83	21.73
		1710.7 (131979)	21.96	21.83	21.66
	1RB-Low (0)	1779.3 (132665)	21.86	21.87	21.70
		1745 (132322)	21.85	22.12	22.02
		1710.7 (131979)	21.84	22.20	22.03
	3RB-High (3)	1779.3 (132665)	21.95	22.17	22.05
		1745 (132322)	21.99	21.84	21.68
		1710.7 (131979)	21.96	21.85	21.72
	3RB-Middle (1)	1779.3 (132665)	21.99	21.82	21.76
		1745 (132322)	21.99	21.70	21.71
		1710.7 (131979)	22.02	21.72	21.72
	3RB-Low (0)	1779.3 (132665)	21.93	21.64	21.66

		1745 (132322)	21.97	21.74	21.77	
		1710.7 (131979)	21.95	21.73	21.73	
		6RB (0)	1779.3 (132665)	21.94	21.72	21.75
			1745 (132322)	21.93	21.73	21.74
			1710.7 (131979)	21.94	21.65	21.66
3MHz	1RB-High (14)	1778.5 (132657)	21.87	21.66	21.65	
		1745 (132322)	21.86	21.72	21.74	
		1711.5 (131987)	21.83	21.68	21.69	
	1RB-Middle (7)	1778.5 (132657)	22.01	21.72	21.66	
		1745 (132322)	22.03	21.95	21.80	
		1711.5 (131987)	22.02	21.97	21.79	
	1RB-Low (0)	1778.5 (132657)	21.87	21.82	21.73	
		1745 (132322)	21.86	22.12	22.00	
		1711.5 (131987)	21.88	22.10	21.98	
	8RB-High (7)	1778.5 (132657)	21.93	21.98	21.88	
		1745 (132322)	21.96	21.90	21.75	
		1711.5 (131987)	21.85	21.99	21.91	
	8RB-Middle (4)	1778.5 (132657)	21.94	21.86	21.83	
		1745 (132322)	21.97	21.74	21.74	
		1711.5 (131987)	21.92	21.79	21.79	
	8RB-Low (0)	1778.5 (132657)	21.92	21.69	21.68	
		1745 (132322)	21.90	21.78	21.76	
		1711.5 (131987)	21.92	21.76	21.76	
	15RB (0)	1778.5 (132657)	21.91	21.75	21.73	
		1745 (132322)	21.88	21.77	21.75	
		1711.5 (131987)	21.87	21.75	21.74	
	5MHz	1RB-High (24)	1777.5 (132647)	21.73	21.75	21.74
			1745 (132322)	21.79	21.76	21.75
			1712.5 (131997)	21.71	21.77	21.76
		1RB-Middle (12)	1777.5 (132647)	22.00	21.73	21.72
			1745 (132322)	22.04	21.80	21.78
			1712.5 (131997)	22.02	21.80	21.79
		1RB-Low (0)	1777.5 (132647)	21.75	21.80	21.70
			1745 (132322)	21.77	21.97	21.83
			1712.5 (131997)	21.74	22.00	21.91
12RB-High (13)		1777.5 (132647)	21.90	22.02	21.86	
		1745 (132322)	21.94	21.76	21.65	
		1712.5 (131997)	21.88	22.02	21.87	
12RB-Middle (6)		1777.5 (132647)	21.96	21.97	21.83	
		1745 (132322)	21.95	21.69	21.71	
		1712.5 (131997)	21.94	21.74	21.76	
12RB-Low		1777.5 (132647)	21.94	21.62	21.64	

	(0)	1745 (132322)	21.90	21.73	21.70	
		1712.5 (131997)	21.88	21.72	21.73	
	25RB (0)	1777.5 (132647)	21.92	21.69	21.74	
		1745 (132322)	21.91	21.70	21.71	
		1712.5 (131997)	21.89	21.70	21.73	
10MHz	1RB-High (49)	1775 (132622)	21.89	21.67	21.73	
		1745 (132322)	21.87	21.68	21.68	
		1715 (132022)	21.78	21.71	21.69	
	1RB-Middle (24)	1775 (132622)	22.01	21.67	21.67	
		1745 (132322)	22.04	21.82	21.74	
		1715 (132022)	21.98	21.73	21.63	
	1RB-Low (0)	1775 (132622)	21.81	21.78	21.60	
		1745 (132322)	21.88	21.90	21.80	
		1715 (132022)	21.88	21.65	21.96	
	25RB-High (25)	1775 (132622)	21.93	22.00	21.93	
		1745 (132322)	22.02	21.61	21.58	
		1715 (132022)	21.88	21.78	21.73	
	25RB-Middle (12)	1775 (132622)	21.98	21.87	21.73	
		1745 (132322)	22.00	21.59	21.60	
		1715 (132022)	21.91	21.76	21.70	
	25RB-Low (0)	1775 (132622)	21.96	21.54	21.55	
		1745 (132322)	21.94	21.70	21.67	
		1715 (132022)	21.97	21.72	21.71	
	50RB (0)	1775 (132622)	21.96	21.65	21.64	
		1745 (132322)	21.97	21.68	21.66	
		1715 (132022)	21.92	21.64	21.66	
	15MHz	1RB-High (74)	1772.5 (132597)	21.80	21.68	21.68
			1745 (132322)	21.78	21.64	21.61
			1717.5 (132047)	21.70	21.63	21.64
		1RB-Middle (37)	1772.5 (132597)	21.90	21.57	21.57
			1745 (132322)	21.95	21.62	21.71
			1717.5 (132047)	21.85	21.52	21.76
1RB-Low (0)		1772.5 (132597)	21.77	21.96	21.85	
		1745 (132322)	21.86	21.62	21.87	
		1717.5 (132047)	21.85	21.57	21.63	
36RB-High (38)		1772.5 (132597)	21.91	21.89	21.91	
		1745 (132322)	21.99	21.94	21.96	
		1717.5 (132047)	21.86	21.82	21.84	
36RB-Middle (19)		1772.5 (132597)	21.94	21.93	21.90	
		1745 (132322)	21.97	21.92	21.93	
		1717.5 (132047)	21.92	21.89	21.94	
36RB-Low	1772.5 (132597)	21.92	21.90	21.91		

	(0)	1745 (132322)	21.92	21.90	21.93
		1717.5 (132047)	21.92	21.87	21.93
	75RB (0)	1772.5 (132597)	21.91	21.88	21.88
		1745 (132322)	21.94	21.91	21.89
		1717.5 (132047)	21.88	21.87	21.87
20MHz	1RB-High (99)	1770 (132572)	21.71	21.62	21.94
		1745 (132322)	21.69	21.93	21.83
		1720 (132072)	21.61	21.98	21.80
	1RB-Middle (50)	1770 (132572)	21.86	21.81	21.90
		1745 (132322)	22.02	21.75	21.76
		1720 (132072)	21.85	21.82	21.73
	1RB-Low (0)	1770 (132572)	21.64	21.81	21.78
		1745 (132322)	21.75	21.98	21.93
		1720 (132072)	21.77	21.67	21.93
	50RB-High (50)	1770 (132572)	21.77	21.79	21.80
		1745 (132322)	21.96	21.96	21.90
		1720 (132072)	21.75	21.74	21.75
	50RB-Middle (25)	1770 (132572)	21.88	21.90	21.87
		1745 (132322)	21.91	21.92	21.91
		1720 (132072)	21.85	21.85	21.84
	50RB-Low (0)	1770 (132572)	21.88	21.88	21.86
		1745 (132322)	21.84	21.84	21.86
		1720 (132072)	21.89	21.88	21.88
	100RB (0)	1770 (132572)	21.84	21.84	21.81
		1745 (132322)	21.86	21.83	21.84
		1720 (132072)	21.78	21.77	21.77

DSI2

Band 66					
BANDWIDTH	Number of RBs	Frequency	QPSK	16QAM	64QAM
1.4MHz	1RB-High (5)	1779.3 (132665)	21.81	21.80	21.73
		1745 (132322)	21.88	21.72	21.69
		1710.7 (131979)	21.82	21.67	21.67
	1RB-Middle (3)	1779.3 (132665)	21.98	21.68	21.66
		1745 (132322)	21.97	21.83	21.73
		1710.7 (131979)	21.96	21.83	21.66
	1RB-Low (0)	1779.3 (132665)	21.86	21.87	21.70
		1745 (132322)	21.85	22.12	22.02
		1710.7 (131979)	21.84	22.20	22.03
	3RB-High (3)	1779.3 (132665)	21.95	22.17	22.05
		1745 (132322)	21.99	21.84	21.68

	3RB-Middle (1)	1710.7 (131979)	21.96	21.85	21.72	
		1779.3 (132665)	21.99	21.82	21.76	
		1745 (132322)	21.99	21.70	21.71	
	3RB-Low (0)	1710.7 (131979)	22.02	21.72	21.72	
		1779.3 (132665)	21.93	21.64	21.66	
		1745 (132322)	21.97	21.74	21.77	
	6RB (0)	1710.7 (131979)	21.95	21.73	21.73	
		1779.3 (132665)	21.94	21.72	21.75	
		1745 (132322)	21.93	21.73	21.74	
3MHz	1RB-High (14)	1710.7 (131979)	21.94	21.65	21.66	
		1779.3 (132665)	21.87	21.66	21.65	
		1745 (132322)	21.86	21.72	21.74	
	1RB-Middle (7)	1711.5 (131987)	21.83	21.68	21.69	
		1778.5 (132657)	22.01	21.72	21.66	
		1745 (132322)	22.03	21.95	21.80	
	1RB-Low (0)	1711.5 (131987)	22.02	21.97	21.79	
		1778.5 (132657)	21.87	21.82	21.73	
		1745 (132322)	21.86	22.12	22.00	
	8RB-High (7)	1711.5 (131987)	21.88	22.10	21.98	
		1778.5 (132657)	21.93	21.98	21.88	
		1745 (132322)	21.96	21.90	21.75	
	8RB-Middle (4)	1711.5 (131987)	21.85	21.99	21.91	
		1778.5 (132657)	21.94	21.86	21.83	
		1745 (132322)	21.97	21.74	21.74	
	8RB-Low (0)	1711.5 (131987)	21.92	21.79	21.79	
		1778.5 (132657)	21.92	21.69	21.68	
		1745 (132322)	21.90	21.78	21.76	
	15RB (0)	1711.5 (131987)	21.92	21.76	21.76	
		1778.5 (132657)	21.91	21.75	21.73	
		1745 (132322)	21.88	21.77	21.75	
	5MHz	1RB-High (24)	1711.5 (131987)	21.87	21.75	21.74
			1777.5 (132647)	21.73	21.75	21.74
			1745 (132322)	21.79	21.76	21.75
1RB-Middle (12)		1712.5 (131997)	21.71	21.77	21.76	
		1777.5 (132647)	22.00	21.73	21.72	
		1745 (132322)	22.04	21.80	21.78	
1RB-Low (0)		1712.5 (131997)	22.02	21.80	21.79	
		1777.5 (132647)	21.75	21.80	21.70	
		1745 (132322)	21.77	21.97	21.83	
12RB-High (13)		1712.5 (131997)	21.74	22.00	21.91	
		1777.5 (132647)	21.90	22.02	21.86	
			1745 (132322)	21.94	21.76	21.65

	12RB-Middle (6)	1712.5 (131997)	21.88	22.02	21.87	
		1777.5 (132647)	21.96	21.97	21.83	
		1745 (132322)	21.95	21.69	21.71	
	12RB-Low (0)	1712.5 (131997)	21.94	21.74	21.76	
		1777.5 (132647)	21.94	21.62	21.64	
		1745 (132322)	21.90	21.73	21.70	
	25RB (0)	1712.5 (131997)	21.88	21.72	21.73	
		1777.5 (132647)	21.92	21.69	21.74	
		1745 (132322)	21.91	21.70	21.71	
10MHz	1RB-High (49)	1712.5 (131997)	21.89	21.70	21.73	
		1775 (132622)	21.89	21.67	21.73	
		1745 (132322)	21.87	21.68	21.68	
	1RB-Middle (24)	1715 (132022)	21.78	21.71	21.69	
		1775 (132622)	22.01	21.67	21.67	
		1745 (132322)	22.04	21.82	21.74	
	1RB-Low (0)	1715 (132022)	21.98	21.73	21.63	
		1775 (132622)	21.81	21.78	21.60	
		1745 (132322)	21.88	21.90	21.80	
	25RB-High (25)	1715 (132022)	21.88	21.65	21.96	
		1775 (132622)	21.93	22.00	21.93	
		1745 (132322)	22.02	21.61	21.58	
	25RB-Middle (12)	1715 (132022)	21.88	21.78	21.73	
		1775 (132622)	21.98	21.87	21.73	
		1745 (132322)	22.00	21.59	21.60	
	25RB-Low (0)	1715 (132022)	21.91	21.76	21.70	
		1775 (132622)	21.96	21.54	21.55	
		1745 (132322)	21.94	21.70	21.67	
	50RB (0)	1715 (132022)	21.97	21.72	21.71	
		1775 (132622)	21.96	21.65	21.64	
		1745 (132322)	21.97	21.68	21.66	
	15MHz	1RB-High (74)	1715 (132022)	21.92	21.64	21.66
			1772.5 (132597)	21.80	21.68	21.68
			1745 (132322)	21.78	21.64	21.61
		1RB-Middle (37)	1717.5 (132047)	21.70	21.63	21.64
			1772.5 (132597)	21.90	21.57	21.57
			1745 (132322)	21.95	21.62	21.71
1RB-Low (0)		1717.5 (132047)	21.85	21.52	21.76	
		1772.5 (132597)	21.77	21.96	21.85	
		1745 (132322)	21.86	21.62	21.87	
36RB-High (38)		1717.5 (132047)	21.85	21.57	21.63	
		1772.5 (132597)	21.91	21.89	21.91	
			1745 (132322)	21.99	21.94	21.96

	36RB-Middle (19)	1717.5 (132047)	21.86	21.82	21.84	
		1772.5 (132597)	21.94	21.93	21.90	
		1745 (132322)	21.97	21.92	21.93	
	36RB-Low (0)	1717.5 (132047)	21.92	21.89	21.94	
		1772.5 (132597)	21.92	21.90	21.91	
		1745 (132322)	21.92	21.90	21.93	
	75RB (0)	1717.5 (132047)	21.92	21.87	21.93	
		1772.5 (132597)	21.91	21.88	21.88	
		1745 (132322)	21.94	21.91	21.89	
	20MHz	1RB-High (99)	1717.5 (132047)	21.88	21.87	21.87
			1772.5 (132597)	21.91	21.88	21.88
			1745 (132322)	21.94	21.91	21.89
1RB-Middle (50)		1770 (132572)	21.71	21.62	21.94	
		1745 (132322)	21.69	21.93	21.83	
		1720 (132072)	21.61	21.98	21.80	
1RB-Low (0)		1770 (132572)	21.86	21.81	21.90	
		1745 (132322)	22.02	21.75	21.76	
		1720 (132072)	21.85	21.82	21.73	
50RB-High (50)		1770 (132572)	21.64	21.81	21.78	
		1745 (132322)	21.75	21.98	21.93	
		1720 (132072)	21.77	21.67	21.93	
50RB-Middle (25)		1770 (132572)	21.77	21.79	21.80	
		1745 (132322)	21.96	21.96	21.90	
		1720 (132072)	21.75	21.74	21.75	
50RB-Low (0)		1770 (132572)	21.88	21.90	21.87	
		1745 (132322)	21.91	21.92	21.91	
		1720 (132072)	21.85	21.85	21.84	
100RB (0)		1770 (132572)	21.88	21.88	21.86	
		1745 (132322)	21.84	21.84	21.86	
		1720 (132072)	21.89	21.88	21.88	
		1RB-Low (0)	1770 (132572)	21.84	21.84	21.81
			1745 (132322)	21.86	21.83	21.84
			1720 (132072)	21.78	21.77	21.77

DSI1/3

Band 71					
BANDWIDTH	Number of RBs	Frequency	QPSK	16QAM	64QAM
5MHz	1RB-High (24)	695.5 (133447)	21.53	21.47	21.37
		680.5 (133297)	21.66	21.73	21.50
		665.5 (133147)	21.56	21.47	21.35
	1RB-Middle (12)	695.5 (133447)	21.65	21.52	21.49
		680.5 (133297)	21.79	21.81	21.70
		665.5 (133147)	21.65	21.58	21.45
	1RB-Low (0)	695.5 (133447)	21.56	21.57	21.42

		680.5 (133297)	21.64	21.68	21.48	
		665.5 (133147)	21.53	21.46	21.33	
		695.5 (133447)	21.67	21.30	21.42	
	12RB-High (13)	680.5 (133297)	21.79	21.44	21.52	
		665.5 (133147)	21.65	21.32	21.39	
		695.5 (133447)	21.68	21.38	21.43	
	12RB-Middle (6)	680.5 (133297)	21.82	21.52	21.62	
		665.5 (133147)	21.71	21.36	21.48	
		695.5 (133447)	21.64	21.34	21.40	
	12RB-Low (0)	680.5 (133297)	21.73	21.45	21.50	
		665.5 (133147)	21.68	21.35	21.45	
		695.5 (133447)	21.64	21.40	20.33	
25RB (0)	680.5 (133297)	21.73	21.53	20.43		
	665.5 (133147)	21.68	21.42	20.39		
	693 (132422)	21.58	21.57	21.39		
10MHz	1RB-High (49)	680.5 (133297)	21.68	21.62	21.59	
		668 (133172)	21.60	21.55	21.38	
		693 (132422)	21.71	21.66	21.58	
	1RB-Middle (24)	680.5 (133297)	21.92	21.92	21.83	
		668 (133172)	21.73	21.71	21.50	
		693 (132422)	21.62	21.61	21.49	
	1RB-Low (0)	680.5 (133297)	21.72	21.73	21.58	
		668 (133172)	21.65	21.55	21.45	
		693 (132422)	21.61	21.37	20.36	
	25RB-High (25)	680.5 (133297)	21.74	21.47	20.49	
		668 (133172)	21.63	21.33	20.39	
		693 (132422)	21.67	21.38	20.39	
	25RB-Middle (12)	680.5 (133297)	21.80	21.56	20.56	
		668 (133172)	21.67	21.40	20.41	
		693 (132422)	21.63	21.41	20.39	
	25RB-Low (0)	680.5 (133297)	21.73	21.50	20.50	
		668 (133172)	21.65	21.36	20.39	
		693 (132422)	21.62	21.31	20.34	
	50RB (0)	680.5 (133297)	21.69	21.43	20.41	
		668 (133172)	21.64	21.35	20.35	
		690.5 (133397)	21.46	21.44	21.26	
	15MHz	1RB-High (74)	680.5 (133297)	21.55	21.58	21.42
			670.5 (133197)	21.48	21.44	21.31
			690.5 (133397)	21.75	21.67	21.72
1RB-Middle (37)		680.5 (133297)	21.85	21.88	21.68	
		670.5 (133197)	21.78	21.73	21.54	
		690.5 (133397)	21.53	21.51	21.34	
1RB-Low (0)		690.5 (133397)	21.53	21.51	21.34	

		680.5 (133297)	21.57	21.48	21.43
		670.5 (133197)	21.63	21.52	21.46
		690.5 (133397)	21.59	21.29	20.33
	36RB-High (38)	680.5 (133297)	21.74	21.41	20.45
		670.5 (133197)	21.61	21.26	20.32
		690.5 (133397)	21.67	21.36	20.39
	36RB-Middle (19)	680.5 (133297)	21.78	21.48	20.51
		670.5 (133197)	21.70	21.37	20.40
		690.5 (133397)	21.60	21.26	20.34
	36RB-Low (0)	680.5 (133297)	21.68	21.40	20.42
		670.5 (133197)	21.71	21.34	20.40
		690.5 (133397)	21.60	21.31	20.33
	75RB (0)	680.5 (133297)	21.71	21.42	20.44
		670.5 (133197)	21.64	21.33	20.35
		688 (133372)	21.68	22.01	21.86
20MHz	1RB-High (99)	683 (133322)	21.66	21.88	21.76
		673 (133222)	21.76	21.95	21.95
		688 (133372)	21.98	21.92	21.90
	1RB-Middle (50)	683 (133322)	21.97	21.93	22.27
		673 (133222)	21.93	21.91	22.07
		688 (133372)	21.87	21.94	22.01
	1RB-Low (0)	683 (133322)	21.79	21.87	21.83
		673 (133222)	21.95	21.89	22.45
		688 (133372)	21.84	21.82	20.87
	50RB-High (50)	683 (133322)	21.92	21.94	20.94
		673 (133222)	21.93	21.92	20.95
		688 (133372)	21.94	21.92	20.93
	50RB-Middle (25)	683 (133322)	21.96	21.98	21.00
		673 (133222)	21.95	21.95	20.96
		688 (133372)	21.86	21.88	20.88
	50RB-Low (0)	683 (133322)	21.91	21.92	20.95
		673 (133222)	21.93	21.93	20.94
		688 (133372)	21.86	21.84	20.87
	100RB (0)	683 (133322)	21.91	21.90	20.93
		673 (133222)	21.91	21.88	20.92

DSI0/2

Band 71					
BANDWIDTH	Number of RBs	Frequency	QPSK	16QAM	64QAM
5MHz	1RB-High (24)	695.5 (133447)	23.85	23.14	21.96
		680.5 (133297)	23.98	23.29	22.20
		665.5 (133147)	24.09	23.25	22.20

	1RB-Middle (12)	695.5 (133447)	23.96	23.24	22.09
		680.5 (133297)	24.13	23.28	22.28
		665.5 (133147)	24.19	23.30	22.23
	1RB-Low (0)	695.5 (133447)	23.88	23.08	22.05
		680.5 (133297)	23.98	23.30	22.17
		665.5 (133147)	24.09	23.16	22.24
	12RB-High (13)	695.5 (133447)	23.97	22.91	22.03
		680.5 (133297)	24.07	23.08	22.15
		665.5 (133147)	24.18	22.99	22.14
	12RB-Middle (6)	695.5 (133447)	24.00	23.04	22.08
		680.5 (133297)	24.17	23.13	22.24
		665.5 (133147)	24.26	23.08	22.27
	12RB-Low (0)	695.5 (133447)	23.96	22.89	22.03
		680.5 (133297)	24.09	23.04	22.18
		665.5 (133147)	24.19	23.15	22.17
25RB (0)	695.5 (133447)	22.96	22.06	20.98	
	680.5 (133297)	23.11	22.20	21.09	
	665.5 (133147)	23.22	22.22	21.18	
10MHz	1RB-High (49)	693 (132422)	23.93	23.13	22.09
		680.5 (133297)	24.00	23.27	22.18
		668 (133172)	24.08	23.24	22.26
	1RB-Middle (24)	693 (132422)	24.08	23.29	22.30
		680.5 (133297)	24.19	23.46	22.42
		668 (133172)	24.27	23.44	22.43
	1RB-Low (0)	693 (132422)	23.95	23.10	22.06
		680.5 (133297)	24.08	23.38	22.25
		668 (133172)	24.14	23.29	22.22
	25RB-High (25)	693 (132422)	22.99	22.02	21.03
		680.5 (133297)	23.04	22.11	21.08
		668 (133172)	23.14	22.21	21.20
	25RB-Middle (12)	693 (132422)	22.99	22.05	21.07
		680.5 (133297)	23.12	22.20	21.16
		668 (133172)	23.18	22.21	21.20
	25RB-Low (0)	693 (132422)	22.95	22.00	21.03
		680.5 (133297)	23.11	22.15	21.12
		668 (133172)	23.13	22.18	21.19
50RB (0)	693 (132422)	23.00	22.03	20.97	
	680.5 (133297)	23.06	22.07	21.06	
	668 (133172)	23.23	22.17	21.15	
15MHz	1RB-High (74)	690.5 (133397)	23.82	23.14	22.00
		680.5 (133297)	23.90	23.18	22.08
		670.5 (133197)	24.01	23.19	22.11

	1RB-Middle (37)	690.5 (133397)	24.11	23.34	22.23
		680.5 (133297)	24.18	23.46	22.35
		670.5 (133197)	24.22	23.50	22.36
	1RB-Low (0)	690.5 (133397)	23.85	23.07	21.96
		680.5 (133297)	23.97	23.21	22.21
		670.5 (133197)	24.00	23.24	22.12
	36RB-High (38)	690.5 (133397)	22.97	21.94	21.00
		680.5 (133297)	23.06	22.00	21.04
		670.5 (133197)	23.12	22.08	21.12
	36RB-Middle (19)	690.5 (133397)	23.05	22.04	21.06
		680.5 (133297)	23.14	22.13	21.14
		670.5 (133197)	23.20	22.13	21.21
	36RB-Low (0)	690.5 (133397)	22.97	21.95	20.99
		680.5 (133297)	23.10	22.08	21.11
		670.5 (133197)	23.14	22.08	21.12
75RB (0)	690.5 (133397)	22.99	22.00	21.00	
	680.5 (133297)	23.05	22.04	21.04	
	670.5 (133197)	23.19	22.14	21.16	
20MHz	1RB-High (99)	688 (133372)	24.12	23.34	22.25
		683 (133322)	23.98	23.27	22.11
		673 (133222)	24.03	23.29	22.24
	1RB-Middle (50)	688 (133372)	24.30	23.52	22.55
		683 (133322)	24.33	23.54	22.5
		673 (133222)	24.40	23.64	22.44
	1RB-Low (0)	688 (133372)	24.22	23.40	22.4
		683 (133322)	24.24	23.38	22.37
		673 (133222)	24.32	23.66	22.54
	50RB-High (50)	688 (133372)	23.23	22.22	21.21
		683 (133322)	23.28	22.25	21.26
		673 (133222)	23.36	22.33	21.36
	50RB-Middle (25)	688 (133372)	23.28	22.29	21.25
		683 (133322)	23.32	22.30	21.31
		673 (133222)	23.45	22.43	21.42
	50RB-Low (0)	688 (133372)	23.23	22.25	21.26
		683 (133322)	23.31	22.30	21.31
		673 (133222)	23.37	22.34	21.35
	100RB (0)	688 (133372)	23.22	22.20	21.21
		683 (133322)	23.28	22.25	21.26
		673 (133222)	23.36	22.35	21.33

The conducted power measurement results of downlink LTE CA Conduced Power are as below:

DSI1/3											
DL LTE CA Class	SCC1					SCC2				Power	
	PCC Bandwidth	UL channel	DL channel	UL RB	UL RB OFFSET	SCC Bandwidth	DL channel	RB	RB OFFSET	tune up	conducted power (dBm)
66A-66A	20M	132072	66536	1	50	20M	67036	1	50	25	23.41
66B	20M	132572	67036	1	50	20M	67108	1	50	25	24.31
66C	20M	132072	66536	1	50	20M	66734	1	50	25	24.28
DSI2											
DL LTE CA Class	SCC1					SCC2				Power	
	PCC Bandwidth	UL channel	DL channel	UL RB	UL RB OFFSET	SCC Bandwidth	DL channel	RB	RB OFFSET	tune up	conducted power (dBm)
66A-66A	20M	132072	66536	1	50	20M	67036	1	50	20	19.8
66B	20M	132572	67036	1	99	20M	67108	1	99	20	19.63
66C	20M	132072	66536	1	0	20M	66734	1	0	20	19.83
DSI0											
DL LTE CA Class	SCC1					SCC2				Power	
	PCC Bandwidth	UL channel	DL channel	UL RB	UL RB OFFSET	SCC Bandwidth	DL channel	RB	RB OFFSET	tune up	conducted power (dBm)
66A-66A	20M	132072	66536	1	50	20M	67036	1	50	22.5	21.75
66B	20M	132572	67036	1	99	20M	67108	1	99	22.5	21.51
66C	20M	132072	66536	1	0	20M	66734	1	0	22.5	21.76

11.4 Wi-Fi and BT Measurement result

The maximum output power of BT is 7.63dBm.

The maximum tune up of BT is 8dBm.

The conducted output power for WiFi 2.4G power is as following

802.11b	Channel\data	1Mbps
WLAN2450	11(2462MHz)	20.09
	6(2437(MHz)	20.33
	1(2412MHz)	20.31
	tuneup	21.00
802.11g	Channel\data	6Mbps
WLAN2450	11(2462MHz)	19.24
	6(2437(MHz)	19.84
	1(2412MHz)	19.69
	tuneup	20.00
802.11n-20MHz	Channel\data	MCS0
WLAN2450	11(2462MHz)	18.65
	6(2437(MHz)	18.86
	1(2412MHz)	18.75
	tuneup	19.00
802.11n-40MHz	Channel\data	MCS0
WLAN2450	9(2452MHz)	18.39
	6(2437MHz)	18.73
	3(2422MHz)	17.74
	tuneup	19.00

12 Simultaneous TX SAR Considerations

12.1 Transmit Antenna Separation Distances

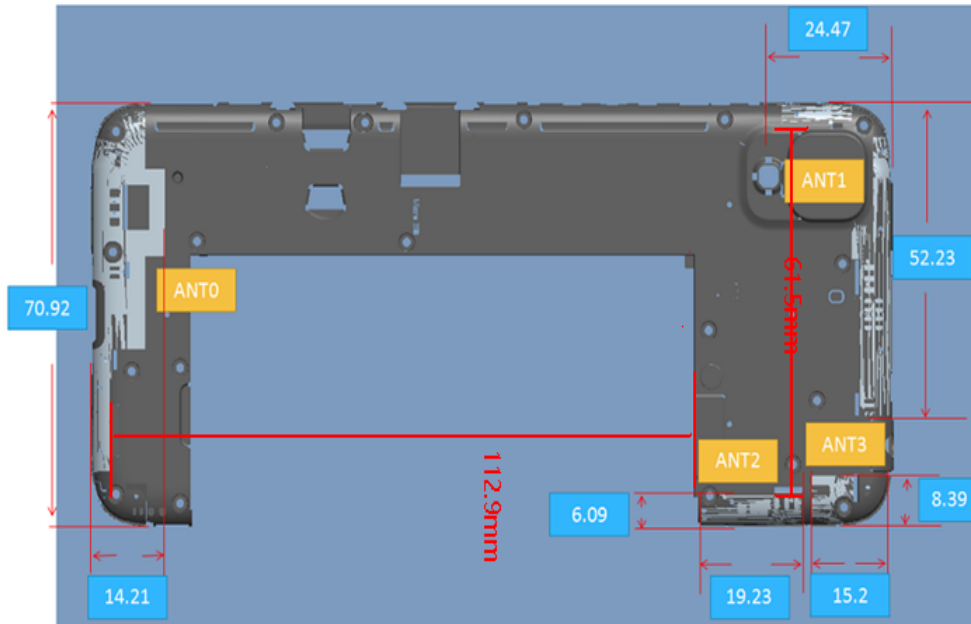

The location of the antennas inside mobile phone is shown below:

Antenna	Pattern	Gain(dBi)			
		GSM 850	GSM 900	DCS1800	PCS1900
GSM	PIFA	-3.49	-5.91	-1.76	-1.54
WCDMA		Band II	Band IV	Band V	
		-1.54	-2.26	-3.49	
		FDD B2	FDD B4	FDD B5	FDD B12
		-1.54	-2.26	-3.49	-2.4
		FDD B13	FDD B25	FDD B26	FDD B66
		-2.56	-1.76	-3.49	-2.26
TDD B41		FDD B71			
		-1.13	-4.8		
GPS	PIFA	-4.5			
WIFI&BT	PIFA	-3.1			

Picture 12.1 Antenna Locations

12.2 SAR Measurement Positions

According to the KDB941225 D06 Hot Spot SAR v01, the edges with less than 2.5 cm distance to the antennas need to be tested for SAR.

SAR measurement positions						
Mode	Front	Rear	Left edge	Right edge	Top edge	Bottom edge
ANT0	Yes	Yes	Yes	Yes	No	Yes
ANT1	Yes	Yes	Yes	Yes	Yes	No

12.3 Standalone SAR Test Exclusion Considerations

Standalone 1-g head or body SAR evaluation by measurement or numerical simulation is not required when the corresponding SAR Exclusion Threshold condition, listed below, is satisfied. The 1-g SAR test exclusion threshold for 100 MHz to 6 GHz at test separation distances ≤ 50 mm are determined by:

$[(\text{max. power of channel, including tune-up tolerance, mW}) / (\text{min. test separation distance, mm})] \cdot [\sqrt{f(\text{GHz})}] \leq 3.0$ for 1-g SAR, where

- $f(\text{GHz})$ is the RF channel transmit frequency in GHz
- Power and distance are rounded to the nearest mW and mm before calculation
- The result is rounded to one decimal place for comparison

Table 12.1: Standalone SAR test exclusion considerations

Band/Mode	F(GHz)	Position	SAR test exclusion threshold(mW)	RF output power		SAR test exclusion
				dBm	mW	
Bluetooth	2.441	Head	9.60	8	6.3	YES
		Body	19.20	8	6.3	YES
2.4GHz WLAN	2.45	Head	9.58	20.5	112.2	No
		Body	19.17	20.5	112.2	No

13 Evaluation of Simultaneous

Table 13.1: The sum of reported SAR values for Main antenna and WiFi+BT

	Position	Cellular antenna	WiFi	BT	Sum
Highest reported SAR value for Head	Right hand, Cheek (LTE Band71)	0.64	0.58	0.26	1.48
Maximum reported SAR value for Body	Rear 10mm (WCDMA1700)	0.94	0.28	0.13	1.35

[1] - Estimated SAR for Bluetooth (see the table 13.2)

Table 13.2: Estimated SAR for Bluetooth

Mode/Band	F (GHz)	Position	Distance (mm)	Upper limit of power *		Estimated _{1g} (W/kg)
				dBm	mW	
Bluetooth	2.441	Head	5	8	6.31	0.26
Bluetooth	2.441	Body	10	8	6.31	0.13

* - Maximum possible output power declared by manufacturer

When standalone SAR test exclusion applies to an antenna that transmits simultaneously with other antennas, the standalone SAR must be estimated according to following to determine simultaneous transmission SAR test exclusion:

$(\text{max. power of channel, including tune-up tolerance, mW}) / (\text{min. test separation distance, mm}) \cdot [\sqrt{f(\text{GHz})} / x]$ W/kg for test separation distances ≤ 50 mm;

where $x = 7.5$ for 1-g SAR.

When the minimum test separation distance is < 5 mm, a distance of 5 mm is applied to determine SAR test exclusion

Conclusion:

According to the above tables, the sum of reported SAR values is < 1.6 W/kg. So the simultaneous transmission SAR with volume scans is not required.

14 SAR Test Result

It is determined by user manual for the distance between the EUT and the phantom bottom. The distance is 10 mm or 15mm and just applied to the condition of body worn accessory.

It is performed for all SAR measurements with area scan based 1-g SAR estimation (Fast SAR). A zoom scan measurement is added when the estimated 1-gSAR is the highest measured SAR in each exposure configuration, wireless mode and frequency band combination or more than 1.2W/kg.

The calculated SAR is obtained by the following formula:

$$\text{Reported SAR} = \text{Measured SAR} \times 10^{(P_{\text{Target}} - P_{\text{Measured}})/10}$$

Where P_{Target} is the power of manufacturing upper limit;

P_{Measured} is the measured power in chapter 11.

Table 14.1: Duty Cycle

Mode	Duty Cycle
GPRS&EGPRS for GSM850	1:2
GPRS&EGPRS for GSM1900	1:8.3
WCDMA<E FDD	1:1
LTE B41 PC3	1:1.58
LTE B41 PC2	1:2.309

Note:

The **B1** is the battery of CAB2880000C7 by VEKEN

The **B2** is the battery of CAB2880001C1 by BYD

14.1 SAR results for Fast SAR

RF Exposure Conditions	Frequency Band	Channel Number	Frequency (MHz)	Mode/RB	Test Position	Distance	Figure No./Note	EUT Measured Power (dBm)	Tune up (dBm)	Measured SAR 1g (W/kg)	Calculated SAR 1g (W/kg)	Measured SAR 10g (W/kg)	Calculated SAR 10g (W/kg)	Power Drift
Head	GSM850	251	848.8	\	Left Cheek	0mm	Fig.A1	31.96	33.30	0.195	0.27	0.150	0.20	-0.08
Head	GSM850	190	836.6	\	Left Cheek	0mm	\	32.05	33.30	0.148	0.20	0.115	0.15	-0.03
Head	GSM850	128	824.2	\	Left Cheek	0mm	\	31.92	33.30	0.107	0.15	0.082	0.11	0.06
Head	GSM850	190	836.6	\	Left Tilt	0mm	\	32.05	33.30	0.068	0.09	0.055	0.07	-0.08
Head	GSM850	190	836.6	\	Right Cheek	0mm	\	32.05	33.30	0.125	0.17	0.099	0.13	-0.18
Head	GSM850	190	836.6	\	Right Tilt	0mm	\	32.05	33.30	0.063	0.08	0.053	0.07	-0.18
Head	GSM850	251	848.8	\	Left Cheek	0mm	B2	31.96	33.30	0.188	0.26	0.141	0.19	0.08
Body	GSM850	190	836.6	GPRS(4TX)	Front	10mm	\	26.29	27.00	0.071	0.08	0.049	0.06	-0.05
Body	GSM850	251	848.8	GPRS(4TX)	Rear	10mm	\	26.01	27.00	0.099	0.12	0.068	0.09	0.13
Body	GSM850	190	836.6	GPRS(4TX)	Rear	10mm	\	26.29	27.00	0.129	0.15	0.090	0.11	0.04
Body	GSM850	128	824.2	GPRS(4TX)	Rear	10mm	Fig.A2	26.21	27.00	0.148	0.18	0.101	0.12	0.04
Body	GSM850	190	836.6	GPRS(4TX)	Left Edge	10mm	\	26.29	27.00	0.068	0.08	0.044	0.05	-0.05
Body	GSM850	190	836.6	GPRS(4TX)	Right Edge	10mm	\	26.29	27.00	0.051	0.06	0.033	0.04	0.16
Body	GSM850	190	836.6	GPRS(4TX)	Bottom Edge	10mm	\	26.29	27.00	0.146	0.17	0.077	0.09	0.18
Body	GSM850	128	824.2	GPRS(4TX)	Rear	10mm	\	26.21	27.00	0.086	0.10	0.057	0.07	-0.16
Body	GSM850	128	824.2	GPRS(4TX)	Rear	10mm	\	26.28	27.00	0.139	0.16	0.091	0.11	-0.18
Body	GSM850	128	824.2	EGPRS(4TX)	Rear	10mm	\	26.28	27.00	0.140	0.17	0.094	0.11	-0.14
Body	GSM850	128	824.2	GPRS(4TX)	Rear	10mm	B2	26.21	27.00	0.137	0.16	0.095	0.11	-0.03
Head	GSM1900	661	1880	\	Left Cheek	0mm	\	30.25	31.00	0.085	0.10	0.054	0.06	0.16
Head	GSM1900	661	1880	\	Left Tilt	0mm	\	30.25	31.00	0.081	0.10	0.052	0.06	-0.13
Head	GSM1900	810	1909.8	\	Right Cheek	0mm	Fig.A3	30.22	31.00	0.124	0.15	0.081	0.10	0.15
Head	GSM1900	661	1880	\	Right Cheek	0mm	\	30.25	31.00	0.105	0.12	0.071	0.08	0.06
Head	GSM1900	512	1850.2	\	Right Cheek	0mm	\	30.23	31.00	0.093	0.11	0.062	0.07	0.07
Head	GSM1900	661	1880	\	Right Tilt	0mm	\	30.25	31.00	0.092	0.11	0.057	0.07	0.14
Head	GSM1900	810	1909.8	\	Right Cheek	0mm	B2	30.22	31.00	0.112	0.13	0.053	0.06	-0.04
Body	GSM1900	661	1880	GPRS(1TX)	Front	10mm	\	30.23	31.00	0.178	0.21	0.105	0.13	-0.10
Body	GSM1900	661	1880	GPRS(1TX)	Rear	10mm	\	30.23	31.00	0.325	0.39	0.182	0.22	0.05
Body	GSM1900	661	1880	GPRS(1TX)	Left Edge	10mm	\	30.23	31.00	0.057	0.07	0.034	0.04	0.12
Body	GSM1900	661	1880	GPRS(1TX)	Right Edge	10mm	\	30.23	31.00	0.099	0.12	0.057	0.07	0.11
Body	GSM1900	810	1909.8	GPRS(1TX)	Bottom Edge	10mm	\	30.25	31.00	0.375	0.45	0.197	0.23	0.14
Body	GSM1900	661	1880	GPRS(1TX)	Bottom Edge	10mm	\	30.23	31.00	0.368	0.44	0.195	0.23	-0.15
Body	GSM1900	512	1850.2	GPRS(1TX)	Bottom Edge	10mm	Fig.A4	30.20	31.00	0.501	0.60	0.264	0.32	-0.09
Body	GSM1900	512	1850.2	EGPRS(1TX)	Bottom Edge	10mm	\	30.20	31.00	0.483	0.58	0.363	0.44	0.15
Body	GSM1900	512	1850.2	GPRS(1TX)	Bottom Edge	10mm	B2	30.26	31.00	0.491	0.58	0.247	0.29	0.08

RF Exposure Conditions	Frequency Band	Channel Number	Frequency (MHz)	Mode/RB	Test Position	Distance	Figure No./Note	EUT Measured Power (dBm)	Tune up (dBm)	Measured SAR 1g (W/kg)	Calculated SAR 1g (W/kg)	Measured SAR 10g (W/kg)	Calculated SAR 10g (W/kg)	Power Drift
Head	WCDMA1900	9400	1880	RMC	Left Cheek	0mm	\	23.82	24.50	0.235	0.28	0.150	0.18	-0.08
Head	WCDMA1900	9400	1880	RMC	Left Tilt	0mm	\	23.82	24.50	0.211	0.25	0.134	0.16	-0.07
Head	WCDMA1900	9538	1907.6	RMC	Right Cheek	0mm	Fig.A5	23.86	24.50	0.285	0.33	0.189	0.22	0.10
Head	WCDMA1900	9400	1880	RMC	Right Cheek	0mm	\	23.82	24.50	0.269	0.31	0.178	0.21	-0.03
Head	WCDMA1900	9262	1852.4	RMC	Right Cheek	0mm	\	23.77	24.50	0.244	0.29	0.163	0.19	-0.11
Head	WCDMA1900	9400	1880	RMC	Right Tilt	0mm	\	23.82	24.50	0.250	0.29	0.149	0.17	0.05
Head	WCDMA1900	9538	1907.6	RMC	Right Cheek	0mm	B2	23.86	24.50	0.270	0.31	0.177	0.21	-0.17
Body	WCDMA1900	9400	1880	RMC	Front	10mm	\	18.94	20.50	0.172	0.25	0.107	0.15	0.08
Body	WCDMA1900	9400	1880	RMC	Rear	10mm	\	18.94	20.50	0.280	0.40	0.163	0.23	-0.03
Body	WCDMA1900	9400	1880	RMC	Left Edge	10mm	\	18.94	20.50	0.054	0.08	0.034	0.05	0.04
Body	WCDMA1900	9400	1880	RMC	Right Edge	10mm	\	18.94	20.50	0.095	0.14	0.060	0.09	0.11
Body	WCDMA1900	9538	1907.6	RMC	Bottom Edge	10mm	\	19.02	20.50	0.340	0.48	0.190	0.27	-0.16
Body	WCDMA1900	9400	1880	RMC	Bottom Edge	10mm	\	18.94	20.50	0.376	0.54	0.206	0.30	-0.13
Body	WCDMA1900	9262	1852.4	RMC	Bottom Edge	10mm	Fig.A6	18.92	20.50	0.408	0.59	0.227	0.33	-0.02
Body	WCDMA1900	9262	1852.4	RMC	Bottom Edge	10mm	B2	18.92	20.50	0.389	0.56	0.216	0.31	0.13
Body	WCDMA1900	9400	1880	RMC	Front	15mm	\	19.94	21.50	0.072	0.10	0.043	0.06	-0.01
Body	WCDMA1900	9538	1907.6	RMC	Rear	15mm	\	20.04	21.50	0.156	0.22	0.091	0.13	0.14
Body	WCDMA1900	9400	1880	RMC	Rear	15mm	\	19.94	21.50	0.161	0.23	0.095	0.14	-0.17
Body	WCDMA1900	9262	1852.4	RMC	Rear	15mm	Fig.A7	19.91	21.50	0.167	0.24	0.100	0.14	0.04
Body	WCDMA1900	9262	1852.4	RMC	Rear	15mm	B2	19.91	21.50	0.160	0.23	0.096	0.14	-0.04
Head	WCDMA1700	1412	1732.4	RMC	Left Cheek	0mm	\	24.59	25.50	0.148	0.18	0.096	0.12	0.03
Head	WCDMA1700	1513	1752.6	RMC	Left Cheek	0mm	Fig.A8	24.54	25.50	0.169	0.21	0.108	0.13	-0.07
Head	WCDMA1700	1312	1712.4	RMC	Left Cheek	0mm	\	24.64	25.50	0.140	0.17	0.089	0.11	0.02
Head	WCDMA1700	1412	1732.4	RMC	Left Tilt	0mm	\	24.59	25.50	0.096	0.12	0.064	0.08	-0.11
Head	WCDMA1700	1412	1732.4	RMC	Right Cheek	0mm	\	24.59	25.50	0.113	0.14	0.076	0.09	0.09
Head	WCDMA1700	1412	1732.4	RMC	Right Tilt	0mm	\	24.59	25.50	0.104	0.13	0.065	0.08	-0.10
Head	WCDMA1700	1513	1752.6	RMC	Left Cheek	0mm	B2	24.54	25.50	0.144	0.18	0.097	0.12	-0.08
Body	WCDMA1700	1412	1732.5	RMC	Front	15mm	\	20.09	22.00	0.127	0.20	0.077	0.12	-0.11
Body	WCDMA1700	1513	1752.6	RMC	Rear	15mm	\	20.15	22.00	0.264	0.40	0.154	0.24	0.02
Body	WCDMA1700	1412	1732.5	RMC	Rear	15mm	\	20.09	22.00	0.267	0.41	0.154	0.24	-0.01
Body	WCDMA1700	1312	1712.4	RMC	Rear	15mm	Fig.A9	20.09	22.00	0.285	0.44	0.164	0.25	0.15
Body	WCDMA1700	1312	1712.4	RMC	Rear	15mm	B2	20.09	22.00	0.267	0.41	0.151	0.23	-0.19
Body	WCDMA1700	1412	1732.5	RMC	Front	10mm	\	19.09	20.00	0.313	0.39	0.175	0.22	-0.10
Body	WCDMA1700	1513	1752.6	RMC	Rear	10mm	\	19.16	20.00	0.686	0.83	0.372	0.45	0.07
Body	WCDMA1700	1412	1732.5	RMC	Rear	10mm	\	19.09	20.00	0.675	0.83	0.360	0.44	0.11
Body	WCDMA1700	1312	1712.4	RMC	Rear	10mm	\	19.04	20.00	0.75	0.94	0.403	0.50	-0.07
Body	WCDMA1700	1412	1732.5	RMC	Left Edge	10mm	\	19.09	20.00	0.088	0.11	0.053	0.07	0.12
Body	WCDMA1700	1412	1732.5	RMC	Right Edge	10mm	\	19.09	20.00	0.053	0.06	0.032	0.04	-0.03
Body	WCDMA1700	1513	1752.6	RMC	Bottom Edge	10mm	Fig.A10	19.16	20.00	0.885	1.07	0.468	0.57	-0.07
Body	WCDMA1700	1412	1732.5	RMC	Bottom Edge	10mm	\	19.09	20.00	0.861	1.06	0.462	0.57	-0.12
Body	WCDMA1700	1312	1712.4	RMC	Bottom Edge	10mm	\	19.04	20.00	0.844	1.05	0.453	0.57	-0.05
Body	WCDMA1700	1513	1752.6	RMC	Bottom Edge	10mm	B2	19.16	20.00	0.865	1.05	0.444	0.54	0.00
Body	WCDMA1700	1513	1752.6	RMC	Rear	0mm	\	20.15	22.00	2.970	4.55	1.200	1.84	-0.16
Body	WCDMA1700	1412	1732.5	RMC	Rear	0mm	\	20.09	22.00	3.110	4.83	1.190	1.85	0.03
Body	WCDMA1700	1312	1712.4	RMC	Rear	0mm	\	20.09	22.00	3.01	4.67	1.240	1.92	-0.05
Body	WCDMA1700	1412	1732.5	RMC	Bottom Edge	0mm	\	20.09	22.00	2.850	4.42	1.200	1.86	-0.06
Body	WCDMA1700	1312	1712.4	RMC	Bottom Edge	0mm	\	20.09	22.00	2.781	4.32	1.100	1.71	-0.18
Body	WCDMA1700	1513	1752.6	RMC	Bottom Edge	0mm	\	20.15	22.00	2.930	4.49	1.280	1.96	0.04
Head	WCDMA 850	4183	836.6	RMC	Left Cheek	0mm	\	22.01	23.00	0.195	0.24	0.107	0.13	0.13
Head	WCDMA 850	4233	846.6	RMC	Left Tilt	0mm	\	22.12	23.00	0.156	0.19	0.089	0.11	0.04
Head	WCDMA 850	4183	836.6	RMC	Left Tilt	0mm	Fig.A11	22.01	23.00	0.213	0.27	0.119	0.15	-0.18
Head	WCDMA 850	4132	826.4	RMC	Left Tilt	0mm	\	22.02	23.00	0.161	0.20	0.094	0.12	0.02
Head	WCDMA 850	4183	836.6	RMC	Right Cheek	0mm	\	22.01	23.00	0.207	0.26	0.116	0.15	-0.02
Head	WCDMA 850	4183	836.6	RMC	Right Tilt	0mm	\	22.01	23.00	0.203	0.26	0.111	0.14	0.16
Head	WCDMA 850	4183	836.6	RMC	Left Tilt	0mm	B2	22.01	23.00	0.199	0.25	0.108	0.14	0.10
Body	WCDMA 850	4183	836.6	RMC	Front	10mm	\	24.21	24.50	0.087	0.09	0.052	0.06	0.17
Body	WCDMA 850	4233	846.6	RMC	Rear	10mm	\	24.25	24.50	0.230	0.24	0.128	0.14	0.07
Body	WCDMA 850	4183	836.6	RMC	Rear	10mm	Fig.A12	24.21	24.50	0.258	0.28	0.145	0.16	-0.12
Body	WCDMA 850	4132	826.4	RMC	Rear	10mm	\	24.17	24.50	0.247	0.27	0.140	0.15	-0.08
Body	WCDMA 850	4183	836.6	RMC	Left Edge	10mm	\	24.21	24.50	0.064	0.07	0.043	0.05	-0.10
Body	WCDMA 850	4183	836.6	RMC	Right Edge	10mm	\	24.21	24.50	0.084	0.09	0.057	0.06	-0.01
Body	WCDMA 850	4183	836.6	RMC	Top Edge	10mm	\	24.21	24.50	0.165	0.18	0.083	0.09	-0.15
Body	WCDMA 850	4183	836.6	RMC	Rear	10mm	B2	24.21	24.50	0.240	0.26	0.137	0.15	0.18

RF Exposure Conditions	Frequency Band	Channel Number	Frequency (MHz)	Mode/RB	Test Position	Distance	Figure No./Note	EUT Measured Power (dBm)	Tune up (dBm)	Measured SAR 1g (W/kg)	Calculated SAR 1g (W/kg)	Measured SAR 10g (W/kg)	Calculated SAR 10g (W/kg)	Power Drift
Head	LTE Band12	23095	707.5	1RB-Middle	Left Cheek	0mm	Fig.A13	21.92	23	0.310	0.40	0.203	0.26	0.14
Head	LTE Band12	23095	707.5	1RB-Middle	Left Tilt	0mm	\	21.92	23	0.187	0.24	0.150	0.19	-0.15
Head	LTE Band12	23095	707.5	1RB-Middle	Right Cheek	0mm	\	21.92	23	0.224	0.29	0.169	0.22	0.08
Head	LTE Band12	23095	707.5	1RB-Middle	Right Tilt	0mm	\	21.92	23	0.178	0.23	0.123	0.16	-0.05
Head	LTE Band12	23135	711	25RB-Low	Left Cheek	0mm	\	21.87	23	0.205	0.27	0.162	0.21	0.01
Head	LTE Band12	23135	711	25RB-Low	Left Tilt	0mm	\	21.87	23	0.173	0.22	0.121	0.16	0.03
Head	LTE Band12	23135	711	25RB-Low	Right Cheek	0mm	\	21.87	23	0.221	0.29	0.165	0.21	-0.09
Head	LTE Band12	23135	711	25RB-Low	Right Tilt	0mm	\	21.87	23	0.168	0.22	0.117	0.15	0.02
Head	LTE Band12	23095	707.5	1RB-Middle	Left Cheek	0mm	B2	21.92	23	0.289	0.37	0.191	0.24	-0.08
Body	LTE Band12	23095	707.5	1RB-Middle	Front	10mm	\	24.36	24.5	0.161	0.17	0.116	0.12	-0.19
Body	LTE Band12	23095	707.5	1RB-Middle	Rear	10mm	Fig.A14	24.36	24.5	0.361	0.37	0.210	0.22	0.17
Body	LTE Band12	23095	707.5	1RB-Middle	Left Edge	10mm	\	24.36	24.5	0.236	0.24	0.156	0.16	-0.10
Body	LTE Band12	23095	707.5	1RB-Middle	Right Edge	10mm	\	24.36	24.5	0.239	0.25	0.159	0.16	0.02
Body	LTE Band12	23095	707.5	1RB-Middle	Top Edge	10mm	\	24.36	24.5	0.160	0.17	0.086	0.09	-0.09
Body	LTE Band12	23130	711	25RB-Middle	Front	10mm	\	23.43	23.50	0.191	0.19	0.138	0.14	0.00
Body	LTE Band12	23130	711	25RB-Middle	Rear	10mm	\	23.43	23.50	0.349	0.35	0.247	0.25	0.01
Body	LTE Band12	23130	711	25RB-Middle	Left Edge	10mm	\	23.43	23.50	0.179	0.18	0.119	0.12	-0.04
Body	LTE Band12	23130	711	25RB-Middle	Right Edge	10mm	\	23.43	23.50	0.237	0.24	0.158	0.16	-0.02
Body	LTE Band12	23130	711	25RB-Middle	Top Edge	10mm	\	23.43	23.50	0.171	0.17	0.092	0.09	0.04
Body	LTE Band12	23095	707.5	1RB-Middle	Rear	10mm	B2	24.36	24.5	0.340	0.35	0.192	0.20	-0.10
Head	LTE Band13	23230	782	1RB-Middle	Left Cheek	0mm	Fig.A15	21.98	23	0.575	0.73	0.367	0.46	-0.09
Head	LTE Band13	23230	782	1RB-Middle	Left Tilt	0mm	\	21.98	23	0.433	0.55	0.240	0.30	0.17
Head	LTE Band13	23230	782	1RB-Middle	Right Cheek	0mm	\	21.98	23	0.377	0.48	0.271	0.34	0.08
Head	LTE Band13	23230	782	1RB-Middle	Right Tilt	0mm	\	21.98	23	0.299	0.38	0.205	0.26	0.03
Head	LTE Band13	23230	782	25RB-Middle	Left Cheek	0mm	\	21.94	23	0.421	0.54	0.302	0.39	0.02
Head	LTE Band13	23230	782	25RB-Middle	Left Tilt	0mm	\	21.94	23	0.316	0.40	0.194	0.25	0.16
Head	LTE Band13	23230	782	25RB-Middle	Right Cheek	0mm	\	21.94	23	0.310	0.40	0.216	0.28	-0.11
Head	LTE Band13	23230	782	25RB-Middle	Right Tilt	0mm	\	21.94	23	0.256	0.33	0.163	0.21	-0.03
Head	LTE Band13	23230	782	1RB-Middle	Left Cheek	0mm	B2	21.98	23	0.551	0.70	0.341	0.43	0.14
Body	LTE Band13	23230	782	1RB-Middle	Front	10mm	\	24.35	24.5	0.104	0.11	0.077	0.08	-0.02
Body	LTE Band13	23230	782	1RB-Middle	Rear	10mm	Fig.A16	24.35	24.5	0.313	0.32	0.181	0.19	0.14
Body	LTE Band13	23230	782	1RB-Middle	Left Edge	10mm	\	24.35	24.5	0.145	0.15	0.099	0.10	-0.19
Body	LTE Band13	23230	782	1RB-Middle	Right Edge	10mm	\	24.35	24.5	0.220	0.23	0.151	0.16	0.00
Body	LTE Band13	23230	782	1RB-Middle	Top Edge	10mm	\	24.35	24.5	0.176	0.18	0.097	0.10	0.09
Body	LTE Band13	23230	782	25RB-Low	Front	10mm	\	23.34	23.50	0.099	0.10	0.073	0.08	0.16
Body	LTE Band13	23230	782	25RB-Low	Rear	10mm	\	23.34	23.50	0.215	0.22	0.122	0.13	-0.01
Body	LTE Band13	23230	782	25RB-Low	Left Edge	10mm	\	23.34	23.50	0.112	0.12	0.076	0.08	0.17
Body	LTE Band13	23230	782	25RB-Low	Right Edge	10mm	\	23.34	23.50	0.193	0.20	0.132	0.14	-0.03
Body	LTE Band13	23230	782	25RB-Low	Top Edge	10mm	\	23.34	23.50	0.130	0.13	0.072	0.07	0.01
Body	LTE Band13	23230	782	1RB-Middle	Rear	10mm	B2	24.35	24.5	0.291	0.30	0.170	0.18	-0.19
Head	LTE Band25	26590	1905	1RB-Middle	Left Cheek	0mm	\	24.28	25	0.238	0.28	0.142	0.17	-0.14
Head	LTE Band25	26590	1905	1RB-Middle	Left Tilt	0mm	\	24.28	25	0.191	0.23	0.116	0.14	0.04
Head	LTE Band25	26590	1905	1RB-Middle	Right Cheek	0mm	Fig.A17	24.28	25	0.262	0.31	0.168	0.20	0.13
Head	LTE Band25	26590	1905	1RB-Middle	Right Tilt	0mm	\	24.28	25	0.258	0.30	0.148	0.17	0.16
Head	LTE Band25	26590	1905	50RB-Middle	Left Cheek	0mm	\	23.22	24.00	0.166	0.20	0.106	0.13	0.05
Head	LTE Band25	26590	1905	50RB-Middle	Left Tilt	0mm	\	23.22	24.00	0.156	0.19	0.099	0.12	-0.05
Head	LTE Band25	26590	1905	50RB-Middle	Right Cheek	0mm	\	23.22	24.00	0.212	0.25	0.138	0.17	-0.14
Head	LTE Band25	26590	1905	50RB-Middle	Right Tilt	0mm	\	23.22	24.00	0.164	0.20	0.096	0.11	-0.08
Head	LTE Band25	26590	1905	1RB-Middle	Right Cheek	0mm	B2	24.28	25	0.249	0.29	0.153	0.18	-0.09
Body	LTE Band25	26590	1905	1RB-Middle	Front	10mm	\	19.24	20.5	0.154	0.21	0.094	0.13	0.05
Body	LTE Band25	26590	1905	1RB-Middle	Rear	10mm	\	19.24	20.5	0.275	0.37	0.160	0.21	-0.15
Body	LTE Band25	26590	1905	1RB-Middle	Left Edge	10mm	\	19.24	20.5	0.054	0.07	0.033	0.04	-0.15
Body	LTE Band25	26590	1905	1RB-Middle	Right Edge	10mm	\	19.24	20.5	0.112	0.15	0.069	0.09	0.06
Body	LTE Band25	26590	1905	1RB-Middle	Bottom Edge	10mm	Fig.A18	19.24	20.5	0.361	0.48	0.192	0.26	0.03
Body	LTE Band25	26590	1905	50RB-Middle	Front	10mm	\	19.20	20.5	0.174	0.23	0.106	0.14	0.00
Body	LTE Band25	26590	1905	50RB-Middle	Rear	10mm	\	19.20	20.5	0.246	0.33	0.139	0.19	-0.09
Body	LTE Band25	26590	1905	50RB-Middle	Left Edge	10mm	\	19.20	20.5	0.053	0.07	0.031	0.04	0.00
Body	LTE Band25	26590	1905	50RB-Middle	Right Edge	10mm	\	19.20	20.5	0.098	0.13	0.061	0.08	0.06
Body	LTE Band25	26590	1905	50RB-Middle	Bottom Edge	10mm	\	19.20	20.5	0.340	0.46	0.180	0.24	0.12
Body	LTE Band25	26590	1905	1RB-Middle	Bottom Edge	10mm	B2	19.24	20.5	0.350	0.47	0.181	0.24	-0.15
Body	LTE Band25	26140	1860	1RB-Middle	Front	15mm	\	20.97	21.5	0.167	0.19	0.100	0.11	-0.12
Body	LTE Band25	26140	1860	1RB-Middle	Rear	15mm	Fig.A19	20.97	21.5	0.279	0.32	0.162	0.18	-0.10
Body	LTE Band25	26590	1905	50RB-High	Front	15mm	\	20.95	21.5	0.156	0.18	0.093	0.11	0.14
Body	LTE Band25	26590	1905	50RB-High	Rear	15mm	\	20.95	21.5	0.230	0.26	0.134	0.15	0.00
Body	LTE Band25	26140	1860	1RB-Middle	Rear	15mm	B2	20.97	21.5	0.260	0.29	0.151	0.17	-0.06

RF Exposure Conditions	Frequency Band	Channel Number	Frequency (MHz)	Mode/RB	Test Position	Distance	Figure No./Note	EUT Measured Power (dBm)	Tune up (dBm)	Measured SAR 1g (W/kg)	Calculated SAR 1g (W/kg)	Measured SAR 10g (W/kg)	Calculated SAR 10g (W/kg)	Power Drift
Head	LTE Band26	26865	831.5	1RB-Middle	Left Cheek	0mm	Fig.A20	21.97	23	0.366	0.46	0.236	0.30	-0.19
Head	LTE Band26	26865	831.5	1RB-Middle	Left Tilt	0mm	\	21.97	23	0.283	0.36	0.159	0.20	-0.05
Head	LTE Band26	26865	831.5	1RB-Middle	Right Cheek	0mm	\	21.97	23	0.319	0.40	0.196	0.25	-0.06
Head	LTE Band26	26865	831.5	1RB-Middle	Right Tilt	0mm	\	21.97	23	0.297	0.38	0.163	0.21	-0.09
Head	LTE Band26	26865	831.5	36RB-Middle	Left Cheek	0mm	\	21.96	23	0.342	0.43	0.220	0.28	-0.19
Head	LTE Band26	26865	831.5	36RB-Middle	Left Tilt	0mm	\	21.96	23	0.305	0.39	0.172	0.22	0.10
Head	LTE Band26	26865	831.5	36RB-Middle	Right Cheek	0mm	\	21.96	23	0.325	0.41	0.197	0.25	0.03
Head	LTE Band26	26865	831.5	36RB-Middle	Right Tilt	0mm	\	21.96	23	0.257	0.33	0.143	0.18	-0.11
Head	LTE Band26	26865	831.5	1RB-Middle	Left Cheek	0mm	B2	21.97	23	0.341	0.43	0.211	0.27	0.11
Body	LTE Band26	26865	831.5	1RB-Middle	Front	10mm	\	24.23	25	0.160	0.19	0.097	0.12	-0.13
Body	LTE Band26	26865	831.5	1RB-Middle	Rear	10mm	Fig.A21	24.23	25	0.398	0.48	0.226	0.27	0.06
Body	LTE Band26	26865	831.5	1RB-Middle	Left Edge	10mm	\	24.23	25	0.167	0.20	0.113	0.13	0.07
Body	LTE Band26	26865	831.5	1RB-Middle	Right Edge	10mm	\	24.23	25	0.234	0.28	0.158	0.19	0.03
Body	LTE Band26	26865	831.5	1RB-Middle	Top Edge	10mm	\	24.23	25	0.214	0.26	0.119	0.14	-0.05
Body	LTE Band26	26865	831.5	36RB-Middle	Front	10mm	\	23.27	24.00	0.134	0.16	0.097	0.11	-0.13
Body	LTE Band26	26865	831.5	36RB-Middle	Rear	10mm	\	23.27	24.00	0.355	0.42	0.197	0.23	-0.02
Body	LTE Band26	26865	831.5	36RB-Middle	Left Edge	10mm	\	23.27	24.00	0.163	0.19	0.107	0.13	0.00
Body	LTE Band26	26865	831.5	36RB-Middle	Right Edge	10mm	\	23.27	24.00	0.191	0.23	0.125	0.15	-0.03
Body	LTE Band26	26865	831.5	36RB-Middle	Top Edge	10mm	\	23.27	24.00	0.169	0.20	0.091	0.11	0.00
Body	LTE Band26	26865	831.5	1RB-Middle	Rear	10mm	B2	24.23	25	0.384	0.46	0.219	0.26	-0.08
Power Class 3 Receiver ON														
Head	LTE Band41	41055	2636.5	1RB-Middle	Left Cheek	0mm	Fig.A22	23.36	24	0.062	0.07	0.034	0.04	0.17
Head	LTE Band41	41055	2636.5	1RB-Middle	Left Tilt	0mm	\	23.36	24	0.019	0.02	0.014	0.02	0.05
Head	LTE Band41	41055	2636.5	1RB-Middle	Right Cheek	0mm	\	23.36	24	0.047	0.05	0.025	0.03	0.18
Head	LTE Band41	41055	2636.5	1RB-Middle	Right Tilt	0mm	\	23.36	24	0.046	0.05	0.023	0.03	0.16
Head	LTE Band41	41055	2636.5	50RB-Low	Left Cheek	0mm	\	22.30	23.00	0.059	0.07	0.031	0.04	0.00
Head	LTE Band41	41055	2636.5	50RB-Low	Left Tilt	0mm	\	22.30	23.00	0.018	0.02	0.012	0.01	-0.12
Head	LTE Band41	41055	2636.5	50RB-Low	Right Cheek	0mm	\	22.30	23.00	0.039	0.05	0.020	0.02	-0.15
Head	LTE Band41	41055	2636.5	50RB-Low	Right Tilt	0mm	\	22.30	23.00	0.021	0.02	0.011	0.01	0.13
Head	LTE Band41	41055	2636.5	1RB-Middle	Left Cheek	0mm	B2	23.36	24	0.059	0.07	0.031	0.04	0.04
Power Class 3 Receiver ON														
Body	LTE Band41	40620	2593	1RB-Middle	Front	10mm	\	18.49	19	0.085	0.10	0.043	0.05	0.10
Body	LTE Band41	40620	2593	1RB-Middle	Rear	10mm	Fig.A23	18.49	19	0.279	0.31	0.126	0.14	-0.09
Body	LTE Band41	40620	2593	1RB-Middle	Left Edge	10mm	\	18.49	19	0.030	0.03	0.008	0.01	-0.13
Body	LTE Band41	40620	2593	1RB-Middle	Right Edge	10mm	\	18.49	19	0.023	0.03	0.012	0.01	-0.06
Body	LTE Band41	40620	2593	1RB-Middle	Bottom Edge	10mm	\	18.49	19	0.160	0.18	0.080	0.09	0.15
Body	LTE Band41	41055	2636.5	50RB-Low	Front	10mm	\	18.45	19	0.076	0.09	0.039	0.04	-0.19
Body	LTE Band41	41055	2636.5	50RB-Low	Rear	10mm	\	18.45	19	0.246	0.28	0.118	0.13	0.10
Body	LTE Band41	41055	2636.5	50RB-Low	Left Edge	10mm	\	18.45	19	0.029	0.03	0.019	0.02	-0.01
Body	LTE Band41	41055	2636.5	50RB-Low	Right Edge	10mm	\	18.45	19	0.033	0.04	0.010	0.01	0.03
Body	LTE Band41	41055	2636.5	50RB-Low	Bottom Edge	10mm	\	18.45	19	0.159	0.18	0.079	0.09	0.09
Body	LTE Band41	40620	2593	1RB-Middle	Rear	10mm	B2	18.49	19	0.260	0.29	0.111	0.12	-0.12
Power Class 3 Receiver ON														
Body	LTE Band41	41055	2636.5	1RB-Middle	Front	15mm	\	19.49	20	0.057	0.06	0.032	0.04	-0.18
Body	LTE Band41	41055	2636.5	1RB-Middle	Rear	15mm	Fig.A24	19.49	20	0.156	0.18	0.077	0.09	-0.02
Body	LTE Band41	41055	2636.5	50RB-Low	Front	15mm	\	19.48	20	0.056	0.06	0.031	0.03	0.04
Body	LTE Band41	41055	2636.5	50RB-Low	Rear	15mm	\	19.48	20	0.154	0.17	0.074	0.08	0.09
Body	LTE Band41	41055	2636.5	1RB-Middle	Rear	15mm	B2	19.49	20	0.152	0.17	0.071	0.08	-0.10
Power Class 2 Receiver ON														
Head	LTE Band41	40620	2593	1RB-Low	Left Cheek	0mm	Fig.A25	26.98	27	0.079	0.08	0.045	0.05	-0.17
Head	LTE Band41	40620	2593	1RB-Low	Left Tilt	0mm	\	26.98	27	0.030	0.03	0.016	0.02	-0.17
Head	LTE Band41	40620	2593	1RB-Low	Right Cheek	0mm	\	26.98	27	0.060	0.06	0.032	0.03	0.17
Head	LTE Band41	40620	2593	1RB-Low	Right Tilt	0mm	\	26.98	27	0.049	0.05	0.026	0.03	-0.19
Head	LTE Band41	41055	2636.5	50RB-Middle	Left Cheek	0mm	\	26.44	26.00	0.056	0.05	0.028	0.03	-0.09
Head	LTE Band41	41055	2636.5	50RB-Middle	Left Tilt	0mm	\	26.44	26.00	0.000	0.00	0.000	0.00	-0.13
Head	LTE Band41	41055	2636.5	50RB-Middle	Right Cheek	0mm	\	26.44	26.00	0.045	0.04	0.022	0.02	0.01
Head	LTE Band41	41055	2636.5	50RB-Middle	Right Tilt	0mm	\	26.44	26.00	0.000	0.00	0.000	0.00	-0.11
Head	LTE Band41	40620	2593	1RB-Low	Left Cheek	0mm	B2	26.98	27	0.072	0.07	0.041	0.04	0.05
Power Class 2 Receiver ON														
Body	LTE Band41	40620	2593	1RB-Middle	Front	10mm	\	21.47	22	0.080	0.09	0.042	0.05	0.03
Body	LTE Band41	40620	2593	1RB-Middle	Rear	10mm	Fig.A26	21.47	22	0.280	0.32	0.131	0.15	-0.05
Body	LTE Band41	40620	2593	1RB-Middle	Left Edge	10mm	\	21.47	22	0.028	0.03	0.017	0.02	-0.08
Body	LTE Band41	40620	2593	1RB-Middle	Right Edge	10mm	\	21.47	22	0.000	0.00	0.000	0.00	0.02
Body	LTE Band41	40620	2593	1RB-Middle	Bottom Edge	10mm	\	21.47	22	0.191	0.22	0.092	0.10	-0.13
Body	LTE Band41	40620	2593	50RB-Middle	Front	10mm	\	21.48	22	0.088	0.10	0.045	0.05	0.01
Body	LTE Band41	40620	2593	50RB-Middle	Rear	10mm	\	21.48	22	0.264	0.30	0.123	0.14	0.07
Body	LTE Band41	40620	2593	50RB-Middle	Left Edge	10mm	\	21.48	22	0.035	0.04	0.018	0.02	-0.12
Body	LTE Band41	40620	2593	50RB-Middle	Right Edge	10mm	\	21.48	22	0.015	0.02	0.006	0.01	0.02
Body	LTE Band41	40620	2593	50RB-Middle	Bottom Edge	10mm	\	21.48	22	0.203	0.23	0.098	0.11	-0.12
Body	LTE Band41	40620	2593	1RB-Middle	Rear	10mm	B2	21.47	22	0.269	0.30	0.120	0.14	0.16
Power Class 2 Receiver ON														
Body	LTE Band41	40620	2593	1RB-Middle	Front	15mm	\	22.50	23	0.072	0.08	0.040	0.04	0.07
Body	LTE Band41	40620	2593	1RB-Middle	Rear	15mm	Fig.A27	22.50	23	0.235	0.26	0.116	0.13	0.09
Body	LTE Band41	41055	2636.5	50RB-Low	Front	15mm	\	22.49	23	0.075	0.08	0.038	0.04	-0.10
Body	LTE Band41	41055	2636.5	50RB-Low	Rear	15mm	\	22.49	23	0.196	0.22	0.092	0.10	0.14
Body	LTE Band41	40620	2593	1RB-Middle	Rear	15mm	B2	22.50	23	0.192	0.22	0.095	0.11	0.13

RF Exposure Conditions	Frequency Band	Channel Number	Frequency (MHz)	Mode/RB	Test Position	Distance	Figure No./Note	EUT Measured Power (dBm)	Tune up (dBm)	Measured SAR 1g (W/kg)	Calculated SAR 1g (W/kg)	Measured SAR 10g (W/kg)	Calculated SAR 10g (W/kg)	Power Drift
Head	LTE Band66	132072	1720	1RB-Middle	Left Cheek	0mm	Fig.A28	24.90	25	0.190	0.19	0.123	0.13	-0.01
Head	LTE Band66	132072	1720	1RB-Middle	Left Tilt	0mm	\	24.90	25	0.114	0.12	0.079	0.08	0.15
Head	LTE Band66	132072	1720	1RB-Middle	Right Cheek	0mm	\	24.90	25	0.158	0.16	0.110	0.11	-0.13
Head	LTE Band66	132072	1720	1RB-Middle	Right Tilt	0mm	\	24.90	25	0.150	0.15	0.097	0.10	0.03
Head	LTE Band66	132572	1770	50RB-Middle	Left Cheek	0mm	\	23.97	24.00	0.095	0.10	0.059	0.06	0.17
Head	LTE Band66	132572	1770	50RB-Middle	Left Tilt	0mm	\	23.97	24.00	0.071	0.07	0.044	0.04	0.03
Head	LTE Band66	132572	1770	50RB-Middle	Right Cheek	0mm	\	23.97	24.00	0.092	0.09	0.060	0.06	0.01
Head	LTE Band66	132572	1770	50RB-Middle	Right Tilt	0mm	\	23.97	24.00	0.081	0.08	0.051	0.05	-0.17
Head	LTE Band66	132072	1720	1RB-Middle	Left Cheek	0mm	B2	24.90	25	0.178	0.18	0.101	0.10	0.17
Body	LTE Band66	132322	1745	1RB-Middle	Front	10mm	\	19.98	21	0.211	0.27	0.121	0.15	0.02
Body	LTE Band66	132322	1745	1RB-Middle	Rear	10mm	\	19.98	21	0.499	0.63	0.274	0.35	0.01
Body	LTE Band66	132322	1745	1RB-Middle	Left Edge	10mm	\	19.98	21	0.061	0.08	0.038	0.05	0.01
Body	LTE Band66	132322	1745	1RB-Middle	Right Edge	10mm	\	19.98	21	0.048	0.06	0.029	0.04	-0.04
Body	LTE Band66	132322	1745	1RB-Middle	Bottom Edge	10mm	Fig.A29	19.98	21	0.618	0.78	0.329	0.42	-0.04
Body	LTE Band66	132322	1745	50RB-Middle	Front	10mm	\	19.92	21	0.220	0.28	0.127	0.16	-0.10
Body	LTE Band66	132322	1745	50RB-Middle	Rear	10mm	\	19.92	21	0.474	0.61	0.257	0.33	-0.14
Body	LTE Band66	132322	1745	50RB-Middle	Left Edge	10mm	\	19.92	21	0.062	0.08	0.039	0.05	0.10
Body	LTE Band66	132322	1745	50RB-Middle	Right Edge	10mm	\	19.92	21	0.050	0.06	0.031	0.04	0.02
Body	LTE Band66	132322	1745	50RB-Middle	Bottom Edge	10mm	\	19.92	21	0.564	0.72	0.306	0.39	-0.11
Body	LTE Band66	132322	1745	1RB-Middle	Bottom Edge	10mm	B2	19.98	21	0.590	0.75	0.300	0.38	-0.10
Body	LTE Band66	132322	1745	1RB-Middle	Front	15mm	\	22.02	22.5	0.190	0.21	0.108	0.12	0.01
Body	LTE Band66	132322	1745	1RB-Middle	Rear	15mm	Fig.A30	22.02	22.5	0.363	0.41	0.209	0.23	0.02
Body	LTE Band66	132322	1745	50RB-High	Front	15mm	\	21.96	22.5	0.189	0.21	0.113	0.13	0.01
Body	LTE Band66	132322	1745	50RB-High	Rear	15mm	\	21.96	22.5	0.353	0.40	0.202	0.23	0.02
Body	LTE Band66	132322	1745	1RB-Middle	Rear	15mm	B2	22.02	22.5	0.340	0.38	0.192	0.21	0.10
Head	LTE Band71	133372	688	1RB-Middle	Left Cheek	0mm	\	21.98	23	0.480	0.61	0.320	0.40	0.18
Head	LTE Band71	133372	688	1RB-Middle	Left Tilt	0mm	\	21.98	23	0.346	0.44	0.213	0.27	-0.09
Head	LTE Band71	133372	688	1RB-Middle	Right Cheek	0mm	Fig.A31	21.98	23	0.505	0.64	0.325	0.41	0.11
Head	LTE Band71	133372	688	1RB-Middle	Right Tilt	0mm	\	21.98	23	0.387	0.49	0.225	0.28	0.09
Head	LTE Band71	133322	683	50RB-Middle	Left Cheek	0mm	\	21.96	23	0.347	0.44	0.234	0.30	-0.01
Head	LTE Band71	133322	683	50RB-Middle	Left Tilt	0mm	\	21.96	23	0.310	0.39	0.184	0.23	0.17
Head	LTE Band71	133322	683	50RB-Middle	Right Cheek	0mm	\	21.96	23	0.396	0.50	0.251	0.32	-0.17
Head	LTE Band71	133322	683	50RB-Middle	Right Tilt	0mm	\	21.96	23	0.315	0.40	0.182	0.23	-0.02
Head	LTE Band71	133372	688	1RB-Middle	Right Cheek	0mm	B2	21.98	23	0.480	0.61	0.301	0.38	-0.17
Body	LTE Band71	133222	673	1RB-Middle	Front	10mm	\	24.40	24.5	0.237	0.24	0.154	0.16	0.13
Body	LTE Band71	133222	673	1RB-Middle	Rear	10mm	Fig.A32	24.40	24.5	0.526	0.54	0.397	0.41	-0.18
Body	LTE Band71	133222	673	1RB-Middle	Left Edge	10mm	\	24.40	24.5	0.168	0.17	0.101	0.10	-0.04
Body	LTE Band71	133222	673	1RB-Middle	Right Edge	10mm	\	24.40	24.5	0.266	0.27	0.161	0.17	-0.05
Body	LTE Band71	133222	673	1RB-Middle	Top Edge	10mm	\	24.40	24.5	0.200	0.20	0.094	0.10	0.08
Body	LTE Band71	133222	673	50RB-Middle	Front	10mm	\	23.45	23.50	0.206	0.21	0.133	0.13	0.07
Body	LTE Band71	133222	673	50RB-Middle	Rear	10mm	\	23.45	23.50	0.390	0.39	0.253	0.26	-0.07
Body	LTE Band71	133222	673	50RB-Middle	Left Edge	10mm	\	23.45	23.50	0.115	0.12	0.068	0.07	-0.08
Body	LTE Band71	133222	673	50RB-Middle	Right Edge	10mm	\	23.45	23.50	0.227	0.23	0.138	0.14	0.10
Body	LTE Band71	133222	673	50RB-Middle	Top Edge	10mm	\	23.45	23.50	0.199	0.20	0.098	0.10	0.17
Body	LTE Band71	133222	673	1RB-Middle	Rear	10mm	B2	24.40	24.5	0.501	0.51	0.380	0.39	0.12

14.2 SAR results for Standard procedure

There is zoom scan measurement to be added for the highest measured SAR in each exposure configuration/band.

RF Exposure Conditions	Frequency Band	Channel Number	Frequency (MHz)	Mode/RB	Test Position	Distance	Figure No./Note	EUT Measured Power (dBm)	Tune up (dBm)	Measured SAR 1g (W/kg)	Calculated SAR 1g (W/kg)	Measured SAR 10g (W/kg)	Calculated SAR 10g (W/kg)	Power Drift
Head	GSM850	251	848.8	\	Left Cheek	0mm	Fig.A1	31.96	33.30	0.195	0.27	0.150	0.20	0.02
Body	GSM850	128	824.2	GPRS(4TX)	Rear	10mm	Fig.A2	26.21	27.00	0.148	0.18	0.101	0.12	-0.11
Head	GSM1900	810	1909.8	\	Right Cheek	0mm	Fig.A3	30.22	31.00	0.124	0.15	0.081	0.10	0.15
Body	GSM1900	512	1850.2	GPRS(1TX)	Bottom Edge	10mm	Fig.A4	30.20	31.00	0.501	0.60	0.264	0.32	-0.06
Head	WCDMA1900	9538	1907.6	RMC	Right Cheek	0mm	Fig.A5	23.86	24.50	0.285	0.33	0.189	0.22	-0.11
Body	WCDMA1900	9262	1852.4	RMC	Bottom Edge	10mm	Fig.A6	18.92	20.50	0.408	0.59	0.227	0.33	-0.12
Body	WCDMA1900	9262	1852.4	RMC	Rear	15mm	Fig.A7	19.91	21.50	0.167	0.24	0.100	0.14	0.12
Head	WCDMA1700	1513	1752.6	RMC	Left Cheek	0mm	Fig.A8	24.54	25.50	0.169	0.21	0.108	0.13	0.09
Body	WCDMA1700	1312	1712.4	RMC	Rear	15mm	Fig.A9	20.09	22.00	0.285	0.44	0.164	0.25	-0.12
Body	WCDMA1700	1513	1752.6	RMC	Bottom Edge	10mm	Fig.A10	19.16	20.00	0.885	1.07	0.468	0.57	-0.05
Head	WCDMA 850	4183	836.6	RMC	Left Tilt	0mm	Fig.A11	22.01	23.00	0.213	0.27	0.119	0.15	-0.18
Body	WCDMA 850	4183	836.6	RMC	Rear	10mm	Fig.A12	24.21	24.50	0.258	0.28	0.145	0.16	-0.12
Head	LTE Band12	23095	707.5	1RB-Middle	Left Cheek	0mm	Fig.A13	21.92	23	0.310	0.40	0.203	0.26	0.14
Body	LTE Band12	23095	707.5	1RB-Middle	Rear	10mm	Fig.A14	24.36	24.5	0.361	0.37	0.210	0.22	0.17
Head	LTE Band13	23230	782	1RB-Middle	Left Cheek	0mm	Fig.A15	21.98	23	0.575	0.73	0.367	0.46	0.18
Body	LTE Band13	23230	782	1RB-Middle	Rear	10mm	Fig.A16	24.35	24.5	0.313	0.32	0.181	0.19	-0.17
Head	LTE Band25	26590	1905	1RB-Middle	Right Cheek	0mm	Fig.A17	24.28	25	0.262	0.31	0.168	0.20	0.13
Body	LTE Band25	26590	1905	1RB-Middle	Bottom Edge	10mm	Fig.A18	19.24	20.5	0.361	0.48	0.192	0.26	-0.16
Body	LTE Band25	26140	1860	1RB-Middle	Rear	15mm	Fig.A19	20.97	21.5	0.279	0.32	0.162	0.18	-0.10
Head	LTE Band26	26865	831.5	1RB-Middle	Left Cheek	0mm	Fig.A20	21.97	23	0.366	0.46	0.236	0.30	-0.19
Body	LTE Band26	26865	831.5	1RB-Middle	Rear	10mm	Fig.A21	24.23	25	0.398	0.48	0.226	0.27	0.09
Head	LTE Band41	41055	2636.5	1RB-Middle	Left Cheek	0mm	Fig.A22	23.36	24	0.062	0.07	0.034	0.04	0.17
Body	LTE Band41	40620	2593	1RB-Middle	Rear	10mm	Fig.A23	18.49	19	0.279	0.31	0.126	0.14	-0.16
Body	LTE Band41	41055	2636.5	1RB-Middle	Rear	15mm	Fig.A24	19.49	20	0.156	0.18	0.077	0.09	-0.18
Head	LTE Band41	40620	2593	1RB-Low	Left Cheek	0mm	Fig.A25	26.98	27	0.079	0.08	0.045	0.05	-0.17
Body	LTE Band41	40620	2593	1RB-Middle	Rear	10mm	Fig.A26	21.47	22	0.280	0.32	0.131	0.15	-0.15
Body	LTE Band41	40620	2593	1RB-Middle	Rear	15mm	Fig.A27	22.50	23	0.235	0.26	0.116	0.13	-0.17
Head	LTE Band66	132072	1720	1RB-Middle	Left Cheek	0mm	Fig.A28	24.90	25	0.190	0.19	0.123	0.13	-0.01
Body	LTE Band66	132322	1745	1RB-Middle	Bottom Edge	10mm	Fig.A29	19.98	21	0.618	0.78	0.329	0.42	-0.04
Body	LTE Band66	132322	1745	1RB-Middle	Rear	15mm	Fig.A30	22.02	22.5	0.363	0.41	0.209	0.23	0.07
Head	LTE Band71	133372	688	1RB-Middle	Right Cheek	0mm	Fig.A31	21.98	23	0.505	0.64	0.325	0.41	-0.07
Body	LTE Band71	133222	673	1RB-Middle	Rear	10mm	Fig.A32	24.40	24.5	0.526	0.54	0.397	0.41	0.17

14.3 WLAN Evaluation for 2.4G

According to the KDB248227 D01, SAR is measured for 2.4GHz 802.11b DSSS using the initial test position procedure.

Head Evaluation-Standalone

Table 14.3-1: SAR Values (WLAN - Head)- 802.11b (Fast SAR)

Frequency		Side	Test Position	Figure No./ Note	Conducted Power (dBm)	Max. tune-up Power (dBm)	Measured SAR(10g) (W/kg)	Reported SAR(10g) (W/kg)	Measured SAR(1g) (W/kg)	Reported SAR(1g) (W/kg)	Power Drift (dB)
MHz	Ch.										
2437	6	Left	Cheek	/	20.33	21.00	0.123	0.14	0.211	0.25	-0.07
2437	6	Left	Tilt	/	20.33	21.00	0.107	0.12	0.198	0.23	0.15
2437	6	Right	Cheek	/	20.33	21.00	0.218	0.25	0.456	0.53	0.19
2437	6	Right	Tilt	/	20.33	21.00	0.125	0.15	0.262	0.31	-0.17
2437	6	Right	Cheek	B2	20.33	21.00	0.220	0.26	0.477	0.56	0.12

As shown above table, the initial test position for head is "Right Cheek". So the head SAR of WLAN is presented as below:

Table 14.3-2: SAR Values (WLAN - Head)– 802.11b (Full SAR)

Frequency		Side	Test Position	Figure No./ Note	Conducted Power (dBm)	Max. tune-up Power (dBm)	Measured SAR(10g) (W/kg)	Reported SAR(10g) (W/kg)	Measured SAR(1g) (W/kg)	Reported SAR(1g)(W/kg)	Power Drift (dB)
MHz	Ch.										
2437	6	Right	Cheek	Fig.33	20.33	21.00	0.236	0.28	0.493	0.58	0.10
2437	6	Right	Cheek	/	20.33	21.00	0.229	0.27	0.480	0.56	0.05

Note1: When the reported SAR of the initial test position is > 0.4 W/kg, SAR is repeated for the 802.11 transmission mode configuration tested in the initial test position using subsequent highest estimated 1-g SAR conditions determined by area scans, on the highest maximum output power channel, until the reported SAR is \leq 0.8 W/kg.

Note2: For all positions/configurations tested using the initial test position and subsequent test positions, when the reported SAR is > 0.8 W/kg, SAR is measured for these test positions/configurations on the subsequent next highest measured output power channel until the reported SAR is \leq 1.2 W/kg or all required channels are tested.

According to the KDB248227 D01, The reported SAR must be scaled to 100% transmission duty factor to determine compliance at the maximum tune-up tolerance limit. The scaled reported SAR is presented as below.

Table 14.3-3: SAR Values (WLAN - Head) – 802.11b (Scaled Reported SAR)

Frequency		Side	Test Position	Actual duty factor	maximum duty factor	Reported SAR (1g)(W/kg)	Scaled reported SAR (1g)(W/kg)
MHz	Ch.						
2437	6	Right	Cheek	100%	100%	0.58	0.58

SAR is not required for OFDM because the 802.11b adjusted SAR \leq 1.2 W/kg.

Body Evaluation- Standalone

Table 14.3-4: SAR Values (WLAN - Body)– 802.11b (Fast SAR)

Frequency		Test Position	Figure No./ Note	Conducted Power (dBm)	Max. tune-up Power (dBm)	Measured SAR(10g) (W/kg)	Reported SAR(10g) (W/kg)	Measured SAR(1g) (W/kg)	Reported SAR(1g)(W/kg)	Power Drift (dB)
MHz	Ch.									
2437	6	Front	/	20.33	21.00	0.042	0.05	0.075	0.09	0.04
2437	6	Rear	/	20.33	21.00	0.112	0.13	0.203	0.24	0.06
2437	6	Left	/	20.33	21.00	0.083	0.10	0.171	0.20	-0.04
2437	6	Top Edge	/	20.33	21.00	0.043	0.05	0.079	0.09	-0.12
2437	6	Rear	B2	20.33	21.00	0.093	0.11	0.195	0.23	-0.18

Note1: The distance between the EUT and the phantom bottom is 10mm.

As shown above table, the initial test position for body is “Rear ”. So the body SAR of WLAN is presented as below:

Table 14.3-5: SAR Values (WLAN - Body)– 802.11b (Full SAR)

Frequency		Test Position	Figure No./ Note	Conducted Power (dBm)	Max. tune-up Power (dBm)	Ambient Temperature: 22.9 °C		Liquid Temperature: 22.5 °C		Power Drift (dB)
MHz	Ch.					Measured SAR(10g) (W/kg)	Reported SAR(10g) (W/kg)	Measured SAR(1g) (W/kg)	Reported SAR(1g) (W/kg)	
2437	6	Rear	Fig.34	20.33	21.00	0.109	0.13	0.239	0.28	-0.03

Note1: When the reported SAR of the initial test position is > 0.4 W/kg, SAR is repeated for the 802.11 transmission mode configuration tested in the initial test position using subsequent highest estimated 1-g SAR conditions determined by area scans, on the highest maximum output power channel, until the reported SAR is \leq 0.8 W/kg.

Note2: For all positions/configurations tested using the initial test position and subsequent test positions, when the reported SAR is > 0.8 W/kg, SAR is measured for these test positions/configurations on the subsequent next highest measured output power channel until the reported SAR is \leq 1.2 W/kg or all required channels are tested.

According to the KDB248227 D01, The reported SAR must be scaled to 100% transmission duty factor to determine compliance at the maximum tune-up tolerance limit. The scaled reported SAR is presented as below.

Table 14.3-6: SAR Values (WLAN - Body) – 802.11b (Scaled Reported SAR)

Frequency		Test Position	Ambient Temperature: 22.9 °C		Liquid Temperature: 22.5 °C	
MHz	Ch.		Actual duty factor	maximum duty factor	Reported SAR (1g)(W/kg)	Scaled reported SAR (1g)(W/kg)
2412	1	Rear	100%	100%	0.28	0.28

SAR is not required for OFDM because the 802.11b adjusted SAR \leq 1.2 W/kg.

Body Evaluation- Standalone

Table 14.3-7: SAR Values (WLAN - Body)– 802.11b (Fast SAR)

Frequency		Test Position	Figure No./ Note	Conducted Power (dBm)	Max. tune-up Power (dBm)	Ambient Temperature: 22.9 °C		Liquid Temperature: 22.5 °C		Power Drift (dB)
MHz	Ch.					Measured SAR(10g) (W/kg)	Reported SAR(10g) (W/kg)	Measured SAR(1g) (W/kg)	Reported SAR(1g) (W/kg)	
2437	6	Front	/	20.33	21.00	0.040	0.05	0.067	0.08	0.06
2437	6	Rear	/	20.33	21.00	0.060	0.07	0.120	0.14	-0.17

Note1: The distance between the EUT and the phantom bottom is 15mm.

As shown above table, the initial test position for body is “Rear”. So the body SAR of WLAN is presented as below:

Table 14.3-8: SAR Values (WLAN - Body)– 802.11b (Full SAR)

Frequency		Test Position	Figure No./ Note	Conducted Power (dBm)	Max. tune-up Power (dBm)	Ambient Temperature: 22.9 °C		Liquid Temperature: 22.5 °C		Power Drift (dB)
MHz	Ch.					Measured SAR(10g) (W/kg)	Reported SAR(10g) (W/kg)	Measured SAR(1g) (W/kg)	Reported SAR(1g) (W/kg)	
2437	6	Rear	/	20.33	21.00	0.086	0.10	0.182	0.21	0.11

Note1: When the reported SAR of the initial test position is > 0.4 W/kg, SAR is repeated for the 802.11 transmission mode configuration tested in the initial test position using subsequent highest estimated 1-g SAR conditions determined by area scans, on the highest maximum output power channel, until the reported SAR is ≤ 0.8 W/kg.

Note2: For all positions/configurations tested using the initial test position and subsequent test positions, when the reported SAR is > 0.8 W/kg, SAR is measured for these test positions/configurations on the subsequent next highest measured output power channel until the reported SAR is ≤ 1.2 W/kg or all required channels are tested.

According to the KDB248227 D01, The reported SAR must be scaled to 100% transmission duty factor to determine compliance at the maximum tune-up tolerance limit. The scaled reported SAR is presented as below.

Table 14.3-9: SAR Values (WLAN - Body) – 802.11b (Scaled Reported SAR)

Frequency		Test Position	Actual duty factor	maximum duty factor	Reported SAR (1g)(W/kg)	Scaled reported SAR (1g)(W/kg)
MHz	Ch.					
2412	1	Rear	100%	100%	0.21	0.21

SAR is not required for OFDM because the 802.11b adjusted SAR ≤ 1.2 W/kg.

Body Evaluation- Standalone

Table 14.3-10: SAR Values (WLAN - Body)– 802.11b (Fast SAR)

Frequency		Test Position	Figure No./ Note	Conducted Power (dBm)	Max. tune-up Power (dBm)	Measured SAR(10g) (W/kg)	Reported SAR(10g) (W/kg)	Measured SAR(1g) (W/kg)	Reported SAR(1g)(W/kg)	Power Drift (dB)
MHz	Ch.									
2437	6	Front	/	20.33	21.00	1.100	1.28	3.290	3.84	0.11

Note1: The distance between the EUT and the phantom Rear is 0mm.

As shown above table, the initial test position for body is “Rear”. So the body SAR of WLAN is presented as below:

Table 14.3-11: SAR Values (WLAN - Body)– 802.11b (Full SAR)

Frequency		Test Position	Figure No./ Note	Conducted Power (dBm)	Max. tune-up Power (dBm)	Measured SAR(10g) (W/kg)	Reported SAR(10g) (W/kg)	Measured SAR(1g) (W/kg)	Reported SAR(1g)(W/kg)	Power Drift (dB)
MHz	Ch.									
2437	6	Rear	/	20.33	21.00	1.203	1.40	3.411	3.98	0.14

Note1: When the reported SAR of the initial test position is > 0.4 W/kg, SAR is repeated for the 802.11 transmission mode configuration tested in the initial test position using subsequent highest estimated 1-g SAR conditions determined by area scans, on the highest maximum output power channel, until the reported SAR is ≤ 0.8 W/kg.

Note2: For all positions/configurations tested using the initial test position and subsequent test positions, when the reported SAR is > 0.8 W/kg, SAR is measured for these test positions/configurations on the subsequent next highest measured output power channel until the reported SAR is ≤ 1.2 W/kg or all required channels are tested.

According to the KDB248227 D01, The reported SAR must be scaled to 100% transmission duty factor to determine compliance at the maximum tune-up tolerance limit. The scaled reported SAR is presented as below.

Table 14.3-12: SAR Values (WLAN - Body) – 802.11b (Scaled Reported SAR)

Frequency		Test Position	Actual duty factor	maximum duty factor	Reported SAR (10g)(W/kg)	Scaled reported SAR (10g)(W/kg)
MHz	Ch.					
2412	1	Rear	100%	100%	1.40	1.40

SAR is not required for OFDM because the 802.11b adjusted SAR ≤ 1.2 W/kg.

14.4 SAR results for Fast BT

Table 14.4-1: SAR Values (Bluetooth - Head)

Frequency		Side	Test Position	Figure No.	Conducted Power (dBm)	Max. tune-up Power (dBm)	Measured SAR(10g) (W/kg)	Reported SAR(10g) (W/kg)	Measured SAR(1g) (W/kg)	Reported SAR(1g) (W/kg)	Power Drift (dB)
Ch.	MHz										
78	2480	Left	Touch	/	7.63	8.00	<0.01	<0.01	<0.01	<0.01	/
78	2480	Left	Tilt	/	7.63	8.00	<0.01	<0.01	<0.01	<0.01	/
78	2480	Right	Touch	/	7.63	8.00	<0.01	<0.01	<0.01	<0.01	/
78	2480	Right	Tilt	/	7.63	8.00	<0.01	<0.01	<0.01	<0.01	/

Table 14.4-1: SAR Values (Bluetooth - Body)

Frequency		Test Position	Figure No.	Conducted Power (dBm)	Max. tune-up Power (dBm)	Measured SAR(10g) (W/kg)	Reported SAR(10g) (W/kg)	Measured SAR(1g) (W/kg)	Reported SAR(1g) (W/kg)	Power Drift (dB)
Ch	MHz									
78	2480	Front	/	7.63	8.00	<0.01	<0.01	<0.01	<0.01	/
78	2480	Rear	/	7.63	8.00	0.004	<0.01	0.011	<0.01	/
78	2480	Left	/	7.63	8.00	<0.01	<0.01	<0.01	<0.01	/
78	2480	Top	/	7.63	8.00	<0.01	<0.01	<0.01	<0.01	/

Note1: The distance between the EUT and the phantom bottom is 10mm

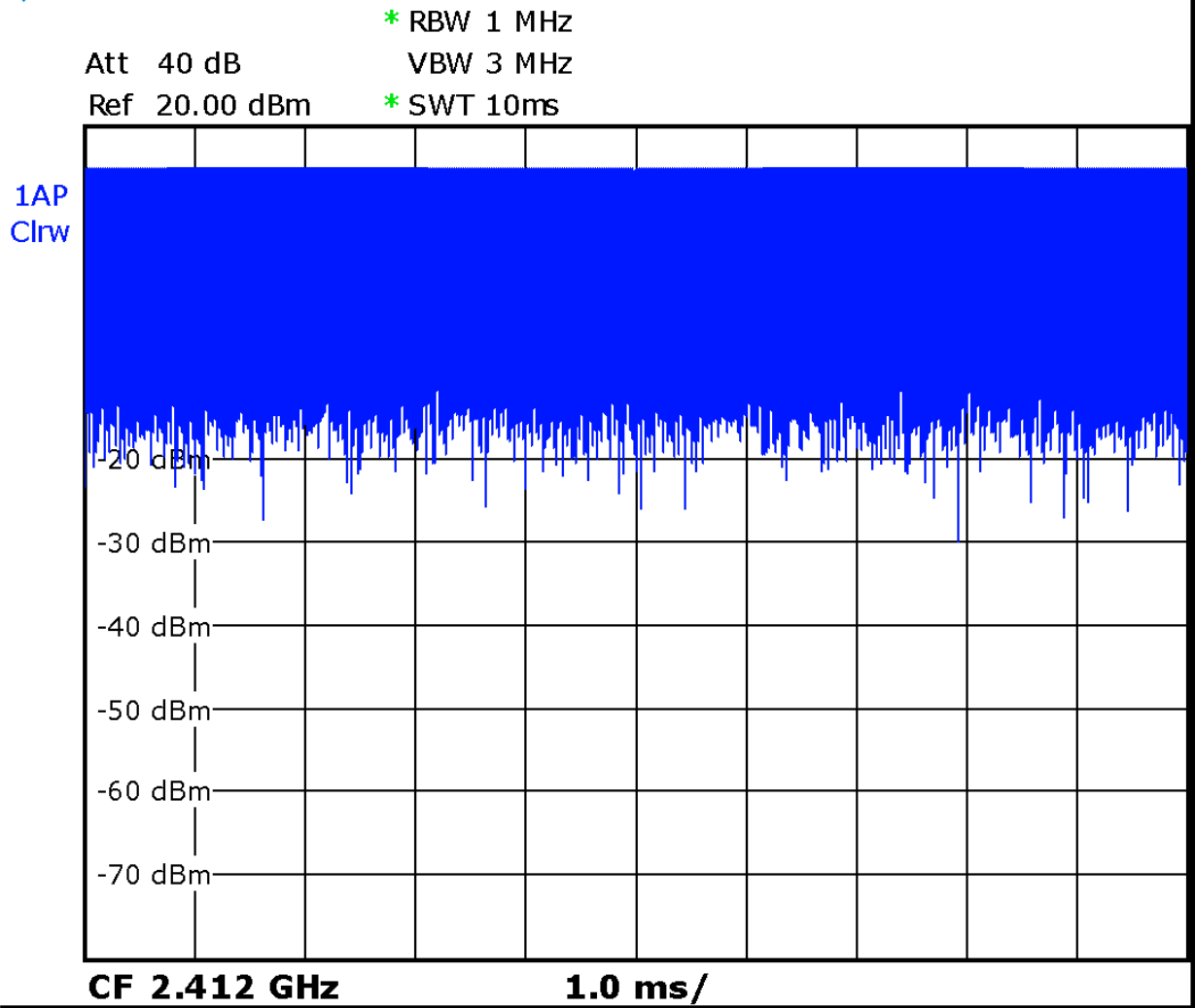

Picture 14.1 Duty factor plot

14.4 SAR Evaluation for Phablet

According to the KDB648474 D04, for smart phones, with a display diagonal dimension > 15.0 cm or an overall diagonal dimension > 16.0 cm, that can provide similar mobile web access and multimedia support found in mini-tablets or UMPC mini-tablets and support voice calls next to the ear, unless it is confirmed otherwise through KDB inquiries, the following phablet procedures should be applied to evaluate SAR compliance for each applicable wireless modes and frequency band. Devices marketed as phablets, regardless of form factors and operating characteristics must be tested as a phablet to determine SAR compliance.

1. The normally required head and body-worn accessory SAR test procedures for handsets, including hotspot mode, must be applied.
2. The UMPC mini-tablet procedures must also be applied to test the SAR of all surfaces and edges with an antenna located at ≤ 25 mm from that surface or edge, in direct contact with a flat phantom, for 10-g extremity SAR according to the body-equivalent tissue dielectric parameters in KDB Publication 865664 D01 to address interactive hand use exposure conditions. When hotspot mode applies, 10-g extremity SAR is required only for the surfaces and edges with hotspot mode 1-g reported SAR > 1.2 W/kg; however, when power reduction applies to hotspot mode the measured SAR must be scaled to the maximum output power, including tolerance, allowed for phablet modes to compare with the 1.2 W/kg SAR test reduction threshold. The normal tablet procedures in KDB Publication 616217 are required when the overall diagonal dimension of the device is > 20.0 cm. Hotspot mode SAR is not required when normal tablet procedures are applied. Extremity 10-g SAR is also not required for the front (top) surface of larger form factor full size tablets. The more conservative normal tablet SAR results can be used to support phablet mode 10-g extremity SAR.
3. The simultaneous transmission operating configurations applicable to voice and data transmissions for both phone and mini-tablet modes must be taken into consideration separately for 1-g and 10-g SAR to determine the simultaneous transmission SAR test exclusion and measurement requirements for the relevant wireless modes and exposure conditions

For the device of this project, the overall diagonal dimension is 179.84 cm (> 16.0 cm), so this device is a phone as “phablet”.

Table 14.4-1: 10g extremity SAR determination

Frequency			Position	Conducted Power (dBm)	Hotspot off tune-up Power (dBm)	Measured SAR(1g) (W/kg)	Adjusted SAR(1g)(W/kg)
Band	Ch.	MHz					
WCDMA1700	1513	1752.6	Rear	19.16	22.00	0.686	1.32
WCDMA1700	1412	1732.5	Rear	19.09	22.00	0.675	1.32
WCDMA1700	1312	1712.4	Rear	19.04	22.00	0.75	1.48
WCDMA1700	1513	1752.6	Bottom Edge	19.16	22.00	0.885	1.70
WCDMA1700	1412	1732.5	Bottom Edge	19.09	22.00	0.861	1.68
WCDMA1700	1312	1712.4	Bottom Edge	19.04	22.00	0.844	1.67

According to the above table, the 10g extremity SAR is required for the WCDMA1700.

Table 14.4-2: SAR Values for 10g extremity SAR

Frequency			Mode/ Figure No.	Conducted Power (dBm)	Max. tune-up Power (dBm)	Measured SAR(10g) (W/kg)	Reported SAR(10g) (W/kg)	Power Drift (dB)	Limited (W/kg)
Band	Ch.	MHz							
			Ambient Temperature: 22.9 °C		Liquid Temperature: 22.5°C				
WCDMA1700	1513	1752.6	Rear	20.15	22.00	1.200	1.84	0.11	4.0
WCDMA1700	1412	1732.5	Rear	20.09	22.00	1.190	1.85	-0.11	4.0
WCDMA1700	1312	1712.4	Rear	20.09	22.00	1.240	1.92	-0.10	4.0
WCDMA1700	1412	1732.5	Bottom Edge	20.09	22.00	1.200	1.86	0.01	4.0
WCDMA1700	1312	1712.4	Bottom Edge	20.09	22.00	1.100	1.71	-0.10	4.0
WCDMA1700	1513	1752.6	Bottom Edge	20.15	22.00	1.280	1.96	0.18	4.0

Note1: The distance between the EUT and the phantom bottom is 0mm.

Table 14.4-3: The sum of SAR values for 10g extremity SAR

	Position	Main antenna	WiFi-2.4G	BT	Sum	Limited
10-g extremity SAR (Separation Distance 0mm)	Bottom Edge (WCDMA1700)	1.96	/	/	1.96	4.0
10-g extremity SAR (Separation Distance 0mm)	Rear (WCDMA1700)	1.92	1.40	/	3.32	4.0

15 SAR Measurement Variability

SAR measurement variability must be assessed for each frequency band, which is determined by the SAR probe calibration point and tissue-equivalent medium used for the device measurements. When both head and body tissue-equivalent media are required for SAR measurements in a frequency band, the variability measurement procedures should be applied to the tissue medium with the highest measured SAR, using the highest measured SAR configuration for that tissue-equivalent medium.

The following procedures are applied to determine if repeated measurements are required.

- 1) Repeated measurement is not required when the original highest measured SAR is < 0.80 W/kg; steps 2) through 4) do not apply.
- 2) When the original highest measured SAR is ≥ 0.80 W/kg, repeat that measurement once.
- 3) Perform a second repeated measurement only if the ratio of largest to smallest SAR for the original and first repeated measurements is > 1.20 or when the original or repeated measurement is ≥ 1.45 W/kg ($\sim 10\%$ from the 1-g SAR limit).
- 4) Perform a third repeated measurement only if the original, first or second repeated measurement is ≥ 1.5 W/kg and the ratio of largest to smallest SAR for the original, first and second repeated measurements is > 1.20 .

Table 15.1: SAR Measurement Variability for Head W1700 (1g)

Frequency		Test Position	Original SAR (W/kg)	First Repeated SAR (W/kg)	The Ratio	Second Repeated SAR (W/kg)
Ch.	MHz					
1513	1752.6	Bottom Edge	0.885	0.87	1.02	/

16 Measurement Uncertainty

16.1 Measurement Uncertainty for Normal SAR Tests (300MHz~3GHz)

No.	Error Description	Type	Uncertainty value	Probably Distribution	Div.	(Ci) 1g	(Ci) 10g	Std. Unc. (1g)	Std. Unc. (10g)	Degree of freedom
Measurement system										
1	Probe calibration	B	6.0	N	1	1	1	6.0	6.0	∞
2	Isotropy	B	4.7	R	$\sqrt{3}$	0.7	0.7	1.9	1.9	∞
3	Boundary effect	B	1.0	R	$\sqrt{3}$	1	1	0.6	0.6	∞
4	Linearity	B	4.7	R	$\sqrt{3}$	1	1	2.7	2.7	∞
5	Detection limit	B	1.0	N	1	1	1	0.6	0.6	∞
6	Readout electronics	B	0.3	R	$\sqrt{3}$	1	1	0.3	0.3	∞
7	Response time	B	0.8	R	$\sqrt{3}$	1	1	0.5	0.5	∞
8	Integration time	B	2.6	R	$\sqrt{3}$	1	1	1.5	1.5	∞
9	RF ambient conditions-noise	B	0	R	$\sqrt{3}$	1	1	0	0	∞

10	RFambient conditions-reflection	B	0	R	$\sqrt{3}$	1	1	0	0	∞
11	Probe positioned mech. restrictions	B	0.4	R	$\sqrt{3}$	1	1	0.2	0.2	∞
12	Probe positioning with respect to phantom shell	B	2.9	R	$\sqrt{3}$	1	1	1.7	1.7	∞
13	Post-processing	B	1.0	R	$\sqrt{3}$	1	1	0.6	0.6	∞
Test sample related										
14	Test sample positioning	A	3.3	N	1	1	1	3.3	3.3	71
15	Device holder uncertainty	A	3.4	N	1	1	1	3.4	3.4	5
16	Drift of output power	B	5.0	R	$\sqrt{3}$	1	1	2.9	2.9	∞
Phantom and set-up										
17	Phantom uncertainty	B	4.0	R	$\sqrt{3}$	1	1	2.3	2.3	∞
18	Liquid conductivity (target)	B	5.0	R	$\sqrt{3}$	0.64	0.43	1.8	1.2	∞
19	Liquid conductivity (meas.)	A	2.06	N	1	0.64	0.43	1.32	0.89	43
20	Liquid permittivity (target)	B	5.0	R	$\sqrt{3}$	0.6	0.49	1.7	1.4	∞
21	Liquid permittivity (meas.)	A	1.6	N	1	0.6	0.49	1.0	0.8	521
Combined standard uncertainty		$u_c = \sqrt{\sum_{i=1}^{21} c_i^2 u_i^2}$						9.55	9.43	257
Expanded uncertainty (confidence interval of 95 %)		$u_e = 2u_c$						19.1	18.9	

16.2 Measurement Uncertainty for Normal SAR Tests (3~6GHz)

No.	Error Description	Type	Uncertainty value	Probably Distribution	Div.	(Ci) 1g	(Ci) 10g	Std. Unc. (1g)	Std. Unc. (10g)	Degree of freedom
Measurement system										
1	Probe calibration	B	6.55	N	1	1	1	6.55	6.55	∞
2	Isotropy	B	4.7	R	$\sqrt{3}$	0.7	0.7	1.9	1.9	∞
3	Boundary effect	B	2.0	R	$\sqrt{3}$	1	1	1.2	1.2	∞
4	Linearity	B	4.7	R	$\sqrt{3}$	1	1	2.7	2.7	∞
5	Detection limit	B	1.0	R	$\sqrt{3}$	1	1	0.6	0.6	∞
6	Readout electronics	B	0.3	R	$\sqrt{3}$	1	1	0.3	0.3	∞
7	Response time	B	0.8	R	$\sqrt{3}$	1	1	0.5	0.5	∞

8	Integration time	B	2.6	R	$\sqrt{3}$	1	1	1.5	1.5	∞
9	RF ambient conditions-noise	B	0	R	$\sqrt{3}$	1	1	0	0	∞
10	RF ambient conditions-reflection	B	0	R	$\sqrt{3}$	1	1	0	0	∞
11	Probe positioned mech. restrictions	B	0.8	R	$\sqrt{3}$	1	1	0.5	0.5	∞
12	Probe positioning with respect to phantom shell	B	6.7	R	$\sqrt{3}$	1	1	3.9	3.9	∞
13	Post-processing	B	4.0	R	$\sqrt{3}$	1	1	2.3	2.3	∞
Test sample related										
14	Test sample positioning	A	3.3	N	1	1	1	3.3	3.3	71
15	Device holder uncertainty	A	3.4	N	1	1	1	3.4	3.4	5
16	Drift of output power	B	5.0	R	$\sqrt{3}$	1	1	2.9	2.9	∞
Phantom and set-up										
17	Phantom uncertainty	B	4.0	R	$\sqrt{3}$	1	1	2.3	2.3	∞
18	Liquid conductivity (target)	B	5.0	R	$\sqrt{3}$	0.64	0.43	1.8	1.2	∞
19	Liquid conductivity (meas.)	A	2.06	N	1	0.64	0.43	1.32	0.89	43
20	Liquid permittivity (target)	B	5.0	R	$\sqrt{3}$	0.6	0.49	1.7	1.4	∞
21	Liquid permittivity (meas.)	A	1.6	N	1	0.6	0.49	1.0	0.8	521
Combined standard uncertainty		$u'_c = \sqrt{\sum_{i=1}^{21} c_i^2 u_i^2}$						10.7	10.6	257
Expanded uncertainty (confidence interval of 95 %)		$u_e = 2u_c$						21.4	21.1	

16.3 Measurement Uncertainty for Fast SAR Tests (300MHz~3GHz)

No.	Error Description	Type	Uncertainty value	Probably Distribution	Div.	(Ci) 1g	(Ci) 10g	Std. Unc. (1g)	Std. Unc. (10g)	Degree of freedom
Measurement system										
1	Probe calibration	B	6.0	N	1	1	1	6.0	6.0	∞
2	Isotropy	B	4.7	R	$\sqrt{3}$	0.7	0.7	1.9	1.9	∞
3	Boundary effect	B	1.0	R	$\sqrt{3}$	1	1	0.6	0.6	∞
4	Linearity	B	4.7	R	$\sqrt{3}$	1	1	2.7	2.7	∞

5	Detection limit	B	1.0	R	$\sqrt{3}$	1	1	0.6	0.6	∞
6	Readout electronics	B	0.3	R	$\sqrt{3}$	1	1	0.3	0.3	∞
7	Response time	B	0.8	R	$\sqrt{3}$	1	1	0.5	0.5	∞
8	Integration time	B	2.6	R	$\sqrt{3}$	1	1	1.5	1.5	∞
9	RF ambient conditions-noise	B	0	R	$\sqrt{3}$	1	1	0	0	∞
10	RF ambient conditions-reflection	B	0	R	$\sqrt{3}$	1	1	0	0	∞
11	Probe positioned mech. Restrictions	B	0.4	R	$\sqrt{3}$	1	1	0.2	0.2	∞
12	Probe positioning with respect to phantom shell	B	2.9	R	$\sqrt{3}$	1	1	1.7	1.7	∞
13	Post-processing	B	1.0	R	$\sqrt{3}$	1	1	0.6	0.6	∞
14	Fast SAR z-Approximation	B	7.0	R	$\sqrt{3}$	1	1	4.0	4.0	∞
Test sample related										
15	Test sample positioning	A	3.3	N	1	1	1	3.3	3.3	71
16	Device holder uncertainty	A	3.4	N	1	1	1	3.4	3.4	5
17	Drift of output power	B	5.0	R	$\sqrt{3}$	1	1	2.9	2.9	∞
Phantom and set-up										
18	Phantom uncertainty	B	4.0	R	$\sqrt{3}$	1	1	2.3	2.3	∞
19	Liquid conductivity (target)	B	5.0	R	$\sqrt{3}$	0.64	0.43	1.8	1.2	∞
20	Liquid conductivity (meas.)	A	2.06	N	1	0.64	0.43	1.32	0.89	43
21	Liquid permittivity (target)	B	5.0	R	$\sqrt{3}$	0.6	0.49	1.7	1.4	∞
22	Liquid permittivity (meas.)	A	1.6	N	1	0.6	0.49	1.0	0.8	521
Combined standard uncertainty		$u'_c = \sqrt{\sum_{i=1}^{22} c_i^2 u_i^2}$						10.4	10.3	257
Expanded uncertainty (confidence interval of 95 %)		$u_e = 2u_c$						20.8	20.6	

16.4 Measurement Uncertainty for Fast SAR Tests (3~6GHz)

No.	Error Description	Type	Uncertainty value	Probably Distribution	Div.	(Ci) 1g	(Ci) 10g	Std. Unc.	Std. Unc.	Degree of
-----	-------------------	------	-------------------	-----------------------	------	---------	----------	-----------	-----------	-----------

								(1g)	(10g)	freedom
Measurement system										
1	Probe calibration	B	6.55	N	1	1	1	6.55	6.55	∞
2	Isotropy	B	4.7	R	$\sqrt{3}$	0.7	0.7	1.9	1.9	∞
3	Boundary effect	B	2.0	R	$\sqrt{3}$	1	1	1.2	1.2	∞
4	Linearity	B	4.7	R	$\sqrt{3}$	1	1	2.7	2.7	∞
5	Detection limit	B	1.0	R	$\sqrt{3}$	1	1	0.6	0.6	∞
6	Readout electronics	B	0.3	R	$\sqrt{3}$	1	1	0.3	0.3	∞
7	Response time	B	0.8	R	$\sqrt{3}$	1	1	0.5	0.5	∞
8	Integration time	B	2.6	R	$\sqrt{3}$	1	1	1.5	1.5	∞
9	RF ambient conditions-noise	B	0	R	$\sqrt{3}$	1	1	0	0	∞
10	RFambient conditions-reflection	B	0	R	$\sqrt{3}$	1	1	0	0	∞
11	Probe positioned mech. Restrictions	B	0.8	R	$\sqrt{3}$	1	1	0.5	0.5	∞
12	Probe positioning with respect to phantom shell	B	6.7	R	$\sqrt{3}$	1	1	3.9	3.9	∞
13	Post-processing	B	1.0	R	$\sqrt{3}$	1	1	0.6	0.6	∞
14	Fast SAR z-Approximation	B	14.0	R	$\sqrt{3}$	1	1	8.1	8.1	∞
Test sample related										
15	Test sample positioning	A	3.3	N	1	1	1	3.3	3.3	71
16	Device holder uncertainty	A	3.4	N	1	1	1	3.4	3.4	5
17	Drift of output power	B	5.0	R	$\sqrt{3}$	1	1	2.9	2.9	∞
Phantom and set-up										
18	Phantom uncertainty	B	4.0	R	$\sqrt{3}$	1	1	2.3	2.3	∞
19	Liquid conductivity (target)	B	5.0	R	$\sqrt{3}$	0.64	0.43	1.8	1.2	∞
20	Liquid conductivity (meas.)	A	2.06	N	1	0.64	0.43	1.32	0.89	43
21	Liquid permittivity (target)	B	5.0	R	$\sqrt{3}$	0.6	0.49	1.7	1.4	∞
22	Liquid permittivity (meas.)	A	1.6	N	1	0.6	0.49	1.0	0.8	521
Combined standard uncertainty		$u_c' = \sqrt{\sum_{i=1}^{22} c_i^2 u_i^2}$						13.5	13.4	257
Expanded uncertainty		$u_e = 2u_c$						27.0	26.8	

(confidence interval of 95 %)								
-------------------------------	--	--	--	--	--	--	--	--

17 MAIN TEST INSTRUMENTS

Table 17.1: List of Main Instruments

No.	Name	Type	Serial Number	Calibration Date	Valid Period
01	Network analyzer	E5071C	MY46110673	January 14, 2021	One year
02	Power meter	NRP2	106277	September 23, 2021	One year
03	Power sensor	NRP8S	104291		
04	Signal Generator	E4438C	MY49071430	February 1, 2021	One Year
05	Amplifier	60S1G4	0331848	No Calibration Requested	
06	BTS	CMW500	159890	January 25 2021	One year
07	BTS	CMW500	159889	January 13 2021	One year
08	E-field Probe	SPEAG EX3DV4	7517	February 03, 2021	One year
09	DAE	SPEAG DAE4	1525	September 1, 2021	One year
10	Dipole Validation Kit	SPEAG D750V3	1017	July 12,2021	One year
11	Dipole Validation Kit	SPEAG D835V2	4d069	July 12,,2021	One year
12	Dipole Validation Kit	SPEAG D1750V2	1003	July 12,,2021	One year
13	Dipole Validation Kit	SPEAG D1900V2	5d101	July 15,2021	One year
14	Dipole Validation Kit	SPEAG D2450V2	853	July 26,2021	One year
15	Dipole Validation Kit	SPEAG D2600V2	1012	July 26,2021	One year

END OF REPORT BODY

ANNEX A Graph Results

GSM850_CH251 Left Cheek

Date: 11/28/2021

Electronics: DAE4 Sn1525

Medium: head 835 MHz

Medium parameters used: $f = 848.8$; $\sigma = 0.993$ mho/m; $\epsilon_r = 40.605$; $\rho = 1000$ kg/m³

Ambient Temperature: 22.5°C, Liquid Temperature: 22.3°C

Communication System: GSM850 848.8 Duty Cycle: 1:8.3

Probe: EX3DV4 – 7517 ConvF(9.40,9.40,9.40)

Area Scan (81x141x1): Interpolated grid: $dx=1.500$ mm, $dy=1.500$ mm

Maximum value of SAR (interpolated) = 0.241 W/kg

Zoom Scan (6x6x7)/Cube 0: Measurement grid: $dx=8$ mm, $dy=8$ mm, $dz=5$ mm

Reference Value = 3.805 V/m; Power Drift = 0.02 dB

Peak SAR (extrapolated) = 0.241 W/kg

SAR(1 g) = 0.195 W/kg; SAR(10 g) = 0.15 W/kg

Maximum value of SAR (measured) = 0.227 W/kg

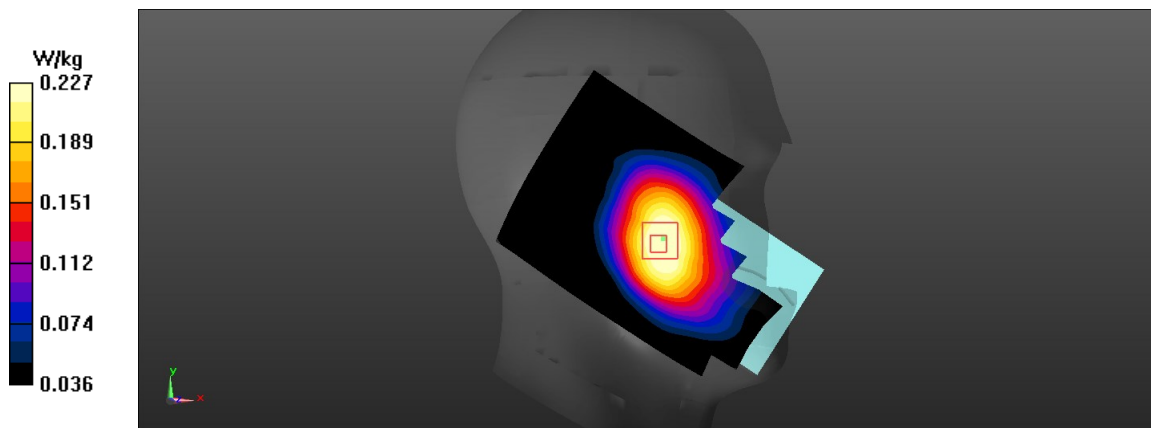

Fig A.1

GSM850_CH128 Rear GPRS(4TX) 10mm

Date: 11/28/2021

Electronics: DAE4 Sn1525

Medium: head 835 MHz

Medium parameters used: $f = 824.2$; $\sigma = 0.983$ mho/m; $\epsilon_r = 40.728$; $\rho = 1000$ kg/m³

Ambient Temperature: 22.5°C, Liquid Temperature: 22.3°C

Communication System: GSM850 824.2 Duty Cycle: 1:2

Probe: EX3DV4 – 7517 ConvF(9.40,9.40,9.40)

Area Scan (41x141x1): Interpolated grid: dx=1.500 mm, dy=1.500 mm

Maximum value of SAR (interpolated) = 0.2 W/kg

Zoom Scan (5x5x7)/Cube 0: Measurement grid: dx=8mm, dy=8mm, dz=5mm

Reference Value = 10.89 V/m; Power Drift = -0.11 dB

Peak SAR (extrapolated) = 0.229 W/kg

SAR(1 g) = 0.148 W/kg; SAR(10 g) = 0.101 W/kg

Maximum value of SAR (measured) = 0.201 W/kg

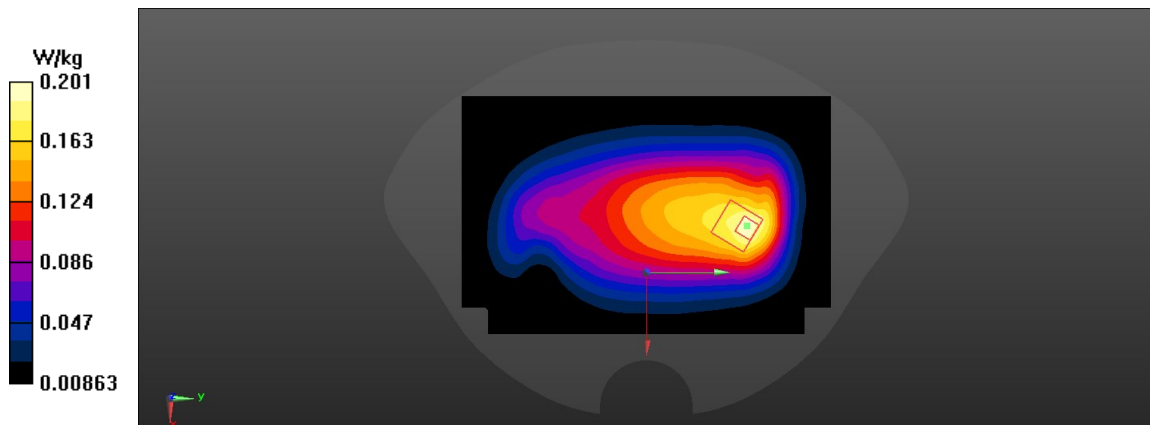

Fig A.2

PCS1900_CH810 Right Cheek

Date: 12/3/2021

Electronics: DAE4 Sn1525

Medium: head 1900 MHz

Medium parameters used: $f = 1909.8$; $\sigma = 1.382$ mho/m; $\epsilon_r = 40.17$; $\rho = 1000$ kg/m³

Ambient Temperature: 22.5°C, Liquid Temperature: 22.3°C

Communication System: PCS1900 1909.8 Duty Cycle: 1:8.3

Probe: EX3DV4 – 7517 ConvF(7.81,7.81,7.81)

Area Scan (81x141x1): Interpolated grid: dx=1.500 mm, dy=1.500 mm

Maximum value of SAR (interpolated) = 0.179 W/kg

Zoom Scan (5x5x7)/Cube 0: Measurement grid: dx=8mm, dy=8mm, dz=5mm

Reference Value = 3.013 V/m; Power Drift = 0.15 dB

Peak SAR (extrapolated) = 0.195 W/kg

SAR(1 g) = 0.57 W/kg; SAR(10 g) = 0.124 W/kg

Maximum value of SAR (measured) = 0.168 W/kg

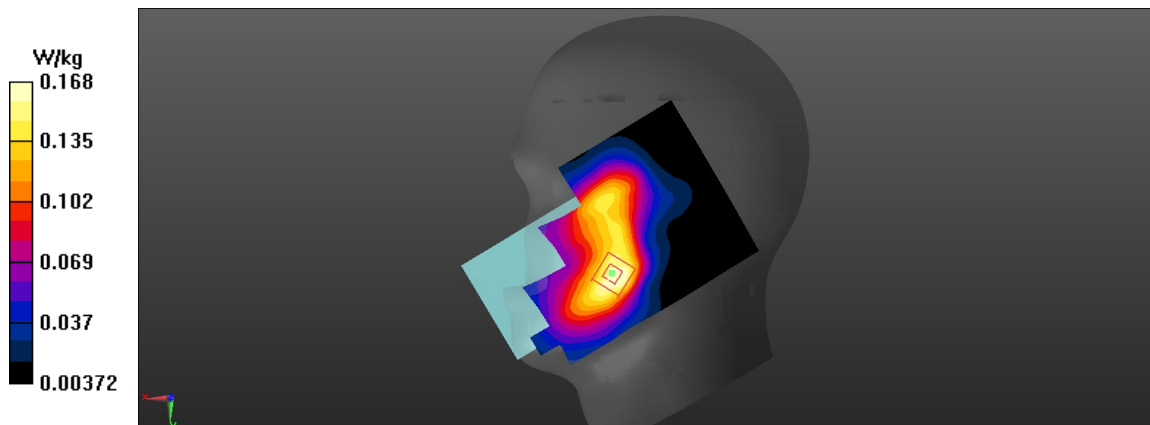
**Fig A.3**

PCS1900_CH512 Bottom Edge GPRS(1TX) 10mm

Date: 12/3/2021

Electronics: DAE4 Sn1525

Medium: head 1900 MHz

Medium parameters used: $f = 1850.2$; $\sigma = 1.36$ mho/m; $\epsilon_r = 40.11$; $\rho = 1000$ kg/m³

Ambient Temperature: 22.5°C, Liquid Temperature: 22.3°C

Communication System: PCS1900 1850.2 Duty Cycle: 1:8.3

Probe: EX3DV4 – 7517 ConvF(7.81,7.81,7.81)

Area Scan (41x141x1): Interpolated grid: dx=1.500 mm, dy=1.500 mm

Maximum value of SAR (interpolated) = 1.01 W/kg

Zoom Scan (5x5x7)/Cube 0: Measurement grid: dx=8mm, dy=8mm, dz=5mm

Reference Value = 18.97 V/m; Power Drift = -0.06 dB

Peak SAR (extrapolated) = 1.23 W/kg

SAR(1 g) = 0.501 W/kg; SAR(10 g) = 0.264 W/kg

Maximum value of SAR (measured) = 1.04 W/kg

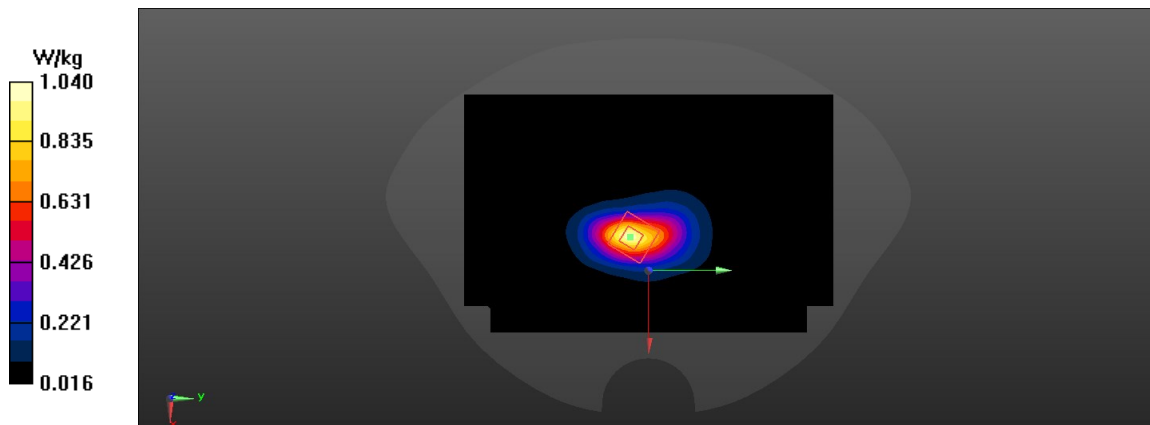
**Fig A.4**

WCDMA1900-BII_CH9538 Right Cheek

Date: 12/3/2021

Electronics: DAE4 Sn1525

Medium: head 1900 MHz

Medium parameters used: $f = 1907.6$; $\sigma = 1.381$ mho/m; $\epsilon_r = 40.17$; $\rho = 1000$ kg/m³

Ambient Temperature: 22.5°C, Liquid Temperature: 22.3°C

Communication System: WCDMA1900-BII 1907.6 Duty Cycle: 1:1

Probe: EX3DV4 – 7517 ConvF(7.81,7.81,7.81)

Area Scan (71x121x1): Interpolated grid: dx=1.500 mm, dy=1.500 mm

Maximum value of SAR (interpolated) = 0.395 W/kg

Zoom Scan (5x5x7)/Cube 0: Measurement grid: dx=8mm, dy=8mm, dz=5mm

Reference Value = 5.257 V/m; Power Drift = -0.11 dB

Peak SAR (extrapolated) = 0.452 W/kg

SAR(1 g) = 0.285 W/kg; SAR(10 g) = 0.189 W/kg

Maximum value of SAR (measured) = 0.385W/kg

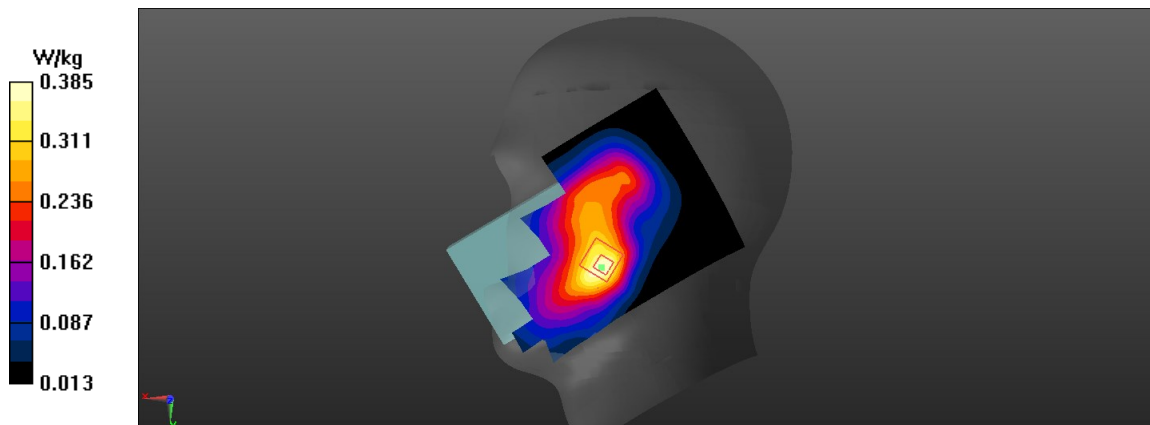

Fig A.5

WCDMA1900-BII_CH9262 Bottom Edge 10mm

Date: 12/3/2021

Electronics: DAE4 Sn1525

Medium: head 1900 MHz

Medium parameters used: $f = 1852.4$; $\sigma = 1.362$ mho/m; $\epsilon_r = 40.11$; $\rho = 1000$ kg/m³

Ambient Temperature: 22.5°C, Liquid Temperature: 22.3°C

Communication System: WCDMA1900-BII 1852.4 MHz Duty Cycle: 1:1

Probe: EX3DV4 – 7517 ConvF(7.81,7.81,7.81)

Area Scan (71x121x1): Interpolated grid: dx=1.500 mm, dy=1.500 mm

Maximum value of SAR (interpolated) = 0.625 W/kg

Zoom Scan (5x5x7)/Cube 0: Measurement grid: dx=8mm, dy=8mm, dz=5mm

Reference Value = 6.302 V/m; Power Drift = -0.12 dB

Peak SAR (extrapolated) = 0.737 W/kg

SAR(1 g) = 0.408 W/kg; SAR(10 g) = 0.227 W/kg

Maximum value of SAR (measured) = 0.611 W/kg

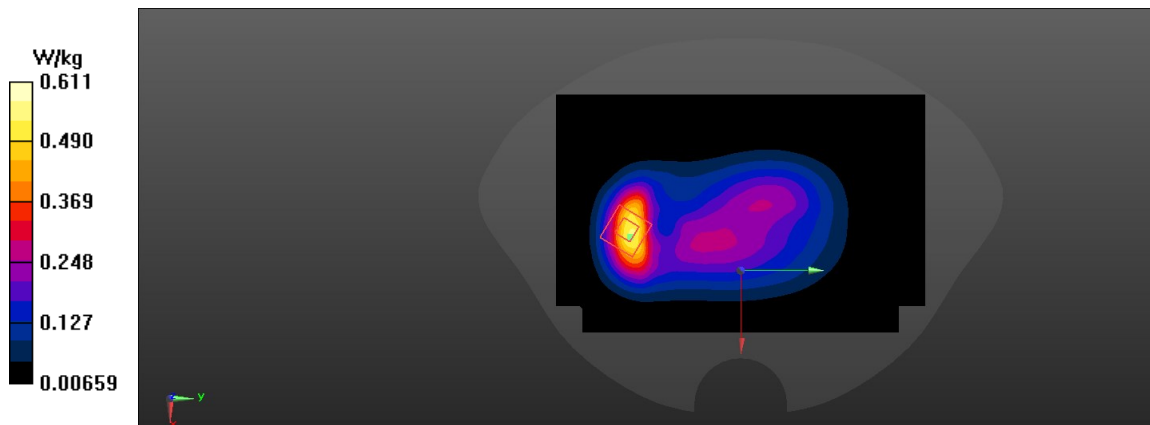
**Fig A.6**

WCDMA1900-BII_CH9262 Rear 15mm

Date: 12/3/2021

Electronics: DAE4 Sn1525

Medium: head 1900 MHz

Medium parameters used: $f = 1852.4$; $\sigma = 1.362$ mho/m; $\epsilon_r = 40.11$; $\rho = 1000$ kg/m³

Ambient Temperature: 22.5°C, Liquid Temperature: 22.3°C

Communication System: WCDMA1900-BII 1852.4 MHz Duty Cycle: 1:1

Probe: EX3DV4 – 7517 ConvF(7.81,7.81,7.81)

Area Scan (71x121x1): Interpolated grid: dx=1.500 mm, dy=1.500 mm

Maximum value of SAR (interpolated) = 0.249 W/kg

Zoom Scan (5x5x7)/Cube 0: Measurement grid: dx=8mm, dy=8mm, dz=5mm

Reference Value = 0.516 V/m; Power Drift = 0.12 dB

Peak SAR (extrapolated) = 0.287 W/kg

SAR(1 g) = 0.167 W/kg; SAR(10 g) = 0.1 W/kg

Maximum value of SAR (measured) = 0.243 W/kg

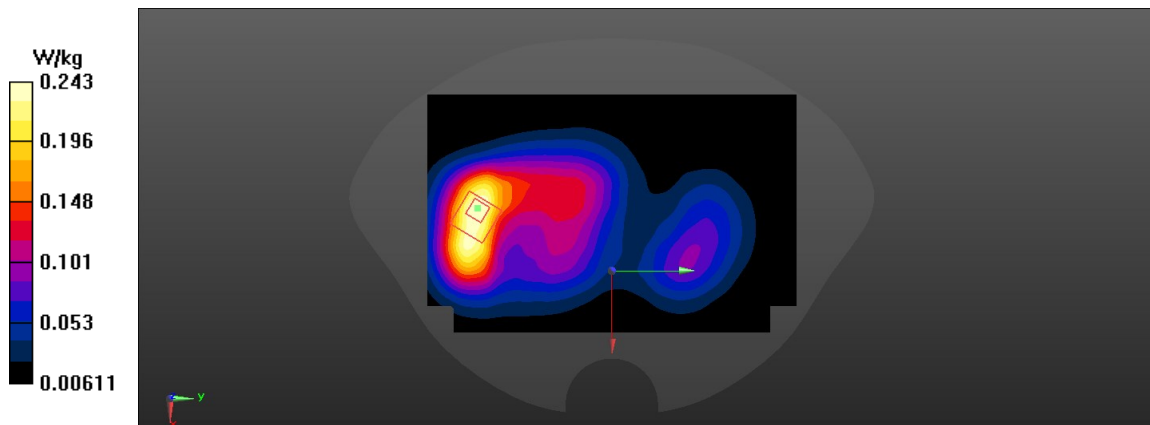
**Fig A.7**

WCDMA1700-BIV_CH1513 Left Cheek

Date: 12/1/2021

Electronics: DAE4 Sn1525

Medium: head 1750 MHz

Medium parameters used: $f = 1752.6$; $\sigma = 1.359$ mho/m; $\epsilon_r = 40.31$; $\rho = 1000$ kg/m³

Ambient Temperature: 22.5°C, Liquid Temperature: 22.3°C

Communication System: WCDMA1700-BIV 1752.6 MHz Duty Cycle: 1:1

Probe: EX3DV4 – 7517 ConvF(8.22,8.22,8.22)

Area Scan (71x121x1): Interpolated grid: dx=1.500 mm, dy=1.500 mm

Maximum value of SAR (interpolated) = 0.244 W/kg

Zoom Scan (5x5x7)/Cube 0: Measurement grid: dx=8mm, dy=8mm, dz=5mm

Reference Value = 3.744 V/m; Power Drift = 0.09 dB

Peak SAR (extrapolated) = 0.261 W/kg

SAR(1 g) = 0.169 W/kg; SAR(10 g) = 0.108 W/kg

Maximum value of SAR (measured) = 0.228 W/kg

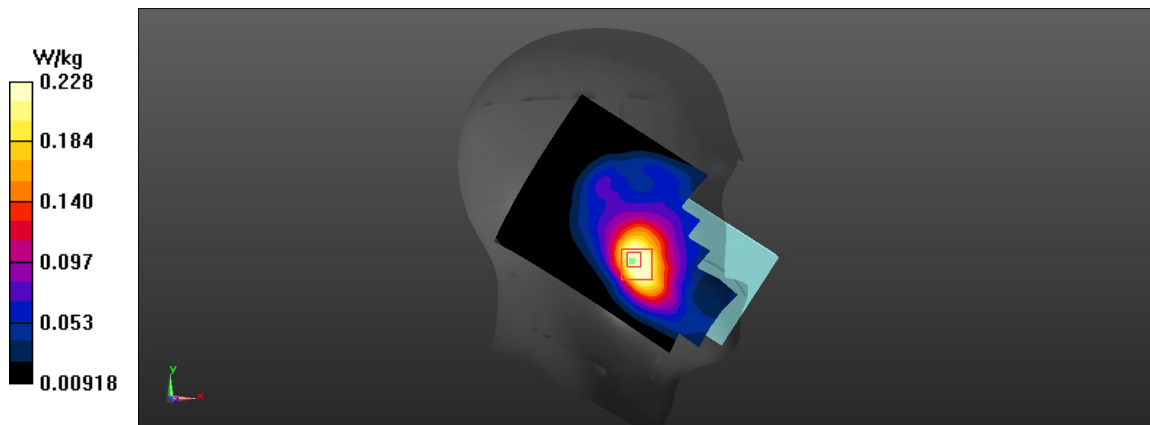
**Fig A.8**

WCDMA1700-BIV_CH1312 Rear 15mm

Date: 12/1/2021

Electronics: DAE4 Sn1525

Medium: head 1750 MHz

Medium parameters used: $f = 1712.4$; $\sigma = 1.316$ mho/m; $\epsilon_r = 40.9$; $\rho = 1000$ kg/m³

Ambient Temperature: 22.5°C, Liquid Temperature: 22.3°C

Communication System: WCDMA1700-BIV 1712.4 MHz Duty Cycle: 1:1

Probe: EX3DV4 – 7517 ConvF(8.22,8.22,8.22)

Area Scan (71x121x1): Interpolated grid: dx=1.500 mm, dy=1.500 mm

Maximum value of SAR (interpolated) = 0.421 W/kg

Zoom Scan (5x5x7)/Cube 0: Measurement grid: dx=8mm, dy=8mm, dz=5mm

Reference Value = 3.032 V/m; Power Drift = -0.12 dB

Peak SAR (extrapolated) = 0.484 W/kg

SAR(1 g) = 0.285 W/kg; SAR(10 g) = 0.164 W/kg

Maximum value of SAR (measured) = 0.407W/kg

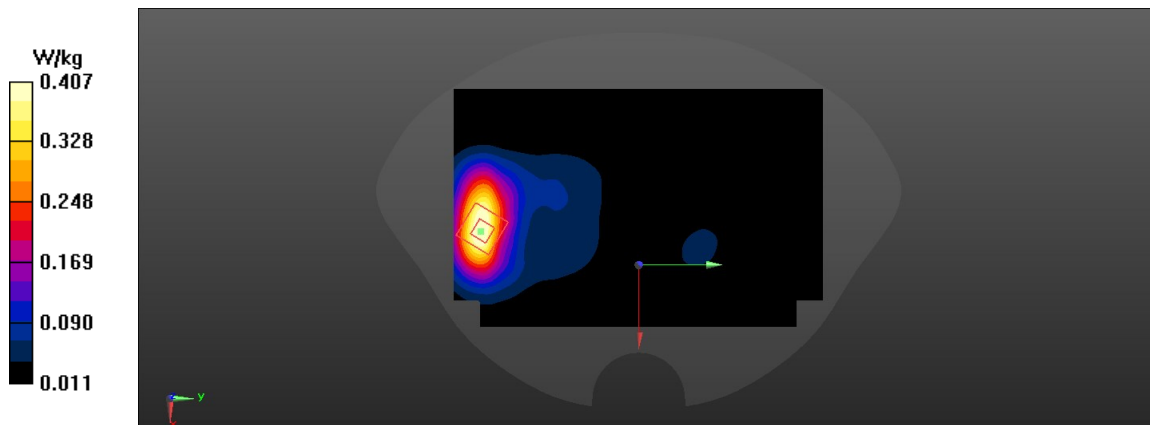
**Fig A.9**

WCDMA1700-BIV_CH1513 Bottom Edge 10mm

Date: 12/1/2021

Electronics: DAE4 Sn1525

Medium: head 1750 MHz

Medium parameters used: $f = 1752.6$; $\sigma = 1.355$ mho/m; $\epsilon_r = 40.85$; $\rho = 1000$ kg/m³

Ambient Temperature: 22.5°C, Liquid Temperature: 22.3°C

Communication System: WCDMA1700-BIV 1752.6 MHz Duty Cycle: 1:1

Probe: EX3DV4 – 7517 ConvF(8.22,8.22,8.22)

Area Scan (71x121x1): Interpolated grid: dx=1.500 mm, dy=1.500 mm

Maximum value of SAR (interpolated) = 1.31 W/kg

Zoom Scan (5x5x7)/Cube 0: Measurement grid: dx=8mm, dy=8mm, dz=5mm

Reference Value = 24.26 V/m; Power Drift = -0.05 dB

Peak SAR (extrapolated) = 1.61 W/kg

SAR(1 g) = 0.885 W/kg; SAR(10 g) = 0.468 W/kg

Maximum value of SAR (measured) = 1.34 W/kg

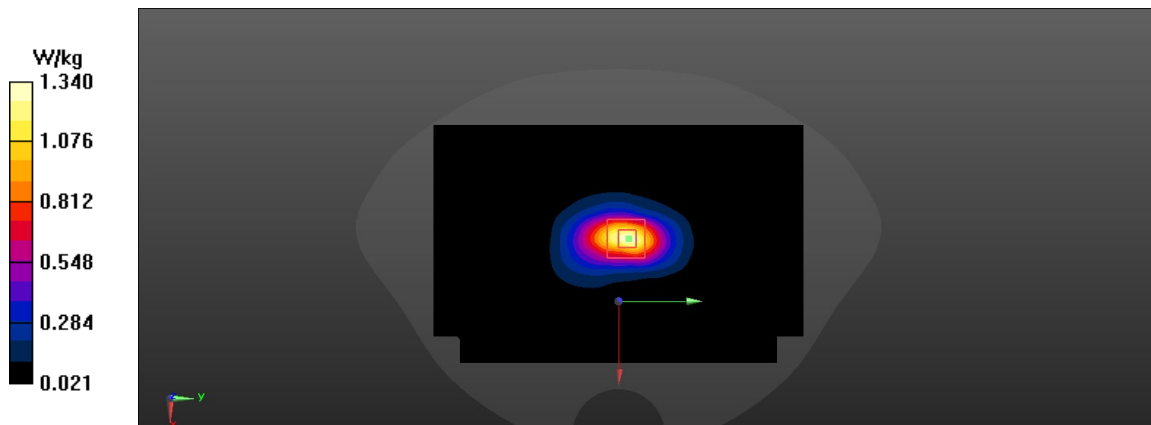

Fig A.10

WCDMA850-BV_CH4183 Left Tilt

Date: 11/28/2021

Electronics: DAE4 Sn1525

Medium: head 835 MHz

Medium parameters used: $f = 836.6$; $\sigma = 0.988$ mho/m; $\epsilon_r =$; $\rho = 1000$ kg/m³

Ambient Temperature: 22.5°C, Liquid Temperature: 22.3°C

Communication System: WCDMA850-BV 836.6 MHz Duty Cycle: 1:1

Probe: EX3DV4 – 7517 ConvF(9.40,9.40,9.40)

Area Scan (71x121x1): Interpolated grid: dx=1.500 mm, dy=1.500 mm

Maximum value of SAR (interpolated) = 0.241 W/kg

Zoom Scan (5x5x7)/Cube 0: Measurement grid: dx=8mm, dy=8mm, dz=5mm

Reference Value = 3.805 V/m; Power Drift = -0.18 dB

Peak SAR (extrapolated) = 0.241 W/kg

SAR(1 g) = 0.213 W/kg; SAR(10 g) = 0.119 W/kg

Maximum value of SAR (measured) = 0.327 W/kg

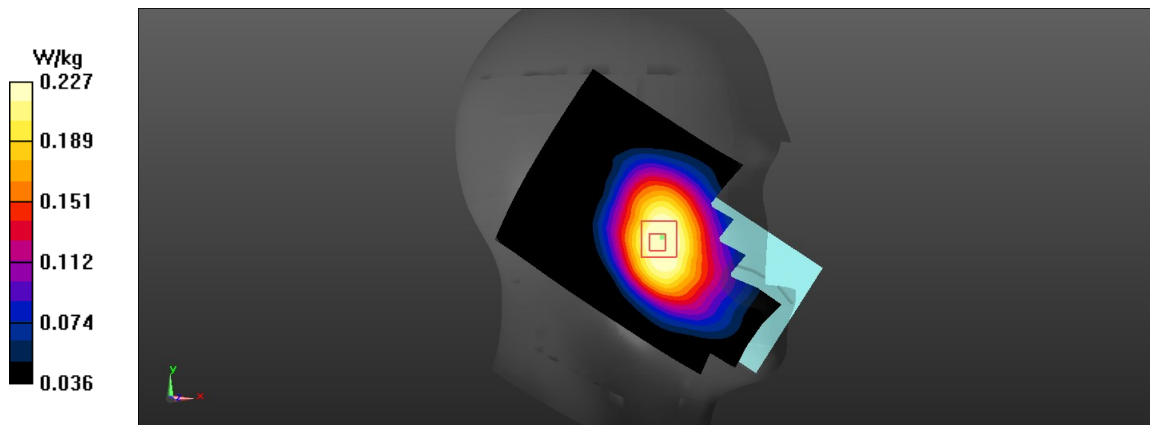

Fig A.11

WCDMA850-BV_CH4183 Rear 10mm

Date: 11/28/2021

Electronics: DAE4 Sn1525

Medium: head 835 MHz

Medium parameters used: $f = 836.6$; $\sigma = 0.988$ mho/m; $\epsilon_r = 40.654$; $\rho = 1000$ kg/m³

Ambient Temperature: 22.5°C, Liquid Temperature: 22.3°C

Communication System: WCDMA850-BV 836.6 MHz Duty Cycle: 1:1

Probe: EX3DV4 – 7517 ConvF(9.40,9.40,9.40)

Area Scan (71x121x1): Interpolated grid: dx=1.500 mm, dy=1.500 mm

Maximum value of SAR (interpolated) = 0.2 W/kg

Zoom Scan (5x5x7)/Cube 0: Measurement grid: dx=8mm, dy=8mm, dz=5mm

Reference Value = 10.89 V/m; Power Drift = -0.12 dB

Peak SAR (extrapolated) = 0.229 W/kg

SAR(1 g) = 0.258 W/kg; SAR(10 g) = 0.145 W/kg

Maximum value of SAR (measured) = 0.391 W/kg

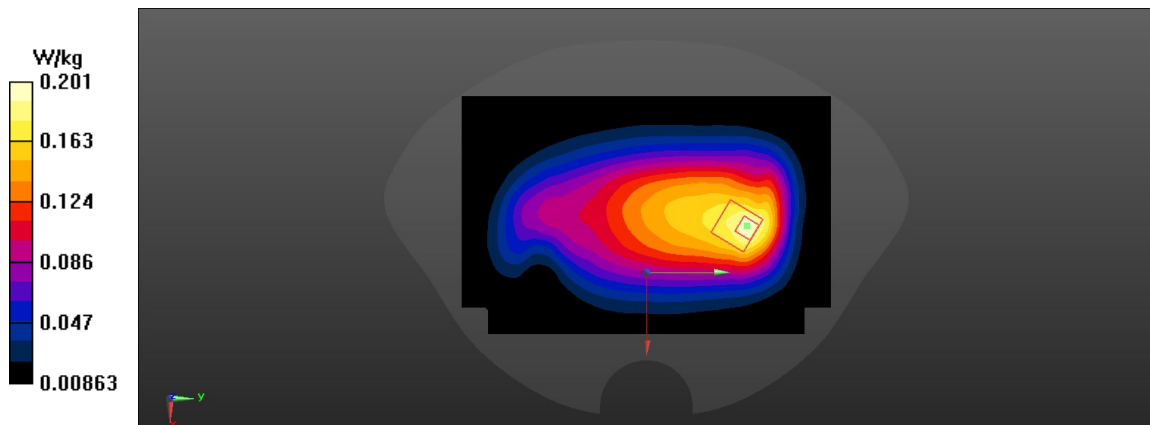
**Fig A.12**

LTE700-FDD12_CH23095 Left Cheek 1RB-Middle

Date: 11/25/2021

Electronics: DAE4 Sn1525

Medium: head 750 MHz

Medium parameters used: $f = 707.5$ MHz; $\sigma = 0.862$ mho/m; $\epsilon_r = 42.17$; $\rho = 1000$ kg/m³

Ambient Temperature: 22.5°C, Liquid Temperature: 22.3°C

Communication System: LTE700-FDD12 707.5 MHz Duty Cycle: 1:1

Probe: EX3DV4 – 7517 ConvF(9.81,9.81,9.81)

Area Scan (71x121x1): Interpolated grid: dx=1.500 mm, dy=1.500 mm

Maximum value of SAR (interpolated) = 0.407 W/kg

Zoom Scan (5x5x7)/Cube 0: Measurement grid: dx=8mm, dy=8mm, dz=5mm

Reference Value = 17.04 V/m; Power Drift = 0.14 dB

Peak SAR (extrapolated) = 0.503 W/kg

SAR(1 g) = 0.31 W/kg; SAR(10 g) = 0.203 W/kg

Maximum value of SAR (measured) = 0.406 W/kg

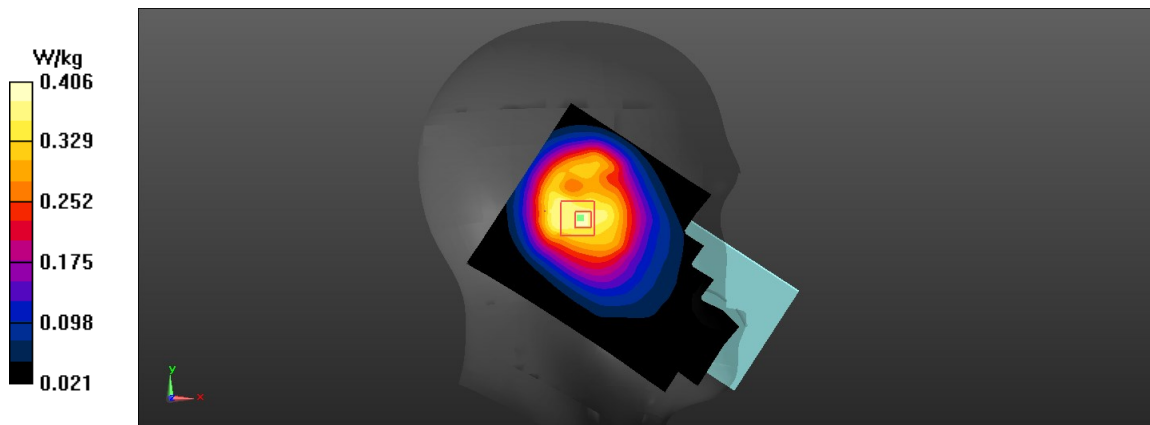

Fig A.13

LTE700-FDD12_CH23095 Rear 1RB-Middle 10mm

Date: 11/25/2021

Electronics: DAE4 Sn1525

Medium: head 750 MHz

Medium parameters used: $f = 707.5$ MHz; $\sigma = 0.852$ mho/m; $\epsilon_r = 41.47$; $\rho = 1000$ kg/m³

Ambient Temperature: 22.5°C, Liquid Temperature: 22.3°C

Communication System: LTE700-FDD12 707.5 MHz Duty Cycle: 1:1

Probe: EX3DV4 – 7517 ConvF(9.81,9.81,9.81)

Area Scan (71x121x1): Interpolated grid: dx=1.500 mm, dy=1.500 mm

Maximum value of SAR (interpolated) = 0.525 W/kg

Zoom Scan (5x5x7)/Cube 0: Measurement grid: dx=8mm, dy=8mm, dz=5mm

Reference Value = 22.23 V/m; Power Drift = -0.25 dB

Peak SAR (extrapolated) = 0.679 W/kg

SAR(1 g) = 0.361 W/kg; SAR(10 g) = 0.17 W/kg

Maximum value of SAR (measured) = 0.544 W/kg

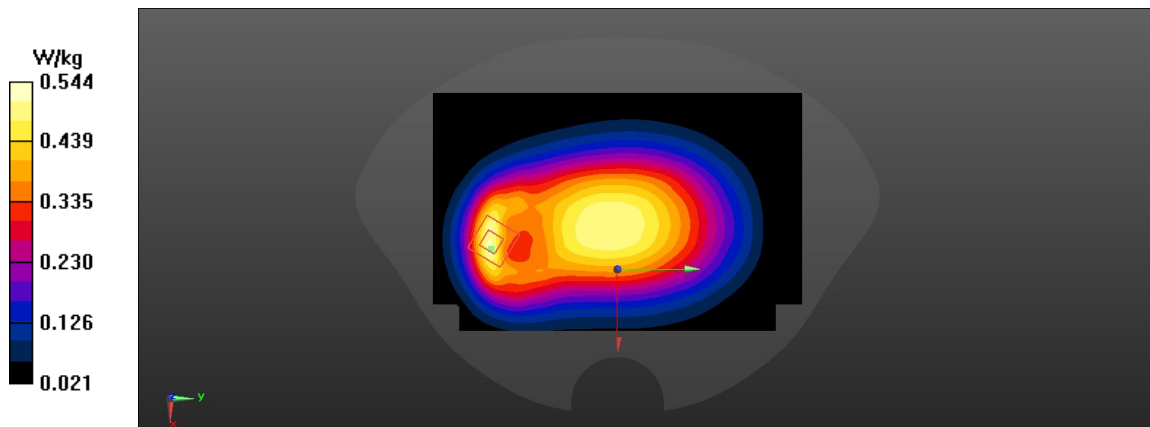

Fig A.14

LTE750-FDD13_CH23230 Left Cheek 1RB-Middle

Date: 11/25/2021

Electronics: DAE4 Sn1525

Medium: head 750 MHz

Medium parameters used: $f = 782 \text{ MHz}$; $\sigma = 0.932 \text{ mho/m}$; $\epsilon_r = 42.08$; $\rho = 1000 \text{ kg/m}^3$

Ambient Temperature: 22.5°C, Liquid Temperature: 22.3°C

Communication System: LTE750-FDD13 782 MHz Duty Cycle: 1:1

Probe: EX3DV4 – 7517 ConvF(9.81,9.81,9.81)

Area Scan (71x121x1): Interpolated grid: $dx=1.500 \text{ mm}$, $dy=1.500 \text{ mm}$

Maximum value of SAR (interpolated) = 0.827 W/kg

Zoom Scan (5x5x7)/Cube 0: Measurement grid: $dx=8\text{mm}$, $dy=8\text{mm}$, $dz=5\text{mm}$

Reference Value = 24.38 V/m; Power Drift = 0.18 dB

Peak SAR (extrapolated) = 0.972 W/kg

SAR(1 g) = 0.575 W/kg; SAR(10 g) = 0.367 W/kg

Maximum value of SAR (measured) = 0.795 W/kg

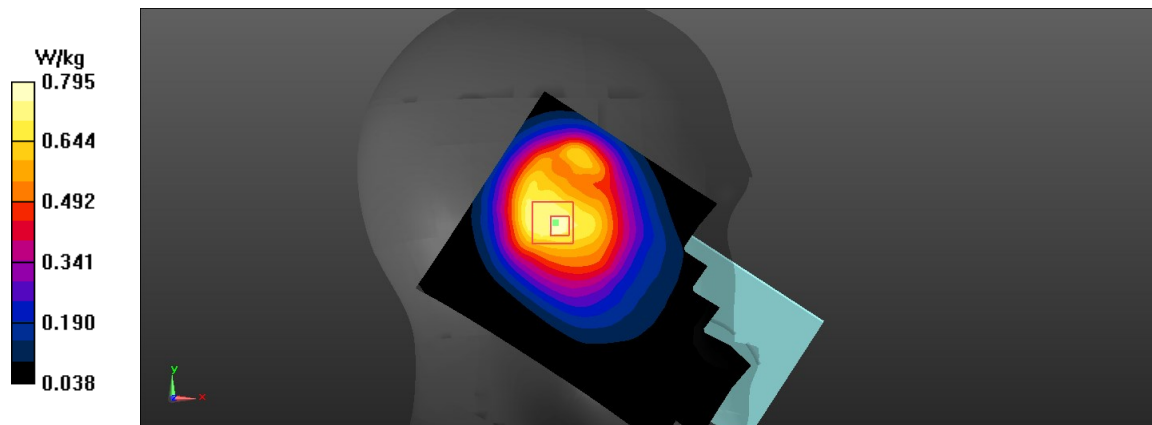

Fig A.15

LTE750-FDD13_CH23230 Rear 1RB-Middle 10mm

Date: 11/25/2021

Electronics: DAE4 Sn1525

Medium: head 750 MHz

Medium parameters used: $f = 782$ MHz; $\sigma = 0.922$ mho/m; $\epsilon_r = 41.38$; $\rho = 1000$ kg/m³

Ambient Temperature: 22.5°C, Liquid Temperature: 22.3°C

Communication System: LTE750-FDD13 782 MHz Duty Cycle: 1:1

Probe: EX3DV4 – 7517 ConvF(9.81,9.81,9.81)

Area Scan (71x121x1): Interpolated grid: dx=1.500 mm, dy=1.500 mm

Maximum value of SAR (interpolated) = 0.489 W/kg

Zoom Scan (5x5x7)/Cube 0: Measurement grid: dx=8mm, dy=8mm, dz=5mm

Reference Value = 19.21 V/m; Power Drift = -0.17 dB

Peak SAR (extrapolated) = 0.569 W/kg

SAR(1 g) = 0.313 W/kg; SAR(10 g) = 0.181 W/kg

Maximum value of SAR (measured) = 0.472 W/kg

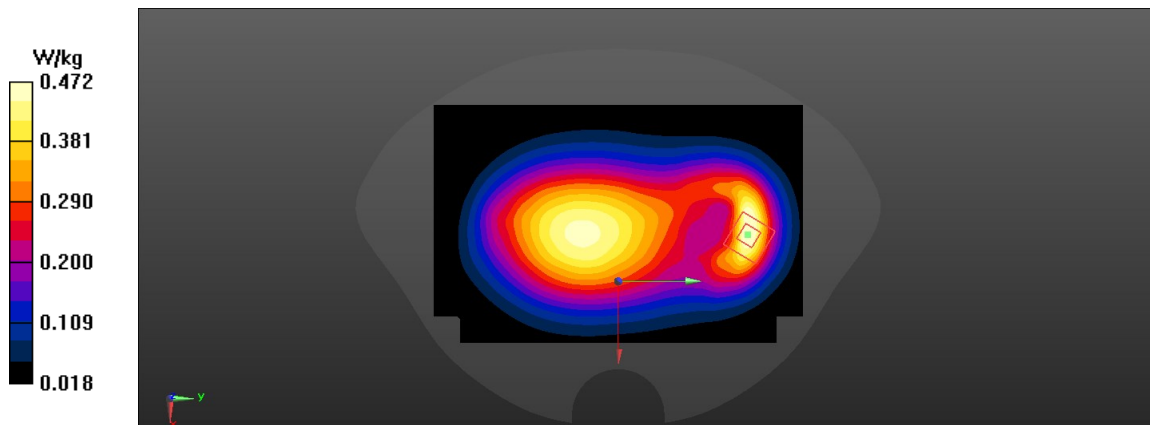

Fig A.16

LTE1900-FDD25_CH26590 Right Cheek 1RB-Middle

Date: 12/4/2021

Electronics: DAE4 Sn1525

Medium: head 1900 MHz

Medium parameters used: $f = 1905$ MHz; $\sigma = 1.378$ mho/m; $\epsilon_r = 40.17$; $\rho = 1000$ kg/m³

Ambient Temperature: 22.5°C, Liquid Temperature: 22.3°C

Communication System: LTE1900-FDD25 1905 MHz Duty Cycle: 1:1

Probe: EX3DV4 – 7517 ConvF(7.81,7.81,7.81)

Area Scan (71x121x1): Interpolated grid: dx=1.500 mm, dy=1.500 mm

Maximum value of SAR (interpolated) = 0.346 W/kg

Zoom Scan (5x5x7)/Cube 0: Measurement grid: dx=8mm, dy=8mm, dz=5mm

Reference Value = 4.328 V/m; Power Drift =0.13 dB

Peak SAR (extrapolated) = 0.451 W/kg

SAR(1 g) = 0.262 W/kg; SAR(10 g) = 0.168 W/kg

Maximum value of SAR (measured) = 0.371 W/kg

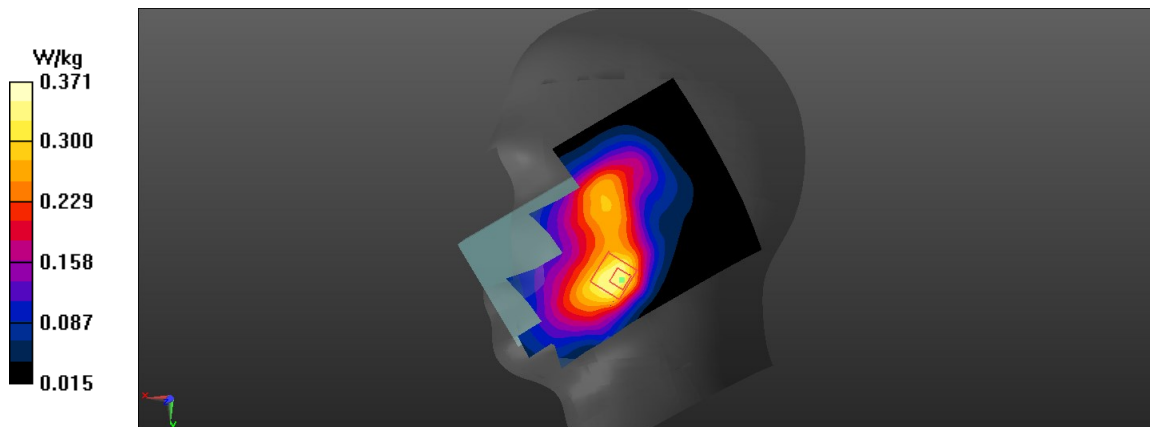

Fig A.17

LTE1900-FDD25_CH26590 Bottom Edge 1RB-Middle 10mm

Date: 12/4/2021

Electronics: DAE4 Sn1525

Medium: head 1900 MHz

Medium parameters used: $f = 1905 \text{ MHz}$; $\sigma = 1.413 \text{ mho/m}$; $\epsilon_r = 40.04$; $\rho = 1000 \text{ kg/m}^3$

Ambient Temperature: 22.5°C , Liquid Temperature: 22.3°C

Communication System: LTE1900-FDD25 1905 MHz Duty Cycle: 1:1

Probe: EX3DV4 – 7517 ConvF(7.81,7.81,7.81)

Area Scan (71x121x1): Interpolated grid: $dx=1.500 \text{ mm}$, $dy=1.500 \text{ mm}$

Maximum value of SAR (interpolated) = 0.587 W/kg

Zoom Scan (5x5x7)/Cube 0: Measurement grid: $dx=8\text{mm}$, $dy=8\text{mm}$, $dz=5\text{mm}$

Reference Value = 9.349 V/m ; Power Drift = -0.16 dB

Peak SAR (extrapolated) = 0.719 W/kg

SAR(1 g) = 0.361 W/kg ; SAR(10 g) = 0.192 W/kg

Maximum value of SAR (measured) = 0.572 W/kg

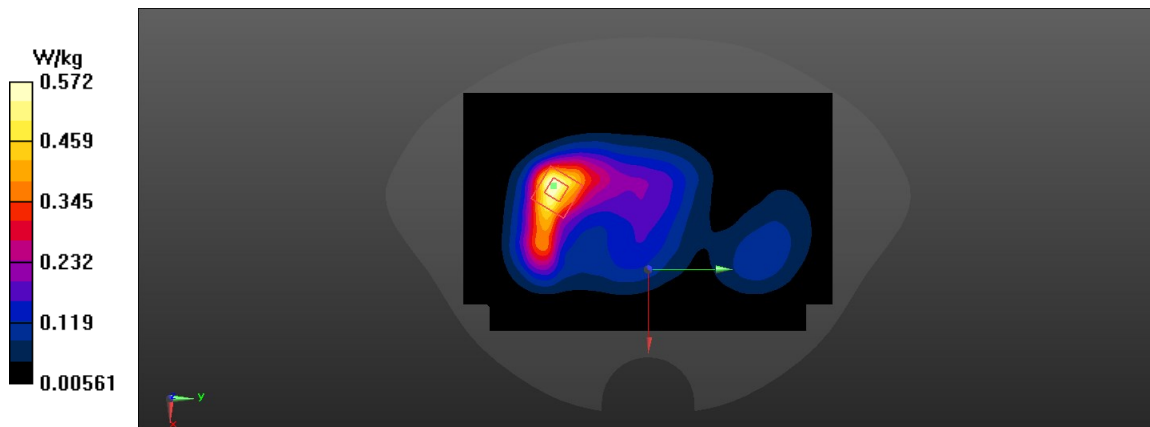

Fig A.18

LTE1900-FDD25_CH26140 Rear 1RB-Middle 15mm

Date: 12/4/2021

Electronics: DAE4 Sn1525

Medium: head 1900 MHz

Medium parameters used: $f = 1860$ MHz; $\sigma = 1.37$ mho/m; $\epsilon_r = 40.1$; $\rho = 1000$ kg/m³

Ambient Temperature: 22.5°C, Liquid Temperature: 22.3°C

Communication System: LTE1900-FDD25 1860 MHz Duty Cycle: 1:1

Probe: EX3DV4 – 7517 ConvF(7.81,7.81,7.81)

Area Scan (71x121x1): Interpolated grid: dx=1.500 mm, dy=1.500 mm

Maximum value of SAR (interpolated) = 0.438 W/kg

Zoom Scan (5x5x7)/Cube 0: Measurement grid: dx=8mm, dy=8mm, dz=5mm

Reference Value = 9.476 V/m; Power Drift = -0.1 dB

Peak SAR (extrapolated) = 0.495 W/kg

SAR(1 g) = 0.279 W/kg; SAR(10 g) = 0.162 W/kg

Maximum value of SAR (measured) = 0.409 W/kg

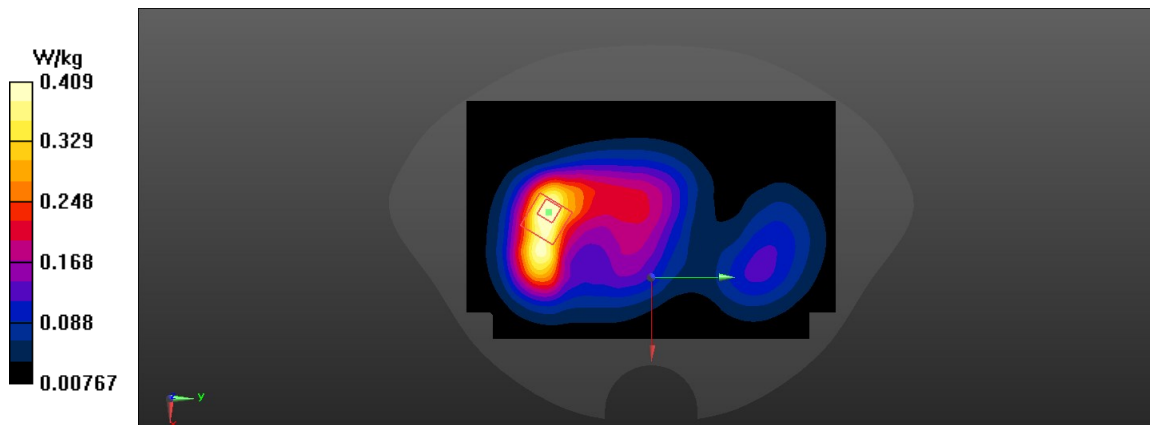

Fig A.19

LTE850-FDD26_CH26865 Left Cheek 1RB-Middle

Date: 11/29/2021

Electronics: DAE4 Sn1525

Medium: head 835 MHz

Medium parameters used: $f = 831.5$ MHz; $\sigma = 1.453$ mho/m; $\epsilon_r = 38.914$; $\rho = 1000$ kg/m³

Ambient Temperature: 22.5°C, Liquid Temperature: 22.3°C

Communication System: LTE850-FDD26 831.5 MHz Duty Cycle: 1:1

Probe: EX3DV4 – 7517 ConvF(9.40,9.40,9.40)

Area Scan (71x121x1): Interpolated grid: dx=1.500 mm, dy=1.500 mm

Maximum value of SAR (interpolated) = 0.662 W/kg

Zoom Scan (5x5x7)/Cube 0: Measurement grid: dx=8mm, dy=8mm, dz=5mm

Reference Value = 17.93 V/m; Power Drift = -0.19 dB

Peak SAR (extrapolated) = 0.769 W/kg

SAR(1 g) = 0.366 W/kg; SAR(10 g) = 0.236 W/kg

Maximum value of SAR (measured) = 0.371 W/kg

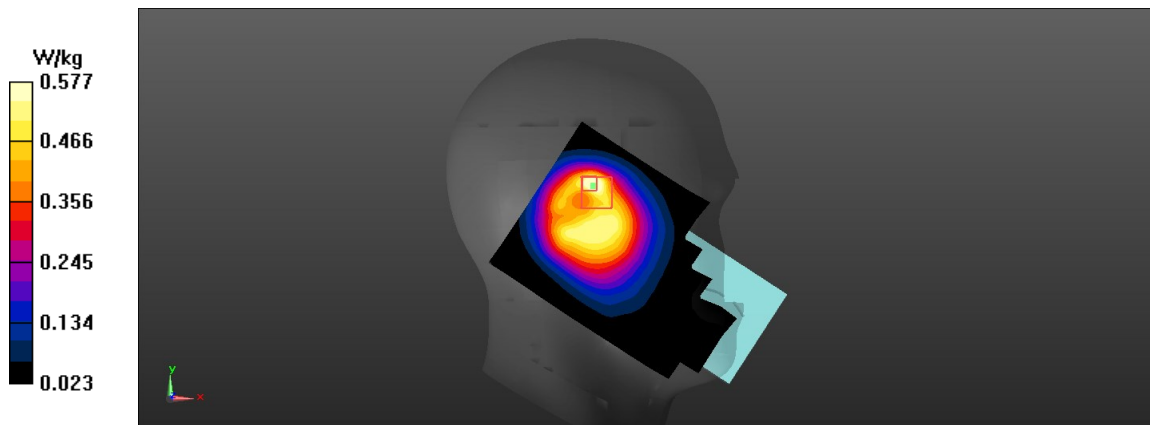

Fig A.20

LTE850-FDD26_CH26865 Rear 1RB-Middle 10mm

Date: 11/29/2021

Electronics: DAE4 Sn1525

Medium: head 835 MHz

Medium parameters used: $f = 831.5$ MHz; $\sigma = 0.986$ mho/m; $\epsilon_r = 40.706$; $\rho = 1000$ kg/m³

Ambient Temperature: 22.5°C, Liquid Temperature: 22.3°C

Communication System: LTE850-FDD26 831.5 MHz Duty Cycle: 1:1

Probe: EX3DV4 – 7517 ConvF(9.40,9.40,9.40)

Area Scan (71x121x1): Interpolated grid: dx=1.500 mm, dy=1.500 mm

Maximum value of SAR (interpolated) = 0.597 W/kg

Zoom Scan (5x5x7)/Cube 0: Measurement grid: dx=8mm, dy=8mm, dz=5mm

Reference Value = 18.84 V/m; Power Drift = 0.09 dB

Peak SAR (extrapolated) = 0.749 W/kg

SAR(1 g) = 0.398 W/kg; SAR(10 g) = 0.226 W/kg

Maximum value of SAR (measured) = 0.601 W/kg

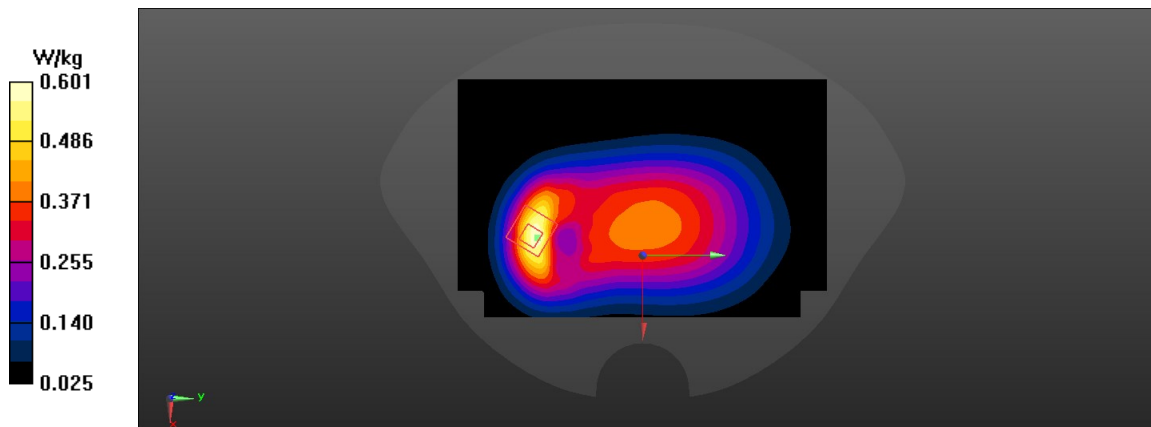

Fig A.21

LTE2600-TDD41 PC3_CH41055 Left Cheek 1RB-Middle

Date: 12/7/2021

Electronics: DAE4 Sn1525

Medium: head 2600 MHz

Medium parameters used: $f=2636.5$ MHz; $\sigma = 1.997$ mho/m; $\epsilon_r=37.823$; $\rho = 1000$ kg/m³

Ambient Temperature: 22.5°C, Liquid Temperature: 22.3°C

Communication System: LTE2600-TDD41PC3 831.5 MHz Duty Cycle: 1:1.58

Probe: EX3DV4 – 7517 ConvF(7.10,7.10,7.10)

Area Scan (71x121x1): Interpolated grid: dx=1.200 mm, dy=1.200 mm

Maximum value of SAR (interpolated) = 0.101 W/kg

Zoom Scan (5x5x7)/Cube 0: Measurement grid: dx=5mm, dy=5mm, dz=5mm

Reference Value = 1.043 V/m; Power Drift = 0.17 dB

Peak SAR (extrapolated) = 0.115 W/kg

SAR(1 g) = 0.062 W/kg; SAR(10 g) = 0.034 W/kg

Maximum value of SAR (measured) = 0.0938 W/kg

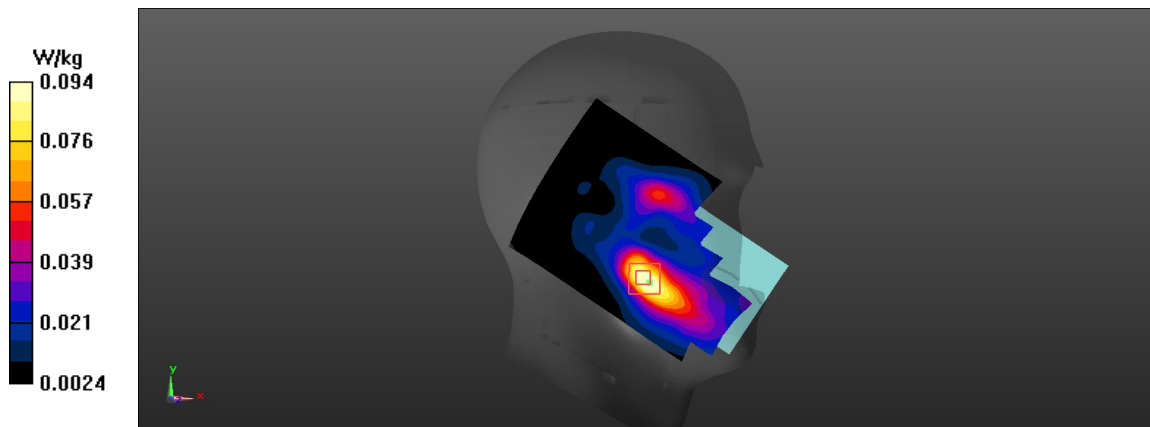

Fig A.22

LTE2600-TDD41 PC3_CH40620 Rear 1RB-Middle 10mm

Date: 12/7/2021

Electronics: DAE4 Sn1525

Medium: head 2600 MHz

Medium parameters used: $f = 2593$ MHz; $\sigma = 1.958$ mho/m; $\epsilon_r = 37.87$; $\rho = 1000$ kg/m³

Ambient Temperature: 22.5°C, Liquid Temperature: 22.3°C

Communication System: LTE2600-TDD41PC3 831.5 MHz Duty Cycle: 1:1.58

Probe: EX3DV4 – 7517 ConvF(7.10,7.10,7.10)

Area Scan (71x121x1): Interpolated grid: dx=1.200 mm, dy=1.200 mm

Maximum value of SAR (interpolated) = 0.479 W/kg

Zoom Scan (5x5x7)/Cube 0: Measurement grid: dx=5mm, dy=5mm, dz=5mm

Reference Value = 1.775 V/m; Power Drift = -0.16 dB

Peak SAR (extrapolated) = 0.59 W/kg

SAR(1 g) = 0.279 W/kg; SAR(10 g) = 0.126 W/kg

Maximum value of SAR (measured) = 0.446 W/kg

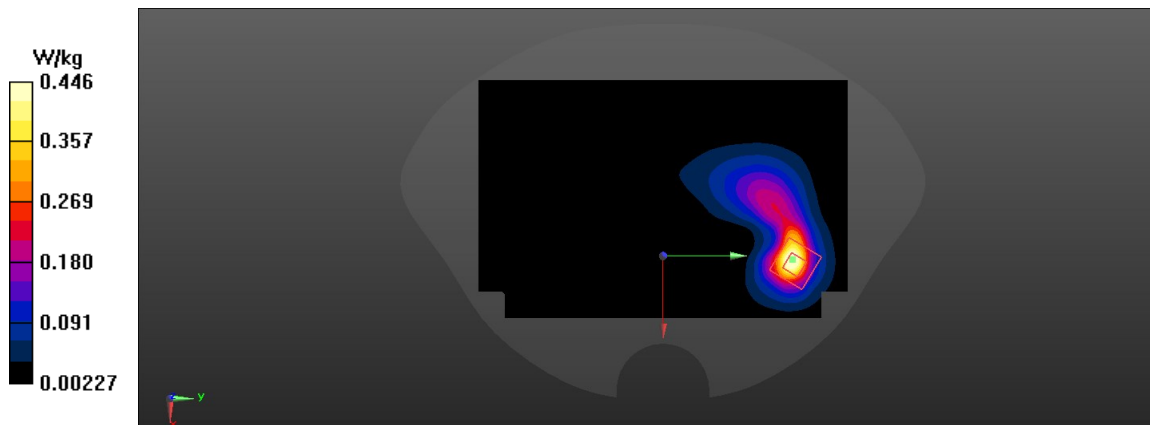

Fig A.23

LTE2600-TDD41 PC3_CH41055 Rear 1RB-Middle 15mm

Date: 12/7/2021

Electronics: DAE4 Sn1525

Medium: head 2600 MHz

 Medium parameters used: $f = 2636.5$ MHz; $\sigma = 1.997$ mho/m; $\epsilon_r = 37.823$; $\rho = 1000$ kg/m³

Ambient Temperature: 22.5°C, Liquid Temperature: 22.3°C

Communication System: LTE2600-TDD41PC3 831.5 MHz Duty Cycle: 1:1.58

Probe: EX3DV4 – 7517 ConvF(7.10,7.10,7.10)

Area Scan (71x121x1): Interpolated grid: dx=1.200 mm, dy=1.200 mm

Maximum value of SAR (interpolated) = 0.247 W/kg

Zoom Scan (5x5x7)/Cube 0: Measurement grid: dx=5mm, dy=5mm, dz=5mm

Reference Value = 1.34 V/m; Power Drift = -0.18 dB

Peak SAR (extrapolated) = 0.313 W/kg

SAR(1 g) = 0.156 W/kg; SAR(10 g) = 0.077 W/kg

Maximum value of SAR (measured) = 0.247 W/kg

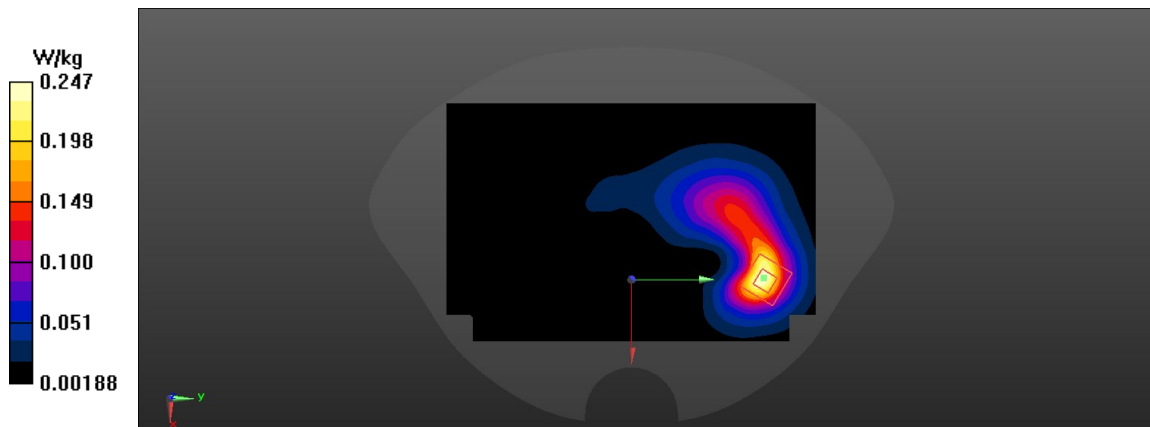

Fig A.24

LTE2600-TDD41 PC2_CH40620 Left Cheek 1RB-Middle

Date: 12/8/2021

Electronics: DAE4 Sn1525

Medium: head 2600 MHz

Medium parameters used: $f = 2636.5$ MHz; $\sigma = 1.997$ mho/m; $\epsilon_r = 37.823$; $\rho = 1000$ kg/m³

Ambient Temperature: 22.5°C, Liquid Temperature: 22.3°C

Communication System: LTE2600-TDD41PC2 831.5 MHz Duty Cycle: 1:2.309

Probe: EX3DV4 – 7517 ConvF(7.10,7.10,7.10)

Area Scan (101x171x1): Interpolated grid: dx=1.200 mm, dy=1.200 mm

Maximum value of SAR (interpolated) = 0.132 W/kg

Zoom Scan (5x5x7)/Cube 0: Measurement grid: dx=5mm, dy=5mm, dz=5mm

Reference Value = 0.913 V/m; Power Drift = -0.17 dB

Peak SAR (extrapolated) = 0.147 W/kg

SAR(1 g) = 0.079 W/kg; SAR(10 g) = 0.045 W/kg

Maximum value of SAR (measured) = 0.120 W/kg

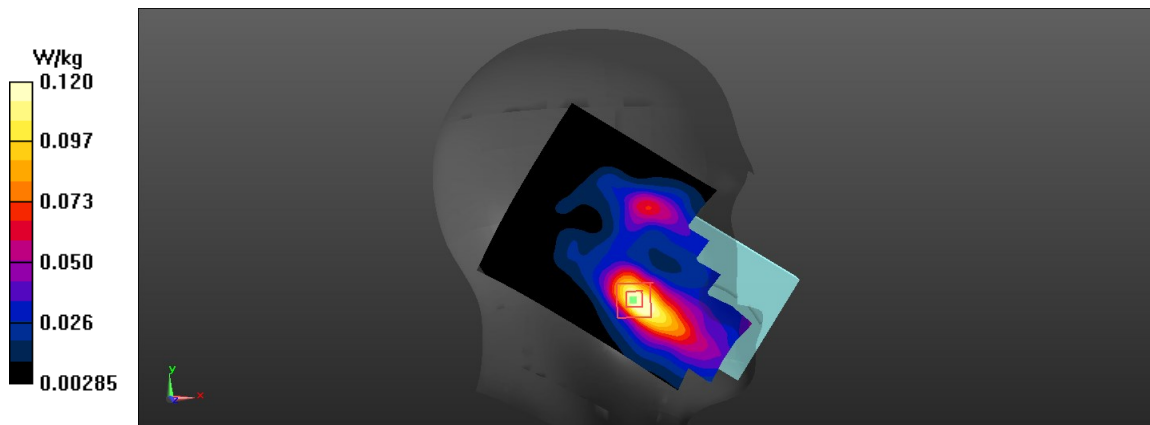

Fig A.25

LTE2600-TDD41 PC2_CH40620 Rear 1RB-Middle 10mm

Date: 12/8/2021

Electronics: DAE4 Sn1525

Medium: head 2600 MHz

Medium parameters used: $f = 2593$ MHz; $\sigma = 1.958$ mho/m; $\epsilon_r = 37.873$; $\rho = 1000$ kg/m³

Ambient Temperature: 22.5°C, Liquid Temperature: 22.3°C

Communication System: LTE2600-TDD41PC2 831.5 MHz Duty Cycle: 1:2.309

Probe: EX3DV4 – 7517 ConvF(7.10,7.10,7.10)

Area Scan (101x171x1): Interpolated grid: $dx = 1.200$ mm, $dy = 1.200$ mm

Maximum value of SAR (interpolated) = 0.48 W/kg

Zoom Scan (5x5x7)/Cube 0: Measurement grid: $dx = 5$ mm, $dy = 5$ mm, $dz = 5$ mm

Reference Value = 1.026 V/m; Power Drift = -0.15 dB

Peak SAR (extrapolated) = 0.564 W/kg

SAR(1 g) = 0.28 W/kg; SAR(10 g) = 0.131 W/kg

Maximum value of SAR (measured) = 0.447 W/kg

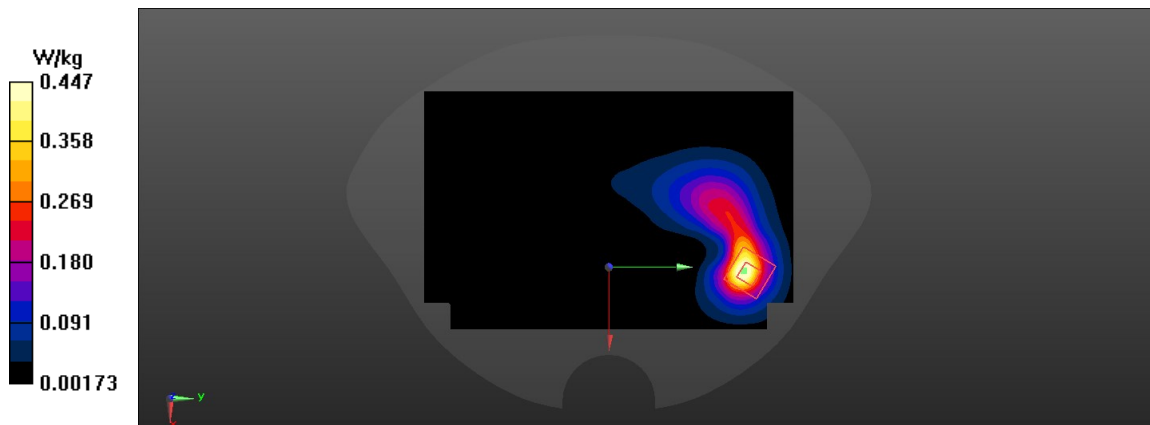

Fig A.26

LTE2600-TDD41 PC2_CH40620 Rear 1RB-Middle 15mm

Date: 12/8/2021

Electronics: DAE4 Sn1525

Medium: head 2600 MHz

Medium parameters used: $f=2593$ MHz; $\sigma = 1.958$ mho/m; $\epsilon_r = 37.873$; $\rho = 1000$ kg/m³

Ambient Temperature: 22.5°C, Liquid Temperature: 22.3°C

Communication System: LTE2600-TDD41PC2 831.5 MHz Duty Cycle: 1:2.309

Probe: EX3DV4 – 7517 ConvF(7.10,7.10,7.10)

Area Scan (101x171x1): Interpolated grid: dx=1.200 mm, dy=1.200 mm

Maximum value of SAR (interpolated) = 0.375 W/kg

Zoom Scan (5x5x7)/Cube 0: Measurement grid: dx=5mm, dy=5mm, dz=5mm

Reference Value = 1.61 V/m; Power Drift = -0.17 dB

Peak SAR (extrapolated) = 0.468 W/kg

SAR(1 g) = 0.235 W/kg; SAR(10 g) = 0.116 W/kg

Maximum value of SAR (measured) = 0.368 W/kg

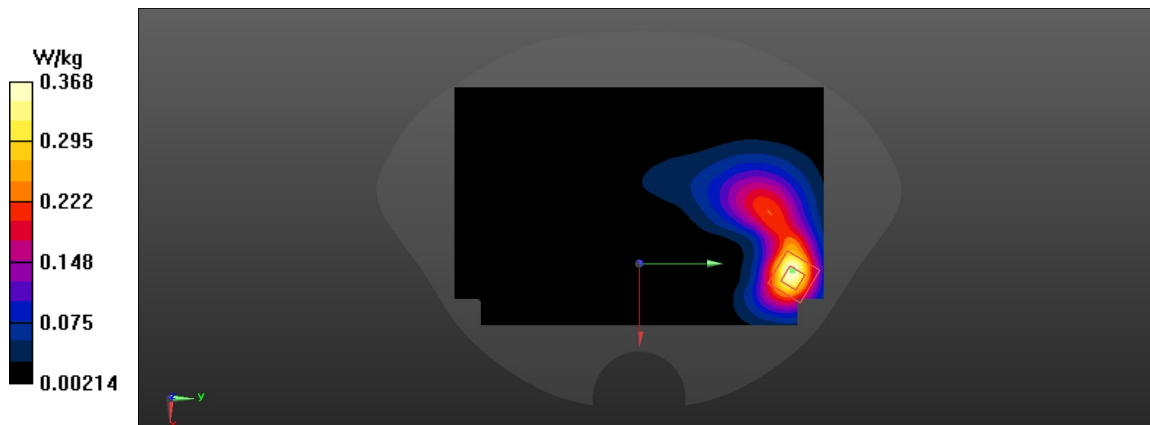

Fig A.27

LTE1700-FDD66_CH132072 Left Cheek 1RB-Middle

Date: 12/2/2021

Electronics: DAE4 Sn1525

Medium: head 1750 MHz

Medium parameters used: $f = 1770$ MHz; $\sigma = 0.484$ mho/m; $\epsilon_r = 41.41$; $\rho = 1000$ kg/m³

Ambient Temperature: 22.5°C, Liquid Temperature: 22.3°C

Communication System: LTE1700-FDD66 831.5 MHz Duty Cycle: 1:1

Probe: EX3DV4 – 7517 ConvF(8.22,8.22,8.22)

Area Scan (101x171x1): Interpolated grid: dx=1.200 mm, dy=1.200 mm

Maximum value of SAR (interpolated) = 0.274 W/kg

Zoom Scan (5x5x7)/Cube 0: Measurement grid: dx=8mm, dy=8mm, dz=5mm

Reference Value = 3.666 V/m; Power Drift = -0.01 dB

Peak SAR (extrapolated) = 0.287 W/kg

SAR(1 g) = 0.19 W/kg; SAR(10 g) = 0.123 W/kg

Maximum value of SAR (measured) = 0.251 W/kg

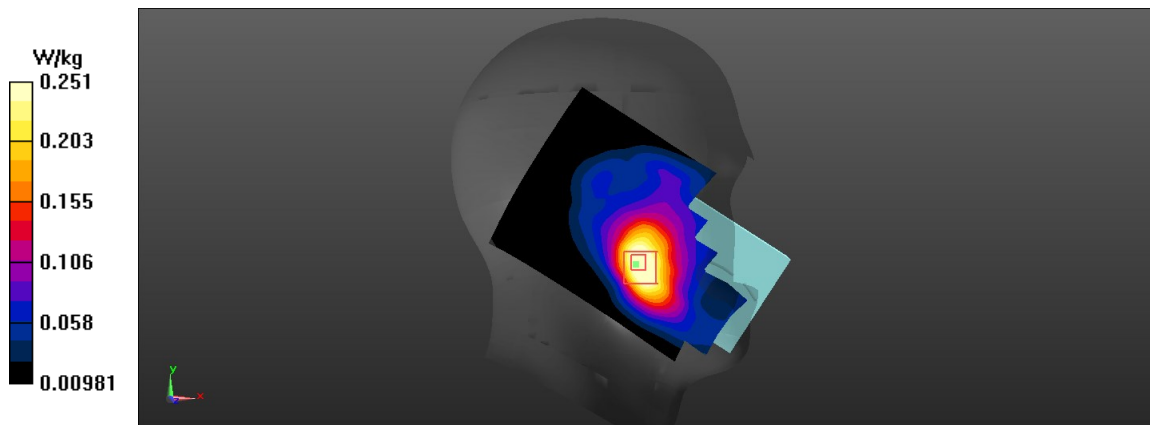

Fig A.28

LTE1700-FDD66_CH132322 Bottom Edge 1RB-Middle 10mm

Date: 12/2/2021

Electronics: DAE4 Sn1525

Medium: head 1750 MHz

Medium parameters used: $f=1745$ MHz; $\sigma=1.394$ mho/m; $\epsilon_r=38.913$; $\rho=1000$ kg/m³

Ambient Temperature: 22.5°C, Liquid Temperature: 22.3°C

Communication System: LTE1700-FDD66 831.5 MHz Duty Cycle: 1:1

Probe: EX3DV4 – 7517 ConvF(8.22,8.22,8.22)

Area Scan (91x141x1): Interpolated grid: dx=1.500 mm, dy=1.500 mm

Maximum value of SAR (interpolated) = 1.04 W/kg

Zoom Scan (5x5x7)/Cube 0: Measurement grid: dx=8mm, dy=8mm, dz=5mm

Reference Value = 20.36 V/m; Power Drift = -0.04 dB

Peak SAR (extrapolated) = 1.13 W/kg

SAR(1 g) = 0.618 W/kg; SAR(10 g) = 0.329 W/kg

Maximum value of SAR (measured) = 0.918 W/kg

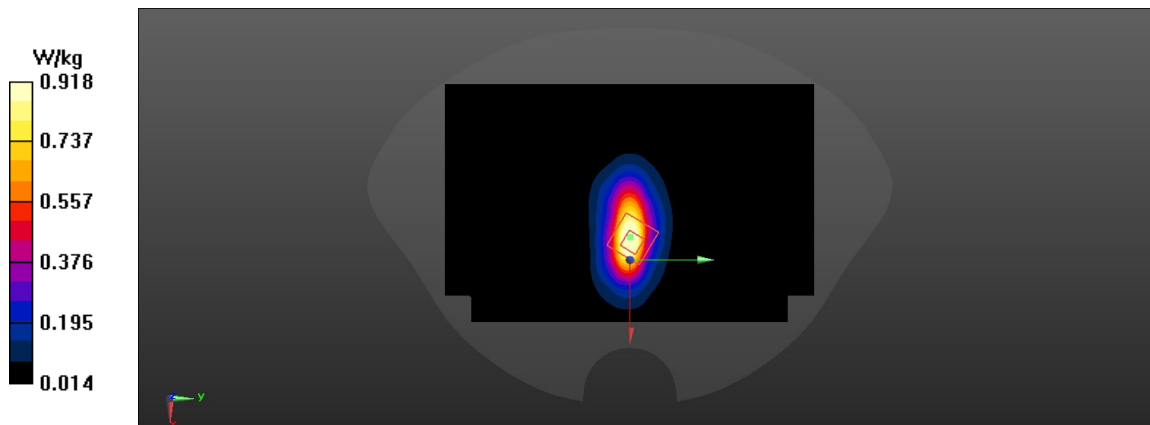

Fig A.29

LTE1700-FDD66_CH132322 Rear 1RB-Middle 15mm

Date: 12/2/2021

Electronics: DAE4 Sn1525

Medium: head 1750 MHz

Medium parameters used: $f = 1745$ MHz; $\sigma = 0.48$ mho/m; $\epsilon_r = 41.95$; $\rho = 1000$ kg/m³

Ambient Temperature: 22.5°C, Liquid Temperature: 22.3°C

Communication System: LTE1700-FDD66 831.5 MHz Duty Cycle: 1:1

Probe: EX3DV4 – 7517 ConvF(8.22,8.22,8.22)

Area Scan (91x141x1): Interpolated grid: dx=1.500 mm, dy=1.500 mm

Maximum value of SAR (interpolated) = 0.551 W/kg

Zoom Scan (5x5x7)/Cube 0: Measurement grid: dx=8mm, dy=8mm, dz=5mm

Reference Value = 3.907 V/m; Power Drift = 0.07 dB

Peak SAR (extrapolated) = 0.608 W/kg

SAR(1 g) = 0.363 W/kg; SAR(10 g) = 0.209 W/kg

Maximum value of SAR (measured) = 0.518 W/kg

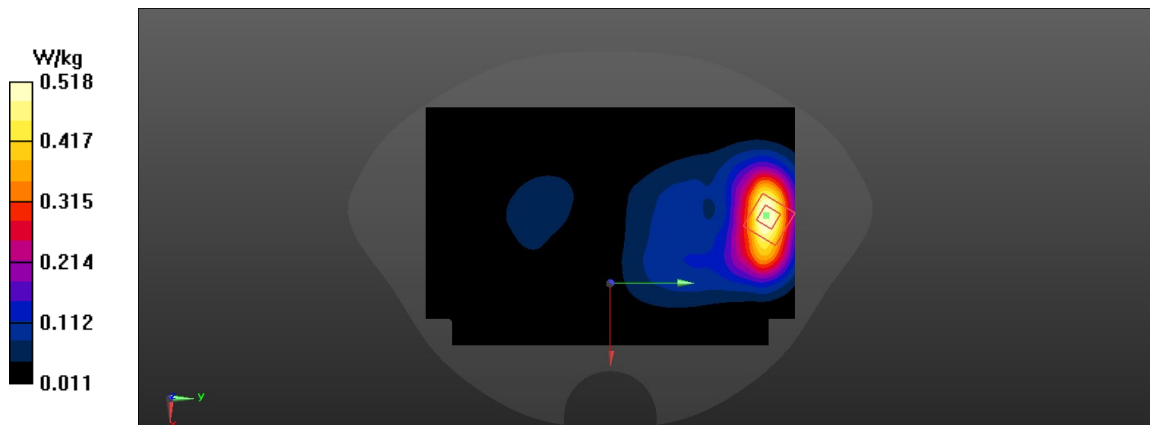

Fig A.30

LTE700-FDD71_CH133372 Right Cheek 1RB-Middle

Date: 11/26/2021

Electronics: DAE4 Sn1525

Medium: head 750 MHz

Medium parameters used: $f = 673$ MHz; $\sigma = 0.98$ mho/m; $\epsilon_r = 42.02$; $\rho = 1000$ kg/m³

Ambient Temperature: 22.5°C, Liquid Temperature: 22.3°C

Communication System: LTE700-FDD71 831.5 MHz Duty Cycle: 1:1

Probe: EX3DV4 – 7517 ConvF(9.81,9.81,9.81)

Area Scan (91x141x1): Interpolated grid: dx=1.500 mm, dy=1.500 mm

Maximum value of SAR (interpolated) = 0.736 W/kg

Zoom Scan (5x5x7)/Cube 0: Measurement grid: dx=8mm, dy=8mm, dz=5mm

Reference Value = 21.9 V/m; Power Drift = -0.07 dB

Peak SAR (extrapolated) = 0.901 W/kg

SAR(1 g) = 0.505 W/kg; SAR(10 g) = 0.325 W/kg

Maximum value of SAR (measured) = 0.733 W/kg

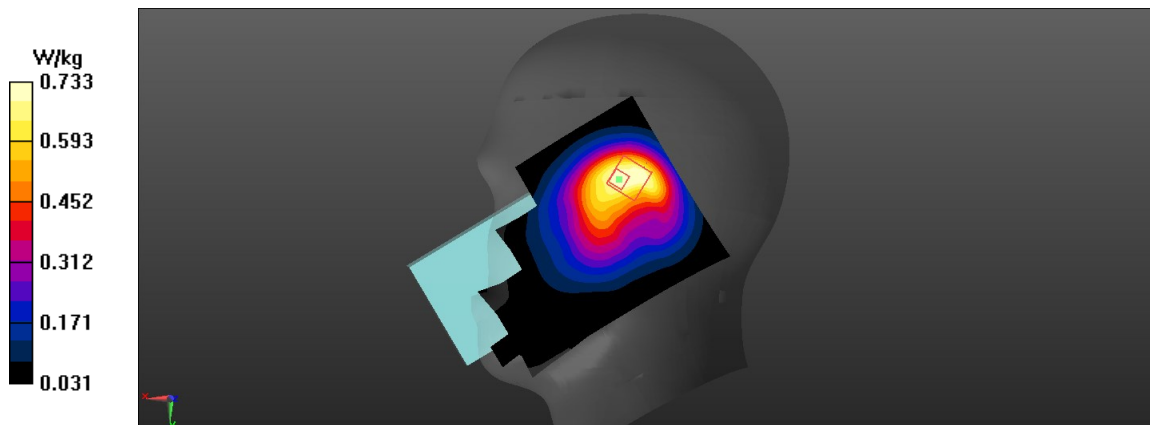

Fig A.31

LTE700-FDD71_CH133222 Rear 1RB-Middle 10mm

Date: 11/26/2021

Electronics: DAE4 Sn1525

Medium: head 750 MHz

Medium parameters used: $f = 673$ MHz; $\sigma = 0.97$ mho/m; $\epsilon_r = 41.32$; $\rho = 1000$ kg/m³

Ambient Temperature: 22.5°C, Liquid Temperature: 22.3°C

Communication System: LTE700-FDD71 831.5 MHz Duty Cycle: 1:1

Probe: EX3DV4 – 7517 ConvF(9.81,9.81,9.81)

Area Scan (91x141x1): Interpolated grid: dx=1.500 mm, dy=1.500 mm

Maximum value of SAR (interpolated) = 0.615 W/kg

Zoom Scan (5x5x7)/Cube 0: Measurement grid: dx=8mm, dy=8mm, dz=5mm

Reference Value = 23.51 V/m; Power Drift = 0.17 dB

Peak SAR (extrapolated) = 0.681 W/kg

SAR(1 g) = 0.526 W/kg; SAR(10 g) = 0.397 W/kg

Maximum value of SAR (measured) = 0.631 W/kg

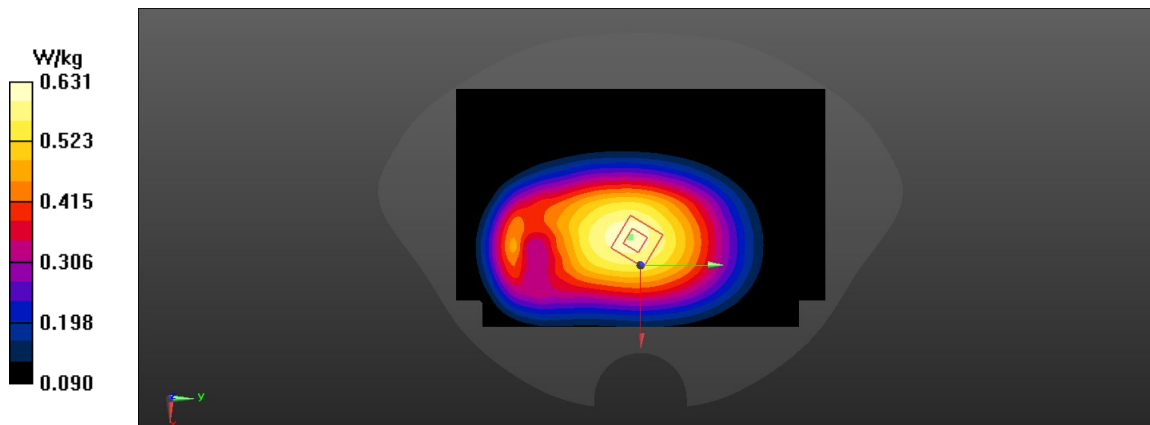

Fig A.32

WLAN2450_CH6 Right Cheek

Date: 12/6/2021

Electronics: DAE4 Sn1525

Medium: head 2450 MHz

Medium parameters used: $f = 2437$; $\sigma = 1.775$ mho/m; $\epsilon_r = 39.38$; $\rho = 1000$ kg/m³

Ambient Temperature: 22.5°C, Liquid Temperature: 22.3°C

Communication System: WLAN2450 2437 Duty Cycle: 1:1

Probe: EX3DV4 – 7517 ConvF(7.34,7.34,7.34)

Area Scan (101x171x1): Interpolated grid: dx=1.200 mm, dy=1.200 mm

Maximum value of SAR (interpolated) = 0.755 W/kg

Zoom Scan (5x5x7)/Cube 0: Measurement grid: dx=5mm, dy=5mm, dz=5mm

Reference Value = 9.548 V/m; Power Drift = 0.1 dB

Peak SAR (extrapolated) = 1.07 W/kg

SAR(1 g) = 0.493 W/kg; SAR(10 g) = 0.236 W/kg

Maximum value of SAR (measured) = 0.824 W/kg

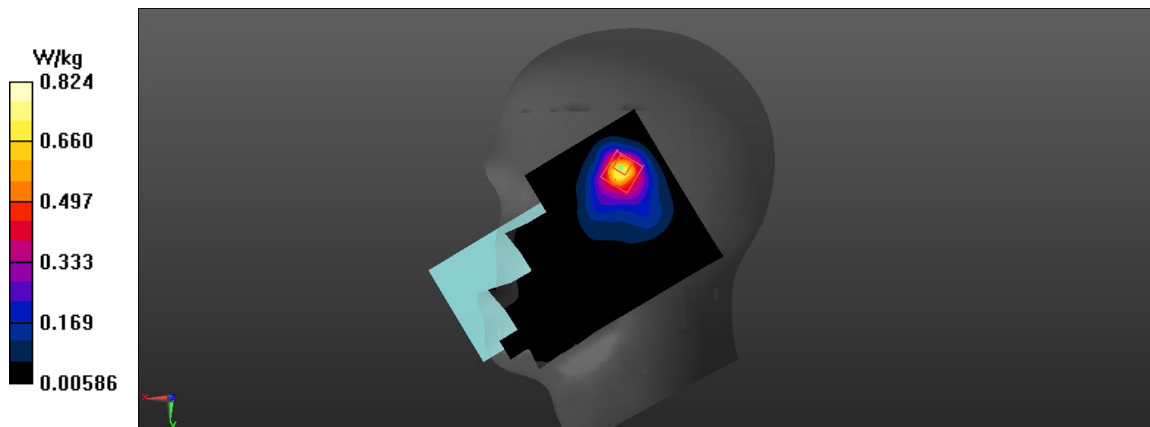

Fig A.33

WLAN2450_CH6 Rear 10mm

Date: 12/6/2021

Electronics: DAE4 Sn1525

Medium: head 2450 MHz

Medium parameters used: $f = 2437$; $\sigma = 1.823$ mho/m; $\epsilon_r = 38.87$; $\rho = 1000$ kg/m³

Ambient Temperature: 22.5°C, Liquid Temperature: 22.3°C

Communication System: WLAN2450 2437 MHz Duty Cycle: 1:1

Probe: EX3DV4 – 7517 ConvF(7.34,7.34,7.34)

Area Scan (101x171x1): Interpolated grid: dx=1.200 mm, dy=1.200 mm

Maximum value of SAR (interpolated) = 0.382 W/kg

Zoom Scan (5x5x7)/Cube 0: Measurement grid: dx=5mm, dy=5mm, dz=5mm

Reference Value = 1.702 V/m; Power Drift = -0.03 dB

Peak SAR (extrapolated) = 0.52 W/kg

SAR(1 g) = 0.239 W/kg; SAR(10 g) = 0.109 W/kg

Maximum value of SAR (measured) = 0.403 W/kg

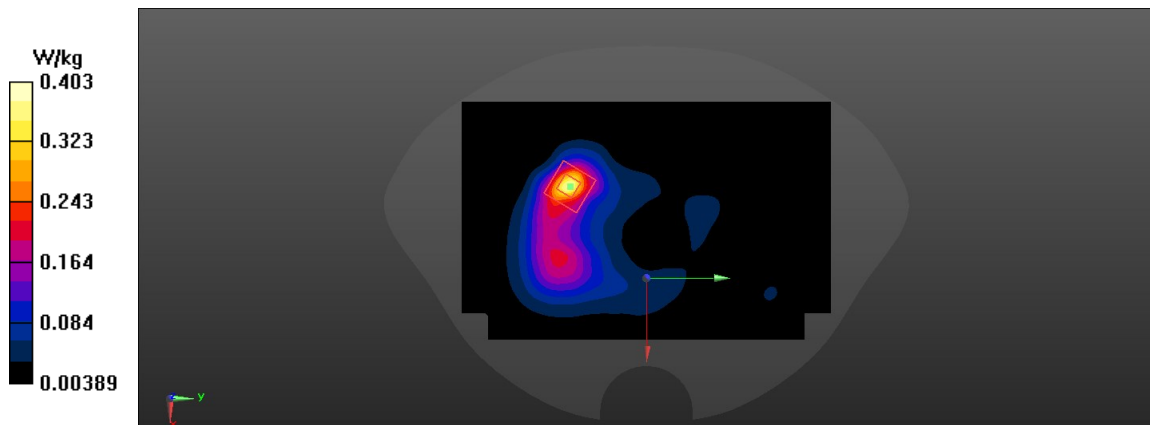

Fig A.34

Fig. 1-1 Z-Scan at power reference point (850 MHz)

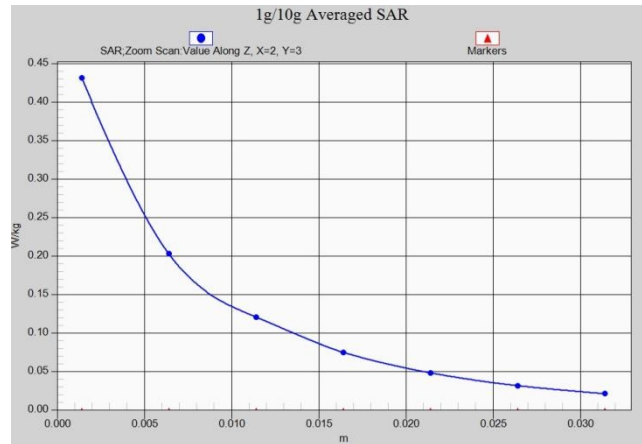

Fig. 1-2 Z-Scan at power reference point (850 MHz)

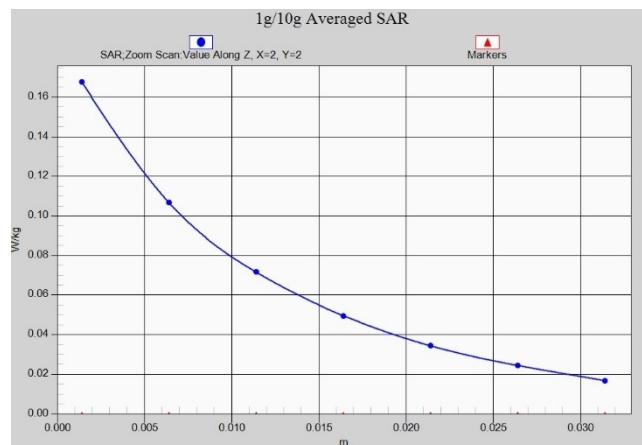

Fig. 1-3 Z-Scan at power reference point (1900 MHz)

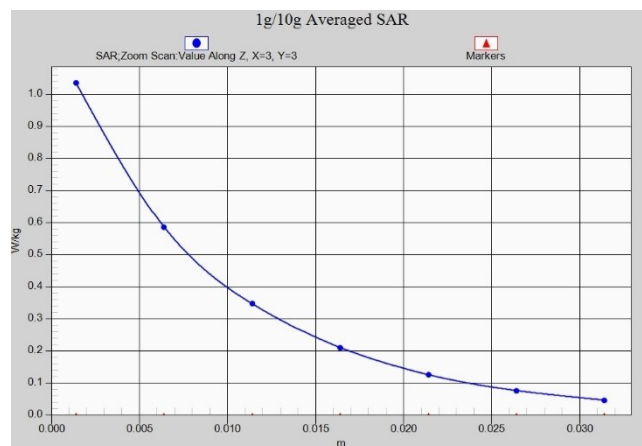

Fig. 1-4 Z-Scan at power reference point (1900 MHz)

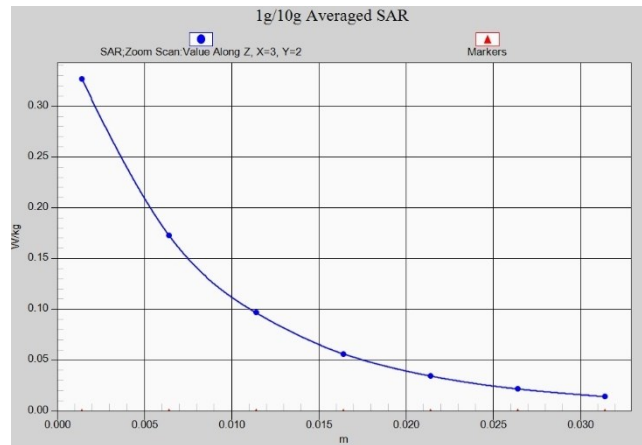

Fig. 1-5 Z-Scan at power reference point (WCDMA850)

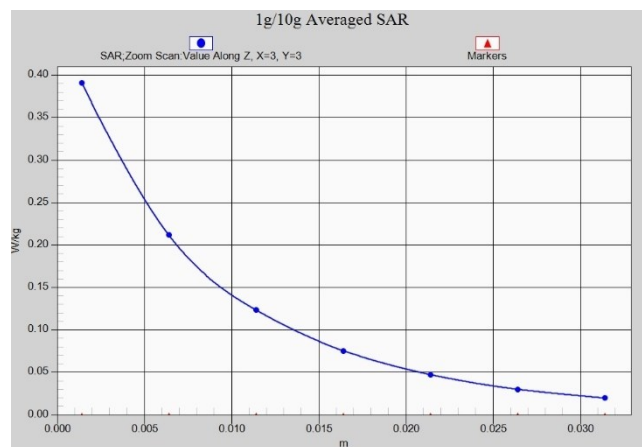

Fig. 1-6 Z-Scan at power reference point (WCDMA850)

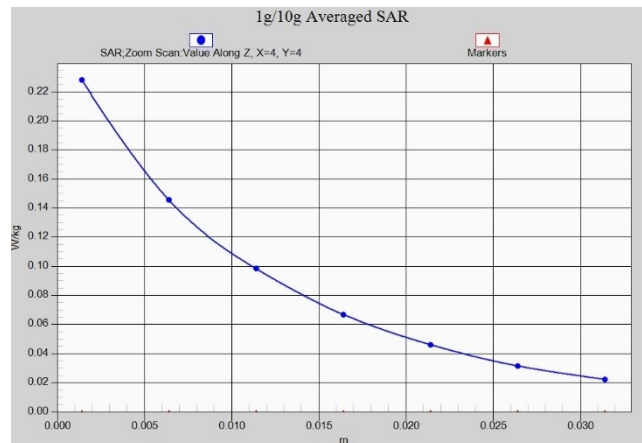

Fig. 1-7 Z-Scan at power reference point (WCDMA1700)

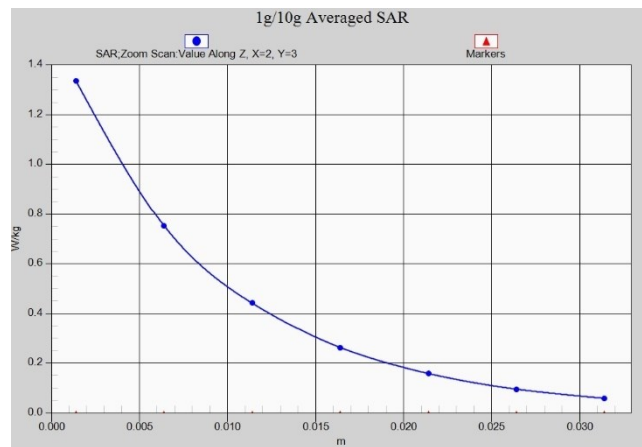

Fig. 1-8 Z-Scan at power reference point (WCDMA1700)

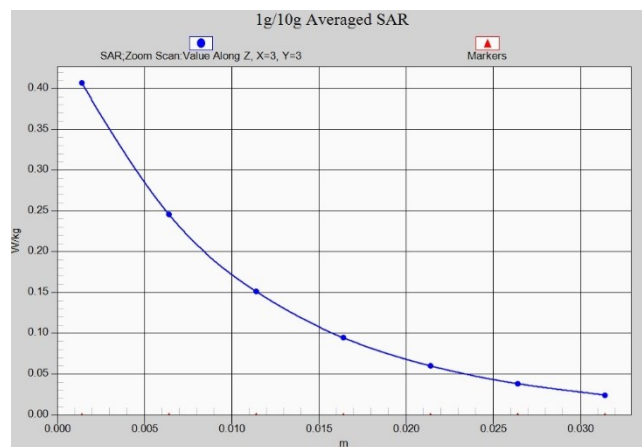

Fig. 1-9 Z-Scan at power reference point (WCDMA1700)

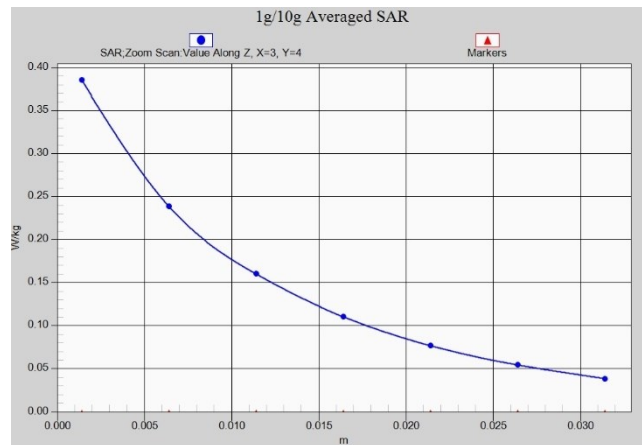

Fig. 1-10 Z-Scan at power reference point (WCDMA1900)

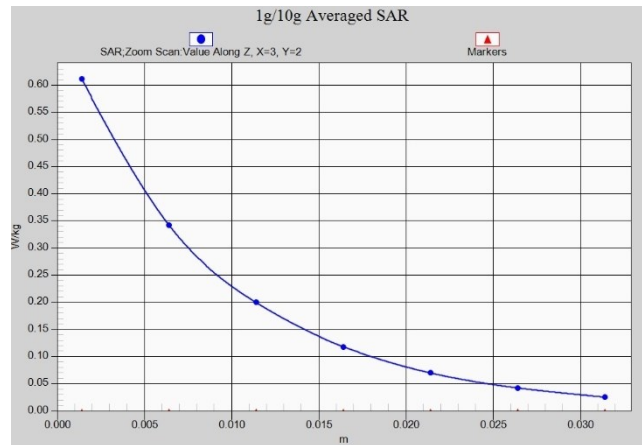

Fig. 1-11 Z-Scan at power reference point (WCDMA1900)

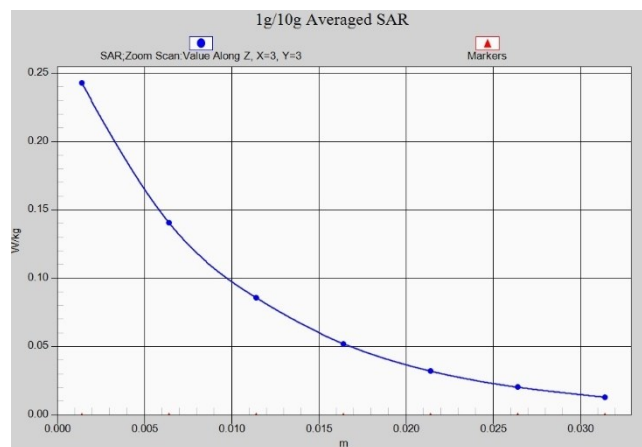

Fig. 1-12 Z-Scan at power reference point (WCDMA1900)

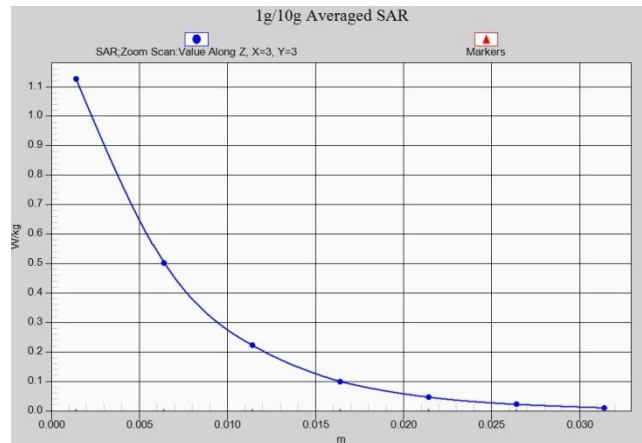

Fig. 1-13 Z-Scan at power reference point (LTE Band12)

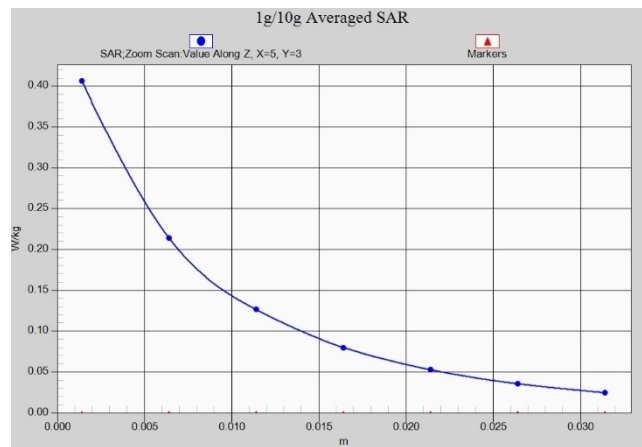

Fig. 1-14 Z-Scan at power reference point (LTE Band12)

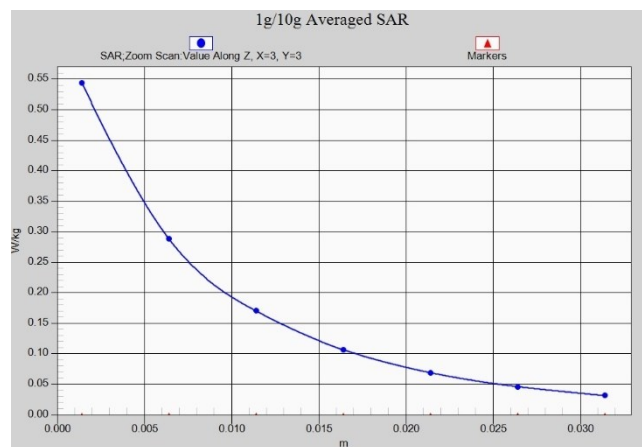

Fig. 1-15 Z-Scan at power reference point (LTE Band13)



Fig. 1-16 Z-Scan at power reference point (LTE Band13)

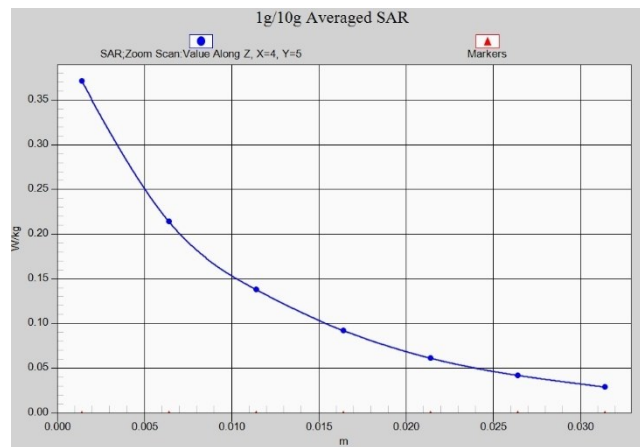

Fig. 1-17 Z-Scan at power reference point (LTE Band25)

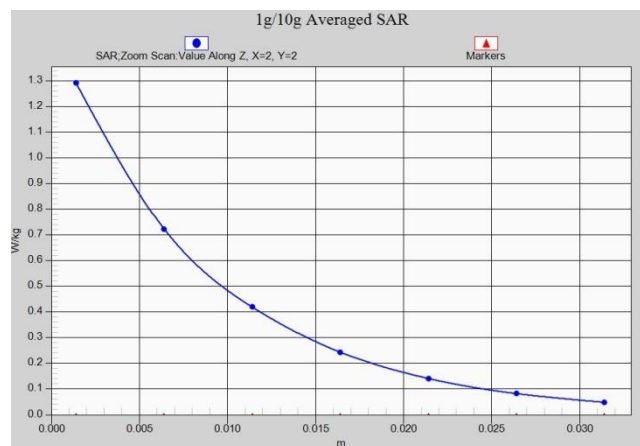

Fig. 1-18 Z-Scan at power reference point (LTE Band25)

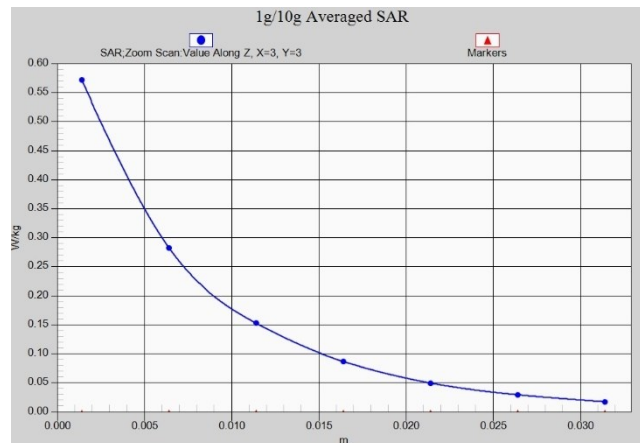

Fig. 1-19 Z-Scan at power reference point (LTE Band25)

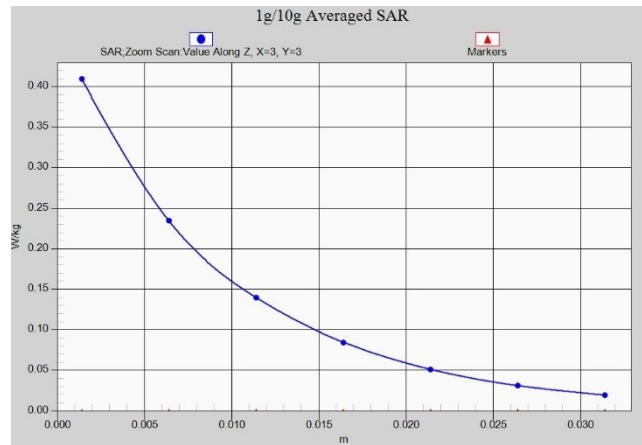

Fig. 1-20 Z-Scan at power reference point (LTE Band26)

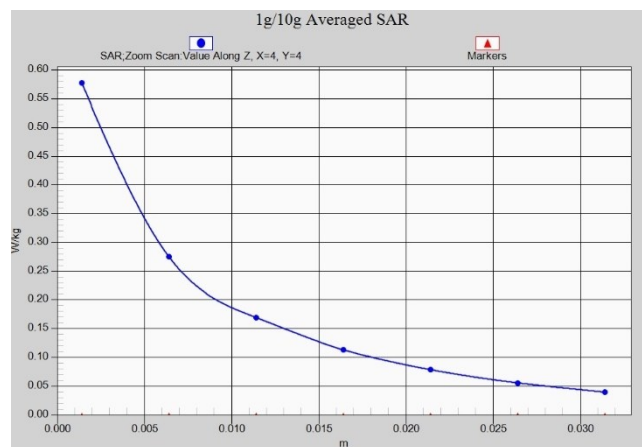

Fig. 1-21 Z-Scan at power reference point (LTE Band26)

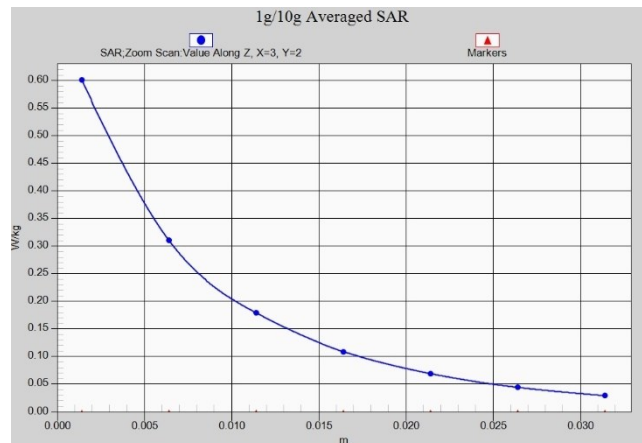

Fig. 1-22 Z-Scan at power reference point (LTE Band41)

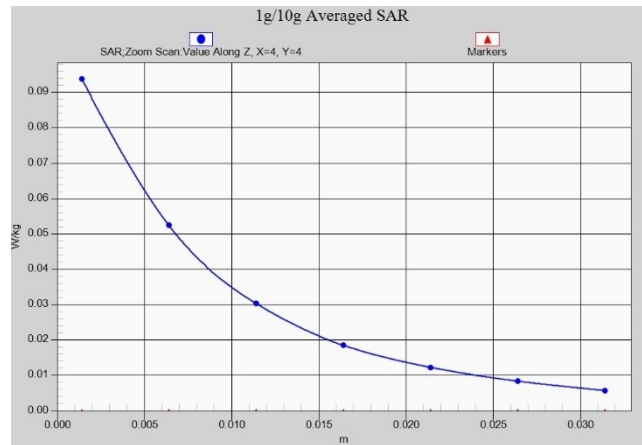

Fig. 1-23 Z-Scan at power reference point (LTE Band41)

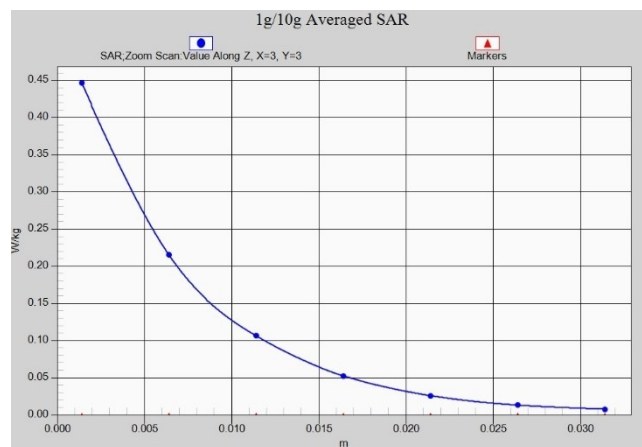

Fig. 1-24 Z-Scan at power reference point (LTE Band41)

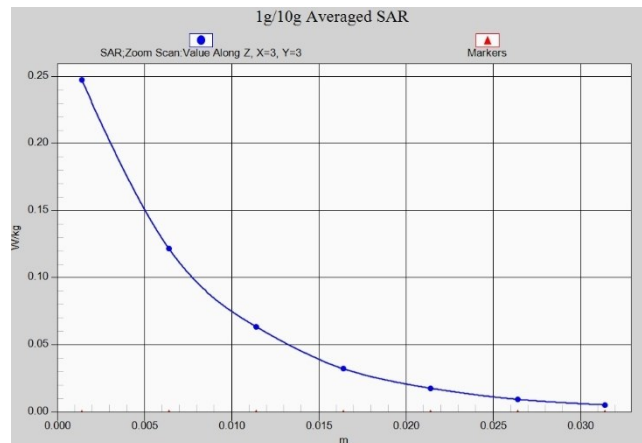

Fig. 1-25 Z-Scan at power reference point (LTE Band41)

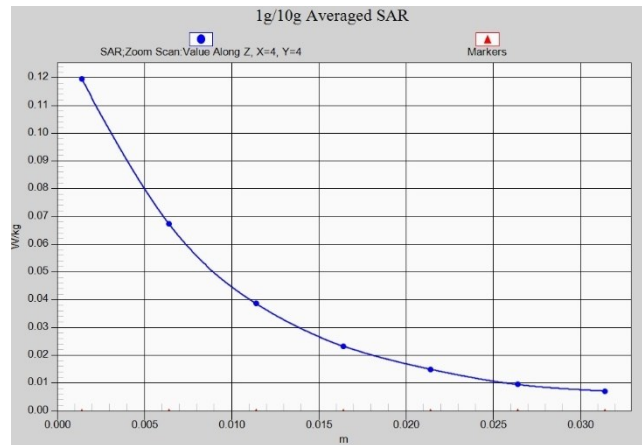

Fig. 1-26 Z-Scan at power reference point (LTE Band41)

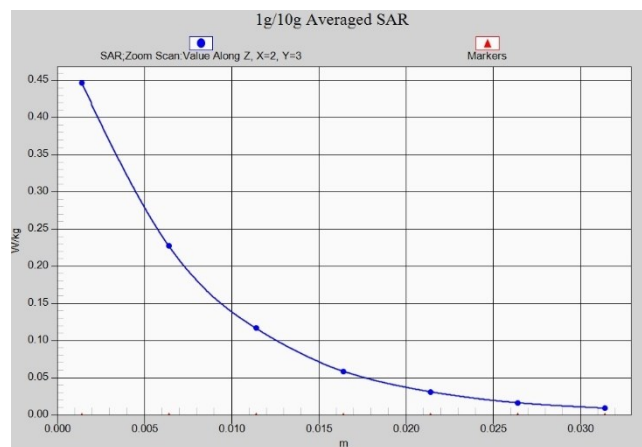

Fig. 1-27 Z-Scan at power reference point (LTE Band41)

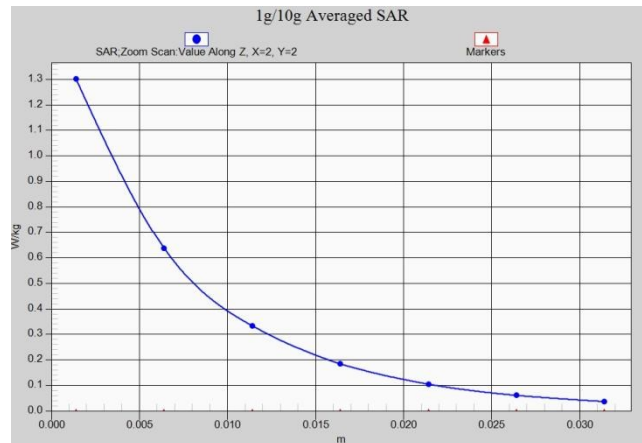

Fig. 1-28 Z-Scan at power reference point (LTE Band66)

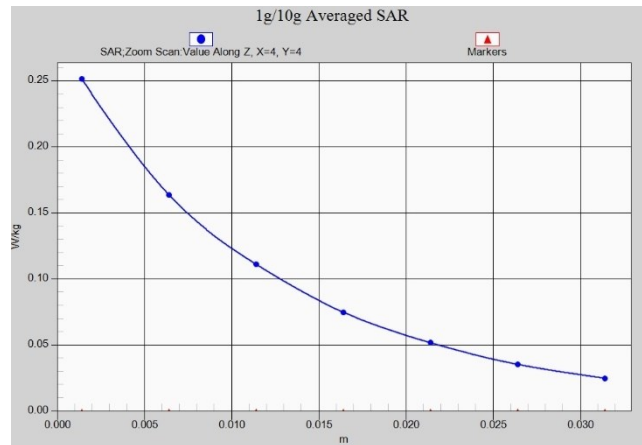

Fig. 1-29 Z-Scan at power reference point (LTE Band66)

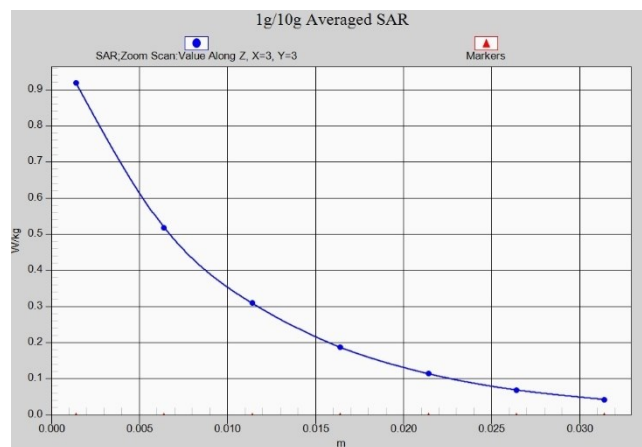

Fig. 1-30 Z-Scan at power reference point (LTE Band66)



Fig. 1-31 Z-Scan at power reference point (LTE Band71)

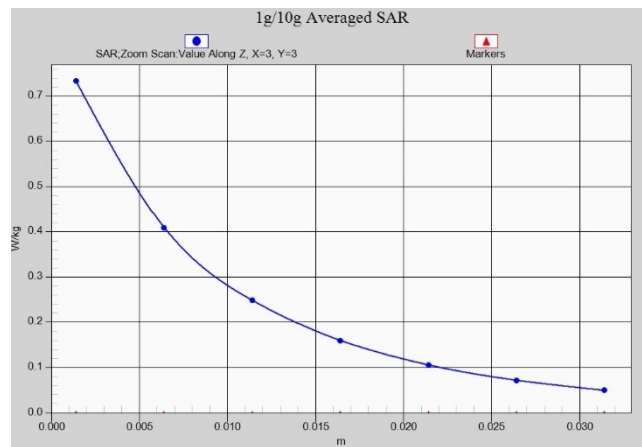

Fig. 1-32 Z-Scan at power reference point (LTE Band71)

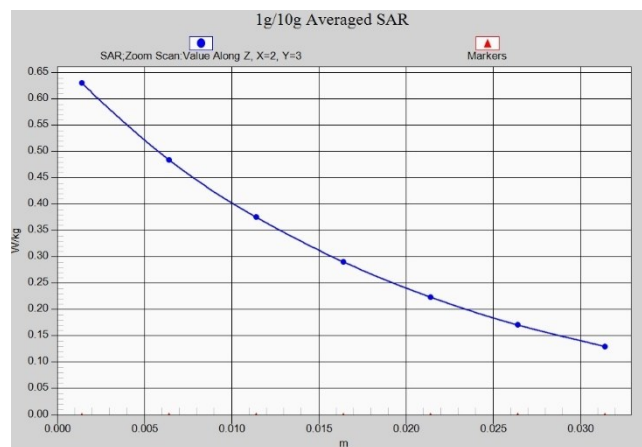

Fig. 1-33 Z-Scan at power reference point (wifi2450)

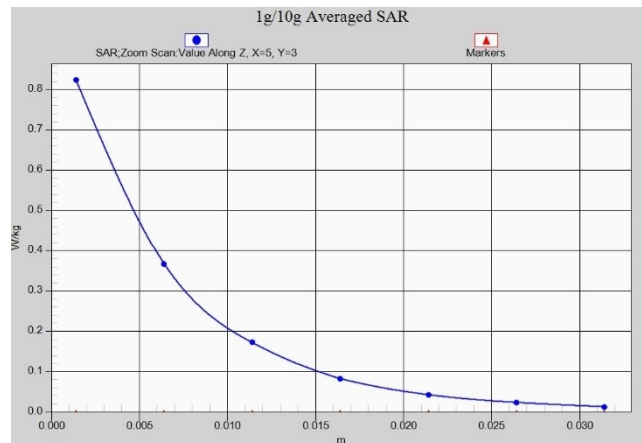
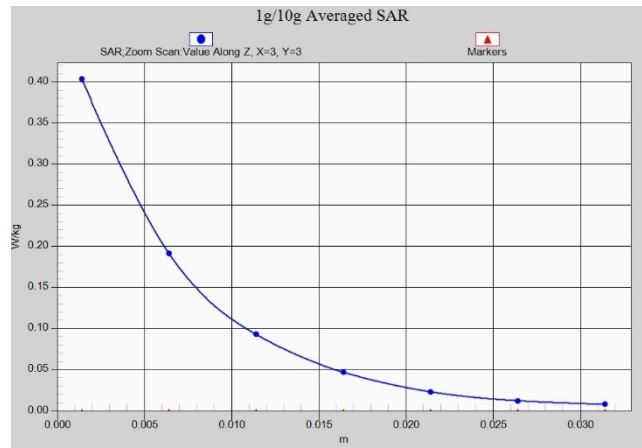

Fig. 1-34 Z-Scan at power reference point (wifi2450)



ANNEX B System Verification Results

750 MHz

Date: 2021/11/25

Electronics: DAE4 Sn1525

Medium: Head 750 MHz

Medium parameters used: $f = 750$ MHz; $\sigma = 0.902$ mho/m; $\epsilon_r = 42.12$; $\rho = 1000$ kg/m³

Ambient Temperature: 22.5°C Liquid Temperature: 22.3°C

Communication System: CW Frequency: 750 MHz Duty Cycle: 1:1

Probe: EX3DV4 – SN7517 ConvF(9.81,9.81,9.81)

System Validation /Area Scan (81x191x1): Interpolated grid: dx=1.000 mm, dy=1.000 mm

Reference Value = 60.42 V/m; Power Drift = 0.02

Fast SAR: SAR(1 g) = 2.13 W/kg; SAR(10 g) = 1.37 W/kg

Maximum value of SAR (interpolated) = 2.81 W/kg

System Validation /Zoom Scan (5x5x7)/Cube 0: Measurement grid: dx=5mm, dy=5mm, dz=5mm

Reference Value =60.42 V/m; Power Drift = 0.02 dB

Peak SAR (extrapolated) = 3.29 W/kg

SAR(1 g) = 2.12 W/kg; SAR(10 g) = 1.37 W/kg

Maximum value of SAR (measured) = 2.85 W/kg

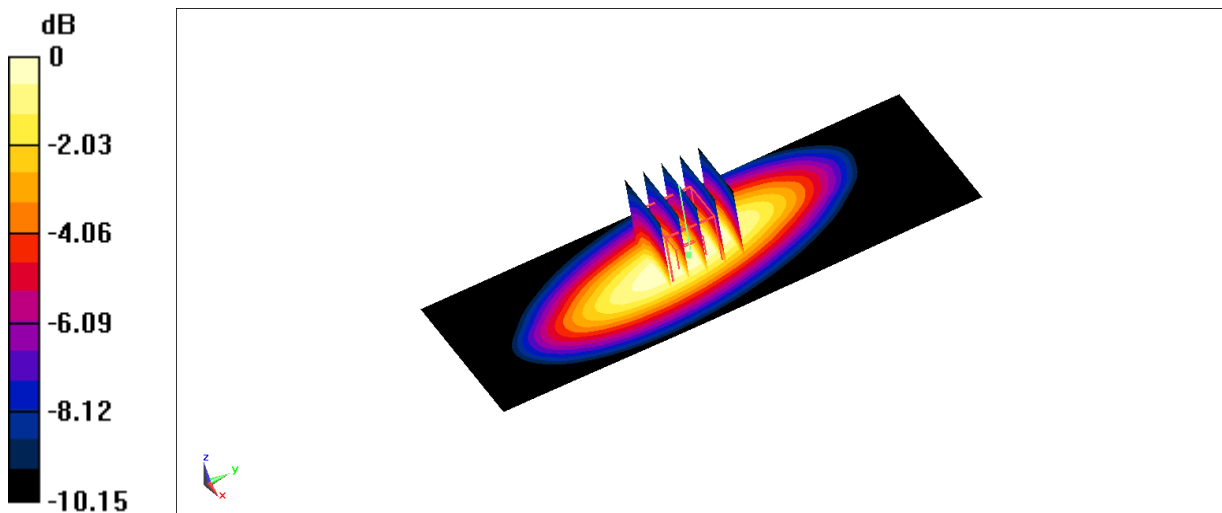

0 dB = 2.85 W/kg = 4.55 dB W/kg

Fig.B.1 validation 750 MHz 250mW

750 MHz

Date: 2021/11/26

Electronics: DAE4 Sn1525

Medium: Head 750 MHz

Medium parameters used: $f = 750 \text{ MHz}$; $\sigma = 0.889 \text{ mho/m}$; $\epsilon_r = 41.73$; $\rho = 1000 \text{ kg/m}^3$

Ambient Temperature: 22.5°C Liquid Temperature: 22.3°C

Communication System: CW Frequency: 750 MHz Duty Cycle: 1:1

Probe: EX3DV4 – SN7517 ConvF(9.81,9.81,9.81)

System Validation /Area Scan (81x191x1): Interpolated grid: $dx=1.000 \text{ mm}$, $dy=1.000 \text{ mm}$

Reference Value = 59.83 V/m ; Power Drift = -0.06

Fast SAR: SAR(1 g) = 2.13 W/kg ; SAR(10 g) = 1.38 W/kg

Maximum value of SAR (interpolated) = 2.84 W/kg

System Validation /Zoom Scan (5x5x7)/Cube 0: Measurement grid: $dx=5\text{mm}$, $dy=5\text{mm}$, $dz=5\text{mm}$

Reference Value = 59.83 V/m ; Power Drift = -0.06 dB

Peak SAR (extrapolated) = 3.21 W/kg

SAR(1 g) = 2.13 W/kg ; SAR(10 g) = 1.36 W/kg

Maximum value of SAR (measured) = 2.82 W/kg

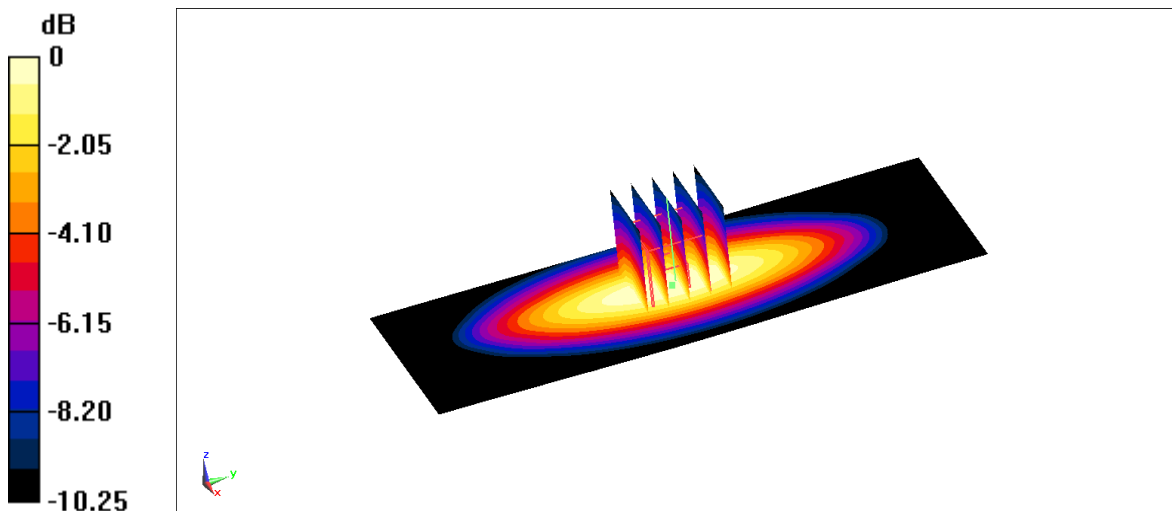

$0 \text{ dB} = 2.82 \text{ W/kg} = 4.5 \text{ dB W/kg}$

Fig.B.3 validation 750 MHz 250mW