



SAR TEST REPORT

No. I21Z60056-SEM02

For

TCL Communication Ltd.

GSM/UMTS/LTE Mobile phone

Model Name: T671H

with

Hardware Version: PIO2

Software Version: 2B5D

FCC ID: 2ACCJH136

Issued Date: 2021-1-28

Note:

The test results in this test report relate only to the devices specified in this report. This report shall not be reproduced except in full without the written approval of CTTL.

The report must not be used by the client to claim product certification, approval, or endorsement by NVLAP, NIST, or any agency of the U.S. Government.

Test Laboratory:

CTTL, Telecommunication Technology Labs, CAICT

No. 51, Xueyuan Road, Haidian District, Beijing, P. R. China 100191.

Tel:+86(0)10-62304633-2512, Fax:+86(0)10-62304633-2504

Email: ctl_terminals@caict.ac.cn, website: www.caict.ac.cn



REPORT HISTORY

Report Number	Revision	Issue Date	Description
I21Z60056-SEM02	Rev.0	2021-1-28	Initial creation of test report

TABLE OF CONTENT

1 TEST LABORATORY	5
1.1 TESTING LOCATION	5
1.2 TESTING ENVIRONMENT.....	5
1.3 PROJECT DATA	5
1.4 SIGNATURE.....	5
2 STATEMENT OF COMPLIANCE	6
3 CLIENT INFORMATION	8
3.1 APPLICANT INFORMATION	8
3.2 MANUFACTURER INFORMATION	8
4 EQUIPMENT UNDER TEST (EUT) AND ANCILLARY EQUIPMENT (AE)	9
4.1 ABOUT EUT	9
4.2 INTERNAL IDENTIFICATION OF EUT USED DURING THE TEST	10
4.3 INTERNAL IDENTIFICATION OF AE USED DURING THE TEST	10
5 TEST METHODOLOGY	11
5.1 APPLICABLE LIMIT REGULATIONS	11
5.2 APPLICABLE MEASUREMENT STANDARDS	11
6 SPECIFIC ABSORPTION RATE (SAR).....	12
6.1 INTRODUCTION.....	12
6.2 SAR DEFINITION.....	12
7 TISSUE SIMULATING LIQUIDS	13
7.1 TARGETS FOR TISSUE SIMULATING LIQUID.....	13
7.2 DIELECTRIC PERFORMANCE	13
8 SYSTEM VERIFICATION	16
8.1 SYSTEM SETUP.....	16
8.2 SYSTEM VERIFICATION.....	17
9 MEASUREMENT PROCEDURES	18
9.1 TESTS TO BE PERFORMED	18
9.2 GENERAL MEASUREMENT PROCEDURE.....	20
9.3 WCDMA MEASUREMENT PROCEDURES FOR SAR	21
9.4 SAR MEASUREMENT FOR LTE.....	22
9.5 BLUETOOTH & WI-FI MEASUREMENT PROCEDURES FOR SAR	24
9.6 POWER DRIFT.....	24
10 AREA SCAN BASED 1-G SAR.....	25
10.1 REQUIREMENT OF KDB.....	25
10.2 FAST SAR ALGORITHMS	25

11 CONDUCTED OUTPUT POWER.....	26
11.1 GSM MEASUREMENT RESULT	27
11.2 WCDMA MEASUREMENT RESULT	29
11.3 LTE MEASUREMENT RESULT	31
11.4 WI-FI AND BT MEASUREMENT RESULT	46
12 SIMULTANEOUS TX SAR CONSIDERATIONS.....	48
12.1 INTRODUCTION.....	48
12.2 TRANSMIT ANTENNA SEPARATION DISTANCES.....	48
12.3 SAR MEASUREMENT POSITIONS	49
12.4 STANDALONE SAR TEST EXCLUSION CONSIDERATIONS	49
13 EVALUATION OF SIMULTANEOUS.....	50
14 SAR TEST RESULT	51
14.1 SAR RESULTS FOR FAST SAR	54
14.2 SAR RESULTS FOR STANDARD PROCEDURE.....	64
14.3 WLAN EVALUATION FOR 2.4G	68
15 SAR MEASUREMENT VARIABILITY.....	72
16 MEASUREMENT UNCERTAINTY	73
16.1 MEASUREMENT UNCERTAINTY FOR NORMAL SAR TESTS (300MHZ~3GHZ).....	73
16.2 MEASUREMENT UNCERTAINTY FOR NORMAL SAR TESTS (3~6GHZ)	74
16.3 MEASUREMENT UNCERTAINTY FOR FAST SAR TESTS (300MHZ~3GHZ).....	75
16.4 MEASUREMENT UNCERTAINTY FOR FAST SAR TESTS (3~6GHZ)	76
17 MAIN TEST INSTRUMENTS.....	78
ANNEX A GRAPH RESULTS.....	79
ANNEX B SYSTEM VERIFICATION RESULTS	105
ANNEX C SAR MEASUREMENT SETUP	110
ANNEX D POSITION OF THE WIRELESS DEVICE IN RELATION TO THE PHANTOM	116
ANNEX E EQUIVALENT MEDIA RECIPES	119
ANNEX F SYSTEM VALIDATION	120
ANNEX G PROBE CALIBRATION CERTIFICATE.....	121
ANNEX H DIPOLE CALIBRATION CERTIFICATE	131
ANNEX J ACCREDITATION CERTIFICATE.....	163

1 Test Laboratory

1.1 Testing Location

Company Name:	CTTL(Shouxiang)
Address:	No. 51 Shouxiang Science Building, Xueyuan Road, Haidian District, Beijing, P. R. China100191

1.2 Testing Environment

Temperature:	18°C~25°C,
Relative humidity:	30%~ 70%
Ground system resistance:	< 0.5 Ω
Ambient noise & Reflection:	< 0.012 W/kg

1.3 Project Data

Project Leader:	Qi Dianyuan
Test Engineer:	Lin Xiaojun
Testing Start Date:	January 22, 2021
Testing End Date:	January 25, 2021

1.4 Signature



Lin Xiaojun
(Prepared this test report)

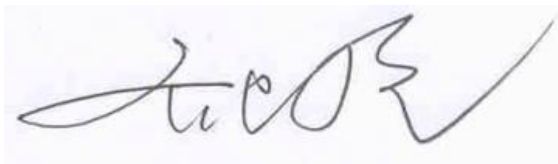

Qi Dianyuan
(Reviewed this test report)

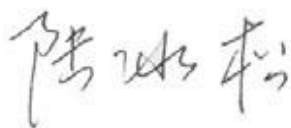

Lu Bingsong
Deputy Director of the laboratory
(Approved this test report)

2 Statement of Compliance

The maximum results of Specific Absorption Rate (SAR) found during testing for TCL Communication Ltd. GSM/UMTS/LTE Mobile phone T671H is as follows:

Table 2.1: Highest Reported SAR (1g)

Exposure Configuration	Technology Band	Highest Reported SAR 1g(W/kg)	Equipment Class
Head (Separation Distance 0mm)	GSM850	0.09	PCE
	GSM1900	0.17	
	WCDMA1900	0.37	
	WCDMA 850	1.07	
	LTE Band5	0.78	
	LTE Band7	0.06	
	LTE Band41	0.07	
	WLAN 2.4 GHz	0.42	DTS
Hotspot (Separation Distance 10mm)	GSM850	0.12	PCE
	GSM1900	0.29	
	WCDMA1900	0.67	
	WCDMA 850	0.19	
	LTE Band5	0.32	
	LTE Band7	1.16	
	LTE Band41	1.19	
	WLAN 2.4 GHz	0.21	DTS
Body-Worn (Separation Distance 15mm)	GSM1900	0.28	PCE
	WCDMA1900	0.65	
		WCDMA850	0.23

The SAR values found for the Mobile Phone are below the maximum recommended levels of 1.6 W/kg as averaged over any 1g tissue according to the ANSI C95.1-1992.

For body operation, this device has been tested and meets FCC RF exposure guidelines when used with any accessory that contains no metal and which provides a minimum separation distance of 10/15 mm between this device and the body of the user. Use of other accessories may not ensure compliance with FCC RF exposure guidelines.

The EUT battery must be fully charged and checked periodically during the test to ascertain uniform power output.

The measurement together with the test system set-up is described in annex C of this test report. A detailed description of the equipment under test can be found in chapter 4 of this test report. The highest reported SAR value is obtained at the case of **(Table 2.1)**, and the values are: **1.19 W/kg(1g)**.

Table 2.2: The sum of SAR values for Main antenna + WiFi-2.4G

	Position	Main antenna	WiFi-2.4G	Sum
Highest SAR value for Head	Right head, Cheek (WCDMA B5)	1.07	0.42	1.49
Highest SAR value for Body	Bottom 10mm (LTE Band7)	1.19	<0.01	1.19

Table 2.3: The sum of reported SAR values for main antenna and BT

	Position	Main antenna	BT	Sum
Maximum reported SAR value for Head	Right head, Cheek (WCDMA B5)	1.07	0.33 ^[1]	1.40
Maximum reported SAR value for Body	Front 10mm (LTE Band66)	1.19	<0.01	1.19

[1] - Estimated SAR for Bluetooth (see the table 13.3)

According to the above tables, the highest sum of reported SAR values is **1.49 W/kg (1g)**. The detail for simultaneous transmission consideration is described in chapter 13.



3 Client Information

3.1 Applicant Information

Company Name:	TCL Communication Ltd.
Address/Post:	5/F, Building 22E, 22 Science Park East Avenue, Hong Kong Science Park, Shatin, NT, Hong Kong
Contact Person:	Gong Zhizhou
Contact Email:	zhizhou.gong@tcl.com
Telephone:	0086-755-36611722

3.2 Manufacturer Information

Company Name:	TCL Communication Ltd.
Address/Post:	5/F, Building 22E, 22 Science Park East Avenue, Hong Kong Science Park, Shatin, NT, Hong Kong
Contact Person:	Gong Zhizhou
Contact Email:	zhizhou.gong@tcl.com
Telephone:	0086-755-36611722

4 Equipment Under Test (EUT) and Ancillary Equipment (AE)

4.1 About EUT

Description:	GSM/UMTS/LTE Mobile phone
Model name:	T671H
Operating mode(s):	GSM850/900/1800/1900, WCDMA B1/B2/B5/B8 LTEBand1/3/5/7/8/20/28/38/41 BT, Wi-Fi2.4G
Tested Tx Frequency:	824 – 849 MHz (GSM 850)
	1850 – 1910 MHz (GSM 1900)
	824 – 849 MHz (WCDMA 850 Band V)
	1850 – 1910 MHz (WCDMA1900 Band II)
	824.7 – 848.3 MHz (LTE Band 5)
	2502.5 – 2567.5 MHz (LTE Band 7)
	2542.5 –2637.5 MHz (LTE Band 41)
	2412 – 2462 MHz (Wi-Fi 2.4G)
2400 – 2483.5 MHz (Bluetooth)	
GPRS/EGPRS Multislot Class:	12
Test device Production information:	Production unit
Device type:	Portable device
Antenna type:	Integrated antenna
Hotspot mode:	Support

4.2 Internal Identification of EUT used during the test

EUT ID*	IMEI	HW Version	SW Version
EUT1	355122660206197/355122660206205	PIO2	2B5D
EUT2	355122660206510/355122660206528	PIO2	2B5D
EUT3	355122660206478/355122660206486	PIO2	2B5D
EUT4	355122660206353/355122660206361	PIO2	2B5D
EUT5	355122660206312/355122660206320	PIO2	2B5D
EUT6	355122660206452/355122660206460	PIO2	2B5D

*EUT ID: is used to identify the test sample in the lab internally.

Note: It is performed to do SAR with the EUT1~4 and conducted power with the EUT5~6.

4.3 Internal Identification of AE used during the test

AE ID*	Description	Model	SN	Manufacturer
AE1	Battery	CAC4850002C7	/	VK
AE2	Battery	CAC4850000C1	/	BYD

*AE ID: is used to identify the test sample in the lab internally.

5 TEST METHODOLOGY

5.1 Applicable Limit Regulations

ANSI C95.1–1992:IEEE Standard for Safety Levels with Respect to Human Exposure to Radio Frequency Electromagnetic Fields, 3 kHz to 300 GHz.

It specifies the maximum exposure limit of **1.6 W/kg** as averaged over any 1 gram of tissue for portable devices being used within 20 cm of the user in the uncontrolled environment.

5.2 Applicable Measurement Standards

IEEE 1528–2013: Recommended Practice for Determining the Peak Spatial-Average Specific Absorption Rate (SAR) in the Human Head from Wireless Communications Devices: Measurement Techniques.

KDB447498 D01: General RF Exposure Guidance v06: Mobile and Portable Devices RF Exposure Procedures and Equipment Authorization Policies.

KDB648474 D04 Handset SAR v01r03: SAR Evaluation Considerations for Wireless Handsets.

KDB941225 D01 SAR test for 3G devices v03r01: SAR Measurement Procedures for 3G Devices

KDB941225 D05 SAR for LTE Devices v02r05: SAR Evaluation Considerations for LTE Devices

KDB941225 D06 Hotspot Mode SAR v02r01: SAR Evaluation Procedures for Portable Devices with Wireless Router Capabilities

KDB248227 D01 802.11 Wi-Fi SAR v02r02: SAR GUIDANCE FOR IEEE 802.11 (Wi-Fi) TRANSMITTERS

KDB865664 D01 SAR measurement 100 MHz to 6 GHz v01r04: SAR Measurement Requirements for 100 MHz to 6 GHz.

KDB865664 D02 RF Exposure Reporting v01r02: RF Exposure Compliance Reporting and Documentation Considerations

6 Specific Absorption Rate (SAR)

6.1 Introduction

SAR is related to the rate at which energy is absorbed per unit mass in an object exposed to a radio field. The SAR distribution in a biological body is complicated and is usually carried out by experimental techniques or numerical modeling. The standard recommends limits for two tiers of groups, occupational/controlled and general population/uncontrolled, based on a person's awareness and ability to exercise control over his or her exposure. In general, occupational/controlled exposure limits are higher than the limits for general population/uncontrolled.

6.2 SAR Definition

The SAR definition is the time derivative (rate) of the incremental energy (dW) absorbed by (dissipated in) an incremental mass (dm) contained in a volume element (dv) of a given density (ρ). The equation description is as below:

$$SAR = \frac{d}{dt} \left(\frac{dW}{dm} \right) = \frac{d}{dt} \left(\frac{dW}{\rho dv} \right)$$

SAR is expressed in units of Watts per kilogram (W/kg)

SAR measurement can be either related to the temperature elevation in tissue by

$$SAR = c \left(\frac{\delta T}{\delta t} \right)$$

Where: C is the specific heat capacity, δT is the temperature rise and δt is the exposure duration, or related to the electrical field in the tissue by

$$SAR = \frac{\sigma |E|^2}{\rho}$$

Where: σ is the conductivity of the tissue, ρ is the mass density of tissue and E is the RMS electrical field strength.

However for evaluating SAR of low power transmitter, electrical field measurement is typically applied.

7 Tissue Simulating Liquids

7.1 Targets for tissue simulating liquid

Table 7.1: Targets for tissue simulating liquid

Frequency(MHz)	Liquid Type	Conductivity(σ)	$\pm 5\%$ Range	Permittivity(ϵ)	$\pm 5\%$ Range
835	Head	0.90	0.86~0.95	41.5	39.4~43.6
1900	Head	1.40	1.33~1.47	40.0	38.0~42.0
2450	Head	1.67	1.59~1.75	39.47	37.5~41.4
2600	Head	1.96	1.86~2.06	39.01	37.1~41.0

7.2 Dielectric Performance

Table 7.2: Dielectric Performance of Tissue Simulating Liquid

Measurement Date (yyyy-mm-dd)	Type	Frequency	Permittivity ϵ	Drift (%)	Conductivity σ (S/m)	Drift (%)
2021-1-22	Head	835 MHz	41.26	-0.58	0.908	0.89
2021-1-23	Head	1900 MHz	40.09	0.23	1.401	0.07
2021-1-24	Head	2450 MHz	39.79	1.51	1.813	0.72
2021-1-25	Head	2600 MHz	38.57	-1.13	1.946	-0.71

Note: The liquid temperature is 22.0°C

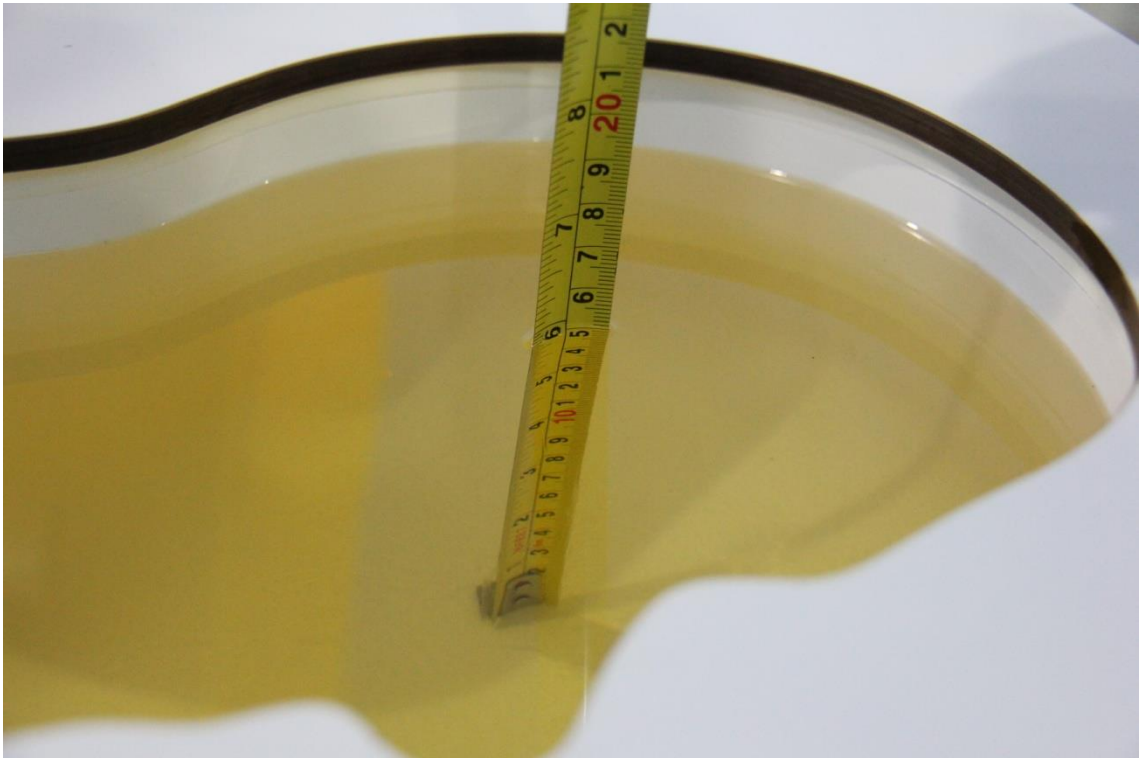

Picture 7-1 Liquid depth in the Head Phantom (835 MHz)

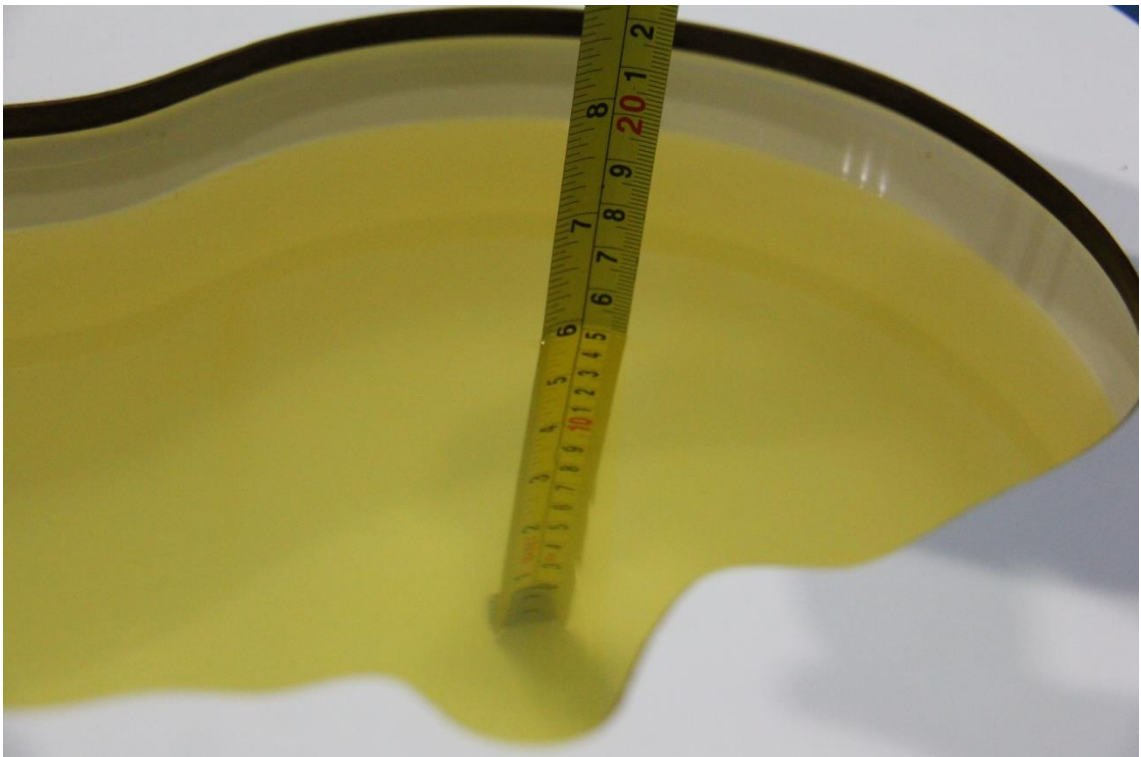

Picture 7-2 Liquid depth in the Head Phantom (1900 MHz)

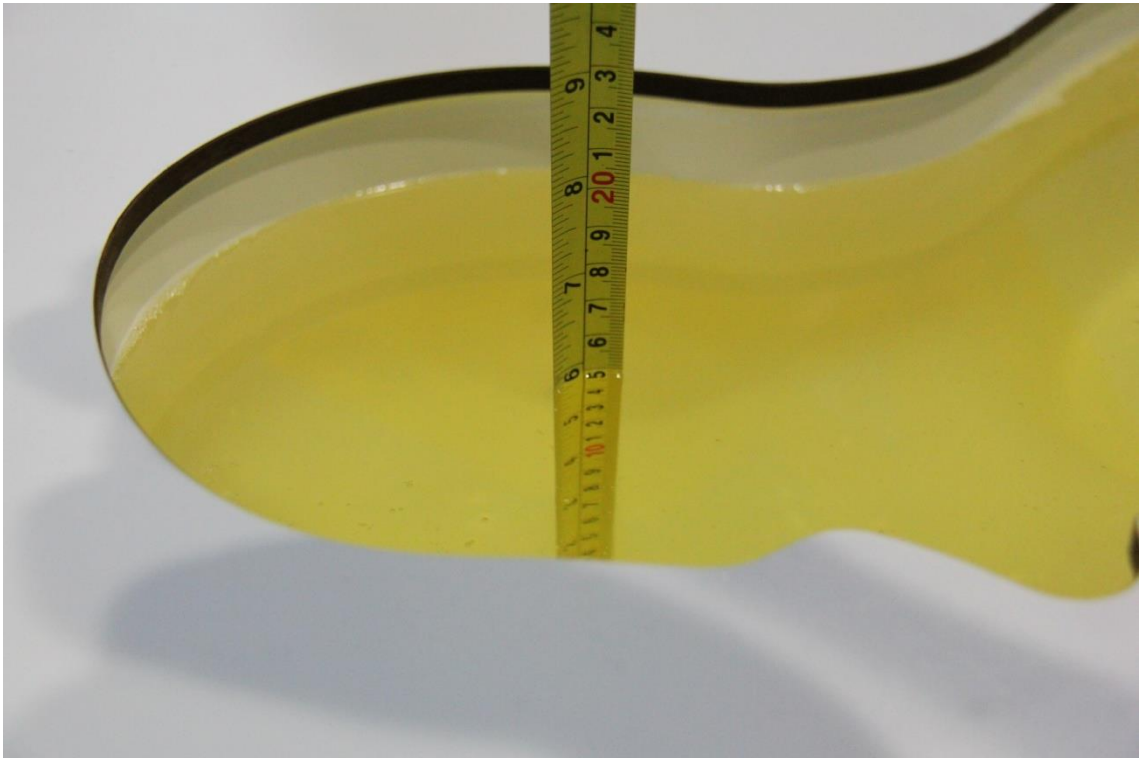

Picture 7-3 Liquid depth in the Head Phantom (2450MHz)



Picture 7-4 Liquid depth in the Head Phantom (2600 MHz)

8 System verification

8.1 System Setup

In the simplified setup for system evaluation, the DUT is replaced by a calibrated dipole and the power source is replaced by a continuous wave that comes from a signal generator. The calibrated dipole must be placed beneath the flat phantom section of the SAM twin phantom with the correct distance holder. The distance holder should touch the phantom surface with a light pressure at the reference marking and be oriented parallel to the long side of the phantom. The equipment setup is shown below:

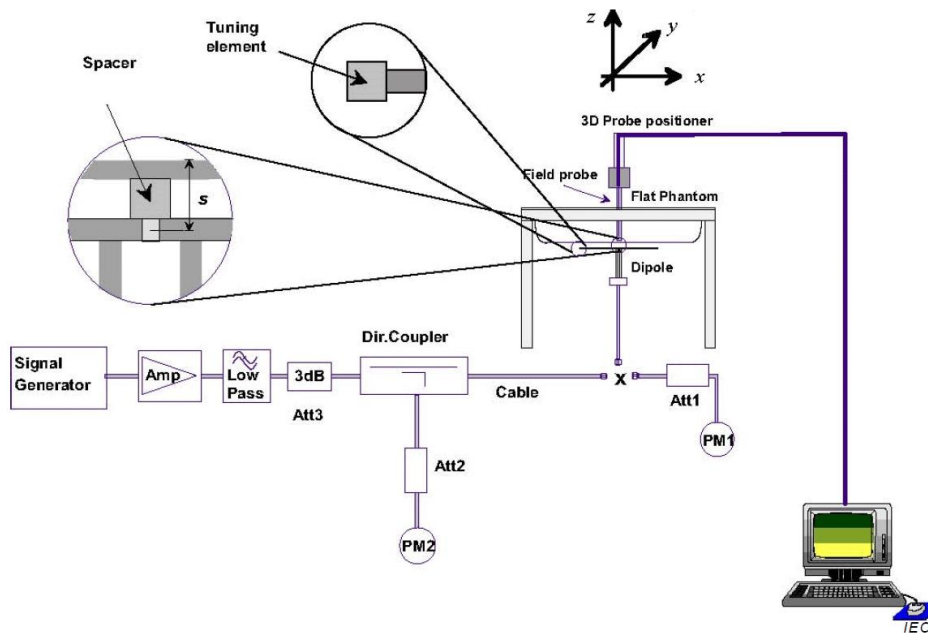

Picture 8.1 System Setup for System Evaluation

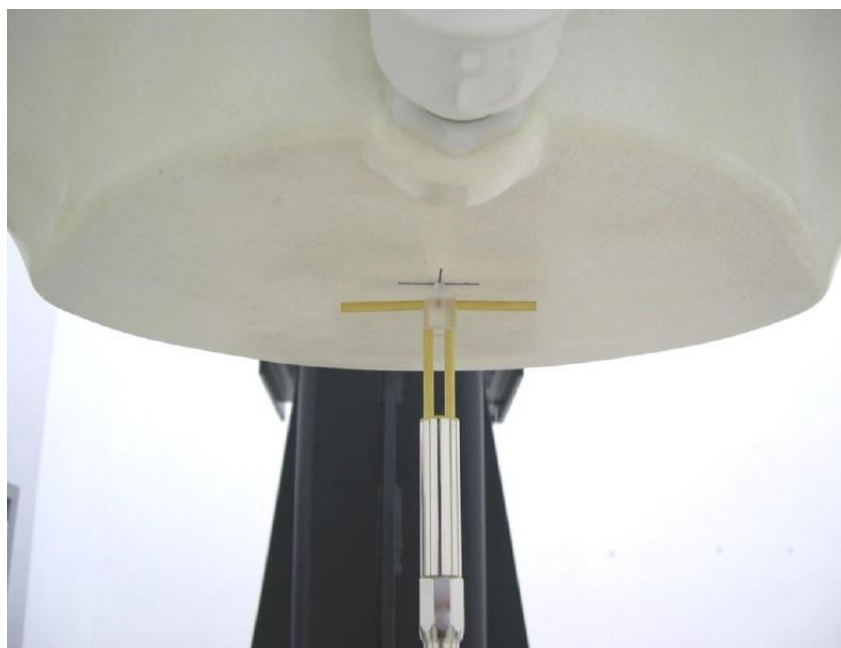

Picture 8.2 Photo of Dipole Setup

8.2 System Verification

SAR system verification is required to confirm measurement accuracy, according to the tissue dielectric media, probe calibration points and other system operating parameters required for measuring the SAR of a test device. The system verification must be performed for each frequency band and within the valid range of each probe calibration point required for testing the device.

The system verification results are required that the area scan estimated 1-g SAR is within 3% of the zoom scan 1-g SAR. The details are presented in annex B.

Table 8.1: System Verification of Head

Measurement Date (yyyy-mm-dd)	Frequency	Target value (W/kg)		Measured value(W/kg)		Deviation	
		10 g Average	1 g Average	10 g Average	1 g Average	10 g Average	1 g Average
2021-1-22	835 MHz	6.25	9.60	6.16	9.6	-1.44%	0.00%
2021-1-23	1900 MHz	20.6	39.6	20.6	40.04	0.00%	1.11%
2021-1-24	2450 MHz	24.5	52.5	24.64	51.68	0.57%	-1.56%
2021-1-25	2600 MHz	25.3	57.0	25.04	57.84	-1.03%	1.47%

9 Measurement Procedures

9.1 Tests to be performed

In order to determine the highest value of the peak spatial-average SAR of a handset, all device positions, configurations and operational modes shall be tested for each frequency band according to steps 1 to 3 below. A flowchart of the test process is shown in picture 9.1.

Step 1: The tests described in 9.2 shall be performed at the channel that is closest to the centre of the transmit frequency band (f_c) for:

- a) all device positions (cheek and tilt, for both left and right sides of the SAM phantom, as described in annex D),
- b) all configurations for each device position in a), e.g., antenna extended and retracted, and
- c) all operational modes, e.g., analogue and digital, for each device position in a) and configuration in b) in each frequency band.

If more than three frequencies need to be tested according to 11.1 (i.e., $N_c > 3$), then all frequencies, configurations and modes shall be tested for all of the above test conditions.

Step 2: For the condition providing highest peak spatial-average SAR determined in Step 1, perform all tests described in 9.2 at all other test frequencies, i.e., lowest and highest frequencies. In addition, for all other conditions (device position, configuration and operational mode) where the peak spatial-average SAR value determined in Step 1 is within 3 dB of the applicable SAR limit, it is recommended that all other test frequencies shall be tested as well.

Step 3: Examine all data to determine the highest value of the peak spatial-average SAR found in Steps 1 to 2.

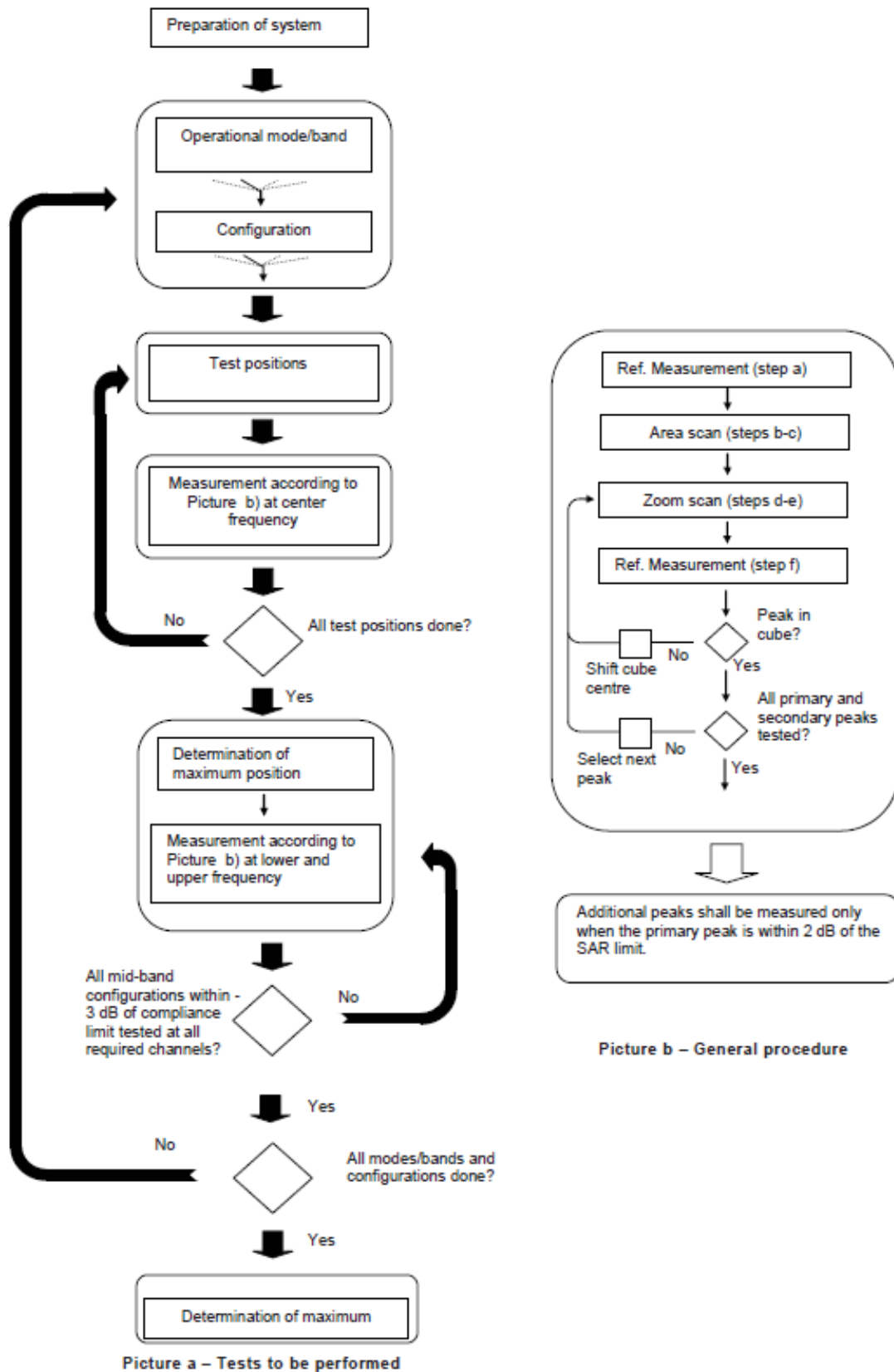

Picture 9.1 Block diagram of the tests to be performed

9.2 General Measurement Procedure

The area and zoom scan resolutions specified in the table below must be applied to the SAR measurements and fully documented in SAR reports to qualify for TCB approval. Probe boundary effect error compensation is required for measurements with the probe tip closer than half a probe tip diameter to the phantom surface. Both the probe tip diameter and sensor offset distance must satisfy measurement protocols; to ensure probe boundary effect errors are minimized and the higher fields closest to the phantom surface can be correctly measured and extrapolated to the phantom surface for computing 1-g SAR. Tolerances of the post-processing algorithms must be verified by the test laboratory for the scan resolutions used in the SAR measurements, according to the reference distribution functions specified in IEEE Std 1528-2003. The results should be documented as part of the system validation records and may be requested to support test results when all the measurement parameters in the following table are not satisfied.

		≤ 3 GHz	> 3 GHz
Maximum distance from closest measurement point (geometric center of probe sensors) to phantom surface		5 ± 1 mm	$\frac{1}{2} \cdot \delta \cdot \ln(2) \pm 0.5$ mm
Maximum probe angle from probe axis to phantom surface normal at the measurement location		$30^\circ \pm 1^\circ$	$20^\circ \pm 1^\circ$
Maximum area scan spatial resolution: $\Delta x_{Area}, \Delta y_{Area}$		≤ 2 GHz: ≤ 15 mm 2 – 3 GHz: ≤ 12 mm	3 – 4 GHz: ≤ 12 mm 4 – 6 GHz: ≤ 10 mm
		When the x or y dimension of the test device, in the measurement plane orientation, is smaller than the above, the measurement resolution must be \leq the corresponding x or y dimension of the test device with at least one measurement point on the test device.	
Maximum zoom scan spatial resolution: $\Delta x_{Zoom}, \Delta y_{Zoom}$		≤ 2 GHz: ≤ 8 mm 2 – 3 GHz: ≤ 5 mm*	3 – 4 GHz: ≤ 5 mm* 4 – 6 GHz: ≤ 4 mm*
Maximum zoom scan spatial resolution, normal to phantom surface	uniform grid: $\Delta z_{Zoom}(n)$	≤ 5 mm	3 – 4 GHz: ≤ 4 mm 4 – 5 GHz: ≤ 3 mm 5 – 6 GHz: ≤ 2 mm
	graded grid	$\Delta z_{Zoom}(1)$: between 1 st two points closest to phantom surface	≤ 4 mm
		$\Delta z_{Zoom}(n>1)$: between subsequent points	$\leq 1.5 \cdot \Delta z_{Zoom}(n-1)$
Minimum zoom scan volume	x, y, z	≥ 30 mm	3 – 4 GHz: ≥ 28 mm 4 – 5 GHz: ≥ 25 mm 5 – 6 GHz: ≥ 22 mm
Note: δ is the penetration depth of a plane-wave at normal incidence to the tissue medium; see draft standard IEEE P1528-2011 for details. * When zoom scan is required and the <i>reported</i> SAR from the area scan based 1-g SAR estimation procedures of KDB 447498 is ≤ 1.4 W/kg, ≤ 8 mm, ≤ 7 mm and ≤ 5 mm zoom scan resolution may be applied, respectively, for 2 GHz to 3 GHz, 3 GHz to 4 GHz and 4 GHz to 6 GHz.			

9.3 WCDMA Measurement Procedures for SAR

The following procedures are applicable to WCDMA handsets operating under 3GPP Release99, Release 5 and Release 6. The default test configuration is to measure SAR with an established radio link between the DUT and a communication test set using a 12.2kbps RMC (reference measurement channel) configured in Test Loop Mode 1. SAR is selectively confirmed for other physical channel configurations (DPCCH & DPDCH_n), HSDPA and HSPA (HSUPA/HSDPA) modes according to output power, exposure conditions and device operating capabilities. Both uplink and downlink should be configured with the same RMC or AMR, when required. SAR for Release 5 HSDPA and Release 6 HSPA are measured using the applicable FRC (fixed reference channel) and E-DCH reference channel configurations. Maximum output power is verified according to applicable versions of 3GPP TS 34.121 and SAR must be measured according to these maximum output conditions. When Maximum Power Reduction (MPR) is not implemented according to Cubic Metric (CM) requirements for Release 6 HSPA, the following procedures do not apply.

For Release 5 HSDPA Data Devices:

Sub-test	β_c	β_d	β_d (SF)	β_c / β_d	β_{hs}	CM/dB
1	2/15	15/15	64	2/15	4/15	0.0
2	12/15	15/15	64	12/15	24/25	1.0
3	15/15	8/15	64	15/8	30/15	1.5
4	15/15	4/15	64	15/4	30/15	1.5

For Release 6 HSPA Data Devices

Sub-test	β_c	β_d	β_d (SF)	β_c / β_d	β_{hs}	β_{ec}	β_{ed}	β_{ed} (SF)	β_{ed} (codes)	CM (dB)	MPR (dB)	AG Index	E-TFCI
1	11/15	15/15	64	11/15	22/15	209/225	1039/225	4	1	1.5	1.5	20	75
2	6/15	15/15	64	6/15	12/15	12/15	12/15	4	1	1.5	1.5	12	67
3	15/15	9/15	64	15/9	30/15	30/15	$\beta_{ed1}:47/15$ $\beta_{ed2}:47/15$	4	2	1.5	1.5	15	92
4	2/15	15/15	64	2/15	4/15	4/15	56/75	4	1	1.5	1.5	17	71
5	15/15	15/15	64	15/15	24/15	30/15	134/15	4	1	1.5	1.5	21	81

Rel.8 DC-HSDPA (Cat 24)

SAR test exclusion for Rel.8 DC-HSDPA must satisfy the SAR test exclusion requirements of Rel.5 HSDPA. SAR test exclusion for DC-HSDPA devices is determined by power measurements according to the H-Set 12, Fixed Reference Channel (FRC) configuration in Table C.8.1.12 of 3GPP TS 34.121-1. A primary and a secondary serving HS-DSCH Cell are required to perform the power measurement and for the results to qualify for SAR test exclusion.

9.4 SAR Measurement for LTE

SAR tests for LTE are performed with a base station simulator, Rohde & Schwarz CMW500. Closed loop power control was used so the UE transmits with maximum output power during SAR testing. All powers were measured with the CMW 500.

It is performed for conducted power and SAR based on the KDB941225 D05.

SAR is evaluated separately according to the following procedures for the different test positions in each exposure condition – head, body, body-worn accessories and other use conditions. The procedures in the following subsections are applied separately to test each LTE frequency band.

1) QPSK with 1 RB allocation

Start with the largest channel bandwidth and measure SAR for QPSK with 1 RB allocation, using the RB offset and required test channel combination with the highest maximum output power among RB offsets at the upper edge, middle and lower edge of each required test channel. When the reported SAR is ≤ 0.8 W/kg, testing of the remaining RB offset configurations and required test channels is not required for 1 RB allocation; otherwise, SAR is required for the remaining required test channels and only for the RB offset configuration with the highest output power for that channel. When the reported SAR of a required test channel is > 1.45 W/kg, SAR is required for all three RB offset configurations for that required test channel.

2) QPSK with 50% RB allocation

The procedures required for 1 RB allocation in 1) are applied to measure the SAR for QPSK with 50% RB allocation.

3) QPSK with 100% RB allocation

For QPSK with 100% RB allocation, SAR is not required when the highest maximum output power for 100 % RB allocation is less than the highest maximum output power in 50% and 1 RB allocations and the highest reported SAR for 1 RB and 50% RB allocation in 1) and 2) are ≤ 0.8 W/kg. Otherwise, SAR is measured for the highest output power channel; and if the reported SAR is > 1.45 W/kg, the remaining required test channels must also be tested.

TDD test:

TDD testing is performed using guidance from FCC KDB 941225 D05 and the SAR test guidance provided in April 2013 TCB works hop notes. TDD is tested at the highest duty factor using UL-DL configuration 0 with special subframe configuration 6 and applying the FDD LTE procedures in KDB 941225 D05. SAR testing is performed using the extended cyclic prefix listed in 3GPP TS 36.211.

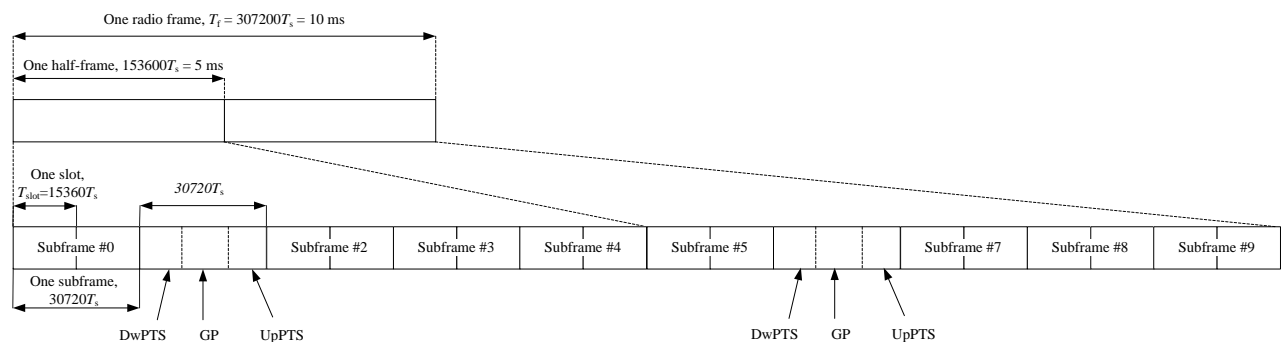

Figure 9.2: Frame structure type 2 (for 5 ms switch-point periodicity)

Table 9.1: Configuration of special subframe (lengths of DwPTS/GP/UpPTS)

Special subframe configuration	Normal cyclic prefix in downlink			Extended cyclic prefix in downlink		
	DwPTS	UpPTS		DwPTS	UpPTS	
		Normal cyclic prefix in uplink	Extended cyclic prefix in uplink		Normal cyclic prefix in uplink	Extended cyclic prefix in uplink
0	$6592 \cdot T_s$	$2192 \cdot T_s$	$2560 \cdot T_s$	$7680 \cdot T_s$	$2192 \cdot T_s$	$2560 \cdot T_s$
1	$19760 \cdot T_s$			$20480 \cdot T_s$		
2	$21952 \cdot T_s$			$23040 \cdot T_s$		
3	$24144 \cdot T_s$			$25600 \cdot T_s$		
4	$26336 \cdot T_s$			$7680 \cdot T_s$		
5	$6592 \cdot T_s$	$4384 \cdot T_s$	$5120 \cdot T_s$	$20480 \cdot T_s$	$4384 \cdot T_s$	$5120 \cdot T_s$
6	$19760 \cdot T_s$			$23040 \cdot T_s$		
7	$21952 \cdot T_s$			$12800 \cdot T_s$		
8	$24144 \cdot T_s$			-		
9	$13168 \cdot T_s$			-		

Table 9.2: Uplink-downlink configurations

Uplink-downlink configuration	Downlink-to-Uplink Switch-point periodicity	Subframe number									
		0	1	2	3	4	5	6	7	8	9
0	5 ms	D	S	U	U	U	D	S	U	U	U
1	5 ms	D	S	U	U	D	D	S	U	U	D
2	5 ms	D	S	U	D	D	D	S	U	D	D
3	10 ms	D	S	U	U	U	D	D	D	D	D
4	10 ms	D	S	U	U	D	D	D	D	D	D
5	10 ms	D	S	U	D	D	D	D	D	D	D
6	5 ms	D	S	U	U	U	D	S	U	U	D

Duty factor is calculated by:

Duty factor = uplink frame*6+UpPTS*2/one frame length

$$= (30720 \cdot T_s * 6 + 5120 \cdot T_s * 2) / 307200 \cdot T_s$$

$$= 0.633$$

9.5 Bluetooth & Wi-Fi Measurement Procedures for SAR

Normal network operating configurations are not suitable for measuring the SAR of 802.11 transmitters in general. Unpredictable fluctuations in network traffic and antenna diversity conditions can introduce undesirable variations in SAR results. The SAR for these devices should be measured using chipset based test mode software to ensure that the results are consistent and reliable.

Chipset based test mode software is hardware dependent and generally varies among manufacturers. The device operating parameters established in a test mode for SAR measurements must be identical to those programmed in production units, including output power levels, amplifier gain settings and other RF performance tuning parameters. The test frequencies should correspond to actual channel frequencies defined for domestic use. SAR for devices with switched diversity should be measured with only one antenna transmitting at a time during each SAR measurement, according to a fixed modulation and data rate. The same data pattern should be used for all measurements.

9.6 Power Drift

To control the output power stability during the SAR test, DASY4 system calculates the power drift by measuring the E-field at the same location at the beginning and at the end of the measurement for each test position. These drift values can be found in section 14 labeled as: (Power Drift [dB]). This ensures that the power drift during one measurement is within 5%.

10 Area Scan Based 1-g SAR

10.1 Requirement of KDB

According to the KDB447498 D01, when the implementation is based the specific polynomial fit algorithm as presented at the 29th Bioelectromagnetics Society meeting (2007) and the estimated 1-gSAR is ≤ 1.2 W/kg, a zoom scan measurement is not required provided it is also not needed for any other purpose; for example, if the peak SAR location required for simultaneous transmission SAR test exclusion can be determined accurately by the SAR system or manually to discriminate between distinctive peaks and scattered noisy SAR distributions from area scans.

There must not be any warning or alert messages due to various measurement concerns identified by the SAR system; for example, noise in measurements, peaks too close to scan boundary, peaks are too sharp, spatial resolution and uncertainty issues etc. The SAR system verification must also demonstrate that the area scan estimated 1-g SAR is within 3% of the zoom scan 1-g SAR (See Annex B). When all the SAR results for each exposure condition in a frequency band and wireless mode are based on estimated 1-g SAR, the 1-g SAR for the highest SAR configuration must be determined by a zoom scan.

10.2 Fast SAR Algorithms

The approach is based on the area scan measurement applying a frequency dependent attenuation parameter. This attenuation parameter was empirically determined by analyzing a large number of phones. The MOTOROLA FAST SAR was developed and validated by the MOTOROLA Research Group in Ft. Lauderdale.

In the initial study, an approximation algorithm based on Linear fit was developed. The accuracy of the algorithm has been demonstrated across a broad frequency range (136-2450 MHz) and for both 1- and 10-g averaged SAR using a sample of 264 SAR measurements from 55 wireless handsets. For the sample size studied, the root-mean-squared errors of the algorithm are 1.2% and 5.8% for 1- and 10-g averaged SAR, respectively. The paper describing the algorithm in detail is expected to be published in August 2004 within the Special Issue of Transactions on MTT.

In the second step, the same research group optimized the fitting algorithm to an Polynomial fit whereby the frequency validity was extended to cover the range 30-6000MHz. Details of this study can be found in the BEMS 2007 Proceedings.

Both algorithms are implemented in DASYS software.

11 Conducted Output Power

Table11: Summary of Receiver detection mechanism

Antenna	Receiver on (head scenario)	Receiver off + Hotspot off (Body scenario)	Receiver off + Hotspot on (Hotspot scenario)
Main Antenna/ Wifi Antenna	Power Level A1	Power Level B1	Power Level C1

For WWAN, when the phone is in body worn mode, receiver off and hotspot off, then power reduction will be implemented immediately at LTEB7/B41. When the phone hotspot worked, then power reduction will be implemented immediately at GSM1900, WCDMA B2/B5 and LTEB7/B41.

For WiFi, when the phone is in head mode and receiver off, then power reduction will be implemented immediately at WiFi2.4G.

11.1 GSM Measurement result

During the process of testing, the EUT was controlled via Agilent Digital Radio Communication tester (E5515C) to ensure the maximum power transmission and proper modulation. This result contains conducted output power for the EUT. In all cases, the measured peak output power should be greater and within 5% than EMI measurement.

Table 11.1-1: The conducted power measurement results-Normal power

GSM 850 Speech (GMSK)	Measured Power (dBm)			Tune up	calculation	Averaged Power (dBm)		
	251	190	128			251	190	128
1 Txslot	31.86	32.01	32.64	33.30	/	/	/	/
GSM 850 GPRS (GMSK)	Measured Power (dBm)				calculation	Averaged Power (dBm)		
	251	190	128			251	190	128
1 Txslot	31.81	31.92	32.56	33.30	-9.03	22.78	22.89	23.53
2 Txslots	28.28	28.17	29.34	30.00	-6.02	22.26	22.15	23.32
3Txslots	26.10	26.02	27.19	27.80	-4.26	21.84	21.76	22.93
4 Txslots	24.95	24.88	25.96	26.50	-3.01	21.94	21.87	22.95
GSM 850 EGPRS (GMSK)	Measured Power (dBm)				calculation	Averaged Power (dBm)		
	251	190	128			251	190	128
1 Txslot	31.72	31.87	32.52	33.30	-9.03	22.69	22.84	23.49
2 Txslots	28.20	28.12	29.30	30.00	-6.02	22.18	22.10	23.28
3 Txslots	26.03	25.97	27.15	27.80	-4.26	21.77	21.71	22.89
4 Txslots	24.88	24.83	25.92	26.50	-3.01	21.87	21.82	22.91
GSM 850 EGPRS (8PSK)	Measured Power (dBm)				calculation	Averaged Power (dBm)		
	251	190	128			251	190	128
1 Txslot	25.02	25.04	26.13	27.00	-9.03	15.99	16.01	17.10
2 Txslots	23.52	23.56	24.65	25.50	-6.02	17.50	17.54	18.63
3Txslots	22.07	22.35	23.26	24.00	-4.26	17.81	18.09	19.00
4 Txslots	20.02	20.03	21.12	21.80	-3.01	17.01	17.02	18.11
PCS1900 Speech (GMSK)	Measured Power (dBm)			Tune up	calculation	Averaged Power (dBm)		
	810	661	512			810	661	512
1 Txslot	29.28	29.34	29.38	30.30	/	/	/	/
PCS1900 GPRS (GMSK)	Measured Power (dBm)				calculation	Averaged Power (dBm)		
	810	661	512			810	661	512
1 Txslot	29.42	29.46	29.51	30.30	-9.03	20.39	20.43	20.48
2 Txslots	25.58	25.74	25.77	27.00	-6.02	19.56	19.72	19.75
3 Txslots	23.38	23.61	23.64	25.00	-4.26	19.12	19.35	19.38
4 Txslots	22.52	22.58	22.62	24.00	-3.01	19.51	19.57	19.61
PCS1900 EGPRS (GMSK)	Measured Power (dBm)				calculation	Averaged Power (dBm)		
	810	661	512			810	661	512
1 Txslot	29.38	29.43	29.46	30.30	-9.03	20.35	20.40	20.43
2 Txslots	25.50	25.68	25.70	27.00	-6.02	19.48	19.66	19.68

3 Txslots	23.31	23.54	23.57	25.00	-4.26	19.05	19.28	19.31
4 Txslots	22.46	22.52	22.55	24.00	-3.01	19.45	19.51	19.54
PCS1900 EGPRS (8PSK)	Measured Power (dBm)				calculation	Averaged Power (dBm)		
	810	661	512			810	661	512
1 Txslot	24.11	24.34	24.55	26.00	-9.03	15.08	15.31	15.52
2 Txslots	22.62	22.75	22.93	24.50	-6.02	16.60	16.73	16.91
3Txslots	21.00	21.11	21.28	23.00	-4.26	16.74	16.85	17.02
4 Txslots	19.74	19.93	19.67	21.50	-3.01	16.73	16.92	16.66

NOTES:

1) Division Factors

To average the power, the division factor is as follows:

1TX-slot = 1 transmit time slot out of 8 time slots=> conducted power divided by (8/1) => -9.03dB

2TX-slots = 2 transmit time slots out of 8 time slots=> conducted power divided by (8/2) => -6.02dB

3TX-slots = 3 transmit time slots out of 8 time slots=> conducted power divided by (8/3) => -4.26dB

4TX-slots = 4 transmit time slots out of 8 time slots=> conducted power divided by (8/4) => -3.01dB

According to the conducted power as above, the body measurements are performed with 1Txslot for GSM850 and GSM1900.

Table 11.1-2: The conducted power measurement results-Power Level C1

PCS1900 Speech (GMSK)	Measured Power (dBm)			Tune up	calculation	Averaged Power (dBm)		
	810	661	512			810	661	512
1 Txslot	25.50	25.66	25.68	27.30	/	/	/	/
PCS1900 GPRS (GMSK)	Measured Power (dBm)				calculation	Averaged Power (dBm)		
	810	661	512			810	661	512
1 Txslot	25.50	25.67	25.69	27.30	-9.03	16.47	16.64	16.66
2 Txslots	22.38	22.42	22.46	24.00	-6.02	16.36	16.40	16.44
3 Txslots	20.23	20.28	20.39	22.00	-4.26	15.97	16.02	16.13
4 Txslots	18.88	19.11	19.20	20.00	-3.01	15.87	16.10	16.19
PCS1900 EGPRS (GMSK)	Measured Power (dBm)				calculation	Averaged Power (dBm)		
	810	661	512			810	661	512
1 Txslot	25.49	25.68	25.71	27.30	-9.03	16.46	16.65	16.68
2 Txslots	22.38	22.44	22.49	24.00	-6.02	16.36	16.42	16.47
3 Txslots	20.22	20.31	20.42	22.00	-4.26	15.96	16.05	16.16
4 Txslots	18.89	19.13	19.23	20.00	-3.01	15.88	16.12	16.22
PCS1900 EGPRS (8PSK)	Measured Power (dBm)				calculation	Averaged Power (dBm)		
	810	661	512			810	661	512
1 Txslot	21.59	21.69	21.86	23.00	-9.03	12.56	12.66	12.83
2 Txslots	19.79	19.81	19.87	21.50	-6.02	13.77	13.79	13.85
3Txslots	18.53	18.67	18.77	20.00	-4.26	14.27	14.41	14.51
4 Txslots	17.93	18.19	18.10	19.50	-3.01	14.92	15.18	15.09

NOTES:

1) Division Factors

To average the power, the division factor is as follows:

1TX-slot = 1 transmit time slot out of 8 time slots=> conducted power divided by (8/1) => -9.03dB

2TX-slots = 2 transmit time slots out of 8 time slots=> conducted power divided by (8/2) => -6.02dB

3TX-slots = 3 transmit time slots out of 8 time slots=> conducted power divided by (8/3) => -4.26dB

4TX-slots = 4 transmit time slots out of 8 time slots=> conducted power divided by (8/4) => -3.01dB

According to the conducted power as above, the body measurements are performed with 1Txslot for GSM1900.

11.2 WCDMA Measurement result

Table 11.2-1: The conducted Power for WCDMA-Normal Power

WCDMA850	FDDV result (dBm)			Tune up
	4233/4458	4183/4408	4132/4357	
	(846.6MHz)	(836.6MHz)	(826.4MHz)	
	23.44	23.63	23.47	24.00
HSUPA	23.00	22.95	22.98	23.00
	19.97	19.96	19.95	21.00
	21.95	21.92	21.96	22.00
	20.97	20.96	20.98	21.00
	22.98	22.95	23.00	23.00
HSPA+(16QAM)	22.40	22.54	22.46	23.00
DC-HSDPA	22.98	23.00	22.96	23.00
	22.95	22.98	22.96	23.00
	22.48	22.56	22.50	23.00
	22.50	22.52	22.48	23.00
WCDMA1900	FDDII result (dBm)			Tune up
	9538/9938	9400/9800	9262/9662	
	(1907.6MHz)	(1880MHz)	(1852.4MHz)	
	23.18	23.15	23.02	24.00
HSUPA	22.37	22.43	22.60	23.00
	20.48	20.41	20.66	21.00
	21.47	21.48	21.68	22.00
	20.47	20.49	20.46	20.50
	22.39	22.33	22.56	23.00
HSPA+(16QAM)	22.00	21.97	22.11	22.50
DC-HSDPA	22.42	22.45	22.54	23.00
	22.46	22.56	22.59	23.00
	22.09	22.11	22.16	23.00
	22.13	22.07	22.11	23.00

Table 11.2-2: The conducted Power for WCDMA- Power Level C1

WCDMA850	FDDV result (dBm)			Tune up
	4233/4458	4183/4408	4132/4357	
	(846.6MHz)	(836.6MHz)	(826.4MHz)	
	20.05	20.21	19.97	21.00
HSUPA	19.52	19.60	19.48	20.00
	17.48	17.56	17.50	19.00
	18.50	18.54	18.48	20.00
	17.51	17.58	17.52	18.50
	19.54	19.62	19.46	21.00
HSPA+(16QAM)	19.08	19.10	19.02	19.50
DC-HSDPA	19.50	19.56	19.48	21.00
	19.52	19.58	19.52	21.00
	19.08	19.10	19.06	21.00
	19.04	19.08	19.02	21.00
WCDMA1900	FDDII result (dBm)			Tune up
	9538/9938	9400/9800	9262/9662	
	(1907.6MHz)	(1880MHz)	(1852.4MHz)	
	19.99	20.00	20.03	21.50
HSUPA	19.46	19.45	19.48	20.00
	17.45	17.43	17.46	19.00
	18.44	18.47	18.45	20.00
	17.44	17.46	17.48	18.50
	19.48	19.46	19.50	20.00
HSPA+(16QAM)	19.00	19.03	19.06	20.50
DC-HSDPA	19.44	19.42	19.46	21.00
	19.46	19.45	19.50	21.00
	19.03	19.00	19.06	21.00
	19.02	19.05	19.09	21.00

11.3 LTE Measurement result

Maximum Target Power for Production Unit – Power Level A1/B1/C1

Band	Tune up (dBm)			
	Normal power	Level A1	Level B1	Level C1
Band 5	24.5	/	/	/
Band 7	24	/	21	21
Band 41	24	/	23	23

Normal power:

Band5-Normal power				
BANDWIDTH	Number of RBs	Frequency	QPSK	16QAM
1.4MHz	1RB-High (5)	848.3 (20643)	23.31	22.36
		836.5 (20525)	23.47	22.25
		824.7 (20407)	23.31	22.56
	1RB-Middle (3)	848.3 (20643)	23.43	22.54
		836.5 (20525)	23.56	22.26
		824.7 (20407)	23.29	22.63
	1RB-Low (0)	848.3 (20643)	23.27	22.48
		836.5 (20525)	23.46	22.34
		824.7 (20407)	23.35	22.61
	3RB-High (3)	848.3 (20643)	23.30	22.54
		836.5 (20525)	23.40	22.53
		824.7 (20407)	23.47	22.17
	3RB-Middle (1)	848.3 (20643)	23.40	22.63
		836.5 (20525)	23.58	22.65
		824.7 (20407)	23.51	22.22
	3RB-Low (0)	848.3 (20643)	23.41	22.73
		836.5 (20525)	23.38	22.46
		824.7 (20407)	23.45	22.17
	6RB (0)	848.3 (20643)	22.39	21.57
		836.5 (20525)	22.49	21.32
		824.7 (20407)	22.43	21.03
3MHz	1RB-High (14)	847.5 (20635)	23.20	22.21
		836.5 (20525)	23.22	22.13
		825.5 (20415)	23.29	22.32
	1RB-Middle (7)	847.5 (20635)	23.49	22.59
		836.5 (20525)	23.49	22.51
		825.5 (20415)	23.61	22.76
	1RB-Low (0)	847.5 (20635)	23.43	22.30
		836.5 (20525)	23.49	22.40
		825.5 (20415)	23.36	22.69
	8RB-High (7)	847.5 (20635)	22.30	21.28
		836.5 (20525)	22.40	21.50
		825.5 (20415)	22.29	21.63
	8RB-Middle (4)	847.5 (20635)	22.27	21.29
		836.5 (20525)	22.32	21.39
		825.5 (20415)	22.38	21.82
	8RB-Low (0)	847.5 (20635)	22.33	21.17
		836.5 (20525)	22.41	21.58
		825.5 (20415)	22.37	21.81
	15RB (0)	847.5 (20635)	22.33	21.38
		836.5 (20525)	22.35	21.15
		825.5 (20415)	22.40	21.46

5MHz	1RB-High (24)	846.5 (20625)	23.00	22.14
		836.5 (20525)	23.06	21.95
		826.5 (20425)	23.16	21.76
	1RB-Middle (12)	846.5 (20625)	23.20	22.55
		836.5 (20525)	23.45	22.44
		826.5 (20425)	23.40	22.25
	1RB-Low (0)	846.5 (20625)	22.99	21.88
		836.5 (20525)	23.12	21.80
		826.5 (20425)	23.27	21.76
	12RB-High (13)	846.5 (20625)	22.18	21.04
		836.5 (20525)	22.32	21.30
		826.5 (20425)	22.35	21.14
	12RB-Middle (6)	846.5 (20625)	22.23	21.11
		836.5 (20525)	22.30	21.36
		826.5 (20425)	22.42	21.12
	12RB-Low (0)	846.5 (20625)	22.19	21.06
		836.5 (20525)	22.33	21.42
		826.5 (20425)	22.41	21.14
25RB (0)	846.5 (20625)	22.23	21.22	
	836.5 (20525)	22.34	21.10	
	826.5 (20425)	22.32	21.44	
10MHz	1RB-High (49)	844 (20600)	23.01	22.30
		836.5 (20525)	23.27	22.32
		829 (20450)	23.03	21.92
	1RB-Middle (24)	844 (20600)	23.91	22.49
		836.5 (20525)	23.58	22.80
		829 (20450)	23.60	22.94
	1RB-Low (0)	844 (20600)	23.01	22.08
		836.5 (20525)	22.79	22.05
		829 (20450)	23.23	22.29
	25RB-High (25)	844 (20600)	22.37	21.35
		836.5 (20525)	22.39	21.53
		829 (20450)	22.39	21.38
	25RB-Middle (12)	844 (20600)	22.38	21.42
		836.5 (20525)	22.41	21.59
		829 (20450)	22.41	21.47
	25RB-Low (0)	844 (20600)	22.41	21.40
		836.5 (20525)	22.49	21.56
		829 (20450)	22.33	21.50
50RB (0)	844 (20600)	22.37	21.26	
	836.5 (20525)	22.42	21.22	
	829 (20450)	22.42	21.41	

Band7-Normal power				
BANDWIDTH	Number of RBs	Frequency	QPSK	16QAM
5MHz	1RB-High (24)	2567.5 (21425)	22.21	22.38
		2535 (21100)	23.37	22.33
		2502.5 (20775)	23.15	22.40
	1RB-Middle (12)	2567.5 (21425)	22.92	21.76
		2535 (21100)	23.74	22.60
		2502.5 (20775)	23.42	22.71
	1RB-Low (0)	2567.5 (21425)	22.27	21.16
		2535 (21100)	23.23	21.85
		2502.5 (20775)	23.23	22.24
	12RB-High (13)	2567.5 (21425)	22.49	21.42
		2535 (21100)	22.60	21.70
		2502.5 (20775)	22.43	21.47
	12RB-Middle (6)	2567.5 (21425)	22.73	21.69
		2535 (21100)	22.58	21.53
		2502.5 (20775)	22.42	21.47
	12RB-Low (0)	2567.5 (21425)	22.55	21.51
		2535 (21100)	22.55	21.68
		2502.5 (20775)	22.49	21.56
	25RB (0)	2567.5 (21425)	22.49	21.39
		2535 (21100)	22.61	21.75
		2502.5 (20775)	22.44	21.42
10MHz	1RB-High (49)	2565 (21400)	23.42	21.11
		2535 (21100)	23.25	22.11
		2505 (20800)	23.45	22.43
	1RB-Middle (24)	2565 (21400)	23.57	22.22
		2535 (21100)	23.77	22.72
		2505 (20800)	23.86	23.00
	1RB-Low (0)	2565 (21400)	23.16	21.40
		2535 (21100)	23.01	21.97
		2505 (20800)	23.11	22.02
	25RB-High (25)	2565 (21400)	22.53	21.50
		2535 (21100)	22.53	21.74
		2505 (20800)	22.45	21.43
	25RB-Middle (12)	2565 (21400)	22.52	21.82
		2535 (21100)	22.51	21.79
		2505 (20800)	22.44	21.54
	25RB-Low (0)	2565 (21400)	22.53	21.62
		2535 (21100)	22.66	21.67
		2505 (20800)	22.42	21.54
	50RB (0)	2565 (21400)	22.51	21.53
		2535 (21100)	22.47	21.61
		2505 (20800)	22.41	21.43

15MHz	1RB-High (74)	2562.5 (21375)	23.08	22.35	
		2535 (21100)	23.14	22.23	
		2507.5 (20825)	23.15	22.87	
	1RB-Middle (37)	2562.5 (21375)	22.98	21.83	
		2535 (21100)	23.62	22.59	
		2507.5 (20825)	23.46	22.54	
	1RB-Low (0)	2562.5 (21375)	22.19	21.04	
		2535 (21100)	22.91	22.16	
		2507.5 (20825)	23.08	22.36	
	36RB-High (38)	2562.5 (21375)	22.56	21.50	
		2535 (21100)	22.48	21.76	
		2507.5 (20825)	22.28	21.19	
	36RB-Middle (19)	2562.5 (21375)	22.48	21.63	
		2535 (21100)	22.55	21.72	
		2507.5 (20825)	22.38	21.25	
	36RB-Low (0)	2562.5 (21375)	22.50	21.45	
		2535 (21100)	22.42	21.57	
		2507.5 (20825)	22.34	21.23	
	75RB (0)	2562.5 (21375)	22.54	21.57	
		2535 (21100)	22.54	21.59	
		2507.5 (20825)	22.34	21.32	
	20MHz	1RB-High (99)	2560 (21350)	22.62	21.89
			2535 (21100)	23.23	22.29
			2510 (20850)	23.31	21.85
		1RB-Middle (50)	2560 (21350)	23.22	22.72
			2535 (21100)	23.94	22.58
			2510 (20850)	23.57	22.36
1RB-Low (0)		2560 (21350)	22.52	21.63	
		2535 (21100)	22.54	22.04	
		2510 (20850)	22.64	22.01	
50RB-High (50)		2560 (21350)	22.59	21.87	
		2535 (21100)	22.46	21.64	
		2510 (20850)	22.25	21.25	
50RB-Middle (25)		2560 (21350)	22.47	21.75	
		2535 (21100)	22.61	21.81	
		2510 (20850)	22.30	21.30	
50RB-Low (0)		2560 (21350)	22.49	21.59	
		2535 (21100)	22.47	21.56	
		2510 (20850)	22.38	21.35	
100RB (0)		2560 (21350)	22.50	21.62	
		2535 (21100)	22.45	21.55	
		2510 (20850)	22.24	21.24	

Band41-Normal Power				
BANDWIDTH	Number of RBs	Frequency	QPSK	16QAM
5MHz	1RB-High (24)	2637.5 (41065)	22.86	21.57
		2606 (40750)	23.19	22.28
		2574 (40430)	22.93	21.47
		2542.5 (40115)	22.52	21.52
	1RB-Middle (12)	2637.5 (41065)	23.46	22.00
		2606 (40750)	23.41	22.47
		2574 (40430)	23.01	22.04
		2542.5 (40115)	23.33	21.74
	1RB-Low (0)	2637.5 (41065)	22.98	21.71
		2606 (40750)	23.00	22.26
		2574 (40430)	22.95	21.50
		2542.5 (40115)	22.83	21.53
	12RB-High (13)	2637.5 (41065)	22.14	20.97
		2606 (40750)	22.14	21.18
		2574 (40430)	22.12	20.75
		2542.5 (40115)	21.98	20.91
	12RB-Middle (6)	2637.5 (41065)	22.15	20.99
		2606 (40750)	22.15	21.24
		2574 (40430)	22.18	20.72
		2542.5 (40115)	22.09	20.95
	12RB-Low (0)	2637.5 (41065)	22.13	20.99
		2606 (40750)	21.95	21.18
		2574 (40430)	22.12	20.74
		2542.5 (40115)	22.07	20.84
	25RB (0)	2637.5 (41065)	22.11	21.06
		2606 (40750)	21.97	20.96
		2574 (40430)	22.12	21.01
		2542.5 (40115)	22.03	20.96

10MHz	1RB-High (49)	2635 (41040)	22.89	21.27
		2605 (40740)	22.82	21.85
		2575 (40440)	22.97	22.61
		2545 (40140)	22.86	21.33
	1RB-Middle (24)	2635 (41040)	23.19	21.46
		2605 (40740)	22.95	21.85
		2575 (40440)	23.23	22.78
		2545 (40140)	22.83	21.45
	1RB-Low (0)	2635 (41040)	22.88	21.38
		2605 (40740)	22.81	21.89
		2575 (40440)	23.08	22.75
		2545 (40140)	22.84	21.25
	25RB-High (25)	2635 (41040)	22.20	20.87
		2605 (40740)	21.90	20.98
		2575 (40440)	22.12	21.16
		2545 (40140)	21.85	20.85
	25RB-Middle (12)	2635 (41040)	22.13	20.90
		2605 (40740)	21.89	20.97
		2575 (40440)	22.08	21.16
		2545 (40140)	21.86	20.86
25RB-Low (0)	2635 (41040)	22.11	20.88	
	2605 (40740)	21.89	20.98	
	2575 (40440)	22.10	21.07	
	2545 (40140)	21.90	20.78	
50RB (0)	2635 (41040)	22.06	20.86	
	2605 (40740)	21.85	21.06	
	2575 (40440)	22.11	21.03	
	2545 (40140)	21.79	20.91	

15MHz	1RB-High (74)	2632.5 (41015)	22.85	21.66
		2604 (40730)	23.06	22.68
		2576 (40450)	22.95	21.28
		2547.5 (40165)	22.67	21.63
	1RB-Middle (37)	2632.5 (41015)	22.74	22.59
		2604 (40730)	22.97	22.75
		2576 (40450)	22.87	21.12
		2547.5 (40165)	22.78	22.56
	1RB-Low (0)	2632.5 (41015)	22.66	22.14
		2604 (40730)	22.85	22.61
		2576 (40450)	22.93	21.12
		2547.5 (40165)	22.77	22.16
	36RB-High (38)	2632.5 (41015)	21.90	20.91
		2604 (40730)	22.06	20.82
		2576 (40450)	22.02	21.00
		2547.5 (40165)	21.91	20.98
	36RB-Middle (19)	2632.5 (41015)	22.01	20.81
		2604 (40730)	22.01	20.78
		2576 (40450)	22.16	20.95
		2547.5 (40165)	21.95	20.82
	36RB-Low (0)	2632.5 (41015)	21.86	20.84
		2604 (40730)	22.05	20.79
		2576 (40450)	22.07	21.05
		2547.5 (40165)	21.89	20.87
	75RB (0)	2632.5 (41015)	21.86	20.88
		2604 (40730)	22.10	20.84
		2576 (40450)	22.10	21.06
		2547.5 (40165)	21.89	21.10

20MHz	1RB-High (99)	2630 (40990)	22.21	21.15
		2603.5 (40725)	22.68	21.02
		2576.5 (40455)	22.78	21.07
		2550 (40190)	22.74	21.89
	1RB-Middle (50)	2630 (40990)	22.82	22.06
		2603.5 (40725)	23.30	21.46
		2576.5 (40455)	23.14	21.05
		2550 (40190)	22.62	22.10
	1RB-Low (0)	2630 (40990)	22.56	21.86
		2603.5 (40725)	22.05	21.04
		2576.5 (40455)	22.83	21.02
		2550 (40190)	22.46	21.88
	50RB-High (50)	2630 (40990)	21.74	20.67
		2603.5 (40725)	21.57	20.69
		2576.5 (40455)	21.88	20.51
		2550 (40190)	21.72	20.96
	50RB-Middle (25)	2630 (40990)	21.80	20.73
		2603.5 (40725)	21.61	20.74
		2576.5 (40455)	21.80	20.77
		2550 (40190)	21.87	20.91
50RB-Low (0)	2630 (40990)	21.77	20.53	
	2603.5 (40725)	21.51	20.71	
	2576.5 (40455)	21.83	20.69	
	2550 (40190)	21.70	20.77	
100RB (0)	2630 (40990)	21.79	20.39	
	2603.5 (40725)	21.64	20.70	
	2576.5 (40455)	21.87	20.66	
	2550 (40190)	21.80	20.82	

Power level B1/C1:

Band7-Power Level B1/C1					
BANDWIDTH	Number of RBs	Frequency	QPSK	16QAM	
5MHz	1RB-High (24)	2567.5 (21425)	20.39	20.51	
		2535 (21100)	20.28	20.59	
		2502.5 (20775)	20.11	20.19	
	1RB-Middle (12)	2567.5 (21425)	20.69	20.56	
		2535 (21100)	20.77	20.69	
		2502.5 (20775)	20.53	20.28	
	1RB-Low (0)	2567.5 (21425)	20.17	20.14	
		2535 (21100)	20.22	19.89	
		2502.5 (20775)	20.34	19.74	
	12RB-High (13)	2567.5 (21425)	20.54	20.37	
		2535 (21100)	20.52	20.64	
		2502.5 (20775)	20.36	20.20	
	12RB-Middle (6)	2567.5 (21425)	20.50	20.75	
		2535 (21100)	20.59	20.61	
		2502.5 (20775)	20.43	20.15	
	12RB-Low (0)	2567.5 (21425)	20.56	20.56	
		2535 (21100)	20.54	20.58	
		2502.5 (20775)	20.51	20.27	
	25RB (0)	2567.5 (21425)	20.51	20.51	
		2535 (21100)	20.59	20.42	
		2502.5 (20775)	20.35	20.25	
	10MHz	1RB-High (49)	2565 (21400)	20.36	20.71
			2535 (21100)	20.52	20.57
			2505 (20800)	20.51	20.29
1RB-Middle (24)		2565 (21400)	20.71	20.65	
		2535 (21100)	20.78	20.85	
		2505 (20800)	20.77	20.84	
1RB-Low (0)		2565 (21400)	20.58	20.04	
		2535 (21100)	20.37	20.55	
		2505 (20800)	20.69	20.47	
25RB-High (25)		2565 (21400)	20.59	20.67	
		2535 (21100)	20.56	20.68	
		2505 (20800)	20.39	20.39	
25RB-Middle (12)		2565 (21400)	20.56	20.74	
		2535 (21100)	20.53	20.69	
		2505 (20800)	20.41	20.43	
25RB-Low (0)		2565 (21400)	20.55	20.58	
		2535 (21100)	20.53	20.58	
		2505 (20800)	20.38	20.46	
50RB (0)		2565 (21400)	20.52	20.78	
		2535 (21100)	20.58	20.48	
		2505 (20800)	20.37	20.51	

15MHz	1RB-High (74)	2562.5 (21375)	20.83	20.34
		2535 (21100)	20.24	20.56
		2507.5 (20825)	20.00	20.85
	1RB-Middle (37)	2562.5 (21375)	20.69	20.67
		2535 (21100)	20.53	20.59
		2507.5 (20825)	20.27	20.79
	1RB-Low (0)	2562.5 (21375)	20.80	20.47
		2535 (21100)	20.24	19.77
		2507.5 (20825)	20.44	20.85
	36RB-High (38)	2562.5 (21375)	20.62	20.73
		2535 (21100)	20.49	20.45
		2507.5 (20825)	20.21	20.25
	36RB-Middle (19)	2562.5 (21375)	20.45	20.49
		2535 (21100)	20.48	20.64
		2507.5 (20825)	20.33	20.44
	36RB-Low (0)	2562.5 (21375)	20.44	20.51
		2535 (21100)	20.37	20.46
		2507.5 (20825)	20.33	20.42
75RB (0)	2562.5 (21375)	20.55	20.55	
	2535 (21100)	20.48	20.62	
	2507.5 (20825)	20.27	20.33	
20MHz	1RB-High (99)	2560 (21350)	20.64	20.12
		2535 (21100)	19.76	19.68
		2510 (20850)	19.73	20.05
	1RB-Middle (50)	2560 (21350)	20.57	20.18
		2535 (21100)	20.54	20.24
		2510 (20850)	20.36	20.41
	1RB-Low (0)	2560 (21350)	20.17	19.98
		2535 (21100)	19.80	19.99
		2510 (20850)	19.75	19.87
	50RB-High (50)	2560 (21350)	20.25	20.39
		2535 (21100)	20.19	20.17
		2510 (20850)	19.89	20.13
	50RB-Middle (25)	2560 (21350)	20.38	20.14
		2535 (21100)	20.41	20.36
		2510 (20850)	19.98	20.09
	50RB-Low (0)	2560 (21350)	20.27	20.07
		2535 (21100)	20.18	20.11
		2510 (20850)	20.10	20.22
100RB (0)	2560 (21350)	20.45	20.14	
	2535 (21100)	20.24	20.22	
	2510 (20850)	20.00	19.95	

Band41-Power Level B1/C1				
BANDWIDTH	Number of RBs	Frequency	QPSK	16QAM
5MHz	1RB-High (24)	2637.5 (41065)	21.88	21.54
		2606 (40750)	22.07	22.26
		2574 (40430)	21.68	21.73
		2542.5 (40115)	21.86	21.48
	1RB-Middle (12)	2637.5 (41065)	22.52	21.95
		2606 (40750)	22.53	22.43
		2574 (40430)	22.10	22.02
		2542.5 (40115)	22.29	21.73
	1RB-Low (0)	2637.5 (41065)	22.08	21.68
		2606 (40750)	22.19	22.23
		2574 (40430)	21.96	21.48
		2542.5 (40115)	22.00	21.52
	12RB-High (13)	2637.5 (41065)	22.14	20.97
		2606 (40750)	22.05	21.14
		2574 (40430)	22.04	20.72
		2542.5 (40115)	21.95	20.89
	12RB-Middle (6)	2637.5 (41065)	22.12	20.95
		2606 (40750)	22.07	21.21
		2574 (40430)	22.11	20.90
		2542.5 (40115)	22.04	20.93
	12RB-Low (0)	2637.5 (41065)	22.12	20.96
		2606 (40750)	22.03	21.16
		2574 (40430)	22.18	20.61
		2542.5 (40115)	21.97	20.83
	25RB (0)	2637.5 (41065)	22.10	20.99
		2606 (40750)	22.15	20.92
		2574 (40430)	22.09	20.93
		2542.5 (40115)	22.03	20.93

10MHz	1RB-High (49)	2635 (41040)	21.99	21.18
		2605 (40740)	21.90	22.55
		2575 (40440)	22.10	22.52
		2545 (40140)	21.90	21.32
	1RB-Middle (24)	2635 (41040)	22.18	21.48
		2605 (40740)	21.94	22.52
		2575 (40440)	22.21	22.58
		2545 (40140)	21.99	21.52
	1RB-Low (0)	2635 (41040)	21.99	21.06
		2605 (40740)	21.81	22.57
		2575 (40440)	22.00	22.53
		2545 (40140)	21.98	21.25
	25RB-High (25)	2635 (41040)	22.19	20.92
		2605 (40740)	21.92	21.04
		2575 (40440)	22.16	21.16
		2545 (40140)	21.97	20.84
	25RB-Middle (12)	2635 (41040)	22.21	20.96
		2605 (40740)	22.05	21.01
		2575 (40440)	22.12	21.07
		2545 (40140)	21.96	20.84
	25RB-Low (0)	2635 (41040)	22.08	20.84
		2605 (40740)	21.99	20.95
		2575 (40440)	22.11	21.06
		2545 (40140)	21.99	20.88
	50RB (0)	2635 (41040)	22.08	20.91
		2605 (40740)	21.84	21.04
		2575 (40440)	22.13	20.99
		2545 (40140)	21.98	20.88

15MHz	1RB-High (74)	2632.5 (41015)	21.78	21.92
		2604 (40730)	22.17	22.61
		2576 (40450)	21.96	21.16
		2547.5 (40165)	21.89	21.89
	1RB-Middle (37)	2632.5 (41015)	21.99	22.55
		2604 (40730)	22.07	22.56
		2576 (40450)	22.07	21.23
		2547.5 (40165)	21.90	22.60
	1RB-Low (0)	2632.5 (41015)	21.81	22.18
		2604 (40730)	21.91	22.59
		2576 (40450)	21.75	21.17
		2547.5 (40165)	21.79	22.43
	36RB-High (38)	2632.5 (41015)	22.10	20.93
		2604 (40730)	22.05	20.79
		2576 (40450)	21.98	21.07
		2547.5 (40165)	21.99	21.03
	36RB-Middle (19)	2632.5 (41015)	22.07	20.94
		2604 (40730)	22.07	20.83
		2576 (40450)	22.11	21.01
		2547.5 (40165)	21.99	20.98
	36RB-Low (0)	2632.5 (41015)	22.06	20.94
		2604 (40730)	22.04	20.83
		2576 (40450)	22.16	21.06
		2547.5 (40165)	21.97	20.94
	75RB (0)	2632.5 (41015)	22.05	20.73
		2604 (40730)	22.07	20.79
		2576 (40450)	22.02	21.04
		2547.5 (40165)	22.08	20.94

20MHz	1RB-High (99)	2630 (40990)	21.78	21.50
		2603.5 (40725)	21.96	21.15
		2576.5 (40455)	21.82	21.16
		2550 (40190)	21.78	21.93
	1RB-Middle (50)	2630 (40990)	21.83	21.94
		2603.5 (40725)	22.27	21.25
		2576.5 (40455)	22.01	21.23
		2550 (40190)	21.74	21.93
	1RB-Low (0)	2630 (40990)	21.64	21.90
		2603.5 (40725)	21.77	21.15
		2576.5 (40455)	21.87	21.16
		2550 (40190)	21.49	21.92
	50RB-High (50)	2630 (40990)	21.81	20.67
		2603.5 (40725)	21.73	20.68
		2576.5 (40455)	21.84	20.84
		2550 (40190)	21.83	20.90
	50RB-Middle (25)	2630 (40990)	21.98	20.71
		2603.5 (40725)	21.88	20.75
		2576.5 (40455)	21.87	20.75
		2550 (40190)	21.86	20.95
	50RB-Low (0)	2630 (40990)	21.85	20.51
		2603.5 (40725)	21.71	20.72
		2576.5 (40455)	22.00	20.70
		2550 (40190)	21.70	20.79
	100RB (0)	2630 (40990)	21.94	20.39
		2603.5 (40725)	21.83	20.71
		2576.5 (40455)	21.82	20.68
		2550 (40190)	21.82	20.83

11.4 Wi-Fi and BT Measurement result

The maximum output power of BT antenna is 8.8dBm.

The maximum tune up of BT antenna is 9dBm.

The average conducted power for Wi-Fi 2.4G is as following-Normal Power:

802.11b								
Channel\data rate	1Mbps	2Mbps	5.5Mbps	11Mbps				
11(2462MHz)	18.31	18.27	18.21	18.09				
6(2437(MHz)	18.05	18.01	/	/				
1(2412MHz)	17.78	17.76	/	/				
Tune up	19.00	19.00	19.00	19.00				
802.11g								
Channel\data rate	6Mbps	9Mbps	12Mbps	18Mbps	24Mbps	36Mbps	48Mbps	54Mbps
11(2462MHz)	15.75	15.69	15.65	16.50	16.23	15.85	15.36	15.28
6(2437(MHz)	15.53	/	/	16.26	/	/	/	/
1(2412MHz)	15.32	/	/	16.04	/	/	/	/
Tune up	16.50	16.50	16.50	16.50	16.50	16.50	16.50	16.50
802.11n-20MHz								
Channel\data rate	MCS0	MCS1	MCS2	MCS3	MCS4	MCS5	MCS6	MCS7
11(2462MHz)	15.57	15.38	16.32	16.25	16.40	15.35	15.34	14.71
6(2437(MHz)	15.36	/	/	/	16.14	/	/	/
1(2412MHz)	15.15	/	/	/	15.99	/	/	/
Tune up	16.50	16.50	16.50	16.50	16.50	16.50	16.50	16.50
802.11n-40MHz								
Channel\data rate	MCS0	MCS1	MCS2	MCS3	MCS4	MCS5	MCS6	MCS7
9(2452MHz)	16.57	16.46	16.33	16.11	16.09	13.66	13.59	12.97
6(2437MHz)	16.12	/	/	/	/	/	/	/
3(2422MHz)	15.81	/	/	/	/	/	/	/
Tune up	17.00	17.00	17.00	17.00	17.00	14.50	14.50	14.50

The average conducted power for Wi-Fi 2.4G is as following-Power Level A1:

802.11b								
Channel\data rate	1Mbps	2Mbps	5.5Mbps	11Mbps				
11(2462MHz)	16.29	16.06	16.00	15.88				
6(2437(MHz)	16.10	15.83	/	/				
1(2412MHz)	15.69	15.50	/	/				
Tune up	17.00	17.00	17.00	17.00				
802.11g								
Channel\data rate	6Mbps	9Mbps	12Mbps	18Mbps	24Mbps	36Mbps	48Mbps	54Mbps
11(2462MHz)	13.60	13.56	13.50	14.32	14.07	13.65	13.25	13.16
6(2437(MHz)	13.58	/	/	14.27	/	/	/	/
1(2412MHz)	13.13	/	/	13.84	/	/	/	/
Tune up	14.50	14.50	14.50	14.50	14.50	14.50	14.50	14.50
802.11n-20MHz								
Channel\data rate	MCS0	MCS1	MCS2	MCS3	MCS4	MCS5	MCS6	MCS7
11(2462MHz)	13.43	13.24	14.17	14.08	14.20	13.26	13.24	12.66
6(2437(MHz)	13.40	/	/	/	14.16	/	/	/
1(2412MHz)	12.98	/	/	/	13.74	/	/	/
Tune up	14.50	14.50	14.50	14.50	14.50	14.50	14.50	14.50
802.11n-40MHz								
Channel\data rate	MCS0	MCS1	MCS2	MCS3	MCS4	MCS5	MCS6	MCS7
9(2452MHz)	14.35	14.25	14.10	13.90	13.85	11.90	11.82	11.22
6(2437MHz)	14.23	/	/	/	/	/	/	/
3(2422MHz)	13.98	/	/	/	/	/	/	/
Tune up	15.00	15.00	15.00	15.00	15.00	13.00	13.00	13.00

12 Simultaneous TX SAR Considerations

12.1 Introduction

The following procedures adopted from “FCC SAR Considerations for Cell Phones with Multiple Transmitters” are applicable to handsets with built-in unlicensed transmitters such as 802.11 a/b/g and Bluetooth devices which may simultaneously transmit with the licensed transmitter.

For this device, the BT and Wi-Fi can transmit simultaneous with other transmitters.

12.2 Transmit Antenna Separation Distances

Ant1 TX:

2G: 850、900、1800、1900

3G: w1、w2

4G: B1、B3、B7、B38、B40、B41

Ant2 TX:

3G: w5、w8

4G: B5、B8、B20、B28

Ant3: BT/WiFi 2.4G、GPS

Ant4: DRX B1\B2\B3\B4\B7\B66\W1\W2\W4

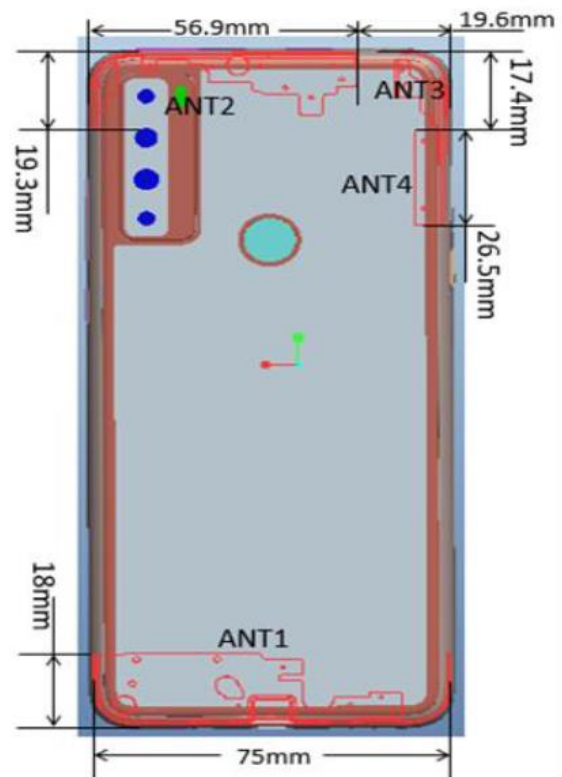

Picture 12.1 Antenna Locations

12.3 SAR Measurement Positions

According to the KDB941225 D06 Hot Spot SAR, the edges with less than 2.5 cm distance to the antennas need to be tested for SAR.

SAR measurement positions						
Mode	Front	Rear	Left edge	Right edge	Top edge	Bottom edge
Main Antenna-ANT1	Yes	Yes	Yes	Yes	No	Yes
Main Antenna-ANT2	Yes	Yes	Yes	Yes	Yes	No
WiFi Antenna-ANT3	Yes	Yes	Yes	No	Yes	No

12.4 Standalone SAR Test Exclusion Considerations

Standalone 1-g head or body SAR evaluation by measurement or numerical simulation is not required when the corresponding SAR Exclusion Threshold condition, listed below, is satisfied. The 1-g SAR test exclusion threshold for 100 MHz to 6 GHz at test separation distances ≤ 50 mm are determined by:

$[(\text{max. power of channel, including tune-up tolerance, mW}) / (\text{min. test separation distance, mm})] \cdot [\sqrt{f(\text{GHz})}] \leq 3.0$ for 1-g SAR, where

- $f(\text{GHz})$ is the RF channel transmit frequency in GHz
- Power and distance are rounded to the nearest mW and mm before calculation
- The result is rounded to one decimal place for comparison

Table 12.1: Standalone SAR test exclusion considerations

Band/Mode	F(GHz)	Position	SAR test exclusion threshold(mW)	RF output power		SAR test exclusion
				dBm	mW	
Bluetooth	2.441	Head	9.60	9	7.94	Yes
		Body	19.20	9	7.94	Yes
2.4GHz WLAN	2.45	Head	9.58	19	79.4	No
		Body	19.17	19	79.4	No

13 Evaluation of Simultaneous

Table 13.1: The sum of SAR values for Main antenna + WiFi-2.4G

	Position	Main antenna	WiFi-2.4G	Sum
Highest SAR value for Head	Right head, Cheek (WCDMA B5)	1.07	0.42	1.49
Highest SAR value for Body	Bottom 10mm (LTE Band7)	1.19	<0.01	1.19

Table 13.2: The sum of reported SAR values for main antenna and BT

	Position	Main antenna	BT	Sum
Maximum reported SAR value for Head	Right head, Cheek (WCDMA B5)	1.07	0.33 ^[1]	1.40
Maximum reported SAR value for Body	Front 10mm (LTE Band66)	1.19	<0.01	1.19

[1] - Estimated SAR for Bluetooth (see the table 13.3)

Table 13.3: Estimated SAR for Bluetooth

Mode/Band	F (GHz)	Position	Distance (mm)	Upper limit of power *		Estimated _{1g} (W/kg)
				dBm	mW	
Bluetooth	2.441	Head	5	9	7.94	0.33
Bluetooth	2.441	Body	10	9	7.94	0.17

* - Maximum possible output power declared by manufacturer

When standalone SAR test exclusion applies to an antenna that transmits simultaneously with other antennas, the standalone SAR must be estimated according to following to determine simultaneous transmission SAR test exclusion:

(max. power of channel, including tune-up tolerance, mW)/(min. test separation distance, mm) · [$\sqrt{f(\text{GHz})/x}$] W/kg for test separation distances ≤ 50 mm;

where x = 7.5 for 1-g SAR.

When the minimum test separation distance is < 5 mm, a distance of 5 mm is applied to determine SAR test exclusion

Conclusion:

According to the above tables, the sum of reported SAR values is < 1.6W/kg. So the simultaneous transmission SAR with volume scans is not required.

14 SAR Test Result

It is determined by user manual for the distance between the EUT and the phantom bottom. The distance is 10 mm and just applied to the condition of body worn accessory.

It is performed for all SAR measurements with area scan based 1-g SAR estimation (Fast SAR). A zoom scan measurement is added when the estimated 1-g SAR is the highest measured SAR in each exposure configuration, wireless mode and frequency band combination or more than 1.2W/kg.

The calculated SAR is obtained by the following formula:

$$\text{Reported SAR} = \text{Measured SAR} \times 10^{(P_{\text{Target}} - P_{\text{Measured}})/10}$$

Where P_{Target} is the power of manufacturing upper limit;

P_{Measured} is the measured power in chapter 11.

Table 14.1: Duty Cycle

Mode	Duty Cycle
Speech for GSM850/1900	1:8.3
GPRS&EGPRS for GSM 850	1:8.3
GPRS&EGPRS for GSM 1900-Normal Power	1:8.3
GPRS&EGPRS for GSM 1900-Power Level C1	1:8.3
WCDMA<E FDD	1:1
LTE TDD	1:1.58

The evaluation of multi-SIM cards:

We'll perform the head measurement in all bands with the primary SIM depending on the evaluation of multi-SIM cards and retest on highest value point with other SIM. Then, repeat the measurement in the Body test.

Frequency		Side	Test Position	SIM cards	SAR(1g) (W/kg)	Power Drift(dB)
MHz	Ch.					
824.2	128	Right	Cheek	S1	0.079	0.03
824.2	128	Right	Cheek	S2	0.072	0.02

Note: According to the values in the above table, the **S1** is the primary SIM card.

We'll perform the head measurement with the **S1** and retest on highest value point with others.

requency		Test Position	Spacing (mm)	SIM cards	SAR(1g) (W/kg)	Power Drift(dB)
MHz	Ch.					
824.2	128	Rear	10	S1	0.101	-0.01
824.2	128	Rear	10	S2	0.099	0.02

Note: According to the values in the above table, the **S1** is the primary SIM card.

We'll perform the body measurement with the **S1** and retest on highest value point with others.

Note

S1: SIM1

S2: SIM2

The evaluation of multi-Batteries:

We'll perform the head measurement in all bands with the primary Battery depending on the evaluation of multi-Batteries and retest on highest value point with other Battery. Then, repeat the measurement in the Body test.

Frequency		Side	Test Position	Batteries	SAR(1g) (W/kg)	Power Drift(dB)
MHz	Ch.					
824.2	128	Right	Cheek	B1	0.079	0.03
824.2	128	Right	Cheek	B2	0.068	0.08

Note: According to the values in the above table, the **B1** is the primary Battery.

We'll perform the head measurement with the **B1** and retest on highest value point with others.

Frequency		Test Position	Spacing (mm)	Batteries	SAR(1g) (W/kg)	Power Drift(dB)
MHz	Ch.					
824.2	128	Rear	10	B1	0.101	-0.01
824.2	128	Rear	10	B2	0.089	0.01

Note: According to the values in the above table, the **B1** is the primary Battery.

We'll perform the body measurement with the **B1** and retest on highest value point with others.

Note

B1: The battery of CAC4850002C7 by VK

B2: The battery of CAC4850000C1 by BYD

14.1 SAR results for Fast SAR

Table 14.1-1: SAR Values (GSM 850 MHz Band - Head)

Ambient Temperature: 22.9°C Liquid Temperature: 22.5°C											
Frequency		Side	Test Position	Figure No.	Conducted Power (dBm)	Max. tune-up Power (dBm)	Measured SAR(10g) (W/kg)	Reported SAR(10g) (W/kg)	Measured SAR(1g) (W/kg)	Reported SAR(1g) (W/kg)	Power Drift (dB)
Ch.	MHz										
190	836.6	Left	Cheek	/	32.01	33.30	0.049	0.07	0.062	0.08	0.12
190	836.6	Left	Tilt	/	32.01	33.30	<0.01	<0.01	<0.01	<0.01	/
251	848.8	Right	Cheek	/	31.86	33.30	0.055	0.08	0.068	0.09	-0.17
190	836.6	Right	Cheek	/	32.01	33.30	0.050	0.07	0.064	0.09	0.09
128	824.2	Right	Cheek	Fig.1	32.64	33.30	0.061	0.07	0.079	0.09	0.03
190	836.6	Right	Tilt	/	32.01	33.30	0.035	0.05	0.044	0.06	-0.06
128	824.2	Right	Cheek	S2	32.64	33.30	0.057	0.07	0.072	0.08	0.02
128	824.2	Right	Cheek	B2	32.64	33.30	0.052	0.06	0.068	0.08	0.08

Table 14.1-2: SAR Values (GSM 850 MHz Band - Body)

Ambient Temperature: 22.9°C Liquid Temperature: 22.5°C											
Frequency		Mode (number of timeslots)	Test Position	Figure No.	Conducted Power (dBm)	Max. tune-up Power (dBm)	Measured SAR(10g) (W/kg)	Reported SAR(10g) (W/kg)	Measured SAR(1g) (W/kg)	Reported SAR(1g) (W/kg)	Power Drift (dB)
Ch.	MHz										
190	836.6	GPRS (1)	Front	/	31.92	33.30	0.035	0.05	0.053	0.07	-0.05
251	848.8	GPRS (1)	Rear	/	31.81	33.30	0.041	0.06	0.079	0.11	0.19
190	836.6	GPRS (1)	Rear	/	31.92	33.30	0.045	0.06	0.083	0.11	0.06
128	824.2	GPRS (1)	Rear	Fig.2	32.56	33.30	0.065	0.08	0.101	0.12	-0.01
190	836.6	GPRS (1)	Left	/	31.92	33.30	0.021	0.03	0.033	0.05	0.12
190	836.6	GPRS (1)	Right	/	31.92	33.30	0.022	0.03	0.032	0.04	0.05
190	836.6	GPRS (1)	Bottom	/	31.92	33.30	0.028	0.04	0.043	0.06	-0.19
251	848.8	EGPRS (1)	Rear	/	31.92	33.30	0.044	0.06	0.082	0.11	0.18
128	824.2	GPRS (1)	Rear	S2	32.56	33.30	0.059	0.07	0.099	0.12	0.02
128	824.2	GPRS (1)	Rear	B2	32.56	33.30	0.054	0.06	0.089	0.11	0.01

Note: The distance between the EUT and the phantom bottom is 10mm.

Table 14.1-3: SAR Values (GSM 1900 MHz Band - Head)

Frequency		Side	Test Position	Figure No.	Conducted Power (dBm)	Max. tune-up Power (dBm)	Measured SAR(10g) (W/kg)	Reported SAR(10g) (W/kg)	Measured SAR(1g) (W/kg)	Reported SAR(1g) (W/kg)	Power Drift (dB)
Ch.	MHz										
810	1909.8	Left	Cheek	/	29.28	30.30	0.081	0.10	0.124	0.16	0.06
661	1880	Left	Cheek	/	29.34	30.30	0.087	0.11	0.134	0.17	0.03
512	1850.2	Left	Cheek	Fig.3	29.38	30.30	0.077	0.10	0.117	0.14	0.15
661	1880	Left	Tilt	/	29.34	30.30	0.062	0.08	0.096	0.12	0.04
661	1880	Right	Cheek	/	29.34	30.30	0.059	0.07	0.089	0.11	0.09
661	1880	Right	Tilt	/	29.34	30.30	0.041	0.05	0.064	0.08	-0.07
661	1880	Left	Cheek	S2	29.34	30.30	0.081	0.10	0.129	0.16	0.09
661	1880	Left	Cheek	B2	29.34	30.30	0.076	0.09	0.124	0.15	0.01

Table 14.1-4: SAR Values (GSM 1900 MHz Band – Body Worn)

Frequency		Mode (number of timeslots)	Test Position	Figure No.	Conducted Power (dBm)	Max. tune-up Power (dBm)	Measured SAR(10g) (W/kg)	Reported SAR(10g) (W/kg)	Measured SAR(1g) (W/kg)	Reported SAR(1g) (W/kg)	Power Drift (dB)
Ch.	MHz										
661	1880	GPRS (1)	Front	/	29.28	30.30	0.081	0.10	0.124	0.16	0.06
810	1909.8	GPRS (1)	Rear	Fig.4	29.34	30.30	0.087	0.11	0.134	0.17	0.03
661	1880	GPRS (1)	Rear	/	29.38	30.30	0.077	0.10	0.117	0.14	0.15
512	1850.2	GPRS (1)	Rear	/	29.34	30.30	0.062	0.08	0.096	0.12	0.04
661	1880	EGPRS (1)	Rear	/	29.34	30.30	0.059	0.07	0.089	0.11	0.09
661	1880	GPRS (1)	Rear	S2	29.34	30.30	0.041	0.05	0.064	0.08	-0.07
661	1880	GPRS (1)	Rear	B2	29.34	30.30	0.081	0.10	0.129	0.16	0.09

Note: The distance between the EUT and the phantom bottom is 15mm

Table 14.1-5: SAR Values (GSM 1900 MHz Band – Hotspot)

Ambient Temperature: 22.9 °C Liquid Temperature: 22.5°C											
Frequency		Mode (number of timeslots)	Test Position	Figure No.	Conducte d Power (dBm)	Max. tune-up Power (dBm)	Measured SAR(10g) (W/kg)	Reported SAR(10g)(W/kg)	Measured SAR(1g) (W/kg)	Reported SAR(1g) (W/kg)	Power Drift (dB)
Ch.	MHz										
661	1880	GPRS (1)	Front	/	25.67	27.30	0.076	0.11	0.135	0.20	0.04
810	1909.8	GPRS (1)	Rear	Fig.5	25.50	27.30	0.107	0.16	0.189	0.29	-0.02
661	1880	GPRS (1)	Rear	/	25.67	27.30	0.105	0.15	0.184	0.27	-0.09
512	1850.2	GPRS (1)	Rear	/	25.69	27.30	0.090	0.13	0.161	0.23	-0.14
661	1880	GPRS (1)	Left	/	25.67	27.30	0.039	0.06	0.070	0.10	0.12
661	1880	GPRS (1)	Right	/	25.67	27.30	<0.01	<0.01	<0.01	<0.01	/
661	1880	GPRS (1)	Bottom	/	25.67	27.30	0.070	0.10	0.138	0.20	-0.14
810	1909.8	EGPRS (1)	Rear	/	25.49	27.30	0.097	0.15	0.178	0.27	0.18
810	1909.8	GPRS (1)	Rear	S2	25.50	27.30	0.101	0.15	0.178	0.27	0.03
810	1909.8	GPRS (1)	Rear	B2	25.50	27.30	0.098	0.15	0.174	0.26	0.01

Note: The distance between the EUT and the phantom bottom is 10mm

Table 14.1-6: SAR Values (WCDMA 1900 MHz Band - Head)

Ambient Temperature: 22.9 °C Liquid Temperature: 22.5°C											
Frequency		Side	Test Position	Figur e No.	Conducted Power (dBm)	Max. tune- up Power (dBm)	Measure d SAR(10g) (W/kg)	Reported SAR(10g) (W/kg)	Measure d SAR(1g) (W/kg)	Reporte d SAR(1g) (W/kg)	Power Drift (dB)
Ch.	MHz										
9538	1907.6	Left	Cheek	/	23.18	24.00	0.182	0.22	0.284	0.34	0.09
9400	1880	Left	Cheek	Fig.6	23.15	24.00	0.194	0.24	0.308	0.37	-0.02
9262	1852.4	Left	Cheek	/	23.02	24.00	0.126	0.16	0.194	0.24	-0.03
9400	1880	Left	Tilt	/	23.15	24.00	0.181	0.22	0.285	0.35	-0.17
9400	1880	Right	Cheek	/	23.15	24.00	0.121	0.15	0.181	0.22	0.02
9400	1880	Right	Tilt	/	23.15	24.00	0.079	0.10	0.120	0.15	0.03
9400	1880	Left	Cheek	S2	23.15	24.00	0.189	0.23	0.299	0.36	0.01
9400	1880	Left	Cheek	B2	23.15	24.00	0.182	0.22	0.287	0.35	0.02

Table 14.1-7: SAR Values (WCDMA 1900 MHz Band – Body Worn)

Ambient Temperature: 22.9 °C						Liquid Temperature: 22.5°C				
Frequency		Test Position	Figure No.	Conduct ed Power (dBm)	Max. tune-up Power (dBm)	Measured SAR(10g) (W/kg)	Reported SAR(10g) (W/kg)	Measured SAR(1g) (W/kg)	Reported SAR(1g) (W/kg)	Power Drift (dB)
Ch.	MHz									
9400	1880	Front	/	23.15	24.00	0.232	0.28	0.399	0.49	-0.03
9538	1907.6	Rear	Fig.7	23.18	24.00	0.309	0.37	0.535	0.65	0.02
9400	1880	Rear	/	23.15	24.00	0.303	0.37	0.528	0.64	0.14
9262	1852.4	Rear	/	23.02	24.00	0.294	0.37	0.518	0.65	-0.07
9538	1907.6	Rear	S2	23.18	24.00	0.300	0.36	0.531	0.64	0.10
9538	1907.6	Rear	B2	23.18	24.00	0.289	0.35	0.527	0.64	0.06

Note: The distance between the EUT and the phantom bottom is 15mm

Table 14.1-8: SAR Values (WCDMA 1900 MHz Band – Hotspot)

Ambient Temperature: 22.9 °C						Liquid Temperature: 22.5°C				
Frequency		Test Position	Figure No.	Conduct ed Power (dBm)	Max. tune-up Power (dBm)	Measured SAR(10g) (W/kg)	Reported SAR(10g) (W/kg)	Measured SAR(1g) (W/kg)	Reported SAR(1g) (W/kg)	Power Drift (dB)
Ch.	MHz									
9400	1880	Front	/	20.00	21.50	0.185	0.26	0.327	0.46	0.13
9538	1907.6	Rear	/	19.99	21.50	0.263	0.37	0.466	0.66	0.08
9400	1880	Rear	Fig.8	20.00	21.50	0.267	0.38	0.474	0.67	0.02
9262	1852.4	Rear	/	20.03	21.50	0.257	0.36	0.463	0.65	0.02
9400	1880	Left	/	20.00	21.50	0.101	0.14	0.179	0.25	0.04
9400	1880	Right	/	20.00	21.50	0.036	0.05	0.068	0.10	-0.01
9400	1880	Bottom	/	20.00	21.50	0.172	0.24	0.339	0.48	-0.15
9400	1880	Rear	S2	20.00	21.50	0.259	0.37	0.468	0.66	0.03
9400	1880	Rear	B2	20.00	21.50	0.255	0.36	0.456	0.64	0.01

Note: The distance between the EUT and the phantom bottom is 10mm

Table 14.1-9: SAR Values (WCDMA 850 MHz Band - Head)

Ambient Temperature: 22.9 °C						Liquid Temperature: 22.5°C					
Frequency		Side	Test Position	Figure No.	Conduct ed Power (dBm)	Max. tune-up Power (dBm)	Measure d SAR(10g) (W/kg)	Reported SAR(10g) (W/kg)	Measured SAR(1g) (W/kg)	Reporte d SAR(1g) (W/kg)	Power Drift (dB)
Ch.	MHz										
4182	836.4	Left	Cheek	/	23.63	24.00	0.504	0.55	0.736	0.80	0.01
4182	836.4	Left	Tilt	/	23.63	24.00	0.380	0.41	0.648	0.71	0.10
4233	846.6	Right	Cheek	Fig.9	23.44	24.00	0.568	0.65	0.940	1.07	0.07
4182	836.4	Right	Cheek	/	23.63	24.00	0.505	0.55	0.822	0.90	0.05
4132	826.4	Right	Cheek	/	23.47	24.00	0.475	0.54	0.786	0.89	0.02
4182	836.4	Right	Tilt	/	23.63	24.00	0.372	0.41	0.598	0.65	-0.04
4233	846.6	Right	Cheek	S2	23.44	24.00	0.556	0.63	0.929	1.06	0.01
4233	846.6	Right	Cheek	B2	23.44	24.00	0.549	0.62	0.911	1.04	0.04

Table 14.1-10: SAR Values (WCDMA 850 MHz Band – Body Worn)

Frequency		Test Position	Figure No.	Conducted Power (dBm)	Max. tune-up Power (dBm)	Ambient Temperature: 22.9 °C		Liquid Temperature: 22.5 °C		Power Drift (dB)
Ch.	MHz					Measured SAR(10g) (W/kg)	Reported SAR(10g) (W/kg)	Measured SAR(1g) (W/kg)	Reported SAR(1g) (W/kg)	
4182	836.4	Front	/	23.63	24.00	0.107	0.12	0.140	0.15	0.16
4233	846.6	Rear	Fig.10	23.44	24.00	0.154	0.18	0.202	0.23	0.06
4182	836.4	Rear	/	23.63	24.00	0.124	0.14	0.189	0.21	-0.15
4132	826.4	Rear	/	23.47	24.00	0.106	0.12	0.162	0.18	-0.05
4233	846.6	Rear	S2	23.44	24.00	0.151	0.17	0.199	0.23	-0.04
4233	846.6	Rear	B2	23.44	24.00	0.148	0.17	0.189	0.22	0.07

Note: The distance between the EUT and the phantom bottom is 15mm.

Table 14.1-11: SAR Values (WCDMA 850 MHz Band - Body)

Frequency		Test Position	Figure No.	Conducted Power (dBm)	Max. tune-up Power (dBm)	Ambient Temperature: 22.9 °C		Liquid Temperature: 22.5 °C		Power Drift (dB)
Ch.	MHz					Measured SAR(10g) (W/kg)	Reported SAR(10g) (W/kg)	Measured SAR(1g) (W/kg)	Reported SAR(1g) (W/kg)	
4182	836.4	Front	/	20.21	21.00	0.064	0.08	0.102	0.12	-0.18
4233	846.6	Rear	Fig.11	20.05	21.00	0.092	0.11	0.150	0.19	-0.13
4182	836.4	Rear	/	20.21	21.00	0.088	0.11	0.144	0.17	0.05
4132	826.4	Rear	/	19.97	21.00	0.074	0.09	0.120	0.15	0.18
4182	836.4	Left	/	20.21	21.00	0.033	0.04	0.049	0.06	-0.01
4182	836.4	Right	/	20.21	21.00	0.060	0.07	0.091	0.11	0.01
4182	836.4	Bottom	/	20.21	21.00	0.073	0.09	0.139	0.17	0.19
4233	846.6	Rear	S2	20.05	21.00	0.090	0.11	0.146	0.18	0.12
4233	846.6	Rear	B2	20.05	21.00	0.089	0.11	0.141	0.18	-0.15

Note: The distance between the EUT and the phantom bottom is 10mm.

Table 14.1-12: SAR Values (LTE Band5 - Head)

Frequency		Ambient Temperature: 22.9 °C					Liquid Temperature: 22.5 °C					
Ch.	MHz	Mode	Side	Test Position	Figure No.	Conducted Power (dBm)	Max. tune-up Power (dBm)	Measured SAR(10g) (W/kg)	Reported SAR(10g) (W/kg)	Measured SAR(1g) (W/kg)	Reported SAR(1g) (W/kg)	Power Drift (dB)
20600	844	1RB_Mid	Left	Cheek	Fig.12	23.91	24.50	0.484	0.55	0.677	0.78	-0.02
20600	844	1RB_Mid	Left	Tilt	/	23.91	24.50	0.420	0.48	0.675	0.77	-0.01
20600	844	1RB_Mid	Right	Cheek	/	23.91	24.50	0.419	0.48	0.559	0.64	0.16
20600	844	1RB_Mid	Right	Tilt	/	23.91	24.50	0.284	0.33	0.420	0.48	-0.15
20525	836.5	25RB-Low	Left	Cheek	/	22.49	23.50	0.378	0.48	0.520	0.66	0.16
20525	836.5	25RB-Low	Left	Tilt	/	22.49	23.50	0.295	0.37	0.479	0.60	-0.18
20525	836.5	25RB-Low	Right	Cheek	/	22.49	23.50	0.388	0.49	0.557	0.70	-0.16
20525	836.5	25RB-Low	Right	Tilt	/	22.49	23.50	0.326	0.41	0.496	0.63	0.15
20600	844	1RB_Mid	Left	Cheek	S2	23.91	24.50	0.460	0.53	0.635	0.73	0.08
20600	844	1RB_Mid	Left	Cheek	B2	23.91	24.50	0.456	0.52	0.617	0.71	0.01

Note1: The LTE mode is QPSK_10MHz.

Table 14.1-13: SAR Values (LTE Band5 - Body)

Frequency		Ambient Temperature: 22.9 °C					Liquid Temperature: 22.5 °C				
Ch.	MHz	Mode	Figure No.	Conducted Power (dBm)	Max. tune-up Power (dBm)	Measured SAR(10g) (W/kg)	Reported SAR(10g) (W/kg)	Measured SAR(1g) (W/kg)	Reported SAR(1g) (W/kg)	Power Drift (dB)	
20600	844	1RB-Mid Front	/	23.91	24.50	0.123	0.14	0.203	0.23	0.07	
20600	844	1RB-Mid Rear	Fig.13	23.91	24.50	0.172	0.20	0.281	0.32	-0.08	
20600	844	1RB-Mid Left	/	23.91	24.50	0.055	0.06	0.084	0.10	0.01	
20600	844	1RB-Mid Right	/	23.91	24.50	0.108	0.12	0.162	0.19	-0.05	
20600	844	1RB-Mid Top	/	23.91	24.50	0.130	0.15	0.245	0.28	-0.17	
20525	836.5	25RB-Low Front	/	22.49	23.50	0.101	0.13	0.162	0.20	0.08	
20525	836.5	25RB-Low Rear	/	22.49	23.50	0.136	0.17	0.218	0.28	-0.03	
20525	836.5	25RB-Low Left	/	22.49	23.50	0.057	0.07	0.091	0.11	0.05	
20525	836.5	25RB-Low Right	/	22.49	23.50	0.101	0.13	0.153	0.19	0.15	
20525	836.5	25RB-Low Bottom	/	22.49	23.50	0.096	0.12	0.179	0.23	-0.01	
20600	844	1RB-Mid Rear	S2	23.91	24.50	0.168	0.19	0.269	0.31	-0.08	
20600	844	1RB-Mid Rear	B2	23.91	24.50	0.155	0.18	0.258	0.30	0.12	

Note: The distance between the EUT and the phantom bottom is 10mm. The LTE mode is QPSK_10MHz.

Table 14.1-14: SAR Values (LTE Band7 - Head)

Frequency		Mode	Side	Test Position	Figure No.	Conducted Power (dBm)	Max. tune-up Power (dBm)	Measured SAR(10g) (W/kg)	Reported SAR(10g) (W/kg)	Measured SAR(1g) (W/kg)	Reported SAR(1g) (W/kg)	Power Drift (dB)
Ch.	MHz											
21100	2535	1RB-Mid	Left	Cheek	/	23.94	24.00	0.013	0.01	0.028	0.03	0.10
21100	2535	1RB-Mid	Left	Tilt	/	23.94	24.00	<0.01	<0.01	<0.01	<0.01	/
21100	2535	1RB-Mid	Right	Cheek	Fig.14	23.94	24.00	0.031	0.03	0.060	0.06	-0.01
21100	2535	1RB-Mid	Right	Tilt	/	23.94	24.00	<0.01	<0.01	<0.01	<0.01	/
21100	2535	50RB-Mid	Left	Cheek	/	22.61	23.00	0.011	0.01	0.022	0.02	-0.11
21100	2535	50RB-Mid	Left	Tilt	/	22.61	23.00	<0.01	<0.01	<0.01	<0.01	/
21100	2535	50RB-Mid	Right	Cheek	/	22.61	23.00	0.023	0.03	0.043	0.05	-0.02
21100	2535	50RB-Mid	Right	Tilt	/	22.61	23.00	<0.01	<0.01	<0.01	<0.01	/
21100	2535	1RB-Mid	Right	Cheek	S2	23.94	24.00	0.028	0.03	0.053	0.05	-0.01
21100	2535	1RB-Mid	Right	Cheek	B2	23.94	24.00	0.022	0.02	0.049	0.05	0.06

Note1: The LTE mode is QPSK_20MHz.

Table 14.1-15: SAR Values (LTE Band7 –Body)

Ambient Temperature: 22.9 °C Liquid Temperature: 22.5 °C

Frequency		Mode	Figure No.	Conducted Power (dBm)	Max. tune-up Power (dBm)	Measured SAR(10g) (W/kg)	Reported SAR(10g) (W/kg)	Measured SAR(1g) (W/kg)	Reported SAR(1g) (W/kg)	Power Drift (dB)
Ch.	MHz									
21350	2560	1RB-High Front	/	20.64	21.00	0.193	0.21	0.401	0.44	0.12
21350	2560	1RB-High Rear	/	20.64	21.00	0.348	0.38	0.774	0.84	0.19
21100	2535	1RB-Mid Rear	/	20.54	21.00	0.304	0.34	0.700	0.78	-0.05
20850	2510	1RB-Mid Rear	/	20.36	21.00	0.250	0.29	0.575	0.67	0.05
21350	2560	100RB-High Rear	/	20.45	21.00	0.324	0.37	0.725	0.82	0.13
21350	2560	1RB-High Left	/	20.64	21.00	0.044	0.05	0.078	0.08	-0.14
21350	2560	1RB-High Right	/	20.64	21.00	0.057	0.06	0.097	0.11	-0.05
21350	2560	1RB-High Bottom	Fig.15	20.64	21.00	0.447	0.49	1.07	1.16	-0.11
21100	2535	1RB-Mid Bottom	/	20.54	21.00	0.348	0.39	0.837	0.93	-0.03
20850	2510	1RB-Mid Bottom	/	20.36	21.00	0.285	0.33	0.686	0.79	-0.03
21350	2560	100RB Bottom	/	20.45	21.00	0.409	0.46	0.978	1.11	0.16
21100	2535	50RB-Mid Front	/	20.30	21.00	0.151	0.18	0.338	0.40	0.15
21100	2535	50RB-Mid Rear	/	20.41	21.00	0.316	0.36	0.692	0.79	-0.11
21100	2535	50RB-Mid Left	/	20.30	21.00	0.037	0.04	0.066	0.08	-0.12
21100	2535	50RB-Mid Right	/	20.30	21.00	0.048	0.06	0.079	0.09	-0.17
21350	2560	50RB-Mid Bottom	/	20.38	21.00	0.418	0.48	0.989	1.14	-0.08
21100	2535	50RB-Mid Bottom	/	20.30	21.00	0.361	0.42	0.882	1.04	0.05
20850	2510	50RB-Mid Bottom	/	19.98	21.00	0.287	0.36	0.693	0.88	0.19
21350	2560	1RB-High Bottom	S2	20.64	21.00	0.434	0.47	1.02	1.11	-0.11
21350	2560	1RB-High Bottom	B2	20.64	21.00	0.421	0.46	1.00	1.08	0.08

Note: The distance between the EUT and the phantom bottom is 10mm. The LTE mode is QPSK_20MHz.

Table 14.1-16: SAR Values (LTE Band41 - Head)

Ambient Temperature: 22.9 °C						Liquid Temperature: 22.5°C						
Frequency		Mode	Side	Test Position	Figure No.	Conducted Power (dBm)	Max. tune-up Power (dBm)	Measured SAR(10g) (W/kg)	Reported SAR(10g) (W/kg)	Measured SAR(1g) (W/kg)	Reported SAR(1g) (W/kg)	Power Drift (dB)
Ch.	MHz											
40725	2603.5	1RB-Mid	Left	Cheek	/	23.30	24.00	0.012	0.01	0.032	0.04	0.14
40725	2603.5	1RB-Mid	Left	Tilt	/	23.30	24.00	<0.01	<0.01	<0.01	<0.01	/
40725	2603.5	1RB-Mid	Right	Cheek	Fig.16	23.30	24.00	0.029	0.03	0.059	0.07	0.00
40725	2603.5	1RB-Mid	Right	Tilt	/	23.30	24.00	<0.01	<0.01	<0.01	<0.01	/
40455	2576.5	50RB-High	Left	Cheek	/	21.88	23.00	0.008	0.01	0.025	0.03	0.19
40455	2576.5	50RB-High	Left	Tilt	/	21.88	23.00	<0.01	<0.01	<0.01	<0.01	/
40455	2576.5	50RB-High	Right	Cheek	/	21.88	23.00	0.019	0.02	0.039	0.05	-0.05
40455	2576.5	50RB-High	Right	Tilt	/	21.88	23.00	<0.01	<0.01	<0.01	<0.01	/
40725	2603.5	1RB-Mid	Right	Cheek	S2	23.30	24.00	0.022	0.03	0.052	0.06	0.00
40725	2603.5	1RB-Mid	Right	Cheek	B2	23.30	24.00	0.018	0.02	0.045	0.05	0.13

Note1: The LTE mode is QPSK_20MHz.

Table 14.1-17: SAR Values (LTE Band41 - Body)

Frequency		Mode	Figure No.	Ambient Temperature: 22.9 °C		Liquid Temperature: 22.5 °C		Measured SAR(1g) (W/kg)	Reported SAR(1g) (W/kg)	Power Drift (dB)
Ch.	MHz			Conducted Power (dBm)	Max. tune-up Power (dBm)	Measured SAR(10g) (W/kg)	Reported SAR(10g) (W/kg)			
40725	2603.5	1RB-Mid Front	/	22.27	23.00	0.148	0.18	0.323	0.38	-0.07
40725	2603.5	1RB-Mid Rear	/	22.27	23.00	0.261	0.31	0.588	0.70	-0.01
40725	2603.5	1RB-Mid Left	/	22.27	23.00	0.034	0.04	0.060	0.07	0.04
40725	2603.5	1RB-Mid Right	/	22.27	23.00	0.032	0.04	0.067	0.08	0.01
40990	2630	1RB-Mid Bottom	/	21.83	23.00	0.379	0.50	0.877	1.15	0.12
40725	2603.5	1RB-Mid Bottom	/	22.27	23.00	0.387	0.46	0.909	1.08	-0.16
40455	2576.5	1RB-Mid Bottom	/	22.01	23.00	0.377	0.47	0.876	1.10	-0.16
40190	2550	1RB-Mid Bottom	/	21.74	23.00	0.324	0.43	0.755	1.01	-0.08
40990	2630	50RB-Low Front	/	21.98	23.00	0.141	0.18	0.287	0.36	-0.10
40455	2576.5	50RB-Low Rear	/	22.00	23.00	0.269	0.34	0.597	0.75	-0.01
40990	2630	50RB-Mid Rear	/	21.89	23.00	0.273	0.35	0.612	0.79	-0.12
40190	2550	50RB-Mid Rear	/	21.86	23.00	0.237	0.31	0.522	0.68	0.10
40725	2603.5	50RB-Mid Rear	/	21.77	23.00	0.288	0.38	0.638	0.85	0.02
40725	2603.5	100RB Rear	/	21.83	23.00	0.278	0.36	0.621	0.81	0.16
40455	2576.5	50RB-Low Left	/	22.00	23.00	0.031	0.04	0.054	0.07	-0.15
40455	2576.5	50RB-Low Right	/	22.00	23.00	0.044	0.06	0.075	0.09	-0.16
40990	2630	50RB-Mid Bottom	Fig.17	21.98	23.00	0.390	0.49	0.941	1.19	-0.01
40725	2603.5	50RB-Mid Bottom	/	21.88	23.00	0.374	0.48	0.911	1.18	-0.17
40455	2576.5	50RB-Low Bottom	/	22.00	23.00	0.376	0.47	0.885	1.11	-0.12
40190	2550	50RB-Mid Bottom	/	21.86	23.00	0.314	0.41	0.762	0.99	-0.12
40990	2630	100RB Bottom	/	21.94	23.00	0.373	0.48	0.913	1.17	0.09
40990	2630	50RB-Mid Bottom	S2	21.98	23.00	0.376	0.48	0.932	1.18	0.04
40990	2630	50RB-Mid Bottom	B2	21.98	23.00	0.367	0.46	0.928	1.17	0.09

Note: The distance between the EUT and the phantom bottom is 10mm. The LTE mode is QPSK_20MHz.

14.2 SAR results for Standard procedure

There is zoom scan measurement to be added for the highest measured SAR in each exposure configuration/band.

Table 14.2-1: SAR Values (GSM 850 MHz Band - Head)

Frequency		Side	Test Position	Figure No.	Conducted Power (dBm)	Max. tune-up Power (dBm)	Measured SAR(10g) (W/kg)	Reported SAR(10g) (W/kg)	Measured SAR(1g) (W/kg)	Reported SAR(1g) (W/kg)	Power Drift (dB)
Ch.	MHz										
128	824.2	Right	Cheek	Fig.1	32.64	33.30	0.061	0.07	0.079	0.09	0.03

Table 14.2-2: SAR Values (GSM 850 MHz Band - Body)

Frequency		Mode (number of timeslots)	Test Position	Figure No.	Conducted Power (dBm)	Max. tune-up Power (dBm)	Measured SAR(10g) (W/kg)	Reported SAR(10g) (W/kg)	Measured SAR(1g) (W/kg)	Reported SAR(1g) (W/kg)	Power Drift (dB)
Ch.	MHz										
128	824.2	GPRS (1)	Rear	Fig.2	32.56	33.30	0.065	0.08	0.101	0.12	-0.01

Note: The distance between the EUT and the phantom bottom is 10mm.

Table 14.2-3: SAR Values (GSM 1900 MHz Band - Head)

Frequency		Side	Test Position	Figure No.	Conducted Power (dBm)	Max. tune-up Power (dBm)	Measured SAR(10g) (W/kg)	Reported SAR(10g) (W/kg)	Measured SAR(1g) (W/kg)	Reported SAR(1g) (W/kg)	Power Drift (dB)
Ch.	MHz										
512	1850.2	Left	Cheek	Fig.3	29.38	30.30	0.077	0.10	0.117	0.14	0.15

Table 14.2-4: SAR Values (GSM 1900 MHz Band – Body Worn)

Frequency		Mode (number of timeslots)	Test Position	Figure No.	Conducted Power (dBm)	Max. tune-up Power (dBm)	Measured SAR(10g) (W/kg)	Reported SAR(10g) (W/kg)	Measured SAR(1g) (W/kg)	Reported SAR(1g) (W/kg)	Power Drift (dB)
Ch.	MHz										
810	1909.8	GPRS (1)	Rear	Fig.4	29.34	30.30	0.087	0.11	0.134	0.17	0.03

Note: The distance between the EUT and the phantom bottom is 15mm

Table 14.2-5: SAR Values (GSM 1900 MHz Band – Hotspot)

Frequency		Mode (number of timeslots)	Test Position	Figure No.	Conducted Power (dBm)	Max. tune-up Power (dBm)	Measured SAR(10g) (W/kg)	Reported SAR(10g) (W/kg)	Measured SAR(1g) (W/kg)	Reported SAR(1g) (W/kg)	Power Drift (dB)
Ch.	MHz										
810	1909.8	GPRS (1)	Rear	Fig.5	25.50	27.30	0.107	0.16	0.189	0.29	-0.02

Note: The distance between the EUT and the phantom bottom is 10mm

Table 14.2-6: SAR Values (WCDMA 1900 MHz Band - Head)

Frequency		Side	Test Position	Figure No.	Conducted Power (dBm)	Max. tune-up Power (dBm)	Measured SAR(10g) (W/kg)	Reported SAR(10g) (W/kg)	Measured SAR(1g) (W/kg)	Reported SAR(1g) (W/kg)	Power Drift (dB)
Ch.	MHz										
9400	1880	Left	Cheek	Fig.6	23.15	24.00	0.194	0.24	0.308	0.37	-0.02

Table 14.2-7: SAR Values (WCDMA 1900 MHz Band – Body Worn)

Frequency		Test Position	Figure No.	Conducted Power (dBm)	Max. tune-up Power (dBm)	Measured SAR(10g) (W/kg)	Reported SAR(10g) (W/kg)	Measured SAR(1g) (W/kg)	Reported SAR(1g) (W/kg)	Power Drift (dB)
Ch.	MHz									
9538	1907.6	Rear	Fig.7	23.18	24.00	0.309	0.37	0.535	0.65	0.02

Note: The distance between the EUT and the phantom bottom is 15mm

Table 14.2-8: SAR Values (WCDMA 1900 MHz Band – Hotspot)

Frequency		Test Position	Figure No.	Conducted Power (dBm)	Max. tune-up Power (dBm)	Measured SAR(10g) (W/kg)	Reported SAR(10g) (W/kg)	Measured SAR(1g) (W/kg)	Reported SAR(1g) (W/kg)	Power Drift (dB)
Ch.	MHz									
9400	1880	Rear	Fig.8	20.00	21.50	0.267	0.38	0.474	0.67	0.02

Note: The distance between the EUT and the phantom bottom is 10mm

Table 14.2-9: SAR Values (WCDMA 850 MHz Band - Head)

Frequency		Side	Test Position	Figure No.	Conducted Power (dBm)	Max. tune-up Power (dBm)	Measured SAR(10g) (W/kg)	Reported SAR(10g) (W/kg)	Measured SAR(1g) (W/kg)	Reported SAR(1g) (W/kg)	Power Drift (dB)
Ch.	MHz										
4233	846.6	Right	Cheek	Fig.9	23.44	24.00	0.568	0.65	0.940	1.07	0.07

Table 14.2-10: SAR Values (WCDMA 850 MHz Band – Body Worn)

Frequency		Test Position	Figure No.	Conducted Power (dBm)	Max. tune-up Power (dBm)	Measured SAR(10g) (W/kg)	Reported SAR(10g) (W/kg)	Measured SAR(1g) (W/kg)	Reported SAR(1g) (W/kg)	Power Drift (dB)
Ch.	MHz									
4233	846.6	Rear	Fig.10	23.44	24.00	0.154	0.18	0.202	0.23	0.06

Note: The distance between the EUT and the phantom bottom is 15mm.

Table 14.2-11: SAR Values (WCDMA 850 MHz Band - Body)

Ambient Temperature: 22.9 °C						Liquid Temperature: 22.5°C				
Frequency		Test Position	Figure No.	Conducted Power (dBm)	Max. tune-up Power (dBm)	Measured SAR(10g) (W/kg)	Reported SAR(10g) (W/kg)	Measured SAR(1g) (W/kg)	Reported SAR(1g) (W/kg)	Power Drift (dB)
Ch.	MHz									
4233	846.6	Rear	Fig.11	20.05	21.00	0.092	0.11	0.150	0.19	-0.13

Note: The distance between the EUT and the phantom bottom is 10mm.

Table 14.2-12: SAR Values (LTE Band5 - Head)

Ambient Temperature: 22.9 °C						Liquid Temperature: 22.5°C						
Frequency		Mode	Side	Test Position	Figure No.	Conducted Power (dBm)	Max. tune-up Power (dBm)	Measured SAR(10g) (W/kg)	Reported SAR(10g) (W/kg)	Measured SAR(1g) (W/kg)	Reported SAR(1g) (W/kg)	Power Drift (dB)
Ch.	MHz											
20600	844	1RB_Mid	Left	Cheek	Fig.12	23.91	24.50	0.484	0.55	0.677	0.78	-0.02

Note1: The LTE mode is QPSK_10MHz.

Table 14.2-13: SAR Values (LTE Band5 - Body)

Ambient Temperature: 22.9 °C						Liquid Temperature: 22.5°C					
Frequency		Mode	Figure No.	Conducted Power (dBm)	Max. tune-up Power (dBm)	Measured SAR(10g) (W/kg)	Reported SAR(10g) (W/kg)	Measured SAR(1g) (W/kg)	Reported SAR(1g) (W/kg)	Power Drift (dB)	
Ch.	MHz										
20600	844	1RB-Mid Rear	Fig.13	23.91	24.50	0.172	0.20	0.281	0.32	-0.08	

Note: The distance between the EUT and the phantom bottom is 10mm. The LTE mode is QPSK_10MHz.

Table 14.2-14: SAR Values (LTE Band7 - Head)

Ambient Temperature: 22.9 °C						Liquid Temperature: 22.5°C						
Frequency		Mode	Side	Test Position	Figure No.	Conducted Power (dBm)	Max. tune-up Power (dBm)	Measured SAR(10g) (W/kg)	Reported SAR(10g) (W/kg)	Measured SAR(1g) (W/kg)	Reported SAR(1g) (W/kg)	Power Drift (dB)
Ch.	MHz											
21100	2535	1RB-Mid	Right	Cheek	Fig.14	23.94	24.00	0.031	0.03	0.060	0.06	-0.01

Note1: The LTE mode is QPSK_20MHz.

Table 14.2-15: SAR Values (LTE Band7 -Body)

Ambient Temperature: 22.9 °C						Liquid Temperature: 22.5°C					
Frequency		Mode	Figure No.	Conducted Power (dBm)	Max. tune-up Power (dBm)	Measured SAR(10g) (W/kg)	Reported SAR(10g) (W/kg)	Measured SAR(1g) (W/kg)	Reported SAR(1g) (W/kg)	Power Drift (dB)	
Ch.	MHz										
21350	2560	1RB-High Bottom	Fig.15	20.64	21.00	0.447	0.49	1.07	1.16	-0.11	

Note: The distance between the EUT and the phantom bottom is 10mm. The LTE mode is QPSK_20MHz.

Table 14.2-16: SAR Values (LTE Band41 - Head)

Frequency		Mode	Side	Test Position	Figure No.	Conducted Power (dBm)	Max. tune-up Power (dBm)	Measured SAR(10g) (W/kg)	Reported SAR(10g) (W/kg)	Measured SAR(1g) (W/kg)	Reported SAR(1g) (W/kg)	Power Drift (dB)
Ch.	MHz											
40725	2603.5	1RB-Mid	Right	Cheek	Fig.16	23.30	24.00	0.029	0.03	0.059	0.07	0.00

Note1: The LTE mode is QPSK_20MHz.

Table 14.2-17: SAR Values (LTE Band41 - Body)

Frequency		Mode	Figure No.	Conducted Power (dBm)	Max. tune-up Power (dBm)	Measured SAR(10g) (W/kg)	Reported SAR(10g) (W/kg)	Measured SAR(1g) (W/kg)	Reported SAR(1g) (W/kg)	Power Drift (dB)
Ch.	MHz									
40990	2630	50RB-Mid Bottom	Fig.17	21.98	23.00	0.390	0.49	0.941	1.19	-0.01

Note: The distance between the EUT and the phantom bottom is 10mm. The LTE mode is QPSK_20MHz.

14.3 WLAN Evaluation for 2.4G

According to the KDB248227 D01, SAR is measured for 2.4GHz 802.11b DSSS using the initial test position procedure.

Head Evaluation

Table 14.3-1: SAR Values (WLAN - Head)– 802.11b (Fast SAR)

Frequency		Side	Test Position	Figure No./ Note	Conducted Power (dBm)	Max. tune-up Power (dBm)	Measured SAR(10g) (W/kg)	Reported SAR(10g)(W/kg)	Measured SAR(1g) (W/kg)	Reported SAR(1g)(W/kg)	Power Drift (dB)
Ch.	MHz										
		Ambient Temperature: 22.9 °C				Liquid Temperature: 22.5°C					
11	2462	Left	Cheek	/	16.29	17.00	0.089	0.10	0.160	0.19	-0.12
11	2462	Left	Tilt	/	16.29	17.00	0.108	0.13	0.226	0.27	-0.12
11	2462	Right	Cheek	/	16.29	17.00	0.168	0.20	0.349	0.41	-0.09
11	2462	Right	Tilt	/	16.29	17.00	0.136	0.16	0.288	0.34	-0.16
11	2462	Right	Cheek	S2	16.29	17.00	0.158	0.19	0.333	0.39	0.08
11	2462	Right	Cheek	B2	16.29	17.00	0.155	0.18	0.328	0.39	0.14

As shown above table, the initial test position for head is “Right Cheek”. So the head SAR of WLAN is presented as below:

Table 14.3-2: SAR Values (WLAN - Head)– 802.11b (Full SAR)

Frequency		Side	Test Position	Figure No./ Note	Conducted Power (dBm)	Max. tune-up Power (dBm)	Measured SAR(10g) (W/kg)	Reported SAR(10g) (W/kg)	Measured SAR(1g) (W/kg)	Reported SAR(1g)(W/kg)	Power Drift (dB)
Ch.	MHz										
		Ambient Temperature: 22.9 °C				Liquid Temperature: 22.5°C					
11	2462	Right	Cheek	Fig.18	16.29	17.00	0.170	0.20	0.353	0.42	-0.09
11	2462	Right	Tilt	/	16.29	17.00	0.139	0.16	0.290	0.34	-0.16

Note1: When the reported SAR of the initial test position is > 0.4 W/kg, SAR is repeated for the 802.11 transmission mode configuration tested in the initial test position using subsequent highest estimated 1-g SAR conditions determined by area scans, on the highest maximum output power channel, until the reported SAR is \leq 0.8 W/kg.
 Note2: For all positions/configurations tested using the initial test position and subsequent test positions, when the reported SAR is > 0.8 W/kg, SAR is measured for these test positions/configurations on the subsequent next highest measured output power channel until the reported SAR is \leq 1.2 W/kg or all required channels are tested.

According to the KDB248227 D01, The reported SAR must be scaled to 100% transmission duty factor to determine compliance at the maximum tune-up tolerance limit. The scaled reported SAR is presented as below.

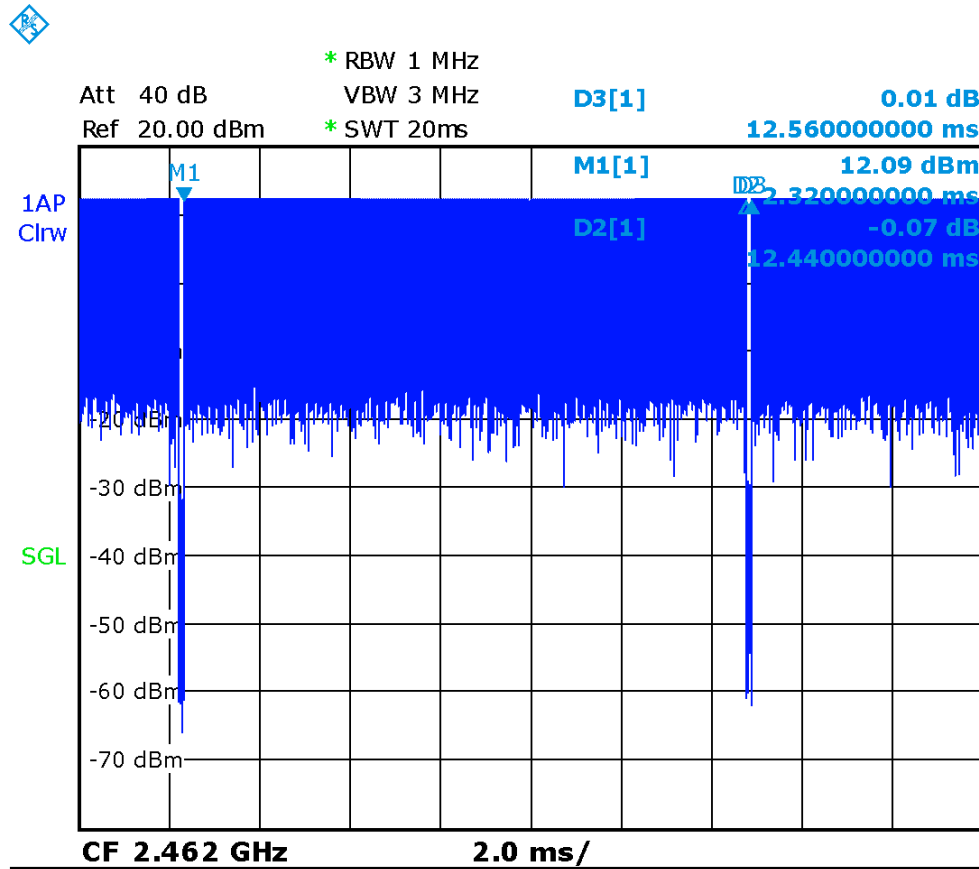

Picture 14.1 Duty factor plot

Table 14.3-3: SAR Values (WLAN - Head) – 802.11b (Scaled Reported SAR)

Frequency		Side	Test Position	Actual duty factor	maximum duty factor	Reported SAR (1g)(W/kg)	Scaled reported SAR (1g)(W/kg)
Ch.	MHz						
11	2462	Right	Cheek	99%	100%	0.42	0.42

SAR is not required for OFDM because the 802.11b adjusted SAR \leq 1.2 W/kg.

Body Evaluation
Table 14.3-4: SAR Values (WLAN - Body)– 802.11b (Fast SAR)

Frequency		Test Position	Figure No./ Note	Conducted Power (dBm)	Max. tune-up Power (dBm)	Measured SAR(10g) (W/kg)	Reported SAR(10g)(W/kg)	Measured SAR(1g) (W/kg)	Reported SAR(1g)(W/kg)	Power Drift (dB)
Ch.	MHz									
Ambient Temperature: 22.9 °C		Liquid Temperature: 22.5 °C								
11	2462	Front	/	18.31	19.00	0.062	0.07	0.107	0.13	0.10
11	2462	Rear	/	18.31	19.00	0.091	0.11	0.174	0.20	0.12
11	2462	Left	/	18.31	19.00	0.057	0.07	0.104	0.12	0.04
11	2462	Top	/	18.31	19.00	0.079	0.09	0.142	0.17	-0.02
11	2462	Rear	S2	18.31	19.00	0.085	0.10	0.164	0.19	0.09
11	2462	Rear	B2	18.31	19.00	0.089	0.10	0.167	0.20	0.16

Note: The distance between the EUT and the phantom bottom is 10mm.

As shown above table, the initial test position for body is “Rear 10mm”. So the body SAR of WLAN is presented as below:

Table 14.3-5: SAR Values (WLAN - Body)– 802.11b (Full SAR)

Frequency		Test Position	Figure No./ Note	Conducted Power (dBm)	Max. tune-up Power (dBm)	Measured SAR(10g) (W/kg)	Reported SAR(10g) (W/kg)	Measured SAR(1g) (W/kg)	Reported SAR(1g)(W/kg)	Power Drift (dB)
Ch.	MHz									
Ambient Temperature: 22.9 °C		Liquid Temperature: 22.5 °C								
11	2462	Right	Fig.19	18.31	19.00	0.094	0.11	0.176	0.21	0.12

Note1: When the reported SAR of the initial test position is > 0.4 W/kg, SAR is repeated for the 802.11 transmission mode configuration tested in the initial test position using subsequent highest estimated 1-g SAR conditions determined by area scans, on the highest maximum output power channel, until the reported SAR is \leq 0.8 W/kg.

Note2: For all positions/configurations tested using the initial test position and subsequent test positions, when the reported SAR is > 0.8 W/kg, SAR is measured for these test positions/configurations on the subsequent next highest measured output power channel until the reported SAR is \leq 1.2 W/kg or all required channels are tested.

According to the KDB248227 D01, The reported SAR must be scaled to 100% transmission duty factor to determine compliance at the maximum tune-up tolerance limit. The scaled reported SAR is presented as below.

Table 14.3-6: SAR Values (WLAN - Body) – 802.11b (Scaled Reported SAR)

Frequency		Test Position	Actual duty factor	maximum duty factor	Reported SAR (1g)(W/kg)	Scaled reported SAR (1g)(W/kg)
Ch.	MHz					
11	2462	Right	99%	100%	0.21	0.21

SAR is not required for OFDM because the 802.11b adjusted SAR ≤ 1.2 W/kg.

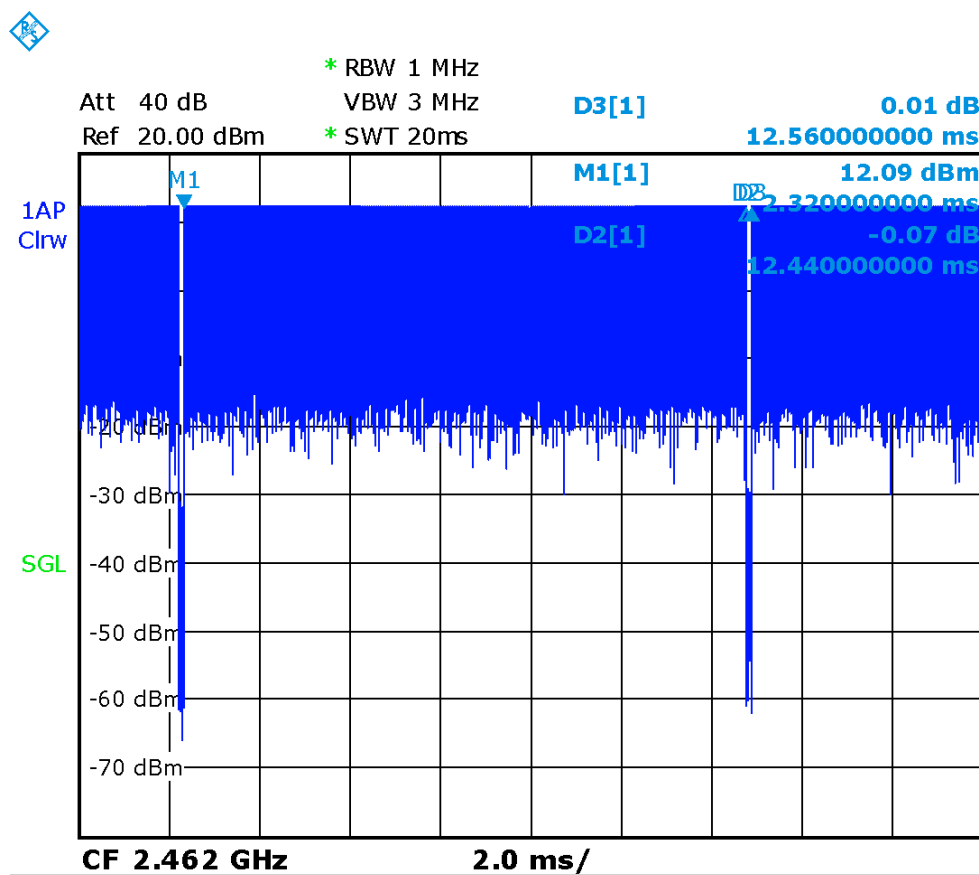

Picture 14.2 Duty factor plot

15 SAR Measurement Variability

SAR measurement variability must be assessed for each frequency band, which is determined by the SAR probe calibration point and tissue-equivalent medium used for the device measurements. When both head and body tissue-equivalent media are required for SAR measurements in a frequency band, the variability measurement procedures should be applied to the tissue medium with the highest measured SAR, using the highest measured SAR configuration for that tissue-equivalent medium.

The following procedures are applied to determine if repeated measurements are required.

- 1) Repeated measurement is not required when the original highest measured SAR is < 0.80 W/kg; steps 2) through 4) do not apply.
- 2) When the original highest measured SAR is ≥ 0.80 W/kg, repeat that measurement once.
- 3) Perform a second repeated measurement only if the ratio of largest to smallest SAR for the original and first repeated measurements is > 1.20 or when the original or repeated measurement is ≥ 1.45 W/kg ($\sim 10\%$ from the 1-g SAR limit).
- 4) Perform a third repeated measurement only if the original, first or second repeated measurement is ≥ 1.5 W/kg and the ratio of largest to smallest SAR for the original, first and second repeated measurements is > 1.20

Table 15.1: SAR Measurement Variability for Head WCDMA850 (1g)

Frequency		Test Position	Original SAR (W/kg)	First Repeated SAR (W/kg)	The Ratio	Second Repeated SAR (W/kg)
Ch.	MHz					
4233	846.6	Right Cheek	0.94	0.935	1.01	/

Table 15.2: SAR Measurement Variability for Body LTE Band7 (1g)

Frequency		Test Position	Spacing (mm)	Original SAR (W/kg)	First Repeated SAR (W/kg)	The Ratio	Second Repeated SAR (W/kg)
Ch.	MHz						
21350	2560	Bottom	10	1.07	1.03	1.04	/

Table 15.3: SAR Measurement Variability for Body LTE Band41(1g)

Frequency		Test Position	Spacing (mm)	Original SAR (W/kg)	First Repeated SAR (W/kg)	The Ratio	Second Repeated SAR (W/kg)
Ch.	MHz						
40990	2630	Bottom	10	0.941	0.933	1.01	/

16 Measurement Uncertainty

16.1 Measurement Uncertainty for Normal SAR Tests (300MHz~3GHz)

No.	Error Description	Type	Uncertainty value	Probably Distribution	Div.	(Ci) 1g	(Ci) 10g	Std. Unc. (1g)	Std. Unc. (10g)	Degree of freedom
Measurement system										
1	Probe calibration	B	6.0	N	1	1	1	6.0	6.0	∞
2	Isotropy	B	4.7	R	$\sqrt{3}$	0.7	0.7	1.9	1.9	∞
3	Boundary effect	B	1.0	R	$\sqrt{3}$	1	1	0.6	0.6	∞
4	Linearity	B	4.7	R	$\sqrt{3}$	1	1	2.7	2.7	∞
5	Detection limit	B	1.0	N	1	1	1	0.6	0.6	∞
6	Readout electronics	B	0.3	R	$\sqrt{3}$	1	1	0.3	0.3	∞
7	Response time	B	0.8	R	$\sqrt{3}$	1	1	0.5	0.5	∞
8	Integration time	B	2.6	R	$\sqrt{3}$	1	1	1.5	1.5	∞
9	RF ambient conditions-noise	B	0	R	$\sqrt{3}$	1	1	0	0	∞
10	RF ambient conditions-reflection	B	0	R	$\sqrt{3}$	1	1	0	0	∞
11	Probe positioned mech. restrictions	B	0.4	R	$\sqrt{3}$	1	1	0.2	0.2	∞
12	Probe positioning with respect to phantom shell	B	2.9	R	$\sqrt{3}$	1	1	1.7	1.7	∞
13	Post-processing	B	1.0	R	$\sqrt{3}$	1	1	0.6	0.6	∞
Test sample related										
14	Test sample positioning	A	3.3	N	1	1	1	3.3	3.3	71
15	Device holder uncertainty	A	3.4	N	1	1	1	3.4	3.4	5
16	Drift of output power	B	5.0	R	$\sqrt{3}$	1	1	2.9	2.9	∞
Phantom and set-up										
17	Phantom uncertainty	B	4.0	R	$\sqrt{3}$	1	1	2.3	2.3	∞
18	Liquid conductivity (target)	B	5.0	R	$\sqrt{3}$	0.64	0.43	1.8	1.2	∞
19	Liquid conductivity (meas.)	A	2.06	N	1	0.64	0.43	1.32	0.89	43
20	Liquid permittivity (target)	B	5.0	R	$\sqrt{3}$	0.6	0.49	1.7	1.4	∞
21	Liquid permittivity (meas.)	A	1.6	N	1	0.6	0.49	1.0	0.8	521

Combined standard uncertainty	$u_c = \sqrt{\sum_{i=1}^{21} c_i^2 u_i^2}$							9.55	9.43	257
Expanded uncertainty (confidence interval of 95 %)	$u_e = 2u_c$							19.1	18.9	

16.2 Measurement Uncertainty for Normal SAR Tests (3~6GHz)

No.	Error Description	Type	Uncertainty value	Probably Distribution	Div.	(Ci) 1g	(Ci) 10g	Std. Unc. (1g)	Std. Unc. (10g)	Degree of freedom
Measurement system										
1	Probe calibration	B	6.55	N	1	1	1	6.55	6.55	∞
2	Isotropy	B	4.7	R	$\sqrt{3}$	0.7	0.7	1.9	1.9	∞
3	Boundary effect	B	2.0	R	$\sqrt{3}$	1	1	1.2	1.2	∞
4	Linearity	B	4.7	R	$\sqrt{3}$	1	1	2.7	2.7	∞
5	Detection limit	B	1.0	R	$\sqrt{3}$	1	1	0.6	0.6	∞
6	Readout electronics	B	0.3	R	$\sqrt{3}$	1	1	0.3	0.3	∞
7	Response time	B	0.8	R	$\sqrt{3}$	1	1	0.5	0.5	∞
8	Integration time	B	2.6	R	$\sqrt{3}$	1	1	1.5	1.5	∞
9	RF ambient conditions-noise	B	0	R	$\sqrt{3}$	1	1	0	0	∞
10	RFambient conditions-reflection	B	0	R	$\sqrt{3}$	1	1	0	0	∞
11	Probe positioned mech. restrictions	B	0.8	R	$\sqrt{3}$	1	1	0.5	0.5	∞
12	Probe positioning with respect to phantom shell	B	6.7	R	$\sqrt{3}$	1	1	3.9	3.9	∞
13	Post-processing	B	4.0	R	$\sqrt{3}$	1	1	2.3	2.3	∞
Test sample related										
14	Test sample positioning	A	3.3	N	1	1	1	3.3	3.3	71
15	Device holder uncertainty	A	3.4	N	1	1	1	3.4	3.4	5
16	Drift of output power	B	5.0	R	$\sqrt{3}$	1	1	2.9	2.9	∞
Phantom and set-up										
17	Phantom uncertainty	B	4.0	R	$\sqrt{3}$	1	1	2.3	2.3	∞
18	Liquid conductivity (target)	B	5.0	R	$\sqrt{3}$	0.64	0.43	1.8	1.2	∞
19	Liquid conductivity (meas.)	A	2.06	N	1	0.64	0.43	1.32	0.89	43
20	Liquid permittivity (target)	B	5.0	R	$\sqrt{3}$	0.6	0.49	1.7	1.4	∞

21	Liquid permittivity (meas.)	A	1.6	N	1	0.6	0.49	1.0	0.8	521
Combined standard uncertainty		$u_c = \sqrt{\sum_{i=1}^{21} c_i^2 u_i^2}$						10.7	10.6	257
Expanded uncertainty (confidence interval of 95 %)		$u_e = 2u_c$						21.4	21.1	

16.3 Measurement Uncertainty for Fast SAR Tests (300MHz~3GHz)

No.	Error Description	Type	Uncertainty value	Probably Distribution	Div.	(Ci) 1g	(Ci) 10g	Std. Unc. (1g)	Std. Unc. (10g)	Degree of freedom
Measurement system										
1	Probe calibration	B	6.0	N	1	1	1	6.0	6.0	∞
2	Isotropy	B	4.7	R	$\sqrt{3}$	0.7	0.7	1.9	1.9	∞
3	Boundary effect	B	1.0	R	$\sqrt{3}$	1	1	0.6	0.6	∞
4	Linearity	B	4.7	R	$\sqrt{3}$	1	1	2.7	2.7	∞
5	Detection limit	B	1.0	R	$\sqrt{3}$	1	1	0.6	0.6	∞
6	Readout electronics	B	0.3	R	$\sqrt{3}$	1	1	0.3	0.3	∞
7	Response time	B	0.8	R	$\sqrt{3}$	1	1	0.5	0.5	∞
8	Integration time	B	2.6	R	$\sqrt{3}$	1	1	1.5	1.5	∞
9	RF ambient conditions-noise	B	0	R	$\sqrt{3}$	1	1	0	0	∞
10	RF ambient conditions-reflection	B	0	R	$\sqrt{3}$	1	1	0	0	∞
11	Probe positioned mech. Restrictions	B	0.4	R	$\sqrt{3}$	1	1	0.2	0.2	∞
12	Probe positioning with respect to phantom shell	B	2.9	R	$\sqrt{3}$	1	1	1.7	1.7	∞
13	Post-processing	B	1.0	R	$\sqrt{3}$	1	1	0.6	0.6	∞
14	Fast SAR z-Approximation	B	7.0	R	$\sqrt{3}$	1	1	4.0	4.0	∞
Test sample related										
15	Test sample positioning	A	3.3	N	1	1	1	3.3	3.3	71
16	Device holder uncertainty	A	3.4	N	1	1	1	3.4	3.4	5
17	Drift of output power	B	5.0	R	$\sqrt{3}$	1	1	2.9	2.9	∞
Phantom and set-up										
18	Phantom uncertainty	B	4.0	R	$\sqrt{3}$	1	1	2.3	2.3	∞
19	Liquid conductivity (target)	B	5.0	R	$\sqrt{3}$	0.64	0.43	1.8	1.2	∞

20	Liquid conductivity (meas.)	A	2.06	N	1	0.64	0.43	1.32	0.89	43
21	Liquid permittivity (target)	B	5.0	R	$\sqrt{3}$	0.6	0.49	1.7	1.4	∞
22	Liquid permittivity (meas.)	A	1.6	N	1	0.6	0.49	1.0	0.8	521
Combined standard uncertainty		$u_c = \sqrt{\sum_{i=1}^{22} c_i^2 u_i^2}$						10.4	10.3	257
Expanded uncertainty (confidence interval of 95 %)		$u_e = 2u_c$						20.8	20.6	

16.4 Measurement Uncertainty for Fast SAR Tests (3~6GHz)

No.	Error Description	Type	Uncertainty value	Probably Distribution	Div.	(Ci) 1g	(Ci) 10g	Std. Unc. (1g)	Std. Unc. (10g)	Degree of freedom
Measurement system										
1	Probe calibration	B	6.55	N	1	1	1	6.55	6.55	∞
2	Isotropy	B	4.7	R	$\sqrt{3}$	0.7	0.7	1.9	1.9	∞
3	Boundary effect	B	2.0	R	$\sqrt{3}$	1	1	1.2	1.2	∞
4	Linearity	B	4.7	R	$\sqrt{3}$	1	1	2.7	2.7	∞
5	Detection limit	B	1.0	R	$\sqrt{3}$	1	1	0.6	0.6	∞
6	Readout electronics	B	0.3	R	$\sqrt{3}$	1	1	0.3	0.3	∞
7	Response time	B	0.8	R	$\sqrt{3}$	1	1	0.5	0.5	∞
8	Integration time	B	2.6	R	$\sqrt{3}$	1	1	1.5	1.5	∞
9	RF ambient conditions-noise	B	0	R	$\sqrt{3}$	1	1	0	0	∞
10	RFambient conditions-reflection	B	0	R	$\sqrt{3}$	1	1	0	0	∞
11	Probe positioned mech. Restrictions	B	0.8	R	$\sqrt{3}$	1	1	0.5	0.5	∞
12	Probe positioning with respect to phantom shell	B	6.7	R	$\sqrt{3}$	1	1	3.9	3.9	∞
13	Post-processing	B	1.0	R	$\sqrt{3}$	1	1	0.6	0.6	∞
14	Fast SAR z-Approximation	B	14.0	R	$\sqrt{3}$	1	1	8.1	8.1	∞
Test sample related										
15	Test sample positioning	A	3.3	N	1	1	1	3.3	3.3	71
16	Device holder uncertainty	A	3.4	N	1	1	1	3.4	3.4	5

17	Drift of output power	B	5.0	R	$\sqrt{3}$	1	1	2.9	2.9	∞
Phantom and set-up										
18	Phantom uncertainty	B	4.0	R	$\sqrt{3}$	1	1	2.3	2.3	∞
19	Liquid conductivity (target)	B	5.0	R	$\sqrt{3}$	0.64	0.43	1.8	1.2	∞
20	Liquid conductivity (meas.)	A	2.06	N	1	0.64	0.43	1.32	0.89	43
21	Liquid permittivity (target)	B	5.0	R	$\sqrt{3}$	0.6	0.49	1.7	1.4	∞
22	Liquid permittivity (meas.)	A	1.6	N	1	0.6	0.49	1.0	0.8	521
Combined standard uncertainty		$u_c = \sqrt{\sum_{i=1}^{22} c_i^2 u_i^2}$						13.5	13.4	257
Expanded uncertainty (confidence interval of 95 %)		$u_e = 2u_c$						27.0	26.8	

17 MAIN TEST INSTRUMENTS

Table 17.1: List of Main Instruments

No.	Name	Type	Serial Number	Calibration Date	Valid Period
01	Network analyzer	N5239A	MY46110673	January 24, 2020	One year
02	Power meter	NRP2	101919	May 12, 2020	One year
03	Power sensor	NRP-Z91	101547		
04	Signal Generator	E4438C	MY49071430	February 25, 2020	One Year
05	Amplifier	60S1G4	0331848	No Calibration Requested	
06	BTS	CMW500	129942	February 10, 2020	One year
07	E-field Probe	SPEAG EX3DV4	3617	Jan 30, 2020	One year
08	DAE	SPEAG DAE4	536	November 6, 2020	One year
10	Dipole Validation Kit	SPEAG D835V2	4d069	July 24,,2020	One year
11	Dipole Validation Kit	SPEAG D1900V2	5d101	July 28,2020	One year
12	Dipole Validation Kit	SPEAG D2450V2	853	July 21,2020	One year
13	Dipole Validation Kit	SPEAG D2600V2	1012	July 21,2020	One year

END OF REPORT BODY

ANNEX A Graph Results

GSM850_CH128 Right Cheek

Date: 1/22/2021

Electronics: DAE4 Sn536

Medium: head 835 MHz

Medium parameters used: $f = 824.2$ MHz; $\sigma = 0.898$ mho/m; $\epsilon_r = 41.27$; $\rho = 1000$ kg/m³

Ambient Temperature: 22.5°C, Liquid Temperature: 22.3°C

Communication System: GSM850 824.2 Duty Cycle: 1:8.3

Probe: EX3DV4 – SN3617 ConvF(9.66,9.66,9.66)

Area Scan (71x121x1): Interpolated grid: dx=1.000 mm, dy=1.000 mm

Maximum value of SAR (interpolated) = 0.0882 W/kg

Zoom Scan (7x7x7)/Cube 0: Measurement grid: dx=5mm, dy=5mm, dz=5mm

Reference Value = 1.883 V/m; Power Drift = 0.03 dB

Peak SAR (extrapolated) = 0.102 W/kg

SAR(1 g) = 0.079 W/kg; SAR(10 g) = 0.061 W/kg

Maximum value of SAR (measured) = 0.0942 W/kg

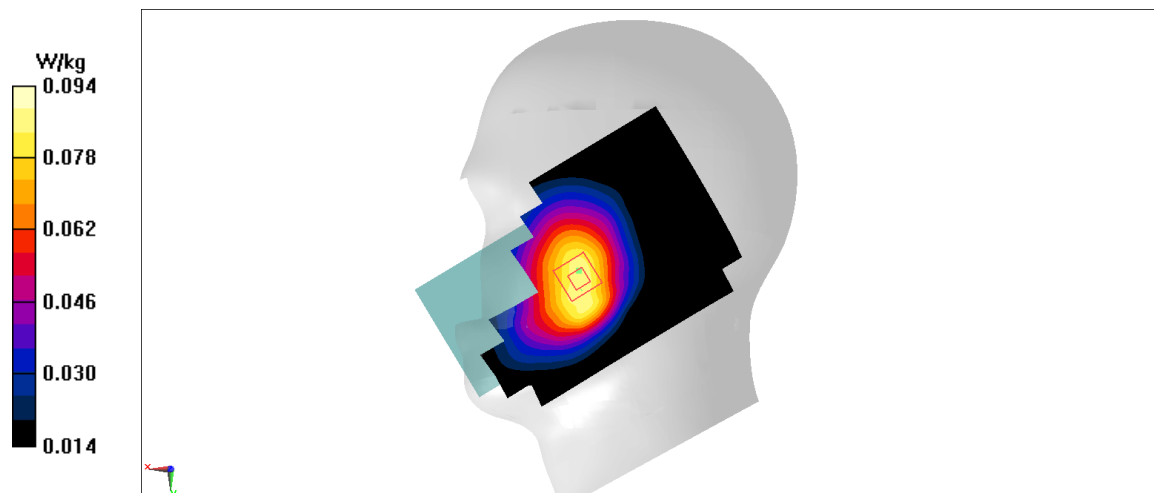

Fig A.1

GSM850_CH128 Rear 10mm

Date: 1/22/2021

Electronics: DAE4 Sn536

Medium: head 835 MHz

Medium parameters used: $f = 824.2$ MHz; $\sigma = 0.898$ mho/m; $\epsilon_r = 41.27$; $\rho = 1000$ kg/m³

Ambient Temperature: 22.5°C, Liquid Temperature: 22.3°C

Communication System: GSM850 824.2 Duty Cycle: 1:8.3

Probe: EX3DV4 – SN3617 ConvF(9.66,9.66,9.66)

Area Scan (71x121x1): Interpolated grid: dx=1.000 mm, dy=1.000 mm

Maximum value of SAR (interpolated) = 0.136 W/kg

Zoom Scan (7x7x7)/Cube 0: Measurement grid: dx=5mm, dy=5mm, dz=5mm

Reference Value = 12.08 V/m; Power Drift = -0.01 dB

Peak SAR (extrapolated) = 0.157 W/kg

SAR(1 g) = 0.101 W/kg; SAR(10 g) = 0.065 W/kg

Maximum value of SAR (measured) = 0.136 W/kg

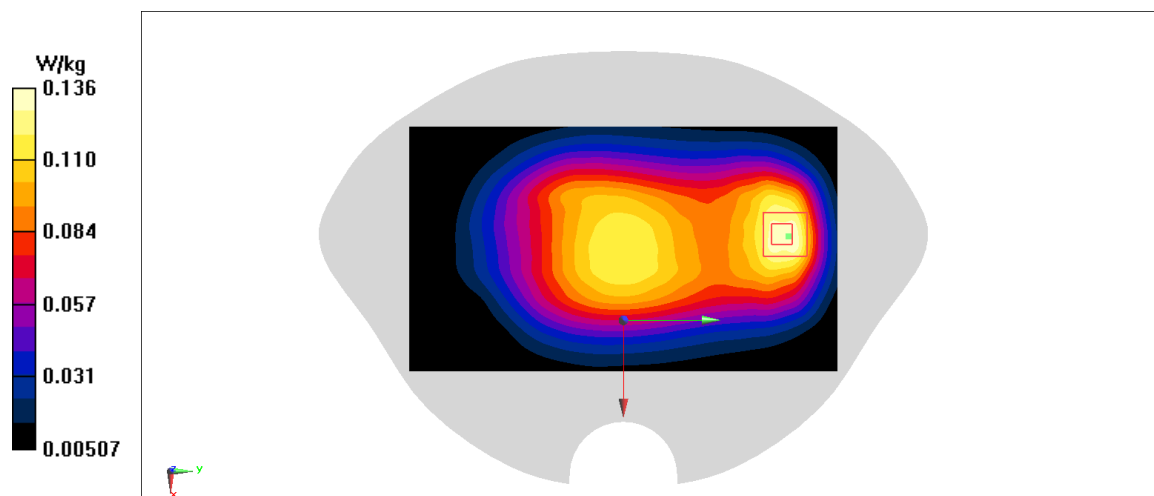

Fig A.2

PCS1900_CH661 Left Cheek

Date: 1/23/2021

Electronics: DAE4 Sn536

Medium: head 1900 MHz

Medium parameters used: $f = 1880$ MHz; $\sigma = 1.382$ mho/m; $\epsilon_r = 40.11$; $\rho = 1000$ kg/m³

Ambient Temperature: 22.5°C, Liquid Temperature: 22.3°C

Communication System: PCS1900 1880 Duty Cycle: 1:8.3

Probe: EX3DV4 – SN3617 ConvF(8.14,8.14,8.14)

Area Scan (71x121x1): Interpolated grid: dx=1.000 mm, dy=1.000 mm

Maximum value of SAR (interpolated) = 0.186 W/kg

Zoom Scan (7x7x7)/Cube 0: Measurement grid: dx=5mm, dy=5mm, dz=5mm

Reference Value = 3.289 V/m; Power Drift = 0.03 dB

Peak SAR (extrapolated) = 0.203 W/kg

SAR(1 g) = 0.134 W/kg; SAR(10 g) = 0.087 W/kg

Maximum value of SAR (measured) = 0.18 W/kg

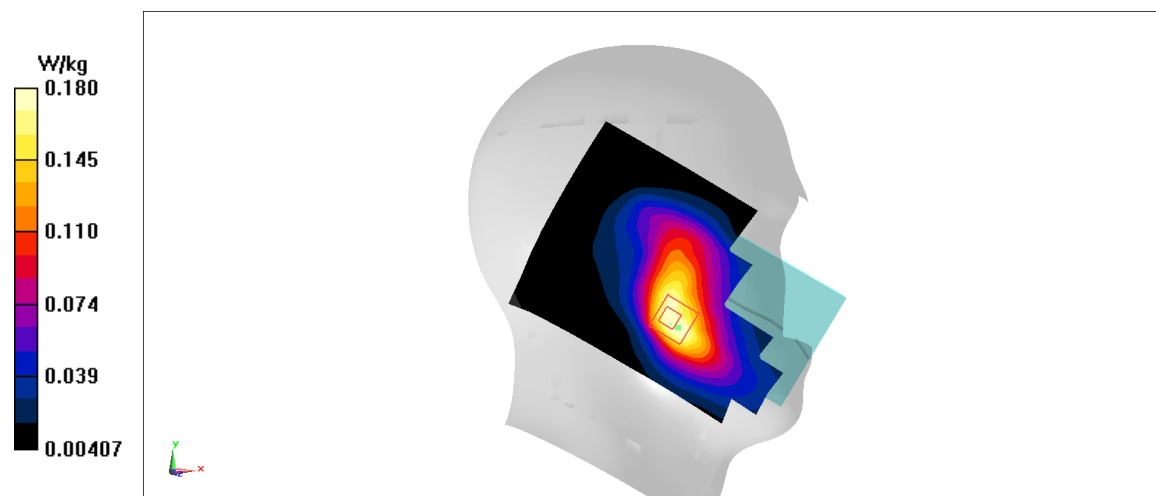

Fig A.3

PCS1900_CH661 Rear 15mm

Date: 1/23/2021

Electronics: DAE4 Sn536

Medium: head 1900 MHz

Medium parameters used: $f = 1880$ MHz; $\sigma = 1.382$ mho/m; $\epsilon_r = 40.11$; $\rho = 1000$ kg/m³

Ambient Temperature: 22.5°C, Liquid Temperature: 22.3°C

Communication System: PCS1900 1880 Duty Cycle: 1:8.3

Probe: EX3DV4 – SN3617 ConvF(8.14,8.14,8.14)

Area Scan (71x121x1): Interpolated grid: dx=1.000 mm, dy=1.000 mm

Maximum value of SAR (interpolated) = 0.341 W/kg

Zoom Scan (7x7x7)/Cube 0: Measurement grid: dx=5mm, dy=5mm, dz=5mm

Reference Value = 6.67 V/m; Power Drift = 0.01 dB

Peak SAR (extrapolated) = 0.404 W/kg

SAR(1 g) = 0.233 W/kg; SAR(10 g) = 0.134 W/kg

Maximum value of SAR (measured) = 0.335 W/kg

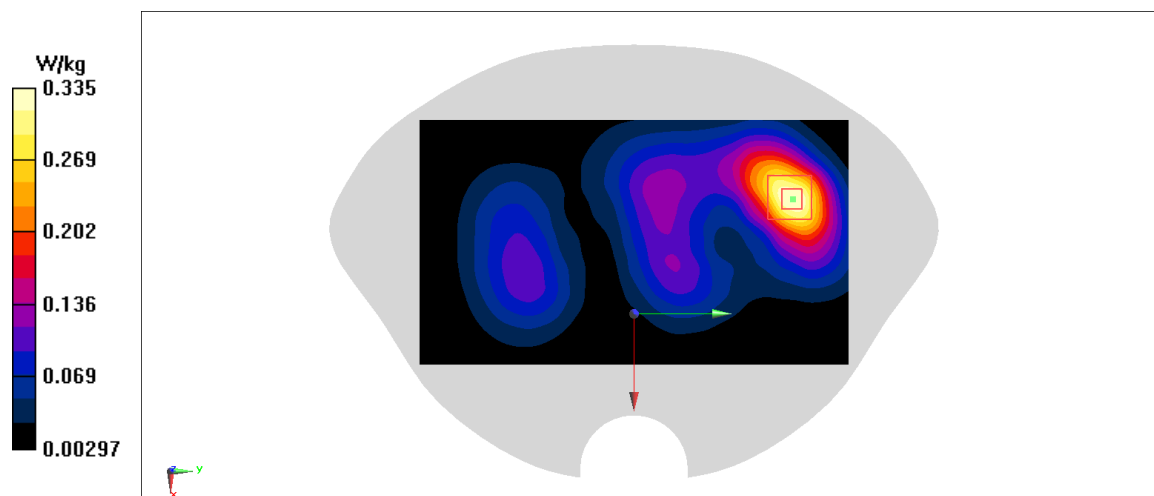

Fig A.4

PCS1900_CH810 Rear 10mm

Date: 1/23/2021

Electronics: DAE4 Sn536

Medium: head 1900 MHz

Medium parameters used: $f = 1909.8$ MHz; $\sigma = 1.41$ mho/m; $\epsilon_r = 40.08$; $\rho = 1000$ kg/m³

Ambient Temperature: 22.5°C, Liquid Temperature: 22.3°C

Communication System: PCS1900 1909.8 MHz Duty Cycle: 1:8.3

Probe: EX3DV4 – SN3617 ConvF(8.14,8.14,8.14)

Area Scan (71x121x1): Interpolated grid: dx=1.000 mm, dy=1.000 mm

Maximum value of SAR (interpolated) = 0.281 W/kg

Zoom Scan (7x7x7)/Cube 0: Measurement grid: dx=5mm, dy=5mm, dz=5mm

Reference Value = 3.534 V/m; Power Drift = -0.02 dB

Peak SAR (extrapolated) = 0.339 W/kg

SAR(1 g) = 0.189 W/kg; SAR(10 g) = 0.107 W/kg

Maximum value of SAR (measured) = 0.281 W/kg

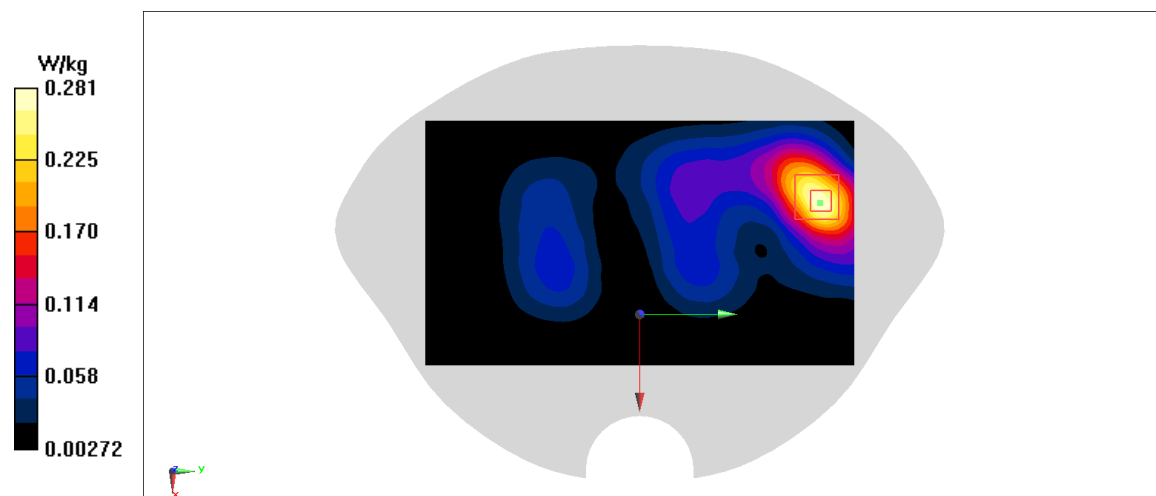

Fig A.5

WCDMA1900-BII_CH9400 Left Cheek

Date: 1/23/2021

Electronics: DAE4 Sn536

Medium: head 1900 MHz

Medium parameters used: $f = 1880$ MHz; $\sigma = 1.382$ mho/m; $\epsilon_r = 40.11$; $\rho = 1000$ kg/m³

Ambient Temperature: 22.5°C, Liquid Temperature: 22.3°C

Communication System: WCDMA1900-BII 1880 Duty Cycle: 1:1

Probe: EX3DV4 – SN3617 ConvF(8.14,8.14,8.14)

Area Scan (71x121x1): Interpolated grid: dx=1.000 mm, dy=1.000 mm

Maximum value of SAR (interpolated) = 0.424 W/kg

Zoom Scan (7x7x7)/Cube 0: Measurement grid: dx=5mm, dy=5mm, dz=5mm

Reference Value = 3.614 V/m; Power Drift = -0.02 dB

Peak SAR (extrapolated) = 0.476 W/kg

SAR(1 g) = 0.308 W/kg; SAR(10 g) = 0.194 W/kg

Maximum value of SAR (measured) = 0.415 W/kg

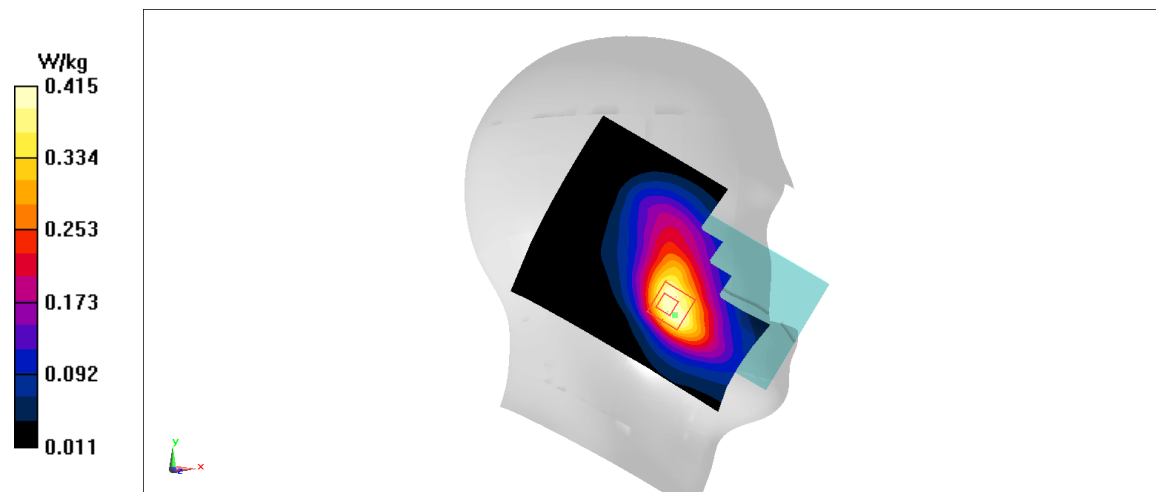

Fig A.6

WCDMA1900-BII_CH9538 Rear 15mm

Date: 1/23/2021

Electronics: DAE4 Sn536

Medium: head 1900 MHz

Medium parameters used: $f = 1907.6$ MHz; $\sigma = 1.409$ mho/m; $\epsilon_r = 40.08$; $\rho = 1000$ kg/m³

Ambient Temperature: 22.5°C, Liquid Temperature: 22.3°C

Communication System: WCDMA1900-BII 1907.6 Duty Cycle: 1:1

Probe: EX3DV4 – SN3617 ConvF(8.14,8.14,8.14)

Area Scan (71x121x1): Interpolated grid: dx=1.000 mm, dy=1.000 mm

Maximum value of SAR (interpolated) = 0.821 W/kg

Zoom Scan (7x7x7)/Cube 0: Measurement grid: dx=5mm, dy=5mm, dz=5mm

Reference Value = 10.21 V/m; Power Drift = 0.02 dB

Peak SAR (extrapolated) = 0.927 W/kg

SAR(1 g) = 0.535 W/kg; SAR(10 g) = 0.309 W/kg

Maximum value of SAR (measured) = 0.777 W/kg

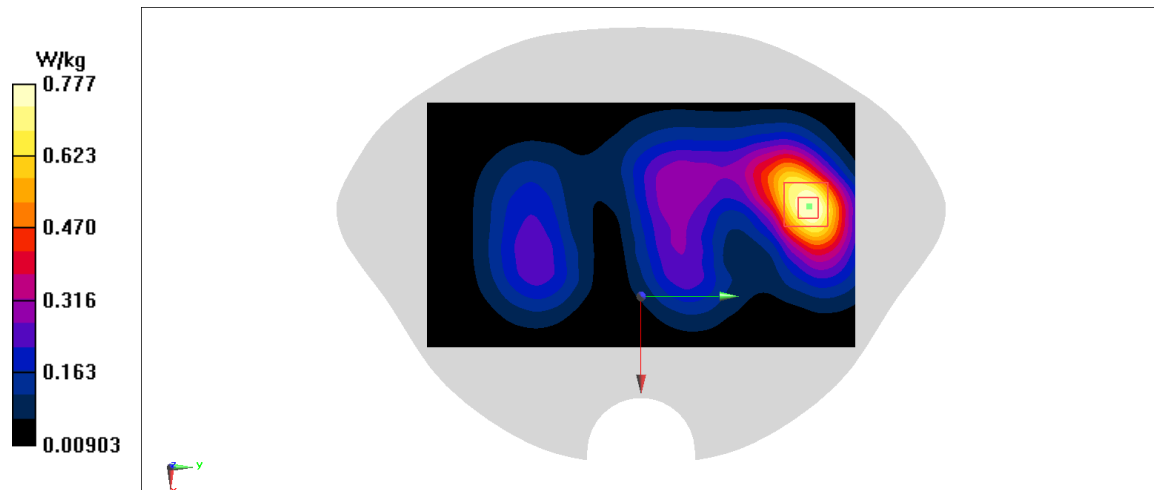
**Fig A.7**

WCDMA1900-BII_CH9400 Rear 10mm

Date: 1/23/2021

Electronics: DAE4 Sn536

Medium: head 1900 MHz

Medium parameters used: $f = 1880$ MHz; $\sigma = 1.382$ mho/m; $\epsilon_r = 40.11$; $\rho = 1000$ kg/m³

Ambient Temperature: 22.5°C, Liquid Temperature: 22.3°C

Communication System: WCDMA1900-BII 1880 MHz Duty Cycle: 1:1

Probe: EX3DV4 – SN3617 ConvF(8.14,8.14,8.14)

Area Scan (71x121x1): Interpolated grid: dx=1.000 mm, dy=1.000 mm

Maximum value of SAR (interpolated) = 0.756 W/kg

Zoom Scan (7x7x7)/Cube 0: Measurement grid: dx=5mm, dy=5mm, dz=5mm

Reference Value = 7.996 V/m; Power Drift = 0.02 dB

Peak SAR (extrapolated) = 0.843 W/kg

SAR(1 g) = 0.474 W/kg; SAR(10 g) = 0.267 W/kg

Maximum value of SAR (measured) = 0.702 W/kg

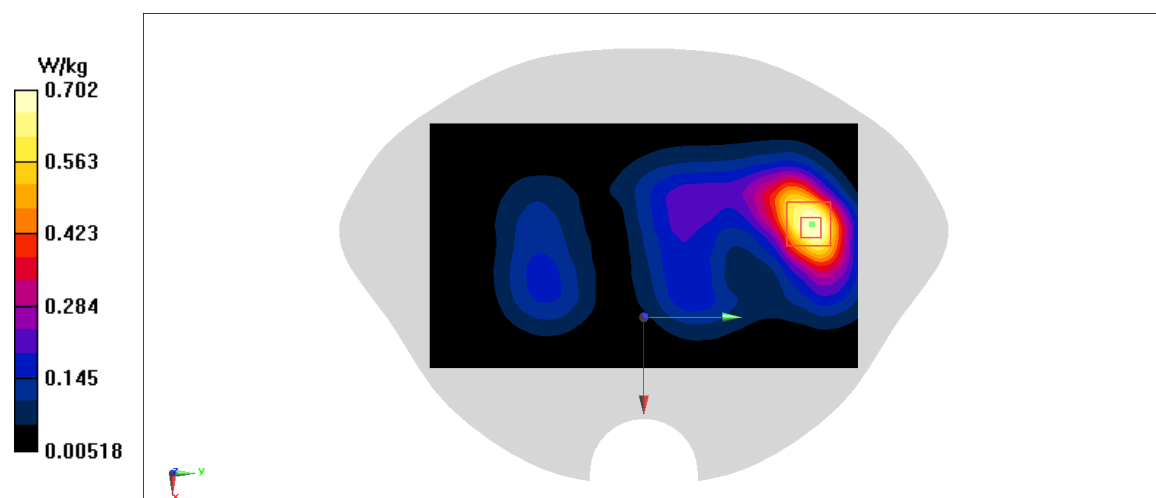

Fig A.8

WCDMA850-BV_CH4233 Right Cheek

Date: 1/22/2021

Electronics: DAE4 Sn536

Medium: head 835 MHz

Medium parameters used: $f = 846.6$ MHz; $\sigma = 0.919$ mho/m; $\epsilon_r = 41.25$; $\rho = 1000$ kg/m³

Ambient Temperature: 22.5°C, Liquid Temperature: 22.3°C

Communication System: WCDMA850-BV 846.6 Duty Cycle: 1:1

Probe: EX3DV4 – SN3617 ConvF(9.66,9.66,9.66)

Area Scan (71x121x1): Interpolated grid: dx=1.000 mm, dy=1.000 mm

Maximum value of SAR (interpolated) = 1.27 W/kg

Zoom Scan (7x7x7)/Cube 0: Measurement grid: dx=5mm, dy=5mm, dz=5mm

Reference Value = 36.7 V/m; Power Drift = 0.07 dB

Peak SAR (extrapolated) = 1.75 W/kg

SAR(1 g) = 0.94 W/kg; SAR(10 g) = 0.568 W/kg

Maximum value of SAR (measured) = 1.39 W/kg

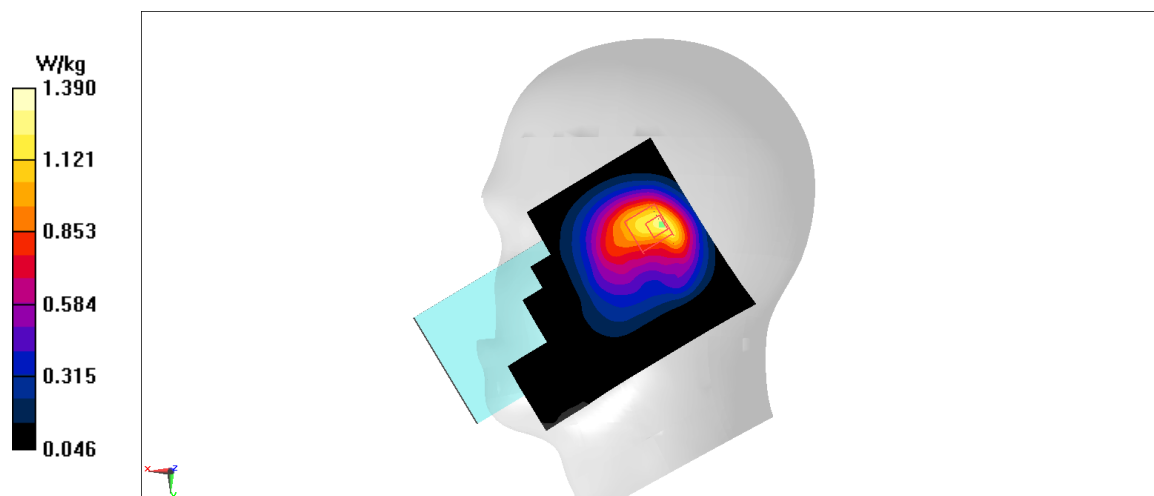
**Fig A.9**

WCDMA850-BV_CH4233 Rear 15mm

Date: 1/22/2021

Electronics: DAE4 Sn536

Medium: head 835 MHz

Medium parameters used: $f = 846.6$ MHz; $\sigma = 0.919$ mho/m; $\epsilon_r = 41.25$; $\rho = 1000$ kg/m³

Ambient Temperature: 22.5°C, Liquid Temperature: 22.3°C

Communication System: WCDMA850-BV 846.6 Duty Cycle: 1:1

Probe: EX3DV4 – SN3617 ConvF(9.66,9.66,9.66)

Area Scan (71x121x1): Interpolated grid: dx=1.000 mm, dy=1.000 mm

Maximum value of SAR (interpolated) = 0.248 W/kg

Zoom Scan (7x7x7)/Cube 0: Measurement grid: dx=5mm, dy=5mm, dz=5mm

Reference Value = 16.82 V/m; Power Drift = 0.06 dB

Peak SAR (extrapolated) = 0.273 W/kg

SAR(1 g) = 0.202 W/kg; SAR(10 g) = 0.154 W/kg

Maximum value of SAR (measured) = 0.247 W/kg

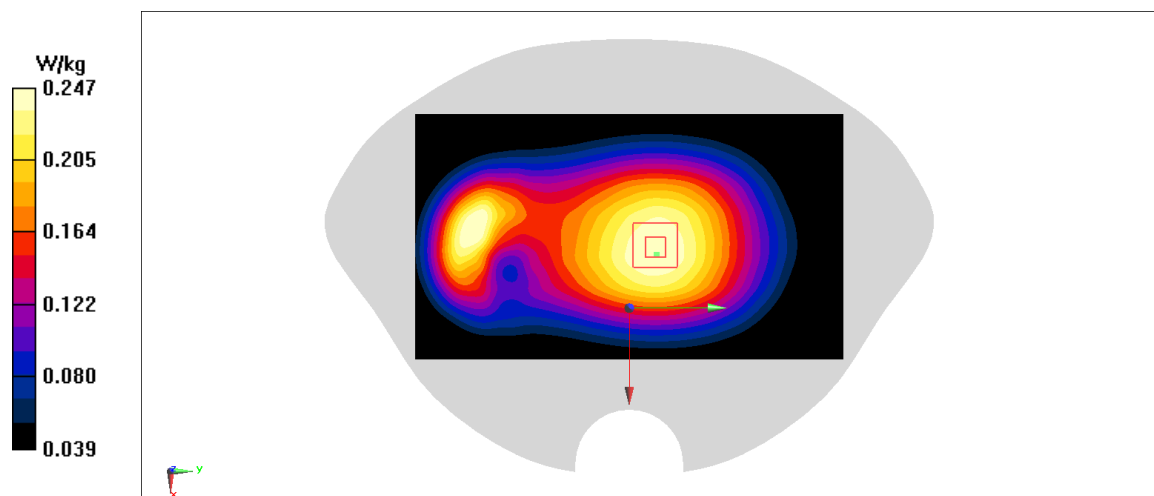

Fig A.10

WCDMA850-BV_CH4233 Rear 10mm

Date: 1/22/2021

Electronics: DAE4 Sn536

Medium: head 835 MHz

Medium parameters used: $f = 846.6$ MHz; $\sigma = 0.919$ mho/m; $\epsilon_r = 41.25$; $\rho = 1000$ kg/m³

Ambient Temperature: 22.5°C, Liquid Temperature: 22.3°C

Communication System: WCDMA850-BV 846.6 MHz Duty Cycle: 1:1

Probe: EX3DV4 – SN3617 ConvF(9.66,9.66,9.66)

Area Scan (71x121x1): Interpolated grid: dx=1.000 mm, dy=1.000 mm

Maximum value of SAR (interpolated) = 0.217 W/kg

Zoom Scan (7x7x7)/Cube 0: Measurement grid: dx=5mm, dy=5mm, dz=5mm

Reference Value = 12.41 V/m; Power Drift = -0.13 dB

Peak SAR (extrapolated) = 0.253 W/kg

SAR(1 g) = 0.15 W/kg; SAR(10 g) = 0.092 W/kg

Maximum value of SAR (measured) = 0.212 W/kg

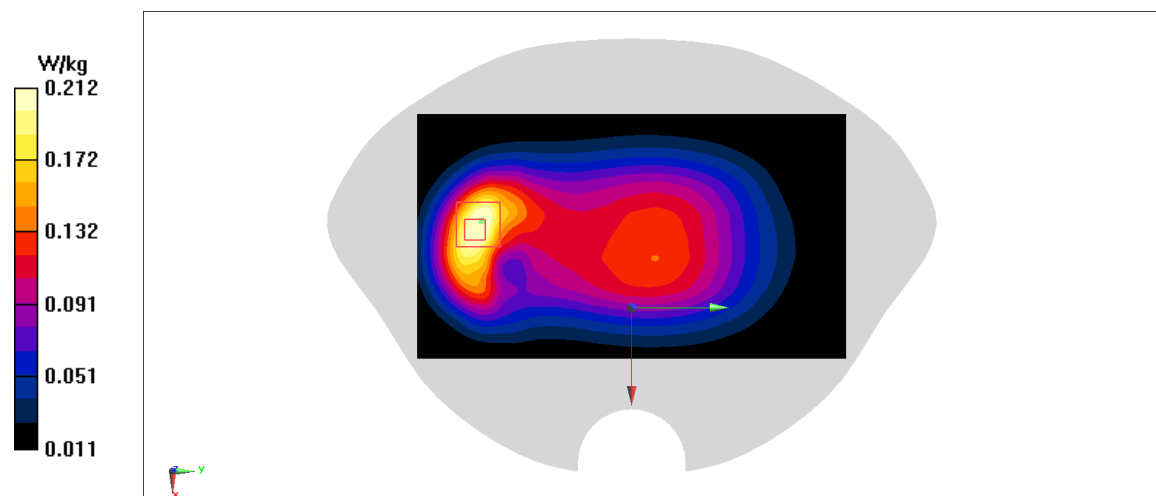

Fig A.11

LTE850-FDD5_CH20600 Left Cheek

Date: 1/22/2021

Electronics: DAE4 Sn536

Medium: head 835 MHz

Medium parameters used: $f = 844 \text{ MHz}$; $\sigma = 0.917 \text{ mho/m}$; $\epsilon_r = 41.25$; $\rho = 1000 \text{ kg/m}^3$ Ambient Temperature: 22.5°C , Liquid Temperature: 22.3°C

Communication System: LTE850-FDD5 844 MHz Duty Cycle: 1:1

Probe: EX3DV4 – SN3617 ConvF(9.66,9.66,9.66)

Area Scan (71x121x1): Interpolated grid: $dx=1.000 \text{ mm}$, $dy=1.000 \text{ mm}$ Maximum value of SAR (interpolated) = 0.959 W/kg **Zoom Scan (7x7x7)/Cube 0:** Measurement grid: $dx=5\text{mm}$, $dy=5\text{mm}$, $dz=5\text{mm}$ Reference Value = 33.38 V/m ; Power Drift = -0.02 dB Peak SAR (extrapolated) = 1.24 W/kg **SAR(1 g) = 0.677 W/kg ; SAR(10 g) = 0.484 W/kg** Maximum value of SAR (measured) = 0.979 W/kg 

Fig A.12

LTE850-FDD5_CH20600 Rear 10mm

Date: 1/22/2021

Electronics: DAE4 Sn536

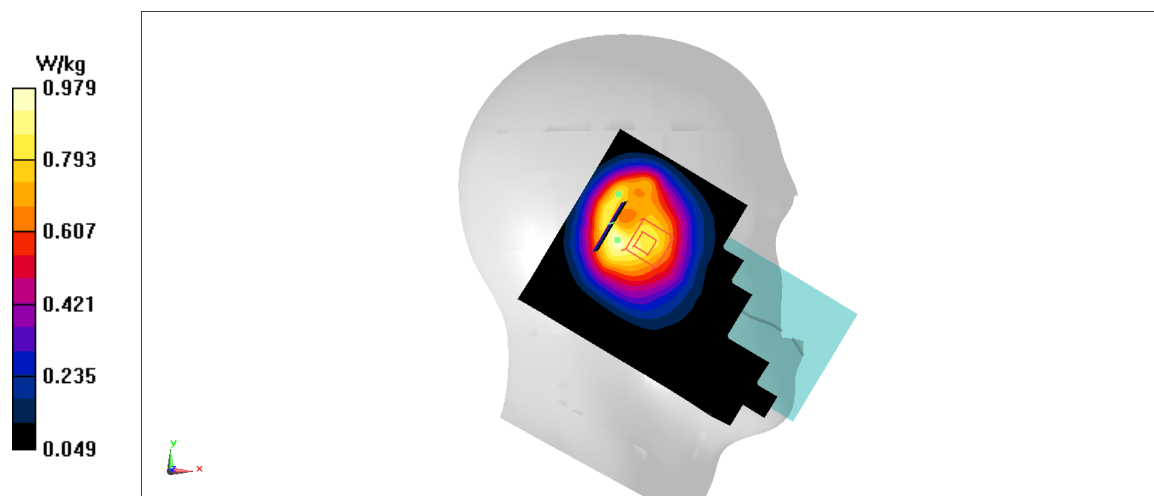
Medium: head 835 MHz

Medium parameters used: $f = 844$ MHz; $\sigma = 0.917$ mho/m; $\epsilon_r = 41.25$; $\rho = 1000$ kg/m³

Ambient Temperature: 22.5°C, Liquid Temperature: 22.3°C

Communication System: LTE850-FDD5 844 MHz Duty Cycle: 1:1

Probe: EX3DV4 – SN3617 ConvF(9.66,9.66,9.66)

Area Scan (71x121x1): Interpolated grid: dx=1.000 mm, dy=1.000 mm

Maximum value of SAR (interpolated) = 0.373 W/kg

Zoom Scan (7x7x7)/Cube 0: Measurement grid: dx=5mm, dy=5mm, dz=5mm

Reference Value = 15.34 V/m; Power Drift = -0.08 dB

Peak SAR (extrapolated) = 0.473 W/kg

SAR(1 g) = 0.281 W/kg; SAR(10 g) = 0.172 W/kg

Maximum value of SAR (measured) = 0.398 W/kg

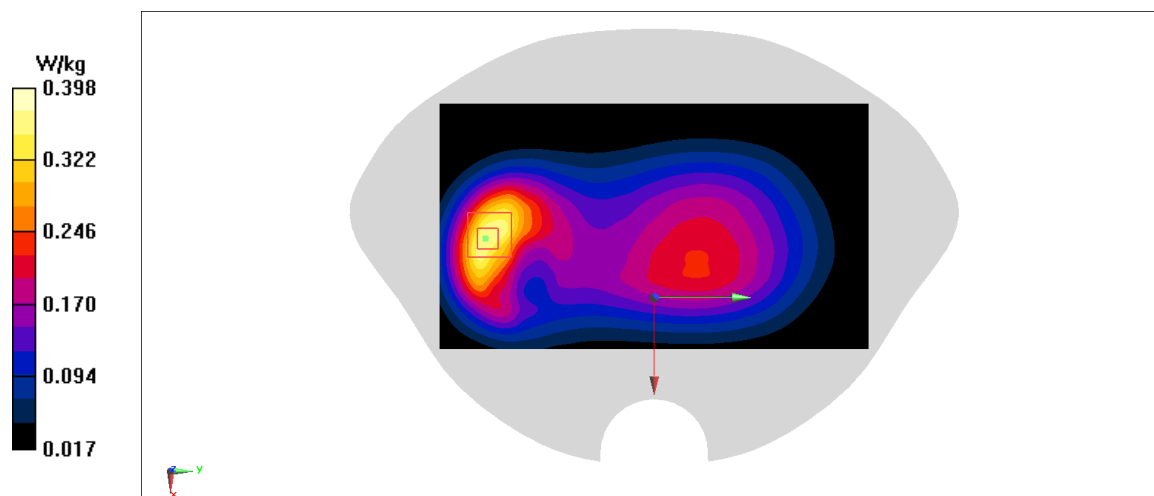

Fig A.13

LTE2500-FDD7_CH21100 Right Cheek

Date: 1/25/2021

Electronics: DAE4 Sn536

Medium: head 2600 MHz

Medium parameters used: $f = 2535$ MHz; $\sigma = 1.884$ mho/m; $\epsilon_r = 38.65$; $\rho = 1000$ kg/m³

Ambient Temperature: 22.5°C, Liquid Temperature: 22.3°C

Communication System: LTE2500-FDD7 2535 MHz Duty Cycle: 1:1

Probe: EX3DV4 – SN3617 ConvF(7.52,7.52,7.52)

Area Scan (71x121x1): Interpolated grid: dx=1.000 mm, dy=1.000 mm

Maximum value of SAR (interpolated) = 0.0933 W/kg

Zoom Scan (7x7x7)/Cube 0: Measurement grid: dx=5mm, dy=5mm, dz=5mm

Reference Value = 0.926 V/m; Power Drift = -0.01 dB

Peak SAR (extrapolated) = 0.114 W/kg

SAR(1 g) = 0.06 W/kg; SAR(10 g) = 0.031 W/kg

Maximum value of SAR (measured) = 0.0932 W/kg

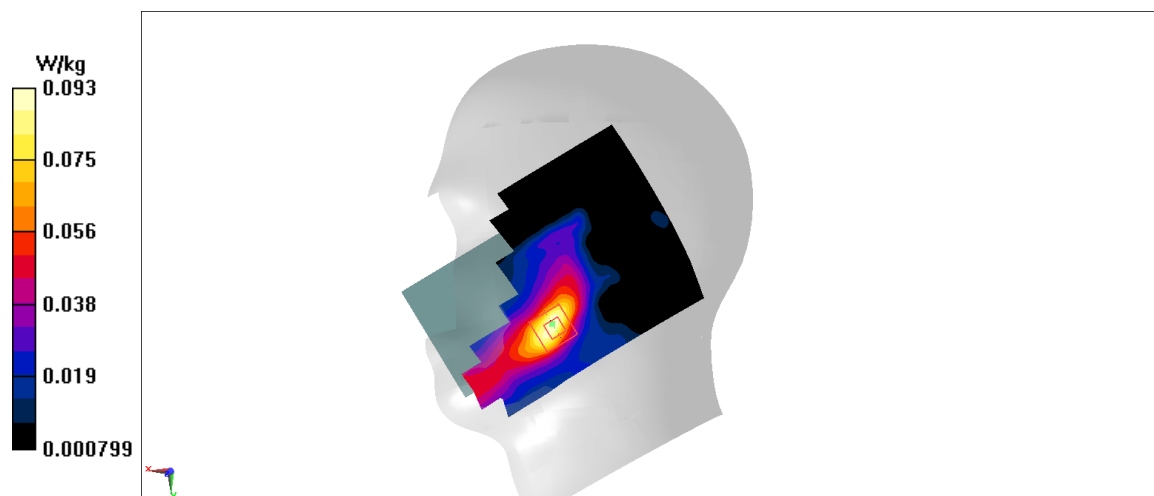

Fig A.14

LTE2500-FDD7_CH21350 Bottom 10mm

Date: 1/25/2021

Electronics: DAE4 Sn536

Medium: head 2600 MHz

Medium parameters used: $f = 2560$ MHz; $\sigma = 1.908$ mho/m; $\epsilon_r = 38.62$; $\rho = 1000$ kg/m³

Ambient Temperature: 22.5°C, Liquid Temperature: 22.3°C

Communication System: LTE2500-FDD7 2560 MHz Duty Cycle: 1:1

Probe: EX3DV4 – SN3617 ConvF(7.65,7.65,7.65)

Area Scan (71x121x1): Interpolated grid: dx=1.000 mm, dy=1.000 mm

Maximum value of SAR (interpolated) = 2 W/kg

Zoom Scan (7x7x7)/Cube 0: Measurement grid: dx=5mm, dy=5mm, dz=5mm

Reference Value = 19.32 V/m; Power Drift = -0.11 dB

Peak SAR (extrapolated) = 2.31 W/kg

SAR(1 g) = 1.07 W/kg; SAR(10 g) = 0.447 W/kg

Maximum value of SAR (measured) = 1.82 W/kg

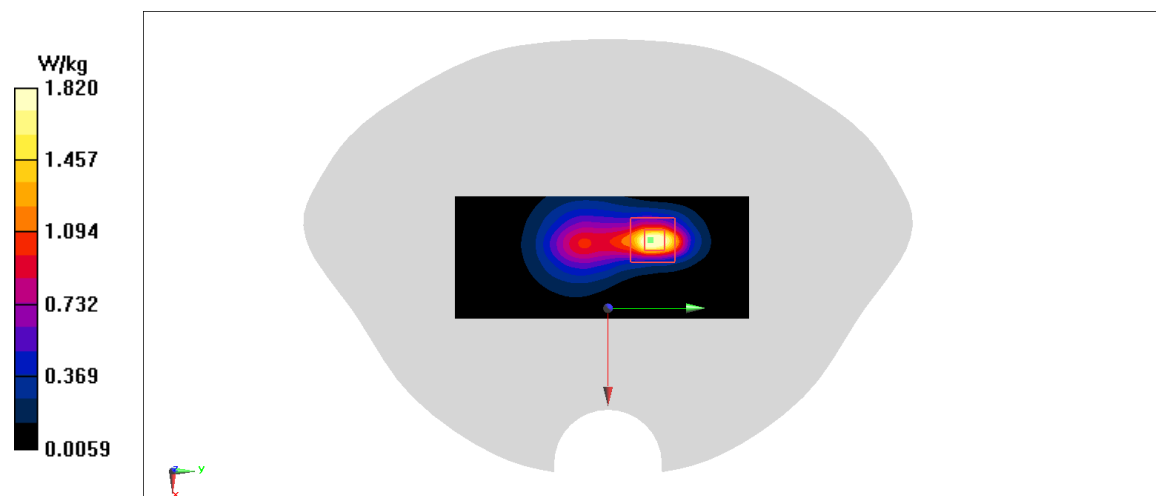

Fig A.15

LTE2500-TDD41_CH40725 Right Cheek

Date: 1/25/2021

Electronics: DAE4 Sn536

Medium: head 2600 MHz

Medium parameters used: $f = 2603.5$ MHz; $\sigma = 2.018$ mho/m; $\epsilon_r = 38.36$; $\rho = 1000$ kg/m³

Ambient Temperature: 22.5°C, Liquid Temperature: 22.3°C

Communication System: LTE2500-TDD41 2603.5 Duty Cycle: 1:1.58

Probe: EX3DV4 – SN3617

Area Scan (71x121x1): Interpolated grid: dx=1.000 mm, dy=1.000 mm

Maximum value of SAR (interpolated) = 0.0924 W/kg

Zoom Scan (7x7x7)/Cube 0: Measurement grid: dx=5mm, dy=5mm, dz=5mm

Reference Value = 0 V/m; Power Drift = 0 dB

Peak SAR (extrapolated) = 0.12 W/kg

SAR(1 g) = 0.059 W/kg; SAR(10 g) = 0.029 W/kg

Maximum value of SAR (measured) = 0.0968 W/kg

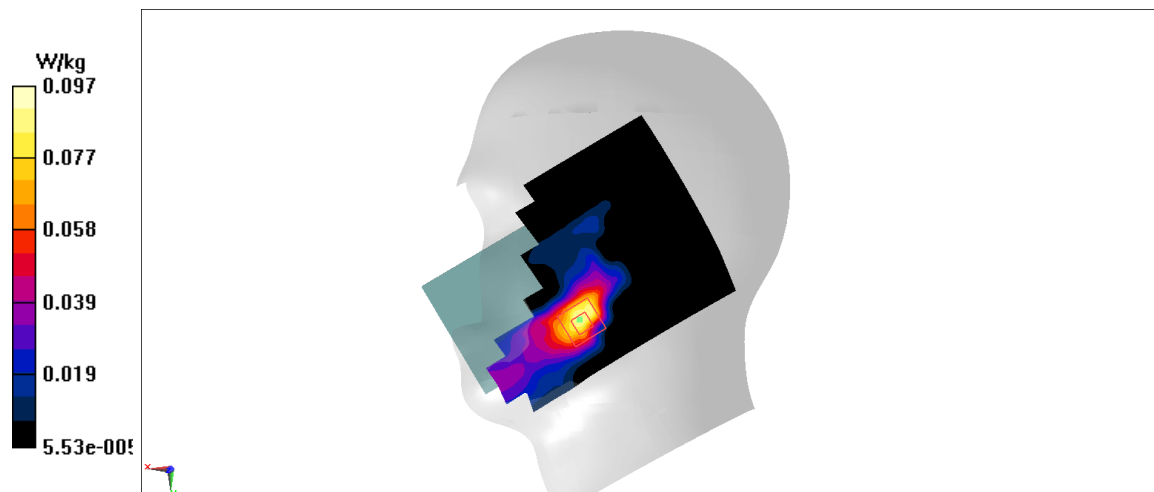

Fig A.16

LTE2500-TDD41_CH40990 Bottom 10mm

Date: 1/25/2021

Electronics: DAE4 Sn536

Medium: head 2600 MHz

Medium parameters used: $f = 2630$ MHz; $\sigma = 2.039$ mho/m; $\epsilon_r = 38.3$; $\rho = 1000$ kg/m³

Ambient Temperature: 22.5°C, Liquid Temperature: 22.3°C

Communication System: LTE2500-TDD41 2630 Duty Cycle: 1:1.58

Probe: EX3DV4 – SN3617

Area Scan (71x121x1): Interpolated grid: dx=1.000 mm, dy=1.000 mm

Maximum value of SAR (interpolated) = 1.71 W/kg

Zoom Scan (7x7x7)/Cube 0: Measurement grid: dx=5mm, dy=5mm, dz=5mm

Reference Value = 17.16 V/m; Power Drift = -0.01 dB

Peak SAR (extrapolated) = 2.05 W/kg

SAR(1 g) = 0.941 W/kg; SAR(10 g) = 0.39 W/kg

Maximum value of SAR (measured) = 1.6 W/kg

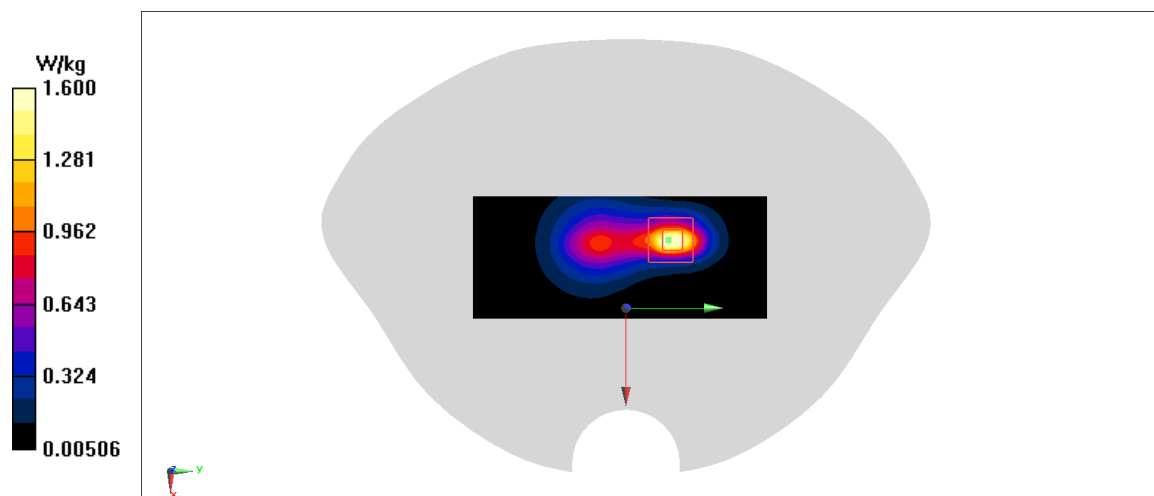

Fig A.17

WLAN2450_CH11 Right Cheek

Date: 1/24/2021

Electronics: DAE4 Sn536

Medium: head 2450 MHz

Medium parameters used: $f = 2462$ MHz; $\sigma = 1.824$ mho/m; $\epsilon_r = 39.78$; $\rho = 1000$ kg/m³

Ambient Temperature: 22.5°C, Liquid Temperature: 22.3°C

Communication System: WLAN2450 2462 Duty Cycle: 1:1

Probe: EX3DV4 – SN3617 ConvF(7.65,7.65,7.65)

Area Scan (71x121x1): Interpolated grid: dx=1.000 mm, dy=1.000 mm

Maximum value of SAR (interpolated) = 0.624 W/kg

Zoom Scan (7x7x7)/Cube 0: Measurement grid: dx=5mm, dy=5mm, dz=5mm

Reference Value = 9.104 V/m; Power Drift = -0.09 dB

Peak SAR (extrapolated) = 0.757 W/kg

SAR(1 g) = 0.353 W/kg; SAR(10 g) = 0.17 W/kg

Maximum value of SAR (measured) = 0.577 W/kg

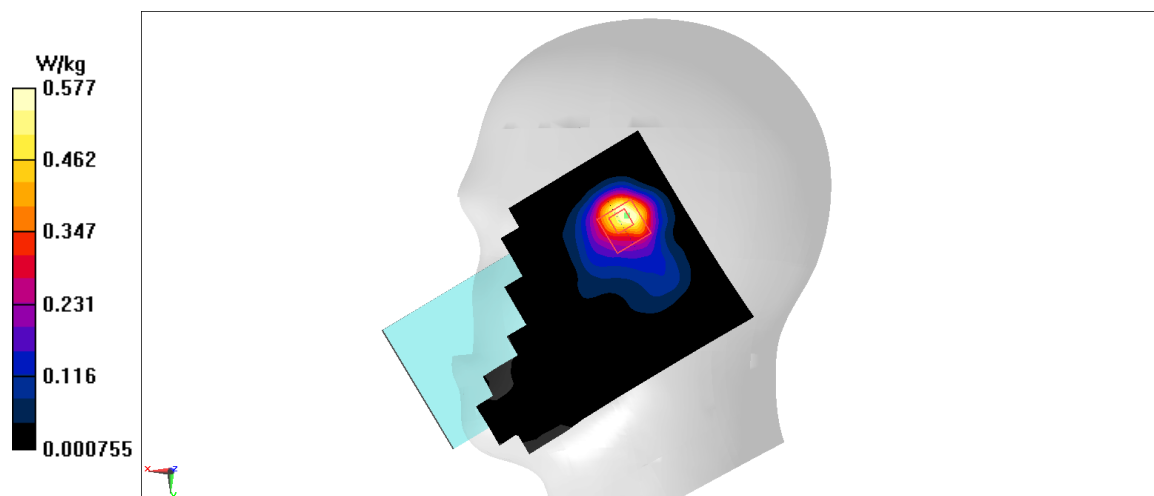

Fig A.18

WLAN2450_CH11 Rear 10mm

Date: 1/24/2021

Electronics: DAE4 Sn536

Medium: head 2450 MHz

Medium parameters used: $f = 2462$ MHz; $\sigma = 1.824$ mho/m; $\epsilon_r = 39.78$; $\rho = 1000$ kg/m³

Ambient Temperature: 22.5°C, Liquid Temperature: 22.3°C

Communication System: WLAN2450 2462 Duty Cycle: 1:1

Probe: EX3DV4 – SN3617 ConvF(7.65,7.65,7.65)

Area Scan (71x121x1): Interpolated grid: dx=1.000 mm, dy=1.000 mm

Maximum value of SAR (interpolated) = 0.302 W/kg

Zoom Scan (7x7x7)/Cube 0: Measurement grid: dx=5mm, dy=5mm, dz=5mm

Reference Value = 2.865 V/m; Power Drift = 0.12 dB

Peak SAR (extrapolated) = 0.376 W/kg

SAR(1 g) = 0.176 W/kg; SAR(10 g) = 0.094 W/kg

Maximum value of SAR (measured) = 0.296 W/kg

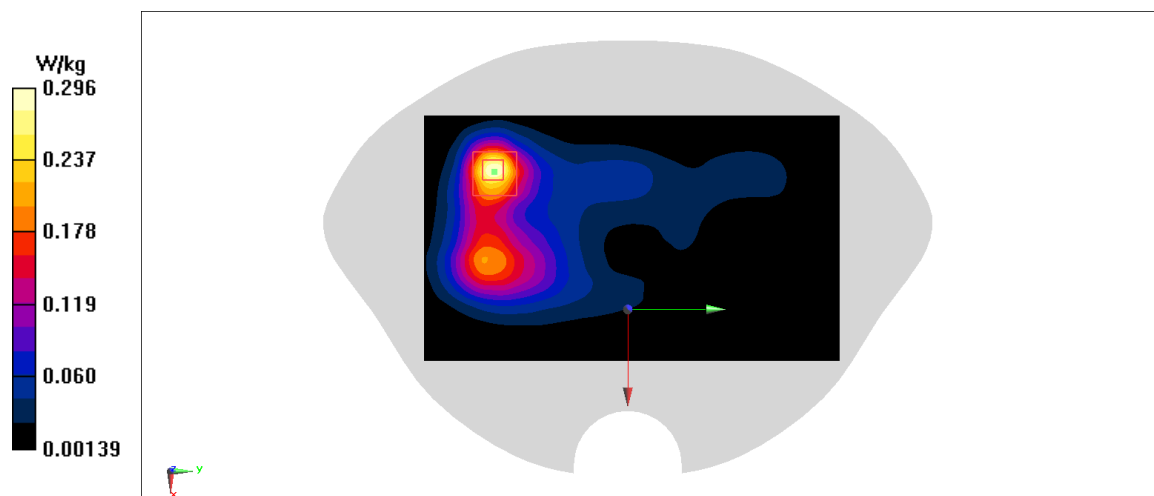
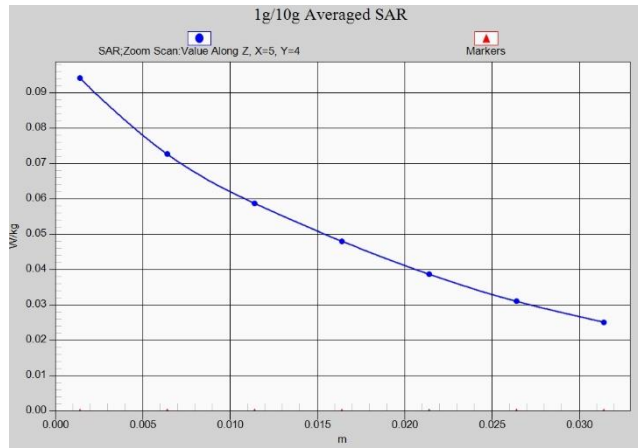
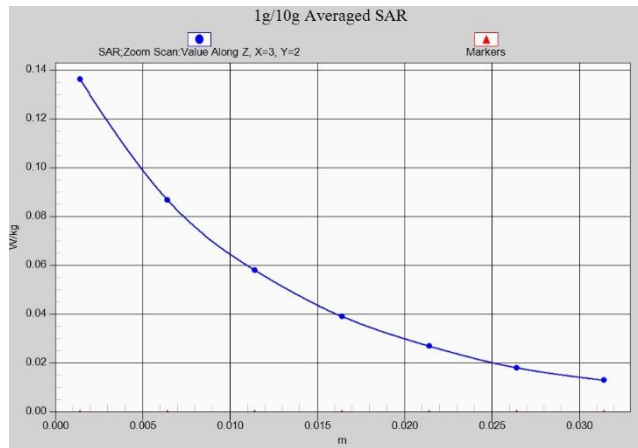

Fig A.19



Z-Scan at power reference point (850 MHz)



Z-Scan at power reference point (850 MHz)

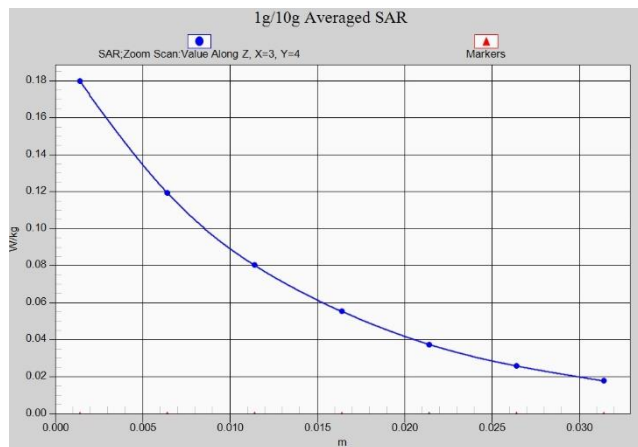

Z-Scan at power reference point (1900 MHz)

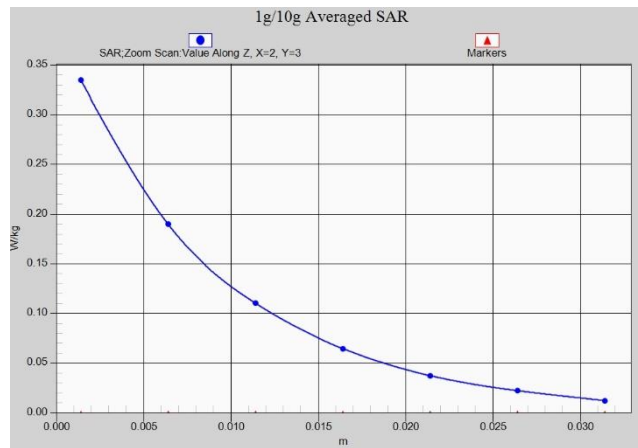

Z-Scan at power reference point (GSM1900)

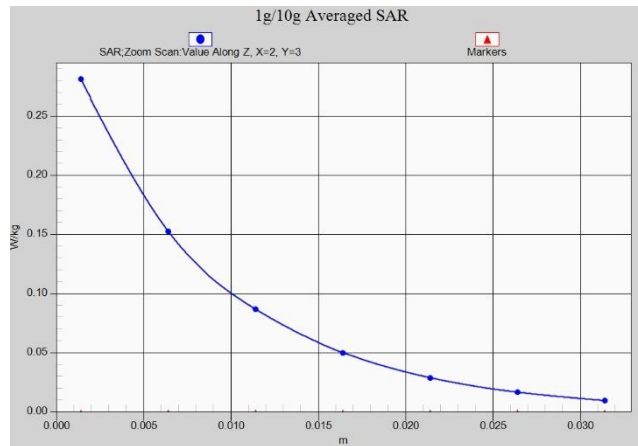

Z-Scan at power reference point (GSM1900)

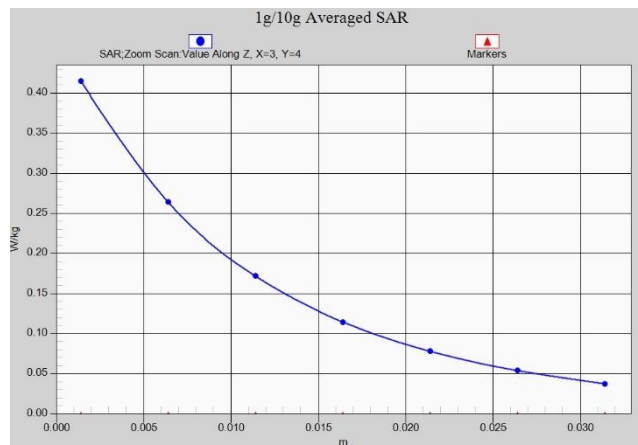

Z-Scan at power reference point (WCDMA1900)

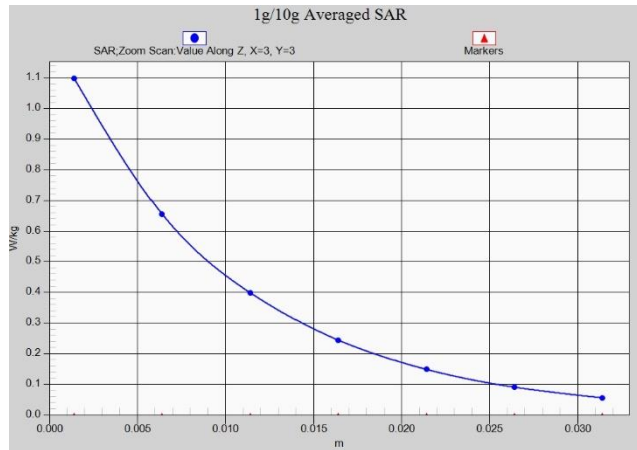

Z-Scan at power reference point (WCDMA1900)

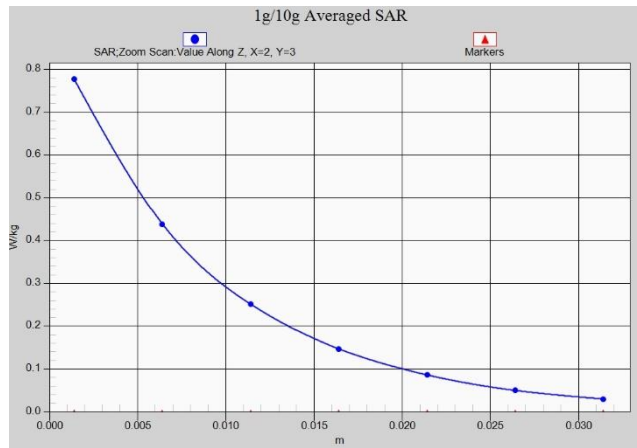

Z-Scan at power reference point (WCDMA1900)

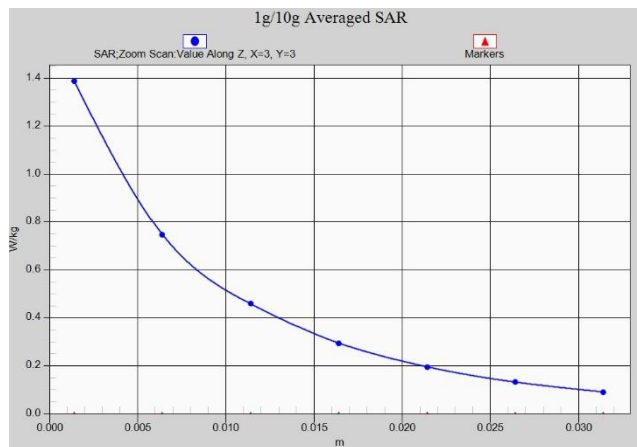

Z-Scan at power reference point (WCDMA850)

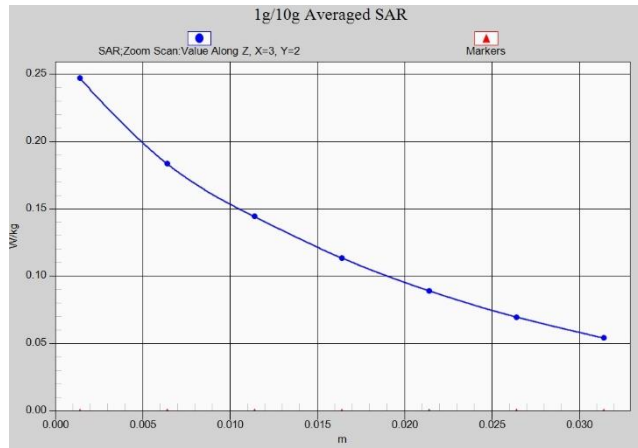

Z-Scan at power reference point (WCDMA850)

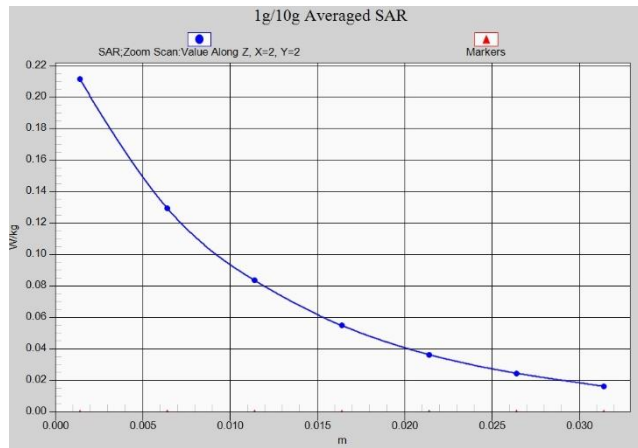

Z-Scan at power reference point (WCDMA850)

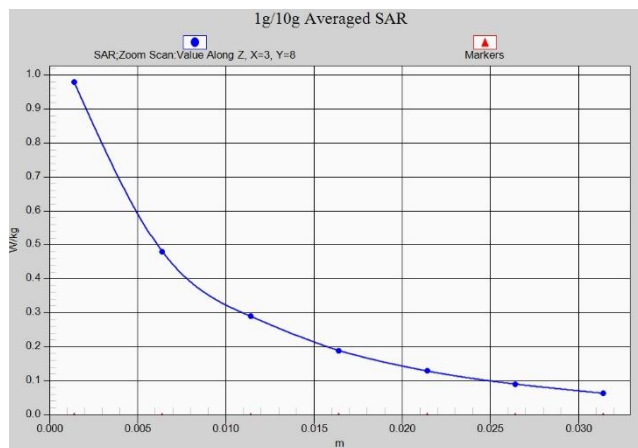

Z-Scan at power reference point (LTEB5)

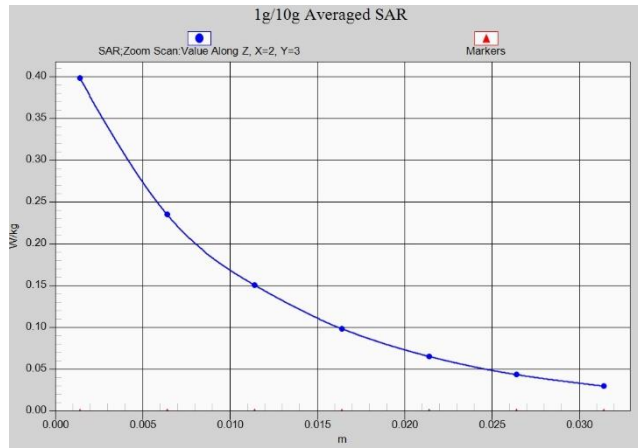

Z-Scan at power reference point (LTEB5)

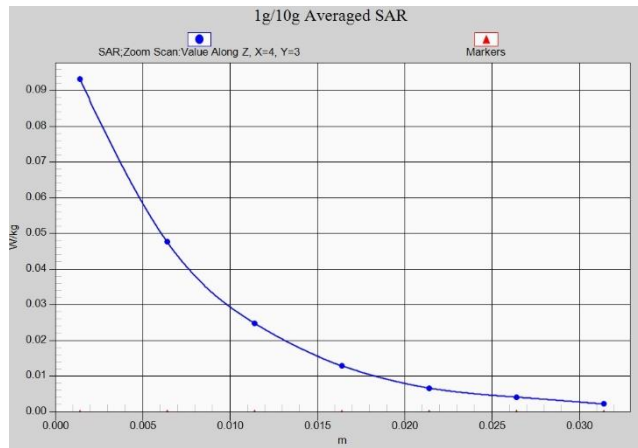

Z-Scan at power reference point (LTEB7)

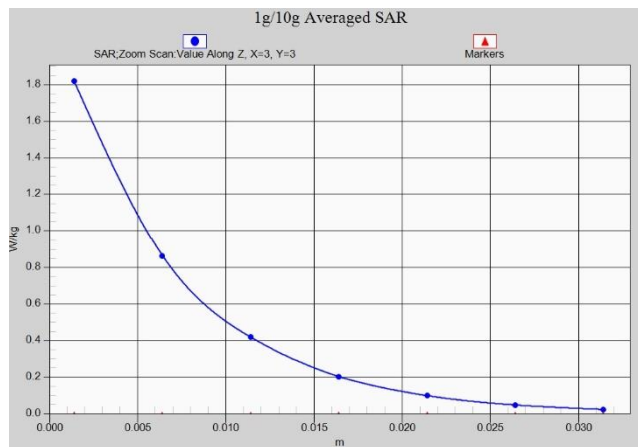

Z-Scan at power reference point (LTEB7)

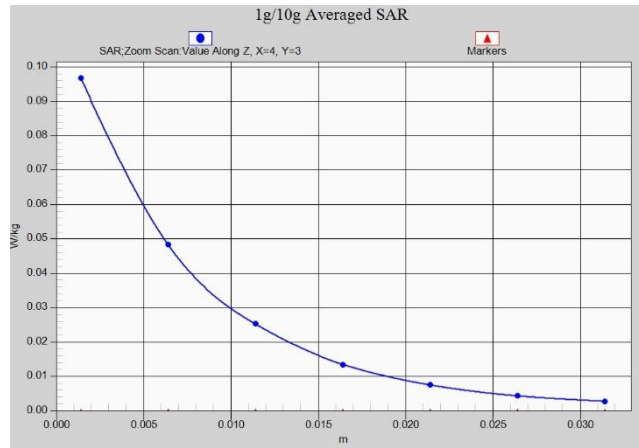

Z-Scan at power reference point (LTEB41)

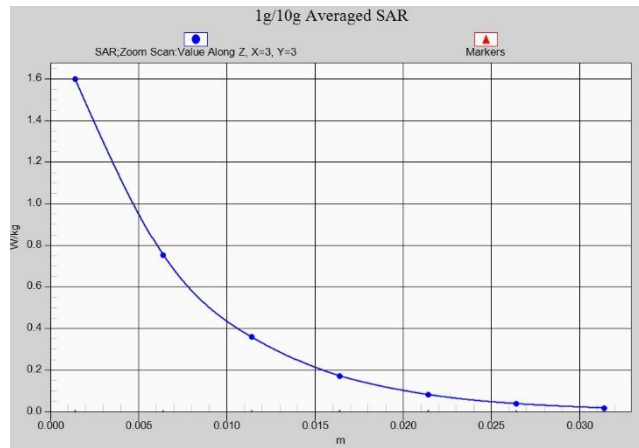

Z-Scan at power reference point (LTEB41)

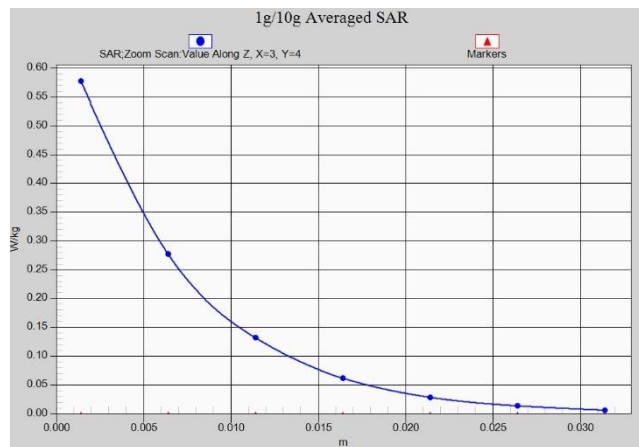

Z-Scan at power reference point (WIFI2.4G)

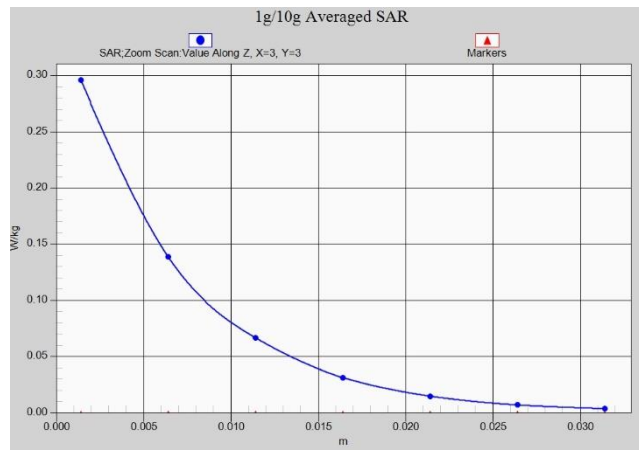

Z-Scan at power reference point (WIFI2.4G)

ANNEX B System Verification Results

835 MHz

Date: 1/22/2021

Electronics: DAE4 Sn536

Medium: Head 835 MHz

Medium parameters used: $f = 835 \text{ MHz}$; $\sigma = 0.908 \text{ mho/m}$; $\epsilon_r = 41.26$; $\rho = 1000 \text{ kg/m}^3$

Ambient Temperature: 22.5°C Liquid Temperature: 22.3°C

Communication System: CW Frequency: 835 MHz Duty Cycle: 1:1

Probe: EX3DV4 – SN3617 ConvF(9.66,9.66,9.66)

System Validation /Area Scan (81x191x1): Interpolated grid: $dx=1.000 \text{ mm}$, $dy=1.000 \text{ mm}$

Reference Value = 64.26 V/m ; Power Drift = 0.03

Fast SAR: SAR(1 g) = 2.36 W/kg ; SAR(10 g) = 1.59 W/kg

Maximum value of SAR (interpolated) = 3.18 W/kg

System Validation /Zoom Scan (7x7x7)/Cube 0: Measurement grid: $dx=5\text{mm}$, $dy=5\text{mm}$, $dz=5\text{mm}$

Reference Value = 64.26 V/m ; Power Drift = 0.03 dB

Peak SAR (extrapolated) = 3.59 W/kg

SAR(1 g) = 2.4 W/kg ; SAR(10 g) = 1.54 W/kg

Maximum value of SAR (measured) = 3.25 W/kg

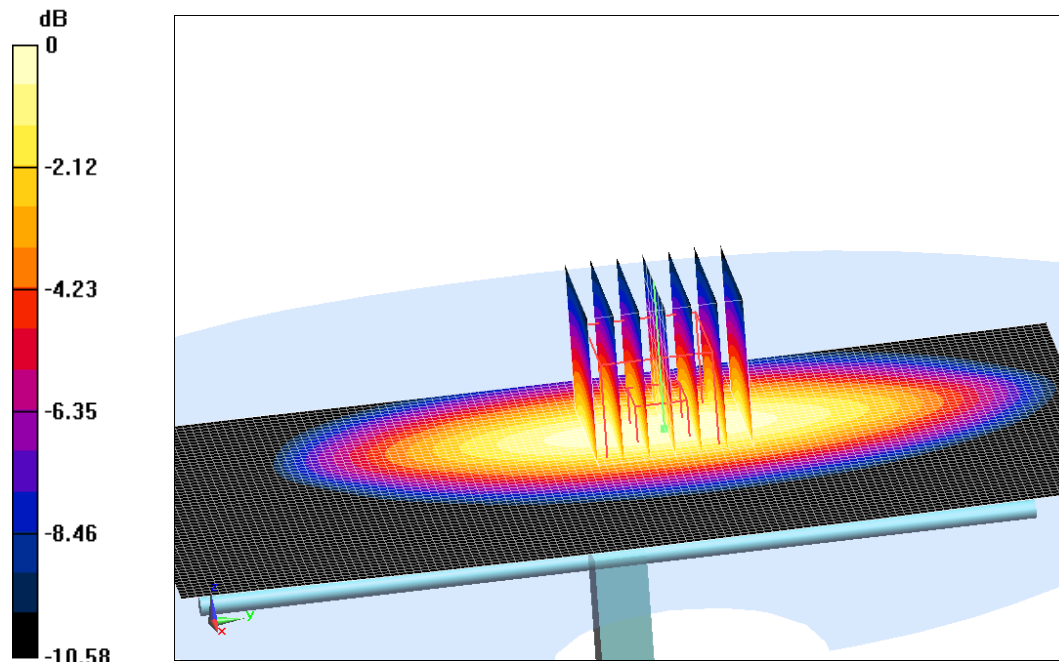

0 dB = $3.25 \text{ W/kg} = 5.12 \text{ dB W/kg}$

Fig.B.1 validation 835 MHz 250mW

1900 MHz

Date: 1/23/2021

Electronics: DAE4 Sn536

Medium: Head 1900 MHz

Medium parameters used: $f = 1900$ MHz; $\sigma = 1.401$ mho/m; $\epsilon_r = 40.09$; $\rho = 1000$ kg/m³

Ambient Temperature: 22.5°C Liquid Temperature: 22.3°C

Communication System: CW Frequency: 1900 MHz Duty Cycle: 1:1

Probe: EX3DV4 – SN3617 ConvF(8.14,8.14,8.14)

System Validation /Area Scan (81x191x1): Interpolated grid: dx=1.000 mm, dy=1.000 mm

Reference Value = 109.59 V/m; Power Drift = 0.04

Fast SAR: SAR(1 g) = 9.9 W/kg; SAR(10 g) = 5.09 W/kg

Maximum value of SAR (interpolated) = 15.45 W/kg

System Validation /Zoom Scan (7x7x7)/Cube 0: Measurement grid:

dx=5mm, dy=5mm, dz=5mm

Reference Value =109.59 V/m; Power Drift = 0.04 dB

Peak SAR (extrapolated) = 18.39 W/kg

SAR(1 g) = 10.01 W/kg; SAR(10 g) = 5.15 W/kg

Maximum value of SAR (measured) = 15.38 W/kg

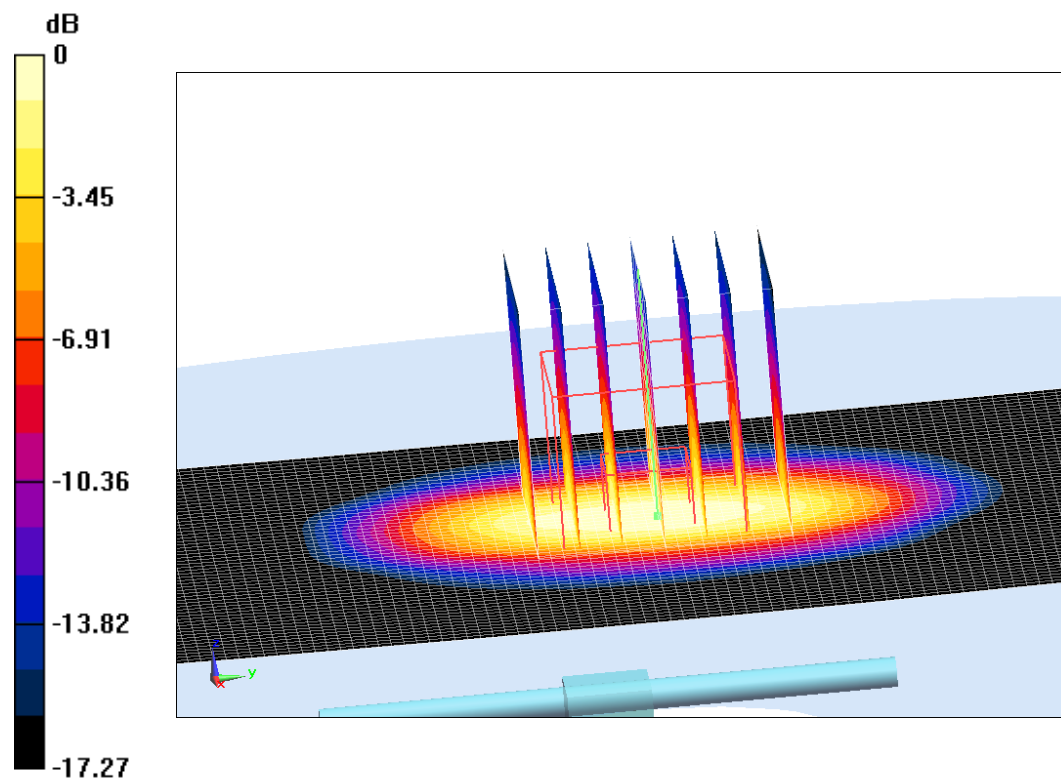

0 dB = 15.38 W/kg = 11.87 dB W/kg

Fig.B.2 validation 1900 MHz 250mW

2450 MHz

Date: 1/24/2021

Electronics: DAE4 Sn536

Medium: Head 2450 MHz

Medium parameters used: $f = 2450$ MHz; $\sigma = 1.813$ mho/m; $\epsilon_r = 39.79$; $\rho = 1000$ kg/m³

Ambient Temperature: 22.5°C Liquid Temperature: 22.3°C

Communication System: CW Frequency: 2450 MHz Duty Cycle: 1:1

Probe: EX3DV4 – SN3617 ConvF(7.65,7.65,7.65)

System Validation /Area Scan (81x191x1): Interpolated grid: dx=1.000 mm, dy=1.000 mm

Reference Value = 116.42 V/m; Power Drift = 0.06

Fast SAR: SAR(1 g) = 12.95 W/kg; SAR(10 g) = 6.13 W/kg

Maximum value of SAR (interpolated) = 22.05 W/kg

System Validation /Zoom Scan (7x7x7)/Cube 0: Measurement grid:

dx=5mm, dy=5mm, dz=5mm

Reference Value =116.42 V/m; Power Drift = 0.06 dB

Peak SAR (extrapolated) = 26.1 W/kg

SAR(1 g) = 12.92 W/kg; SAR(10 g) = 6.16 W/kg

Maximum value of SAR (measured) = 21.8 W/kg

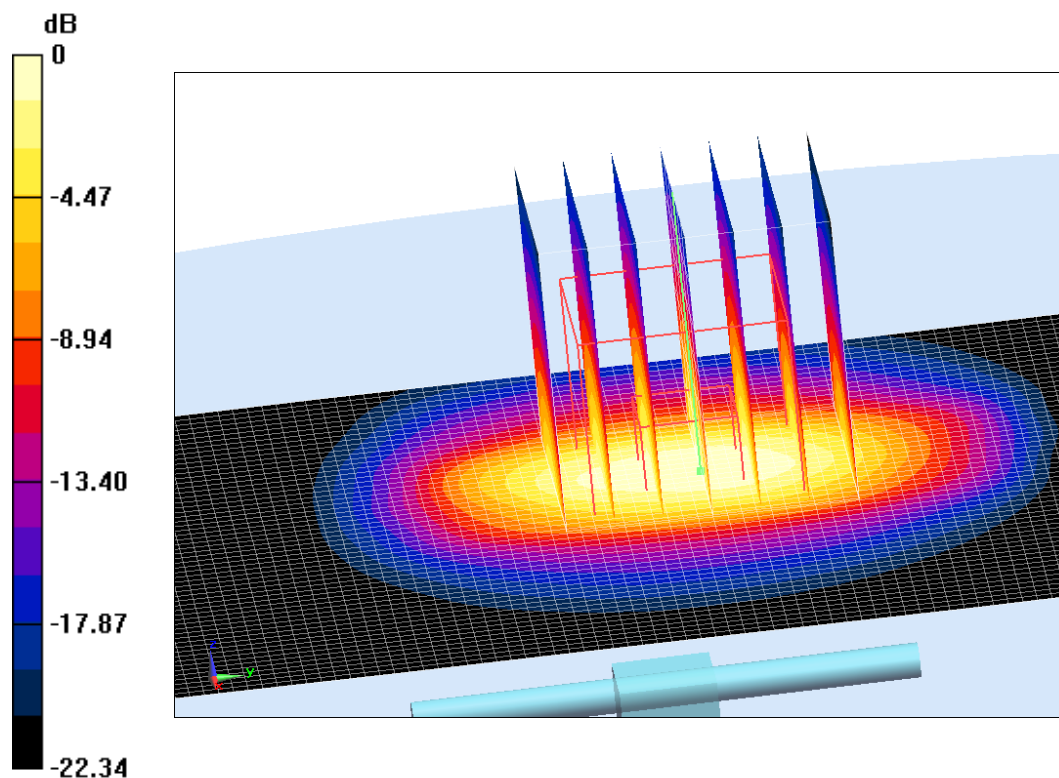

0 dB = 21.8 W/kg = 13.38 dB W/kg

Fig.B.3 validation 2450 MHz 250mW

2600 MHz

Date: 1/25/2021

Electronics: DAE4 Sn536

Medium: Head 2600 MHz

Medium parameters used: $f = 2600$ MHz; $\sigma = 1.946$ mho/m; $\epsilon_r = 38.57$; $\rho = 1000$ kg/m³

Ambient Temperature: 22.5°C Liquid Temperature: 22.3°C

Communication System: CW Frequency: 2600 MHz Duty Cycle: 1:1

Probe: EX3DV4 – SN3617 ConvF(7.52,7.52,7.52)

System Validation /Area Scan (81x191x1): Interpolated grid: dx=1.000 mm, dy=1.000 mm

Reference Value = 119.92 V/m; Power Drift = 0.02

Fast SAR: SAR(1 g) = 14.35 W/kg; SAR(10 g) = 6.33 W/kg

Maximum value of SAR (interpolated) = 24.55 W/kg

System Validation /Zoom Scan (7x7x7)/Cube 0: Measurement grid:

dx=5mm, dy=5mm, dz=5mm

Reference Value =119.92 V/m; Power Drift = 0.02 dB

Peak SAR (extrapolated) = 29.17 W/kg

SAR(1 g) = 14.46 W/kg; SAR(10 g) = 6.26 W/kg

Maximum value of SAR (measured) = 24.25 W/kg

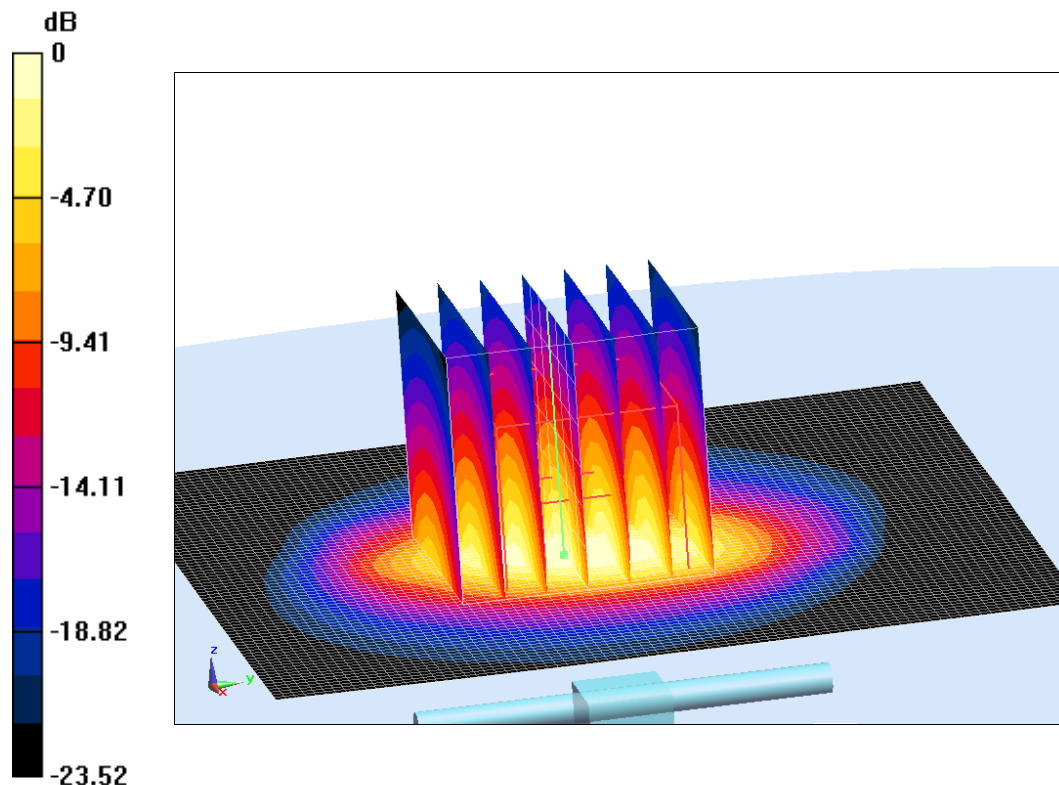

0 dB = 24.25 W/kg = 13.85 dB W/kg

Fig.B.4 validation 2600 MHz 250mW

The SAR system verification must be required that the area scan estimated 1-g SAR is within 3% of the zoom scan 1-g SAR.

Table B.1 Comparison between area scan and zoom scan for system verification

Date	Band	Position	Area scan (1g)	Zoom scan (1g)	Drift (%)
2021-1-22	835 MHz	Head	2.36	2.4	-1.67
2021-1-23	1900 MHz	Head	9.9	10.01	-1.10
2021-1-24	2450 MHz	Head	12.95	12.92	0.23
2021-1-25	2600 MHz	Head	14.35	14.46	-0.76

ANNEX C SAR Measurement Setup

C.1 Measurement Set-up

The Dasy4 or DASY5 system for performing compliance tests is illustrated above graphically. This system consists of the following items:

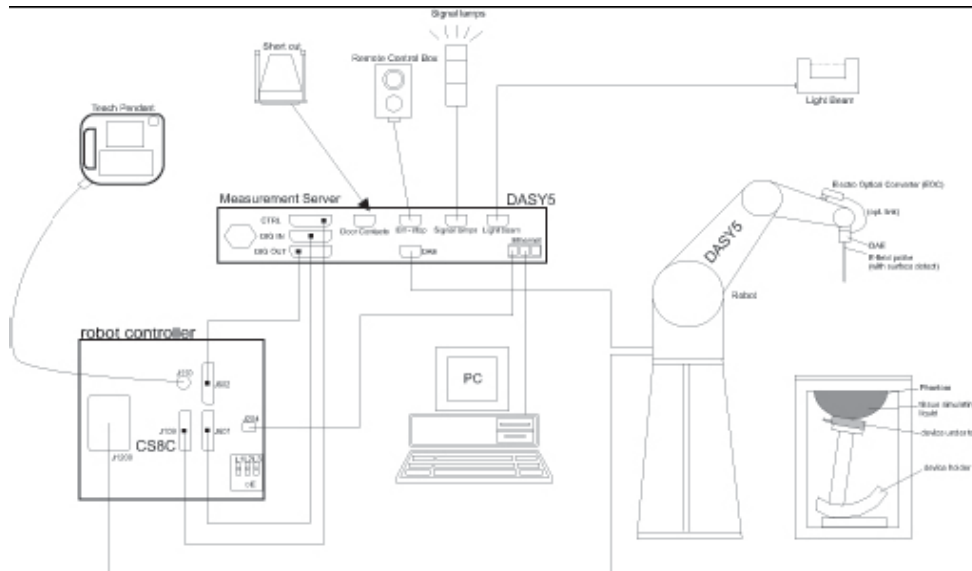

Picture C.1 SAR Lab Test Measurement Set-up

- A standard high precision 6-axis robot (StäubliTX=RX family) with controller, teach pendant and software. An arm extension for accommodating the data acquisition electronics (DAE).
- An isotropic field probe optimized and calibrated for the targeted measurement.
- A data acquisition electronics (DAE) which performs the signal amplification, signal multiplexing, AD-conversion, offset measurements, mechanical surface detection, collision detection, etc. The unit is battery powered with standard or rechargeable batteries. The signal is optically transmitted to the EOC.
- The Electro-optical converter (EOC) performs the conversion from optical to electrical signals for the digital communication to the DAE. To use optical surface detection, a special version of the EOC is required. The EOC signal is transmitted to the measurement server.
- The function of the measurement server is to perform the time critical tasks such as signal filtering, control of the robot operation and fast movement interrupts.
- The Light Beam used is for probe alignment. This improves the (absolute) accuracy of the probe positioning.
- A computer running WinXP and the DASY4 or DASY5 software.
- Remote control and teach pendant as well as additional circuitry for robot safety such as
- warning lamps, etc.
- The phantom, the device holder and other accessories according to the targeted measurement.

C.2 Dasy4 or DASY5 E-field Probe System

The SAR measurements were conducted with the dosimetric probe designed in the classical triangular configuration and optimized for dosimetric evaluation. The probe is constructed using the thick film technique; with printed resistive lines on ceramic substrates. The probe is equipped with an optical multifiber line ending at the front of the probe tip. It is connected to the EOC box on the robot arm and provides an automatic detection of the phantom surface. Half of the fibers are connected to a pulsed infrared transmitter, the other half to a synchronized receiver. As the probe approaches the surface, the reflection from the surface produces a coupling from the transmitting to the receiving fibers. This reflection increases first during the approach, reaches maximum and then decreases. If the probe is flatly touching the surface, the coupling is zero. The distance of the coupling maximum to the surface is independent of the surface reflectivity and largely independent of the surface to probe angle. The DASY4 or DASY5 software reads the reflection during a software approach and looks for the maximum using 2nd ord curve fitting. The approach is stopped at reaching the maximum.

Probe Specifications:

Model:	ES3DV3, EX3DV4
Frequency	10MHz — 6.0GHz(EX3DV4)
Range:	10MHz — 4GHz(ES3DV3)
Calibration:	In head and body simulating tissue at Frequencies from 835 up to 5800MHz
Linearity:	± 0.2 dB(30 MHz to 6 GHz) for EX3DV4 ± 0.2 dB(30 MHz to 4 GHz) for ES3DV3
DynamicRange:	10 mW/kg — 100W/kg
Probe Length:	330 mm
Probe Tip	
Length:	20 mm
Body Diameter:	12 mm
Tip Diameter:	2.5 mm (3.9 mm for ES3DV3)
Tip-Center:	1 mm (2.0mm for ES3DV3)
Application:	SAR Dosimetry Testing Compliance tests of mobile phones Dosimetry in strong gradient fields



Picture C.2Near-field Probe



Picture C.3E-field Probe

C.3 E-field Probe Calibration

Each E-Probe/Probe Amplifier combination has unique calibration parameters. A TEM cell calibration procedure is conducted to determine the proper amplifier settings to enter in the probe parameters. The amplifier settings are determined for a given frequency by subjecting the probe to a known E-field density (1 mW/cm²) using an RF Signal generator, TEM cell, and RF Power Meter.

The free space E-field from amplified probe outputs is determined in a test chamber. This calibration can be performed in a TEM cell if the frequency is below 1 GHz and in a waveguide or

other methodologies above 1 GHz for free space. For the free space calibration, the probe is placed in the volumetric center of the cavity and at the proper orientation with the field. The probe is then rotated 360 degrees until the three channels show the maximum reading. The power density readings equates to 1 mW/cm².

E-field temperature correlation calibration is performed in a flat phantom filled with the appropriate simulated brain tissue. The E-field in the medium correlates with the temperature rise in the dielectric medium. For temperature correlation calibration a RF transparent thermistor-based temperature probe is used in conjunction with the E-field probe.

$$SAR = C \frac{\Delta T}{\Delta t}$$

Where:

Δt = Exposure time (30 seconds),

C = Heat capacity of tissue (brain or muscle),

ΔT = Temperature increase due to RF exposure.

$$SAR = \frac{|E|^2 \cdot \sigma}{\rho}$$

Where:

σ = Simulated tissue conductivity,

ρ = Tissue density (kg/m³).

C.4 Other Test Equipment

C.4.1 Data Acquisition Electronics(DAE)

The data acquisition electronics consist of a highly sensitive electrometer-grade preamplifier with auto-zeroing, a channel and gain-switching multiplexer, a fast 16 bit AD-converter and a command decoder with a control logic unit. Transmission to the measurement server is accomplished through an optical downlink for data and status information, as well as an optical uplink for commands and the clock.

The mechanical probe mounting device includes two different sensor systems for frontal and sideways probe contacts. They are used for mechanical surface detection and probe collision detection.

The input impedance of the DAE is 200 MOhm; the inputs are symmetrical and floating. Common mode rejection is above 80 dB.



PictureC.4: DAE

C.4.2 Robot

The SPEAG DASY system uses the high precision robots (DASY4: RX90XL; DASY5: RX160L) type from Stäubli SA (France). For the 6-axis controller system, the robot controller version from Stäubli is used. The Stäubli robot series have many features that are important for our application:

- High precision (repeatability 0.02mm)
- High reliability (industrial design)
- Low maintenance costs (virtually maintenance free due to direct drive gears; no belt drives)
- Jerk-free straight movements (brushless synchron motors; no stepper motors)
- Low ELF interference (motor control fields shielded via the closed metallic construction shields)



Picture C.5 DASY 4



Picture C.6 DASY 5

C.4.3 Measurement Server

The Measurement server is based on a PC/104 CPU board with CPU (dasy4: 166 MHz, Intel Pentium; DASY5: 400 MHz, Intel Celeron), chipdisk (DASY4: 32 MB; DASY5: 128MB), RAM (DASY4: 64 MB, DASY5: 128MB). The necessary circuits for communication with the DAE electronic box, as well as the 16 bit AD converter system for optical detection and digital I/O interface are contained on the DASY I/O board, which is directly connected to the PC/104 bus of the CPU board.

The measurement server performs all real-time data evaluation of field measurements and surface detection, controls robot movements and handles safety operation. The PC operating system cannot interfere with these time critical processes. All connections are supervised by a watchdog, and disconnection of any of the cables to the measurement server will automatically disarm the robot and disable all program-controlled robot movements. Furthermore, the measurement server is equipped with an expansion port which is reserved for future applications. Please note that this expansion port does not have a standardized pinout, and therefore only devices provided by SPEAG can be connected. Devices from any other supplier could seriously damage the measurement server.



Picture C.7 Server for DASY 4



Picture C.8 Server for DASY 5

C.4.4 Device Holder for Phantom

The SAR in the phantom is approximately inversely proportional to the square of the distance between the source and the liquid surface. For a source at 5mm distance, a positioning uncertainty of $\pm 0.5\text{mm}$ would produce a SAR uncertainty of $\pm 20\%$. Accurate device positioning is therefore crucial for accurate and repeatable measurements. The positions in which the devices must be measured are defined by the standards.

The DASY device holder is designed to cope with the different positions given in the standard. It has two scales for device rotation (with respect to the body axis) and device inclination (with respect to the line between the ear reference points). The rotation centers for both scales are the ear reference point (ERP). Thus the device needs no repositioning when changing the angles.

The DASY device holder is constructed of low-loss POM material having the following dielectric parameters: relative permittivity $\epsilon = 3$ and loss tangent $\delta = 0.02$. The amount of dielectric material has been reduced in the closest vicinity of the device, since measurements have suggested that the influence of the clamp on the test results could thus be lowered.

<Laptop Extension Kit>

The extension is lightweight and made of POM, acrylic glass and foam. It fits easily on the upper part of the Mounting Device in place of the phone positioner. The extension is fully compatible with the Twin-SAM and ELI phantoms.



Picture C.9-1: Device Holder

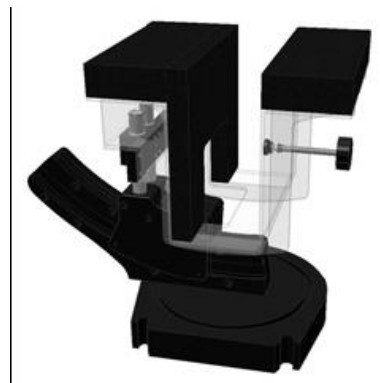

Picture C.9-2: Laptop Extension Kit

C.4.5 Phantom

The SAM Twin Phantom V4.0 is constructed of a fiberglass shell integrated in a table. The shape of the shell is based on data from an anatomical study designed to

Represent the 90th percentile of the population. The phantom enables the dissymmetric evaluation of SAR for both left and right handed handset usage, as well as body-worn usage using the flat phantom region. Reference markings on the Phantom allow the complete setup of all predefined phantom positions and measurement grids by manually teaching three points in the robot. The shell phantom has a 2mm shell thickness (except the ear region where shell thickness increases to 6 mm).

Shell Thickness: 2 ± 0.2 mm

Filling Volume: Approx. 25 liters

Dimensions: 810 x 1000 x 500 mm (H x L x W)

Available: Special



Picture C.10: SAM Twin Phantom

ANNEX D Position of the wireless device in relation to the phantom

D.1 General considerations

This standard specifies two handset test positions against the head phantom – the “cheek” position and the “tilt” position.

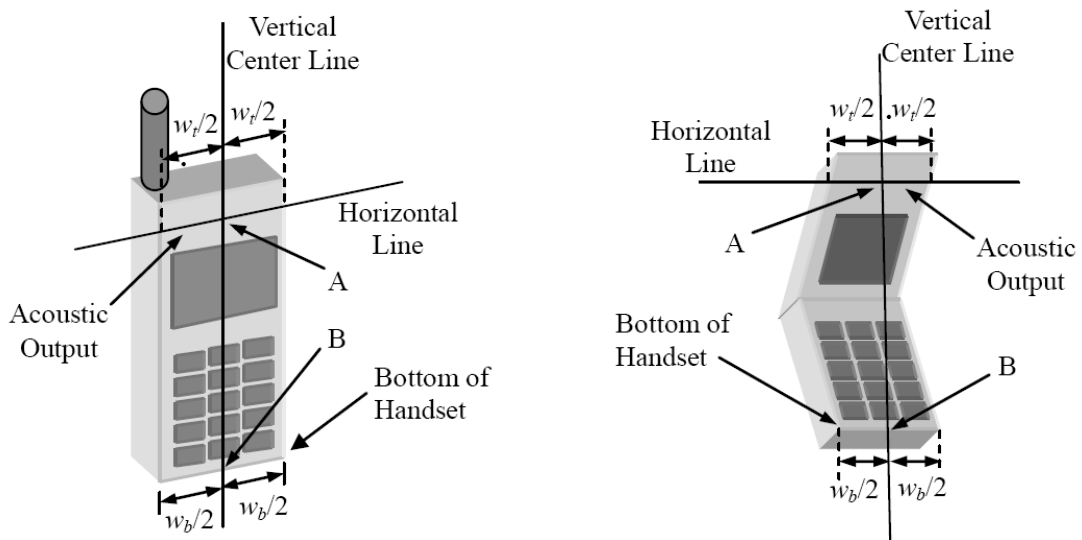

- w_t Width of the handset at the level of the acoustic
- w_b Width of the bottom of the handset
- A Midpoint of the width w_t of the handset at the level of the acoustic output
- B Midpoint of the width w_b of the bottom of the handset

Picture D.1-a Typical “fixed” case handset Picture D.1-b Typical “clam-shell” case handset

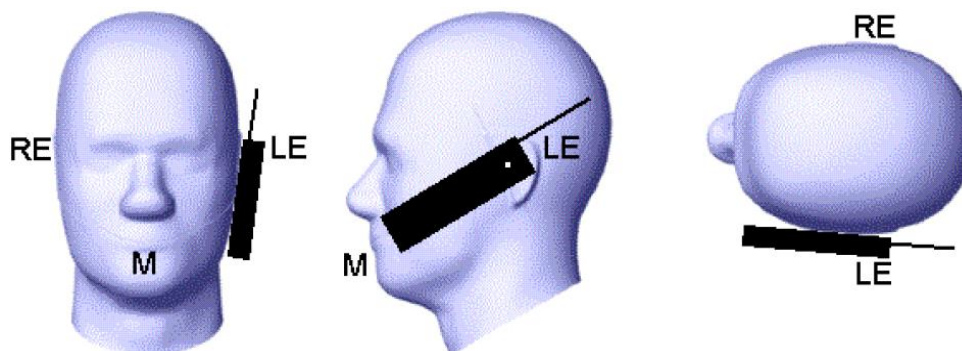

Picture D.2 Cheek position of the wireless device on the left side of SAM

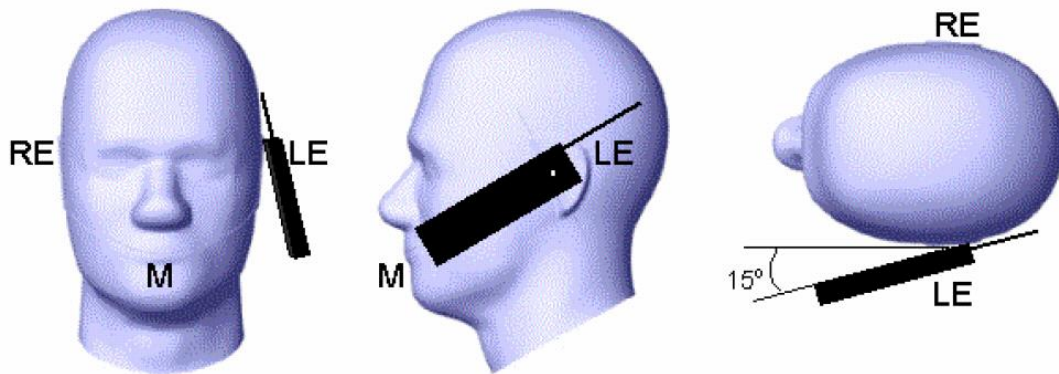

Picture D.3 Tilt position of the wireless device on the left side of SAM

D.2 Body-worn device

A typical example of a body-worn device is a mobile phone, wireless enabled PDA or other battery operated wireless device with the ability to transmit while mounted on a person's body using a carry accessory approved by the wireless device manufacturer.

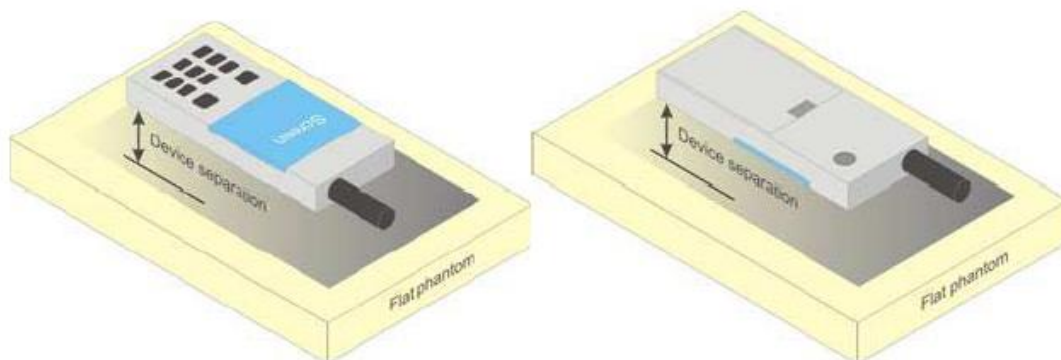

Picture D.4 Test positions for body-worn devices

D.3 Desktop device

A typical example of a desktop device is a wireless enabled desktop computer placed on a table or desk when used.

The DUT shall be positioned at the distance and in the orientation to the phantom that corresponds to the intended use as specified by the manufacturer in the user instructions. For devices that employ an external antenna with variable positions, tests shall be performed for all antenna positions specified. Picture 8.5 show positions for desktop device SAR tests. If the intended use is not specified, the device shall be tested directly against the flat phantom.

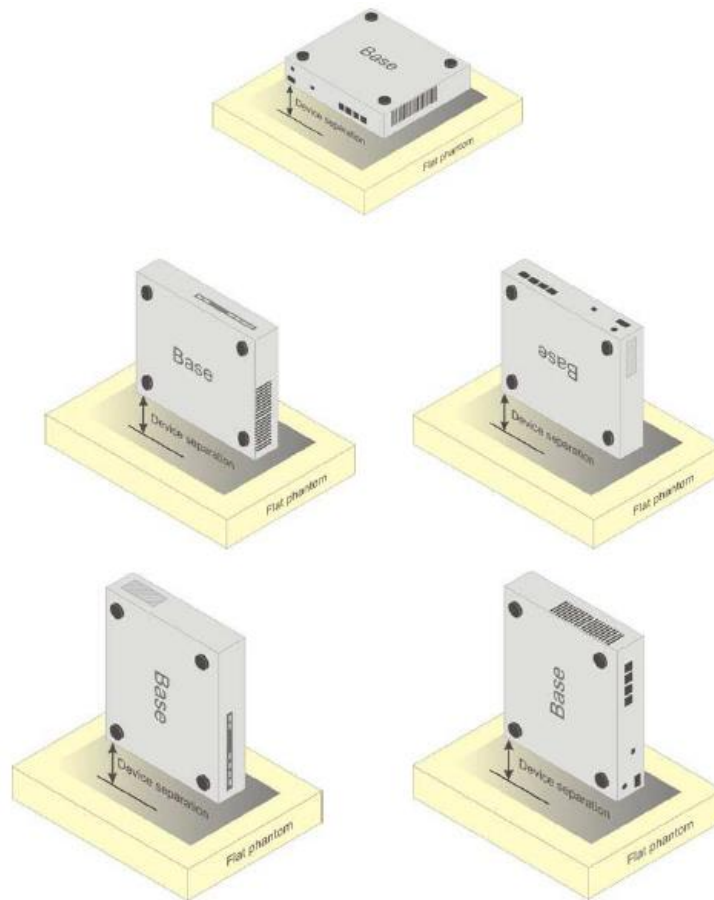

Picture D.5 Test positions for desktop devices

D.4 DUT Setup Photos



Picture D.6

ANNEX E Equivalent Media Recipes

The liquid used for the frequency range of 800-3000 MHz consisted of water, sugar, salt, preventol, glycol monobutyl and Cellulose. The liquid has been previously proven to be suited for worst-case. The Table E.1 shows the detail solution. It's satisfying the latest tissue dielectric parameters requirements proposed by the IEEE 1528 and IEC 62209.

TableE.1: Composition of the Tissue Equivalent Matter

Frequency (MHz)	835Head	835Body	1900 Head	1900 Body	2450 Head	2450 Body	5800 Head	5800 Body
Ingredients (% by weight)								
Water	41.45	52.5	55.242	69.91	58.79	72.60	65.53	65.53
Sugar	56.0	45.0	\	\	\	\	\	\
Salt	1.45	1.4	0.306	0.13	0.06	0.18	\	\
Preventol	0.1	0.1	\	\	\	\	\	\
Cellulose	1.0	1.0	\	\	\	\	\	\
Glycol Monobutyl	\	\	44.452	29.96	41.15	27.22	\	\
Diethylenglycol monohexylether	\	\	\	\	\	\	17.24	17.24
Triton X-100	\	\	\	\	\	\	17.24	17.24
Dielectric Parameters Target Value	$\epsilon=41.5$ $\sigma=0.90$	$\epsilon=55.2$ $\sigma=0.97$	$\epsilon=40.0$ $\sigma=1.40$	$\epsilon=53.3$ $\sigma=1.52$	$\epsilon=39.2$ $\sigma=1.80$	$\epsilon=52.7$ $\sigma=1.95$	$\epsilon=35.3$ $\sigma=5.27$	$\epsilon=48.2$ $\sigma=6.00$

Note: There are a little adjustment respectively for 750, 1750, 2600, 5200, 5300 and 5600 based on the recipe of closest frequency in table E.1.

ANNEX F System Validation

The SAR system must be validated against its performance specifications before it is deployed. When SAR probes, system components or software are changed, upgraded or recalibrated, these must be validated with the SAR system(s) that operates with such components.

Table F.1: System Validation for 3617

Probe SN.	Liquid name	Validation date	Frequency point	Status (OK or Not)
3617	Head 750MHz	January 30,2020	750 MHz	OK
3617	Head 850MHz	January 30,2020	835 MHz	OK
3617	Head 900MHz	January 30,2020	900 MHz	OK
3617	Head 1750MHz	January 30,2020	1750 MHz	OK
3617	Head 1810MHz	January 30,2020	1810 MHz	OK
3617	Head 1900MHz	January 30,2020	1900 MHz	OK
3617	Head 2000MHz	January 30,2020	2000 MHz	OK
3617	Head 2100MHz	January 30,2020	2100 MHz	OK
3617	Head 2300MHz	January 30,2020	2300 MHz	OK
3617	Head 2450MHz	January 30,2020	2450 MHz	OK
3617	Head 2600MHz	January 30,2020	2600 MHz	OK
3617	Head 3500MHz	January 30,2020	3500 MHz	OK
3617	Head 3700MHz	January 30,2020	3700 MHz	OK
3617	Head 5200MHz	January 30,2020	5250 MHz	OK
3617	Head 5500MHz	January 30,2020	5600 MHz	OK
3617	Head 5800MHz	January 30,2020	5800 MHz	OK
3617	Body 750MHz	January 30,2020	750 MHz	OK
3617	Body 850MHz	January 30,2020	835 MHz	OK
3617	Body 900MHz	January 30,2020	900 MHz	OK
3617	Body 1750MHz	January 30,2020	1750 MHz	OK
3617	Body 1810MHz	January 30,2020	1810 MHz	OK
3617	Body 1900MHz	January 30,2020	1900 MHz	OK
3617	Body 2000MHz	January 30,2020	2000 MHz	OK
3617	Body 2100MHz	January 30,2020	2100 MHz	OK
3617	Body 2300MHz	January 30,2020	2300 MHz	OK
3617	Body 2450MHz	January 30,2020	2450 MHz	OK
3617	Body 2600MHz	January 30,2020	2600 MHz	OK
3617	Body 3500MHz	January 30,2020	3500 MHz	OK
3617	Body 3700MHz	January 30,2020	3700 MHz	OK
3617	Body 5200MHz	January 30,2020	5250 MHz	OK
3617	Body 5500MHz	January 30,2020	5600 MHz	OK
3617	Body 5800MHz	January 30,2020	5800 MHz	OK