

Fig.56. Conducted spurious emission: 8DPSK, Channel 39, 1GHz - 3GHz

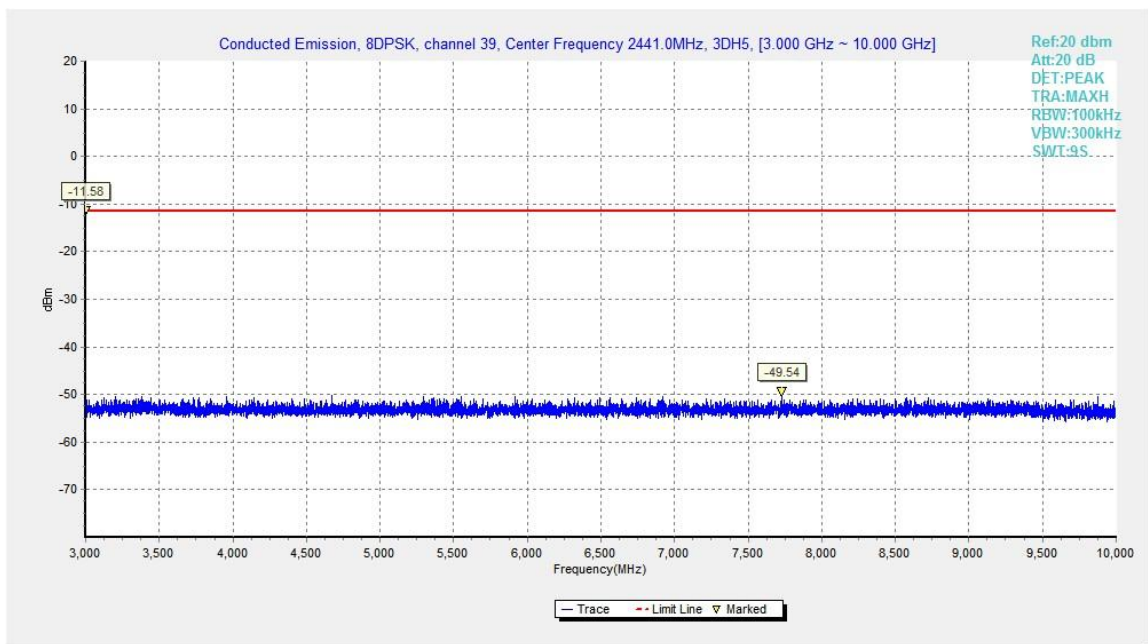

Fig.57. Conducted spurious emission: 8DPSK, Channel 39, 3GHz - 10GHz

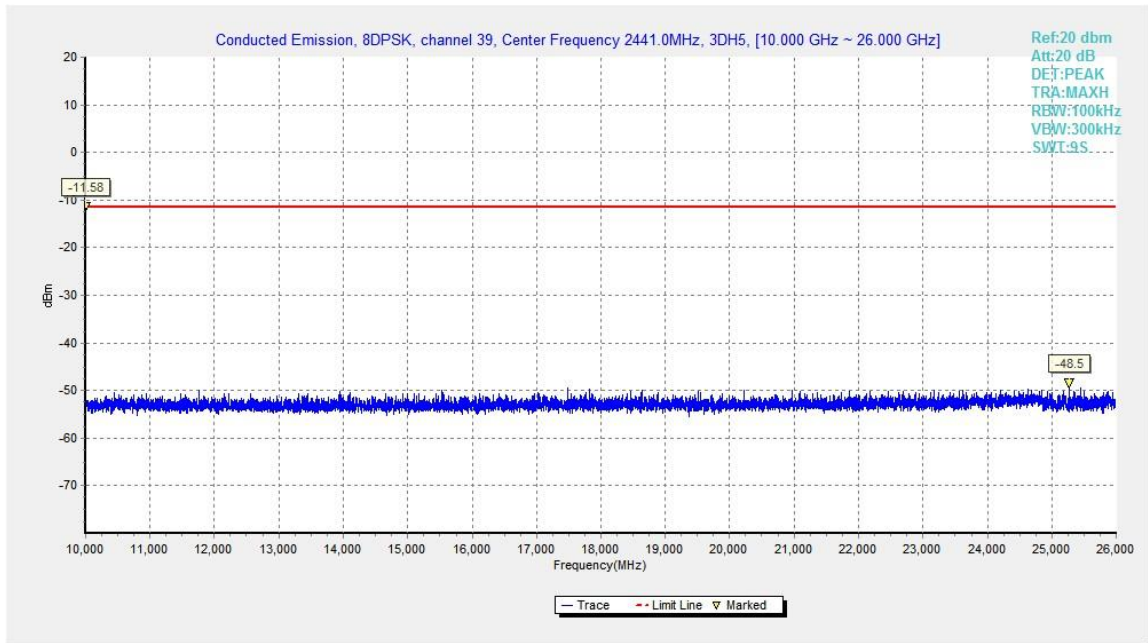

Fig.58. Conducted spurious emission: 8DPSK, Channel 39, 10GHz – 26GHz

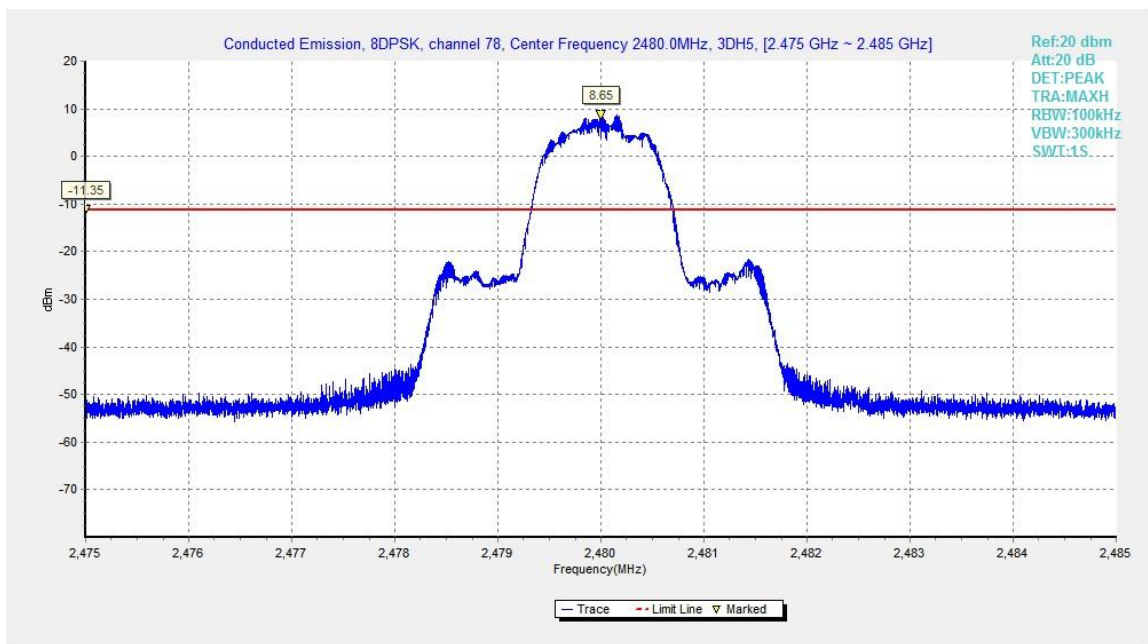

Fig.59. Conducted spurious emission: 8DPSK, Channel 78, 2480MHz

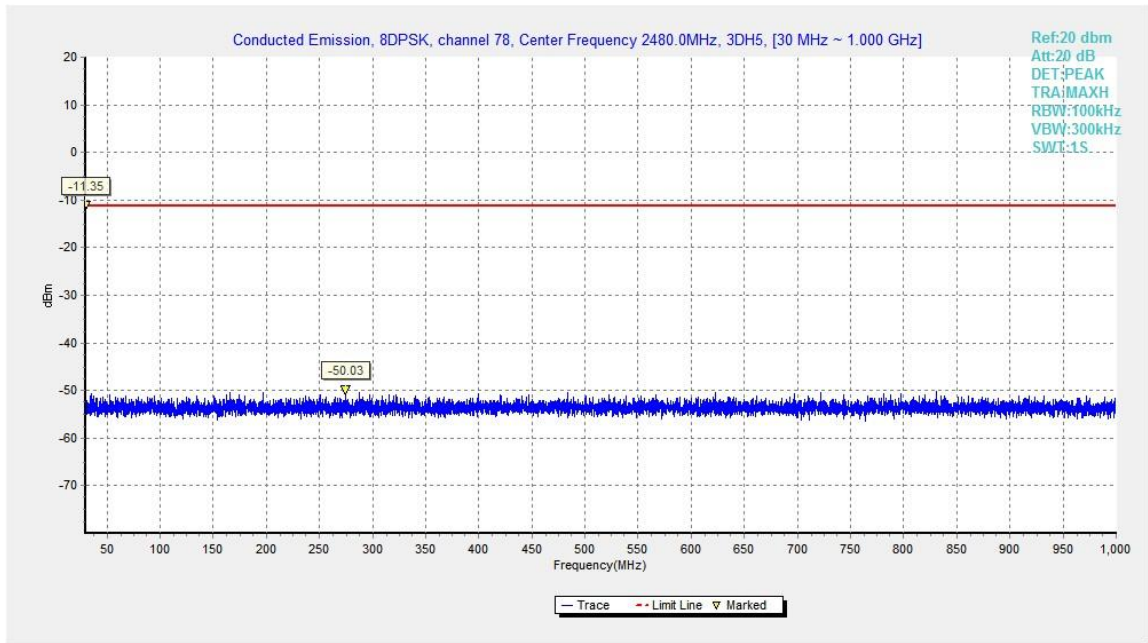

Fig.60. Conducted spurious emission: 8DPSK, Channel 78, 30MHz - 1GHz

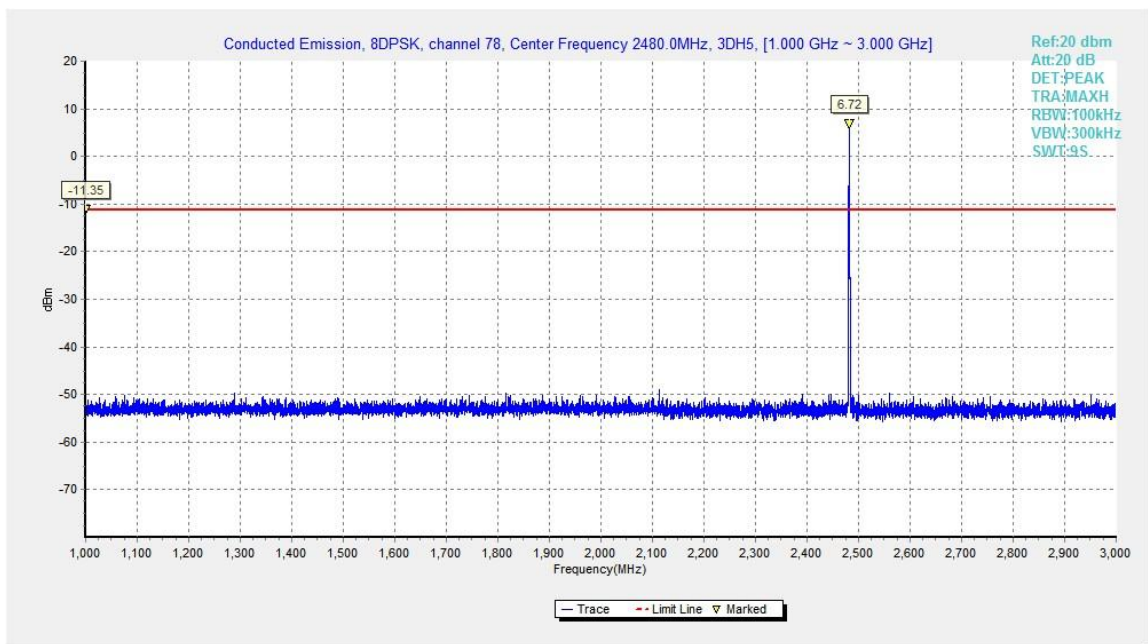

Fig.61. Conducted spurious emission: 8DPSK, Channel 78, 1GHz - 3GHz

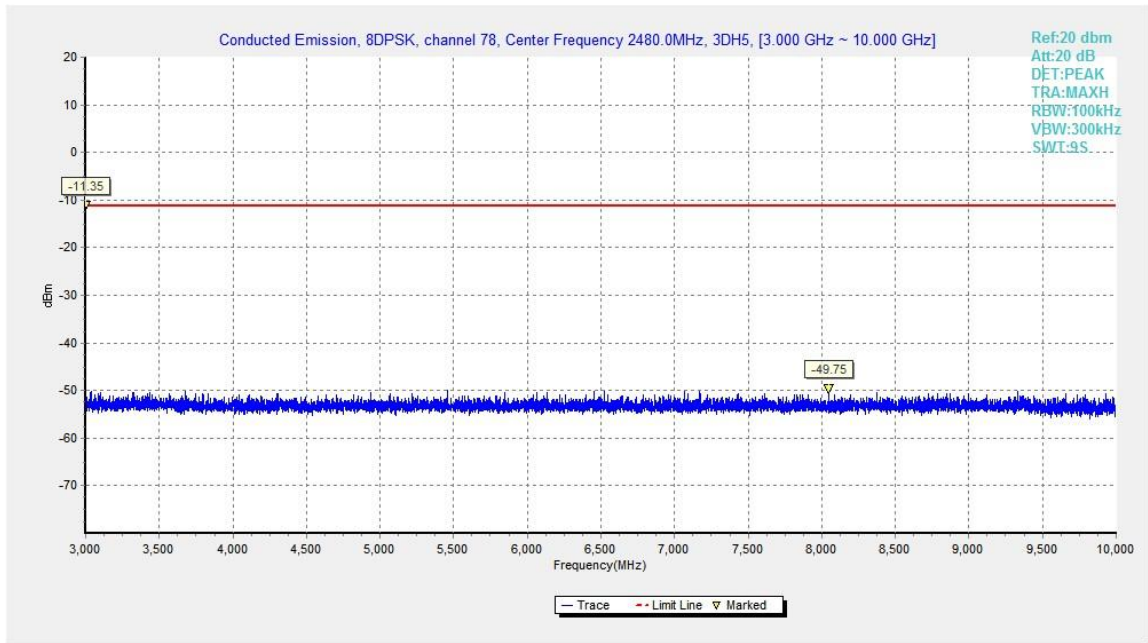

Fig.62. Conducted spurious emission: 8DPSK, Channel 78, 3GHz - 10GHz

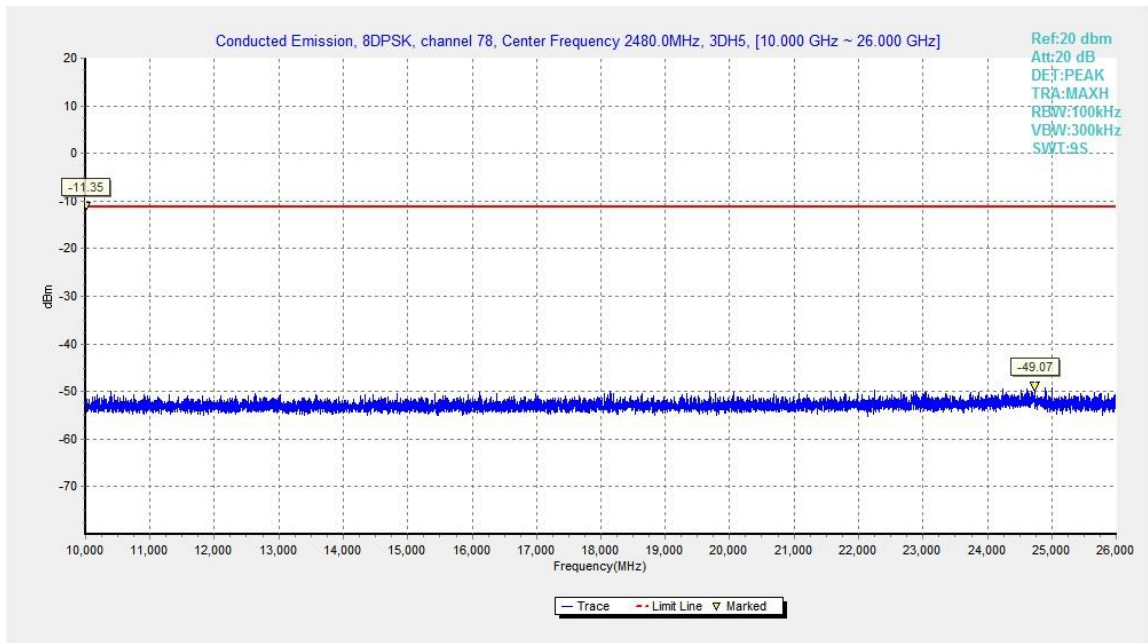

Fig.63. Conducted spurious emission: 8DPSK, Channel 78, 10GHz - 26GHz

## B.6. Transmitter Spurious Emission - Radiated

**Method of Measurement:** See ANSI C63.10-2013-clause 6.4 & 6.5 & 6.6

**Measurement Limit:**

Standard	Limit
FCC 47 CFR Part 15.247, 15.205, 15.209	20dB below peak output power

radiated emissions which fall in the restricted bands, as defined in § 15.205(a), must also comply with the radiated emission limits specified in § 15.209(a) (see § 15.205(c)).

**Limit in restricted band:**

Frequency (MHz)	Field strength( $\mu$ V/m)	Measurement distance (m)
0.009 - 0.490	2400/F(kHz)	300
0.490 - 1.705	24000/F(kHz)	30
1.705 – 30.0	30	30

Frequency of emission (MHz)	Field strength( $\mu$ V/m)	Field strength(dBuV/m)
30-88	100	40
88-216	150	43.5
216-960	200	46
Above 960	500	54

**Set up:**

Tabletop devices shall be placed on a nonconducting platform with nominal top surface dimensions 1 m by 1.5 m. For emissions testing at or below 1 GHz, the table height shall be 80 cm above the reference ground plane. For emission measurements above 1 GHz, the table height shall be 1.5 m

The EUT and transmitting antenna shall be centered on the turntable.

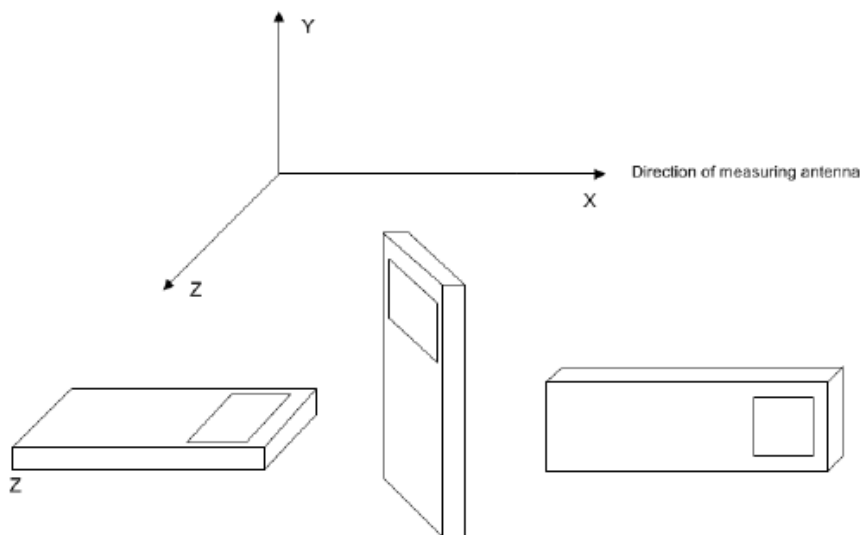
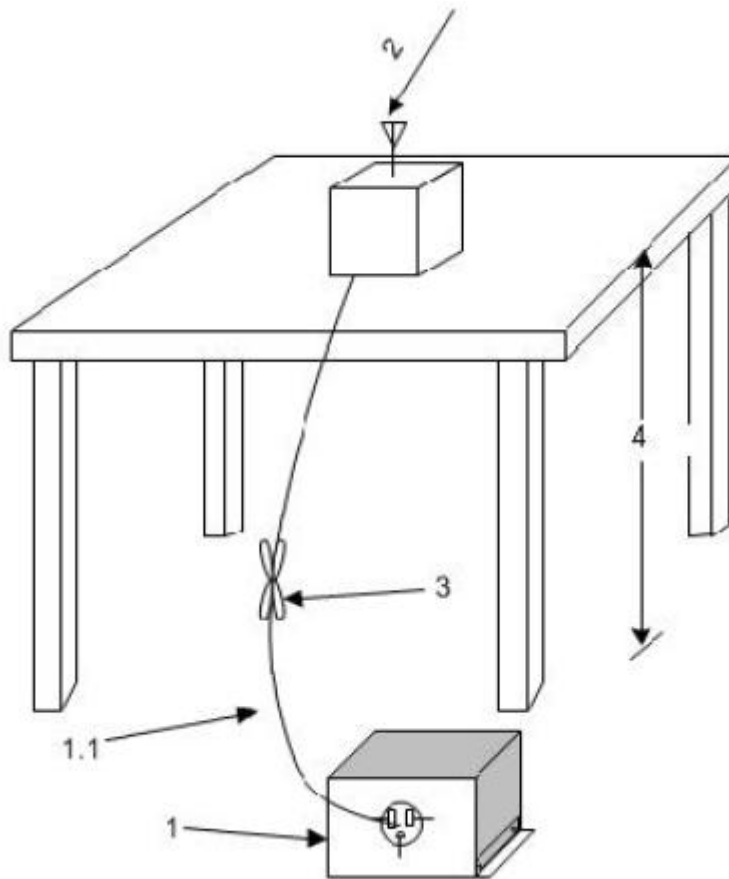

**Test Condition**

The EUT shall be tested 1 near top, 1 near middle, and 1 near bottom. Set the unlicensed wireless device to operate in continuous transmit mode. For unlicensed wireless devices unable to be configured for 100% duty cycle even in test mode, configure the system for the maximum duty cycle supported.

When required for unlicensed wireless devices, measurements of the variation of the input power or the radiated signal level of the fundamental frequency component of the emission, as appropriate, shall be performed with the supply voltage varied between 85% and 115% of the

nominal rated supply voltage.

### **Exploratory radiated emissions measurements**

Exploratory radiated measurements shall be performed at the measurement distance or at a closer distance than that specified for compliance to determine the emission characteristics of the EUT and, if applicable, the EUT configuration that produces the maximum level of emissions. The frequencies of maximum emission may be determined by manually positioning the antenna close to the EUT, and then moving the antenna over all sides of the EUT while observing a spectral display. It is advantageous to have prior knowledge of the frequencies of emissions, although this may be determined from such a near-field scan. The near-field scan shall only be used to determine the frequency but not the amplitude of the emissions. Where exploratory measurements are not adequate to determine the worst-case operating modes and are used only to identify the frequencies of the highest emissions, additional preliminary tests can be required.

For emissions from the EUT, the maximum level shall be determined by rotating the EUT and its antenna through 0° to 360°. For each mode of operation required to be tested, the frequency spectrum (based on findings from exploratory measurements) shall be monitored.

Broadband antennas and a spectrum analyzer or a radio-noise meter with a panoramic display are often useful in this type of test. If either antenna height or EUT azimuth are not fully measured during exploratory testing, then complete testing can be required at the OATS or semi-anechoic chamber when the final full spectrum testing is performed.

### **Final radiated emissions measurements**

The final measurements are using the orientation and equipment arrangement of the EUT based on the measurement results found during the preliminary (exploratory) measurements, the EUT arrangement, appropriate modulation, and modes of operation that produce the emissions that have the highest amplitude relative to the limit shall be selected for the final measurement.

For each mode of operation required to be tested, the frequency spectrum (based on findings from exploratory measurements) shall be monitored. The highest signal levels relative to the limit shall be determined by rotating the EUT from 0° to 360° and with varying the measurement antenna height between 1 m and 4 m in vertical and horizontal polarizations.

For each mode selected, record the frequency and amplitude of the highest fundamental emission (if applicable), as well as the frequency and amplitude of the six highest spurious emissions relative to the limit. Emissions more than 20 dB below the limit do not need to be reported.

This maximization process was repeated with the EUT positioned in each of its three orthogonal orientations.

#### **The receiver references:**

Frequency of emission (MHz)	RBW/VBW	Sweep Time(s)
30-1000	100KHz/300KHz	5
1000-4000	1MHz/3MHz	15
4000-18000	1MHz/3MHz	40
18000-26500	1MHz/3MHz	20

$P_{Mea}$  is the field strength recorded from the instrument.

The measurement results are obtained as described below:

Result=  $P_{Mea}$  + Cable Loss + Antenna Factor

Where:

$P_{Mea}$  field strength recorded from the instrument

### Peak Measurement results

#### GFSK Ch0

Frequency (MHz)	Measurement Result (dB $\mu$ V/m)	Cable loss (dB)	Antenna Factor (dB/m)	Receiver Reading (dB $\mu$ V)	Limit (dB $\mu$ V/m)	Margin (dB)	Antenna Pol. (H/V)	Antenna Height (cm)	Turntable angle (deg)
2369.332	60.56	2.9	32.0	25.73	74.0	13.4	H	155	176
2381.596	60.49	2.9	32.0	25.64	74.0	13.5	H	155	0
4804.000	40.40	-33.3	34.1	39.54	74.0	33.6	V	155	22
7206.000	41.78	-31.2	35.8	37.16	74.0	32.2	V	155	352
9608.000	43.29	-30.6	36.7	37.18	74.0	30.7	V	155	0
12010.000	46.10	-28.9	38.7	36.32	74.0	27.9	H	155	0

#### GFSK Ch39

Frequency (MHz)	Measurement Result (dB $\mu$ V/m)	Cable loss (dB)	Antenna Factor (dB/m)	Receiver Reading (dB $\mu$ V)	Limit (dB $\mu$ V/m)	Margin (dB)	Antenna Pol. (H/V)	Antenna Height (cm)	Turntable angle (deg)
2362.600	44.16	-35.3	32.0	47.52	74.0	29.8	V	155	270
2508.200	44.04	-35.0	32.1	46.88	74.0	30.0	V	155	270
4882.000	39.62	-33.3	34.2	38.78	74.0	34.4	V	155	22
7323.000	43.44	-30.9	35.8	38.52	74.0	30.6	H	155	0
9764.000	42.52	-30.3	36.9	35.98	74.0	31.5	H	155	44
12205.000	46.06	-28.0	38.8	35.26	74.0	27.9	V	155	132

#### GFSK Ch78

Frequency (MHz)	Measurement Result (dB $\mu$ V/m)	Cable loss (dB)	Antenna Factor (dB/m)	Receiver Reading (dB $\mu$ V)	Limit (dB $\mu$ V/m)	Margin (dB)	Antenna Pol. (H/V)	Antenna Height (cm)	Turntable angle (deg)
2493.580	60.73	2.9	32.1	25.69	74.0	13.3	H	155	22
2494.015	60.84	2.9	32.1	25.81	74.0	13.2	H	155	44
4960.000	39.52	-33.6	34.2	38.93	74.0	34.5	V	155	0
7440.000	41.97	-31.7	35.9	37.78	74.0	32.0	H	155	0
9920.000	43.98	-30.0	37.1	36.89	74.0	30.0	V	155	22
12400.000	45.61	-28.1	38.9	34.77	74.0	28.4	H	155	176



**$\pi/4$  DQPSK Ch0**

Frequency (MHz)	Measurement Result (dB $\mu$ V/m)	Cable loss (dB)	Antenna Factor (dB/m)	Receiver Reading (dB $\mu$ V)	Limit (dB $\mu$ V/m)	Margin (dB)	Antenna Pol. (H/V)	Antenna Height (cm)	Turntable angle (deg)
2368.926	60.45	2.9	32.0	25.62	74.0	13.5	H	155	90
2382.926	60.68	2.9	32.0	25.82	74.0	13.3	H	155	78
4804.000	38.97	-33.3	34.1	38.12	74.0	35.0	H	155	110
7206.000	41.52	-31.2	35.8	36.90	74.0	32.5	V	155	132
9608.000	42.00	-30.6	36.7	35.90	74.0	32.0	V	155	66
12010.000	46.32	-28.9	38.7	36.55	74.0	27.7	V	155	88

 **$\pi/4$  DQPSK Ch39**

Frequency (MHz)	Measurement Result (dB $\mu$ V/m)	Cable loss (dB)	Antenna Factor (dB/m)	Receiver Reading (dB $\mu$ V)	Limit (dB $\mu$ V/m)	Margin (dB)	Antenna Pol. (H/V)	Antenna Height (cm)	Turntable angle (deg)
2367.600	44.92	-35.3	32.0	48.28	74.0	29.1	V	155	270
2531.800	45.14	-34.7	32.2	47.73	74.0	28.9	V	155	268
4882.000	39.67	-33.3	34.2	38.83	74.0	34.3	V	155	176
7323.000	41.75	-30.9	35.8	36.83	74.0	32.3	V	155	198
9764.000	43.77	-30.3	36.9	37.23	74.0	30.2	H	155	0
12205.000	46.60	-28.0	38.8	35.79	74.0	27.4	V	155	22

 **$\pi/4$  DQPSK Ch78**

Frequency (MHz)	Measurement Result (dB $\mu$ V/m)	Cable loss (dB)	Antenna Factor (dB/m)	Receiver Reading (dB $\mu$ V)	Limit (dB $\mu$ V/m)	Margin (dB)	Antenna Pol. (H/V)	Antenna Height (cm)	Turntable angle (deg)
2491.790	60.87	2.9	32.1	25.84	74.0	13.1	H	155	22
2498.815	60.46	2.9	32.1	25.41	74.0	13.5	H	155	242
4960.000	39.80	-33.6	34.2	39.22	74.0	34.2	V	155	44
7440.000	41.03	-31.7	35.9	36.85	74.0	33.0	H	155	88
9920.000	43.22	-30.0	37.1	36.13	74.0	30.8	V	155	176
12400.000	45.75	-28.1	38.9	34.91	74.0	28.2	H	155	0

**8DPSK Ch0**

Frequency (MHz)	Measurement Result (dB $\mu$ V/m)	Cable loss (dB)	Antenna Factor (dB/m)	Receiver Reading (dB $\mu$ V)	Limit (dB $\mu$ V/m)	Margin (dB)	Antenna Pol. (H/V)	Antenna Height (cm)	Turntable angle (deg)
2378.936	60.41	2.9	32.0	25.57	74.0	13.6	V	155	0
2385.446	60.77	2.9	32.0	25.91	74.0	13.2	V	155	22
4804.000	40.42	-33.3	34.1	39.56	74.0	33.6	H	155	0
7206.000	42.83	-31.2	35.8	38.21	74.0	31.2	H	155	264
9608.000	42.32	-30.6	36.7	36.22	74.0	31.7	H	155	110
12010.000	46.21	-28.9	38.7	36.44	74.0	27.8	H	155	242

**8DPSK Ch39**

Frequency (MHz)	Measurement Result (dB $\mu$ V/m)	Cable loss (dB)	Antenna Factor (dB/m)	Receiver Reading (dB $\mu$ V)	Limit (dB $\mu$ V/m)	Margin (dB)	Antenna Pol. (H/V)	Antenna Height (cm)	Turntable angle (deg)
2364.400	44.79	-35.3	32.0	48.15	74.0	29.2	H	155	266
2509.000	44.12	-34.9	32.1	46.94	74.0	29.9	V	155	260
4882.000	39.51	-33.3	34.2	38.67	74.0	34.5	V	155	44
7323.000	41.63	-30.9	35.8	36.70	74.0	32.4	H	155	88
9764.000	42.97	-30.3	36.9	36.43	74.0	31.0	V	155	176
12205.000	46.25	-28.0	38.8	35.44	74.0	27.8	H	155	0

**8DPSK Ch78**

Frequency (MHz)	Measurement Result (dB $\mu$ V/m)	Cable loss (dB)	Antenna Factor (dB/m)	Receiver Reading (dB $\mu$ V)	Limit (dB $\mu$ V/m)	Margin (dB)	Antenna Pol. (H/V)	Antenna Height (cm)	Turntable angle (deg)
2485.115	60.52	2.9	32.1	25.50	74.0	13.5	H	155	22
2491.395	60.82	2.9	32.1	25.79	74.0	13.2	H	155	66
4960.000	41.43	-33.6	34.2	40.84	74.0	32.6	V	155	132
7440.000	41.37	-31.7	35.9	37.18	74.0	32.6	H	155	0
9920.000	43.77	-30.0	37.1	36.67	74.0	30.2	V	155	88
12400.000	46.38	-28.1	38.9	35.54	74.0	27.6	V	155	242

**Average Measurement results**  
**GFSK Ch0**

Frequency (MHz)	Measurement Result (dB $\mu$ V/m)	Cable loss (dB)	Antenna Factor (dB/m)	Receiver Reading (dB $\mu$ V)	Limit (dB $\mu$ V/m)	Margin (dB)	Antenna Pol. (H/V)	Antenna Height (cm)	Turntable angle (deg)
2388.900	46.56	2.9	32.0	11.69	54.0	7.4	H	155	184
2390.000	46.47	2.9	32.0	11.61	54.0	7.5	H	155	6
4804.000	28.79	-33.3	34.1	27.93	54.0	25.2	H	155	26
7206.000	30.50	-31.2	35.8	25.88	54.0	23.5	H	155	246
9608.000	31.42	-30.6	36.7	25.32	54.0	22.6	H	155	8
12010.000	33.98	-28.9	38.7	24.21	54.0	20.0	H	155	2

**GFSK Ch39**

Frequency (MHz)	Measurement Result (dB $\mu$ V/m)	Cable loss (dB)	Antenna Factor (dB/m)	Receiver Reading (dB $\mu$ V)	Limit (dB $\mu$ V/m)	Margin (dB)	Antenna Pol. (H/V)	Antenna Height (cm)	Turntable angle (deg)
2436.900	46.64	2.9	32.0	11.70	54.0	7.4	H	155	8
2445.400	46.84	2.9	32.1	11.88	54.0	7.2	H	155	52
4882.000	28.66	-33.3	34.2	27.82	54.0	25.3	H	155	18
7323.000	30.80	-30.9	35.8	25.88	54.0	23.2	H	155	6
9764.000	31.78	-30.3	36.9	25.24	54.0	22.2	H	155	48
12205.000	34.88	-28.0	38.8	24.08	54.0	19.1	H	155	128

**GFSK Ch78**

Frequency (MHz)	Measurement Result (dB $\mu$ V/m)	Cable loss (dB)	Antenna Factor (dB/m)	Receiver Reading (dB $\mu$ V)	Limit (dB $\mu$ V/m)	Margin (dB)	Antenna Pol. (H/V)	Antenna Height (cm)	Turntable angle (deg)
2483.500	49.07	2.9	32.1	14.06	54.0	4.9	H	155	28
2483.600	48.04	2.9	32.1	13.02	54.0	6.0	H	155	46
4960.000	28.45	-33.6	34.2	27.86	54.0	25.5	H	155	8
7440.000	30.10	-31.7	35.9	25.92	54.0	23.9	H	155	6
9920.000	31.93	-30.0	37.1	24.84	54.0	22.1	H	155	24
12400.000	34.82	-28.1	38.9	23.98	54.0	19.2	H	155	185

**$\pi/4$  DQPSK Ch0**

Frequency (MHz)	Measurement Result (dB $\mu$ V/m)	Cable loss (dB)	Antenna Factor (dB/m)	Receiver Reading (dB $\mu$ V)	Limit (dB $\mu$ V/m)	Margin (dB)	Antenna Pol. (H/V)	Antenna Height (cm)	Turntable angle (deg)
2388.300	46.54	2.9	32.0	11.68	54.0	7.5	H	155	88
2390.000	46.51	2.9	32.0	11.65	54.0	7.5	H	155	84
4804.000	28.76	-33.3	34.1	27.91	54.0	25.2	H	155	119
7206.000	30.49	-31.2	35.8	25.87	54.0	23.5	H	155	146
9608.000	31.45	-30.6	36.7	25.35	54.0	22.5	H	155	76
12010.000	34.07	-28.9	38.7	24.30	54.0	19.9	H	155	94

 **$\pi/4$  DQPSK Ch39**

Frequency (MHz)	Measurement Result (dB $\mu$ V/m)	Cable loss (dB)	Antenna Factor (dB/m)	Receiver Reading (dB $\mu$ V)	Limit (dB $\mu$ V/m)	Margin (dB)	Antenna Pol. (H/V)	Antenna Height (cm)	Turntable angle (deg)
2436.700	46.60	2.9	32.0	11.66	54.0	7.4	H	155	92
2445.500	46.65	2.9	32.1	11.69	54.0	7.4	H	155	115
4882.000	28.57	-33.3	34.2	27.73	54.0	25.4	H	155	174
7323.000	30.67	-30.9	35.8	25.74	54.0	23.3	H	155	195
9764.000	31.77	-30.3	36.9	25.23	54.0	22.2	H	155	2
12205.000	34.96	-28.0	38.8	24.15	54.0	19.0	H	155	25

 **$\pi/4$  DQPSK Ch78**

Frequency (MHz)	Measurement Result (dB $\mu$ V/m)	Cable loss (dB)	Antenna Factor (dB/m)	Receiver Reading (dB $\mu$ V)	Limit (dB $\mu$ V/m)	Margin (dB)	Antenna Pol. (H/V)	Antenna Height (cm)	Turntable angle (deg)
2483.500	48.21	2.9	32.1	13.19	54.0	5.8	H	155	28
2483.600	48.07	2.9	32.1	13.06	54.0	5.9	H	155	248
4960.000	28.55	-33.6	34.2	27.96	54.0	25.5	H	155	38
7440.000	30.09	-31.7	35.9	25.90	54.0	23.9	H	155	98
9920.000	31.93	-30.0	37.1	24.83	54.0	22.1	H	155	183
12400.000	34.69	-28.1	38.9	23.85	54.0	19.3	H	155	356

**8DPSK Ch0**

Frequency (MHz)	Measurement Result (dB $\mu$ V/m)	Cable loss (dB)	Antenna Factor (dB/m)	Receiver Reading (dB $\mu$ V)	Limit (dB $\mu$ V/m)	Margin (dB)	Antenna Pol. (H/V)	Antenna Height (cm)	Turntable angle (deg)
2388.100	46.54	2.9	32.0	11.68	54.0	7.5	H	155	8
2390.000	46.51	2.9	32.0	11.65	54.0	7.5	H	155	28
4804.000	28.77	-33.3	34.1	27.91	54.0	25.2	H	155	6
7206.000	30.61	-31.2	35.8	26.00	54.0	23.4	H	155	278
9608.000	31.45	-30.6	36.7	25.35	54.0	22.5	H	155	122
12010.000	34.06	-28.9	38.7	24.28	54.0	19.9	H	155	245

**8DPSK Ch39**

Frequency (MHz)	Measurement Result (dB $\mu$ V/m)	Cable loss (dB)	Antenna Factor (dB/m)	Receiver Reading (dB $\mu$ V)	Limit (dB $\mu$ V/m)	Margin (dB)	Antenna Pol. (H/V)	Antenna Height (cm)	Turntable angle (deg)
2436.800	46.73	2.9	32.0	11.79	54.0	7.3	H	155	28
2445.500	46.73	2.9	32.1	11.77	54.0	7.3	H	155	248
4882.000	28.72	-33.3	34.2	27.88	54.0	25.3	H	155	38
7323.000	30.77	-30.9	35.8	25.85	54.0	23.2	H	155	98
9764.000	31.81	-30.3	36.9	25.27	54.0	22.2	H	155	183
12205.000	34.88	-28.0	38.8	24.07	54.0	19.1	H	155	356

**8DPSK Ch78**

Frequency (MHz)	Measurement Result (dB $\mu$ V/m)	Cable loss (dB)	Antenna Factor (dB/m)	Receiver Reading (dB $\mu$ V)	Limit (dB $\mu$ V/m)	Margin (dB)	Antenna Pol. (H/V)	Antenna Height (cm)	Turntable angle (deg)
2483.500	48.37	2.9	32.1	13.35	54.0	5.6	H	155	28
2483.600	48.09	2.9	32.1	13.07	54.0	5.9	H	155	74
4960.000	28.52	-33.6	34.2	27.93	54.0	25.5	H	155	140
7440.000	30.13	-31.7	35.9	25.94	54.0	23.9	H	155	8
9920.000	31.99	-30.0	37.1	24.90	54.0	22.0	H	155	80
12400.000	34.78	-28.1	38.9	23.93	54.0	19.2	H	155	243

**Conclusion: Pass**

## B.7. Time of Occupancy (Dwell Time)

**Method of Measurement: See ANSI C63.10-clause 7.8.4**

The EUT must have its hopping function enabled. Use the following spectrum analyzer settings:

- Span = zero span, centered on a hopping channel
- RBW = 1 MHz
- VBW  $\geq$  RBW
- Sweep = as necessary to capture the entire dwell time per hopping channel
- Detector function = peak
- Trace = max hold

Measure a pulse time in time domain at middle frequency and then count the hopping number in 31.6s(which equals with 0.4 multiply 79) of middle frequency ,then multiply the pulse time and hopping number and record them.

### Measurement Limit:

Standard	Limit (ms)
FCC 47 CFR Part 15.247(a) (1)(iii)	< 400

### Measurement Result:

#### For GFSK

Channel	Packet	Pulse time (ms)		Number of Transmissions		Dwell Time (ms)	Conclusion
		Fig.	Value	Fig.	Value		
39	DH1	Fig.64	0.38	Fig.65	321	121.98	P
	DH3	Fig.66	1.64	Fig.67	101	165.64	P
	DH5	Fig.68	2.89	Fig.69	66	190.74	P

#### For $\pi/4$ DQPSK

Channel	Packet	Pulse time (ms)		Number of Transmissions		Dwell Time (ms)	Conclusion
		Fig.	Value	Fig.	Value		
39	2DH1	Fig.70	0.39	Fig.71	320	124.8	P
	2DH3	Fig.72	1.64	Fig.73	112	183.68	P
	2DH5	Fig.74	2.88	Fig.75	61	175.68	P

**For 8DPSK**

Channel	Packet	Pulse time (ms)		Number of Transmissions		Dwell Time (ms)	Conclusion
		Fig.76	0.39	Fig.77	319		
39	3DH1	Fig.76	0.39	Fig.77	319	124.41	P
	3DH3	Fig.78	1.64	Fig.79	102	167.28	P
	3DH5	Fig.80	2.89	Fig.81	58	167.62	P

**Conclusion: PASS**

**Test graphs as below:**

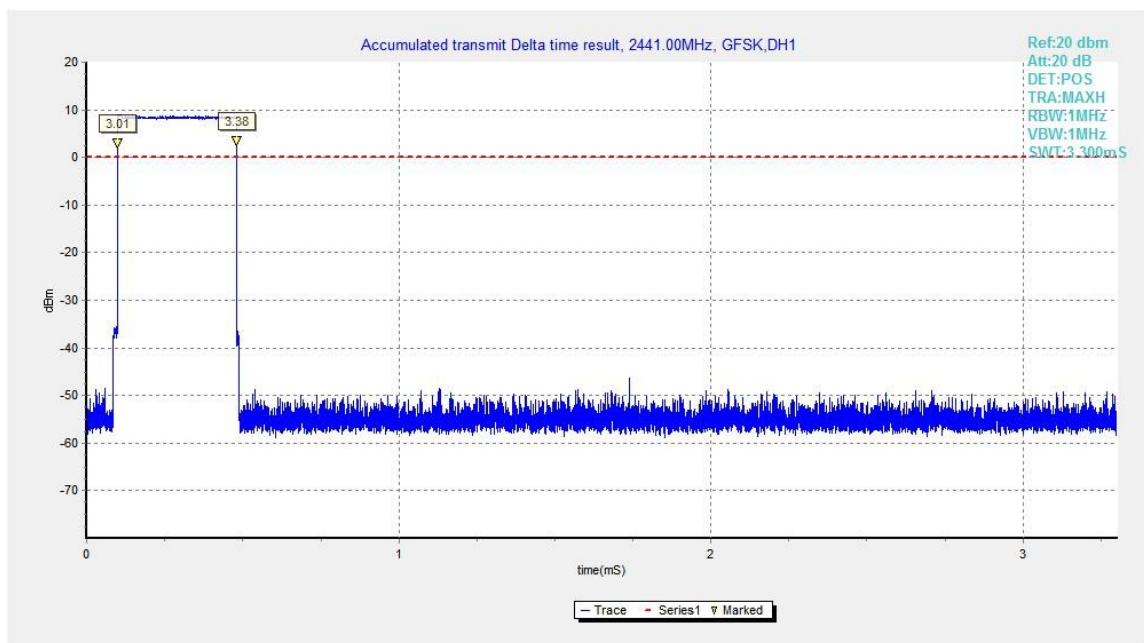

Fig.64. Time of occupancy (Dwell Time): Channel 39, Packet DH1

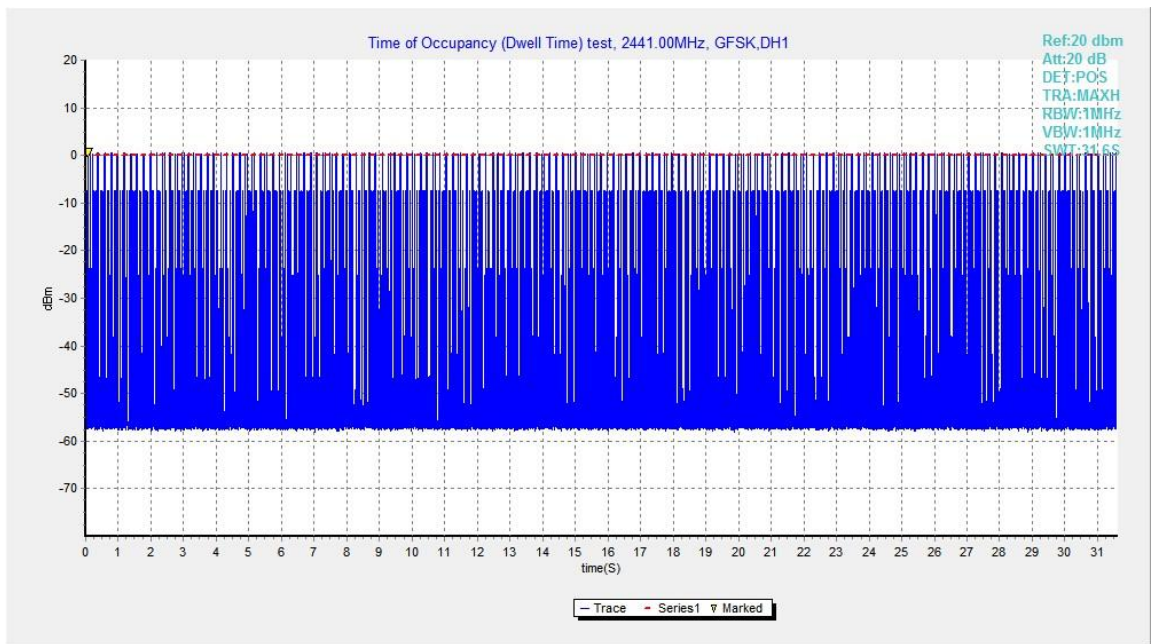

Fig.65. Number of Transmissions Measurement: Channel 39,Packet DH1

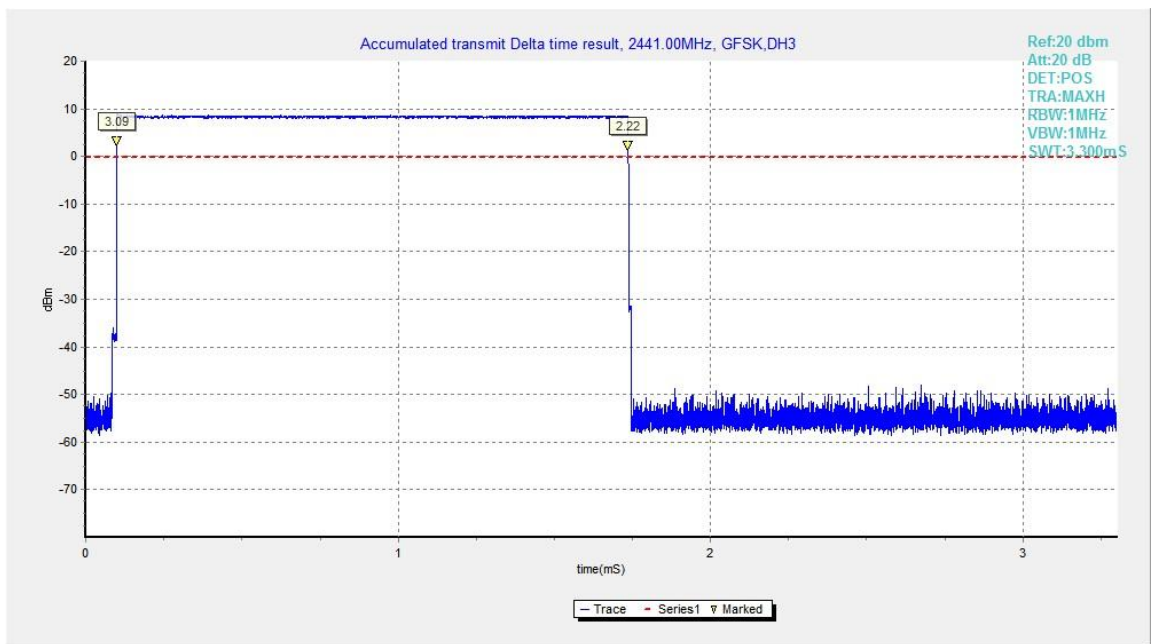

Fig.66. Time of occupancy (Dwell Time): Channel 39, Packet DH3



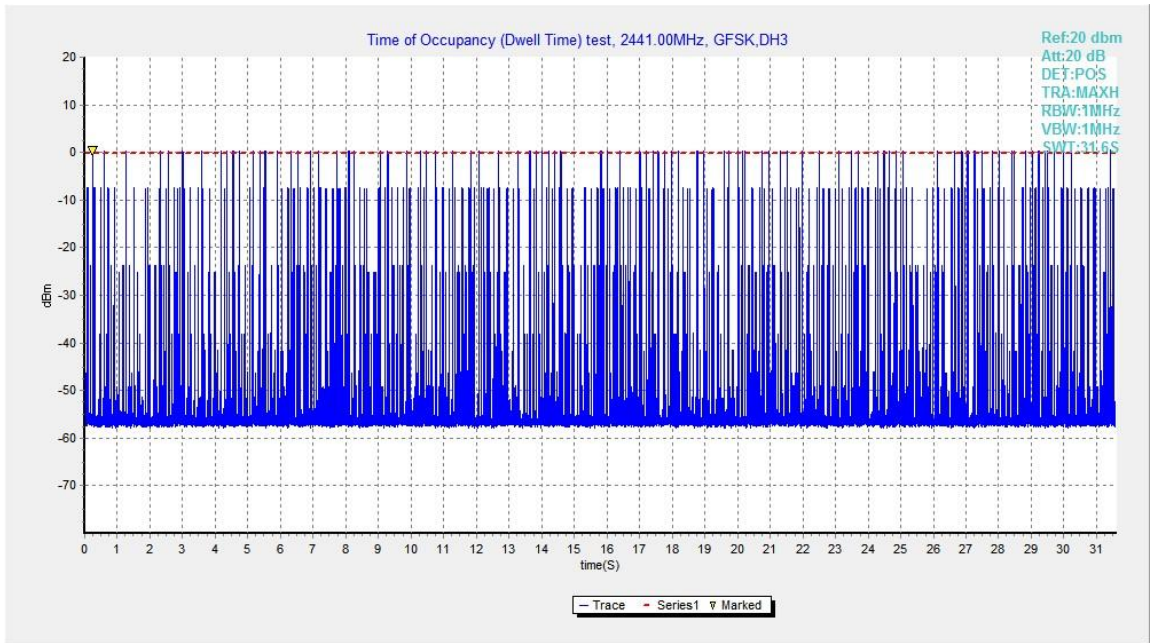

Fig.67. Number of Transmissions Measurement: Channel 39,Packet DH3

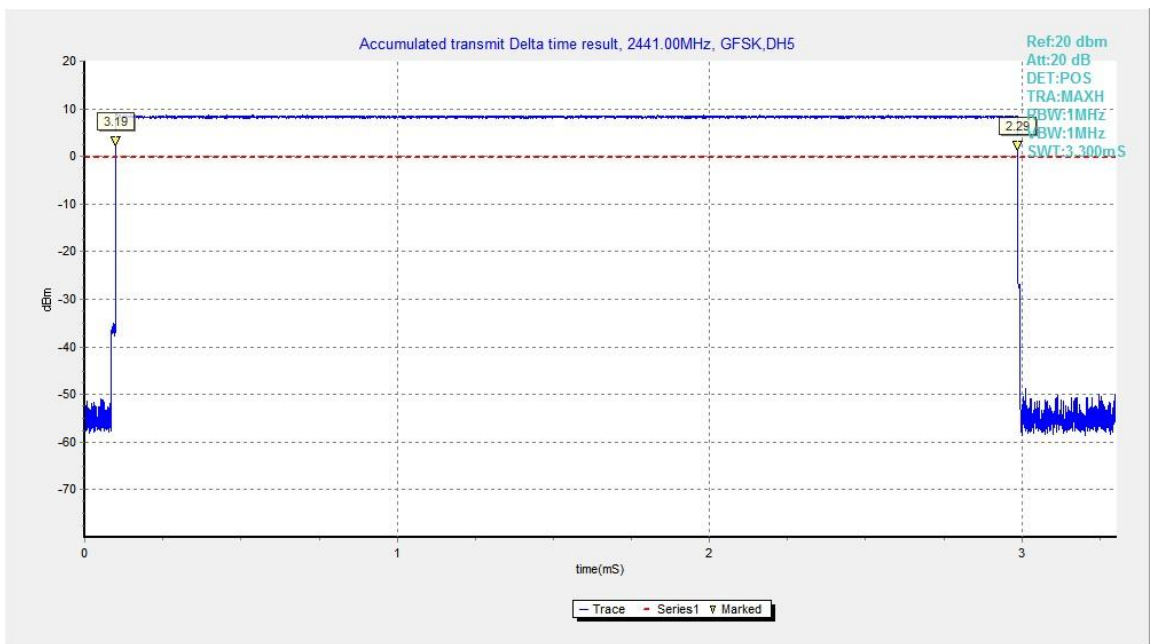

Fig.68. Time of occupancy (Dwell Time): Channel 39, Packet DH5

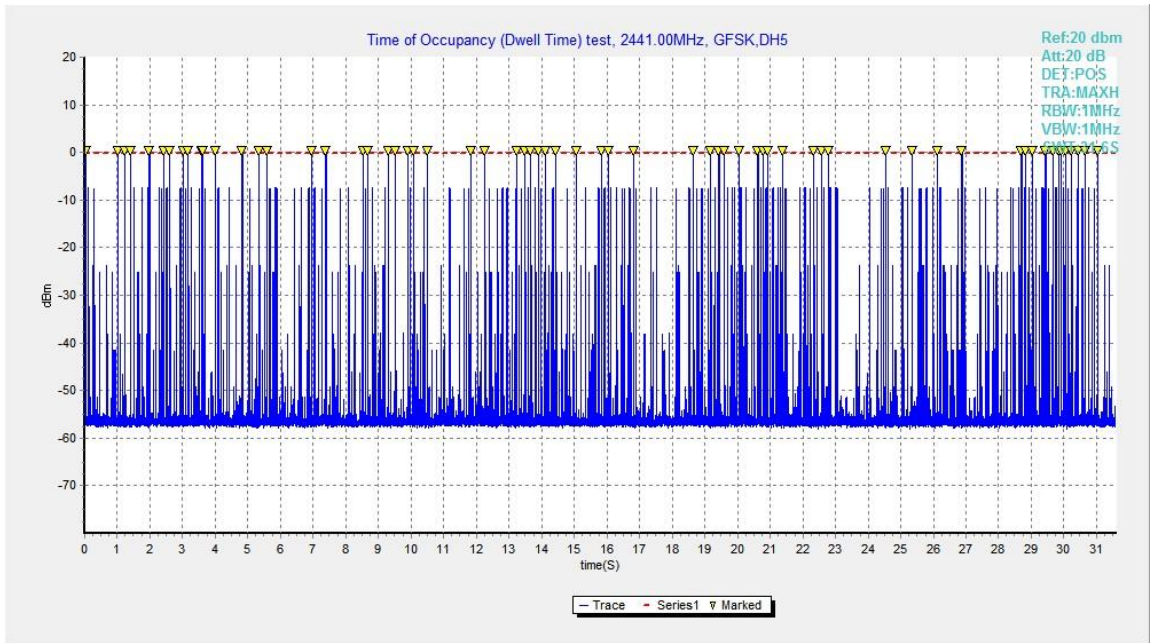

Fig.69. Number of Transmissions Measurement: Channel 39,Packet DH5

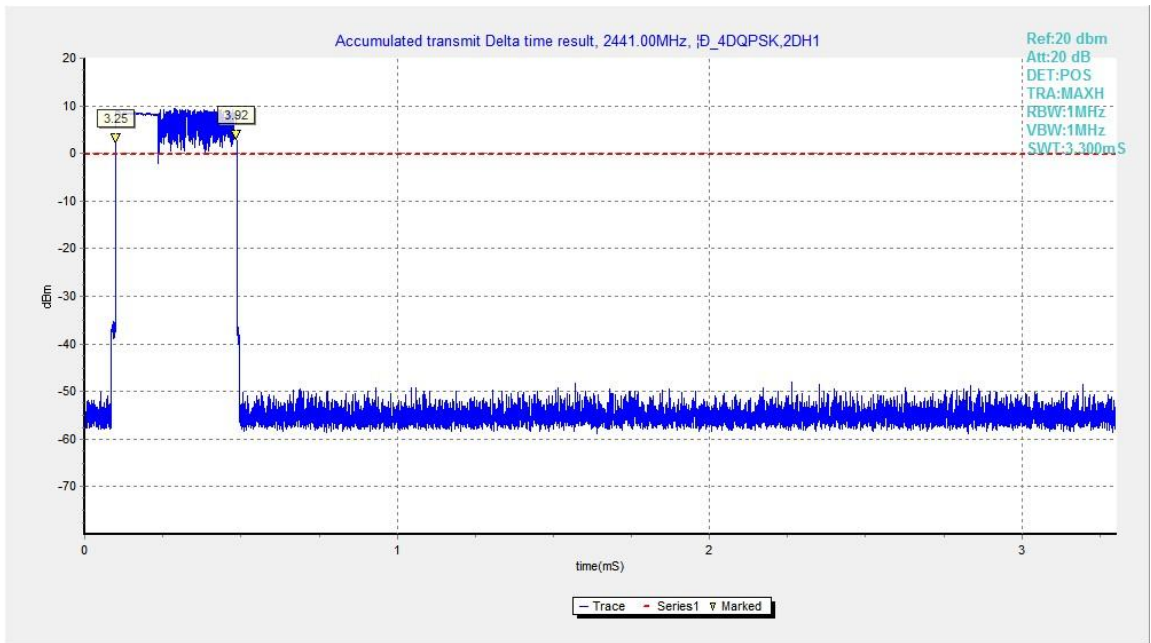

Fig.70. Time of occupancy (Dwell Time): Channel 39, Packet 2-DH1

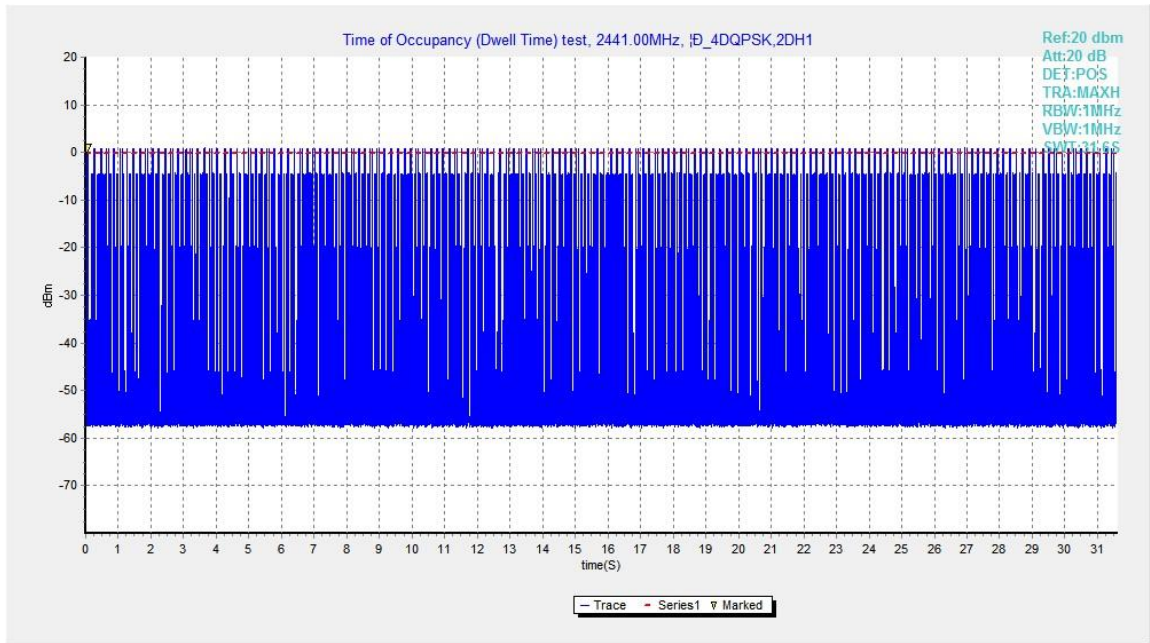

Fig.71. Number of Transmissions Measurement: Channel 39,Packet 2-DH1

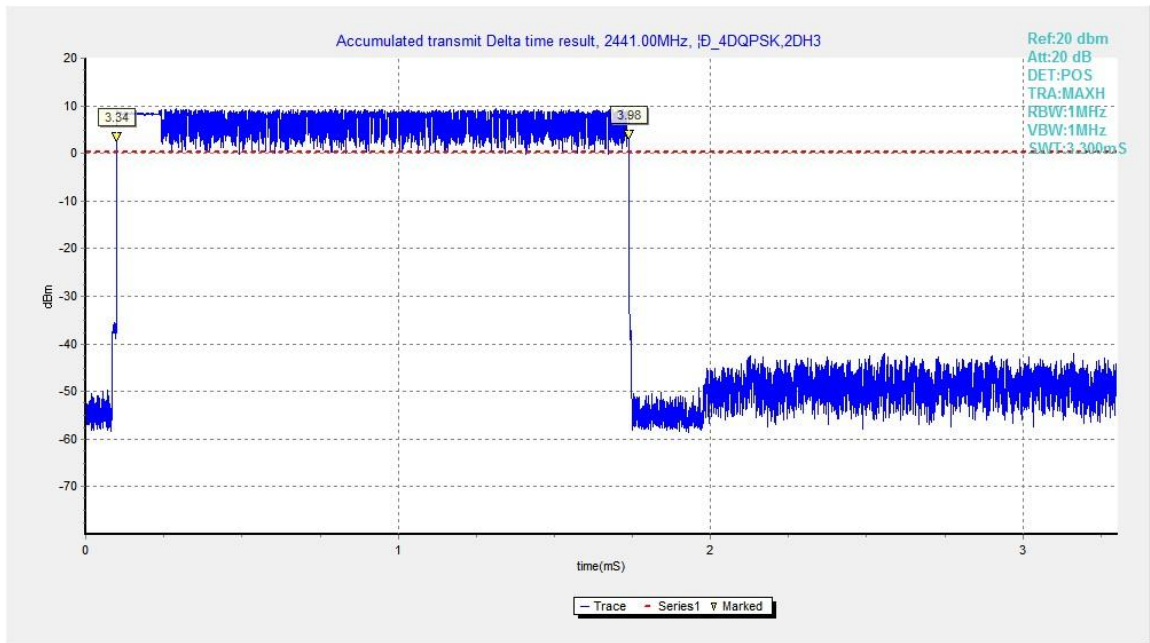

Fig.72. Time of occupancy (Dwell Time): Channel 39, Packet 2-DH3

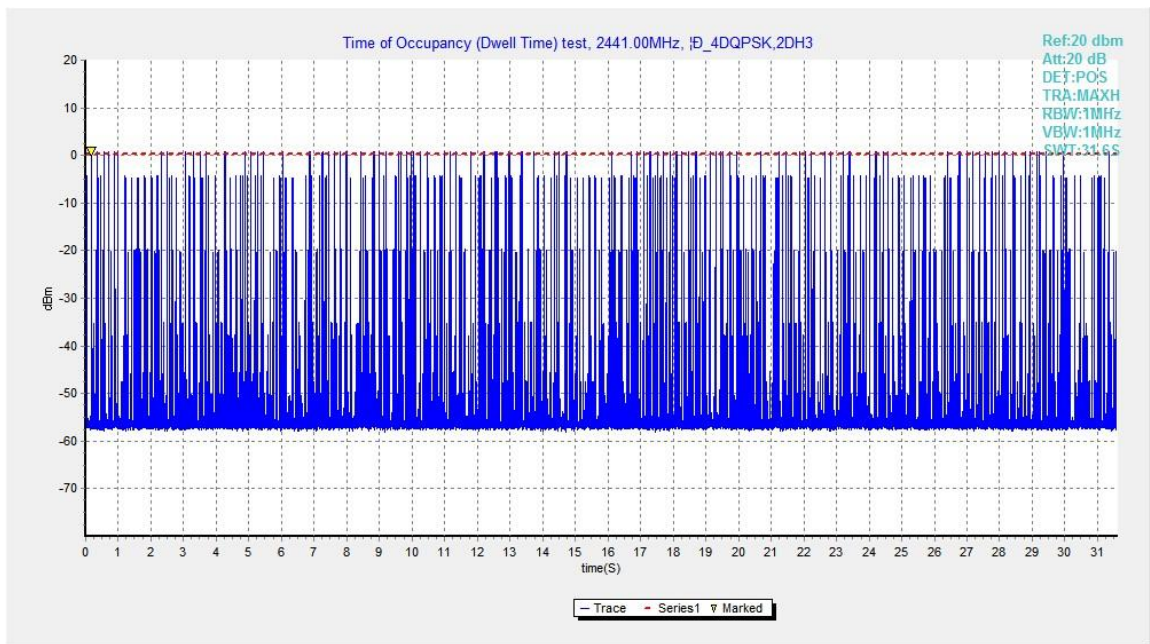

Fig.73. Number of Transmissions Measurement: Channel 39, Packet 2-DH3

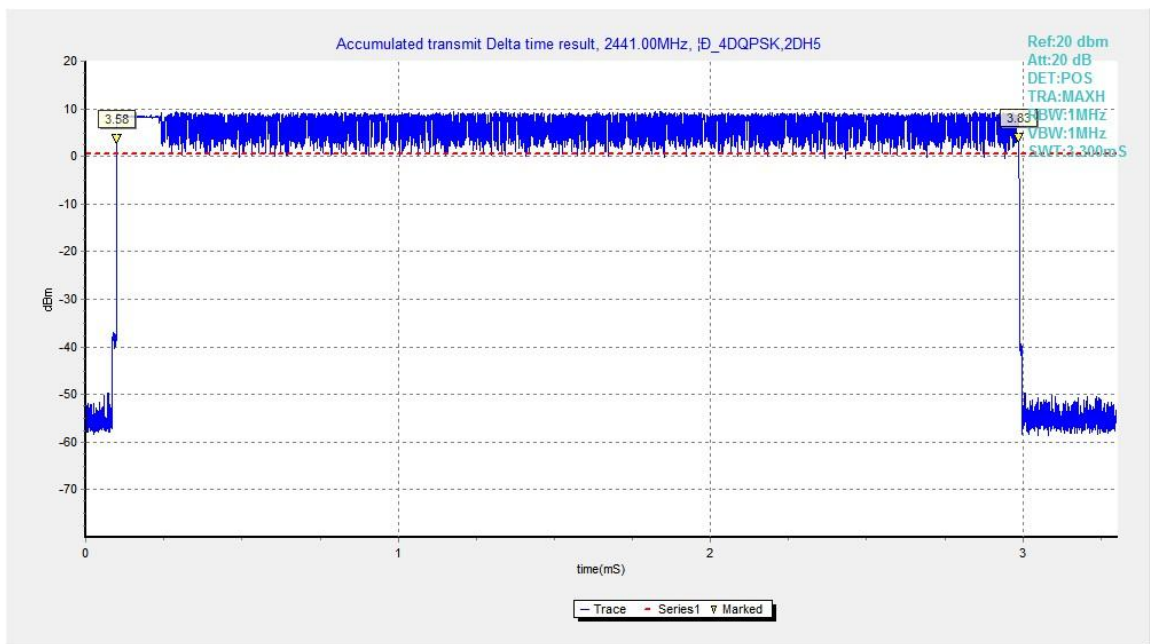

Fig.74. Time of occupancy (Dwell Time): Channel 39, Packet 2-DH5

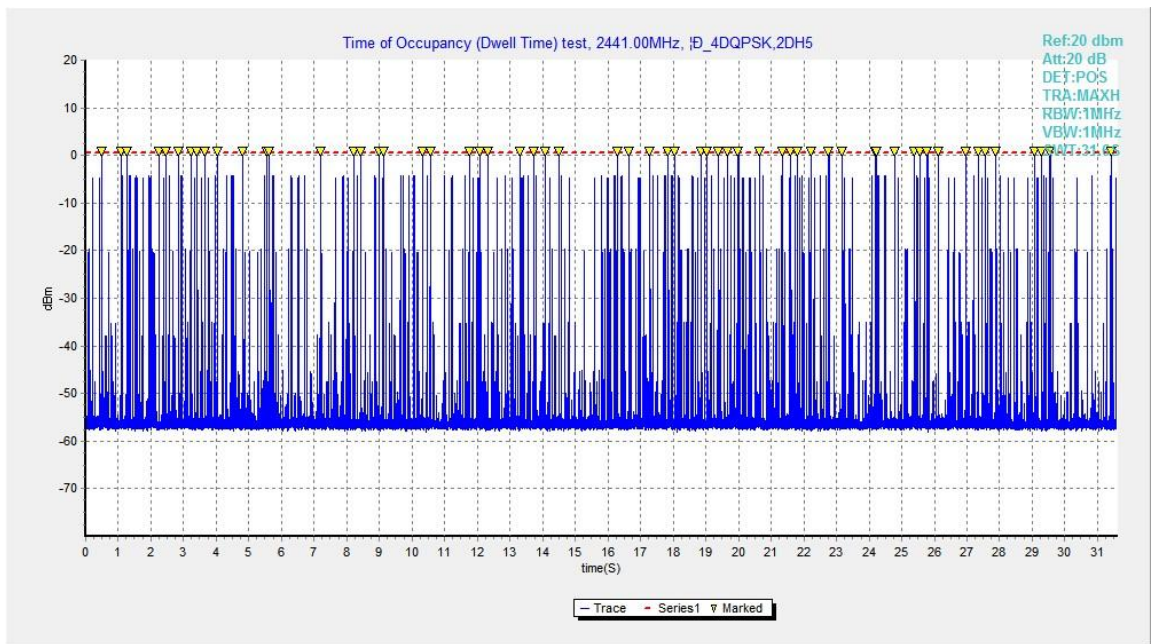

Fig.75. Number of Transmissions Measurement: Channel 39,Packet 2-DH5

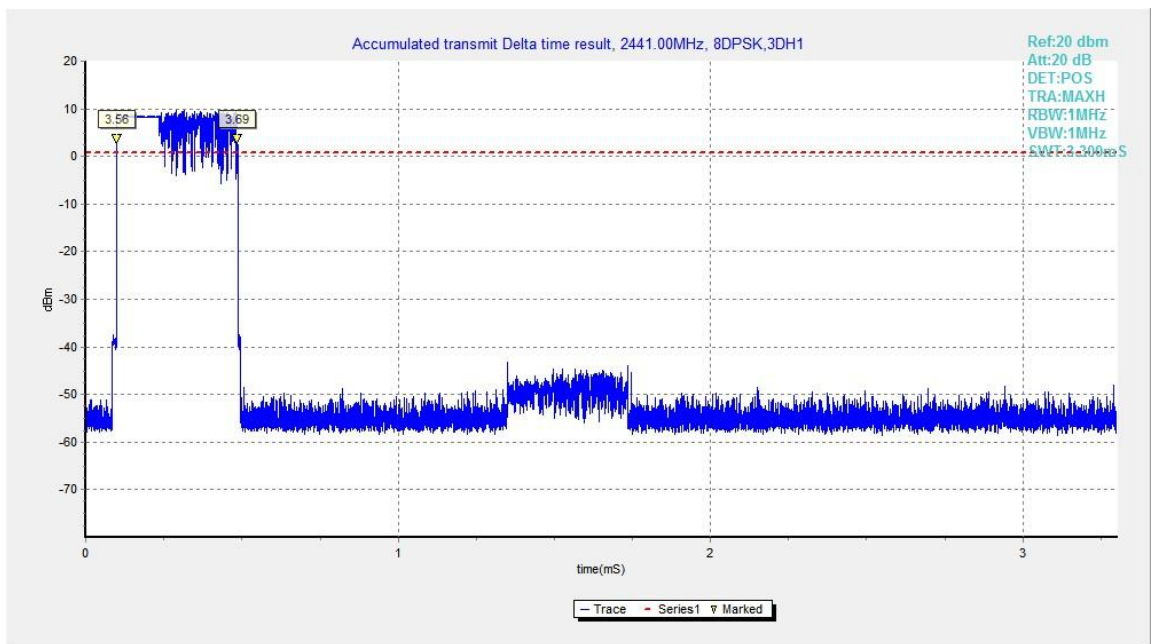

Fig.76. Time of occupancy (Dwell Time): Channel 39, Packet 3-DH1

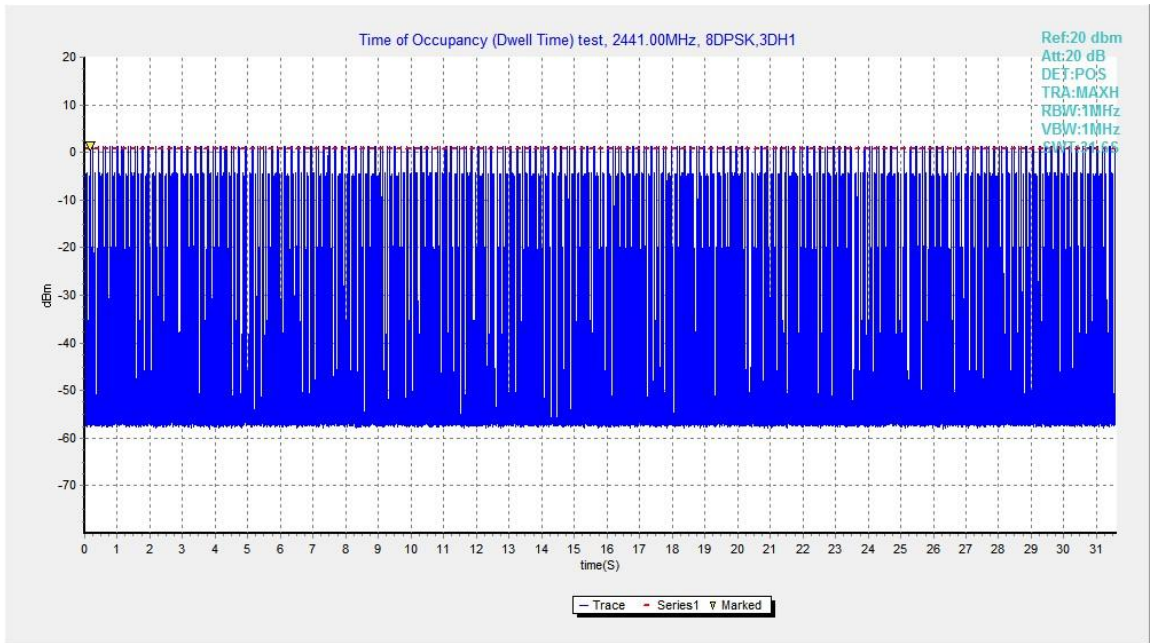

Fig.77. Number of Transmissions Measurement: Channel 39,Packet 3-DH1

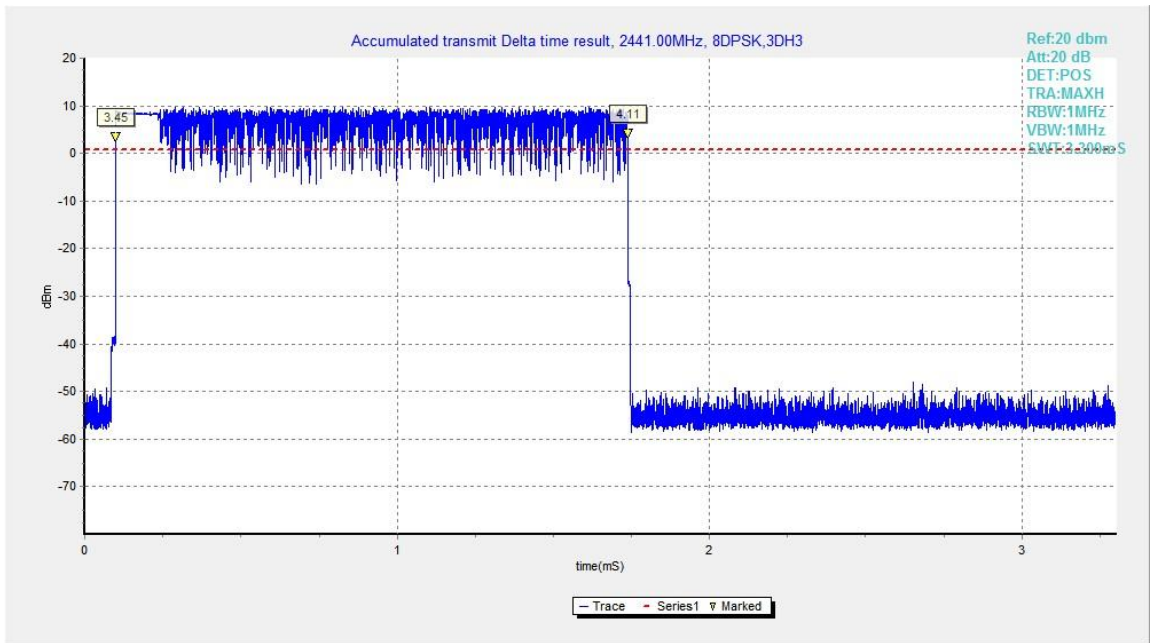

Fig.78. Time of occupancy (Dwell Time): Channel 39, Packet 3-DH3

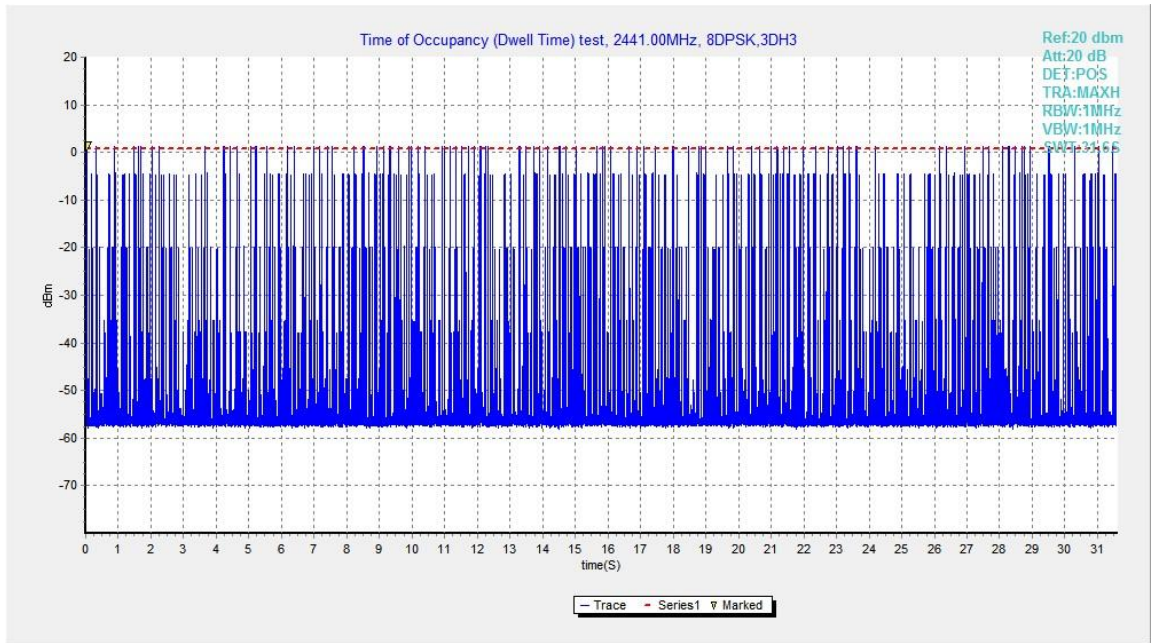

Fig.79. Number of Transmissions Measurement: Channel 39,Packet 3-DH3

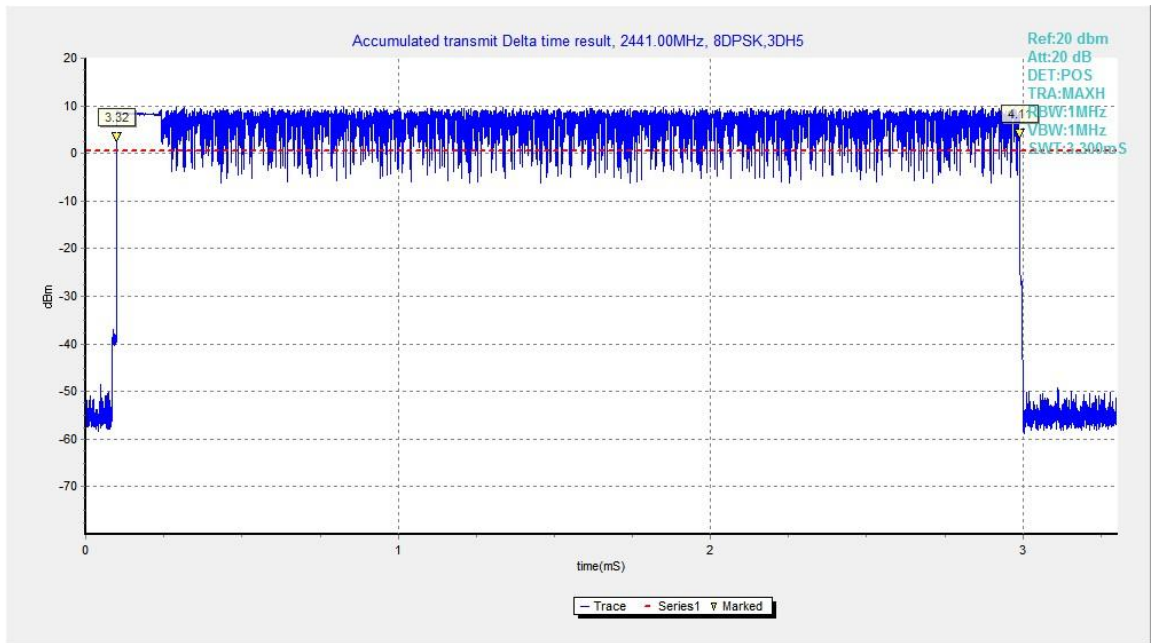

Fig.80. Time of occupancy (Dwell Time): Channel 39, Packet 3-DH5

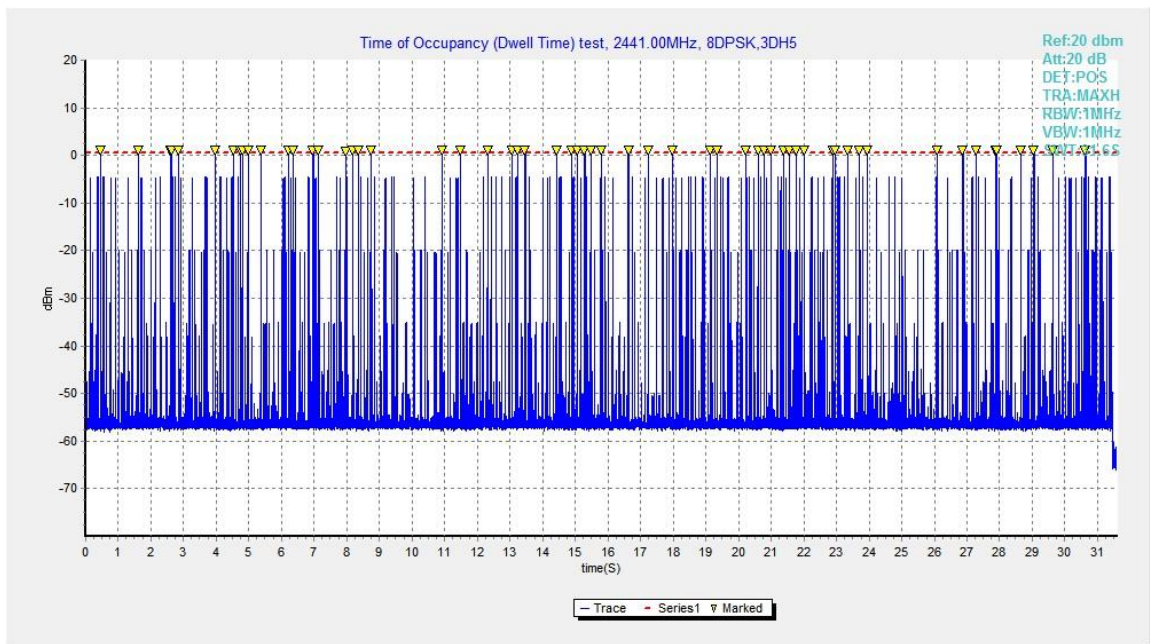

Fig.81. Number of Transmissions Measurement: Channel 39,Packet 3-DH5



## B.8. 20dB Bandwidth

**Method of Measurement: See ANSI C63.10-clause 6.9.2**

Measurement Procedure - Unwanted Emissions

1. Set RBW = 30kHz.
2. Set VBW = 100 kHz.
3. Set span to 3MHz
4. Detector = peak.
5. Trace Mode = max hold.
6. Sweep = auto couple.
7. Allow the trace to stabilize (this may take some time, depending on the extent of the span).

### Measurement Limit:

Standard	Limit
FCC 47 CFR Part 15.247(a)(1)	NA *

Use NdB Down function of the SA to measure the 20dB Bandwidth

\* Comment: This test case is not required according to the latest FCC 47 CFR Part 15.247. But the test results are necessary for “carrier frequency separation” test case, in Annex A.8.

### Measurement Results:

#### For GFSK

Channel	20dB Bandwidth (kHz)		Conclusion
0	Fig.82	946.50	NA
39	Fig.83	926.25	NA
78	Fig.84	928.50	NA

#### For $\pi/4$ DQPSK

Channel	20dB Bandwidth (kHz)		Conclusion
0	Fig.85	1311.75	NA
39	Fig.86	1308.00	NA
78	Fig.87	1310.25	NA

#### For 8DPSK

Channel	20dB Bandwidth (kHz)		Conclusion
0	Fig.88	1302.75	NA
39	Fig.89	1284.00	NA
78	Fig.90	1283.25	NA

**Conclusion: NA**

**Test graphs as below:**

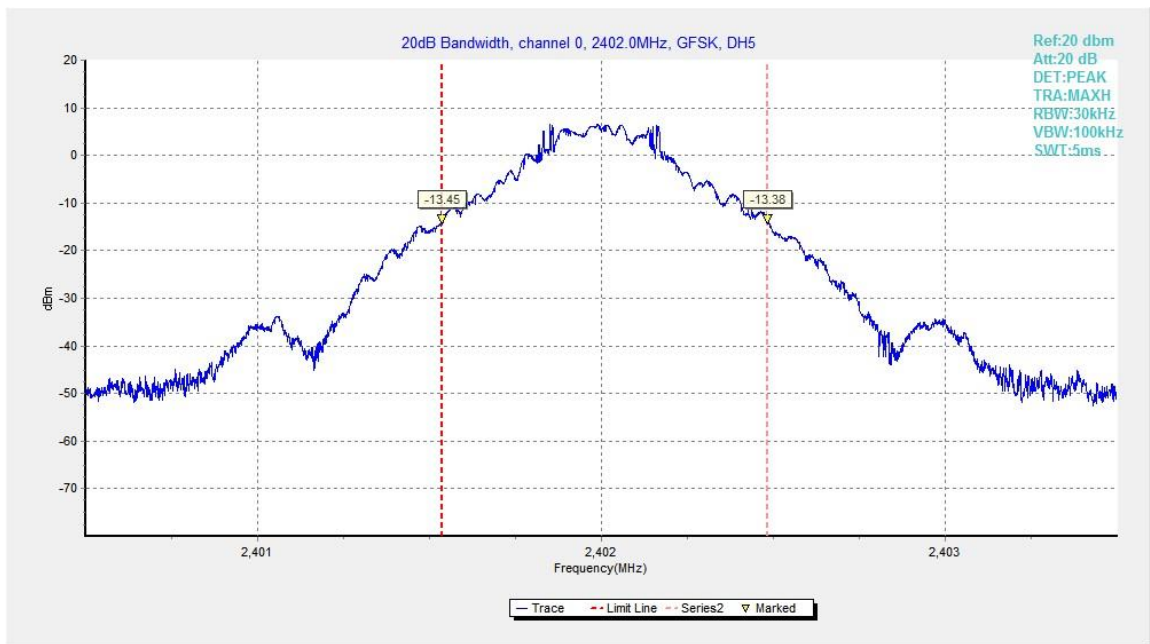

Fig.82. 20dB Bandwidth: GFSK, Channel 0

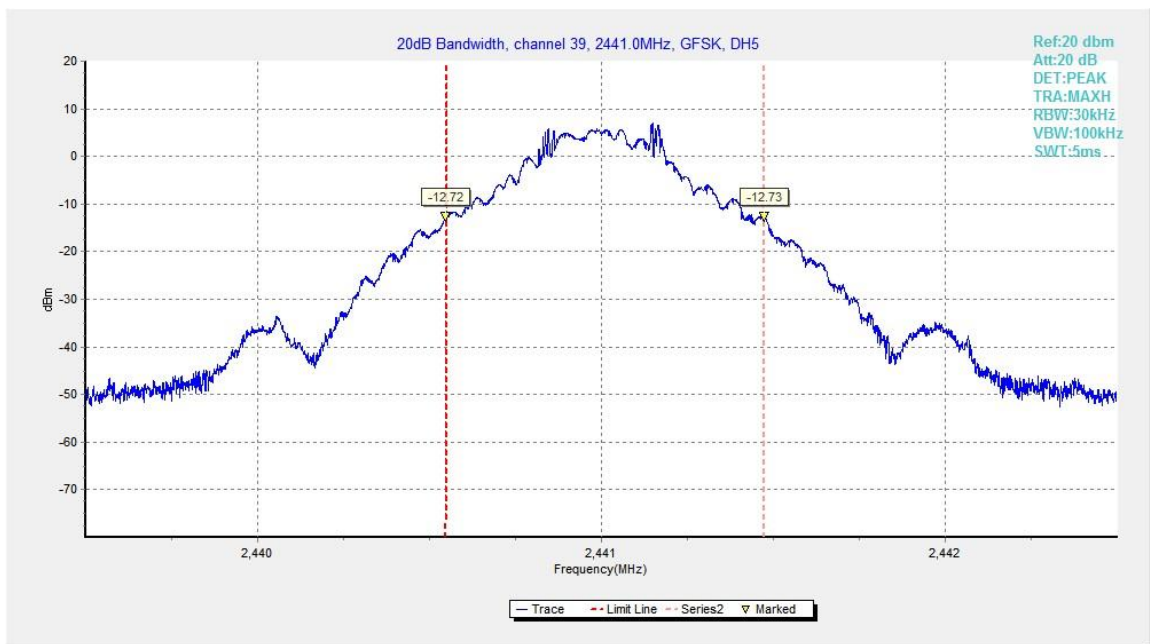

Fig.83. 20dB Bandwidth: GFSK, Channel 39

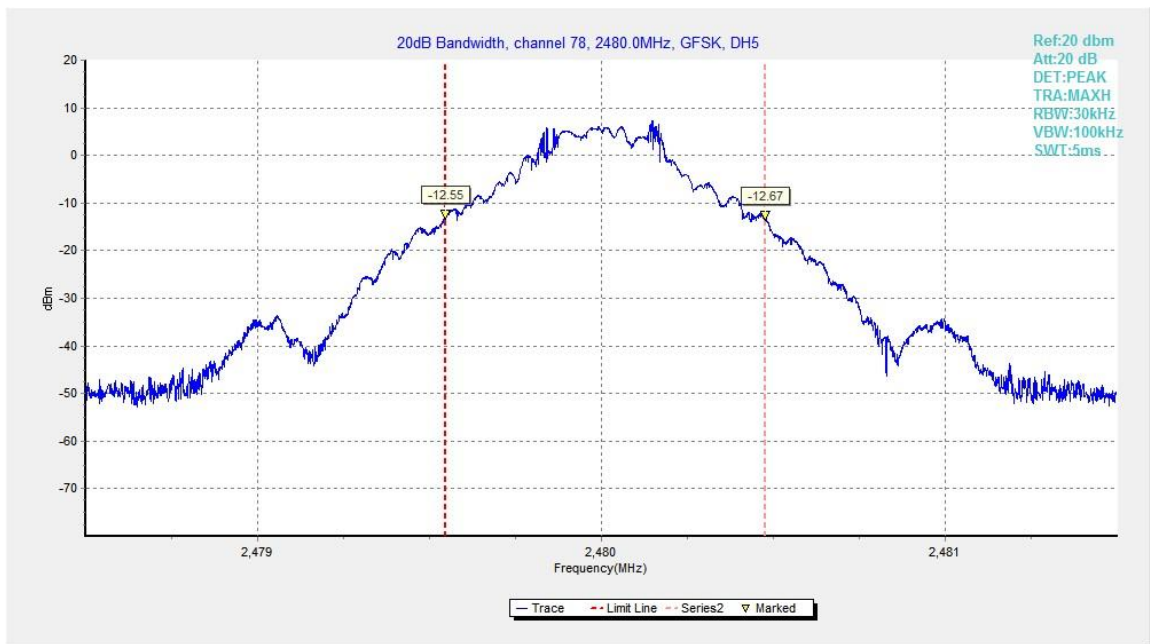

Fig.84. 20dB Bandwidth: GFSK, Channel 78

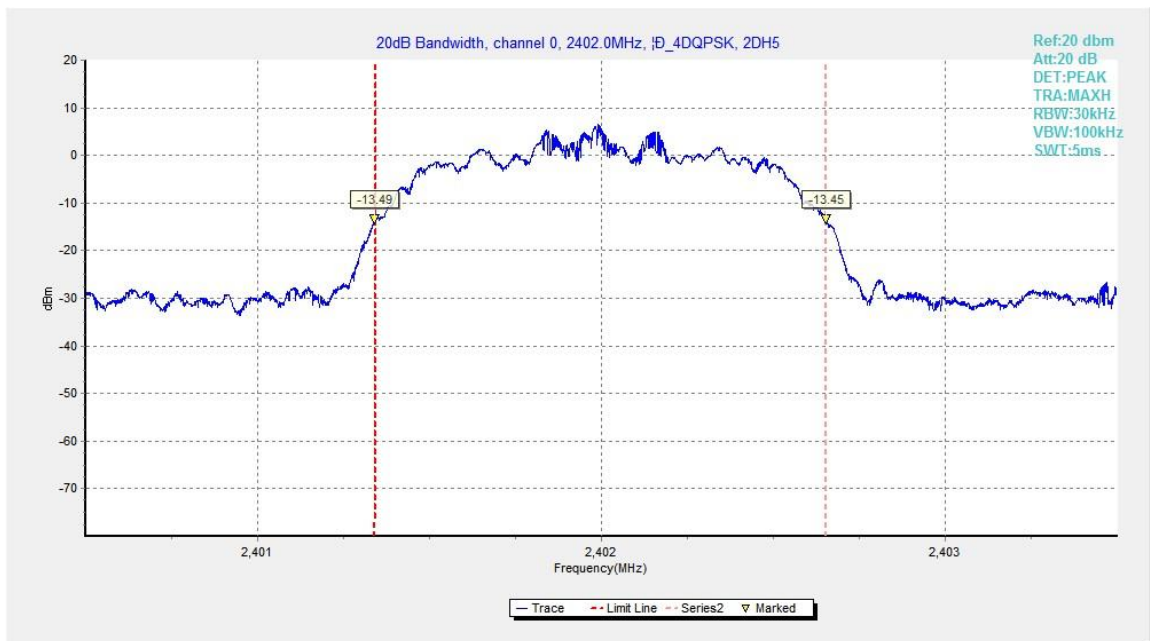

Fig.85. 20dB Bandwidth:  $\pi/4$  DQPSK, Channel 0

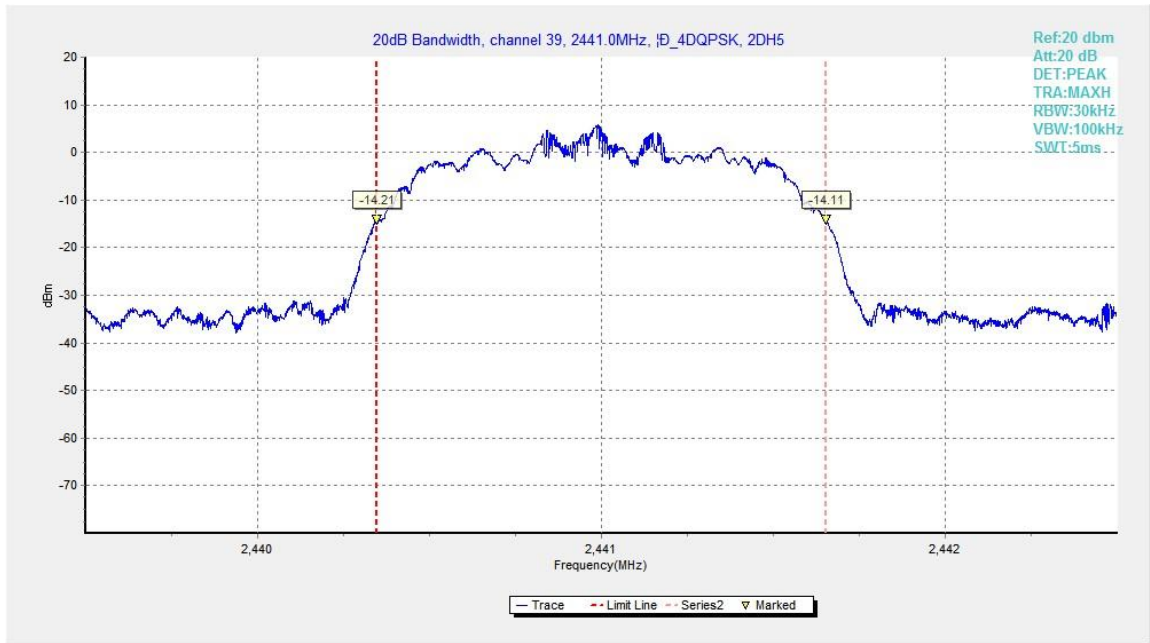

Fig.86. 20dB Bandwidth:  $\pi/4$  DQPSK, Channel 39

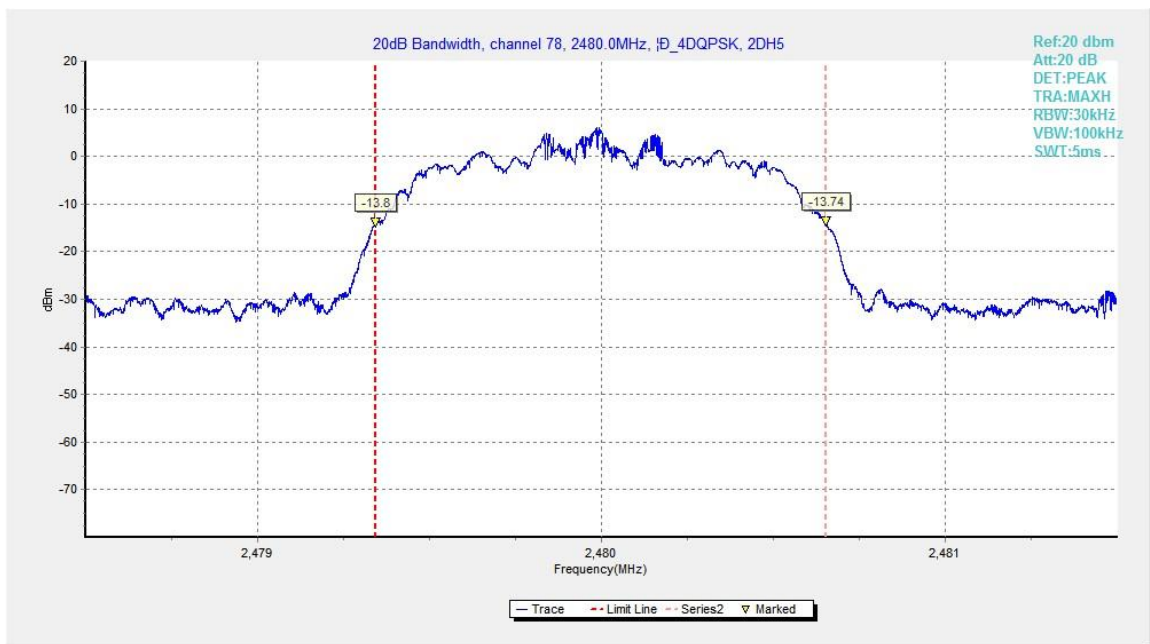

Fig.87. 20dB Bandwidth:  $\pi/4$  DQPSK, Channel 78

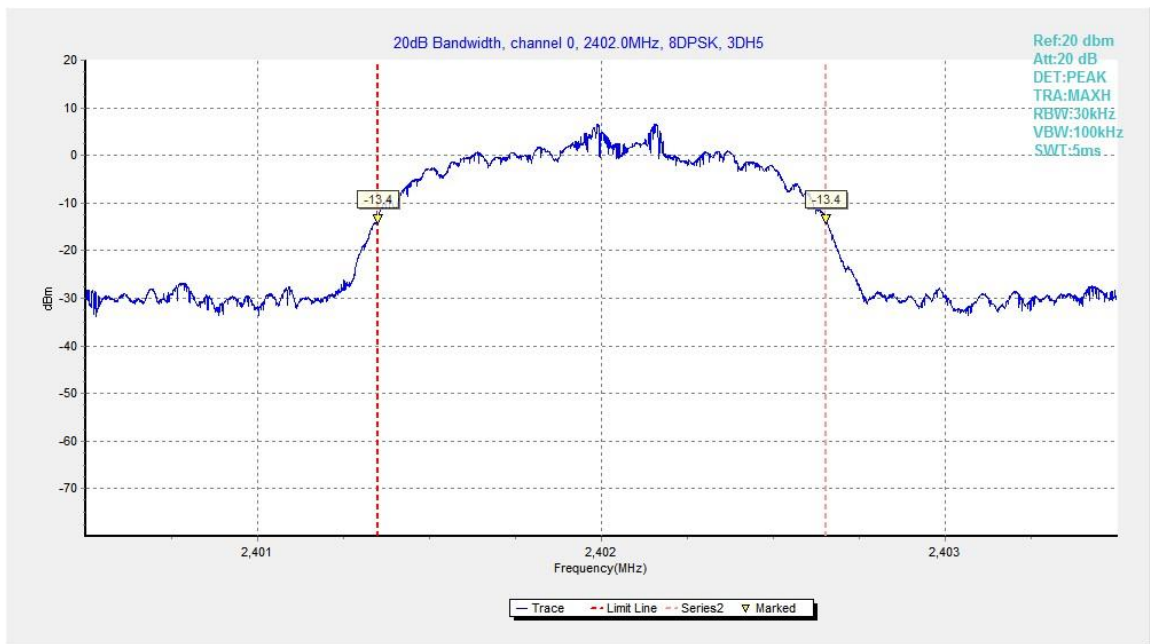

Fig.88. 20dB Bandwidth: 8DPSK, Channel 0

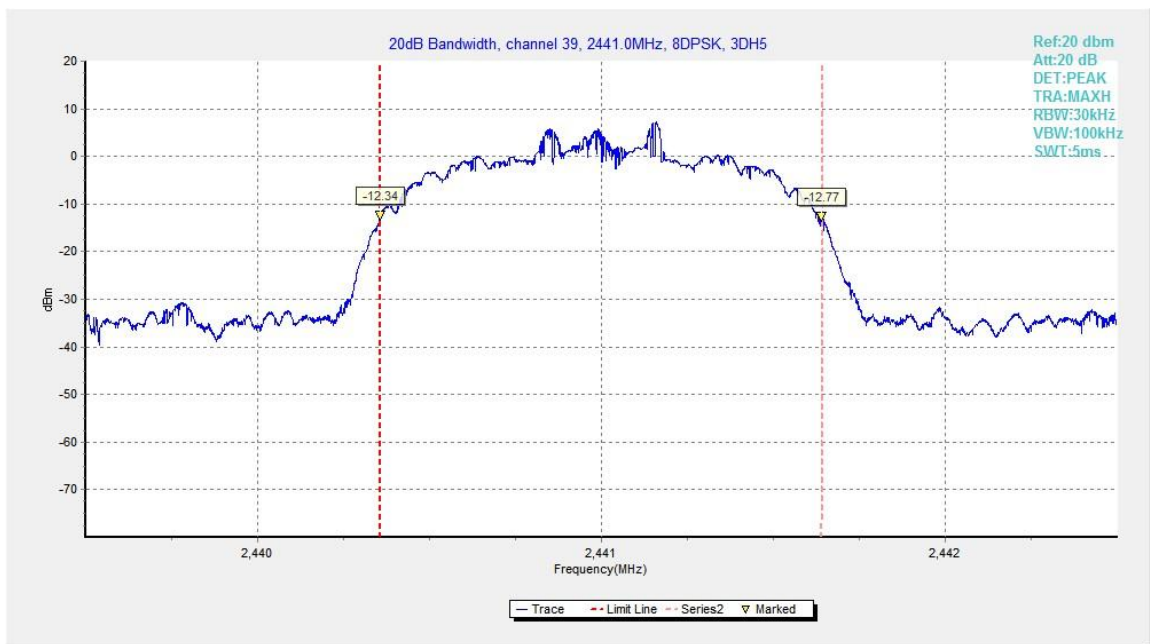

Fig.89. 20dB Bandwidth: 8DPSK, Channel 39

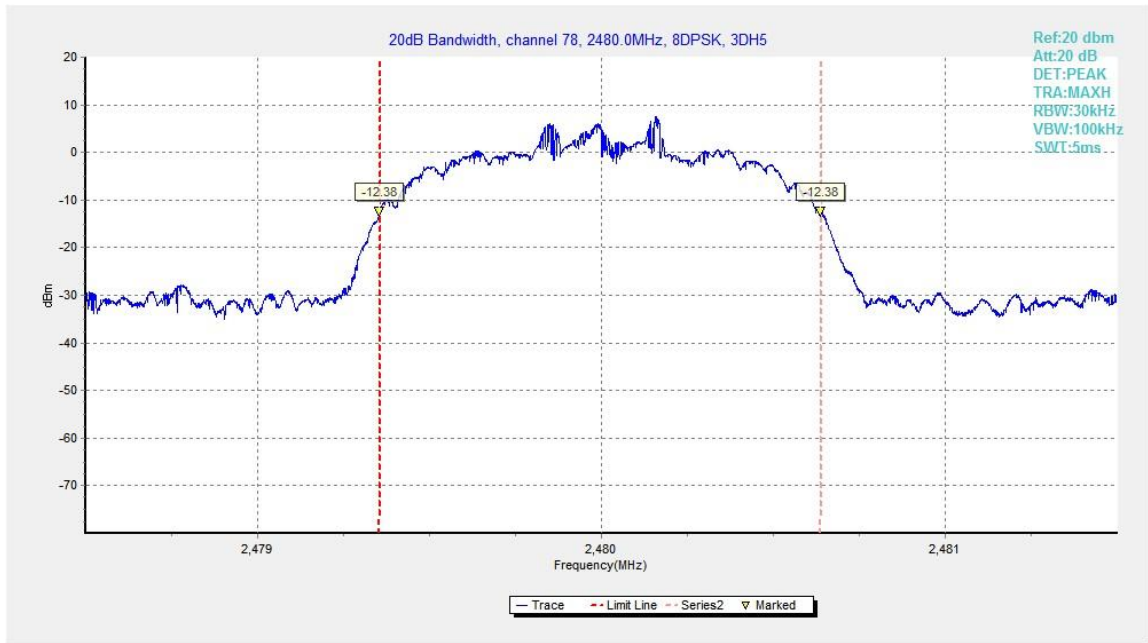

Fig.90. 20dB Bandwidth: 8DPSK, Channel 78

## B.9. Carrier Frequency Separation

**Method of Measurement: See ANSI C63.10-clause 7.8.2**

The EUT must have its hopping function enabled. Use the following spectrum analyzer settings:

- Span = 3MHz
- RBW=300kHz
- VBW=300kHz
- Sweep = auto
- Detector function = peak
- Trace = max hold
- Allow the trace to stabilize

Search the peak marks of the middle frequency and adjacent channel, then record the separation between them.

\* Comment: This limit should be over 25 kHz or  $(2/3) * 20\text{dB}$  bandwidth, whichever is greater.

### Measurement Limit:

Standard	Limit(kHz)
FCC 47 CFR Part 15.247(a)(1)	over 25 kHz or $(2/3) * 20\text{dB}$ bandwidth

### Measurement Result:

#### For GFSK

Channel	Carrier frequency separation (kHz)	Conclusion
39	Fig.91 972.75	P

#### For $\pi/4$ DQPSK

Channel	Carrier frequency separation (kHz)	Conclusion
39	Fig.92 974.25	P

#### For 8DPSK

Channel	Carrier frequency separation (kHz)	Conclusion
39	Fig.93 1123.50	P

**Conclusion: PASS**

**Test graphs as below:**

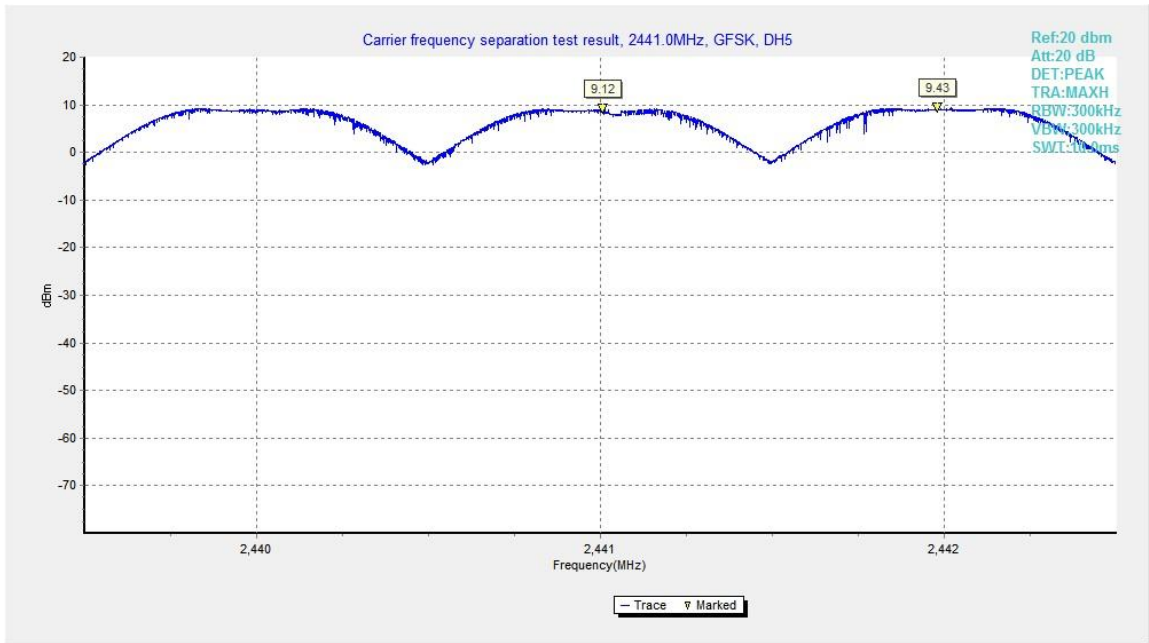

Fig.91. Carrier frequency separation measurement: GFSK, Channel 39

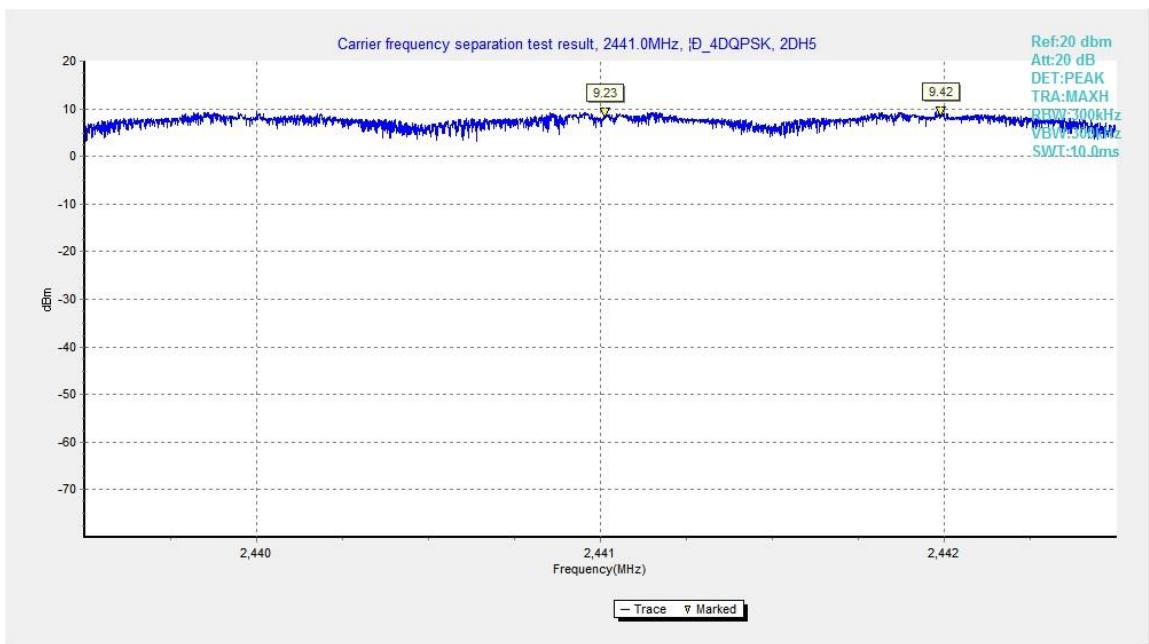

Fig.92. Carrier frequency separation measurement:  $\pi/4$  DQPSK, Channel 39



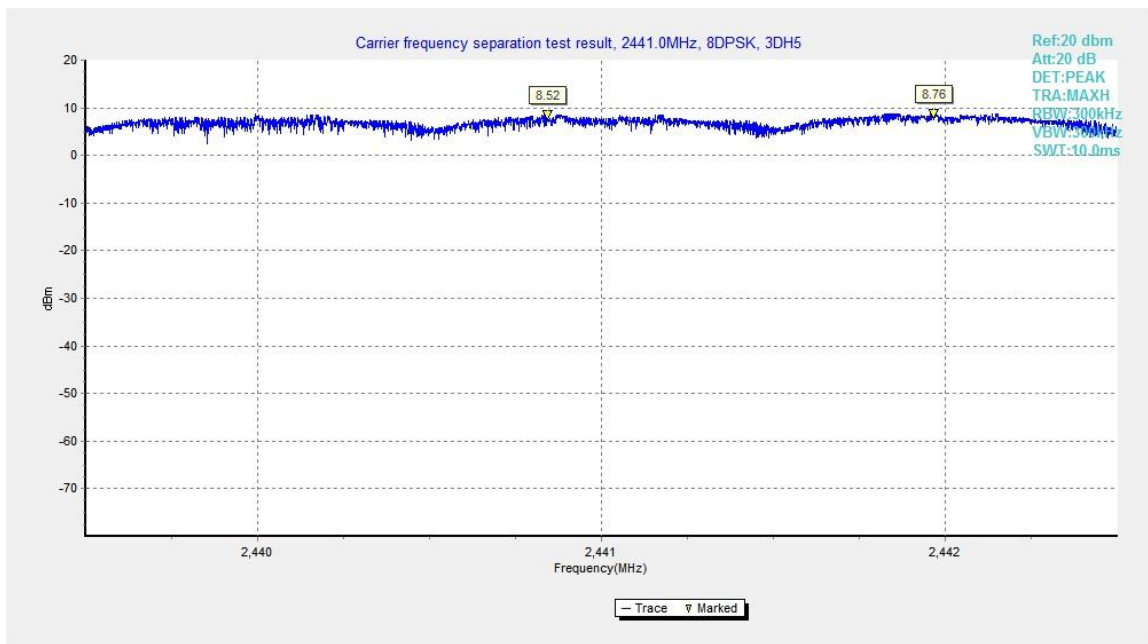

Fig.93. Carrier frequency separation measurement: 8DPSK, Channel 39

## B.10. Number of Hopping Channels

**Method of Measurement: See ANSI C63.10-clause 7.8.3**

The EUT must have its hopping function enabled. Use the following spectrum analyzer settings:

- Span = the frequency band of operation
- RBW = 500kHz
- VBW = 500kHz
- Sweep = auto
- Detector function = peak
- Trace = max hold
- Allow the trace to stabilize

It might prove necessary to break the span up into subranges to show clearly all of the hopping frequencies. Compliance of an EUT with the appropriate regulatory limit shall be determined for the number of hopping channels. A plot of the data shall be included in the test report.

### Measurement Limit:

Standard	Limit
FCC 47 CFR Part 15.247(a) (1)(iii)	At least 15 non-overlapping channels

### Measurement Result:

#### For GFSK

Channel	Number of hopping channels	Conclusion
0~39	Fig.94	79 P
40~78	Fig.95	

#### For $\pi/4$ DQPSK

Channel	Number of hopping channels	Conclusion
0~39	Fig.96	79 P
40~78	Fig.97	

#### For 8DPSK

Channel	Number of hopping channels	Conclusion
0~39	Fig.98	79 P
40~78	Fig.99	

**Conclusion: PASS**

**Test graphs as below:**

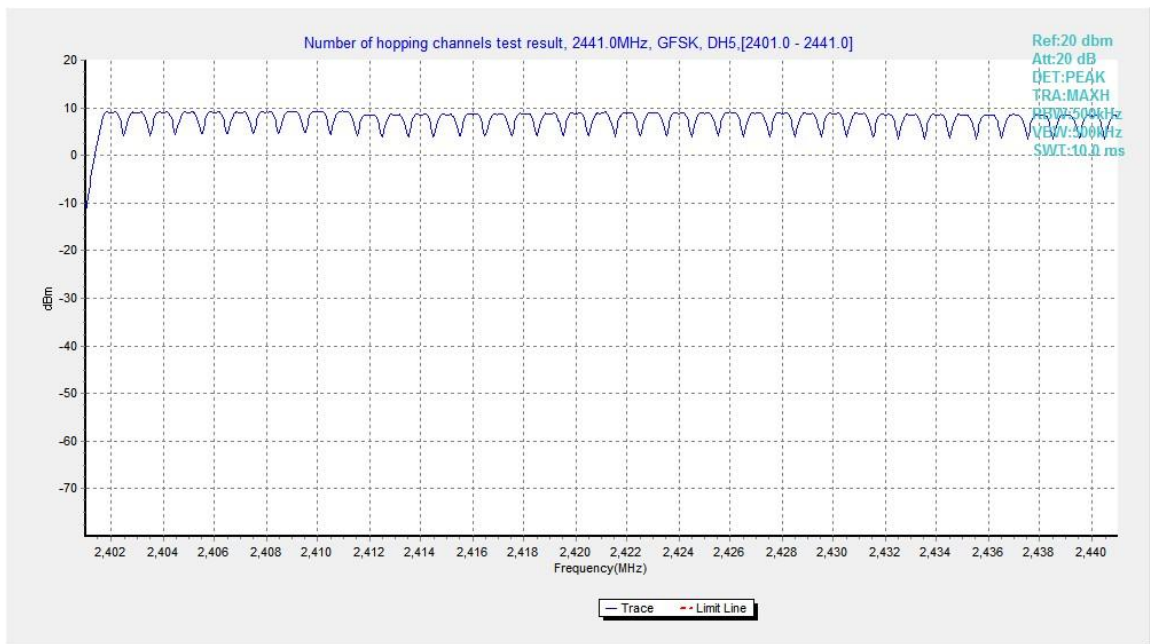

Fig.94. Number of hopping frequencies: GFSK, Channel 0 - 39

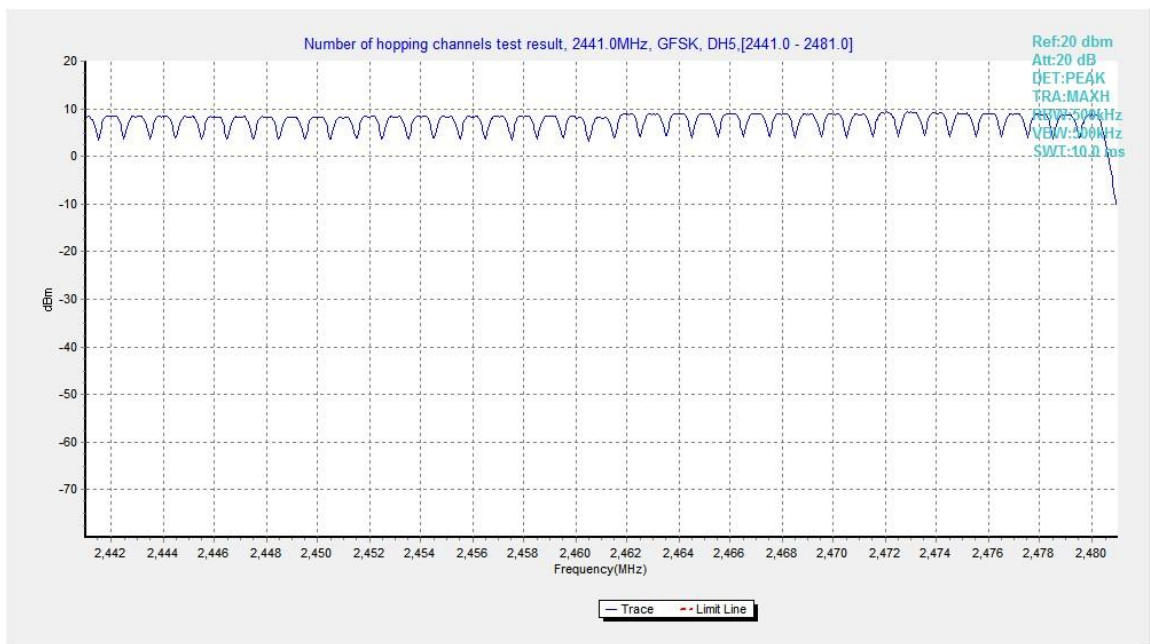

Fig.95. Number of hopping frequencies: GFSK, Channel 40 - 78

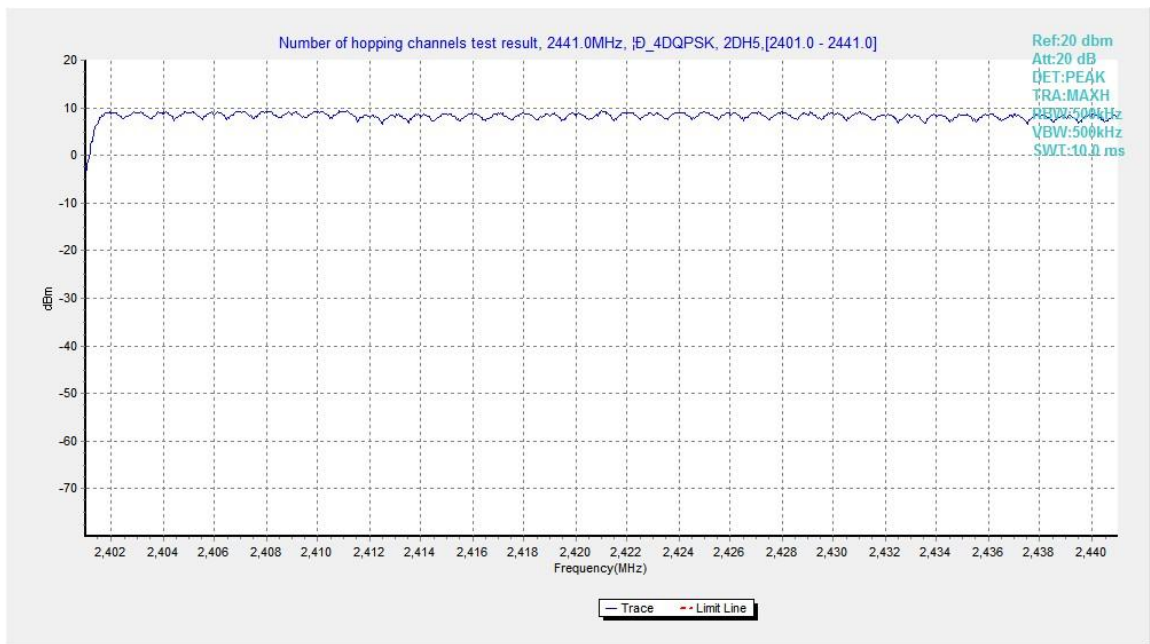

Fig.96. Number of hopping frequencies:  $\pi/4$  DQPSK, Channel 0 - 39

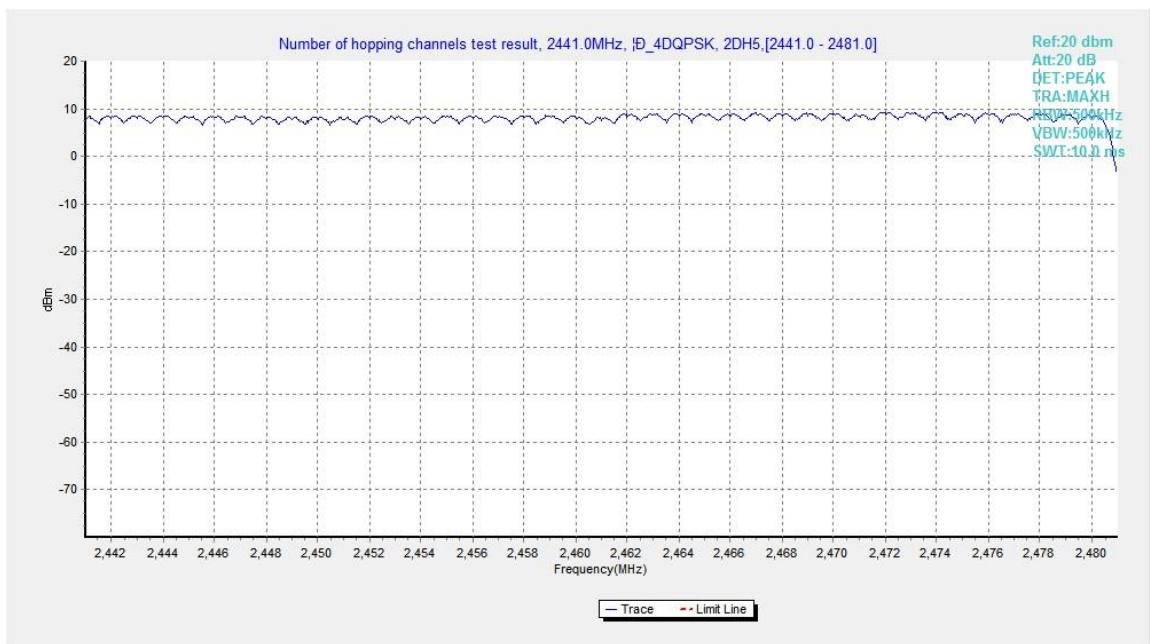

Fig.97. Number of hopping frequencies:  $\pi/4$  DQPSK, Channel 40 - 78

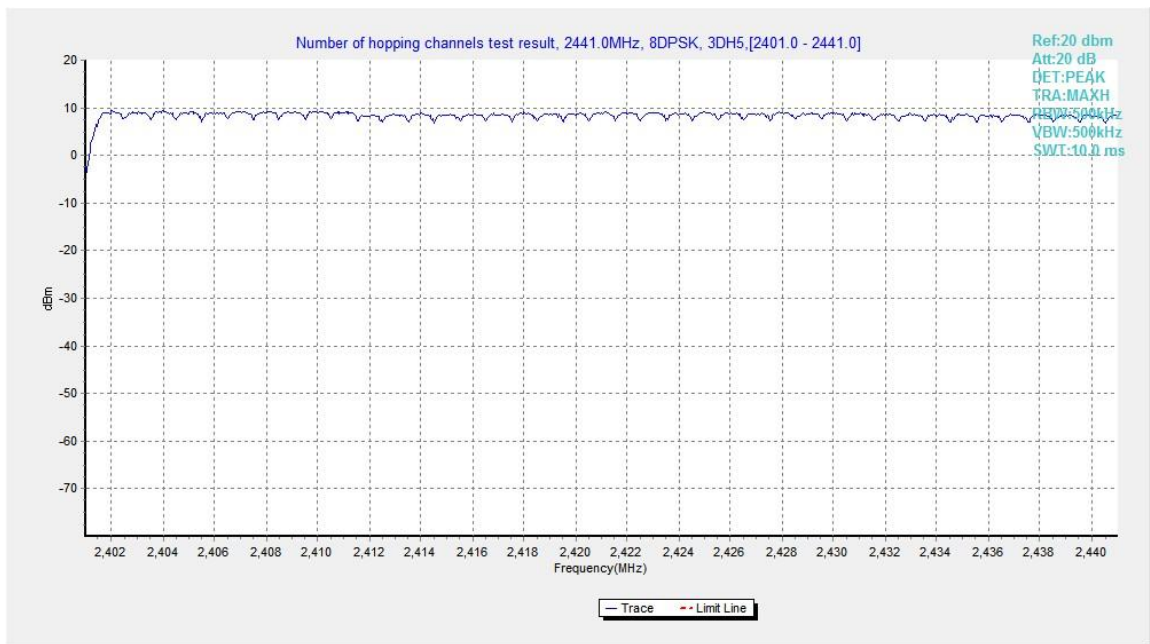

Fig.98. Number of hopping frequencies: 8DPSK, Channel 0 - 39

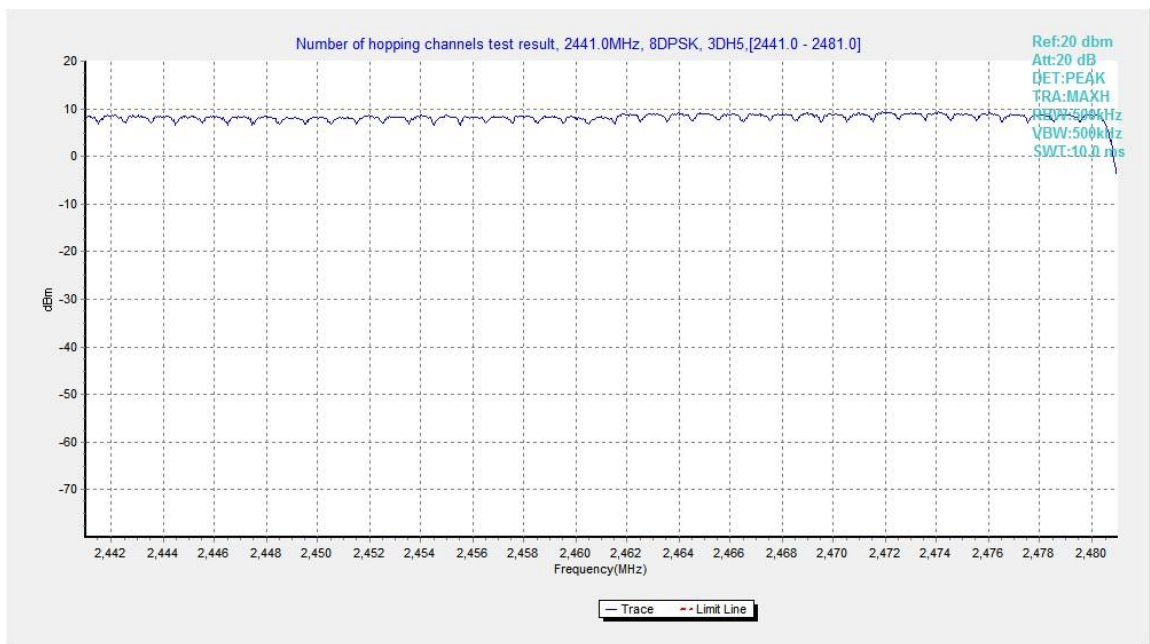

Fig.99. Number of hopping frequencies: 8DPSK, Channel 40 - 78

## B.11. AC Powerline Conducted Emission

**Method of Measurement: See ANSI C63.10-clause 6.2**

### Setup:

A stand-alone EUT shall be placed in the center along the back edge of the tabletop. For multiunit tabletop systems, the EUT shall be centered laterally (left to right facing the tabletop) on the tabletop and its rear shall be flush with the rear of the table.

Accessories that are part of an EUT system tested on a tabletop shall be placed in a test arrangement on one or both sides of the host with a 10 cm separation between the nearest points of the cabinets. The rear of the host and accessories shall be flush with the back of the supporting tabletop unless that would not be typical of normal use. If more than two accessories are present, then an equipment test arrangement shall be chosen that maintains 10 cm spacing between cabinets unless the equipment is normally located closer together.

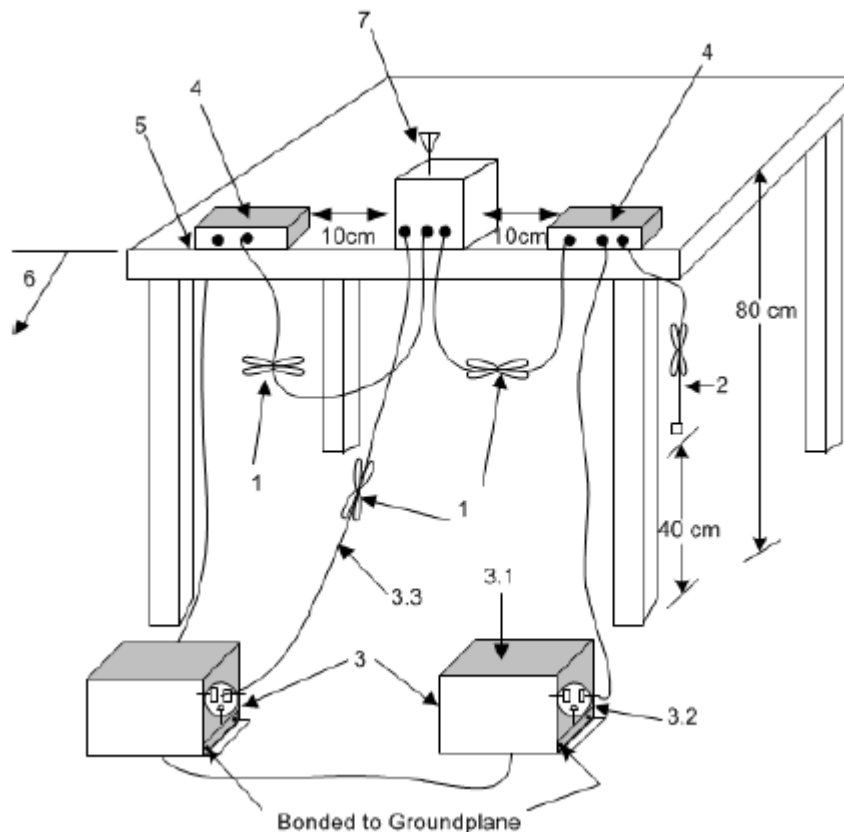

### Exploratory ac power-line conducted emission measurements

Exploratory measurements shall be used to identify the frequency of the emission that has the highest amplitude relative to the limit by operating the EUT in a range of typical modes of operation, cable positions, and with a typical system equipment configuration and arrangement. For each mode of operation and for each ac power current-carrying conductor, cable manipulation shall be performed within the range of likely configurations. For this measurement or series of measurements, the frequency spectrum of interest shall be monitored looking for the emission that has the highest amplitude relative to the limit. Once that emission is found for each current-carrying conductor of each power cord associated with the EUT (but not the cords

associated with non-EUT equipment in the overall system), the one configuration and arrangement and mode of operation that produces the emission closest to the limit over all of the measured conductors shall be recorded.

### Final ac power-line conducted emission measurements

Based on the exploratory tests of the EUT, the one EUT cable configuration and arrangement and mode of operation that produced the emission with the highest amplitude relative to the limit is selected for the final measurement, while applying the appropriate modulating signal to the EUT. If the EUT is relocated from an exploratory test site to a final test site, the highest emissions shall be remaximized at the final test location before final ac power-line conducted emission measurements are performed. The final test on all current-carrying conductors of all of the power cords to the equipment that comprises the EUT (but not the cords associated with other non-EUT equipment in the system) is then performed for the full frequency range for which the EUT is being tested for compliance without further variation of the EUT arrangement, cable positions, or EUT mode of operation. If the EUT is composed of equipment units that have their own separate ac power connections (e.g., floor-standing equipment with independent power cords for each shelf that are able to connect directly to the ac power network), then each current-carrying conductor of one unit is measured while the other units are connected to a second (or more) LISN(s). All units shall be measured separately. If a power strip is provided by the manufacturer, to supply all of the units making up the EUT, only the conductors in the power cord of the power strip shall be measured.

### Test Condition:

Voltage (V)	Frequency (Hz)
120	60

### Measurement Result and limit:

EUT ID: UT38a

Bluetooth (Quasi-peak Limit)

Frequency range (MHz)	Quasi-peak Limit (dB $\mu$ V)	Result (dB $\mu$ V)		Conclusion
		With charger		
		bluetooth	Idle	
0.15 to 0.5	66 to 56	Fig.B.11.1	Fig.B.11.2	<b>P</b>
0.5 to 5	56			
5 to 30	60			

NOTE: The limit decreases linearly with the logarithm of the frequency in the range 0.15 MHz to 0.5 MHz.

Bluetooth (Average Limit)

Frequency range (MHz)	Average Limit (dB $\mu$ V)	Result (dB $\mu$ V)		Conclusion
		With charger		
		bluetooth	Idle	
0.15 to 0.5	56 to 46	Fig.B.11.1	Fig.B.11.2	<b>P</b>
0.5 to 5	46			
5 to 30	50			

NOTE: The limit decreases linearly with the logarithm of the frequency in the range 0.15 MHz to 0.5 MHz.

**Conclusion: Pass**

Test graphs as below:

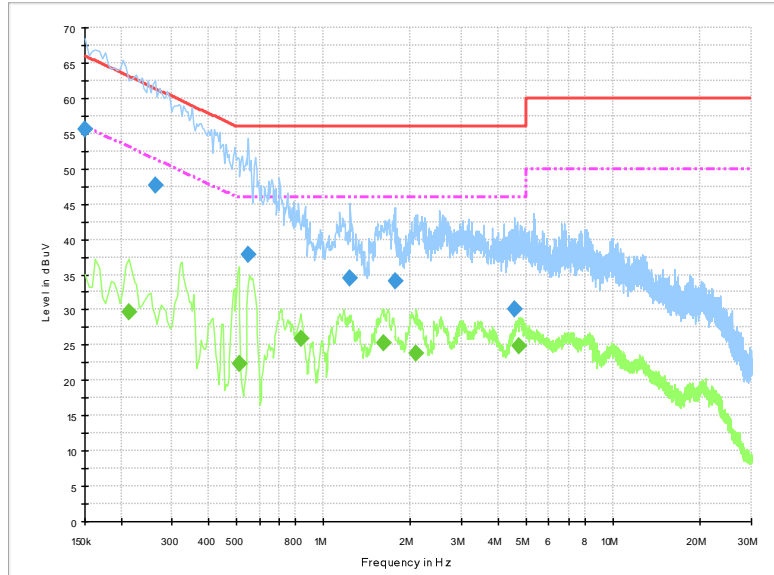

**Fig.B.11.1 AC Powerline Conducted Emission-traffic**

Note: The graphic result above is the maximum of the measurements for both phase line and neutral line.

### Final Result 1

Frequency (MHz)	QuasiPeak (dBuV)	Meas. Time (ms)	Bandwidth (kHz)	Filter	Line	Corr. (dB)	Margin (dB)	Limit (dBuV)	Comment
0.150000	55.5	10000.0	9.000	On	L1	20.0	10.5	66.0	
0.262500	47.6	10000.0	9.000	On	L1	19.9	13.8	61.4	
0.550500	37.9	10000.0	9.000	On	L1	19.8	18.1	56.0	
1.234500	34.4	10000.0	9.000	On	L1	19.7	21.6	56.0	
1.761000	34.1	10000.0	9.000	On	L1	19.7	21.9	56.0	
4.542000	30.0	10000.0	9.000	On	L1	19.6	26.0	56.0	

### Final Result 2

Frequency (MHz)	Average (dBuV)	Meas. Time (ms)	Bandwidth (kHz)	Filter	Line	Corr. (dB)	Margin (dB)	Limit (dBuV)	Comment
0.213000	29.6	10000.0	9.000	On	L1	19.9	23.5	53.1	
0.510000	22.3	10000.0	9.000	On	L1	19.8	23.7	46.0	
0.834000	25.9	10000.0	9.000	On	L1	19.7	20.1	46.0	
1.608000	25.3	10000.0	9.000	On	L1	19.7	20.7	46.0	
2.094000	23.8	10000.0	9.000	On	L1	19.7	22.2	46.0	
4.726500	24.9	10000.0	9.000	On	L1	19.6	21.1	46.0	



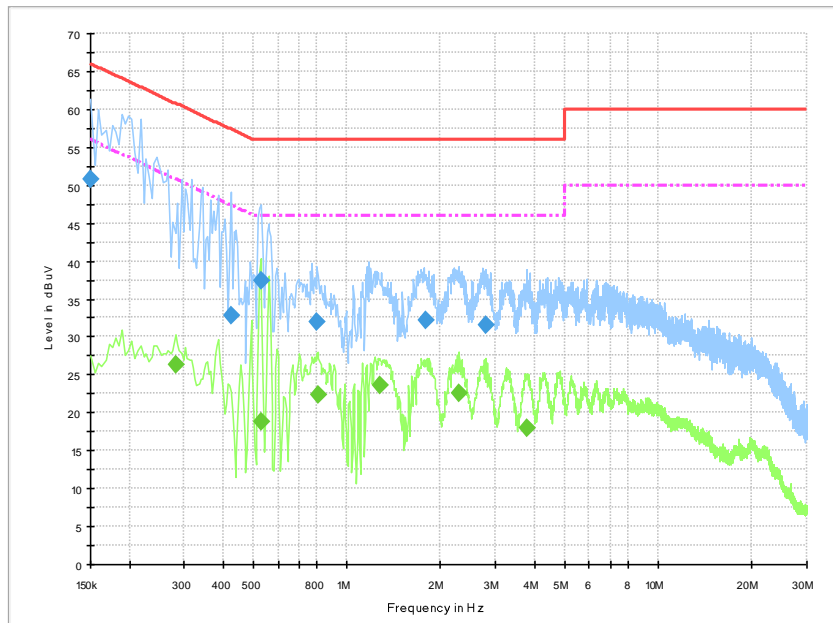

**Fig.B.11.2 AC Powerline Conducted Emission-Idle**

Note: The graphic result above is the maximum of the measurements for both phase line and neutral line.

### Final Result 1

Frequency (MHz)	QuasiPeak (dBuV)	Meas. Time (ms)	Bandwidth (kHz)	Filter	Line	Corr. (dB)	Margin (dB)	Limit (dBuV)	Comment
0.150000	50.7	10000.0	9.000	On	N	20.0	15.3	66.0	
0.424500	32.8	10000.0	9.000	On	N	19.8	24.5	57.4	
0.528000	37.4	10000.0	9.000	On	L1	19.8	18.6	56.0	
0.802500	32.0	10000.0	9.000	On	L1	19.7	24.0	56.0	
1.797000	32.2	10000.0	9.000	On	L1	19.7	23.8	56.0	
2.787000	31.6	10000.0	9.000	On	N	19.6	24.4	56.0	

### Final Result 2

Frequency (MHz)	Average (dBuV)	Meas. Time (ms)	Bandwidth (kHz)	Filter	Line	Corr. (dB)	Margin (dB)	Limit (dBuV)	Comment
0.280500	26.3	10000.0	9.000	On	L1	19.9	24.5	50.8	
0.528000	18.8	10000.0	9.000	On	L1	19.8	27.2	46.0	
0.807000	22.4	10000.0	9.000	On	L1	19.7	23.6	46.0	
1.270500	23.6	10000.0	9.000	On	L1	19.7	22.4	46.0	
2.296500	22.5	10000.0	9.000	On	L1	19.6	23.5	46.0	
3.790500	18.0	10000.0	9.000	On	L1	19.6	28.0	46.0	

## ANNEX C: Accreditation Certificate

<p>United States Department of Commerce National Institute of Standards and Technology</p>  	
<hr/> <b>Certificate of Accreditation to ISO/IEC 17025:2017</b> <hr/>	
NVLAP LAB CODE: 600118-0	
<b>Telecommunication Technology Labs, CAICT</b> Beijing China	
<i>is accredited by the National Voluntary Laboratory Accreditation Program for specific services, listed on the Scope of Accreditation, for:</i>	
<b>Electromagnetic Compatibility &amp; Telecommunications</b>	
<i>This laboratory is accredited in accordance with the recognized International Standard ISO/IEC 17025:2017. This accreditation demonstrates technical competence for a defined scope and the operation of a laboratory quality management system (refer to joint ISO-ILAC-IAF Communique dated January 2009).</i>	
<hr/> 2020-09-29 through 2021-09-30 <i>Effective Dates</i>	  <i>For the National Voluntary Laboratory Accreditation Program</i>

\*\*\*END OF REPORT\*\*\*