



NFC TEST REPORT

No.I20Z61503-IOT06

for

TCL Communication Ltd.

5G NR/LTE/WCDMA/GSM Mobile phone

T781

FCC ID : 2ACCJH133

with

Hardware Version: PIO

Software Version: 1A5A

Issued Date: 2020-10-26

Note:

The test results in this test report relate only to the devices specified in this report. This report shall not be reproduced except in full without the written approval of CTTL.

The report must not be used by the client to claim product certification, approval, or endorsement by NVLAP, NIST, or any agency of the U.S.Government.

Test Laboratory:

CTTL-Telecommunication Technology Labs, CAICT

No. 52, Huayuan North Road, Haidian District, Beijing, P. R. China 100191.

Tel:+86(0)10-62304633-2512, Fax:+86(0)10-62304633-2504

Email: ctl_terminals@caict.ac.cn, website: www.caict.ac.cn



REPORT HISTORY

Report Number	Revision	Description	Issue Date
I20Z61503-IOT06	Rev.0	1st edition	2020-10-26

CONTENTS

1. TEST LABORATORY	4
1.1. INTRODUCTION & ACCREDITATION.....	4
1.2. TESTING LOCATION	4
1.3. TESTING ENVIRONMENT.....	5
1.4. PROJECT DATA	5
1.5. SIGNATURE.....	5
2. CLIENT INFORMATION.....	6
2.1. APPLICANT INFORMATION.....	6
2.2. MANUFACTURER INFORMATION.....	6
3. EQUIPMENT UNDER TEST (EUT) AND ANCILLARY EQUIPMENT (AE)	7
3.1. ABOUT EUT	7
3.2. INTERNAL IDENTIFICATION OF EUT	7
3.3. INTERNAL IDENTIFICATION OF AE	7
3.4. EUT SET-UPS.....	8
4. REFERENCE DOCUMENTS.....	9
4.1. DOCUMENTS SUPPLIED BY APPLICANT	9
4.2. REFERENCE DOCUMENTS FOR TESTING.....	9
5. TEST RESULTS	10
5.1. SUMMARY OF TEST RESULTS	10
5.2. STATEMENTS.....	11
6. TEST FACILITIES UTILIZED	12
7. MEASUREMENT UNCERTAINTY	13
ANNEX A: EUT PARAMETERS.....	14
ANNEX B: DETAILED TEST RESULTS.....	15
ANNEX C: PERSONS INVOLVED IN THIS TESTING	30
ANNEX D: ACCREDITATION CERTIFICATE	33



1. Test Laboratory

1.1. Introduction & Accreditation

Telecommunication Technology Labs, CAICT is an ISO/IEC 17025:2005 accredited test laboratory under NATIONAL VOLUNTARY LABORATORY ACCREDITATION PROGRAM (NVLAP) with lab code 600118-0, and is also an FCC accredited test laboratory (CN5017), and ISED accredited test laboratory (ISED#: 24849). The detail accreditation scope can be found on NVLAP website.

1.2. Testing Location

Location 1: CTTL(huayuan North Road)

Address: No. 52, Huayuan North Road, Haidian District, Beijing,
P. R. China 100191

Location 2: CTTL(BDA)

Address: No.18A, Kangding Street, Beijing Economic-Technology
Development Area, Beijing, P. R. China 100176

1.3. Testing Environment

Normal Temperature: 15-35°C
Extreme Temperature: -20/+50°C
Normal Relative Humidity: 20-75%
Normal Air Pressure: 86Kpa-106Kpa

1.4. Project data

Testing Start Date: 2020-09-30
Testing End Date: 2020-10-25

1.5. Signature



Zhou Bin
(Prepared this test report)



Pang Shuai
(Reviewed this test report)



Zhu Liang
(Approved this test report)



2. Client Information

2.1. Applicant Information

Company Name: TCL Communication Ltd.
Address: 5/F, Building 22E, 22 Science Park East Avenue, Hong Kong Science Park, Shatin, NT, Hong Kong
Postal Code: /
Country: CHINA
Contact: Gong Zhizhou
Telephone: 0086-755-36611722
E-mail: zhizhou.gong@tcl.com

2.2. Manufacturer Information

Company Name: TCL Communication Ltd.
Address: 5/F, Building 22E, 22 Science Park East Avenue, Hong Kong Science Park, Shatin, NT, Hong Kong
Postal Code: /
Country: CHINA
Contact: Gong Zhizhou
Telephone: 0086-755-36611722
E-mail: zhizhou.gong@tcl.com

3. Equipment Under Test (EUT) and Ancillary Equipment (AE)

3.1. About EUT

Description	5G NR/LTE/WCDMA/GSM Mobile phone
Model name/HVIN	T781
FCC ID	2ACCJH133
UMTS Frequency Band(s)	FDD I/II/V/VIII
GSM Frequency Band(s)	GSM1900/850/900/1800
E-UTRA Frequency Band(s)	FDD 1/3/5/7/8/20/26/28/32 TDD 38/40/41
5G NR Band(s)	n 1/3/5/28/41/78
Extreme Temperature	-10/+55°C
Nominal Voltage	3.8V
Extreme High Voltage	4.4V
Extreme Low Voltage	3.5V

3.2. Internal Identification of EUT

EUT ID*	SN or IMEI	HW Version	SW Version	Date of receipt
57a	358008610207350 & 358008610207368	PIO	1A5A	2020-10-03
38a	358008610207418 & 358008610207426	PIO	1A5A	2020-9-28

*EUT ID: is used to identify the test sample in the lab internally.

3.3. Internal Identification of AE

AE ID*	Description	SN
AE1	Battery	/
AE6	Charger	/
AE13	USB Cable	/
AE14	USB Cable	/

AE1

Model	TLp043E7(CAC4360002C7)
Manufacturer	veken
Capacitance	4500mAh
Nominal voltage	3.85V

AE6

Model	CBA0059BGTC5
Manufacturer	PUAN
Length of cable	/

AE13

Model	CDA0000128C1
Manufacturer	JUWEI
Length of cable	/

AE14

Model	CDA0000128C2
Manufacturer	SHENGHUA
Length of cable	/

*AE ID: is used to identify the ancillary equipment in the lab internally.

3.4. EUT Set-ups

Table 1: Eut Set-ups

EUT Set-up No.	Combination of EUT and AE	Remarks
Set.NFC01	38a + AE1 + AE6 + AE13/ AE14	--
Set.NFC02	38a + AE1	--
Set. NFC03	57a	--

The Transmit State of NFC: the NFC function is on. The EUT will transmit the NFC data and command continuously during the test.

The Transmit state without modulation: The EUT will transmit the CW signal at the Hoperating frequency.

4. Reference Documents

4.1. Documents supplied by applicant

EUT parameters, referring to Annex A for detailed information, are supplied by the client or manufacturer, which are the bases of testing.

4.2. Reference Documents for testing

The following documents listed in this section are referred for testing.

Reference	Title	Version
CFR 47 Part 2	Part 2 — Frequency Allocations and Radio Treaty Matters; General Rules and Regulations.	2018
CFR 47 Part 15	Part 15 — Radio Frequency Devices. Subpart C — Intentional Radiators. § 15.35 Measurement detector functions and bandwidths. § 15.207 Conducted limits. § 15.209 Radiated emission limits, general requirements. § 15.215 Additional provisions to the general radiated emission limitations. § 15.225 Operation within the band 13.110–14.010 MHz.	2018
ANSI C63.10	American National Standard of Procedures for Compliance Testing of Unlicensed Wireless Devices	2013

5. Test Results

5.1. Summary of Test Results

Table 2: Summary of Test Results

No	Test Cases	Clause in Regulation	Section in This Report	Verdict
1	Electric Field Strength of Fundamental Emissions	CFR 47 § 15.225(a)	B.1	P(Set. NFC02)
2	Electric Field Strength of Outside the Allocated Bands	CFR 47 § 15.225(b) CFR 47 § 15.225(c)		P(Set. NFC02)
3	Electric Field Radiated Emissions	CFR 47 § 15.209	B.2	P(Set. NFC01)
		CFR 47 § 15.225(d)	B.3	P(Set. NFC01)
4	Frequency Tolerance	CFR 47 § 15.225(e)	B.4	P(Set. NFC03)
5	20dB Bandwidth	CFR 47 § 15.215(c)	B.5	P(Set. NFC03)
6	Conducted Emissions	CFR 47 § 15.207	B.6	P(Set. NFC01)
The measurement is carried out according to ANSI C63.10. See ANNEX B for details.				

Test Conditions:

For this report, all the test cases listed above were tested under normal Temperature, Voltage, humidity and Air Pressure except the Frequency Tolerance test case. The specific conditions of Frequency Tolerance test case are listed in section B.4.3

See Table 3 for terms for result verdict:

Table 3 Terms for result verdict

P	Pass, The EUT complies with the essential requirements in the standard.
NP	Not Perform, The test was not performed by CTTL
NA	Not Applicable, The test was not applicable
F	Fail, The EUT does not comply with the essential requirements in the standard



5.2. Statements

The test cases listed in Section 5.1 of this report for the EUT specified in Section 3 were performed by CTTL according to the reference documents in Section 4.

The EUT meets all applicable requirements of the regulations and standards in Section 4.2.

6. Test Facilities Utilized

Table 4: Test Facilities Utilized

NO.	NAME	TYPE	SERIES NUMBER	PRODUCER	CAL. DUE DATE	CAL. INTERVAL
1.	Spectrum Analyzer	RSA3408A	B010277	Tektronix	2021-09-24	1 Year
2.	Climatic chamber	SH242	93008658	ESPEC	2021-01-18	1 Year
3.	Test Receiver	ESU26	100235	Rohde & Schwarz	2021-03-03	1 Year
4.	BiLog Antenna	VULB9163	9163-483	Schwarzbeck	2021-09-17	1 Year
5.	LISN	ESH3-Z5	825562/028	Rohde & Schwarz	2021-10-05	1 Year
6.	Test Receiver	ESCI 7	100344	Rohde & Schwarz	2021-02-26	1 Year
7.	Test Receiver	ESU26	100376	Rohde & Schwarz	2020-10-30	1 Year
8.	H-field Antenna	HFH2-Z2	829324/007	R&S	2020-12-03	1 Year

7. Measurement Uncertainty

Table 5: Measurement Uncertainty

Item	Uncertainty
Frequency Tolerance	$U = 77 \text{ Hz, } k=2$
20dB Bandwidth	$U = 77 \text{ Hz, } k=2$
Radiated Emissions (<1GHz)	$U = 4.86 \text{ dB, } k=2$
Radiated Emissions (>1GHz)	$U = 5.26 \text{ dB, } k=2$
Conducted emission	$U = 3.38 \text{ dB, } k=2$



ANNEX A: EUT parameters

/

ANNEX B: Detailed Test Results

B.1. Electric Field Strength of Fundamental and Outside the Allocated bands

B.1.1. Reference

See Clause 4, Clause 5 of ANSI C63.10-2013 generally.

B.1.2. Measurement Methods

The transmitter carrier output levels (E-Field) from the EUT are measured in a semi-anechoic chamber. The EUT is placed on a non-conductive stand of 80cm high, and at a measurement distance of 3m from the receiving antenna. The center of the receiving loop antenna is 1.0 meter above the ground. The E-field is measured with a shielded loop antenna connected to a measurement receiver. Detected E-field was maximized by rotating the EUT through 360° and adjusting the receiving antenna polarizations. The maximization processes were repeated with the EUT positioned respectively in its three orthogonal axes. The measurements were performed with the peak detector and if required, the quasi-peak detector.

The measurement bandwidth is:

Table B-1: Measurement bandwidth

Frequency of Emission (MHz)	RBW/VBW
12.56-14.56	10/30 kHz

The E-field measured at 3m is calculated as:

$$\text{E-field (dB}\mu\text{V/m)} = \text{Rx (dB}\mu\text{V)} + \text{Cable Loss (dB)} + \text{AF@3m (dB/m)}$$

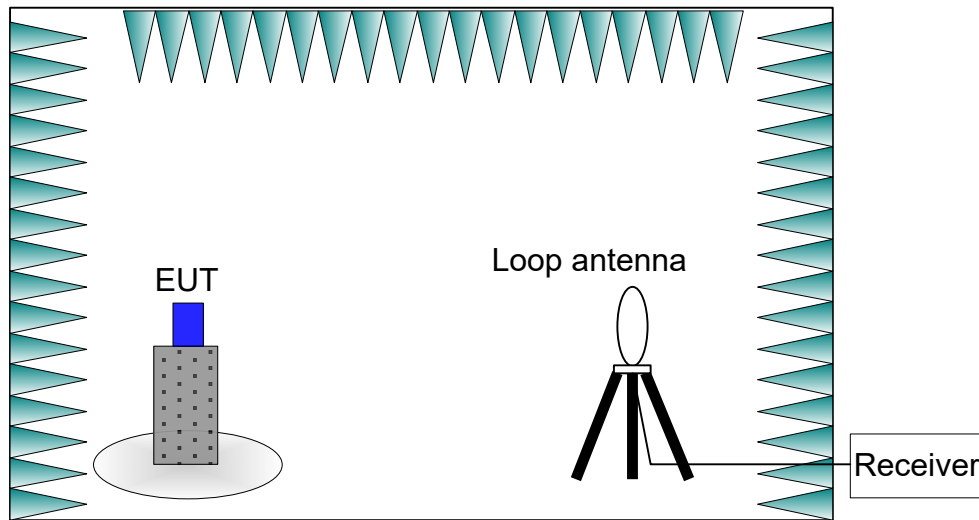

Figure B-1: Measurement Setup

B.1.3. EUT Operating Mode and Test Conditions

The measurement of EUT is carried out under the transmit state of NFC(See 3.4).

The EUT is powered by a travel adapter.

During the measurements, the ambient temperature of the electromagnetic anechoic chamber is in the range of 15 ~ 25 °C.

B.1.4. Limits

Table B-2: Limits

Frequency Range (MHz)	E-field Strength Limit @ 30 m ($\mu\text{V/m}$)	E-field Strength Limit @ 3 m ($\text{dB}\mu\text{V/m}$)
13.560 \pm 0.007	+15,848	124
13.410 to 13.553 13.567 to 13.710	+334	90
13.110 to 13.410 13.710 to 14.010	+106	81
Note: Where the limits have been defined at one distance, and a signal level measured at another, the limits have been extrapolated using the following formula: $\text{Extrapolation(dB)} = 40\log_{10}(\text{Measurement Distance}/\text{Specification Distance})$		

B.1.5. Measurement Results

Measurement results of normal conditions see Figure B-2 for different set-ups of EUT. The results displayed take into account applicable antenna factors and cable losses.

Conclusions: Set.NFC02, **PASS**.

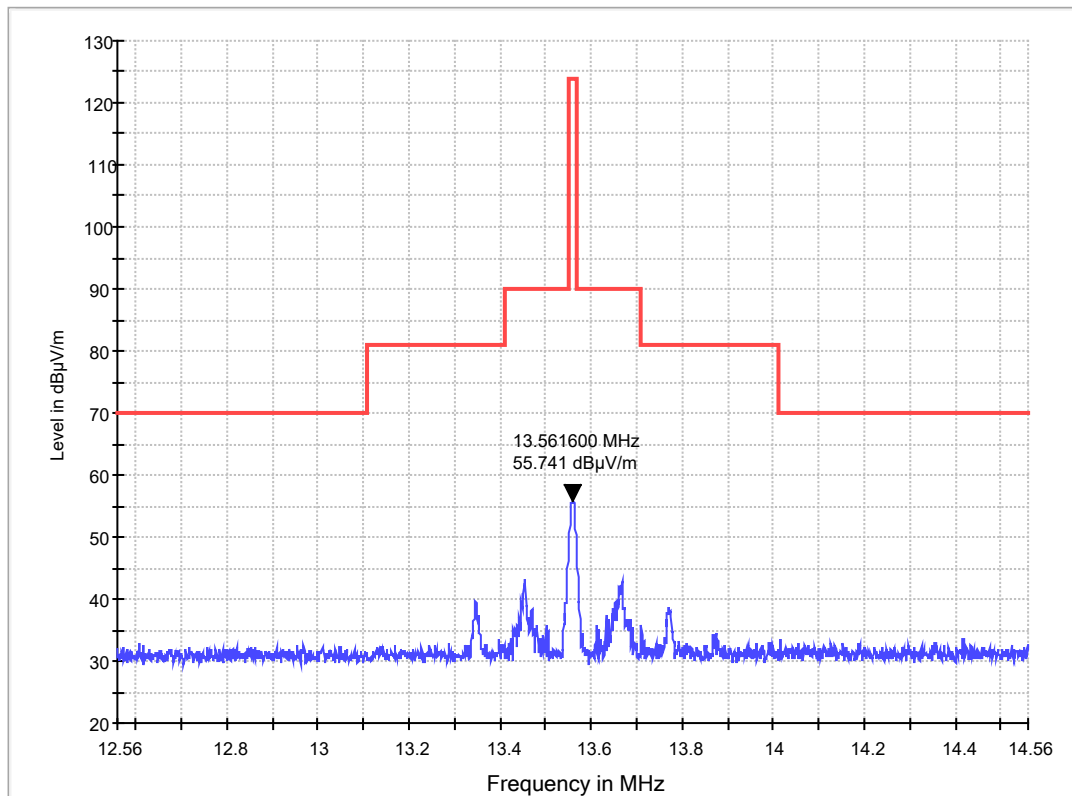

Figure B-2: Measurement results for Electric Field Strength of Fundamental and Outside the Allocated bands

B.2. Electric Field Radiated Emissions (< 30MHz)

B.2.1. Reference

See Clause 6.4 of ANSI C63.10-2013 specifically.

See Clause 4 and Clause 5 of ANSI C63.10-2013 generally.

B.2.2. Measurement Methods

The transmitter carrier output levels (E-Field) from the EUT are measured in a semi-anechoic

chamber. The EUT is placed on a non-conductive stand of 80cm high, and at a measurement distance of 3m from the receiving antenna. The center of the receiving loop antenna is 1.0 meter above the ground. The E-field is measured with a shielded loop antenna connected to a measurement receiver. Detected E-field was maximized by rotating the EUT through 360° and adjusting the receiving antenna polarizations. The maximization processes were repeated with the EUT positioned respectively in its three orthogonal axes. The measurements were performed with the peak detector and if required, the quasi-peak detector.

The measurement bandwidth is:

Table B-3: Measurement bandwidth

Frequency of Emission (MHz)	RBW/VBW
0.009-0.15	100/300 Hz
0.15-30	10/30 kHz

The E-field measured at 3m is calculated as:

$$\text{E-field (dB}\mu\text{V/m)} = \text{Rx (dB}\mu\text{V)} + \text{Cable Loss (dB)} + \text{AF@3m (dB/m)}$$

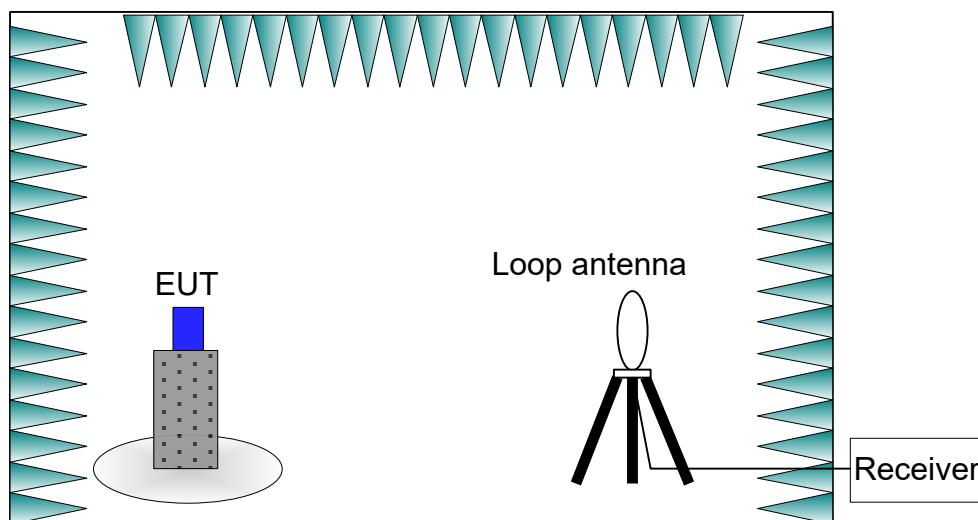

Figure B-3: Measurement Setup

B.2.3. EUT Operating Mode and Test Conditions

The measurement of EUT is carried out under the transmit state of NFC(See 3.4).

The EUT is powered by a travel adapter.

During the measurements, the ambient temperature of the electromagnetic anechoic chamber is in the range of 15 ~ 25 °C.

B.2.4. Limits

Table B-4: Limits

Frequency Range (MHz)	E-field Strength Limit @ 30m (mV/m)	E-field Strength Limit @ 3m (dB μ V/m)
0.009-0.490	2400/F(kHz)	129-94
0.490-1.705	24000/F(kHz)	74-63
1.705-30	30	70

Note: Where the limits have been defined at one distance, and a signal level measured at another, the limits have been extrapolated using the following formula:
Extrapolation(dB) = $40\log_{10}(\text{Measurement Distance}/\text{Specification Distance})$

B.2.5. Measurement Results

Measurement results of normal conditions see Figure B-4 for different set-ups of EUT. The results displayed take into account applicable antenna factors and cable losses.

Conclusions: Set.NFC01, **PASS**.

RE 9kHz-30MHz

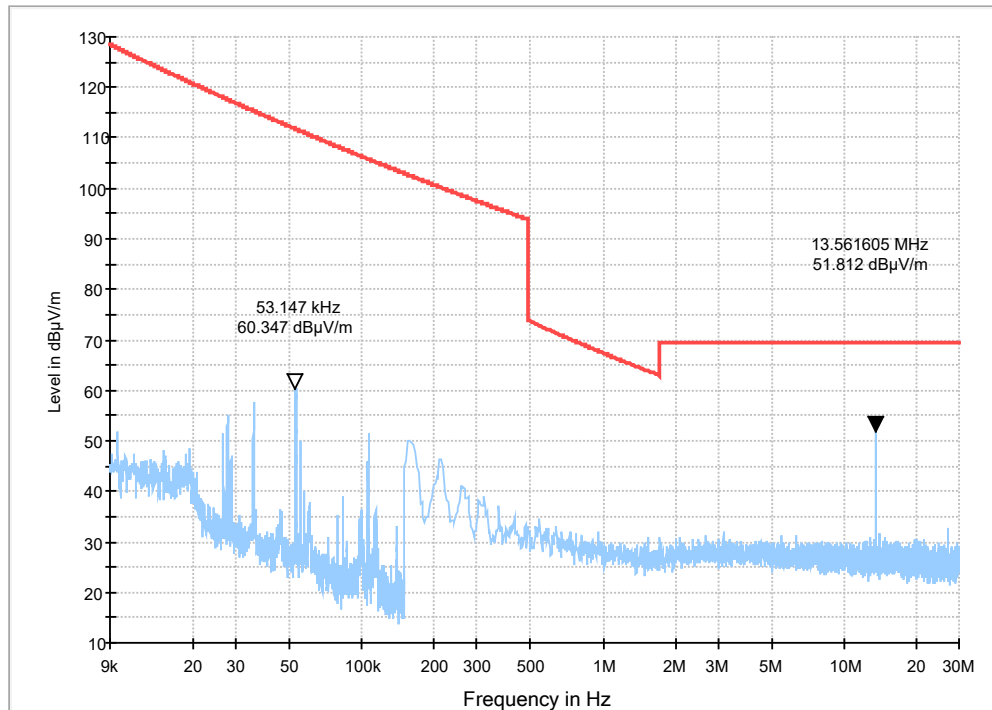

Figure B-4: Measurement results for Electric Field Radiated Emissions (< 30MHz)

B.3. Electric Field Radiated Emissions ($\geq 30\text{MHz}$)

B.3.1. Reference

See Clause 6.5 of ANSI C63.10-2013 specifically.

See Clause 4 and Clause 5 of ANSI C63.10-2013 generally.

B.3.2. Measurement Methods

The electric field radiated emissions from the EUT are measured in a semi-anechoic chamber. The EUT is placed on a non-conductive stand of 80cm high, and at a measurement distance of 10m from the receiving antenna. The receiving antennas connected to a measurement receiver. In order to search for maximum field strength emitted from the EUT, the receiving antenna can be moved between the height of 1.0 m to 4.0 m. Detected E-field was maximized at each frequency by rotating the EUT through 360° and adjusting the receiving antenna positions for both vertical and horizontal antenna polarizations. The maximization processes were repeated with the EUT positioned respectively in its three orthogonal axes. The measurements were performed with the peak detector

and if required, the quasi-peak detector.

The measurement bandwidth is:

Table B-5: Measurement bandwidth

Frequency of Emission (MHz)	RBW/VBW
30-1000	120kHz

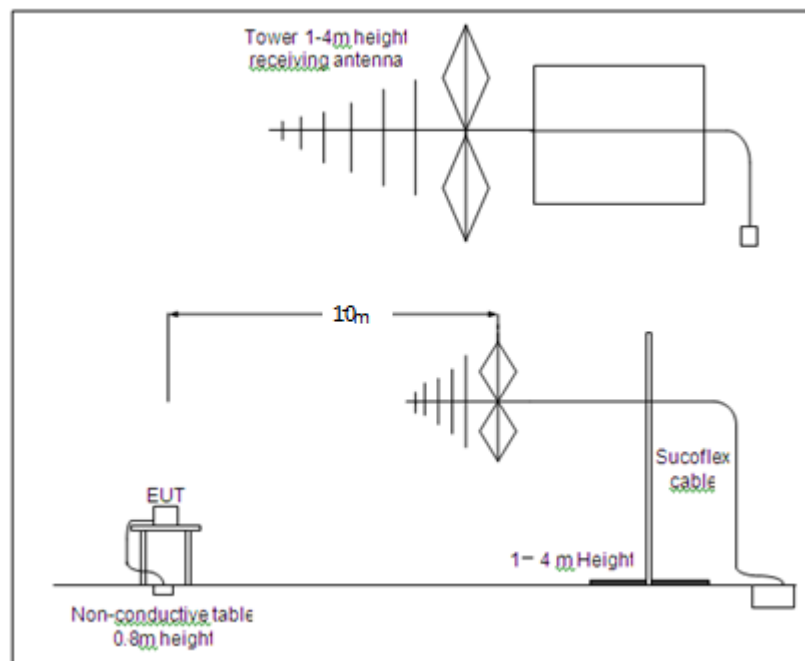

Figure B-5: Measurement Setup

B.3.3. EUT Operating Mode and Test Conditions

The measurement of EUT is carried out under the transmit state of NFC(See 3.4).

The EUT had been connected to a travel adapter.

During the measurements, the ambient temperature of the electromagnetic anechoic chamber is in the range of 15 ~ 25 °C.

B.3.4. Limits

Table B-6: Limits

Frequency Range (MHz)	E-field Strength Limit @ 3m (mV/m)	E-field Strength Limit @ 3m (dB μ V/m)	E-field Strength Limit @ 10m (dB μ V/m)
30-88	100	40	30
88-216	150	43.5	33.5
216-960	200	46	36
960-1000	500	54	44

B.3.5. Measurement Results

Measurement results of normal conditions see Figure B-6 for different set-ups of EUT. The results displayed take into account applicable antenna factors and cable losses.

Conclusions: Set.NFC01, **PASS.**

RE 30MHz-1GHz

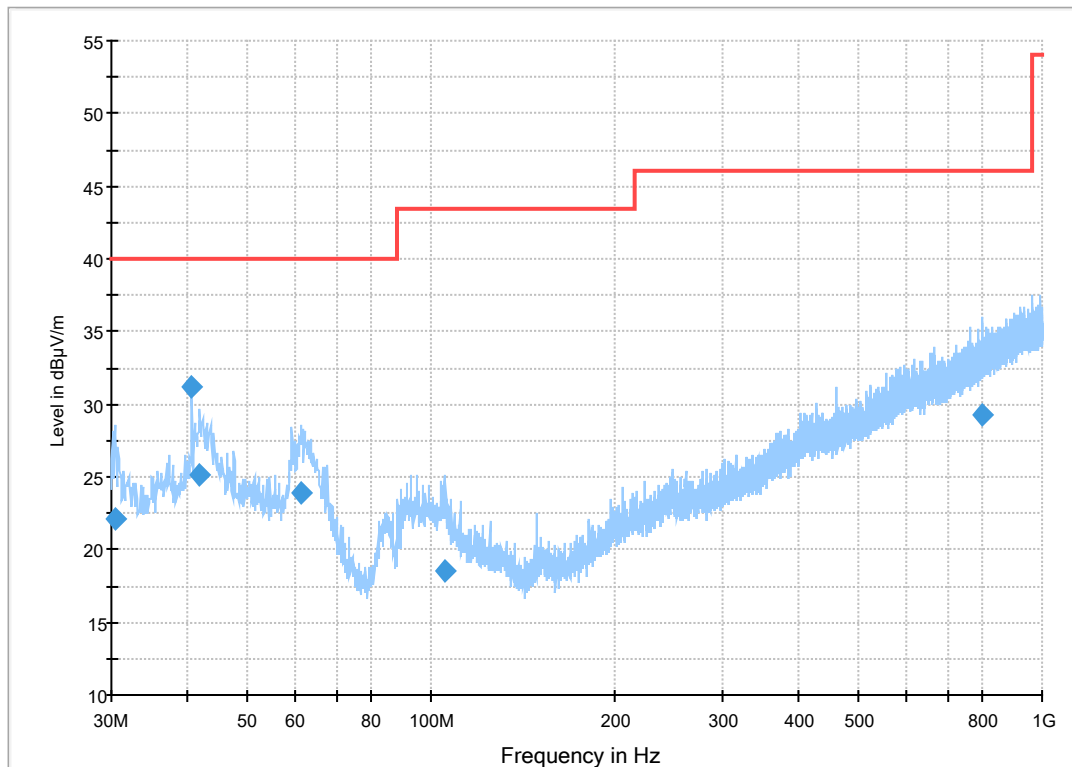

Figure B-6: Measurement results for Electric Field Radiated Emissions (≥ 30 MHz)

Final_Result

Frequency (MHz)	QuasiPeak (dB μ V/m)	Height (cm)	Polarization	Azimuth (deg)	Corr. (dB)	Margin (dB)	Limit (dB μ V/m)	Comment
30.388000	22.1	100.0	V	225.0	-1.9	17.9	40.0	
40.670000	31.1	100.0	V	135.0	-0.1	8.9	40.0	
41.931000	25.1	100.0	V	45.0	-0.1	14.9	40.0	
61.331000	23.9	100.0	V	125.0	-0.8	16.1	40.0	
105.078000	18.5	111.0	V	271.0	-1.4	25.0	43.5	
800.180000	29.2	119.0	V	130.0	10.2	16.8	46.0	

B.4. Frequency Tolerance

B.4.1. Reference

See Clause 6.8 of ANSI C63.10-2013 specifically.

See Clause 4 and Clause 5 of ANSI C63.10-2013 generally.

B.4.2. Measurement Methods

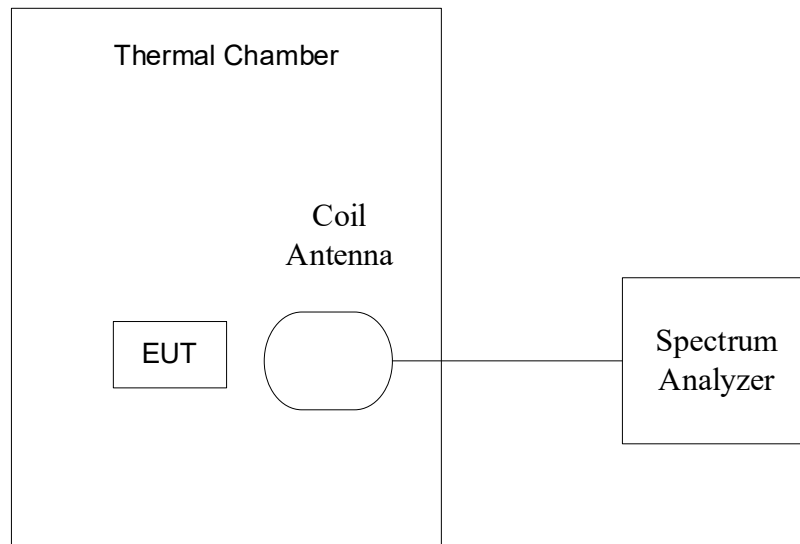

Figure B-7: Measurement Setup

The transmitter output signal was picked up by coil antenna connected to the spectrum analyzer. The center frequency was measured with 30Hz RBW and 1kHz span.

During the test, the EUT was placed in a thermal chamber until thermal balance and lasting appropriate time.

B.4.3. EUT Operating Mode and Test Conditions

The measurement of EUT was carried out under the transmit state of without modulation(See 3.4).

EUT had not been connected to a travel adapter. The frequency stability was measured with the different voltage and temperature combinations:

- a) The nominal voltage 3.85V(See 3.1)was used and the temperature was varied from -20°C to +50°C in 10°C increments using an environmental chamber.
- b) The 20°C was used and the voltages were 3.5V, 3.8V and 4.4V (The extreme low voltage ,the nominal voltage and the extreme high voltage defined in section 3.1).

The details were as following:

Table B-7: Combinations of Voltage and Temperature

Test items	Voltage	Temperature
Frequency stability with respect to ambient temperature	3.8V	-20°C
		-10°C
		0°C
		10°C
		20°C
		30°C
		40°C
		50°C
Frequency stability when varying supply voltage	3.5V	20°C
	3.8V	
	4.4V	

B.4.4. Test Layouts

See B.4.2.

B.4.5. Limits

The frequency tolerance of the carrier signal shall be maintained within +/- 0.01% of the operating frequency.

B.4.6. Measurement Results

Measurement results see Table B-9 for different test conditions.

Conclusions: Set.NFC03, **PASS**.

Table B-8: Measurement results for Frequency Tolerance

Temperature	Voltage	Frequency (MHz)			
		Startup	2 Min Later	5 Min Later	10 Min Later
-20°C	3.8V	13.560089375	13.560090625	13.560098125	13.560101250
-10°C	3.8V	13.560103125	13.560101250	13.560101875	13.560102350
0°C	3.8V	13.560093750	13.560090625	13.560089375	13.560088125
10°C	3.8V	13.560083125	13.560079375	13.560078125	13.560075625
20°C	3.8V	13.560046875	13.560041875	13.560036250	13.560029375
30°C	3.8V	13.559988125	13.559984375	13.559981875	13.559980625
40°C	3.8V	13.559965625	13.559956875	13.559953125	13.559950625
50°C	3.8V	13.559938750	13.559935625	13.559930625	13.559928125
20°C	3.5V	13.560021875	13.560023750	13.560023125	13.560022150
20°C	4.4 V	13.560025625	13.560021875	13.560021250	13.560018750

Temperature	Voltage	Frequency Error (%)			
		Startup	2 Min Later	5 Min Later	10 Min Later
-20°C	3.8V	0.001	0.001	0.001	0.001

-10°C	3.8V	0.001	0.001	0.001	0.001
0°C	3.8V	0.001	0.001	0.001	0.001
10°C	3.8V	0.001	0.001	0.001	0.001
20°C	3.8V	0.000	0.000	0.000	0.000
30°C	3.8V	0.000	0.000	0.000	0.000
40°C	3.8V	0.000	0.000	0.000	0.000
50°C	3.8V	0.000	0.000	-0.001	-0.001
20°C	3.5V	0.000	0.000	0.000	0.000
20°C	4.4V	0.000	0.000	0.000	0.000

B.4.7. Measurement Uncertainty

Measurement uncertainty: $U = 77 \text{ Hz}$, $k=2$

B.5. 20dB Bandwidth

B.5.1. Reference

See Clause 6.9 of ANSI C63.10-2013 specifically.

See Clause 4 and Clause 5 of ANSI C63.10-2013 generally.

B.5.2. Measurement Methods

The transmitter output signal was picked up by coil antenna connected to the spectrum analyzer. The bandwidth of the center frequency was measured with 140Hz RBW, 420Hz VBW and 14kHz span.

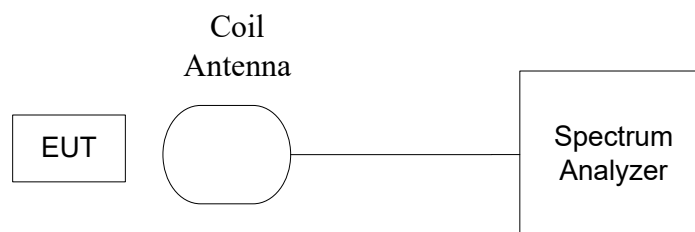

Figure B-8: Measurement Setup

B.5.3. EUT Operating Mode and Test Conditions

The measurement of EUT was carried out under the transmit state of NFC (See 3.4).

EUT had not been connected to a travel adapter.

During the measurements, the ambient temperature was in the range of 15 ~ 25 °C.

B.5.4. Test Layouts

See B.5.2.

B.5.5. Limits

The 20dB bandwidth shall be less than 80% of the permitted frequency band. For 13.56 MHz NFC, the permitted frequency band is 14kHz, so the limit is 11.2 kHz.

B.5.6. Measurement Results

Measurement results see Figure B-9.

Conclusions: Set.NFC03, **PASS**.

The conducted emission measurements were made with the following detector of the test receiver:
Quasi-Peak / Average Detector.

The measurement bandwidth is:

Table B-9: Measurement Bandwidth

Frequency of Emission (MHz)	RBW/VBW
0.15-30	9kHz

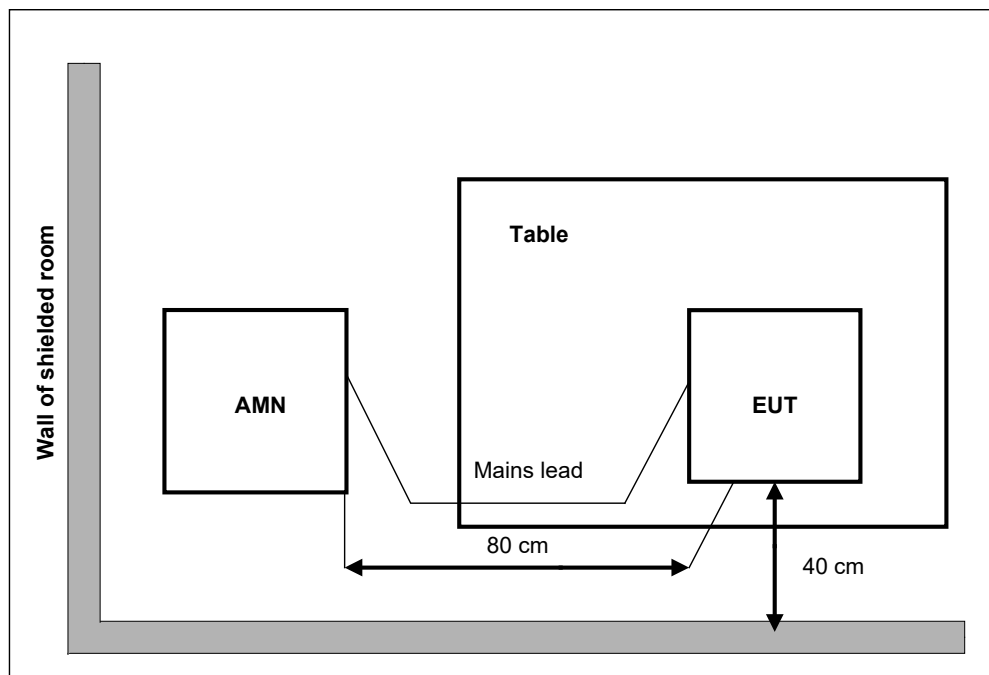

Figure B-10: Measurement Setup

B.6.3. EUT Operating Mode and Test Conditions

The measurement of EUT is carried out under the transmit state of NFC(See 3.4).

The EUT is powered by a travel adapter.

During the measurements, the ambient temperature is in the range of 15 ~ 25 °C.

B.6.4. Limits

Table B-10: Limits

Frequency range (MHz)	Quasi-peak Limit (dB μ V)	Average Limit (dB μ V)
0.15 to 0.5	66 to 56	56 to 46
0.5 to 5	56	46
5 to 30	60	50

B.6.5. Measurement Results

Measurement results see Figure B-11.

Conclusions: Set.NFC01, **PASS.**

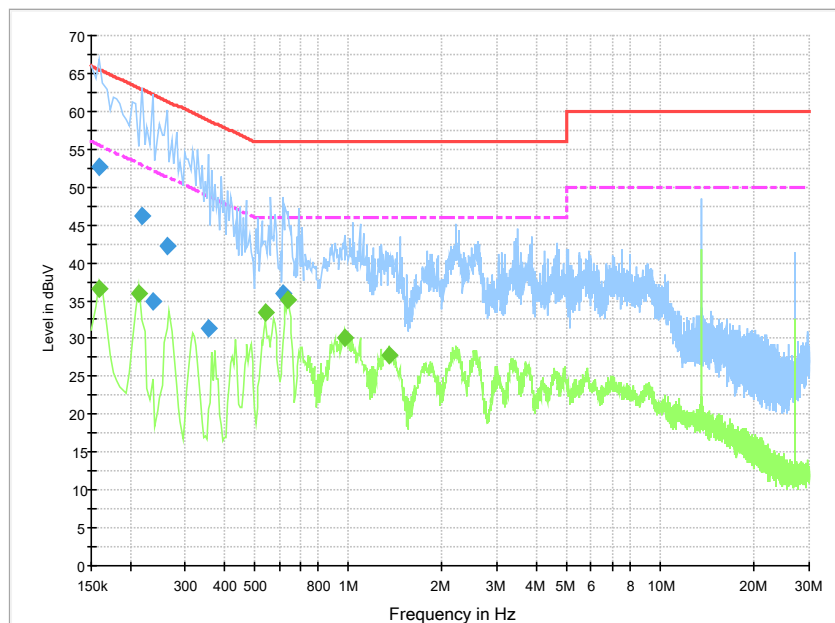

Note: the spike over the limit is the NFC carrier frequency and coming from the radio equipment.

Figure B-11: Measurement results for Conducted Emission

Final Result 1

Frequency (MHz)	QuasiPeak (dBuV)	Meas. Time (ms)	Bandwidth (kHz)	Filter	Line	Corr. (dB)	Margin (dB)	Limit (dBuV)	Comment
0.159000	52.6	5000.0	9.000	On	L1	20.0	12.9	65.5	
0.217500	46.1	5000.0	9.000	On	L1	19.9	16.8	62.9	
0.235500	34.8	5000.0	9.000	On	N	19.9	27.4	62.3	
0.262500	42.2	5000.0	9.000	On	L1	19.9	19.1	61.4	
0.357000	31.4	5000.0	9.000	On	L1	19.9	27.4	58.8	
0.618000	36.0	5000.0	9.000	On	N	19.9	20.0	56.0	

Final Result 2

Frequency (MHz)	Average (dBuV)	Meas. Time (ms)	Bandwidth (kHz)	Filter	Line	Corr. (dB)	Margin (dB)	Limit (dBuV)	Comment
0.159000	36.6	5000.0	9.000	On	L1	20.0	18.9	55.5	
0.213000	35.9	5000.0	9.000	On	L1	19.9	17.2	53.1	
0.541500	33.5	5000.0	9.000	On	L1	20.0	12.5	46.0	
0.636000	35.1	5000.0	9.000	On	L1	19.9	10.9	46.0	
0.978000	30.1	5000.0	9.000	On	L1	19.8	15.9	46.0	
1.351500	27.9	5000.0	9.000	On	L1	19.8	18.1	46.0	

ANNEX C: Persons involved in this testing

Table C-1: Persons involved

Test Item	Tester
20dB Bandwidth	Zhou Bin
Frequency Tolerance	Zhou Bin
Electric Field Strength of Fundamental and Outside the Allocated bands	Li Zong Liang
Electric Field Radiated Emissions (< 30MHz)	Li Zong Liang
Electric Field Radiated Emissions (≥ 30 MHz)	Li Zong Liang
Conducted Emissions	Guo Qian

ANNEX D: Accreditation Certificate

<p>United States Department of Commerce National Institute of Standards and Technology</p> <p>NVLAP® </p> <hr/> <p>Certificate of Accreditation to ISO/IEC 17025:2017</p> <hr/> <p>NVLAP LAB CODE: 600118-0</p> <p>Telecommunication Technology Labs, CAICT Beijing China</p> <p><i>is accredited by the National Voluntary Laboratory Accreditation Program for specific services, listed on the Scope of Accreditation, for:</i></p> <p>Electromagnetic Compatibility & Telecommunications</p> <p><i>This laboratory is accredited in accordance with the recognized International Standard ISO/IEC 17025:2017. This accreditation demonstrates technical competence for a defined scope and the operation of a laboratory quality management system (refer to joint ISO-ILAC-IAF Communique dated January 2009).</i></p> <hr/> <table border="0" style="width: 100%;"><tr><td style="width: 40%; text-align: center;"><p>2020-09-29 through 2021-09-30 <i>Effective Dates</i></p></td><td style="width: 20%; text-align: center;"></td><td style="width: 40%; text-align: center;"> <i>For the National Voluntary Laboratory Accreditation Program</i></td></tr></table>		<p>2020-09-29 through 2021-09-30 <i>Effective Dates</i></p>		 <i>For the National Voluntary Laboratory Accreditation Program</i>
<p>2020-09-29 through 2021-09-30 <i>Effective Dates</i></p>		 <i>For the National Voluntary Laboratory Accreditation Program</i>		

END OF REPORT