



# SAR TEST REPORT

No. I20Z60778-SEM05

For

**TCL Communication Ltd.**

**GSM/UMTS/LTE Mobile phone**

**Model name: 5004R,5004C**

With

**Hardware Version: 03**

**Software Version: 6G2KUDK0**

**FCC ID: 2ACCJH129**

**Issued Date: 2020-7-8**

**Note:**

The test results in this test report relate only to the devices specified in this report. This report shall not be reproduced except in full without the written approval of CTTL.

The report must not be used by the client to claim product certification, approval, or endorsement by NVLAP, NIST, or any agency of the U.S. Government.

**Test Laboratory:**

CTTL, Telecommunication Technology Labs, CAICT

No. 51, Xueyuan Road, Haidian District, Beijing, P. R. China 100191.

Tel:+86(0)10-62304633-2512, Fax:+86(0)10-62304633-2504

Email: [ctl\\_terminals@caict.ac.cn](mailto:ctl_terminals@caict.ac.cn), website: [www.caict.ac.cn](http://www.caict.ac.cn)

**REPORT HISTORY**

Report Number	Revision	Issue Date	Description
I20Z60778-SEM05	Rev.0	2020-7-2	Initial creation of test report
I20Z60778-SEM05	Rev.1	2020-7-8	<ol style="list-style-type: none"><li>1.Remove frequency information of LTE Band7 on section 4.1.</li><li>2.Update the tune up of WCDMA Band2 on page29, and LTE Band2 on page30.</li><li>3.Update the tune-up power for 802.11n(20) MCS4~7 on page 52.</li><li>4.Update the duty cycle for GSM1900 low power on section 14 page 56.</li><li>5.Update test position of LTE Band12 on page 64, which is a clerical error.</li><li>6.Add headset evaluation result in Table 14.1-8, add setup photo in the file of photos.</li></ol>



## TABLE OF CONTENT

<b>1 TEST LABORATORY</b> .....	<b>5</b>
1.1 TESTING LOCATION .....	5
1.2 TESTING ENVIRONMENT.....	5
1.3 PROJECT DATA .....	5
1.4 SIGNATURE.....	5
<b>2 STATEMENT OF COMPLIANCE</b> .....	<b>6</b>
<b>3 CLIENT INFORMATION</b> .....	<b>8</b>
3.1 APPLICANT INFORMATION .....	8
3.2 MANUFACTURER INFORMATION .....	8
<b>4 EQUIPMENT UNDER TEST (EUT) AND ANCILLARY EQUIPMENT (AE)</b> .....	<b>9</b>
4.1 ABOUT EUT .....	9
4.2 INTERNAL IDENTIFICATION OF EUT USED DURING THE TEST .....	9
4.3 INTERNAL IDENTIFICATION OF AE USED DURING THE TEST .....	9
<b>5 TEST METHODOLOGY</b> .....	<b>10</b>
5.1 APPLICABLE LIMIT REGULATIONS .....	10
5.2 APPLICABLE MEASUREMENT STANDARDS .....	10
<b>6 SPECIFIC ABSORPTION RATE (SAR)</b> .....	<b>11</b>
6.1 INTRODUCTION.....	11
6.2 SAR DEFINITION.....	11
<b>7 TISSUE SIMULATING LIQUIDS</b> .....	<b>12</b>
7.1 TARGETS FOR TISSUE SIMULATING LIQUID.....	12
7.2 DIELECTRIC PERFORMANCE .....	12
<b>8 SYSTEM VERIFICATION</b> .....	<b>16</b>
8.1 SYSTEM SETUP .....	16
8.2 SYSTEM VERIFICATION.....	17
<b>9 MEASUREMENT PROCEDURES</b> .....	<b>18</b>
9.1 TESTS TO BE PERFORMED .....	18
9.2 GENERAL MEASUREMENT PROCEDURE.....	20
9.3 WCDMA MEASUREMENT PROCEDURES FOR SAR .....	21
9.4 SAR MEASUREMENT FOR LTE.....	22
9.5 BLUETOOTH & WI-FI MEASUREMENT PROCEDURES FOR SAR .....	24
9.6 POWER DRIFT .....	24
<b>10 AREA SCAN BASED 1-G SAR</b> .....	<b>25</b>
10.1 REQUIREMENT OF KDB.....	25
10.2 FAST SAR ALGORITHMS .....	25

<b>11 CONDUCTED OUTPUT POWER.....</b>	<b>26</b>
11.1 GSM MEASUREMENT RESULT .....	26
11.2 WCDMA MEASUREMENT RESULT .....	28
11.3 LTE MEASUREMENT RESULT .....	30
11.4 WI-FI AND BT MEASUREMENT RESULT .....	52
<b>12 SIMULTANEOUS TX SAR CONSIDERATIONS.....</b>	<b>53</b>
12.1 INTRODUCTION.....	53
12.2 TRANSMIT ANTENNA SEPARATION DISTANCES.....	53
12.3 SAR MEASUREMENT POSITIONS.....	54
12.4 STANDALONE SAR TEST EXCLUSION CONSIDERATIONS .....	54
<b>13 EVALUATION OF SIMULTANEOUS.....</b>	<b>55</b>
<b>14 SAR TEST RESULT .....</b>	<b>56</b>
14.1 SAR RESULTS FOR FAST SAR .....	57
14.2 SAR RESULTS FOR STANDARD PROCEDURE.....	69
14.3 WLAN EVALUATION FOR 2.4G .....	76
14.4 SAR RESULTS FOR BT.....	79
<b>15 SAR MEASUREMENT VARIABILITY.....</b>	<b>80</b>
<b>16 MEASUREMENT UNCERTAINTY .....</b>	<b>82</b>
16.1 MEASUREMENT UNCERTAINTY FOR NORMAL SAR TESTS (300MHZ~3GHZ).....	82
16.2 MEASUREMENT UNCERTAINTY FOR NORMAL SAR TESTS (3~6GHZ) .....	83
16.3 MEASUREMENT UNCERTAINTY FOR FAST SAR TESTS (300MHZ~3GHZ).....	84
16.4 MEASUREMENT UNCERTAINTY FOR FAST SAR TESTS (3~6GHZ) .....	85
<b>17 MAIN TEST INSTRUMENTS.....</b>	<b>87</b>
<b>ANNEX A GRAPH RESULTS.....</b>	<b>1</b>
<b>ANNEX B SYSTEM VERIFICATION RESULTS .....</b>	<b>39</b>
<b>ANNEX C SAR MEASUREMENT SETUP .....</b>	<b>46</b>
<b>ANNEX D POSITION OF THE WIRELESS DEVICE IN RELATION TO THE PHANTOM .....</b>	<b>52</b>
<b>ANNEX E EQUIVALENT MEDIA RECIPES.....</b>	<b>55</b>
<b>ANNEX F SYSTEM VALIDATION .....</b>	<b>56</b>
<b>ANNEX G PROBE CALIBRATION CERTIFICATE.....</b>	<b>57</b>
<b>ANNEX H DIPOLE CALIBRATION CERTIFICATE .....</b>	<b>80</b>
<b>ANNEX J ACCREDITATION CERTIFICATE.....</b>	<b>137</b>

## 1 Test Laboratory

### 1.1 Testing Location

Company Name:	CTTL(Shouxiang)
Address:	No. 51 Shouxiang Science Building, Xueyuan Road, Haidian District, Beijing, P. R. China100191

### 1.2 Testing Environment

Temperature:	18°C~25°C,
Relative humidity:	30%~ 70%
Ground system resistance:	< 0.5 $\Omega$
Ambient noise & Reflection:	< 0.012 W/kg

### 1.3 Project Data

Project Leader:	Qi Dianyuan
Test Engineer:	Lin Xiaojun
Testing Start Date:	June 25, 2020
Testing End Date:	June 30, 2020

### 1.4 Signature



Lin Xiaojun  
(Prepared this test report)

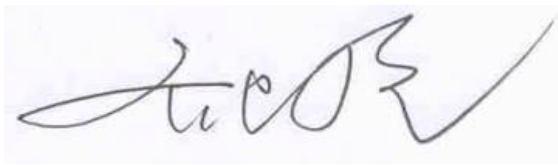

Qi Dianyuan  
(Reviewed this test report)

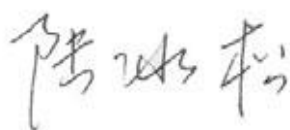

Lu Bingsong  
Deputy Director of the laboratory  
(Approved this test report)

## 2 Statement of Compliance

The maximum results of SAR found during testing for TCL Communication Ltd. GSM/UMTS/LTE

Mobile phone 5004R,5004C are as follows:

**Table 2.1: Highest Reported SAR (1g)**

Exposure Configuration	Technology Band	Highest Reported SAR 1g(W/kg)	Equipment Class
Head	GSM 850	0.26	PCE
	PCS 1900	0.10	
	UMTS FDD 2	0.20	
	UMTS FDD 4	0.52	
	UMTS FDD 5	1.17	
	LTE Band 2	0.27	
	LTE Band 5	1.04	
	LTE Band 12	1.03	
	LTE Band 14	0.28	
	LTE Band 30	0.24	
	LTE Band 66	0.46	
	WLAN 2.4 GHz	0.53	DTS
Hotspot 10mm	GSM 850	0.70	PCE
	PCS 1900	1.13	
	UMTS FDD 2	1.34	
	UMTS FDD 4	0.87	
	UMTS FDD 5	0.38	
	LTE Band 2	1.01	
	LTE Band 5	0.43	
	LTE Band 12	0.49	
	LTE Band 14	0.55	
	LTE Band 30	0.23	
	LTE Band 66	0.62	
	WLAN 2.4 GHz	0.24	DTS
Body Worn 15mm	PCS 1900	0.70	PCE
	UMTS FDD 2	0.60	
	UMTS FDD 4	0.52	
	LTE Band 2	0.82	
	LTE Band 30	0.67	
	LTE Band 66	0.80	

The SAR values found for the Mobile Phone are below the maximum recommended levels of 1.6 W/kg as averaged over any 1g tissue according to the ANSI C95.1-1992.

For body operation, this device has been tested and meets FCC RF exposure guidelines when used with any accessory that contains no metal and which provides a minimum separation distance of 10 mm for hotspot and 15mm for body worn between this device and the body of the user. Use of other accessories may not ensure compliance with FCC RF exposure guidelines.

The EUT battery must be fully charged and checked periodically during the test to ascertain uniform power output.

The measurement together with the test system set-up is described in annex C of this test report. A detailed description of the equipment under test can be found in chapter 4 of this test report. The highest reported SAR value is obtained at the case of (Table 2.1), and the values are: **1.34 W/kg(1g)**.

**Table 2.2: The sum of reported SAR values for main antenna and WiFi2.4G**

	Position	Main antenna	WiFi	Sum
<b>Highest reported SAR value for Head</b>	Left head, Cheek (WCDMA850)	1.17	0.17	<b>1.34</b>
<b>Highest reported SAR value for Body</b>	Bottom 10mm (WCDMA1900)	1.34	<0.01	<b>1.34</b>

**Table 2.3: The sum of reported SAR values for main antenna and BT**

	Position	Main antenna	BT	Sum
<b>Maximum reported SAR value for Head</b>	Left head, Cheek (WCDMA850)	1.17	0.04	<b>1.21</b>
<b>Maximum reported SAR value for Body</b>	Bottom 10mm (WCDMA1900)	1.34	<0.01	<b>1.34</b>

According to the above tables, the highest sum of reported SAR values is **1.34 W/kg (1g)**. The detail for simultaneous transmission consideration is described in chapter 13.

**Table 2.4: 0mm Reported SAR for phablet**

Exposure Configuration	Technology Band	Highest Reported SAR 10g(W/kg)	Limited SAR 10g(W/kg)
Separation Distance 0mm	GSM 1900	3.78	4.0
	WCDMA 1900	3.92	
	WCDMA 1700	3.07	
	LTE Band 2	3.81	
	LTE Band 66	3.62	



### 3 Client Information

#### 3.1 Applicant Information

Company Name:	TCL Communication Ltd.
Address/Post:	5/F, Building 22E, 22 Science Park East Avenue, Hong Kong Science Park, Shatin, NT, Hong Kong
Contact Person:	Gong Zhizhou
Contact Email:	zhizhou.gong@tcl.com
Telephone:	0086-755-36611722
Fax	0086-755-36612000-81722

#### 3.2 Manufacturer Information

Company Name:	TCL Communication Ltd.
Address/Post:	5/F, Building 22E, 22 Science Park East Avenue, Hong Kong Science Park, Shatin, NT, Hong Kong
Contact Person:	Gong Zhizhou
Contact Email:	zhizhou.gong@tcl.com
Telephone:	0086-755-36611722
Fax	0086-755-36612000-81722



## 4 Equipment Under Test (EUT) and Ancillary Equipment (AE)

### 4.1 About EUT

Description:	GSM/UMTS/LTE Mobile phone
Model name:	5004R,5004C
Operating mode(s):	GSM 850/900/1800/1900, UMTS FDD 2/4/5, BT, Wi-Fi2.4G, LTE Band 2/4/5/12/14/30/66
Tested Tx Frequency:	824 – 849 MHz (GSM 850)
	1850 – 1910 MHz (GSM 1900)
	824–849 MHz (WCDMA 850 Band V)
	1710 – 1755 MHz (WCDMA 1700 Band IV)
	1850–1910 MHz (WCDMA1900 Band II)
	1850.7 – 1909.3 MHz(LTE Band 2)
	824.7 – 848.3 MHz(LTE Band 5)
	699.7 – 715.3 MHz (LTE Band 12)
	790.5 – 795.5 MHz (LTE Band 14)
	2312.5 – 2307.5 MHz (LTE Band 30)
	1710.7 – 1779.3 MHz (LTE Band 66)
2412 – 2462 MHz (Wi-Fi 2.4G)	
GPRS/EGPRS Multislot Class:	12
GPRS capability Class:	B
Test device Production information:	Production unit
Device type:	Portable device
Antenna type:	Integrated antenna
Hotspot mode:	Support

### 4.2 Internal Identification of EUT used during the test

EUT ID*	IMEI	HW	SW Version
EUT1	015730000011408	03	6G2KUDK0
EUT2	015730000010111	03	6G2KUDK0
EUT3	015730000011044	03	6G2KUDK0
EUT4	015730000010764	03	6G2KUDK0

\*EUT ID: is used to identify the test sample in the lab internally.

**Note:** It is performed to test SAR with the EUT1~3 and conducted power with the EUT4.

### 4.3 Internal Identification of AE used during the test

AE ID*	Description	Model	SN	Manufacturer
AE1	Battery	CAC3400011C1	/	BYD

\*AE ID: is used to identify the test sample in the lab internally.

## 5 TEST METHODOLOGY

### 5.1 Applicable Limit Regulations

**ANSI C95.1–1992:** IEEE Standard for Safety Levels with Respect to Human Exposure to Radio Frequency Electromagnetic Fields, 3 kHz to 300 GHz.

It specifies the maximum exposure limit of **1.6 W/kg** as averaged over any 1 gram of tissue for portable devices being used within 20 cm of the user in the uncontrolled environment.

### 5.2 Applicable Measurement Standards

**IEEE 1528–2013:** Recommended Practice for Determining the Peak Spatial-Average Specific Absorption Rate (SAR) in the Human Head from Wireless Communications Devices: Measurement Techniques.

**KDB447498 D01: General RF Exposure Guidance v06:** Mobile and Portable Devices RF Exposure Procedures and Equipment Authorization Policies.

**KDB648474 D04 Handset SAR v01r03:** SAR Evaluation Considerations for Wireless Handsets.

**KDB941225 D01 SAR test for 3G devices v03r01:** SAR Measurement Procedures for 3G Devices

**KDB941225 D05 SAR for LTE Devices v02r05:** SAR Evaluation Considerations for LTE Devices

**KDB941225 D06 Hotspot Mode SAR v02r01:** SAR Evaluation Procedures for Portable Devices with Wireless Router Capabilities

**KDB248227 D01 802.11 Wi-Fi SAR v02r02:** SAR GUIDANCE FOR IEEE 802.11 (Wi-Fi) TRANSMITTERS

**KDB865664 D01 SAR measurement 100 MHz to 6 GHz v01r04:** SAR Measurement Requirements for 100 MHz to 6 GHz.

**KDB865664 D02 RF Exposure Reporting v01r02:** RF Exposure Compliance Reporting and Documentation Considerations

## 6 Specific Absorption Rate (SAR)

### 6.1 Introduction

SAR is related to the rate at which energy is absorbed per unit mass in an object exposed to a radio field. The SAR distribution in a biological body is complicated and is usually carried out by experimental techniques or numerical modeling. The standard recommends limits for two tiers of groups, occupational/controlled and general population/uncontrolled, based on a person's awareness and ability to exercise control over his or her exposure. In general, occupational/controlled exposure limits are higher than the limits for general population/uncontrolled.

### 6.2 SAR Definition

The SAR definition is the time derivative (rate) of the incremental energy ( $dW$ ) absorbed by (dissipated in) an incremental mass ( $dm$ ) contained in a volume element ( $dv$ ) of a given density ( $\rho$ ). The equation description is as below:

$$SAR = \frac{d}{dt} \left( \frac{dW}{dm} \right) = \frac{d}{dt} \left( \frac{dW}{\rho dv} \right)$$

SAR is expressed in units of Watts per kilogram (W/kg)

SAR measurement can be either related to the temperature elevation in tissue by

$$SAR = c \left( \frac{\delta T}{\delta t} \right)$$

Where:  $C$  is the specific heat capacity,  $\delta T$  is the temperature rise and  $\delta t$  is the exposure duration, or related to the electrical field in the tissue by

$$SAR = \frac{\sigma |E|^2}{\rho}$$

Where:  $\sigma$  is the conductivity of the tissue,  $\rho$  is the mass density of tissue and  $E$  is the RMS electrical field strength.

However for evaluating SAR of low power transmitter, electrical field measurement is typically applied.

## 7 Tissue Simulating Liquids

### 7.1 Targets for tissue simulating liquid

**Table 7.1: Targets for tissue simulating liquid**

Frequency(MHz)	Liquid Type	Conductivity( $\sigma$ )	$\pm 5\%$ Range	Permittivity( $\epsilon$ )	$\pm 5\%$ Range
750	Head	0.89	0.85~0.93	41.94	39.8~44.0
835	Head	0.90	0.86~0.95	41.5	39.4~43.6
1750	Head	1.37	1.30~1.44	40.08	38.1~42.1
1900	Head	1.40	1.33~1.47	40.0	38.0~42.0
2300	Head	1.67	1.59~1.75	39.47	37.50~41.40
2450	Head	1.80	1.71~1.89	39.2	37.2~41.2

### 7.2 Dielectric Performance

**Table 7.2: Dielectric Performance of Tissue Simulating Liquid**

Measurement Date (yyyy-mm-dd)	Type	Frequency	Permittivity $\epsilon$	Drift (%)	Conductivity $\sigma$ (S/m)	Drift (%)
2020/6/25	Head	750 MHz	42.07	0.31	0.897	0.79
2020/6/26	Head	835 MHz	41.45	-0.12	0.884	-1.78
2020/6/27	Head	1750 MHz	39.44	-1.60	1.374	0.29
2020/6/28	Head	1900 MHz	39.33	-1.68	1.382	-1.29
2020/6/29	Head	2300 MHz	39.52	0.05	1.682	0.72
2020/6/30	Head	2450 MHz	38.58	-1.58	1.8	0.00

Note: The liquid temperature is 22.0°C

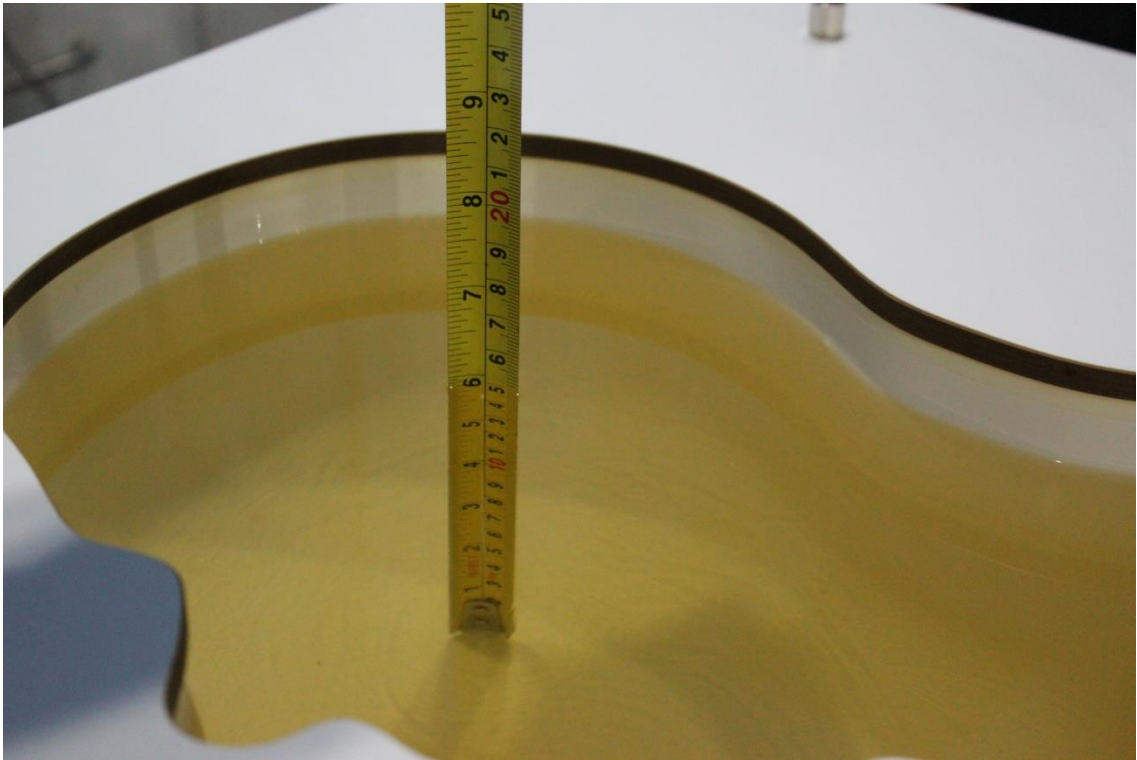

**Picture 7-1 Liquid depth in the Head Phantom (750MHz)**

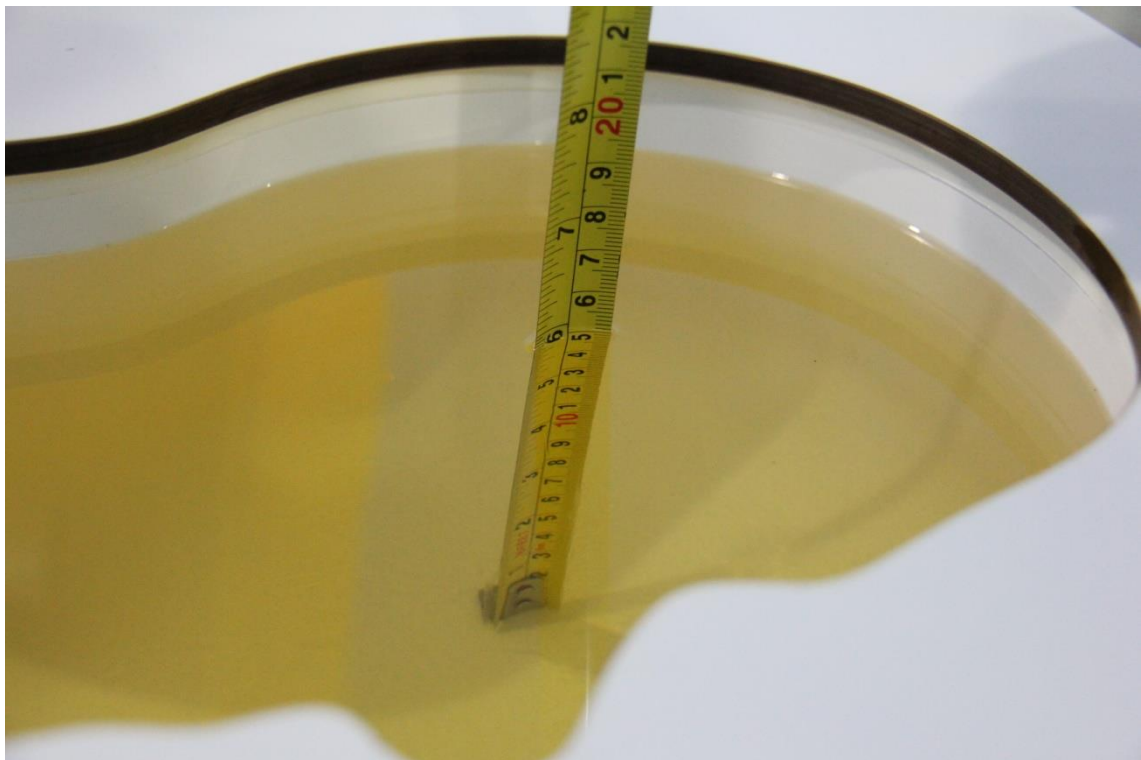

**Picture 7-2 Liquid depth in the Head Phantom (835 MHz)**

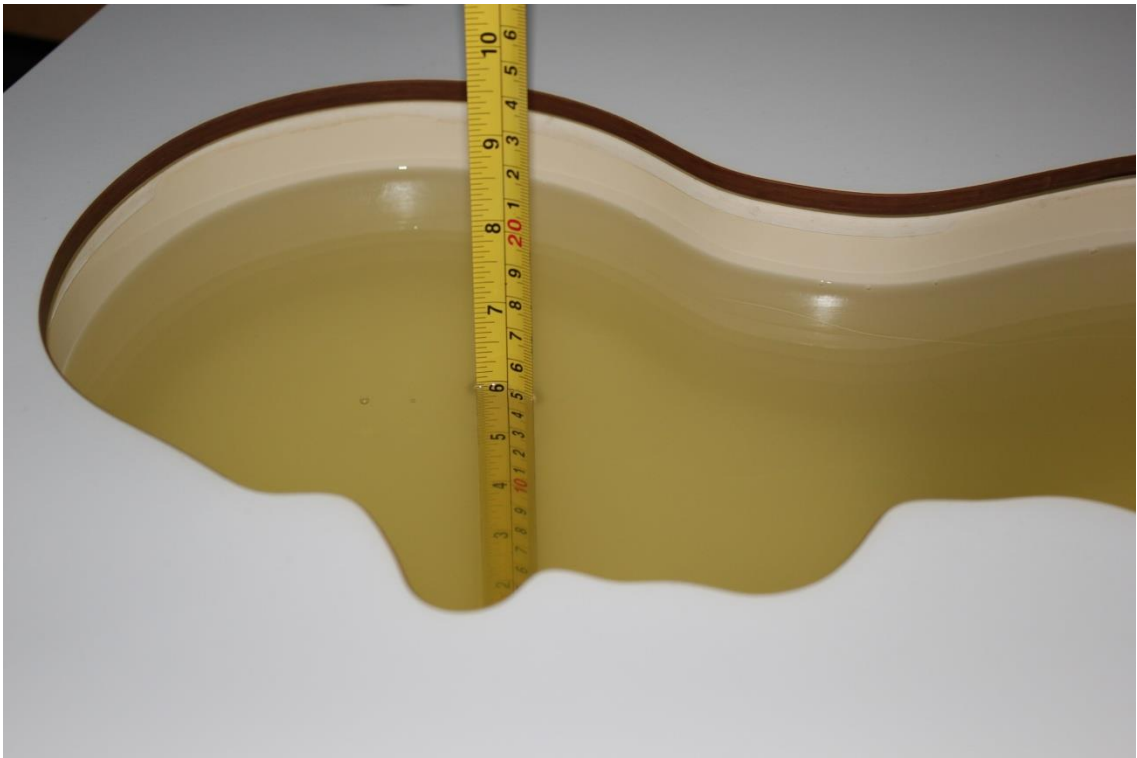

Picture 7-3 Liquid depth in the Head Phantom (1750 MHz)



Picture 7-4 Liquid depth in the Head Phantom (1900 MHz)

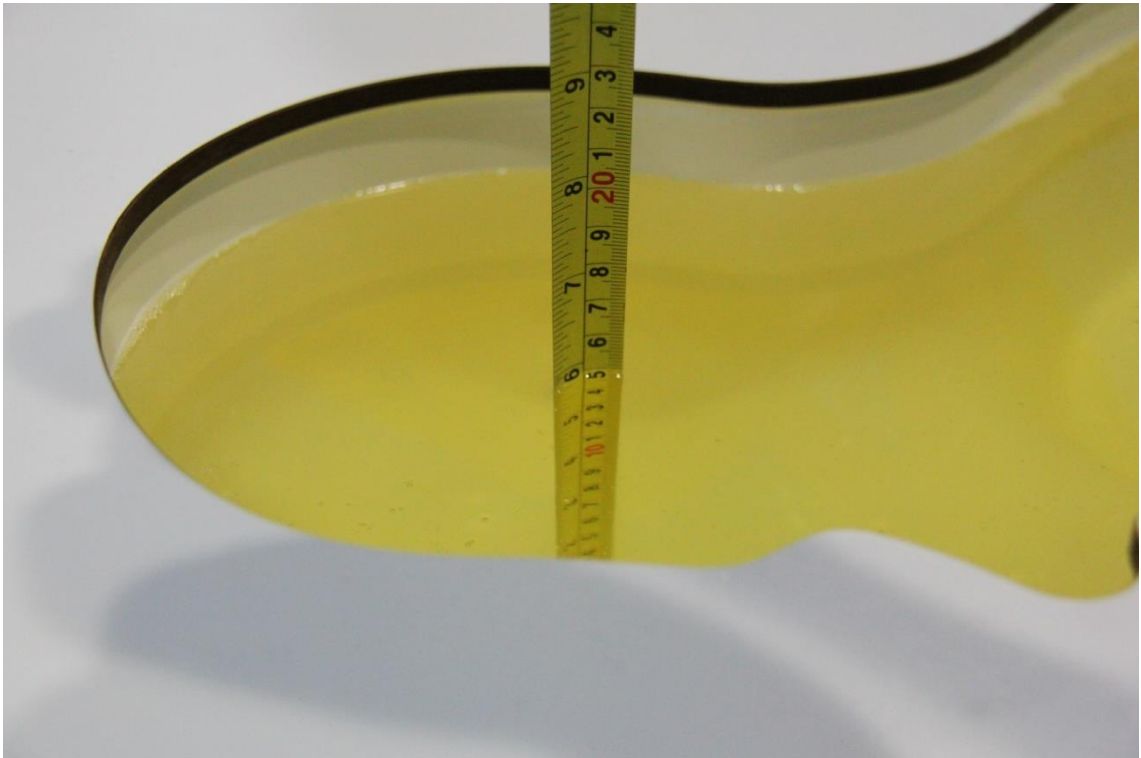

**Picture 7-5 Liquid depth in the Head Phantom (2450MHz)**



**Picture 7-6 Liquid depth in the Head Phantom (2300 MHz)**

## 8 System verification

### 8.1 System Setup

In the simplified setup for system evaluation, the DUT is replaced by a calibrated dipole and the power source is replaced by a continuous wave that comes from a signal generator. The calibrated dipole must be placed beneath the flat phantom section of the SAM twin phantom with the correct distance holder. The distance holder should touch the phantom surface with a light pressure at the reference marking and be oriented parallel to the long side of the phantom. The equipment setup is shown below:

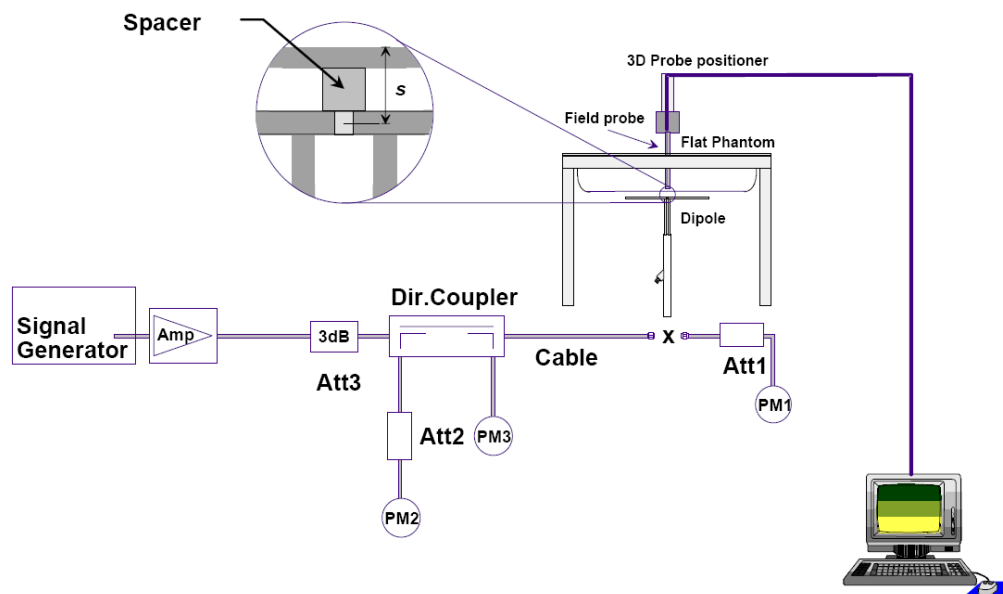

Picture 8.1 System Setup for System Evaluation



Picture 8.2 Photo of Dipole Setup



## 8.2 System Verification

SAR system verification is required to confirm measurement accuracy, according to the tissue dielectric media, probe calibration points and other system operating parameters required for measuring the SAR of a test device. The system verification must be performed for each frequency band and within the valid range of each probe calibration point required for testing the device.

The system verification results are required that the area scan estimated 1-g SAR is within 3% of the zoom scan 1-g SAR. The details are presented in annex B.

**Table 8.1: System Verification of Head**

Measurement Date (yyyy-mm-dd)	Frequency	Target value (W/kg)		Measured value(W/kg)		Deviation	
		10 g Average	1 g Average	10 g Average	1 g Average	10 g Average	1 g Average
2020/6/25	750 MHz	5.57	8.57	5.64	8.52	1.26%	-0.58%
2020/6/26	835 MHz	6.29	9.70	6.24	9.76	-0.79%	0.62%
2020/6/27	1750 MHz	19.3	36.6	19.24	36.12	-0.31%	-1.31%
2020/6/28	1900 MHz	20.8	39.7	21.16	39.8	1.73%	0.25%
2020/6/29	2300 MHz	24.1	49.7	23.88	49	-0.91%	-1.41%
2020/6/30	2450 MHz	24.2	51.6	24.36	50.56	0.66%	-2.02%

## 9 Measurement Procedures

### 9.1 Tests to be performed

In order to determine the highest value of the peak spatial-average SAR of a handset, all device positions, configurations and operational modes shall be tested for each frequency band according to steps 1 to 3 below. A flowchart of the test process is shown in picture 9.1.

**Step 1:** The tests described in 9.2 shall be performed at the channel that is closest to the centre of the transmit frequency band ( $f_c$ ) for:

- a) all device positions (cheek and tilt, for both left and right sides of the SAM phantom, as described in annex D),
- b) all configurations for each device position in a), e.g., antenna extended and retracted, and
- c) all operational modes, e.g., analogue and digital, for each device position in a) and configuration in b) in each frequency band.

If more than three frequencies need to be tested according to 11.1 (i.e.,  $N_c > 3$ ), then all frequencies, configurations and modes shall be tested for all of the above test conditions.

**Step 2:** For the condition providing highest peak spatial-average SAR determined in Step 1, perform all tests described in 9.2 at all other test frequencies, i.e., lowest and highest frequencies. In addition, for all other conditions (device position, configuration and operational mode) where the peak spatial-average SAR value determined in Step 1 is within 3 dB of the applicable SAR limit, it is recommended that all other test frequencies shall be tested as well.

**Step 3:** Examine all data to determine the highest value of the peak spatial-average SAR found in Steps 1 to 2.

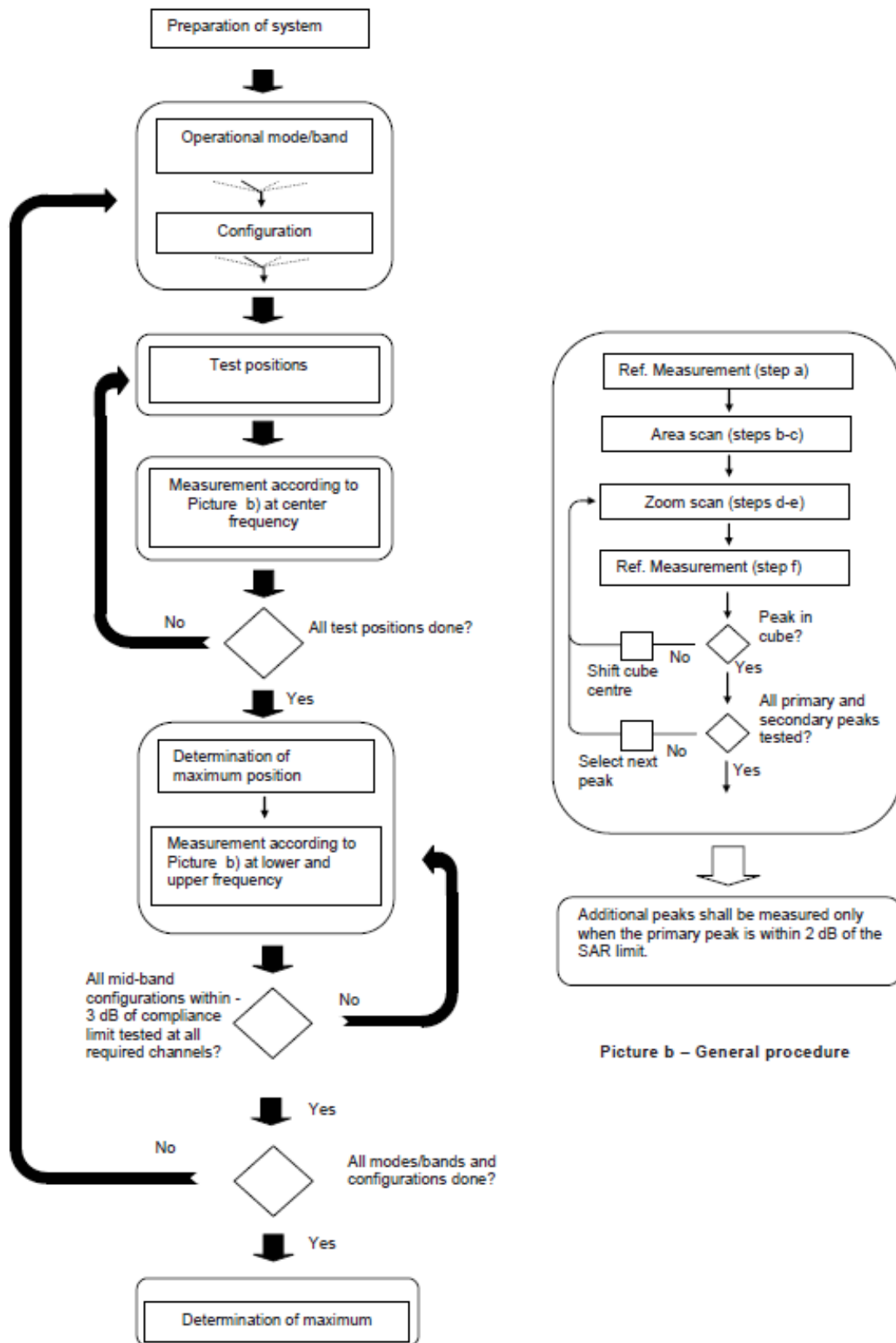

Picture a – Tests to be performed

Picture b – General procedure

Picture 9.1 Block diagram of the tests to be performed

## 9.2 General Measurement Procedure

The area and zoom scan resolutions specified in the table below must be applied to the SAR measurements and fully documented in SAR reports to qualify for TCB approval. Probe boundary effect error compensation is required for measurements with the probe tip closer than half a probe tip diameter to the phantom surface. Both the probe tip diameter and sensor offset distance must satisfy measurement protocols; to ensure probe boundary effect errors are minimized and the higher fields closest to the phantom surface can be correctly measured and extrapolated to the phantom surface for computing 1-g SAR. Tolerances of the post-processing algorithms must be verified by the test laboratory for the scan resolutions used in the SAR measurements, according to the reference distribution functions specified in IEEE Std 1528-2003. The results should be documented as part of the system validation records and may be requested to support test results when all the measurement parameters in the following table are not satisfied.

		$\leq 3$ GHz	$> 3$ GHz	
Maximum distance from closest measurement point (geometric center of probe sensors) to phantom surface		$5 \pm 1$ mm	$\frac{1}{2} \cdot \delta \cdot \ln(2) \pm 0.5$ mm	
Maximum probe angle from probe axis to phantom surface normal at the measurement location		$30^\circ \pm 1^\circ$	$20^\circ \pm 1^\circ$	
Maximum area scan spatial resolution: $\Delta x_{Area}$ , $\Delta y_{Area}$		$\leq 2$ GHz: $\leq 15$ mm 2 – 3 GHz: $\leq 12$ mm	3 – 4 GHz: $\leq 12$ mm 4 – 6 GHz: $\leq 10$ mm	
		When the x or y dimension of the test device, in the measurement plane orientation, is smaller than the above, the measurement resolution must be $\leq$ the corresponding x or y dimension of the test device with at least one measurement point on the test device.		
Maximum zoom scan spatial resolution: $\Delta x_{Zoom}$ , $\Delta y_{Zoom}$		$\leq 2$ GHz: $\leq 8$ mm 2 – 3 GHz: $\leq 5$ mm*	3 – 4 GHz: $\leq 5$ mm* 4 – 6 GHz: $\leq 4$ mm*	
Maximum zoom scan spatial resolution, normal to phantom surface	uniform grid: $\Delta z_{Zoom}(n)$	$\leq 5$ mm	3 – 4 GHz: $\leq 4$ mm 4 – 5 GHz: $\leq 3$ mm 5 – 6 GHz: $\leq 2$ mm	
	graded grid	$\Delta z_{Zoom}(1)$ : between 1 <sup>st</sup> two points closest to phantom surface	$\leq 4$ mm	3 – 4 GHz: $\leq 3$ mm 4 – 5 GHz: $\leq 2.5$ mm 5 – 6 GHz: $\leq 2$ mm
		$\Delta z_{Zoom}(n>1)$ : between subsequent points	$\leq 1.5 \cdot \Delta z_{Zoom}(n-1)$	
Minimum zoom scan volume	x, y, z	$\geq 30$ mm	3 – 4 GHz: $\geq 28$ mm 4 – 5 GHz: $\geq 25$ mm 5 – 6 GHz: $\geq 22$ mm	
Note: $\delta$ is the penetration depth of a plane-wave at normal incidence to the tissue medium; see draft standard IEEE P1528-2011 for details. * When zoom scan is required and the <i>reported</i> SAR from the area scan based 1-g SAR estimation procedures of KDB 447498 is $\leq 1.4$ W/kg, $\leq 8$ mm, $\leq 7$ mm and $\leq 5$ mm zoom scan resolution may be applied, respectively, for 2 GHz to 3 GHz, 3 GHz to 4 GHz and 4 GHz to 6 GHz.				

### 9.3 WCDMA Measurement Procedures for SAR

The following procedures are applicable to WCDMA handsets operating under 3GPP Release99, Release 5 and Release 6. The default test configuration is to measure SAR with an established radio link between the DUT and a communication test set using a 12.2kbps RMC (reference measurement channel) configured in Test Loop Mode 1. SAR is selectively confirmed for other physical channel configurations (DPCCH & DPDCH<sub>n</sub>), HSDPA and HSPA (HSUPA/HSDPA) modes according to output power, exposure conditions and device operating capabilities. Both uplink and downlink should be configured with the same RMC or AMR, when required. SAR for Release 5 HSDPA and Release 6 HSPA are measured using the applicable FRC (fixed reference channel) and E-DCH reference channel configurations. Maximum output power is verified according to applicable versions of 3GPP TS 34.121 and SAR must be measured according to these maximum output conditions. When Maximum Power Reduction (MPR) is not implemented according to Cubic Metric (CM) requirements for Release 6 HSPA, the following procedures do not apply.

#### For Release 5 HSDPA Data Devices:

Sub-test	$\beta_c$	$\beta_d$	$\beta_d$ (SF)	$\beta_c / \beta_d$	$\beta_{hs}$	CM/dB
1	2/15	15/15	64	2/15	4/15	0.0
2	12/15	15/15	64	12/15	24/25	1.0
3	15/15	8/15	64	15/8	30/15	1.5
4	15/15	4/15	64	15/4	30/15	1.5

#### For Release 6 HSPA Data Devices

Sub-test	$\beta_c$	$\beta_d$	$\beta_d$ (SF)	$\beta_c / \beta_d$	$\beta_{hs}$	$\beta_{ec}$	$\beta_{ed}$	$\beta_{ed}$ (SF)	$\beta_{ed}$ (codes)	CM (dB)	MPR (dB)	AG Index	E-TFCI
1	11/15	15/15	64	11/15	22/15	209/225	1039/225	4	1	1.5	1.5	20	75
2	6/15	15/15	64	6/15	12/15	12/15	12/15	4	1	1.5	1.5	12	67
3	15/15	9/15	64	15/9	30/15	30/15	$\beta_{ed1}:47/15$ $\beta_{ed2}:47/15$	4	2	1.5	1.5	15	92
4	2/15	15/15	64	2/15	4/15	4/15	56/75	4	1	1.5	1.5	17	71
5	15/15	15/15	64	15/15	24/15	30/15	134/15	4	1	1.5	1.5	21	81

#### Rel.8 DC-HSDPA (Cat 24)

SAR test exclusion for Rel.8 DC-HSDPA must satisfy the SAR test exclusion requirements of Rel.5 HSDPA. SAR test exclusion for DC-HSDPA devices is determined by power measurements according to the H-Set 12, Fixed Reference Channel (FRC) configuration in Table C.8.1.12 of 3GPP TS 34.121-1. A primary and a secondary serving HS-DSCH Cell are required to perform the power measurement and for the results to qualify for SAR test exclusion.

### 9.4 SAR Measurement for LTE

SAR tests for LTE are performed with a base station simulator, Rohde & Schwarz CMW500. Closed loop power control was used so the UE transmits with maximum output power during SAR testing. All powers were measured with the CMW 500.

It is performed for conducted power and SAR based on the KDB941225 D05.

SAR is evaluated separately according to the following procedures for the different test positions in each exposure condition – head, body, body-worn accessories and other use conditions. The procedures in the following subsections are applied separately to test each LTE frequency band.

1) QPSK with 1 RB allocation

Start with the largest channel bandwidth and measure SAR for QPSK with 1 RB allocation, using the RB offset and required test channel combination with the highest maximum output power among RB offsets at the upper edge, middle and lower edge of each required test channel. When the reported SAR is  $\leq 0.8$  W/kg, testing of the remaining RB offset configurations and required test channels is not required for 1 RB allocation; otherwise, SAR is required for the remaining required test channels and only for the RB offset configuration with the highest output power for that channel. When the reported SAR of a required test channel is  $> 1.45$  W/kg, SAR is required for all three RB offset configurations for that required test channel.

2) QPSK with 50% RB allocation

The procedures required for 1 RB allocation in 1) are applied to measure the SAR for QPSK with 50% RB allocation.

3) QPSK with 100% RB allocation

For QPSK with 100% RB allocation, SAR is not required when the highest maximum output power for 100 % RB allocation is less than the highest maximum output power in 50% and 1 RB allocations and the highest reported SAR for 1 RB and 50% RB allocation in 1) and 2) are  $\leq 0.8$  W/kg. Otherwise, SAR is measured for the highest output power channel; and if the reported SAR is  $> 1.45$  W/kg, the remaining required test channels must also be tested.

**TDD test:**

TDD testing is performed using guidance from FCC KDB 941225 D05 v02r05 and the SAR test guidance provided in April 2013 TCB works hop notes. TDD is tested at the highest duty factor using UL-DL configuration 0 with special subframe configuration 6 and applying the FDD LTE procedures in KDB 941225 D05 v02r05. SAR testing is performed using the extended cyclic prefix listed in 3GPP TS 36.211.

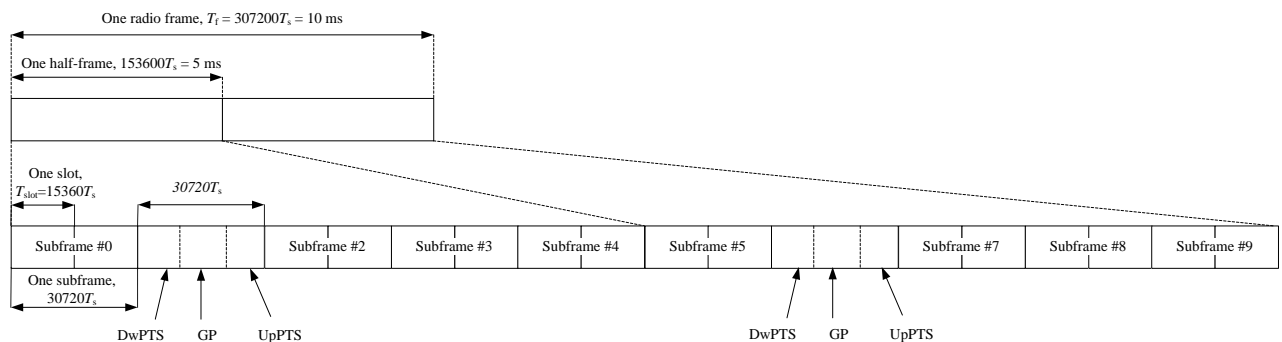

**Figure 9.2: Frame structure type 2 (for 5 ms switch-point periodicity)**

**Table 9.1: Configuration of special subframe (lengths of DwPTS/GP/UpPTS)**

Special subframe configuration	Normal cyclic prefix in downlink			Extended cyclic prefix in downlink		
	DwPTS	UpPTS		DwPTS	UpPTS	
		Normal cyclic prefix in uplink	Extended cyclic prefix in uplink		Normal cyclic prefix in uplink	Extended cyclic prefix in uplink
0	$6592 \cdot T_s$	$2192 \cdot T_s$	$2560 \cdot T_s$	$7680 \cdot T_s$	$2192 \cdot T_s$	$2560 \cdot T_s$
1	$19760 \cdot T_s$			$20480 \cdot T_s$		
2	$21952 \cdot T_s$			$23040 \cdot T_s$		
3	$24144 \cdot T_s$			$25600 \cdot T_s$		
4	$26336 \cdot T_s$	$4384 \cdot T_s$	$5120 \cdot T_s$	$7680 \cdot T_s$	$4384 \cdot T_s$	$5120 \cdot T_s$
5	$6592 \cdot T_s$			$20480 \cdot T_s$		
6	$19760 \cdot T_s$			$23040 \cdot T_s$		
7	$21952 \cdot T_s$			$12800 \cdot T_s$		
8	$24144 \cdot T_s$			-		
9	$13168 \cdot T_s$	-	-	-	-	-

**Table 9.2: Uplink-downlink configurations**

Uplink-downlink configuration	Downlink-to-Uplink Switch-point periodicity	Subframe number									
		0	1	2	3	4	5	6	7	8	9
0	5 ms	D	S	U	U	U	D	S	U	U	U
1	5 ms	D	S	U	U	D	D	S	U	U	D
2	5 ms	D	S	U	D	D	D	S	U	D	D
3	10 ms	D	S	U	U	U	D	D	D	D	D
4	10 ms	D	S	U	U	D	D	D	D	D	D
5	10 ms	D	S	U	D	D	D	D	D	D	D
6	5 ms	D	S	U	U	U	D	S	U	U	D

Duty factor is calculated by:

$$\begin{aligned}
 \text{Duty factor} &= \text{uplink frame} \cdot 6 + \text{UpPTS} \cdot 2 / \text{one frame length} \\
 &= (30720 \cdot T_s \cdot 6 + 5120 \cdot T_s \cdot 2) / 307200 \cdot T_s \\
 &= 0.633
 \end{aligned}$$

According to the KDB 447498 D01, SAR should be evaluated at more than 3 frequencies for devices supporting transmit bands wider than 100MHz. Oct.2014 FCC-TCB conference notes (Dec. 2014 rev.) specifies the 5 test channels to use for 3GPP band 41 SAR evaluation.

## 9.5 Bluetooth & Wi-Fi Measurement Procedures for SAR

Normal network operating configurations are not suitable for measuring the SAR of 802.11 transmitters in general. Unpredictable fluctuations in network traffic and antenna diversity conditions can introduce undesirable variations in SAR results. The SAR for these devices should be measured using chipset based test mode software to ensure that the results are consistent and reliable.

Chipset based test mode software is hardware dependent and generally varies among manufacturers. The device operating parameters established in a test mode for SAR measurements must be identical to those programmed in production units, including output power levels, amplifier gain settings and other RF performance tuning parameters. The test frequencies should correspond to actual channel frequencies defined for domestic use. SAR for devices with switched diversity should be measured with only one antenna transmitting at a time during each SAR measurement, according to a fixed modulation and data rate. The same data pattern should be used for all measurements.

## 9.6 Power Drift

To control the output power stability during the SAR test, DASY4 system calculates the power drift by measuring the E-field at the same location at the beginning and at the end of the measurement for each test position. These drift values can be found in section 14 labeled as: (Power Drift [dB]). This ensures that the power drift during one measurement is within 5%.



## 10 Area Scan Based 1-g SAR

### 10.1 Requirement of KDB

According to the KDB447498 D01 v05, when the implementation is based the specific polynomial fit

algorithm as presented at the 29th Bioelectromagnetics Society meeting (2007) and the estimated 1-gSAR is  $\leq 1.2$  W/kg, a zoom scan measurement is not required provided it is also not needed for any other purpose; for example, if the peak SAR location required for simultaneous transmission SAR test exclusion can be determined accurately by the SAR system or manually to discriminate between distinctive peaks and scattered noisy SAR distributions from area scans.

There must not be any warning or alert messages due to various measurement concerns identified by the SAR system; for example, noise in measurements, peaks too close to scan boundary, peaks are too sharp, spatial resolution and uncertainty issues etc. The SAR system verification must also demonstrate that the area scan estimated 1-g SAR is within 3% of the zoom scan 1-g SAR (See Annex B). When all the SAR results for each exposure condition in a frequency band and wireless mode are based on estimated 1-g SAR, the 1-g SAR for the highest SAR configuration must be determined by a zoom scan.

### 10.2 Fast SAR Algorithms

The approach is based on the area scan measurement applying a frequency dependent attenuation parameter. This attenuation parameter was empirically determined by analyzing a large number of phones. The MOTOROLA FAST SAR was developed and validated by the MOTOROLA Research Group in Ft. Lauderdale.

In the initial study, an approximation algorithm based on Linear fit was developed. The accuracy of the algorithm has been demonstrated across a broad frequency range (136-2450 MHz) and for both 1- and 10-g averaged SAR using a sample of 264 SAR measurements from 55 wireless handsets. For the sample size studied, the root-mean-squared errors of the algorithm are 1.2% and 5.8% for 1- and 10-g averaged SAR, respectively. The paper describing the algorithm in detail is expected to be published in August 2004 within the Special Issue of Transactions on MTT.

In the second step, the same research group optimized the fitting algorithm to an Polynomial fit whereby the frequency validity was extended to cover the range 30-6000MHz. Details of this study can be found in the BEMS 2007 Proceedings.

Both algorithms are implemented in DASY software.

## 11 Conducted Output Power

For Main antenna, there are two sets of tune-up power, Normal power and Low power, used for different use cases for PCS1900/WCDMA1700/WCDMA1900 and LTE Band2/4/30. Normal power status is applied for head test of above bands and body worn test when hotspot is off. Low power status is applied for body worn test of above bands when hotspot is on. For other bands, Normal power status is applied for both head and body test.

### 11.1 GSM Measurement result

During the process of testing, the EUT was controlled via Agilent Digital Radio Communication tester (E5515C) to ensure the maximum power transmission and proper modulation. This result contains conducted output power for the EUT. In all cases, the measured peak output power should be greater and within 5% than EMI measurement.

#### Normal Power

**Table 11.1-1: The conducted power measurement results for GSM, GPRS and EGPRS**

GSM 850 Speech (GMSK)	Measured Power (dBm)			Tune up	calculation	Averaged Power (dBm)		
	251	190	128			251	190	128
1 Txslot	32.18	32.19	32.00	33.3	/	/	/	/
GSM 850 GPRS (GMSK)	Measured Power (dBm)				calculation	Averaged Power (dBm)		
	251	190	128			251	190	128
1 Txslot	32.17	32.18	32.00	33.30	-9.03	23.14	23.15	22.97
2 Txslots	29.82	29.87	29.74	30.50	-6.02	23.80	23.85	23.72
3 Txslots	27.84	27.87	27.77	28.50	-4.26	23.58	23.61	23.51
4 Txslots	26.53	26.58	26.48	27.50	-3.01	23.52	23.57	23.47
GSM 850 EGPRS (GMSK)	Measured Power (dBm)				calculation	Averaged Power (dBm)		
	251	190	128			251	190	128
1 Txslot	32.17	32.19	32.00	33.30	-9.03	23.14	23.16	22.97
2 Txslots	29.82	29.88	29.74	30.50	-6.02	23.80	23.86	23.72
3 Txslots	27.84	27.88	27.78	28.50	-4.26	23.58	23.62	23.52
4 Txslots	26.53	26.59	26.48	27.50	-3.01	23.52	23.58	23.47
GSM 850 EGPRS (8PSK)	Measured Power (dBm)				calculation	Averaged Power (dBm)		
	251	190	128			251	190	128
1 Txslot	26.86	27.13	26.82	27.80	-9.03	17.83	18.10	17.79
2 Txslots	23.59	23.67	23.51	24.50	-6.02	17.57	17.65	17.49
3 Txslots	22.33	22.30	22.22	23.00	-4.26	18.07	18.04	17.96
4 Txslots	20.71	20.59	20.51	21.50	-3.01	17.70	17.58	17.50
PCS1900 Speech (GMSK)	Measured Power (dBm)			Tune up	calculation	Averaged Power (dBm)		
	810	661	512			810	661	512
1 Txslot	28.65	28.66	28.69	30.30	/	/	/	/
PCS1900 GPRS (GMSK)	Measured Power (dBm)				calculation	Averaged Power (dBm)		
	810	661	512			810	661	512
1 Txslot	28.62	28.69	28.70	30.30	-9.03	19.59	19.66	19.67

2 Txslots	27.00	26.95	26.91	28.00	-6.02	20.98	20.93	20.89
3 Txslots	24.55	24.47	24.39	25.50	-4.26	20.29	20.21	20.13
4 Txslots	23.46	23.39	23.28	24.50	-3.01	20.45	20.38	20.27
PCS1900 EGPRS (GMSK)	Measured Power (dBm)				calculation	Averaged Power (dBm)		
	810	661	512			810	661	512
1 Txslot	28.67	28.69	28.69	30.30	-9.03	19.64	19.66	19.66
2 Txslots	27.02	26.95	26.90	28.00	-6.02	21.00	20.93	20.88
3 Txslots	24.58	24.47	24.39	25.50	-4.26	20.32	20.21	20.13
4 Txslots	23.50	23.39	23.30	24.50	-3.01	20.49	20.38	20.29
PCS1900 EGPRS (8PSK)	Measured Power (dBm)				calculation	Averaged Power (dBm)		
	810	661	512			810	661	512
1 Txslot	25.57	25.45	25.33	26.30	-9.03	16.54	16.42	16.30
2 Txslots	23.25	23.48	23.58	25.00	-6.02	17.23	17.46	17.56
3 Txslots	22.05	22.14	22.01	23.00	-4.26	17.79	17.88	17.75
4 Txslots	20.64	20.72	20.55	21.80	-3.01	17.63	17.71	17.54

## NOTES:

## 1) Division Factors

To average the power, the division factor is as follows:

1TX-slot = 1 transmit time slot out of 8 time slots=> conducted power divided by (8/1) => -9.03dB

2TX-slots = 2 transmit time slots out of 8 time slots=> conducted power divided by (8/2) => -6.02dB

3TX-slots = 3 transmit time slots out of 8 time slots=> conducted power divided by (8/3) => -4.26dB

4TX-slots = 4 transmit time slots out of 8 time slots=> conducted power divided by (8/4) => -3.01dB

**According to the conducted power as above, the body measurements are performed with 2Txslots for GSM850 and GSM1900.**

**Low Power**

PCS1900 Speech (GMSK)	Measured Power (dBm)			Tune up	calculation	Averaged Power (dBm)		
	810	661	512			810	661	512
1 Txslot	25.88	25.82	25.72	26.50	/	/	/	/
PCS1900 GPRS (GMSK)	Measured Power (dBm)				calculation	Averaged Power (dBm)		
	810	661	512			810	661	512
1 Txslot	25.89	25.80	25.73	26.50	-9.03	16.86	16.77	16.70
2 Txslots	23.90	23.81	23.72	24.50	-6.02	17.88	17.79	17.70
3 Txslots	21.68	21.51	21.37	22.50	-4.26	17.42	17.25	17.11
4 Txslots	20.55	20.35	20.14	21.50	-3.01	17.54	17.34	17.13
PCS1900 EGPRS (GMSK)	Measured Power (dBm)				calculation	Averaged Power (dBm)		
	810	661	512			810	661	512
1 Txslot	25.90	25.81	25.73	26.50	-9.03	16.87	16.78	16.70
2 Txslots	23.90	23.82	23.72	24.50	-6.02	17.88	17.80	17.70
3 Txslots	21.68	21.52	21.38	22.50	-4.26	17.42	17.26	17.12
4 Txslots	20.55	20.37	20.14	21.50	-3.01	17.54	17.36	17.13
PCS1900	Measured Power (dBm)				calculation	Averaged Power (dBm)		

EGPRS (8PSK)	810	661	512			810	661	512
1 Txslot	25.37	25.42	25.27	26.30	-9.03	16.34	16.39	16.24
2 Txslots	22.22	22.24	22.02	23.00	-6.02	16.20	16.22	16.00
3 Txslots	20.19	20.21	20.02	21.00	-4.26	15.93	15.95	15.76
4 Txslots	18.62	18.65	18.46	19.80	-3.01	15.61	15.64	15.45

NOTES:

1) Division Factors

To average the power, the division factor is as follows:

1TX-slot = 1 transmit time slot out of 8 time slots=> conducted power divided by (8/1) => -9.03dB

2TX-slots = 2 transmit time slots out of 8 time slots=> conducted power divided by (8/2) => -6.02dB

3TX-slots = 3 transmit time slots out of 8 time slots=> conducted power divided by (8/3) => -4.26dB

4TX-slots = 4 transmit time slots out of 8 time slots=> conducted power divided by (8/4) => -3.01dB

**According to the conducted power as above, the body measurements are performed with 2Txslots for GSM1900.**

## 11.2 WCDMA Measurement result

Normal power

**Table 11.2-1: The conducted Power for WCDMA**

Item	band	FDDV result			Tune up
	ARFCN	4233 (846.6MHz)	4182 (836.4MHz)	4132 (826.4MHz)	
WCDMA	\	22.61	22.69	22.60	24
HSUPA	1	19.7	19.74	19.73	21
	2	19.69	19.72	19.68	21
	3	20.62	20.68	20.67	22
	4	19.14	19.17	19.15	20
	5	20.59	20.61	20.62	21
DC-HSDPA	1	21.68	21.65	21.61	23
	2	21.62	21.57	21.56	23
	3	21.14	21.11	21.06	22
	4	21.12	21.08	21.05	22
HSPA+	\	21.16	21.24	21.19	22
Item	band	FDDIV result			Tune up
	ARFCN	1513 (1752.6MHz)	1412 (1732.4MHz)	1312 (1712.4MHz)	
WCDMA	\	22.63	22.82	22.96	24
HSUPA	1	19.55	19.69	19.82	21
	2	19.54	19.67	19.83	21
	3	20.54	20.66	20.77	22
	4	19.01	19.19	19.32	20
	5	20.53	20.65	20.79	22
DC-HSDPA	1	21.65	21.76	21.88	23

	2	21.61	21.67	21.84	23
	3	21.12	21.28	21.36	22
	4	21.11	21.22	21.33	22
HSPA+	\	21.24	21.29	21.43	22
Item	band	FDDII result			
	ARFCN	9538 (1907.6MHz)	9400 (1880MHz)	9262 (1852.4MHz)	Tune up
WCDMA	\	22.95	23.03	22.98	23.5
HSUPA	1	19.84	19.86	19.89	21
	2	19.86	19.91	19.88	21
	3	20.85	20.93	20.90	22
	4	19.38	19.35	19.37	21
	5	20.83	20.88	20.87	21
DC-HSDPA	1	21.92	21.93	21.89	23
	2	21.9	21.89	21.88	23
	3	21.38	21.42	21.39	23
	4	21.39	21.41	21.38	23
HSPA+	\	21.51	21.47	21.45	23

## Low power

Table 11.2-2: The conducted Power for WCDMA

Item	band	FDDIV result			
	ARFCN	1513 (1752.6MHz)	1412(1732.4MHz)	1312 (1712.4MHz)	Tune up
WCDMA	\	20.55	20.66	20.73	22.00
HSUPA	1	18.54	18.68	18.81	20.00
	2	18.56	18.67	18.80	20.00
	3	19.55	19.68	19.79	20.50
	4	18.05	18.17	18.28	19.00
	5	19.53	19.66	19.78	20.50
DC-HSDPA	1	20.65	20.73	20.89	22.00
	2	20.62	20.71	20.86	22.00
	3	20.11	20.20	20.34	21.00
	4	20.09	20.18	20.32	21.00
HSPA+	\	20.11	20.24	20.35	21.00
Item	band	FDDII result			
	ARFCN	9538 (1907.6MHz)	9400 (1880MHz)	9262 (1852.4MHz)	Tune up
WCDMA	\	21.01	21.04	21.02	21.50
HSUPA	1	18.83	18.88	18.86	20.00
	2	18.84	18.87	18.88	20.00
	3	19.85	19.89	19.88	21.00
	4	18.35	18.38	18.34	19.00
	5	19.83	19.86	19.84	21.00

DC-HSDPA	1	20.97	20.96	20.95	22.00
	2	20.92	20.92	20.91	22.00
	3	20.40	20.44	20.42	21.00
	4	20.39	20.40	20.37	21.00
HSPA+	\	20.36	20.37	20.25	21.00

### 11.3 LTE Measurement result

**Table 11.3-1: Maximum Power Reduction (MPR) for LTE**

Modulation	Channel bandwidth / Transmission bandwidth configuration [RB]						MPR (dB)
	1.4	3	5	10	15	20	
	MHz	MHz	MHz	MHz	MHz	MHz	
QPSK	> 5	> 4	> 8	> 12	> 16	> 18	1
16 QAM	≤ 5	≤ 4	≤ 8	≤ 12	≤ 16	≤ 18	1
16 QAM	> 5	> 4	> 8	> 12	> 16	> 18	2

**Table 11.3-2: The tune up for LTE – Normal Power**

Band	Tune up
LTE Band 2	23
LTE Band 5	22.5
LTE Band 12	24
LTE Band 14	24
LTE Band 30	24
LTE Band 66	24

**Table 11.3-3: The tune up for LTE – Low Power**

Band	Tune up
LTE Band 2	20
LTE Band 30	20
LTE Band 66	20

**Normal power**

Band2						
BANDWIDTH	Number of RBs	Frequency	QPSK	16QAM	64QAM	
1.4MHz	1RB-High (5)	1909.3 (19193)	23.05	22.28	20.88	
		1880 (18900)	23.02	22.05	20.93	
		1850.7 (18607)	23.00	22.08	20.93	
	1RB-Middle (3)	1909.3 (19193)	23.09	22.45	20.96	
		1880 (18900)	23.01	22.12	21.06	
		1850.7 (18607)	23.06	22.24	21.03	
	1RB-Low (0)	1909.3 (19193)	22.02	22.30	20.92	
		1880 (18900)	22.36	22.02	20.91	
		1850.7 (18607)	22.93	22.07	20.98	
	3RB-High (3)	1909.3 (19193)	23.05	22.22	20.97	
		1880 (18900)	22.97	22.27	20.93	
		1850.7 (18607)	22.87	22.13	20.86	
	3RB-Middle (1)	1909.3 (19193)	23.09	22.28	20.97	
		1880 (18900)	23.11	22.34	20.98	
		1850.7 (18607)	23.10	22.14	20.97	
	3RB-Low (0)	1909.3 (19193)	23.04	22.30	20.97	
		1880 (18900)	23.12	22.29	20.93	
		1850.7 (18607)	23.04	22.12	20.93	
	6RB (0)	1909.3 (19193)	22.06	20.99	19.84	
		1880 (18900)	22.06	21.30	19.84	
		1850.7 (18607)	22.10	21.24	19.85	
	3MHz	1RB-High (14)	1908.5 (19185)	22.98	21.93	20.95
			1880 (18900)	23.02	21.90	20.91
			1851.5 (18615)	22.97	22.34	20.92
		1RB-Middle (7)	1908.5 (19185)	23.20	22.16	21.01
			1880 (18900)	23.01	22.06	21.05
			1851.5 (18615)	22.99	22.52	21.03
1RB-Low (0)		1908.5 (19185)	22.93	21.97	20.85	
		1880 (18900)	22.91	21.91	20.96	
		1851.5 (18615)	22.90	22.36	20.93	
8RB-High (7)		1908.5 (19185)	21.99	21.05	19.84	
		1880 (18900)	22.01	21.17	19.82	
		1851.5 (18615)	22.04	21.13	19.79	
8RB-Middle (4)		1908.5 (19185)	22.01	21.16	19.85	
		1880 (18900)	22.04	21.22	19.85	
		1851.5 (18615)	22.03	21.14	19.84	
8RB-Low (0)		1908.5 (19185)	22.04	21.10	19.84	
		1880 (18900)	22.02	21.17	19.86	
		1851.5 (18615)	22.03	21.13	19.84	
15RB (0)		1908.5 (19185)	21.99	21.01	19.80	
		1880 (18900)	22.03	21.09	19.76	
		1851.5 (18615)	22.02	21.10	19.76	

5MHz	1RB-High (24)	1907.5 (19175)	22.88	22.02	21.65	
		1880 (18900)	22.95	22.08	20.84	
		1852.5 (18625)	22.89	22.37	20.82	
	1RB-Middle (12)	1907.5 (19175)	23.18	22.26	21.04	
		1880 (18900)	23.26	22.35	21.18	
		1852.5 (18625)	23.15	22.63	21.02	
	1RB-Low (0)	1907.5 (19175)	22.89	22.01	20.83	
		1880 (18900)	22.97	22.10	20.79	
		1852.5 (18625)	22.85	22.36	20.80	
	12RB-High (13)	1907.5 (19175)	22.01	21.05	19.76	
		1880 (18900)	22.06	21.13	19.81	
		1852.5 (18625)	22.02	21.15	19.78	
	12RB-Middle (6)	1907.5 (19175)	22.08	21.15	19.87	
		1880 (18900)	22.10	21.20	19.86	
		1852.5 (18625)	22.10	21.24	19.85	
	12RB-Low (0)	1907.5 (19175)	22.05	21.07	19.81	
		1880 (18900)	22.07	21.09	19.77	
		1852.5 (18625)	22.00	21.14	19.79	
	25RB (0)	1907.5 (19175)	22.04	21.01	19.78	
		1880 (18900)	22.07	21.07	19.79	
		1852.5 (18625)	22.00	21.11	19.76	
	10MHz	1RB-High (49)	1905 (19150)	22.89	22.00	20.87
			1880 (18900)	22.99	21.91	20.94
			1855 (18650)	23.04	22.34	20.87
1RB-Middle (24)		1905 (19150)	23.00	22.16	20.97	
		1880 (18900)	23.11	22.08	21.09	
		1855 (18650)	23.15	22.43	21.03	
1RB-Low (0)		1905 (19150)	22.89	22.00	20.89	
		1880 (18900)	23.01	21.91	20.97	
		1855 (18650)	23.03	22.35	20.98	
25RB-High (25)		1905 (19150)	21.94	21.12	19.79	
		1880 (18900)	22.11	21.16	19.90	
		1855 (18650)	22.05	21.09	19.83	
25RB-Middle (12)		1905 (19150)	22.09	21.23	19.86	
		1880 (18900)	22.11	21.18	19.87	
		1855 (18650)	22.13	21.16	19.84	
25RB-Low (0)		1905 (19150)	22.04	21.20	19.86	
		1880 (18900)	22.05	21.09	19.82	
		1855 (18650)	22.08	21.15	19.79	
50RB (0)		1905 (19150)	22.06	21.12	19.83	
		1880 (18900)	22.10	21.12	19.85	
		1855 (18650)	22.05	21.07	19.83	



15MHz	1RB-High (74)	1902.5 (19125)	22.86	22.28	20.88
		1880 (18900)	22.87	21.85	20.89
		1857.5 (18675)	22.93	22.24	20.80
	1RB-Middle (37)	1902.5 (19125)	22.99	22.46	20.99
		1880 (18900)	23.01	22.01	20.99
		1857.5 (18675)	23.06	22.36	20.96
	1RB-Low (0)	1902.5 (19125)	22.91	22.34	20.89
		1880 (18900)	22.93	21.85	20.89
		1857.5 (18675)	22.96	22.31	20.86
	36RB-High (38)	1902.5 (19125)	22.06	21.06	19.79
		1880 (18900)	22.13	21.07	19.86
		1857.5 (18675)	22.18	21.13	19.79
	36RB-Middle (19)	1902.5 (19125)	22.11	21.10	19.88
		1880 (18900)	22.17	21.14	19.85
		1857.5 (18675)	22.23	21.17	19.84
	36RB-Low (0)	1902.5 (19125)	22.10	21.08	19.88
		1880 (18900)	22.12	21.07	19.81
		1857.5 (18675)	22.18	21.17	19.82
	75RB (0)	1902.5 (19125)	22.11	21.07	19.83
		1880 (18900)	22.19	21.13	19.84
		1857.5 (18675)	22.10	21.12	19.79
20MHz	1RB-High (99)	1900 (19100)	22.85	22.36	20.74
		1880 (18900)	22.91	22.34	20.75
		1860 (18700)	22.90	22.47	20.80
	1RB-Middle (50)	1900 (19100)	23.24	22.69	21.01
		1880 (18900)	23.23	22.60	21.11
		1860 (18700)	23.25	22.75	21.06
	1RB-Low (0)	1900 (19100)	22.86	22.32	20.76
		1880 (18900)	22.94	22.32	20.72
		1860 (18700)	22.91	22.49	20.78
	50RB-High (50)	1900 (19100)	22.00	21.02	19.74
		1880 (18900)	22.17	21.10	19.82
		1860 (18700)	22.10	21.16	19.74
	50RB-Middle (25)	1900 (19100)	22.19	21.17	19.83
		1880 (18900)	22.19	21.16	19.84
		1860 (18700)	22.18	21.23	19.83
	50RB-Low (0)	1900 (19100)	22.16	21.18	19.84
		1880 (18900)	22.13	21.03	19.74
		1860 (18700)	22.21	21.20	19.81
	100RB (0)	1900 (19100)	22.08	21.11	19.82
		1880 (18900)	22.10	21.15	19.78
		1860 (18700)	22.15	21.20	19.75

Band5					
BANDWIDTH	Number of RBs	Frequency	QPSK	16QAM	64QAM
1.4MHz	1RB-High (5)	848.3 (20643)	21.42	21.53	20.51
		836.5 (20525)	21.52	21.62	20.53
		824.7 (20407)	21.63	21.98	20.68
	1RB-Middle (3)	848.3 (20643)	21.65	21.70	20.71
		836.5 (20525)	21.65	21.74	20.60
		824.7 (20407)	21.79	22.07	20.68
	1RB-Low (0)	848.3 (20643)	21.44	21.54	20.58
		836.5 (20525)	21.53	21.59	20.54
		824.7 (20407)	21.61	21.96	20.60
	3RB-High (3)	848.3 (20643)	21.57	21.73	20.52
		836.5 (20525)	21.58	21.64	20.52
		824.7 (20407)	21.68	21.89	20.58
	3RB-Middle (1)	848.3 (20643)	21.60	21.75	20.64
		836.5 (20525)	21.63	21.65	20.61
		824.7 (20407)	21.71	21.90	20.65
	3RB-Low (0)	848.3 (20643)	21.57	21.69	20.54
		836.5 (20525)	21.59	21.63	20.46
		824.7 (20407)	21.69	21.86	20.60
	6RB (0)	848.3 (20643)	21.50	20.76	19.47
		836.5 (20525)	21.59	20.72	19.44
		824.7 (20407)	21.60	20.57	21.47
3MHz	1RB-High (14)	847.5 (20635)	21.48	21.89	20.63
		836.5 (20525)	21.52	21.48	20.50
		825.5 (20415)	21.63	21.55	21.63
	1RB-Middle (7)	847.5 (20635)	21.62	22.05	20.69
		836.5 (20525)	21.66	21.70	20.70
		825.5 (20415)	21.78	21.66	21.79
	1RB-Low (0)	847.5 (20635)	21.53	21.89	20.62
		836.5 (20525)	21.50	21.59	20.59
		825.5 (20415)	21.62	21.54	21.57
	8RB-High (7)	847.5 (20635)	21.51	20.59	19.42
		836.5 (20525)	21.51	20.56	19.40
		825.5 (20415)	21.58	20.72	19.53
	8RB-Middle (4)	847.5 (20635)	21.60	20.69	19.48
		836.5 (20525)	21.59	20.62	19.46
		825.5 (20415)	21.65	20.79	19.50
	8RB-Low (0)	847.5 (20635)	21.52	20.61	19.47
		836.5 (20525)	21.56	20.61	19.43
		825.5 (20415)	21.55	20.72	19.46
	15RB (0)	847.5 (20635)	21.52	20.54	19.41
		836.5 (20525)	21.55	20.50	19.37
		825.5 (20415)	21.57	20.62	19.41

5MHz	1RB-High (24)	846.5 (20625)	21.36	21.57	20.51	
		836.5 (20525)	21.45	21.57	20.42	
		826.5 (20425)	21.55	22.05	20.48	
	1RB-Middle (12)	846.5 (20625)	21.68	21.81	20.67	
		836.5 (20525)	21.71	21.85	20.67	
		826.5 (20425)	21.76	22.31	20.81	
	1RB-Low (0)	846.5 (20625)	21.40	21.56	20.57	
		836.5 (20525)	21.47	21.62	20.42	
		826.5 (20425)	21.47	22.00	20.57	
	12RB-High (13)	846.5 (20625)	21.46	20.53	19.39	
		836.5 (20525)	21.48	20.50	19.34	
		826.5 (20425)	21.61	20.74	19.48	
	12RB-Middle (6)	846.5 (20625)	21.58	20.62	19.49	
		836.5 (20525)	21.57	20.65	19.46	
		826.5 (20425)	21.65	20.77	19.49	
	12RB-Low (0)	846.5 (20625)	21.52	20.59	19.45	
		836.5 (20525)	21.56	20.63	19.47	
		826.5 (20425)	21.50	20.70	19.42	
	25RB (0)	846.5 (20625)	21.52	20.49	19.43	
		836.5 (20525)	21.51	20.56	19.39	
		826.5 (20425)	21.62	20.71	19.43	
	10MHz	1RB-High (49)	844 (20600)	21.52	21.83	20.64
			836.5 (20525)	21.49	21.50	20.51
			829 (20450)	21.52	21.46	20.60
1RB-Middle (24)		844 (20600)	21.58	21.96	20.71	
		836.5 (20525)	21.60	21.58	20.64	
		829 (20450)	21.63	21.58	20.69	
1RB-Low (0)		844 (20600)	21.51	21.79	20.59	
		836.5 (20525)	21.45	21.53	20.60	
		829 (20450)	21.52	21.49	20.57	
25RB-High (25)		844 (20600)	21.46	20.57	19.44	
		836.5 (20525)	21.45	20.54	19.37	
		829 (20450)	21.54	20.59	19.47	
25RB-Middle (12)		844 (20600)	21.57	20.63	19.47	
		836.5 (20525)	21.52	20.63	19.46	
		829 (20450)	21.60	20.65	19.49	
25RB-Low (0)		844 (20600)	21.62	20.63	19.56	
		836.5 (20525)	21.59	20.73	19.54	
		829 (20450)	21.55	20.60	19.45	
50RB (0)		844 (20600)	21.58	20.58	19.51	
		836.5 (20525)	21.55	20.58	19.50	
		829 (20450)	21.52	20.55	19.46	

Band12					
BANDWIDTH	Number of RBs	Frequency	QPSK	16QAM	64QAM
1.4MHz	1RB-High (5)	715.3	22.60	21.63	20.57
		707.5	22.84	21.93	20.78
		699.7	22.92	22.20	20.87
	1RB-Middle (3)	715.3	22.79	21.78	20.66
		707.5	23.01	22.13	20.93
		699.7	23.11	22.38	20.95
	1RB-Low (0)	715.3	22.65	21.70	20.64
		707.5	22.88	21.92	20.80
		699.7	22.96	22.23	20.90
	3RB-High (3)	715.3	22.72	21.84	20.55
		707.5	22.90	21.89	20.80
		699.7	22.98	22.09	20.91
	3RB-Middle (1)	715.3	22.78	21.90	20.63
		707.5	22.93	21.95	20.81
		699.7	23.06	22.12	20.99
	3RB-Low (0)	715.3	22.73	21.87	20.61
		707.5	22.88	21.91	20.83
		699.7	22.99	22.08	20.92
	6RB (0)	715.3	21.75	20.90	19.58
		707.5	21.91	21.03	19.78
		699.7	21.99	20.89	19.85
3MHz	1RB-High (14)	714.5	22.72	21.56	20.64
		707.5	22.94	22.26	20.98
		700.5	22.94	21.95	21.00
	1RB-Middle (7)	714.5	22.93	21.80	20.84
		707.5	23.09	22.43	21.12
		700.5	23.10	22.14	21.13
	1RB-Low (0)	714.5	22.74	21.71	20.78
		707.5	22.93	22.24	20.85
		700.5	22.95	21.97	21.02
	8RB-High (7)	714.5	21.72	20.82	19.63
		707.5	21.89	20.96	19.82
		700.5	22.01	21.01	19.94
	8RB-Middle (4)	714.5	21.85	20.92	19.72
		707.5	21.97	21.06	19.87
		700.5	22.02	21.07	19.96
	8RB-Low (0)	714.5	21.78	20.87	19.70
		707.5	21.91	20.99	19.85
		700.5	21.97	21.00	19.94
	15RB (0)	714.5	21.74	20.76	19.60
		707.5	21.90	20.95	19.79
		700.5	21.95	20.91	21.83

5MHz	1RB-High (24)	713.5	22.64	22.11	20.54	
		707.5	22.85	21.92	20.79	
		701.5	22.96	21.98	20.80	
	1RB-Middle (12)	713.5	22.93	22.40	21.00	
		707.5	23.13	22.17	21.17	
		701.5	23.20	22.28	21.13	
	1RB-Low (0)	713.5	22.76	22.22	20.70	
		707.5	22.84	21.88	20.83	
		701.5	22.95	22.03	20.93	
	12RB-High (13)	713.5	21.76	20.85	19.66	
		707.5	21.88	20.88	19.76	
		701.5	21.89	20.94	19.82	
	12RB-Middle (6)	713.5	21.86	20.96	19.73	
		707.5	21.99	21.01	19.88	
		701.5	22.02	21.06	19.94	
	12RB-Low (0)	713.5	21.76	20.88	19.71	
		707.5	22.01	20.98	19.89	
		701.5	21.95	21.00	19.88	
	25RB (0)	713.5	21.78	20.85	19.64	
		707.5	21.95	20.88	19.83	
		701.5	21.97	20.96	19.88	
	10MHz	1RB-High (49)	711	22.66	21.66	20.67
			707.5	22.79	21.67	20.81
			704	22.90	22.20	20.93
1RB-Middle (24)		711	22.86	21.93	20.98	
		707.5	22.97	21.88	21.02	
		704	23.01	22.27	21.09	
1RB-Low (0)		711	22.84	21.87	20.96	
		707.5	22.86	21.75	20.99	
		704	22.94	22.22	21.13	
25RB-High (25)		711	21.84	20.99	19.83	
		707.5	21.93	20.91	19.80	
		704	21.80	20.85	19.74	
25RB-Middle (12)		711	21.85	20.97	19.77	
		707.5	21.93	20.95	19.88	
		704	21.96	20.97	19.90	
25RB-Low (0)		711	21.93	21.03	19.94	
		707.5	21.99	21.02	20.00	
		704	21.98	21.00	19.97	
50RB (0)		711	21.91	20.95	19.91	
		707.5	21.98	20.93	19.91	
		704	21.89	20.89	19.88	

Band14					
BANDWIDTH	Number of RBs	Frequency	QPSK	16QAM	
5MHz	1RB-High (24)	790.5 (23305)	22.75	22.24	20.68
		793 (23330)	22.81	21.88	21.71
		795.5 (23355)	22.86	21.95	20.71
	1RB-Middle (12)	790.5 (23305)	23.04	22.53	21.10
		793 (23330)	23.10	22.11	21.87
		795.5 (23355)	23.20	22.23	21.87
	1RB-Low (0)	790.5 (23305)	22.74	22.25	20.80
		793 (23330)	22.85	21.90	21.77
		795.5 (23355)	22.92	21.89	20.84
	12RB-High (13)	790.5 (23305)	21.90	20.98	19.76
		793 (23330)	21.90	20.91	19.69
		795.5 (23355)	21.81	20.89	20.70
	12RB-Middle (6)	790.5 (23305)	21.95	21.05	19.83
		793 (23330)	21.95	20.96	19.80
		795.5 (23355)	21.99	21.00	20.82
	12RB-Low (0)	790.5 (23305)	21.85	21.00	19.74
		793 (23330)	21.94	20.99	19.83
		795.5 (23355)	21.94	20.96	20.74
	25RB (0)	790.5 (23305)	21.90	21.02	19.75
		793 (23330)	21.92	20.86	19.76
		795.5 (23355)	21.91	20.88	19.74
10MHz	1RB-High (49)	793 (23330)	22.89	22.23	21.62
	1RB-Middle (24)	793 (23330)	23.03	22.27	21.82
	1RB-Low (0)	793 (23330)	22.87	22.14	21.73
	25RB-High (25)	793 (23330)	21.98	20.99	19.79
	25RB-Middle (12)	793 (23330)	21.92	21.01	19.80
	25RB-Low (0)	793 (23330)	22.03	21.09	19.92
	50RB (0)	793 (23330)	22.01	20.99	19.85

Band30						
BANDWIDTH	Number of RBs	Frequency	QPSK	16QAM	64QAM	
5MHz	1RB-High (24)	2312.5 (27735)	23.07	21.97	20.18	
		2310 (27710)	23.07	22.07	20.26	
		2307.5 (27685)	23.09	22.39	20.27	
	1RB-Middle (12)	2312.5 (27735)	23.24	22.23	20.51	
		2310 (27710)	23.29	22.35	20.55	
		2307.5 (27685)	23.34	22.68	20.56	
	1RB-Low (0)	2312.5 (27735)	23.06	22.04	20.30	
		2310 (27710)	22.98	22.10	20.31	
		2307.5 (27685)	23.13	22.47	20.42	
	12RB-High (13)	2312.5 (27735)	22.05	21.03	19.28	
		2310 (27710)	22.09	21.07	19.35	
		2307.5 (27685)	22.07	21.19	19.39	
	12RB-Middle (6)	2312.5 (27735)	22.12	21.11	19.39	
		2310 (27710)	22.15	21.16	19.45	
		2307.5 (27685)	22.13	21.25	19.42	
	12RB-Low (0)	2312.5 (27735)	22.09	21.07	19.36	
		2310 (27710)	22.07	21.11	19.36	
		2307.5 (27685)	22.08	21.19	19.36	
	25RB (0)	2312.5 (27735)	22.04	21.02	19.32	
		2310 (27710)	22.06	21.08	19.37	
		2307.5 (27685)	22.05	21.14	21.31	
	10MHz	1RB-High (49)	2310 (27710)	23.23	21.84	20.25
		1RB-Middle (24)	2310 (27710)	23.33	21.97	20.57
		1RB-Low (0)	2310 (27710)	23.14	21.88	20.50
25RB-High (25)		2310 (27710)	22.12	21.08	19.38	
25RB-Middle (12)		2310 (27710)	22.16	21.16	19.42	
25RB-Low (0)		2310 (27710)	22.13	21.12	19.45	
50RB (0)		2310 (27710)	22.14	21.05	19.43	

Band66					
BANDWIDTH	Number of RBs	Frequency	QPSK	16QAM	64QAM
1.4MHz	1RB-High (5)	1779.3 (132665)	22.64	21.81	20.53
		1745 (132322)	22.81	22.23	20.74
		1710.7 (131979)	22.94	22.12	20.93
	1RB-Middle (3)	1779.3 (132665)	22.71	22.02	20.70
		1745 (132322)	22.97	22.39	20.88
		1710.7 (131979)	23.14	22.26	21.10
	1RB-Low (0)	1779.3 (132665)	22.63	21.76	20.63
		1745 (132322)	22.81	22.25	20.82
		1710.7 (131979)	22.94	22.06	20.98
	3RB-High (3)	1779.3 (132665)	22.74	21.81	20.64
		1745 (132322)	22.91	22.16	20.79
		1710.7 (131979)	23.14	22.34	21.00
	3RB-Middle (1)	1779.3 (132665)	22.75	21.86	20.69
		1745 (132322)	22.99	22.20	20.82
		1710.7 (131979)	23.19	22.42	21.02
	3RB-Low (0)	1779.3 (132665)	22.68	21.80	20.58
		1745 (132322)	22.92	22.14	20.76
		1710.7 (131979)	23.10	22.33	21.06
	6RB (0)	1779.3 (132665)	21.69	20.84	19.48
		1745 (132322)	21.91	20.84	19.64
		1710.7 (131979)	22.13	21.31	19.85
3MHz	1RB-High (14)	1778.5 (132657)	22.68	21.60	20.69
		1745 (132322)	22.88	22.32	20.89
		1711.5 (131987)	23.03	22.17	21.11
	1RB-Middle (7)	1778.5 (132657)	22.76	21.79	20.84
		1745 (132322)	23.01	22.46	20.98
		1711.5 (131987)	23.17	22.30	21.23
	1RB-Low (0)	1778.5 (132657)	22.61	21.67	20.69
		1745 (132322)	22.88	22.31	20.85
		1711.5 (131987)	23.04	22.16	21.14
	8RB-High (7)	1778.5 (132657)	21.69	20.82	19.54
		1745 (132322)	21.83	20.97	19.73
		1711.5 (131987)	22.14	21.23	19.95
	8RB-Middle (4)	1778.5 (132657)	21.73	20.88	19.57
		1745 (132322)	21.89	21.06	19.73
		1711.5 (131987)	22.21	21.29	20.00
	8RB-Low (0)	1778.5 (132657)	21.70	20.85	19.54
		1745 (132322)	21.94	21.08	19.74
		1711.5 (131987)	22.14	21.21	19.94
	15RB (0)	1778.5 (132657)	21.72	20.79	19.48
		1745 (132322)	21.92	21.00	19.70
		1711.5 (131987)	22.16	21.16	19.94



5MHz	1RB-High (24)	1777.5 (132647)	22.71	21.84	20.57	
		1745 (132322)	22.77	22.36	20.71	
		1712.5 (131997)	23.05	22.20	21.06	
	1RB-Middle (12)	1777.5 (132647)	22.93	22.04	20.91	
		1745 (132322)	23.01	22.58	21.06	
		1712.5 (131997)	23.29	22.37	21.17	
	1RB-Low (0)	1777.5 (132647)	22.69	21.85	20.54	
		1745 (132322)	22.81	22.41	20.78	
		1712.5 (131997)	23.05	22.17	21.03	
	12RB-High (13)	1777.5 (132647)	21.72	20.81	19.52	
		1745 (132322)	21.89	21.04	19.65	
		1712.5 (131997)	22.20	21.22	19.92	
	12RB-Middle (6)	1777.5 (132647)	21.76	20.87	19.58	
		1745 (132322)	21.97	21.16	19.76	
		1712.5 (131997)	22.22	21.27	19.98	
	12RB-Low (0)	1777.5 (132647)	21.73	20.80	19.49	
		1745 (132322)	21.95	21.11	19.70	
		1712.5 (131997)	22.15	21.22	19.94	
	25RB (0)	1777.5 (132647)	21.71	20.77	19.50	
		1745 (132322)	21.93	21.06	19.71	
		1712.5 (131997)	22.17	21.17	19.93	
	10MHz	1RB-High (49)	1775 (132622)	22.65	21.71	20.71
			1745 (132322)	22.85	22.32	20.86
			1715 (132022)	23.03	22.19	20.98
1RB-Middle (24)		1775 (132622)	22.80	21.79	20.80	
		1745 (132322)	23.01	22.42	20.95	
		1715 (132022)	23.15	22.29	21.16	
1RB-Low (0)		1775 (132622)	22.66	21.71	20.70	
		1745 (132322)	22.96	22.36	20.96	
		1715 (132022)	23.03	22.16	21.02	
25RB-High (25)		1775 (132622)	21.75	20.81	19.58	
		1745 (132322)	21.95	21.04	19.68	
		1715 (132022)	22.18	21.35	20.98	
25RB-Middle (12)		1775 (132622)	21.82	20.86	19.55	
		1745 (132322)	22.05	21.08	19.77	
		1715 (132022)	22.22	21.33	20.94	
25RB-Low (0)		1775 (132622)	21.79	20.90	19.61	
		1745 (132322)	22.04	21.15	19.80	
		1715 (132022)	22.21	21.35	20.95	
50RB (0)		1775 (132622)	21.84	20.89	19.60	
		1745 (132322)	22.02	21.08	20.78	
		1715 (132022)	22.23	21.30	19.97	

15MHz	1RB-High (74)	1772.5 (132597)	22.66	22.16	20.69	
		1745 (132322)	22.70	21.77	20.81	
		1717.5 (132047)	23.03	22.51	21.04	
	1RB-Middle (37)	1772.5 (132597)	22.73	22.27	20.71	
		1745 (132322)	22.80	21.92	20.89	
		1717.5 (132047)	23.15	22.53	21.09	
	1RB-Low (0)	1772.5 (132597)	22.70	22.24	20.73	
		1745 (132322)	22.82	21.90	20.93	
		1717.5 (132047)	23.08	22.52	20.98	
	36RB-High (38)	1772.5 (132597)	21.72	20.72	19.52	
		1745 (132322)	21.91	20.89	19.67	
		1717.5 (132047)	22.16	21.29	19.92	
	36RB-Middle (19)	1772.5 (132597)	21.73	20.74	19.54	
		1745 (132322)	22.01	21.00	19.76	
		1717.5 (132047)	22.22	21.27	19.95	
	36RB-Low (0)	1772.5 (132597)	21.78	20.78	19.60	
		1745 (132322)	22.04	20.99	19.78	
		1717.5 (132047)	22.27	21.29	19.96	
	75RB (0)	1772.5 (132597)	21.76	20.75	19.52	
		1745 (132322)	22.02	21.01	19.70	
		1717.5 (132047)	22.23	21.28	19.93	
	20MHz	1RB-High (99)	1770 (132572)	22.11	22.16	20.90
			1745 (132322)	22.71	22.38	21.02
			1720 (132072)	22.96	22.62	21.25
1RB-Middle (50)		1770 (132572)	22.06	22.40	20.92	
		1745 (132322)	22.96	22.69	21.10	
		1720 (132072)	23.20	22.82	21.30	
1RB-Low (0)		1770 (132572)	22.70	22.22	20.94	
		1745 (132322)	22.78	22.49	21.14	
		1720 (132072)	22.94	22.54	21.19	
50RB-High (50)		1770 (132572)	21.81	20.81	19.72	
		1745 (132322)	21.94	21.04	19.87	
		1720 (132072)	22.27	21.32	20.12	
50RB-Middle (25)		1770 (132572)	21.85	20.87	19.74	
		1745 (132322)	22.01	21.09	19.96	
		1720 (132072)	22.21	21.32	20.15	
50RB-Low (0)		1770 (132572)	21.85	20.89	19.80	
		1745 (132322)	22.05	21.13	19.98	
		1720 (132072)	22.25	21.31	20.16	
100RB (0)		1770 (132572)	21.85	20.88	19.72	
		1745 (132322)	21.98	21.06	19.90	
		1720 (132072)	22.21	21.26	20.13	



The conducted power measurement results of downlink LTE CA are as below :

DL LTE CA Class	PCC								SCC			Power		
	PCC Band	PCC Bandwidth (MHz)	PCC UL RB size	PCC UL RB offset	PCC DL RB size	PCC DL RB offset	PCC UL Channel	PCC DL Channel	SCC Band	SCC Bandwidth	SCC	Rel 8 LTE Tx Power(dBm)	Rel 10 DL LTE CA Tx Power(dBm)	Tune-up
										(MHz)	DL Channel			
2A-5A	2	20	1	50	100	0	18700	700	5	10	2525	23.25	22.43	24
2A-12A	2	20	1	50	100	0	18700	700	12	10	5060	23.25	22.43	24
2A-14A	2	20	1	50	100	0	18700	700	14	10	5330	23.25	22.45	24
2A-2A	2	20	1	25	50	0	18700	700	2	15	1125	23.25	23.42	24
14A-66A	14	5	1	12	25	0	23330	5330	66	20	66786	23.2	23.16	24
12A-30A	12	5	1	12	25	0	23035	5035	30	10	9820	23.2	23.33	24
5A-30A	5	5	1	12	25	0	20425	2425	30	10	9820	21.79	21.92	22
5A-30A	5	5	1	12	25	0	20425	2425	30	10	9820	21.79	21.92	22
5A-66A	5	5	1	12	25	0	20425	2425	66	20	66786	21.79	21.83	22
12A-66A	12	5	1	12	25	0	23035	5035	66	20	66786	23.2	23.3	24
66A-66A	66	5	1	12	25	0	131997	66461	66	20	67236	23.29	23.4	24

Note: Testing is not required in bands or modes not intended/allowed for US operation.

**Low power**

Band2-Low power						
BANDWIDTH	Number of RBs	Frequency	QPSK	16QAM	64QAM	
1.4MHz	1RB-High (5)	1909.3 (19193)	18.90	19.05	19.80	
		1880 (18900)	18.96	19.18	19.93	
		1850.7 (18607)	19.06	19.44	19.87	
	1RB-Middle (3)	1909.3 (19193)	19.16	19.26	20.00	
		1880 (18900)	19.19	19.41	19.99	
		1850.7 (18607)	19.26	19.66	19.95	
	1RB-Low (0)	1909.3 (19193)	18.89	19.09	19.91	
		1880 (18900)	18.98	19.18	19.91	
		1850.7 (18607)	19.07	19.46	19.88	
	3RB-High (3)	1909.3 (19193)	19.14	19.33	19.85	
		1880 (18900)	19.12	19.21	19.92	
		1850.7 (18607)	19.10	19.39	19.88	
	3RB-Middle (1)	1909.3 (19193)	19.17	19.37	19.98	
		1880 (18900)	19.15	19.28	19.98	
		1850.7 (18607)	19.22	19.45	19.96	
	3RB-Low (0)	1909.3 (19193)	19.07	19.30	19.95	
		1880 (18900)	19.14	19.21	19.93	
		1850.7 (18607)	19.19	19.36	19.91	
	6RB (0)	1909.3 (19193)	19.07	19.22	18.82	
		1880 (18900)	19.07	19.27	18.86	
		1850.7 (18607)	19.11	19.05	18.85	
	3MHz	1RB-High (14)	1908.5 (19185)	18.95	19.03	19.90
			1880 (18900)	19.04	19.00	19.92
			1851.5 (18615)	19.08	19.51	19.89
1RB-Middle (7)		1908.5 (19185)	19.13	19.26	19.98	
		1880 (18900)	19.18	19.18	19.96	
		1851.5 (18615)	19.24	19.64	20.00	
1RB-Low (0)		1908.5 (19185)	18.96	19.11	19.85	
		1880 (18900)	18.99	19.05	19.84	
		1851.5 (18615)	19.10	19.45	19.84	
8RB-High (7)		1908.5 (19185)	19.01	19.08	18.80	
		1880 (18900)	19.00	19.17	18.79	
		1851.5 (18615)	19.06	19.19	18.80	
8RB-Middle (4)		1908.5 (19185)	19.05	19.14	18.85	
		1880 (18900)	19.13	19.22	18.80	
		1851.5 (18615)	19.06	19.26	18.84	
8RB-Low (0)		1908.5 (19185)	19.02	19.13	18.83	
		1880 (18900)	19.07	19.18	18.80	
		1851.5 (18615)	19.05	19.19	18.82	
15RB (0)		1908.5 (19185)	19.02	19.02	18.75	
		1880 (18900)	19.07	19.09	18.76	
		1851.5 (18615)	19.05	19.13	18.75	

5MHz	1RB-High (24)	1907.5 (19175)	18.90	19.11	19.60	
		1880 (18900)	18.99	19.16	19.69	
		1852.5 (18625)	18.92	19.50	19.58	
	1RB-Middle (12)	1907.5 (19175)	19.24	19.33	19.83	
		1880 (18900)	19.26	19.43	19.91	
		1852.5 (18625)	19.20	19.83	19.94	
	1RB-Low (0)	1907.5 (19175)	18.95	19.08	19.65	
		1880 (18900)	19.01	19.13	19.64	
		1852.5 (18625)	18.97	19.49	19.69	
	12RB-High (13)	1907.5 (19175)	18.99	19.00	18.59	
		1880 (18900)	19.06	19.14	18.63	
		1852.5 (18625)	19.03	19.22	18.59	
	12RB-Middle (6)	1907.5 (19175)	19.09	19.13	18.67	
		1880 (18900)	19.09	19.24	18.71	
		1852.5 (18625)	19.17	19.28	18.69	
	12RB-Low (0)	1907.5 (19175)	19.05	19.07	18.61	
		1880 (18900)	18.99	19.11	18.59	
		1852.5 (18625)	19.06	19.22	18.60	
	25RB (0)	1907.5 (19175)	19.01	19.00	18.62	
		1880 (18900)	19.05	19.09	18.63	
		1852.5 (18625)	19.07	19.12	18.58	
	10MHz	1RB-High (49)	1905 (19150)	18.99	19.06	18.93
			1880 (18900)	19.01	19.05	18.72
			1855 (18650)	19.12	19.46	19.05
1RB-Middle (24)		1905 (19150)	19.10	19.19	19.09	
		1880 (18900)	19.12	19.15	18.91	
		1855 (18650)	19.19	19.64	19.12	
1RB-Low (0)		1905 (19150)	18.98	19.08	18.98	
		1880 (18900)	19.01	19.05	18.76	
		1855 (18650)	19.07	19.48	19.15	
25RB-High (25)		1905 (19150)	19.02	19.12	18.80	
		1880 (18900)	19.13	19.19	18.91	
		1855 (18650)	19.08	19.17	19.82	
25RB-Middle (12)		1905 (19150)	19.10	19.22	18.84	
		1880 (18900)	19.14	19.23	18.87	
		1855 (18650)	19.10	19.22	19.86	
25RB-Low (0)		1905 (19150)	19.09	19.19	18.88	
		1880 (18900)	19.05	19.13	18.81	
		1855 (18650)	19.12	19.16	19.84	
50RB (0)		1905 (19150)	19.05	19.11	18.84	
		1880 (18900)	19.10	19.14	18.86	
		1855 (18650)	19.07	19.16	19.84	

15MHz	1RB-High (74)	1902.5 (19125)	18.94	19.45	18.85
		1880 (18900)	18.99	18.94	18.89
		1857.5 (18675)	18.99	19.40	18.89
	1RB-Middle (37)	1902.5 (19125)	19.10	19.60	19.06
		1880 (18900)	19.06	19.11	19.07
		1857.5 (18675)	19.15	19.53	18.96
	1RB-Low (0)	1902.5 (19125)	19.01	19.47	18.90
		1880 (18900)	18.96	19.01	18.94
		1857.5 (18675)	19.08	19.41	18.92
	36RB-High (38)	1902.5 (19125)	19.03	18.98	18.82
		1880 (18900)	19.13	19.14	18.87
		1857.5 (18675)	19.10	19.15	18.82
	36RB-Middle (19)	1902.5 (19125)	19.12	19.08	18.86
		1880 (18900)	19.12	19.15	18.88
		1857.5 (18675)	19.16	19.20	18.88
	36RB-Low (0)	1902.5 (19125)	19.08	19.01	18.88
		1880 (18900)	19.10	19.07	18.82
		1857.5 (18675)	19.11	19.16	18.84
	75RB (0)	1902.5 (19125)	19.06	19.05	18.82
		1880 (18900)	19.06	19.15	18.83
		1857.5 (18675)	19.15	19.13	18.79
20MHz	1RB-High (99)	1900 (19100)	18.94	19.51	18.87
		1880 (18900)	18.89	19.39	18.84
		1860 (18700)	18.97	19.52	18.79
	1RB-Middle (50)	1900 (19100)	19.23	19.84	19.13
		1880 (18900)	19.27	19.74	19.08
		1860 (18700)	19.29	19.83	19.08
	1RB-Low (0)	1900 (19100)	18.93	19.45	18.82
		1880 (18900)	18.95	19.41	18.86
		1860 (18700)	18.99	19.54	18.91
	50RB-High (50)	1900 (19100)	18.98	19.06	18.77
		1880 (18900)	19.05	19.16	18.82
		1860 (18700)	19.10	19.18	18.72
	50RB-Middle (25)	1900 (19100)	19.14	19.18	18.83
		1880 (18900)	19.18	19.20	18.84
		1860 (18700)	19.16	19.23	18.81
	50RB-Low (0)	1900 (19100)	19.09	19.13	18.87
		1880 (18900)	19.04	19.07	18.73
		1860 (18700)	19.13	19.19	18.83
	100RB (0)	1900 (19100)	19.09	19.12	18.82
		1880 (18900)	19.09	19.14	18.79
		1860 (18700)	19.11	19.18	18.74

Band30-Low Power					
BANDWIDTH	Number of RBs	Frequency	QPSK	16QAM	64QAM
5MHz	1RB-High (24)	2312.5 (27735)	19.05	19.11	18.37
		2310 (27710)	19.02	19.19	18.38
		2307.5 (27685)	19.06	19.51	18.41
	1RB-Middle (12)	2312.5 (27735)	19.20	19.35	18.67
		2310 (27710)	19.21	19.46	18.66
		2307.5 (27685)	19.25	19.74	18.62
	1RB-Low (0)	2312.5 (27735)	19.03	19.15	18.41
		2310 (27710)	19.04	19.20	18.47
		2307.5 (27685)	19.03	19.59	18.50
	12RB-High (13)	2312.5 (27735)	19.02	19.14	18.30
		2310 (27710)	19.02	19.14	18.36
		2307.5 (27685)	19.06	19.22	18.37
	12RB-Middle (6)	2312.5 (27735)	19.10	19.17	18.42
		2310 (27710)	19.11	19.24	18.43
		2307.5 (27685)	19.11	19.30	18.47
	12RB-Low (0)	2312.5 (27735)	19.03	19.09	18.37
		2310 (27710)	19.07	19.15	18.38
		2307.5 (27685)	19.05	19.21	18.37
	25RB (0)	2312.5 (27735)	19.03	19.06	18.32
		2310 (27710)	19.04	19.12	18.35
		2307.5 (27685)	19.05	19.20	18.38
10MHz	1RB-High (49)	2310 (27710)	19.04	19.39	18.42
	1RB-Middle (24)	2310 (27710)	19.37	19.56	18.66
	1RB-Low (0)	2310 (27710)	19.10	19.38	18.59
	25RB-High (25)	2310 (27710)	19.02	19.14	18.37
	25RB-Middle (12)	2310 (27710)	19.08	19.18	18.43
	25RB-Low (0)	2310 (27710)	19.04	19.17	18.45
	50RB (0)	2310 (27710)	19.03	19.10	18.41

Band66-Low power					
BANDWIDTH	Number of RBs	Frequency	QPSK	16QAM	64QAM
1.4MHz	1RB-High (5)	1779.3 (132665)	18.63	18.84	20.63
		1745 (132322)	18.84	19.23	20.82
		1710.7 (131979)	18.94	19.16	21.03
	1RB-Middle (3)	1779.3 (132665)	18.85	19.04	20.75
		1745 (132322)	19.07	19.46	20.86
		1710.7 (131979)	19.15	19.29	21.12
	1RB-Low (0)	1779.3 (132665)	18.71	18.82	20.68
		1745 (132322)	18.87	19.25	20.87
		1710.7 (131979)	18.97	19.14	21.04
	3RB-High (3)	1779.3 (132665)	18.75	18.83	20.66
		1745 (132322)	18.90	19.15	20.85
		1710.7 (131979)	19.12	19.42	20.96
	3RB-Middle (1)	1779.3 (132665)	18.75	18.86	20.72
		1745 (132322)	19.00	19.19	20.85
		1710.7 (131979)	19.13	19.42	21.04
	3RB-Low (0)	1779.3 (132665)	18.71	18.87	20.65
		1745 (132322)	18.95	19.12	20.80
		1710.7 (131979)	19.09	19.37	21.04
	6RB (0)	1779.3 (132665)	18.70	18.88	19.52
		1745 (132322)	18.87	18.86	19.69
		1710.7 (131979)	19.08	19.29	19.93
3MHz	1RB-High (14)	1778.5 (132657)	18.71	18.73	18.70
		1745 (132322)	18.89	19.34	18.79
		1711.5 (131987)	19.05	19.20	19.14
	1RB-Middle (7)	1778.5 (132657)	18.81	18.87	18.82
		1745 (132322)	19.06	19.47	18.91
		1711.5 (131987)	19.16	19.37	19.27
	1RB-Low (0)	1778.5 (132657)	18.65	18.76	18.68
		1745 (132322)	18.95	19.35	18.91
		1711.5 (131987)	19.05	19.27	21.10
	8RB-High (7)	1778.5 (132657)	18.68	18.84	18.53
		1745 (132322)	18.84	18.98	18.70
		1711.5 (131987)	19.12	19.17	20.03
	8RB-Middle (4)	1778.5 (132657)	18.74	18.90	18.58
		1745 (132322)	18.88	19.09	18.72
		1711.5 (131987)	19.15	19.28	20.02
	8RB-Low (0)	1778.5 (132657)	18.73	18.86	18.55
		1745 (132322)	18.90	19.05	18.76
		1711.5 (131987)	19.06	19.17	19.95
	15RB (0)	1778.5 (132657)	18.74	18.80	18.48
		1745 (132322)	18.88	18.95	18.66
		1711.5 (131987)	19.09	19.15	19.93





5MHz	1RB-High (24)	1777.5 (132647)	18.68	18.81	18.62	
		1745 (132322)	18.82	19.35	18.74	
		1712.5 (131997)	19.07	19.22	19.01	
	1RB-Middle (12)	1777.5 (132647)	18.93	19.10	18.82	
		1745 (132322)	19.07	19.62	19.08	
		1712.5 (131997)	19.30	19.50	19.25	
	1RB-Low (0)	1777.5 (132647)	18.69	18.82	18.61	
		1745 (132322)	18.81	19.39	18.80	
		1712.5 (131997)	19.04	19.17	18.96	
	12RB-High (13)	1777.5 (132647)	18.71	18.83	18.49	
		1745 (132322)	18.84	19.08	18.65	
		1712.5 (131997)	19.10	19.25	18.93	
	12RB-Middle (6)	1777.5 (132647)	18.76	18.85	18.54	
		1745 (132322)	18.96	19.14	18.77	
		1712.5 (131997)	19.12	19.25	18.98	
	12RB-Low (0)	1777.5 (132647)	18.72	18.83	18.50	
		1745 (132322)	18.92	19.11	18.70	
		1712.5 (131997)	19.06	19.17	18.92	
	25RB (0)	1777.5 (132647)	18.68	18.77	18.50	
		1745 (132322)	18.91	19.04	18.67	
		1712.5 (131997)	19.07	19.10	18.91	
	10MHz	1RB-High (49)	1775 (132622)	18.72	18.79	18.64
			1745 (132322)	18.81	18.92	18.85
			1715 (132022)	19.15	19.55	19.00
1RB-Middle (24)		1775 (132622)	18.79	18.90	18.81	
		1745 (132322)	18.96	18.99	18.90	
		1715 (132022)	19.28	19.68	19.28	
1RB-Low (0)		1775 (132622)	18.74	18.83	18.71	
		1745 (132322)	18.89	18.96	18.92	
		1715 (132022)	19.16	19.55	19.16	
25RB-High (25)		1775 (132622)	18.78	18.91	18.53	
		1745 (132322)	18.91	18.97	18.64	
		1715 (132022)	19.13	19.25	18.94	
25RB-Middle (12)		1775 (132622)	18.77	18.95	18.56	
		1745 (132322)	19.01	19.09	18.74	
		1715 (132022)	19.18	19.30	18.98	
25RB-Low (0)		1775 (132622)	18.80	18.95	18.62	
		1745 (132322)	19.00	19.10	18.81	
		1715 (132022)	19.15	19.25	18.99	
50RB (0)		1775 (132622)	18.83	18.87	18.55	
		1745 (132322)	18.96	18.99	18.72	
		1715 (132022)	19.22	19.26	18.93	



15MHz	1RB-High (74)	1772.5 (132597)	18.64	19.09	18.68
		1745 (132322)	18.78	19.31	18.78
		1717.5 (132047)	18.95	19.02	19.01
	1RB-Middle (37)	1772.5 (132597)	18.77	19.18	18.76
		1745 (132322)	18.93	19.43	18.83
		1717.5 (132047)	19.05	19.13	19.06
	1RB-Low (0)	1772.5 (132597)	18.75	19.16	18.79
		1745 (132322)	18.87	19.39	18.91
		1717.5 (132047)	19.00	19.07	19.06
	36RB-High (38)	1772.5 (132597)	18.71	18.78	18.51
		1745 (132322)	18.86	18.84	18.66
		1717.5 (132047)	19.11	19.12	18.92
	36RB-Middle (19)	1772.5 (132597)	18.74	18.83	18.55
		1745 (132322)	18.96	18.93	18.75
		1717.5 (132047)	19.18	19.16	18.97
	36RB-Low (0)	1772.5 (132597)	18.79	18.83	18.60
		1745 (132322)	18.98	18.93	18.75
		1717.5 (132047)	19.16	19.15	18.97
	75RB (0)	1772.5 (132597)	18.73	18.73	18.50
		1745 (132322)	18.92	18.90	18.69
		1717.5 (132047)	19.17	19.12	18.95
20MHz	1RB-High (99)	1770 (132572)	18.59	19.10	18.87
		1745 (132322)	18.80	19.31	18.97
		1720 (132072)	18.96	19.62	19.20
	1RB-Middle (50)	1770 (132572)	18.87	19.41	18.95
		1745 (132322)	19.12	19.60	19.02
		1720 (132072)	19.25	19.89	19.25
	1RB-Low (0)	1770 (132572)	18.68	19.15	18.98
		1745 (132322)	18.91	19.51	19.10
		1720 (132072)	19.10	19.65	19.25
	50RB-High (50)	1770 (132572)	18.65	18.67	18.70
		1745 (132322)	18.88	18.96	18.85
		1720 (132072)	19.17	19.24	19.11
	50RB-Middle (25)	1770 (132572)	18.76	18.75	18.74
		1745 (132322)	19.00	19.00	18.94
		1720 (132072)	19.16	19.23	19.16
	50RB-Low (0)	1770 (132572)	18.78	18.79	18.79
		1745 (132322)	19.05	19.09	18.94
		1720 (132072)	19.22	19.24	19.16
	100RB (0)	1770 (132572)	18.75	18.79	18.69
		1745 (132322)	18.93	18.96	18.88
		1720 (132072)	19.15	19.17	19.14



The conducted power measurement results of downlink LTE CA are as below :

DL LTE CA Class	PCC								SCC			Power		
	PCC Band	PCC Bandwidth (MHz)	PCC UL RB size	PCC UL RB offset	PCC DL RB size	PCC DL RB offset	PCC UL Channel	PCC DL Channel	SCC Band	SCC Bandwidth (MHz)	SCC DL Channel	Rel 8 LTE Tx Power(dBm)	Rel 10 DL LTE CA Tx Power(dBm)	Tune-up
2A-2A	2	20	1	50	100	0	18700	700	2	15	1125	19.29	19.56	20
2A-5A	2	20	1	50	100	0	18700	700	5	10	2525	19.29	19.55	20
2A-12A	2	20	1	50	100	0	18700	700	12	10	5060	19.29	19.61	20
2A-14A	2	20	1	50	100	0	18700	700	14	10	5330	19.29	19.59	20
66A-66A	66	5	1	12	25	0	131997	66461	66	20	67236	1.93	19.63	20

Note: Testing is not required in bands or modes not intended/allowed for US operation.

### 11.4 Wi-Fi and BT Measurement result

The maximum output power of BT is 10.19dBm.

The maximum tune up of BT is 10.7dBm.

The average conducted power for Wi-Fi is as following:

802.11b				
Channel\data rate	1Mbps	2Mbps	5.5Mbps	11Mbps
11(2462MHz)	16.16	/	/	15.97
6(2437(MHz)	16.29	16.27	16.36	16.41
1(2412MHz)	16.23	/	/	16.00
Tune up	16.60	16.60	16.60	16.60

802.11g								
Channel\data rate	6Mbps	9Mbps	12Mbps	18Mbps	24Mbps	36Mbps	48Mbps	54Mbps
11(2462MHz)	14.70	/	/	/	/	/	/	/
6(2437(MHz)	14.98	14.80	14.81	14.78	14.30	14.34	14.55	14.93
1(2412MHz)	14.80	/	/	/	/	/	/	/
Tune up	15.80	15.80	15.80	15.80	15.80	15.80	15.80	15.80

802.11n 20MHz								
Channel\data rate	MCS0	MCS1	MCS2	MCS3	MCS4	MCS5	MCS6	MCS7
11(2462MHz)	13.72	/	/	/	/	/	/	13.70
6(2437(MHz)	13.95	13.70	13.76	13.73	13.66	14.06	14.07	14.10
1(2412MHz)	13.74	/	/	/	/	/	/	14.01
Tune up	15.00	15.00	15.00	15.00	14.80	14.80	14.80	14.80

802.11n 40MHz								
Channel\data rate	MCS0	MCS1	MCS2	MCS3	MCS4	MCS5	MCS6	MCS7
9(2452MHz)	12.17	/	/	/	/	/	/	12.25
6(2437MHz)	12.16	/	/	/	/	/	/	12.29
3(2422MHz)	12.23	12.14	12.15	12.14	12.13	12.21	12.51	12.57
Tune up	13.00	13.00	13.00	13.00	13.00	13.00	13.00	13.00

## 12 Simultaneous TX SAR Considerations

### 12.1 Introduction

The following procedures adopted from “FCC SAR Considerations for Cell Phones with Multiple Transmitters” are applicable to handsets with built-in unlicensed transmitters such as 802.11 a/b/g and Bluetooth devices which may simultaneously transmit with the licensed transmitter. For this device, the BT and Wi-Fi can transmit simultaneous with other transmitters.

### 12.2 Transmit Antenna Separation Distances

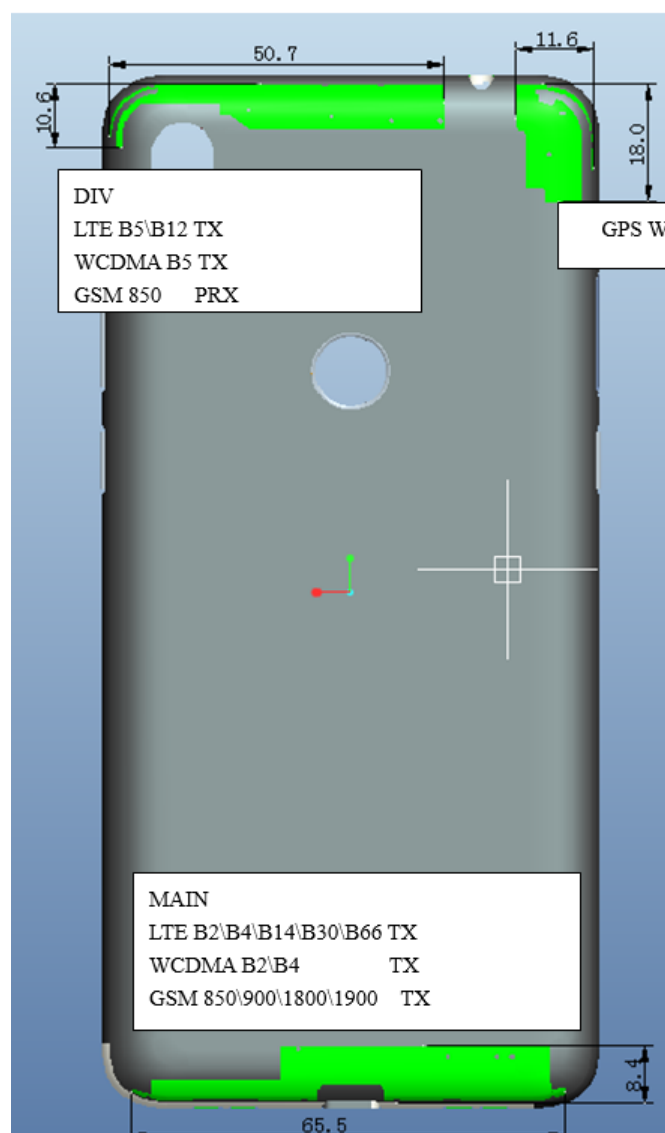

Picture 12.1 Antenna Locations

### 12.3 SAR Measurement Positions

According to the KDB941225 D06 Hot Spot SAR v01, the edges with less than 2.5 cm distance to the antennas need to be tested for SAR.

SAR measurement positions						
Mode	Front	Rear	Left edge	Right edge	Top edge	Bottom edge
Main antenna	Yes	Yes	Yes	Yes	No	Yes
Div antenna	Yes	Yes	Yes	Yes	Yes	No
WLAN	Yes	Yes	Yes	No	Yes	No

### 12.4 Standalone SAR Test Exclusion Considerations

Standalone 1-g head or body SAR evaluation by measurement or numerical simulation is not required when the corresponding SAR Exclusion Threshold condition, listed below, is satisfied. The 1-g SAR test exclusion threshold for 100 MHz to 6 GHz at test separation distances  $\leq 50$  mm are determined by:

$[(\text{max. power of channel, including tune-up tolerance, mW}) / (\text{min. test separation distance, mm})] \cdot [\sqrt{f(\text{GHz})}] \leq 3.0$  for 1-g SAR, where

- $f(\text{GHz})$  is the RF channel transmit frequency in GHz
- Power and distance are rounded to the nearest mW and mm before calculation
- The result is rounded to one decimal place for comparison

**Table 12.1: Standalone SAR test exclusion considerations**

Band/Mode	F(GHz)	Position	SAR test exclusion threshold(mW)	RF output power		SAR test exclusion
				dBm	mW	
Bluetooth	2.441	Head	9.60	10.7	11.75	No
		Body	19.20	10.7	11.75	Yes
2.4GHz WLAN	2.45	Head	9.58	16.6	45.7	No
		Body	19.17	16.6	45.7	No

### 13 Evaluation of Simultaneous

**Table 13.1: The sum of reported SAR values for main antenna and WiFi2.4G**

	<b>Position</b>	<b>Main antenna</b>	<b>WiFi</b>	<b>Sum</b>
<b>Highest reported SAR value for Head</b>	Left head, Cheek (WCDMA850)	1.17	0.17	<b>1.34</b>
<b>Highest reported SAR value for Body</b>	Bottom 10mm (WCDMA1900)	1.34	<0.01	<b>1.34</b>

**Table 13.2: The sum of reported SAR values for main antenna and BT**

	<b>Position</b>	<b>Main antenna</b>	<b>BT</b>	<b>Sum</b>
<b>Maximum reported SAR value for Head</b>	Left head, Cheek (WCDMA850)	1.17	0.04	<b>1.21</b>
<b>Maximum reported SAR value for Body</b>	Bottom 10mm (WCDMA1900)	1.34	<0.01	<b>1.34</b>

**Conclusion:**

According to the above tables, the sum of reported SAR values is <1.6W/kg. So the simultaneous transmission SAR with volume scans is not required.

## 14 SAR Test Result

It is determined by user manual for the distance between the EUT and the phantom bottom. The distance is 10 mm or 15mm and just applied to the condition of body worn accessory.

It is performed for all SAR measurements with area scan based 1-g SAR estimation (Fast SAR). A zoom scan measurement is added when the estimated 1-gSAR is the highest measured SAR in each exposure configuration, wireless mode and frequency band combination or more than 1.2W/kg.

The calculated SAR is obtained by the following formula:

$$\text{Reported SAR} = \text{Measured SAR} \times 10^{(P_{\text{Target}} - P_{\text{Measured}})/10}$$

Where  $P_{\text{Target}}$  is the power of manufacturing upper limit;

$P_{\text{Measured}}$  is the measured power in chapter 11.

**Table 14.1: Duty Cycle**

<b>Mode</b>	<b>Duty Cycle</b>
Speech for GSM850	1:8.3
Speech for GSM1900	1:8.3
GPRS&EGPRS for GSM850	1:4
GPRS&EGPRS for GSM1900-Normal Power	1:4
GPRS&EGPRS for GSM1900-Low Power	1:4
WCDMA&LTE FDD	1:1



### 14.1 SAR results for Fast SAR

**Table 14.1-1: SAR Values (GSM 850 MHz Band - Head)**

Ambient Temperature: 22.9 °C						Liquid Temperature: 22.5°C					
Frequency		Side	Test Position	Figure No.	Conducted Power (dBm)	Max. tune-up Power (dBm)	Measured SAR(10g) (W/kg)	Reported SAR(10g) (W/kg)	Measured SAR(1g) (W/kg)	Reported SAR(1g) (W/kg)	Power Drift (dB)
Ch.	MHz										
190	836.6	Left	Touch	/	32.19	33.3	0.095	<b>0.12</b>	0.123	<b>0.16</b>	0.04
190	836.6	Left	Tilt	/	32.19	33.3	0.05	<b>0.06</b>	0.106	<b>0.14</b>	-0.05
251	848.8	Right	Touch	Fig.1	32.18	33.3	0.152	<b>0.20</b>	0.202	<b>0.26</b>	0.13
190	836.6	Right	Touch	/	32.19	33.3	0.124	<b>0.16</b>	0.167	<b>0.22</b>	0.06
128	824.2	Right	Touch	/	32	33.3	0.119	<b>0.16</b>	0.161	<b>0.22</b>	0.11
190	836.6	Right	Tilt	/	32.19	33.3	0.057	<b>0.07</b>	0.08	<b>0.10</b>	-0.15

**Table 14.1-2: SAR Values (GSM 850 MHz Band - Body)**

Ambient Temperature: 22.9 °C						Liquid Temperature: 22.5°C					
Frequency		Mode (number of timeslots)	Test Position	Figure No.	Conducted Power (dBm)	Max. tune-up Power (dBm)	Measured SAR(10g) (W/kg)	Reported SAR(10g) (W/kg)	Measured SAR(1g) (W/kg)	Reported SAR(1g) (W/kg)	Power Drift (dB)
Ch.	MHz										
190	836.6	GPRS (2)	Front	/	29.87	30.5	0.152	<b>0.18</b>	0.2	<b>0.23</b>	0.12
251	848.8	GPRS (2)	Rear	/	29.82	30.5	0.304	<b>0.36</b>	0.543	<b>0.64</b>	0.01
190	836.6	GPRS (2)	Rear	Fig.2	29.87	30.5	0.329	<b>0.38</b>	0.604	<b>0.70</b>	-0.04
128	824.2	GPRS (2)	Rear	/	29.74	30.5	0.259	<b>0.31</b>	0.463	<b>0.55</b>	0.10
190	836.6	GPRS (2)	Left	/	29.87	30.5	<0.01	<0.01	<0.01	<0.01	/
190	836.6	GPRS (2)	Right	/	29.87	30.5	<0.01	<0.01	<0.01	<0.01	/
190	836.6	GPRS (2)	Bottom	/	29.87	30.5	0.148	<b>0.17</b>	0.323	<b>0.37</b>	-0.17
190	836.6	EGPRS (2)	Rear	/	29.88	30.5	0.286	<b>0.33</b>	0.504	<b>0.58</b>	-0.15

Note: The distance between the EUT and the phantom bottom is 10mm.

**Table 14.1-3: SAR Values (GSM 1900 MHz Band - Head)**

Ambient Temperature: 22.9 °C						Liquid Temperature: 22.5°C					
Frequency		Side	Test Position	Figure No.	Conducted Power (dBm)	Max. tune-up Power (dBm)	Measured SAR(10g) (W/kg)	Reported SAR(10g) (W/kg)	Measured SAR(1g) (W/kg)	Reported SAR(1g) (W/kg)	Power Drift (dB)
Ch.	MHz										
810	1909.8	Left	Touch	/	28.65	30.3	0.04	<b>0.06</b>	0.064	<b>0.09</b>	-0.12
661	1880	Left	Touch	Fig.3	28.66	30.3	0.041	<b>0.06</b>	0.066	<b>0.10</b>	0.05
512	1850.2	Left	Touch	/	28.69	30.3	0.037	<b>0.05</b>	0.061	<b>0.09</b>	0.12
661	1880	Left	Tilt	/	28.66	30.3	0.025	<b>0.04</b>	0.039	<b>0.06</b>	-0.19
661	1880	Right	Touch	/	28.66	30.3	0.029	<b>0.04</b>	0.049	<b>0.07</b>	-0.10
661	1880	Right	Tilt	/	28.66	30.3	0.026	<b>0.04</b>	0.045	<b>0.07</b>	0.03

**Table 14.1-4: SAR Values (GSM 1900 MHz Band - Body)**

Frequency		Mode (number of timeslots)	Test Positio n	Figure No.	Conducted Power (dBm)	Max. tune-up Power (dBm)	Measured SAR(10g) (W/kg)	Reported SAR(10g) (W/kg)	Measured SAR(1g) (W/kg)	Reported SAR(1g) (W/kg)	Power Drift (dB)
Ch.	MHz										
Ambient Temperature: 22.9 °C      Liquid Temperature: 22.5 °C											
661	1880	GPRS (2)	Front	/	26.95	28	0.268	<b>0.34</b>	0.516	<b>0.66</b>	-0.12
810	1909.8	GPRS (2)	Rear	Fig.4	27	28	0.318	<b>0.40</b>	0.557	<b>0.70</b>	0.09
661	1880	GPRS (2)	Rear	/	26.95	28	0.266	<b>0.34</b>	0.467	<b>0.59</b>	-0.06
512	1850.2	GPRS (2)	Rear	/	26.91	28	0.234	<b>0.30</b>	0.403	<b>0.52</b>	0.07
810	1909.8	EGPRS (2)	Rear	/	27.02	28	0.283	<b>0.35</b>	0.49	<b>0.61</b>	-0.17
810	1909.8	GPRS (2)	Bottom	Note1	27	28	3	<b>3.78</b>	8.15	<b>10.26</b>	0.05
661	1880	GPRS (2)	Bottom	Note1	26.95	28	2.64	<b>3.36</b>	6.91	<b>8.80</b>	-0.05
512	1850.2	GPRS (2)	Bottom	Note1	26.91	28	2.94	<b>3.78</b>	7.71	<b>9.91</b>	0.14

Note: The distance between the EUT and the phantom bottom is 15mm

Note1: The distance between the EUT and the phantom bottom is 0mm

**Table 14.1-5: SAR Values (GSM 1900 MHz Band - Body)**

Frequency		Mode (number of timeslots)	Test Positio n	Figure No.	Conducted Power (dBm)	Max. tune-up Power (dBm)	Measured SAR(10g) (W/kg)	Reported SAR(10g) (W/kg)	Measured SAR(1g) (W/kg)	Reported SAR(1g) (W/kg)	Power Drift (dB)
Ch.	MHz										
Ambient Temperature: 22.9 °C      Liquid Temperature: 22.5 °C											
661	1880	GPRS (2)	Front	/	23.81	24.5	0.284	<b>0.33</b>	0.525	<b>0.62</b>	-0.03
661	1880	GPRS (2)	Rear	/	23.81	24.5	0.299	<b>0.35</b>	0.543	<b>0.64</b>	0.12
661	1880	GPRS (2)	Left	/	23.81	24.5	0.042	<b>0.05</b>	0.07	<b>0.08</b>	0.11
661	1880	GPRS (2)	Right	/	23.81	24.5	0.035	<b>0.04</b>	0.056	<b>0.07</b>	-0.09
810	1909.8	GPRS (2)	Bottom	Fig.5	23.9	24.5	0.511	<b>0.59</b>	0.981	<b>1.13</b>	-0.08
661	1880	GPRS (2)	Bottom	/	23.81	24.5	0.428	<b>0.50</b>	0.822	<b>0.96</b>	0.03
512	1850.2	GPRS (2)	Bottom	/	23.72	24.5	0.376	<b>0.45</b>	0.709	<b>0.85</b>	0.07
810	1909.8	EGPRS (2)	Bottom	/	23.9	24.5	0.463	<b>0.53</b>	0.912	<b>1.05</b>	-0.09

Note: The distance between the EUT and the phantom bottom is 10mm

**Table 14.1-6: SAR Values (WCDMA 1900 MHz Band - Head)**

Frequency		Side	Test Position	Figur e No.	Conducted Power (dBm)	Max. tune- up Power (dBm)	Measure d SAR(10g ) (W/kg)	Reported SAR(10g ) (W/kg)	Measure d SAR(1g) (W/kg)	Reporte d SAR(1g) (W/kg)	Power Drift (dB)
Ch.	MHz										
Ambient Temperature: 22.9 °C      Liquid Temperature: 22.5 °C											
9400	1880	Left	Touch	/	23.03	23.5	0.037	<b>0.04</b>	0.061	<b>0.07</b>	-0.14
9400	1880	Left	Tilt	/	23.03	23.5	0.032	<b>0.04</b>	0.05	<b>0.06</b>	0.12
9538	1907.6	Right	Touch	/	22.95	23.5	0.095	<b>0.11</b>	0.159	<b>0.18</b>	0.09
9400	1880	Right	Touch	/	23.03	23.5	0.079	<b>0.09</b>	0.134	<b>0.15</b>	0.16
9262	1852.4	Right	Touch	Fig.6	22.98	23.5	0.105	<b>0.12</b>	0.176	<b>0.20</b>	0.04
9400	1880	Right	Tilt	/	23.03	23.5	0.033	<b>0.04</b>	0.056	<b>0.06</b>	-0.01

**Table 14.1-7: SAR Values (WCDMA 1900 MHz Band - Body)**

Ambient Temperature: 22.9 °C						Liquid Temperature: 22.5°C				
Frequency		Test Position	Figure No.	Conducted Power (dBm)	Max. tune-up Power (dBm)	Measured SAR(10g) (W/kg)	Reported SAR(10g) (W/kg)	Measured SAR(1g) (W/kg)	Reported SAR(1g) (W/kg)	Power Drift (dB)
Ch.	MHz									
9400	1880	Front	/	23.03	23.5	0.263	<b>0.29</b>	0.461	<b>0.51</b>	0.12
9400	1880	Rear	Fig.7	23.03	23.5	0.319	<b>0.36</b>	0.541	<b>0.60</b>	0.01
9538	1907.6	Rear	/	22.95	23.5	0.309	<b>0.35</b>	0.532	<b>0.60</b>	0.09
9262	1852.4	Rear	/	22.98	23.5	0.316	<b>0.36</b>	0.527	<b>0.59</b>	-0.18
9538	1907.6	Bottom	Note1	22.95	23.5	3.45	<b>3.92</b>	9.46	<b>10.74</b>	0.11
9400	1880	Bottom	Note1	22.95	23.5	3.38	<b>3.84</b>	9.38	<b>10.65</b>	0.04
9262	1852.4	Bottom	Note1	22.95	23.5	3.36	<b>3.81</b>	9.35	<b>10.61</b>	-0.09

Note: The distance between the EUT and the phantom bottom is 15mm

Note1: The distance between the EUT and the phantom bottom is 0mm

**Table 14.1-8: SAR Values (WCDMA 1900 MHz Band - Body)**

Ambient Temperature: 22.9 °C						Liquid Temperature: 22.5°C				
Frequency		Test Position	Figure No.	Conducted Power (dBm)	Max. tune-up Power (dBm)	Measured SAR(10g) (W/kg)	Reported SAR(10g) (W/kg)	Measured SAR(1g) (W/kg)	Reported SAR(1g) (W/kg)	Power Drift (dB)
Ch.	MHz									
9400	1880	Front	/	21.04	21.5	0.307	<b>0.34</b>	0.576	<b>0.64</b>	-0.08
9400	1880	Rear	/	21.04	21.5	0.332	<b>0.37</b>	0.598	<b>0.66</b>	0.07
9400	1880	Left	/	21.04	21.5	0.064	<b>0.07</b>	0.105	<b>0.12</b>	-0.09
9400	1880	Right	/	21.04	21.5	0.064	<b>0.07</b>	0.107	<b>0.12</b>	0.08
9538	1907.6	Bottom	Fig.8	21.01	21.5	0.623	<b>0.70</b>	1.2	<b>1.34</b>	0.04
9400	1880	Bottom	/	21.04	21.5	0.575	<b>0.64</b>	1.11	<b>1.23</b>	-0.03
9262	1852.4	Bottom	/	21.02	21.5	0.537	<b>0.60</b>	1.01	<b>1.13</b>	0.03
9538	1907.6	Bottom	Headset	21.01	21.5	0.618	<b>0.69</b>	1.17	<b>1.31</b>	0.04

Note1: The distance between the EUT and the phantom bottom is 10mm

Note2: The headset is after-market accessories, which is used to evaluate effective of headset for SAR.

**Table 14.1-9: SAR Values (WCDMA 1700 MHz Band - Head)**

Ambient Temperature: 22.9 °C						Liquid Temperature: 22.5°C					
Frequency		Side	Test Position	Figure No.	Conducted Power (dBm)	Max. tune-up Power (dBm)	Measured SAR(10g) (W/kg)	Reported SAR(10g) (W/kg)	Measured SAR(1g) (W/kg)	Reported SAR(1g) (W/kg)	Power Drift (dB)
Ch.	MHz										
1513	1752.6	Left	Touch	/	22.63	24	0.108	<b>0.15</b>	0.167	<b>0.23</b>	-0.13
1412	1732.4	Left	Touch	Fig.9	22.82	24	0.12	<b>0.16</b>	0.185	<b>0.24</b>	0.18
1312	1712.4	Left	Touch	/	22.96	24	0.113	<b>0.14</b>	0.174	<b>0.22</b>	0.10
1412	1732.4	Left	Tilt	/	22.82	24	0.061	<b>0.08</b>	0.093	<b>0.12</b>	0.13
1412	1732.4	Right	Touch	/	22.82	24	0.114	<b>0.15</b>	0.177	<b>0.23</b>	-0.01
1412	1732.4	Right	Tilt	/	22.82	24	0.06	<b>0.08</b>	0.093	<b>0.12</b>	0.19

**Table 14.1-10: SAR Values (WCDMA 1700 MHz Band - Body)**

Ambient Temperature: 22.9 °C						Liquid Temperature: 22.5°C				
Frequency		Test Position	Figure No.	Conducted Power (dBm)	Max. tune-up Power (dBm)	Measured SAR(10g) (W/kg)	Reported SAR(10g) (W/kg)	Measured SAR(1g) (W/kg)	Reported SAR(1g) (W/kg)	Power Drift (dB)
Ch.	MHz									
1412	1732.5	Front	/	22.82	24	0.234	<b>0.31</b>	0.382	<b>0.50</b>	-0.12
1412	1732.5	Rear	Fig.10	22.82	24	0.238	<b>0.31</b>	0.397	<b>0.52</b>	0.05
1513	1752.6	Rear	/	22.63	24	0.228	<b>0.31</b>	0.371	<b>0.51</b>	0.12
1312	1712.4	Rear	/	22.96	24	0.195	<b>0.25</b>	0.313	<b>0.40</b>	0.01
1513	1752.6	Bottom	Note1	22.63	24	2.24	<b>3.07</b>	5.36	<b>7.35</b>	-0.09
1412	1732.5	Bottom	Note1	22.82	24	2.14	<b>2.81</b>	5.21	<b>6.84</b>	0.01
1312	1712.4	Bottom	Note1	22.96	24	2.16	<b>2.74</b>	5.13	<b>6.52</b>	0.06

Note: The distance between the EUT and the phantom bottom is 15mm

Note1: The distance between the EUT and the phantom bottom is 0mm

**Table 14.1-11: SAR Values (WCDMA 1700 MHz Band - Body)**

Ambient Temperature: 22.9 °C						Liquid Temperature: 22.5°C				
Frequency		Test Position	Figure No.	Conducted Power (dBm)	Max. tune-up Power (dBm)	Measured SAR(10g) (W/kg)	Reported SAR(10g) (W/kg)	Measured SAR(1g) (W/kg)	Reported SAR(1g) (W/kg)	Power Drift (dB)
Ch.	MHz									
1412	1732.5	Front	/	20.66	22	0.233	<b>0.32</b>	0.408	<b>0.56</b>	0.16
1412	1732.5	Rear	/	20.66	22	0.235	<b>0.32</b>	0.42	<b>0.57</b>	-0.13
1412	1732.5	Left	/	20.66	22	0.113	<b>0.15</b>	0.189	<b>0.26</b>	0.18
1412	1732.5	Right	/	20.66	22	0.039	<b>0.05</b>	0.066	<b>0.09</b>	-0.10
1513	1752.6	Bottom	Fig.11	20.55	22	0.334	<b>0.47</b>	0.623	<b>0.87</b>	-0.04
1412	1732.5	Bottom	/	20.66	22	0.326	<b>0.44</b>	0.594	<b>0.81</b>	0.03
1312	1712.4	Bottom	/	20.73	22	0.294	<b>0.39</b>	0.551	<b>0.74</b>	0.01

Note: The distance between the EUT and the phantom bottom is 10mm

**Table 14.1-12: SAR Values (WCDMA 850 MHz Band - Head)**

Ambient Temperature: 22.9 °C						Liquid Temperature: 22.5°C					
Frequency		Side	Test Position	Figure No.	Conducted Power (dBm)	Max. tune-up Power (dBm)	Measured SAR(10g) (W/kg)	Reported SAR(10g) (W/kg)	Measured SAR(1g) (W/kg)	Reported SAR(1g) (W/kg)	Power Drift (dB)
Ch.	MHz										
4183	836.6	Left	Touch	/	22.61	24	0.436	<b>0.60</b>	0.693	<b>0.95</b>	0.14
4183	836.6	Left	Touch	/	22.69	24	0.505	<b>0.68</b>	0.728	<b>0.98</b>	0.19
4233	846.6	Left	Touch	Fig.12	22.6	24	0.538	<b>0.74</b>	0.846	<b>1.17</b>	0.02
4183	836.6	Left	Tilt	/	22.69	24	0.33	<b>0.45</b>	0.543	<b>0.73</b>	0.00
4132	826.4	Right	Touch	/	22.69	24	0.363	<b>0.49</b>	0.464	<b>0.63</b>	-0.09

4183	836.6	Right	Tilt	/	22.69	24	0.337	<b>0.46</b>	0.462	<b>0.62</b>	-0.12
------	-------	-------	------	---	-------	----	-------	-------------	-------	-------------	-------

**Table 14.1-13: SAR Values (WCDMA 850 MHz Band - Body)**

Ambient Temperature: 22.9 °C						Liquid Temperature: 22.5 °C				
Frequency		Test Position	Figure No.	Conducted Power (dBm)	Max. tune-up Power (dBm)	Measured SAR(10g) (W/kg)	Reported SAR(10g) (W/kg)	Measured SAR(1g) (W/kg)	Reported SAR(1g) (W/kg)	Power Drift (dB)
Ch.	MHz									
4183	836.6	Front	/	22.69	24	0.135	<b>0.18</b>	0.189	<b>0.26</b>	-0.06
4183	836.6	Rear	/	22.69	24	0.172	<b>0.23</b>	0.239	<b>0.32</b>	0.16
4183	836.6	Left	/	22.69	24	0.063	<b>0.09</b>	0.095	<b>0.13</b>	-0.01
4183	836.6	Right	/	22.69	24	0.11	<b>0.15</b>	0.171	<b>0.23</b>	0.00
4183	836.6	Top	Fig.13	22.69	24	0.163	<b>0.22</b>	0.284	<b>0.38</b>	0.03
4233	846.6	Top	/	22.61	24	0.133	<b>0.18</b>	0.247	<b>0.34</b>	-0.09
4132	826.4	Top	/	22.6	24	0.123	<b>0.17</b>	0.237	<b>0.33</b>	0.11

Note: The distance between the EUT and the phantom bottom is 10mm.

**Table 14.1-14: SAR Values (LTE Band2 - Head)**

Ambient Temperature: 22.9 °C						Liquid Temperature: 22.5 °C						
Frequency		Mode	Side	Test Position	Figure No.	Conducted Power (dBm)	Max. tune-up Power (dBm)	Measured SAR(10g) (W/kg)	Reported SAR(10g) (W/kg)	Measured SAR(1g) (W/kg)	Reported SAR(1g) (W/kg)	Power Drift (dB)
Ch.	MHz											
18700	1860	1RB_Mid	Left	Touch	/	22.36	23	0.081	<b>0.09</b>	0.133	<b>0.15</b>	0.14
18700	1860	1RB_Mid	Left	Tilt	/	22.36	23	0.051	<b>0.06</b>	0.09	<b>0.10</b>	-0.08
18700	1860	1RB_Mid	Right	Touch	Fig.14	22.36	23	0.143	<b>0.17</b>	0.236	<b>0.27</b>	-0.03
18700	1860	1RB_Mid	Right	Tilt	/	22.36	23	0.04	<b>0.05</b>	0.105	<b>0.12</b>	-0.09
18700	1860	50RB_Low	Left	Touch	/	22.21	23	0.068	<b>0.08</b>	0.109	<b>0.13</b>	0.12
18700	1860	50RB_Low	Left	Tilt	/	22.21	23	0.058	<b>0.07</b>	0.092	<b>0.11</b>	0.03
18700	1860	50RB_Low	Right	Touch	/	22.21	23	0.094	<b>0.11</b>	0.158	<b>0.19</b>	0.09
18700	1860	50RB_Low	Right	Tilt	/	22.21	23	0.051	<b>0.06</b>	0.083	<b>0.10</b>	-0.08

Note1: The LTE mode is QPSK\_20MHz.

**Table 14.1-15: SAR Values (LTE Band2 - Body)**

Ambient Temperature: 22.9 °C						Liquid Temperature: 22.5 °C					
Frequency		Mode	Test Position	Figure No.	Conducted Power (dBm)	Max. tune-up Power (dBm)	Measured SAR(10g) (W/kg)	Reported SAR(10g) (W/kg)	Measured SAR(1g) (W/kg)	Reported SAR(1g) (W/kg)	Power Drift (dB)
Ch.	MHz										
18700	1860	1RB_Mid	Front	/	22.36	23	0.381	<b>0.44</b>	0.682	<b>0.79</b>	-0.09
18900	1880	1RB_Mid	Rear	Fig.15	22.31	23	0.406	<b>0.48</b>	0.703	<b>0.82</b>	-0.01
18700	1860	1RB_Mid	Rear	/	22.36	23	0.398	<b>0.46</b>	0.69	<b>0.80</b>	0.07
19100	1900	1RB_Mid	Rear	/	22.26	23	0.385	<b>0.46</b>	0.681	<b>0.81</b>	-0.09
18700	1860	50RB_Low	Front	/	22.21	23	0.336	<b>0.40</b>	0.62	<b>0.74</b>	0.09
18700	1860	50RB_Low	Rear	/	22.21	23	0.354	<b>0.42</b>	0.658	<b>0.79</b>	-0.08

18900	1880	100RB	Rear	/	22.1	23	0.296	<b>0.36</b>	0.532	<b>0.65</b>	0.01
19100	1900	1RB_Mid	Bottom	Note1	22.26	23	3.18	<b>3.77</b>	8.38	<b>9.94</b>	-0.06
18900	1880	1RB_Mid	Bottom	Note1	22.31	23	3.25	<b>3.81</b>	8.49	<b>9.95</b>	0.20
18700	1860	1RB_Mid	Bottom	Note1	22.36	23	3.21	<b>3.72</b>	8.41	<b>9.75</b>	0.06

Note: The distance between the EUT and the phantom bottom is 15mm.

Note1: The distance between the EUT and the phantom bottom is 0mm.

**Table 14.1-16: SAR Values (LTE Band2 - Body)**

Ambient Temperature: 22.9 °C						Liquid Temperature: 22.5°C					
Frequency		Mode	Test Position	Figure No.	Conducted Power (dBm)	Max. tune-up Power (dBm)	Measured SAR(10g) (W/kg)	Reported SAR(10g) (W/kg)	Measured SAR(1g) (W/kg)	Reported SAR(1g) (W/kg)	Power Drift (dB)
Ch.	MHz										
18700	1860	1RB_Mid	Front	/	19.29	20	0.231	<b>0.27</b>	0.413	<b>0.49</b>	-0.12
18700	1860	1RB_Mid	Rear	/	19.29	20	0.27	<b>0.32</b>	0.463	<b>0.55</b>	0.06
18700	1860	1RB_Mid	Left	/	19.29	20	0.065	<b>0.08</b>	0.103	<b>0.12</b>	-0.05
18700	1860	1RB_Mid	Right	/	19.29	20	0.062	<b>0.07</b>	0.098	<b>0.12</b>	-0.13
19100	1900	1RB_Mid	Bottom	/	19.23	20	0.392	<b>0.47</b>	0.735	<b>0.88</b>	0.02
18700	1860	1RB_Mid	Bottom		19.29	20	0.437	<b>0.51</b>	0.831	<b>0.98</b>	-0.06
18900	1880	1RB_Mid	Bottom		19.27	20	0.369	<b>0.44</b>	0.689	<b>0.82</b>	-0.20
18900	1880	50RB_Mid	Front	/	19.18	20	0.221	<b>0.27</b>	0.399	<b>0.48</b>	-0.20
18900	1880	50RB_Mid	Rear	/	19.18	20	0.256	<b>0.31</b>	0.447	<b>0.54</b>	0.13
18900	1880	50RB_Mid	Left	/	19.18	20	0.063	<b>0.08</b>	0.104	<b>0.13</b>	-0.09
18900	1880	50RB_Mid	Right	/	19.18	20	0.057	<b>0.07</b>	0.094	<b>0.11</b>	-0.17
19100	1900	50RB_Mid	Bottom	/	19.14	20	0.345	<b>0.42</b>	0.643	<b>0.78</b>	-0.06
18900	1880	50RB_Mid	Bottom	Fig.16	19.18	20	0.437	<b>0.53</b>	0.839	<b>1.01</b>	0.15
18700	1860	50RB_Mid	Bottom	/	19.16	20	0.335	<b>0.41</b>	0.627	<b>0.76</b>	-0.20
18900	1880	100RB	Bottom	/	19.09	20	0.402	<b>0.50</b>	0.784	<b>0.97</b>	-0.06
18700	1860	100RB	Bottom	/	19.11	20	0.389	<b>0.48</b>	0.743	<b>0.91</b>	0.08

Note1: The distance between the EUT and the phantom bottom is 10mm.

Note2: The LTE mode is QPSK\_20MHz.

**Table 14.1-17: SAR Values (LTE Band5 - Head)**

Ambient Temperature: 22.9 °C						Liquid Temperature: 22.5°C						
Frequency		Mode	Side	Test Position	Figure No.	Conducted Power (dBm)	Max. tune-up Power (dBm)	Measured SAR(10g) (W/kg)	Reported SAR(10g) (W/kg)	Measured SAR(1g) (W/kg)	Reported SAR(1g) (W/kg)	Power Drift (dB)
Ch.	MHz											
20600	844	1RB_Mid	Left	Touch	/	21.58	22.5	0.401	<b>0.50</b>	0.599	<b>0.74</b>	-0.03
20450	829	1RB_Mid	Left	Touch	Fig.17	21.63	22.5	0.523	<b>0.64</b>	0.852	<b>1.04</b>	-0.12
20525	836.5	1RB_Mid	Left	Touch	/	21.6	22.5	0.436	<b>0.54</b>	0.639	<b>0.79</b>	0.14
20450	829	1RB_Mid	Left	Tilt	/	21.63	22.5	0.403	<b>0.49</b>	0.728	<b>0.89</b>	0.08
20450	829	1RB_Mid	Right	Touch	/	21.63	22.5	0.411	<b>0.50</b>	0.542	<b>0.66</b>	-0.08

20450	829	1RB_Mid	Right	Tilt	/	21.63	22.5	0.335	<b>0.41</b>	0.47	<b>0.57</b>	0.09
20600	844	25RB_Low	Left	Touch	/	21.62	22.5	0.327	<b>0.40</b>	0.491	<b>0.60</b>	-0.06
20600	844	25RB_Low	Left	Tilt	/	21.62	22.5	0.263	<b>0.32</b>	0.443	<b>0.54</b>	0.17
20600	844	25RB_Low	Right	Touch	/	21.62	22.5	0.294	<b>0.36</b>	0.419	<b>0.51</b>	0.12
20600	844	25RB_Low	Right	Tilt	/	21.62	22.5	0.247	<b>0.30</b>	0.354	<b>0.43</b>	-0.06
20450	829	50RB	Left	Touch	/	21.52	22.5	0.33	<b>0.41</b>	0.468	<b>0.59</b>	-0.05

Note: The LTE mode is QPSK\_10MHz.

**Table 14.1-18: SAR Values (LTE Band5 - Body)**

Ambient Temperature: 22.9 °C						Liquid Temperature: 22.5 °C					
Frequency		Mode	Test Position	Figure No.	Conducted Power (dBm)	Max. tune-up Power (dBm)	Measured SAR(10g) (W/kg)	Reported SAR(10g) (W/kg)	Measured SAR(1g) (W/kg)	Reported SAR(1g) (W/kg)	Power Drift (dB)
Ch.	MHz										
20450	829	1RB_Middle	Front	/	21.63	22.5	0.211	<b>0.26</b>	0.264	<b>0.32</b>	-0.08
20450	829	1RB_Middle	Rear	Fig.18	21.63	22.5	0.275	<b>0.34</b>	0.356	<b>0.43</b>	-0.18
20450	829	1RB_Middle	Left	/	21.63	22.5	0.161	<b>0.20</b>	0.222	<b>0.27</b>	0.12
20450	829	1RB_Middle	Right	/	21.63	22.5	0.23	<b>0.28</b>	0.311	<b>0.38</b>	0.09
20450	829	1RB_Middle	Top	/	21.63	22.5	0.182	<b>0.22</b>	0.327	<b>0.40</b>	-0.08
20600	844	25RB_Low	Front	/	21.62	22.5	0.161	<b>0.20</b>	0.203	<b>0.25</b>	0.09
20600	844	25RB_Low	Rear	/	21.62	22.5	0.165	<b>0.20</b>	0.257	<b>0.31</b>	-0.14
20600	844	25RB_Low	Left	/	21.62	22.5	0.12	<b>0.15</b>	0.168	<b>0.21</b>	-0.08
20600	844	25RB_Low	Right	/	21.62	22.5	0.155	<b>0.19</b>	0.232	<b>0.28</b>	0.14
20600	844	25RB_Low	Top	/	21.62	22.5	0.156	<b>0.19</b>	0.238	<b>0.29</b>	0.12

Note1: The distance between the EUT and the phantom bottom is 10mm.

Note2: The LTE mode is QPSK\_10MHz.

**Table 14.1-19: SAR Values (LTE Band12 - Head)**

Ambient Temperature: 22.9 °C						Liquid Temperature: 22.5 °C						
Frequency		Mode	Side	Test Position	Figure No.	Conducted Power (dBm)	Max. tune-up Power (dBm)	Measured SAR(10g) (W/kg)	Reported SAR(10g) (W/kg)	Measured SAR(1g) (W/kg)	Reported SAR(1g) (W/kg)	Power Drift (dB)
Ch.	MHz											
23130	711	1RB_Mid	Left	Touch	/	22.86	24	0.521	<b>0.68</b>	0.743	<b>0.97</b>	0.17
23060	704	1RB_Mid	Left	Touch	Fig.19	23.01	24	0.56	<b>0.70</b>	0.821	<b>1.03</b>	0.00
23095	707.5	1RB_Mid	Left	Touch	/	22.97	24	0.504	<b>0.64</b>	0.722	<b>0.92</b>	0.07
23060	704	1RB_Mid	Left	Tilt	/	23.01	24	0.464	<b>0.58</b>	0.714	<b>0.90</b>	-0.06
23060	704	1RB_Mid	Right	Touch	/	23.01	24	0.445	<b>0.56</b>	0.483	<b>0.61</b>	0.12
23060	704	1RB_Mid	Right	Tilt	/	23.01	24	0.356	<b>0.45</b>	0.434	<b>0.55</b>	-0.10
23095	707.5	25RB_Low	Left	Touch	/	21.99	23	0.536	<b>0.68</b>	0.733	<b>0.92</b>	-0.15
23095	707.5	25RB_Low	Left	Tilt	/	21.99	23	0.368	<b>0.46</b>	0.547	<b>0.69</b>	-0.13
23095	707.5	25RB_Low	Right	Touch	/	21.99	23	0.225	<b>0.28</b>	0.274	<b>0.35</b>	0.11
23095	707.5	25RB_Low	Right	Tilt	/	21.99	23	0.23	<b>0.29</b>	0.286	<b>0.36</b>	-0.02
23060	704	50RB	Left	Touch	/	21.89	23	0.387	<b>0.50</b>	0.685	<b>0.88</b>	0.12

Note: The LTE mode is QPSK\_10MHz.

**Table 14.1-20: SAR Values (LTE Band12 - Body)**

Ambient Temperature: 22.9 °C						Liquid Temperature: 22.5 °C					
Frequency		Mode	Test Position	Figure No.	Conduct ed Power (dBm)	Max. tune-up Power (dBm)	Measured SAR(10g) (W/kg)	Reported SAR(10g) (W/kg)	Measured SAR(1g) (W/kg)	Reported SAR(1g) (W/kg)	Power Drift (dB)
Ch.	MHz										
23060	704	1RB_Mid	Front	/	23.01	24	0.204	<b>0.26</b>	0.263	<b>0.33</b>	-0.12
23060	704	1RB_Mid	Rear	Fig.20	23.01	24	0.297	<b>0.37</b>	0.387	<b>0.49</b>	0.04
23060	704	1RB_Mid	Left	/	23.01	24	0.206	<b>0.26</b>	0.287	<b>0.36</b>	0.13
23060	704	1RB_Mid	Right	/	23.01	24	0.247	<b>0.31</b>	0.347	<b>0.44</b>	0.14
23060	704	1RB_Mid	Top	/	23.01	24	0.105	<b>0.13</b>	0.189	<b>0.24</b>	0.18
23095	707.5	25RB_Low	Front	/	21.99	23	0.153	<b>0.19</b>	0.201	<b>0.25</b>	0.20
23095	707.5	25RB_Low	Rear	/	21.99	23	0.245	<b>0.31</b>	0.319	<b>0.40</b>	-0.07
23095	707.5	25RB_Low	Left	/	21.99	23	0.172	<b>0.22</b>	0.241	<b>0.30</b>	0.04
23095	707.5	25RB_Low	Right	/	21.99	23	0.242	<b>0.31</b>	0.34	<b>0.43</b>	-0.12
23095	707.5	25RB_Low	Top	/	21.99	23	0.087	<b>0.11</b>	0.157	<b>0.20</b>	0.18

Note1: The distance between the EUT and the phantom bottom is 10mm

Note2: The LTE mode is QPSK\_10MHz.

**Table 14.1-21: SAR Values (LTE Band14 - Head)**

Ambient Temperature: 22.9 °C						Liquid Temperature: 22.5 °C						
Frequency		Mode	Side	Test Position	Figure No.	Condu cted Power (dBm)	Max. tune-up Power (dBm)	Measured SAR(10g) (W/kg)	Reported SAR(10g) (W/kg)	Measure d SAR(1g) (W/kg)	Reporte d SAR(1g) (W/kg)	Power Drift (dB)
Ch.	MHz											
23330	793	1RB_Mid	Left	Touch	/	23.03	24	0.127	<b>0.16</b>	0.162	<b>0.20</b>	-0.11
23330	793	1RB_Mid	Left	Tilt	/	23.03	24	0.08	<b>0.10</b>	0.104	<b>0.13</b>	0.08
23330	793	1RB_Mid	Right	Touch	Fig.21	23.03	24	0.172	<b>0.22</b>	0.226	<b>0.28</b>	0.18
23330	793	1RB_Mid	Right	Tilt	/	23.03	24	0.098	<b>0.12</b>	0.126	<b>0.16</b>	0.14
23330	793	25RB_Low	Left	Touch	/	22.03	24	0.09	<b>0.14</b>	0.117	<b>0.18</b>	-0.14
23330	793	25RB_Low	Left	Tilt	/	22.03	24	0.049	<b>0.08</b>	0.074	<b>0.12</b>	0.16
23330	793	25RB_Low	Right	Touch	/	22.03	24	0.111	<b>0.17</b>	0.151	<b>0.24</b>	-0.14
23330	793	25RB_Low	Right	Tilt	/	22.03	24	0.082	<b>0.13</b>	0.105	<b>0.17</b>	0.09

Note: The LTE mode is QPSK\_10MHz.



**Table 14.1-22: SAR Values (LTE Band14 - Body)**

Ambient Temperature: 22.9 °C						Liquid Temperature: 22.5°C					
Frequency		Mode	Test Position	Figure No.	Conducted Power (dBm)	Max. tune-up Power (dBm)	Measured SAR(10g) (W/kg)	Reported SAR(10g) (W/kg)	Measured SAR(1g) (W/kg)	Reported SAR(1g) (W/kg)	Power Drift (dB)
Ch.	MHz										
23330	793	1RB_Mid	Front	/	23.03	24	0.143	<b>0.18</b>	0.19	<b>0.24</b>	-0.18
23330	793	1RB_Mid	Rear	Fig.22	23.03	24	0.237	<b>0.30</b>	0.442	<b>0.55</b>	0.18
23330	793	1RB_Mid	Left	/	23.03	24	0.118	<b>0.15</b>	0.175	<b>0.22</b>	0.08
23330	793	1RB_Mid	Right	/	23.03	24	0.149	<b>0.19</b>	0.221	<b>0.28</b>	-0.12
23330	793	1RB_Mid	Bottom	/	23.03	24	0.117	<b>0.15</b>	0.23	<b>0.29</b>	-0.11
23330	793	25RB_Low	Front	/	22.03	23	0.116	<b>0.15</b>	0.153	<b>0.19</b>	-0.07
23330	793	25RB_Low	Rear	/	22.03	23	0.164	<b>0.21</b>	0.293	<b>0.37</b>	-0.11
23330	793	25RB_Low	Left	/	22.03	23	0.084	<b>0.11</b>	0.125	<b>0.16</b>	0.15
23330	793	25RB_Low	Right	/	22.03	23	0.108	<b>0.14</b>	0.161	<b>0.20</b>	-0.04
23330	793	25RB_Low	Bottom	/	22.03	23	0.086	<b>0.11</b>	0.178	<b>0.22</b>	-0.12

Note1: The distance between the EUT and the phantom bottom is 10mm.

Note2: The LTE mode is QPSK\_10MHz.

**Table 14.1-23: SAR Values (LTE Band30 - Head)**

Ambient Temperature: 22.9 °C						Liquid Temperature: 22.5°C						
Frequency		Mode	Side	Test Position	Figure No.	Conducted Power (dBm)	Max. tune-up Power (dBm)	Measured SAR(10g) (W/kg)	Reported SAR(10g) (W/kg)	Measured SAR(1g) (W/kg)	Reported SAR(1g) (W/kg)	Power Drift (dB)
Ch.	MHz											
27710	2310	1RB_Mid	Left	Touch	Fig.23	23.33	24	0.124	<b>0.14</b>	0.208	<b>0.24</b>	0.02
27710	2310	1RB_Mid	Left	Tilt	/	23.33	24	0.048	<b>0.06</b>	0.086	<b>0.10</b>	-0.10
27710	2310	1RB_Mid	Right	Touch	/	23.33	24	0.111	<b>0.13</b>	0.194	<b>0.23</b>	-0.12
27710	2310	1RB_Mid	Right	Tilt	/	23.33	24	0.068	<b>0.08</b>	0.122	<b>0.14</b>	0.12
27710	2310	25RB_Mid	Left	Touch	/	22.16	23	0.087	<b>0.11</b>	0.146	<b>0.18</b>	0.14
27710	2310	25RB_Mid	Left	Tilt	/	22.16	23	0.032	<b>0.04</b>	0.056	<b>0.07</b>	0.06
27710	2310	25RB_Mid	Right	Touch	/	22.16	23	0.082	<b>0.10</b>	0.131	<b>0.16</b>	0.17
27710	2310	25RB_Mid	Right	Tilt	/	22.16	23	0.058	<b>0.07</b>	0.1	<b>0.12</b>	-0.04

Note: The LTE mode is QPSK\_10MHz.

**Table 14.1-24: SAR Values (LTE Band30 - Body)**

Frequency		Mode	Test Position	Figure No.	Conducted Power (dBm)	Max. tune-up Power (dBm)	Measured SAR(10g) (W/kg)	Reported SAR(10g) (W/kg)	Measured SAR(1g) (W/kg)	Reported SAR(1g) (W/kg)	Power Drift (dB)
Ch.	MHz										
Ambient Temperature: 22.9 °C					Liquid Temperature: 22.5 °C						
27710	2310	1RB_Mid	Front	/	23.33	24	0.279	<b>0.33</b>	0.496	<b>0.58</b>	0.09
27710	2310	1RB_Mid	Rear	Fig.24	23.33	24	0.324	<b>0.38</b>	0.576	<b>0.67</b>	0.05
27710	2310	25RB_Mid	Left	/	22.16	23	0.209	<b>0.25</b>	0.373	<b>0.45</b>	-0.10
27710	2310	25RB_Mid	Right	/	22.16	23	0.247	<b>0.30</b>	0.438	<b>0.53</b>	0.20

Note1: The distance between the EUT and the phantom bottom is 15mm.

Note2: The LTE mode is QPSK\_10MHz.

**Table 14.1-25: SAR Values (LTE Band30 - Body)**

Frequency		Mode	Test Position	Figure No.	Conducted Power (dBm)	Max. tune-up Power (dBm)	Measured SAR(10g) (W/kg)	Reported SAR(10g) (W/kg)	Measured SAR(1g) (W/kg)	Reported SAR(1g) (W/kg)	Power Drift (dB)
Ch.	MHz										
Ambient Temperature: 22.9 °C					Liquid Temperature: 22.5 °C						
27710	2310	1RB_Mid	Front	/	19.37	20	0.045	<b>0.05</b>	0.106	<b>0.12</b>	0.18
27710	2310	1RB_Mid	Rear	/	19.37	20	0.094	<b>0.11</b>	0.192	<b>0.22</b>	0.02
27710	2310	1RB_Mid	Left	/	19.37	20	0.031	<b>0.04</b>	0.069	<b>0.08</b>	0.02
27710	2310	1RB_Mid	Right	/	19.37	20	0.027	<b>0.03</b>	0.05	<b>0.06</b>	0.13
27710	2310	1RB_Mid	Bottom	Fig.25	19.37	20	0.09	<b>0.10</b>	0.197	<b>0.23</b>	0.13
27710	2310	25RB_Mid	Front	/	19.08	20	0.074	<b>0.09</b>	0.127	<b>0.16</b>	-0.14
27710	2310	25RB_Mid	Rear	/	19.08	20	0.074	<b>0.09</b>	0.158	<b>0.20</b>	-0.06
27710	2310	25RB_Mid	Left	/	19.08	20	0.026	<b>0.03</b>	0.045	<b>0.06</b>	-0.12
27710	2310	25RB_Mid	Right	/	19.08	20	0.022	<b>0.03</b>	0.049	<b>0.06</b>	-0.09
27710	2310	25RB_Mid	Bottom	/	19.08	20	0.055	<b>0.07</b>	0.132	<b>0.16</b>	0.10

Note1: The distance between the EUT and the phantom bottom is 10mm.

Note2: The LTE mode is QPSK\_10MHz.

**Table 14.1-26: SAR Values (LTE Band66 - Head)**

Frequency		Ambient Temperature: 22.9 °C						Liquid Temperature: 22.5 °C				
Ch.	MHz	Mode	Side	Test Position	Figure No.	Conducted Power (dBm)	tune-up Power (dBm)	Measured SAR(10g) (W/kg)	Reported SAR(10g) (W/kg)	Measured SAR(1g) (W/kg)	Reported SAR(1g) (W/kg)	Power Drift (dB)
132072	1720	1RB_Mid	Left	Touch	/	23.2	24	0.195	<b>0.23</b>	0.296	<b>0.36</b>	0.02
132072	1720	1RB_Mid	Left	Tilt	/	23.2	24	0.106	<b>0.13</b>	0.161	<b>0.19</b>	-0.16
132072	1720	1RB_Mid	Right	Touch	Fig.26	23.2	24	0.239	<b>0.29</b>	0.381	<b>0.46</b>	-0.02
132072	1720	1RB_Mid	Right	Tilt	/	23.2	24	0.113	<b>0.14</b>	0.179	<b>0.22</b>	0.12
132072	1720	50RB_High	Left	Touch	/	22.27	23	0.182	<b>0.22</b>	0.29	<b>0.34</b>	0.06
132072	1720	50RB_High	Left	Tilt	/	22.27	23	0.081	<b>0.10</b>	0.129	<b>0.15</b>	0.20
132072	1720	50RB_High	Right	Touch	/	22.27	23	0.149	<b>0.18</b>	0.227	<b>0.27</b>	0.05
132072	1720	50RB_High	Right	Tilt	/	22.27	23	0.084	<b>0.10</b>	0.127	<b>0.15</b>	-0.07

Note1: The LTE mode is QPSK\_20MHz.

**Table 14.1-27: SAR Values (LTE Band66 - Body)**

Frequency		Ambient Temperature: 22.9 °C						Liquid Temperature: 22.5 °C				
Ch.	MHz	Mode	Test Position	Figure No.	Conducted Power (dBm)	Max. tune-up Power (dBm)	Measured SAR(10g) (W/kg)	Reported SAR(10g) (W/kg)	Measured SAR(1g) (W/kg)	Reported SAR(1g) (W/kg)	Power Drift (dB)	
132072	1720	1RB_Mid	Front	Fig.27	23.2	24	0.393	<b>0.47</b>	0.662	<b>0.80</b>	-0.02	
132072	1720	1RB_Mid	Rear	/	23.2	24	0.326	<b>0.39</b>	0.565	<b>0.68</b>	0.14	
132072	1720	50RB_High	Front	/	22.27	23	0.299	<b>0.35</b>	0.509	<b>0.60</b>	-0.08	
132072	1720	50RB_High	Rear	/	22.27	23	0.251	<b>0.30</b>	0.438	<b>0.52</b>	0.09	
132572	1770	1RB_Low	Bottom	Note1	22.7	24	2.66	<b>3.59</b>	6.89	<b>9.29</b>	-0.09	
132322	1745	1RB_Mid	Bottom	Note1	22.96	24	2.77	<b>3.52</b>	6.98	<b>8.87</b>	0.07	
132072	1720	1RB_Mid	Bottom	Note1	23.2	24	3.01	<b>3.62</b>	7.24	<b>8.70</b>	0.05	

Note: The distance between the EUT and the phantom bottom is 15mm. The LTE mode is QPSK\_20MHz.

Note1: The distance between the EUT and the phantom bottom is 0mm.

**Table 14.1-28: SAR Values (LTE Band66 - Body)**

Frequency		Mode	Test Position	Figure No.	Conducted Power (dBm)	Max. tune-up Power (dBm)	Measured SAR(10g) (W/kg)	Reported SAR(10g) (W/kg)	Measured SAR(1g) (W/kg)	Reported SAR(1g) (W/kg)	Power Drift (dB)
Ch.	MHz										
Ambient Temperature: 22.9 °C					Liquid Temperature: 22.5 °C						
132072	1720	1RB_Mid	Front	/	19.25	20	0.222	<b>0.26</b>	0.376	<b>0.45</b>	-0.06
132072	1720	1RB_Mid	Rear	/	19.25	20	0.223	<b>0.27</b>	0.378	<b>0.45</b>	0.01
132072	1720	1RB_Mid	Left	/	19.25	20	0.112	<b>0.13</b>	0.179	<b>0.21</b>	0.08
132072	1720	1RB_Mid	Right	/	19.25	20	0.065	<b>0.08</b>	0.104	<b>0.12</b>	0.05
132072	1720	1RB_Mid	Bottom	Fig.28	19.25	20	0.279	<b>0.33</b>	0.519	<b>0.62</b>	0.09
132072	1720	50RB_Low	Front	/	19.22	20	0.208	<b>0.25</b>	0.344	<b>0.41</b>	-0.09
132072	1720	50RB_Low	Rear	/	19.22	20	0.207	<b>0.25</b>	0.357	<b>0.43</b>	0.18
132072	1720	50RB_Low	Left	/	19.22	20	0.078	<b>0.09</b>	0.124	<b>0.15</b>	0.10
132072	1720	50RB_Low	Right	/	19.22	20	0.05	<b>0.06</b>	0.08	<b>0.10</b>	0.04
132072	1720	50RB_Low	Bottom	/	19.22	20	0.259	<b>0.31</b>	0.485	<b>0.58</b>	0.02

Note: The distance between the EUT and the phantom bottom is 10mm. The LTE mode is QPSK\_20MHz.

## 14.2 SAR results for Standard procedure

There is zoom scan measurement to be added for the highest measured SAR in each exposure configuration/band.

**Table 14.2-1: SAR Values (GSM 850 MHz Band - Head)**

Frequency		Side	Test Position	Figure No.	Conducted Power (dBm)	Max. tune-up Power (dBm)	Measured SAR(10g) (W/kg)	Reported SAR(10g) (W/kg)	Measured SAR(1g) (W/kg)	Reported SAR(1g) (W/kg)	Power Drift (dB)
Ch.	MHz										
251	848.8	Right	Touch	Fig.1	32.18	33.3	0.152	<b>0.20</b>	0.202	<b>0.26</b>	0.13

**Table 14.2-2: SAR Values (GSM 850 MHz Band - Body)**

Frequency		Mode (number of timeslots)	Test Position	Figure No.	Conducted Power (dBm)	Max. tune-up Power (dBm)	Measured SAR(10g) (W/kg)	Reported SAR(10g) (W/kg)	Measured SAR(1g) (W/kg)	Reported SAR(1g) (W/kg)	Power Drift (dB)
Ch.	MHz										
190	836.6	GPRS (2)	Rear	Fig.2	29.87	30.5	0.329	<b>0.38</b>	0.604	<b>0.70</b>	-0.04

Note: The distance between the EUT and the phantom bottom is 10mm.

**Table 14.2-3: SAR Values (GSM 1900 MHz Band - Head)**

Frequency		Side	Test Position	Figure No.	Conducted Power (dBm)	Max. tune-up Power (dBm)	Measured SAR(10g) (W/kg)	Reported SAR(10g) (W/kg)	Measured SAR(1g) (W/kg)	Reported SAR(1g) (W/kg)	Power Drift (dB)
Ch.	MHz										
661	1880	Left	Touch	Fig.3	28.66	30.3	0.041	<b>0.06</b>	0.066	<b>0.10</b>	0.05

**Table 14.2-4: SAR Values (GSM 1900 MHz Band - Body)**

Frequency		Mode (number of timeslots)	Test Position	Figure No.	Conducted Power (dBm)	Max. tune-up Power (dBm)	Measured SAR(10g) (W/kg)	Reported SAR(10g) (W/kg)	Measured SAR(1g) (W/kg)	Reported SAR(1g) (W/kg)	Power Drift (dB)
Ch.	MHz										
810	1909.8	GPRS (2)	Rear	Fig.4	27	28	0.318	<b>0.40</b>	0.557	<b>0.70</b>	0.09

Note: The distance between the EUT and the phantom bottom is 15mm

**Table 14.2-5: SAR Values (GSM 1900 MHz Band - Body)**

Frequency		Mode (number of timeslots)	Test Position	Figure No.	Conducted Power (dBm)	Max. tune-up Power (dBm)	Measured SAR(10g) (W/kg)	Reported SAR(10g) (W/kg)	Measured SAR(1g) (W/kg)	Reported SAR(1g) (W/kg)	Power Drift (dB)
Ch.	MHz										
810	1909.8	GPRS (2)	Bottom	Fig.5	23.9	24.5	0.511	<b>0.59</b>	0.981	<b>1.13</b>	-0.08

Note: The distance between the EUT and the phantom bottom is 10mm