



HAC T-Coil TEST REPORT

No. I20Z60778-SEM04

For

TCL Communication Ltd.

GSM/UMTS/LTE Mobile phone

Model Name: 5004R, 5004C

With

Hardware Version: 03

Software Version: 6G2KUDK0

FCC ID: 2ACCJH129

Results Summary: T Category = T3

Issued Date: 2020-7-8

Note:

The test results in this test report relate only to the devices specified in this report. This report shall not be reproduced except in full without the written approval of CTTL.

The report must not be used by the client to claim product certification, approval, or endorsement by NVLAP, NIST, or any agency of the U.S. Government.

Test Laboratory:

CTTL, Telecommunication Technology Labs, CAICT

No. 51, Xueyuan Road, Haidian District, Beijing, P. R. China 100191.

Tel:+86(0)10-62304633-2512, Fax:+86(0)10-62304633-2504

Email: ctl_terminals@caict.ac.cn, website: www.caict.ac.cn

**REPORT HISTORY**

Report Number	Revision	Issue Date	Description
I20Z60778-SEM04	Rev.0	2020-7-3	Initial creation of test report
I20Z60778-SEM04	Rev.1	2020-7-8	Update the version of KDB285076 D01 on page 8

TABLE OF CONTENT

1 TEST LABORATORY	5
1.1 TESTING LOCATION	5
1.2 TESTING ENVIRONMENT	5
1.3 PROJECT DATA	5
1.4 SIGNATURE	5
2 CLIENT INFORMATION	6
2.1 APPLICANT INFORMATION	6
2.2 MANUFACTURER INFORMATION	6
3 EQUIPMENT UNDER TEST (EUT) AND ANCILLARY EQUIPMENT (AE)	7
3.1 ABOUT EUT	7
3.2 INTERNAL IDENTIFICATION OF EUT USED DURING THE TEST	7
3.3 INTERNAL IDENTIFICATION OF AE USED DURING THE TEST	7
3.4 AIR INTERFACES / BANDS INDICATING OPERATING MODES	7
4 REFERENCE DOCUMENTS	8
5 OPERATIONAL CONDITIONS DURING TEST	9
5.1 HAC MEASUREMENT SET-UP	9
5.2 AM1D PROBE	10
5.3 AMCC	11
5.4 AMMI	11
5.5 TEST ARCH PHANTOM & PHONE POSITIONER	11
5.6 ROBOTIC SYSTEM SPECIFICATIONS	12
5.7 T-COIL MEASUREMENT POINTS AND REFERENCE PLANE	12
6 T-COIL TEST PROCEDURES	14
7 T-COIL PERFORMANCE REQUIREMENTS	15
7.1 T-COIL COUPLING FIELD INTENSITY	15
7.2 FREQUENCY RESPONSE	15
8 CMRS VOICE DUT CONFIGURATION	17
8.1 GSM CODEC INVESTIGATION	17
8.2 UMTS CODEC INVESTIGATION	17
9 VOLTE TEST SYSTEM SETUP AND DUT CONFIGURATION	18
9.1 TEST SYSTEM SETUP FOR VOLTE OVER IMS T-COIL TESTING	18
9.2 CODEC CONFIGURATION	19
9.3 RADIO CONFIGURATION	19
10 VOWIFI TEST SYSTEM SETUP AND DUT CONFIGURATION	20
10.1 TEST SYSTEM SETUP FOR VOWIFI OVER IMS T-COIL TESTING	20
10.2 CODEC CONFIGURATION	21
10.3 RADIO CONFIGURATION	21
11 OTT VOIP TEST SYSTEM AND DUT CONFIGURATION	23
11.1 TEST SYSTEM SETUP FOR OTT VOIP T-COIL TESTING	23
11.2 CODEC CONFIGURATION	27
11.3 RADIO CONFIGURATION FOR OTT VOIP (LTE)	28
11.4 RADIO CONFIGURATION FOR OTT VOIP (WiFi)	29
12 HAC T-COIL TEST DATA SUMMARY	30
12.1 TEST RESULTS FOR 2/3G	30
12.2 TEST RESULTS FOR LTE	31
12.3 TEST RESULTS FOR WiFi	31
12.4 TEST RESULTS FOR OTT VOIP	32
12.5 TOTAL MEASUREMENT CONCLUSION	34



13 MEASUREMENT UNCERTAINTY 35

14 MAIN TEST INSTRUMENTS 36

ANNEX A TEST LAYOUT 37

ANNEX B TEST PLOTS 38

ANNEX C FREQUENCY REPOSE CURVES 62

ANNEX D PROBE CALIBRATION CERTIFICATE 64

ANNEX E DAE CALIBRATION CERTIFICATE 67

1 Test Laboratory

1.1 Testing Location

Company Name:	CTTL(Shouxiang)
Address:	No. 51 Shouxiang Science Building, Xueyuan Road, Haidian District, Beijing, P. R. China100191

1.2 Testing Environment

Temperature:	18°C~25°C,
Relative humidity:	30%~ 70%
Ground system resistance:	< 0.5 Ω
Ambient noise is checked and found very low and in compliance with requirement of standards. Reflection of surrounding objects is minimized and in compliance with requirement of standards.	

1.3 Project Data

Project Leader:	Qi Dianyuan
Test Engineer:	Lin Hao
Testing Start Date:	June 9, 2020
Testing End Date:	June 24, 2020

1.4 Signature



Lin Xiaojun
(Prepared this test report)

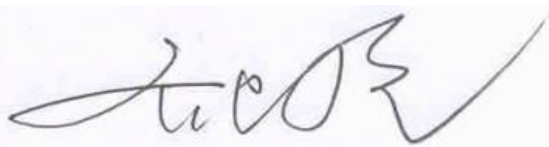

Qi Dianyuan
(Reviewed this test report)



Lu Bingsong
Deputy Director of the laboratory
(Approved this test report)



2 Client Information

2.1 Applicant Information

Company Name:	TCL Communication Ltd.
Address/Post:	5/F, Building 22E, 22 Science Park East Avenue, Hong Kong Science Park, Shatin, NT, Hong Kong
Contact Person:	Gong Zhizhou
Contact Email:	zhizhou.gong@tcl.com
Telephone:	0086-755-36611722
Fax	0086-755-36612000-81722

2.2 Manufacturer Information

Company Name:	TCL Communication Ltd.
Address/Post:	5/F, Building 22E, 22 Science Park East Avenue, Hong Kong Science Park, Shatin, NT, Hong Kong
Contact Person:	Gong Zhizhou
Contact Email:	zhizhou.gong@tcl.com
Telephone:	0086-755-36611722
Fax	0086-755-36612000-81722

3 Equipment Under Test (EUT) and Ancillary Equipment (AE)

3.1 About EUT

Description:	GSM/UMTS/LTE Mobile phone
Model name:	5004R, 5004C
Operating mode(s):	GSM 850/900/1800/1900, UMTS FDD 2/4/5, BT, Wi-Fi, LTE Band 2/4/5/12/14/30/66

3.2 Internal Identification of EUT used during the test

EUT ID*	IMEI	HW Version	SW Version
EUT1	015730000011309	03	6G2KUDK0
EUT2	015730000011481	03	6G2KUDK0

*EUT ID: is used to identify the test sample in the lab internally.

3.3 Internal Identification of AE used during the test

AE ID*	Description	Model	SN	Manufacturer
AE1	Battery	CAC3400011C1	/	BYD

*AE ID: is used to identify the test sample in the lab internally.

3.4 Air Interfaces / Bands Indicating Operating Modes

Air-interface	Band(MHz)	Type	C63.19/tested	Simultaneous Transmission s	Name of Voice Service
GSM	850	VO	Yes	BT, WLAN	CMRS Voice
	1900				
GPRS/EDGE	850	DT	Yes		Google duo
	1900				
WCDMA (UMTS)	850	VO	Yes	BT, WLAN	CMRS Voice
	1700				
	1900	DT	Yes		Google duo
LTE FDD	Band2/5/12/14/30/66	V/D	Yes	BT, WLAN	VoLTE, Google duo
BT	2450	DT	NA	GSM, WCDMA, LTE	NA
WLAN	2450	V/D	Yes	GSM, WCDMA, LTE	VoWiFi, Google duo

NA: Not Applicable VO: Voice Only V/D: CMRS and IP Voice Service over Digital Transport

DT: Digital Transport

* HAC Rating was not based on concurrent voice and data modes, Non current mode was found to represent worst case rating for both M and T rating

Note1 = No Associated T-Coil measurement has been made in accordance with 285076 D02 T-Coil testing for CMRS IP

4 Reference Documents

The following document listed in this section is referred for testing.

Reference	Title	Version
ANSI C63.19-2011	American National Standard for Methods of Measurement of Compatibility between Wireless Communication Devices and Hearing Aids	2011 Edition
KDB285076 D01v05r01	Equipment Authorization Guidance for Hearing Aid Compatibility	2017 Edition
KDB285076 D02v03	Guidance for performing T-Coil tests for air interfaces supporting voice over IP (e.g., LTE and WiFi) to support CMRS based telephone services	2017 Edition

5 OPERATIONAL CONDITIONS DURING TEST

5.1 HAC MEASUREMENT SET-UP

These measurements are performed using the DASY5 NEO automated dosimetric assessment system. It is made by Schmid & Partner Engineering AG (SPEAG) in Zurich, Switzerland. It consists of high precision robotics system (Stäubli), robot controller, Intel Core2 computer, near-field probe, probe alignment sensor. The robot is a six-axis industrial robot performing precise movements. A cell controller system contains the power supply, robot controller, teach pendant (Joystick), and remote control, is used to drive the robot motors. The PC consists of the HP Intel Core2 1.86 GHz computer with Windows XP system and HAC Measurement Software DASY5 NEO, A/D interface card, monitor, mouse, and keyboard. The Stäubli Robot is connected to the cell controller to allow software manipulation of the robot. A data acquisition electronic (DAE) circuit performs the signal amplification, signal multiplexing, AD-conversion, offset measurements, mechanical surface detection, collision detection, etc. is connected to the Electro-optical coupler (EOC). The EOC performs the conversion from the optical into digital electric signal of the DAE and transfers data to the PC plug-in card.

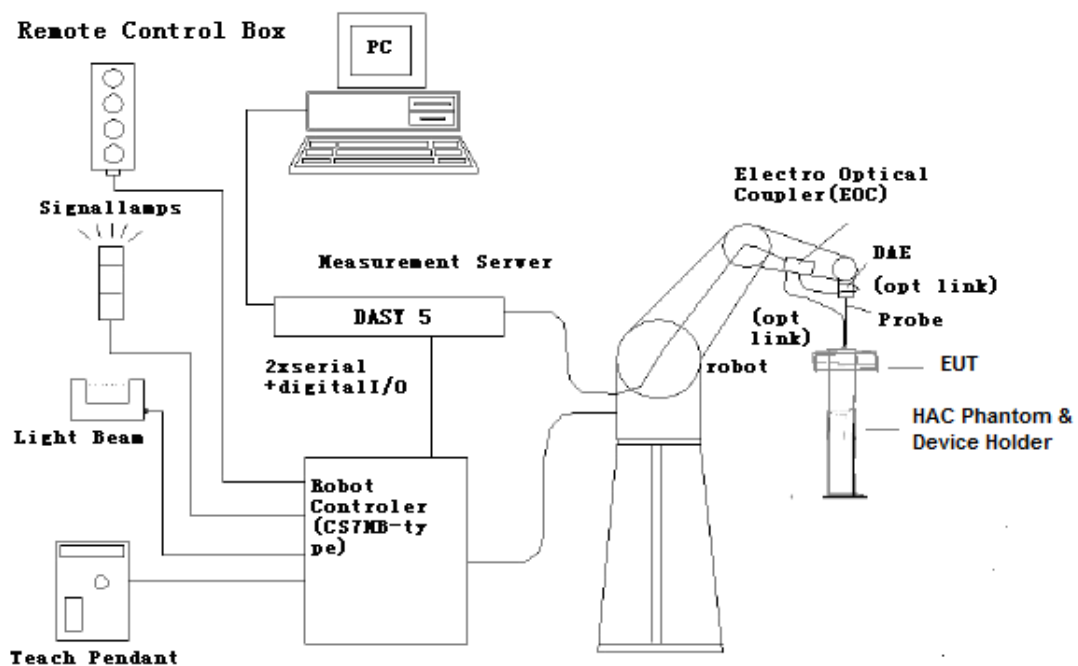

Figure 5.1 HAC Test Measurement Set-up

The DAE4 consists of a highly sensitive electrometer-grade preamplifier with auto-zeroing, a channel and gain-switching multiplexer, a fast 16 bit AD-converter and a command decoder and control logic unit. Transmission to the PC-card is accomplished through an optical downlink for data and status information and an optical uplink for commands and clock lines. The mechanical probe mounting device includes two different sensor systems for frontal and sidewise probe contacts. They are also used for mechanical surface detection and probe collision detection. The robot uses its own controller with a built in VME-bus computer.

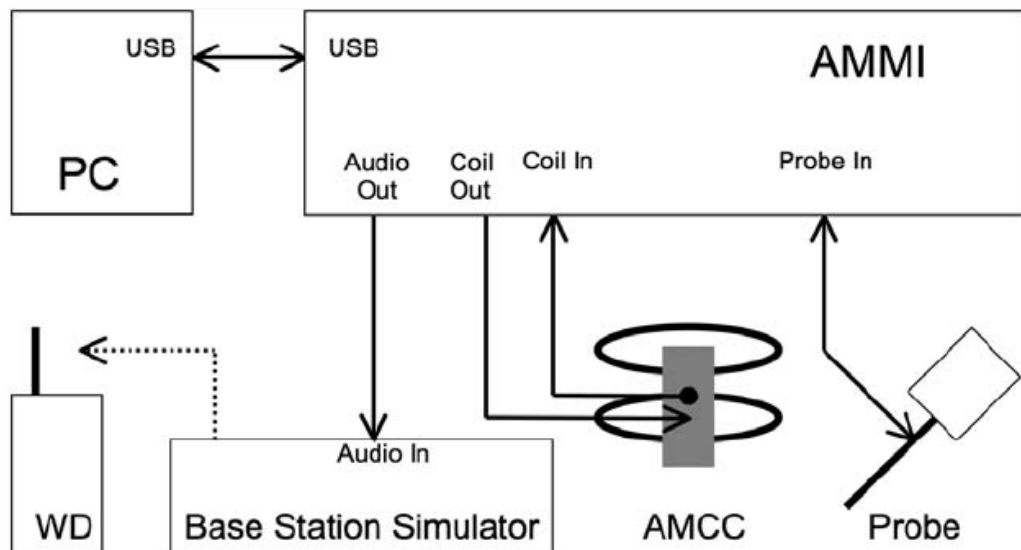

Figure 5.2 T-Coil setup with HAC Test Arch and AMCC

5.2 AM1D probe

The AM1D probe is an active probe with a single sensor. It is fully RF-shielded and has a rounded tip 6mm in diameter incorporating a pickup coil with its center offset 3mm from the tip and the sides. The symmetric signal preamplifier in the probe is fed via the shielded symmetric output cable from the AMMI with a 48V "phantom" voltage supply. The 7-pin connector on the back in the axis of the probe does not carry any signals. It is mounted to the DAE for the correct orientation of the sensor. If the probe axis is tilted 54.7 degree from the vertical, the sensor is approximately vertical when

the signal connector is at the underside of the probe (cable hanging downwards).

Specification:

Frequency range	0.1~20kHz (RF sensitivity < -100dB, fully RF shielded)
Sensitivity	< -50dB A/m @ 1kHz
Pre-amplifier	40dB, symmetric
Dimensions	Tip diameter/length: 6/290mm, sensor according to ANSI-C63.19

5.3 AMCC

The Audio Magnetic Calibration coil is a Helmholtz Coil designed for calibration of the AM1D probe. The two horizontal coils generate a homogeneous magnetic field in the z direction. The DC input resistance is adjusted by a series resistor to approximately 50Ohm, and a shunt resistor of 10Ohm permits monitoring the current with a scale of 1:10

Port description:

Signal	Connector	Resistance
Coil In	BNC	Typically 50Ohm
Coil Monitor	BNO	100ohm±1% (100mV corresponding to 1 A/m)

Specification:

Dimensions	370 x 370 x 196 mm, according to ANSI-C63.19
-------------------	--

5.4 AMMI



Figure 5.3 AMMI front panel

The Audio Magnetic Measuring Instrument (AMMI) is a desktop 19-inch unit containing a sampling unit, a waveform generator for test and calibration signals, and a USB interface.

Specification:

Sampling rate	48 kHz / 24 bit
Dynamic range	85 dB
Test signal generation	User selectable and predefined (vis PC)
Calibration	Auto-calibration / full system calibration using AMCC with monitor output
Dimensions	482 x 65 x 270 mm

5.5 Test Arch Phantom & Phone Positioner

The Test Arch phantom should be positioned horizontally on a stable surface. Reference markings on the Phantom allow the complete setup of all predefined phantom positions and measurement grids by manually teaching three points in the robot. It enables easy and well defined positioning of the phone and validation dipoles as well as simple teaching of the robot (Dimensions: 370 x 370 x 370 mm).

The Phone Positioner supports accurate and reliable positioning of any phone with effect on near

field $< \pm 0.5$ dB.

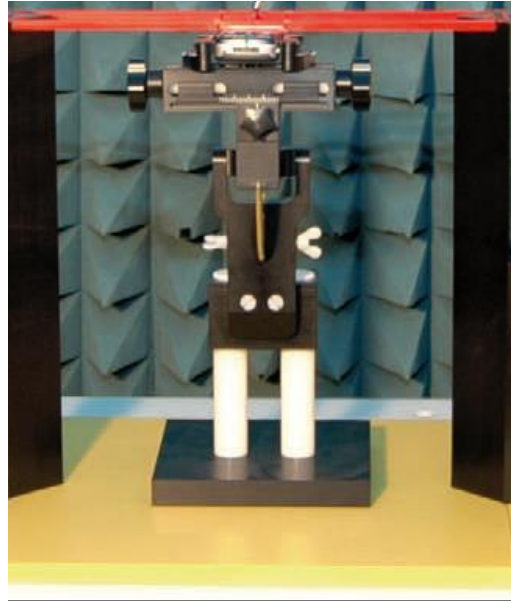

Figure 5.4 HAC Phantom & Device Holder

5.6 Robotic System Specifications

Specifications

Positioner: Stäubli Unimation Corp. Robot Model: RX160L

Repeatability: ± 0.02 mm

No. of Axis: 6

Data Acquisition Electronic (DAE) System

Cell Controller

Processor: Intel Core2

Clock Speed: 1.86GHz

Operating System: Windows XP

Data Converter

Features: Signal Amplifier, multiplexer, A/D converter, and control logic

Software: DASY5 software

Connecting Lines: Optical downlink for data and status info.

Optical uplink for commands and clock

5.7 T-Coil measurement points and reference plane

Figure 6.5 illustrates the standard probe orientations. Position 1 is the perpendicular orientation of the probe coil; orientation 2 is the transverse orientations. The space between the measurement positions is not fixed. It is recommended that a scan of the WD be done for each probe coil orientation and that the maximum level recorded be used as the reading for that orientation of the probe coil.

1) The reference plane is the planar area that contains the highest point in the area of the phone that normally rests against the user's ear. It is parallel to the centerline of the receiver area of the

phone and is defined by the points of the receiver-end of the WD handset, which, in normal handset use, rest against the ear.

- 2) The measurement plane is parallel to, and 10 mm in front of, the reference plane.
- 3) The reference axis is normal to the reference plane and passes through the center of the receiver speaker section (or the center of the hole array); or may be centered on a secondary inductive source. The actual location of the measurement point shall be noted in the test report as the measurement reference point.
- 4) The measurement points may be located where the axial and radial field intensity measurements are optimum with regard to the requirements. However, the measurement points should be near the acoustic output of the WD and shall be located in the same half of the phone as the WD receiver. In a WD handset with a centered receiver and a circularly symmetrical magnetic field, the measurement axis and the reference axis would coincide.
- 5) The relative spacing of each measurement orientation is not fixed. The axial and two radial orientations should be chosen to select the optimal position.
- 6) The measurement point for the axial position is located 10 mm from the reference plane on the measurement axis. The actual location of the measurement point shall be noted in test reports and designated as the measurement reference point.

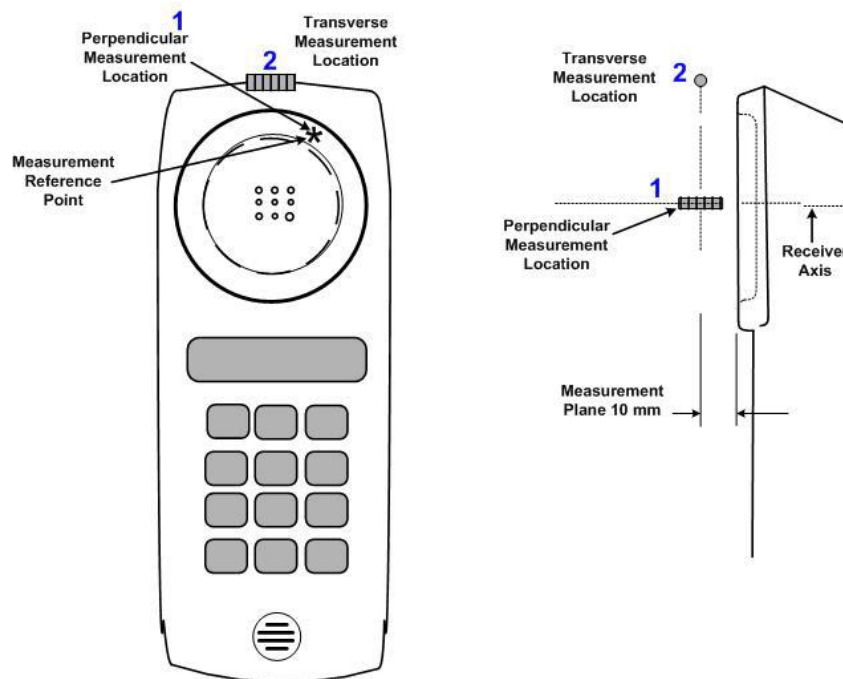

Figure 5.5 Axis and planes for WD audio frequency magnetic field measurements

6 T-Coil TEST PROCEDURES

The following illustrate a typical test scan over a wireless communications device:

- 1) Geometry and signal check: system probe alignment, proper operation of the field probe, probe measurement system, other instrumentation, and the positioning system was confirmed. A surface calibration was performed before each setup change to ensure repeatable spacing and proper maintenance of the measurement plane using the test Arch.
- 2) Set the reference drive level of signal voice defined in C63.19 per 7.4.2.1.
- 3) The ambient and test system background noise (dB A/m) was measured as well as ABM2 over the full measurement. The maximum noise level must be at least 10dB below the limit.
- 4) The DUT was positioned in its intended test position, acoustic output point of the device perpendicular to the field probe.
- 5) The DUT operation for maximum rated RF output power was configured and connected by using of coaxial cable connection to the base station simulator at the test channel and other normal operating parameters as intended for the test. The battery was ensured to be fully charged before each test. The center sub-grid was centered over the center of the acoustic output (also audio band magnetic output, if applicable). The DUT audio output was positioned tangent (as physically possible) to the measurement plane.
- 6) The DUT's RF emission field was eliminated from T-coil results by using a well RF-shielding of the probe, AM1D, and by using of coaxial cable connection to a Base Station Simulator. One test channel was pre-measurement to avoid this possibility.
- 7) Determined the optimal measurement locations for the DUT by following the three steps, coarse resolution scan, fine resolution scans, and point measurement, as described in C63.19 per 7.4.4.2. At each measurement locations, samples in the measurement window duration were evaluated to get ABM1 and the signal spectrum. The noise measurement was performed after the scan with the signal, the same happened, just with the voice signal switched off. The ABM2 was calculated from this second scan.
- 8) All results resulting from a measurement point in a T-Coil job were calculated from the signal samples during this window interval. ABM values were averaged over the sequence of these samples.
- 9) At an optimal point measurement, the SNR (ABM1/ABM2) was calculated for perpendicular and transverse orientation, and the frequency response was measured for perpendicular.
- 10) Corrected for the frequency response after the DUT measurement since the DASY5 system had known the spectrum of the input signal by using a reference job.
- 11) In SEMCAD postprocessing, the spectral points are in addition scaled with the high-pass (half-band) and the A-weighting, bandwidth compensated factor (BWC) and those results are final as shown in this report.

7 T-Coil PERFORMANCE REQUIREMENTS

In order to be rated for T-Coil use, a WD shall meet the requirements for signal level and signal quality contained in this part.

7.1 T-Coil coupling field intensity

When measured as specified in ANSI C63.19, the T-Coil signal shall be ≥ -18 dB (A/m) at 1 kHz, in a 1/3 octave band filter for all orientations.

7.2 Frequency response

The frequency response of the axial component of the magnetic field, measured in 1/3 octave bands, shall follow the response curve specified in this sub-clause, over the frequency range 300 Hz to 3000 Hz. Figure 7.1 and Figure 7.2 provide the boundaries for the specified frequency. These response curves are for true field strength measurements of the T-Coil signal. Thus the 6 dB/octave probe response has been corrected from the raw readings.

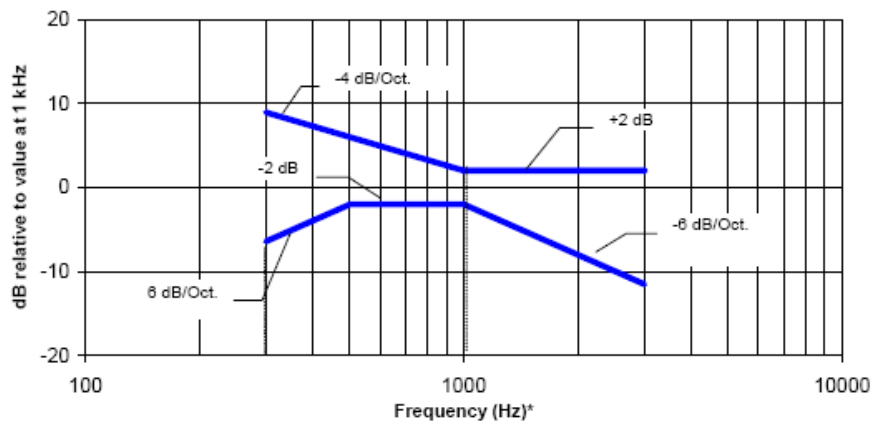

NOTE—Frequency response is between 300 Hz and 3000 Hz.

Figure 7.1—Magnetic field frequency response for WDs with a field ≤ -15 dB (A/m) at 1 kHz

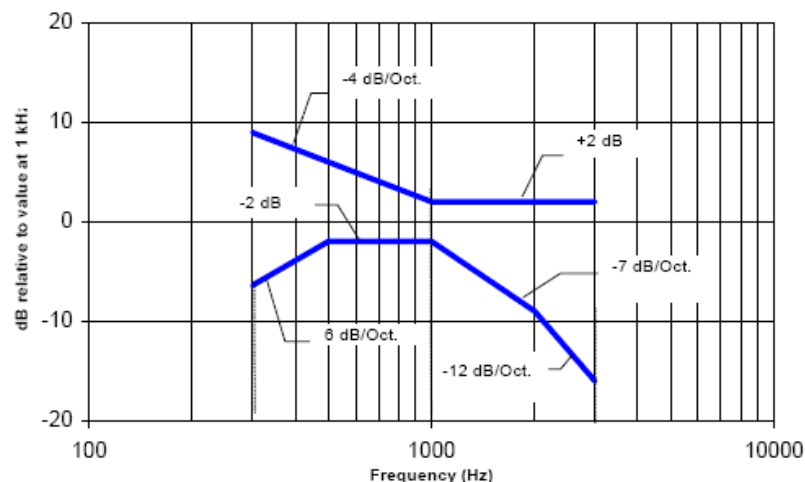

NOTE—Frequency response is between 300 Hz and 3000 Hz.

Figure 7.2—Magnetic field frequency response for WDs with a field that exceeds -15 dB (A/m) at 1 kHz

7.3 Signal quality

This part provides the signal quality requirement for the intended T-Coil signal from a WD. Only the RF immunity of the hearing aid is measured in T-Coil mode. It is assumed that a hearing aid can have no immunity to an interference signal in the audio band, which is the intended reception band for this mode. So, the only criteria that can be measured is the RF immunity in T-Coil mode. This is measured using the same procedure as for the audio coupling mode and at the same levels.

The worst signal quality of the three T-Coil signal measurements shall be used to determine the T-Coil mode category per Table 1

Table 1:T-Coil signal quality categories

Category	Telephone parameters WD signal quality [(signal + noise) – to – noise ratio in decibels]
Category T1	0 dB to 10 dB
Category T2	10 dB to 20 dB
Category T3	20 dB to 30 dB
Category T4	> 30 dB

8 CMRS Voice DUT CONFIGURATION

8.1 GSM Codec Investigation

The middle channel of each frequency band is used for T-coil testing according ANSI C63.19-2011. Choose worst case from radio configuration investigation. After investigation was performed to determine the audio codec configuration to be used for testing, the following tests results which the worst case codec would be remarked to be used for the testing for the DUT. According to C63 and KDB 285076 D02v03, GSM input level is -16dBm0.

Table 8-1 GSM CMRS Codec Investigation

Codec Setting	FR VR	HR V1	EFR	Orientation	Band	Channel
ABM1 (dBA/m)	14.38	13.27	14.1	Z(axial)	GSM1900	661
Frequency Response	PASS	PASS	PASS			
SNR (dB)	31.82	32.16	31.97			

8.2 UMTS Codec Investigation

The middle channel of each frequency band is used for T-coil testing according ANSI C63.19-2011. Choose worst case from radio configuration investigation. After investigation was performed to determine the audio codec configuration to be used for testing, the following tests results which the worst case codec would be remarked to be used for the testing for the DUT. According to C63 and KDB 285076 D02v03, UMTS input level is -16dBm0.

Table 8-2 WCDMA/UMTS CMRS Codec Investigation

Codec Setting	AMR 12.2kbps	AMR 7.95kbps	AMR 4.75kbps	Orientation	Band	Channel
ABM1 (dBA/m)	12.87	14.05	13.74	Z(axial)	WCDMA 1900	9400
Frequency Response	PASS	PASS	PASS			
SNR (dB)	42.31	41.20	41.36			

9 VoLTE TEST SYSTEM SETUP AND DUT CONFIGURATION

9.1 Test System Setup for VoLTE over IMS T-coil Testing

The general test setup used for VoLTE over IMS is shown below. The callbox used when performing VoLTE over IMS T-coil measurements is a CMW500. The Data Application Unit (DAU) of the CMW500 was used to simulate the IP Multimedia Subsystem (IMS) server. According to C63 and KDB 285076 D02v03, VoLTE input level is -20dBm0.

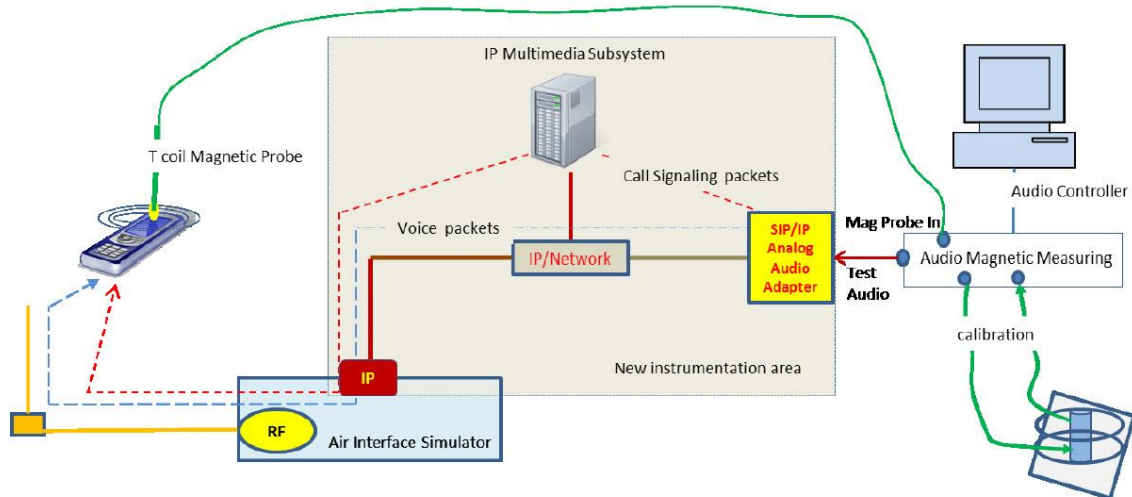

Figure 9.1 Test Setup for VoLTE over IMS T-coil Measurements

No correction gain factors were measured for VoLTE due to the Rohde & Schwarz CMW500, hosting a calibrated audio board. The gains used to measure VoLTE are set to 100.

The following software/firmware was used to simulate the VoLTE server for testing:

Firmware	License Keys	Software Name
V3.7.50 for LTE	KS500	LTE FDD R8 SIG BASIC
	KS550	LTE TDD R8 SIG BASIC
	KA100	IP APPL ENABLING IPv4
	KA150	IP APPL ENABLING IPv6
V3.7.20 for Audio	KAA20	IP APPL IMS BASIC
	KM050	DATA APPL MEAS
	KS104	EVS SPEECH CODEC

9.2 Codec Configuration

An investigation was performed to determine the audio codec configuration to be used for testing. NB AMR 12.2kbps setting was used for the audio codec on the CMW500 for VoLTE over IMS T-coil testing. See below table for comparisons between different codecs and codec data rates:

Table 9-1 AMR Codec Investigation – VoLTE over IMS

Codec Setting	WB AMR 23.85kbps	WB AMR 6.60kbps	NB AMR 12.2kbps	NB AMR 4.75kbps	Orientation	Band/BW	Channel
ABM1 (dBA/m)	15.89	15.21	15.23	14.73	Z(axial)	B2/20M	18900
Frequency Response	PASS	PASS	PASS	PASS			
SNR (dB)	37.03	37.14	36.74	36.91			

Table 9-2 EVS Codec Investigation – VoLTE over IMS

Codec Setting	EVS Primary WB 13.2kbps	EVS Primary WB 5.9kbps	EVS Primary NB 13.2kbps	EVS Primary NB 5.9kbps	Orientation	Band /BW	Channel
ABM1 (dBA/m)	14.36	15.18	15.83	14.93	Z(axial)	B2/20M	18900
Frequency Response	PASS	PASS	PASS	PASS			
SNR (dB)	37.41	37.86	37.49	37.88			

9.3 Radio Configuration

An investigation was performed to determine the modulation, the bandwidth configuration and RB configuration to be used for testing. 20MHz BW, 16QAM, 1RB, 50RB offset was used for the testing as the worst-case configuration for the handset. See below table for comparisons between different radio configurations:

Table 9-3 VoLTE over IMS SNR by Radio Configuration

Band	Channel	Bandwidth [MHz]	Modulation	RB Size	RB Offset	ABM1 [dB(A/m)]	SNR [dB]
LTE B2	18900	20	QPSK	1	0	13.34	37.28
LTE B2	18900	20	QPSK	1	50	15.23	36.74
LTE B2	18900	20	QPSK	1	99	14.59	37.35
LTE B2	18900	20	QPSK	50	0	15.74	38.51
LTE B2	18900	20	QPSK	50	25	13.42	38.12
LTE B2	18900	20	QPSK	50	50	15.74	37.84
LTE B2	18900	20	QPSK	100	0	14.83	37.16
LTE B2	18900	20	16QAM	1	50	14.58	36.64
LTE B2	18900	20	64QAM	1	50	15.21	37.81
LTE B2	18900	15	16QAM	1	50	14.64	39.16
LTE B2	18900	10	16QAM	1	50	15.36	38.75
LTE B2	18900	5	16QAM	1	50	15.26	38.81
LTE B2	18900	3	16QAM	1	50	15.74	39.22
LTE B2	18900	1.4	16QAM	1	50	15.41	38.93

10 VoWiFi TEST SYSTEM SETUP AND DUT CONFIGURATION

10.1 Test System Setup for VoWiFi over IMS T-coil Testing

Note1: the yellow highlight section has been approved for reuse.

General Note2:

Regards the protocols, the highlighting section of the test set up, reference levels used, will be re-used in future.

The general test setup used for VoWiFi over IMS, or CMRS WiFi Calling, is shown below. The callbox used when performing VoWiFi over IMS T-coil measurements is a CMW500. The Data Application Unit (DAU) of the CMW500 was used to simulate the IP Multimedia Subsystem (IMS) server. According to C63 and KDB 285076 D02v03, VoWiFi input level is -20dBm0.

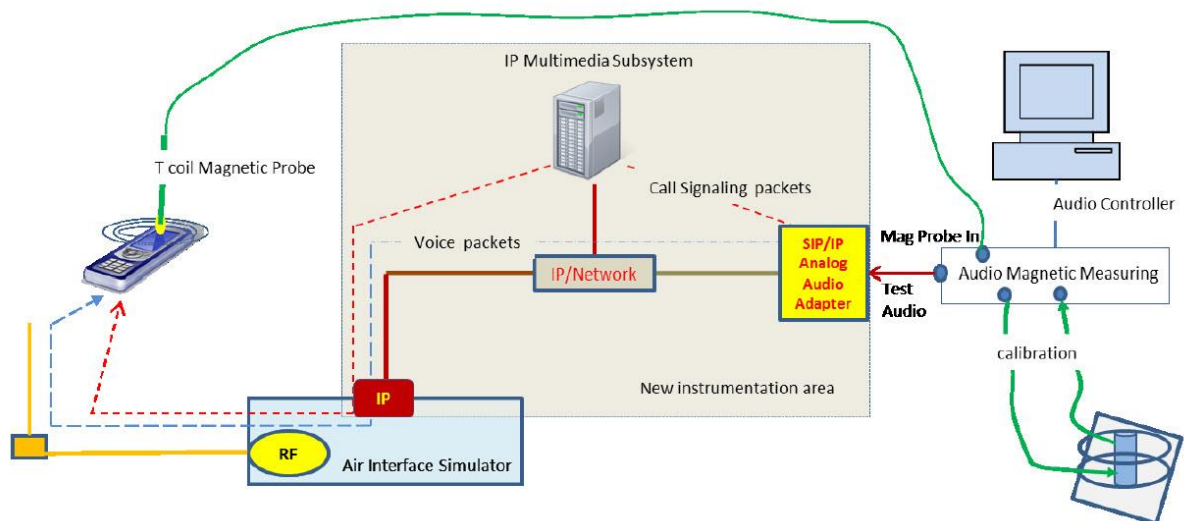

Figure 10.1 Test Setup for VoWiFi over IMS T-coil Measurements

No correction gain factors were measured for VoWiFi due to the Rohde & Schwarz CMW500, hosting a calibrated audio board. The gains used to measure VoWiFi are set to 100.

Firmware	License Keys	Software Name
V3.7.40 for WLAN	KS650	WLAN A/B/G SIG BASIC
	KS651	WLAN N SIG BASIC
	KA100	IP APPL ENABLING IPv4
	KA150	IP APPL ENABLING IPv6
V3.7.20 for Audio	KAA20	IP APPL IMS BASIC
	KM050	DATA APPL MEAS
	KS104	EVS SPEECH CODEC

10.2 Codec Configuration

An investigation was performed to determine the audio codec configuration to be used for testing. The WB AMR 23.85kbps setting was used for the audio codec on the CMW500 for VoWiFi over IMS T-coil testing. See below table for comparisons between different codecs and codec data rates:

Table 10-1 AMR Codec Investigation – VoWiFi over IMS

Codec Setting	WB AMR 23.85kbps	WB AMR 6.60kbps	NB AMR 12.2kbps	NB AMR 4.75kbps	Orientation	Band/BW	Channel
ABM1 (dBA/m)	16.53	16.37	16.13	16.24	Z(axial)	2.4GHz 802.11b	6
Frequency Response	PASS	PASS	PASS	PASS			
SNR (dB)	56.09	56.75	57.64	57.13			

Table 10-2 EVS Codec Investigation – VoWiFi over IMS

Codec Setting	EVS Primary WB 13.2kbps	EVS Primary WB 5.9kbps	EVS Primary NB 13.2kbps	EVS Primary NB 5.9kbps	Orientation	Band /BW	Channel
ABM1 (dBA/m)	16.5	14.55	15.72	15.99	Z(axial)	2.4GHz 802.11b	6
Frequency Response	PASS	PASS	PASS	PASS			
SNR (dB)	56.39	56.78	57.44	57.36			

10.3 Radio Configuration

An investigation was performed on all applicable data rates and modulations to determine the radio configuration to be used for testing. See below table for comparisons between different radio configurations in each 802.11 standard:

Table 10-3 802.11b SNR by Radio Configuration

Mode	Channel	Modulation	Data Rate [Mbps]	ABM1 [dB(A/m)]	SNR [dB]
802.11b	6	DSSS	1	16.53	56.09
802.11b	6	DSSS	2	15.79	56.2
802.11b	6	CCK	5.5	14.77	56.61
802.11b	6	CCK	11	15.22	57.54

Table 10-4 802.11g SNR by Radio Configuration

Mode	Channel	Modulation	Data Rate [Mbps]	ABM1 [dB(A/m)]	SNR [dB]
802.11g	6	BPSK	6	11.97	44.21
802.11g	6	BPSK	9	11.71	44.29
802.11g	6	QPSK	12	13.74	45.41
802.11g	6	QPSK	18	12.75	45.78
802.11g	6	16-QAM	24	14.16	44.8
802.11g	6	16-QAM	36	13.22	44.87
802.11g	6	64-QAM	48	13.78	45.95
802.11g	6	64-QAM	54	11.84	44.43

Table 10-5 802.11n 20MHz BW SNR by Radio Configuration

Mode	Bandwidth [MHz]	Channel	Modulation	Data Rate [Mbps]	ABM1 [dB(A/m)]	SNR [dB]
802.11n	20	6	BPSK	6.5	15.47	50.27
802.11n	20	6	QPSK	13	15.33	51.3
802.11n	20	6	QPSK	19.5	15.91	49.48
802.11n	20	6	16-QAM	26	14.84	50.36
802.11n	20	6	16-QAM	39	15.37	51.06
802.11n	20	6	64-QAM	52	15.34	50.91
802.11n	20	6	64-QAM	58.5	14.34	50.7
802.11n	20	6	64-QAM	65	13.74	49.66

Table 10-6 802.11n 40MHz BW SNR by Radio Configuration

Mode	Bandwidth [MHz]	Channel	Modulation	Data Rate [Mbps]	ABM1 [dB(A/m)]	SNR [dB]
802.11n	40	6	BPSK	13.5	16.35	56.37
802.11n	40	6	QPSK	27	14.51	56.41
802.11n	40	6	QPSK	40.5	16.28	56.52
802.11n	40	6	16-QAM	54	13.16	57.17
802.11n	40	6	16-QAM	81	15.17	56.81
802.11n	40	6	64-QAM	108	13.69	56.81
802.11n	40	6	64-QAM	121.5	14.26	57.13
802.11n	40	6	64-QAM	135	13.16	56.83

11 OTT VoIP TEST SYSTEM AND DUT CONFIGURATION

11.1 Test System Setup for OTT VoIP T-coil Testing

Note1: the yellow highlight section has been approved for reuse.

General Note2:

Regards the protocols, Google Duo, the highlighting section of the test set up, reference levels used, codec(s) and the fact that an investigation was done to determine the worst-case codec/rate documented in the test results below, will be re-used in future.

OTT VoIP Application

Google Duo is a pre-installed application on the DUT which allows for VoIP calls in a head-to-ear scenario. Duo uses the OPUS audio codec and supports a bitrate range of 6kbps to 75kbps. All air interfaces capable of a data connection were evaluated with Google Duo. When HAC testing we are using the Google Duo version is 26.0.179825522.alpha.DEV and the bitrate configuration can find at settings → Voice call parameters settings → Audio codec bitrate(6-75kbps).

Test Procedure and Equipment Setup

The test procedure for OTT testing is identical to the section above, except for how the signal is sent to the DUT, as outlined in the diagram below.

The AMMI is connected to the support device's Mic via Audio Data Line. The support device is connected to the Internet via Wi-Fi and the DUT is connected to the mobile base station via the technology under test. Using the DUT's OTT application, a VoIP call is established with the support device. The test signal is sent from the DASY PC to the AMMI, from the AMMI to the support device, and finally to the DUT. To exercise the license antenna, the DUT was simultaneously connected to an external AP and to a mobile base station.

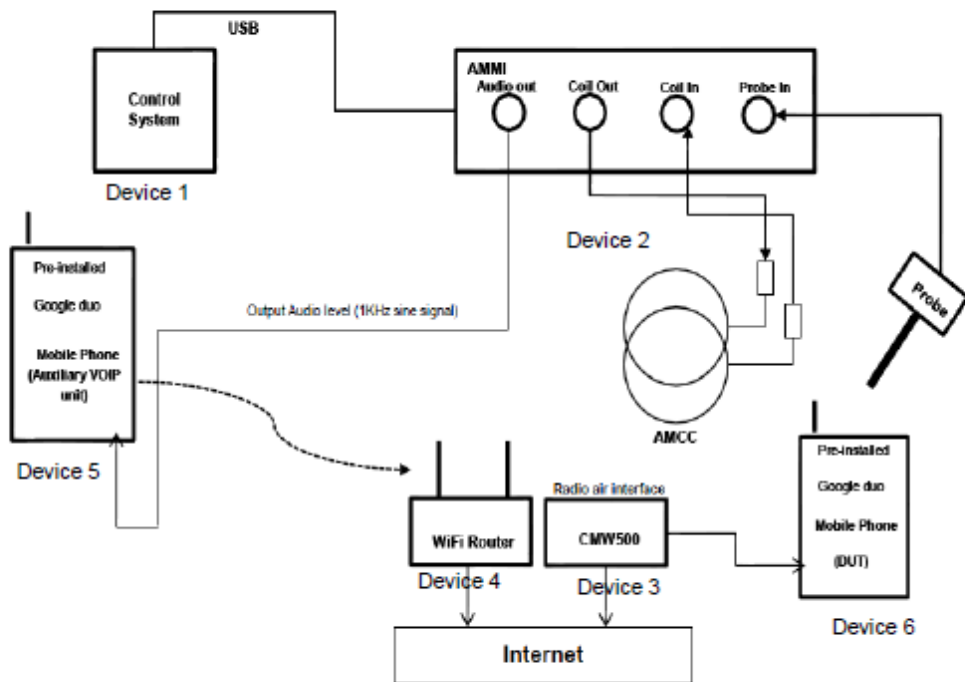

Device 1 :

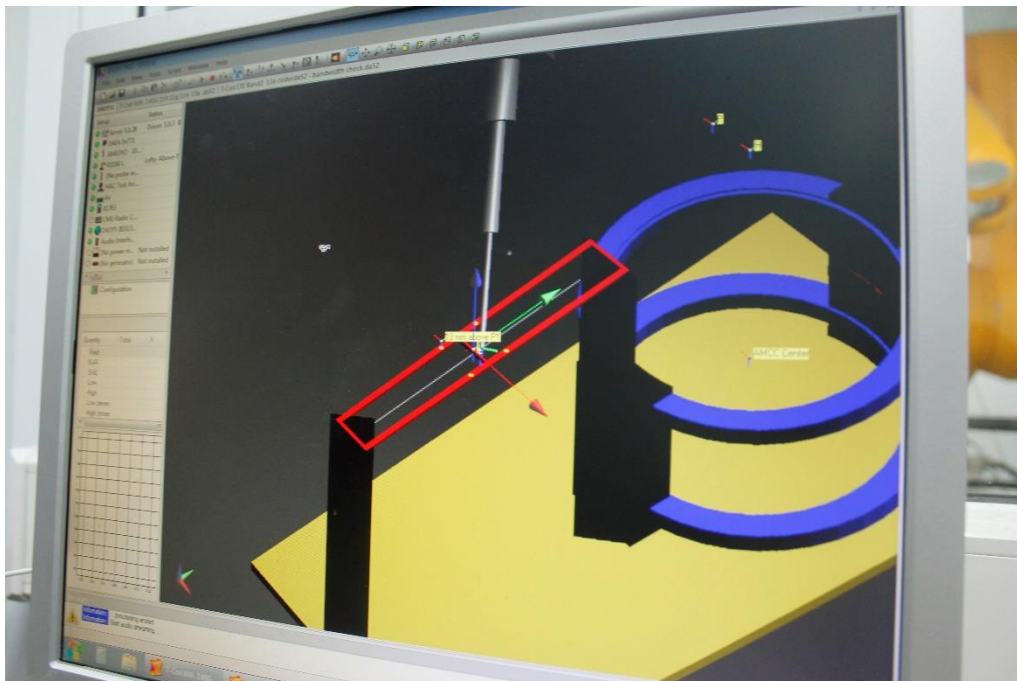

Device2:

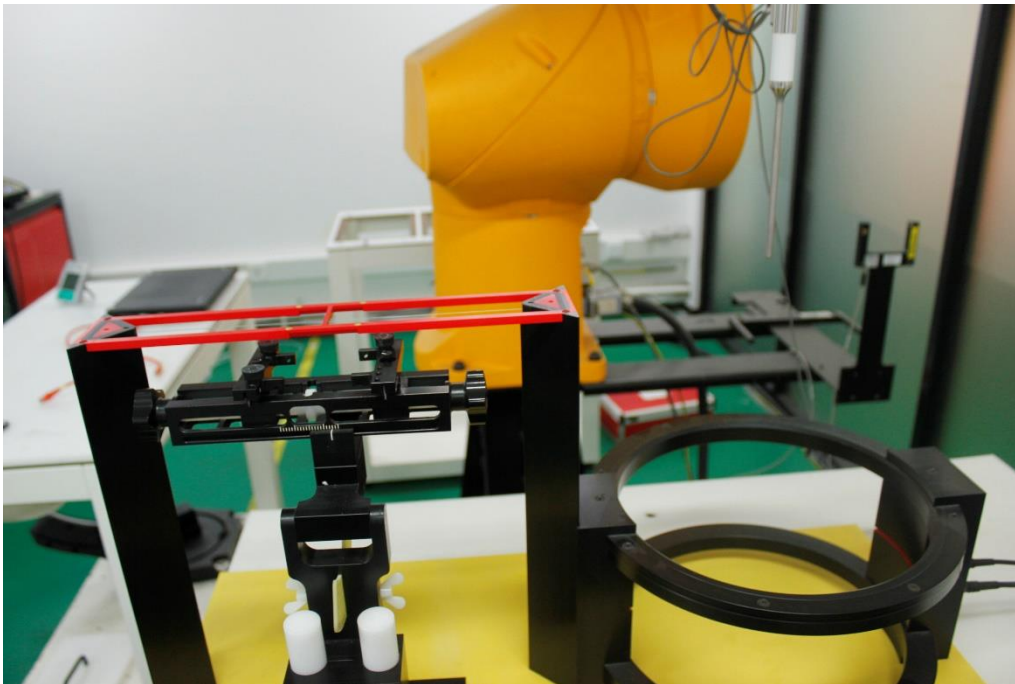

Device3:



Device4:

Device5: The auxiliary device is pre-installed with a test version of Google duo app, The test version app can control the configurations of audio codec bitrate

Device6: The photo of DUT are presented in the additional document: Appendix to test report No.I20Z60778-SEM03/04 The photos of HAC test

Audio Level Settings

According to KDB 285076 D02, the average speech level of -20dBm0 shall be used for protocols not specifically listed in Table 7.1 of ANSI C63.19-2011.

Determine Input Audio level is based on the Added additional dBFS level readout by Google Duo customize application and three steps need to do.

1. Input a gain value to readout the -23dBFS level as reference. (0dBFS = 3.14 dBm0)
2. Adjust gain level to readout the dBFS level until it changes to -24dBFS.
3. Based on the step 1 and 2, and then calculate the gain value(dB) by interpolation to get the -20dBm0 corresponding gain value.

Codec Bit-rate Investigation

An investigation between the various bit-rate configurations (Low/Mid/High bit rates for Narrowband, Wideband, and EVS) are documented (ABM, SNNR, frequency response) to determine the worst case bit-rate for each voice service type. The tables below compare the varying bit-rate configurations

Air Interface Investigation

Using the worst-case bit-rate and Radio Configuration found in §11.2/11.3/11.4, a limited set of bands/channel/ bandwidths were then tested to confirm that there is no effect to the T-rating when changing the band/channel/bandwidth, it is necessary to report only a set band/channel/bandwidth for each orientation for a voice service/air interface.

11.2 Codec Configuration

An investigation was performed for each applicable data mode to determine the audio codec configuration to be used for testing. The 6kbps codec setting was used for the audio codec on the auxiliary VoIP unit for OTT VoIP T-coil testing. See below tables for comparisons between codec data rates on all applicable data modes:

Table 11-1 Codec Investigation – OTT over EDGE

Codec Setting	64kbps	6kbps	Orientation	Channel
ABM1 (dBA/m)	2.06	1.98	Z(axial)	661
Frequency Response	Pass	Pass		
SNR (dB)	31.53	30.64		

Table 11-2 Codec Investigation – OTT over HSPA

Codec Setting	64kbps	6kbps	Orientation	Channel
ABM1 (dBA/m)	4.17	3.29	Z(axial)	9400
Frequency Response	Pass	Pass		
SNR (dB)	35.12	34.65		

Table 11-3 Codec Investigation – OTT over LTE

Codec Setting	64kbps	6kbps	Orientation	Band/BW	Channel
ABM1 (dBA/m)	-2.06	-1.60	Z(axial)	B2/20M	18900
Frequency Response	Pass	Pass			
SNR (dB)	44.32	44.10			

Table 11-4 Codec Investigation – OTT over WiFi

Codec Setting	64kbps	6kbps	Orientation	Band/BW	Channel
ABM1 (dBA/m)	-7.43	-8.51	Z(axial)	2.4GHz 802.11b	6
Frequency Response	Pass	Pass			
SNR (dB)	32.07	31.26			

11.3 Radio Configuration for OTT VoIP (LTE)

An investigation was performed to determine the modulation and RB configuration to be used for testing. 20MHz BW, QPSK, 1RB, 50RB offset was used for the testing as the worst-case configuration for the handset. See below table for comparisons between different radio configurations:

Table 11-5 OTT VoIP (LTE) SNR by Radio Configuration

Band	Channel	Bandwidth [MHz]	Modulation	RB Size	RB Offset	ABM1 [dB(A/m)]	SNR [dB]
LTE B2	18900	20	QPSK	1	0	-1.75	45.11
LTE B2	18900	20	QPSK	1	50	-1.60	44.10
LTE B2	18900	20	QPSK	1	99	-2.02	45.06
LTE B2	18900	20	QPSK	50	0	-1.33	44.46
LTE B2	18900	20	QPSK	50	25	-2.46	45.04
LTE B2	18900	20	QPSK	50	50	-0.75	45.72
LTE B2	18900	20	QPSK	100	0	-2.22	45.89
LTE B2	18900	20	16QAM	1	50	-1.26	44.8
LTE B2	18900	20	64QAM	1	50	-0.66	45.99
LTE B2	18900	15	QPSK	1	50	-0.11	45.51
LTE B2	18900	10	QPSK	1	50	-2.11	44.39
LTE B2	18900	5	QPSK	1	50	-0.98	45.26
LTE B2	18900	3	QPSK	1	50	-0.43	45.77
LTE B2	18900	1.4	QPSK	1	50	-0.26	46.05

An investigation was performed to determine the worst-case LTE band to be used for OTT VoIP testing. LTE Band 2 of FDD was used for the testing as the worst-case configuration for the handset. See below table for comparisons between different LTE bands:

Table 11-6 OTT VoIP (LTE) SNR by LTE bands

Band	Channel	Bandwidth [MHz]	Modulation	RB Size	RB Offset	ABM1 [dB(A/m)]	SNR [dB]
LTE B2	18900	20	QPSK	1	50	-1.60	44.10
LTE B5	20525	10	QPSK	1	50	-1.83	45.86
LTE B12	23095	20	QPSK	1	50	-2.33	45.18
LTE B14	23330	10	QPSK	1	50	-1.25	46.02
LTE B30	27710	20	QPSK	1	50	-2.04	44.75
LTE B66	132322	20	QPSK	1	50	-1.28	45.83

11.4 Radio Configuration for OTT VoIP (WiFi)

An investigation was performed on all applicable data rates and modulations to determine the radio configuration to be used for testing. See below tables for comparisons between different radio configurations in each 802.11 standard:

Table 11-7 802.11b SNR by Radio Configuration

Mode	Channel	Modulation	Data Rate [Mbps]	ABM1 [dB(A/m)]	SNR [dB]
802.11b	6	DSSS	1	-8.51	31.26
802.11b	6	DSSS	2	-9.34	31.15
802.11b	6	CCK	5.5	-8.31	32.14
802.11b	6	CCK	11	-7.92	32.08

Table 11-8 802.11g/a SNR by Radio Configuration

Mode	Channel	Modulation	Data Rate [Mbps]	ABM1 [dB(A/m)]	SNR [dB]
802.11g	6	BPSK	6	-9.63	33.17
802.11g	6	BPSK	9	-9.29	32.67
802.11g	6	QPSK	12	-8.09	32.80
802.11g	6	QPSK	18	-9.9	33.78
802.11g	6	16-QAM	24	-8.88	32.96
802.11g	6	16-QAM	36	-9.55	33.47
802.11g	6	64-QAM	48	-8.98	32.96
802.11g	6	64-QAM	54	-8.81	34.12

Table 11-9 802.11n 20MHz BW SNR by Radio Configuration

Mode	Bandwidth [MHz]	Channel	Modulation	Data Rate [Mbps]	ABM1 [dB(A/m)]	SNR [dB]
802.11n	20	6	BPSK	6.5	-8.41	31.94
802.11n	20	6	QPSK	13	-8.64	32.55
802.11n	20	6	QPSK	19.5	-9.37	33.19
802.11n	20	6	16-QAM	26	-9.09	32.59
802.11n	20	6	16-QAM	39	-8.73	34.17
802.11n	20	6	64-QAM	52	-9.91	33.61
802.11n	20	6	64-QAM	58.5	-8.02	32.43
802.11n	20	6	64-QAM	65	-8.22	33.09
802.11n	20	6	256-QAM	78	-8.05	33.99

Table 11-10 802.11n 40MHz BW SNR by Radio Configuration

Mode	Bandwidth [MHz]	Channel	Modulation	Data Rate [Mbps]	ABM1 [dB(A/m)]	SNR [dB]
802.11n	40	6	BPSK	13.5	-9.92	33.38
802.11n	40	6	QPSK	27	-9.79	34.58
802.11n	40	6	QPSK	40.5	-9.51	32.51
802.11n	40	6	16-QAM	54	-9.74	33.82
802.11n	40	6	16-QAM	81	-9.16	34.31
802.11n	40	6	64-QAM	108	-8.82	34.63
802.11n	40	6	64-QAM	121.5	-8.32	33.04
802.11n	40	6	64-QAM	135	-8.10	34.71

12 HAC T-Coil TEST DATA SUMMARY

12.1 Test Results for 2/3G

Table 12-1 Test results for 2/3G

Probe Position	Band	Ch.	Measurement Position (x mm, y mm)	ABM1 (dB A/m)	SNR (dB)	T category
transverse	GSM 850	190	10.4,0	4.61	29.57	T3
	GSM 1900	661	9.2,0	7.22	37.02	T4
	WCDMA850	4182	7.9,0.4	6.89	52.28	T4
	WCDMA1900	9400	8.3,0.4	7.24	51.99	T4
	WCDMA1700	1412	7.9,0.4	6.51	51.33	T4
perpendicular	GSM 850	190	8.8,-6.7	10.92	28.85	T3
	GSM 1900	661	8.8,-7.5	14.38	31.82	T4
	WCDMA850	4182	9.6,-7.9	15.26	44.73	T4
	WCDMA1900	9400	8.3,-7.9	14.05	41.20	T4
	WCDMA1700	1412	11.3,-7.9	15.81	43.34	T4

Note:

1. Bluetooth and WiFi function is turn off and microphone is muted.
2. Signal strength measurement scan plots are presented in Annex B.
3. The volume is adjusted to maximum level during T-Coil testing.

12.2 Test Results for LTE

Table 12-2 Test results for LTE

Probe Position	Band	Ch.	Bandwidth	Measurement Position (x mm, y mm)	ABM1 (dB A/m)	SNR (dB)	Category T ?
Transverse y	LTE B2	18900	20M	7.9,0.4	5.18	44.65	T4
	LTE B5	20525	10M	7.9,0	5.14	48.00	T4
	LTE B12	23095	10M	7.9,0	4.73	46.06	T4
	LTE B14	23330	10M	7.9,0	5.66	46.08	T4
	LTE B30	27710	10M	7.9,0	5.66	47.56	T4
	LTE B66	132322	20M	7.9,0	5.89	47.66	T4
Perpendicular z	LTE B2	18900	20M	9.6,-7.1	14.58	36.64	T4
	LTE B5	20525	10M	10.8,-7.5	14.96	39.08	T4
	LTE B12	23095	10M	10.8,-7.1	14.97	37.73	T4
	LTE B14	23330	10M	10.8,-7.5	14.77	38.42	T4
	LTE B30	27710	10M	11.3,-7.9	15.53	36.74	T4
	LTE B66	132322	20M	11.3,-7.5	15.66	37.38	T4

Note:

1. Bluetooth and WiFi function is turn off and microphone is muted.
2. The worse case of each band for signal strength measurement scan plots are presented in Annex B.
3. The volume is adjusted to maximum level during T-Coil testing.

12.3 Test Results for WiFi

Table 12-3 Test results for WiFi

Probe Position	Mode	Ch.	Bandwidth	Measurement Position (x mm, y mm)	ABM1 (dB A/m)	SNR (dB)	Category T ?
Transverse y	802.11b	6	20M	9.6,-15	6.38	52.6	T4
	802.11g	6	20M	8.8,0.8	6.0	51.3	T4
	802.11n	6	20M	9.6,0.8	6.82	50.95	T4
	802.11n	6	40M	12.5,-15.8	6.63	54.23	T4
Perpendicular z	802.11b	6	20M	13.8,-4.6	16.53	56.09	T4
	802.11g	6	20M	8.8,-7.9	11.97	44.21	T4
	802.11n	6	20M	12.5,-4.2	15.91	49.48	T4
	802.11n	6	40M	14.2,-5.8	16.35	56.37	T4

Note:

1. Bluetooth and WiFi function is turn off and microphone is muted.
2. The worse case of each mode for signal strength measurement scan plots are presented in Annex B.
3. The volume is adjusted to maximum level during T-Coil testing.

12.4 Test Results for OTT VoIP

Table 12-4 Test results for 2/3G

Probe Position	Band	Ch.	Measurement Position (x mm, y mm)	ABM1 (dB A/m)	SNR (dB)	Category T ?
Transverse y	EDGE850	190	6.8,0.6	0.51	37.53	T4
	EDGE1900	661	7.9,0	0.35	36.34	T4
	W850	4407	6.4,2.9	-1.19	41.28	T4
	W1900	9800	5,3.7	-2.03	42.02	T4
	W1700	1637	4,2.3	-2.13	43.16	T4
Perpendicular z	EDGE850	190	0.4,-3.8	2.06	31.28	T4
	EDGE1900	661	0,-5	1.98	30.64	T4
	W850	4407	1.1,-3.7	2.17	34.79	T4
	W1900	9800	0.4,-4.2	3.29	34.65	T4
	W1700	1637	0.2,-2.8	3.14	35.16	T4

Note:

1. Bluetooth and WiFi function is turn off and microphone is muted.
2. Signal strength measurement scan plots are presented in Annex B.
3. The volume is adjusted to maximum level during T-Coil testing.

Table 12-5 Test results for LTE

Probe Position	Band	Ch.	Band width	Measurement Position (x mm, y mm)	ABM1 (dB A/m)	SNR (dB)	Category T ?
Transverse y	LTE B2	18900	20	-1.2,0.4	-0.17	49.21	T4
Perpendicular z	LTE B2	18900	20	-7.5,-6.3	-1.60	44.10	T4

Note:

1. Bluetooth and WiFi function is turn off and microphone is muted.
2. The worse case of each band for signal strength measurement scan plots are presented in Annex B.
3. The volume is adjusted to maximum level during T-Coil testing.

Table 12-6 Test results for WiFi

Probe Position	Mode	Ch.	Bandwidth	Measurement Position (x mm, y mm)	ABM1 (dB A/m)	SNR (dB)	Category T ?
Transverse y	802.11b	6	20M	3.8,-15.8	-9.61	36.58	T4
	802.11g	6	20M	3.1,-13.6	-9.42	37.26	T4
	802.11n	6	20M	2.9,-14.7	-9.21	37.69	T4
	802.11n	6	40M	3.7,-15.3	-8.37	37.82	T4
Perpendicular z	802.11b	6	20M	-0.4,-5.4	-9.34	31.15	T4
	802.11g	6	20M	-0.1,-3.8	-9.29	32.67	T4



	802.11n	6	20M	-1.2,-4.9	-8.41	31.94	T4
	802.11n	6	40M	-0.7,-4.1	-9.51	32.51	T4

Note:

1. Bluetooth and WiFi function is turn off and microphone is muted.
2. The worse case of each mode for signal strength measurement scan plots are presented in Annex B.
3. The volume is adjusted to maximum level during T-Coil testing.

12.5 Total Measurement Conclusion

Probe Position	Frequency Band(MHz)	ABM1	Frequency Response	T Category
Transverse	GSM 850	Pass	/	T3
	GSM 1900	Pass		T4
	WCDMA850	Pass		T4
	WCDMA1900	Pass		T4
	WCDMA1700	Pass		T4
	LTE B2	Pass		T4
	LTE B5	Pass		T4
	LTE B12	Pass		T4
	LTE B14	Pass		T4
	LTE B30	Pass		T4
	LTE B66	Pass		T4
WiFi 2.4G	Pass	T4		
Perpendicular	GSM 850	Pass	Pass	T3
	GSM 1900	Pass	Pass	T4
	WCDMA850	Pass	Pass	T4
	WCDMA1900	Pass	Pass	T4
	WCDMA1700	Pass	Pass	T4
	LTE B2	Pass	Pass	T4
	LTE B5	Pass	Pass	T4
	LTE B12	Pass	Pass	T4
	LTE B14	Pass	Pass	T4
	LTE B30	Pass	Pass	T4
	LTE B66	Pass	Pass	T4
WiFi 2.4G	Pass	Pass	T4	

13 MEASUREMENT UNCERTAINTY

No.	Error source	Type	Uncertainty Value a_i (%)	Prob. Dist.	Div.	ABM1 c_i	ABM2 c_i	Std. Unc. ABM1 u_i (%)	Std. Unc. ABM2 u_i (%)
1	System Repeatability	A	0.016	N	1	1	1	0.016	0.016
Probe Sensitivity									
2	Reference Level	B	3.0	R	$\sqrt{3}$	1	1	3.0	3.0
3	AMCC Geometry	B	0.4	R	$\sqrt{3}$	1	1	0.2	0.2
4	AMCC Current	B	0.6	R	$\sqrt{3}$	1	1	0.4	0.4
5	Probe Positioning during Calibration	B	0.1	R	$\sqrt{3}$	1	1	0.1	0.1
6	Noise Contribution	B	0.7	R	$\sqrt{3}$	0.014 3	1	0.0	0.4
7	Frequency Slope	B	5.9	R	$\sqrt{3}$	0.1	1	0.3	3.5
Probe System									
8	Repeatability / Drift	B	1.0	R	$\sqrt{3}$	1	1	0.6	0.6
9	Linearity / Dynamic Range	B	0.6	N	1	1	1	0.4	0.4
10	Acoustic Noise	B	1.0	R	$\sqrt{3}$	0.1	1	0.1	0.6
11	Probe Angle	B	2.3	R	$\sqrt{3}$	1	1	1.4	1.4
12	Spectral Processing	B	0.9	R	$\sqrt{3}$	1	1	0.5	0.5
13	Integration Time	B	0.6	N	1	1	5	0.6	3.0
14	Field Distribution	B	0.2	R	$\sqrt{3}$	1	1	0.1	0.1
Test Signal									
15	Ref.Signal Spectral Response	B	0.6	R	$\sqrt{3}$	0	1	0.0	0.4
Positioning									
16	Probe Positioning	B	1.9	R	$\sqrt{3}$	1	1	1.1	1.1
17	Phantom Thickness	B	0.9	R	$\sqrt{3}$	1	1	0.5	0.5

18	DUT Positioning	B	1.9	R	$\sqrt{3}$	1	1	1.1	1.1	
External Contributions										
19	RF Interference	B	0.0	R	$\sqrt{3}$	1	0.3	0.0	0.0	
20	Test Signal Variation	B	2.0	R	$\sqrt{3}$	1	1	1.2	1.2	
Combined Std. Uncertainty (ABM Field)		$u_c = \sqrt{\sum_{i=1}^{20} c_i^2 u_i^2}$							4.1	6.1
Expanded Std. Uncertainty		$u_e = 2u_c$		N	$k = 2$				8.2	12.2

14 MAIN TEST INSTRUMENTS

List of Main Instruments

No.	Name	Type	Serial Number	Calibration Date	Valid Period
01	Audio Magnetic 1D Field Probe	AM1DV2	1064	July 23, 2019	One year
02	Audio Magnetic Calibration Coil	AMCC	1064	NCR	NCR
03	Audio Measuring Instrument	AMMI	1044	NCR	NCR
04	HAC Test Arch	N/A	1014	NCR	NCR
05	DAE	SPEAG DAE4	777	January 8, 2020	One year
06	Software	DASY5 V5.0 Build 119.9	N/A	NCR	NCR
07	Software	SEMCAD V13.2 Build 87	N/A	NCR	NCR
08	Universal Radio Communication Tester	CMW 500	166370	June 26, 2019	One year

END OF REPORT BODY

ANNEX A TEST LAYOUT



Picture A1: HAC T-Coil System Layout



ANNEX B TEST PLOTS

T-Coil GSM 850 Transverse

Date: 2020-6-9

Electronics: DAE4 Sn777

Medium: Air

Medium parameters used: $\sigma = 0$ mho/m, $\epsilon_r = 1$; $\rho = 1$ kg/m³

Ambient Temperature: 22.5°C

Communication System: GSM 850; Frequency: 836.6 MHz; Duty Cycle: 1:8.3

Probe: AM1DV2 - 1064;

T-Coil/General Scans/y (transversal) 4.2mm 50 x 50 2/ABM

Interpolated Signal(x, y, z) (121x121x1): Interpolated grid: dx=1.000 mm,

dy=1.000 mm

Signal Type: Audio File (.wav) 48k_voice_1kHz_1s.wav

Output Gain: 100

Measure Window Start: 300ms

Measure Window Length: 1000ms

BWC applied: 0.16 dB

Device Reference Point: 0, 0, -6.3 mm

Cursor:

ABM1 = 6.55 dBA/m

BWC Factor = 0.16 dB

Location: 12.9, -12.5, 3.7 mm

T-Coil/General Scans/y (transversal) 4.2mm 50 x 50 2/ABM

Interpolated SNR(x, y, z) (121x121x1): Interpolated grid: dx=1.000 mm,

dy=1.000 mm

Signal Type: Audio File (.wav) 48k_voice_1kHz_1s.wav

Output Gain: 100

Measure Window Start: 300ms

Measure Window Length: 1000ms

BWC applied: 0.16 dB

Device Reference Point: 0, 0, -6.3 mm

Cursor:

ABM1/ABM2 = 29.57 dB

ABM1 comp = 4.61 dBA/m

BWC Factor = 0.16 dB

Location: 10.4, 0, 3.7 mm

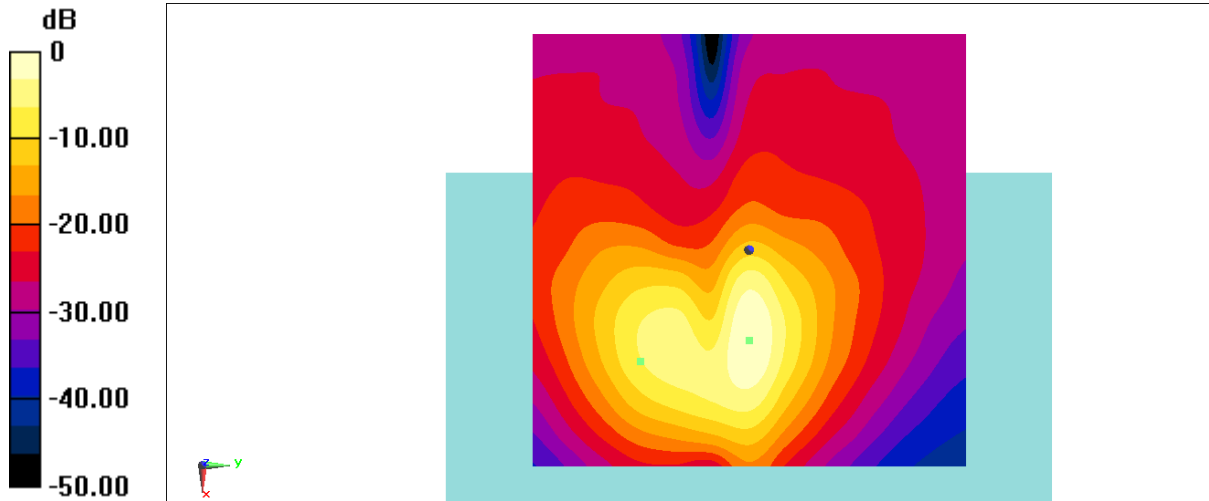

0 dB = 2.125 A/m = 6.55 dBA/m

Fig B.1 T-Coil GSM 850

**T-Coil GSM 850 Perpendicular**

Date: 2020-6-9

Electronics: DAE4 Sn777

Medium: Air

Medium parameters used: $\sigma = 0$ mho/m, $\epsilon_r = 1$; $\rho = 1$ kg/m³

Ambient Temperature: 22.5°C

Communication System: GSM 850; Frequency: 836.6 MHz; Duty Cycle: 1:8.3

Probe: AM1DV2 - 1064;

T-Coil/General Scans/z (axial) 4.2mm 50 x 50/ABM Interpolated**Signal(x, y, z) (121x121x1):** Interpolated grid: dx=1.000 mm, dy=1.000 mm

Signal Type: Audio File (.wav) 48k_voice_1kHz_1s.wav

Output Gain: 100

Measure Window Start: 300ms

Measure Window Length: 1000ms

BWC applied: 0.16 dB

Device Reference Point: 0, 0, -6.3 mm

Cursor:

ABM1 = 15.05 dBA/m

BWC Factor = 0.16 dB

Location: 12.9, -5, 3.7 mm

T-Coil/General Scans/z (axial) 4.2mm 50 x 50/ABM Interpolated**SNR(x, y, z) (121x121x1):** Interpolated grid: dx=1.000 mm, dy=1.000 mm

Signal Type: Audio File (.wav) 48k_voice_1kHz_1s.wav

Output Gain: 100

Measure Window Start: 300ms

Measure Window Length: 1000ms

BWC applied: 0.16 dB

Device Reference Point: 0, 0, -6.3 mm

Cursor:

ABM1/ABM2 = 28.85 dB

ABM1 comp = 10.92 dBA/m

BWC Factor = 0.16 dB

Location: 8.8, -6.7, 3.7 mm

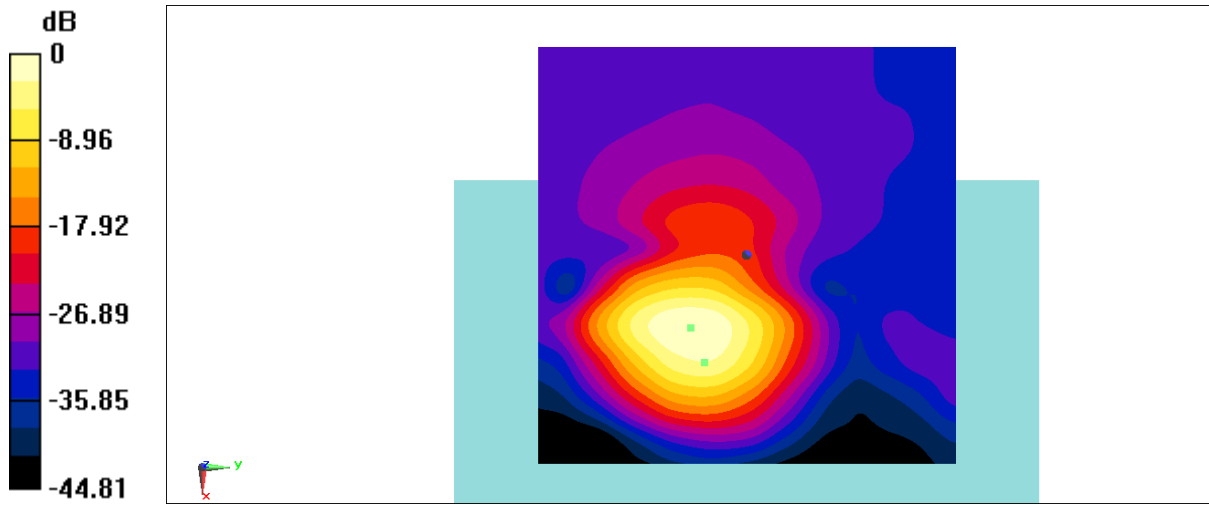

0 dB = 5.656 A/m = 15.05 dBA/m

Fig B.2 T-Coil GSM 850

**T-Coil LTE B2 Transverse**

Date: 2020-6-10

Electronics: DAE4 Sn777

Medium: Air

Medium parameters used: $\sigma = 0$ mho/m, $\epsilon_r = 1$; $\rho = 1$ kg/m³

Ambient Temperature: 22.5°C

Communication System: LTE B2; Frequency: 1880 MHz; Duty Cycle: 1:1

Probe: AM1DV2 - 1064;

T-Coil/General Scans/y (transversal) 4.2mm 50 x 50 2/ABM

Interpolated Signal(x, y, z) (121x121x1): Interpolated grid: dx=1.000 mm,

dy=1.000 mm

Signal Type: Audio File (.wav) 48k_voice_1kHz_1s.wav

Output Gain: 100

Measure Window Start: 300ms

Measure Window Length: 1000ms

BWC applied: 0.16 dB

Device Reference Point: 0, 0, -6.3 mm

Cursor:

ABM1 = 8.02 dBA/m

BWC Factor = 0.16 dB

Location: 12.5, 0.8, 3.7 mm

T-Coil/General Scans/y (transversal) 4.2mm 50 x 50 2/ABM

Interpolated SNR(x, y, z) (121x121x1): Interpolated grid: dx=1.000 mm,

dy=1.000 mm

Signal Type: Audio File (.wav) 48k_voice_1kHz_1s.wav

Output Gain: 100

Measure Window Start: 300ms

Measure Window Length: 1000ms

BWC applied: 0.16 dB

Device Reference Point: 0, 0, -6.3 mm

Cursor:

ABM1/ABM2 = 44.65 dB

ABM1 comp = 5.18 dBA/m

BWC Factor = 0.16 dB

Location: 7.9, 0.4, 3.7 mm

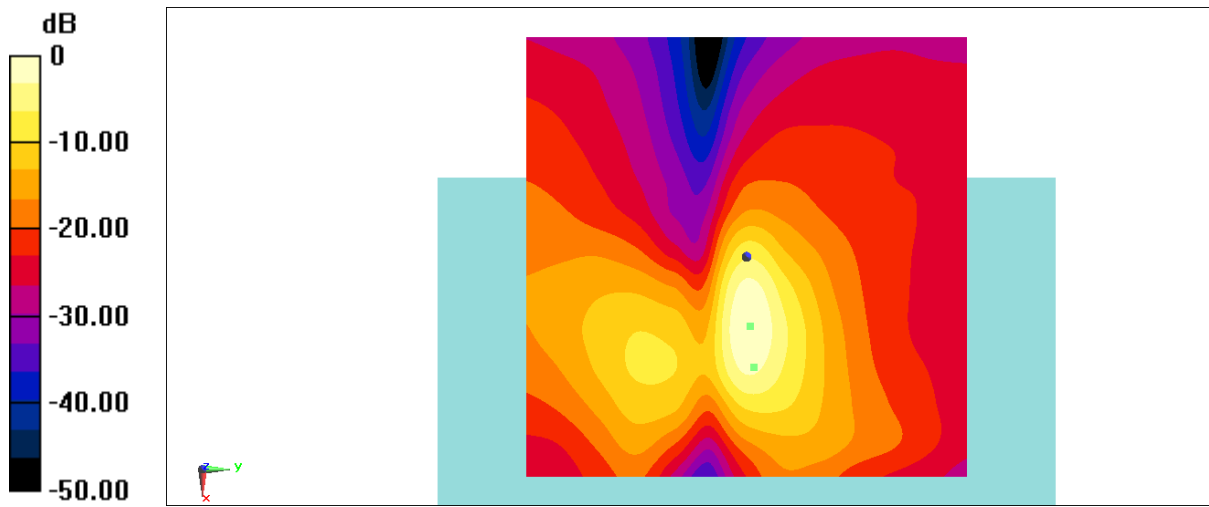

0 dB = 2.517 A/m = 8.02 dBA/m

Fig B.3 T-Coil LTE B2

**T-Coil LTE B2 Perpendicular**

Date: 2020-6-10

Electronics: DAE4 Sn777

Medium: Air

Medium parameters used: $\sigma = 0$ mho/m, $\epsilon_r = 1$; $\rho = 1$ kg/m³

Ambient Temperature: 22.5°C

Communication System: LTE B2; Frequency: 1880 MHz; Duty Cycle: 1:1

Probe: AM1DV2 - 1064;

T-Coil/General Scans/z (axial) 4.2mm 50 x 50 16QAM/ABM**Interpolated Signal (x, y, z) (121x121x1):** Interpolated grid: dx=1.000

mm, dy=1.000 mm

Signal Type: Audio File (.wav) 48k_voice_1kHz_1s.wav

Output Gain: 100

Measure Window Start: 300ms

Measure Window Length: 1000ms

BWC applied: 0.15 dB

Device Reference Point: 0, 0, -6.3 mm

Cursor:

ABM1 = 15.78 dBA/m

BWC Factor = 0.15 dB

Location: 12.5, -5.8, 3.7 mm

T-Coil/General Scans/z (axial) 4.2mm 50 x 50 16QAM/ABM**Interpolated SNR (x, y, z) (121x121x1):** Interpolated grid: dx=1.000 mm,

dy=1.000 mm

Signal Type: Audio File (.wav) 48k_voice_1kHz_1s.wav

Output Gain: 100

Measure Window Start: 300ms

Measure Window Length: 1000ms

BWC applied: 0.15 dB

Device Reference Point: 0, 0, -6.3 mm

Cursor:

ABM1/ABM2 = 36.64 dB

ABM1 comp = 14.58 dBA/m
BWC Factor = 0.15 dB
Location: 9.6, -7.1, 3.7 mm

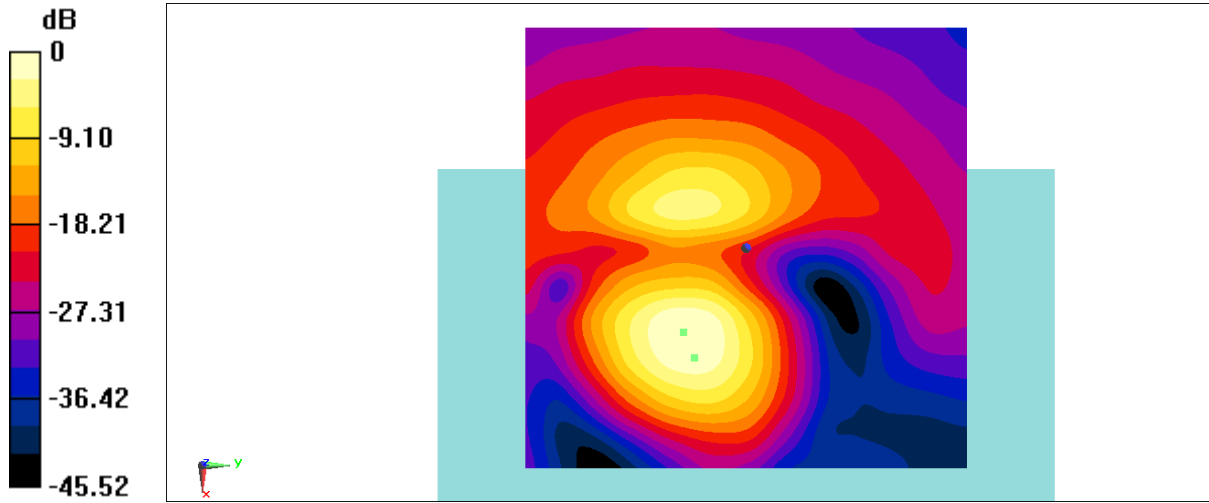

0 dB = 6.155 A/m = 15.78 dBA/m

Fig B.4 T-Coil LTE B2

**T-Coil WiFi-2.4G 11n Transverse**

Date: 2020-6-18

Electronics: DAE4 Sn777

Medium: Air

Medium parameters used: $\sigma = 0$ mho/m, $\epsilon_r = 1$; $\rho = 1$ kg/m³

Ambient Temperature: 22.5°C

Communication System: WiFi-2.4G; Frequency: 2437 MHz; Duty Cycle: 1:1

Probe: AM1DV2 - 1064;

T-Coil/General Scans/y (transversal) 4.2mm 50 x 50 11n MCO/ABM**Interpolated Signal(x, y, z) (121x121x1):** Interpolated grid: dx=1.000 mm,

dy=1.000 mm

Signal Type: Audio File (.wav) 48k_voice_1kHz_1s.wav

Output Gain: 100

Measure Window Start: 300ms

Measure Window Length: 1000ms

BWC applied: 0.16 dB

Device Reference Point: 0, 0, -6.3 mm

Cursor:

ABM1 = 8.90 dBA/m

BWC Factor = 0.16 dB

Location: 13.3, 1.2, 3.7 mm

T-Coil/General Scans/y (transversal) 4.2mm 50 x 50 11n MCO/ABM**Interpolated SNR(x, y, z) (121x121x1):** Interpolated grid: dx=1.000 mm,

dy=1.000 mm

Signal Type: Audio File (.wav) 48k_voice_1kHz_1s.wav

Output Gain: 100

Measure Window Start: 300ms

Measure Window Length: 1000ms

BWC applied: 0.16 dB

Device Reference Point: 0, 0, -6.3 mm

Cursor:

ABM1/ABM2 = 50.95 dB

ABM1 comp = 6.82 dBA/m

BWC Factor = 0.16 dB

Location: 9.6, 0.8, 3.7 mm

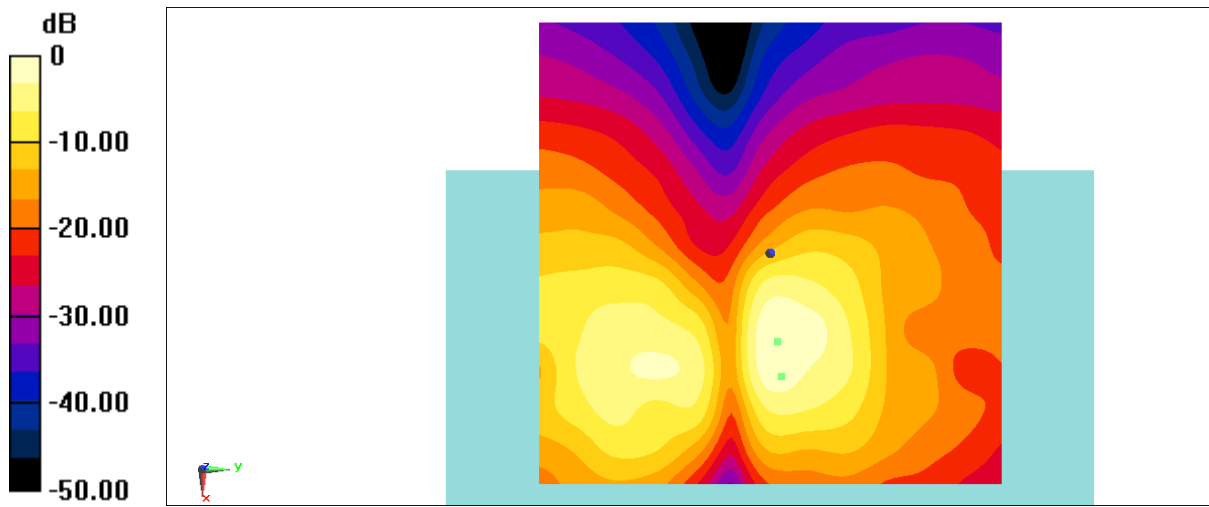

0 dB = 2.785 A/m = 8.90 dBA/m

Fig B.5 T-Coil WiFi-2.4G

**T-Coil WiFi-2.4G 11b Perpendicular**

Date: 2020-6-18

Electronics: DAE4 Sn777

Medium: Air

Medium parameters used: $\sigma = 0$ mho/m, $\epsilon_r = 1$; $\rho = 1$ kg/m³

Ambient Temperature: 22.5°C

Communication System: WiFi-2.4G; Frequency: 2437 MHz; Duty Cycle: 1:1

Probe: AM1DV2 - 1064;

T-Coil/General Scans/z (axial) 4.2mm 50 x 50 11g 6M/ABM**Interpolated Signal (x, y, z) (121x121x1):** Interpolated grid: dx=1.000

mm, dy=1.000 mm

Signal Type: Audio File (.wav) 48k_voice_1kHz_1s.wav

Output Gain: 100

Measure Window Start: 300ms

Measure Window Length: 1000ms

BWC applied: 0.16 dB

Device Reference Point: 0, 0, -6.3 mm

Cursor:

ABM1 = 16.58 dBA/m

BWC Factor = 0.16 dB

Location: 12.9, -5.4, 3.7 mm

T-Coil/General Scans/z (axial) 4.2mm 50 x 50 11g 6M/ABM**Interpolated SNR (x, y, z) (121x121x1):** Interpolated grid: dx=1.000 mm,

dy=1.000 mm

Signal Type: Audio File (.wav) 48k_voice_1kHz_1s.wav

Output Gain: 100

Measure Window Start: 300ms

Measure Window Length: 1000ms

BWC applied: 0.16 dB

Device Reference Point: 0, 0, -6.3 mm

Cursor:

ABM1/ABM2 = 44.21 dB

ABM1 comp = 11.97 dBA/m
BWC Factor = 0.16 dB
Location: 8.8, -7.9, 3.7 mm

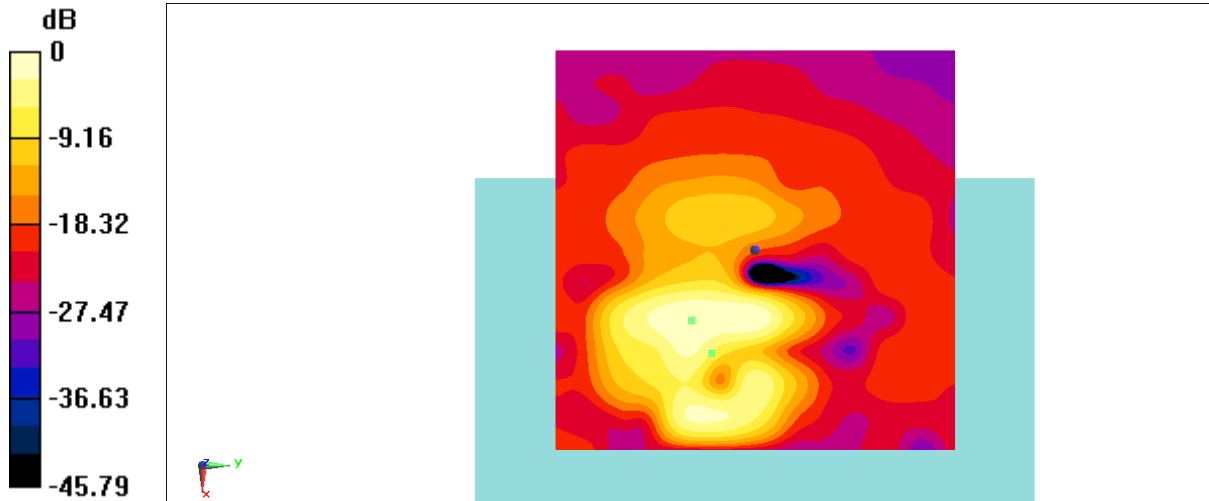

0 dB = 6.742 A/m = 16.58 dBA/m

Fig B.6 T-Coil WiFi-2.4G

**T-Coil EDGE 1900 Transverse – OTT VoIP**

Date: 2020-6-20

Electronics: DAE4 Sn777

Medium: Air

Medium parameters used: $\sigma = 0$ mho/m, $\epsilon_r = 1$; $\rho = 1$ kg/m³

Ambient Temperature: 22.5°C

Communication System: EDGE 1900; Frequency: 1880 MHz; Duty Cycle: 1:4

Probe: AM1DV2 - 1064;

T-Coil/General Scans/y (transversal) 4.2mm 50 x 50 2/ABM

Interpolated Signal(x, y, z) (121x121x1): Interpolated grid: dx=1.000 mm,

dy=1.000 mm

Signal Type: Audio File (.wav) 48k_voice_1kHz_1s.wav

Output Gain: 100

Measure Window Start: 300ms

Measure Window Length: 1000ms

BWC applied: 0.16 dB

Device Reference Point: 0, 0, -6.3 mm

Cursor:

ABM1 = 4.88 dBA/m

BWC Factor = 0.16 dB

Location: 16.7, -12.5, 3.7 mm

T-Coil/General Scans/y (transversal) 4.2mm 50 x 50 2/ABM

Interpolated SNR(x, y, z) (121x121x1): Interpolated grid: dx=1.000 mm,

dy=1.000 mm

Signal Type: Audio File (.wav) 48k_voice_1kHz_1s.wav

Output Gain: 100

Measure Window Start: 300ms

Measure Window Length: 1000ms

BWC applied: 0.16 dB

Device Reference Point: 0, 0, -6.3 mm

Cursor:

ABM1/ABM2 = 36.34 dB

ABM1 comp = 0.35 dBA/m

BWC Factor = 0.16 dB

Location: 7.9, 0, 3.7 mm

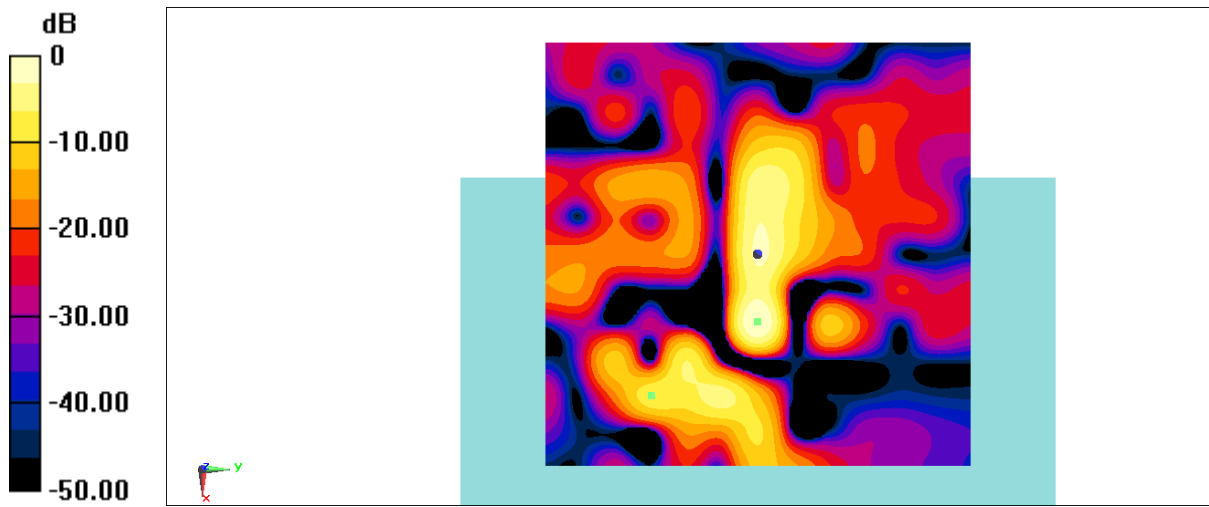

0 dB = 1.755 A/m = 4.88 dBA/m

Fig B.7 T-Coil EDGE 1900

**T-Coil EDGE 1900 Perpendicular - OTT VoIP**

Date: 2020-6-20

Electronics: DAE4 Sn777

Medium: Air

Medium parameters used: $\sigma = 0$ mho/m, $\epsilon_r = 1$; $\rho = 1$ kg/m³

Ambient Temperature: 22.5°C

Communication System: EDGE 1900; Frequency: 1880 MHz; Duty Cycle: 1:4

Probe: AM1DV2 - 1064;

T-Coil/General Scans/z (axial) 4.2mm 50 x 50/ABM Interpolated**Signal(x, y, z) (121x121x1):** Interpolated grid: dx=1.000 mm, dy=1.000 mm

Signal Type: Audio File (.wav) 48k_voice_1kHz_1s.wav

Output Gain: 100

Measure Window Start: 300ms

Measure Window Length: 1000ms

BWC applied: 0.16 dB

Device Reference Point: 0, 0, -6.3 mm

Cursor:

ABM1 = 10.13 dBA/m

BWC Factor = 0.16 dB

Location: 12.5, 0, 3.7 mm

T-Coil/General Scans/z (axial) 4.2mm 50 x 50/ABM Interpolated**SNR(x, y, z) (121x121x1):** Interpolated grid: dx=1.000 mm, dy=1.000 mm

Signal Type: Audio File (.wav) 48k_voice_1kHz_1s.wav

Output Gain: 100

Measure Window Start: 300ms

Measure Window Length: 1000ms

BWC applied: 0.16 dB

Device Reference Point: 0, 0, -6.3 mm

Cursor:

ABM1/ABM2 = 30.64 dB

ABM1 comp = 1.98 dBA/m

BWC Factor = 0.16 dB

Location: 0, -5, 3.7 mm

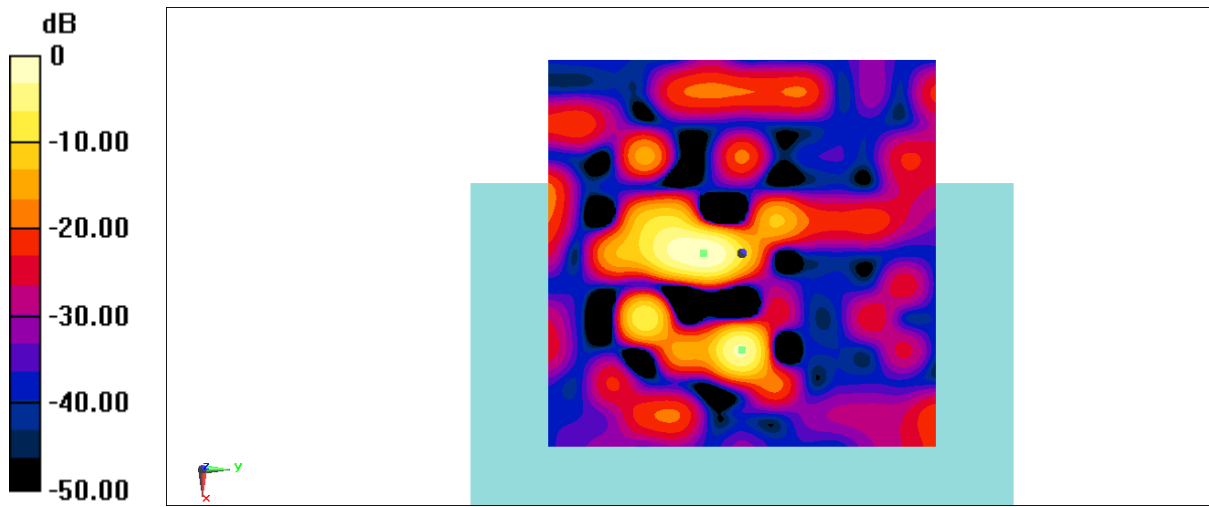

0 dB = 3.212 A/m = 10.13 dBA/m

Fig B.8 T-Coil EDGE 1900

**T-Coil LTE B2 Transverse - OTT VoIP**

Date: 2020-6-21

Electronics: DAE4 Sn777

Medium: Air

Medium parameters used: $\sigma = 0$ mho/m, $\epsilon_r = 1$; $\rho = 1$ kg/m³

Ambient Temperature: 22.5°C

Communication System: LTE B2; Frequency: 1880 MHz; Duty Cycle: 1:1

Probe: AM1DV2 - 1064;

T-Coil/General Scans/y (transversal) 4.2mm 50 x 50 2/ABM**Interpolated Signal(x, y, z) (121x121x1):** Interpolated grid: dx=1.000 mm,

dy=1.000 mm

Signal Type: Audio File (.wav) 48k_voice_1kHz_1s.wav

Output Gain: 100

Measure Window Start: 300ms

Measure Window Length: 1000ms

BWC applied: 0.16 dB

Device Reference Point: 0, 0, -6.3 mm

Cursor:

ABM1 = 0.46 dBA/m

BWC Factor = 0.16 dB

Location: 0.8, 1.2, 3.7 mm

T-Coil/General Scans/y (transversal) 4.2mm 50 x 50 2/ABM**Interpolated SNR(x, y, z) (121x121x1):** Interpolated grid: dx=1.000 mm,

dy=1.000 mm

Signal Type: Audio File (.wav) 48k_voice_1kHz_1s.wav

Output Gain: 100

Measure Window Start: 300ms

Measure Window Length: 1000ms

BWC applied: 0.16 dB

Device Reference Point: 0, 0, -6.3 mm

Cursor:

ABM1/ABM2 = 49.21 dB

ABM1 comp = -0.17 dBA/m

BWC Factor = 0.16 dB

Location: -1.2, 0.4, 3.7 mm

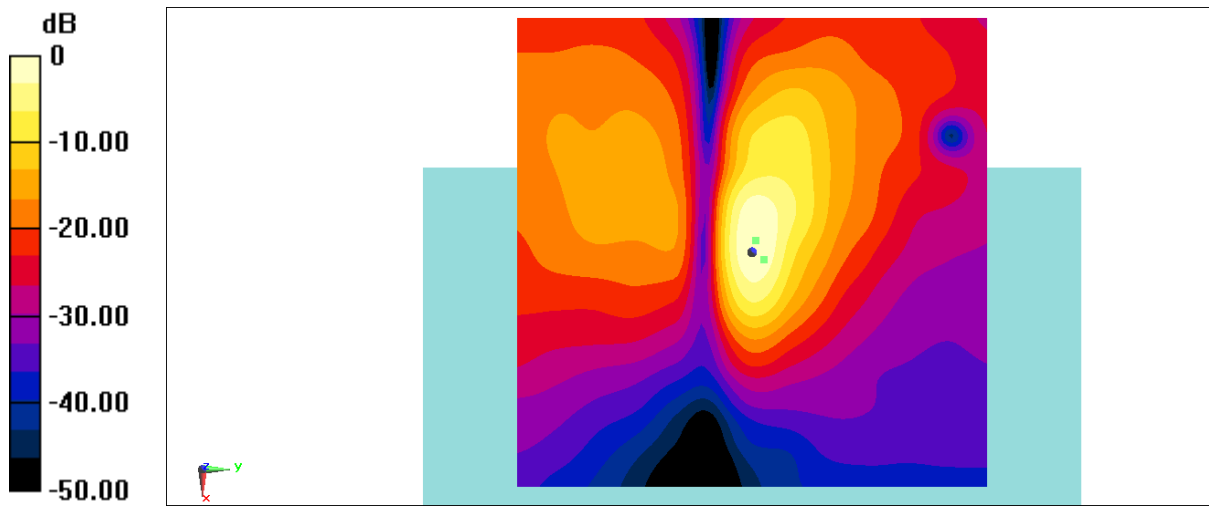

0 dB = 1.054 A/m = 0.46 dBA/m

Fig B.9 T-Coil LTE B2

**T-Coil LTE B2 Perpendicular - OTT VoIP**

Date: 2020-6-21

Electronics: DAE4 Sn777

Medium: Air

Medium parameters used: $\sigma = 0$ mho/m, $\epsilon_r = 1$; $\rho = 1$ kg/m³

Ambient Temperature: 22.5°C

Communication System: LTE B2; Frequency: 1880 MHz; Duty Cycle: 1:1

Probe: AM1DV2 - 1064;

T-Coil/General Scans/z (axial) 4.2mm 50 x 50/ABM Interpolated**Signal(x, y, z) (121x121x1):** Interpolated grid: dx=1.000 mm, dy=1.000 mm

Signal Type: Audio File (.wav) 48k_voice_1kHz_1s.wav

Output Gain: 100

Measure Window Start: 300ms

Measure Window Length: 1000ms

BWC applied: 0.16 dB

Device Reference Point: 0, 0, -6.3 mm

Cursor:

ABM1 = 8.54 dBA/m

BWC Factor = 0.16 dB

Location: 0.4, -6.7, 3.7 mm

T-Coil/General Scans/z (axial) 4.2mm 50 x 50/ABM Interpolated**SNR(x, y, z) (121x121x1):** Interpolated grid: dx=1.000 mm, dy=1.000 mm

Signal Type: Audio File (.wav) 48k_voice_1kHz_1s.wav

Output Gain: 100

Measure Window Start: 300ms

Measure Window Length: 1000ms

BWC applied: 0.16 dB

Device Reference Point: 0, 0, -6.3 mm

Cursor:

ABM1/ABM2 = 44.10 dB

ABM1 comp = -1.60 dBA/m

BWC Factor = 0.16 dB

Location: -7.5, -6.3, 3.7 mm

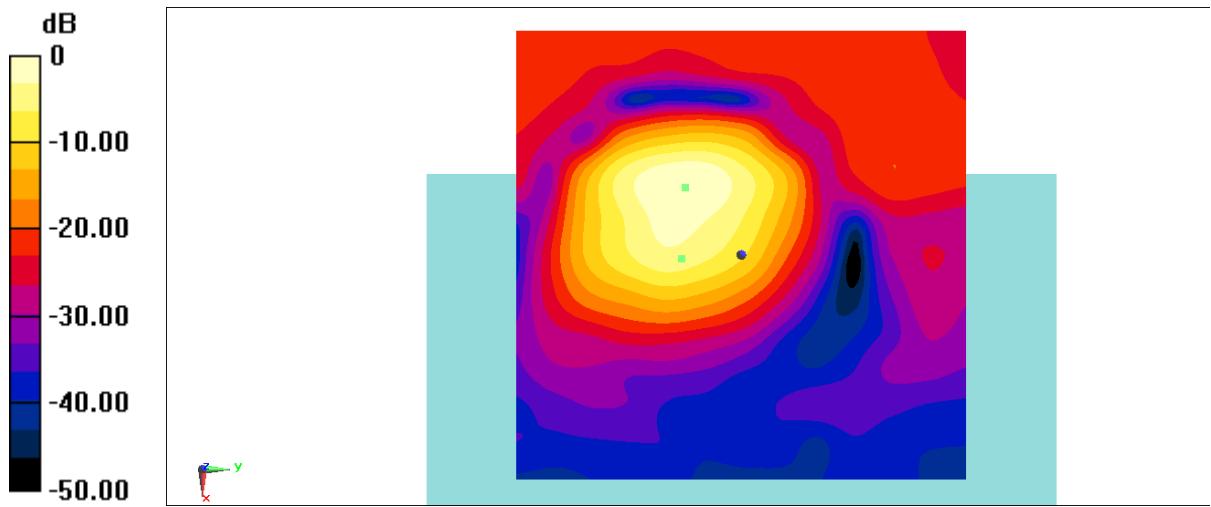

0 dB = 2.672 A/m = 8.54 dBA/m

Fig B.10 T-Coil LTE B2

**T-Coil WiFi-2.4G 11b Transverse - OTT VoIP**

Date: 2020-6-24

Electronics: DAE4 Sn777

Medium: Air

Medium parameters used: $\sigma = 0$ mho/m, $\epsilon_r = 1$; $\rho = 1$ kg/m³

Ambient Temperature: 22.5°C

Communication System: WiFi-2.4G; Frequency: 2437 MHz; Duty Cycle: 1:1

Probe: AM1DV2 - 1064;

T-Coil/General Scans/y (transversal) 4.2mm 50 x 50/ABM Interpolated**Signal(x, y, z) (121x121x1):** Interpolated grid: dx=1.000 mm, dy=1.000 mm

Signal Type: Audio File (.wav) 48k_voice_1kHz_1s.wav

Output Gain: 100

Measure Window Start: 300ms

Measure Window Length: 1000ms

BWC applied: 0.16 dB

Device Reference Point: 0, 0, -6.3 mm

Cursor:

ABM1 = -7.83 dBA/m

BWC Factor = 0.16 dB

Location: 4.2, 2.9, 3.7 mm

T-Coil/General Scans/y (transversal) 4.2mm 50 x 50/ABM**Interpolated SNR(x, y, z) (121x121x1):** Interpolated grid: dx=1.000 mm,

dy=1.000 mm

Signal Type: Audio File (.wav) 48k_voice_1kHz_1s.wav

Output Gain: 100

Measure Window Start: 300ms

Measure Window Length: 1000ms

BWC applied: 0.16 dB

Device Reference Point: 0, 0, -6.3 mm

Cursor:

ABM1/ABM2 = 36.58 dB

ABM1 comp = -9.61 dBA/m

BWC Factor = 0.16 dB

Location: 3.8, -15.8, 3.7 mm

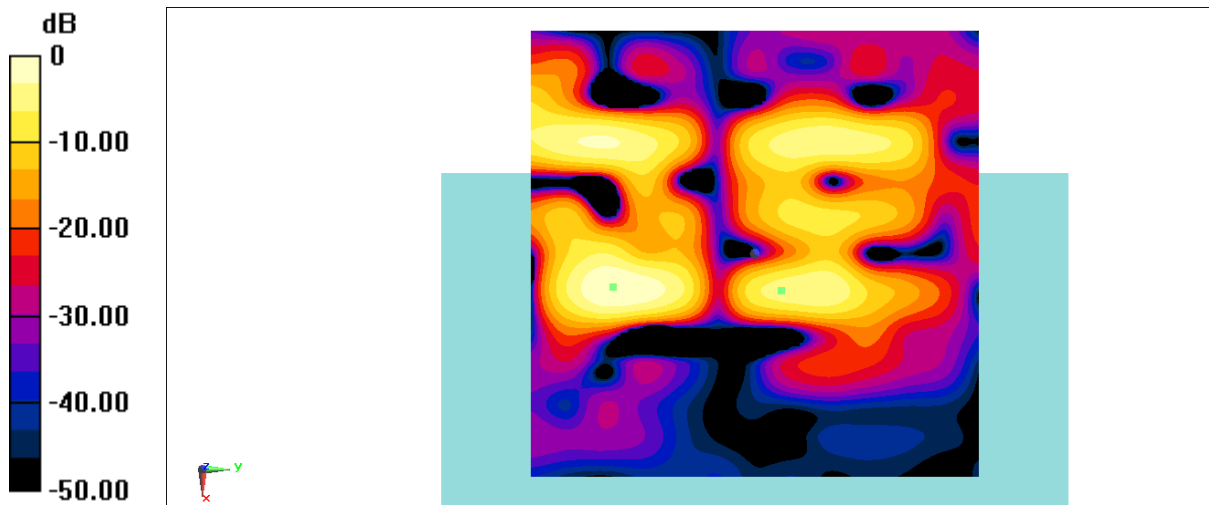

0 dB = 0.4059 A/m = -7.83 dBA/m

Fig B.11 T-Coil WiFi-2. 4G

**T-Coil WiFi-2.4G 11b Perpendicular - OTT VoIP**

Date: 2020-6-24

Electronics: DAE4 Sn777

Medium: Air

Medium parameters used: $\sigma = 0$ mho/m, $\epsilon_r = 1$; $\rho = 1$ kg/m³

Ambient Temperature: 22.5°C

Communication System: WiFi-2.4G; Frequency: 2437 MHz; Duty Cycle: 1:1

Probe: AM1DV2 - 1064;

T-Coil/General Scans/z (axial) 4.2mm 50 x 50 WB6.6/ABM**Interpolated Signal (x, y, z) (121x121x1):** Interpolated grid: dx=1.000

mm, dy=1.000 mm

Signal Type: Audio File (.wav) 48k_voice_1kHz_1s.wav

Output Gain: 100

Measure Window Start: 300ms

Measure Window Length: 1000ms

BWC applied: 0.16 dB

Device Reference Point: 0, 0, -6.3 mm

Cursor:

ABM1 = -6.16 dBA/m

BWC Factor = 0.16 dB

Location: 8.3, -8.3, 3.7 mm

T-Coil/General Scans/z (axial) 4.2mm 50 x 50 WB6.6/ABM**Interpolated SNR (x, y, z) (121x121x1):** Interpolated grid: dx=1.000 mm,

dy=1.000 mm

Signal Type: Audio File (.wav) 48k_voice_1kHz_1s.wav

Output Gain: 100

Measure Window Start: 300ms

Measure Window Length: 1000ms

BWC applied: 0.16 dB

Device Reference Point: 0, 0, -6.3 mm

Cursor:

ABM1/ABM2 = 31.15 dB

ABM1 comp = -9.34 dBA/m
BWC Factor = 0.16 dB
Location: -0.4, -5.4, 3.7 mm

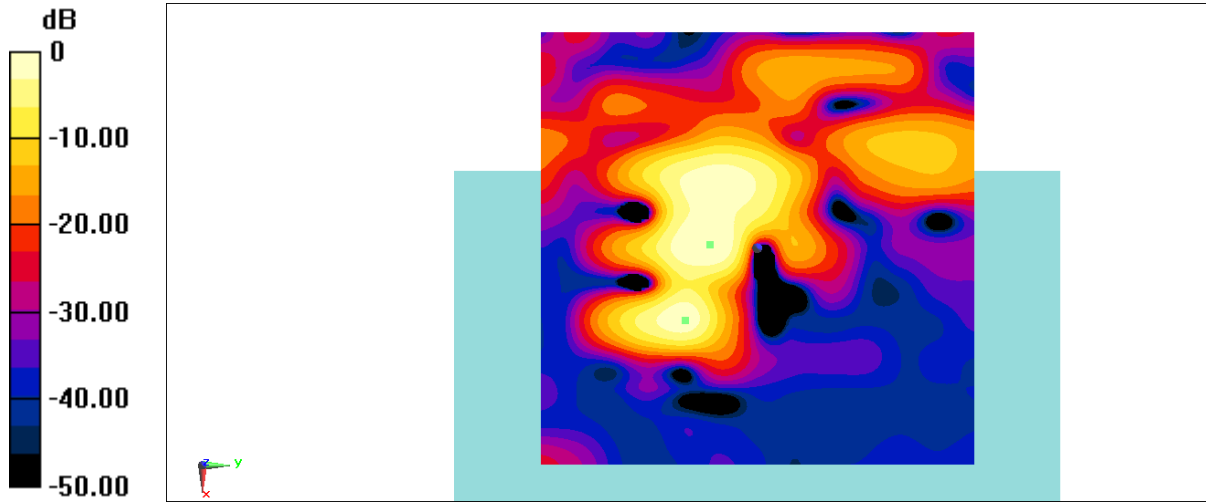

0 dB = 0.4923 A/m = -6.16 dBA/m

Fig B.12 T-Coil WiFi-2.4G

ANNEX C FREQUENCY RESPONSE CURVES

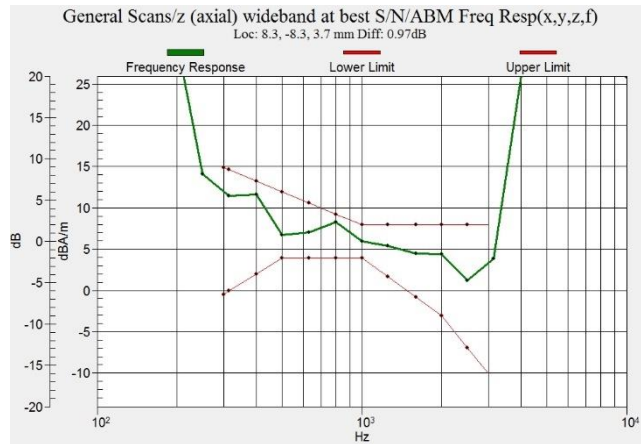

Figure C.1 Frequency Response of GSM 850

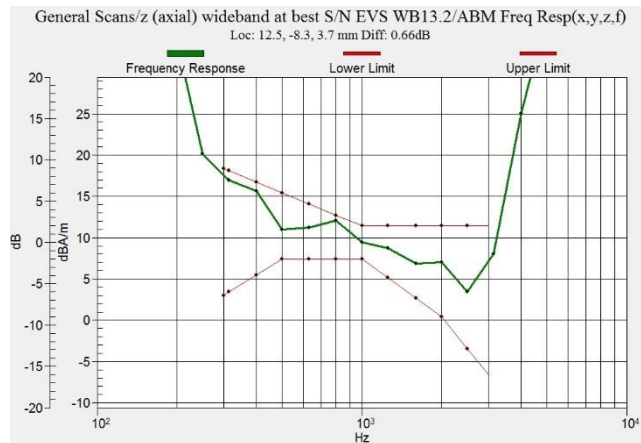

Figure C.2 Frequency Response of LTE B2

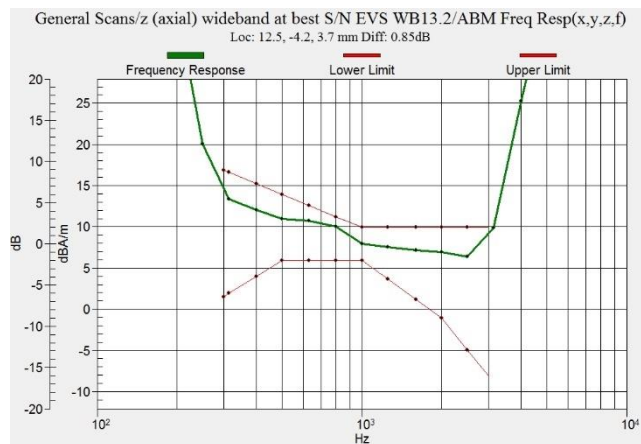

Figure C.3 Frequency Response of WiFi-2.4G

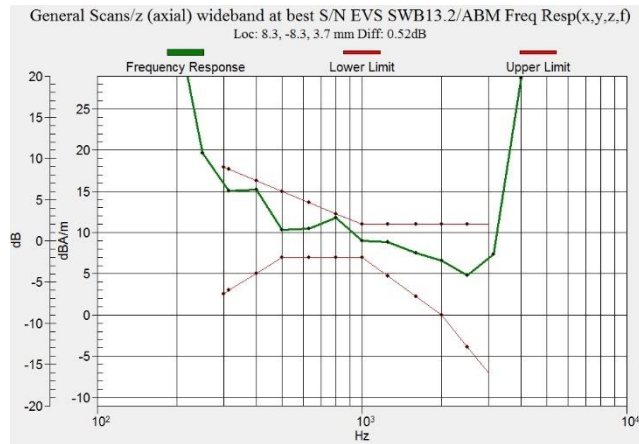

Figure C.4 Frequency Response of EDGE1900 - OTT VoIP

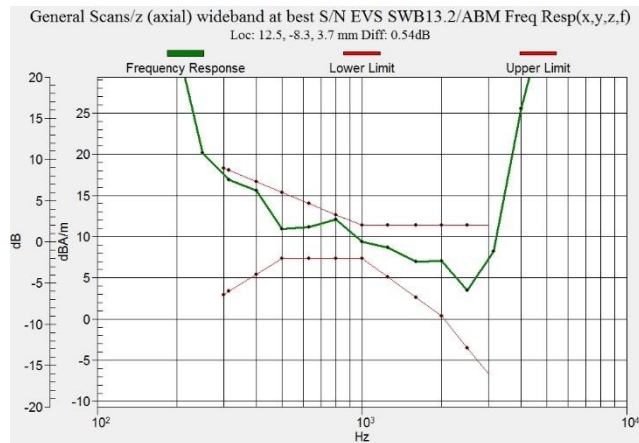

Figure C.5 Frequency Response of LTE B2 - OTT VoIP



Figure C.6 Frequency Response of WiFi-2.4G - OTT VoIP



No.I20Z60778-SEM04

ANNEX D PROBE CALIBRATION CERTIFICATE

**Calibration Laboratory of
Schmid & Partner
Engineering AG**
Zeughausstrasse 43, 8004 Zurich, Switzerland



S Schweizerischer Kalibrierdienst
C Service suisse d'étalonnage
S Servizio svizzero di taratura
S Swiss Calibration Service

Accredited by the Swiss Accreditation Service (SAS)
The Swiss Accreditation Service is one of the signatories to the EA
Multilateral Agreement for the recognition of calibration certificates

Accreditation No.: **SCS 0108**

Client **CTTL (Auden)**

Certificate No: **AM1DV2-1064_Jul19**

CALIBRATION CERTIFICATE																															
Object	AM1DV2 - SN: 1064																														
Calibration procedure(s)	QA CAL-24.v4 Calibration procedure for AM1D magnetic field probes and TMFS in the audio range																														
Calibration date:	July 23, 2019																														
<p>This calibration certificate documents the traceability to national standards, which realize the physical units of measurements (SI). The measurements and the uncertainties with confidence probability are given on the following pages and are part of the certificate.</p> <p>All calibrations have been conducted in the closed laboratory facility: environment temperature (22 ± 3)°C and humidity < 70%.</p> <p>Calibration Equipment used (M&TE critical for calibration)</p> <table border="1"> <thead> <tr> <th>Primary Standards</th> <th>ID #</th> <th>Cal Date (Certificate No.)</th> <th>Scheduled Calibration</th> </tr> </thead> <tbody> <tr> <td>Keithley Multimeter Type 2001</td> <td>SN: 0810278</td> <td>03-Sep-18 (No. 23488)</td> <td>Sep-19</td> </tr> <tr> <td>Reference Probe AM1DV2</td> <td>SN: 1008</td> <td>20-Dec-18 (No. AM1DV2-1008_Dec18)</td> <td>Dec-19</td> </tr> <tr> <td>DAE4</td> <td>SN: 781</td> <td>09-Jan-19 (No. DAE4-781_Jan19)</td> <td>Jan-20</td> </tr> </tbody> </table> <table border="1"> <thead> <tr> <th>Secondary Standards</th> <th>ID #</th> <th>Check Date (in house)</th> <th>Scheduled Check</th> </tr> </thead> <tbody> <tr> <td>AMCC</td> <td>SN: 1050</td> <td>01-Oct-13 (in house check Oct-17)</td> <td>Oct-19</td> </tr> <tr> <td>AMMI Audio Measuring Instrument</td> <td>SN: 1062</td> <td>26-Sep-12 (in house check Oct-17)</td> <td>Oct-19</td> </tr> </tbody> </table>				Primary Standards	ID #	Cal Date (Certificate No.)	Scheduled Calibration	Keithley Multimeter Type 2001	SN: 0810278	03-Sep-18 (No. 23488)	Sep-19	Reference Probe AM1DV2	SN: 1008	20-Dec-18 (No. AM1DV2-1008_Dec18)	Dec-19	DAE4	SN: 781	09-Jan-19 (No. DAE4-781_Jan19)	Jan-20	Secondary Standards	ID #	Check Date (in house)	Scheduled Check	AMCC	SN: 1050	01-Oct-13 (in house check Oct-17)	Oct-19	AMMI Audio Measuring Instrument	SN: 1062	26-Sep-12 (in house check Oct-17)	Oct-19
Primary Standards	ID #	Cal Date (Certificate No.)	Scheduled Calibration																												
Keithley Multimeter Type 2001	SN: 0810278	03-Sep-18 (No. 23488)	Sep-19																												
Reference Probe AM1DV2	SN: 1008	20-Dec-18 (No. AM1DV2-1008_Dec18)	Dec-19																												
DAE4	SN: 781	09-Jan-19 (No. DAE4-781_Jan19)	Jan-20																												
Secondary Standards	ID #	Check Date (in house)	Scheduled Check																												
AMCC	SN: 1050	01-Oct-13 (in house check Oct-17)	Oct-19																												
AMMI Audio Measuring Instrument	SN: 1062	26-Sep-12 (in house check Oct-17)	Oct-19																												
Calibrated by:	Name Claudio Leubler	Function Laboratory Technician	Signature 																												
Approved by:	Name Katja Pokovic	Function Technical Manager																													
			Issued: July 23, 2019																												
This calibration certificate shall not be reproduced except in full without written approval of the laboratory.																															

[References

- [1] ANSI-C63.19-2007
American National Standard for Methods of Measurement of Compatibility between Wireless Communications Devices and Hearing Aids.
- [2] ANSI-C63.19-2011
American National Standard, Methods of Measurement of Compatibility between Wireless Communications Devices and Hearing Aids.
- [3] DASY5 manual, Chapter: Hearing Aid Compatibility (HAC) T-Coil Extension

Description of the AM1D probe

The AM1D Audio Magnetic Field Probe is a fully shielded magnetic field probe for the frequency range from 100 Hz to 20 kHz. The pickup coil is compliant with the dimensional requirements of [1+2]. The probe includes a symmetric low noise amplifier for the signal available at the shielded 3 pin connector at the side. Power is supplied via the same connector (phantom power supply) and monitored via the LED near the connector. The 7 pin connector at the end of the probe does not carry any signals, but determines the angle of the sensor when mounted on the DAE. The probe supports mechanical detection of the surface.

The single sensor in the probe is arranged in a tilt angle allowing measurement of 3 orthogonal field components when rotating the probe by 120° around its axis. It is aligned with the perpendicular component of the field, if the probe axis is tilted nominally 35.3° above the measurement plane, using the connector rotation and sensor angle stated below.

The probe is fully RF shielded when operated with the matching signal cable (shielded) and allows measurement of audio magnetic fields in the close vicinity of RF emitting wireless devices according to [1+2] without additional shielding.

Handling of the item

The probe is manufactured from stainless steel. In order to maintain the performance and calibration of the probe, it must not be opened. The probe is designed for operation in air and shall not be exposed to humidity or liquids. For proper operation of the surface detection and emergency stop functions in a DASY system, the probe must be operated with the special probe cup provided (larger diameter).

Methods Applied and Interpretation of Parameters

- *Coordinate System:* The AM1D probe is mounted in the DASY system for operation with a HAC Test Arch phantom with AMCC Helmholtz calibration coil according to [3], with the tip pointing to “southwest” orientation.
- *Functional Test:* The functional test preceding calibration includes test of Noise level
RF immunity (1kHz AM modulated signal). The shield of the probe cable must be well connected. Frequency response verification from 100 Hz to 10 kHz.
- *Connector Rotation:* The connector at the end of the probe does not carry any signals and is used for fixation to the DAE only. The probe is operated in the center of the AMCC Helmholtz coil using a 1 kHz magnetic field signal. Its angle is determined from the two minima at nominally +120° and –120° rotation, so the sensor in the tip of the probe is aligned to the vertical plane in z-direction, corresponding to the field maximum in the AMCC Helmholtz calibration coil.
- *Sensor Angle:* The sensor tilting in the vertical plane from the ideal vertical direction is determined from the two minima at nominally +120° and –120°. DASY system uses this angle to align the sensor for radial measurements to the x and y axis in the horizontal plane.

Sensitivity: With the probe sensor aligned to the z-field in the AMCC, the output of the probe is compared to the magnetic field in the AMCC at 1 kHz. The field in the AMCC Helmholtz coil is given by the geometry and the current through the coil, which is monitored on the precision shunt resistor of the coil.

AM1D probe identification and configuration data

Item	AM1DV2 Audio Magnetic 1D Field Probe
Type No	SP AM1 001 AF
Serial No	1064

Overall length	296 mm
Tip diameter	6.0 mm (at the tip)
Sensor offset	3.0 mm (centre of sensor from tip)
Internal Amplifier	40 dB

Manufacturer / Origin	Schmid & Partner Engineering AG, Zurich, Switzerland
-----------------------	--

Calibration data

Connector rotation angle	(in DASY system)	103.0°	+/- 3.6 ° (k=2)
Sensor angle	(in DASY system)	0.63°	+/- 0.5 ° (k=2)
Sensitivity at 1 kHz	(in DASY system)	0.0657 V/(A/m)	+/- 2.2 % (k=2)

The reported uncertainty of measurement is stated as the standard uncertainty of measurement multiplied by the coverage factor k=2, which for a normal distribution corresponds to a coverage probability of approximately 95%.



ANNEX E DAE CALIBRATION CERTIFICATE



In Collaboration with
s p e a g
CALIBRATION LABORATORY



中国认可
国际互认
校准
CALIBRATION
CNAS L0570

Add: No.51 Xueyuan Road, Haidian District, Beijing, 100191, China
Tel: +86-10-62304633-2512 Fax: +86-10-62304633-2504
E-mail: cttl@chinattl.com [Http://www.chinattl.cn](http://www.chinattl.cn)

Client : **CTTL**

Certificate No: **Z20-60014**

CALIBRATION CERTIFICATE

Object: DAE4 - SN: 777

Calibration Procedure(s): FF-Z11-002-01
Calibration Procedure for the Data Acquisition Electronics (DAEx)

Calibration date: January 08, 2020

This calibration Certificate documents the traceability to national standards, which realize the physical units of measurements(SI). The measurements and the uncertainties with confidence probability are given on the following pages and are part of the certificate.

All calibrations have been conducted in the closed laboratory facility: environment temperature(22±3)°C and humidity<70%.

Calibration Equipment used (M&TE critical for calibration)

Primary Standards	ID #	Cal Date(Calibrated by, Certificate No.)	Scheduled Calibration
Process Calibrator 753	1971018	24-Jun-19 (CTTL, No.J19X05126)	Jun-20

	Name	Function	Signature
Calibrated by:	Yu Zongying	SAR Test Engineer	
Reviewed by:	Lin Hao	SAR Test Engineer	
Approved by:	Qi Dianyuan	SAR Project Leader	

Issued: January 10, 2020

This calibration certificate shall not be reproduced except in full without written approval of the laboratory.



Add: No.51 Xueyuan Road, Haidian District, Beijing, 100191, China
Tel: +86-10-62304633-2512 Fax: +86-10-62304633-2504
E-mail: cttl@chinattl.com Http://www.chinattl.cn

Glossary:

DAE data acquisition electronics
Connector angle information used in DASY system to align probe sensor X to the robot coordinate system.

Methods Applied and Interpretation of Parameters:

- *DC Voltage Measurement:* Calibration Factor assessed for use in DASY system by comparison with a calibrated instrument traceable to national standards. The figure given corresponds to the full scale range of the voltmeter in the respective range.
- *Connector angle:* The angle of the connector is assessed measuring the angle mechanically by a tool inserted. Uncertainty is not required.
- The report provide only calibration results for DAE, it does not contain other performance test results.



Add: No.51 Xueyuan Road, Haidian District, Beijing, 100191, China
Tel: +86-10-62304633-2512 Fax: +86-10-62304633-2504
E-mail: cttl@chinattl.com Http://www.chinattl.cn

DC Voltage Measurement

A/D - Converter Resolution nominal
High Range: 1LSB = 6.1µV, full range = -100...+300 mV
Low Range: 1LSB = 61nV, full range = -1.....+3mV
DASY measurement parameters: Auto Zero Time: 3 sec; Measuring time: 3 sec

Table with 4 columns: Calibration Factors, X, Y, Z. Rows include High Range and Low Range with numerical values and error margins.

Connector Angle

Table with 2 columns: Connector Angle to be used in DASY system, 95.5° ± 1°



The photos of HAC test are presented in the additional document:

Appendix to test report No.I20Z60778-SEM03/04

The photos of HAC test