



SAR TEST REPORT

No. I20Z60986-SEM02

For

TCL Communication Ltd.

LTE/UMTS/GSM Mobile Phone

Model Name: T766A

With

Hardware Version: PIO

Software Version: 6J57

FCC ID: 2ACCJH126

Issued Date: 2020-7-17

Note:

The test results in this test report relate only to the devices specified in this report. This report shall not be reproduced except in full without the written approval of CTTL.

The report must not be used by the client to claim product certification, approval, or endorsement by NVLAP, NIST, or any agency of the U.S. Government.

Test Laboratory:

CTTL, Telecommunication Technology Labs, CAICT

No. 51, Xueyuan Road, Haidian District, Beijing, P. R. China 100191.

Tel:+86(0)10-62304633-2512, Fax:+86(0)10-62304633-2504

Email: ctl_terminals@caict.ac.cn, website: www.caict.ac.cn



No.I20Z60986-SEM02

REPORT HISTORY

Report Number	Revision	Issue Date	Description
I20Z60986-SEM02	Rev.0	2020-7-17	Initial creation of test report

**TABLE OF CONTENT**

1 TEST LABORATORY	5
1.1 TESTING LOCATION	5
1.2 TESTING ENVIRONMENT.....	5
1.3 PROJECT DATA	5
1.4 SIGNATURE.....	5
2 STATEMENT OF COMPLIANCE	6
3 CLIENT INFORMATION	8
3.1 APPLICANT INFORMATION	8
3.2 MANUFACTURER INFORMATION	8
4 EQUIPMENT UNDER TEST (EUT) AND ANCILLARY EQUIPMENT (AE)	9
4.1 ABOUT EUT	9
4.2 INTERNAL IDENTIFICATION OF EUT USED DURING THE TEST	9
4.3 INTERNAL IDENTIFICATION OF AE USED DURING THE TEST	9
5 TEST METHODOLOGY	10
5.1 APPLICABLE LIMIT REGULATIONS	10
5.2 APPLICABLE MEASUREMENT STANDARDS	10
6 SPECIFIC ABSORPTION RATE (SAR)	11
6.1 INTRODUCTION.....	11
6.2 SAR DEFINITION.....	11
7 TISSUE SIMULATING LIQUIDS	12
7.1 TARGETS FOR TISSUE SIMULATING LIQUID.....	12
7.2 DIELECTRIC PERFORMANCE	12
8 SYSTEM VERIFICATION	16
8.1 SYSTEM SETUP.....	16
8.2 SYSTEM VERIFICATION.....	17
9 MEASUREMENT PROCEDURES	17
9.1 TESTS TO BE PERFORMED	17
9.2 GENERAL MEASUREMENT PROCEDURE.....	19
9.3 WCDMA MEASUREMENT PROCEDURES FOR SAR	20
9.4 SAR MEASUREMENT FOR LTE.....	21
9.5 BLUETOOTH & WI-FI MEASUREMENT PROCEDURES FOR SAR	22
9.6 POWER DRIFT.....	22
10 AREA SCAN BASED 1-G SAR	23
10.1 REQUIREMENT OF KDB.....	23
10.2 FAST SAR ALGORITHMS.....	23



11 CONDUCTED OUTPUT POWER.....	24
11.1 GSM MEASUREMENT RESULT	24
11.2 WCDMA MEASUREMENT RESULT	26
11.3 LTE MEASUREMENT RESULT	27
11.4 WI-FI AND BT MEASUREMENT RESULT	45
12 SIMULTANEOUS TX SAR CONSIDERATIONS.....	46
12.1 INTRODUCTION.....	46
12.2 TRANSMIT ANTENNA SEPARATION DISTANCES.....	46
12.3 SAR MEASUREMENT POSITIONS	47
12.4 STANDALONE SAR TEST EXCLUSION CONSIDERATIONS	47
13 EVALUATION OF SIMULTANEOUS.....	48
14 SAR TEST RESULT	49
14.1 SAR RESULTS FOR FAST SAR	50
14.2 SAR RESULTS FOR STANDARD PROCEDURE	63
14.3 WLAN EVALUATION FOR 2.4G	69
14.4 BT EVALUATION.....	72
15 SAR MEASUREMENT VARIABILITY.....	72
16 MEASUREMENT UNCERTAINTY	74
16.1 MEASUREMENT UNCERTAINTY FOR NORMAL SAR TESTS (300MHZ~3GHZ).....	74
16.2 MEASUREMENT UNCERTAINTY FOR NORMAL SAR TESTS (3~6GHZ)	75
16.3 MEASUREMENT UNCERTAINTY FOR FAST SAR TESTS (300MHZ~3GHZ).....	76
16.4 MEASUREMENT UNCERTAINTY FOR FAST SAR TESTS (3~6GHZ)	77
17 MAIN TEST INSTRUMENTS.....	78
ANNEX A GRAPH RESULTS.....	79
ANNEX B SYSTEM VERIFICATION RESULTS	117
ANNEX C SAR MEASUREMENT SETUP	124
ANNEX D POSITION OF THE WIRELESS DEVICE IN RELATION TO THE PHANTOM	130
ANNEX E EQUIVALENT MEDIA RECIPES.....	134
ANNEX F SYSTEM VALIDATION.....	135
ANNEX G PROBE CALIBRATION CERTIFICATE.....	136
ANNEX H DIPOLE CALIBRATION CERTIFICATE	159
ANNEX I SPOT CHECK.....	207
ANNEX J ACCREDITATION CERTIFICATE.....	318

1 Test Laboratory

1.1 Testing Location

Company Name:	CTTL(Shouxiang)
Address:	No. 51 Shouxiang Science Building, Xueyuan Road, Haidian District, Beijing, P. R. China100191

1.2 Testing Environment

Temperature:	18°C~25°C,
Relative humidity:	30%~ 70%
Ground system resistance:	< 0.5 Ω
Ambient noise & Reflection:	< 0.012 W/kg

1.3 Project Data

Project Leader:	Qi Dianyuan
Test Engineer:	Lin Xiaojun
Testing Start Date:	July 13, 2020
Testing End Date:	July 16, 2020

1.4 Signature



Lin Xiaojun

(Prepared this test report)

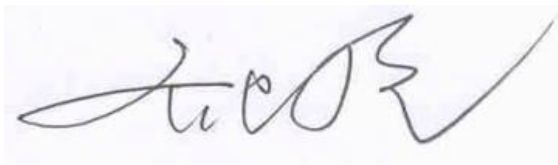

Qi Dianyuan

(Reviewed this test report)

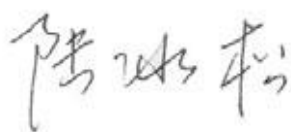

Lu Bingsong

Deputy Director of the laboratory

(Approved this test report)

2 Statement of Compliance

This EUT is a variant product and the report of original sample is No.I20Z60652-SEM02. We share the test results of original sample and do spot check. The results of spot check are presented in the annex I.

The maximum results of SAR found during testing for TCL Communication Ltd. LTE/UMTS/GSM Mobile Phone T766A are as follows:

Table 2.1: Highest Reported SAR (1g)

Exposure Configuration	Technology Band	Highest Reported SAR 1g(W/kg)	Equipment Class
Head (Separation Distance 0mm)	GSM 850	1.27	PCE
	PCS 1900	0.14	
	WCDMA1900	0.18	
	WCDMA1700	0.16	
	WCDMA850	0.86	
	LTE Band 2	0.16	
	LTE Band 5	0.96	
	LTE Band 7	0.08	
	LTE Band 12	0.13	
	LTE Band 13	0.37	
	LTE Band 66	0.16	
WLAN 2.4 GHz	0.46	DTS	
Hotspot (Separation Distance 10mm)	GSM 850	0.41	PCE
	PCS 1900	0.50	
	WCDMA1900	0.72	
	WCDMA1700	1.12	
	WCDMA850	0.28	
	LTE Band 2	0.84	
	LTE Band 5	0.20	
	LTE Band 7	0.97	
	LTE Band 12	0.27	
	LTE Band 13	0.60	
	LTE Band 66	0.93	
WLAN 2.4 GHz	0.15	DTS	
Body-worn (Separation Distance 15mm)	PCS 1900	0.38	PCE
	WCDMA1900	0.45	
	LTE Band 2	0.46	
	LTE Band 7	0.57	

The SAR values found for the Mobile Phone are below the maximum recommended levels of 1.6 W/kg as averaged over any 1g tissue according to the ANSI C95.1-1992.

For body operation, this device has been tested and meets FCC RF exposure guidelines when used with any accessory that contains no metal and which provides a minimum separation distance of 10 mm for hotspot and 15mm for body worn between this device and the body of the user. Use of other accessories may not ensure compliance with FCC RF exposure guidelines.

The EUT battery must be fully charged and checked periodically during the test to ascertain uniform

power output.

The measurement together with the test system set-up is described in annex C of this test report. A detailed description of the equipment under test can be found in chapter 4 of this test report. The highest reported SAR value is obtained at the case of (Table 2.1), and the values are: **1.27 W/kg(1g)**.

Table 2.2: The sum of reported SAR values for main antenna and WiFi2.4G

	Position	Main antenna	WiFi	Sum
Highest reported SAR value for Head	Left Tilt	1.27 (GSM850)	0.27	1.54
Highest reported SAR value for Body	Bottom 10mm	1.12 (WCDMA1700)	0.00	1.12

Table 2.4: The sum of reported SAR values for main antenna and BT

	Position	Main antenna	BT	Sum
Maximum reported SAR value for Head	Right hand, Touch cheek	1.27 (GSM850)	<0.01	1.27
Maximum reported SAR value for Body	Bottom 10mm	1.12 (WCDMA1700)	<0.01	1.12

[1] - Estimated SAR for Bluetooth (see the table 13.3)

According to the above tables, the highest sum of reported SAR values is **1.54 W/kg (1g)**. The detail for simultaneous transmission consideration is described in chapter 13.

According to the KDB648474 D04, the UMPC mini-tablet procedures must also be applied to test the SAR of all surfaces and edges with an antenna located at ≤ 25 mm from that surface or edge, in direct contact with a flat phantom, for 10-g extremity SAR according to the body-equivalent tissue dielectric parameters in KDB Publication 865664 D01 to address interactive hand use exposure conditions. When hotspot mode applies, 10-g extremity SAR is required only for the surfaces and edges with hotspot mode 1-g reported SAR > 1.2 W/kg

Table 2.5: 0mm Reported SAR for phablet (10g)

Exposure Configuration	Technology Band	Highest Reported SAR 10g(W/kg)	Limit 10g (W/kg)
Hotspot (SeparationDistance0mm)	LTE B2	3.88	4.0
	LTE Band7	3.74	4.0



3 Client Information

3.1 Applicant Information

Company Name:	TCL Communication Ltd.
Address/Post:	5/F, Building 22E, 22 Science Park East Avenue,Hong Kong Science Park, Shatin, NT, Hong Kong
Contact Person:	Gong Zhizhou
Contact Email:	zhizhou.gong@tcl.com
Telephone:	0086-755-36611722
Fax:	/

3.2 Manufacturer Information

Company Name:	TCL Communication Ltd.
Address/Post:	5/F, Building 22E, 22 Science Park East Avenue,Hong Kong Science Park, Shatin, NT, Hong Kong
Contact Person:	Gong Zhizhou
Contact Email:	zhizhou.gong@tcl.com
Telephone:	0086-755-36611722
Fax:	/

4 Equipment Under Test (EUT) and Ancillary Equipment (AE)

4.1 About EUT

Description:	LTE/UMTS/GSM mobile phone
Model name:	T766A
Operating mode(s):	GSM 850/900/1800/1900, UMTS FDD 1/2/4/5/8, BT, Wi-Fi, LTE Band 1/2/3/4/5/7/8/12/13/17/28/66
Tested Tx Frequency:	824 – 849 MHz (GSM 850)
	1850 – 1910 MHz (GSM 1900)
	824–849 MHz (WCDMA 850 Band V)
	1710 – 1755 MHz (WCDMA 1700 Band IV)
	1850–1910 MHz (WCDMA1900 Band II)
	1860 – 1900 MHz (LTE Band 2)
	824-849 MHz (LTE Band 5)
	2502.5 – 2567.5 MHz(LTE Band 7)
	699.7 – 715.3 MHz (LTE Band 12)
	779.5 –784.5 MHz (LTE Band 13)
	1710.7 – 1779.3 MHz (LTE Band 66)
2412 – 2462 MHz (Wi-Fi 2.4G)	
GPRS/EGPRS Multislot Class:	12
GPRS capability Class:	B
Test device Production information:	Production unit
Device type:	Mobile phone(touchscreen)
Antenna type:	Embedded
Hotspot mode:	Support

4.2 Internal Identification of EUT used during the test

EUT ID*	IMEI	HW	SW Version
EUT1	354841190000322	PIO	6J57
EUT2	354841190000314	PIO	6J57

*EUT ID: is used to identify the test sample in the lab internally.

Note: It is performed to test SAR with the EUT1 and conducted power with the EUT2.

4.3 Internal Identification of AE used during the test

AE ID*	Description	Model	SN	Manufacturer
AE1	Battery	CAC3860025C7	/	VEKEN
AE2	Battery	CAC3860024C1	/	BYD
AE3	Headset	CCB0046A15C1	/	DALIN
AE4	Headset	CCB0070B10C1	/	JUWEI

*AE ID: is used to identify the test sample in the lab internally.

5 TEST METHODOLOGY

5.1 Applicable Limit Regulations

ANSI C95.1–1992: IEEE Standard for Safety Levels with Respect to Human Exposure to Radio Frequency Electromagnetic Fields, 3 kHz to 300 GHz.

It specifies the maximum exposure limit of **1.6 W/kg** as averaged over any 1 gram of tissue for portable devices being used within 20 cm of the user in the uncontrolled environment.

5.2 Applicable Measurement Standards

IEEE 1528–2013: Recommended Practice for Determining the Peak Spatial-Average Specific Absorption Rate (SAR) in the Human Head from Wireless Communications Devices: Measurement Techniques.

KDB447498 D01: General RF Exposure Guidance v06: Mobile and Portable Devices RF Exposure Procedures and Equipment Authorization Policies.

KDB648474 D04 Handset SAR v01r03: SAR Evaluation Considerations for Wireless Handsets.

KDB941225 D01 SAR test for 3G devices v03r01: SAR Measurement Procedures for 3G Devices

KDB941225 D05 SAR for LTE Devices v02r05: SAR Evaluation Considerations for LTE Devices

KDB941225 D06 Hotspot Mode SAR v02r01: SAR Evaluation Procedures for Portable Devices with Wireless Router Capabilities

KDB248227 D01 802.11 Wi-Fi SAR v02r02: SAR GUIDANCE FOR IEEE 802.11 (Wi-Fi) TRANSMITTERS

KDB865664 D01 SAR measurement 100 MHz to 6 GHz v01r04: SAR Measurement Requirements for 100 MHz to 6 GHz.

KDB865664 D02 RF Exposure Reporting v01r02: RF Exposure Compliance Reporting and Documentation Considerations

6 Specific Absorption Rate (SAR)

6.1 Introduction

SAR is related to the rate at which energy is absorbed per unit mass in an object exposed to a radio field. The SAR distribution in a biological body is complicated and is usually carried out by experimental techniques or numerical modeling. The standard recommends limits for two tiers of groups, occupational/controlled and general population/uncontrolled, based on a person's awareness and ability to exercise control over his or her exposure. In general, occupational/controlled exposure limits are higher than the limits for general population/uncontrolled.

6.2 SAR Definition

The SAR definition is the time derivative (rate) of the incremental energy (dW) absorbed by (dissipated in) an incremental mass (dm) contained in a volume element (dv) of a given density (ρ). The equation description is as below:

$$SAR = \frac{d}{dt} \left(\frac{dW}{dm} \right) = \frac{d}{dt} \left(\frac{dW}{\rho dv} \right)$$

SAR is expressed in units of Watts per kilogram (W/kg)

SAR measurement can be either related to the temperature elevation in tissue by

$$SAR = c \left(\frac{\delta T}{\delta t} \right)$$

Where: C is the specific heat capacity, δT is the temperature rise and δt is the exposure duration, or related to the electrical field in the tissue by

$$SAR = \frac{\sigma |E|^2}{\rho}$$

Where: σ is the conductivity of the tissue, ρ is the mass density of tissue and E is the RMS electrical field strength.

However for evaluating SAR of low power transmitter, electrical field measurement is typically applied.

7 Tissue Simulating Liquids

7.1 Targets for tissue simulating liquid

Table 7.1: Targets for tissue simulating liquid

Frequency(MHz)	Liquid Type	Conductivity(σ)	$\pm 5\%$ Range	Permittivity(ϵ)	$\pm 5\%$ Range
750	Head	0.89	0.85~0.93	41.94	39.8~44.0
835	Head	0.90	0.86~0.95	41.5	39.4~43.6
1750	Head	1.37	1.30~1.44	40.08	38.1~42.1
1900	Head	1.40	1.33~1.47	40.0	38.0~42.0
2450	Head	1.80	1.71~1.89	39.2	37.2~41.2
2600	Head	1.96	1.86~2.06	39.01	37.1~41.0

7.2 Dielectric Performance

Table 7.2: Dielectric Performance of Tissue Simulating Liquid

Measurement Date yyyy/mm/dd	Frequency	Type	Permittivity ϵ	Drift (%)	Conductivity σ (S/m)	Drift (%)
2020/6/17	750 MHz	Head	42.07	0.31	0.897	0.79
2020/6/18	835 MHz	Head	41.45	-0.12	0.884	-1.78
2020/6/19	1750 MHz	Head	39.44	-1.60	1.374	0.29
2020/6/20	1900 MHz	Head	39.33	-1.68	1.382	-1.29
2020/6/21	2450 MHz	Head	39.22	0.05	1.813	0.72
2020/6/22	2600 MHz	Head	38.4	-1.56	1.96	0.00

Note: The liquid temperature is 22.0°C

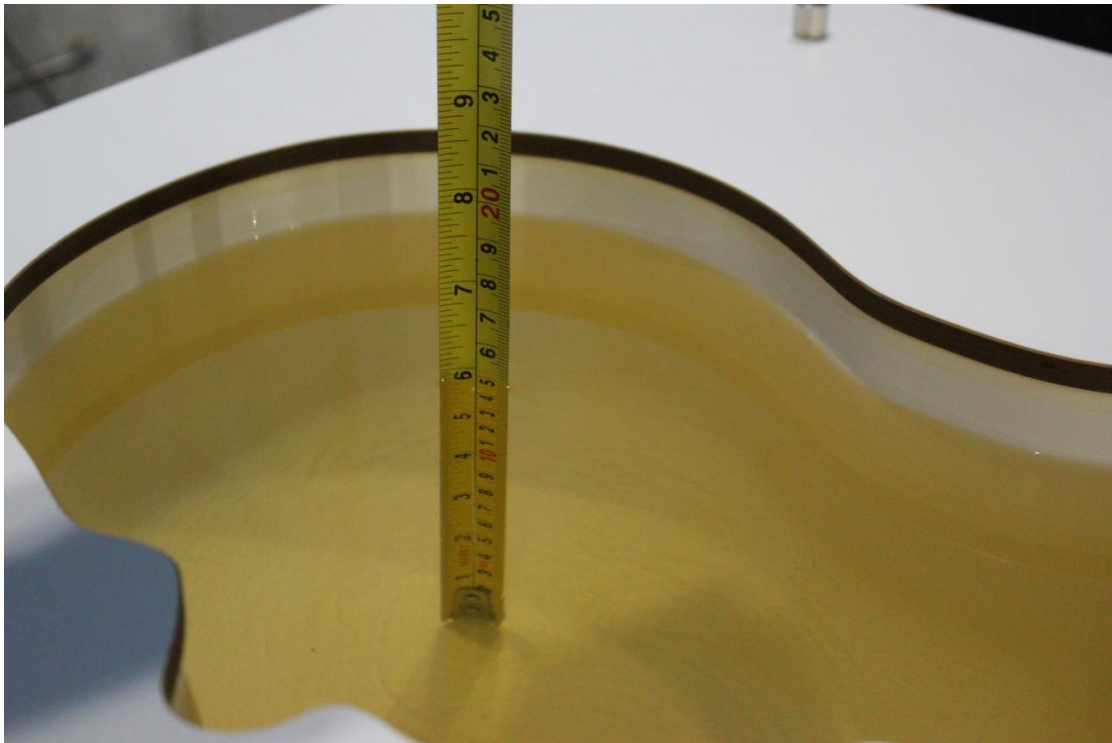

Picture 7-1 Liquid depth in the Head Phantom (750MHz)

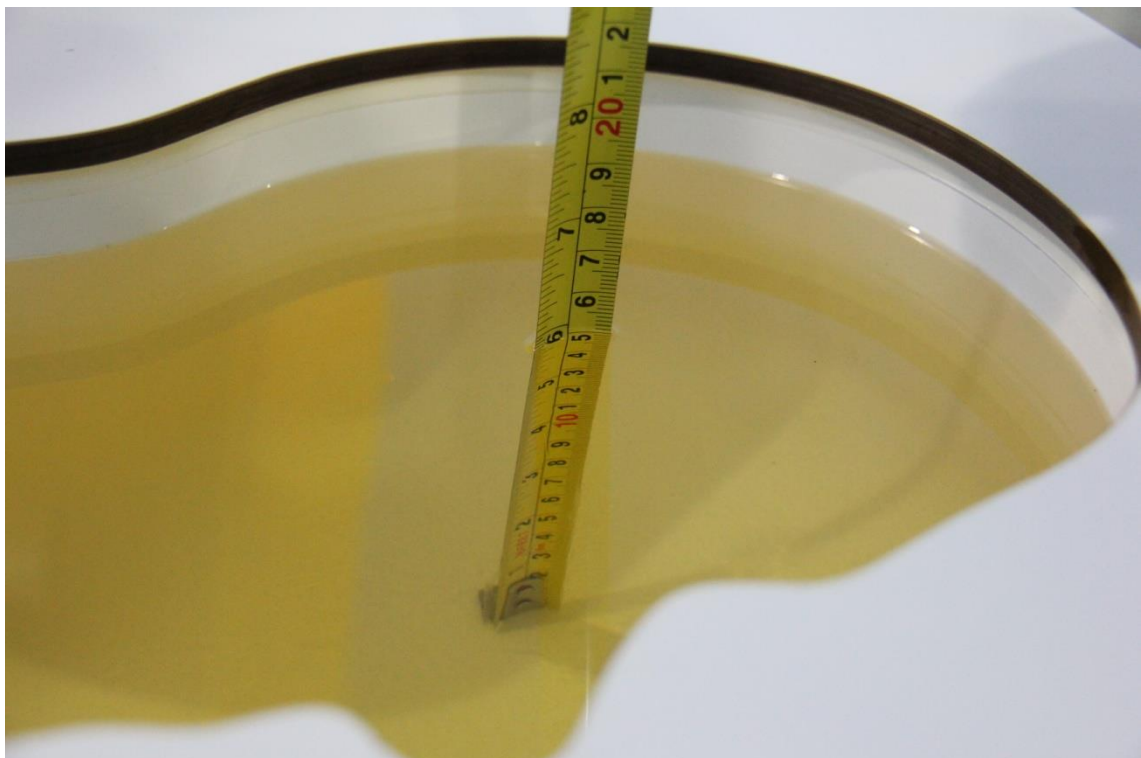

Picture 7-2 Liquid depth in the Head Phantom (835 MHz)



Picture 7-3 Liquid depth in the Head Phantom (1750 MHz)



Picture 7-4 Liquid depth in the Head Phantom (1900 MHz)

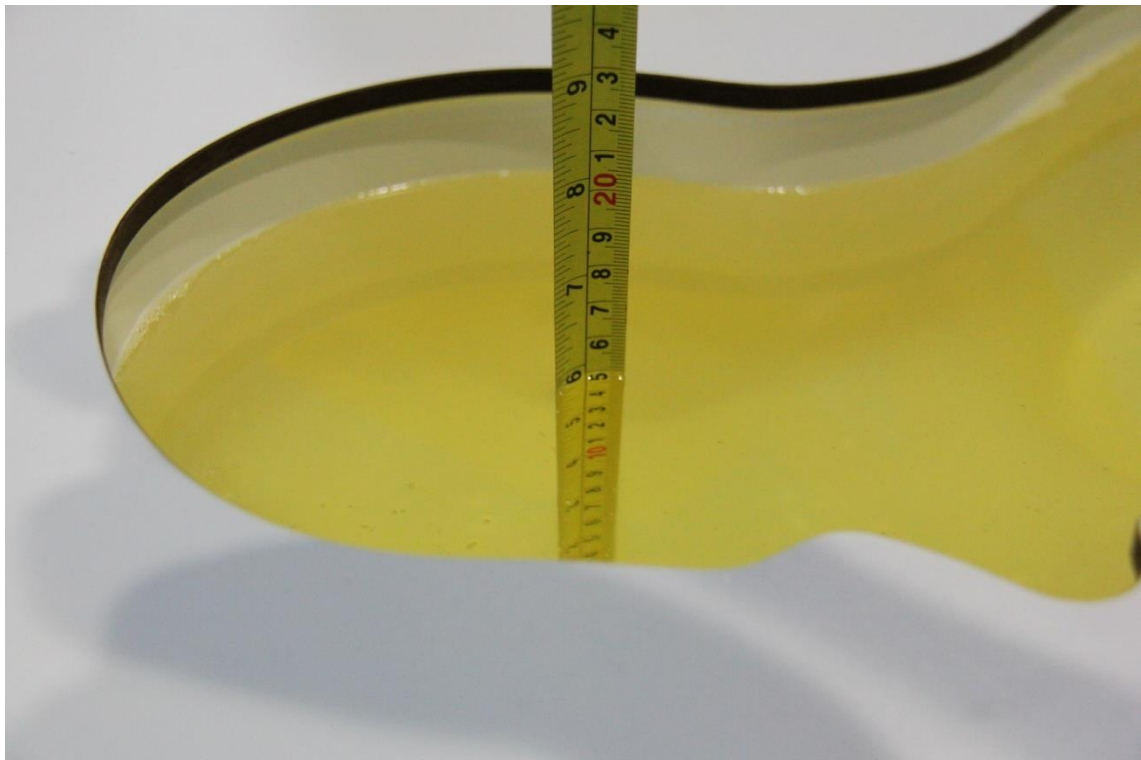

Picture 7-5 Liquid depth in the Head Phantom (2450MHz)

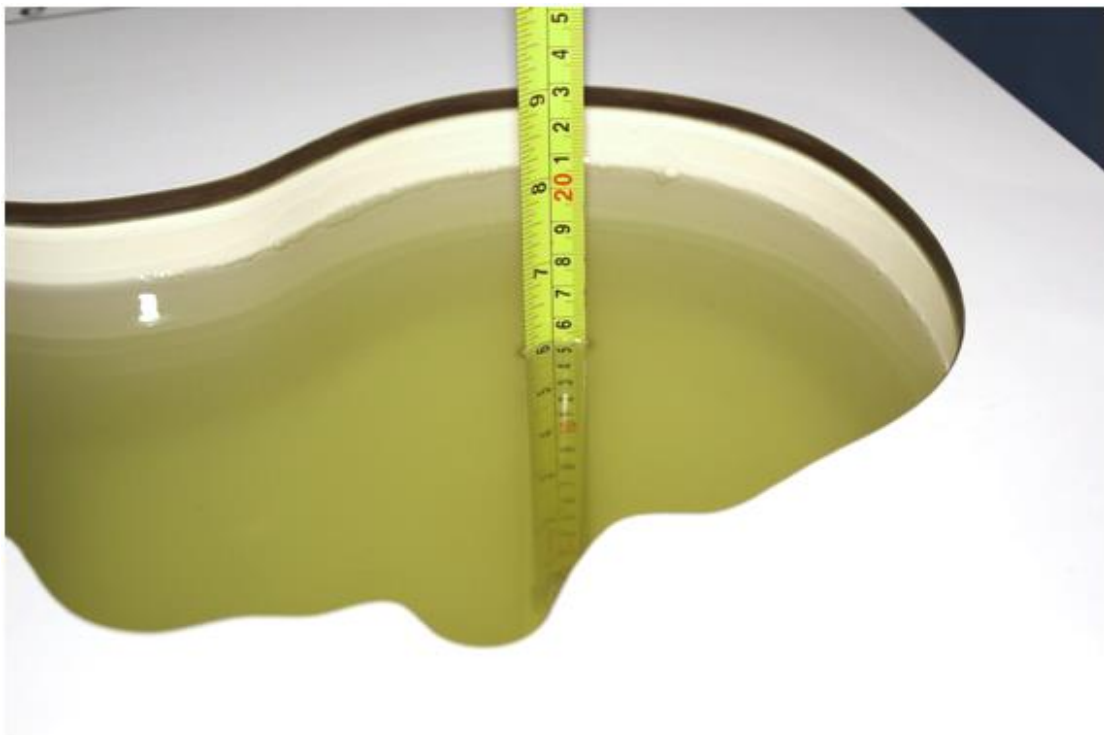

Picture 7-6 Liquid depth in the Head Phantom (2600 MHz)

8 System verification

8.1 System Setup

In the simplified setup for system evaluation, the DUT is replaced by a calibrated dipole and the power source is replaced by a continuous wave that comes from a signal generator. The calibrated dipole must be placed beneath the flat phantom section of the SAM twin phantom with the correct distance holder. The distance holder should touch the phantom surface with a light pressure at the reference marking and be oriented parallel to the long side of the phantom. The equipment setup is shown below:

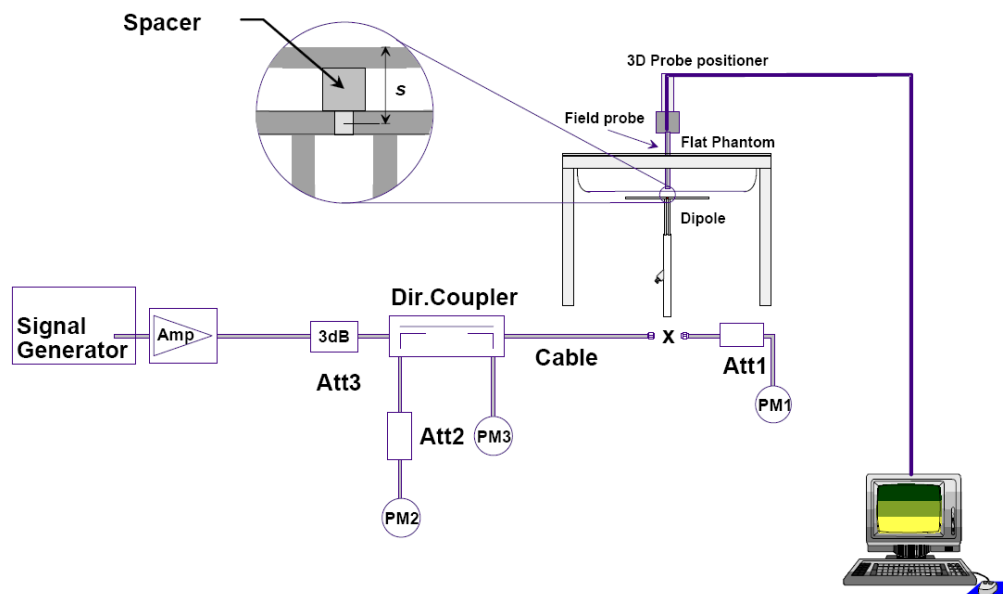

Picture 8.1 System Setup for System Evaluation



Picture 8.2 Photo of Dipole Setup

8.2 System Verification

SAR system verification is required to confirm measurement accuracy, according to the tissue dielectric media, probe calibration points and other system operating parameters required for measuring the SAR of a test device. The system verification must be performed for each frequency band and within the valid range of each probe calibration point required for testing the device.

The system verification results are required that the area scan estimated 1-g SAR is within 3% of the zoom scan 1-g SAR. The details are presented in annex B.

Table 8.1: System Verification of Head

Measurement Date (yyyy-mm-dd)	Frequency	Target value (W/kg)		Measured value (W/kg)		Deviation	
		10 g Average	1 g Average	10 g Average	1 g Average	10 g Average	1 g Average
2020/6/17	750 MHz	5.57	8.57	5.64	8.52	1.26%	-0.58%
2020/6/18	835 MHz	6.29	9.70	6.24	9.76	-0.79%	0.62%
2020/6/19	1750 MHz	19.3	36.6	19.24	36.12	-0.31%	-1.31%
2020/6/20	1900 MHz	20.8	39.7	21.16	39.8	1.73%	0.25%
2020/6/21	2450 MHz	24.2	51.6	23.96	50.88	-0.99%	-1.40%
2020/6/22	2600 MHz	25.1	55.8	25.24	54.68	0.56%	-2.01%

9 Measurement Procedures

9.1 Tests to be performed

In order to determine the highest value of the peak spatial-average SAR of a handset, all device positions, configurations and operational modes shall be tested for each frequency band according to steps 1 to 3 below. A flowchart of the test process is shown in picture 9.1.

Step 1: The tests described in 9.2 shall be performed at the channel that is closest to the centre of the transmit frequency band (f_c) for:

- all device positions (cheek and tilt, for both left and right sides of the SAM phantom, as described in annex D),
- all configurations for each device position in a), e.g., antenna extended and retracted, and
- all operational modes, e.g., analogue and digital, for each device position in a) and configuration in b) in each frequency band.

If more than three frequencies need to be tested according to 11.1 (i.e., $N_c > 3$), then all frequencies, configurations and modes shall be tested for all of the above test conditions.

Step 2: For the condition providing highest peak spatial-average SAR determined in Step 1, perform all tests described in 9.2 at all other test frequencies, i.e., lowest and highest frequencies. In addition, for all other conditions (device position, configuration and operational

mode) where the peak spatial-average SAR value determined in Step 1 is within 3 dB of the applicable SAR limit, it is recommended that all other test frequencies shall be tested as well.

Step 3: Examine all data to determine the highest value of the peak spatial-average SAR found in Steps 1 to 2.

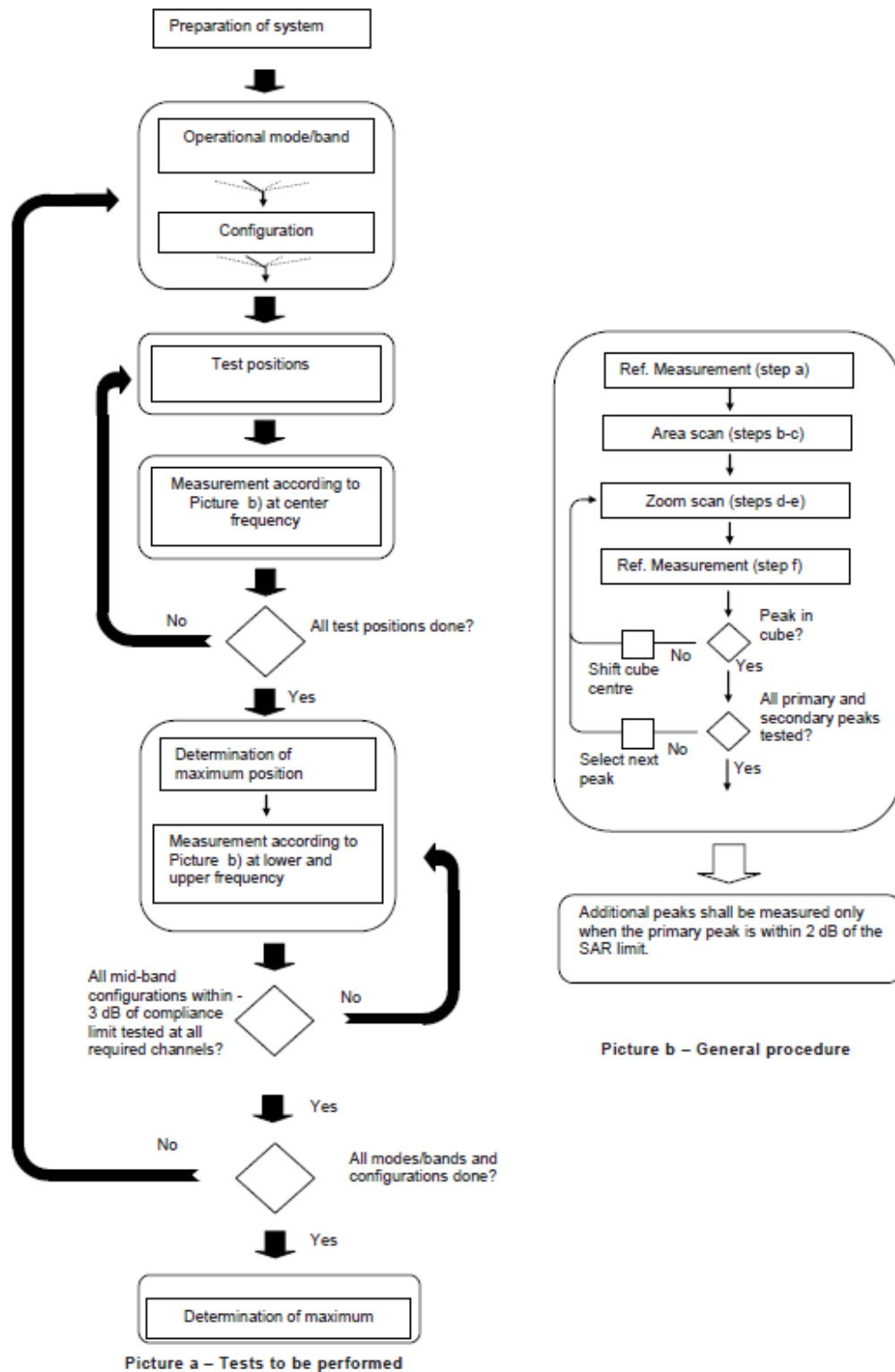

Picture 9.1 Block diagram of the tests to be performed

9.2 General Measurement Procedure

The area and zoom scan resolutions specified in the table below must be applied to the SAR measurements and fully documented in SAR reports to qualify for TCB approval. Probe boundary effect error compensation is required for measurements with the probe tip closer than half a probe tip diameter to the phantom surface. Both the probe tip diameter and sensor offset distance must satisfy measurement protocols; to ensure probe boundary effect errors are minimized and the higher fields closest to the phantom surface can be correctly measured and extrapolated to the phantom surface for computing 1-g SAR. Tolerances of the post-processing algorithms must be verified by the test laboratory for the scan resolutions used in the SAR measurements, according to the reference distribution functions specified in IEEE Std 1528-2003. The results should be documented as part of the system validation records and may be requested to support test results when all the measurement parameters in the following table are not satisfied.

		≤ 3 GHz	> 3 GHz
Maximum distance from closest measurement point (geometric center of probe sensors) to phantom surface		5 ± 1 mm	$\frac{1}{2} \cdot \delta \cdot \ln(2) \pm 0.5$ mm
Maximum probe angle from probe axis to phantom surface normal at the measurement location		$30^\circ \pm 1^\circ$	$20^\circ \pm 1^\circ$
Maximum area scan spatial resolution: Δx_{Area} , Δy_{Area}		≤ 2 GHz: ≤ 15 mm 2 – 3 GHz: ≤ 12 mm	3 – 4 GHz: ≤ 12 mm 4 – 6 GHz: ≤ 10 mm
		When the x or y dimension of the test device, in the measurement plane orientation, is smaller than the above, the measurement resolution must be \leq the corresponding x or y dimension of the test device with at least one measurement point on the test device.	
Maximum zoom scan spatial resolution: Δx_{Zoom} , Δy_{Zoom}		≤ 2 GHz: ≤ 8 mm 2 – 3 GHz: ≤ 5 mm*	3 – 4 GHz: ≤ 5 mm* 4 – 6 GHz: ≤ 4 mm*
Maximum zoom scan spatial resolution, normal to phantom surface	uniform grid: $\Delta z_{Zoom}(n)$	≤ 5 mm	3 – 4 GHz: ≤ 4 mm 4 – 5 GHz: ≤ 3 mm 5 – 6 GHz: ≤ 2 mm
	graded grid	$\Delta z_{Zoom}(1)$: between 1 st two points closest to phantom surface	≤ 4 mm
		$\Delta z_{Zoom}(n>1)$: between subsequent points	$\leq 1.5 \cdot \Delta z_{Zoom}(n-1)$
Minimum zoom scan volume	x, y, z	≥ 30 mm	3 – 4 GHz: ≥ 28 mm 4 – 5 GHz: ≥ 25 mm 5 – 6 GHz: ≥ 22 mm
Note: δ is the penetration depth of a plane-wave at normal incidence to the tissue medium; see draft standard IEEE P1528-2011 for details. * When zoom scan is required and the <i>reported</i> SAR from the area scan based 1-g SAR estimation procedures of KDB 447498 is ≤ 1.4 W/kg, ≤ 8 mm, ≤ 7 mm and ≤ 5 mm zoom scan resolution may be applied, respectively, for 2 GHz to 3 GHz, 3 GHz to 4 GHz and 4 GHz to 6 GHz.			

9.3 WCDMA Measurement Procedures for SAR

The following procedures are applicable to WCDMA handsets operating under 3GPP Release99, Release 5 and Release 6. The default test configuration is to measure SAR with an established radio link between the DUT and a communication test set using a 12.2kbps RMC (reference measurement channel) configured in Test Loop Mode 1. SAR is selectively confirmed for other physical channel configurations (DPCCH & DPDCH_n), HSDPA and HSPA (HSUPA/HSDPA) modes according to output power, exposure conditions and device operating capabilities. Both uplink and downlink should be configured with the same RMC or AMR, when required. SAR for Release 5 HSDPA and Release 6 HSPA are measured using the applicable FRC (fixed reference channel) and E-DCH reference channel configurations. Maximum output power is verified according to applicable versions of 3GPP TS 34.121 and SAR must be measured according to these maximum output conditions. When Maximum Power Reduction (MPR) is not implemented according to Cubic Metric (CM) requirements for Release 6 HSPA, the following procedures do not apply.

For Release 5 HSDPA Data Devices:

Sub-test	β_c	β_d	β_d (SF)	β_c / β_d	β_{hs}	CM/dB
1	2/15	15/15	64	2/15	4/15	0.0
2	12/15	15/15	64	12/15	24/25	1.0
3	15/15	8/15	64	15/8	30/15	1.5
4	15/15	4/15	64	15/4	30/15	1.5

For Release 6 HSPA Data Devices

Sub-test	β_c	β_d	β_d (SF)	β_c / β_d	β_{hs}	β_{ec}	β_{ed}	β_{ed} (SF)	β_{ed} (codes)	CM (dB)	MPR (dB)	AG Index	E-TFCI
1	11/15	15/15	64	11/15	22/15	209/225	1039/225	4	1	1.5	1.5	20	75
2	6/15	15/15	64	6/15	12/15	12/15	12/15	4	1	1.5	1.5	12	67
3	15/15	9/15	64	15/9	30/15	30/15	$\beta_{ed1}:47/15$ $\beta_{ed2}:47/15$	4	2	1.5	1.5	15	92
4	2/15	15/15	64	2/15	4/15	4/15	56/75	4	1	1.5	1.5	17	71
5	15/15	15/15	64	15/15	24/15	30/15	134/15	4	1	1.5	1.5	21	81

Rel.8 DC-HSDPA (Cat 24)

SAR test exclusion for Rel.8 DC-HSDPA must satisfy the SAR test exclusion requirements of Rel.5 HSDPA. SAR test exclusion for DC-HSDPA devices is determined by power measurements according to the H-Set 12, Fixed Reference Channel (FRC) configuration in Table C.8.1.12 of 3GPP TS 34.121-1. A primary and a secondary serving HS-DSCH Cell are required to perform the power measurement and for the results to qualify for SAR test exclusion.

9.4 SAR Measurement for LTE

SAR tests for LTE are performed with a base station simulator, Rohde & Schwarz CMW500. Closed loop power control was used so the UE transmits with maximum output power during SAR testing. All powers were measured with the CMW 500.

It is performed for conducted power and SAR based on the KDB941225 D05.

SAR is evaluated separately according to the following procedures for the different test positions in each exposure condition – head, body, body-worn accessories and other use conditions. The procedures in the following subsections are applied separately to test each LTE frequency band.

1) QPSK with 1 RB allocation

Start with the largest channel bandwidth and measure SAR for QPSK with 1 RB allocation, using the RB offset and required test channel combination with the highest maximum output power among RB offsets at the upper edge, middle and lower edge of each required test channel. When the reported SAR is ≤ 0.8 W/kg, testing of the remaining RB offset configurations and required test channels is not required for 1 RB allocation; otherwise, SAR is required for the remaining required test channels and only for the RB offset configuration with the highest output power for that channel. When the reported SAR of a required test channel is > 1.45 W/kg, SAR is required for all three RB offset configurations for that required test channel.

2) QPSK with 50% RB allocation

The procedures required for 1 RB allocation in 1) are applied to measure the SAR for QPSK with 50% RB allocation.

3) QPSK with 100% RB allocation

For QPSK with 100% RB allocation, SAR is not required when the highest maximum output power for 100 % RB allocation is less than the highest maximum output power in 50% and 1 RB allocations and the highest reported SAR for 1 RB and 50% RB allocation in 1) and 2) are ≤ 0.8 W/kg. Otherwise, SAR is measured for the highest output power channel; and if the reported SAR is > 1.45 W/kg, the remaining required test channels must also be tested.

9.5 Bluetooth & Wi-Fi Measurement Procedures for SAR

Normal network operating configurations are not suitable for measuring the SAR of 802.11 transmitters in general. Unpredictable fluctuations in network traffic and antenna diversity conditions can introduce undesirable variations in SAR results. The SAR for these devices should be measured using chipset based test mode software to ensure that the results are consistent and reliable.

Chipset based test mode software is hardware dependent and generally varies among manufacturers. The device operating parameters established in a test mode for SAR measurements must be identical to those programmed in production units, including output power levels, amplifier gain settings and other RF performance tuning parameters. The test frequencies should correspond to actual channel frequencies defined for domestic use. SAR for devices with switched diversity should be measured with only one antenna transmitting at a time during each SAR measurement, according to a fixed modulation and data rate. The same data pattern should be used for all measurements.

9.6 Power Drift

To control the output power stability during the SAR test, DASY4 system calculates the power drift by measuring the E-field at the same location at the beginning and at the end of the measurement for each test position. These drift values can be found in section 14 labeled as: (Power Drift [dB]). This ensures that the power drift during one measurement is within 5%.

10 Area Scan Based 1-g SAR

10.1 Requirement of KDB

According to the KDB447498 D01 v05, when the implementation is based the specific polynomial fit

algorithm as presented at the 29th Bioelectromagnetics Society meeting (2007) and the estimated 1-gSAR is ≤ 1.2 W/kg, a zoom scan measurement is not required provided it is also not needed for any other purpose; for example, if the peak SAR location required for simultaneous transmission SAR test exclusion can be determined accurately by the SAR system or manually to discriminate between distinctive peaks and scattered noisy SAR distributions from area scans.

There must not be any warning or alert messages due to various measurement concerns identified by the SAR system; for example, noise in measurements, peaks too close to scan boundary, peaks are too sharp, spatial resolution and uncertainty issues etc. The SAR system verification must also demonstrate that the area scan estimated 1-g SAR is within 3% of the zoom scan 1-g SAR (See Annex B). When all the SAR results for each exposure condition in a frequency band and wireless mode are based on estimated 1-g SAR, the 1-g SAR for the highest SAR configuration must be determined by a zoom scan.

10.2 Fast SAR Algorithms

The approach is based on the area scan measurement applying a frequency dependent attenuation parameter. This attenuation parameter was empirically determined by analyzing a large number of phones. The MOTOROLA FAST SAR was developed and validated by the MOTOROLA Research Group in Ft. Lauderdale.

In the initial study, an approximation algorithm based on Linear fit was developed. The accuracy of the algorithm has been demonstrated across a broad frequency range (136-2450 MHz) and for both 1- and 10-g averaged SAR using a sample of 264 SAR measurements from 55 wireless handsets. For the sample size studied, the root-mean-squared errors of the algorithm are 1.2% and 5.8% for 1- and 10-g averaged SAR, respectively. The paper describing the algorithm in detail is expected to be published in August 2004 within the Special Issue of Transactions on MTT.

In the second step, the same research group optimized the fitting algorithm to an Polynomial fit whereby the frequency validity was extended to cover the range 30-6000MHz. Details of this study can be found in the BEMS 2007 Proceedings.

Both algorithms are implemented in DASY software.

11 Conducted Output Power

For Main antenna, there are two sets of tune-up power, Normal power and Low power, used for different use cases for PCS1900WCDMA1900 and LTE Band2/7. Normal power status is applied for head test and body worn test of above bands. Low power(hotspot on) status is applied for hotspot test of above bands. For other bands, Normal power status is applied for both head and body test.

11.1 GSM Measurement result

During the process of testing, the EUT was controlled via Agilent Digital Radio Communication tester (E5515C) to ensure the maximum power transmission and proper modulation. This result contains conducted output power for the EUT. In all cases, the measured peak output power should be greater and within 5% than EMI measurement.

**Table 11.1-1: The conducted power measurement results for GSM, GPRS and EGPRS-
Normal power**

GSM 850 Speech (GMSK)	Measured Power (dBm)			Tune up	calculation	Averaged Power (dBm)		
	251	190	128			251	190	128
1 Txslot	31.78	32.18	32.15	32.8	/	/	/	/
GSM 850 GPRS (GMSK)	Measured Power (dBm)				calculation	Averaged Power (dBm)		
	251	190	128			251	190	128
1 Txslot	31.75	32.13	32.15	32.80	-9.03	22.72	23.10	23.12
2 Txslots	28.84	29.09	29.00	29.50	-6.02	22.82	23.07	22.98
3Txslots	26.80	27.17	27.21	27.50	-4.26	22.54	22.91	22.95
4 Txslots	25.80	26.23	26.28	26.50	-3.01	22.79	23.22	23.27
GSM 850 EGPRS (GMSK)	Measured Power (dBm)				calculation	Averaged Power (dBm)		
	251	190	128			251	190	128
1 Txslot	31.75	32.05	31.93	32.80	-9.03	22.72	23.02	22.90
2 Txslots	28.73	29.03	28.95	29.50	-6.02	22.71	23.01	22.93
3Txslots	26.72	27.13	27.15	27.50	-4.26	22.46	22.87	22.89
4 Txslots	25.73	26.18	26.22	26.50	-3.01	22.72	23.17	23.21
GSM 850 EGPRS (8PSK)	Measured Power (dBm)				calculation	Averaged Power (dBm)		
	251	190	128			251	190	128
1 Txslot	25.52	25.65	25.69	26.50	-9.03	16.49	16.62	16.66
2 Txslots	24.43	24.31	24.63	25.50	-6.02	18.41	18.29	18.61
3Txslots	23.35	22.92	23.44	24.00	-4.26	19.09	18.66	19.18
4 Txslots	21.60	21.97	21.76	22.50	-3.01	18.59	18.96	18.75
PCS1900 Speech (GMSK)	Measured Power (dBm)			Tune up	calculation	Averaged Power (dBm)		
	810	661	512			810	661	512
1 Txslot	28.80	28.92	28.81	29.30	/	/	/	/
PCS1900 GPRS (GMSK)	Measured Power (dBm)				calculation	Averaged Power (dBm)		
	810	661	512			810	661	512
1 Txslot	28.76	28.86	28.62	29.30	-9.03	19.73	19.83	19.59

2 Txslots	26.70	26.80	26.51	27.50	-6.02	20.68	20.78	20.49
3Txslots	24.65	24.71	24.37	25.50	-4.26	20.39	20.45	20.11
4 Txslots	23.59	23.64	23.29	24.50	-3.01	20.58	20.63	20.28
PCS1900 EGPRS (GMSK)	Measured Power (dBm)				calculation	Averaged Power (dBm)		
	810	661	512			810	661	512
1 Txslot	28.81	28.89	28.84	29.30	-9.03	19.78	19.86	19.81
2 Txslots	26.72	26.82	26.52	27.50	-6.02	20.70	20.80	20.50
3Txslots	24.66	24.73	24.39	25.50	-4.26	20.40	20.47	20.13
4 Txslots	23.61	23.66	23.50	24.50	-3.01	20.60	20.65	20.49
PCS1900 EGPRS (8PSK)	Measured Power (dBm)				calculation	Averaged Power (dBm)		
	810	661	512			810	661	512
1 Txslot	24.99	25.11	24.75	26.00	-9.03	15.96	16.08	15.72
2 Txslots	24.06	24.28	23.82	25.00	-6.02	18.04	18.26	17.80
3Txslots	22.48	22.40	22.24	23.50	-4.26	18.22	18.14	17.98
4 Txslots	21.37	21.17	21.11	21.50	-3.01	18.36	18.16	18.10

NOTES:

1) Division Factors

To average the power, the division factor is as follows:

1TX-slot = 1 transmit time slot out of 8 time slots=> conducted power divided by (8/1) => -9.03dB

2TX-slots = 2 transmit time slots out of 8 time slots=> conducted power divided by (8/2) => -6.02dB

3TX-slots = 3 transmit time slots out of 8 time slots=> conducted power divided by (8/3) => -4.26dB

4TX-slots = 4 transmit time slots out of 8 time slots=> conducted power divided by (8/4) => -3.01dB

According to the conducted power as above, the body measurements are performed with 4Txslots for GSM850 and 2Txslots for GSM1900.

Table 11.1-2: The conducted power measurement results for GSM, GPRS and EGPRS-Low power

PCS1900 Speech (GMSK)	Measured Power (dBm)			Tune up	calculation	Averaged Power (dBm)		
	810	661	512			810	661	512
1 Txslot	27.25	27.31	27.05	27.8	/	/	/	/
PCS1900 GPRS (GMSK)	Measured Power (dBm)				calculation	Averaged Power (dBm)		
	810	661	512			810	661	512
1 Txslot	27.30	27.32	27.05	27.80	-9.03	18.27	18.29	18.02
2 Txslots	24.29	24.29	23.99	25.00	-6.02	18.27	18.27	17.97
3Txslots	22.50	22.53	22.12	23.00	-4.26	18.24	18.27	17.86
4 Txslots	21.20	21.21	20.78	22.00	-3.01	18.19	18.20	17.77
PCS1900 EGPRS (GMSK)	Measured Power (dBm)				calculation	Averaged Power (dBm)		
	810	661	512			810	661	512
1 Txslot	27.35	27.36	27.08	27.80	-9.03	18.32	18.33	18.05
2 Txslots	24.32	24.32	24.01	25.00	-6.02	18.30	18.30	17.99
3Txslots	22.52	22.55	22.14	23.00	-4.26	18.26	18.29	17.88
4 Txslots	21.22	21.23	20.79	22.00	-3.01	18.21	18.22	17.78
PCS1900	Measured Power (dBm)				calculation	Averaged Power (dBm)		

EGPRS (8PSK)	810	661	512			810	661	512
1 Txslot	23.02	22.80	22.62	24.00	-9.03	13.99	13.77	13.59
2 Txslots	20.55	19.90	20.38	21.00	-6.02	14.53	13.88	14.36
3Txslots	18.48	18.75	18.19	19.50	-4.26	14.22	14.49	13.93
4 Txslots	19.00	18.87	18.71	19.50	-3.01	15.99	15.86	15.70

According to the conducted power as above, the body measurements are performed with 1Txslot for GSM1900.

11.2 WCDMA Measurement result

Normal power

Table 11.2-1: The conducted Power for WCDMA

Item	band	FDDV result			
	ARFCN	4233 (846.6MHz)	4182 (836.4MHz)	4132 (826.4MHz)	Tune up
WCDMA	\	22.68	22.73	22.69	23.50
HSUPA	1	19.81	19.77	19.79	21.00
	2	19.79	19.75	19.76	21.00
	3	20.74	20.75	20.73	22.00
	4	19.31	19.25	19.28	20.50
	5	20.47	20.45	20.46	20.50
HSPA+		21.45	21.37	21.29	22.50
DC-HSDPA	1	21.78	21.83	21.85	23.00
	2	21.68	21.78	21.73	23.00
	3	21.22	21.24	21.26	23.00
	4	21.19	21.23	21.23	23.00
Item	band	FDDIV result			
	ARFCN	1513 (1752.6MHz)	1412 (1732.4MHz)	1312 (1712.4MHz)	Tune up
WCDMA	\	22.46	22.43	22.48	23.00
HSUPA	1	19.81	19.78	19.83	21.00
	2	19.80	19.82	19.85	21.00
	3	20.79	20.78	20.84	22.00
	4	19.34	19.29	19.33	20.50
	5	20.76	20.77	20.81	22.00
HSPA+		21.40	21.41	21.39	22.50
DC-HSDPA	1	21.87	21.83	21.95	23.00
	2	21.85	21.79	21.84	23.00
	3	21.29	21.31	21.30	23.00
	4	21.26	21.27	21.31	23.00
Item	band	FDDII result			
	ARFCN	9538 (1907.6MHz)	9400 (1880MHz)	9262 (1852.4MHz)	Tune up
WCDMA	\	22.86	22.85	22.75	23.50

HSUPA	1	19.93	19.88	19.83	21.00
	2	19.98	19.90	19.87	21.00
	3	20.96	20.90	20.85	22.00
	4	19.49	19.46	19.36	20.50
	5	20.95	20.88	20.86	22.00
HSPA+		21.53	21.50	21.46	22.50
DC-HSDPA	1	22.12	22.03	22.01	23.00
	2	22.04	21.97	22.08	23.00
	3	21.52	21.47	21.43	23.00
	4	21.46	21.42	21.37	23.00

Low power

Table 11.2-2: The conducted Power for WCDMA

Item	band	FDDII result			
	ARFCN	9538 (1907.6MHz)	9400 (1880MHz)	9262 (1852.4MHz)	Tune up
WCDMA	\	20.88	20.85	20.73	21.50
HSUPA	1	18.96	18.92	18.87	19.00
	2	18.97	18.94	18.89	19.00
	3	19.93	19.89	19.83	20.00
	4	18.48	18.43	18.36	18.50
	5	19.91	19.85	19.80	20.00
HSPA+		20.45	20.43	20.29	20.50
DC-HSDPA	1	20.99	20.93	20.87	21.00
	2	20.93	20.88	20.83	21.00
	3	20.41	20.40	20.33	21.00
	4	20.42	20.38	20.32	21.00

11.3 LTE Measurement result

Table 13.3-1: Maximum Power Reduction (MPR) for LTE

Modulation	Channel bandwidth / Transmission bandwidth configuration [RB]						MPR (dB)
	1.4	3	5	10	15	20	
	MHz	MHz	MHz	MHz	MHz	MHz	
QPSK	> 5	> 4	> 8	> 12	> 16	> 18	1
16 QAM	≤ 5	≤ 4	≤ 8	≤ 12	≤ 16	≤ 18	1
16 QAM	> 5	> 4	> 8	> 12	> 16	> 18	2

Table 13.3-2: The tune up for LTE – Normal Power

Band	Tune up
LTE Band 2	23.5
LTE Band 5	23.5
LTE Band 7	23

LTE Band 12	23.5
LTE Band 13	23.5
LTE Band 66	23.5

Table 13.3-3: The tune up for LTE – Low Power

Band	Tune up
LTE Band 2	21.5
LTE Band 7	19.5

Normal power
Table 11.3-4: The conducted Power for LTE

Band 2					
Bandwidth (MHz)	RB allocation	Frequency (MHz)	QPSK	16QAM	
	RB offset (Start RB)		Actual output power (dBm)	Actual output power (dBm)	
1.4 MHz	1RB High (5)	1909.3	22.81	22.17	
		1880	22.71	21.79	
		1850.7	22.66	21.85	
	1RB Middle (3)	1909.3	22.99	22.27	
		1880	22.58	21.93	
		1850.7	22.72	21.93	
	1RB Low (0)	1909.3	22.81	22.16	
		1880	22.42	21.79	
		1850.7	22.55	21.81	
	3RB High (3)	1909.3	22.63	22.02	
		1880	22.46	21.96	
		1850.7	22.80	21.83	
	3RB Middle (1)	1909.3	22.61	22.05	
		1880	22.38	22.00	
		1850.7	22.53	21.86	
	3RB Low (0)	1909.3	22.49	22.00	
		1880	22.31	21.94	
		1850.7	22.49	21.85	
	6RB (0)	1909.3	21.53	20.89	
		1880	21.80	21.05	
		1850.7	21.76	21.00	
	3 MHz	1RB High (14)	1908.5	22.88	21.82
			1880	22.82	21.72
			1851.5	22.89	22.13
1RB Middle (7)		1908.5	23.04	22.03	
		1880	22.99	21.90	
		1851.5	23.01	22.32	
1RB Low (0)		1908.5	22.91	21.84	
		1880	22.79	21.76	
		1851.5	22.86	22.13	
8RB High (7)		1908.5	21.89	20.95	
		1880	21.80	20.95	

	8RB Middle (4)	1851.5	21.81	20.91	
		1908.5	21.95	21.03	
		1880	21.85	21.01	
		1851.5	21.86	21.02	
	8RB Low (0)	1908.5	21.93	20.96	
		1880	21.83	21.01	
		1851.5	21.84	20.93	
	15RB (0)	1908.5	21.86	20.85	
		1880	21.82	20.88	
		1851.5	21.79	20.88	
	5 MHz	1RB High (24)	1907.5	22.78	21.87
			1880	22.69	21.87
1852.5			22.72	22.18	
1RB Middle (12)		1907.5	23.06	22.14	
		1880	22.99	22.16	
		1852.5	23.00	22.47	
1RB Low (0)		1907.5	22.77	21.87	
		1880	22.66	21.90	
		1852.5	22.72	22.20	
12RB High (13)		1907.5	21.83	20.89	
		1880	21.81	20.90	
		1852.5	21.74	20.96	
12RB Middle (6)		1907.5	21.91	21.00	
		1880	21.84	20.94	
		1852.5	21.83	21.00	
12RB Low (0)		1907.5	21.89	20.95	
		1880	21.78	20.89	
		1852.5	21.80	20.94	
25RB (0)		1907.5	21.83	20.85	
		1880	21.78	20.87	
		1852.5	21.77	20.89	
10 MHz		1RB High (49)	1905	22.91	21.83
			1880	22.80	21.70
			1855	22.80	22.12
		1RB Middle (24)	1905	22.99	21.91
			1880	22.96	21.82
			1855	22.93	22.22
		1RB Low (0)	1905	22.77	21.75
	1880		22.74	21.70	
	1855		22.70	22.05	
	25RB High (25)	1905	21.83	20.95	
		1880	21.80	20.91	
		1855	21.80	20.92	
	25RB Middle (12)	1905	21.84	20.97	
		1880	21.78	20.85	
		1855	21.79	20.90	
	25RB Low (0)	1905	21.87	21.00	
		1880	21.86	20.89	

	50RB (0)	1855	21.81	20.90	
		1905	21.82	20.88	
		1880	21.81	20.85	
		1855	21.79	20.87	
15 MHz	1RB High (74)	1902.5	22.81	22.12	
		1880	22.68	21.61	
		1857.5	22.74	22.06	
	1RB Middle (37)	1902.5	22.89	22.24	
		1880	22.85	21.76	
		1857.5	22.83	22.10	
	1RB Low (0)	1902.5	22.77	22.17	
		1880	22.72	21.65	
		1857.5	22.73	22.01	
	36RB High (38)	1902.5	21.93	20.92	
		1880	21.83	20.84	
		1857.5	21.81	20.91	
	36RB Middle (19)	1902.5	21.94	20.92	
		1880	21.87	20.88	
		1857.5	21.81	20.90	
	36RB Low (0)	1902.5	21.88	20.87	
		1880	21.87	20.85	
		1857.5	21.82	20.90	
	75RB (0)	1902.5	21.90	20.91	
		1880	21.85	20.86	
		1857.5	21.81	20.85	
	20 MHz	1RB High (99)	1900	22.69	21.98
			1880	22.61	21.92
			1860	22.71	22.00
1RB Middle (50)		1900	23.18	22.40	
		1880	23.15	22.33	
		1860	23.14	22.43	
1RB Low (0)		1900	22.62	21.99	
		1880	22.59	21.91	
		1860	22.63	21.98	
50RB High (50)		1900	21.69	20.76	
		1880	21.66	20.68	
		1860	21.74	20.81	
50RB Middle (25)		1900	21.80	20.86	
		1880	21.78	20.80	
		1860	21.77	20.84	
50RB Low (0)		1900	21.79	20.87	
		1880	21.80	20.81	
		1860	21.78	20.82	
100RB (0)		1900	21.78	20.86	
		1880	21.81	20.81	
		1860	21.76	20.86	

Band 5					
Bandwidth (MHz)	RB allocation	Frequency (MHz)	QPSK	16QAM	
	RB offset (Start RB)		Actual output power (dBm)	Actual output power (dBm)	
1.4 MHz	1RB High (5)	848.3	22.75	21.51	
		836.5	22.81	21.60	
		824.7	22.71	21.96	
	1RB Middle (3)	848.3	22.94	21.53	
		836.5	22.72	21.72	
		824.7	22.68	22.13	
	1RB Low (0)	848.3	22.77	21.45	
		836.5	22.37	21.53	
		824.7	22.52	21.95	
	3RB High (3)	848.3	22.80	21.61	
		836.5	22.40	21.44	
		824.7	22.38	21.92	
	3RB Middle (1)	848.3	22.80	21.59	
		836.5	22.42	21.39	
		824.7	22.53	21.87	
	3RB Low (0)	848.3	22.55	21.57	
		836.5	22.34	21.45	
		824.7	22.45	21.90	
	6RB (0)	848.3	21.54	20.76	
		836.5	21.80	21.01	
		824.7	21.90	20.77	
	3 MHz	1RB High (14)	847.5	22.72	21.51
			836.5	22.83	21.57
			825.5	22.86	22.21
		1RB Middle (7)	847.5	22.96	21.64
			836.5	22.89	21.69
			825.5	22.59	22.22
1RB Low (0)		847.5	22.87	21.39	
		836.5	22.58	21.46	
		825.5	22.42	22.12	
8RB High (7)		847.5	21.89	20.54	
		836.5	21.84	20.87	
		825.5	21.76	20.91	
8RB Middle (4)		847.5	21.93	20.81	
		836.5	21.89	20.93	
		825.5	21.93	20.97	
8RB Low (0)		847.5	21.93	20.76	
		836.5	21.88	20.92	
		825.5	21.86	20.92	
15RB (0)		847.5	21.72	20.81	
		836.5	21.80	20.79	
		825.5	21.79	20.82	
5 MHz		1RB	846.5	22.74	21.64

	High (24)	836.5	22.81	21.80
		826.5	22.73	22.28
		846.5	23.02	21.75
	1RB Middle (12)	836.5	23.04	22.00
		826.5	22.82	22.28
		846.5	22.76	21.59
	1RB Low (0)	836.5	22.81	21.71
		826.5	22.48	21.83
		846.5	21.79	20.58
	12RB High (13)	836.5	21.78	20.75
		826.5	21.66	20.85
		846.5	21.88	20.80
	12RB Middle (6)	836.5	21.86	20.87
		826.5	21.88	21.00
		846.5	21.85	20.80
	12RB Low (0)	836.5	21.74	20.79
		826.5	21.81	20.93
		846.5	21.82	20.74
	25RB (0)	836.5	21.69	20.80
		826.5	21.72	20.89
		844	22.76	21.72
	1RB High (49)	836.5	22.86	21.59
		829	22.85	22.14
		844	22.92	21.81
1RB Middle (24)	836.5	22.94	21.69	
	829	22.92	22.23	
	844	22.87	21.66	
1RB Low (0)	836.5	22.90	21.73	
	829	22.93	22.04	
	844	21.76	20.83	
25RB High (25)	836.5	21.83	20.80	
	829	21.86	20.88	
	844	21.80	20.86	
25RB Middle (12)	836.5	21.79	20.78	
	829	21.85	20.86	
	844	21.81	20.86	
25RB Low (0)	836.5	21.79	20.78	
	829	21.81	20.89	
	844	21.79	20.77	
50RB (0)	836.5	21.79	20.76	
	829	21.85	20.86	
	844	21.79	20.76	

Band 7					
Bandwidth (MHz)	RB allocation	Frequency (MHz)	QPSK	16QAM	
	RB offset (Start RB)		Actual output power (dBm)	Actual output power (dBm)	
5 MHz	1RB High (24)	2567.5	22.58	21.62	
		2535	22.60	21.68	
		2502.5	22.56	21.99	
	1RB Middle (12)	2567.5	22.86	21.90	
		2535	22.87	21.93	
		2502.5	22.82	22.25	
	1RB Low (0)	2567.5	22.57	21.58	
		2535	22.61	21.72	
		2502.5	22.48	22.01	
	12RB High (13)	2567.5	21.66	20.74	
		2535	21.58	20.69	
		2502.5	21.65	20.75	
	12RB Middle (6)	2567.5	21.72	20.79	
		2535	21.65	20.75	
		2502.5	21.68	20.80	
	12RB Low (0)	2567.5	21.70	20.68	
		2535	21.55	20.69	
		2502.5	21.56	20.66	
	25RB (0)	2567.5	21.69	20.71	
		2535	21.62	20.65	
		2502.5	21.58	20.61	
	10 MHz	1RB High (49)	2565	22.59	21.61
			2535	22.59	21.60
			2505	22.59	21.96
1RB Middle (24)		2565	22.70	21.78	
		2535	22.70	21.63	
		2505	22.72	22.06	
1RB Low (0)		2565	22.56	21.58	
		2535	22.53	21.48	
		2505	22.59	21.89	
25RB High (25)		2565	21.58	20.80	
		2535	21.61	20.67	
		2505	21.62	20.66	
25RB Middle (12)		2565	21.63	20.80	
		2535	21.64	20.74	
		2505	21.66	20.76	
25RB Low (0)		2565	21.63	20.76	
		2535	21.59	20.66	
		2505	21.55	20.58	
50RB (0)		2565	21.61	20.69	
		2535	21.62	20.64	
		2505	21.58	20.60	

15 MHz	1RB High (74)	2562.5	22.58	21.90	
		2535	22.52	21.91	
		2507.5	22.21	21.61	
	1RB Middle (37)	2562.5	22.68	21.96	
		2535	22.60	22.02	
		2507.5	22.60	21.49	
	1RB Low (0)	2562.5	22.59	21.90	
		2535	22.54	22.00	
		2507.5	22.44	21.36	
	36RB High (38)	2562.5	21.71	20.72	
		2535	21.65	20.62	
		2507.5	21.65	20.66	
	36RB Middle (19)	2562.5	21.73	20.72	
		2535	21.65	20.63	
		2507.5	21.70	20.64	
	36RB Low (0)	2562.5	21.68	20.72	
		2535	21.61	20.57	
		2507.5	21.65	20.58	
	75RB (0)	2562.5	21.67	20.70	
		2535	21.67	20.61	
		2507.5	21.66	20.64	
	20 MHz	1RB High (99)	2560	22.39	21.78
			2535	22.36	21.93
			2510	22.35	21.86
		1RB Middle (50)	2560	22.78	22.10
			2535	22.72	22.26
			2510	22.72	22.18
1RB Low (0)		2560	22.35	21.76	
		2535	22.30	21.89	
		2510	22.30	21.75	
50RB High (50)		2560	21.60	20.60	
		2535	21.60	20.71	
		2510	21.64	20.71	
50RB Middle (25)		2560	21.65	20.69	
		2535	21.65	20.71	
		2510	21.64	20.68	
50RB Low (0)		2560	21.66	20.69	
		2535	21.58	20.66	
		2510	21.64	20.65	
100RB (0)		2560	21.65	20.69	
		2535	21.62	20.70	
		2510	21.67	20.69	

Band 12				
Bandwidth (MHz)	RB allocation	Frequency (MHz)	QPSK	16QAM
	RB offset (Start RB)		Actual output power (dBm)	Actual output power (dBm)
1.4 MHz	1RB High (5)	715.3	22.62	21.18
		707.5	22.18	21.32
		699.7	22.22	21.56
	1RB Middle (3)	715.3	22.56	21.30
		707.5	22.30	21.41
		699.7	22.35	21.57
	1RB Low (0)	715.3	22.11	21.17
		707.5	22.18	21.28
		699.7	22.23	21.55
	3RB High (3)	715.3	22.23	21.37
		707.5	22.25	21.28
		699.7	22.27	21.44
	3RB Middle (1)	715.3	22.29	21.42
		707.5	22.27	21.29
		699.7	22.32	21.45
	3RB Low (0)	715.3	22.19	21.37
		707.5	22.30	21.25
		699.7	22.27	21.40
	6RB (0)	715.3	21.21	20.44
		707.5	21.26	20.42
		699.7	21.25	20.19
3 MHz	1RB High (14)	714.5	22.51	21.19
		707.5	22.23	21.10
		700.5	22.29	21.64
	1RB Middle (7)	714.5	22.36	21.40
		707.5	22.28	21.26
		700.5	22.40	21.72
	1RB Low (0)	714.5	22.21	21.28
		707.5	22.19	21.16
		700.5	22.29	21.57
	8RB High (7)	714.5	21.22	20.31
		707.5	21.19	20.38
		700.5	21.23	20.36
	8RB Middle (4)	714.5	21.24	20.36
		707.5	21.26	20.42
		700.5	21.29	20.38
	8RB Low (0)	714.5	21.23	20.33
		707.5	21.20	20.34
		700.5	21.24	20.42
	15RB (0)	714.5	21.22	20.26
		707.5	21.21	20.29
		700.5	21.22	20.42
5 MHz	1RB High (24)	713.5	22.65	21.20
		707.5	22.21	21.28

	1RB Middle (12)	701.5	22.22	21.66	
		713.5	22.95	21.46	
		707.5	22.43	21.51	
	1RB Low (0)	701.5	22.46	21.92	
		713.5	22.59	21.17	
		707.5	22.22	21.30	
	12RB High (13)	701.5	22.13	21.63	
		713.5	21.40	20.29	
		707.5	21.26	20.39	
	12RB Middle (6)	701.5	21.19	20.34	
		713.5	21.34	20.33	
		707.5	21.24	20.37	
	12RB Low (0)	701.5	21.26	20.44	
		713.5	21.29	20.39	
		707.5	21.11	20.25	
	25RB (0)	701.5	21.30	20.47	
		713.5	21.27	20.27	
		707.5	21.19	20.25	
	10 MHz	1RB High (49)	701.5	21.21	20.35
			711	22.69	21.23
			707.5	22.73	21.21
1RB Middle (24)		704	22.54	21.58	
		711	22.80	21.31	
		707.5	22.80	21.27	
1RB Low (0)		704	22.56	21.73	
		711	22.69	21.22	
		707.5	22.47	21.16	
25RB High (25)		704	22.28	21.50	
		711	21.62	20.27	
		707.5	21.60	20.37	
25RB Middle (12)		704	21.40	20.44	
		711	21.75	20.49	
		707.5	21.61	20.35	
25RB Low (0)		704	21.27	20.38	
		711	21.64	20.28	
		707.5	21.31	20.26	
50RB (0)		704	21.39	20.47	
		711	21.64	20.22	
		707.5	21.34	20.29	
		704	21.39	20.44	

Band 13				
Bandwidth (MHz)	RB allocation	Frequency (MHz)	QPSK	16QAM
	RB offset (Start RB)		Actual output power (dBm)	Actual output power (dBm)
5 MHz	1RB High (24)	784.4	22.64	21.66
		782	22.59	21.69
		799.5	22.66	22.08
	1RB Middle (12)	784.4	22.88	21.86
		782	22.88	21.96
		799.5	22.89	22.29
	1RB Low (0)	784.4	22.64	21.62
		782	22.59	21.73
		799.5	22.62	22.07
	12RB High (13)	784.4	21.69	20.69
		782	21.68	20.71
		799.5	21.73	20.84
	12RB Middle (6)	784.4	21.76	20.75
		782	21.75	20.78
		799.5	21.77	20.87
	12RB Low (0)	784.4	21.70	20.71
		782	21.66	20.70
		799.5	21.71	20.80
	25RB (0)	784.4	21.65	20.59
		782	21.68	20.69
		799.5	21.71	20.76
10 MHz	1RB High (49)	782	22.75	21.65
	1RB Middle (24)	782	22.88	21.77
	1RB Low (0)	782	22.69	21.66
	25RB High (25)	782	21.69	20.78
	25RB Middle (12)	782	21.73	20.81
	25RB Low (0)	782	21.70	20.76
	50RB (0)	782	21.70	20.71

Band 66				
Bandwidth (MHz)	RB allocation	Frequency (MHz)	QPSK	16QAM
	RB offset (Start RB)		Actual output power (dBm)	Actual output power (dBm)
1.4 MHz	1RB High (5)	1779.3	22.58	21.60
		1745	22.58	21.67
		1710.7	22.59	21.92
	1RB Middle (3)	1779.3	22.75	21.75
		1745	22.76	21.84
		1710.7	22.78	22.04
	1RB	1779.3	22.55	21.55

	Low (0)	1745	22.60	21.65	
		1710.7	22.58	21.94	
		1779.3	22.70	21.80	
	3RB High (3)	1745	22.63	21.66	
		1710.7	22.65	21.86	
		1779.3	22.68	21.82	
	3RB Middle (1)	1745	22.67	21.71	
		1710.7	22.72	21.86	
		1779.3	22.63	21.72	
	3RB Low (0)	1745	22.61	21.66	
		1710.7	22.69	21.86	
		1779.3	21.74	20.82	
	6RB (0)	1745	21.69	20.81	
		1710.7	21.70	20.60	
		1778.5	22.68	21.54	
3 MHz	1RB High (14)	1745	22.64	21.47	
		1711.5	22.68	21.99	
		1778.5	22.82	21.72	
	1RB Middle (7)	1745	22.61	21.63	
		1711.5	22.56	22.12	
		1778.5	22.69	21.61	
	1RB Low (0)	1745	22.64	21.52	
		1711.5	22.59	21.94	
		1778.5	21.64	20.67	
	8RB High (7)	1745	21.60	20.72	
		1711.5	21.60	20.69	
		1778.5	21.68	20.71	
	8RB Middle (4)	1745	21.66	20.79	
		1711.5	21.63	20.74	
		1778.5	21.69	20.64	
	8RB Low (0)	1745	21.62	20.74	
		1711.5	21.63	20.76	
		1778.5	21.65	20.57	
	15RB (0)	1745	21.62	20.65	
		1711.5	21.62	20.68	
		1777.5	22.60	21.62	
	5 MHz	1RB High (24)	1745	22.48	22.04
			1712.5	22.58	21.62
			1777.5	22.84	21.92
		1RB Middle (12)	1745	22.75	22.26
			1712.5	22.83	21.87
			1777.5	22.62	21.68
1RB Low (0)		1745	22.49	22.02	
		1712.5	22.54	21.61	
		1777.5	21.63	20.65	
12RB High (13)		1745	21.62	20.68	
		1712.5	21.68	20.64	
		1777.5	21.68	20.72	
12RB		1777.5	21.68	20.72	

	Middle (6)	1745	21.65	20.81	
		1712.5	21.71	20.68	
		1777.5	21.64	20.72	
	12RB Low (0)	1745	21.63	20.71	
		1712.5	21.63	20.63	
		1777.5	21.62	20.64	
	25RB (0)	1745	21.65	20.66	
		1712.5	21.60	20.61	
		1775	22.64	21.53	
10 MHz	1RB High (49)	1745	22.61	21.94	
		1715	22.60	21.64	
		1775	22.75	21.60	
	1RB Middle (24)	1745	22.72	22.04	
		1715	22.69	21.74	
		1775	22.60	21.51	
	1RB Low (0)	1745	22.63	21.94	
		1715	22.59	21.63	
		1775	21.68	20.72	
	25RB High (25)	1745	21.65	20.64	
		1715	21.82	20.88	
		1775	21.68	20.72	
	25RB Middle (12)	1745	21.68	20.71	
		1715	21.69	20.77	
		1775	21.75	20.73	
	25RB Low (0)	1745	21.73	20.72	
		1715	21.69	20.75	
		1775	21.71	20.69	
	50RB (0)	1745	21.54	20.64	
		1715	21.76	20.81	
		1772.5	22.56	21.82	
	15 MHz	1RB High (74)	1745	22.42	21.41
			1717.5	22.50	21.85
			1772.5	22.71	21.92
		1RB Middle (37)	1745	22.59	21.55
			1717.5	22.66	22.01
			1772.5	22.55	21.86
1RB Low (0)		1745	22.47	21.39	
		1717.5	22.55	21.87	
		1772.5	21.80	20.69	
36RB High (38)		1745	21.68	20.62	
		1717.5	21.76	20.77	
		1772.5	21.83	20.71	
36RB Middle (19)		1745	21.75	20.65	
		1717.5	21.77	20.76	
		1772.5	21.78	20.68	
36RB Low (0)		1745	21.73	20.65	
		1717.5	21.77	20.74	
		1772.5	21.80	20.75	
75RB		1772.5	21.80	20.75	

20 MHz	(0)	1745	21.74	20.66
		1717.5	21.79	20.75
	1RB High (99)	1770	22.35	21.68
		1745	22.28	21.85
		1720	22.31	21.76
	1RB Middle (50)	1770	22.74	22.08
		1745	22.69	22.23
		1720	22.74	22.14
	1RB Low (0)	1770	22.23	21.68
		1745	22.26	21.82
		1720	22.32	21.74
	50RB High (50)	1770	21.59	20.55
		1745	21.62	20.63
		1720	21.66	20.63
	50RB Middle (25)	1770	21.64	20.64
		1745	21.66	20.72
		1720	21.67	20.65
	50RB Low (0)	1770	21.62	20.60
		1745	21.66	20.70
		1720	21.60	20.63
100RB (0)	1770	21.60	20.63	
	1745	21.68	20.73	
	1720	21.66	20.65	

Low power
Table 11.3-5: The conducted Power for LTE

Band 2				
Bandwidth (MHz)	RB allocation	Frequency (MHz)	QPSK	16QAM
	RB offset (Start RB)		Actual output power (dBm)	Actual output power (dBm)
1.4 MHz	1RB High (5)	1909.3	20.82	20.88
		1880	20.75	20.81
		1850.7	20.80	20.88
	1RB Middle (3)	1909.3	21.01	21.03
		1880	20.92	20.94
		1850.7	20.95	21.07
	1RB Low (0)	1909.3	20.79	20.86
		1880	20.80	20.81
		1850.7	20.78	20.86
	3RB High (3)	1909.3	20.92	21.10
		1880	20.87	21.00
		1850.7	20.82	20.84
	3RB Middle (1)	1909.3	20.96	21.11
		1880	20.88	21.03
		1850.7	20.88	20.87
	3RB Low (0)	1909.3	20.87	21.05
		1880	20.89	20.99

		1850.7	20.83	20.85
	6RB (0)	1909.3	20.93	21.08
		1880	20.85	21.00
		1850.7	20.80	20.95
3 MHz	1RB High (14)	1908.5	20.86	20.91
		1880	20.84	20.76
		1851.5	20.87	21.22
	1RB Middle (7)	1908.5	21.06	21.12
		1880	20.94	20.94
		1851.5	21.04	21.17
	1RB Low (0)	1908.5	20.86	20.96
		1880	20.80	20.81
		1851.5	20.86	21.19
	8RB High (7)	1908.5	20.92	20.94
		1880	20.82	20.95
		1851.5	20.85	20.91
	8RB Middle (4)	1908.5	20.95	21.02
		1880	20.90	21.02
		1851.5	20.86	20.99
	8RB Low (0)	1908.5	20.93	20.97
		1880	20.87	20.97
		1851.5	20.87	20.95
	15RB (0)	1908.5	20.90	20.88
		1880	20.85	20.87
		1851.5	20.80	20.87
5 MHz	1RB High (24)	1907.5	20.88	20.94
		1880	20.81	20.94
		1852.5	20.75	21.19
	1RB Middle (12)	1907.5	21.15	21.22
		1880	21.08	21.23
		1852.5	21.04	21.21
	1RB Low (0)	1907.5	20.84	20.93
		1880	20.80	20.95
		1852.5	20.73	21.21
	12RB High (13)	1907.5	20.91	20.89
		1880	20.84	20.92
		1852.5	20.83	20.94
	12RB Middle (6)	1907.5	20.96	21.02
		1880	20.95	20.96
		1852.5	20.92	21.01
	12RB Low (0)	1907.5	20.91	20.97
		1880	20.85	20.87
		1852.5	20.83	20.93
	25RB (0)	1907.5	20.91	20.88
		1880	20.84	20.86
		1852.5	20.83	20.87
10 MHz	1RB High (49)	1905	20.89	20.88
		1880	20.77	20.80

	1RB Middle (24)	1855	20.85	21.14
		1905	20.99	20.99
		1880	20.90	20.89
	1RB Low (0)	1855	20.98	21.28
		1905	20.79	20.87
		1880	20.79	20.75
	25RB High (25)	1855	20.82	21.12
		1905	20.87	20.94
		1880	20.85	20.90
	25RB Middle (12)	1855	20.87	20.89
		1905	20.92	21.00
		1880	20.86	20.90
	25RB Low (0)	1855	20.85	20.89
		1905	20.93	21.00
		1880	20.90	20.89
	50RB (0)	1855	20.86	20.90
		1905	20.85	20.91
		1880	20.89	20.87
15 MHz	1RB High (74)	1855	20.85	20.88
		1902.5	20.78	20.72
		1880	20.77	21.11
	1RB Middle (37)	1857.5	20.72	21.18
		1902.5	20.83	20.83
		1880	20.88	21.25
	1RB Low (0)	1857.5	20.88	21.26
		1902.5	20.75	20.72
		1880	20.81	21.12
	36RB High (38)	1857.5	20.77	21.18
		1902.5	20.95	20.90
		1880	20.85	20.89
	36RB Middle (19)	1857.5	20.88	20.79
		1902.5	20.96	20.91
		1880	20.91	20.93
	36RB Low (0)	1857.5	20.88	20.81
		1902.5	20.89	20.89
		1880	20.91	20.90
75RB (0)	1857.5	20.86	20.82	
	1902.5	20.92	20.89	
	1880	20.93	20.87	
20 MHz	1RB High (99)	1857.5	20.84	20.83
		1900	20.53	21.10
		1880	20.51	21.02
	1RB Middle (50)	1860	20.44	20.94
		1900	20.93	21.22
		1880	20.94	21.27
1RB Low (0)	1860	20.87	21.18	
	1900	20.50	21.02	
		1880	20.49	21.04

	50RB High (50)	1860	20.41	20.93
		1900	20.78	20.71
		1880	20.69	20.73
		1860	20.75	20.72
	50RB Middle (25)	1900	20.78	20.83
		1880	20.79	20.83
		1860	20.78	20.76
	50RB Low (0)	1900	20.83	20.83
		1880	20.76	20.80
		1860	20.77	20.76
	100RB (0)	1900	20.85	20.81
		1880	20.78	20.79
1860		20.78	20.77	

Band 7					
Bandwidth (MHz)	RB allocation	Frequency (MHz)	QPSK	16QAM	
	RB offset (Start RB)		Actual output power (dBm)	Actual output power (dBm)	
5 MHz	1RB High (24)	2567.5	19.09	19.25	
		2535	19.07	19.22	
		2502.5	19.04	19.44	
	1RB Middle (12)	2567.5	19.38	19.48	
		2535	19.37	19.48	
		2502.5	19.34	19.46	
	1RB Low (0)	2567.5	19.09	19.19	
		2535	19.07	19.24	
		2502.5	19.02	19.43	
	12RB High (13)	2567.5	19.16	19.20	
		2535	19.10	19.21	
		2502.5	19.13	19.26	
	12RB Middle (6)	2567.5	19.25	19.34	
		2535	19.19	19.28	
		2502.5	19.19	19.33	
	12RB Low (0)	2567.5	19.21	19.23	
		2535	19.06	19.16	
		2502.5	19.07	19.21	
	25RB (0)	2567.5	19.15	19.15	
		2535	19.09	19.14	
		2502.5	19.05	19.16	
	10 MHz	1RB High (49)	2565	19.16	19.23
			2535	19.04	19.08
			2505	19.17	19.49
1RB Middle (24)		2565	19.19	19.33	
		2535	19.18	19.18	
		2505	19.29	15.38	
1RB Low (0)		2565	19.06	19.18	
		2535	19.01	19.09	

	25RB High (25)	2505	19.11	19.46
		2565	19.16	19.27
		2535	19.10	19.15
	25RB Middle (12)	2505	19.09	19.17
		2565	19.21	19.31
		2535	19.14	19.22
	25RB Low (0)	2505	19.19	19.24
		2565	19.14	19.30
		2535	19.06	19.15
	50RB (0)	2505	19.05	19.15
		2565	19.14	19.21
		2535	19.11	19.11
15 MHz	1RB High (74)	2505	19.07	19.13
		2562.5	19.06	19.39
		2535	18.98	19.01
	1RB Middle (37)	2507.5	19.07	19.45
		2562.5	19.15	19.46
		2535	19.06	19.11
	1RB Low (0)	2507.5	19.18	19.46
		2562.5	19.06	19.43
		2535	18.97	19.02
	36RB High (38)	2507.5	19.07	19.44
		2562.5	19.17	19.12
		2535	19.13	19.14
	36RB Middle (19)	2507.5	19.15	19.21
		2562.5	19.15	19.12
		2535	19.14	19.14
	36RB Low (0)	2507.5	19.14	19.20
		2562.5	19.18	19.10
		2535	19.11	19.08
75RB (0)	2507.5	19.08	19.14	
	2562.5	19.12	19.15	
	2535	19.10	19.08	
20 MHz	1RB High (99)	2507.5	19.10	19.12
		2560	18.86	19.41
		2535	18.84	19.38
	1RB Middle (50)	2510	18.75	19.06
		2560	19.29	19.36
		2535	19.21	19.46
	1RB Low (0)	2510	19.20	19.10
		2560	18.81	19.36
		2535	18.79	19.35
	50RB High (50)	2510	19.12	19.13
		2560	19.03	19.10
		2535	19.05	19.12
	50RB Middle (25)	2510	19.07	19.04
		2560	19.12	19.22
		2535	19.10	19.18

	50RB Low (0)	2510	19.08	19.04
		2560	19.11	19.18
		2535	19.05	19.10
		2510	19.06	19.06
	100RB (0)	2560	19.12	19.19
		2535	19.06	19.13
		2510	19.05	19.06

11.4 Wi-Fi and BT Measurement result

The maximum output power of BT is 10.9 dBm.

The maximum tune up of BT is 11 dBm.

The average conducted power for Wi-Fi is as following:

FCC									
802.11b	Channel data rate	1Mbps	2Mbps	5.5Mbps	11Mbps				
WLAN2450	11(2462MHz)	15.80	/	/	/				
	6(2437(MHz)	16.10	16.07	15.98	15.94				
	1(2412MHz)	15.91	/	/	/				
	Tune up	16.50	16.50	16.50	16.50				
802.11g	Channel data rate	6Mbps	9Mbps	12Mbps	18Mbps	24Mbps	36Mbps	48Mbps	54Mbps
WLAN2450	11(2462MHz)	15.28	/	/	/	/	/	/	/
	6(2437(MHz)	15.50	15.25	15.46	15.23	15.28	15.06	15.46	15.42
	1(2412MHz)	15.29	/	/	/	/	/	/	/
	Tune up	16.00	16.00	16.00	16.00	16.00	16.00	16.00	16.00
802.11n-20MHz	Channel data rate	MCS0	MCS1	MCS2	MCS3	MCS4	MCS5	MCS6	MCS7
WLAN2450	11(2462MHz)	14.25	/	/	/	/	/	/	14.31
	6(2437(MHz)	14.27	14.02	14.20	14.38	14.24	14.56	14.59	14.61
	1(2412MHz)	14.08	/	/	/	/	/	/	14.52
	Tune up	15.00	15.00	15.00	15.00	15.00	15.00	15.00	15.00
802.11n-40MHz	Channel data rate	MCS0	MCS1	MCS2	MCS3	MCS4	MCS5	MCS6	MCS7
WLAN2450	9(2452MHz)	10.79	10.54	10.53	10.52	10.53	10.94	10.95	10.96
	6(2437MHz)	10.73	/	/	/	/	/	/	10.89
	3(2422MHz)	10.70	/	/	/	/	/	/	10.87
	Tune up	11.50	11.50	11.50	11.50	11.50	11.50	11.50	11.50

12 Simultaneous TX SAR Considerations

12.1 Introduction

The following procedures adopted from “FCC SAR Considerations for Cell Phones with Multiple Transmitters” are applicable to handsets with built-in unlicensed transmitters such as 802.11 a/b/g and Bluetooth devices which may simultaneously transmit with the licensed transmitter. For this device, the BT and Wi-Fi can transmit simultaneous with other transmitters.

12.2 Transmit Antenna Separation Distances

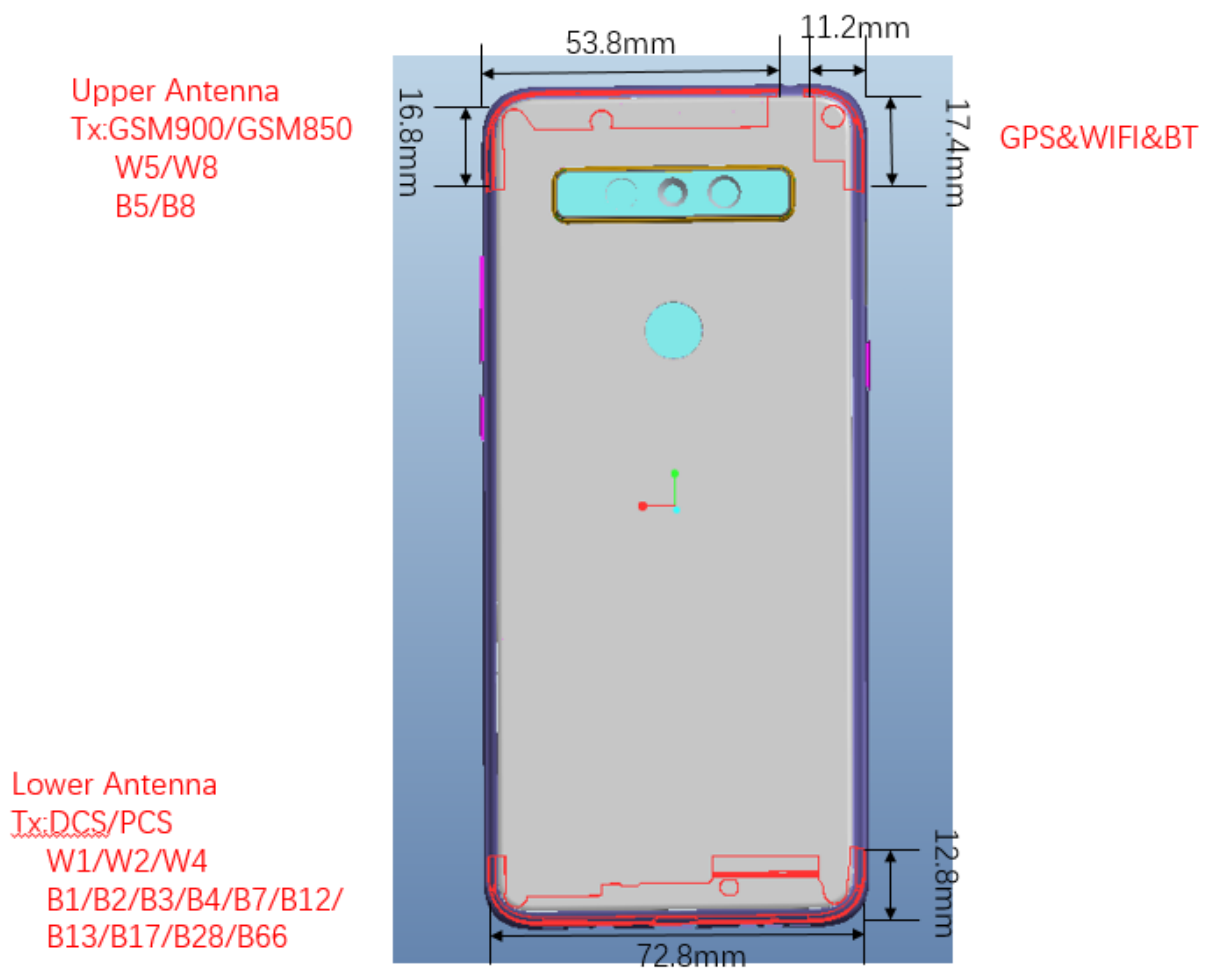

Picture 12.1 Antenna Locations

12.3 SAR Measurement Positions

According to the KDB941225 D06 Hot Spot SAR v01, the edges with less than 2.5 cm distance to the antennas need to be tested for SAR.

SAR measurement positions						
Mode	Front	Rear	Left edge	Right edge	Top edge	Bottom edge
Upper antenna	Yes	Yes	Yes	Yes	Yes	No
Lower antenna	Yes	Yes	Yes	Yes	No	Yes
WLAN	Yes	Yes	Yes	No	Yes	No

12.4 Standalone SAR Test Exclusion Considerations

Standalone 1-g head or body SAR evaluation by measurement or numerical simulation is not required when the corresponding SAR Exclusion Threshold condition, listed below, is satisfied. The 1-g SAR test exclusion threshold for 100 MHz to 6 GHz at test separation distances ≤ 50 mm are determined by:

$[(\text{max. power of channel, including tune-up tolerance, mW}) / (\text{min. test separation distance, mm})] \cdot [\sqrt{f(\text{GHz})}] \leq 3.0$ for 1-g SAR, where

- $f(\text{GHz})$ is the RF channel transmit frequency in GHz
- Power and distance are rounded to the nearest mW and mm before calculation
- The result is rounded to one decimal place for comparison

Table 12.1: Standalone SAR test exclusion considerations

Band/Mode	F(GHz)	Position	SAR test exclusion threshold(mW)	RF output power		SAR test exclusion
				dBm	mW	
Bluetooth	2.441	Head	9.60	11	12.59	No
		Body	19.20	11	12.59	Yes
2.4GHz WLAN	2.45	Head	9.58	16.5	44.67	No
		Body	19.17	16.5	44.67	No

13 Evaluation of Simultaneous

Table 13.1: The sum of reported SAR values for main antenna and WiFi2.4G

	Position	Main antenna	WiFi	Sum
Highest reported SAR value for Head	Left Tilt	1.27 (GSM850)	0.27	1.54
Highest reported SAR value for Body	Bottom 10mm	1.12 (WCDMA1700)	0.00	1.12

Table 13.2: The sum of reported SAR values for main antenna and BT

	Position	Main antenna	BT	Sum
Maximum reported SAR value for Head	Right hand, Touch cheek	1.27 (GSM850)	<0.01	1.27
Maximum reported SAR value for Body	Bottom 10mm	1.12 (WCDMA1700)	<0.01	1.12

[1] – The SAR of BT is too low to get it, so the “<0.01” is used to indicate the SAR of BT.

14 SAR Test Result

It is determined by user manual for the distance between the EUT and the phantom bottom. The distance is 10 mm or 15mm and just applied to the condition of body worn accessory.

It is performed for all SAR measurements with area scan based 1-g SAR estimation (Fast SAR). A zoom scan measurement is added when the estimated 1-gSAR is the highest measured SAR in each exposure configuration, wireless mode and frequency band combination or more than 1.2W/kg.

The calculated SAR is obtained by the following formula:

$$\text{Reported SAR} = \text{Measured SAR} \times 10^{(P_{\text{Target}} - P_{\text{Measured}})/10}$$

Where P_{Target} is the power of manufacturing upper limit;

P_{Measured} is the measured power in chapter 11.

Table 14.1: Duty Cycle

Mode	Duty Cycle
GPRS&EGPRS for GSM850	1:2
GPRS&EGPRS for GSM1900 (Low power)	1:8.3
GPRS&EGPRS for GSM1900(Normal power)	1:4
WCDMA<E FDD	1:1

14.1 SAR results for Fast SAR

We'll perform the head measurement in all bands with the primary battery and SIM card depending on the evaluation of multi-batteries and multi-SIM cards and retest on highest value point with other batteries and SIM cards. Then, repeat the measurement in the Body test.

Table 14.2: The evaluation of multi-batteries for Head Test

Frequency		Side	Test Position	Battery Type	SAR(1g) (W/kg)	Power Drift(dB)
MHz	Ch.					
707.5	23095	Left	Touch	B1	0.110	0.16
707.5	23095	Left	Touch	B2	0.092	0.01

Note: According to the values in the above table, the battery of **B1** is the primary battery.

We'll perform the head measurement with this battery and retest on highest value point with others.

Table 14.3: The evaluation of multi-batteries for Body Test

Frequency		Test Position	Spacing (mm)	Battery Type	SAR(1g) (W/kg)	Power Drift(dB)
MHz	Ch.					
707.5	23095	Rear	10	B1	0.227	-0.05
707.5	23095	Rear	10	B2	0.213	0.01

Note: According to the values in the above table, the battery of **B1** is the primary battery.

We'll perform the body measurement with this battery and retest on highest value point with others.

Table 14.4: The evaluation of multi-SIM cards for Head Test

Frequency		Side	Test Position	SIM	SAR(1g) (W/kg)	Power Drift(dB)
MHz	Ch.					
782	23230	Right	Touch	SIM1	0.317	0.00
782	23230	Right	Touch	SIM2	0.306	0.03

Note: According to the values in the above table, the **SIM1** is the primary SIM card.

We'll perform the head measurement with the SIM2 and retest on highest value point with others.

Table 14.5: The evaluation of multi-SIM cards for Body Test

Frequency		Test Position	Spacing (mm)	SIM	SAR(1g) (W/kg)	Power Drift(dB)
MHz	Ch.					
782	23230	Rear	10	SIM1	0.522	-0.09
782	23230	Rear	10	SIM2	0.513	0.02

Note: According to the values in the above table, the **SIM1** is the primary SIM card.

We'll perform the body measurement with the SIM2 and retest on highest value point with others.

Note:

B1: CAC3860025C7 VEKEN

B2: CAC3860024C1 BYD

S1: SIM1 S2: SIM2

H: CCB0046A15C1 DALIN

Table 14.1-1: SAR Values (GSM 850 MHz Band - Head)

Ambient Temperature: 22.9°C Liquid Temperature: 22.5°C											
Frequency		Side	Test Position	Figure No.	Conducted Power (dBm)	Max. tune-up Power (dBm)	Measured SAR(10g) (W/kg)	Reported SAR(10g) (W/kg)	Measured SAR(1g) (W/kg)	Reported SAR(1g) (W/kg)	Power Drift (dB)
Ch.	MHz										
190	836.6	Left	Touch	/	26.23	26.5	0.616	0.66	0.934	0.99	0.16
251	848.8	Left	Tilt	/	25.80	26.5	0.471	0.55	0.85	1.00	0.01
190	836.6	Left	Tilt	/	26.23	26.5	0.616	0.66	1.12	1.19	0.09
128	824.2	Left	Tilt	Fig.1	26.28	26.5	0.644	0.68	1.21	1.27	-0.06
190	836.6	Right	Touch	/	26.23	26.5	0.494	0.53	0.844	0.90	-0.03
190	836.6	Right	Tilt	/	26.23	26.5	0.434	0.46	0.593	0.63	0.08
128	824.2	Left	Tilt	S2	26.28	26.5	0.589	0.62	1.09	1.15	0.01
128	824.2	Left	Tilt	B2	26.28	26.5	0.486	0.51	0.98	1.03	0.02

Note: the head SAR of GSM850 is tested with GPRS (4Txslots) mode because of VoIP.

Table 14.1-2: SAR Values (GSM 850 MHz Band - Body)

Ambient Temperature: 22.9°C Liquid Temperature: 22.5°C											
Frequency		Mode (number of timeslots)	Test Position	Figure No.	Conducted Power (dBm)	Max. tune-up Power (dBm)	Measured SAR(10g) (W/kg)	Reported SAR(10g) (W/kg)	Measured SAR(1g) (W/kg)	Reported SAR(1g) (W/kg)	Power Drift (dB)
Ch.	MHz										
190	836.6	GPRS (4)	Front	/	26.23	26.5	0.108	0.11	0.129	0.14	0.09
190	836.6	GPRS (4)	Rear	/	26.23	26.5	0.142	0.15	0.163	0.17	0.12
190	836.6	GPRS (4)	Left	/	26.23	26.5	0.046	0.05	0.059	0.06	-0.09
190	836.6	GPRS (4)	Right	/	26.23	26.5	0.127	0.14	0.148	0.16	0.15
128	824.2	GPRS (4)	Top	Fig.2	26.28	26.5	0.209	0.22	0.387	0.41	-0.04
251	848.8	GPRS (4)	Top	/	25.80	26.5	0.121	0.14	0.179	0.21	-0.09
190	836.6	GPRS (4)	Top	/	26.23	26.5	0.138	0.15	0.118	0.13	0.11
190	836.6	GPRS (4)	Bottom	/	26.23	26.5	<0.01	<0.01	<0.01	<0.01	-0.05
190	836.6	EGPRS (4)	Top	/	26.22	26.5	0.2	0.21	0.376	0.40	-0.07
128	824.2	GPRS (4)	Top	S2	26.28	26.5	0.177	0.19	0.306	0.32	0.03
128	824.2	GPRS (4)	Top	B2	26.28	26.5	0.108	0.187	0.200	0.33	0.09

Note: The distance between the EUT and the phantom bottom is 10mm.

Table 14.1-3: SAR Values (GSM 1900 MHz Band - Head)

Ambient Temperature: 22.9°C Liquid Temperature: 22.5°C											
Frequency		Side	Test Position	Figure No.	Conducted Power (dBm)	Max. tune-up Power (dBm)	Measured SAR(10g) (W/kg)	Reported SAR(10g) (W/kg)	Measured SAR(1g) (W/kg)	Reported SAR(1g) (W/kg)	Power Drift (dB)
Ch.	MHz										
661	1880	Left	Touch	/	26.80	27.5	0.067	0.08	0.109	0.13	0.14
661	1880	Left	Tilt	/	26.80	27.5	0.074	0.09	0.112	0.13	0.09
810	1909.8	Right	Touch	/	26.70	27.5	0.049	0.06	0.082	0.10	0.07

661	1880	Right	Touch	Fig.3	26.80	27.5	0.074	0.09	0.122	0.14	0.05
512	1850.2	Right	Touch	/	26.51	27.5	0.073	0.09	0.103	0.13	-0.06
661	1880	Right	Tilt	/	26.80	27.5	0.052	0.06	0.088	0.10	0.04
661	1880	Right	Touch	S2	26.80	27.5	0.056	0.07	0.113	0.13	0.08
661	1880	Left	Touch	B2	26.80	27.5	0.069	0.08	0.109	0.13	0.03

Note: the head SAR of GSM850 is tested with GPRS (2Txslots) mode because of VoIP.

Table 14.1-4: SAR Values (GSM 1900 MHz Band - Body)

Ambient Temperature: 22.9 °C Liquid Temperature: 22.5 °C											
Frequency		Mode (number of timeslots)	Test Position	Figure No.	Conducte d Power (dBm)	Max. tune- up Power (dBm)	Measure d SAR(10g) (W/kg)	Reported SAR(10g) (W/kg)	Measure d SAR(1g) (W/kg)	Reporte d SAR(1g) (W/kg)	Power Drift (dB)
Ch.	MHz										
661	1880	GPRS (1)	Front	/	27.32	27.8	0.152	0.17	0.271	0.30	-0.06
661	1880	GPRS (1)	Rear	/	27.32	27.8	0.234	0.26	0.426	0.47	0.12
661	1880	GPRS (1)	Left	/	27.32	27.8	0.047	0.05	0.084	0.09	0.13
661	1880	GPRS (1)	Right	/	27.32	27.8	0.000	0.00	0.000	0.00	0.01
661	1880	GPRS (1)	Top	/	27.32	27.8	0.000	0.00	0.000	0.00	-0.04
810	1909.8	GPRS (1)	Bottom	/	27.30	27.8	0.188	0.21	0.383	0.43	-0.10
512	1850.2	GPRS (1)	Bottom	/	27.05	27.8	0.176	0.21	0.416	0.49	0.13
661	1880	GPRS (1)	Bottom	Fig.4	27.32	27.8	0.236	0.26	0.450	0.50	-0.05
661	1880	EGPRS (1)	Bottom	/	27.32	27.8	0.226	0.25	0.413	0.46	0.06
661	1880	GPRS (1)	Bottom	S2	27.32	27.8	0.198	0.22	0.398	0.44	0.06
661	1880	GPRS (1)	Bottom	B2	27.32	27.8	0.187	0.21	0.376	0.42	0.07

Note1: The distance between the EUT and the phantom bottom is 10mm

Table 14.1-5: SAR Values (GSM 1900 MHz Band - Body)

Ambient Temperature: 22.9 °C Liquid Temperature: 22.5 °C											
Frequency		Mode (number of timeslots)	Test Position	Figure No.	Conducte d Power (dBm)	Max. tune- up Power (dBm)	Measure d SAR(10g) (W/kg)	Reported SAR(10g) (W/kg)	Measure d SAR(1g) (W/kg)	Reporte d SAR(1g) (W/kg)	Power Drift (dB)
Ch.	MHz										
661	1880	GPRS (2)	Front	/	26.80	27.5	0.180	0.21	0.192	0.23	0.02
810	1909.8	GPRS (2)	Rear	/	26.70	27.5	0.000	0.00	0.250	0.30	0.12
661	1880	GPRS (2)	Rear	/	26.80	27.5	0.267	0.31	0.285	0.33	-0.01
512	1850.2	GPRS (2)	Rear	Fig.5	26.51	27.5	0.180	0.23	0.300	0.38	-0.03

Note1: The distance between the EUT and the phantom bottom is 15mm

Table 14.1-6: SAR Values (WCDMA 1900 MHz Band - Head)

Frequency		Side	Test Position	Figure No.	Conducted Power (dBm)	Max. tune-up Power (dBm)	Measured SAR(10g) (W/kg)	Reported SAR(10g)(W/kg)	Measured SAR(1g) (W/kg)	Reported SAR(1g) (W/kg)	Power Drift (dB)
Ch.	MHz										
Ambient Temperature: 22.9°C Liquid Temperature: 22.5°C											
9400	1880	Left	Touch	/	22.85	23.5	0.046	0.05	0.093	0.11	-0.06
9400	1880	Left	Tilt	/	22.85	23.5	0.055	0.06	0.088	0.10	0.12
9538	1907.6	Right	Touch	/	22.86	23.5	0.040	0.05	0.061	0.07	0.09
9400	1880	Right	Touch	Fig.6	22.85	23.5	0.076	0.09	0.122	0.14	-0.02
9262	1852.4	Right	Touch	/	22.75	23.5	0.061	0.07	0.097	0.11	-0.08
9400	1880	Right	Tilt	/	22.85	23.5	0.052	0.06	0.080	0.09	-0.12
9400	1880	Right	Touch	S2	22.85	23.5	0.067	0.08	0.115	0.13	0.06
9400	1880	Right	Touch	B2	22.85	23.5	0.059	0.07	0.103	0.12	0.03

Table 14.1-7: SAR Values (WCDMA 1900 MHz Band - Body)

Frequency		Test Position	Figure No.	Conducted Power (dBm)	Max. tune-up Power (dBm)	Measured SAR(10g) (W/kg)	Reported SAR(10g)(W/kg)	Measured SAR(1g) (W/kg)	Reported SAR(1g) (W/kg)	Power Drift (dB)
Ch.	MHz									
Ambient Temperature: 22.9°C Liquid Temperature: 22.5°C										
9400	1880	Front	/	20.85	21.5	0.152	0.18	0.269	0.31	-0.12
9400	1880	Rear	/	20.85	21.5	0.240	0.28	0.431	0.50	0.05
9400	1880	Left	/	20.85	21.5	0.056	0.06	0.097	0.11	-0.15
9400	1880	Right	/	20.85	21.5	0.035	0.04	0.058	0.07	-0.09
9538	1907.6	Bottom	/	20.88	21.5	0.297	0.34	0.569	0.66	0.11
9400	1880	Bottom	/	20.85	21.5	0.493	0.57	0.586	0.68	0.13
9262	1852.4	Bottom	Fig.7	20.73	21.5	0.316	0.38	0.600	0.72	-0.12
9400	1880	Top	/	20.85	21.5	<0.01	<0.01	<0.01	<0.01	0.10
9262	1852.4	Bottom	S2	20.73	21.5	0.269	0.32	0.578	0.69	-0.03
9262	1852.4	Bottom	B2	20.73	21.5	0.231	0.28	0.498	0.59	0.06

Note1: The distance between the EUT and the phantom bottom is 10mm

Table 14.1-8: SAR Values (WCDMA 1900 MHz Band - Body)

Frequency		Test Position	Figure No.	Conducted Power (dBm)	Max. tune-up Power (dBm)	Measured SAR(10g) (W/kg)	Reported SAR(10g)(W/kg)	Measured SAR(1g) (W/kg)	Reported SAR(1g) (W/kg)	Power Drift (dB)
Ch.	MHz									
Ambient Temperature: 22.9°C Liquid Temperature: 22.5°C										
9400	1880	Front	/	22.85	23.5	0.118	0.14	0.196	0.23	-0.16
9538	1907.6	Rear	/	22.86	23.5	0.210	0.24	0.353	0.41	-0.02
9400	1880	Rear	Fig.8	22.85	23.5	0.212	0.25	0.359	0.42	-0.04
9262	1852.4	Rear	/	22.75	23.5	0.205	0.24	0.344	0.41	-0.05

Note1: The distance between the EUT and the phantom bottom is 15mm

Table 14.1-9: SAR Values (WCDMA 1700 MHz Band - Head)

Frequency		Side	Test Position	Figure No.	Conducted Power (dBm)	Max. tune-up Power (dBm)	Measured SAR(10g) (W/kg)	Reported SAR(10g) (W/kg)	Measured SAR(1g) (W/kg)	Reported SAR(1g) (W/kg)	Power Drift (dB)
Ch.	MHz										
Ambient Temperature: 22.9°C Liquid Temperature: 22.5°C											
1412	1732.4	Left	Touch	/	22.43	23	0.054	0.06	0.079	0.09	0.01
1412	1732.4	Left	Tilt	/	22.43	23	0.045	0.05	0.070	0.08	-0.11
1513	1752.6	Right	Touch	/	22.46	23	0.081	0.09	0.126	0.14	0.06
1412	1732.4	Right	Touch	/	22.43	23	0.087	0.10	0.136	0.15	-0.12
1312	1712.4	Right	Touch	Fig.9	22.48	23	0.089	0.10	0.139	0.16	0.06
1412	1732.4	Right	Tilt	/	22.43	23	0.030	0.03	0.048	0.05	-0.02
1312	1712.4	Right	Touch	S2	22.48	23	0.071	0.08	0.112	0.13	0.01
1312	1712.4	Right	Touch	B2	22.48	23	0.062	0.07	0.098	0.11	0.03

Table 14.1-10: SAR Values (WCDMA 1700 MHz Band - Body)

Frequency		Test Position	Figure No.	Conducted Power (dBm)	Max. tune-up Power (dBm)	Measured SAR(10g) (W/kg)	Reported SAR(10g) (W/kg)	Measured SAR(1g) (W/kg)	Reported SAR(1g) (W/kg)	Power Drift (dB)
Ch.	MHz									
Ambient Temperature: 22.9°C Liquid Temperature: 22.5°C										
1412	1732.4	Front	/	22.43	23	0.281	0.32	0.480	0.55	-0.01
1412	1732.4	Rear	/	22.43	23	0.434	0.49	0.757	0.86	0.01
1412	1732.4	Left	/	22.43	23	0.093	0.11	0.151	0.17	0.09
1412	1732.4	Right	/	22.43	23	0.070	0.08	0.109	0.12	-0.04
1513	1752.6	Bottom	/	22.46	23	0.498	0.56	0.938	1.06	0.04
1312	1712.4	Bottom	Fig.10	22.48	23	0.530	0.60	0.994	1.12	-0.02
1412	1732.4	Bottom	/	22.43	23	0.512	0.58	0.965	1.10	-0.14
1412	1732.4	Top	/	22.43	23	0.000	0.00	0.000	0.00	-0.16
1312	1712.4	Bottom	S2	22.48	23	0.523	0.59	0.985	1.11	0.05
1312	1712.4	Bottom	B2	22.48	23	0.497	0.56	0.923	1.04	0.03

Note1: The distance between the EUT and the phantom bottom is 10mm

Table 14.1-11: SAR Values (WCDMA 850 MHz Band - Head)

Frequency		Side	Test Position	Figure No.	Conducted Power (dBm)	Max. tune-up Power (dBm)	Measured SAR(10g) (W/kg)	Reported SAR(10g) (W/kg)	Measured SAR(1g) (W/kg)	Reported SAR(1g) (W/kg)	Power Drift (dB)
Ch.	MHz										
Ambient Temperature: 22.9°C Liquid Temperature: 22.5°C											
4183	836.6	Left	Touch	/	22.73	23.5	0.377	0.45	0.625	0.75	0.14
4233	846.6	Left	Tilt	/	22.68	23.5	0.351	0.42	0.637	0.77	0.00
4183	836.6	Left	Tilt	/	22.73	23.5	0.371	0.44	0.669	0.80	0.16
4132	826.4	Left	Tilt	Fig.11	22.69	23.5	0.362	0.44	0.717	0.86	0.07
4183	836.6	Right	Touch	/	22.73	23.5	0.198	0.24	0.317	0.38	0.00

4183	836.6	Right	Tilt	/	22.73	23.5	0.237	0.28	0.405	0.48	0.02
4132	826.4	Left	Tilt	S2	22.69	23.5	0.313	0.38	0.687	0.83	0.03
4132	826.4	Left	Tilt	B2	22.69	23.5	0.287	0.35	0.615	0.74	0.05

Table 14.1-12: SAR Values (WCDMA 850 MHz Band - Body)

Ambient Temperature: 22.9 °C						Liquid Temperature: 22.5 °C					
Frequency		Test Position	Figure No.	Conducted Power (dBm)	Max. tune-up Power (dBm)	Measured SAR(10g) (W/kg)	Reported SAR(10g)(W/kg)	Measured SAR(1g) (W/kg)	Reported SAR(1g) (W/kg)	Power Drift (dB)	
Ch.	MHz										
4183	836.6	Front	/	22.73	23.5	0.080	0.10	0.130	0.15	0.16	
4183	836.6	Rear	/	22.73	23.5	0.137	0.16	0.196	0.23	0.00	
4183	836.6	Left	/	22.73	23.5	0.043	0.05	0.063	0.08	0.00	
4183	836.6	Right	/	22.73	23.5	0.093	0.11	0.139	0.17	0.14	
4233	846.6	Top	/	22.68	23.5	0.112	0.14	0.211	0.25	0.05	
4132	826.4	Top	/	22.69	23.5	0.107	0.13	0.202	0.24	-0.11	
4183	836.6	Top	Fig.12	22.73	23.5	0.132	0.16	0.238	0.28	-0.11	
4183	836.6	Bottom	/	22.69	23.5	0.000	0.00	0.000	0.00	0.16	
4183	836.6	Top	S2	22.73	23.5	0.112	0.13	0.213	0.25	0.07	
4183	836.6	Top	B2	22.73	23.5	0.098	0.12	0.198	0.24	0.06	

Note: The distance between the EUT and the phantom bottom is 10mm.

Table 14.1-13: SAR Values (LTE Band2 - Head)

Ambient Temperature: 22.9 °C						Liquid Temperature: 22.5 °C						
Frequency		Mode	Side	Test Position	Figure No.	Conduct ed Power (dBm)	Max. tune-up Power (dBm)	Measure d SAR(10g) (W/kg)	Reported SAR(10g)(W/kg)	Measure d SAR(1g) (W/kg)	Reporte d SAR(1g) (W/kg)	Powe r Drift (dB)
Ch.	MHz											
19100	1900	1RB-Mid	Left	Touch	/	23.18	23.5	0.049	0.05	0.133	0.14	-0.16
19100	1900	1RB-Mid	Left	Tilt	/	23.18	23.5	0.050	0.05	0.135	0.15	-0.02
19100	1900	1RB-Mid	Right	Touch	Fig.13	23.18	23.5	0.088	0.09	0.145	0.16	0.07
19100	1900	1RB-Mid	Right	Tilt	/	23.18	23.5	0.027	0.03	0.074	0.08	0.07
19100	1900	50RB-Mid	Left	Touch	/	21.80	22.5	0.045	0.05	0.118	0.14	0.02
19100	1900	50RB-Mid	Left	Tilt	/	21.80	22.5	0.035	0.04	0.094	0.11	0.16
19100	1900	50RB-Mid	Right	Touch	/	21.80	22.5	0.046	0.05	0.126	0.15	-0.13
19100	1900	50RB-Mid	Right	Tilt	/	21.80	22.5	0.000	0.00	0.000	0.00	0.07
19100	1900	1RB-Mid	Right	Touch	S2	23.18	23.5	0.077	0.08	0.136	0.15	0.03
19100	1900	1RB-Mid	Right	Touch	B2	23.18	23.5	0.063	0.07	0.115	0.12	0.02

Note1: The LTE mode is QPSK_20MHz.

Table 14.1-14: SAR Values (LTE Band2 - Body)

Frequency		Mode	Test Position	Figure No.	Conducted Power (dBm)	Max. tune-up Power (dBm)	Measured SAR(10g) (W/kg)	Reported SAR(10g) (W/kg)	Measured SAR(1g) (W/kg)	Reported SAR(1g) (W/kg)	Power Drift (dB)
Ch.	MHz										
Ambient Temperature: 22.9 °C Liquid Temperature: 22.5°C											
18900	1880	1RB-Mid	Front	/	20.94	21.5	0.144	0.16	0.267	0.30	0.04
18900	1880	1RB-Mid	Rear	/	20.94	21.5	0.221	0.25	0.407	0.46	0.16
18900	1880	1RB-Mid	Left	/	20.94	21.5	0.052	0.06	0.095	0.11	-0.01
18900	1880	1RB-Mid	Right	/	20.94	21.5	0.032	0.04	0.054	0.06	-0.02
18900	1880	1RB-Mid	Top	/	20.94	21.5	0.000	0.00	0.000	0.00	-0.12
18900	1880	1RB-Mid	Bottom	/	20.94	21.5	0.303	0.34	0.581	0.66	-0.10
19100	1900	50RB-Low	Front	/	20.83	21.5	0.155	0.18	0.279	0.33	-0.10
19100	1900	50RB-Low	Rear	/	20.83	21.5	0.257	0.30	0.473	0.55	-0.11
19100	1900	50RB-Low	Left	/	20.83	21.5	0.068	0.08	0.127	0.15	0.16
19100	1900	50RB-Low	Right	/	20.83	21.5	0.042	0.05	0.086	0.10	-0.16
19100	1900	50RB-Low	Top	/	20.83	21.5	0.000	0.00	0.000	0.00	0.16
19100	1900	50RB-Low	Bottom	Fig.14	20.83	21.5	0.370	0.43	0.717	0.84	-0.06
18700	1860	50RB-Mid	Bottom	/	20.79	21.5	0.319	0.38	0.623	0.73	-0.14
18900	1880	50RB-Mid	Bottom	/	20.78	21.5	0.297	0.35	0.580	0.68	0.13
19100	1900	100RB	Bottom	/	20.85	21.5	0.299	0.35	0.587	0.68	0.04
19100	1900	50RB-Low	Bottom	S2	20.83	21.5	0.318	0.37	0.675	0.79	0.08
19100	1900	50RB-Low	Bottom	B2	20.83	21.5	0.298	0.35	0.598	0.70	0.07

Note1: The distance between the EUT and the phantom bottom is 10mm

Note2: The LTE mode is QPSK_20MHz.

Table 14.1-15: SAR Values (LTE Band2 - Body)

Frequency		Mode	Test Position	Figure No.	Conducted Power (dBm)	Max. tune-up Power (dBm)	Measured SAR(10g) (W/kg)	Reported SAR(10g) (W/kg)	Measured SAR(1g) (W/kg)	Reported SAR(1g) (W/kg)	Power Drift (dB)
Ch.	MHz										
Ambient Temperature: 22.9 °C Liquid Temperature: 22.5°C											
19100	1900	1RB-Mid	Front	/	23.18	23.5	0.133	0.14	0.221	0.24	0.14
19100	1900	1RB-Mid	Rear	Fig.15	23.18	23.5	0.225	0.24	0.383	0.41	0.04
19100	1900	50RB-Mid	Front	/	21.80	23.5	0.105	0.16	0.174	0.26	0.14
19100	1900	50RB-Mid	Rear	/	21.80	23.5	0.167	0.25	0.281	0.42	-0.13

Note1: The distance between the EUT and the phantom bottom is 15mm

Note2: The LTE mode is QPSK_20MHz.

Table 14.1-16: SAR Values (LTE Band2 - Limb)

Frequency		Mode	Test Position	Figure No.	Conducted Power (dBm)	Max. tune-up Power (dBm)	Measured SAR(10g) (W/kg)	Reported SAR(10g) (W/kg)	Measured SAR(1g) (W/kg)	Reported SAR(1g) (W/kg)	Power Drift (dB)
Ch.	MHz										
19100	1900	1RB-Mid	Bottom	/	23.18	23.5	3.280	3.53	8.170	8.79	0.04
18900	1880	1RB-Mid	Bottom	/	23.15	23.5	3.440	3.73	8.530	9.25	-0.08
18700	1860	1RB-Mid	Bottom	/	23.14	23.5	3.570	3.88	8.810	9.57	-0.01

Note1: The distance between the EUT and the phantom bottom is 0mm

Note2: The LTE mode is QPSK_20MHz.

Table 14.1-17: SAR Values (LTE Band5 - Head)

Frequency		Mode	Side	Test Position	Figure No.	Conducted Power (dBm)	Max. tune-up Power (dBm)	Measured SAR(10g) (W/kg)	Reported SAR(10g) (W/kg)	Measured SAR(1g) (W/kg)	Reported SAR(1g) (W/kg)	Power Drift (dB)
Ch.	MHz											
20525	836.5	1RB-Mid	Left	Touch	Fig.16	22.86	23.5	0.512	0.59	0.796	0.92	-0.07
20525	836.5	1RB-Mid	Left	Tilt	/	22.86	23.5	0.575	0.67	0.728	0.84	-0.10
20525	836.5	1RB-Mid	Right	Touch	/	22.86	23.5	0.543	0.63	0.543	0.63	-0.11
20525	836.5	1RB-Mid	Right	Tilt	/	22.86	23.5	0.431	0.50	0.467	0.54	0.14
20450	829	25RB-High	Left	Touch	/	21.86	22.5	0.571	0.66	0.643	0.74	0.12
20450	829	25RB-High	Left	Tilt	/	21.86	22.5	0.422	0.49	0.533	0.62	0.01
20450	829	25RB-High	Right	Touch	/	21.86	22.5	0.393	0.46	0.394	0.46	-0.09
20450	829	25RB-High	Right	Tilt	/	21.86	22.5	0.320	0.37	0.345	0.40	0.06
20525	836.5	1RB-Mid	Left	Touch	S2	22.86	23.5	0.487	0.56	0.736	0.85	0.07
20525	836.5	1RB-Mid	Left	Touch	B2	22.86	23.5	0.415	0.48	0.698	0.81	0.02

Note1: The LTE mode is QPSK_10MHz.

Table 14.1-18: SAR Values (LTE Band5 - Body)

Frequency		Mode	Test Position	Figure No.	Conducted Power (dBm)	Max. tune-up Power (dBm)	Measured SAR(10g) (W/kg)	Reported SAR(10g) (W/kg)	Measured SAR(1g) (W/kg)	Reported SAR(1g) (W/kg)	Power Drift (dB)
Ch.	MHz										
20525	836.5	1RB-Mid	Front	/	22.86	23.5	0.092	0.11	0.140	0.16	0.14
20525	836.5	1RB-Mid	Rear	Fig.17	22.86	23.5	0.114	0.13	0.173	0.20	-0.17
20525	836.5	1RB-Mid	Left	/	22.86	23.5	0.053	0.06	0.085	0.10	-0.15
20525	836.5	1RB-Mid	Right	/	22.86	23.5	0.085	0.10	0.133	0.15	0.10
20525	836.5	1RB-Mid	Top	/	22.86	23.5	0.073	0.08	0.138	0.16	0.15

20525	836.5	1RB-Mid	Bottom	/	22.86	23.5	0.000	0.00	0.000	0.00	0.07
20450	829	25RB-High	Front	/	21.86	22.5	0.066	0.08	0.099	0.11	0.14
20450	829	25RB-High	Rear	/	21.86	22.5	0.085	0.10	0.128	0.15	-0.14
20450	829	25RB-High	Left	/	21.86	22.5	0.039	0.05	0.062	0.07	-0.13
20450	829	25RB-High	Right	/	21.86	22.5	0.062	0.07	0.100	0.12	0.12
20450	829	25RB-High	Top	/	21.86	22.5	0.053	0.06	0.106	0.12	0.07
20450	829	25RB-High	Bottom	/	21.86	22.5	0.000	0.00	0.000	0.00	-0.10
20525	836.5	1RB-Mid	Rear	S2	22.86	23.5	0.098	0.11	0.143	0.17	0.02
20525	836.5	1RB-Mid	Rear	B2	22.86	23.5	0.079	0.09	0.135	0.16	-0.01

Note1: The distance between the EUT and the phantom bottom is 10mm.

Note2: The LTE mode is QPSK_10MHz.

Table 14.1-19: SAR Values (LTE Band7 - Head)

Ambient Temperature: 22.9 °C Liquid Temperature: 22.5 °C												
Frequency		Mode	Side	Test Position	Figure No.	Conducted Power (dBm)	Max. tune-up Power (dBm)	Measured SAR(10g) (W/kg)	Reported SAR(10g) (W/kg)	Measured SAR(1g) (W/kg)	Reported SAR(1g) (W/kg)	Power Drift (dB)
Ch.	MHz											
21350	2560	1RB-Mid	Left	Touch	Fig.18	22.78	23	0.041	0.04	0.076	0.08	0.00
21350	2560	1RB-Mid	Left	Tilt	/	22.78	23	0.019	0.02	0.036	0.04	-0.03
21350	2560	1RB-Mid	Right	Touch	/	22.78	23	0.028	0.03	0.047	0.05	0.01
21350	2560	1RB-Mid	Right	Tilt	/	22.78	23	0.027	0.03	0.050	0.05	-0.14
20850	2510	50RB-Low	Left	Touch	/	21.66	22	0.039	0.04	0.073	0.08	-0.16
20850	2510	50RB-Low	Left	Tilt	/	21.66	22	0.000	0.00	0.000	0.00	0.03
20850	2510	50RB-Low	Right	Touch	/	21.66	22	0.000	0.00	0.000	0.00	0.10
20850	2510	50RB-Low	Right	Tilt	/	21.66	22	0.000	0.00	0.000	0.00	-0.15
21350	2560	1RB-Mid	Left	Touch	S2	22.78	23	0.039	0.04	0.064	0.07	0.01
21350	2560	1RB-Mid	Left	Touch	B2	22.78	23	0.031	0.03	0.059	0.06	0.02

Note1: The LTE mode is QPSK_20MHz.

Table 14.1-20: SAR Values (LTE Band7 - Body)

Ambient Temperature: 22.9 °C Liquid Temperature: 22.5 °C												
Frequency		Mode	Test Position	Figure No.	Conducted Power (dBm)	Max. tune-up Power (dBm)	Measured SAR(10g) (W/kg)	Reported SAR(10g) (W/kg)	Measured SAR(1g) (W/kg)	Reported SAR(1g) (W/kg)	Power Drift (dB)	
Ch.	MHz											
21350	2560	1RB-Mid	Front	/	19.29	19.5	0.159	0.17	0.329	0.35	0.02	
21350	2560	1RB-Mid	Rear	/	19.29	19.5	0.26	0.27	0.545	0.57	-0.03	
21350	2560	1RB-Mid	Left	/	19.29	19.5	0.023	0.02	0.043	0.05	0.01	
21350	2560	1RB-Mid	Right	/	19.29	19.5	0.016	0.02	0.033	0.03	-0.05	
21350	2560	1RB-Mid	Top	/	19.29	19.5	<0.01	<0.01	<0.01	<0.01	0.03	
20850	2510	1RB-Mid	Bottom	Fig.19	19.20	19.5	0.421	0.45	0.89	0.95	0.01	

21100	2535	1RB-Mid	Bottom	/	19.21	19.5	0.418	0.45	0.879	0.94	0.06
21350	2560	1RB-Mid	Bottom	/	19.29	19.5	0.418	0.44	0.884	0.93	0.04
21350	2560	100RB	Bottom	/	19.12	19.5	0.408	0.45	0.865	0.94	-0.11
21350	2560	50RB-Mid	Front	/	19.12	19.5	0.142	0.15	0.307	0.34	0.06
21350	2560	50RB-Mid	Rear	/	19.12	19.5	0.251	0.27	0.528	0.58	0.05
21350	2560	50RB-Mid	Left	/	19.12	19.5	0.023	0.03	0.042	0.05	-0.02
21350	2560	50RB-Mid	Right	/	19.12	19.5	<0.01	<0.01	<0.01	<0.01	0.01
21350	2560	50RB-Mid	Top	/	19.12	19.5	<0.01	<0.01	<0.01	<0.01	0.02
20850	2510	50RB-Mid	Bottom	/	19.08	19.5	0.421	0.46	0.856	0.94	0.03
21100	2535	50RB-Mid	Bottom	/	19.10	19.5	0.411	0.45	0.839	0.92	-0.01
21350	2560	50RB-Mid	Bottom	/	19.12	19.5	0.414	0.45	0.846	0.92	-0.05
20850	2510	100RB	Bottom	/	19.12	19.5	0.402	0.44	0.837	0.91	0.06
20850	2510	1RB-Mid	Bottom	S2	19.20	19.5	0.398	0.43	0.871	0.93	0.09
20850	2510	1RB-Mid	Bottom	B2	19.20	19.5	0.368	0.39	0.791	0.85	0.03

Note1: The distance between the EUT and the phantom bottom is 10mm

Note2: The LTE mode is QPSK_20MHz.

Table 14.1-21: SAR Values (LTE Band7 - Body)

Frequency		Mode	Test Position	Figure No.	Conducted Power (dBm)	Max. tune-up Power (dBm)	Measured SAR(10g) (W/kg)	Reported SAR(10g) (W/kg)	Measured SAR(1g) (W/kg)	Reported SAR(1g) (W/kg)	Power Drift (dB)
Ch.	MHz										
21350	2560	1RB-Mid	Front	/	22.78	23	0.171	0.18	0.333	0.35	0.10
21350	2560	1RB-Mid	Rear	Fig.20	22.78	23	0.265	0.28	0.541	0.57	-0.16
20850	2510	50RB-Low	Front	/	21.66	22	0.136	0.15	0.258	0.28	-0.01
20850	2510	50RB-Low	Rear	/	21.66	22	0.243	0.26	0.468	0.51	-0.16

Note1: The distance between the EUT and the phantom bottom is 15mm

Note2: The LTE mode is QPSK_20MHz.

Table 14.1-22: SAR Values (LTE Band7 - Limb)

Frequency		Mode	Test Position	Figure No.	Conducted Power (dBm)	Max. tune-up Power (dBm)	Measured SAR(10g) (W/kg)	Reported SAR(10g) (W/kg)	Measured SAR(1g) (W/kg)	Reported SAR(1g) (W/kg)	Power Drift (dB)
Ch.	MHz										
20850	2510	1RB-Mid	Bottom	/	22.72	23	3.51	3.74	9.65	10.29	0.01
21100	2535	1RB-Mid	Bottom	/	22.72	23	3.20	3.41	8.56	9.13	0.03
21350	2560	1RB-Mid	Bottom	/	22.78	23	3.05	3.21	7.27	7.65	-0.02

Note1: The distance between the EUT and the phantom bottom is 0mm

Note2: The LTE mode is QPSK_20MHz.

Table 14.1-23: SAR Values (LTE Band12 - Head)

Frequency		Mode	Side	Test Position	Figure No.	Conducted Power (dBm)	Max. tune-up Power (dBm)	Measured SAR(10g) (W/kg)	Reported SAR(10g) (W/kg)	Measured SAR(1g) (W/kg)	Reported SAR(1g) (W/kg)	Power Drift (dB)
Ch.	MHz											
Ambient Temperature: 22.9°C Liquid Temperature: 22.5°C												
23095	707.5	1RB-Mid	Left	Touch	Fig.21	22.80	23.5	0.089	0.10	0.110	0.13	0.160
23095	707.5	1RB-Mid	Left	Tilt	/	22.80	23.5	0.052	0.06	0.063	0.07	0.07
23095	707.5	1RB-Mid	Right	Touch	/	22.80	23.5	0.072	0.08	0.092	0.11	-0.04
23095	707.5	1RB-Mid	Right	Tilt	/	22.80	23.5	0.061	0.07	0.074	0.09	0.07
23130	711	25RB-Mid	Left	Touch	/	21.75	22.5	0.073	0.09	0.090	0.11	0.12
23130	711	25RB-Mid	Left	Tilt	/	21.75	22.5	0.000	0.00	0.000	0.00	-0.01
23130	711	25RB-Mid	Right	Touch	/	21.75	22.5	0.084	0.10	0.104	0.12	-0.12
23130	711	25RB-Mid	Right	Tilt	/	21.75	22.5	0.049	0.06	0.060	0.07	-0.14
23095	707.5	1RB-Mid	Left	Touch	B2	22.80	23.5	0.046	0.05	0.092	0.11	0.010
23095	707.5	1RB-Mid	Left	Touch	S2	22.80	23.5	0.039	0.05	0.087	0.10	0.030

Note1: The LTE mode is QPSK_10MHz.

Table 14.1-24: SAR Values (LTE Band12 - Body)

Frequency		Mode	Test Position	Figure No.	Conducted Power (dBm)	Max. tune-up Power (dBm)	Measured SAR(10g) (W/kg)	Reported SAR(10g) (W/kg)	Measured SAR(1g) (W/kg)	Reported SAR(1g) (W/kg)	Power Drift (dB)
Ch.	MHz										
Ambient Temperature: 22.9°C Liquid Temperature: 22.5°C											
23095	707.5	1RB-Mid	Front	/	22.80	23.5	0.108	0.13	0.142	0.17	-0.05
23095	707.5	1RB-Mid	Rear	Fig.22	22.80	23.5	0.173	0.20	0.227	0.27	-0.05
23095	707.5	1RB-Mid	Left	/	22.80	23.5	0.043	0.05	0.062	0.07	-0.05
23095	707.5	1RB-Mid	Right	/	22.80	23.5	0.055	0.06	0.077	0.09	-0.15
23095	707.5	1RB-Mid	Top		22.80	23.5	0.000	0.00	0.000	0.00	0.12
23095	707.5	1RB-Mid	Bottom		22.80	23.5	0.057	0.07	0.113	0.13	0.15
23130	711	25RB-Mid	Front		21.75	22.5	0.078	0.09	0.102	0.12	0.03
23130	711	25RB-Mid	Rear		21.75	22.5	0.129	0.15	0.169	0.20	-0.15
23130	711	25RB-Mid	Left		21.75	22.5	0.056	0.07	0.080	0.09	-0.15
23130	711	25RB-Mid	Right	/	21.75	22.5	0.057	0.07	0.082	0.10	0.04
23130	711	25RB-Mid	Top	/	21.75	22.5	0.000	0.00	0.000	0.00	0.15
23130	711	25RB-Mid	Bottom	/	21.75	22.5	0.040	0.05	0.068	0.08	-0.13
23095	707.5	1RB-Mid	Rear	S2	22.80	23.5	0.158	0.19	0.198	0.23	0.03
23095	707.5	1RB-Mid	Rear	B2	22.80	23.5	0.165	0.19	0.213	0.25	0.01

Note1: The distance between the EUT and the phantom bottom is 10mm.

Note2: The LTE mode is QPSK_10MHz.

Table 14.1-25: SAR Values (LTE Band13 - Head)

Frequency		Mode	Side	Test Position	Figure No.	Conducted Power (dBm)	Max. tune-up Power (dBm)	Measured SAR(10g) (W/kg)	Reported SAR(10g)(W/kg)	Measured SAR(1g) (W/kg)	Reported SAR(1g) (W/kg)	Power Drift (dB)
Ch.	MHz											
23230	782	1RB-Mid	Left	Touch	/	22.88	23.5	0.433	0.50	0.277	0.32	0.01
23230	782	1RB-Mid	Left	Tilt	/	22.88	23.5	0.251	0.29	0.154	0.18	-0.03
23230	782	1RB-Mid	Right	Touch	Fig.23	22.88	23.5	0.251	0.29	0.317	0.37	0.00
23230	782	1RB-Mid	Right	Tilt	/	22.88	23.5	0.494	0.57	0.315	0.36	-0.16
23230	782	25RB-Mid	Left	Touch	/	21.73	22.5	0.295	0.35	0.186	0.22	-0.15
23230	782	25RB-Mid	Left	Tilt	/	21.73	22.5	0.195	0.23	0.121	0.14	0.12
23230	782	25RB-Mid	Right	Touch	/	21.73	22.5	0.456	0.54	0.293	0.35	-0.15
23230	782	25RB-Mid	Right	Tilt	/	21.73	22.5	0.377	0.45	0.239	0.28	0.14
23230	782	1RB-Mid	Right	Touch	S2	22.88	23.5	0.243	0.28	0.306	0.35	0.03
23230	782	1RB-Mid	Right	Touch	B2	22.88	23.5	0.239	0.28	0.298	0.34	0.05

Note1: The LTE mode is QPSK_10MHz.

Table 14.1-26: SAR Values (LTE Band13 - Body)

Frequency		Mode	Test Position	Figure No.	Conducted Power (dBm)	Max. tune-up Power (dBm)	Measured SAR(10g) (W/kg)	Reported SAR(10g)(W/kg)	Measured SAR(1g) (W/kg)	Reported SAR(1g) (W/kg)	Power Drift (dB)
Ch.	MHz										
23230	782	1RB-Mid	Front	/	22.88	23.5	0.224	0.26	0.316	0.36	0.03
23230	782	1RB-Mid	Rear	Fig.24	22.88	23.5	0.292	0.34	0.522	0.60	-0.09
23230	782	1RB-Mid	Left	/	22.88	23.5	<0.01	<0.01	<0.01	<0.01	/
23230	782	1RB-Mid	Right	/	22.88	23.5	0.049	0.06	0.076	0.09	0.04
23230	782	1RB-Mid	Top	/	22.88	23.5	0.000	0.00	0.000	0.00	-0.09
23230	782	1RB-Mid	Bottom	/	22.88	23.5	0.200	0.23	0.365	0.42	-0.06
23230	782	25RB-Mid	Front	/	21.73	22.5	0.163	0.19	0.231	0.28	-0.07
23230	782	25RB-Mid	Rear	/	21.73	22.5	0.212	0.25	0.375	0.45	0.06
23230	782	25RB-Mid	Left	/	21.73	22.5	<0.01	<0.01	<0.01	<0.01	-0.05
23230	782	25RB-Mid	Right	/	21.73	22.5	0.027	0.03	0.041	0.05	-0.12
23230	782	25RB-Mid	Top	/	21.73	22.5	<0.01	<0.01	<0.01	<0.01	-0.14
23230	782	25RB-Mid	Bottom	/	21.73	22.5	0.149	0.18	0.268	0.32	0.11
23230	782	1RB-Mid	Rear	S2	22.88	23.5	0.281	0.32	0.513	0.59	0.02
23230	782	1RB-Mid	Rear	B2	22.88	23.5	0.275	0.32	0.498	0.57	0.05

Note1: The distance between the EUT and the phantom bottom is 10mm.

Note2: The LTE mode is QPSK_10MHz.

Table 14.1-27 SAR Values (LTE Band66 - Head)

Frequency		Mode	Side	Test Position	Figure No.	Conducted Power (dBm)	Max. tune-up Power (dBm)	Measured SAR(10g) (W/kg)	Reported SAR(10g)(W/kg)	Measured SAR(1g) (W/kg)	Reported SAR(1g) (W/kg)	Power Drift (dB)
Ch.	MHz											
Ambient Temperature: 22.9°C Liquid Temperature: 22.5°C												
132072	1720	1RB-Mid	Left	Touch	/	22.74	23.5	0.036	0.04	0.055	0.07	-0.04
132072	1720	1RB-Mid	Left	Tilt	/	22.74	23.5	0.037	0.04	0.056	0.07	0.09
132072	1720	1RB-Mid	Right	Touch	Fig.25	22.74	23.5	0.059	0.07	0.090	0.11	0.06
132072	1720	1RB-Mid	Right	Tilt	/	22.74	23.5	0.025	0.03	0.039	0.05	-0.11
132072	1720	50RB-Mid	Left	Touch	/	21.67	22.5	0.034	0.04	0.048	0.06	-0.02
132072	1720	50RB-Mid	Left	Tilt	/	21.67	22.5	0.028	0.03	0.042	0.05	0.05
132072	1720	50RB-Mid	Right	Touch	/	21.67	22.5	0.046	0.06	0.071	0.09	-0.06
132072	1720	50RB-Mid	Right	Tilt	/	21.67	22.5	0.020	0.02	0.030	0.04	0.08
132072	1720	1RB-Mid	Right	Touch	S2	22.74	23.5	0.045	0.05	0.081	0.10	0.02
132072	1720	1RB-Mid	Right	Touch	B2	22.74	23.5	0.039	0.05	0.077	0.09	0.03

Note1: The LTE mode is QPSK_20MHz.

Table 14.1-28: SAR Values (LTE Band66 - Body)

Frequency		Mode	Test Position	Figure No.	Conducted Power (dBm)	Max. tune-up Power (dBm)	Measured SAR(10g) (W/kg)	Reported SAR(10g)(W/kg)	Measured SAR(1g) (W/kg)	Reported SAR(1g) (W/kg)	Power Drift (dB)
Ch.	MHz										
Ambient Temperature: 22.9°C Liquid Temperature: 22.5°C											
132072	1720	1RB-Mid	Front	/	22.74	23.5	0.291	0.35	0.521	0.62	-0.07
132072	1720	1RB-Mid	Rear	Fig.26	22.74	23.5	0.421	0.50	0.778	0.93	0.05
132072	1720	1RB-Mid	Left	/	22.74	23.5	0.071	0.08	0.124	0.15	0.02
132072	1720	1RB-Mid	Right	/	22.74	23.5	0.000	0.00	0.000	0.00	-0.05
132072	1720	1RB-Mid	Top	/	22.74	23.5	0.000	0.00	0.000	0.00	0.11
132072	1720	1RB-Mid	Bottom	/	22.74	23.5	0.365	0.44	0.742	0.88	0.07
132072	1720	50RB-Mid	Front	/	21.67	22.5	0.225	0.27	0.406	0.49	0.15
132072	1720	50RB-Mid	Rear	/	21.67	22.5	0.328	0.40	0.623	0.75	0.07
132072	1720	50RB-Mid	Left	/	21.67	22.5	0.043	0.05	0.077	0.09	-0.07
132072	1720	50RB-Mid	Right	/	21.67	22.5	0.000	0.00	0.000	0.00	-0.13
132072	1720	50RB-Mid	Top	/	21.67	22.5	0.000	0.00	0.000	0.00	-0.04
132072	1720	50RB-Mid	Bottom	/	21.67	22.5	0.279	0.34	0.563	0.68	-0.11
132072	1720	1RB-Mid	Rear	S2	22.74	23.5	0.389	0.46	0.738	0.88	0.02
132072	1720	1RB-Mid	Rear	B2	22.74	23.5	0.354	0.42	0.697	0.83	0.05

Note1: The distance between the EUT and the phantom bottom is 10mm

Note2: The LTE mode is QPSK_20MHz.

14.2 SAR results for Standard procedure

There is zoom scan measurement to be added for the highest measured SAR in each exposure configuration/band.

Table 14.2-1: SAR Values (GSM 850 MHz Band - Head)

Frequency		Side	Test Position	Figure No.	Conducted Power (dBm)	Max. tune-up Power (dBm)	Measured SAR(10g) (W/kg)	Reported SAR(10g) (W/kg)	Measured SAR(1g) (W/kg)	Reported SAR(1g) (W/kg)	Power Drift (dB)
Ch.	MHz										
128	824.2	Left	Tilt	Fig.1	26.28	26.5	0.644	0.68	1.21	1.27	-0.06

Table 14.2-2: SAR Values (GSM 850 MHz Band - Body)

Frequency		Mode (number of timeslots)	Test Position	Figure No.	Conducted Power (dBm)	Max. tune-up Power (dBm)	Measured SAR(10g) (W/kg)	Reported SAR(10g) (W/kg)	Measured SAR(1g) (W/kg)	Reported SAR(1g) (W/kg)	Power Drift (dB)
Ch.	MHz										
128	824.2	GPRS(4)	Top	Fig.2	26.28	26.5	0.209	0.22	0.387	0.41	-0.04

Note: The distance between the EUT and the phantom bottom is 10mm.

Table 14.2-3: SAR Values (GSM 1900 MHz Band - Head)

Frequency		Side	Test Position	Figure No.	Conducted Power (dBm)	Max. tune-up Power (dBm)	Measured SAR(10g) (W/kg)	Reported SAR(10g) (W/kg)	Measured SAR(1g) (W/kg)	Reported SAR(1g) (W/kg)	Power Drift (dB)
Ch.	MHz										
661	1880	Right	Touch	Fig.3	26.80	27.5	0.074	0.09	0.122	0.14	0.05

Table 14.2-4: SAR Values (GSM 1900 MHz Band - Body)

Frequency		Mode (number of timeslots)	Test Position	Figure No.	Conducted Power (dBm)	Max. tune-up Power (dBm)	Measured SAR(10g) (W/kg)	Reported SAR(10g) (W/kg)	Measured SAR(1g) (W/kg)	Reported SAR(1g) (W/kg)	Power Drift (dB)
Ch.	MHz										
661	1880	GPRS (1)	Bottom	Fig.4	27.32	27.8	0.236	0.26	0.450	0.50	-0.05

Note1: The distance between the EUT and the phantom bottom is 10mm

Table 14.2-5: SAR Values (GSM 1900 MHz Band - Body)

Frequency		Mode (number of timeslots)	Test Position	Figure No.	Conducted Power (dBm)	Max. tune-up Power (dBm)	Measured SAR(10g) (W/kg)	Reported SAR(10g) (W/kg)	Measured SAR(1g) (W/kg)	Reported SAR(1g) (W/kg)	Power Drift (dB)
Ch.	MHz										
512	1850.2	GPRS (2)	Rear	Fig.5	26.51	27.5	0.180	0.23	0.300	0.38	-0.03

Note1: The distance between the EUT and the phantom bottom is 15mm

Table 14.2-6: SAR Values (WCDMA 1900 MHz Band - Head)

Frequency		Side	Test Position	Figure No.	Conducted Power (dBm)	Max. tune-up Power (dBm)	Measured SAR(10g) (W/kg)	Reported SAR(10g) (W/kg)	Measured SAR(1g) (W/kg)	Reported SAR(1g) (W/kg)	Power Drift (dB)
Ch.	MHz										
Ambient Temperature: 22.9 °C Liquid Temperature: 22.5 °C											
9400	1880	Right	Touch	Fig.6	22.85	23.5	0.076	0.09	0.122	0.14	-0.02

Table 14.2-7: SAR Values (WCDMA 1900 MHz Band - Body)

Frequency		Test Position	Figure No.	Conducted Power (dBm)	Max. tune-up Power (dBm)	Measured SAR(10g) (W/kg)	Reported SAR(10g) (W/kg)	Measured SAR(1g) (W/kg)	Reported SAR(1g) (W/kg)	Power Drift (dB)
Ch.	MHz									
Ambient Temperature: 22.9 °C Liquid Temperature: 22.5 °C										
9262	1852.4	Bottom	Fig.7	20.73	21.5	0.316	0.38	0.600	0.72	-0.12

Note1: The distance between the EUT and the phantom bottom is 10mm

Table 14.2-8: SAR Values (WCDMA 1900 MHz Band - Body)

Frequency		Test Position	Figure No.	Conducted Power (dBm)	Max. tune-up Power (dBm)	Measured SAR(10g) (W/kg)	Reported SAR(10g) (W/kg)	Measured SAR(1g) (W/kg)	Reported SAR(1g) (W/kg)	Power Drift (dB)
Ch.	MHz									
Ambient Temperature: 22.9 °C Liquid Temperature: 22.5 °C										
9400	1880	Rear	Fig.8	22.85	23.5	0.212	0.25	0.359	0.42	-0.04

Note1: The distance between the EUT and the phantom bottom is 15mm

Table 14.2-9: SAR Values (WCDMA 1700 MHz Band - Head)

Frequency		Side	Test Position	Figure No.	Conducted Power (dBm)	Max. tune-up Power (dBm)	Measured SAR(10g) (W/kg)	Reported SAR(10g) (W/kg)	Measured SAR(1g) (W/kg)	Reported SAR(1g) (W/kg)	Power Drift (dB)
Ch.	MHz										
Ambient Temperature: 22.9 °C Liquid Temperature: 22.5 °C											
1312	1712.4	Right	Touch	Fig.9	22.48	23	0.089	0.10	0.139	0.16	0.06

Table 14.2-10: SAR Values (WCDMA 1700 MHz Band - Body)

Frequency		Test Position	Figure No.	Conducted Power (dBm)	Max. tune-up Power (dBm)	Measured SAR(10g) (W/kg)	Reported SAR(10g) (W/kg)	Measured SAR(1g) (W/kg)	Reported SAR(1g) (W/kg)	Power Drift (dB)
Ch.	MHz									
Ambient Temperature: 22.9 °C Liquid Temperature: 22.5 °C										
1312	1712.4	Bottom	Fig.10	22.48	23	0.530	0.60	0.994	1.12	-0.02

Note1: The distance between the EUT and the phantom bottom is 10mm

Table 14.2-11: SAR Values (WCDMA 850 MHz Band - Head)

Frequency		Side	Test Position	Figure No.	Conducted Power (dBm)	Max. tune-up Power (dBm)	Measured SAR(10g) (W/kg)	Reported SAR(10g) (W/kg)	Measured SAR(1g) (W/kg)	Reported SAR(1g) (W/kg)	Power Drift (dB)	
Ch.	MHz											
		Ambient Temperature: 22.9°C Liquid Temperature: 22.5°C										
4132	826.4	Left	Tilt	Fig.11	22.69	23.5	0.362	0.44	0.717	0.86	0.07	

Table 14.2-12: SAR Values (WCDMA 850 MHz Band - Body)

Frequency		Test Position	Figure No.	Conducted Power (dBm)	Max. tune-up Power (dBm)	Measured SAR(10g) (W/kg)	Reported SAR(10g) (W/kg)	Measured SAR(1g) (W/kg)	Reported SAR(1g) (W/kg)	Power Drift (dB)	
Ch.	MHz										
		Ambient Temperature: 22.9°C Liquid Temperature: 22.5°C									
4183	836.6	Top	Fig.12	22.73	23.5	0.132	0.16	0.238	0.28	-0.11	

Note: The distance between the EUT and the phantom bottom is 10mm.

Table 14.2-13: SAR Values (LTE Band2 - Head)

Frequency		Mode	Side	Test Position	Figure No.	Conducted Power (dBm)	Max. tune-up Power (dBm)	Measured SAR(10g) (W/kg)	Reported SAR(10g) (W/kg)	Measured SAR(1g) (W/kg)	Reported SAR(1g) (W/kg)	Power Drift (dB)
Ch.	MHz											
		Ambient Temperature: 22.9°C Liquid Temperature: 22.5°C										
19100	1900	1RB-Mid	Right	Touch	Fig.13	22.95	23.5	0.088	0.10	0.145	0.16	0.07

Note1: The LTE mode is QPSK_20MHz.

Table 14.2-14: SAR Values (LTE Band2 - Body)

Frequency		Mode	Test Position	Figure No.	Conducted Power (dBm)	Max. tune-up Power (dBm)	Measured SAR(10g) (W/kg)	Reported SAR(10g) (W/kg)	Measured SAR(1g) (W/kg)	Reported SAR(1g) (W/kg)	Power Drift (dB)	
Ch.	MHz											
		Ambient Temperature: 22.9°C Liquid Temperature: 22.5°C										
19100	1900	50RB-Low	Bottom	Fig.14	20.83	21.5	0.370	0.43	0.717	0.84	-0.06	

Note1: The distance between the EUT and the phantom bottom is 10mm

Note2: The LTE mode is QPSK_20MHz.

Table 14.2-15: SAR Values (LTE Band2 - Body)

Frequency		Mode	Test Position	Figure No.	Conducted Power (dBm)	Max. tune-up Power (dBm)	Measured SAR(10g) (W/kg)	Reported SAR(10g) (W/kg)	Measured SAR(1g) (W/kg)	Reported SAR(1g) (W/kg)	Power Drift (dB)	
Ch.	MHz											
		Ambient Temperature: 22.9°C Liquid Temperature: 22.5°C										
19100	1900	1RB-Mid	Rear	Fig.15	23.18	23.5	0.225	0.24	0.383	0.41	0.04	

Note1: The distance between the EUT and the phantom bottom is 15mm

Note2: The LTE mode is QPSK_20MHz.

Table 14.2-16: SAR Values (LTE Band5 - Head)

Frequency		Mode	Side	Test Position	Figure No.	Conducted Power (dBm)	Max. tune-up Power (dBm)	Measured SAR(10g) (W/kg)	Reported SAR(10g) (W/kg)	Measured SAR(1g) (W/kg)	Reported SAR(1g) (W/kg)	Power Drift (dB)
Ch.	MHz											
20525	836.5	1RB-Mid	Left	Touch	Fig.16	22.86	23.5	0.512	0.59	0.796	0.92	-0.07

Note1: The LTE mode is QPSK_10MHz.

Table 14.2-17: SAR Values (LTE Band5 - Body)

Frequency		Mode	Test Position	Figure No.	Conducted Power (dBm)	Max. tune-up Power (dBm)	Measured SAR(10g) (W/kg)	Reported SAR(10g) (W/kg)	Measured SAR(1g) (W/kg)	Reported SAR(1g) (W/kg)	Power Drift (dB)
Ch.	MHz										
20525	836.5	1RB-Mid	Rear	Fig.17	22.86	23.5	0.114	0.13	0.173	0.20	-0.17

Note1: The distance between the EUT and the phantom bottom is 10mm.

Note2: The LTE mode is QPSK_10MHz.

Table 14.2-18: SAR Values (LTE Band7 - Head)

Frequency		Mode	Side	Test Position	Figure No.	Conducted Power (dBm)	Max. tune-up Power (dBm)	Measured SAR(10g) (W/kg)	Reported SAR(10g) (W/kg)	Measured SAR(1g) (W/kg)	Reported SAR(1g) (W/kg)	Power Drift (dB)
Ch.	MHz											
21350	2560	1RB-Mid	Left	Touch	Fig.18	22.78	23	0.041	0.04	0.076	0.08	0.00

Note1: The LTE mode is QPSK_20MHz.

Table 14.2-19: SAR Values (LTE Band7 - Body)

Frequency		Mode	Test Position	Figure No.	Conducted Power (dBm)	Max. tune-up Power (dBm)	Measured SAR(10g) (W/kg)	Reported SAR(10g) (W/kg)	Measured SAR(1g) (W/kg)	Reported SAR(1g) (W/kg)	Power Drift (dB)
Ch.	MHz										
20850	2510	1RB-Mid	Bottom	Fig.19	19.20	19.5	0.421	0.45	0.89	0.95	0.01

Note1: The distance between the EUT and the phantom bottom is 10mm

Note2: The LTE mode is QPSK_20MHz.

Table 14.2-20: SAR Values (LTE Band7 - Body)

Frequency		Mode	Test Position	Figure No.	Conducted Power (dBm)	Max. tune-up Power (dBm)	Measured SAR(10g) (W/kg)	Reported SAR(10g) (W/kg)	Measured SAR(1g) (W/kg)	Reported SAR(1g) (W/kg)	Power Drift (dB)
Ch.	MHz										

Frequency		Mode	Test Position	Figure No.	Conducted Power (dBm)	Max. tune-up Power (dBm)	Measured SAR(10g) (W/kg)	Reported SAR(10g) (W/kg)	Measured SAR(1g) (W/kg)	Reported SAR(1g) (W/kg)	Power Drift (dB)
Ch.	MHz										
21350	2560	1RB-Mid	Rear	Fig.20	22.78	23	0.265	0.28	0.541	0.57	-0.06

Note1: The distance between the EUT and the phantom bottom is 15mm

Note2: The LTE mode is QPSK_20MHz.

Table 14.2-21: SAR Values (LTE Band12 - Head)

Ambient Temperature: 22.9 °C						Liquid Temperature: 22.5°C						
Frequency		Mode	Side	Test Position	Figure No.	Conducted Power (dBm)	Max. tune-up Power (dBm)	Measured SAR(10g) (W/kg)	Reported SAR(10g) (W/kg)	Measured SAR(1g) (W/kg)	Reported SAR(1g) (W/kg)	Power Drift (dB)
Ch.	MHz											
23095	707.5	1RB-Mid	Left	Touch	Fig.21	22.80	23.5	0.089	0.10	0.110	0.13	0.160

Note1: The LTE mode is QPSK_10MHz.

Table 14.2-22: SAR Values (LTE Band12 - Body)

Ambient Temperature: 22.9 °C						Liquid Temperature: 22.5°C					
Frequency		Mode	Test Position	Figure No.	Conducted Power (dBm)	Max. tune-up Power (dBm)	Measured SAR(10g) (W/kg)	Reported SAR(10g) (W/kg)	Measured SAR(1g) (W/kg)	Reported SAR(1g) (W/kg)	Power Drift (dB)
Ch.	MHz										
23095	707.5	1RB-Mid	Rear	Fig.22	22.80	23.5	0.173	0.20	0.227	0.27	-0.05

Note1: The distance between the EUT and the phantom bottom is 10mm.

Note2: The LTE mode is QPSK_10MHz.

Table 14.2-23: SAR Values (LTE Band13 - Head)

Ambient Temperature: 22.9 °C						Liquid Temperature: 22.5°C						
Frequency		Mode	Side	Test Position	Figure No.	Conducted Power (dBm)	Max. tune-up Power (dBm)	Measured SAR(10g) (W/kg)	Reported SAR(10g) (W/kg)	Measured SAR(1g) (W/kg)	Reported SAR(1g) (W/kg)	Power Drift (dB)
Ch.	MHz											
23230	782	1RB-Mid	Right	Touch	Fig.23	22.88	23.5	0.251	0.29	0.317	0.37	0.00

Note1: The LTE mode is QPSK_10MHz.

Table 14.2-24: SAR Values (LTE Band13 - Body)

Ambient Temperature: 22.9 °C						Liquid Temperature: 22.5°C					
Frequency		Mode	Test Position	Figure No.	Conducted Power (dBm)	Max. tune-up Power (dBm)	Measured SAR(10g) (W/kg)	Reported SAR(10g) (W/kg)	Measured SAR(1g) (W/kg)	Reported SAR(1g) (W/kg)	Power Drift (dB)
Ch.	MHz										
23230	782	1RB-Mid	Rear	Fig.24	22.88	23.5	0.292	0.34	0.522	0.60	-0.09

Note1: The distance between the EUT and the phantom bottom is 10mm.

Note2: The LTE mode is QPSK_10MHz.

Table 14.2-25 SAR Values (LTE Band66 - Head)

Frequency		Mode	Side	Test Position	Figure No.	Conducted Power (dBm)	Max. tune-up Power (dBm)	Measured SAR(10g) (W/kg)	Reported SAR(10g) (W/kg)	Measured SAR(1g) (W/kg)	Reported SAR(1g) (W/kg)	Power Drift (dB)	
Ch.	MHz												
		Ambient Temperature: 22.9 °C						Liquid Temperature: 22.5 °C					
132072	1720	1RB-Mid	Right	Touch	Fig.25	22.74	23.5	0.059	0.07	0.090	0.11	0.06	

Note1: The LTE mode is QPSK_20MHz.

Table 14.2-26: SAR Values (LTE Band66 - Body)

Frequency		Mode	Test Position	Figure No.	Conducted Power (dBm)	Max. tune-up Power (dBm)	Measured SAR(10g) (W/kg)	Reported SAR(10g) (W/kg)	Measured SAR(1g) (W/kg)	Reported SAR(1g) (W/kg)	Power Drift (dB)		
Ch.	MHz												
		Ambient Temperature: 22.9 °C						Liquid Temperature: 22.5 °C					
132072	1720	1RB-Mid	Rear	Fig.26	22.74	23.5	0.421	0.50	0.778	0.93	0.05		

Note1: The distance between the EUT and the phantom bottom is 10mm

Note2: The LTE mode is QPSK_20MHz.