



SAR TEST REPORT

No. I20Z60295-SEM05

For

**TCL Communication Ltd.
LTE/UMTS/GSM mobile phone**

Model name: 50070

With

HW: 01

SW: v5F5S

FCC ID: 2ACCJH123

Issued Date: 2020-5-7

Note:

The test results in this test report relate only to the devices specified in this report. This report shall not be reproduced except in full without the written approval of CTTL.

The report must not be used by the client to claim product certification, approval, or endorsement by NVLAP, NIST, or any agency of the U.S. Government.

Test Laboratory:

CTTL, Telecommunication Technology Labs, CAICT

No. 51, Xueyuan Road, Haidian District, Beijing, P. R. China 100191.

Tel:+86(0)10-62304633-2512, Fax:+86(0)10-62304633-2504

Email: ctl_terminals@caict.ac.cn, website: www.caict.ac.cn



REPORT HISTORY

Report Number	Revision	Issue Date	Description
I20Z60295-SEM05	Rev.0	2020-4-21	Initial creation of test report
I20Z60295-SEM05	Rev.1	2020-4-29	Updated the low power tuneup for LTE band 2 on page 30. Updated the RF output power for WiFi on table 12.1 page 56. Updated the max tune-up power for GSM1900 body on page 59 and 71. Updated the max tune-up power for WCDMA band IV on page 61 and 73. Added the measurement variability test result on section 15. Updated the calibration date for dipoles on section 17. Updated the probe ConvF in all test plots and system validation. Updated the body test medium in body test plots. Updated the duty cycle on page 88.
I20Z60295-SEM05	Rev.2	2020-4-30	Added the headset test result with GSM/WCDMA 1900 and LTE B2/66.
I20Z60295-SEM05	Rev.3	2020-5-7	Updated 3TXslots for GSM1900 low power shall be tested instead of 2TXslots on Table 14.1-5 Page 59 and 71. Updated the “Body” into “Head” in all body SAR test plots. Supplement the top position test data of UMTS B5 LTE B5/B12/B71.

TABLE OF CONTENT

1 TEST LABORATORY	5
1.1 TESTING LOCATION	5
1.2 TESTING ENVIRONMENT	5
1.3 PROJECT DATA.....	5
1.4 SIGNATURE.....	5
2 STATEMENT OF COMPLIANCE	6
3 CLIENT INFORMATION	8
3.1 APPLICANT INFORMATION	8
3.2 MANUFACTURER INFORMATION	8
4 EQUIPMENT UNDER TEST (EUT) AND ANCILLARY EQUIPMENT (AE)	9
4.1 ABOUT EUT	9
4.2 INTERNAL IDENTIFICATION OF EUT USED DURING THE TEST	9
4.3 INTERNAL IDENTIFICATION OF AE USED DURING THE TEST	9
5 TEST METHODOLOGY	10
5.1 APPLICABLE LIMIT REGULATIONS	10
5.2 APPLICABLE MEASUREMENT STANDARDS.....	10
6 SPECIFIC ABSORPTION RATE (SAR).....	11
6.1 INTRODUCTION.....	11
6.2 SAR DEFINITION	11
7 TISSUE SIMULATING LIQUIDS	12
7.1 TARGETS FOR TISSUE SIMULATING LIQUID	12
7.2 DIELECTRIC PERFORMANCE	12
8 SYSTEM VERIFICATION	16
8.1 SYSTEM SETUP	16
8.2 SYSTEM VERIFICATION	17
9 MEASUREMENT PROCEDURES	18
9.1 TESTS TO BE PERFORMED	18
9.2 GENERAL MEASUREMENT PROCEDURE.....	20
9.3 WCDMA MEASUREMENT PROCEDURES FOR SAR	21
9.4 SAR MEASUREMENT FOR LTE	22
9.5 BLUETOOTH & WI-FI MEASUREMENT PROCEDURES FOR SAR.....	24
9.6 POWER DRIFT.....	24
10 AREA SCAN BASED 1-G SAR.....	25
10.1 REQUIREMENT OF KDB	25
10.2 FAST SAR ALGORITHMS	25



11 CONDUCTED OUTPUT POWER.....	26
11.1 GSM MEASUREMENT RESULT.....	26
11.2 WCDMA MEASUREMENT RESULT	28
11.3 LTE MEASUREMENT RESULT	30
11.4 WI-FI AND BT MEASUREMENT RESULT	54
12 SIMULTANEOUS TX SAR CONSIDERATIONS.....	55
12.1 INTRODUCTION.....	55
12.2 TRANSMIT ANTENNA SEPARATION DISTANCES	55
12.3 SAR MEASUREMENT POSITIONS.....	56
12.4 STANDALONE SAR TEST EXCLUSION CONSIDERATIONS	56
13 EVALUATION OF SIMULTANEOUS.....	57
14 SAR TEST RESULT	58
14.1 SAR RESULTS FOR FAST SAR.....	58
14.2 SAR RESULTS FOR STANDARD PROCEDURE	71
14.3 WLAN EVALUATION FOR 2.4G.....	78
15 SAR MEASUREMENT VARIABILITY.....	81
16 MEASUREMENT UNCERTAINTY	82
16.1 MEASUREMENT UNCERTAINTY FOR NORMAL SAR TESTS (300MHZ~3GHZ).....	82
16.2 MEASUREMENT UNCERTAINTY FOR NORMAL SAR TESTS (3~6GHZ)	83
16.3 MEASUREMENT UNCERTAINTY FOR FAST SAR TESTS (300MHZ~3GHZ).....	84
16.4 MEASUREMENT UNCERTAINTY FOR FAST SAR TESTS (3~6GHZ)	85
17 MAIN TEST INSTRUMENTS.....	86
ANNEX A GRAPH RESULTS.....	87
ANNEX B SYSTEM VERIFICATION RESULTS	129
ANNEX C SAR MEASUREMENT SETUP	136
ANNEX D POSITION OF THE WIRELESS DEVICE IN RELATION TO THE PHANTOM	142
ANNEX E EQUIVALENT MEDIA RECIPES	145
ANNEX F SYSTEM VALIDATION	146
ANNEX G PROBE CALIBRATION CERTIFICATE.....	147
ANNEX H DIPOLE CALIBRATION CERTIFICATE	167
ANNEX I ACCREDITATION CERTIFICATE.....	215

1 Test Laboratory

1.1 Testing Location

Company Name:	CTTL(Shouxiang)
Address:	No. 51 Shouxiang Science Building, Xueyuan Road, Haidian District, Beijing, P. R. China100191

1.2 Testing Environment

Temperature:	18°C~25°C,
Relative humidity:	30%~ 70%
Ground system resistance:	< 0.5 Ω
Ambient noise & Reflection:	< 0.012 W/kg

1.3 Project Data

Project Leader:	Qi Dianyuan
Test Engineer:	Lin Xiaojun
Testing Start Date:	April 4, 2020
Testing End Date:	April 10, 2020

1.4 Signature



Lin Xiaojun
(Prepared this test report)

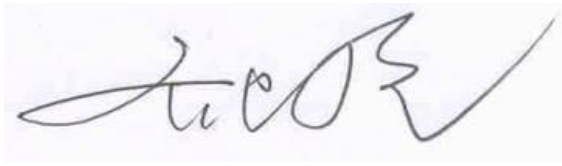

Qi Dianyuan
(Reviewed this test report)

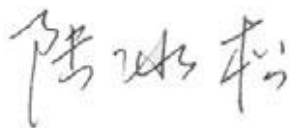

Lu Bingsong
Deputy Director of the laboratory
(Approved this test report)

2 Statement of Compliance

The maximum results of SAR found during testing for TCL Communication Ltd. LTE/UMTS/GSM mobile phone 5007O are as follows:

Table 2.1: Highest Reported SAR (1g)

Exposure Configuration	Technology Band	Highest Reported SAR 1g(W/kg)	Equipment Class
Head (Separation Distance 0mm)	GSM850	0.43	PCE
	GSM1900	0.12	
	WCDMA1900	0.14	
	WCDMA1700	0.54	
	WCDMA 850	0.77	
	LTE Band2	0.19	
	LTE Band5	0.89	
	LTE Band7	0.31	
	LTE Band12	0.92	
	LTE Band13	0.47	
	LTE Band66	0.34	
	LTE Band71	0.63	
	WLAN	0.61	
	Hotspot (Separation Distance 10mm)	GSM850	0.65
GSM1900		1.39	
WCDMA1900		1.34	
WCDMA1700		1.10	
WCDMA 850		0.45	
LTE Band2		1.23	
LTE Band5		0.42	
LTE Band7		0.68	
LTE Band12		0.25	
LTE Band13		0.56	
LTE Band66		1.22	
LTE Band71		0.29	
WLAN		0.39	DTS
Hotspot (Separation Distance 15mm)		GSM1900	0.63
	WCDMA1900	0.96	
	WCDMA1700	0.90	
	LTE Band2	0.79	
	LTE Band7	0.73	
	LTE Band66	0.69	

The SAR values found for the Mobile Phone are below the maximum recommended levels of 1.6 W/kg as averaged over any 1g tissue according to the ANSI C95.1-1992.

For body operation, this device has been tested and meets FCC RF exposure guidelines when used with any accessory that contains no metal and which provides a minimum separation distance of 10 mm between this device and the body of the user. Use of other accessories may not ensure compliance with FCC RF exposure guidelines.

The EUT battery must be fully charged and checked periodically during the test to ascertain uniform

power output.

The measurement together with the test system set-up is described in annex C of this test report. A detailed description of the equipment under test can be found in chapter 4 of this test report. The highest reported SAR value is obtained at the case of **(Table 2.1)**, and the values are: **1.39W/kg(1g)**.

Table 2.2: The sum of reported SAR values for main antenna and WiFi

	Position	Main antenna	WiFi	Sum
Highest reported SAR value for Head	Right hand, Touch cheek	0.83	0.61	1.44
Highest reported SAR value for Body	Bottom 10mm	1.39	/	1.39

[1] - Estimated SAR for Bluetooth (see the table 13.1)

Table 2.3: The sum of reported SAR values for main antenna and BT

	Position	Main antenna	BT	Sum
Maximum reported SAR value for Head	Right hand, Touch cheek	0.83	0.21	1.04
Maximum reported SAR value for Body	Bottom 10mm	1.39	0.10	1.49

[1] - Estimated SAR for Bluetooth (see the table 13.2)

According to the above tables, the highest sum of reported SAR values is **1.49 W/kg (1g)**. The detail for simultaneous transmission consideration is described in chapter 13.



3 Client Information

3.1 Applicant Information

Company Name:	TCL Communication Ltd.
Address/Post:	5/F, Building 22E, 22 Science Park East Avenue, Hong Kong Science Park, Shatin, NT, Hong Kong
Contact Person:	Gong Zhizhou
Contact Email:	zhizhou.gong@tcl.com
Telephone:	0086-755-36611722
FAX	0086-755-36612000-81722

3.2 Manufacturer Information

Company Name:	TCL Communication Ltd.
Address/Post:	5/F, Building 22E, 22 Science Park East Avenue, Hong Kong Science Park, Shatin, NT, Hong Kong
Contact Person:	Gong Zhizhou
Contact Email:	zhizhou.gong@tcl.com
Telephone:	0086-755-36611722
FAX	0086-755-36612000-81722

4 Equipment Under Test (EUT) and Ancillary Equipment (AE)

4.1 About EUT

Description:	LTE/UMTS/GSM mobile phone
Model name:	5007O
Operating mode(s):	GSM 850/900/1800/1900, UMTS FDD 2/4/5, BT, Wi-Fi LTE Band 2/4/5/7/12/13/17/66/71
Tested Tx Frequency:	824.2 – 848.8 MHz (GSM 850)
	1850.2 – 1909.8 MHz (GSM 1900)
	824 - 849MHz (WCDMA850)
	1710 -1755MHz (WCDMA1700)
	1850 –1910 MHz (WCDMA1900)
	1850 – 1910 MHz (LTE Band2)
	824 – 849 MHz (LTE Band5)
	2500 – 2570 MHz (LTE Band7)
	699 – 716 MHz (LTE Band12)
	777 – 787 MHz (LTE Band13)
	1710 – 1780MHz (LTE Band66)
663 – 698 MHz (LTE Band71)	
2412 – 2462 MHz (Wi-Fi 2.4G)	
GPRS/EGPRS Multislot Class:	12
Test device Production information:	Production unit
Device type:	Portable device
Antenna type:	Integrated antenna
Hotspot mode:	Support

4.2 Internal Identification of EUT used during the test

EUT ID*	IMEI	HW	SW Version
EUT1	015683000201521	01	v5F5S
EUT2	015683000201844	01	v5F5S
EUT3	015683000201919	01	v5F5S
EUT4	015683000201513	01	v5F5S
EUT5	015683000201869	01	v5F5S
EUT6	015683000201927	01	v5F5S

*EUT ID: is used to identify the test sample in the lab internally.

Note: It is performed to test SAR with the EUT1-3 and conducted power with the EUT4-6.

4.3 Internal Identification of AE used during the test

AE ID*	Description	Model	Manufacturer
AE1	Battery	CAC3400011C1	BYD

*AE ID: is used to identify the test sample in the lab internally.

5 TEST METHODOLOGY

5.1 Applicable Limit Regulations

ANSI C95.1–1992: IEEE Standard for Safety Levels with Respect to Human Exposure to Radio Frequency Electromagnetic Fields, 3 kHz to 300 GHz.

It specifies the maximum exposure limit of **1.6 W/kg** as averaged over any 1 gram of tissue for portable devices being used within 20 cm of the user in the uncontrolled environment.

5.2 Applicable Measurement Standards

IEEE 1528–2013: Recommended Practice for Determining the Peak Spatial-Average Specific Absorption Rate (SAR) in the Human Head from Wireless Communications Devices: Measurement Techniques.

KDB447498 D01: General RF Exposure Guidance v06: Mobile and Portable Devices RF Exposure Procedures and Equipment Authorization Policies.

KDB648474 D04 Handset SAR v01r03: SAR Evaluation Considerations for Wireless Handsets.

KDB941225 D01 SAR test for 3G devices v03r01: SAR Measurement Procedures for 3G Devices

KDB941225 D05 SAR for LTE Devices v02r05: SAR Evaluation Considerations for LTE Devices

KDB941225 D06 Hotspot Mode SAR v02r01: SAR Evaluation Procedures for Portable Devices with Wireless Router Capabilities

KDB248227 D01 802.11 Wi-Fi SAR v02r02: SAR GUIDANCE FOR IEEE 802.11 (Wi-Fi) TRANSMITTERS

KDB865664 D01 SAR measurement 100 MHz to 6 GHz v01r04: SAR Measurement Requirements for 100 MHz to 6 GHz.

KDB865664 D02 RF Exposure Reporting v01r02: RF Exposure Compliance Reporting and Documentation Considerations

6 Specific Absorption Rate (SAR)

6.1 Introduction

SAR is related to the rate at which energy is absorbed per unit mass in an object exposed to a radio field. The SAR distribution in a biological body is complicated and is usually carried out by experimental techniques or numerical modeling. The standard recommends limits for two tiers of groups, occupational/controlled and general population/uncontrolled, based on a person's awareness and ability to exercise control over his or her exposure. In general, occupational/controlled exposure limits are higher than the limits for general population/uncontrolled.

6.2 SAR Definition

The SAR definition is the time derivative (rate) of the incremental energy (dW) absorbed by (dissipated in) an incremental mass (dm) contained in a volume element (dv) of a given density (ρ). The equation description is as below:

$$SAR = \frac{d}{dt} \left(\frac{dW}{dm} \right) = \frac{d}{dt} \left(\frac{dW}{\rho dv} \right)$$

SAR is expressed in units of Watts per kilogram (W/kg)

SAR measurement can be either related to the temperature elevation in tissue by

$$SAR = c \left(\frac{\delta T}{\delta t} \right)$$

Where: C is the specific heat capacity, δT is the temperature rise and δt is the exposure duration, or related to the electrical field in the tissue by

$$SAR = \frac{\sigma |E|^2}{\rho}$$

Where: σ is the conductivity of the tissue, ρ is the mass density of tissue and E is the RMS electrical field strength.

However for evaluating SAR of low power transmitter, electrical field measurement is typically applied.

7 Tissue Simulating Liquids

7.1 Targets for tissue simulating liquid

Table 7.1: Targets for tissue simulating liquid

Frequency(MHz)	Liquid Type	Conductivity(σ)	$\pm 5\%$ Range	Permittivity(ϵ)	$\pm 5\%$ Range
750	Head	0.89	0.85~0.93	41.94	39.8~44.0
835	Head	0.90	0.86~0.95	41.5	39.4~43.6
1750	Head	1.37	1.30~1.44	40.08	38.1~42.1
1900	Head	1.40	1.33~1.47	40.0	38.0~42.0
2450	Head	1.80	1.71~1.89	39.2	37.2~41.2
2600	Head	1.96	1.86~2.06	39.01	37.1~41.0

7.2 Dielectric Performance

Table 7.2: Dielectric Performance of Tissue Simulating Liquid

Measurement Date (yyyy-mm-dd)	Type	Frequency	Permittivity ϵ	Drift (%)	Conductivity σ (S/m)	Drift (%)
2020-4-5	750 MHz	Head	41.35	-1.41	0.888	-0.22
2020-4-6	835 MHz	Head	41.1	-0.96	0.892	-0.89
2020-4-7	1750 MHz	Head	40.82	1.85	1.377	0.51
2020-4-8	1900 MHz	Head	39.99	-0.02	1.428	2.00
2020-4-9	2450 MHz	Head	38.99	-0.54	1.78	-1.11
2020-4-10	2600 MHz	Head	39.06	0.13	1.925	-1.79

Note: The liquid temperature is 22.0°C



Picture 7-1 Liquid depth in the Flat Phantom (750MHz)

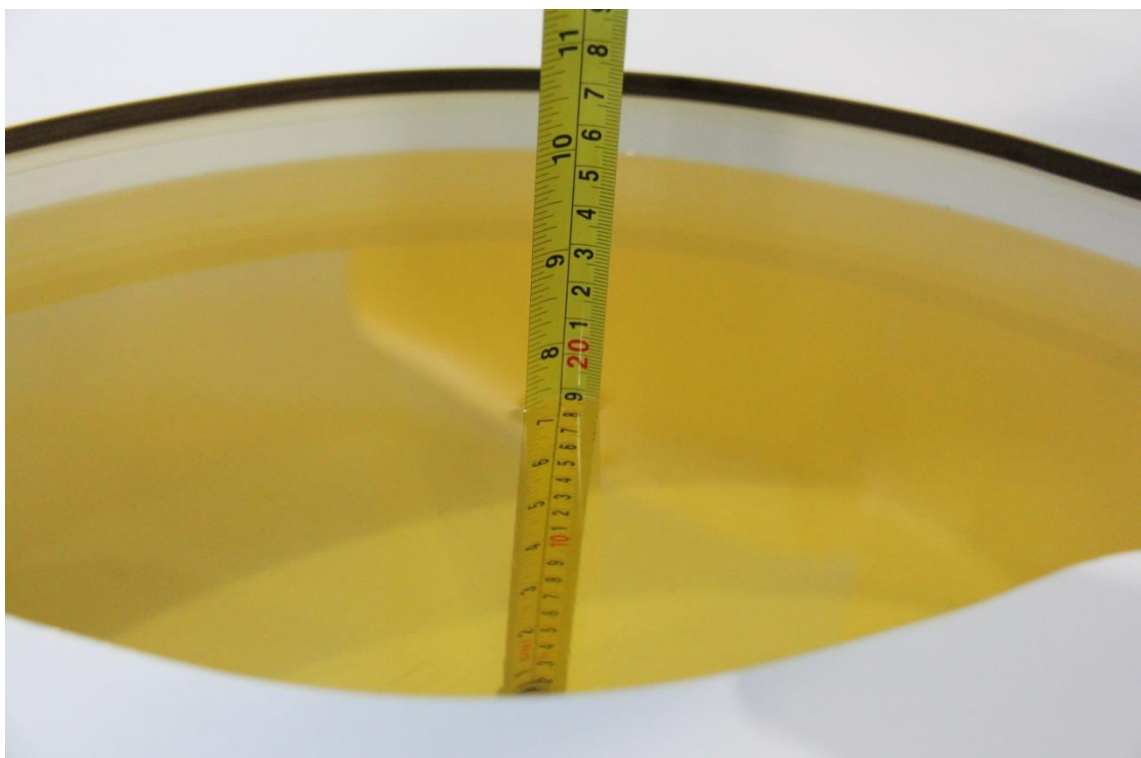

Picture 7-2 Liquid depth in the Flat Phantom (835 MHz)

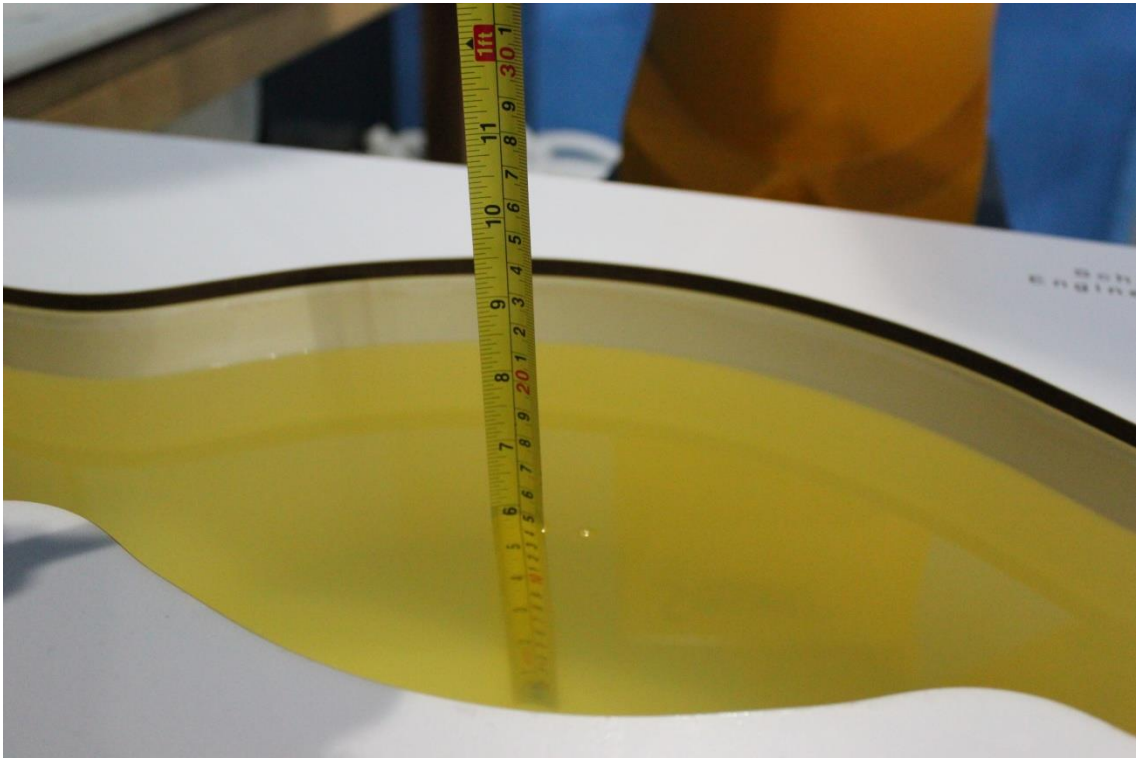

Picture 7-3 Liquid depth in the Flat Phantom (1750MHz)

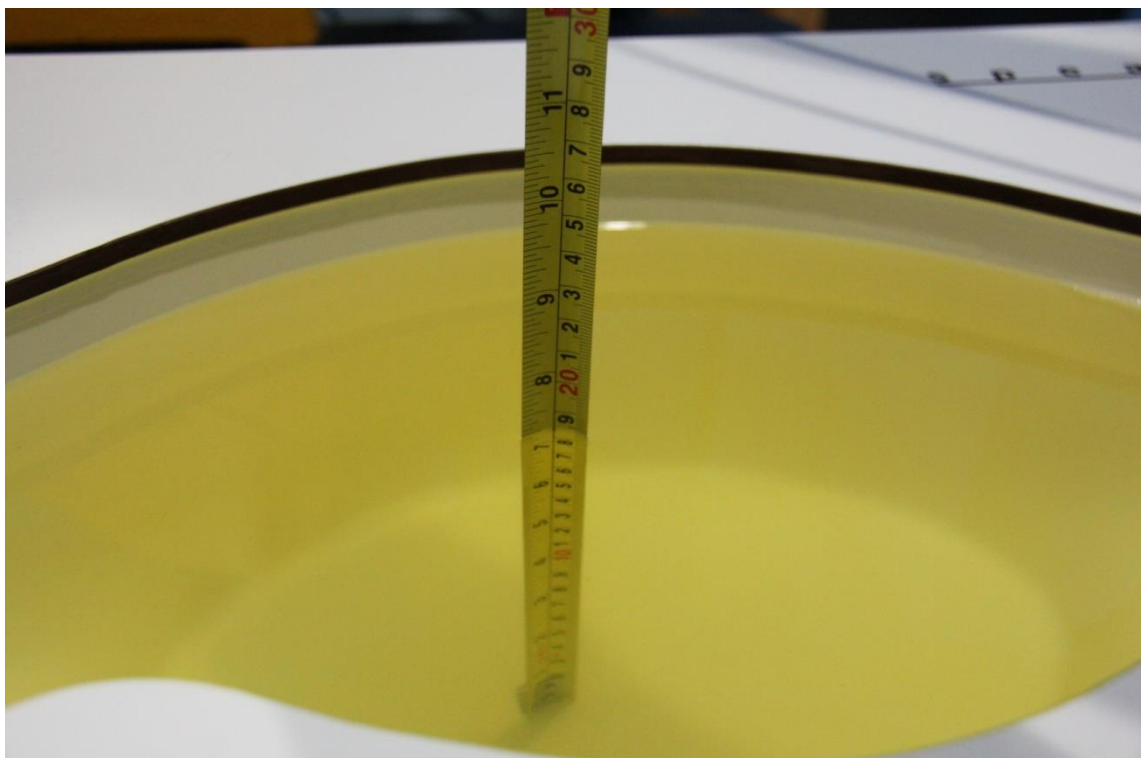

Picture 7-4 Liquid depth in the Flat Phantom (1900MHz)

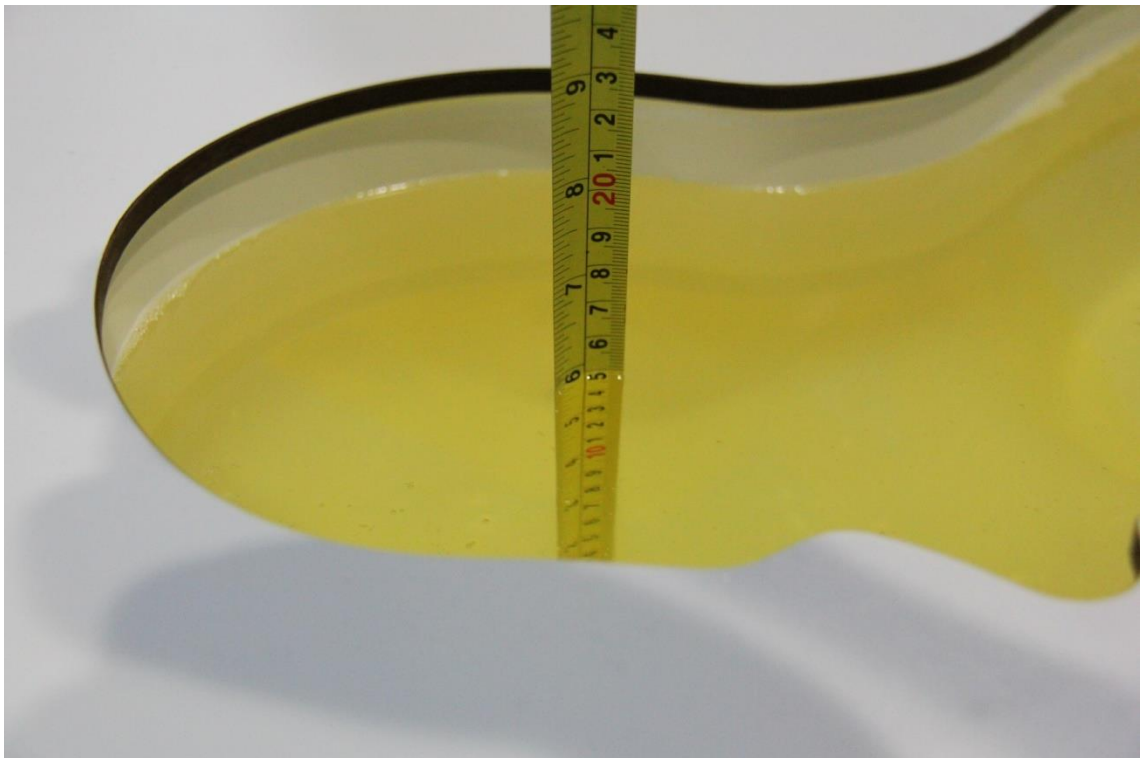

Picture 7-5 Liquid depth in the Flat Phantom (2450 MHz Head)

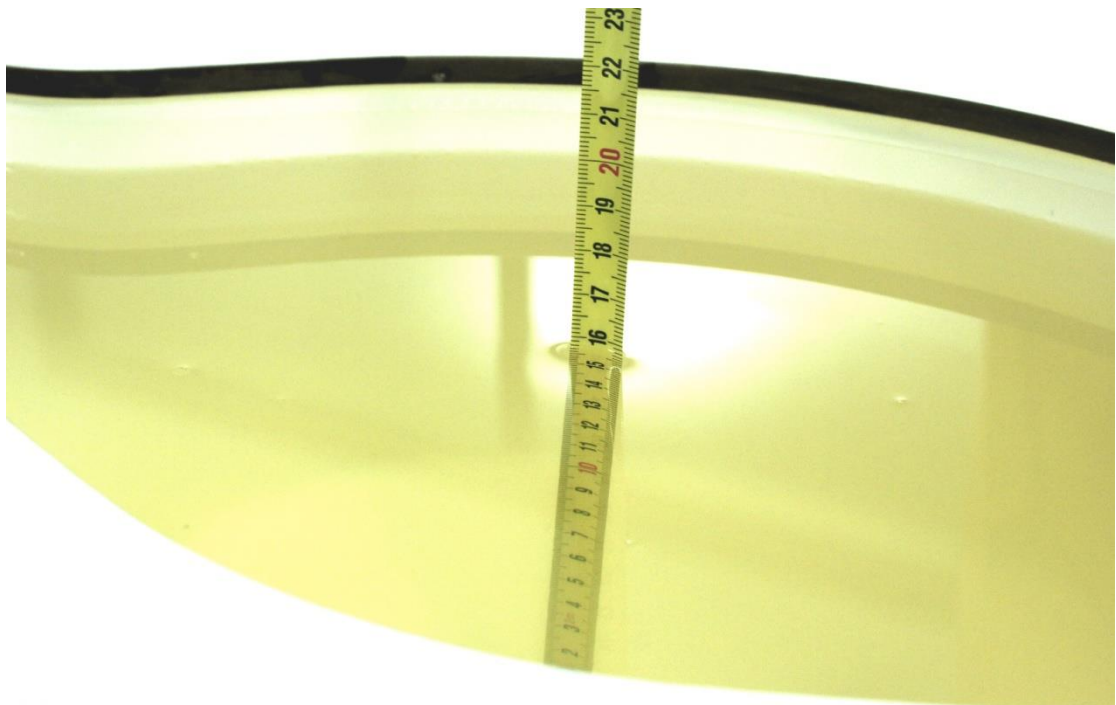

Picture 7-6 Liquid depth in the Flat Phantom (2600MHz)

8 System verification

8.1 System Setup

In the simplified setup for system evaluation, the DUT is replaced by a calibrated dipole and the power source is replaced by a continuous wave that comes from a signal generator. The calibrated dipole must be placed beneath the flat phantom section of the SAM twin phantom with the correct distance holder. The distance holder should touch the phantom surface with a light pressure at the reference marking and be oriented parallel to the long side of the phantom. The equipment setup is shown below:

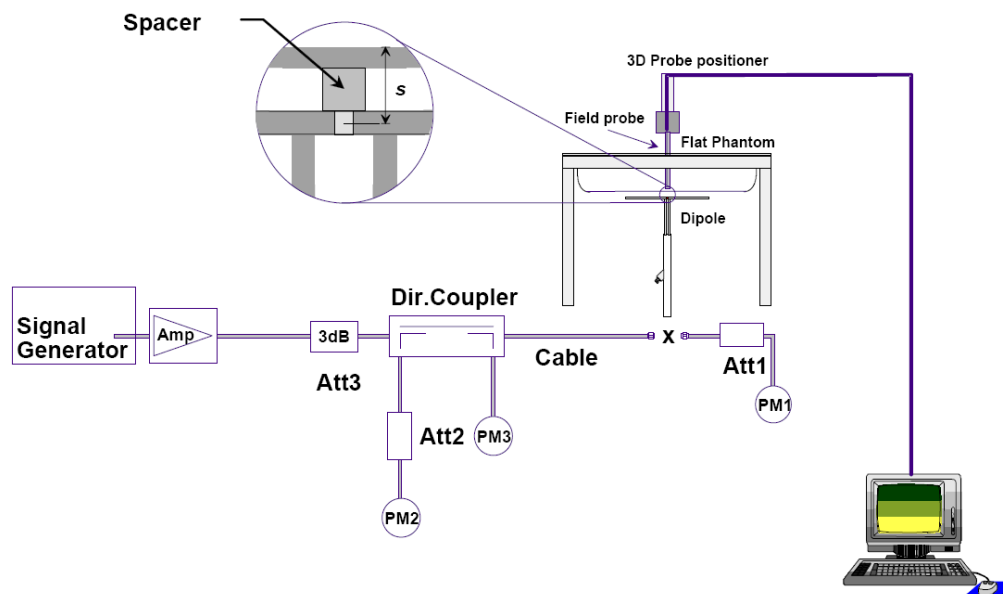

Picture 8.1 System Setup for System Evaluation



Picture 8.2 Photo of Dipole Setup

8.2 System Verification

SAR system verification is required to confirm measurement accuracy, according to the tissue dielectric media, probe calibration points and other system operating parameters required for measuring the SAR of a test device. The system verification must be performed for each frequency band and within the valid range of each probe calibration point required for testing the device.

The system verification results are required that the area scan estimated 1-g SAR is within 3% of the zoom scan 1-g SAR. The details are presented in annex B.

Table 8.1: System Verification of Head

Measurement Date (yyyy-mm-dd)	Frequency	Target value (W/kg)		Measured value(W/kg)		Deviation	
		10 g Average	1 g Average	10 g Average	1 g Average	10 g Average	1 g Average
2020-4-5	750 MHz	5.57	8.57	5.68	8.6	1.97%	0.35%
2020-4-6	835 MHz	6.29	9.70	6.32	9.6	0.48%	-1.03%
2020-4-7	1750 MHz	19.3	36.6	19.32	36.68	0.10%	0.22%
2020-4-8	1900 MHz	20.8	39.7	21.12	39.68	1.54%	-0.05%
2020-4-9	2450 MHz	24.2	51.6	24.48	50.72	1.16%	-1.71%
2020-4-10	2600 MHz	25.1	55.8	25	54.72	-0.40%	-1.94%

9 Measurement Procedures

9.1 Tests to be performed

In order to determine the highest value of the peak spatial-average SAR of a handset, all device positions, configurations and operational modes shall be tested for each frequency band according to steps 1 to 3 below. A flowchart of the test process is shown in picture 9.1.

Step 1: The tests described in 9.2 shall be performed at the channel that is closest to the centre of the transmit frequency band (f_c) for:

- a) all device positions (cheek and tilt, for both left and right sides of the SAM phantom, as described in annex D),
- b) all configurations for each device position in a), e.g., antenna extended and retracted, and
- c) all operational modes, e.g., analogue and digital, for each device position in a) and configuration in b) in each frequency band.

If more than three frequencies need to be tested according to 11.1 (i.e., $N_c > 3$), then all frequencies, configurations and modes shall be tested for all of the above test conditions.

Step 2: For the condition providing highest peak spatial-average SAR determined in Step 1, perform all tests described in 9.2 at all other test frequencies, i.e., lowest and highest frequencies. In addition, for all other conditions (device position, configuration and operational mode) where the peak spatial-average SAR value determined in Step 1 is within 3 dB of the applicable SAR limit, it is recommended that all other test frequencies shall be tested as well.

Step 3: Examine all data to determine the highest value of the peak spatial-average SAR found in Steps 1 to 2.

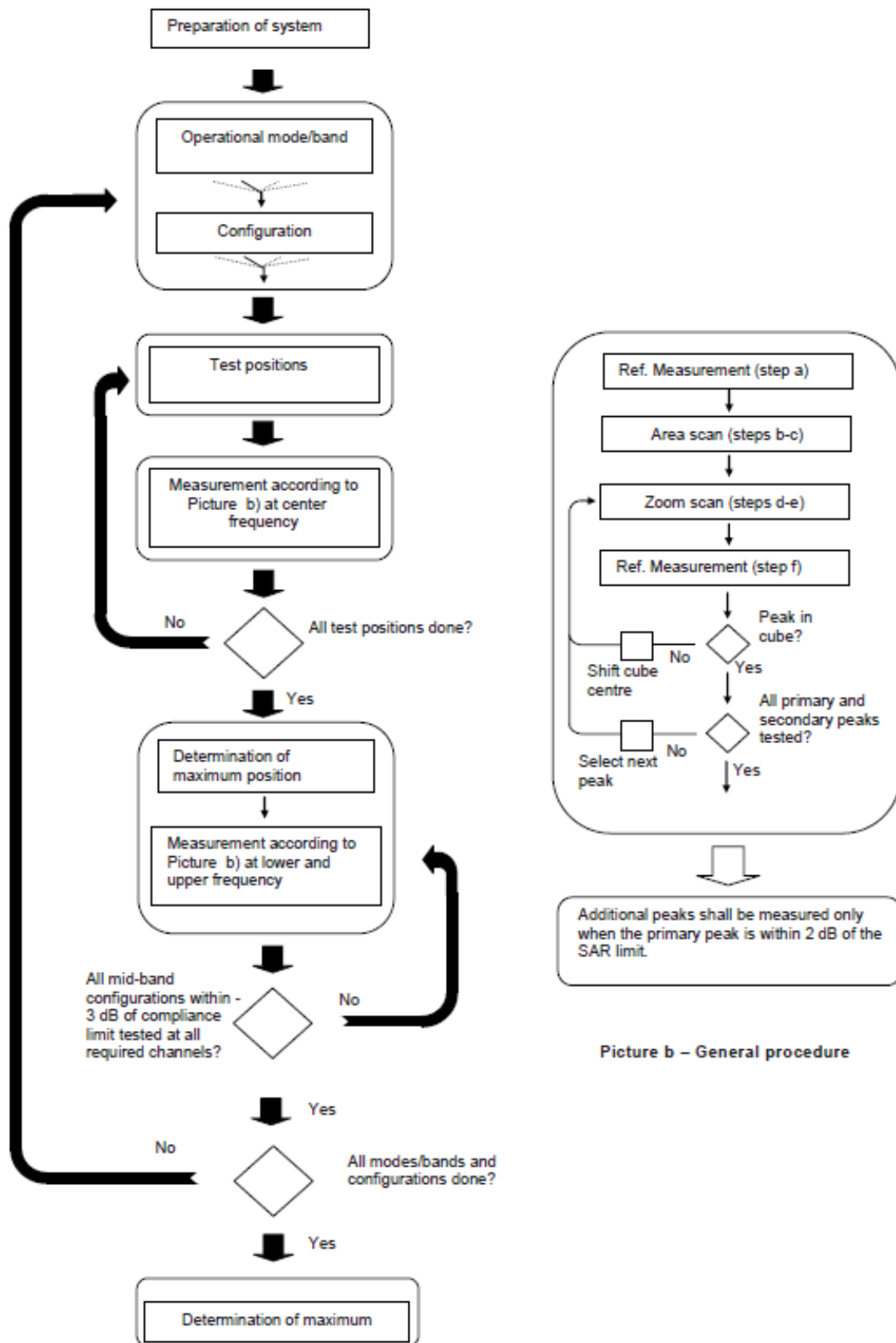

Picture a – Tests to be performed

Picture b – General procedure

Picture 9.1 Block diagram of the tests to be performed

9.2 General Measurement Procedure

The area and zoom scan resolutions specified in the table below must be applied to the SAR measurements and fully documented in SAR reports to qualify for TCB approval. Probe boundary effect error compensation is required for measurements with the probe tip closer than half a probe tip diameter to the phantom surface. Both the probe tip diameter and sensor offset distance must satisfy measurement protocols; to ensure probe boundary effect errors are minimized and the higher fields closest to the phantom surface can be correctly measured and extrapolated to the phantom surface for computing 1-g SAR. Tolerances of the post-processing algorithms must be verified by the test laboratory for the scan resolutions used in the SAR measurements, according to the reference distribution functions specified in IEEE Std 1528-2003. The results should be documented as part of the system validation records and may be requested to support test results when all the measurement parameters in the following table are not satisfied.

		≤ 3 GHz	> 3 GHz	
Maximum distance from closest measurement point (geometric center of probe sensors) to phantom surface		5 ± 1 mm	$\frac{1}{2} \cdot \delta \cdot \ln(2) \pm 0.5$ mm	
Maximum probe angle from probe axis to phantom surface normal at the measurement location		$30^\circ \pm 1^\circ$	$20^\circ \pm 1^\circ$	
Maximum area scan spatial resolution: Δx_{Area} , Δy_{Area}		≤ 2 GHz: ≤ 15 mm 2 – 3 GHz: ≤ 12 mm	3 – 4 GHz: ≤ 12 mm 4 – 6 GHz: ≤ 10 mm	
		When the x or y dimension of the test device, in the measurement plane orientation, is smaller than the above, the measurement resolution must be \leq the corresponding x or y dimension of the test device with at least one measurement point on the test device.		
Maximum zoom scan spatial resolution: Δx_{Zoom} , Δy_{Zoom}		≤ 2 GHz: ≤ 8 mm 2 – 3 GHz: ≤ 5 mm*	3 – 4 GHz: ≤ 5 mm* 4 – 6 GHz: ≤ 4 mm*	
Maximum zoom scan spatial resolution, normal to phantom surface	uniform grid: $\Delta z_{Zoom}(n)$	≤ 5 mm	3 – 4 GHz: ≤ 4 mm 4 – 5 GHz: ≤ 3 mm 5 – 6 GHz: ≤ 2 mm	
	graded grid	$\Delta z_{Zoom}(1)$: between 1 st two points closest to phantom surface	≤ 4 mm	3 – 4 GHz: ≤ 3 mm 4 – 5 GHz: ≤ 2.5 mm 5 – 6 GHz: ≤ 2 mm
		$\Delta z_{Zoom}(n>1)$: between subsequent points	$\leq 1.5 \cdot \Delta z_{Zoom}(n-1)$	
Minimum zoom scan volume	x, y, z	≥ 30 mm	3 – 4 GHz: ≥ 28 mm 4 – 5 GHz: ≥ 25 mm 5 – 6 GHz: ≥ 22 mm	
Note: δ is the penetration depth of a plane-wave at normal incidence to the tissue medium; see draft standard IEEE P1528-2011 for details.				
* When zoom scan is required and the <i>reported</i> SAR from the area scan based 1-g SAR estimation procedures of KDB 447498 is ≤ 1.4 W/kg, ≤ 8 mm, ≤ 7 mm and ≤ 5 mm zoom scan resolution may be applied, respectively, for 2 GHz to 3 GHz, 3 GHz to 4 GHz and 4 GHz to 6 GHz.				

9.3 WCDMA Measurement Procedures for SAR

The following procedures are applicable to WCDMA handsets operating under 3GPP Release99, Release 5 and Release 6. The default test configuration is to measure SAR with an established radio link between the DUT and a communication test set using a 12.2kbps RMC (reference measurement channel) configured in Test Loop Mode 1. SAR is selectively confirmed for other physical channel configurations (DPCCH & DPDCH_n), HSDPA and HSPA (HSUPA/HSDPA) modes according to output power, exposure conditions and device operating capabilities. Both uplink and downlink should be configured with the same RMC or AMR, when required. SAR for Release 5 HSDPA and Release 6 HSPA are measured using the applicable FRC (fixed reference channel) and E-DCH reference channel configurations. Maximum output power is verified according to applicable versions of 3GPP TS 34.121 and SAR must be measured according to these maximum output conditions. When Maximum Power Reduction (MPR) is not implemented according to Cubic Metric (CM) requirements for Release 6 HSPA, the following procedures do not apply.

For Release 5 HSDPA Data Devices:

Sub-test	β_c	β_d	β_d (SF)	β_c/β_d	β_{hs}	CM/dB
1	2/15	15/15	64	2/15	4/15	0.0
2	12/15	15/15	64	12/15	24/25	1.0
3	15/15	8/15	64	15/8	30/15	1.5
4	15/15	4/15	64	15/4	30/15	1.5

For Release 6 HSPA Data Devices

Sub-test	β_c	β_d	β_d (SF)	β_c/β_d	β_{hs}	β_{ec}	β_{ed}	β_{ed} (SF)	β_{ed} (codes)	CM (dB)	MPR (dB)	AG Index	E-TFCI
1	11/15	15/15	64	11/15	22/15	209/225	1039/225	4	1	1.5	1.5	20	75
2	6/15	15/15	64	6/15	12/15	12/15	12/15	4	1	1.5	1.5	12	67
3	15/15	9/15	64	15/9	30/15	30/15	$\beta_{ed1}:47/15$ $\beta_{ed2}:47/15$	4	2	1.5	1.5	15	92
4	2/15	15/15	64	2/15	4/15	4/15	56/75	4	1	1.5	1.5	17	71
5	15/15	15/15	64	15/15	24/15	30/15	134/15	4	1	1.5	1.5	21	81

Rel.8 DC-HSDPA (Cat 24)

SAR test exclusion for Rel.8 DC-HSDPA must satisfy the SAR test exclusion requirements of Rel.5 HSDPA. SAR test exclusion for DC-HSDPA devices is determined by power measurements according to the H-Set 12, Fixed Reference Channel (FRC) configuration in Table C.8.1.12 of 3GPP TS 34.121-1. A primary and a secondary serving HS-DSCH Cell are required to perform the power measurement and for the results to qualify for SAR test exclusion.

9.4 SAR Measurement for LTE

SAR tests for LTE are performed with a base station simulator, Rohde & Schwarz CMW500. Closed loop power control was used so the UE transmits with maximum output power during SAR testing. All powers were measured with the CMW 500.

It is performed for conducted power and SAR based on the KDB941225 D05.

SAR is evaluated separately according to the following procedures for the different test positions in each exposure condition – head, body, body-worn accessories and other use conditions. The procedures in the following subsections are applied separately to test each LTE frequency band.

1) QPSK with 1 RB allocation

Start with the largest channel bandwidth and measure SAR for QPSK with 1 RB allocation, using the RB offset and required test channel combination with the highest maximum output power among RB offsets at the upper edge, middle and lower edge of each required test channel. When the reported SAR is ≤ 0.8 W/kg, testing of the remaining RB offset configurations and required test channels is not required for 1 RB allocation; otherwise, SAR is required for the remaining required test channels and only for the RB offset configuration with the highest output power for that channel. When the reported SAR of a required test channel is > 1.45 W/kg, SAR is required for all three RB offset configurations for that required test channel.

2) QPSK with 50% RB allocation

The procedures required for 1 RB allocation in 1) are applied to measure the SAR for QPSK with 50% RB allocation.

3) QPSK with 100% RB allocation

For QPSK with 100% RB allocation, SAR is not required when the highest maximum output power for 100 % RB allocation is less than the highest maximum output power in 50% and 1 RB allocations and the highest reported SAR for 1 RB and 50% RB allocation in 1) and 2) are ≤ 0.8 W/kg. Otherwise, SAR is measured for the highest output power channel; and if the reported SAR is > 1.45 W/kg, the remaining required test channels must also be tested.

TDD test:

TDD testing is performed using guidance from FCC KDB 941225 D05 v02r05 and the SAR test guidance provided in April 2013 TCB works hop notes. TDD is tested at the highest duty factor using UL-DL configuration 0 with special subframe configuration 6 and applying the FDD LTE procedures in KDB 941225 D05 v02r05. SAR testing is performed using the extended cyclic prefix listed in 3GPP TS 36.211.

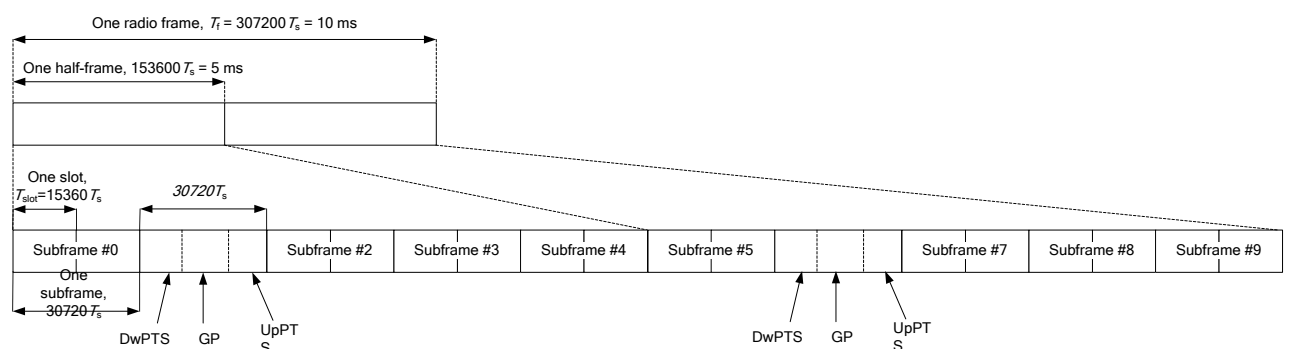

Figure 9.2: Frame structure type 2 (for 5 ms switch-point periodicity)

Table 9.1: Configuration of special subframe (lengths of DwPTS/GP/UpPTS)

Special subframe configuration	Normal cyclic prefix in downlink			Extended cyclic prefix in downlink		
	DwPTS	UpPTS		DwPTS	UpPTS	
		Normal cyclic prefix in uplink	Extended cyclic prefix in uplink		Normal cyclic prefix in uplink	Extended cyclic prefix in uplink
0	$6592 \cdot T_s$	$2192 \cdot T_s$	$2560 \cdot T_s$	$7680 \cdot T_s$	$2192 \cdot T_s$	$2560 \cdot T_s$
1	$19760 \cdot T_s$			$20480 \cdot T_s$		
2	$21952 \cdot T_s$			$23040 \cdot T_s$		
3	$24144 \cdot T_s$			$25600 \cdot T_s$		
4	$26336 \cdot T_s$	$4384 \cdot T_s$	$5120 \cdot T_s$	$7680 \cdot T_s$	$4384 \cdot T_s$	$5120 \cdot T_s$
5	$6592 \cdot T_s$			$20480 \cdot T_s$		
6	$19760 \cdot T_s$			$23040 \cdot T_s$		
7	$21952 \cdot T_s$			$12800 \cdot T_s$		
8	$24144 \cdot T_s$			-		
9	$13168 \cdot T_s$	-	-	-	-	-

Table 9.2: Uplink-downlink configurations

Uplink-downlink configuration	Downlink-to-Uplink Switch-point periodicity	Subframe number										
		0	1	2	3	4	5	6	7	8	9	
0	5 ms	D	S	U	U	U	D	S	U	U	U	
1	5 ms	D	S	U	U	D	D	S	U	U	D	
2	5 ms	D	S	U	D	D	D	S	U	D	D	
3	10 ms	D	S	U	U	U	D	D	D	D	D	
4	10 ms	D	S	U	U	D	D	D	D	D	D	
5	10 ms	D	S	U	D	D	D	D	D	D	D	
6	5 ms	D	S	U	U	U	D	S	U	U	D	

Duty factor is calculated by:

$$\begin{aligned}
 \text{Duty factor} &= \text{uplink frame} \cdot 6 + \text{UpPTS} \cdot 2 / \text{one frame length} \\
 &= (30720 \cdot T_s \cdot 6 + 5120 \cdot T_s \cdot 2) / 307200 \cdot T_s \\
 &= 0.633
 \end{aligned}$$

According to the KDB 447498 D01, SAR should be evaluated at more than 3 frequencies for devices supporting transmit bands wider than 100MHz. Oct.2014 FCC-TCB conference notes (Dec. 2014 rev.) specifies the 5 test channels to use for 3GPP band 41 SAR evaluation.

9.5 Bluetooth & Wi-Fi Measurement Procedures for SAR

Normal network operating configurations are not suitable for measuring the SAR of 802.11 transmitters in general. Unpredictable fluctuations in network traffic and antenna diversity conditions can introduce undesirable variations in SAR results. The SAR for these devices should be measured using chipset based test mode software to ensure that the results are consistent and reliable.

Chipset based test mode software is hardware dependent and generally varies among manufacturers. The device operating parameters established in a test mode for SAR measurements must be identical to those programmed in production units, including output power levels, amplifier gain settings and other RF performance tuning parameters. The test frequencies should correspond to actual channel frequencies defined for domestic use. SAR for devices with switched diversity should be measured with only one antenna transmitting at a time during each SAR measurement, according to a fixed modulation and data rate. The same data pattern should be used for all measurements.

9.6 Power Drift

To control the output power stability during the SAR test, DASY4 system calculates the power drift by measuring the E-field at the same location at the beginning and at the end of the measurement for each test position. These drift values can be found in section 14 labeled as: (Power Drift [dB]). This ensures that the power drift during one measurement is within 5%.

10 Area Scan Based 1-g SAR

10.1 Requirement of KDB

According to the KDB447498 D01 v05, when the implementation is based the specific polynomial fit algorithm as presented at the 29th Bioelectromagnetics Society meeting (2007) and the estimated 1-gSAR is ≤ 1.2 W/kg, a zoom scan measurement is not required provided it is also not needed for any other purpose; for example, if the peak SAR location required for simultaneous transmission SAR test exclusion can be determined accurately by the SAR system or manually to discriminate between distinctive peaks and scattered noisy SAR distributions from area scans.

There must not be any warning or alert messages due to various measurement concerns identified by the SAR system; for example, noise in measurements, peaks too close to scan boundary, peaks are too sharp, spatial resolution and uncertainty issues etc. The SAR system verification must also demonstrate that the area scan estimated 1-g SAR is within 3% of the zoom scan 1-g SAR (See Annex B). When all the SAR results for each exposure condition in a frequency band and wireless mode are based on estimated 1-g SAR, the 1-g SAR for the highest SAR configuration must be determined by a zoom scan.

10.2 Fast SAR Algorithms

The approach is based on the area scan measurement applying a frequency dependent attenuation parameter. This attenuation parameter was empirically determined by analyzing a large number of phones. The MOTOROLA FAST SAR was developed and validated by the MOTOROLA Research Group in Ft. Lauderdale.

In the initial study, an approximation algorithm based on Linear fit was developed. The accuracy of the algorithm has been demonstrated across a broad frequency range (136-2450 MHz) and for both 1- and 10-g averaged SAR using a sample of 264 SAR measurements from 55 wireless handsets. For the sample size studied, the root-mean-squared errors of the algorithm are 1.2% and 5.8% for 1- and 10-g averaged SAR, respectively. The paper describing the algorithm in detail is expected to be published in August 2004 within the Special Issue of Transactions on MTT.

In the second step, the same research group optimized the fitting algorithm to an Polynomial fit whereby the frequency validity was extended to cover the range 30-6000MHz. Details of this study can be found in the BEMS 2007 Proceedings.

Both algorithms are implemented in DASY software.

11 Conducted Output Power

For Main antenna, there are two sets of tune-up power, Normal power and Low power, used for different use cases for GSM1900 W1700/1900 and LTE Band2/7/66/. Normal power status is applied for head test and body worn test of above bands. Low power status is applied for hotspot test of above bands. For other bands, Normal power status is applied for both head and body test. For WLAN, when the phone is in talking mode and receiver worked, then power reduction will be applied

11.1 GSM Measurement result

During the process of testing, the EUT was controlled via Agilent Digital Radio Communication tester (E5515C) to ensure the maximum power transmission and proper modulation. This result contains conducted output power for the EUT. In all cases, the measured peak output power should be greater and within 5% than EMI measurement.

Table 11.1-1: The conducted power measurement results for GSM, GPRS and EGPRS normal power

GSM 850 Speech (GMSK)	Measured Power (dBm)			Tune up	calculation	Averaged Power (dBm)		
	251	190	128			251	190	128
1 Txslot	32.25	31.70	31.57	33.30	/	/	/	/
GSM 850 GPRS (GMSK)	Measured Power (dBm)				calculation	Averaged Power (dBm)		
	251	190	128			251	190	128
1 Txslot	32.12	31.80	31.75	33.30	-9.03	23.09	22.77	22.72
2 Txslots	29.88	29.61	29.59	30.50	-6.02	23.86	23.59	23.57
3Txslots	27.92	27.44	27.24	28.50	-4.26	23.66	23.18	22.98
4 Txslots	26.50	26.06	26.02	27.50	-3.01	23.49	23.05	23.01
GSM 850 EGPRS (GMSK)	Measured Power (dBm)				calculation	Averaged Power (dBm)		
	251	190	128			251	190	128
1 Txslot	32.05	31.75	31.69	33.30	-9.03	23.02	22.72	22.66
2 Txslots	29.84	29.62	29.60	30.50	-6.02	23.82	23.60	23.58
3Txslots	27.87	27.38	27.21	28.50	-4.26	23.61	23.12	22.95
4 Txslots	26.45	25.98	25.79	27.50	-3.01	23.44	22.97	22.78
GSM 850 EGPRS (8PSK)	Measured Power (dBm)				calculation	Averaged Power (dBm)		
	251	190	128			251	190	128
1 Txslot	26.08	25.81	25.81	27.80	-9.03	17.05	16.78	16.78
2 Txslots	23.97	24.46	23.75	25.50	-6.02	17.95	18.44	17.73
3Txslots	22.27	22.09	22.01	24.00	-4.26	18.01	17.83	17.75
4 Txslots	20.95	20.70	20.69	22.50	-3.01	17.94	17.69	17.68
PCS1900 Speech (GMSK)	Measured Power (dBm)			Tune up	calculation	Averaged Power (dBm)		
	810	661	512			810	661	512
1 Txslot	29.22	29.47	29.67	30.30	/	/	/	/
PCS1900	Measured Power (dBm)				calculation	Averaged Power (dBm)		

GPRS (GMSK)	810	661	512			810	661	512
1 Txslot	29.21	29.45	29.70	30.30	-9.03	20.18	20.42	20.67
2 Txslots	27.48	27.70	27.96	28.50	-6.02	21.46	21.68	21.94
3Txslots	25.05	25.24	25.51	26.00	-4.26	20.79	20.98	21.25
4 Txslots	23.99	24.20	24.45	25.00	-3.01	20.98	21.19	21.44
PCS1900	Measured Power (dBm)				calculation	Averaged Power (dBm)		
EGPRS (GMSK)	810	661	512			810	661	512
1 Txslot	29.23	29.47	29.71	30.30	-9.03	20.20	20.44	20.68
2 Txslots	27.48	27.71	27.96	28.50	-6.02	21.46	21.69	21.94
3Txslots	25.05	25.25	25.50	26.00	-4.26	20.79	20.99	21.24
4 Txslots	23.99	24.20	24.45	25.00	-3.01	20.98	21.19	21.44
PCS1900	Measured Power (dBm)				calculation	Averaged Power (dBm)		
EGPRS (8PSK)	810	661	512			810	661	512
1 Txslot	25.85	25.87	26.17	27.30	-9.03	16.82	16.84	17.14
2 Txslots	24.33	24.20	24.06	25.00	-6.02	18.31	18.18	18.04
3Txslots	22.82	22.83	22.81	24.00	-4.26	18.56	18.57	18.55
4 Txslots	21.60	21.58	21.61	22.80	-3.01	18.59	18.57	18.60

NOTES:

1) Division Factors

To average the power, the division factor is as follows:

1TX-slot = 1 transmit time slot out of 8 time slots=> conducted power divided by (8/1) => -9.03dB

2TX-slots = 2 transmit time slots out of 8 time slots=> conducted power divided by (8/2) => -6.02dB

3TX-slots = 3 transmit time slots out of 8 time slots=> conducted power divided by (8/3) => -4.26dB

4TX-slots = 4 transmit time slots out of 8 time slots=> conducted power divided by (8/4) => -3.01dB

According to the conducted power as above, the body measurements are performed with 2Txslots for GSM850 and GSM1900.

Table 11.1-2: The conducted power measurement results for GSM, GPRS and EGPRS Low power

PCS1900 GPRS (GMSK)	Measured Power (dBm)			calculation	Averaged Power (dBm)			
	810	661	512		810	661	512	
1 Txslot	27.87	27.93	27.93	28.50	-9.03	18.84	18.90	18.90
2 Txslots	24.15	24.18	24.16	26.00	-6.02	18.13	18.16	18.14
3Txslots	23.22	23.25	23.28	24.30	-4.26	18.96	18.99	18.96
4 Txslots	21.85	21.95	21.99	23.30	-3.01	18.84	18.94	18.98
PCS1900 EGPRS (GMSK)	Measured Power (dBm)			calculation	Averaged Power (dBm)			
	810	661	512		810	661	512	
1 Txslot	27.82	27.90	27.89	28.50	-9.03	18.79	18.87	18.86
2 Txslots	24.11	24.16	24.12	26.00	-6.02	18.09	18.14	18.10
3Txslots	23.18	23.22	23.18	24.30	-4.26	18.92	18.96	18.92
4 Txslots	21.92	21.95	21.91	23.30	-3.01	18.91	18.94	18.90

NOTES:

1) Division Factors

To average the power, the division factor is as follows:

1TX-slot = 1 transmit time slot out of 8 time slots=> conducted power divided by (8/1) => -9.03dB

2TX-slots = 2 transmit time slots out of 8 time slots=> conducted power divided by (8/2) => -6.02dB

3TX-slots = 3 transmit time slots out of 8 time slots=> conducted power divided by (8/3) => -4.26dB

4TX-slots = 4 transmit time slots out of 8 time slots=> conducted power divided by (8/4) => -3.01dB

According to the conducted power as above, the body measurements are performed with 3Txslots for GSM1900.

11.2 WCDMA Measurement result

Table 11.2-1: The conducted Power for WCDMA normal power

Item	band	FDDV result			Tune up
	ARFCN	4233 (846.6MHz)	4182 (836.4MHz)	4132 (826.4MHz)	
WCDMA	\	23.35	23.36	23.29	24.00
HSUPA	1	20.42	20.34	20.30	22.00
	2	20.44	20.35	20.32	22.00
	3	21.42	21.35	21.32	22.00
	4	19.92	19.84	19.82	21.00
	5	21.4	21.31	21.30	22.00
DC-HSDPA	1	22.37	22.36	22.34	23.00
	2	22.32	22.30	22.31	23.00
	3	21.82	21.83	21.78	23.00
	4	21.81	21.80	21.77	23.00
Item	band	FDDII result			

	ARFCN	9538 (1907.6MHz)	9400 (1880MHz)	9262 (1852.4MHz)	Tune up
WCDMA	\	22.54	22.57	22.87	24.00
HSUPA	1	20.05	20.09	20.08	22.00
	2	20.04	20.06	20.04	22.00
	3	20.49	20.54	20.84	22.00
	4	20.04	20.07	20.01	22.00
	5	20.47	20.51	20.79	21.00
DC-HSDPA	1	21.41	21.59	21.81	22.00
	2	21.37	21.56	21.82	22.00
	3	20.89	21.06	21.36	22.00
	4	20.87	21.04	21.34	22.00
Item	band	FDDIV result			
	ARFCN	1513 (1752.6MHz)	1412 (1732.4MHz)	1312(1712.4MHz)	Tune up
WCDMA	\	23.25	23.30	23.36	24.00
HSUPA	1	20.13	20.30	20.31	22.00
	2	20.17	20.31	20.33	22.00
	3	21.18	21.29	21.30	22.00
	4	19.68	19.83	19.82	21.00
	5	20.95	20.96	20.94	21.00
DC-HSDPA	1	21.96	21.94	21.92	22.00
	2	20.93	20.97	20.91	21.00
	3	20.93	20.99	20.94	21.00
	4	20.95	20.97	20.97	21.00

Table 11.2-1: The conducted Power for WCDMA Low power

Item	band	FDDII result			
	ARFCN	9538 (1907.6MHz)	9400 (1880MHz)	9262 (1852.4MHz)	Tune up
WCDMA	\	19.53	19.60	19.83	20.50
HSUPA	1	17.49	17.52	17.76	19.00
	2	17.62	17.66	17.95	19.00
	3	18.54	18.58	18.87	20.00
	4	17.02	17.10	17.36	18.00
	5	18.48	18.52	18.80	20.00
DC-HSDPA	1	19.45	19.51	19.76	20.00
	2	19.41	19.47	19.73	20.00
	3	18.89	19.01	19.31	20.00
	4	18.88	18.99	19.29	20.00
Item	band	FDDIV result			
	ARFCN	1513 (1752.6MHz)	1412 (1732.4MHz)	1312(1712.4MHz)	Tune up
WCDMA	\	20.19	20.32	20.31	21.50
HSUPA	1	18.13	18.25	18.26	19.00

	2	18.22	18.36	18.38	19.00
	3	19.21	19.32	19.30	21.00
	4	17.67	17.77	17.79	19.00
	5	19.14	19.31	19.30	21.00
DC-HSDPA	1	20.1	20.21	20.23	21.50
	2	20.07	20.16	20.19	21.00
	3	19.62	19.78	19.73	21.00
	4	19.61	19.72	19.71	21.00

11.3 LTE Measurement result

Table 13.3-1: Maximum Power Reduction (MPR) for LTE normal power

Modulation	Channel bandwidth / Transmission bandwidth configuration [RB]						MPR (dB)
	1.4	3	5	10	15	20	
	MHz	MHz	MHz	MHz	MHz	MHz	
QPSK	> 5	> 4	> 8	> 12	> 16	> 18	1
16 QAM	≤ 5	≤ 4	≤ 8	≤ 12	≤ 16	≤ 18	1
16 QAM	> 5	> 4	> 8	> 12	> 16	> 18	2

Table 13.3-2: The tune up for LTE normal power

Band	Tune up
LTE Band 2	24
LTE Band 5	24
LTE Band 7	24
LTE Band 12	24
LTE Band 13	24
LTE Band 66	24
LTE Band 71	24

Table 13.3-2: The tune up for LTE low power

Band	Tune up
LTE Band 2	20.5
LTE Band 7	21
LTE Band 66	20.8

Table 11.3-4: The conducted Power for LTE normal power

Band 2					
Bandwidth (MHz)	RB allocation	Frequency (MHz)	Actual output power (dBm)		
	RB offset		QPSK	16QAM	
1.4MHz	1RB-High (5)	1909.3 (19193)	22.37	21.43	
		1880 (18900)	22.39	21.67	
		1850.7 (18607)	22.61	21.68	
	1RB-Middle (3)	1909.3 (19193)	22.56	21.58	
		1880 (18900)	22.56	21.89	
		1850.7 (18607)	22.79	21.81	
	1RB-Low (0)	1909.3 (19193)	22.35	21.41	
		1880 (18900)	22.37	21.73	
		1850.7 (18607)	22.58	21.66	
	3RB-High (3)	1909.3 (19193)	22.40	21.38	
		1880 (18900)	22.44	21.62	
		1850.7 (18607)	22.78	21.98	
	3RB-Middle (1)	1909.3 (19193)	22.49	21.50	
		1880 (18900)	22.52	21.64	
		1850.7 (18607)	22.79	21.99	
	3RB-Low (0)	1909.3 (19193)	22.42	21.49	
		1880 (18900)	22.48	21.59	
		1850.7 (18607)	22.74	21.92	
	6RB (0)	1909.3 (19193)	21.44	20.54	
		1880 (18900)	21.44	20.35	
		1850.7 (18607)	21.73	20.88	
	3MHz	1RB-High (14)	1908.5 (19185)	22.38	21.33
			1880 (18900)	22.27	21.30
			1851.5 (18615)	22.57	22.02
1RB-Middle (7)		1908.5 (19185)	22.51	21.53	
		1880 (18900)	22.48	21.47	
		1851.5 (18615)	22.71	22.16	
1RB-Low (0)		1908.5 (19185)	22.30	21.42	
		1880 (18900)	22.35	21.30	
		1851.5 (18615)	22.65	22.00	
8RB-High (7)		1908.5 (19185)	21.29	20.42	
		1880 (18900)	21.36	20.49	
		1851.5 (18615)	21.62	20.73	
8RB-Middle (4)		1908.5 (19185)	21.36	20.47	
		1880 (18900)	21.41	20.53	
		1851.5 (18615)	21.72	20.81	
8RB-Low (0)		1908.5 (19185)	21.36	20.45	
		1880 (18900)	21.40	20.50	
		1851.5 (18615)	21.67	20.83	
15RB (0)		1908.5 (19185)	21.35	20.33	
		1880 (18900)	21.38	20.41	
		1851.5 (18615)	21.66	20.73	

5MHz	1RB-High (24)	1907.5 (19175)	22.19	21.39	
		1880 (18900)	22.21	21.42	
		1852.5 (18625)	22.46	22.01	
	1RB-Middle (12)	1907.5 (19175)	22.47	21.66	
		1880 (18900)	22.48	21.73	
		1852.5 (18625)	22.76	22.28	
	1RB-Low (0)	1907.5 (19175)	22.19	21.34	
		1880 (18900)	22.23	21.48	
		1852.5 (18625)	22.52	22.06	
	12RB-High (13)	1907.5 (19175)	21.29	20.37	
		1880 (18900)	21.33	20.43	
		1852.5 (18625)	21.58	20.74	
	12RB-Middle (6)	1907.5 (19175)	21.37	20.44	
		1880 (18900)	21.42	20.48	
		1852.5 (18625)	21.66	20.82	
	12RB-Low (0)	1907.5 (19175)	21.33	20.36	
		1880 (18900)	21.36	20.43	
		1852.5 (18625)	21.66	20.81	
	25RB (0)	1907.5 (19175)	21.32	20.32	
		1880 (18900)	21.35	20.41	
		1852.5 (18625)	21.62	20.70	
	10MHz	1RB-High (49)	1905 (19150)	22.33	21.35
			1880 (18900)	22.33	21.30
			1855 (18650)	22.51	21.95
1RB-Middle (24)		1905 (19150)	22.43	21.46	
		1880 (18900)	22.48	21.34	
		1855 (18650)	22.64	22.07	
1RB-Low (0)		1905 (19150)	22.36	21.37	
		1880 (18900)	22.26	21.26	
		1855 (18650)	22.55	21.98	
25RB-High (25)		1905 (19150)	21.33	20.46	
		1880 (18900)	21.34	20.40	
		1855 (18650)	21.62	20.71	
25RB-Middle (12)		1905 (19150)	21.39	20.52	
		1880 (18900)	21.40	20.47	
		1855 (18650)	21.65	20.71	
25RB-Low (0)		1905 (19150)	21.37	20.50	
		1880 (18900)	21.37	20.44	
		1855 (18650)	21.67	20.75	
50RB (0)		1905 (19150)	21.39	20.44	
		1880 (18900)	21.38	20.40	
		1855 (18650)	21.65	20.71	

15MHz	1RB-High (74)	1902.5 (19125)	22.26	21.68
		1880 (18900)	22.20	21.21
		1857.5 (18675)	22.38	21.81
	1RB-Middle (37)	1902.5 (19125)	22.35	21.81
		1880 (18900)	22.34	21.31
		1857.5 (18675)	22.58	22.00
	1RB-Low (0)	1902.5 (19125)	22.27	21.69
		1880 (18900)	22.29	21.27
		1857.5 (18675)	22.61	21.93
	36RB-High (38)	1902.5 (19125)	21.39	20.35
		1880 (18900)	21.41	20.33
		1857.5 (18675)	21.63	20.66
	36RB-Middle (19)	1902.5 (19125)	21.40	20.36
		1880 (18900)	21.43	20.40
		1857.5 (18675)	21.62	20.65
	36RB-Low (0)	1902.5 (19125)	21.39	20.35
		1880 (18900)	21.41	20.36
		1857.5 (18675)	21.65	20.70
75RB (0)	1902.5 (19125)	21.37	20.38	
	1880 (18900)	21.39	20.36	
	1857.5 (18675)	21.62	20.64	
20MHz	1RB-High (99)	1900 (19100)	22.09	21.70
		1880 (18900)	22.15	21.69
		1860 (18700)	22.18	21.79
	1RB-Middle (50)	1900 (19100)	22.42	22.01
		1880 (18900)	22.48	21.93
		1860 (18700)	22.59	22.07
	1RB-Low (0)	1900 (19100)	22.08	21.72
		1880 (18900)	22.25	21.75
		1860 (18700)	22.38	21.91
	50RB-High (50)	1900 (19100)	21.27	20.35
		1880 (18900)	21.26	20.33
		1860 (18700)	21.54	20.57
	50RB-Middle (25)	1900 (19100)	21.35	20.42
		1880 (18900)	21.38	20.41
		1860 (18700)	21.57	20.61
	50RB-Low (0)	1900 (19100)	21.33	20.41
		1880 (18900)	21.36	20.41
		1860 (18700)	21.54	20.60
100RB (0)	1900 (19100)	21.31	20.36	
	1880 (18900)	21.30	20.35	
	1860 (18700)	21.61	20.63	

Band 5					
Bandwidth (MHz)	RB allocation	Frequency (MHz)	Actual output power (dBm)		
	RB offset		QPSK	16QAM	
1.4MHz	1RB-High (5)	848.3 (20643)	23.08	22.09	
		836.5 (20525)	23.07	22.16	
		824.7 (20407)	23.13	22.46	
	1RB-Middle (3)	848.3 (20643)	23.30	22.24	
		836.5 (20525)	23.24	22.39	
		824.7 (20407)	23.29	22.65	
	1RB-Low (0)	848.3 (20643)	23.07	22.12	
		836.5 (20525)	23.10	22.14	
		824.7 (20407)	23.09	22.46	
	3RB-High (3)	848.3 (20643)	23.22	22.27	
		836.5 (20525)	23.14	22.14	
		824.7 (20407)	23.16	22.36	
	3RB-Middle (1)	848.3 (20643)	23.22	22.34	
		836.5 (20525)	23.16	22.19	
		824.7 (20407)	23.24	22.38	
	3RB-Low (0)	848.3 (20643)	23.17	22.28	
		836.5 (20525)	23.14	22.17	
		824.7 (20407)	23.22	22.34	
	6RB (0)	848.3 (20643)	22.20	21.33	
		836.5 (20525)	22.14	21.33	
		824.7 (20407)	22.10	21.10	
	3MHz	1RB-High (14)	847.5 (20635)	23.24	22.00
			836.5 (20525)	23.13	22.46
			825.5 (20415)	23.07	22.12
1RB-Middle (7)		847.5 (20635)	23.39	22.18	
		836.5 (20525)	23.26	22.63	
		825.5 (20415)	23.25	22.28	
1RB-Low (0)		847.5 (20635)	23.23	22.05	
		836.5 (20525)	23.16	22.44	
		825.5 (20415)	23.18	22.18	
8RB-High (7)		847.5 (20635)	22.14	21.25	
		836.5 (20525)	22.08	21.24	
		825.5 (20415)	22.10	21.18	
8RB-Middle (4)		847.5 (20635)	22.23	21.30	
		836.5 (20525)	22.18	21.26	
		825.5 (20415)	22.13	21.30	
8RB-Low (0)		847.5 (20635)	22.18	21.33	
		836.5 (20525)	22.12	21.27	
		825.5 (20415)	22.12	21.20	
15RB (0)		847.5 (20635)	22.15	21.20	
		836.5 (20525)	22.11	21.17	
		825.5 (20415)	22.11	21.12	

5MHz	1RB-High (24)	846.5 (20625)	23.03	22.12
		836.5 (20525)	23.03	22.16
		826.5 (20425)	23.00	22.52
	1RB-Middle (12)	846.5 (20625)	23.33	22.37
		836.5 (20525)	23.26	22.43
		826.5 (20425)	23.27	22.75
	1RB-Low (0)	846.5 (20625)	23.05	22.16
		836.5 (20525)	22.99	22.18
		826.5 (20425)	23.03	22.52
	12RB-High (13)	846.5 (20625)	22.06	21.14
		836.5 (20525)	22.06	21.17
		826.5 (20425)	22.10	21.28
	12RB-Middle (6)	846.5 (20625)	22.21	21.25
		836.5 (20525)	22.14	21.24
		826.5 (20425)	22.10	21.29
	12RB-Low (0)	846.5 (20625)	22.18	21.21
		836.5 (20525)	22.11	21.19
		826.5 (20425)	22.07	21.25
	25RB (0)	846.5 (20625)	22.13	21.10
		836.5 (20525)	22.10	21.14
		826.5 (20425)	22.11	21.21
10MHz	1RB-High (49)	844 (20600)	23.15	22.12
		836.5 (20525)	23.18	22.06
		829 (20450)	23.09	22.47
	1RB-Middle (24)	844 (20600)	23.24	22.25
		836.5 (20525)	23.29	22.14
		829 (20450)	23.21	22.58
	1RB-Low (0)	844 (20600)	23.14	22.15
		836.5 (20525)	23.14	21.98
		829 (20450)	23.05	22.44
	25RB-High (25)	844 (20600)	22.09	21.22
		836.5 (20525)	22.12	21.20
		829 (20450)	22.18	21.25
	25RB-Middle (12)	844 (20600)	22.18	21.29
		836.5 (20525)	22.19	21.19
		829 (20450)	22.18	21.22
	25RB-Low (0)	844 (20600)	22.19	21.29
		836.5 (20525)	22.15	21.18
		829 (20450)	22.12	21.20
	50RB (0)	844 (20600)	22.12	21.17
		836.5 (20525)	22.15	21.18
		829 (20450)	22.14	21.22

Band 7					
Bandwidth (MHz)	RB allocation	Frequency (MHz)	Actual output power (dBm)		
	RB offset		QPSK	16QAM	
5MHz	1RB-High (24)	2567.5 (21425)	22.76	21.83	
		2535 (21100)	23.04	22.09	
		2502.5 (20775)	22.90	22.26	
	1RB-Middle (12)	2567.5 (21425)	23.05	22.11	
		2535 (21100)	23.33	22.35	
		2502.5 (20775)	23.16	22.55	
	1RB-Low (0)	2567.5 (21425)	22.83	21.87	
		2535 (21100)	23.02	22.07	
		2502.5 (20775)	22.89	22.28	
	12RB-High (13)	2567.5 (21425)	21.75	20.81	
		2535 (21100)	22.04	21.08	
		2502.5 (20775)	22.02	21.08	
	12RB-Middle (6)	2567.5 (21425)	21.92	20.94	
		2535 (21100)	22.08	21.14	
		2502.5 (20775)	22.05	21.12	
	12RB-Low (0)	2567.5 (21425)	21.83	20.92	
		2535 (21100)	22.01	21.06	
		2502.5 (20775)	21.94	21.01	
	25RB (0)	2567.5 (21425)	21.83	20.82	
		2535 (21100)	22.06	21.04	
		2502.5 (20775)	21.95	21.00	
	10MHz	1RB-High (49)	2565 (21400)	22.78	21.76
			2535 (21100)	23.05	21.97
			2505 (20800)	23.08	22.29
1RB-Middle (24)		2565 (21400)	22.95	21.93	
		2535 (21100)	23.12	22.03	
		2505 (20800)	23.17	22.39	
1RB-Low (0)		2565 (21400)	22.86	21.88	
		2535 (21100)	23.00	21.92	
		2505 (20800)	22.98	22.20	
25RB-High (25)		2565 (21400)	21.82	20.94	
		2535 (21100)	22.06	21.11	
		2505 (20800)	22.07	21.12	
25RB-Middle (12)		2565 (21400)	21.91	21.03	
		2535 (21100)	22.11	21.10	
		2505 (20800)	21.98	21.04	
25RB-Low (0)		2565 (21400)	21.94	21.02	
		2535 (21100)	22.09	21.09	
		2505 (20800)	21.94	20.97	
50RB (0)		2565 (21400)	21.87	20.90	
		2535 (21100)	22.09	21.07	
		2505 (20800)	22.02	21.01	

15MHz	1RB-High (74)	2562.5 (21375)	22.77	22.05
		2535 (21100)	22.93	21.83
		2507.5 (20825)	22.95	22.23
	1RB-Middle (37)	2562.5 (21375)	22.89	22.20
		2535 (21100)	23.01	21.95
		2507.5 (20825)	23.05	22.28
	1RB-Low (0)	2562.5 (21375)	22.88	22.29
		2535 (21100)	22.95	21.82
		2507.5 (20825)	22.95	22.15
	36RB-High (38)	2562.5 (21375)	21.91	20.80
		2535 (21100)	22.09	21.02
		2507.5 (20825)	22.07	21.05
	36RB-Middle (19)	2562.5 (21375)	21.99	20.90
		2535 (21100)	22.12	21.03
		2507.5 (20825)	22.13	21.05
	36RB-Low (0)	2562.5 (21375)	21.91	20.88
		2535 (21100)	22.07	21.02
		2507.5 (20825)	22.04	21.00
	75RB (0)	2562.5 (21375)	21.92	20.92
		2535 (21100)	22.10	21.04
		2507.5 (20825)	22.09	21.00
20MHz	1RB-High (99)	2560 (21350)	22.64	22.11
		2535 (21100)	22.90	22.31
		2510 (20850)	22.86	22.25
	1RB-Middle (50)	2560 (21350)	22.96	22.49
		2535 (21100)	23.16	22.57
		2510 (20850)	23.15	22.47
	1RB-Low (0)	2560 (21350)	22.75	22.32
		2535 (21100)	22.86	22.27
		2510 (20850)	22.76	22.05
	50RB-High (50)	2560 (21350)	21.81	20.88
		2535 (21100)	21.97	20.99
		2510 (20850)	21.92	20.91
	50RB-Middle (25)	2560 (21350)	21.85	20.90
		2535 (21100)	22.01	21.03
		2510 (20850)	21.99	20.97
	50RB-Low (0)	2560 (21350)	21.82	20.88
		2535 (21100)	21.95	20.97
		2510 (20850)	21.87	20.84
	100RB (0)	2560 (21350)	21.82	20.92
		2535 (21100)	21.94	20.98
		2510 (20850)	21.89	20.94

Band 12				
Bandwidth (MHz)	RB allocation	Frequency (MHz)	Actual output power (dBm)	
	RB offset		QPSK	16QAM
1.4MHz	1RB-High (5)	715.3	23.00	22.05
		707.5	22.95	22.02
		699.7	22.89	22.16
	1RB-Middle (3)	715.3	23.25	22.20
		707.5	23.18	22.21
		699.7	23.10	22.34
	1RB-Low (0)	715.3	22.96	21.99
		707.5	22.99	22.03
		699.7	22.91	22.18
	3RB-High (3)	715.3	23.10	22.25
		707.5	23.03	22.04
		699.7	22.95	22.07
	3RB-Middle (1)	715.3	23.18	22.34
		707.5	23.08	22.08
		699.7	23.06	22.12
	3RB-Low (0)	715.3	23.09	22.23
		707.5	23.06	22.04
		699.7	22.97	22.09
	6RB (0)	715.3	22.14	21.28
		707.5	22.05	21.17
		699.7	21.98	20.86
3MHz	1RB-High (14)	714.5	23.00	21.96
		707.5	23.00	21.82
		700.5	22.95	22.16
	1RB-Middle (7)	714.5	23.17	22.15
		707.5	23.07	21.99
		700.5	23.04	22.29
	1RB-Low (0)	714.5	23.03	21.98
		707.5	22.91	21.80
		700.5	22.90	22.16
	8RB-High (7)	714.5	22.07	21.09
		707.5	21.96	21.05
		700.5	21.92	20.94
	8RB-Middle (4)	714.5	22.14	21.12
		707.5	22.02	21.10
		700.5	21.99	21.01
	8RB-Low (0)	714.5	22.09	21.09
		707.5	21.95	21.04
		700.5	21.92	20.95
	15RB (0)	714.5	22.03	20.98
		707.5	22.00	21.00
		700.5	21.92	20.91

5MHz	1RB-High (24)	713.5	22.99	22.00
		707.5	22.95	22.03
		701.5	22.82	22.25
	1RB-Middle (12)	713.5	23.21	22.23
		707.5	23.20	22.29
		701.5	23.10	22.49
	1RB-Low (0)	713.5	22.85	21.97
		707.5	22.92	21.94
		701.5	22.76	22.23
	12RB-High (13)	713.5	21.95	21.00
		707.5	22.00	21.08
		701.5	21.91	21.04
	12RB-Middle (6)	713.5	22.08	21.11
		707.5	22.00	21.01
		701.5	22.00	21.05
	12RB-Low (0)	713.5	22.02	21.07
		707.5	21.92	20.98
		701.5	21.94	21.02
	25RB (0)	713.5	21.99	20.96
		707.5	21.96	21.01
		701.5	21.93	21.00
10MHz	1RB-High (49)	711	23.06	21.87
		707.5	23.03	22.28
		704	22.92	21.92
	1RB-Middle (24)	711	23.00	21.97
		707.5	23.07	22.37
		704	22.99	21.93
	1RB-Low (0)	711	22.89	21.81
		707.5	22.90	22.17
		704	22.79	21.77
	25RB-High (25)	711	21.97	21.01
		707.5	22.07	21.12
		704	22.02	21.11
	25RB-Middle (12)	711	22.00	21.05
		707.5	22.04	21.04
		704	22.01	21.06
	25RB-Low (0)	711	21.91	20.98
		707.5	21.92	20.96
		704	21.97	21.04
	50RB (0)	711	21.96	21.00
		707.5	22.02	21.02
		704	21.98	21.01

Band 13					
Bandwidth (MHz)	RB allocation	Frequency (MHz)	Actual output power (dBm)		
	RB offset		QPSK	16QAM	
5MHz	1RB-High (24)	784.5 (23255)	22.35	21.46	
		782 (23230)	22.44	21.55	
		779.5 (23205)	22.40	21.84	
	1RB-Middle (12)	784.5 (23255)	22.61	21.68	
		782 (23230)	22.65	21.71	
		779.5 (23205)	22.59	22.04	
	1RB-Low (0)	784.5 (23255)	22.36	21.43	
		782 (23230)	22.42	21.45	
		779.5 (23205)	22.35	21.73	
	12RB-High (13)	784.5 (23255)	21.41	20.47	
		782 (23230)	21.41	20.47	
		779.5 (23205)	21.46	20.57	
	12RB-Middle (6)	784.5 (23255)	21.51	20.53	
		782 (23230)	21.44	20.53	
		779.5 (23205)	21.47	20.57	
	12RB-Low (0)	784.5 (23255)	21.47	20.52	
		782 (23230)	21.38	20.49	
		779.5 (23205)	21.33	20.40	
	25RB (0)	784.5 (23255)	21.45	20.39	
		782 (23230)	21.40	20.41	
		779.5 (23205)	21.39	20.45	
	10MHz	1RB-High (49)	782 (23230)	22.52	21.83
		1RB-Middle (24)	782 (23230)	22.62	21.89
		1RB-Low (0)	782 (23230)	22.44	21.70
25RB-High (25)		782 (23230)	21.49	20.55	
25RB-Middle (12)		782 (23230)	21.50	20.54	
25RB-Low (0)		782 (23230)	21.35	20.43	
50RB (0)		782 (23230)	21.39	20.48	

Band 66					
Bandwidth (MHz)	RB allocation	Frequency (MHz)	Actual output power (dBm)		
	RB offset		QPSK	16QAM	
1.4MHz	1RB-High (5)	1779.3 (132665)	23.31	22.42	
		1745 (132322)	23.03	22.37	
		1710.7 (131979)	22.75	21.82	
	1RB-Middle (3)	1779.3 (132665)	23.47	22.55	
		1745 (132322)	23.21	22.57	
		1710.7 (131979)	22.91	22.02	
	1RB-Low (0)	1779.3 (132665)	23.36	22.39	
		1745 (132322)	23.01	22.40	
		1710.7 (131979)	22.72	21.79	
	3RB-High (3)	1779.3 (132665)	23.39	22.40	
		1745 (132322)	23.08	22.27	
		1710.7 (131979)	22.91	22.01	
	3RB-Middle (1)	1779.3 (132665)	23.45	22.47	
		1745 (132322)	23.19	22.34	
		1710.7 (131979)	22.87	22.09	
	3RB-Low (0)	1779.3 (132665)	23.44	22.42	
		1745 (132322)	23.11	22.27	
		1710.7 (131979)	22.84	21.99	
	6RB (0)	1779.3 (132665)	22.43	21.60	
		1745 (132322)	22.10	21.01	
		1710.7 (131979)	21.88	21.04	
	3MHz	1RB-High (14)	1778.5 (132657)	23.26	22.20
			1745 (132322)	23.05	22.39
			1711.5 (131987)	22.70	21.71
1RB-Middle (7)		1778.5 (132657)	23.39	22.36	
		1745 (132322)	23.20	22.51	
		1711.5 (131987)	22.84	21.94	
1RB-Low (0)		1778.5 (132657)	23.22	22.25	
		1745 (132322)	22.97	22.37	
		1711.5 (131987)	22.70	21.81	
8RB-High (7)		1778.5 (132657)	22.28	21.43	
		1745 (132322)	22.01	21.10	
		1711.5 (131987)	21.77	20.79	
8RB-Middle (4)		1778.5 (132657)	22.34	21.49	
		1745 (132322)	22.04	21.14	
		1711.5 (131987)	21.82	20.84	
8RB-Low (0)		1778.5 (132657)	22.32	21.46	
		1745 (132322)	21.99	21.08	
		1711.5 (131987)	21.79	20.80	
15RB (0)		1778.5 (132657)	22.31	21.37	
		1745 (132322)	22.00	21.00	
		1711.5 (131987)	21.78	20.74	

5MHz	1RB-High (24)	1777.5 (132647)	23.27	22.34
		1745 (132322)	22.90	22.42
		1712.5 (131997)	22.65	21.78
	1RB-Middle (12)	1777.5 (132647)	23.54	22.62
		1745 (132322)	23.15	22.69
		1712.5 (131997)	22.97	22.04
	1RB-Low (0)	1777.5 (132647)	23.26	22.33
		1745 (132322)	22.87	22.35
		1712.5 (131997)	22.68	21.76
	12RB-High (13)	1777.5 (132647)	22.29	21.36
		1745 (132322)	22.01	21.13
		1712.5 (131997)	21.76	20.75
	12RB-Middle (6)	1777.5 (132647)	22.34	21.43
		1745 (132322)	22.05	21.15
		1712.5 (131997)	21.86	20.85
	12RB-Low (0)	1777.5 (132647)	22.30	21.38
		1745 (132322)	21.94	21.07
		1712.5 (131997)	21.78	20.78
25RB (0)	1777.5 (132647)	22.29	21.35	
	1745 (132322)	21.98	21.05	
	1712.5 (131997)	21.74	20.74	
10MHz	1RB-High (49)	1775 (132622)	23.22	22.21
		1745 (132322)	22.97	22.34
		1715 (132022)	22.71	21.81
	1RB-Middle (24)	1775 (132622)	23.38	22.31
		1745 (132322)	23.15	22.44
		1715 (132022)	22.81	21.85
	1RB-Low (0)	1775 (132622)	23.20	22.17
		1745 (132322)	22.92	22.33
		1715 (132022)	22.69	21.71
	25RB-High (25)	1775 (132622)	22.34	21.42
		1745 (132322)	22.08	21.06
		1715 (132022)	21.83	20.90
	25RB-Middle (12)	1775 (132622)	22.34	21.45
		1745 (132322)	22.06	21.09
		1715 (132022)	21.83	20.92
	25RB-Low (0)	1775 (132622)	22.40	21.47
		1745 (132322)	22.03	21.04
		1715 (132022)	21.83	20.91
50RB (0)	1775 (132622)	22.36	21.39	
	1745 (132322)	22.02	21.03	
	1715 (132022)	21.84	20.85	

15MHz	1RB-High (74)	1772.5 (132597)	23.18	22.16
		1745 (132322)	22.94	22.30
		1717.5 (132047)	22.75	22.22
	1RB-Middle (37)	1772.5 (132597)	23.25	22.24
		1745 (132322)	23.05	22.40
		1717.5 (132047)	22.77	22.20
	1RB-Low (0)	1772.5 (132597)	23.14	22.06
		1745 (132322)	22.87	22.28
		1717.5 (132047)	22.69	22.05
	36RB-High (38)	1772.5 (132597)	22.35	21.34
		1745 (132322)	22.09	21.08
		1717.5 (132047)	21.83	20.78
	36RB-Middle (19)	1772.5 (132597)	22.37	21.38
		1745 (132322)	22.03	21.09
		1717.5 (132047)	21.85	20.78
	36RB-Low (0)	1772.5 (132597)	22.36	21.34
		1745 (132322)	21.97	20.99
		1717.5 (132047)	21.83	20.75
75RB (0)	1772.5 (132597)	22.39	21.37	
	1745 (132322)	22.02	21.02	
	1717.5 (132047)	21.82	20.78	
20MHz	1RB-High (99)	1770 (132572)	23.05	22.56
		1745 (132322)	22.85	22.33
		1720 (132072)	22.68	22.23
	1RB-Middle (50)	1770 (132572)	23.32	22.83
		1745 (132322)	23.14	22.55
		1720 (132072)	22.90	22.47
	1RB-Low (0)	1770 (132572)	22.90	22.39
		1745 (132322)	22.70	22.20
		1720 (132072)	22.56	22.13
	50RB-High (50)	1770 (132572)	22.18	21.27
		1745 (132322)	21.92	20.93
		1720 (132072)	21.75	20.84
	50RB-Middle (25)	1770 (132572)	22.23	21.30
		1745 (132322)	21.95	20.96
		1720 (132072)	21.75	20.84
	50RB-Low (0)	1770 (132572)	22.19	21.28
		1745 (132322)	21.84	20.85
		1720 (132072)	21.72	20.84
100RB (0)	1770 (132572)	22.19	21.26	
	1745 (132322)	21.89	20.90	
	1720 (132072)	21.72	20.77	

Band 71				
Bandwidth (MHz)	RB allocation	Frequency (MHz)	Actual output power (dBm)	
	RB offset		QPSK	16QAM
5MHz	1RB-High (24)	695.5 (133447)	23.06	22.19
		680.5 (133297)	23.08	22.16
		665.5 (133147)	23.30	22.82
	1RB-Middle (12)	695.5 (133447)	23.36	22.43
		680.5 (133297)	23.33	22.42
		665.5 (133147)	23.69	23.21
	1RB-Low (0)	695.5 (133447)	23.05	22.15
		680.5 (133297)	23.07	22.18
		665.5 (133147)	23.64	23.11
	12RB-High (13)	695.5 (133447)	22.17	21.20
		680.5 (133297)	22.08	21.10
		665.5 (133147)	22.43	21.57
	12RB-Middle (6)	695.5 (133447)	22.19	21.26
		680.5 (133297)	22.16	21.23
		665.5 (133147)	22.58	21.72
	12RB-Low (0)	695.5 (133447)	22.07	21.20
		680.5 (133297)	22.10	21.18
		665.5 (133147)	22.49	21.61
	25RB (0)	695.5 (133447)	22.16	21.11
		680.5 (133297)	22.09	21.12
		665.5 (133147)	22.44	21.55
10MHz	1RB-High (49)	693 (132422)	23.15	22.09
		680.5 (133297)	22.99	22.42
		668 (133172)	23.15	22.16
	1RB-Middle (24)	693 (132422)	23.34	22.35
		680.5 (133297)	23.15	22.58
		668 (133172)	23.42	22.42
	1RB-Low (0)	693 (132422)	23.39	22.47
		680.5 (133297)	23.01	22.44
		668 (133172)	23.62	22.58
	25RB-High (25)	693 (132422)	22.35	21.29
		680.5 (133297)	22.02	21.07
		668 (133172)	22.28	21.35
	25RB-Middle (12)	693 (132422)	22.34	21.46
		680.5 (133297)	22.11	21.23
		668 (133172)	22.47	21.53
	25RB-Low (0)	693 (132422)	22.48	21.48
		680.5 (133297)	22.08	21.12
		668 (133172)	22.48	21.51
	50RB (0)	693 (132422)	22.42	21.38
		680.5 (133297)	22.09	21.07
		668 (133172)	22.36	21.40

15MHz	1RB-High (74)	690.5 (133397)	23.07	22.56
		680.5 (133297)	22.99	21.93
		670.5 (133197)	23.10	22.42
	1RB-Middle (37)	690.5 (133397)	23.11	22.53
		680.5 (133297)	23.06	22.01
		670.5 (133197)	23.25	22.57
	1RB-Low (0)	690.5 (133397)	23.03	22.38
		680.5 (133297)	23.02	22.00
		670.5 (133197)	23.67	22.93
	36RB-High (38)	690.5 (133397)	22.20	21.19
		680.5 (133297)	22.05	21.01
		670.5 (133197)	22.30	21.36
	36RB-Middle (19)	690.5 (133397)	22.15	21.10
		680.5 (133297)	22.11	21.11
		670.5 (133197)	22.34	21.34
	36RB-Low (0)	690.5 (133397)	22.17	21.13
		680.5 (133297)	22.02	20.95
		670.5 (133197)	22.52	21.47
	75RB (0)	690.5 (133397)	22.19	21.18
		680.5 (133297)	22.07	21.00
		670.5 (133197)	22.41	21.42
20MHz	1RB-High (99)	688 (133372)	22.99	22.43
		683 (133322)	22.99	22.55
		673 (133222)	22.95	22.45
	1RB-Middle (50)	688 (133372)	23.10	22.57
		683 (133322)	23.11	22.73
		673 (133222)	23.25	22.75
	1RB-Low (0)	688 (133372)	22.91	22.33
		683 (133322)	22.98	22.53
		673 (133222)	23.46	22.92
	50RB-High (50)	688 (133372)	22.22	21.23
		683 (133322)	22.05	21.04
		673 (133222)	22.26	21.31
	50RB-Middle (25)	688 (133372)	22.10	21.12
		683 (133322)	22.13	21.14
		673 (133222)	22.27	21.28
	50RB-Low (0)	688 (133372)	22.26	21.22
		683 (133322)	22.00	21.01
		673 (133222)	22.43	21.48
	100RB (0)	688 (133372)	22.23	21.22
		683 (133322)	22.00	21.06
		673 (133222)	22.35	21.37

Low power

Band 2					
Bandwidth (MHz)	RB allocation	Frequency (MHz)	Actual output power (dBm)		
	RB offset		QPSK	16QAM	
1.4MHz	1RB-High (5)	1909.3 (19193)	19.27	19.42	
		1880 (18900)	19.31	19.49	
		1850.7 (18607)	19.46	19.59	
	1RB-Middle (3)	1909.3 (19193)	19.47	19.61	
		1880 (18900)	19.54	19.40	
		1850.7 (18607)	19.48	19.30	
	1RB-Low (0)	1909.3 (19193)	19.26	19.37	
		1880 (18900)	19.36	19.50	
		1850.7 (18607)	19.60	19.50	
	3RB-High (3)	1909.3 (19193)	19.43	19.59	
		1880 (18900)	19.40	19.51	
		1850.7 (18607)	19.17	19.49	
	3RB-Middle (1)	1909.3 (19193)	19.44	19.65	
		1880 (18900)	19.46	19.58	
		1850.7 (18607)	19.58	19.29	
	3RB-Low (0)	1909.3 (19193)	19.50	19.61	
		1880 (18900)	19.42	19.48	
		1850.7 (18607)	19.37	19.29	
	6RB (0)	1909.3 (19193)	19.40	19.57	
		1880 (18900)	19.41	19.58	
		1850.7 (18607)	19.38	19.36	
	3MHz	1RB-High (14)	1908.5 (19185)	19.43	19.37
			1880 (18900)	19.35	19.38
			1851.5 (18615)	19.61	19.58
		1RB-Middle (7)	1908.5 (19185)	19.55	19.90
			1880 (18900)	19.50	19.60
			1851.5 (18615)	19.37	19.76
1RB-Low (0)		1908.5 (19185)	19.37	19.72	
		1880 (18900)	19.36	19.48	
		1851.5 (18615)	19.64	19.64	
8RB-High (7)		1908.5 (19185)	19.31	19.47	
		1880 (18900)	19.34	19.42	
		1851.5 (18615)	19.60	19.76	
8RB-Middle (4)		1908.5 (19185)	19.38	19.52	
		1880 (18900)	19.37	19.47	
		1851.5 (18615)	19.27	19.82	
8RB-Low (0)		1908.5 (19185)	19.39	19.49	
		1880 (18900)	19.37	19.42	
		1851.5 (18615)	19.69	19.81	
15RB (0)		1908.5 (19185)	19.36	19.43	
		1880 (18900)	19.37	19.35	
		1851.5 (18615)	19.65	19.70	

5MHz	1RB-High (24)	1907.5 (19175)	19.22	19.45
		1880 (18900)	19.25	19.46
		1852.5 (18625)	19.49	19.35
	1RB-Middle (12)	1907.5 (19175)	19.49	19.66
		1880 (18900)	19.55	19.74
		1852.5 (18625)	19.58	19.22
	1RB-Low (0)	1907.5 (19175)	19.19	19.37
		1880 (18900)	19.27	19.47
		1852.5 (18625)	19.57	19.15
	12RB-High (13)	1907.5 (19175)	19.33	19.38
		1880 (18900)	19.31	19.41
		1852.5 (18625)	19.57	19.70
	12RB-Middle (6)	1907.5 (19175)	19.39	19.47
		1880 (18900)	19.40	19.50
		1852.5 (18625)	19.57	19.80
	12RB-Low (0)	1907.5 (19175)	19.36	19.39
		1880 (18900)	19.36	19.45
		1852.5 (18625)	19.56	19.82
25RB (0)	1907.5 (19175)	19.36	19.31	
	1880 (18900)	19.34	19.39	
	1852.5 (18625)	19.61	19.70	
10MHz	1RB-High (49)	1905 (19150)	19.32	19.30
		1880 (18900)	19.34	19.72
		1855 (18650)	19.53	19.57
	1RB-Middle (24)	1905 (19150)	19.42	19.50
		1880 (18900)	19.47	19.86
		1855 (18650)	19.64	19.71
	1RB-Low (0)	1905 (19150)	19.45	19.29
		1880 (18900)	19.43	19.74
		1855 (18650)	19.61	19.65
	25RB-High (25)	1905 (19150)	19.32	19.39
		1880 (18900)	19.33	19.41
		1855 (18650)	19.60	19.72
	25RB-Middle (12)	1905 (19150)	19.41	19.41
		1880 (18900)	19.39	19.48
		1855 (18650)	19.63	19.77
25RB-Low (0)	1905 (19150)	19.42	19.45	
	1880 (18900)	19.38	19.47	
	1855 (18650)	19.56	19.79	
50RB (0)	1905 (19150)	19.34	19.38	
	1880 (18900)	19.38	19.44	
	1855 (18650)	19.66	19.70	

15MHz	1RB-High (74)	1902.5 (19125)	19.28	19.74
		1880 (18900)	19.24	19.23
		1857.5 (18675)	19.45	19.84
	1RB-Middle (37)	1902.5 (19125)	19.40	19.85
		1880 (18900)	19.35	19.38
		1857.5 (18675)	19.60	19.93
	1RB-Low (0)	1902.5 (19125)	19.27	19.75
		1880 (18900)	19.34	19.34
		1857.5 (18675)	19.56	19.90
	36RB-High (38)	1902.5 (19125)	19.33	19.32
		1880 (18900)	19.35	19.35
		1857.5 (18675)	19.58	19.66
	36RB-Middle (19)	1902.5 (19125)	19.39	19.33
		1880 (18900)	19.39	19.42
		1857.5 (18675)	19.60	19.66
	36RB-Low (0)	1902.5 (19125)	19.34	19.31
		1880 (18900)	19.40	19.39
		1857.5 (18675)	19.62	19.72
	75RB (0)	1902.5 (19125)	19.35	19.36
		1880 (18900)	19.37	19.38
		1857.5 (18675)	19.60	19.61
20MHz	1RB-High (99)	1900 (19100)	19.14	19.60
		1880 (18900)	19.24	19.57
		1860 (18700)	19.25	19.50
	1RB-Middle (50)	1900 (19100)	19.54	19.49
		1880 (18900)	19.53	19.36
		1860 (18700)	19.61	19.61
	1RB-Low (0)	1900 (19100)	19.14	19.16
		1880 (18900)	19.30	19.26
		1860 (18700)	19.47	19.66
	50RB-High (50)	1900 (19100)	19.29	19.35
		1880 (18900)	19.27	19.33
		1860 (18700)	19.53	19.57
	50RB-Middle (25)	1900 (19100)	19.40	19.42
		1880 (18900)	19.40	19.46
		1860 (18700)	19.60	19.61
	50RB-Low (0)	1900 (19100)	19.38	19.37
		1880 (18900)	19.37	19.45
		1860 (18700)	19.58	19.61
	100RB (0)	1900 (19100)	19.34	19.39
		1880 (18900)	19.34	19.37
		1860 (18700)	19.59	19.65

Band 7					
Bandwidth (MHz)	RB allocation	Frequency (MHz)	Actual output power (dBm)		
	RB offset		QPSK	16QAM	
5MHz	1RB-High (24)	2567.5 (21425)	19.80	19.84	
		2535 (21100)	19.98	20.11	
		2502.5 (20775)	19.89	20.35	
	1RB-Middle (12)	2567.5 (21425)	20.07	20.15	
		2535 (21100)	20.28	20.42	
		2502.5 (20775)	20.14	20.63	
	1RB-Low (0)	2567.5 (21425)	19.82	19.94	
		2535 (21100)	20.01	20.09	
		2502.5 (20775)	19.88	20.37	
	12RB-High (13)	2567.5 (21425)	19.84	19.85	
		2535 (21100)	20.07	20.08	
		2502.5 (20775)	19.99	20.10	
	12RB-Middle (6)	2567.5 (21425)	19.90	19.96	
		2535 (21100)	20.12	20.16	
		2502.5 (20775)	20.01	20.11	
	12RB-Low (0)	2567.5 (21425)	19.88	19.95	
		2535 (21100)	20.01	20.06	
		2502.5 (20775)	19.92	20.04	
	25RB (0)	2567.5 (21425)	19.83	19.82	
		2535 (21100)	20.00	20.06	
		2502.5 (20775)	19.93	20.00	
	10MHz	1RB-High (49)	2565 (21400)	19.78	19.85
			2535 (21100)	20.00	19.98
			2505 (20800)	20.04	20.34
1RB-Middle (24)		2565 (21400)	19.89	20.06	
		2535 (21100)	20.12	20.11	
		2505 (20800)	20.12	20.43	
1RB-Low (0)		2565 (21400)	19.87	19.92	
		2535 (21100)	19.98	19.92	
		2505 (20800)	19.98	20.26	
25RB-High (25)		2565 (21400)	19.86	19.99	
		2535 (21100)	20.10	20.13	
		2505 (20800)	20.06	20.11	
25RB-Middle (12)		2565 (21400)	19.97	20.08	
		2535 (21100)	20.11	20.14	
		2505 (20800)	20.04	20.07	
25RB-Low (0)		2565 (21400)	19.90	20.00	
		2535 (21100)	20.07	20.11	
		2505 (20800)	19.96	19.99	
50RB (0)		2565 (21400)	19.87	19.94	
		2535 (21100)	20.05	20.11	
		2505 (20800)	20.04	20.05	

15MHz	1RB-High (74)	2562.5 (21375)	19.73	20.17
		2535 (21100)	19.92	19.87
		2507.5 (20825)	19.93	20.29
	1RB-Middle (37)	2562.5 (21375)	19.92	20.36
		2535 (21100)	19.99	19.97
		2507.5 (20825)	20.02	20.35
	1RB-Low (0)	2562.5 (21375)	19.89	20.29
		2535 (21100)	19.92	19.88
		2507.5 (20825)	19.95	20.24
	36RB-High (38)	2562.5 (21375)	19.84	19.80
		2535 (21100)	20.04	20.03
		2507.5 (20825)	20.03	20.07
	36RB-Middle (19)	2562.5 (21375)	19.94	19.90
		2535 (21100)	20.06	20.04
		2507.5 (20825)	20.05	20.07
	36RB-Low (0)	2562.5 (21375)	19.91	19.87
		2535 (21100)	20.04	20.03
		2507.5 (20825)	19.95	20.02
75RB (0)	2562.5 (21375)	19.85	19.89	
	2535 (21100)	20.00	20.06	
	2507.5 (20825)	20.02	20.02	
20MHz	1RB-High (99)	2560 (21350)	19.72	20.17
		2535 (21100)	19.85	20.29
		2510 (20850)	19.85	20.40
	1RB-Middle (50)	2560 (21350)	20.09	20.56
		2535 (21100)	20.14	20.58
		2510 (20850)	20.13	20.66
	1RB-Low (0)	2560 (21350)	19.84	20.38
		2535 (21100)	19.77	20.29
		2510 (20850)	19.71	20.29
	50RB-High (50)	2560 (21350)	19.83	19.91
		2535 (21100)	19.96	19.94
		2510 (20850)	19.96	20.00
	50RB-Middle (25)	2560 (21350)	19.89	19.94
		2535 (21100)	20.02	20.03
		2510 (20850)	19.99	20.06
	50RB-Low (0)	2560 (21350)	19.91	19.94
		2535 (21100)	19.97	19.99
		2510 (20850)	19.88	19.91
100RB (0)	2560 (21350)	19.86	19.90	
	2535 (21100)	19.98	20.02	
	2510 (20850)	19.95	19.98	

Band 66				
Bandwidth (MHz)	RB allocation	Frequency (MHz)	Actual output power (dBm)	
	RB offset		QPSK	16QAM
1.4MHz	1RB-High (5)	1779.3 (132665)	20.32	20.48
		1745 (132322)	20.06	20.43
		1710.7 (131979)	19.72	19.86
	1RB-Middle (3)	1779.3 (132665)	20.52	20.69
		1745 (132322)	20.30	20.57
		1710.7 (131979)	19.94	19.99
	1RB-Low (0)	1779.3 (132665)	20.34	20.46
		1745 (132322)	20.03	20.42
		1710.7 (131979)	19.73	19.82
	3RB-High (3)	1779.3 (132665)	20.42	20.47
		1745 (132322)	20.06	20.31
		1710.7 (131979)	19.86	20.02
	3RB-Middle (1)	1779.3 (132665)	20.44	20.50
		1745 (132322)	20.16	20.32
		1710.7 (131979)	19.88	20.07
	3RB-Low (0)	1779.3 (132665)	20.42	20.49
		1745 (132322)	20.10	20.26
		1710.7 (131979)	19.81	19.99
	6RB (0)	1779.3 (132665)	20.42	20.54
		1745 (132322)	20.08	20.05
		1710.7 (131979)	19.84	20.03
3MHz	1RB-High (14)	1778.5 (132657)	20.31	20.28
		1745 (132322)	20.05	20.39
		1711.5 (131987)	19.71	19.76
	1RB-Middle (7)	1778.5 (132657)	20.47	20.44
		1745 (132322)	20.20	20.55
		1711.5 (131987)	19.85	19.96
	1RB-Low (0)	1778.5 (132657)	20.30	20.36
		1745 (132322)	20.02	20.35
		1711.5 (131987)	19.76	19.80
	8RB-High (7)	1778.5 (132657)	20.29	20.44
		1745 (132322)	19.97	20.07
		1711.5 (131987)	19.74	19.79
	8RB-Middle (4)	1778.5 (132657)	20.38	20.49
		1745 (132322)	20.00	20.11
		1711.5 (131987)	19.79	19.86
	8RB-Low (0)	1778.5 (132657)	20.31	20.45
		1745 (132322)	19.99	20.08
		1711.5 (131987)	19.76	19.80
15RB (0)	1778.5 (132657)	20.33	20.34	
	1745 (132322)	19.90	19.97	
	1711.5 (131987)	19.73	19.73	

5MHz	1RB-High (24)	1777.5 (132647)	20.29	20.41
		1745 (132322)	19.93	20.39
		1712.5 (131997)	19.72	19.84
	1RB-Middle (12)	1777.5 (132647)	20.53	20.69
		1745 (132322)	20.22	20.69
		1712.5 (131997)	20.01	20.10
	1RB-Low (0)	1777.5 (132647)	20.28	20.44
		1745 (132322)	19.89	20.38
		1712.5 (131997)	19.72	19.80
	12RB-High (13)	1777.5 (132647)	20.29	20.37
		1745 (132322)	20.00	20.10
		1712.5 (131997)	19.72	19.77
	12RB-Middle (6)	1777.5 (132647)	20.38	20.43
		1745 (132322)	20.02	20.14
		1712.5 (131997)	19.83	19.85
	12RB-Low (0)	1777.5 (132647)	20.30	20.39
		1745 (132322)	19.95	20.09
		1712.5 (131997)	19.78	19.78
	25RB (0)	1777.5 (132647)	20.32	20.35
		1745 (132322)	19.94	20.04
		1712.5 (131997)	19.74	19.71
10MHz	1RB-High (49)	1775 (132622)	20.27	20.28
		1745 (132322)	20.07	20.38
		1715 (132022)	19.73	19.78
	1RB-Middle (24)	1775 (132622)	20.38	20.39
		1745 (132322)	20.15	20.52
		1715 (132022)	19.86	19.89
	1RB-Low (0)	1775 (132622)	20.25	20.26
		1745 (132322)	19.98	20.32
		1715 (132022)	19.70	19.76
	25RB-High (25)	1775 (132622)	20.39	20.42
		1745 (132322)	20.06	20.12
		1715 (132022)	19.82	19.90
	25RB-Middle (12)	1775 (132622)	20.41	20.43
		1745 (132322)	20.03	20.09
		1715 (132022)	19.82	19.91
	25RB-Low (0)	1775 (132622)	20.38	20.45
		1745 (132322)	19.98	20.08
		1715 (132022)	19.82	19.93
	50RB (0)	1775 (132622)	20.41	20.40
		1745 (132322)	20.02	20.07
		1715 (132022)	19.82	19.84

15MHz	1RB-High (74)	1772.5 (132597)	20.27	20.26
		1745 (132322)	20.04	20.34
		1717.5 (132047)	19.75	20.24
	1RB-Middle (37)	1772.5 (132597)	20.34	20.30
		1745 (132322)	20.09	20.43
		1717.5 (132047)	19.81	20.26
	1RB-Low (0)	1772.5 (132597)	20.17	20.15
		1745 (132322)	19.95	20.28
		1717.5 (132047)	19.70	20.15
	36RB-High (38)	1772.5 (132597)	20.39	20.35
		1745 (132322)	20.06	20.11
		1717.5 (132047)	19.86	19.79
	36RB-Middle (19)	1772.5 (132597)	20.41	20.38
		1745 (132322)	20.05	20.05
		1717.5 (132047)	19.83	19.76
	36RB-Low (0)	1772.5 (132597)	20.38	20.35
		1745 (132322)	19.98	19.96
		1717.5 (132047)	19.81	19.75
75RB (0)	1772.5 (132597)	20.38	20.36	
	1745 (132322)	20.00	20.05	
	1717.5 (132047)	19.82	19.78	
20MHz	1RB-High (99)	1770 (132572)	20.16	20.68
		1745 (132322)	19.96	20.36
		1720 (132072)	19.76	20.26
	1RB-Middle (50)	1770 (132572)	20.44	20.93
		1745 (132322)	20.14	20.55
		1720 (132072)	19.98	20.44
	1RB-Low (0)	1770 (132572)	20.00	20.52
		1745 (132322)	19.77	20.18
		1720 (132072)	19.64	20.11
	50RB-High (50)	1770 (132572)	20.28	20.25
		1745 (132322)	19.99	19.93
		1720 (132072)	19.78	19.81
	50RB-Middle (25)	1770 (132572)	20.31	20.32
		1745 (132322)	19.99	19.96
		1720 (132072)	19.80	19.82
	50RB-Low (0)	1770 (132572)	20.28	20.32
		1745 (132322)	19.90	19.86
		1720 (132072)	19.79	19.80
100RB (0)	1770 (132572)	20.31	20.31	
	1745 (132322)	19.92	19.92	
	1720 (132072)	19.77	19.81	

11.4 Wi-Fi and BT Measurement result

The maximum tune up of BT is 7dBm.

The average conducted power for Wi-Fi normal power is as following:

802.11b	Channel\ld	1Mbps	2Mbps	5.5Mbps	11Mbps
WLAN2450	11(2462M	20.42	/	/	/
	6(2437(M	20.41	/	/	/
	1(2412MH	20.61	20.57	20.56	20.54
	tuneup	21.50	21.50	21.50	21.50

802.11g	Channel\ld	6Mbps	9Mbps	12Mbps	18Mbps	24Mbps	36Mbps	48Mbps	54Mbps
WLAN2450	11(2462M	17.19	17.16	17.15	17.08	17.06	17.13	17.12	17.11
	6(2437(M	17.11	/	/	/	/	/	/	/
	1(2412MH	17.17	/	/	/	/	/	/	/
	tuneup	19.00	19.00	19.00	19.00	19.00	19.00	18.00	18.00
802.11n-20MHz	Channel\ld	MCS0	MCS1	MCS2	MCS3	MCS4	MCS5	MCS6	MCS7
WLAN2450	11(2462M	16.29	16.26	16.24	16.23	16.21	15.78	15.74	15.72
	6(2437(M	16.19	/	/	/	/	/	/	/
	1(2412MH	16.22	/	/	/	/	/	/	/
	tuneup	17.00	17.00	17.00	17.00	17.00	17.00	17.00	17.00
802.11n-40MHz	Channel\ld	MCS0	MCS1	MCS2	MCS3	MCS4	MCS5	MCS6	MCS7
WLAN2450	9(2452MH	15.32	15.18	15.02	14.87	14.63	14.10	14.03	13.87
	6(2437MH	15.30	/	/	/	/	/	/	/
	3(2422MH	15.19	/	/	/	/	/	/	/
	tuneup	15.50	15.50	15.50	15.50	15.50	15.50	15.50	15.50

Low power

802.11b	Channel\ld	1Mbps	2Mbps	5.5Mbps	11Mbps
WLAN2450	11(2462M	16.43	/	/	/
	6(2437(M	16.38	/	/	/
	1(2412MH	16.50	16.44	16.41	16.40
	tuneup	18.00	18.00	18.00	18.00

802.11g	Channel\ld	6Mbps	9Mbps	12Mbps	18Mbps	24Mbps	36Mbps	48Mbps	54Mbps
WLAN2450	11(2462M	16.66	/	/	/	/	/	/	/
	6(2437(M	16.61	/	/	/	/	/	/	/
	1(2412MH	16.69	16.65	16.63	16.62	16.57	16.59	16.61	16.60
	tuneup	18.00	18.00	18.00	18.00	18.00	18.00	18.00	18.00
802.11n-20MHz	Channel\ld	MCS0	MCS1	MCS2	MCS3	MCS4	MCS5	MCS6	MCS7
WLAN2450	11(2462M	16.29	16.26	16.24	16.23	16.21	15.78	15.74	15.72
	6(2437(M	16.19	/	/	/	/	/	/	/
	1(2412MH	16.22	/	/	/	/	/	/	/
	tuneup	17.00	17.00	17.00	17.00	17.00	17.00	17.00	17.00
802.11n-40MHz	Channel\ld	MCS0	MCS1	MCS2	MCS3	MCS4	MCS5	MCS6	MCS7
WLAN2450	9(2452MH	15.32	15.18	15.02	14.87	14.63	14.10	14.03	13.87
	6(2437MH	15.30	/	/	/	/	/	/	/
	3(2422MH	15.19	/	/	/	/	/	/	/
	tuneup	15.50	15.50	15.50	15.50	15.50	15.50	15.50	15.50

12 Simultaneous TX SAR Considerations

12.1 Introduction

The following procedures adopted from “FCC SAR Considerations for Cell Phones with Multiple Transmitters” are applicable to handsets with built-in unlicensed transmitters such as 802.11 a/b/g and Bluetooth devices which may simultaneously transmit with the licensed transmitter. For this device, the BT and Wi-Fi can transmit simultaneous with other transmitters.

12.2 Transmit Antenna Separation Distances

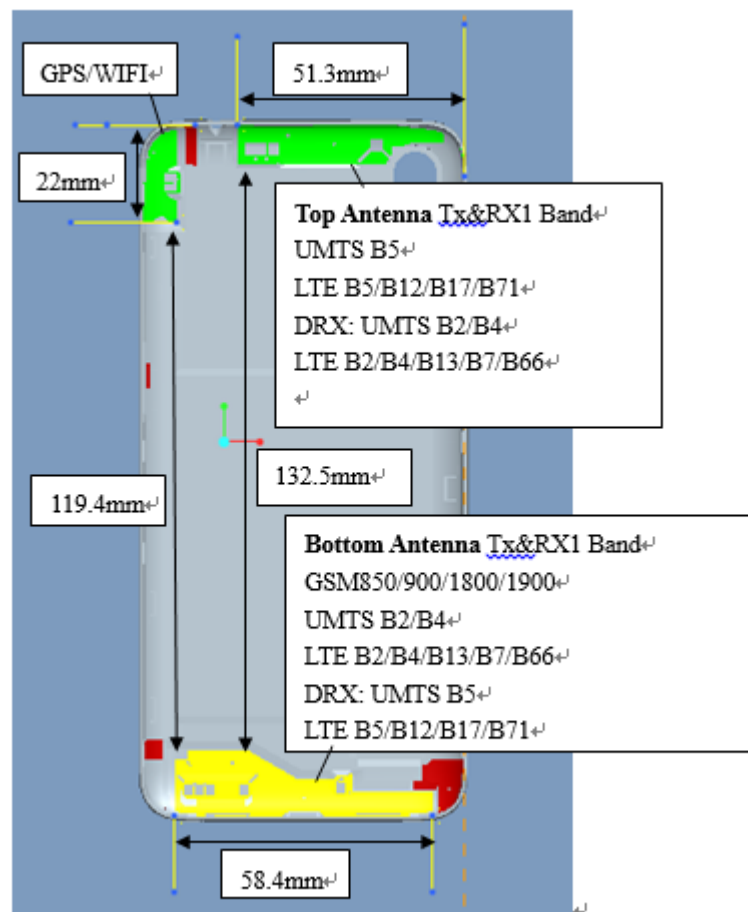

Picture 12.1 Antenna Locations

12.3 SAR Measurement Positions

According to the KDB941225 D06 Hot Spot SAR v01, the edges with less than 2.5 cm distance to the antennas need to be tested for SAR.

SAR measurement positions						
Mode	Front	Rear	Left edge	Right edge	Top edge	Bottom edge
Top Antenna	Yes	Yes	Yes	Yes	Yes	No
Bottom Antenna	Yes	Yes	Yes	Yes	No	Yes
WLAN2.4G	Yes	Yes	Yes	No	Yes	No

12.4 Standalone SAR Test Exclusion Considerations

Standalone 1-g head or body SAR evaluation by measurement or numerical simulation is not required when the corresponding SAR Exclusion Threshold condition, listed below, is satisfied. The 1-g SAR test exclusion threshold for 100 MHz to 6 GHz at test separation distances ≤ 50 mm are determined by:

$[(\text{max. power of channel, including tune-up tolerance, mW}) / (\text{min. test separation distance, mm})] \cdot [\sqrt{f(\text{GHz})}] \leq 3.0$ for 1-g SAR, where

- $f(\text{GHz})$ is the RF channel transmit frequency in GHz
- Power and distance are rounded to the nearest mW and mm before calculation
- The result is rounded to one decimal place for comparison

Table 12.1: Standalone SAR test exclusion considerations

Band/Mode	F(GHz)	Position	SAR test exclusion threshold(mW)	RF output power		SAR test exclusion
				dBm	mW	
Bluetooth	2.441	Head	9.60	7	5.01	Yes
		Body	19.20	7	5.01	Yes
2.4GHz WLAN	2.45	Head	9.58	18	63	No
		Body	19.17	21.5	141	No

13 Evaluation of Simultaneous

Table 13.1: The sum of reported SAR values for main antenna and WiFi

	Position	Main antenna	WiFi	Sum
Highest reported SAR value for Head	Right hand, Touch cheek	0.83	0.61	1.44
Highest reported SAR value for Body	Bottom 10mm	1.39	/	1.39

Table 13.2: The sum of reported SAR values for main antenna and BT

	Position	Main antenna	BT	Sum
Maximum reported SAR value for Head	Right hand, Touch cheek	0.83	0.21	1.04
Maximum reported SAR value for Body	Bottom 10mm	1.39	0.10	1.49

Table 13.3: Estimated SAR for Bluetooth

Mode/Band	F (GHz)	Position	Distance (mm)	Upper limit of power *		Estimated _{1g} (W/kg)
				dBm	mW	
Bluetooth	2.441	Head	5	7	5.01	0.21
Bluetooth	2.441	Body	10	7	5.01	0.10

* - Maximum possible output power declared by manufacturer

When standalone SAR test exclusion applies to an antenna that transmits simultaneously with other antennas, the standalone SAR must be estimated according to following to determine simultaneous transmission SAR test exclusion:

(max. power of channel, including tune-up tolerance, mW)/(min. test separation distance, mm) · [$\sqrt{f(\text{GHz})/x}$] W/kg for test separation distances ≤ 50 mm;
where $x = 7.5$ for 1-g SAR.

When the minimum test separation distance is < 5 mm, a distance of 5 mm is applied to determine SAR test exclusion

Conclusion:

According to the above tables, the sum of reported SAR values is < 1.6 W/kg. So the simultaneous transmission SAR with volume scans is not required.

14 SAR Test Result

It is determined by user manual for the distance between the EUT and the phantom bottom.

The distance is 10 mm and just applied to the condition of body worn accessory.

It is performed for all SAR measurements with area scan based 1-g SAR estimation (Fast SAR). A zoom scan measurement is added when the estimated 1-gSAR is the highest measured SAR in each exposure configuration, wireless mode and frequency band combination or more than 1.2W/kg.

The calculated SAR is obtained by the following formula:

$$\text{Reported SAR} = \text{Measured SAR} \times 10^{(P_{\text{Target}} - P_{\text{Measured}})/10}$$

Where P_{Target} is the power of manufacturing upper limit;

P_{Measured} is the measured power in chapter 11.

14.1 SAR results for Fast SAR

H:handset

Table 14.1-1: SAR Values (GSM 850 MHz Band - Head)

Ambient Temperature: 22.9 °C Liquid Temperature: 22.5 °C											
Frequency		Side	Test Position	Figure No.	Conducted Power (dBm)	Max. tune-up Power (dBm)	Measured SAR(10g) (W/kg)	Reported SAR(10g) (W/kg)	Measured SAR(1g) (W/kg)	Reported SAR(1g) (W/kg)	Power Drift (dB)
Ch.	MHz										
190	836.6	Left	Cheek	/	31.70	33.3	0.132	0.19	0.172	0.25	-0.14
190	836.6	Left	Tilt	/	31.70	33.3	0.076	0.11	0.099	0.14	-0.01
251	848.8	Right	Cheek	/	32.25	33.3	0.169	0.22	0.225	0.29	0.08
190	836.6	Right	Cheek	/	31.70	33.3	0.217	0.31	0.293	0.42	-0.03
128	824.2	Right	Cheek	Fig.1	31.57	33.3	0.213	0.32	0.288	0.43	0.10
190	836.6	Right	Tilt	/	31.70	33.3	0.104	0.15	0.132	0.19	0.00

Table 14.1-2: SAR Values (GSM 850 MHz Band - Body)

Ambient Temperature: 22.9 °C Liquid Temperature: 22.5 °C											
Frequency		Mode (number of timeslots)	Test Position	Figure No.	Conducted Power (dBm)	Max. tune-up Power (dBm)	Measured SAR(10g) (W/kg)	Reported SAR(10g) (W/kg)	Measured SAR(1g) (W/kg)	Reported SAR(1g) (W/kg)	Power Drift (dB)
Ch.	MHz										
190	836.6	GPRS (2)	Front	/	29.61	30.50	0.162	0.20	0.220	0.27	0.05
251	848.8	GPRS (2)	Rear	/	29.88	30.50	0.259	0.30	0.467	0.54	0.08
190	836.6	GPRS (2)	Rear	Fig.2	29.61	30.50	0.296	0.36	0.532	0.65	-0.02
128	824.2	GPRS (2)	Rear	/	29.59	30.50	0.287	0.35	0.488	0.60	0.10
190	836.6	GPRS (2)	Left	/	29.61	30.50	0.080	0.10	0.111	0.14	0.06
190	836.6	GPRS (2)	Right	/	29.61	30.50	0.105	0.13	0.141	0.17	0.10
190	836.6	GPRS (2)	Bottom	/	29.61	30.50	0.162	0.20	0.299	0.37	-0.03
190	836.6	EGPRS (2)	Rear	/	29.62	30.50	0.291	0.36	0.512	0.63	0.11

Note: The distance between the EUT and the phantom bottom is 10mm.

Table 14.1-3: SAR Values (GSM 1900 MHz Band - Head)

Frequency		Side	Test Position	Figure No.	Conducted Power (dBm)	Max. tune-up Power (dBm)	Measured SAR(10g) (W/kg)	Reported SAR(10g) (W/kg)	Measured SAR(1g) (W/kg)	Reported SAR(1g) (W/kg)	Power Drift (dB)
Ch.	MHz										
Ambient Temperature: 22.9 °C Liquid Temperature: 22.5 °C											
810	1909.8	Left	Cheek	/	29.22	30.3	0.033	0.04	0.056	0.07	0.02
661	1880	Left	Cheek	/	29.47	30.3	0.041	0.05	0.067	0.08	-0.03
512	1850.2	Left	Cheek	Fig.3	29.67	30.3	0.061	0.07	0.100	0.12	-0.06
661	1880	Left	Tilt	/	29.47	30.3	0.037	0.04	0.062	0.08	0.11
661	1880	Right	Cheek	/	29.47	30.3	0.039	0.05	0.065	0.08	-0.13
661	1880	Right	Tilt	/	29.47	30.3	0.035	0.04	0.061	0.07	-0.10

Table 14.1-4: SAR Values (GSM 1900 MHz Band - Body)

Frequency		Mode (number of timeslots)	Test Position	Figure No.	Conducted Power (dBm)	Max. tune-up Power (dBm)	Measured SAR(10g) (W/kg)	Reported SAR(10g) (W/kg)	Measured SAR(1g) (W/kg)	Reported SAR(1g) (W/kg)	Power Drift (dB)
Ch.	MHz										
Ambient Temperature: 22.9 °C Liquid Temperature: 22.5 °C											
661	1880	GPRS (2)	Front	/	27.70	28.50	0.236	0.28	0.430	0.52	-0.04
810	1909.8	GPRS (2)	Rear	/	27.48	28.50	0.257	0.33	0.451	0.57	0.11
661	1880	GPRS (2)	Rear	/	27.70	28.50	0.265	0.32	0.464	0.56	-0.09
512	1850.2	GPRS (2)	Rear	Fig.4	27.96	28.50	0.324	0.37	0.559	0.63	-0.15
512	1850.2	EGPRS (2)	Rear	/	27.96	28.50	0.319	0.36	0.523	0.59	0.02

Note1: The distance between the EUT and the phantom bottom is 15mm

Table 14.1-5: SAR Values (GSM 1900 MHz Band - Body)

Frequency		Mode (number of timeslots)	Test Position	Figure No.	Conducted Power (dBm)	Max. tune-up Power (dBm)	Measured SAR(10g) (W/kg)	Reported SAR(10g) (W/kg)	Measured SAR(1g) (W/kg)	Reported SAR(1g) (W/kg)	Power Drift (dB)
Ch.	MHz										
Ambient Temperature: 22.9 °C Liquid Temperature: 22.5 °C											
661	1880	GPRS (3)	Front	/	23.25	24.30	0.241	0.31	0.446	0.57	-0.12
661	1880	GPRS (3)	Rear	/	23.25	24.30	0.281	0.36	0.505	0.64	-0.05
661	1880	GPRS (3)	Left	/	23.25	24.30	0.029	0.04	0.047	0.06	0.08
661	1880	GPRS (3)	Right	/	23.25	24.30	0.028	0.04	0.047	0.06	-0.14
810	1909.8	GPRS (3)	Bottom	/	23.22	24.30	0.397	0.51	0.782	1.00	0.10
661	1880	GPRS (3)	Bottom	/	23.25	24.30	0.453	0.58	0.885	1.13	0.09
512	1850.2	GPRS (3)	Bottom	Fig.4	23.28	24.30	0.581	0.73	1.100	1.39	-0.06
512	1850.2	EGPRS (3)	Bottom	/	23.28	24.30	0.575	0.73	1.080	1.37	-0.04
512	1850.2	EGPRS (3)	Bottom	H	23.28	24.30	0.569	0.72	0.992	1.25	0.04

Note1: The distance between the EUT and the phantom bottom is 10mm

Table 14.1-6: SAR Values (WCDMA 1900 MHz Band - Head)

Frequency		Side	Test Position	Figure No.	Ambient Temperature: 22.9 °C		Liquid Temperature: 22.5 °C		Measured SAR(1g) (W/kg)	Reported SAR(1g) (W/kg)	Power Drift (dB)
Ch.	MHz				Conducted Power (dBm)	Max. tune-up Power (dBm)	Measured SAR(10g) (W/kg)	Reported SAR(10g) (W/kg)			
1412	1732.4	Left	Cheek	Fig.6	22.54	24	0.053	0.07	0.088	0.12	0.13
1412	1732.4	Left	Cheek	/	22.57	24	0.055	0.08	0.091	0.13	-0.14
1513	1752.6	Left	Cheek	/	22.87	24	0.064	0.08	0.106	0.14	0.04
1412	1732.4	Left	Tilt	/	22.57	24	0.046	0.06	0.078	0.11	0.06
1312	1712.4	Right	Cheek	/	22.57	24	0.054	0.08	0.090	0.13	-0.04
1412	1732.4	Right	Tilt	/	22.57	24	0.050	0.07	0.086	0.12	-0.15

Table 14.1-7: SAR Values (WCDMA 1900 MHz Band - Body)

Frequency		Test Position	Figure No.	Ambient Temperature: 22.9 °C		Liquid Temperature: 22.5 °C		Measured SAR(1g) (W/kg)	Reported SAR(1g) (W/kg)	Power Drift (dB)
Ch.	MHz			Conducted Power (dBm)	Max. tune-up Power (dBm)	Measured SAR(10g) (W/kg)	Reported SAR(10g) (W/kg)			
9400	1880	Front	/	22.57	24	0.307	0.43	0.570	0.79	-0.11
9538	1907.6	Rear	/	22.54	24	0.334	0.47	0.598	0.84	0.11
9400	1880	Rear	/	22.57	24	0.345	0.48	0.615	0.85	0.05
9262	1852.4	Rear	Fig.7	22.87	24	0.422	0.55	0.741	0.96	0.12

Note1: The distance between the EUT and the phantom bottom is 15mm

Table 14.1-8: SAR Values (WCDMA 1900 MHz Band - Body)

Frequency		Test Position	Figure No.	Ambient Temperature: 22.9 °C		Liquid Temperature: 22.5 °C		Measured SAR(1g) (W/kg)	Reported SAR(1g) (W/kg)	Power Drift (dB)
Ch.	MHz			Conducted Power (dBm)	Max. tune-up Power (dBm)	Measured SAR(10g) (W/kg)	Reported SAR(10g) (W/kg)			
9400	1880	Front	/	19.60	20.5	0.241	0.30	0.446	0.55	-0.09
9400	1880	Rear	/	19.60	20.5	0.281	0.35	0.505	0.62	-0.11
9400	1880	Left	/	19.60	20.5	0.029	0.04	0.047	0.06	-0.02
9400	1880	Right	/	19.60	20.5	0.028	0.03	0.047	0.06	-0.11
9538	1907.6	Bottom	/	19.53	20.5	0.397	0.50	0.782	0.98	0.11
9400	1880	Bottom	/	19.60	20.5	0.453	0.56	0.885	1.09	-0.06
9262	1852.4	Bottom	Fig.8	19.83	20.5	0.581	0.68	1.150	1.34	-0.09
9262	1852.4	Bottom	H	19.83	20.5	0.558	0.65	1.010	1.18	0.05

Note1: The distance between the EUT and the phantom bottom is 10mm

Table 14.1-9: SAR Values (WCDMA 1700 MHz Band - Head)

Frequency		Side	Test Position	Figure No.	Conducted Power (dBm)	Max. tune-up Power (dBm)	Measured SAR(10g) (W/kg)	Reported SAR(10g) (W/kg)	Measured SAR(1g) (W/kg)	Reported SAR(1g) (W/kg)	Power Drift (dB)
Ch.	MHz										
1412	1732.4	Left	Cheek	/	23.30	24	0.239	0.28	0.378	0.44	-0.10
1412	1732.4	Left	Tilt	/	23.30	24	0.153	0.18	0.239	0.28	-0.08
1513	1752.6	Right	Cheek	/	23.25	24	0.213	0.25	0.344	0.41	-0.11
1412	1732.4	Right	Cheek	/	23.30	24	0.249	0.29	0.401	0.47	0.13
1312	1712.4	Right	Cheek	Fig.9	23.36	24	0.293	0.34	0.468	0.54	-0.01
1412	1732.4	Right	Tilt	/	23.30	24	0.161	0.19	0.260	0.31	-0.05

Table 14.1-10: SAR Values (WCDMA 1700 MHz Band - Body)

Frequency		Test Position	Figure No.	Conducted Power (dBm)	Max. tune-up Power (dBm)	Measured SAR(10g) (W/kg)	Reported SAR(10g) (W/kg)	Measured SAR(1g) (W/kg)	Reported SAR(1g) (W/kg)	Power Drift (dB)
Ch.	MHz									
1513	1752.6	Front	/	23.25	24	0.430	0.51	0.742	0.88	-0.06
1412	1732.4	Rear	Fig.10	23.30	24	0.443	0.52	0.763	0.90	-0.01
1312	1712.4	Rear	/	23.36	24	0.420	0.49	0.714	0.83	0.15
1412	1732.4	Rear	/	23.30	24	0.435	0.51	0.721	0.85	-0.13

Note1: The distance between the EUT and the phantom bottom is 15mm

Table 14.1-11: SAR Values (WCDMA 1700 MHz Band - Body)

Frequency		Test Position	Figure No.	Conducted Power (dBm)	Max. tune-up Power (dBm)	Measured SAR(10g) (W/kg)	Reported SAR(10g) (W/kg)	Measured SAR(1g) (W/kg)	Reported SAR(1g) (W/kg)	Power Drift (dB)
Ch.	MHz									
1412	1732.4	Front	/	20.32	21.50	0.293	0.38	0.549	0.72	0.01
1412	1732.4	Rear	/	20.32	21.50	0.268	0.35	0.485	0.64	-0.14
1412	1732.4	Left	/	20.32	21.50	0.045	0.06	0.077	0.10	-0.07
1412	1732.4	Right	/	20.32	21.50	0.046	0.06	0.074	0.10	-0.13
1513	1752.6	Bottom	Fig.11	20.19	21.50	0.416	0.56	0.816	1.10	0.15
1412	1732.4	Bottom	/	20.32	21.50	0.417	0.55	0.821	1.08	-0.09
1312	1712.4	Bottom	/	20.31	21.50	0.383	0.50	0.751	0.99	0.08

Note1: The distance between the EUT and the phantom bottom is 10mm

Table 14.1-12: SAR Values (WCDMA 850 MHz Band - Head)

Ambient Temperature: 22.9 °C						Liquid Temperature: 22.5 °C					
Frequency		Side	Test Position	Figure No.	Conducted Power (dBm)	Max. tune-up Power (dBm)	Measured SAR(10g) (W/kg)	Reported SAR(10g) (W/kg)	Measured SAR(1g) (W/kg)	Reported SAR(1g) (W/kg)	Power Drift (dB)
Ch.	MHz										
4233	846.6	Left	Cheek	/	23.35	24	0.405	0.47	0.554	0.64	-0.07
4183	836.6	Left	Cheek	/	23.36	24	0.418	0.48	0.603	0.70	-0.02
4132	826.4	Left	Cheek	Fig.12	23.29	24	0.481	0.57	0.651	0.77	0.01
4183	836.6	Left	Tilt	/	23.36	24	0.287	0.33	0.472	0.55	-0.11
4233	846.6	Right	Cheek	/	23.35	24	0.301	0.35	0.433	0.50	0.00
4183	836.6	Right	Cheek	/	23.36	24	0.449	0.52	0.624	0.72	-0.07
4132	826.4	Right	Cheek	/	23.29	24	0.331	0.39	0.481	0.57	-0.06
4183	836.6	Right	Tilt	/	23.36	24	0.299	0.35	0.444	0.51	-0.10

Table 14.1-13: SAR Values (WCDMA 850 MHz Band - Body)

Ambient Temperature: 22.9 °C						Liquid Temperature: 22.5 °C				
Frequency		Test Position	Figure No.	Conducted Power (dBm)	Max. tune-up Power (dBm)	Measured SAR(10g) (W/kg)	Reported SAR(10g) (W/kg)	Measured SAR(1g) (W/kg)	Reported SAR(1g) (W/kg)	Power Drift (dB)
Ch.	MHz									
4183	836.6	Front	/	23.36	24	0.171	0.20	0.291	0.34	0.10
4233	846.6	Rear	/	23.35	24	0.201	0.23	0.322	0.37	0.05
4183	836.6	Rear	/	23.36	24	0.207	0.24	0.351	0.41	-0.11
4132	826.4	Rear	Fig.13	23.29	24	0.239	0.28	0.379	0.45	-0.12
4183	836.6	Left	/	23.36	24	0.101	0.12	0.185	0.21	0.08
4183	836.6	Right	/	23.36	24	0.175	0.20	0.324	0.38	0.08
4183	836.6	Top	/	23.36	24	0.229	0.27	0.360	0.42	0.11

Note: The distance between the EUT and the phantom bottom is 10mm.

Table 14.1-14: SAR Values (LTE Band2 - Head)

Ambient Temperature: 22.9 °C						Liquid Temperature: 22.5 °C						
Frequency		Mode	Side	Test Position	Figure No.	Conducted Power (dBm)	Max. tune-up Power (dBm)	Measured SAR(10g) (W/kg)	Reported SAR(10g) (W/kg)	Measured SAR(1g) (W/kg)	Reported SAR(1g) (W/kg)	Power Drift (dB)
Ch.	MHz											
18700	1860	1RB_Mid	Left	Cheek	Fig.14	22.59	24	0.086	0.12	0.140	0.19	0.04
18700	1860	1RB_Mid	Left	Tilt	/	22.59	24	0.068	0.09	0.114	0.16	0.02
18700	1860	1RB_Mid	Right	Cheek	/	22.59	24	0.079	0.11	0.126	0.17	0.08
18700	1860	1RB_Mid	Right	Tilt	/	22.59	24	0.071	0.10	0.119	0.16	0.15
18700	1860	50RB_Mid	Left	Cheek	/	21.57	23	0.066	0.09	0.108	0.15	0.09
18700	1860	50RB_Mid	Left	Tilt	/	21.57	23	0.054	0.08	0.090	0.13	0.01
18700	1860	50RB_Mid	Right	Cheek	/	21.57	23	0.061	0.08	0.097	0.13	0.07
18700	1860	50RB_Mid	Right	Tilt	/	21.57	23	0.055	0.08	0.092	0.13	-0.15

Note1: The LTE mode is QPSK_20MHz.

Table 14.1-15: SAR Values (LTE Band2 - Body)

Ambient Temperature: 22.9 °C						Liquid Temperature: 22.5 °C					
Frequency		Mode	Test Position	Figure No.	Conduct ed Power (dBm)	Max. tune-up Power (dBm)	Measured SAR(10g) (W/kg)	Reported SAR(10g) (W/kg)	Measured SAR(1g) (W/kg)	Reported SAR(1g) (W/kg)	Power Drift (dB)
Ch.	MHz										
18700	1860	1RB_Mid	Front	/	22.59	24	0.282	0.39	0.515	0.71	0.12
18700	1860	1RB_Mid	Rear	Fig.15	22.59	24	0.332	0.46	0.575	0.79	-0.16
18700	1860	1RB_Mid	Front	/	21.57	23	0.239	0.33	0.402	0.56	-0.13
18700	1860	1RB_Mid	Rear	/	21.57	23	0.220	0.31	0.440	0.61	-0.03

Note1: The distance between the EUT and the phantom bottom is 15mm

Table 14.1-16: SAR Values (LTE Band2 - Body)

Ambient Temperature: 22.9 °C						Liquid Temperature: 22.5 °C					
Frequency		Mode	Test Position	Figure No.	Conduct ed Power (dBm)	Max. tune-up Power (dBm)	Measured SAR(10g) (W/kg)	Reported SAR(10g) (W/kg)	Measured SAR(1g) (W/kg)	Reported SAR(1g) (W/kg)	Power Drift (dB)
Ch.	MHz										
18700	1860	1RB_Mid	Front	/	19.61	20.5	0.251	0.31	0.495	0.61	0.01
18700	1860	1RB_Mid	Rear	/	19.61	20.5	0.275	0.34	0.525	0.64	-0.14
18700	1860	1RB_Mid	Left	/	19.61	20.5	0.039	0.05	0.068	0.08	-0.03
18700	1860	1RB_Mid	Right	/	19.61	20.5	0.032	0.04	0.054	0.07	0.10
19100	1900	1RB_Mid	Bottom	Fig.16	19.54	20.5	0.498	0.62	0.990	1.23	-0.04
18900	1880	1RB_Mid	Bottom	/	19.53	20.5	0.480	0.60	0.956	1.20	0.10

18700	1860	1RB_Mid	Bottom	/	19.61	20.5	0.458	0.56	0.902	1.11	-0.13
18700	1860	50RB_Mid	Front	/	19.60	20.5	0.245	0.30	0.480	0.59	0.02
18700	1860	50RB_Mid	Rear	/	19.60	20.5	0.270	0.33	0.515	0.63	-0.03
18700	1860	50RB_Mid	Left	/	19.60	20.5	0.032	0.04	0.054	0.07	-0.06
18700	1860	50RB_Mid	Right	/	19.60	20.5	0.030	0.04	0.051	0.06	-0.09
19100	1900	50RB_Mid	Bottom	/	19.40	20.5	0.485	0.62	0.950	1.22	0.11
18900	1880	50RB_Mid	Bottom	/	19.40	20.5	0.465	0.60	0.923	1.19	-0.08
18700	1860	50RB_Mid	Bottom	/	19.60	20.5	0.441	0.54	0.869	1.07	0.13
18700	1860	100RB	Bottom	/	19.59	20.5	0.470	0.58	0.936	1.15	-0.14
19100	1900	1RB_Mid	Bottom	H	19.54	20.5	0.471	0.59	0.965	1.20	0.08

Note1: The distance between the EUT and the phantom bottom is 10mm

Table 14.1-17: SAR Values (LTE Band5 - Head)

Ambient Temperature: 22.9 °C						Liquid Temperature: 22.5 °C						
Frequency		Mode	Side	Test Position	Figure No.	Conducted Power (dBm)	Max. tune-up Power (dBm)	Measured SAR(10g) (W/kg)	Reported SAR(10g) (W/kg)	Measured SAR(1g) (W/kg)	Reported SAR(1g) (W/kg)	Power Drift (dB)
Ch.	MHz											
20525	836.5	1RB_Mid	Left	Cheek	Fig.17	23.29	24	0.555	0.65	0.752	0.89	-0.15
20525	836.5	1RB_Mid	Left	Tilt	/	23.29	24	0.383	0.45	0.609	0.72	0.05
20525	836.5	1RB_Mid	Right	Cheek	/	23.29	24	0.519	0.61	0.704	0.83	-0.04
20525	836.5	1RB_Mid	Right	Tilt	/	23.29	24	0.380	0.45	0.563	0.66	-0.12
20525	836.5	25RB_Mid	Left	Cheek	/	22.19	23	0.429	0.52	0.583	0.70	-0.07
20525	836.5	25RB_Mid	Left	Tilt	/	22.19	23	0.297	0.36	0.472	0.57	0.14
20525	836.5	25RB_Mid	Right	Cheek	/	22.19	23	0.399	0.48	0.542	0.65	0.00
20525	836.5	25RB_Mid	Right	Tilt	/	22.19	23	0.294	0.35	0.437	0.53	0.13

Note1: The LTE mode is QPSK_10MHz.

Table 14.1-18: SAR Values (LTE Band5 - Body)

Ambient Temperature: 22.9 °C						Liquid Temperature: 22.5 °C					
Frequency		Mode	Test Position	Figure No.	Conducted Power (dBm)	Max. tune-up Power (dBm)	Measured SAR(10g) (W/kg)	Reported SAR(10g) (W/kg)	Measured SAR(1g) (W/kg)	Reported SAR(1g) (W/kg)	Power Drift (dB)
Ch.	MHz										
20525	836.5	1RB_Mid	Front	/	23.29	24	0.212	0.25	0.347	0.41	0.15
20525	836.5	1RB_Mid	Rear	Fig.18	23.29	24	0.220	0.26	0.360	0.42	-0.19
20525	836.5	1RB_Mid	Left	/	23.29	24	0.096	0.11	0.169	0.20	0.03
20525	836.5	1RB_Mid	Right	/	23.29	24	0.159	0.19	0.279	0.33	-0.06
20525	836.5	1RB_Mid	Top	/	23.29	24	0.213	0.26	0.349	0.42	0.10
20525	836.5	25RB_Mid	Front	/	22.19	23	0.163	0.20	0.266	0.32	-0.02
20525	836.5	25RB_Mid	Rear	/	22.19	23	0.169	0.20	0.276	0.33	-0.11
20525	836.5	25RB_Mid	Left	/	22.19	23	0.074	0.09	0.130	0.16	0.07
20525	836.5	25RB_Mid	Right	/	22.19	23	0.121	0.15	0.212	0.26	0.12

20525	836.5	25RB_Mid	Top	/	22.19	23	0.160	0.19	0.225	0.27	0.01
-------	-------	----------	-----	---	-------	----	-------	-------------	-------	-------------	------

Note1: The distance between the EUT and the phantom bottom is 10mm

Table 14.1-19: SAR Values (LTE Band7 - Head)

Ambient Temperature: 22.9 °C						Liquid Temperature: 22.5 °C						
Frequency		Mode	Side	Test Position	Figure No.	Conduct ed Power (dBm)	Max. tune-up Power (dBm)	Measured SAR(10g) (W/kg)	Reported SAR(10g) (W/kg)	Measured SAR(1g) (W/kg)	Reported SAR(1g) (W/kg)	Power Drift (dB)
Ch.	MHz											
21100	2535	1RB_Mid	Left	Cheek	/	23.16	24	0.069	0.08	0.135	0.16	0.09
21100	2535	1RB_Mid	Left	Tilt	/	23.16	24	0.073	0.09	0.137	0.17	0.06
21100	2535	1RB_Mid	Right	Cheek	Fig.19	23.16	24	0.132	0.16	0.252	0.31	0.05
21100	2535	1RB_Mid	Right	Tilt	/	23.16	24	0.102	0.12	0.210	0.25	-0.11
21100	2535	50RB_Mid	Left	Cheek	/	22.01	23	0.054	0.07	0.105	0.13	-0.08
21100	2535	50RB_Mid	Left	Tilt	/	22.01	23	0.054	0.07	0.103	0.13	-0.03
21100	2535	50RB_Mid	Right	Cheek	/	22.01	23	0.103	0.13	0.197	0.25	-0.01
21100	2535	50RB_Mid	Right	Tilt	/	22.01	23	0.078	0.10	0.161	0.20	0.06

Note1: The LTE mode is QPSK_20MHz.

Table 14.1-20: SAR Values (LTE Band7 - Body)

Ambient Temperature: 22.9 °C						Liquid Temperature: 22.5 °C					
Frequency		Mode	Test Position	Figure No.	Conducted Power (dBm)	Max. tune-up Power (dBm)	Measured SAR(10g) (W/kg)	Reported SAR(10g) (W/kg)	Measured SAR(1g) (W/kg)	Reported SAR(1g) (W/kg)	Power Drift (dB)
Ch.	MHz										
21100	2535	1RB_Mid	Front	/	23.16	24	0.265	0.32	0.531	0.64	0.14
21100	2535	1RB_Mid	Rear	Fig.20	23.16	24	0.309	0.37	0.601	0.73	0.07
21100	2535	50RB_Mid	Front	/	22.01	23	0.205	0.26	0.409	0.51	0.11
21100	2535	50RB_Mid	Rear	/	22.01	23	0.240	0.30	0.467	0.59	-0.04

Note1: The distance between the EUT and the phantom bottom is 15mm.

Note2: The LTE mode is QPSK_20MHz.

Table 14.1-21: SAR Values (LTE Band7 - Body)

Ambient Temperature: 22.9 °C						Liquid Temperature: 22.5 °C					
Frequency		Mode	Test Position	Figure No.	Conducted Power (dBm)	Max. tune-up Power (dBm)	Measured SAR(10g) (W/kg)	Reported SAR(10g) (W/kg)	Measured SAR(1g) (W/kg)	Reported SAR(1g) (W/kg)	Power Drift (dB)
Ch.	MHz										
21100	2535	1RB_Mid	Front	/	20.14	21	0.219	0.27	0.438	0.53	0.15
21100	2535	1RB_Mid	Rear	Fig.21	20.14	21	0.278	0.34	0.557	0.68	0.01
21100	2535	1RB_Mid	Left	/	20.14	21	0.065	0.08	0.127	0.15	0.08
21100	2535	1RB_Mid	Right	/	20.14	21	0.105	0.13	0.191	0.23	-0.01

21100	2535	1RB_Mid	Bottom	/	20.14	21	0.226	0.28	0.498	0.61	0.13
21100	2535	50RB_Mid	Front	/	20.02	21	0.214	0.27	0.422	0.53	-0.01
21100	2535	50RB_Mid	Rear	/	20.02	21	0.270	0.34	0.530	0.66	0.08
21100	2535	50RB_Mid	Left	/	20.02	21	0.062	0.08	0.122	0.15	0.04
21100	2535	50RB_Mid	Right	/	20.02	21	0.102	0.13	0.185	0.23	0.03
21100	2535	50RB_Mid	Bottom	/	20.02	21	0.218	0.27	0.480	0.60	-0.03

Note1: The distance between the EUT and the phantom bottom is 10mm.

Note2: The LTE mode is QPSK_20MHz.

Table 14.1-22: SAR Values (LTE Band12 - Head)

Ambient Temperature: 22.9 °C						Liquid Temperature: 22.5 °C						
Frequency		Mode	Side	Test Position	Figure No.	Conduct ed Power (dBm)	Max. tune-up Power (dBm)	Measured SAR(10g) (W/kg)	Reported SAR(10g) (W/kg)	Measured SAR(1g) (W/kg)	Reported SAR(1g) (W/kg)	Power Drift (dB)
Ch.	MHz											
23095	707.5	1RB_Mid	Left	Cheek	Fig.22	23.07	24	0.531	0.66	0.741	0.92	0.18
23095	707.5	1RB_Mid	Left	Tilt	/	23.07	24	0.440	0.55	0.681	0.84	0.14
23095	707.5	1RB_Mid	Right	Cheek	/	23.07	24	0.466	0.58	0.641	0.79	-0.05
23095	707.5	1RB_Mid	Right	Tilt	/	23.07	24	0.378	0.47	0.536	0.66	-0.04
23095	707.5	25RB_High	Left	Cheek	/	22.07	23	0.417	0.52	0.579	0.72	0.10
23095	707.5	25RB_High	Left	Tilt	/	22.07	23	0.343	0.43	0.530	0.66	-0.10
23095	707.5	25RB_High	Right	Cheek	/	22.07	23	0.372	0.46	0.511	0.63	0.04
23095	707.5	25RB_High	Right	Tilt	/	22.07	23	0.297	0.37	0.422	0.52	-0.06

Note1: The LTE mode is QPSK_10MHz.

Table 14.1-23: SAR Values (LTE Band12 - Body)

Ambient Temperature: 22.9 °C						Liquid Temperature: 22.5 °C					
Frequency		Mode	Test Position	Figure No.	Conducted Power (dBm)	Max. tune-up Power (dBm)	Measured SAR(10g) (W/kg)	Reported SAR(10g) (W/kg)	Measured SAR(1g) (W/kg)	Reported SAR(1g) (W/kg)	Power Drift (dB)
Ch.	MHz										
23095	707.5	1RB_Mid	Front	/	23.07	24	0.106	0.13	0.142	0.18	-0.13
23095	707.5	1RB_Mid	Rear	Fig.23	23.07	24	0.137	0.17	0.184	0.23	-0.09
23095	707.5	1RB_Mid	Left	/	23.07	24	0.092	0.11	0.133	0.16	-0.04
23095	707.5	1RB_Mid	Right	/	23.07	24	0.140	0.17	0.203	0.25	0.01
23095	707.5	1RB_Mid	Top	/	22.07	23	0.125	0.15	0.194	0.24	0.05
23095	707.5	25RB_High	Front	/	22.07	23	0.083	0.10	0.111	0.14	0.05
23095	707.5	25RB_High	Rear	/	22.07	23	0.108	0.13	0.147	0.18	0.05
23095	707.5	25RB_High	Left	/	22.07	23	0.074	0.09	0.107	0.13	0.12
23095	707.5	25RB_High	Right	/	22.07	23	0.110	0.14	0.160	0.20	-0.10
23095	707.5	25RB_High	Top	/	22.07	23	0.101	0.13	0.155	0.19	0.02

Note1: The distance between the EUT and the phantom bottom is 10mm.

Note2: The LTE mode is QPSK_20MHz.

Table 14.1-24: SAR Values (LTE Band13 - Head)

Frequency		Mode	Side	Test Position	Figure No.	Conduct ed Power (dBm)	Max. tune-up Power (dBm)	Measured SAR(10g) (W/kg)	Reported SAR(10g) (W/kg)	Measured SAR(1g) (W/kg)	Reported SAR(1g) (W/kg)	Power Drift (dB)
Ch.	MHz											
Ambient Temperature: 22.9 °C						Liquid Temperature: 22.5 °C						
23230	782	1RB_Mid	Left	Cheek	Fig.24	22.62	24	0.233	0.32	0.294	0.40	0.15
23230	782	1RB_Mid	Left	Tilt	/	22.62	24	0.174	0.24	0.218	0.30	0.13
23230	782	1RB_Mid	Right	Cheek	/	22.62	24	0.256	0.35	0.339	0.47	-0.04
23230	782	1RB_Mid	Right	Tilt	/	22.62	24	0.181	0.25	0.228	0.31	-0.05
23230	782	25RB_Mid	Left	Cheek	/	21.50	23	0.175	0.25	0.222	0.31	0.02
23230	782	25RB_Mid	Left	Tilt	/	21.50	23	0.133	0.19	0.168	0.24	-0.07
23230	782	25RB_Mid	Right	Cheek	/	21.50	23	0.194	0.27	0.257	0.36	0.12
23230	782	25RB_Mid	Right	Tilt	/	21.50	23	0.138	0.19	0.174	0.25	-0.05

Note1: The LTE mode is QPSK_10MHz.

Table 14.1-25: SAR Values (LTE Band13 - Body)

Frequency		Mode	Test Position	Figure No.	Conducted Power (dBm)	Max. tune-up Power (dBm)	Measured SAR(10g) (W/kg)	Reported SAR(10g) (W/kg)	Measured SAR(1g) (W/kg)	Reported SAR(1g) (W/kg)	Power Drift (dB)	
Ch.	MHz											
Ambient Temperature: 22.9 °C						Liquid Temperature: 22.5 °C						
23230	782	1RB_Mid	Front	/	22.62	24	0.243	0.33	0.327	0.45	0.12	
23230	782	1RB_Mid	Rear	Fig.25	22.62	24	0.225	0.31	0.406	0.56	0.02	
23230	782	1RB_Mid	Left	/	22.62	24	0.174	0.24	0.261	0.36	0.03	
23230	782	1RB_Mid	Right	/	22.62	24	0.225	0.31	0.335	0.46	-0.15	
23230	782	1RB_Mid	Bottom	/	22.62	24	0.128	0.18	0.245	0.34	-0.14	
23230	782	25RB_Mid	Front	/	21.50	23	0.183	0.26	0.248	0.35	0.14	
23230	782	25RB_Mid	Rear	/	21.50	23	0.169	0.24	0.306	0.43	0.09	
23230	782	25RB_Mid	Left	/	21.50	23	0.134	0.19	0.200	0.28	-0.07	
23230	782	25RB_Mid	Right	/	21.50	23	0.169	0.24	0.253	0.36	-0.05	
23230	782	25RB_Mid	Bottom	/	21.50	23	0.097	0.14	0.186	0.26	-0.12	

Note1: The distance between the EUT and the phantom bottom is 10mm.

Note2: The LTE mode is QPSK_10MHz.

Table 14.1-26: SAR Values (LTE Band66 - Head)

Ambient Temperature: 22.9 °C						Liquid Temperature: 22.5 °C						
Frequency		Mode	Side	Test Position	Figure No.	Conducted Power (dBm)	Max. tune-up Power (dBm)	Measured SAR(10g) (W/kg)	Reported SAR(10g) (W/kg)	Measured SAR(1g) (W/kg)	Reported SAR(1g) (W/kg)	Power Drift (dB)
Ch.	MHz											
132572	1770	1RB_Mid	Left	Cheek	/	23.32	24	0.174	0.20	0.255	0.30	-0.01
132572	1770	1RB_Mid	Left	Tilt	/	23.32	24	0.112	0.13	0.179	0.21	0.14
132572	1770	1RB_Mid	Right	Cheek	Fig.26	23.32	24	0.179	0.21	0.289	0.34	0.18
132572	1770	1RB_Mid	Right	Tilt	/	23.32	24	0.126	0.15	0.206	0.24	-0.08
132572	1770	50RB_Mid	Left	Cheek	/	22.23	23	0.138	0.16	0.222	0.27	0.06
132572	1770	50RB_Mid	Left	Tilt	/	22.23	23	0.087	0.10	0.140	0.17	0.05
132572	1770	50RB_Mid	Right	Cheek	/	22.23	23	0.138	0.16	0.223	0.27	-0.01
132572	1770	50RB_Mid	Right	Tilt	/	22.23	23	0.098	0.12	0.160	0.19	-0.15

Note1: The LTE mode is QPSK_10MHz.

Table 14.1-27: SAR Values (LTE Band66 - Body)

Ambient Temperature: 22.9 °C						Liquid Temperature: 22.5 °C					
Frequency		Mode	Test Position	Figure No.	Conducted Power (dBm)	Max. tune-up Power (dBm)	Measured SAR(10g) (W/kg)	Reported SAR(10g) (W/kg)	Measured SAR(1g) (W/kg)	Reported SAR(1g) (W/kg)	Power Drift (dB)
Ch.	MHz										
132572	1770	1RB_Mid	Front	Fig.27	23.32	24	0.342	0.40	0.592	0.69	-0.09
132572	1770	1RB_Mid	Rear	/	23.32	24	0.348	0.41	0.580	0.68	-0.15
132572	1770	1RB_Mid	Front	/	22.23	23	0.266	0.32	0.459	0.55	-0.02
132572	1770	1RB_Mid	Rear	/	22.23	23	0.271	0.32	0.452	0.54	-0.15

Note1: The distance between the EUT and the phantom bottom is 15mm.

Note2: The LTE mode is QPSK_10MHz.

Table 14.1-28: SAR Values (LTE Band66 - Body)

Ambient Temperature: 22.9 °C						Liquid Temperature: 22.5 °C					
Frequency		Mode	Test Position	Figure No.	Conducted Power (dBm)	Max. tune-up Power (dBm)	Measured SAR(10g) (W/kg)	Reported SAR(10g) (W/kg)	Measured SAR(1g) (W/kg)	Reported SAR(1g) (W/kg)	Power Drift (dB)
Ch.	MHz										
132572	1770	1RB_Mid	Front	/	20.44	20.8	0.422	0.46	0.652	0.71	-0.04
132572	1770	1RB_Mid	Rear	/	20.44	20.8	0.340	0.37	0.617	0.67	-0.06
132572	1770	1RB_Mid	Left	/	20.44	20.8	0.046	0.05	0.079	0.09	-0.02

132572	1770	1RB_Mid	Right	/	20.44	20.8	0.051	0.05	0.084	0.09	-0.02
132572	1770	1RB_Mid	Bottom	/	20.44	20.8	0.521	0.57	1.015	1.10	-0.02
132322	1745	1RB_Mid	Bottom	Fig.28	20.14	20.8	0.542	0.63	1.050	1.22	-0.06
132072	1720	1RB_Mid	Bottom	/	19.98	20.8	0.511	0.62	0.976	1.18	-0.04
132572	1770	25RB_Mid	Front	/	20.31	20.8	0.339	0.38	0.632	0.71	-0.01
132572	1770	25RB_Mid	Rear	/	20.31	20.8	0.332	0.37	0.606	0.68	0.05
132572	1770	25RB_Mid	Left	/	20.31	20.8	0.046	0.05	0.079	0.09	0.01
132572	1770	25RB_Mid	Right	/	20.31	20.8	0.051	0.06	0.084	0.09	-0.04
132572	1770	25RB_Mid	Bottom	/	20.31	20.8	0.506	0.57	0.984	1.10	0.03
132322	1745	25RB_Mid	Bottom	/	19.99	20.8	0.522	0.63	1.001	1.21	-0.05
132072	1720	25RB_Mid	Bottom	/	19.80	20.8	0.502	0.63	0.960	1.21	-0.13
132572	1770	100RB	Bottom	/	20.31	20.8	0.497	0.56	0.960	1.07	-0.06
132322	1745	1RB_Mid	Bottom	H	20.14	20.8	0.528	0.62	0.990	1.15	0.07

Note1: The distance between the EUT and the phantom bottom is 10mm.

Note2: The LTE mode is QPSK_20MHz.

Table 14.1-29: SAR Values (LTE Band71 - Head)

Ambient Temperature: 22.9 °C						Liquid Temperature: 22.5°C						
Frequency		Mode	Side	Test Position	Figure No.	Conduct ed Power (dBm)	Max. tune-up Power (dBm)	Measured SAR(10g) (W/kg)	Reported SAR(10g) (W/kg)	Measured SAR(1g) (W/kg)	Reported SAR(1g) (W/kg)	Power Drift (dB)
Ch.	MHz											
133222	673	1RB-Low	Left	Cheek	Fig.29	23.46	24	0.390	0.44	0.556	0.63	-0.04
133222	673	1RB-Low	Left	Tilt	/	23.46	24	0.328	0.37	0.517	0.59	-0.01
133222	673	1RB-Low	Right	Cheek	/	23.46	24	0.341	0.39	0.487	0.55	-0.07
133222	673	1RB-Low	Right	Tilt	/	23.46	24	0.279	0.32	0.415	0.47	-0.05
133222	673	50RB-Low	Left	Cheek	/	22.43	23	0.308	0.35	0.437	0.50	0.10
133222	673	50RB-Low	Left	Tilt	/	22.43	23	0.260	0.30	0.411	0.47	0.09
133222	673	50RB-Low	Right	Cheek	/	22.43	23	0.275	0.31	0.392	0.45	0.08
133222	673	50RB-Low	Right	Tilt	/	22.43	23	0.222	0.25	0.334	0.38	0.12

Note1: The LTE mode is QPSK_20MHz.

Table 14.1-30: SAR Values (LTE Band71 - Body)

Ambient Temperature: 22.9 °C						Liquid Temperature: 22.5°C					
Frequency		Mode	Test Position	Figure No.	Conducted Power (dBm)	Max. tune-up Power (dBm)	Measured SAR(10g) (W/kg)	Reported SAR(10g) (W/kg)	Measured SAR(1g) (W/kg)	Reported SAR(1g) (W/kg)	Power Drift (dB)
Ch.	MHz										
133222	673	1RB_Low	Front	/	23.46	24	0.131	0.15	0.171	0.19	0.03
133222	673	1RB_Low	Rear	Fig.30	23.46	24	0.177	0.20	0.234	0.27	-0.13
133222	673	1RB_Low	Left	/	23.46	24	0.118	0.13	0.168	0.19	0.08
133222	673	1RB_Low	Right	/	23.46	24	0.180	0.20	0.257	0.29	-0.03

133222	673	1RB_Low	Bottom	/	23.46	24	<0.01	<0.01	<0.01	<0.01	/
133222	673	50RB_Low	Front	/	22.43	23	0.100	0.11	0.131	0.15	-0.14
133222	673	50RB_Low	Rear	/	22.43	23	0.130	0.15	0.173	0.20	0.09
133222	673	50RB_Low	Left	/	22.43	23	0.090	0.10	0.129	0.15	-0.08
133222	673	50RB_Low	Right	/	22.43	23	0.138	0.16	0.197	0.22	-0.03
133222	673	50RB_Low	Top	/	22.43	23	0.141	0.16	0.239	0.27	0.05

Note1: The distance between the EUT and the phantom bottom is 10mm.

Note2: The LTE mode is QPSK_20MHz.

14.2 SAR results for Standard procedure

There is zoom scan measurement to be added for the highest measured SAR in each exposure configuration/band.

Table 14.2-1: SAR Values (GSM 850 MHz Band - Head)

Ambient Temperature: 22.9 °C						Liquid Temperature: 22.5 °C					
Frequency		Side	Test Position	Figure No.	Conducted Power (dBm)	Max. tune-up Power (dBm)	Measured SAR(10g) (W/kg)	Reported SAR(10g) (W/kg)	Measured SAR(1g) (W/kg)	Reported SAR(1g) (W/kg)	Power Drift (dB)
Ch.	MHz										
128	824.2	Right	Cheek	Fig.1	31.57	33.3	0.213	0.32	0.288	0.43	0.10

Table 14.2-2: SAR Values (GSM 850 MHz Band - Body)

Ambient Temperature: 22.9 °C						Liquid Temperature: 22.5 °C					
Frequency		Mode (number of timeslots)	Test Position	Figure No.	Conducted Power (dBm)	Max. tune-up Power (dBm)	Measured SAR(10g) (W/kg)	Reported SAR(10g) (W/kg)	Measured SAR(1g) (W/kg)	Reported SAR(1g) (W/kg)	Power Drift (dB)
Ch.	MHz										
190	836.6	GPRS (2)	Rear	Fig.2	29.61	30.50	0.296	0.36	0.532	0.65	-0.02

Note: The distance between the EUT and the phantom bottom is 10mm.

Table 14.2-3: SAR Values (GSM 1900 MHz Band - Head)

Ambient Temperature: 22.9 °C						Liquid Temperature: 22.5 °C					
Frequency		Side	Test Position	Figure No.	Conducted Power (dBm)	Max. tune-up Power (dBm)	Measured SAR(10g) (W/kg)	Reported SAR(10g) (W/kg)	Measured SAR(1g) (W/kg)	Reported SAR(1g) (W/kg)	Power Drift (dB)
Ch.	MHz										
512	1850.2	Left	Cheek	Fig.3	29.67	30.3	0.061	0.07	0.100	0.12	-0.06

Table 14.2-4: SAR Values (GSM 1900 MHz Band - Body)

Ambient Temperature: 22.9 °C						Liquid Temperature: 22.5 °C					
Frequency		Mode (number of timeslots)	Test Position	Figure No.	Conducted Power (dBm)	Max. tune-up Power (dBm)	Measured SAR(10g) (W/kg)	Reported SAR(10g) (W/kg)	Measured SAR(1g) (W/kg)	Reported SAR(1g) (W/kg)	Power Drift (dB)
Ch.	MHz										
512	1850.2	GPRS (2)	Rear	Fig.4	27.96	28.50	0.324	0.37	0.559	0.63	-0.15

Note1: The distance between the EUT and the phantom bottom is 15mm

Table 14.2-5: SAR Values (GSM 1900 MHz Band - Body)

Ambient Temperature: 22.9 °C						Liquid Temperature: 22.5 °C					
Frequency		Mode (number of timeslots)	Test Position	Figure No.	Conducted Power (dBm)	Max. tune-up Power (dBm)	Measured SAR(10g) (W/kg)	Reported SAR(10g) (W/kg)	Measured SAR(1g) (W/kg)	Reported SAR(1g) (W/kg)	Power Drift (dB)
Ch.	MHz										

512	1850.2	GPRS (3)	Bottom	Fig.4	23.28	24.30	0.581	0.73	1.100	1.39	-0.06
-----	--------	----------	--------	-------	-------	-------	-------	------	-------	------	-------

Note1: The distance between the EUT and the phantom bottom is 10mm

Table 14.2-6: SAR Values (WCDMA 1900 MHz Band - Head)

Frequency		Side	Test Position	Figure No.	Conducted Power (dBm)	Max. tune-up Power (dBm)	Measured SAR(10g) (W/kg)	Reported SAR(10g) (W/kg)	Measured SAR(1g) (W/kg)	Reported SAR(1g) (W/kg)	Power Drift (dB)
Ch.	MHz										
1412	1732.4	Left	Cheek	Fig.6	22.87	24	0.064	0.08	0.106	0.14	0.04

Table 14.2-7: SAR Values (WCDMA 1900 MHz Band - Body)

Frequency		Test Position	Figure No.	Conducted Power (dBm)	Max. tune-up Power (dBm)	Measured SAR(10g) (W/kg)	Reported SAR(10g) (W/kg)	Measured SAR(1g) (W/kg)	Reported SAR(1g) (W/kg)	Power Drift (dB)
Ch.	MHz									
9262	1852.4	Rear	Fig.7	22.87	24	0.422	0.55	0.741	0.96	0.12

Note1: The distance between the EUT and the phantom bottom is 15mm

Table 14.2-8: SAR Values (WCDMA 1900 MHz Band - Body)

Frequency		Test Position	Figure No.	Conducted Power (dBm)	Max. tune-up Power (dBm)	Measured SAR(10g) (W/kg)	Reported SAR(10g) (W/kg)	Measured SAR(1g) (W/kg)	Reported SAR(1g) (W/kg)	Power Drift (dB)
Ch.	MHz									
9262	1852.4	Bottom	Fig.8	19.83	20.5	0.581	0.68	1.150	1.34	-0.09

Note1: The distance between the EUT and the phantom bottom is 10mm

Table 14.2-9: SAR Values (WCDMA 1700 MHz Band - Head)

Frequency		Side	Test Position	Figure No.	Conducted Power (dBm)	Max. tune-up Power (dBm)	Measured SAR(10g) (W/kg)	Reported SAR(10g) (W/kg)	Measured SAR(1g) (W/kg)	Reported SAR(1g) (W/kg)	Power Drift (dB)
Ch.	MHz										
1312	1712.4	Right	Cheek	Fig.9	23.36	24	0.293	0.34	0.468	0.54	-0.01

Table 14.2-10: SAR Values (WCDMA 1700 MHz Band - Body)

Frequency		Test Position	Figure No.	Conducted Power (dBm)	Max. tune-up Power (dBm)	Measured SAR(10g) (W/kg)	Reported SAR(10g) (W/kg)	Measured SAR(1g) (W/kg)	Reported SAR(1g) (W/kg)	Power Drift (dB)
Ch.	MHz									
1412	1732.4	Rear	Fig.10	23.30	24	0.443	0.52	0.763	0.90	-0.01

Note1: The distance between the EUT and the phantom bottom is 15mm

Table 14.2-11: SAR Values (WCDMA 1700 MHz Band - Body)

Ambient Temperature: 22.9 °C						Liquid Temperature: 22.5 °C				
Frequency		Test Position	Figure No.	Conducted Power (dBm)	Max. tune-up Power (dBm)	Measured SAR(10g) (W/kg)	Reported SAR(10g) (W/kg)	Measured SAR(1g) (W/kg)	Reported SAR(1g) (W/kg)	Power Drift (dB)
Ch.	MHz									
1513	1752.6	Bottom	Fig.11	20.19	21.50	0.416	0.56	0.816	1.10	0.15

Note1: The distance between the EUT and the phantom bottom is 10mm

Table 14.2-12: SAR Values (WCDMA 850 MHz Band - Head)

Ambient Temperature: 22.9 °C						Liquid Temperature: 22.5 °C					
Frequency		Side	Test Position	Figure No.	Conducted Power (dBm)	Max. tune-up Power (dBm)	Measured SAR(10g) (W/kg)	Reported SAR(10g) (W/kg)	Measured SAR(1g) (W/kg)	Reported SAR(1g) (W/kg)	Power Drift (dB)
Ch.	MHz										
4132	826.4	Left	Cheek	Fig.12	23.29	24	0.481	0.57	0.651	0.77	0.01

Table 14.2-13: SAR Values (WCDMA 850 MHz Band - Body)

Ambient Temperature: 22.9 °C						Liquid Temperature: 22.5 °C				
Frequency		Test Position	Figure No.	Conducted Power (dBm)	Max. tune-up Power (dBm)	Measured SAR(10g) (W/kg)	Reported SAR(10g) (W/kg)	Measured SAR(1g) (W/kg)	Reported SAR(1g) (W/kg)	Power Drift (dB)
Ch.	MHz									
4132	826.4	Rear	Fig.13	23.29	24	0.239	0.28	0.379	0.45	-0.12

Note: The distance between the EUT and the phantom bottom is 10mm.

Table 14.2-14: SAR Values (LTE Band2 - Head)

Ambient Temperature: 22.9 °C						Liquid Temperature: 22.5 °C						
Frequency		Mode	Side	Test Position	Figure No.	Conducted Power (dBm)	Max. tune-up Power (dBm)	Measured SAR(10g) (W/kg)	Reported SAR(10g) (W/kg)	Measured SAR(1g) (W/kg)	Reported SAR(1g) (W/kg)	Power Drift (dB)
Ch.	MHz											
18700	1860	1RB_Mid	Left	Cheek	Fig.14	22.59	24	0.086	0.12	0.140	0.19	0.04

Note1: The LTE mode is QPSK_20MHz.

Table 14.2-15: SAR Values (LTE Band2 - Body)

Ambient Temperature: 22.9 °C						Liquid Temperature: 22.5 °C					
Frequency		Mode	Test Position	Figure No.	Conducted Power (dBm)	Max. tune-up Power (dBm)	Measured SAR(10g) (W/kg)	Reported SAR(10g) (W/kg)	Measured SAR(1g) (W/kg)	Reported SAR(1g) (W/kg)	Power Drift (dB)
Ch.	MHz										
18700	1860	1RB_Mid	Rear	Fig.15	22.59	24	0.332	0.46	0.575	0.79	-0.16

Note1: The distance between the EUT and the phantom bottom is 15mm

Table 14.2-16: SAR Values (LTE Band2 - Body)

Frequency		Mode	Test Position	Figure No.	Conduct ed Power (dBm)	Max. tune-up Power (dBm)	Measured SAR(10g) (W/kg)	Reported SAR(10g) (W/kg)	Measured SAR(1g) (W/kg)	Reported SAR(1g) (W/kg)	Power Drift (dB)
Ch.	MHz										
19100	1900	1RB_Mid	Bottom	Fig.16	19.54	20.5	0.498	0.62	0.990	1.23	-0.04

Note1: The distance between the EUT and the phantom bottom is 10mm

Table 14.2-17: SAR Values (LTE Band5 - Head)

Frequency		Mode	Side	Test Position	Figure No.	Conducted Power (dBm)	Max. tune-up Power (dBm)	Measured SAR(10g) (W/kg)	Reported SAR(10g) (W/kg)	Measured SAR(1g) (W/kg)	Reported SAR(1g) (W/kg)	Power Drift (dB)
Ch.	MHz											
20525	836.5	1RB_Mid	Left	Cheek	Fig.17	23.29	24	0.555	0.65	0.752	0.89	-0.15

Note1: The LTE mode is QPSK_10MHz.

Table 14.2-18: SAR Values (LTE Band5 - Body)

Frequency		Mode	Test Position	Figure No.	Conduct ed Power (dBm)	Max. tune-up Power (dBm)	Measured SAR(10g) (W/kg)	Reported SAR(10g) (W/kg)	Measured SAR(1g) (W/kg)	Reported SAR(1g) (W/kg)	Power Drift (dB)
Ch.	MHz										
20525	836.5	1RB_Mid	Rear	Fig.18	23.29	24	0.220	0.26	0.360	0.42	-0.19

Note1: The distance between the EUT and the phantom bottom is 10mm

Table 14.2-19: SAR Values (LTE Band7 - Head)

Frequency		Mode	Side	Test Position	Figure No.	Conduct ed Power (dBm)	Max. tune-up Power (dBm)	Measured SAR(10g) (W/kg)	Reported SAR(10g) (W/kg)	Measured SAR(1g) (W/kg)	Reported SAR(1g) (W/kg)	Power Drift (dB)
Ch.	MHz											
21100	2535	1RB_Mid	Right	Cheek	Fig.19	23.16	24	0.132	0.16	0.252	0.31	0.05

Note1: The LTE mode is QPSK_20MHz.

Table 14.2-20: SAR Values (LTE Band7 - Body)

Ambient Temperature: 22.9 °C						Liquid Temperature: 22.5 °C					
Frequency		Mode	Test Position	Figure No.	Conducted Power (dBm)	Max. tune-up Power (dBm)	Measured SAR(10g) (W/kg)	Reported SAR(10g) (W/kg)	Measured SAR(1g) (W/kg)	Reported SAR(1g) (W/kg)	Power Drift (dB)
Ch.	MHz										
21100	2535	1RB_Mid	Rear	Fig.20	23.16	24	0.309	0.37	0.601	0.73	0.07

Note1: The distance between the EUT and the phantom bottom is 15mm.

Note2: The LTE mode is QPSK_20MHz.

Table 14.2-21: SAR Values (LTE Band7 - Body)

Ambient Temperature: 22.9 °C						Liquid Temperature: 22.5 °C					
Frequency		Mode	Test Position	Figure No.	Conducted Power (dBm)	Max. tune-up Power (dBm)	Measured SAR(10g) (W/kg)	Reported SAR(10g) (W/kg)	Measured SAR(1g) (W/kg)	Reported SAR(1g) (W/kg)	Power Drift (dB)
Ch.	MHz										
21100	2535	1RB_Mid	Rear	Fig.21	20.14	21	0.278	0.34	0.557	0.68	0.01

Note1: The distance between the EUT and the phantom bottom is 10mm.

Note2: The LTE mode is QPSK_20MHz.

Table 14.2-22: SAR Values (LTE Band12 - Head)

Ambient Temperature: 22.9 °C						Liquid Temperature: 22.5 °C						
Frequency		Mode	Side	Test Position	Figure No.	Conduct ed Power (dBm)	Max. tune-up Power (dBm)	Measured SAR(10g) (W/kg)	Reported SAR(10g) (W/kg)	Measured SAR(1g) (W/kg)	Reported SAR(1g) (W/kg)	Power Drift (dB)
Ch.	MHz											
23095	707.5	1RB_Mid	Left	Cheek	Fig.22	23.07	24	0.531	0.66	0.741	0.92	0.18

Note1: The LTE mode is QPSK_10MHz.

Table 14.2-23: SAR Values (LTE Band12 - Body)

Ambient Temperature: 22.9 °C						Liquid Temperature: 22.5 °C					
Frequency		Mode	Test Position	Figure No.	Conducted Power (dBm)	Max. tune-up Power (dBm)	Measured SAR(10g) (W/kg)	Reported SAR(10g) (W/kg)	Measured SAR(1g) (W/kg)	Reported SAR(1g) (W/kg)	Power Drift (dB)
Ch.	MHz										
23095	707.5	1RB_Mid	Rear	Fig.23	23.07	24	0.140	0.17	0.203	0.25	0.01

Note1: The distance between the EUT and the phantom bottom is 10mm.

Note2: The LTE mode is QPSK_20MHz.

Table 14.2-24: SAR Values (LTE Band13 - Head)

Ambient Temperature: 22.9 °C						Liquid Temperature: 22.5°C						
Frequency		Mode	Side	Test Position	Figure No.	Conducted Power (dBm)	Max. tune-up Power (dBm)	Measured SAR(10g) (W/kg)	Reported SAR(10g) (W/kg)	Measured SAR(1g) (W/kg)	Reported SAR(1g) (W/kg)	Power Drift (dB)
Ch.	MHz											
23230	782	1RB_Mid	Left	Cheek	Fig.24	22.62	24	0.256	0.35	0.339	0.47	-0.04

Note1: The LTE mode is QPSK_10MHz.

Table 14.2-25: SAR Values (LTE Band13 - Body)

Ambient Temperature: 22.9 °C						Liquid Temperature: 22.5°C					
Frequency		Mode	Test Position	Figure No.	Conducted Power (dBm)	Max. tune-up Power (dBm)	Measured SAR(10g) (W/kg)	Reported SAR(10g) (W/kg)	Measured SAR(1g) (W/kg)	Reported SAR(1g) (W/kg)	Power Drift (dB)
Ch.	MHz										
23230	782	1RB_Mid	Rear	Fig.25	22.62	24	0.225	0.31	0.406	0.56	0.02

Note1: The distance between the EUT and the phantom bottom is 10mm.

Note2: The LTE mode is QPSK_10MHz.

Table 14.2-26: SAR Values (LTE Band66 - Head)

Ambient Temperature: 22.9 °C						Liquid Temperature: 22.5°C						
Frequency		Mode	Side	Test Position	Figure No.	Conducted Power (dBm)	Max. tune-up Power (dBm)	Measured SAR(10g) (W/kg)	Reported SAR(10g) (W/kg)	Measured SAR(1g) (W/kg)	Reported SAR(1g) (W/kg)	Power Drift (dB)
Ch.	MHz											
132572	1770	1RB_Mid	Right	Cheek	Fig.26	23.32	24	0.179	0.21	0.289	0.34	0.18

Note1: The LTE mode is QPSK_10MHz.

Table 14.2-27: SAR Values (LTE Band66 - Body)

Ambient Temperature: 22.9 °C						Liquid Temperature: 22.5°C					
Frequency		Mode	Test Position	Figure No.	Conducted Power (dBm)	Max. tune-up Power (dBm)	Measured SAR(10g) (W/kg)	Reported SAR(10g) (W/kg)	Measured SAR(1g) (W/kg)	Reported SAR(1g) (W/kg)	Power Drift (dB)
Ch.	MHz										
132572	1770	1RB_Mid	Front	Fig.27	23.32	24	0.342	0.40	0.592	0.69	-0.09

Note1: The distance between the EUT and the phantom bottom is 15mm.

Note2: The LTE mode is QPSK_10MHz.

Table 14.2-28: SAR Values (LTE Band66 - Body)

Ambient Temperature: 22.9 °C						Liquid Temperature: 22.5 °C					
Frequency		Mode	Test Position	Figure No.	Conducted Power (dBm)	Max. tune-up Power (dBm)	Measured SAR(10g) (W/kg)	Reported SAR(10g) (W/kg)	Measured SAR(1g) (W/kg)	Reported SAR(1g) (W/kg)	Power Drift (dB)
Ch.	MHz										
132322	1745	1RB_Mid	Bottom	Fig.28	20.14	20.8	0.542	0.63	1.050	1.22	-0.06

Note1: The distance between the EUT and the phantom bottom is 10mm.

Note2: The LTE mode is QPSK_20MHz.

Table 14.2-29: SAR Values (LTE Band71 - Head)

Ambient Temperature: 22.9 °C						Liquid Temperature: 22.5 °C						
Frequency		Mode	Side	Test Position	Figure No.	Conducted Power (dBm)	Max. tune-up Power (dBm)	Measured SAR(10g) (W/kg)	Reported SAR(10g) (W/kg)	Measured SAR(1g) (W/kg)	Reported SAR(1g) (W/kg)	Power Drift (dB)
Ch.	MHz											
133222	673	1RB-Low	Left	Cheek	Fig.29	23.46	24	0.390	0.44	0.556	0.63	-0.04

Note1: The LTE mode is QPSK_20MHz.

Table 14.2-30: SAR Values (LTE Band71 - Body)

Ambient Temperature: 22.9 °C						Liquid Temperature: 22.5 °C					
Frequency		Mode	Test Position	Figure No.	Conducted Power (dBm)	Max. tune-up Power (dBm)	Measured SAR(10g) (W/kg)	Reported SAR(10g) (W/kg)	Measured SAR(1g) (W/kg)	Reported SAR(1g) (W/kg)	Power Drift (dB)
Ch.	MHz										
133222	673	1RB_Low	Rear	Fig.30	23.46	24	0.180	0.20	0.257	0.29	-0.03

Note1: The distance between the EUT and the phantom bottom is 10mm.

Note2: The LTE mode is QPSK_20MHz.

14.3 WLAN Evaluation for 2.4G

According to the KDB248227 D01, SAR is measured for 2.4GHz 802.11b DSSS using the initial test position procedure.

Head Evaluation

Table 14.3-1: SAR Values (WLAN - Head)– 802.11b (Fast SAR)

Ambient Temperature: 22.9 °C						Liquid Temperature: 22.5 °C					
Frequency		Side	Test Position	Figure No.	Conducted Power (dBm)	Max. tune-up Power (dBm)	Measured SAR(10g) (W/kg)	Reported SAR(10g) (W/kg)	Measured SAR(1g) (W/kg)	Reported SAR(1g)(W/kg)	Power Drift (dB)
MHz	Ch.										
2412	1	Left	Cheek	/	16.50	18	0.069	0.10	0.128	0.18	0.08
2412	1	Left	Tilt	/	16.50	18	0.062	0.09	0.148	0.21	0.03
2412	1	Right	Cheek	/	16.50	18	0.211	0.30	0.417	0.59	-0.03
2412	1	Right	Tilt	/	16.50	18	0.161	0.23	0.310	0.44	0.15

As shown above table, the initial test position for head is “Right Tilt”. So the head SAR of WLAN is presented as below:

Table 14.3-2: SAR Values (WLAN - Head)– 802.11b (Full SAR)

Ambient Temperature: 22.9 °C						Liquid Temperature: 22.5 °C					
Frequency		Side	Test Position	Figure No.	Conducted Power (dBm)	Max. tune-up Power (dBm)	Measured SAR(10g) (W/kg)	Reported SAR(10g) (W/kg)	Measured SAR(1g) (W/kg)	Reported SAR(1g)(W/kg)	Power Drift (dB)
MHz	Ch.										
2412	1	Right	Cheek	Fig.30	16.50	18	0.225	0.32	0.432	0.61	-0.03
2412	1	Right	Cheek	/	16.50	18	0.209	0.30	0.419	0.59	0.07

Note1: When the reported SAR of the initial test position is > 0.4 W/kg, SAR is repeated for the 802.11 transmission mode configuration tested in the initial test position using subsequent highest estimated 1-g SAR conditions determined by area scans, on the highest maximum output power channel, until the reported SAR is ≤ 0.8 W/kg.

Note2: For all positions/configurations tested using the initial test position and subsequent test positions, when the reported SAR is > 0.8 W/kg, SAR is measured for these test positions/configurations on the subsequent next highest measured output power channel until the reported SAR is ≤ 1.2 W/kg or all required channels are tested.

According to the KDB248227 D01, The reported SAR must be scaled to 100% transmission duty factor to determine compliance at the maximum tune-up tolerance limit. The scaled reported SAR is presented as below.

Table 14.3-3: SAR Values (WLAN - Head) – 802.11b (Scaled Reported SAR)

Ambient Temperature: 22.9 °C						Liquid Temperature: 22.5 °C	
Frequency		Side	Test Position	Actual duty factor	maximum duty factor	Reported SAR (1g)(W/kg)	Scaled reported SAR (1g)(W/kg)
MHz	Ch.						
2412	1	Right	Cheek	100%	100%	0.61	0.61

SAR is not required for OFDM because the 802.11b adjusted SAR ≤ 1.2 W/kg.

Body Evaluation
Table 14.3-4: SAR Values (WLAN - Body)– 802.11b (Fast SAR)

Frequency		Test Position	Figure No.	Ambient Temperature: 22.9 °C		Liquid Temperature: 22.5 °C				Power Drift (dB)
MHz	Ch.			Conducted Power (dBm)	Max. tune-up Power (dBm)	Measured SAR(10g) (W/kg)	Reported SAR(10g) (W/kg)	Measured SAR(1g) (W/kg)	Reported SAR(1g) (W/kg)	
2412	1	Front	/	20.61	21.5	0.101	0.12	0.173	0.21	-0.03
2412	1	Rear	/	20.61	21.5	0.157	0.19	0.312	0.38	0.18
2412	1	Right	/	20.61	21.5	0.022	0.03	0.037	0.05	-0.04
2412	1	Top	/	20.61	21.5	0.098	0.12	0.194	0.24	-0.09

As shown above table, the initial test position for body is “Rear”. So the body SAR of WLAN is presented as below:

Table 14.3-5: SAR Values (WLAN - Body)– 802.11b (Full SAR)

Frequency		Test Position	Figure No.	Ambient Temperature: 22.9 °C		Liquid Temperature: 22.5 °C				Power Drift (dB)
MHz	Ch.			Conducted Power (dBm)	Max. tune-up Power (dBm)	Measured SAR(10g) (W/kg)	Reported SAR(10g) (W/kg)	Measured SAR(1g) (W/kg)	Reported SAR(1g) (W/kg)	
2412	1	Rear	Fig.14	20.61	21.5	0.143	0.18	0.314	0.39	0.18

Note1: When the reported SAR of the initial test position is > 0.4 W/kg, SAR is repeated for the 802.11 transmission mode configuration tested in the initial test position using subsequent highest estimated 1-g SAR conditions determined by area scans, on the highest maximum output power channel, until the reported SAR is \leq 0.8 W/kg.

Note2: For all positions/configurations tested using the initial test position and subsequent test positions, when the reported SAR is > 0.8 W/kg, SAR is measured for these test positions/configurations on the subsequent next highest measured output power channel until the reported SAR is \leq 1.2 W/kg or all required channels are tested.

According to the KDB248227 D01, The reported SAR must be scaled to 100% transmission duty factor to determine compliance at the maximum tune-up tolerance limit. The scaled reported SAR is presented as below.

Table 14.3-6: SAR Values (WLAN - Body) – 802.11b (Scaled Reported SAR)

Frequency		Test Position	Ambient Temperature: 22.9 °C		Liquid Temperature: 22.5 °C	
MHz	Ch.		Actual duty factor	maximum duty factor	Reported SAR (1g)(W/kg)	Scaled reported SAR (1g)(W/kg)
2412	1	Rear	100%	100%	0.39	0.39

SAR is not required for OFDM because the 802.11b adjusted SAR \leq 1.2 W/kg.

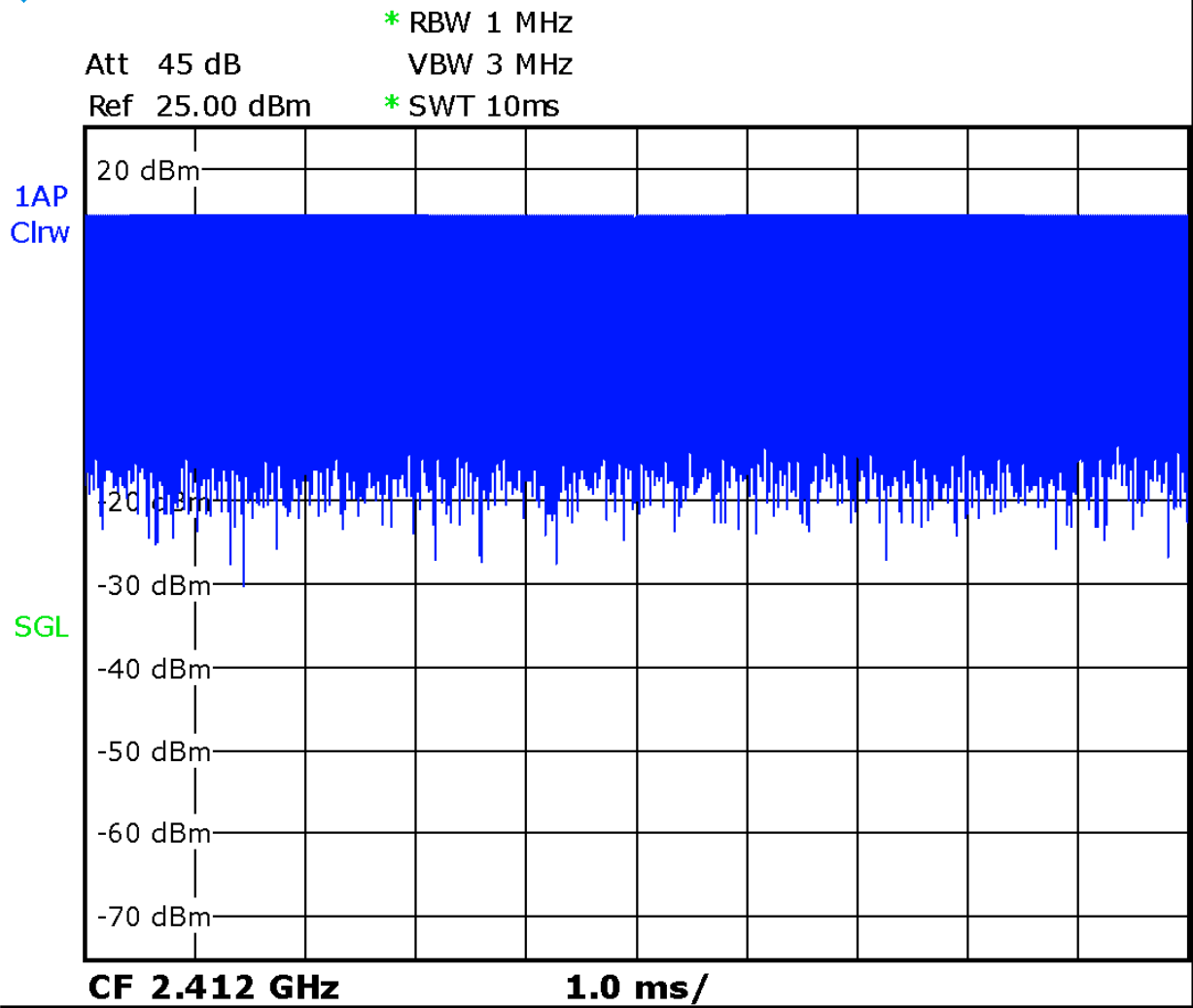

Picture 14.1 Duty factor plot

15 SAR Measurement Variability

SAR measurement variability must be assessed for each frequency band, which is determined by the SAR probe calibration point and tissue-equivalent medium used for the device measurements. When both head and body tissue-equivalent media are required for SAR measurements in a frequency band, the variability measurement procedures should be applied to the tissue medium with the highest measured SAR, using the highest measured SAR configuration for that tissue-equivalent medium.

The following procedures are applied to determine if repeated measurements are required.

- 1) Repeated measurement is not required when the original highest measured SAR is < 0.80 W/kg; steps 2) through 4) do not apply.
- 2) When the original highest measured SAR is ≥ 0.80 W/kg, repeat that measurement once.
- 3) Perform a second repeated measurement only if the ratio of largest to smallest SAR for the original and first repeated measurements is > 1.20 or when the original or repeated measurement is ≥ 1.45 W/kg (~ 10% from the 1-g SAR limit).
- 4) Perform a third repeated measurement only if the original, first or second repeated measurement is ≥ 1.5 W/kg and the ratio of largest to smallest SAR for the original, first and second repeated measurements is > 1.20.

Frequency Band	Channel Number	Frequency (MHz)	Test setup	Original SAR (W/kg) 1g(W/kg)	First Repeated SAR 1g (W/kg)	The Ratio
GSM1900	661.00	1880.00	Bottom Edge GPRS 10mm	0.89	0.86	1.03
GSM1900	512.00	1850.20	Bottom Edge GPRS 10mm	1.10	0.99	1.11
GSM1900	512.00	1850.20	Bottom Edge EGPRS 10mm	1.08	1.00	1.08
WCDMA1900	9400	1880.00	Bottom Edge 10mm	0.89	0.86	1.02
WCDMA1900	9262	1852.40	Bottom Edge 10mm	1.15	1.01	1.14
WCDMA1700	1513	1752.60	Bottom Edge 10mm	0.82	0.78	1.04
WCDMA1700	1412	1732.40	Bottom Edge 10mm	0.82	0.80	1.02
LTE Band2	19100	1900.00	1RB-Middle Bottom Edge 10mm	0.99	0.98	1.01
LTE Band2	18900	1880.00	1RB-Middle Bottom Edge 10mm	0.96	0.95	1.01
LTE Band2	18700	1860.00	1RB-Middle Bottom Edge 10mm	0.90	0.89	1.02
LTE Band2	19100	1900.00	50RB-Middle Bottom Edge 10mm	0.95	0.94	1.01
LTE Band2	18900	1880.00	50RB-Middle Bottom Edge 10mm	0.92	0.92	1.01
LTE Band2	18700	1860.00	50RB-Middle Bottom Edge 10mm	0.87	0.85	1.02
LTE Band2	18700	1860.00	100RB Bottom Edge 10mm	0.94	0.92	1.02
LTE Band66	132572	1770.00	1RB-Middle Bottom Edge 10mm	1.01	0.99	1.02
LTE Band66	132322	1745.00	1RB-Middle Bottom Edge 10mm	1.05	0.98	1.07
LTE Band66	132072	1720.00	1RB-Middle Bottom Edge 10mm	0.98	0.96	1.02
LTE Band66	132572	1770.00	50RB-Middle Bottom Edge 10mm	0.98	0.97	1.01
LTE Band66	132322	1745.00	50RB-Middle Bottom Edge 10mm	1.00	0.99	1.01
LTE Band66	132072	1720.00	50RB-Middle Bottom Edge 10mm	0.96	0.95	1.01
LTE Band66	132572	1770.00	100RB Bottom Edge 10mm	0.96	0.94	1.02

16 Measurement Uncertainty

16.1 Measurement Uncertainty for Normal SAR Tests (300MHz~3GHz)

No.	Error Description	Type	Uncertainty value	Probably Distribution	Div.	(Ci) 1g	(Ci) 10g	Std. Unc. (1g)	Std. Unc. (10g)	Degree of freedom
Measurement system										
1	Probe calibration	B	6.0	N	1	1	1	6.0	6.0	∞
2	Isotropy	B	4.7	R	$\sqrt{3}$	0.7	0.7	1.9	1.9	∞
3	Boundary effect	B	1.0	R	$\sqrt{3}$	1	1	0.6	0.6	∞
4	Linearity	B	4.7	R	$\sqrt{3}$	1	1	2.7	2.7	∞
5	Detection limit	B	1.0	N	1	1	1	0.6	0.6	∞
6	Readout electronics	B	0.3	R	$\sqrt{3}$	1	1	0.3	0.3	∞
7	Response time	B	0.8	R	$\sqrt{3}$	1	1	0.5	0.5	∞
8	Integration time	B	2.6	R	$\sqrt{3}$	1	1	1.5	1.5	∞
9	RF ambient conditions-noise	B	0	R	$\sqrt{3}$	1	1	0	0	∞
10	RFambient conditions-reflection	B	0	R	$\sqrt{3}$	1	1	0	0	∞
11	Probe positioned mech. restrictions	B	0.4	R	$\sqrt{3}$	1	1	0.2	0.2	∞
12	Probe positioning with respect to phantom shell	B	2.9	R	$\sqrt{3}$	1	1	1.7	1.7	∞
13	Post-processing	B	1.0	R	$\sqrt{3}$	1	1	0.6	0.6	∞
Test sample related										
14	Test sample positioning	A	3.3	N	1	1	1	3.3	3.3	71
15	Device holder uncertainty	A	3.4	N	1	1	1	3.4	3.4	5
16	Drift of output power	B	5.0	R	$\sqrt{3}$	1	1	2.9	2.9	∞
Phantom and set-up										
17	Phantom uncertainty	B	4.0	R	$\sqrt{3}$	1	1	2.3	2.3	∞
18	Liquid conductivity (target)	B	5.0	R	$\sqrt{3}$	0.64	0.43	1.8	1.2	∞
19	Liquid conductivity (meas.)	A	2.06	N	1	0.64	0.43	1.32	0.89	43
20	Liquid permittivity (target)	B	5.0	R	$\sqrt{3}$	0.6	0.49	1.7	1.4	∞
21	Liquid permittivity (meas.)	A	1.6	N	1	0.6	0.49	1.0	0.8	521

Combined standard uncertainty	$u_c = \sqrt{\sum_{i=1}^{21} c_i^2 u_i^2}$							9.55	9.43	257
Expanded uncertainty (confidence interval of 95 %)	$u_e = 2u_c$							19.1	18.9	

16.2 Measurement Uncertainty for Normal SAR Tests (3~6GHz)

No.	Error Description	Type	Uncertainty value	Probably Distribution	Div.	(Ci) 1g	(Ci) 10g	Std. Unc. (1g)	Std. Unc. (10g)	Degree of freedom
Measurement system										
1	Probe calibration	B	6.55	N	1	1	1	6.55	6.55	∞
2	Isotropy	B	4.7	R	$\sqrt{3}$	0.7	0.7	1.9	1.9	∞
3	Boundary effect	B	2.0	R	$\sqrt{3}$	1	1	1.2	1.2	∞
4	Linearity	B	4.7	R	$\sqrt{3}$	1	1	2.7	2.7	∞
5	Detection limit	B	1.0	R	$\sqrt{3}$	1	1	0.6	0.6	∞
6	Readout electronics	B	0.3	R	$\sqrt{3}$	1	1	0.3	0.3	∞
7	Response time	B	0.8	R	$\sqrt{3}$	1	1	0.5	0.5	∞
8	Integration time	B	2.6	R	$\sqrt{3}$	1	1	1.5	1.5	∞
9	RF ambient conditions-noise	B	0	R	$\sqrt{3}$	1	1	0	0	∞
10	RFambient conditions-reflection	B	0	R	$\sqrt{3}$	1	1	0	0	∞
11	Probe positioned mech. restrictions	B	0.8	R	$\sqrt{3}$	1	1	0.5	0.5	∞
12	Probe positioning with respect to phantom shell	B	6.7	R	$\sqrt{3}$	1	1	3.9	3.9	∞
13	Post-processing	B	4.0	R	$\sqrt{3}$	1	1	2.3	2.3	∞
Test sample related										
14	Test sample positioning	A	3.3	N	1	1	1	3.3	3.3	71
15	Device holder uncertainty	A	3.4	N	1	1	1	3.4	3.4	5
16	Drift of output power	B	5.0	R	$\sqrt{3}$	1	1	2.9	2.9	∞
Phantom and set-up										
17	Phantom uncertainty	B	4.0	R	$\sqrt{3}$	1	1	2.3	2.3	∞
18	Liquid conductivity (target)	B	5.0	R	$\sqrt{3}$	0.64	0.43	1.8	1.2	∞
19	Liquid conductivity (meas.)	A	2.06	N	1	0.64	0.43	1.32	0.89	43
20	Liquid permittivity	B	5.0	R	$\sqrt{3}$	0.6	0.49	1.7	1.4	∞

	(target)									
21	Liquid permittivity (meas.)	A	1.6	N	1	0.6	0.49	1.0	0.8	521
Combined standard uncertainty		$u_c = \sqrt{\sum_{i=1}^{21} c_i^2 u_i^2}$						10.7	10.6	257
Expanded uncertainty (confidence interval of 95 %)		$u_e = 2u_c$						21.4	21.1	

16.3 Measurement Uncertainty for Fast SAR Tests (300MHz~3GHz)

No.	Error Description	Type	Uncertainty value	Probably Distribution	Div.	(Ci) 1g	(Ci) 10g	Std. Unc. (1g)	Std. Unc. (10g)	Degree of freedom
Measurement system										
1	Probe calibration	B	6.0	N	1	1	1	6.0	6.0	∞
2	Isotropy	B	4.7	R	$\sqrt{3}$	0.7	0.7	1.9	1.9	∞
3	Boundary effect	B	1.0	R	$\sqrt{3}$	1	1	0.6	0.6	∞
4	Linearity	B	4.7	R	$\sqrt{3}$	1	1	2.7	2.7	∞
5	Detection limit	B	1.0	R	$\sqrt{3}$	1	1	0.6	0.6	∞
6	Readout electronics	B	0.3	R	$\sqrt{3}$	1	1	0.3	0.3	∞
7	Response time	B	0.8	R	$\sqrt{3}$	1	1	0.5	0.5	∞
8	Integration time	B	2.6	R	$\sqrt{3}$	1	1	1.5	1.5	∞
9	RF ambient conditions-noise	B	0	R	$\sqrt{3}$	1	1	0	0	∞
10	RFambient conditions-reflection	B	0	R	$\sqrt{3}$	1	1	0	0	∞
11	Probe positioned mech. Restrictions	B	0.4	R	$\sqrt{3}$	1	1	0.2	0.2	∞
12	Probe positioning with respect to phantom shell	B	2.9	R	$\sqrt{3}$	1	1	1.7	1.7	∞
13	Post-processing	B	1.0	R	$\sqrt{3}$	1	1	0.6	0.6	∞
14	Fast SAR z-Approximation	B	7.0	R	$\sqrt{3}$	1	1	4.0	4.0	∞
Test sample related										
15	Test sample positioning	A	3.3	N	1	1	1	3.3	3.3	71
16	Device holder uncertainty	A	3.4	N	1	1	1	3.4	3.4	5
17	Drift of output power	B	5.0	R	$\sqrt{3}$	1	1	2.9	2.9	∞
Phantom and set-up										
18	Phantom uncertainty	B	4.0	R	$\sqrt{3}$	1	1	2.3	2.3	∞

19	Liquid conductivity (target)	B	5.0	R	$\sqrt{3}$	0.64	0.43	1.8	1.2	∞
20	Liquid conductivity (meas.)	A	2.06	N	1	0.64	0.43	1.32	0.89	43
21	Liquid permittivity (target)	B	5.0	R	$\sqrt{3}$	0.6	0.49	1.7	1.4	∞
22	Liquid permittivity (meas.)	A	1.6	N	1	0.6	0.49	1.0	0.8	521
Combined standard uncertainty		$u_c = \sqrt{\sum_{i=1}^{22} c_i^2 u_i^2}$						10.4	10.3	257
Expanded uncertainty (confidence interval of 95 %)		$u_e = 2u_c$						20.8	20.6	

16.4 Measurement Uncertainty for Fast SAR Tests (3~6GHz)

No.	Error Description	Type	Uncertainty value	Probably Distribution	Div.	(Ci) 1g	(Ci) 10g	Std. Unc. (1g)	Std. Unc. (10g)	Degree of freedom
Measurement system										
1	Probe calibration	B	6.55	N	1	1	1	6.55	6.55	∞
2	Isotropy	B	4.7	R	$\sqrt{3}$	0.7	0.7	1.9	1.9	∞
3	Boundary effect	B	2.0	R	$\sqrt{3}$	1	1	1.2	1.2	∞
4	Linearity	B	4.7	R	$\sqrt{3}$	1	1	2.7	2.7	∞
5	Detection limit	B	1.0	R	$\sqrt{3}$	1	1	0.6	0.6	∞
6	Readout electronics	B	0.3	R	$\sqrt{3}$	1	1	0.3	0.3	∞
7	Response time	B	0.8	R	$\sqrt{3}$	1	1	0.5	0.5	∞
8	Integration time	B	2.6	R	$\sqrt{3}$	1	1	1.5	1.5	∞
9	RF ambient conditions-noise	B	0	R	$\sqrt{3}$	1	1	0	0	∞
10	RF ambient conditions-reflection	B	0	R	$\sqrt{3}$	1	1	0	0	∞
11	Probe positioned mech. Restrictions	B	0.8	R	$\sqrt{3}$	1	1	0.5	0.5	∞
12	Probe positioning with respect to phantom shell	B	6.7	R	$\sqrt{3}$	1	1	3.9	3.9	∞
13	Post-processing	B	1.0	R	$\sqrt{3}$	1	1	0.6	0.6	∞
14	Fast SAR z-Approximation	B	14.0	R	$\sqrt{3}$	1	1	8.1	8.1	∞
Test sample related										
15	Test sample positioning	A	3.3	N	1	1	1	3.3	3.3	71

16	Device holder uncertainty	A	3.4	N	1	1	1	3.4	3.4	5
17	Drift of output power	B	5.0	R	$\sqrt{3}$	1	1	2.9	2.9	∞
Phantom and set-up										
18	Phantom uncertainty	B	4.0	R	$\sqrt{3}$	1	1	2.3	2.3	∞
19	Liquid conductivity (target)	B	5.0	R	$\sqrt{3}$	0.64	0.43	1.8	1.2	∞
20	Liquid conductivity (meas.)	A	2.06	N	1	0.64	0.43	1.32	0.89	43
21	Liquid permittivity (target)	B	5.0	R	$\sqrt{3}$	0.6	0.49	1.7	1.4	∞
22	Liquid permittivity (meas.)	A	1.6	N	1	0.6	0.49	1.0	0.8	521
Combined standard uncertainty		$u_c = \sqrt{\sum_{i=1}^{22} c_i^2 u_i^2}$						13.5	13.4	257
Expanded uncertainty (confidence interval of 95 %)		$u_e = 2u_c$						27.0	26.8	

17 MAIN TEST INSTRUMENTS

Table 17.1: List of Main Instruments

No.	Name	Type	Serial Number	Calibration Date	Valid Period
01	Network analyzer	N5239A	MY55491241	June 10, 2019	One year
02	Power meter	NRP2	106277	September 4, 2019	One year
03	Power sensor	NRP8S	104291		
04	Signal Generator	E4438C	MG3700A	June 18, 2019	One Year
05	Amplifier	60S1G4	0331848	No Calibration Requested	
06	BTS	CMW500	166370	June 27, 2019	One year
07	E-field Probe	SPEAG EX3DV4	7307	May 24, 2019	One year
08	DAE	SPEAG DAE4	1289	April 11, 2019	One year
09	Dipole Validation Ki	SPEAG D750V3	1017	July 18, 2019	One year
10	Dipole Validation Kit	SPEAG D835V2	4d069	July 18, 2019	One year
11	Dipole Validation Ki	SPEAG D1750V2	1003	July 16, 2019	One year
12	Dipole Validation Kit	SPEAG D1900V2	5d101	July 17, 2019	One year
13	Dipole Validation Kit	SPEAG D2450V2	853	July 17, 2019	One year
14	Dipole Validation Kit	SPEAG D2600V2	1012	July 17, 2019	One year

END OF REPORT BODY

ANNEX A Graph Results

GSM850_CH128 Right Cheek

Date: 4/6/2020

Electronics: DAE4 Sn1289

Medium: head 835 MHz

Medium parameters used: $f = 824.2$; $\sigma = 0.874$ mho/m; $\epsilon_r = 41.46$; $\rho = 1000$ kg/m³

Ambient Temperature: 22.5°C, Liquid Temperature: 22.3°C

Communication System: GSM850 824.2 Duty Cycle: 1:8.3

Probe: EX3DV4 – SN7307 ConvF(10.45,10.45,10.45)

Area Scan (71x121x1): Interpolated grid: $dx=1.000$ mm, $dy=1.000$ mm

Maximum value of SAR (interpolated) = 0.375 W/kg

Zoom Scan (7x7x7)/Cube 0: Measurement grid: $dx=5$ mm, $dy=5$ mm, $dz=5$ mm

Reference Value = 6.432 V/m; Power Drift = 0.1 dB

Peak SAR (extrapolated) = 0.409 W/kg

SAR(1 g) = 0.288 W/kg; SAR(10 g) = 0.213 W/kg

Maximum value of SAR (measured) = 0.364 W/kg

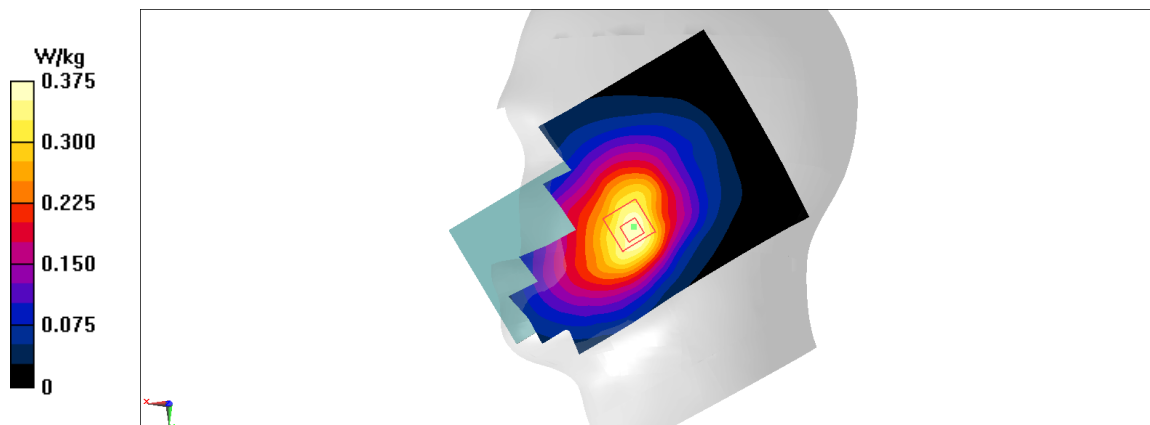

Fig A.1

GSM850_CH190 Rear GPRS 10mm

Date: 4/6/2020

Electronics: DAE4 Sn1289

Medium: head 835 MHz

Medium parameters used: $f = 836.6$; $\sigma = 0.874$ mho/m; $\epsilon_r = 41.46$; $\rho = 1000$ kg/m³

Ambient Temperature: 22.5°C, Liquid Temperature: 22.3°C

Communication System: GSM850 836.6 Duty Cycle: 1:4

Probe: EX3DV4 – SN7307 ConvF(10.45,10.45,10.45)

Area Scan (71x121x1): Interpolated grid: dx=1.000 mm, dy=1.000 mm

Maximum value of SAR (interpolated) = 0.991 W/kg

Zoom Scan (7x7x7)/Cube 0: Measurement grid: dx=5mm, dy=5mm, dz=5mm

Reference Value = 17.63 V/m; Power Drift = -0.03 dB

Peak SAR (extrapolated) = 1.25 W/kg

SAR(1 g) = 0.532 W/kg; SAR(10 g) = 0.296 W/kg

Maximum value of SAR (measured) = 0.996 W/kg

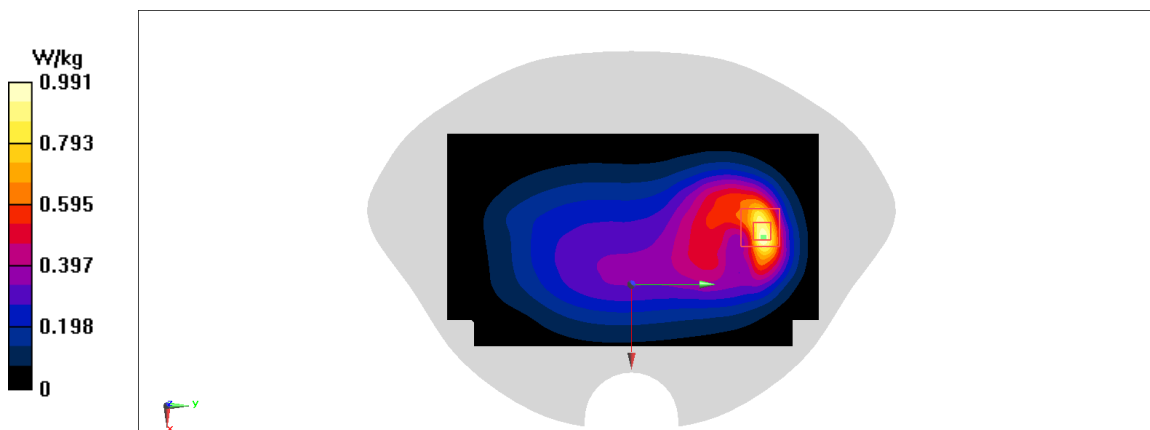
**Fig A.2**

PCS1900_CH512 Left Cheek

Date: 4/8/2020

Electronics: DAE4 Sn1289

Medium: head 1900 MHz

Medium parameters used: $f = 1850.2$; $\sigma = 1.334$ mho/m; $\epsilon_r = 39.39$; $\rho = 1000$ kg/m³

Ambient Temperature: 22.5°C, Liquid Temperature: 22.3°C

Communication System: PCS1900 1850.2 Duty Cycle: 1:8.3

Probe: EX3DV4 – SN7307 ConvF(8.56,8.56,8.56)

Area Scan (71x121x1): Interpolated grid: dx=1.000 mm, dy=1.000 mm

Maximum value of SAR (interpolated) = 0.143 W/kg

Zoom Scan (7x7x7)/Cube 0: Measurement grid: dx=5mm, dy=5mm, dz=5mm

Reference Value = 4.05 V/m; Power Drift = -0.06 dB

Peak SAR (extrapolated) = 0.165 W/kg

SAR(1 g) = 0.1 W/kg; SAR(10 g) = 0.061 W/kg

Maximum value of SAR (measured) = 0.141 W/kg

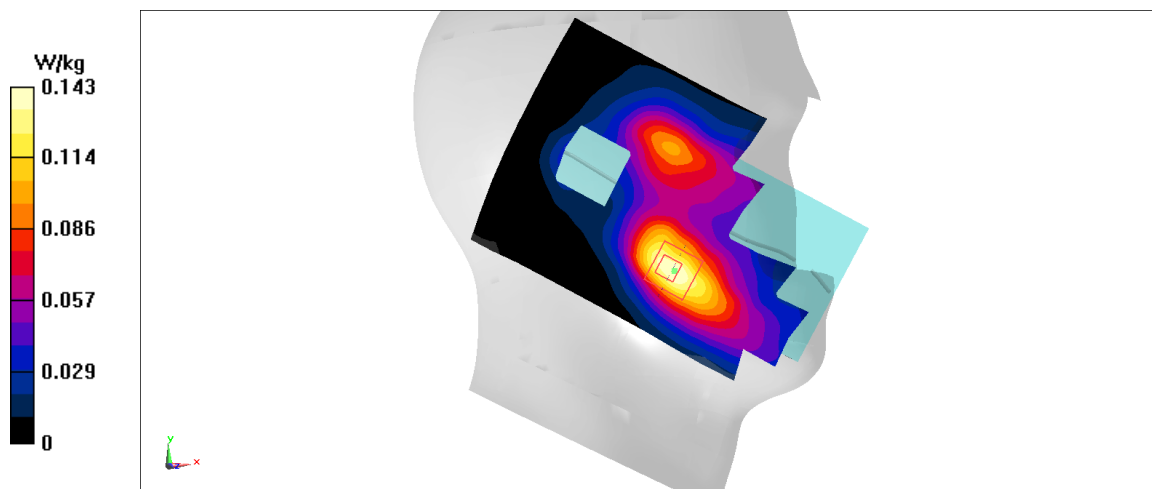
**Fig A.3**

PCS1900_CH512 Rear GPRS 15mm

Date: 4/8/2020

Electronics: DAE4 Sn1289

Medium: head 1900 MHz

Medium parameters used: $f = 1850.2$; $\sigma = 1.334$ mho/m; $\epsilon_r = 39.39$; $\rho = 1000$ kg/m³

Ambient Temperature: 22.5°C, Liquid Temperature: 22.3°C

Communication System: PCS1900 1850.2 Duty Cycle: 1:4

Probe: EX3DV4 – SN7307 ConvF(8.56,8.56,8.56)

Area Scan (71x121x1): Interpolated grid: dx=1.000 mm, dy=1.000 mm

Maximum value of SAR (interpolated) = 0.801 W/kg

Zoom Scan (7x7x7)/Cube 0: Measurement grid: dx=5mm, dy=5mm, dz=5mm

Reference Value = 10.86 V/m; Power Drift = -0.15 dB

Peak SAR (extrapolated) = 0.93 W/kg

SAR(1 g) = 0.559 W/kg; SAR(10 g) = 0.324 W/kg

Maximum value of SAR (measured) = 0.796 W/kg

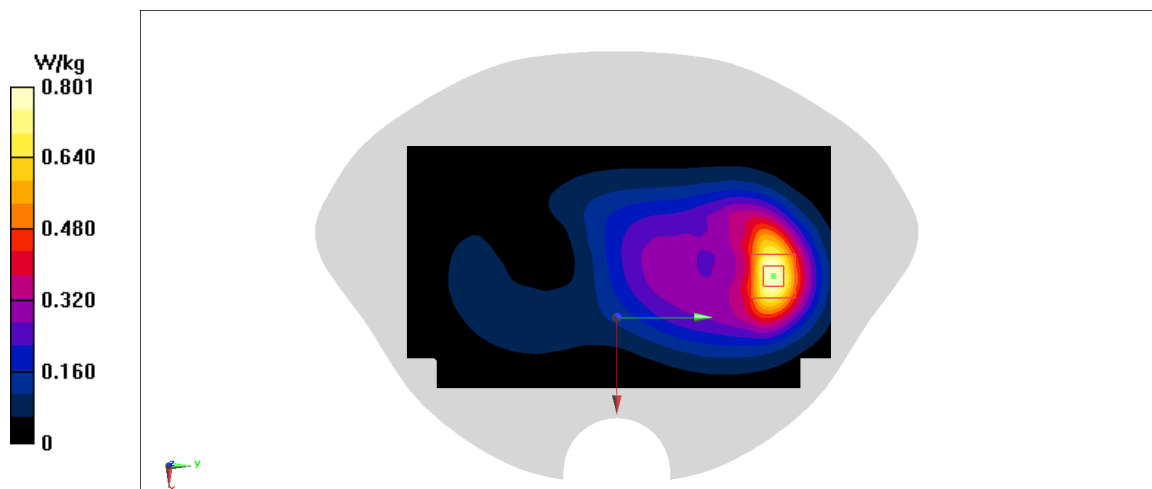
**Fig A.4**

PCS1900_CH512 Bottom Edge 10mm

Date: 4/8/2020

Electronics: DAE4 Sn1289

Medium: head 1900 MHz

Medium parameters used: $f = 1850.2$; $\sigma = 1.334$ mho/m; $\epsilon_r = 39.39$; $\rho = 1000$ kg/m³

Ambient Temperature: 22.5°C, Liquid Temperature: 22.3°C

Communication System: PCS1900 1850.2 Duty Cycle: 1:2.67

Probe: EX3DV4 – SN7307 ConvF(8.56,8.56,8.56)

Area Scan (71x121x1): Interpolated grid: dx=1.000 mm, dy=1.000 mm

Maximum value of SAR (interpolated) = 2.42 W/kg

Zoom Scan (7x7x7)/Cube 0: Measurement grid: dx=5mm, dy=5mm, dz=5mm

Reference Value = 30.56 V/m; Power Drift = -0.06 dB

Peak SAR (extrapolated) = 2.81 W/kg

SAR(1 g) = 1.1 W/kg; SAR(10 g) = 0.581 W/kg

Maximum value of SAR (measured) = 2.31 W/kg

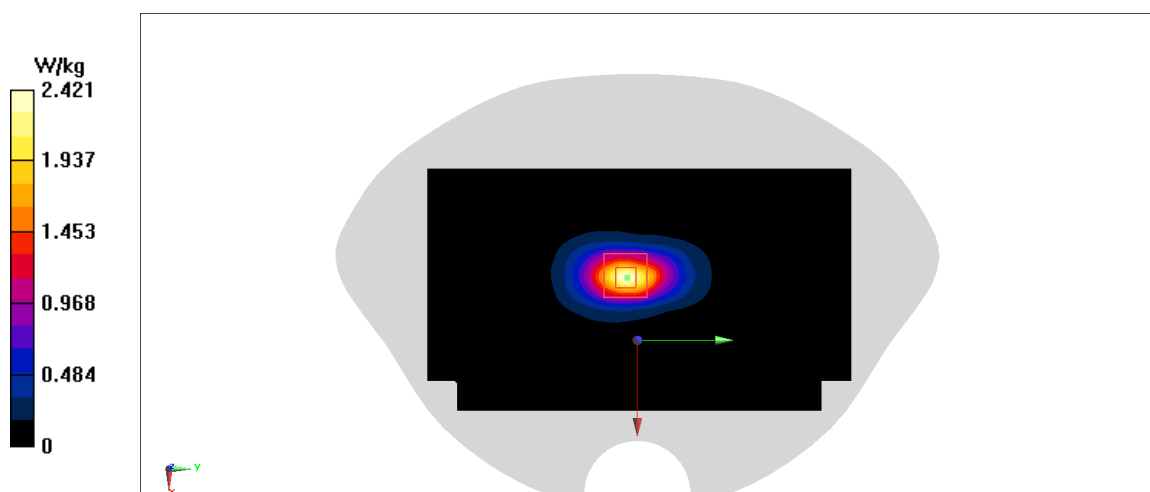

Fig A.5

WCDMA1900-BII_CH9262 Left Cheek

Date: 4/8/2020

Electronics: DAE4 Sn1289

Medium: head 1900 MHz

Medium parameters used: $f = 1852.4$; $\sigma = 1.336$ mho/m; $\epsilon_r = 39.39$; $\rho = 1000$ kg/m³

Ambient Temperature: 22.5°C, Liquid Temperature: 22.3°C

Communication System: WCDMA1900-BII 1852.4 Duty Cycle: 1:1

Probe: EX3DV4 – SN7307 ConvF(8.56,8.56,8.56)

Area Scan (71x121x1): Interpolated grid: dx=1.000 mm, dy=1.000 mm

Maximum value of SAR (interpolated) = 0.152 W/kg

Zoom Scan (7x7x7)/Cube 0: Measurement grid: dx=5mm, dy=5mm, dz=5mm

Reference Value = 3.621 V/m; Power Drift = 0.04 dB

Peak SAR (extrapolated) = 0.174 W/kg

SAR(1 g) = 0.106 W/kg; SAR(10 g) = 0.064 W/kg

Maximum value of SAR (measured) = 0.149 W/kg

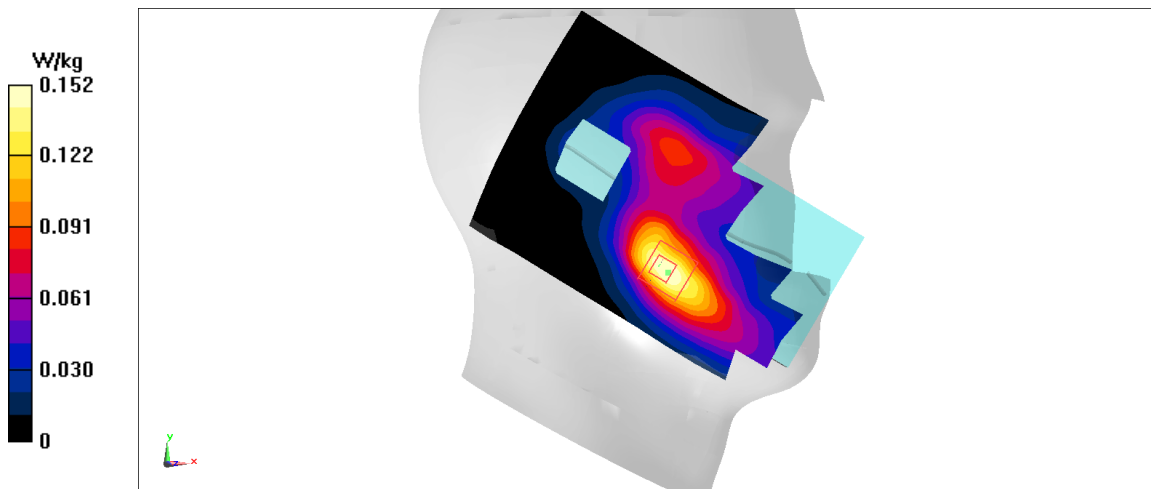
**Fig A.6**

WCDMA1900-BII_CH9262 Rear 15mm

Date: 4/8/2020

Electronics: DAE4 Sn1289

Medium: head 1900 MHz

Medium parameters used: $f = 1852.4$; $\sigma = 1.336$ mho/m; $\epsilon_r = 39.39$; $\rho = 1000$ kg/m³

Ambient Temperature: 22.5°C, Liquid Temperature: 22.3°C

Communication System: WCDMA1900-BII 1852.4 Duty Cycle: 1:1

Probe: EX3DV4 – SN7307 ConvF(8.56,8.56,8.56)

Area Scan (71x121x1): Interpolated grid: dx=1.000 mm, dy=1.000 mm

Maximum value of SAR (interpolated) = 2.36 W/kg

Zoom Scan (7x7x7)/Cube 0: Measurement grid: dx=5mm, dy=5mm, dz=5mm

Reference Value = 35.27 V/m; Power Drift = 0.12 dB

Peak SAR (extrapolated) = 2.81 W/kg

SAR(1 g) = 0.741 W/kg; SAR(10 g) = 0.422 W/kg

Maximum value of SAR (measured) = 2.34 W/kg

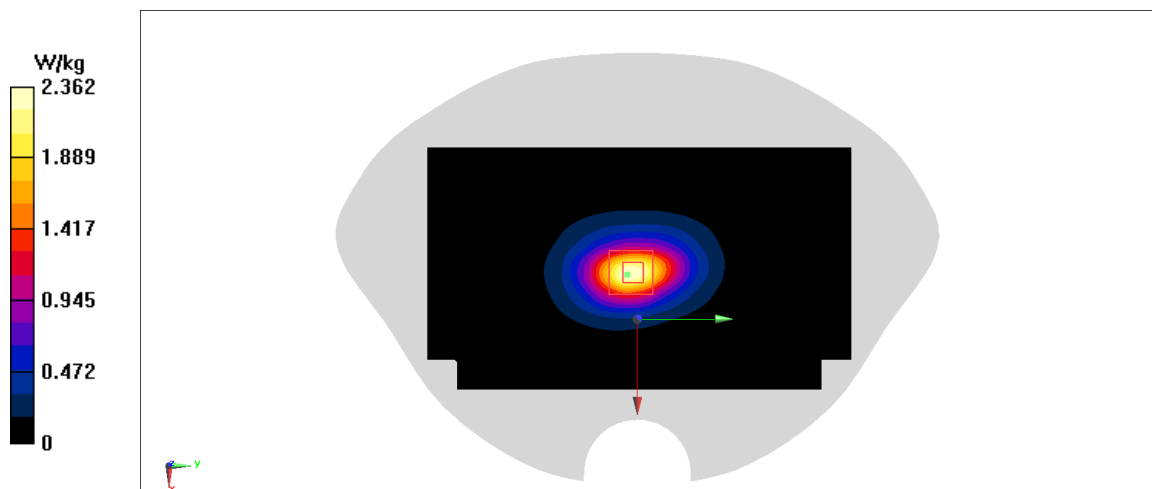

Fig A.7

WCDMA1900-BII_CH9262 Bottom Edge 10mm

Date: 4/8/2020

Electronics: DAE4 Sn1289

Medium: head 1900 MHz

Medium parameters used: $f = 1852.4$; $\sigma = 1.336$ mho/m; $\epsilon_r = 39.39$; $\rho = 1000$ kg/m³

Ambient Temperature: 22.5°C, Liquid Temperature: 22.3°C

Communication System: WCDMA1900-BII 1852.4 Duty Cycle: 1:1

Probe: EX3DV4 – SN7307 ConvF(8.56,8.56,8.56)

Area Scan (71x121x1): Interpolated grid: dx=1.000 mm, dy=1.000 mm

Maximum value of SAR (interpolated) = 2.43 W/kg

Zoom Scan (7x7x7)/Cube 0: Measurement grid: dx=5mm, dy=5mm, dz=5mm

Reference Value = 35.02 V/m; Power Drift = -0.09 dB

Peak SAR (extrapolated) = 2.96 W/kg

SAR(1 g) = 1.15 W/kg; SAR(10 g) = 0.581 W/kg

Maximum value of SAR (measured) = 2.42 W/kg

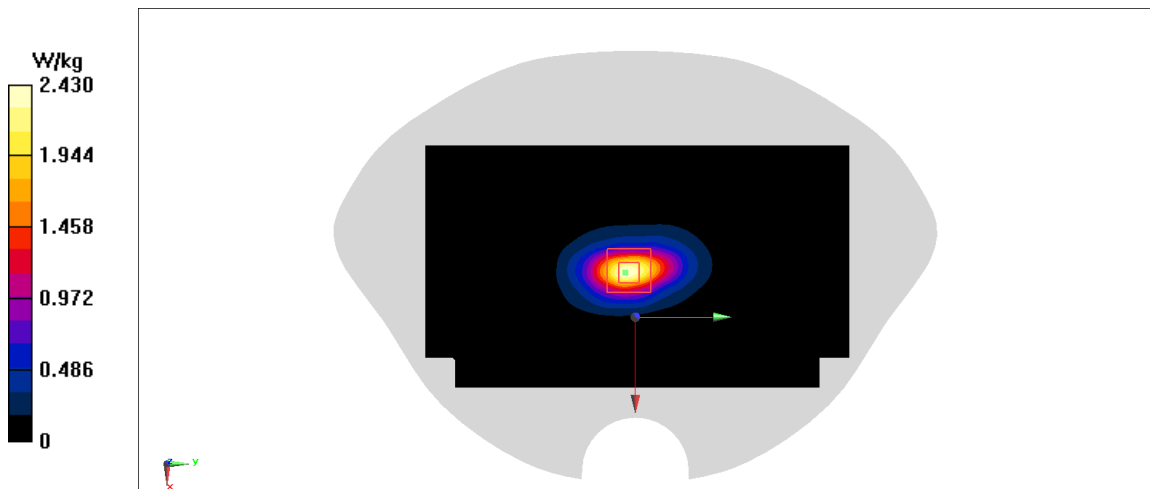
**Fig A.8**

WCDMA1700-BIV_CH1312 Right Cheek

Date: 4/7/2020

Electronics: DAE4 Sn1289

Medium: head 1750 MHz

Medium parameters used: $f = 1712.4$; $\sigma = 1.338$ mho/m; $\epsilon_r = 39.49$; $\rho = 1000$ kg/m³

Ambient Temperature: 22.5°C, Liquid Temperature: 22.3°C

Communication System: WCDMA1700-BIV 1712.4 Duty Cycle: 1:1

Probe: EX3DV4 – SN7307 ConvF(8.86,8.86,8.86)

Area Scan (71x121x1): Interpolated grid: dx=1.000 mm, dy=1.000 mm

Maximum value of SAR (interpolated) = 0.678 W/kg

Zoom Scan (7x7x7)/Cube 0: Measurement grid: dx=5mm, dy=5mm, dz=5mm

Reference Value = 9.349 V/m; Power Drift = -0.01 dB

Peak SAR (extrapolated) = 0.729 W/kg

SAR(1 g) = 0.468 W/kg; SAR(10 g) = 0.293 W/kg

Maximum value of SAR (measured) = 0.632 W/kg

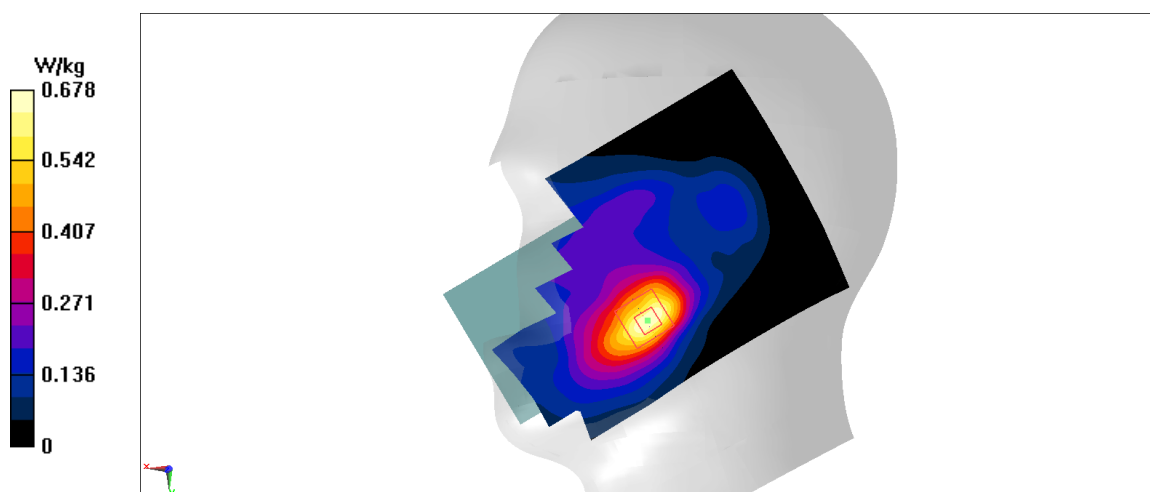
**Fig A.9**

WCDMA1700-BIV_CH1412 Front 15mm

Date: 4/7/2020

Electronics: DAE4 Sn1289

Medium: head 1750 MHz

Medium parameters used: $f = 1732.4$; $\sigma = 1.338$ mho/m; $\epsilon_r = 39.49$; $\rho = 1000$ kg/m³

Ambient Temperature: 22.5°C, Liquid Temperature: 22.3°C

Communication System: WCDMA1700-BIV 1732.4 Duty Cycle: 1:1

Probe: EX3DV4 – SN7307 ConvF(8.86,8.86,8.86)

Area Scan (71x121x1): Interpolated grid: dx=1.000 mm, dy=1.000 mm

Maximum value of SAR (interpolated) = 1.24 W/kg

Zoom Scan (7x7x7)/Cube 0: Measurement grid: dx=5mm, dy=5mm, dz=5mm

Reference Value = 25.6 V/m; Power Drift = -0.01 dB

Peak SAR (extrapolated) = 1.53 W/kg

SAR(1 g) = 0.763 W/kg; SAR(10 g) = 0.443 W/kg

Maximum value of SAR (measured) = 1.26 W/kg

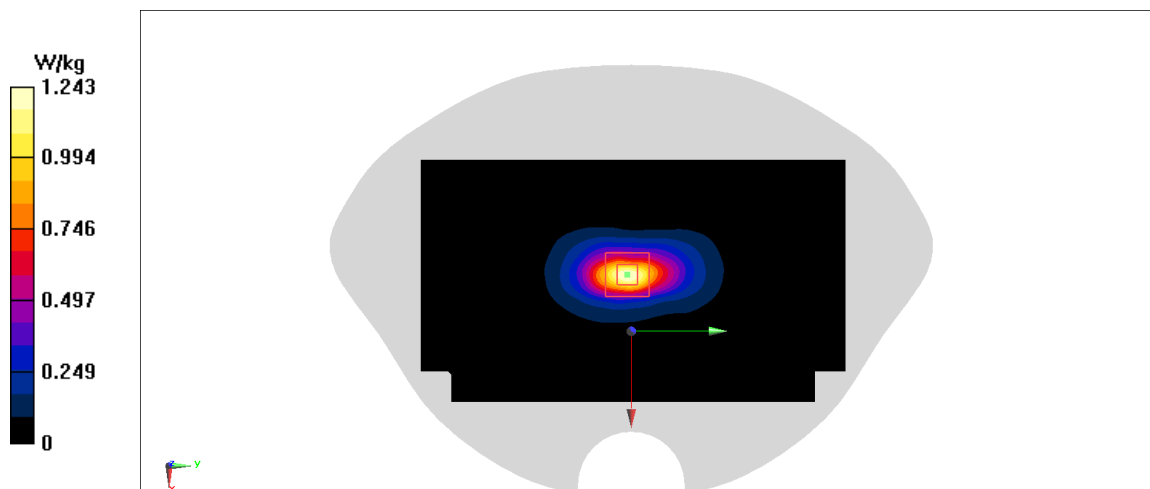
**Fig A.10**

WCDMA1700-BIV_CH1513 Bottom Edge 10mm

Date: 4/7/2020

Electronics: DAE4 Sn1289

Medium: head 1750 MHz

Medium parameters used: $f = 1752.6$; $\sigma = 1.338$ mho/m; $\epsilon_r = 39.49$; $\rho = 1000$ kg/m³

Ambient Temperature: 22.5°C, Liquid Temperature: 22.3°C

Communication System: WCDMA1700-BIV 1752.6 Duty Cycle: 1:1

Probe: EX3DV4 – SN7307 ConvF(8.86,8.86,8.86)

Area Scan (71x121x1): Interpolated grid: dx=1.000 mm, dy=1.000 mm

Maximum value of SAR (interpolated) = 2.35 W/kg

Zoom Scan (7x7x7)/Cube 0: Measurement grid: dx=5mm, dy=5mm, dz=5mm

Reference Value = 35.17 V/m; Power Drift = 0.15 dB

Peak SAR (extrapolated) = 2.87 W/kg

SAR(1 g) = 0.816 W/kg; SAR(10 g) = 0.416 W/kg

Maximum value of SAR (measured) = 2.32 W/kg

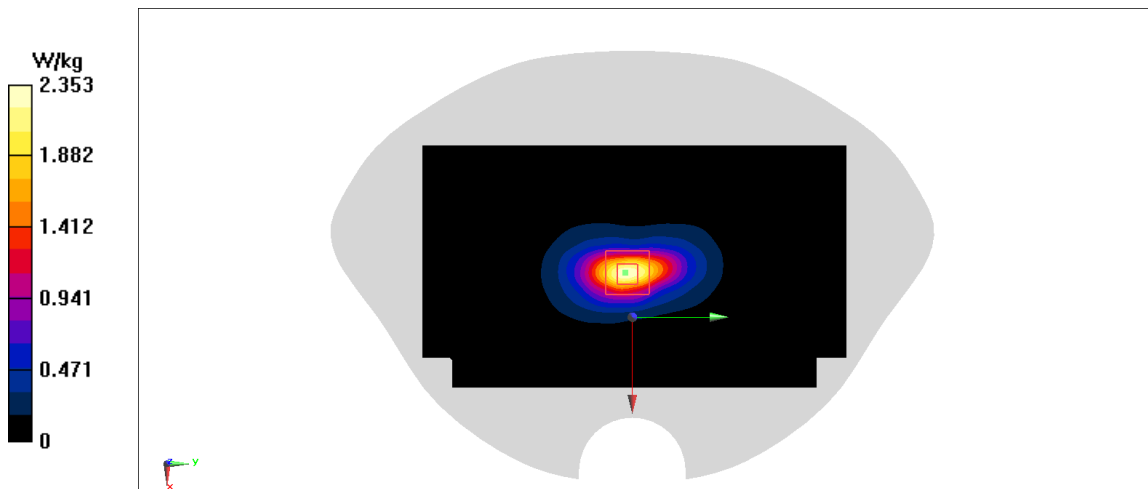

Fig A.11

WCDMA850-BV_CH4132 Left Cheek

Date: 4/6/2020

Electronics: DAE4 Sn1289

Medium: head 835 MHz

Medium parameters used: $f = 826.4$; $\sigma = 0.875$ mho/m; $\epsilon_r = 41.46$; $\rho = 1000$ kg/m³

Ambient Temperature: 22.5°C, Liquid Temperature: 22.3°C

Communication System: WCDMA850-BV 826.4 Duty Cycle: 1:1

Probe: EX3DV4 – SN7307 ConvF(10.45,10.45,10.45)

Area Scan (71x121x1): Interpolated grid: dx=1.000 mm, dy=1.000 mm

Maximum value of SAR (interpolated) = 0.375 W/kg

Zoom Scan (7x7x7)/Cube 0: Measurement grid: dx=5mm, dy=5mm, dz=5mm

Reference Value = 6.432 V/m; Power Drift = 0.01 dB

Peak SAR (extrapolated) = 0.409 W/kg

SAR(1 g) = 0.651 W/kg; SAR(10 g) = 0.481 W/kg

Maximum value of SAR (measured) = 0.364 W/kg

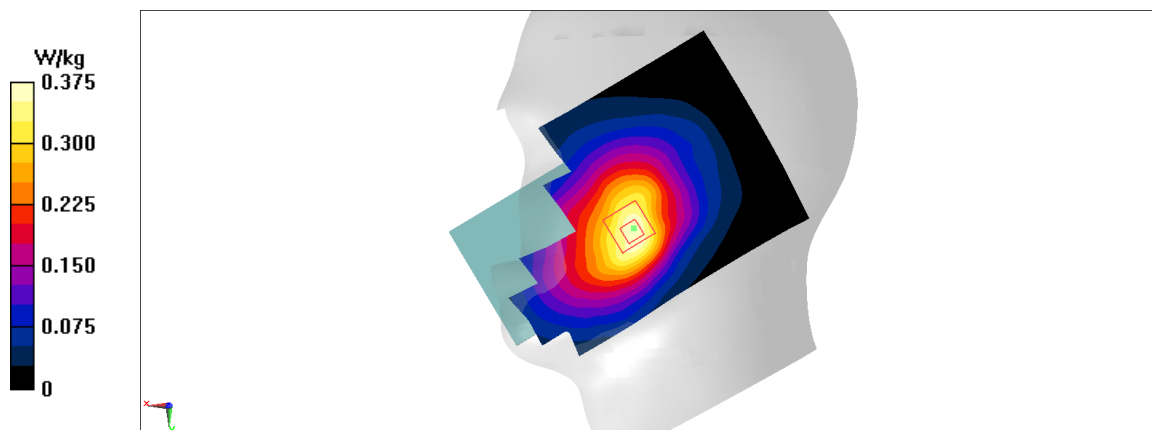
**Fig A.12**

WCDMA850-BV_CH4132 Rear 10mm

Date: 4/6/2020

Electronics: DAE4 Sn1289

Medium: head 835 MHz

Medium parameters used: $f = 826.4$; $\sigma = 0.875$ mho/m; $\epsilon_r = 41.46$; $\rho = 1000$ kg/m³

Ambient Temperature: 22.5°C, Liquid Temperature: 22.3°C

Communication System: WCDMA850-BV 826.4 Duty Cycle: 1:1

Probe: EX3DV4 – SN7307 ConvF(10.45,10.45,10.45)

Area Scan (71x121x1): Interpolated grid: dx=1.000 mm, dy=1.000 mm

Maximum value of SAR (interpolated) = 0.991 W/kg

Zoom Scan (7x7x7)/Cube 0: Measurement grid: dx=5mm, dy=5mm, dz=5mm

Reference Value = 17.63 V/m; Power Drift = -0.12 dB

Peak SAR (extrapolated) = 1.25 W/kg

SAR(1 g) = 0.379 W/kg; SAR(10 g) = 0.239 W/kg

Maximum value of SAR (measured) = 0.996 W/kg

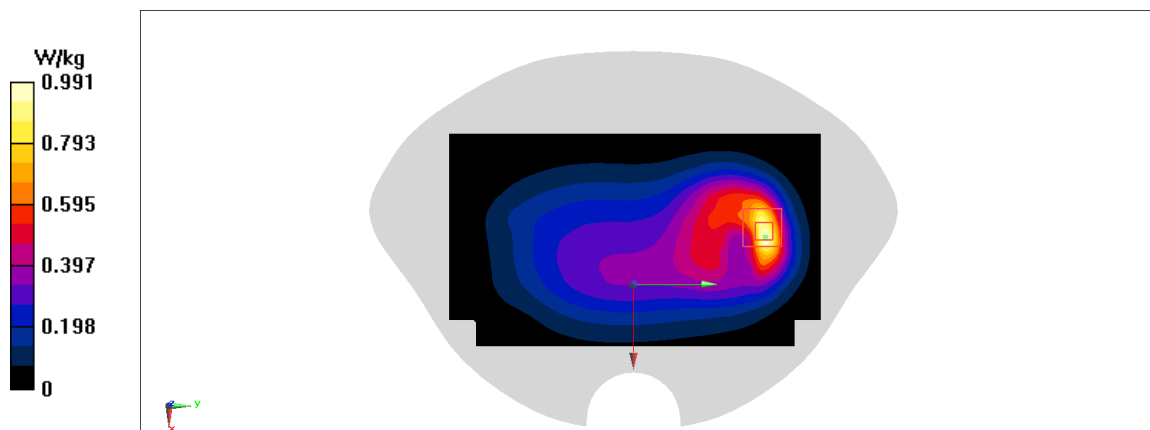
**Fig A.13**

LTE1900-FDD2_CH 18700 Left Cheek

Date: 4/8/2020

Electronics: DAE4 Sn1289

Medium: head 1900 MHz

Medium parameters used: $f = 1860 \text{ MHz}$; $\sigma = 1.344 \text{ mho/m}$; $\epsilon_r = 39.38$; $\rho = 1000 \text{ kg/m}^3$

Ambient Temperature: 22.5°C , Liquid Temperature: 22.3°C

Communication System: LTE1900-FDD2 1860 MHz Duty Cycle: 1:1

Probe: EX3DV4 – SN7307 ConvF(8.56,8.56,8.56)

Area Scan (71x121x1): Interpolated grid: $dx=1.000 \text{ mm}$, $dy=1.000 \text{ mm}$

Maximum value of SAR (interpolated) = 0.199 W/kg

Zoom Scan (7x7x7)/Cube 0: Measurement grid: $dx=5\text{mm}$, $dy=5\text{mm}$, $dz=5\text{mm}$

Reference Value = 5.059 V/m ; Power Drift = 0.04 dB

Peak SAR (extrapolated) = 0.228 W/kg

SAR(1 g) = 0.14 W/kg ; SAR(10 g) = 0.086 W/kg

Maximum value of SAR (measured) = 0.196 W/kg

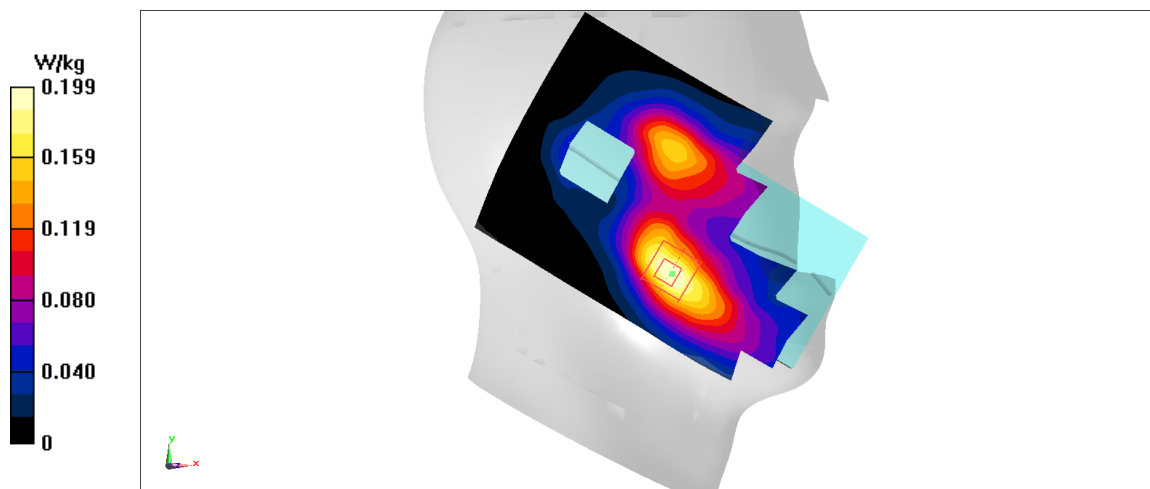

Fig A.14

LTE1900-FDD2_CH 18700 Rear 15mm

Date: 4/8/2020

Electronics: DAE4 Sn1289

Medium: head 1900 MHz

Medium parameters used: $f = 1860$ MHz; $\sigma = 1.344$ mho/m; $\epsilon_r = 39.38$; $\rho = 1000$ kg/m³

Ambient Temperature: 22.5°C, Liquid Temperature: 22.3°C

Communication System: LTE1900-FDD2 1860 MHz Duty Cycle: 1:1

Probe: EX3DV4 – SN7307 ConvF(8.56,8.56,8.56)

Area Scan (71x121x1): Interpolated grid: dx=1.000 mm, dy=1.000 mm

Maximum value of SAR (interpolated) = 1.6 W/kg

Zoom Scan (7x7x7)/Cube 0: Measurement grid: dx=5mm, dy=5mm, dz=5mm

Reference Value = 27.11 V/m; Power Drift = -0.16 dB

Peak SAR (extrapolated) = 1.88 W/kg

SAR(1 g) = 0.575 W/kg; SAR(10 g) = 0.332 W/kg

Maximum value of SAR (measured) = 1.53 W/kg

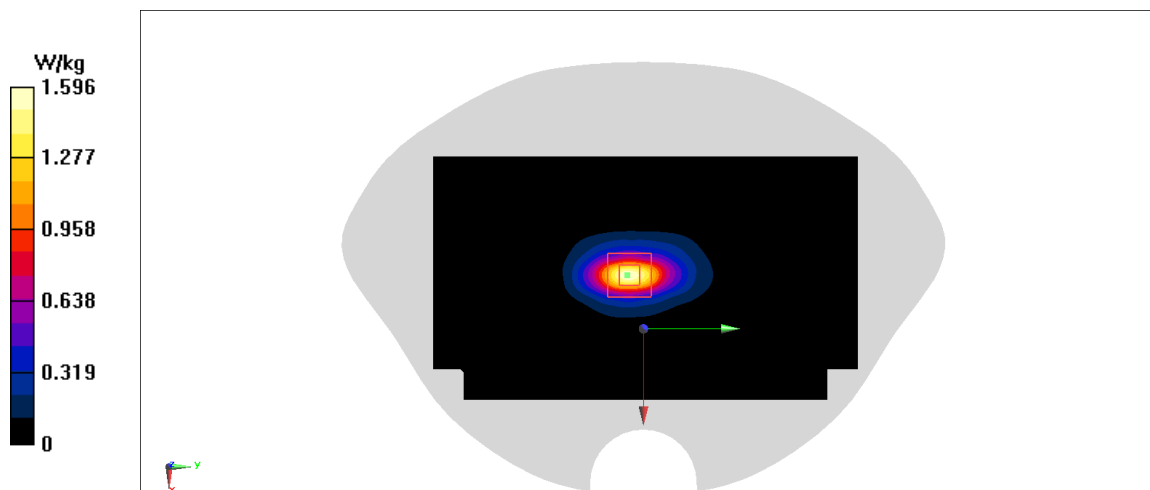

Fig A.15

LTE1900-FDD2_CH19100 Bottom Edge 10mm

Date: 4/8/2020

Electronics: DAE4 Sn1289

Medium: head 1900 MHz

Medium parameters used: $f = 1900$ MHz; $\sigma = 1.344$ mho/m; $\epsilon_r = 39.38$; $\rho = 1000$ kg/m³

Ambient Temperature: 22.5°C, Liquid Temperature: 22.3°C

Communication System: LTE1900-FDD2 1900 MHz Duty Cycle: 1:1

Probe: EX3DV4 – SN7307 ConvF(8.56,8.56,8.56)

Area Scan (71x121x1): Interpolated grid: dx=1.000 mm, dy=1.000 mm

Maximum value of SAR (interpolated) = 2.35 W/kg

Zoom Scan (7x7x7)/Cube 0: Measurement grid: dx=5mm, dy=5mm, dz=5mm

Reference Value = 33.68 V/m; Power Drift = -0.04 dB

Peak SAR (extrapolated) = 2.83 W/kg

SAR(1 g) = 0.99 W/kg; SAR(10 g) = 0.498 W/kg

Maximum value of SAR (measured) = 2.26 W/kg

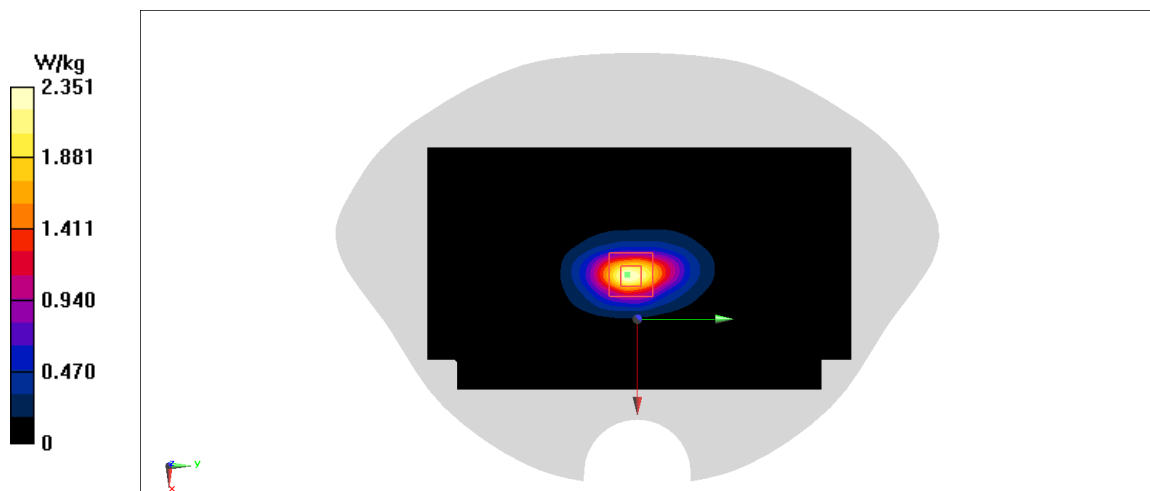
**Fig A.16**

LTE850-FDD5_CH20525 Left Cheek

Date: 4/6/2020

Electronics: DAE4 Sn1289

Medium: head 835 MHz

Medium parameters used: $f = 836.5$ MHz; $\sigma = 0.885$ mho/m; $\epsilon_r = 41.45$; $\rho = 1000$ kg/m³

Ambient Temperature: 22.5°C, Liquid Temperature: 22.3°C

Communication System: LTE850-FDD5 836.5 MHz Duty Cycle: 1:1

Probe: EX3DV4 – SN7307 ConvF(10.45,10.45,10.45)

Area Scan (71x121x1): Interpolated grid: dx=1.000 mm, dy=1.000 mm

Maximum value of SAR (interpolated) = 0.919 W/kg

Zoom Scan (7x7x7)/Cube 0: Measurement grid: dx=5mm, dy=5mm, dz=5mm

Reference Value = 27.67 V/m; Power Drift = -0.15 dB

Peak SAR (extrapolated) = 1.02 W/kg

SAR(1 g) = 0.752 W/kg; SAR(10 g) = 0.555 W/kg

Maximum value of SAR (measured) = 0.917 W/kg

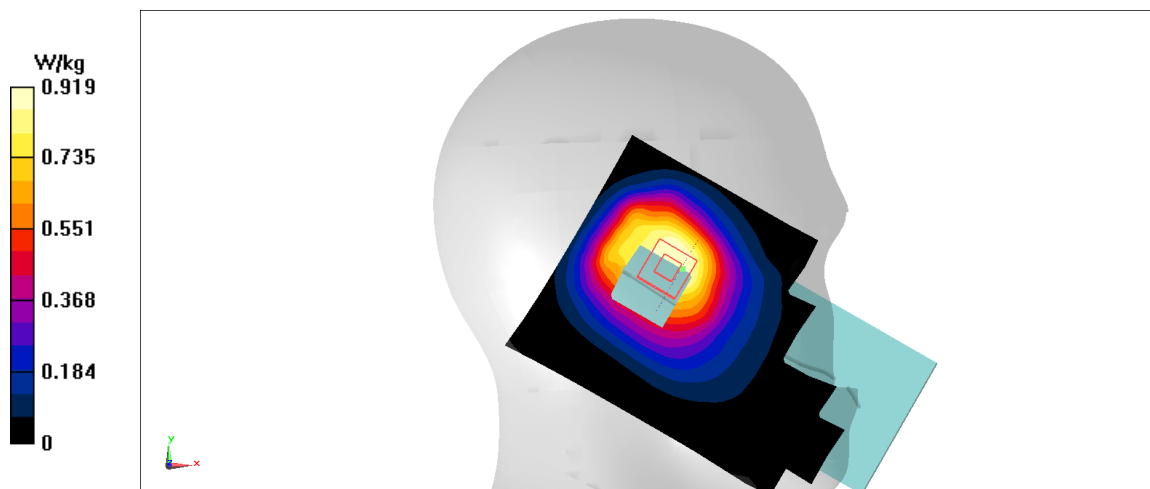

Fig A.17

LTE850-FDD5_CH20525 Rear 10mm

Date: 4/6/2020

Electronics: DAE4 Sn1289

Medium: head 835 MHz

Medium parameters used: $f = 836.5$ MHz; $\sigma = 0.885$ mho/m; $\epsilon_r = 41.45$; $\rho = 1000$ kg/m³

Ambient Temperature: 22.5°C, Liquid Temperature: 22.3°C

Communication System: LTE850-FDD5 836.5 MHz Duty Cycle: 1:1

Probe: EX3DV4 – SN7307 ConvF(10.45,10.45,10.45)

Area Scan (71x121x1): Interpolated grid: dx=1.000 mm, dy=1.000 mm

Maximum value of SAR (interpolated) = 0.546 W/kg

Zoom Scan (7x7x7)/Cube 0: Measurement grid: dx=5mm, dy=5mm, dz=5mm

Reference Value = 18.85 V/m; Power Drift = -0.19 dB

Peak SAR (extrapolated) = 0.626 W/kg

SAR(1 g) = 0.36 W/kg; SAR(10 g) = 0.22 W/kg

Maximum value of SAR (measured) = 0.511 W/kg

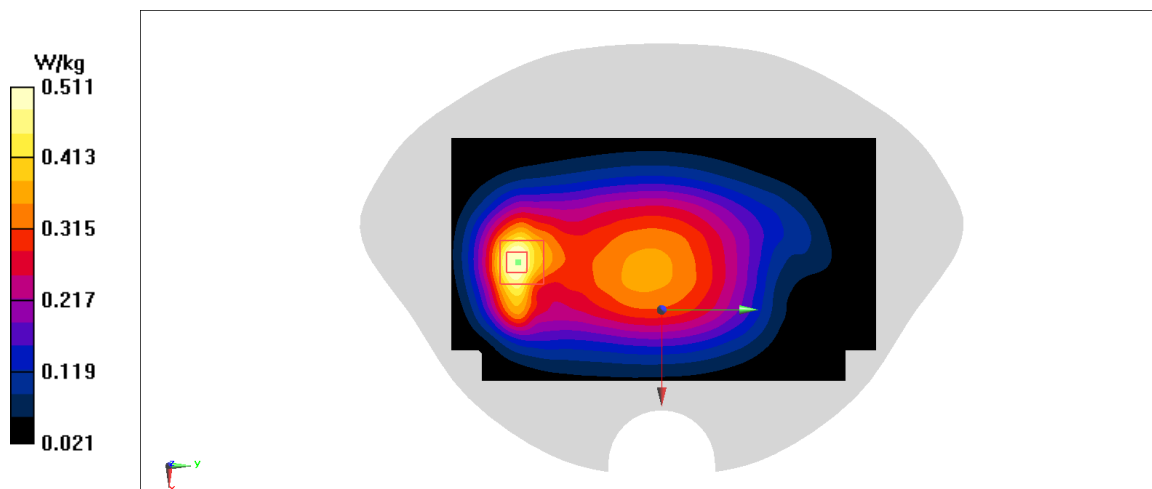
**Fig A.18**

LTE2500-FDD7_CH21100 Right Cheek

Date: 4/10/2020

Electronics: DAE4 Sn1289

Medium: head 2600 MHz

Medium parameters used: $f = 2535$ MHz; $\sigma = 1.894$ mho/m; $\epsilon_r = 38.54$; $\rho = 1000$ kg/m³

Ambient Temperature: 22.5°C, Liquid Temperature: 22.3°C

Communication System: LTE2500-FDD7 2535 MHz Duty Cycle: 1:1

Probe: EX3DV4 – SN7307 ConvF(7.65,7.65,7.65)

Area Scan (71x121x1): Interpolated grid: dx=1.000 mm, dy=1.000 mm

Maximum value of SAR (interpolated) = 0.406 W/kg

Zoom Scan (7x7x7)/Cube 0: Measurement grid: dx=5mm, dy=5mm, dz=5mm

Reference Value = 3.447 V/m; Power Drift = 0.05 dB

Peak SAR (extrapolated) = 0.484 W/kg

SAR(1 g) = 0.252 W/kg; SAR(10 g) = 0.132 W/kg

Maximum value of SAR (measured) = 0.385 W/kg

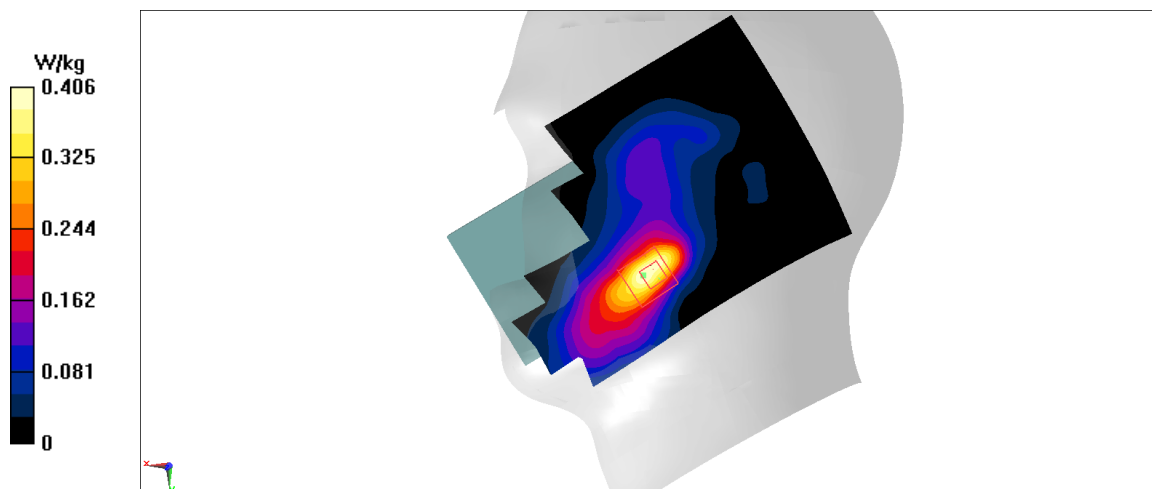
**Fig A.19**

LTE2500-FDD7_CH21100 Rear 15mm

Date: 4/10/2020

Electronics: DAE4 Sn1289

Medium: head 2600 MHz

Medium parameters used: $f = 2535$ MHz; $\sigma = 1.894$ mho/m; $\epsilon_r = 38.54$; $\rho = 1000$ kg/m³

Ambient Temperature: 22.5°C, Liquid Temperature: 22.3°C

Communication System: LTE2500-FDD7 2535 MHz Duty Cycle: 1:1

Probe: EX3DV4 – SN7307 ConvF(7.65,7.65,7.65)

Area Scan (71x121x1): Interpolated grid: dx=1.000 mm, dy=1.000 mm

Maximum value of SAR (interpolated) = 0.924 W/kg

Zoom Scan (7x7x7)/Cube 0: Measurement grid: dx=5mm, dy=5mm, dz=5mm

Reference Value = 6.124 V/m; Power Drift = 0.07 dB

Peak SAR (extrapolated) = 1.19 W/kg

SAR(1 g) = 0.601 W/kg; SAR(10 g) = 0.309 W/kg

Maximum value of SAR (measured) = 0.954 W/kg

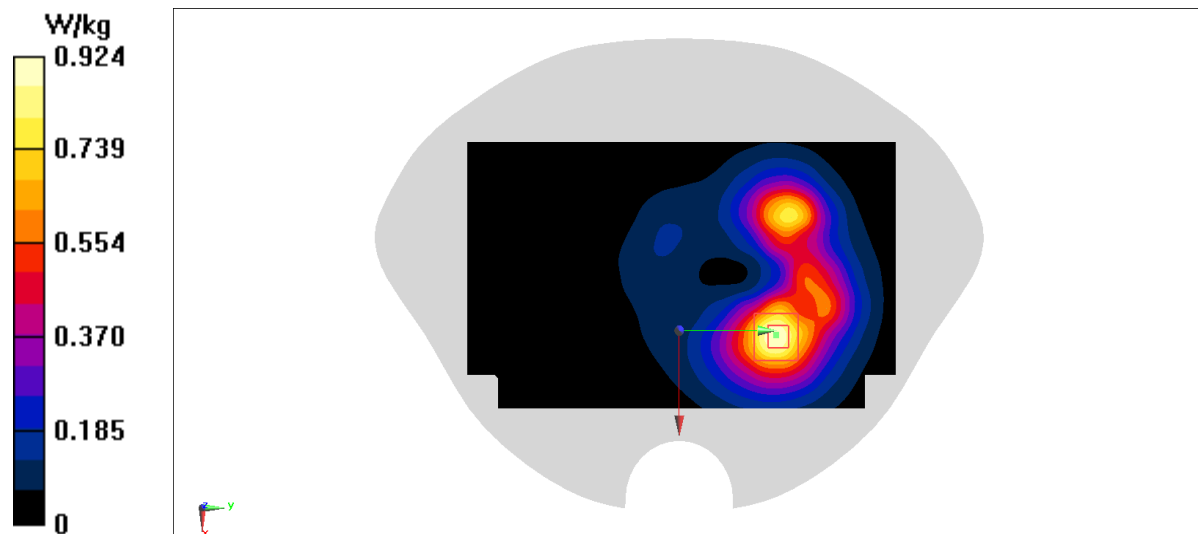

Fig A.20

LTE2500-FDD7_CH21100 Rear 10mm

Date: 4/10/2020

Electronics: DAE4 Sn1289

Medium: head 2600 MHz

Medium parameters used: $f = 2535$ MHz; $\sigma = 1.894$ mho/m; $\epsilon_r = 38.54$; $\rho = 1000$ kg/m³

Ambient Temperature: 22.5°C, Liquid Temperature: 22.3°C

Communication System: LTE2500-FDD7 2535 MHz Duty Cycle: 1:1

Probe: EX3DV4 – SN7307 ConvF(7.65,7.65,7.65)

Area Scan (71x121x1): Interpolated grid: dx=1.000 mm, dy=1.000 mm

Maximum value of SAR (interpolated) = 0.831 W/kg

Zoom Scan (7x7x7)/Cube 0: Measurement grid: dx=5mm, dy=5mm, dz=5mm

Reference Value = 5.073 V/m; Power Drift = 0.01 dB

Peak SAR (extrapolated) = 1.13 W/kg

SAR(1 g) = 0.557 W/kg; SAR(10 g) = 0.278 W/kg

Maximum value of SAR (measured) = 0.887 W/kg

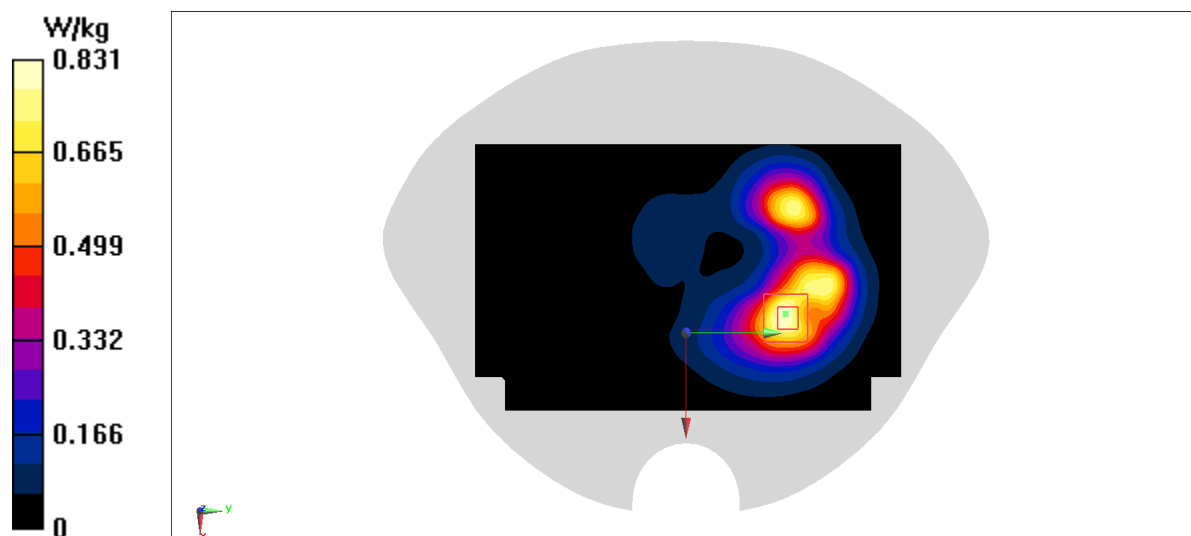

Fig A.21

LTE700-FDD12_CH23095 Left Cheek

Date: 4/5/2020

Electronics: DAE4 Sn1289

Medium: head 750 MHz

Medium parameters used: $f = 707.5$ MHz; $\sigma = 0.857$ mho/m; $\epsilon_r = 42.12$; $\rho = 1000$ kg/m³

Ambient Temperature: 22.5°C, Liquid Temperature: 22.3°C

Communication System: LTE700-FDD12 707.5 MHz Duty Cycle: 1:1

Probe: EX3DV4 – SN7307 ConvF(10.58,10.58,10.58)

Area Scan (71x121x1): Interpolated grid: dx=1.000 mm, dy=1.000 mm

Maximum value of SAR (interpolated) = 1.01 W/kg

Zoom Scan (7x7x7)/Cube 0: Measurement grid: dx=5mm, dy=5mm, dz=5mm

Reference Value = 29.57 V/m; Power Drift = 0.18 dB

Peak SAR (extrapolated) = 1.63 W/kg

SAR(1 g) = 0.741 W/kg; SAR(10 g) = 0.531 W/kg

Maximum value of SAR (measured) = 1.13 W/kg

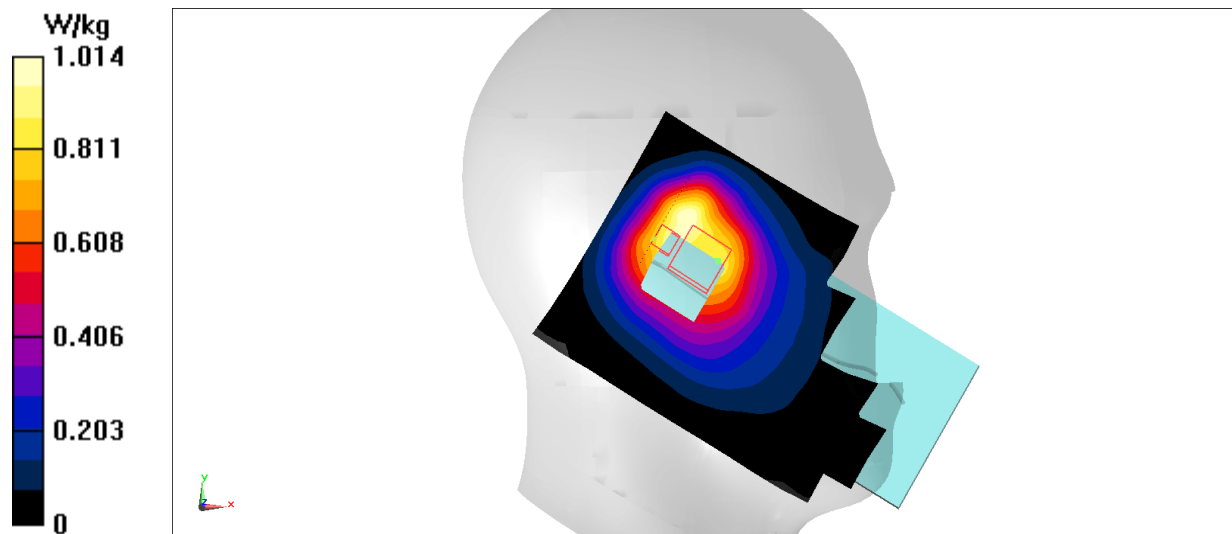

Fig A.22

LTE700-FDD12_CH23095 Right Edge 10mm

Date: 4/5/2020

Electronics: DAE4 Sn1289

Medium: head 750 MHz

Medium parameters used: $f = 707.5$ MHz; $\sigma = 0.857$ mho/m; $\epsilon_r = 42.12$; $\rho = 1000$ kg/m³

Ambient Temperature: 22.5°C, Liquid Temperature: 22.3°C

Communication System: LTE700-FDD12 707.5 MHz Duty Cycle: 1:1

Probe: EX3DV4 – SN7307 ConvF(10.58,10.58,10.58)

Area Scan (71x121x1): Interpolated grid: dx=1.000 mm, dy=1.000 mm

Maximum value of SAR (interpolated) = 0.262 W/kg

Zoom Scan (7x7x7)/Cube 0: Measurement grid: dx=5mm, dy=5mm, dz=5mm

Reference Value = 16.19 V/m; Power Drift = 0.01 dB

Peak SAR (extrapolated) = 0.31 W/kg

SAR(1 g) = 0.203 W/kg; SAR(10 g) = 0.14 W/kg

Maximum value of SAR (measured) = 0.271 W/kg

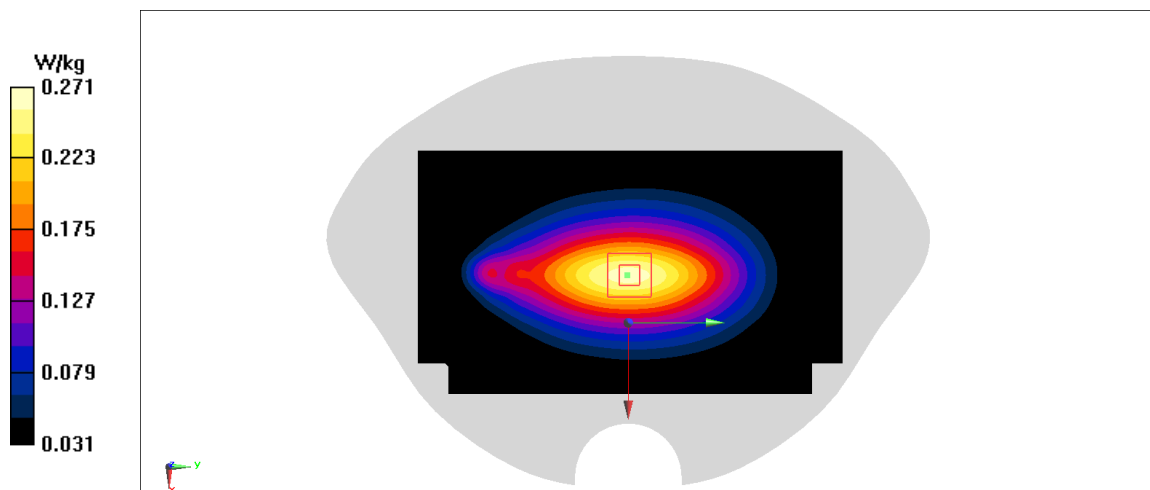

Fig A.23

LTE750-FDD13_CH23230 Right Cheek

Date: 4/5/2020

Electronics: DAE4 Sn1289

Medium: head 750 MHz

Medium parameters used: $f = 782 \text{ MHz}$; $\sigma = 0.927 \text{ mho/m}$; $\epsilon_r = 42.03$; $\rho = 1000 \text{ kg/m}^3$

Ambient Temperature: 22.5°C , Liquid Temperature: 22.3°C

Communication System: LTE750-FDD13 782 MHz Duty Cycle: 1:1

Probe: EX3DV4 – SN7307 ConvF(10.58,10.58,10.58)

Area Scan (71x121x1): Interpolated grid: $dx=1.000 \text{ mm}$, $dy=1.000 \text{ mm}$

Maximum value of SAR (interpolated) = 0.418 W/kg

Zoom Scan (7x7x7)/Cube 0: Measurement grid: $dx=5\text{mm}$, $dy=5\text{mm}$, $dz=5\text{mm}$

Reference Value = 7.223 V/m ; Power Drift = -0.04 dB

Peak SAR (extrapolated) = 0.455 W/kg

SAR(1 g) = 0.339 W/kg ; SAR(10 g) = 0.256 W/kg

Maximum value of SAR (measured) = 0.415 W/kg

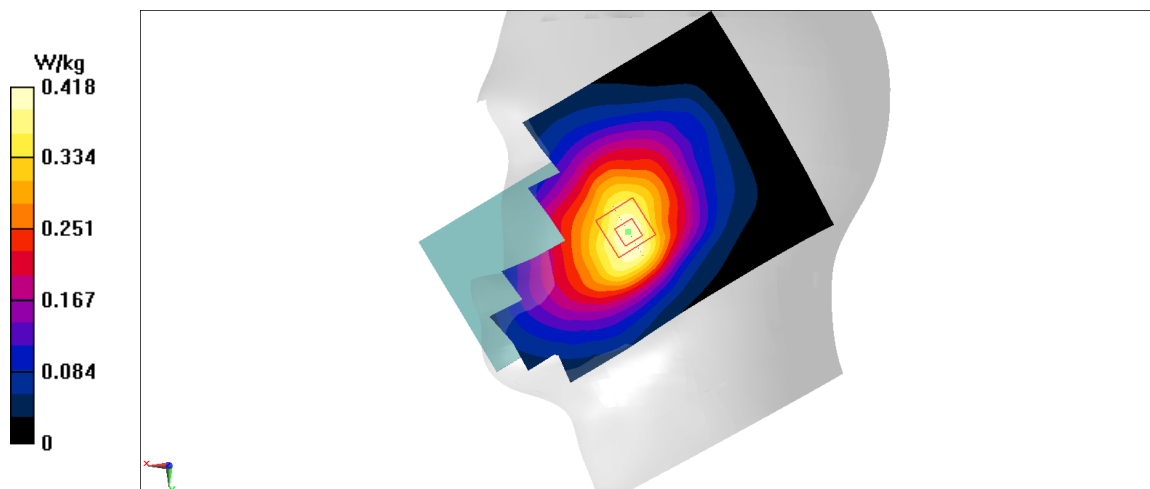

Fig A.24

LTE750-FDD13_CH23230 Rear 10mm

Date: 4/5/2020

Electronics: DAE4 Sn1289

Medium: head 750 MHz

Medium parameters used: $f = 782 \text{ MHz}$; $\sigma = 0.927 \text{ mho/m}$; $\epsilon_r = 42.03$; $\rho = 1000 \text{ kg/m}^3$

Ambient Temperature: 22.5°C, Liquid Temperature: 22.3°C

Communication System: LTE750-FDD13 782 MHz Duty Cycle: 1:1

Probe: EX3DV4 – SN7307 ConvF(10.58,10.58,10.58)

Area Scan (71x121x1): Interpolated grid: $dx=1.000 \text{ mm}$, $dy=1.000 \text{ mm}$

Maximum value of SAR (interpolated) = 0.61 W/kg

Zoom Scan (7x7x7)/Cube 0: Measurement grid: $dx=5\text{mm}$, $dy=5\text{mm}$, $dz=5\text{mm}$

Reference Value = 21.31 V/m; Power Drift = 0.02 dB

Peak SAR (extrapolated) = 0.832 W/kg

SAR(1 g) = 0.406 W/kg; SAR(10 g) = 0.225 W/kg

Maximum value of SAR (measured) = 0.647 W/kg

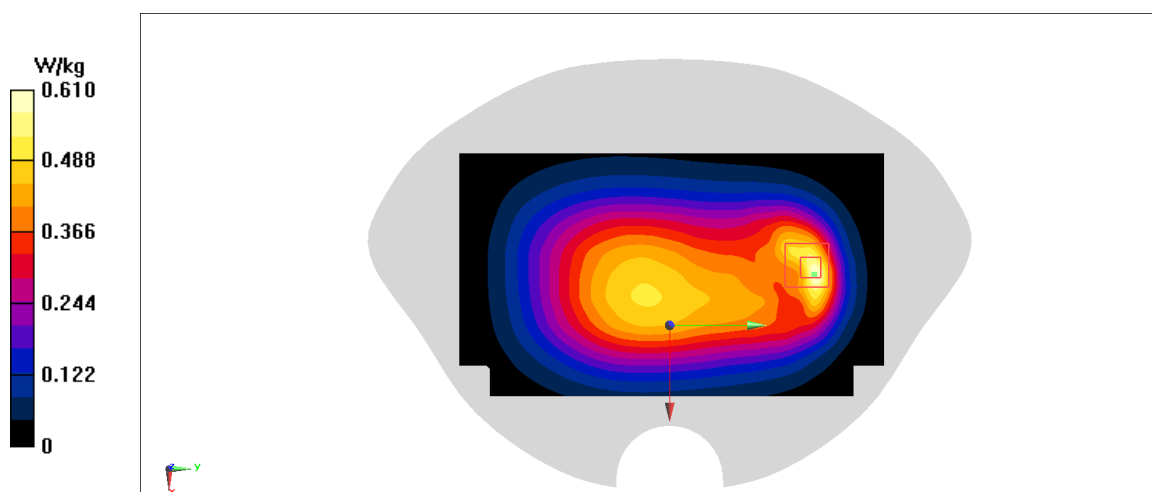

Fig A.25

LTE1700-FDD66_CH132572 Right Cheek

Date: 4/7/2020

Electronics: DAE4 Sn1289

Medium: head 1750 MHz

Medium parameters used: $f = 782 \text{ MHz}$; $\sigma = 0.454 \text{ mho/m}$; $\epsilon_r = 40.6$; $\rho = 1000 \text{ kg/m}^3$

Ambient Temperature: 22.5°C, Liquid Temperature: 22.3°C

Communication System: LTE1700-FDD66 782 MHz Duty Cycle: 1:1

Probe: EX3DV4 – SN7307 ConvF(8.86,8.86,8.86)

Area Scan (71x121x1): Interpolated grid: $dx=1.000 \text{ mm}$, $dy=1.000 \text{ mm}$

Maximum value of SAR (interpolated) = 0.299 W/kg

Zoom Scan (7x7x7)/Cube 0: Measurement grid: $dx=5\text{mm}$, $dy=5\text{mm}$, $dz=5\text{mm}$

Reference Value = 6.076 V/m; Power Drift = 0.18 dB

Peak SAR (extrapolated) = 0.339 W/kg

SAR(1 g) = 0.289 W/kg; SAR(10 g) = 0.179 W/kg

Maximum value of SAR (measured) = 0.295 W/kg

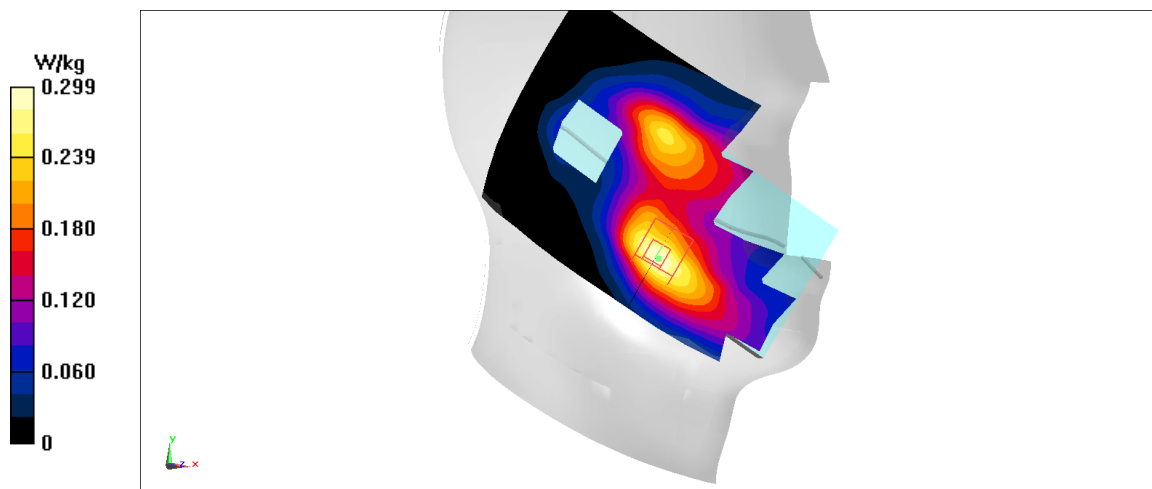

Fig A.26

LTE1700-FDD66_CH132572 Front 15mm

Date: 4/7/2020

Electronics: DAE4 Sn1289

Medium: head 1750 MHz

Medium parameters used: $f = 782 \text{ MHz}$; $\sigma = 0.454 \text{ mho/m}$; $\epsilon_r = 40.6$; $\rho = 1000 \text{ kg/m}^3$

Ambient Temperature: 22.5°C, Liquid Temperature: 22.3°C

Communication System: LTE1700-FDD66 782 MHz Duty Cycle: 1:1

Probe: EX3DV4 – SN7307 ConvF(8.86,8.86,8.86)

Area Scan (71x121x1): Interpolated grid: $dx=1.000 \text{ mm}$, $dy=1.000 \text{ mm}$

Maximum value of SAR (interpolated) = 0.786 W/kg

Zoom Scan (7x7x7)/Cube 0: Measurement grid: $dx=5\text{mm}$, $dy=5\text{mm}$, $dz=5\text{mm}$

Reference Value = 7.011 V/m; Power Drift = -0.09 dB

Peak SAR (extrapolated) = 0.541 W/kg

SAR(1 g) = 0.592 W/kg; SAR(10 g) = 0.342 W/kg

Maximum value of SAR (measured) = 0.315 W/kg

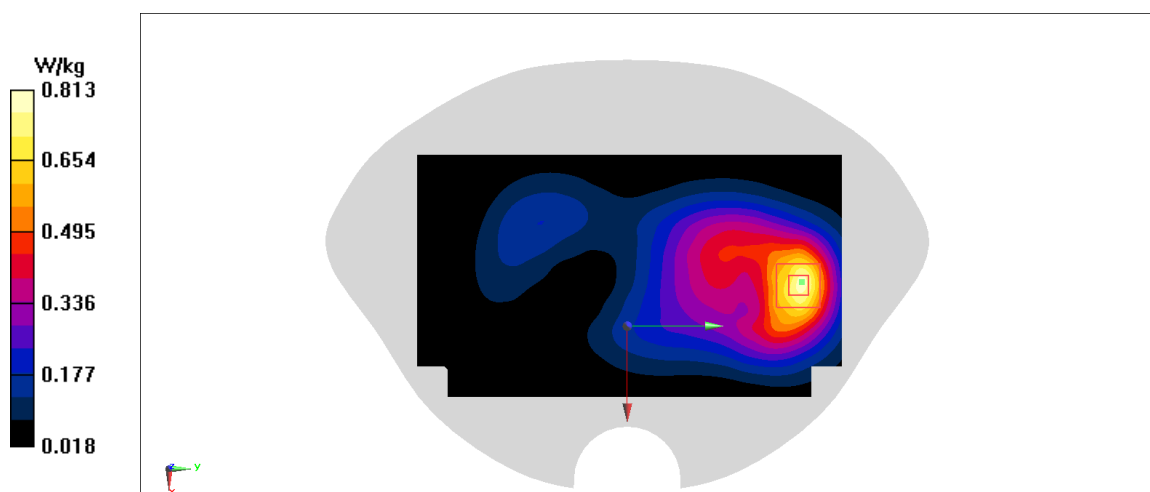

Fig A.27

LTE1700-FDD66_CH132322 Bottom Edge 10mm

Date: 4/7/2020

Electronics: DAE4 Sn1289

Medium: head 1750 MHz

Medium parameters used: $f = 782 \text{ MHz}$; $\sigma = 0.454 \text{ mho/m}$; $\epsilon_r = 40.6$; $\rho = 1000 \text{ kg/m}^3$

Ambient Temperature: 22.5°C, Liquid Temperature: 22.3°C

Communication System: LTE1700-FDD66 782 MHz Duty Cycle: 1:1

Probe: EX3DV4 – SN7307 ConvF(8.86,8.86,8.86)

Area Scan (71x121x1): Interpolated grid: $dx=1.000 \text{ mm}$, $dy=1.000 \text{ mm}$

Maximum value of SAR (interpolated) = 1.62 W/kg

Zoom Scan (7x7x7)/Cube 0: Measurement grid: $dx=5\text{mm}$, $dy=5\text{mm}$, $dz=5\text{mm}$

Reference Value = 29.86 V/m; Power Drift = -0.06 dB

Peak SAR (extrapolated) = 1.94 W/kg

SAR(1 g) = 1.05 W/kg; SAR(10 g) = 0.542 W/kg

Maximum value of SAR (measured) = 1.57 W/kg

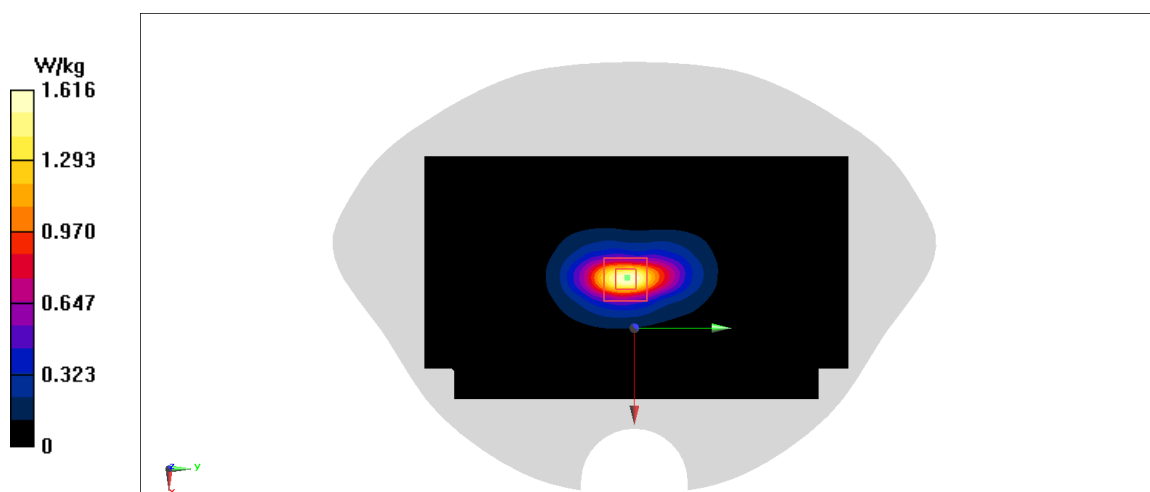

Fig A.28

LTE700-FDD71_CH133222 Left Cheek

Date: 4/5/2020

Electronics: DAE4 Sn1289

Medium: head 750 MHz

Medium parameters used: $f = 782$ MHz; $\sigma = 0.927$ mho/m; $\epsilon_r = 42.03$; $\rho = 1000$ kg/m³

Ambient Temperature: 22.5°C, Liquid Temperature: 22.3°C

Communication System: LTE700-FDD71 782 MHz Duty Cycle: 1:1

Probe: EX3DV4 – SN7307 ConvF(10.58,10.58,10.58)

Area Scan (71x121x1): Interpolated grid: dx=1.000 mm, dy=1.000 mm

Maximum value of SAR (interpolated) = 0.794 W/kg

Zoom Scan (7x7x7)/Cube 0: Measurement grid: dx=5mm, dy=5mm, dz=5mm

Reference Value = 26.89 V/m; Power Drift = -0.04 dB

Peak SAR (extrapolated) = 1.27 W/kg

SAR(1 g) = 0.556 W/kg; SAR(10 g) = 0.39 W/kg

Maximum value of SAR (measured) = 0.871 W/kg

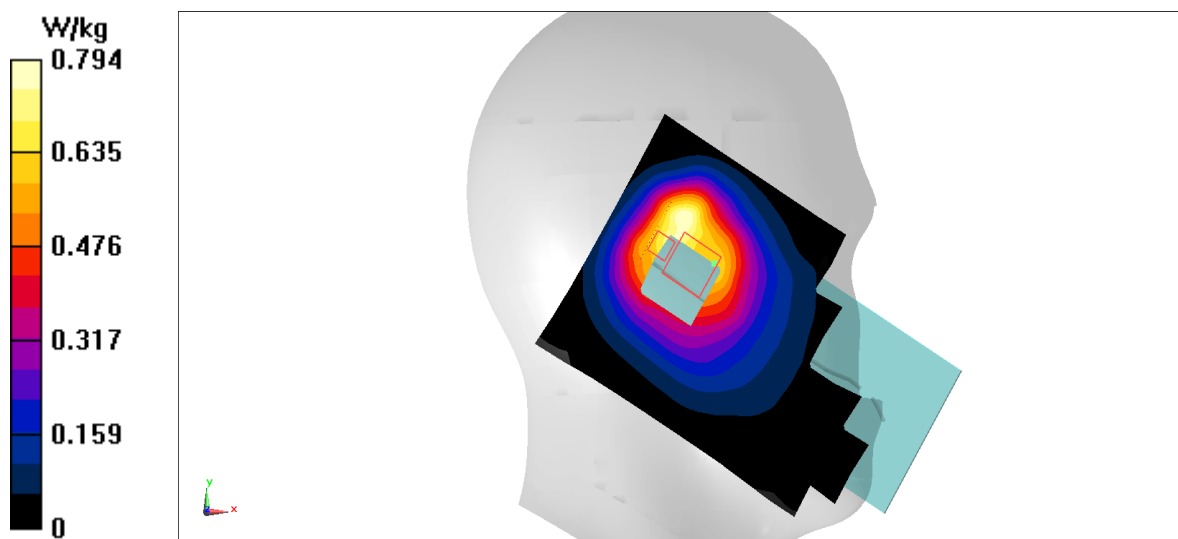

Fig A.29

LTE700-FDD71_CH133222 Right Edge 10mm

Date: 4/5/2020

Electronics: DAE4 Sn1289

Medium: head 750 MHz

Medium parameters used: $f = 782$ MHz; $\sigma = 0.927$ mho/m; $\epsilon_r = 42.03$; $\rho = 1000$ kg/m³

Ambient Temperature: 22.5°C, Liquid Temperature: 22.3°C

Communication System: LTE700-FDD71 782 MHz Duty Cycle: 1:1

Probe: EX3DV4 – SN7307 ConvF(10.58,10.58,10.58)

Area Scan (71x121x1): Interpolated grid: dx=1.000 mm, dy=1.000 mm

Maximum value of SAR (interpolated) = 0.339 W/kg

Zoom Scan (7x7x7)/Cube 0: Measurement grid: dx=5mm, dy=5mm, dz=5mm

Reference Value = 17.82 V/m; Power Drift = -0.03 dB

Peak SAR (extrapolated) = 0.39 W/kg

SAR(1 g) = 0.257 W/kg; SAR(10 g) = 0.18 W/kg

Maximum value of SAR (measured) = 0.339 W/kg

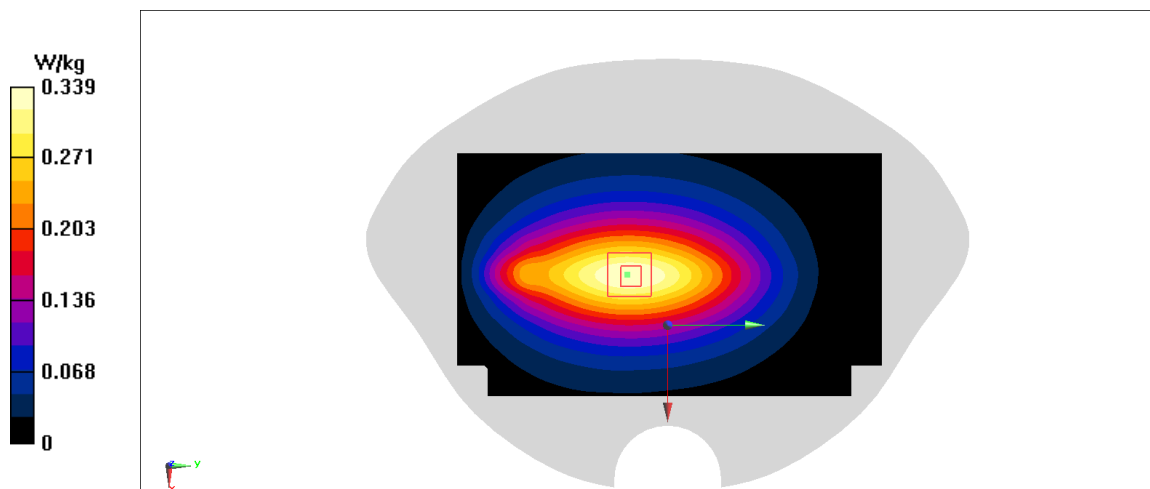
**Fig A.30**

WLAN2450_CH1 Right Cheek

Date: 4/9/2020

Electronics: DAE4 Sn1289

Medium: head 2450 MHz

Medium parameters used: $f = 2412$; $\sigma = 1.764$ mho/m; $\epsilon_r = 38.63$; $\rho = 1000$ kg/m³

Ambient Temperature: 22.5°C, Liquid Temperature: 22.3°C

Communication System: WLAN2450 2412 Duty Cycle: 1:1

Probe: EX3DV4 – SN7307 ConvF(7.83,7.83,7.83)

Area Scan (71x121x1): Interpolated grid: dx=1.000 mm, dy=1.000 mm

Maximum value of SAR (interpolated) = 0.75 W/kg

Zoom Scan (7x7x7)/Cube 0: Measurement grid: dx=5mm, dy=5mm, dz=5mm

Reference Value = 11.1 V/m; Power Drift = -0.03 dB

Peak SAR (extrapolated) = 0.859 W/kg

SAR(1 g) = 0.432 W/kg; SAR(10 g) = 0.225 W/kg

Maximum value of SAR (measured) = 0.681 W/kg

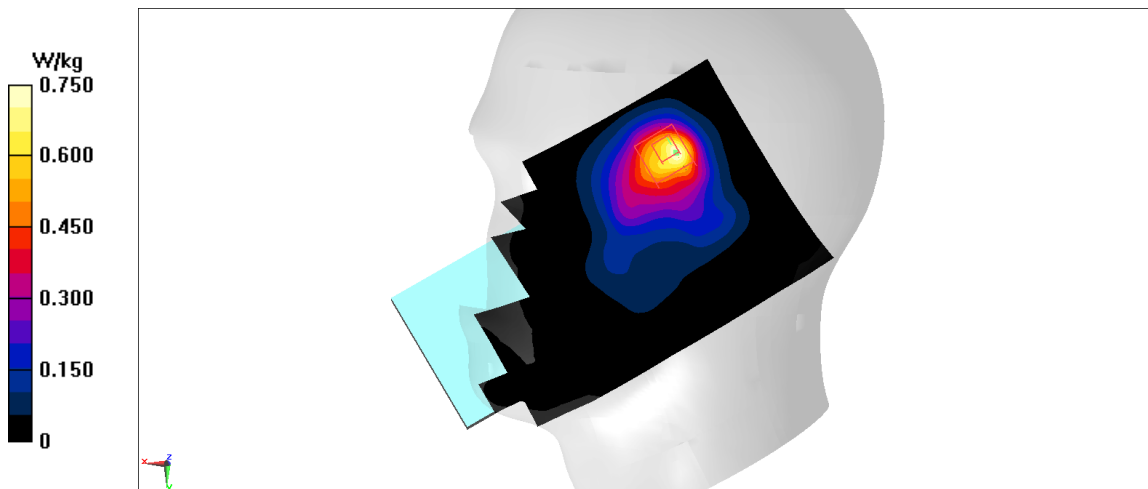

Fig A.31

WLAN2450_CH1 Rear 10mm

Date: 4/9/2020

Electronics: DAE4 Sn1289

Medium: head 2450 MHz

Medium parameters used: $f = 2412$; $\sigma = 1.764$ mho/m; $\epsilon_r = 38.63$; $\rho = 1000$ kg/m³

Ambient Temperature: 22.5°C, Liquid Temperature: 22.3°C

Communication System: WLAN2450 2412 Duty Cycle: 1:1

Probe: EX3DV4 – SN7307 ConvF(7.83,7.83,7.83)

Area Scan (71x121x1): Interpolated grid: dx=1.000 mm, dy=1.000 mm

Maximum value of SAR (interpolated) = 0.513 W/kg

Zoom Scan (7x7x7)/Cube 0: Measurement grid: dx=5mm, dy=5mm, dz=5mm

Reference Value = 5.957 V/m; Power Drift = 0.18 dB

Peak SAR (extrapolated) = 0.759 W/kg

SAR(1 g) = 0.314 W/kg; SAR(10 g) = 0.143 W/kg

Maximum value of SAR (measured) = 0.574 W/kg

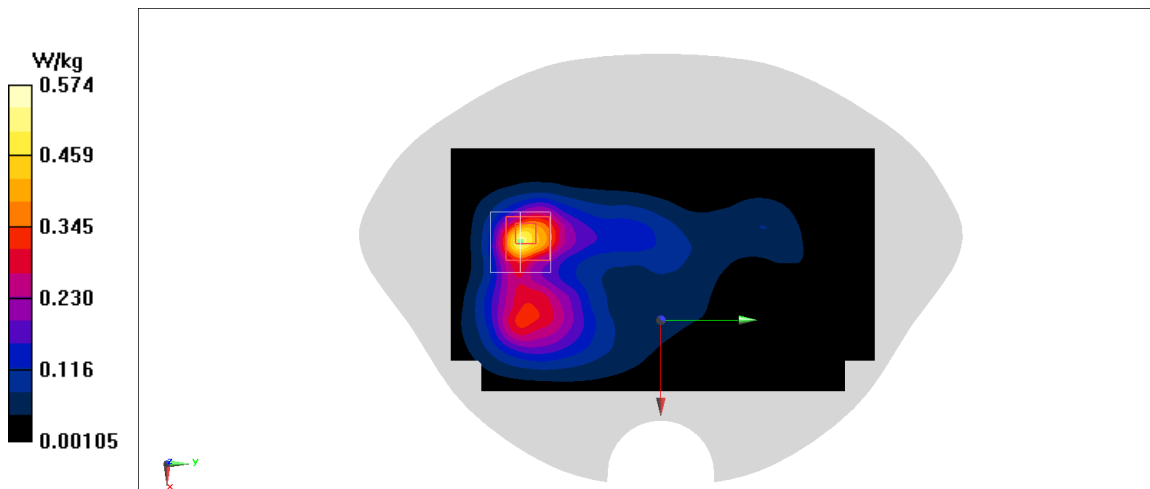

Fig A.32

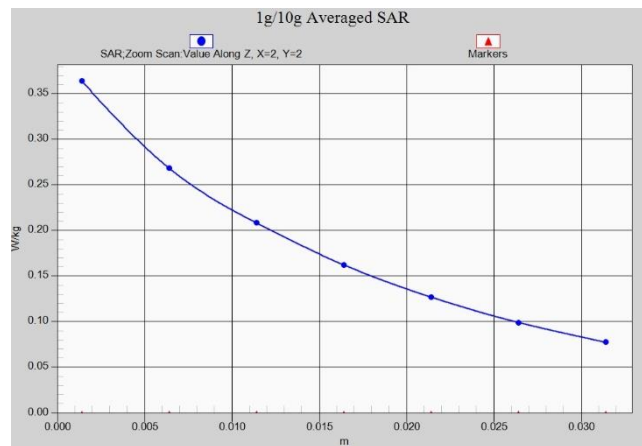

Fig. 1-1 Z-Scan at power reference point (GSM850)

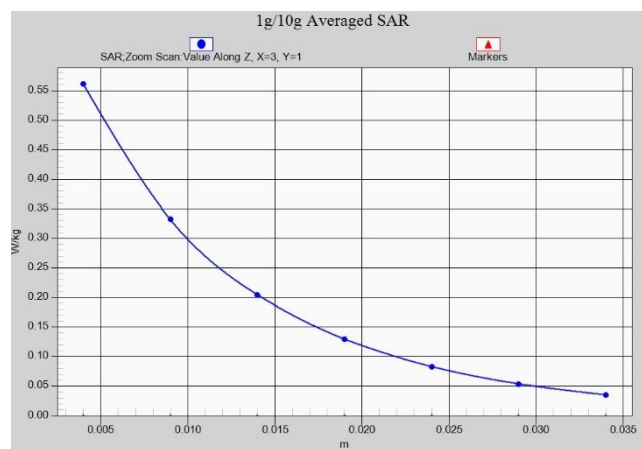

Fig. 1-2 Z-Scan at power reference point (GSM850)

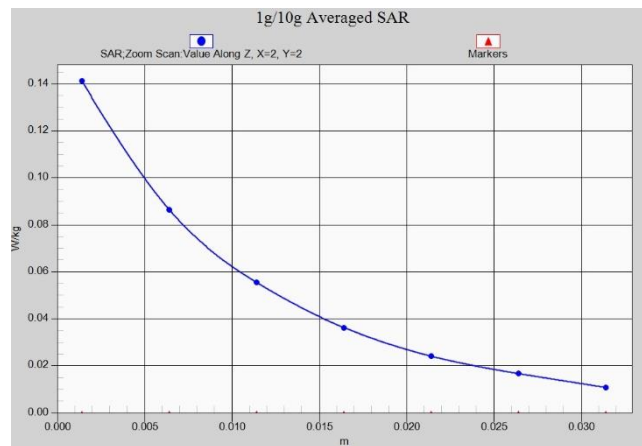

Fig. 1-3 Z-Scan at power reference point (PCS1900)

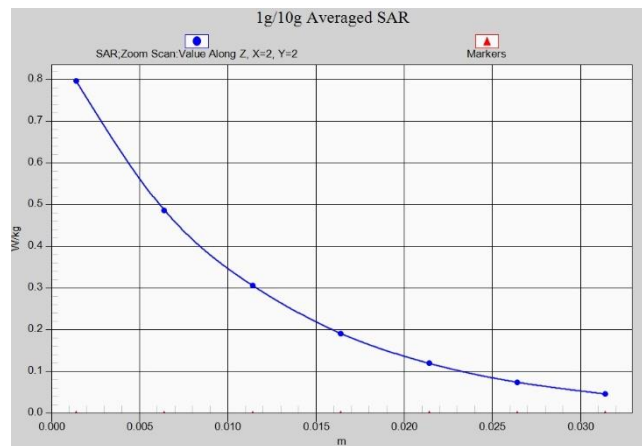

Fig. 1-4 Z-Scan at power reference point (PCS1900)

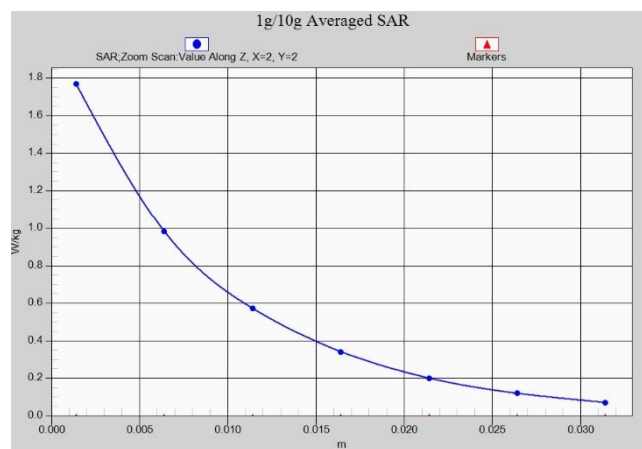

Fig. 1-5 Z-Scan at power reference point (PCS1900)

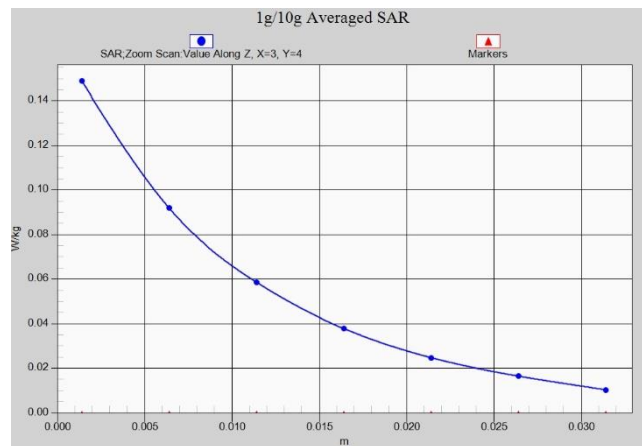

Fig. 1-6 Z-Scan at power reference point (WCDMA1900)

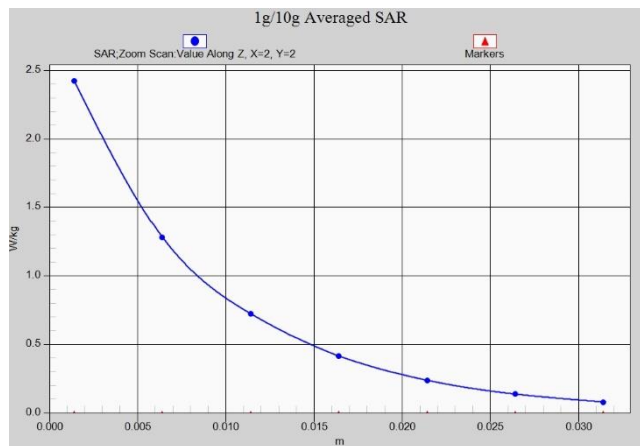

Fig. 1-7 Z-Scan at power reference point (WCDMA1900)

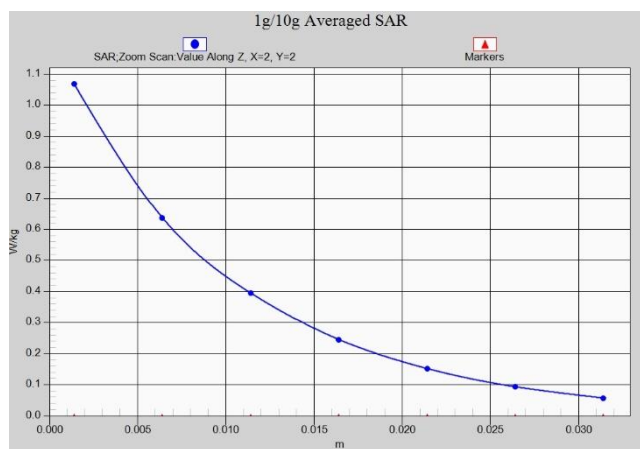

Fig. 1-8 Z-Scan at power reference point (WCDMA1900)

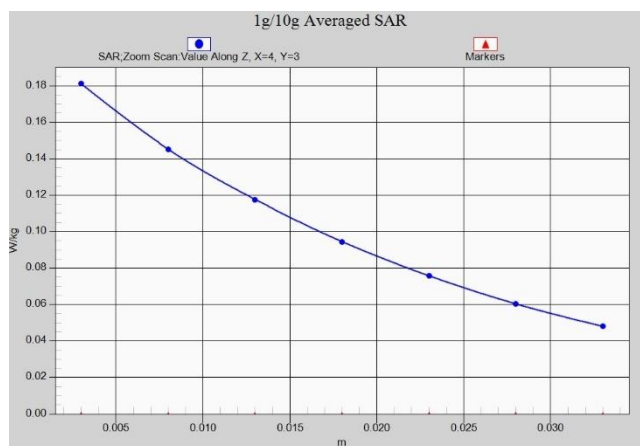

Fig. 1-9 Z-Scan at power reference point (WCDMA850)

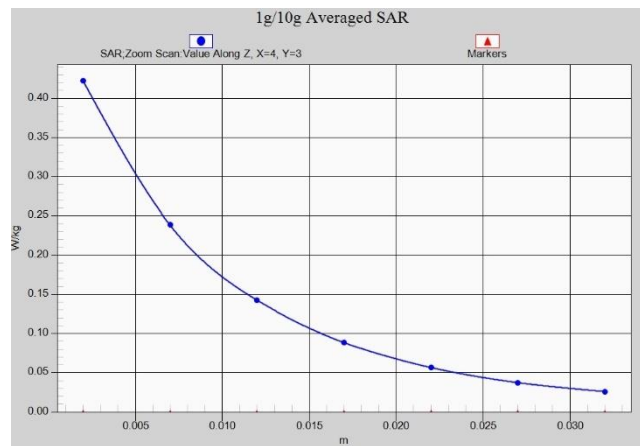

Fig. 1-10 Z-Scan at power reference point (WCDMA850)

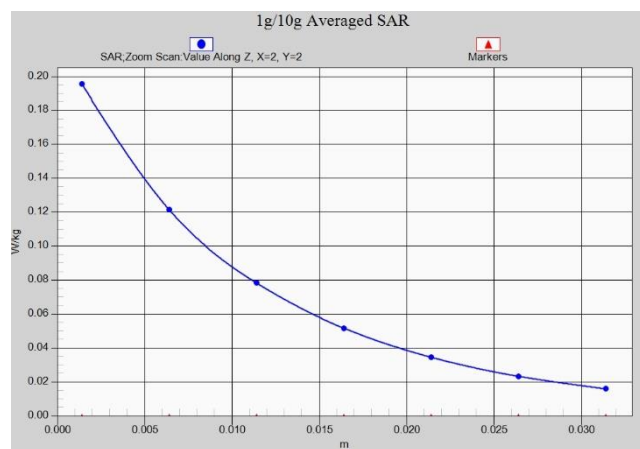

Fig. 1-11 Z-Scan at power reference point (LTE Band2)

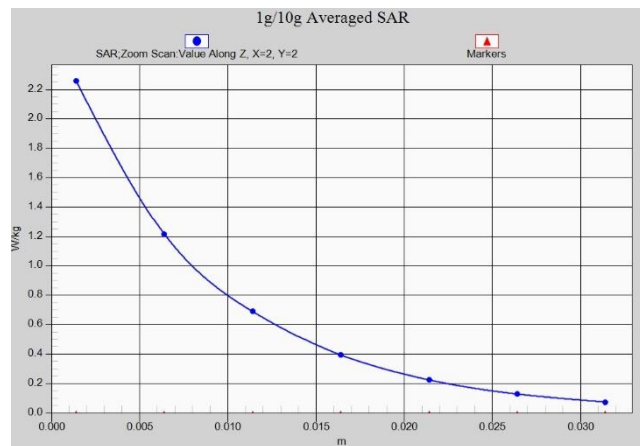

Fig. 1-12 Z-Scan at power reference point (LTE Band2)

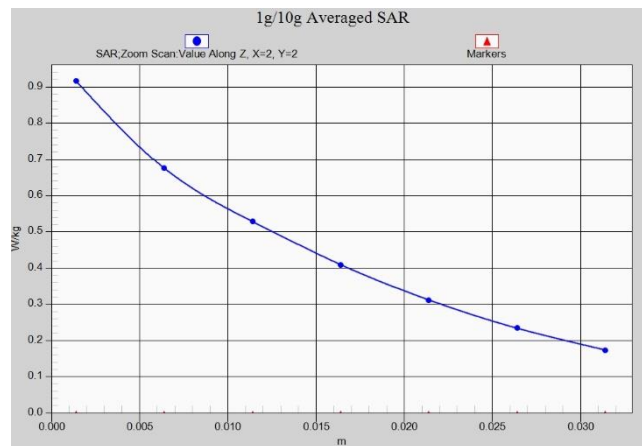

Fig. 1-13 Z-Scan at power reference point (LTE Band5)

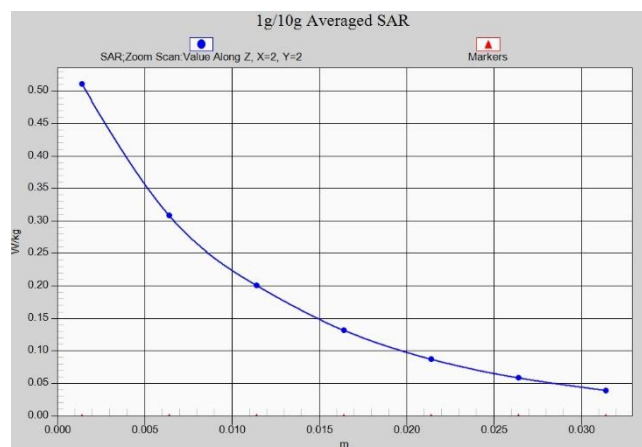

Fig. 1-14 Z-Scan at power reference point (LTE Band5)

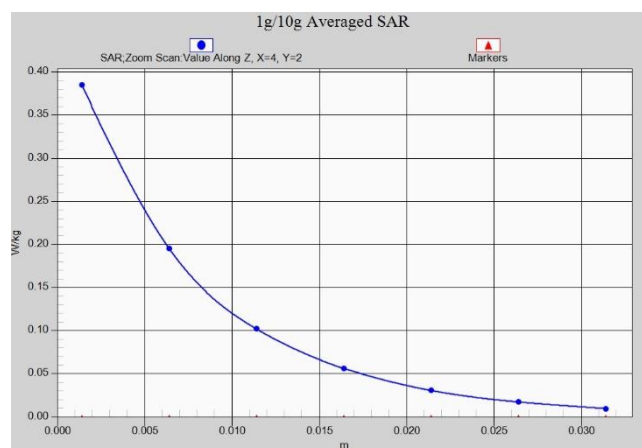

Fig. 1-15 Z-Scan at power reference point (LTE Band7)

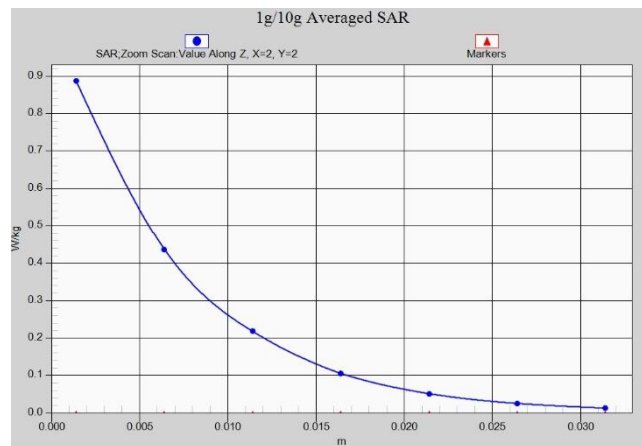

Fig. 1-16 Z-Scan at power reference point (LTE Band7)

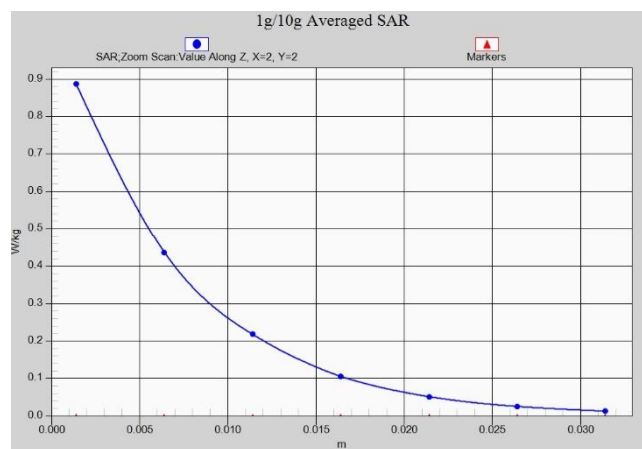

Fig. 1-17 Z-Scan at power reference point (LTE Band7)

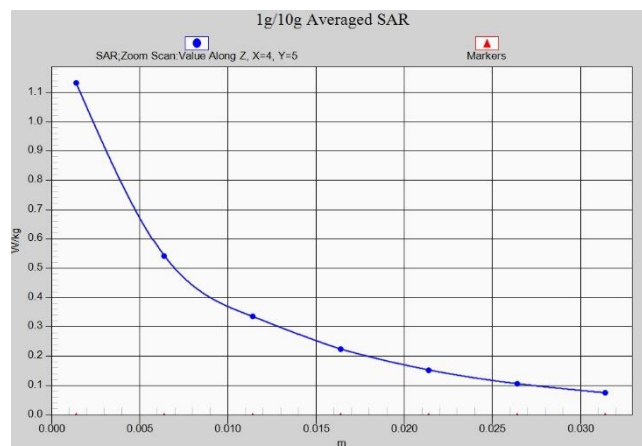

Fig. 1-18 Z-Scan at power reference point (LTE Band12)

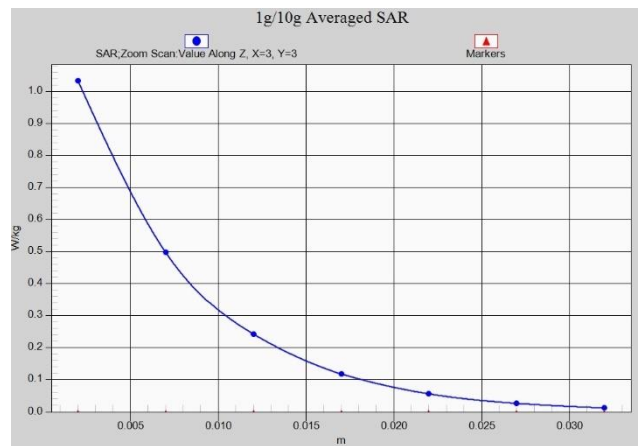

Fig. 1-19 Z-Scan at power reference point (LTE Band12)



Fig. 1-20 Z-Scan at power reference point (LTE Band13)

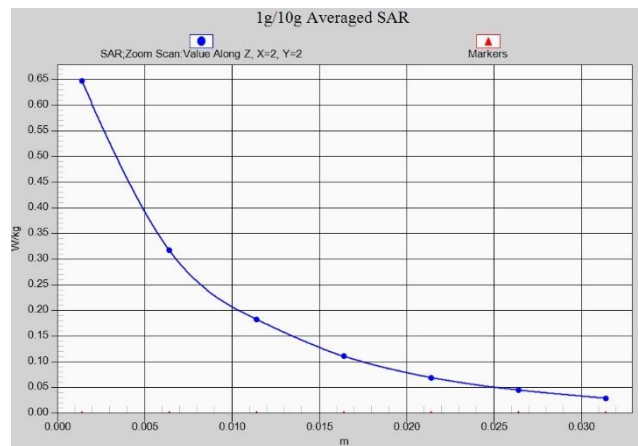

Fig. 1-21 Z-Scan at power reference point (LTE Band13)

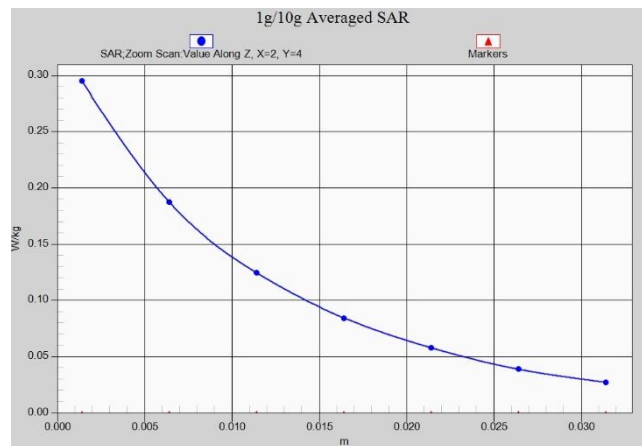

Fig. 1-22 Z-Scan at power reference point (LTE Band66)

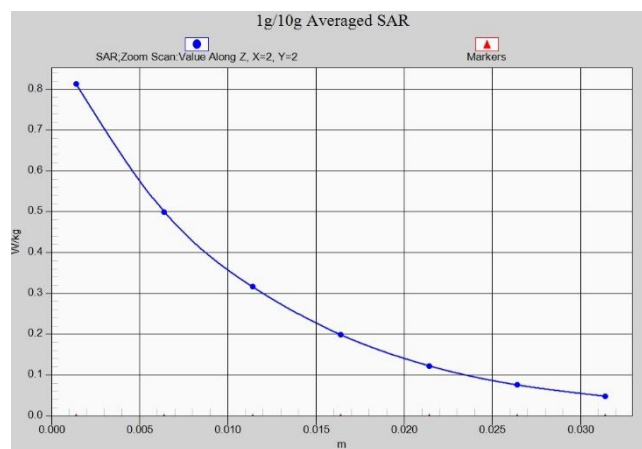

Fig. 1-23 Z-Scan at power reference point (LTE Band66)

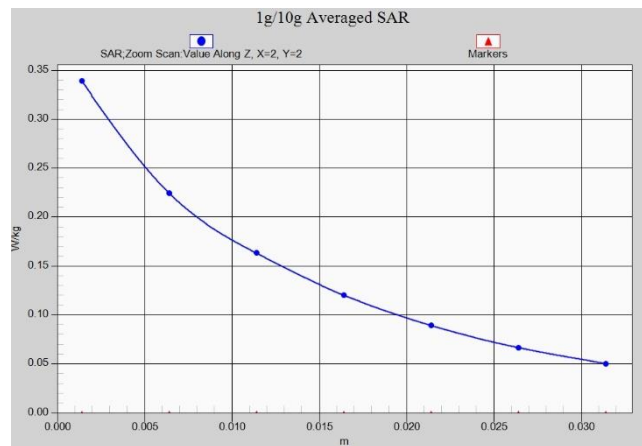

Fig. 1-24 Z-Scan at power reference point (LTE Band66)

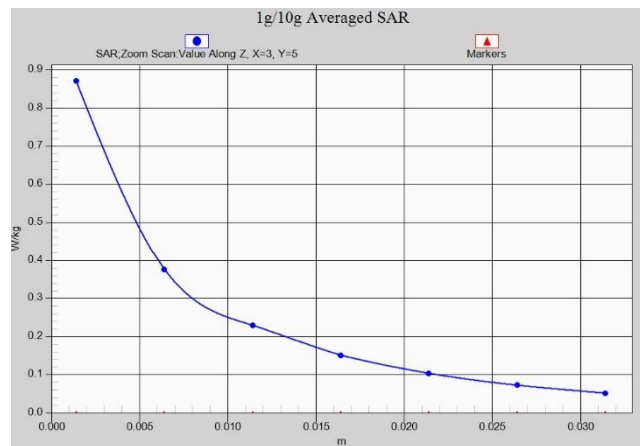

Fig. 1-25 Z-Scan at power reference point (LTE Band71)

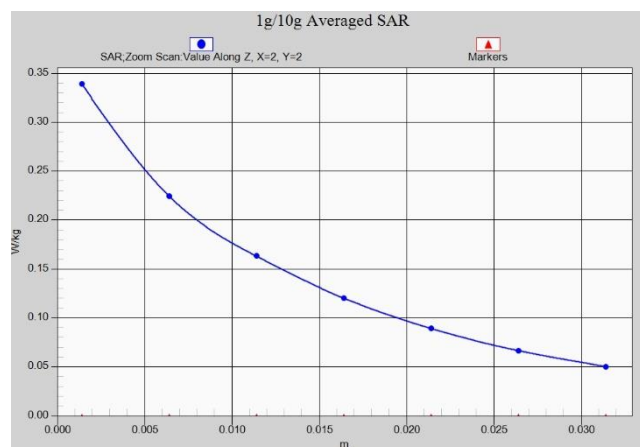

Fig. 1-26 Z-Scan at power reference point (LTE Band71)

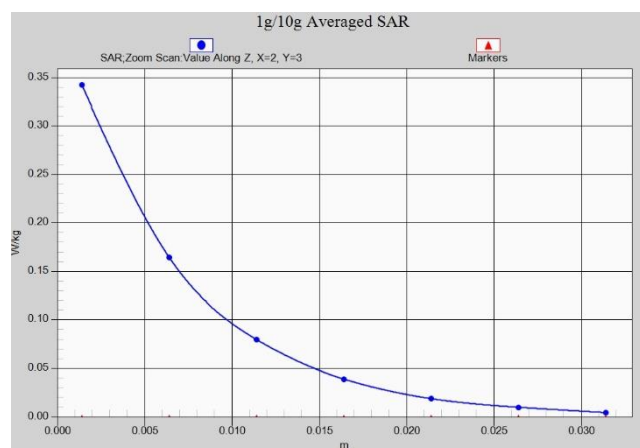

Fig. 1-27 Z-Scan at power reference point (2450 MHz)

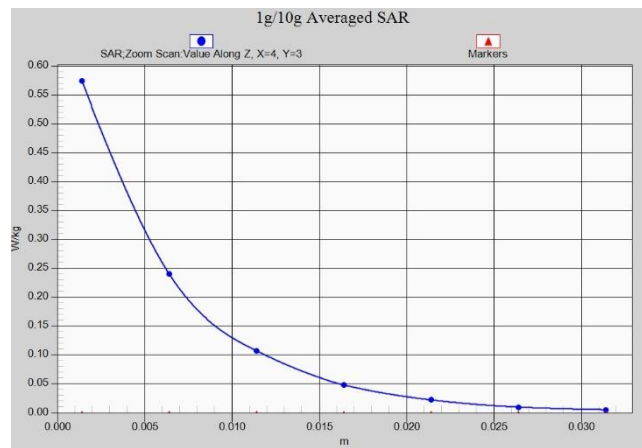

Fig. 1-28 Z-Scan at power reference point (2450 MHz)

ANNEX B System Verification Results

750 MHz

Date: 4/5/2020

Electronics: DAE4 Sn1289

Medium: Head 750 MHz

Medium parameters used: $f = 750 \text{ MHz}$; $\sigma = 0.888 \text{ mho/m}$; $\epsilon_r = 41.35$; $\rho = 1000 \text{ kg/m}^3$

Ambient Temperature: 22.5°C Liquid Temperature: 22.3°C

Communication System: CW Frequency: 750 MHz Duty Cycle: 1:1

Probe: EX3DV4 – SN7307 ConvF(10.58,10.58,10.58)

System Validation /Area Scan (81x191x1): Interpolated grid: $dx=1.000 \text{ mm}$, $dy=1.000 \text{ mm}$

Reference Value = 60.74 V/m ; Power Drift = -0.08

Fast SAR: SAR(1 g) = 2.14 W/kg ; SAR(10 g) = 1.38 W/kg

Maximum value of SAR (interpolated) = 2.82 W/kg

System Validation /Zoom Scan (7x7x7)/Cube 0: Measurement grid: $dx=5\text{mm}$, $dy=5\text{mm}$, $dz=5\text{mm}$

Reference Value = 60.74 V/m ; Power Drift = -0.08 dB

Peak SAR (extrapolated) = 3.2 W/kg

SAR(1 g) = 2.15 W/kg ; SAR(10 g) = 1.42 W/kg

Maximum value of SAR (measured) = 2.83 W/kg

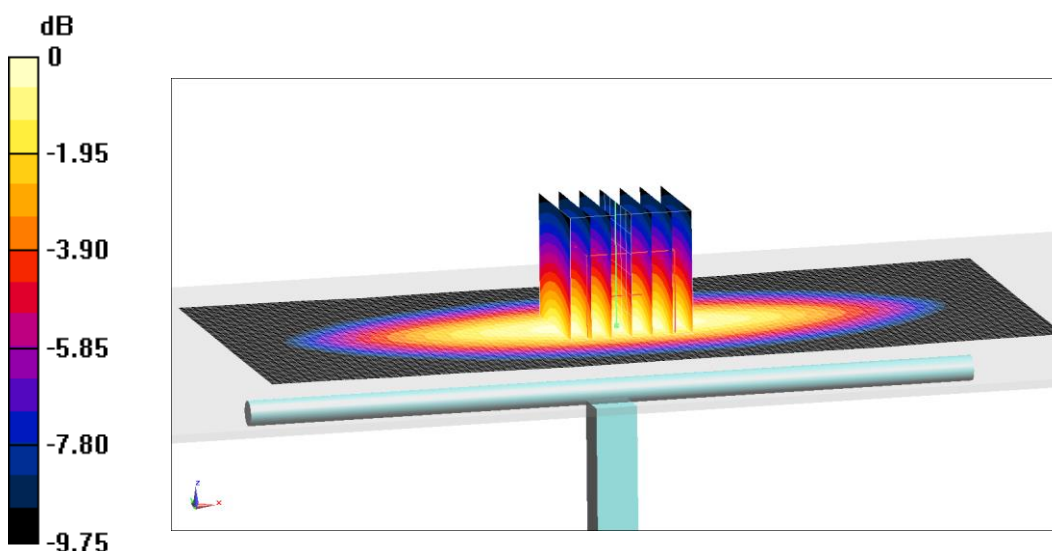

0 dB = 2.83 W/kg = 4.52 dB W/kg

Fig.B.1 validation 750 MHz 250mW

835 MHz

Date: 4/6/2020

Electronics: DAE4 Sn1289

Medium: Head 835 MHz

Medium parameters used: $f = 835 \text{ MHz}$; $\sigma = 0.892 \text{ mho/m}$; $\epsilon_r = 41.1$; $\rho = 1000 \text{ kg/m}^3$

Ambient Temperature: 22.5°C Liquid Temperature: 22.3°C

Communication System: CW Frequency: 835 MHz Duty Cycle: 1:1

Probe: EX3DV4 – SN7307 ConvF(10.45,10.45,10.45)

System Validation /Area Scan (81x191x1): Interpolated grid: $dx=1.000 \text{ mm}$, $dy=1.000 \text{ mm}$

Reference Value = 62.29 V/m; Power Drift = 0.06

Fast SAR: SAR(1 g) = 2.4 W/kg; SAR(10 g) = 1.54 W/kg

Maximum value of SAR (interpolated) = 3.11 W/kg

System Validation /Zoom Scan (7x7x7)/Cube 0: Measurement grid: $dx=5\text{mm}$, $dy=5\text{mm}$, $dz=5\text{mm}$

Reference Value = 62.29 V/m; Power Drift = 0.06 dB

Peak SAR (extrapolated) = 3.54 W/kg

SAR(1 g) = 2.4 W/kg; SAR(10 g) = 1.58 W/kg

Maximum value of SAR (measured) = 3.28 W/kg

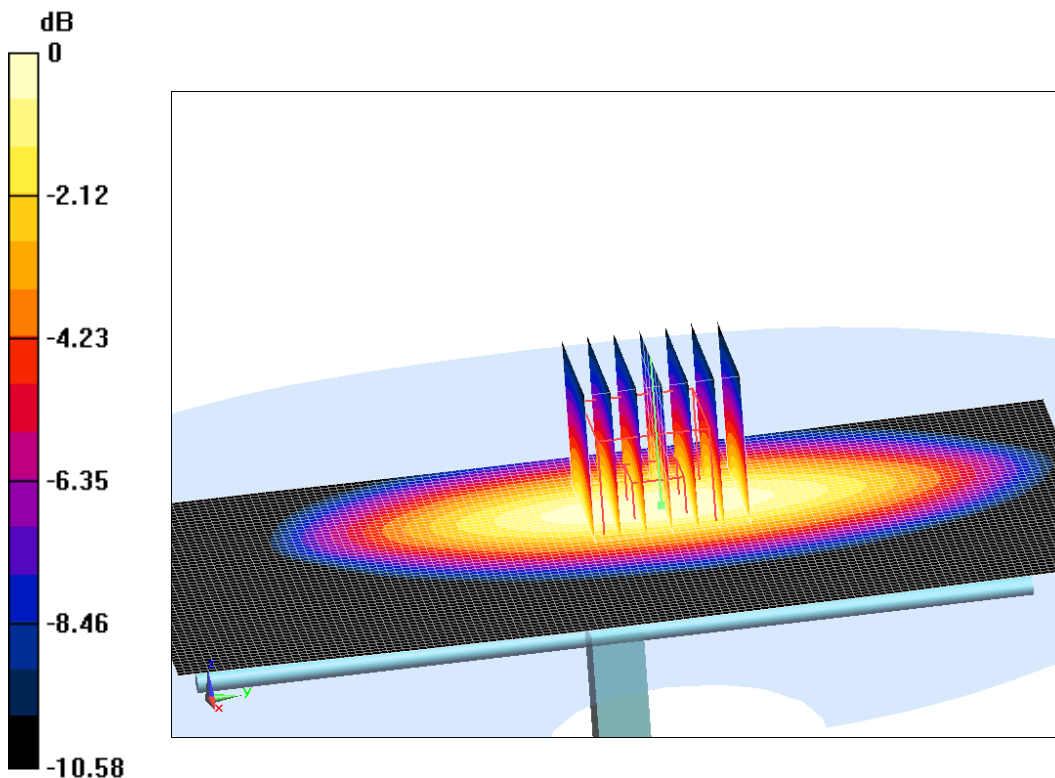

0 dB = 3.28 W/kg = 5.16 dB W/kg

Fig.B.3 validation 835 MHz 250mW

1750 MHz

Date: 4/7/2020

Electronics: DAE4 Sn1289

Medium: Head 1750 MHz

Medium parameters used: $f = 1750$ MHz; $\sigma = 1.377$ mho/m; $\epsilon_r = 40.82$; $\rho = 1000$ kg/m³

Ambient Temperature: 22.5°C Liquid Temperature: 22.3°C

Communication System: CW Frequency: 1750 MHz Duty Cycle: 1:1

Probe: EX3DV4 – SN7307 ConvF(8.86,8.86,8.86)

System Validation /Area Scan (81x191x1): Interpolated grid: dx=1.000 mm, dy=1.000 mm

Reference Value = 107.9 V/m; Power Drift = -0.03

Fast SAR: SAR(1 g) = 9.33 W/kg; SAR(10 g) = 4.73 W/kg

Maximum value of SAR (interpolated) = 14.19 W/kg

System Validation /Zoom Scan (7x7x7)/Cube 0: Measurement grid: dx=5mm, dy=5mm, dz=5mm

Reference Value = 107.9 V/m; Power Drift = -0.03 dB

Peak SAR (extrapolated) = 16.59 W/kg

SAR(1 g) = 9.17 W/kg; SAR(10 g) = 4.83 W/kg

Maximum value of SAR (measured) = 14.09 W/kg

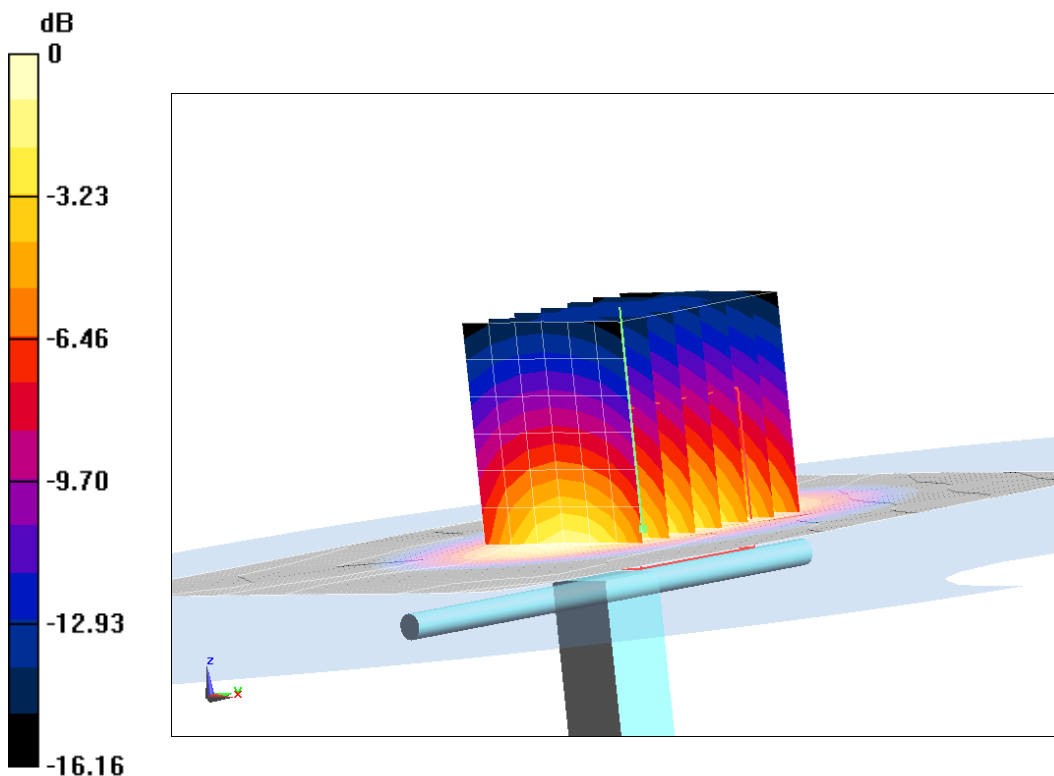

0 dB = 14.09 W/kg = 11.49 dB W/kg

Fig.B.5 validation 1750 MHz 250mW

1900 MHz

Date: 4/8/2020

Electronics: DAE4 Sn1289

Medium: Head 1900 MHz

Medium parameters used: $f = 1900$ MHz; $\sigma = 1.428$ mho/m; $\epsilon_r = 39.99$; $\rho = 1000$ kg/m³

Ambient Temperature: 22.5°C Liquid Temperature: 22.3°C

Communication System: CW Frequency: 1900 MHz Duty Cycle: 1:1

Probe: EX3DV4 – SN7307 ConvF(8.56,8.56,8.56)

System Validation /Area Scan (81x191x1): Interpolated grid: dx=1.000 mm, dy=1.000 mm

Reference Value = 109.25 V/m; Power Drift = -0.02

Fast SAR: SAR(1 g) = 9.9 W/kg; SAR(10 g) = 5.14 W/kg

Maximum value of SAR (interpolated) = 14.98 W/kg

System Validation /Zoom Scan (7x7x7)/Cube 0: Measurement grid: dx=5mm, dy=5mm, dz=5mm

Reference Value = 109.25 V/m; Power Drift = -0.02 dB

Peak SAR (extrapolated) = 17.82 W/kg

SAR(1 g) = 9.92 W/kg; SAR(10 g) = 5.28 W/kg

Maximum value of SAR (measured) = 14.78 W/kg

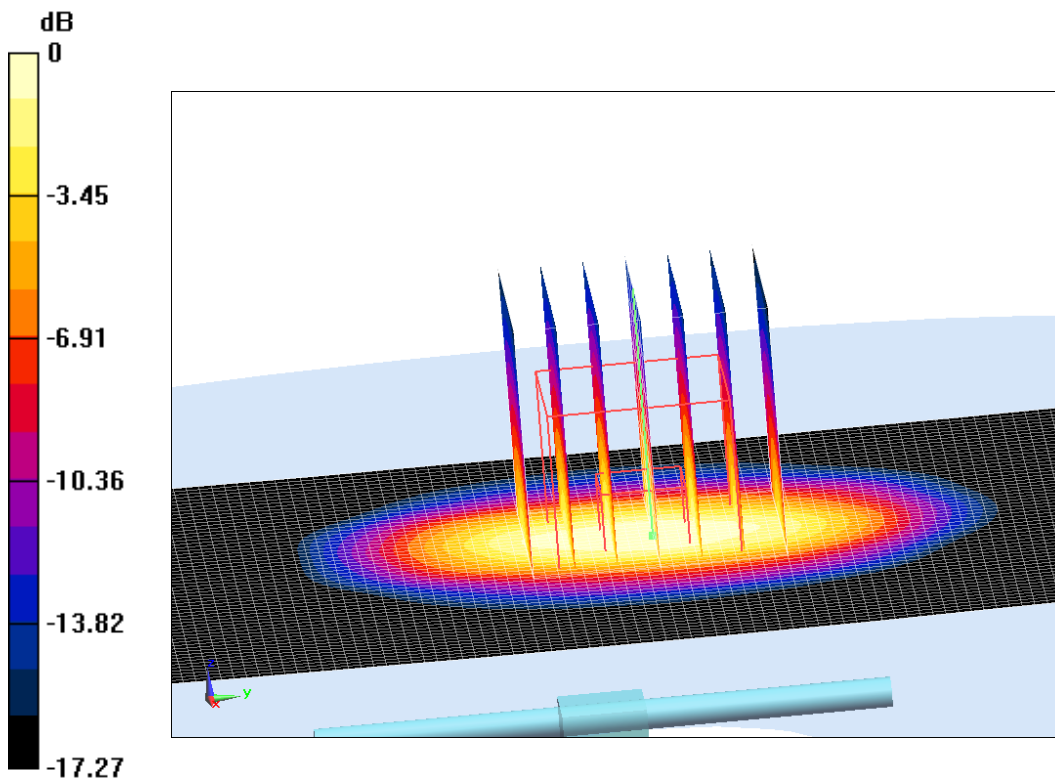

0 dB = 14.78 W/kg = 11.7 dB W/kg

Fig.B.7 validation 1900 MHz 250mW

2450 MHz

Date: 4/9/2020

Electronics: DAE4 Sn1289

Medium: Head 2450 MHz

Medium parameters used: $f = 2450$ MHz; $\sigma = 1.78$ mho/m; $\epsilon_r = 38.99$; $\rho = 1000$ kg/m³

Ambient Temperature: 22.5°C Liquid Temperature: 22.3°C

Communication System: CW Frequency: 2450 MHz Duty Cycle: 1:1

Probe: EX3DV4 – SN7307 ConvF(7.83,7.83,7.83)

System Validation /Area Scan (81x191x1): Interpolated grid: dx=1.000 mm, dy=1.000 mm

Reference Value = 115.5 V/m; Power Drift = 0.04

Fast SAR: SAR(1 g) = 12.73 W/kg; SAR(10 g) = 5.98 W/kg

Maximum value of SAR (interpolated) = 21.56 W/kg

System Validation /Zoom Scan (7x7x7)/Cube 0: Measurement grid: dx=5mm, dy=5mm, dz=5mm

Reference Value = 115.5 V/m; Power Drift = 0.04 dB

Peak SAR (extrapolated) = 25.82 W/kg

SAR(1 g) = 12.68 W/kg; SAR(10 g) = 6.12 W/kg

Maximum value of SAR (measured) = 21.47 W/kg

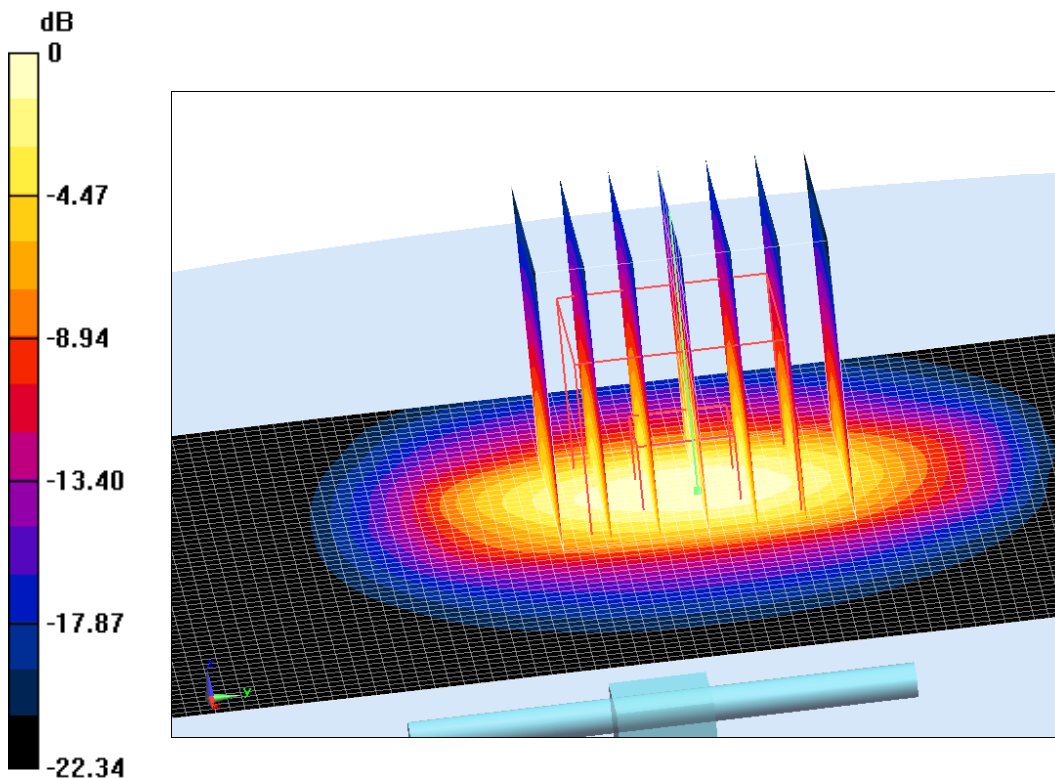

0 dB = 21.47 W/kg = 13.32 dB W/kg

Fig.B.9 validation 2450 MHz 250mW

2600 MHz

Date: 4/10/2020

Electronics: DAE4 Sn1289

Medium: Head 2600 MHz

Medium parameters used: $f = 2600$ MHz; $\sigma = 1.925$ mho/m; $\epsilon_r = 39.06$; $\rho = 1000$ kg/m³

Ambient Temperature: 22.5°C Liquid Temperature: 22.3°C

Communication System: CW Frequency: 2600 MHz Duty Cycle: 1:1

Probe: EX3DV4 – SN7307 ConvF(7.65,7.65,7.65)

System Validation /Area Scan (81x191x1): Interpolated grid: dx=1.000 mm, dy=1.000 mm

Reference Value = 117.26 V/m; Power Drift = 0.05

Fast SAR: SAR(1 g) = 14.09 W/kg; SAR(10 g) = 6.31 W/kg

Maximum value of SAR (interpolated) = 24.99 W/kg

System Validation /Zoom Scan (7x7x7)/Cube 0: Measurement grid: dx=5mm, dy=5mm, dz=5mm

Reference Value = 117.26 V/m; Power Drift = 0.05 dB

Peak SAR (extrapolated) = 28.68 W/kg

SAR(1 g) = 13.68 W/kg; SAR(10 g) = 6.25 W/kg

Maximum value of SAR (measured) = 24.47 W/kg

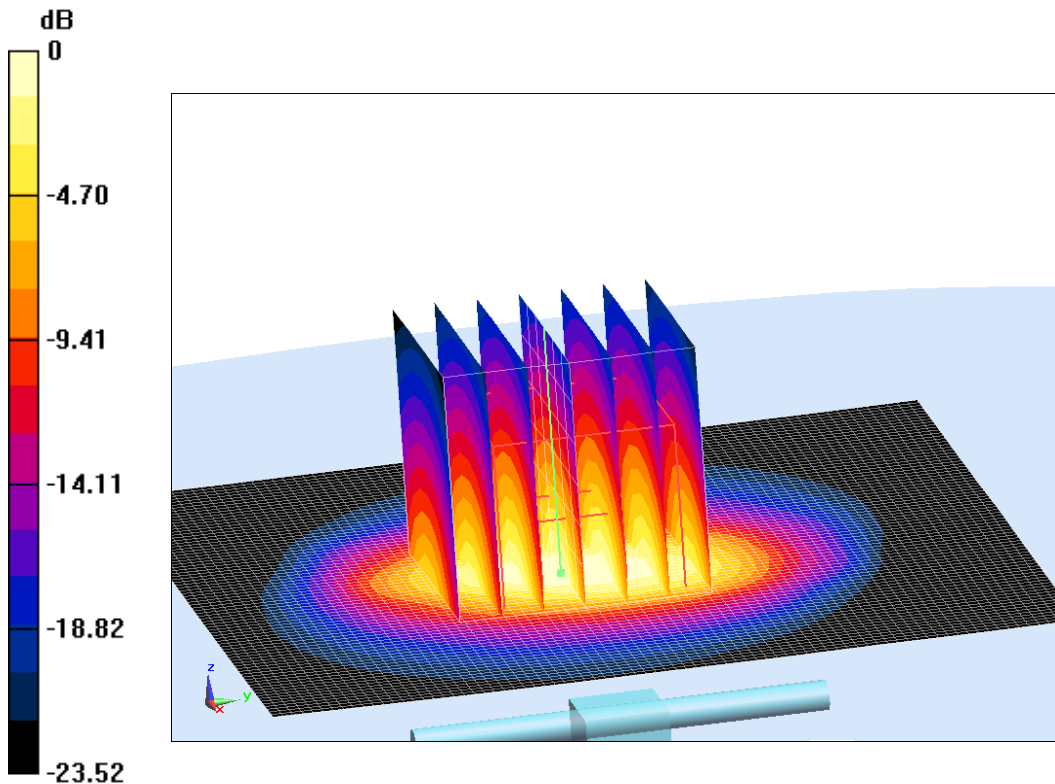

0 dB = 24.47 W/kg = 13.89 dB W/kg

Fig.B.11 validation 2600 MHz 250mW



The SAR system verification must be required that the area scan estimated 1-g SAR is within 3% of the zoom scan 1-g SAR.

Table B.1 Comparison between area scan and zoom scan for system verification

Date	Band	Position	Area scan (1g)	Zoom scan (1g)	Drift (%)
2020-4-5	750 MHz	Head	2.14	2.15	-0.47
2020-4-6	835 MHz	Head	2.4	2.4	0.00
2020-4-7	1750 MHz	Head	9.33	9.17	1.74
2020-4-8	1900 MHz	Head	9.9	9.92	-0.20
2020-4-9	2450 MHz	Head	12.73	12.68	0.39
2020-4-10	2600 MHz	Head	14.09	13.88	1.51

ANNEX C SAR Measurement Setup

C.1 Measurement Set-up

The Dasy4 or DASY5 system for performing compliance tests is illustrated above graphically. This system consists of the following items:

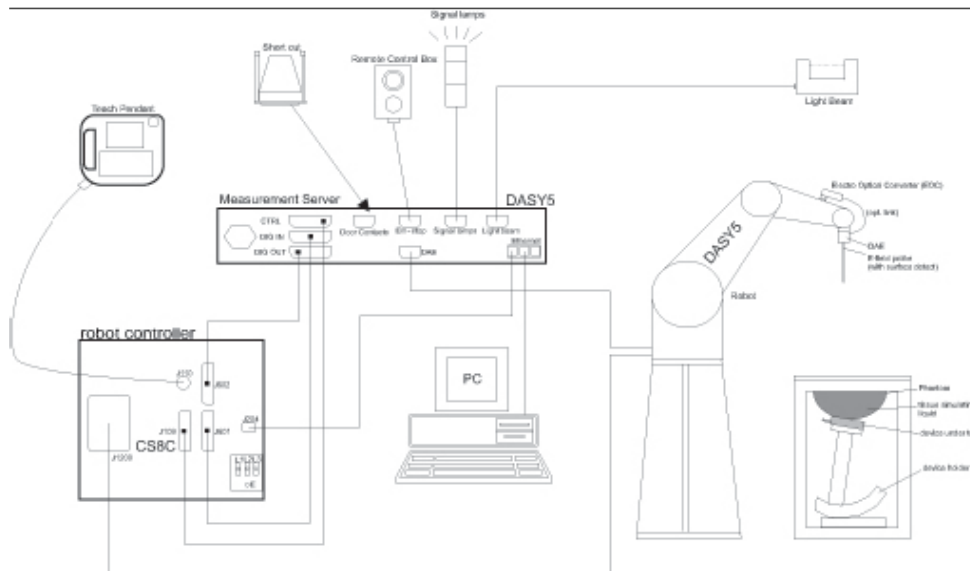

Picture C.1 SAR Lab Test Measurement Set-up

- A standard high precision 6-axis robot (StäubliTX=RX family) with controller, teach pendant and software. An arm extension for accommodating the data acquisition electronics (DAE).
- An isotropic field probe optimized and calibrated for the targeted measurement.
- A data acquisition electronics (DAE) which performs the signal amplification, signal multiplexing, AD-conversion, offset measurements, mechanical surface detection, collision detection, etc. The unit is battery powered with standard or rechargeable batteries. The signal is optically transmitted to the EOC.
- The Electro-optical converter (EOC) performs the conversion from optical to electrical signals for the digital communication to the DAE. To use optical surface detection, a special version of the EOC is required. The EOC signal is transmitted to the measurement server.
- The function of the measurement server is to perform the time critical tasks such as signal filtering, control of the robot operation and fast movement interrupts.
- The Light Beam used is for probe alignment. This improves the (absolute) accuracy of the probe positioning.
- A computer running WinXP and the DASY4 or DASY5 software.
- Remote control and teach pendant as well as additional circuitry for robot safety such as
- warning lamps, etc.
- The phantom, the device holder and other accessories according to the targeted measurement.

C.2 Dasy4 or DASY5 E-field Probe System

The SAR measurements were conducted with the dosimetric probe designed in the classical triangular configuration and optimized for dosimetric evaluation. The probe is constructed using the thick film technique; with printed resistive lines on ceramic substrates. The probe is equipped with an optical multifiber line ending at the front of the probe tip. It is connected to the EOC box on the robot arm and provides an automatic detection of the phantom surface. Half of the fibers are connected to a pulsed infrared transmitter, the other half to a synchronized receiver. As the probe approaches the surface, the reflection from the surface produces a coupling from the transmitting to the receiving fibers. This reflection increases first during the approach, reaches maximum and then decreases. If the probe is flatly touching the surface, the coupling is zero. The distance of the coupling maximum to the surface is independent of the surface reflectivity and largely independent of the surface to probe angle. The DASY4 or DASY5 software reads the reflection during a software approach and looks for the maximum using 2nd order curve fitting. The approach is stopped at reaching the maximum.

Probe Specifications:

Model:	ES3DV3, EX3DV4
Frequency	10MHz — 6.0GHz(EX3DV4)
Range:	10MHz — 4GHz(ES3DV3)
Calibration:	In head and body simulating tissue at Frequencies from 835 up to 5800MHz
Linearity:	± 0.2 dB(30 MHz to 6 GHz) for EX3DV4 ± 0.2 dB(30 MHz to 4 GHz) for ES3DV3
DynamicRange:	10 mW/kg — 100W/kg
Probe Length:	330 mm
Probe Tip Length:	20 mm
Body Diameter:	12 mm
Tip Diameter:	2.5 mm (3.9 mm for ES3DV3)
Tip-Center:	1 mm (2.0mm for ES3DV3)
Application:	SAR Dosimetry Testing Compliance tests of mobile phones Dosimetry in strong gradient fields



Picture C.2 Near-field Probe



Picture C.3 E-field Probe

C.3 E-field Probe Calibration

Each E-Probe/Probe Amplifier combination has unique calibration parameters. A TEM cell calibration procedure is conducted to determine the proper amplifier settings to enter in the probe parameters. The amplifier settings are determined for a given frequency by subjecting the probe to a known E-field density (1 mW/cm²) using an RF Signal generator, TEM cell, and RF Power Meter.

The free space E-field from amplified probe outputs is determined in a test chamber. This calibration can be performed in a TEM cell if the frequency is below 1 GHz and in a waveguide or

other methodologies above 1 GHz for free space. For the free space calibration, the probe is placed in the volumetric center of the cavity and at the proper orientation with the field. The probe is then rotated 360 degrees until the three channels show the maximum reading. The power density readings equates to 1 mW/cm².

E-field temperature correlation calibration is performed in a flat phantom filled with the appropriate simulated brain tissue. The E-field in the medium correlates with the temperature rise in the dielectric medium. For temperature correlation calibration a RF transparent thermistor-based temperature probe is used in conjunction with the E-field probe.

$$SAR = C \frac{\Delta T}{\Delta t}$$

Where:

Δt = Exposure time (30 seconds),

C = Heat capacity of tissue (brain or muscle),

ΔT = Temperature increase due to RF exposure.

$$SAR = \frac{|E|^2 \cdot \sigma}{\rho}$$

Where:

σ = Simulated tissue conductivity,

ρ = Tissue density (kg/m³).

C.4 Other Test Equipment

C.4.1 Data Acquisition Electronics(DAE)

The data acquisition electronics consist of a highly sensitive electrometer-grade preamplifier with auto-zeroing, a channel and gain-switching multiplexer, a fast 16 bit AD-converter and a command decoder with a control logic unit. Transmission to the measurement server is accomplished through an optical downlink for data and status information, as well as an optical uplink for commands and the clock.

The mechanical probe mounting device includes two different sensor systems for frontal and sideways probe contacts. They are used for mechanical surface detection and probe collision detection.

The input impedance of the DAE is 200 MOhm; the inputs are symmetrical and floating. Common mode rejection is above 80 dB.



PictureC.4: DAE

C.4.2 Robot

The SPEAG DASY system uses the high precision robots (DASY4: RX90XL; DASY5: RX160L) type from Stäubli SA (France). For the 6-axis controller system, the robot controller version from Stäubli is used. The Stäubli robot series have many features that are important for our application:

- High precision (repeatability 0.02mm)
- High reliability (industrial design)
- Low maintenance costs (virtually maintenance free due to direct drive gears; no belt drives)
- Jerk-free straight movements (brushless synchron motors; no stepper motors)
- Low ELF interference (motor control fields shielded via the closed metallic construction shields)



Picture C.5 DASY 4



Picture C.6 DASY 5

C.4.3 Measurement Server

The Measurement server is based on a PC/104 CPU board with CPU (dasy4: 166 MHz, Intel Pentium; DASY5: 400 MHz, Intel Celeron), chipdisk (DASY4: 32 MB; DASY5: 128MB), RAM (DASY4: 64 MB, DASY5: 128MB). The necessary circuits for communication with the DAE electronic box, as well as the 16 bit AD converter system for optical detection and digital I/O interface are contained on the DASY I/O board, which is directly connected to the PC/104 bus of the CPU board.

The measurement server performs all real-time data evaluation of field measurements and surface detection, controls robot movements and handles safety operation. The PC operating system cannot interfere with these time critical processes. All connections are supervised by a watchdog, and disconnection of any of the cables to the measurement server will automatically disarm the robot and disable all program-controlled robot movements. Furthermore, the measurement server is equipped with an expansion port which is reserved for future applications. Please note that this expansion port does not have a standardized pinout, and therefore only devices provided by SPEAG can be connected. Devices from any other supplier could seriously damage the measurement server.



Picture C.7 Server for DASY 4



Picture C.8 Server for DASY 5

C.4.4 Device Holder for Phantom

The SAR in the phantom is approximately inversely proportional to the square of the distance between the source and the liquid surface. For a source at 5mm distance, a positioning uncertainty of $\pm 0.5\text{mm}$ would produce a SAR uncertainty of $\pm 20\%$. Accurate device positioning is therefore crucial for accurate and repeatable measurements. The positions in which the devices must be measured are defined by the standards.

The DASY device holder is designed to cope with the different positions given in the standard. It has two scales for device rotation (with respect to the body axis) and device inclination (with respect to the line between the ear reference points). The rotation centers for both scales are the ear reference point (ERP). Thus the device needs no repositioning when changing the angles.

The DASY device holder is constructed of low-loss POM material having the following dielectric parameters: relative permittivity $\epsilon = 3$ and loss tangent $\delta = 0.02$. The amount of dielectric material has been reduced in the closest vicinity of the device, since measurements have suggested that the influence of the clamp on the test results could thus be lowered.

<Laptop Extension Kit>

The extension is lightweight and made of POM, acrylic glass and foam. It fits easily on the upper part of the Mounting Device in place of the phone positioner. The extension is fully compatible with the Twin-SAM and ELI phantoms.



Picture C.9-1: Device Holder

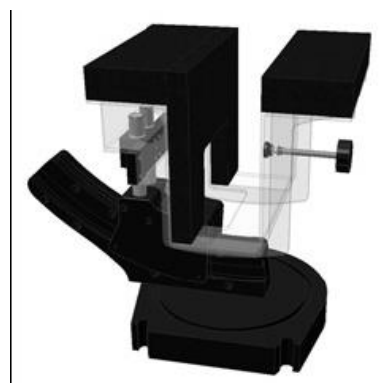

Picture C.9-2: Laptop Extension Kit

C.4.5 Phantom

The SAM Twin Phantom V4.0 is constructed of a fiberglass shell integrated in a table. The shape of the shell is based on data from an anatomical study designed to represent the 90th percentile of the population. The phantom enables the dissymmetric evaluation

of SAR for both left and right handed handset usage, as well as body-worn usage using the flat phantom region. Reference markings on the Phantom allow the complete setup of all predefined phantom positions and measurement grids by manually teaching three points in the robot. The shell phantom has a 2mm shell thickness (except the ear region where shell thickness increases to 6 mm).

Shell Thickness: 2 ± 0.2 mm

Filling Volume: Approx. 25 liters

Dimensions: 810 x 1000 x 500 mm (H x L x W)

Available: Special



Picture C.10: SAM Twin Phantom

ANNEX D Position of the wireless device in relation to the phantom

D.1 General considerations

This standard specifies two handset test positions against the head phantom – the “cheek” position and the “tilt” position.

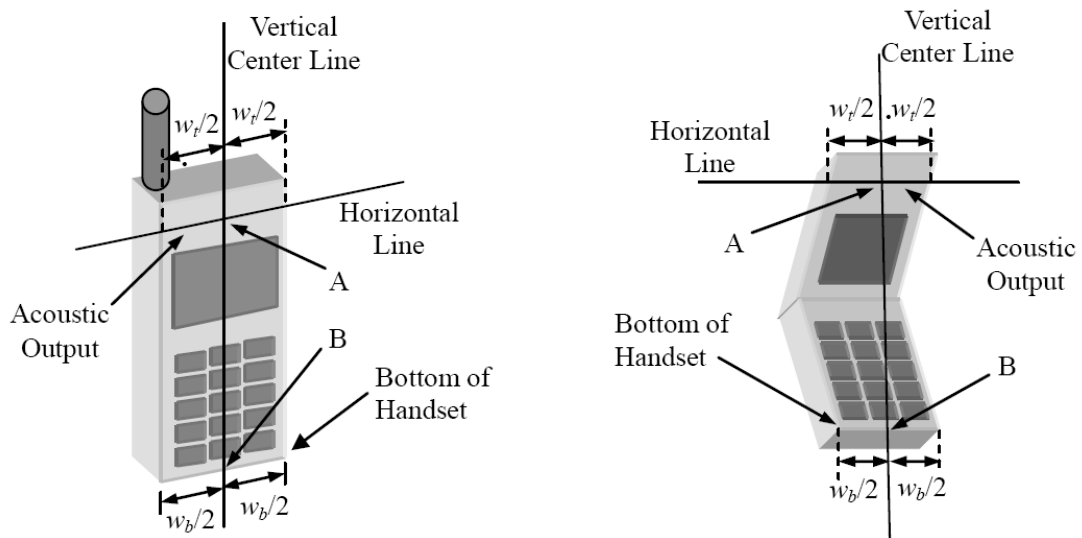

- w_t Width of the handset at the level of the acoustic
- w_b Width of the bottom of the handset
- A Midpoint of the width w_t of the handset at the level of the acoustic output
- B Midpoint of the width w_b of the bottom of the handset

Picture D.1-a Typical “fixed” case handset Picture D.1-b Typical “clam-shell” case handset

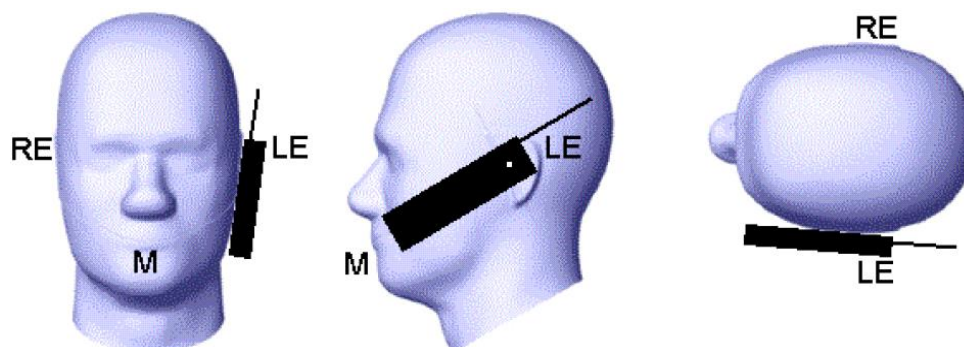

Picture D.2 Cheek position of the wireless device on the left side of SAM

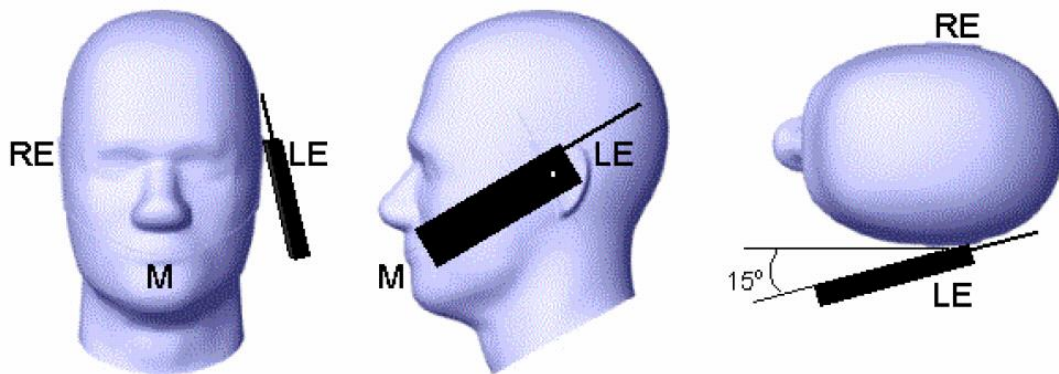

Picture D.3 Tilt position of the wireless device on the left side of SAM

D.2 Body-worn device

A typical example of a body-worn device is a mobile phone, wireless enabled PDA or other battery operated wireless device with the ability to transmit while mounted on a person's body using a carry accessory approved by the wireless device manufacturer.

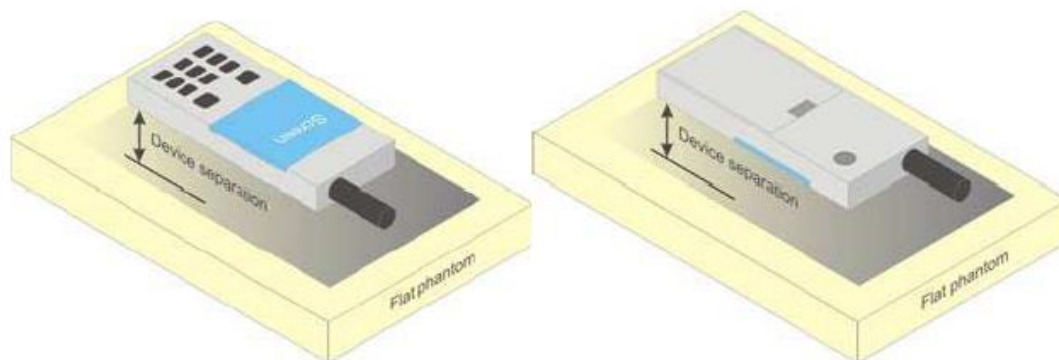

Picture D.4 Test positions for body-worn devices

D.3 Desktop device

A typical example of a desktop device is a wireless enabled desktop computer placed on a table or desk when used.

The DUT shall be positioned at the distance and in the orientation to the phantom that corresponds to the intended use as specified by the manufacturer in the user instructions. For devices that employ an external antenna with variable positions, tests shall be performed for all antenna positions specified. Picture 8.5 show positions for desktop device SAR tests. If the intended use is not specified, the device shall be tested directly against the flat phantom.

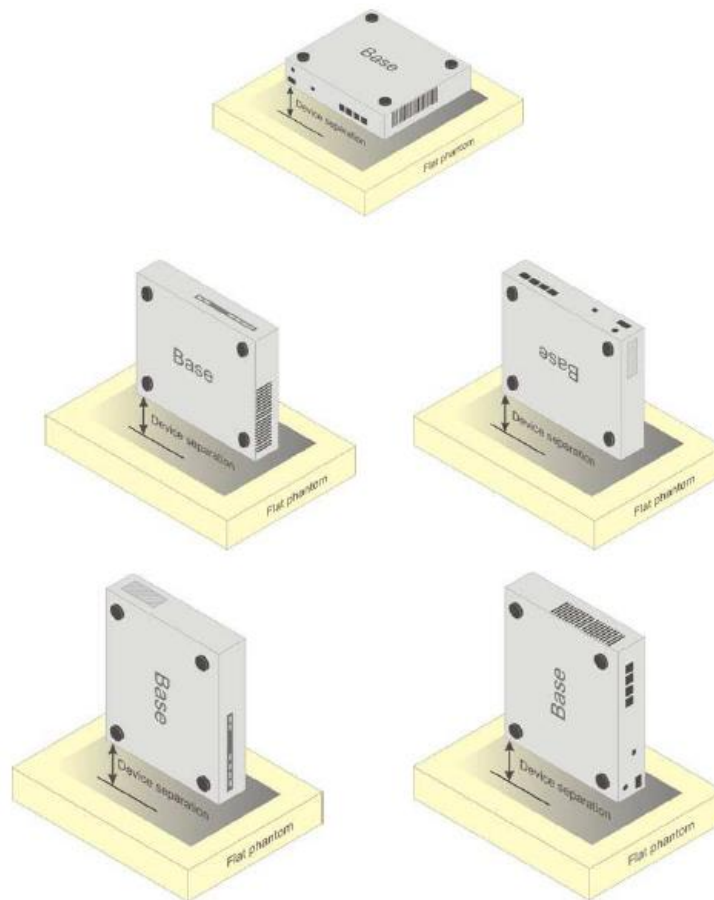

Picture D.5 Test positions for desktop devices

D.4 DUT Setup Photos



Picture D.6

ANNEX E Equivalent Media Recipes

The liquid used for the frequency range of 800-3000 MHz consisted of water, sugar, salt, preventol, glycol monobutyl and Cellulose. The liquid has been previously proven to be suited for worst-case. The Table E.1 shows the detail solution. It's satisfying the latest tissue dielectric parameters requirements proposed by the IEEE 1528 and IEC 62209.

TableE.1: Composition of the Tissue Equivalent Matter

Frequency (MHz)	835Head	835Body	1900 Head	1900 Body	2450 Head	2450 Body	5800 Head	5800 Body
Ingredients (% by weight)								
Water	41.45	52.5	55.242	69.91	58.79	72.60	65.53	65.53
Sugar	56.0	45.0	\	\	\	\	\	\
Salt	1.45	1.4	0.306	0.13	0.06	0.18	\	\
Preventol	0.1	0.1	\	\	\	\	\	\
Cellulose	1.0	1.0	\	\	\	\	\	\
Glycol Monobutyl	\	\	44.452	29.96	41.15	27.22	\	\
Diethylenglycol monohexylether	\	\	\	\	\	\	17.24	17.24
Triton X-100	\	\	\	\	\	\	17.24	17.24
Dielectric Parameters Target Value	$\epsilon=41.5$ $\sigma=0.90$	$\epsilon=55.2$ $\sigma=0.97$	$\epsilon=40.0$ $\sigma=1.40$	$\epsilon=53.3$ $\sigma=1.52$	$\epsilon=39.2$ $\sigma=1.80$	$\epsilon=52.7$ $\sigma=1.95$	$\epsilon=35.3$ $\sigma=5.27$	$\epsilon=48.2$ $\sigma=6.00$

Note: There are a little adjustment respectively for 750, 1750, 2600, 5200, 5300 and 5600 based on the recipe of closest frequency in table E.1.

ANNEX F System Validation

The SAR system must be validated against its performance specifications before it is deployed. When SAR probes, system components or software are changed, upgraded or recalibrated, these must be validated with the SAR system(s) that operates with such components.

Table F.1: System Validation for 7307

Probe SN.	Liquid name	Validation date	Frequency point	Status (OK or Not)
7307	Head 750MHz	June 14,2019	750 MHz	OK
7307	Head 850MHz	June 14,2019	835 MHz	OK
7307	Head 900MHz	June 14,2019	900 MHz	OK
7307	Head 1750MHz	June 14,2019	1750 MHz	OK
7307	Head 1810MHz	June 14,2019	1810 MHz	OK
7307	Head 1900MHz	June 15,2019	1900 MHz	OK
7307	Head 2000MHz	June 15,2019	2000 MHz	OK
7307	Head 2100MHz	June 15,2019	2100 MHz	OK
7307	Head 2300MHz	June 15,2019	2300 MHz	OK
7307	Head 2450MHz	June 15,2019	2450 MHz	OK
7307	Head 2600MHz	June 16,2019	2600 MHz	OK
7307	Head 3500MHz	June 16,2019	3500 MHz	OK
7307	Head 3700MHz	June 16,2019	3700 MHz	OK
7307	Head 5200MHz	June 16,2019	5250 MHz	OK
7307	Head 5500MHz	June 16,2019	5600 MHz	OK
7307	Head 5800MHz	June 16,2019	5800 MHz	OK
7307	Body 750MHz	June 16,2019	750 MHz	OK
7307	Body 850MHz	June 13,2019	835 MHz	OK
7307	Body 900MHz	June 13,2019	900 MHz	OK
7307	Body 1750MHz	June 13,2019	1750 MHz	OK
7307	Body 1810MHz	June 13,2019	1810 MHz	OK
7307	Body 1900MHz	June 13,2019	1900 MHz	OK
7307	Body 2000MHz	June 17,2019	2000 MHz	OK
7307	Body 2100MHz	June 17,2019	2100 MHz	OK
7307	Body 2300MHz	June 17,2019	2300 MHz	OK
7307	Body 2450MHz	June 17,2019	2450 MHz	OK
7307	Body 2600MHz	June 17,2019	2600 MHz	OK
7307	Body 3500MHz	June 12,2019	3500 MHz	OK
7307	Body 3700MHz	June 12,2019	3700 MHz	OK
7307	Body 5200MHz	June 12,2019	5250 MHz	OK
7307	Body 5500MHz	June 12,2019	5600 MHz	OK
7307	Body 5800MHz	June 12,2019	5800 MHz	OK



No.I20Z60295-SEM05

ANNEX G Probe Calibration Certificate

Probe 7307 Calibration Certificate

**Calibration Laboratory of
Schmid & Partner
Engineering AG**
Zeughausstrasse 43, 8004 Zurich, Switzerland



S Schweizerischer Kalibrierdienst
C Service suisse d'étalonnage
S Servizio svizzero di taratura
S Swiss Calibration Service

Accredited by the Swiss Accreditation Service (SAS)
The Swiss Accreditation Service is one of the signatories to the EA
Multilateral Agreement for the recognition of calibration certificates

Accreditation No.: **SCS 0108**

Client **CTTL (Auden)**

Certificate No: **EX3-7307_May19/2**

CALIBRATION CERTIFICATE (Replacement of No: EX3-7307_May19)

Object **EX3DV4 - SN:7307**

Calibration procedure(s) **QA CAL-01.v9, QA CAL-12.v9, QA CAL-14.v5, QA CAL-23.v5,
QA CAL-25.v7
Calibration procedure for dosimetric E-field probes**

Calibration date: **May 24, 2019**

This calibration certificate documents the traceability to national standards, which realize the physical units of measurements (SI).
The measurements and the uncertainties with confidence probability are given on the following pages and are part of the certificate.

All calibrations have been conducted in the closed laboratory facility: environment temperature (22 ± 3)°C and humidity < 70%.

Calibration Equipment used (M&TE critical for calibration)

Primary Standards	ID	Cal Date (Certificate No.)	Scheduled Calibration
Power meter NRP	SN: 104778	03-Apr-19 (No. 217-02892/02893)	Apr-20
Power sensor NRP-Z91	SN: 103244	03-Apr-19 (No. 217-02892)	Apr-20
Power sensor NRP-Z91	SN: 103245	03-Apr-19 (No. 217-02893)	Apr-20
Reference 20 dB Attenuator	SN: S5277 (20x)	04-Apr-19 (No. 217-02894)	Apr-20
DAE4	SN: 660	19-Dec-18 (No. DAE4-660_Dec18)	Dec-19
Reference Probe ES3DV2	SN: 3013	31-Dec-18 (No. ES3-3013_Dec18)	Dec-19
Secondary Standards	ID	Check Date (in house)	Scheduled Check
Power meter E4419B	SN: GB41293874	06-Apr-16 (in house check Jun-18)	In house check: Jun-20
Power sensor E4412A	SN: MY41498087	06-Apr-16 (in house check Jun-18)	In house check: Jun-20
Power sensor E4412A	SN: 000110210	06-Apr-16 (in house check Jun-18)	In house check: Jun-20
RF generator HP 8648C	SN: US3642U01700	04-Aug-99 (in house check Jun-18)	In house check: Jun-20
Network Analyzer E8358A	SN: US41080477	31-Mar-14 (in house check Oct-18)	In house check: Oct-19

	Name	Function	Signature
Calibrated by:	Jeton Kastrati	Laboratory Technician	
Approved by:	Katja Pokovic	Technical Manager	

Issued: August 29, 2019

This calibration certificate shall not be reproduced except in full without written approval of the laboratory.