



SAR TEST REPORT

No. I20Z60553-SEM05

For

TCL Communication Ltd.

GSM/UMTS/LTE Mobile phone

Model name: 5062W,5062Z

With

Hardware Version: 06

Software Version: 2ASC

FCC ID: 2ACCJH122

Issued Date: 2020-6-10

Note:

The test results in this test report relate only to the devices specified in this report. This report shall not be reproduced except in full without the written approval of CTTL.

The report must not be used by the client to claim product certification, approval, or endorsement by NVLAP, NIST, or any agency of the U.S. Government.

Test Laboratory:

CTTL, Telecommunication Technology Labs, CAICT

No. 51, Xueyuan Road, Haidian District, Beijing, P. R. China 100191.

Tel:+86(0)10-62304633-2512, Fax:+86(0)10-62304633-2504

Email: ctl_terminals@caict.ac.cn, website: www.caict.ac.cn



No.I20Z60553-SEM05

REPORT HISTORY

Report Number	Revision	Issue Date	Description
I20Z60553-SEM05	Rev.0	2020-6-10	Initial creation of test report
I20Z60553-SEM05	Rev.1	2020-6-19	Update Page63 LTE band71 64QAM power. update page64 power



TABLE OF CONTENT

1 TEST LABORATORY	5
1.1 TESTING LOCATION	5
1.2 TESTING ENVIRONMENT.....	5
1.3 PROJECT DATA	5
1.4 SIGNATURE.....	5
2 STATEMENT OF COMPLIANCE	6
3 CLIENT INFORMATION	8
3.1 APPLICANT INFORMATION	8
3.2 MANUFACTURER INFORMATION	9
4 EQUIPMENT UNDER TEST (EUT) AND ANCILLARY EQUIPMENT (AE)	10
4.1 ABOUT EUT.....	10
4.2 INTERNAL IDENTIFICATION OF EUT USED DURING THE TEST	10
4.3 INTERNAL IDENTIFICATION OF AE USED DURING THE TEST	11
5 TEST METHODOLOGY	11
5.1 APPLICABLE LIMIT REGULATIONS.....	11
5.2 APPLICABLE MEASUREMENT STANDARDS	11
7 TISSUE SIMULATING LIQUIDS	12
7.1 TARGETS FOR TISSUE SIMULATING LIQUID.....	12
7.2 DIELECTRIC PERFORMANCE	12
8 SYSTEM VERIFICATION	16
8.1 SYSTEM SETUP.....	16
8.2 SYSTEM VERIFICATION.....	17
9 MEASUREMENT PROCEDURES	19
9.1 TESTS TO BE PERFORMED	19
6 SPECIFIC ABSORPTION RATE (SAR)	21
6.1 INTRODUCTION.....	21
6.2 SAR DEFINITION.....	21
9.2 GENERAL MEASUREMENT PROCEDURE.....	22
9.3 WCDMA MEASUREMENT PROCEDURES FOR SAR	23
9.4 SAR MEASUREMENT FOR LTE.....	24
9.5 BLUETOOTH & WI-FI MEASUREMENT PROCEDURES FOR SAR	26
9.6 POWER DRIFT.....	26
10 AREA SCAN BASED 1-G SAR	27
10.1 REQUIREMENT OF KDB.....	27
10.2 FAST SAR ALGORITHMS.....	27



11 CONDUCTED OUTPUT POWER.....	28
11.1 GSM MEASUREMENT RESULT	28
11.2 WCDMA MEASUREMENT RESULT	30
11.3 CDMA MEASUREMENT RESULT	32
11.4 LTE MEASUREMENT RESULT	33
11.4 WI-FI AND BT MEASUREMENT RESULT	65
12 SIMULTANEOUS TX SAR CONSIDERATIONS.....	69
12.1 INTRODUCTION.....	69
12.2 TRANSMIT ANTENNA SEPARATION DISTANCES.....	69
12.3 SAR MEASUREMENT POSITIONS	70
12.4 STANDALONE SAR TEST EXCLUSION CONSIDERATIONS	70
13 EVALUATION OF SIMULTANEOUS.....	71
14 SAR TEST RESULT	73
14.1 SAR RESULTS FOR FAST SAR	74
14.2 SAR RESULTS FOR STANDARD PROCEDURE	93
14.3 WLAN EVALUATION FOR 2.4G	100
14.4 WLAN EVALUATION FOR 5G.....	103
15 SAR MEASUREMENT VARIABILITY.....	110
16 MEASUREMENT UNCERTAINTY	111
16.1 MEASUREMENT UNCERTAINTY FOR NORMAL SAR TESTS (300MHZ~3GHZ).....	111
16.2 MEASUREMENT UNCERTAINTY FOR NORMAL SAR TESTS (3~6GHZ)	112
16.3 MEASUREMENT UNCERTAINTY FOR FAST SAR TESTS (300MHZ~3GHZ).....	113
16.4 MEASUREMENT UNCERTAINTY FOR FAST SAR TESTS (3~6GHZ)	114
17 MAIN TEST INSTRUMENTS.....	115
ANNEX A GRAPH RESULTS	116
ANNEX B SYSTEM VERIFICATION RESULTS	179
ANNEX C SAR MEASUREMENT SETUP	189
ANNEX D POSITION OF THE WIRELESS DEVICE IN RELATION TO THE PHANTOM	195
ANNEX E EQUIVALENT MEDIA RECIPES	198
ANNEX F SYSTEM VALIDATION	199
ANNEX G PROBE CALIBRATION CERTIFICATE.....	200
ANNEX H DIPOLE CALIBRATION CERTIFICATE	224
ANNEX I ACCREDITATION CERTIFICATE.....	295

1 Test Laboratory

1.1 Testing Location

Company Name:	CTTL(Shouxiang)
Address:	No. 51 Shouxiang Science Building, Xueyuan Road, Haidian District, Beijing, P. R. China100191

1.2 Testing Environment

Temperature:	18°C~25°C,
Relative humidity:	30%~ 70%
Ground system resistance:	< 0.5 Ω
Ambient noise & Reflection:	< 0.012 W/kg

1.3 Project Data

Project Leader:	Qi Dianyuan
Test Engineer:	Lin Xiaojun
Testing Start Date:	May 12, 2020
Testing End Date:	June 9, 2020

1.4 Signature



Lin Xiaojun
(Prepared this test report)

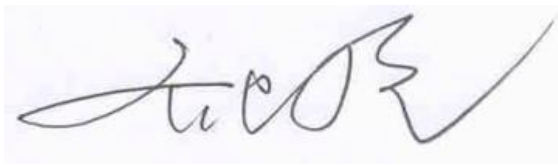

Qi Dianyuan
(Reviewed this test report)

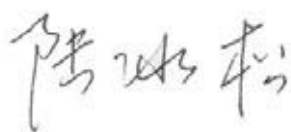

Lu Bingsong
Deputy Director of the laboratory
(Approved this test report)

2 Statement of Compliance

The maximum results of SAR found during testing for TCL Communication Ltd. GSM/UMTS/LTE Mobile phone 5062W,5062Z are as follows:

Table 2.1: Highest Reported SAR (1g)

Exposure Configuration	Technology Band	Highest Reported SAR 1g(W/kg)	Equipment Class
Head (Separation Distance 0mm)	GSM 850	0.13	PCE
	PCS 1900	0.01	
	UMTS FDD 2	0.10	
	UMTS FDD 4	0.21	
	UMTS FDD 5	0.55	
	LTE Band 7	0.08	
	LTE Band 12	0.52	
	LTE Band 13	0.13	
	LTE Band 25	0.08	
	LTE Band 26	1.02	
	LTE Band 41(PC3)	0.07	
	LTE Band 41(PC2)	0.09	
	LTE Band 66	0.23	
	LTE Band 71	0.44	
	CDMA BC0	0.83	
	CDMA BC1	0.06	
	CDMA BC10	0.99	
WLAN 2.4 GHz	0.44	DTS	
WLAN 5 GHz	0.33	UNII	
Hotspot (Separation Distance 10mm)	GSM 850	0.31	PCE
	PCS 1900	0.58	
	UMTS FDD 2	0.92	
	UMTS FDD 4	0.52	
	UMTS FDD 5	0.23	
	LTE Band 7	1.18	
	LTE Band 12	0.14	
	LTE Band 13	0.31	
	LTE Band 25	0.59	
	LTE Band 26	0.21	
	LTE Band 41(PC3)	1.34	
	LTE Band 41(PC2)	1.06	
	LTE Band 66	0.39	
	LTE Band 71	0.24	
	CDMA BC0	0.33	
	CDMA BC1	0.68	
	CDMA BC10	0.25	
WLAN 2.4 GHz	0.47	DTS	
WLAN 5 GHz	0.70	UNII	
Body-worn (Separation Distance)	PCS 1900	0.12	PCE
	WCDMA1700	0.27	
	WCDMA1900	0.29	

15mm)	CDMA BC1	0.44
	LTE Band7	0.44
	LTE Band25	0.14
	LTE Band41 (PC3)	0.45
	LTE Band41 (PC2)	0.31
	LTE Band66	0.47

The SAR values found for the Mobile Phone are below the maximum recommended levels of 1.6 W/kg as averaged over any 1g tissue according to the ANSI C95.1-1992.

For body operation, this device has been tested and meets FCC RF exposure guidelines when used with any accessory that contains no metal and which provides a minimum separation distance of 10 mm for hotspot and 15mm for body worn between this device and the body of the user. Use of other accessories may not ensure compliance with FCC RF exposure guidelines.

The EUT battery must be fully charged and checked periodically during the test to ascertain uniform power output.

The measurement together with the test system set-up is described in annex C of this test report. A detailed description of the equipment under test can be found in chapter 4 of this test report. The highest reported SAR value is obtained at the case of (Table 2.1), and the values are: **1.34 W/kg(1g)**.

Table 2.2: The sum of reported SAR values for main antenna and WiFi2.4G

	Position	Main antenna	WiFi	Sum
Highest reported SAR value for Head	Left head, Cheek (LTE B26)	1.02	0.19	1.21
Highest reported SAR value for Head	Right head, Cheek (WCDMA BC10)	0.99	0.44	1.43
Highest reported SAR value for Hotspot	Rear 10mm (LTE B41(PC2))	0.75	0.47	1.22
Highest reported SAR value for Body	Rear 15mm (LTE Band66)	0.47	0.47 ^[1]	0.94

[1] – the wifi value with 10mm is used to evaluate the sum value with 15mm

Table 2.3: The sum of reported SAR values for main antenna and WiFi5G

	Position	Main antenna	WiFi	Sum
Highest reported SAR value for Head	Left head, Cheek (LTE B26)	1.02	0.33	1.35
Highest reported SAR value for Hotspot	Bottom10mm (LTE B41(PC3))	1.34	0.00	1.34

Highest reported SAR value for Body	Rear 15mm (LTE Band66)	0.47	0.55	1.02
--	---------------------------	------	------	-------------

Table 2.4: The sum of reported SAR values for main antenna and BT

	Position	Main antenna	BT	Sum
Maximum reported SAR value for Head	Left head, Cheek (LTE B26)	1.02	0.26 ^[1]	1.28
Maximum reported SAR value for Hotspot	Bottom 10mm (LTE B7)	1.34	0.13 ^[1]	1.47
Highest reported SAR value for Body	Rear 15mm (LTE Band66)	0.47	0.09 ^[1]	0.56

[1] - Estimated SAR for Bluetooth (see the table 13.4)

According to the above tables, the highest sum of reported SAR values is **1.47W/kg (1g)**. The detail for simultaneous transmission consideration is described in chapter 13.

According to the KDB648474 D04, the UMPC mini-tablet procedures must also be applied to test the SAR of all surfaces and edges with an antenna located at ≤ 25 mm from that surface or edge, in direct contact with a flat phantom, for 10-g extremity SAR according to the body-equivalent tissue dielectric parameters in KDB Publication 865664 D01 to address interactive hand use exposure conditions. When hotspot mode applies, 10-g extremity SAR is required only for the surfaces and edges with hotspot mode 1-g reported SAR > 1.2 W/kg

Table 2.5: 0mm Reported SAR for phablet (10g)

Exposure Configuration	Technology Band	Highest Reported SAR 10g(W/kg)	Limit 10g (W/kg)
Hotspot (Separation Distance 0mm)	WCDMA 1900	3.65	4.0
	CDMA BC1	1.11	4.0
	LTE Band7	3.59	4.0
	LTE Band25	3.86	4.0
	LTE Band41(PC3)	1.40	4.0
	LTE Band41(PC2)	1.20	4.0

3 Client Information

3.1 Applicant Information

Company Name:	TCL Communication Ltd.
Address/Post:	5/F, Building 22E, 22 Science Park East Avenue, Hong Kong Science



	Park, Shatin, NT, Hong Kong
Contact Person:	Gong Zhizhou
Contact Email:	zhizhou.gong@tcl.com
Telephone:	0086-755-36611722
Fax	0086-755-36612000-81722

3.2 Manufacturer Information

Company Name:	TCL Communication Ltd.
Address/Post:	5/F, Building 22E, 22 Science Park East Avenue, Hong Kong Science Park, Shatin, NT, Hong Kong
Contact Person:	Gong Zhizhou
Contact Email:	zhizhou.gong@tcl.com
Telephone:	0086-755-36611722
Fax	0086-755-36612000-81722

4 Equipment Under Test (EUT) and Ancillary Equipment (AE)

4.1 About EUT

Description:	GSM/UMTS/LTE Mobile phone
Model name:	5062W,5062Z
Operating mode(s):	GSM 850/900/1800/1900, WCDMA850/1700/1900/2100, BT, Wi-Fi(2.4G/5G) CDMA BC0/1/10 ,LTE Band 1/2/3/4/5/7/8/12/13/17/20/25/26/28/38/39/40/41/66/71
Tested Tx Frequency:	824 – 849 MHz (GSM 850)
	1850 – 1910 MHz (GSM 1900)
	824–849 MHz (WCDMA 850 Band V)
	1710 – 1755 MHz (WCDMA 1700 Band IV)
	1850–1910 MHz (WCDMA1900 Band II)
	824.7 - 848.31 MHz (CDMA BC0)
	1851.25 - 1908.75 MHz (CDMA BC1)
	817.9 - 823.1 MHz (CDMA BC10)
	2502.5 – 2567.5 MHz(LTE Band 7)
	699.7 – 715.3 MHz (LTE Band 12)
	779.5 –784.5 MHz (LTE Band 13)
	1850.7 – 1914.3MHz(LTE Band 25)
	814.7 – 848.3MHz(LTE Band 26)
	2498.5 – 2687.5 MHz (LTE Band 41)
	1710.7 – 1779.3 MHz (LTE Band 66)
665.5 – 695.5 MHz (LTE Band 71)	
2412 – 2462 MHz (Wi-Fi 2.4G)	
5.15 – 5.825 GHz(Wi-Fi 5G)	
GPRS/EGPRS Multislot Class:	12
GPRS capability Class:	B
Test device Production information:	Production unit
Device type:	Portable device
Antenna type:	Integrated antenna
Hotspot mode:	Support

4.2 Internal Identification of EUT used during the test

EUT ID*	IMEI	HW	SW Version
EUT1	015702000204713	06	2ASC
EUT2	015702000005433	06	2ASC
EUT3	015702000204523	06	2ASC
EUT4	015702000204531	06	2ASC
EUT5	015702000204556	06	2ASC
EUT6	015702000007231	06	2ASC

*EUT ID: is used to identify the test sample in the lab internally.

Note: It is performed to test SAR with the EUT4~6 and conducted power with the EUT1~3.

**4.3 Internal Identification of AE used during the test**

AE ID*	Description	Model	SN	Manufacturer
AE1	Battery	CAC3860024C1	/	BYD

*AE ID: is used to identify the test sample in the lab internally.

5 TEST METHODOLOGY**5.1 Applicable Limit Regulations**

ANSI C95.1–1992:IEEE Standard for Safety Levels with Respect to Human Exposure to Radio Frequency Electromagnetic Fields, 3 kHz to 300 GHz.

It specifies the maximum exposure limit of **1.6 W/kg** as averaged over any 1 gram of tissue for portable devices being used within 20 cm of the user in the uncontrolled environment.

5.2 Applicable Measurement Standards

IEEE 1528–2013: Recommended Practice for Determining the Peak Spatial-Average Specific Absorption Rate (SAR) in the Human Head from Wireless Communications Devices: Measurement Techniques.

KDB447498 D01: General RF Exposure Guidance v06: Mobile and Portable Devices RF Exposure Procedures and Equipment Authorization Policies.

KDB648474 D04 Handset SAR v01r03: SAR Evaluation Considerations for Wireless Handsets.

KDB941225 D01 SAR test for 3G devices v03r01: SAR Measurement Procedures for 3G Devices

KDB941225 D05 SAR for LTE Devices v02r05: SAR Evaluation Considerations for LTE Devices

KDB941225 D06 Hotspot Mode SAR v02r01: SAR Evaluation Procedures for Portable Devices with Wireless Router Capabilities

KDB248227 D01 802.11 Wi-Fi SAR v02r02: SAR GUIDANCE FOR IEEE 802.11 (Wi-Fi) TRANSMITTERS

KDB865664 D01 SAR measurement 100 MHz to 6 GHz v01r04: SAR Measurement Requirements for 100 MHz to 6 GHz.

KDB865664 D02 RF Exposure Reporting v01r02: RF Exposure Compliance Reporting and Documentation Considerations

7 Tissue Simulating Liquids

7.1 Targets for tissue simulating liquid

Table 7.1: Targets for tissue simulating liquid

Frequency(MHz)	Liquid Type	Conductivity(σ)	$\pm 5\%$ Range	Permittivity(ϵ)	$\pm 5\%$ Range
750	Head	0.89	0.85~0.93	41.94	39.8~44.0
835	Head	0.90	0.86~0.95	41.5	39.4~43.6
1750	Head	1.37	1.30~1.44	40.08	38.1~42.1
1900	Head	1.40	1.33~1.47	40.0	38.0~42.0
2450	Head	1.80	1.71~1.89	39.2	37.2~41.2
2600	Head	1.96	1.86~2.06	39.01	37.1~41.0
5250	Head	4.71	4.47~4.95	35.93	34.13~37.73
5600	Head	5.07	4.82~5.32	35.53	33.8~37.3
5750	Head	5.22	4.96~5.48	35.36	33.59~37.13

7.2 Dielectric Performance

Table 7.2: Dielectric Performance of Tissue Simulating Liquid

Measurement Date yyyy/mm/dd	Frequency	Type	Permittivity ϵ	Drift (%)	Conductivity σ (S/m)	Drift (%)
2020/5/12	750 MHz	Head	42.07	0.31	0.897	0.79
2020/5/13	835 MHz	Head	41.45	-0.12	0.884	-1.78
2020/5/14	1750 MHz	Head	39.44	-1.60	1.374	0.29
2020/5/15	1900 MHz	Head	39.33	-1.68	1.382	-1.29
2020/5/17	2450 MHz	Head	39.22	0.05	1.813	0.72
2020/5/18	2600 MHz	Head	38.4	-1.56	1.96	0.00
2020/6/5	5250 MHz	Head	35.43	-1.39	4.701	-0.19
2020/6/6	5600 MHz	Head	35.18	-0.99	5.024	-0.91
2020/6/7	5750 MHz	Head	36.01	1.84	5.248	0.54

Note: The liquid temperature is 22.0°C

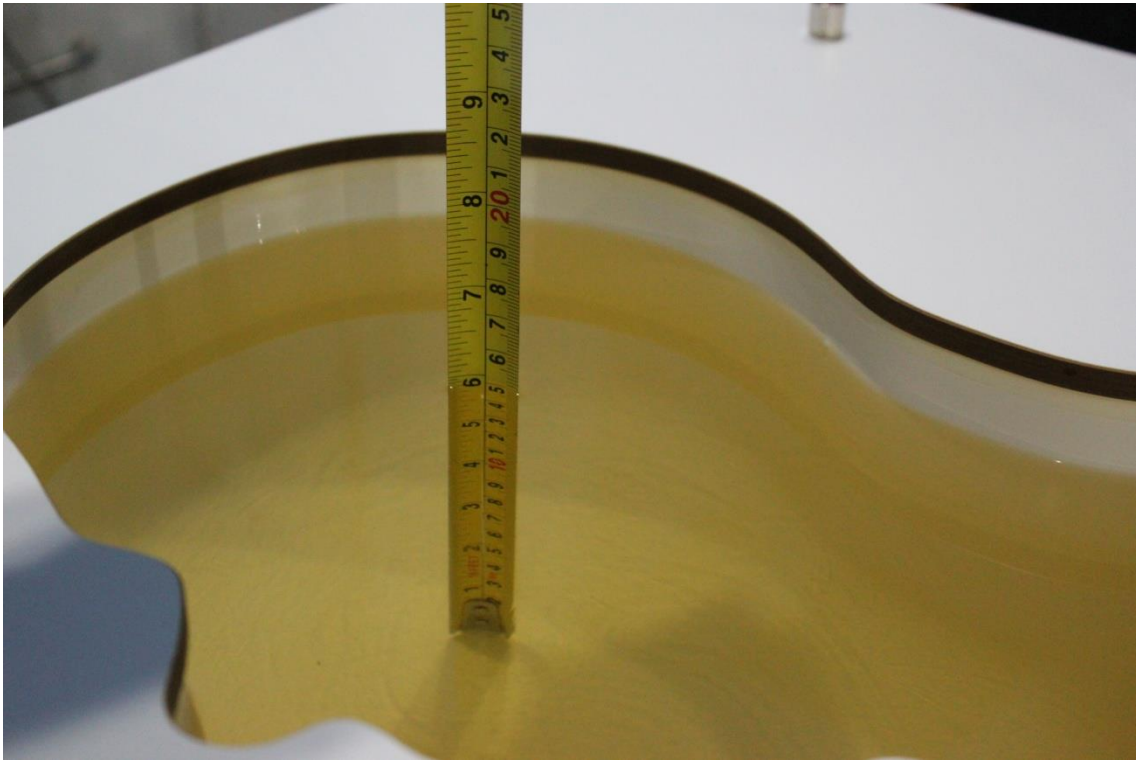

Picture 7-1 Liquid depth in the Head Phantom (750MHz)

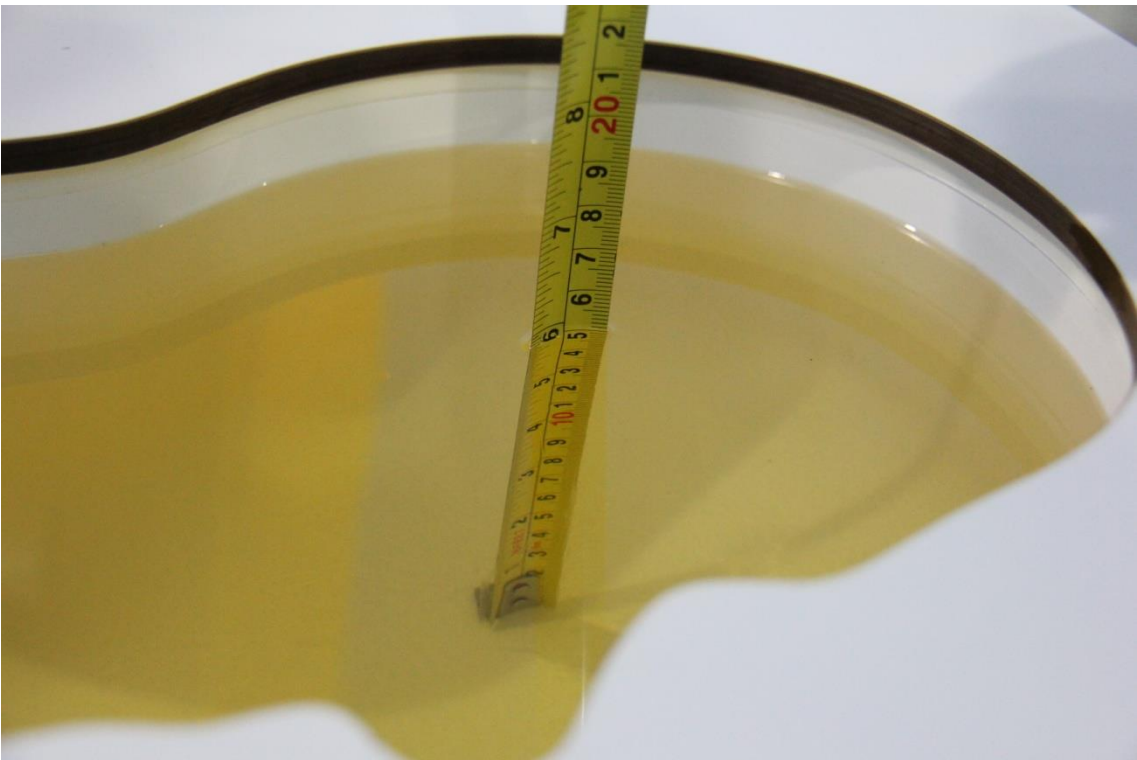

Picture 7-2 Liquid depth in the Head Phantom (835 MHz)



Picture 7-3 Liquid depth in the Head Phantom (1750 MHz)



Picture 7-4 Liquid depth in the Head Phantom (1900 MHz)

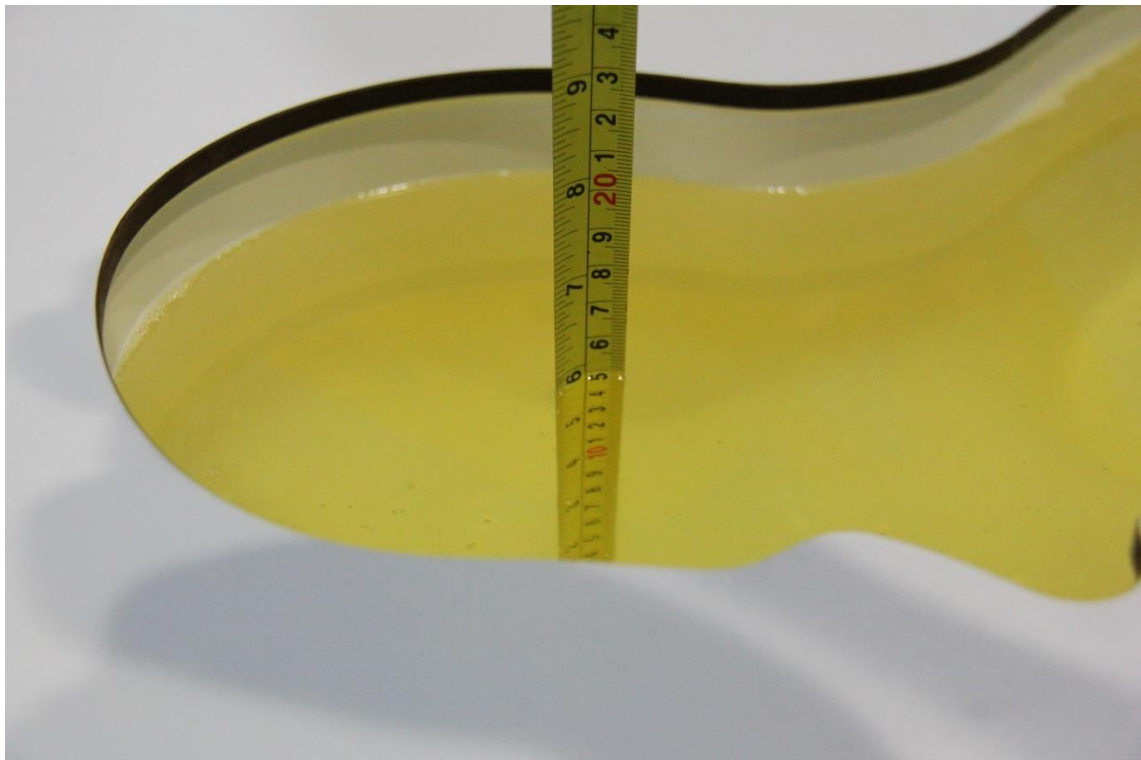

Picture 7-5 Liquid depth in the Head Phantom (2450MHz)

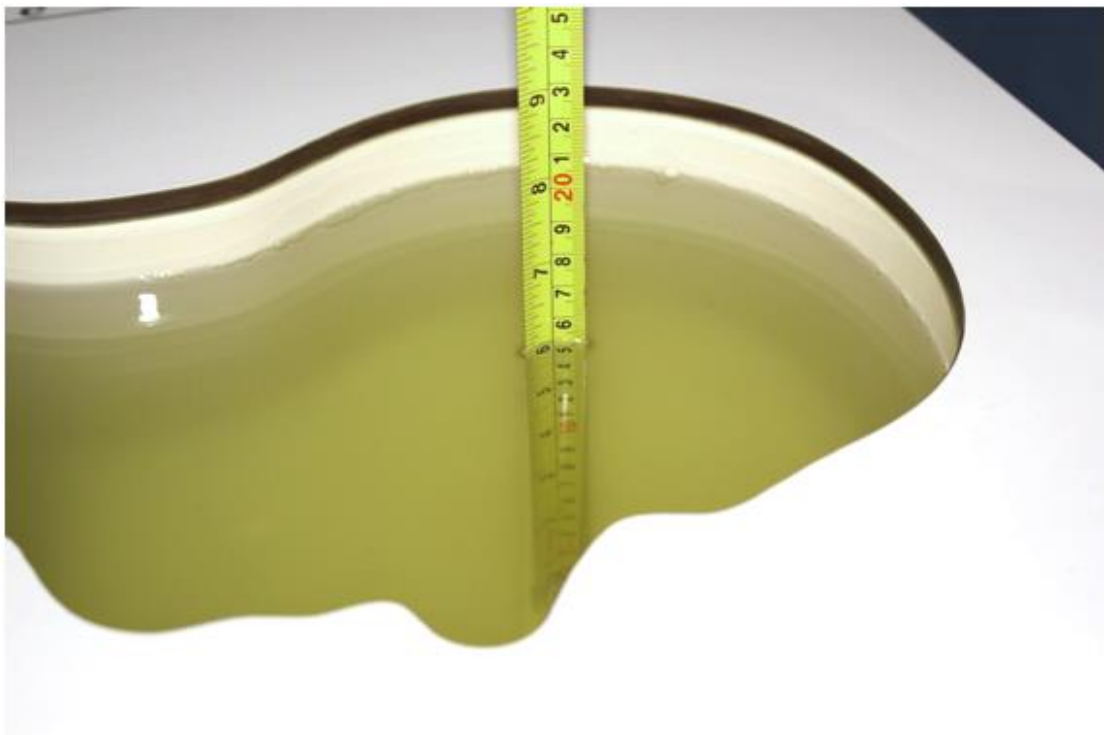

Picture 7-6 Liquid depth in the Head Phantom (2600 MHz)



Picture 7-7 Liquid depth in the Head Phantom (5GHz)

8 System verification

8.1 System Setup

In the simplified setup for system evaluation, the DUT is replaced by a calibrated dipole and the power source is replaced by a continuous wave that comes from a signal generator. The calibrated dipole must be placed beneath the flat phantom section of the SAM twin phantom with the correct distance holder. The distance holder should touch the phantom surface with a light pressure at the reference marking and be oriented parallel to the long side of the phantom. The equipment setup is shown below:

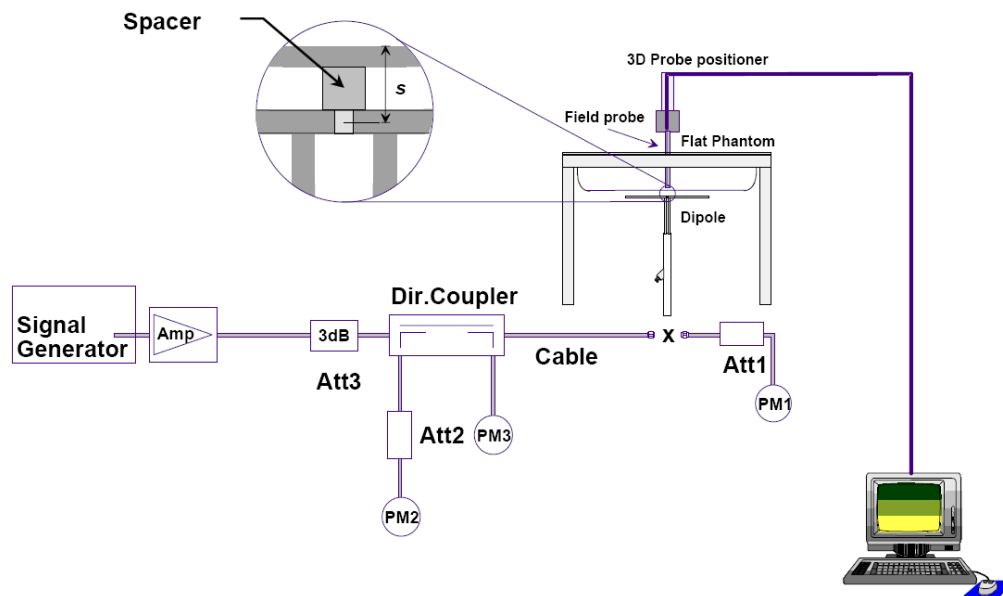

Picture 8.1 System Setup for System Evaluation



Picture 8.2 Photo of Dipole Setup

8.2 System Verification

SAR system verification is required to confirm measurement accuracy, according to the tissue dielectric media, probe calibration points and other system operating parameters required for measuring the SAR of a test device. The system verification must be performed for each frequency band and within the valid range of each probe calibration point required for testing the device.

The system verification results are required that the area scan estimated 1-g SAR is within 3% of the zoom scan 1-g SAR. The details are presented in annex B.

Table 8.1: System Verification of Head

Measurement Date (yyyy-mm-dd)	Frequency	Target value (W/kg)		Measured value (W/kg)		Deviation	
		10 g Average	1 g Average	10 g Average	1 g Average	10 g Average	1 g Average
2020/5/12	750 MHz	5.57	8.57	5.64	8.52	1.26%	-0.58%
2020/5/13	835 MHz	6.29	9.70	6.24	9.76	-0.79%	0.62%
2020/5/14	1750 MHz	19.3	36.6	19.24	36.12	-0.31%	-1.31%
2020/5/15	1900 MHz	20.8	39.7	21.16	39.8	1.73%	0.25%
2020/5/16	2450 MHz	24.2	51.6	23.96	50.88	-0.99%	-1.40%
2020/5/17	2600 MHz	25.1	55.8	25.24	54.68	0.56%	-2.01%
2020/6/5	5250 MHz	23.2	80.4	23.6	80.7	1.72%	0.35%
2020/6/6	5600 MHz	24.1	84.5	24.2	83.5	0.41%	-1.16%
2020/6/7	5750 MHz	23.0	80.4	23.0	80.6	0.17%	0.20%

9 Measurement Procedures

9.1 Tests to be performed

In order to determine the highest value of the peak spatial-average SAR of a handset, all device positions, configurations and operational modes shall be tested for each frequency band according to steps 1 to 3 below. A flowchart of the test process is shown in picture 9.1.

Step 1: The tests described in 9.2 shall be performed at the channel that is closest to the centre of the transmit frequency band (f_c) for:

- a) all device positions (cheek and tilt, for both left and right sides of the SAM phantom, as described in annex D),
- b) all configurations for each device position in a), e.g., antenna extended and retracted, and
- c) all operational modes, e.g., analogue and digital, for each device position in a) and configuration in b) in each frequency band.

If more than three frequencies need to be tested according to 11.1 (i.e., $N_c > 3$), then all frequencies, configurations and modes shall be tested for all of the above test conditions.

Step 2: For the condition providing highest peak spatial-average SAR determined in Step 1, perform all tests described in 9.2 at all other test frequencies, i.e., lowest and highest frequencies. In addition, for all other conditions (device position, configuration and operational mode) where the peak spatial-average SAR value determined in Step 1 is within 3 dB of the applicable SAR limit, it is recommended that all other test frequencies shall be tested as well.

Step 3: Examine all data to determine the highest value of the peak spatial-average SAR found in Steps 1 to 2.

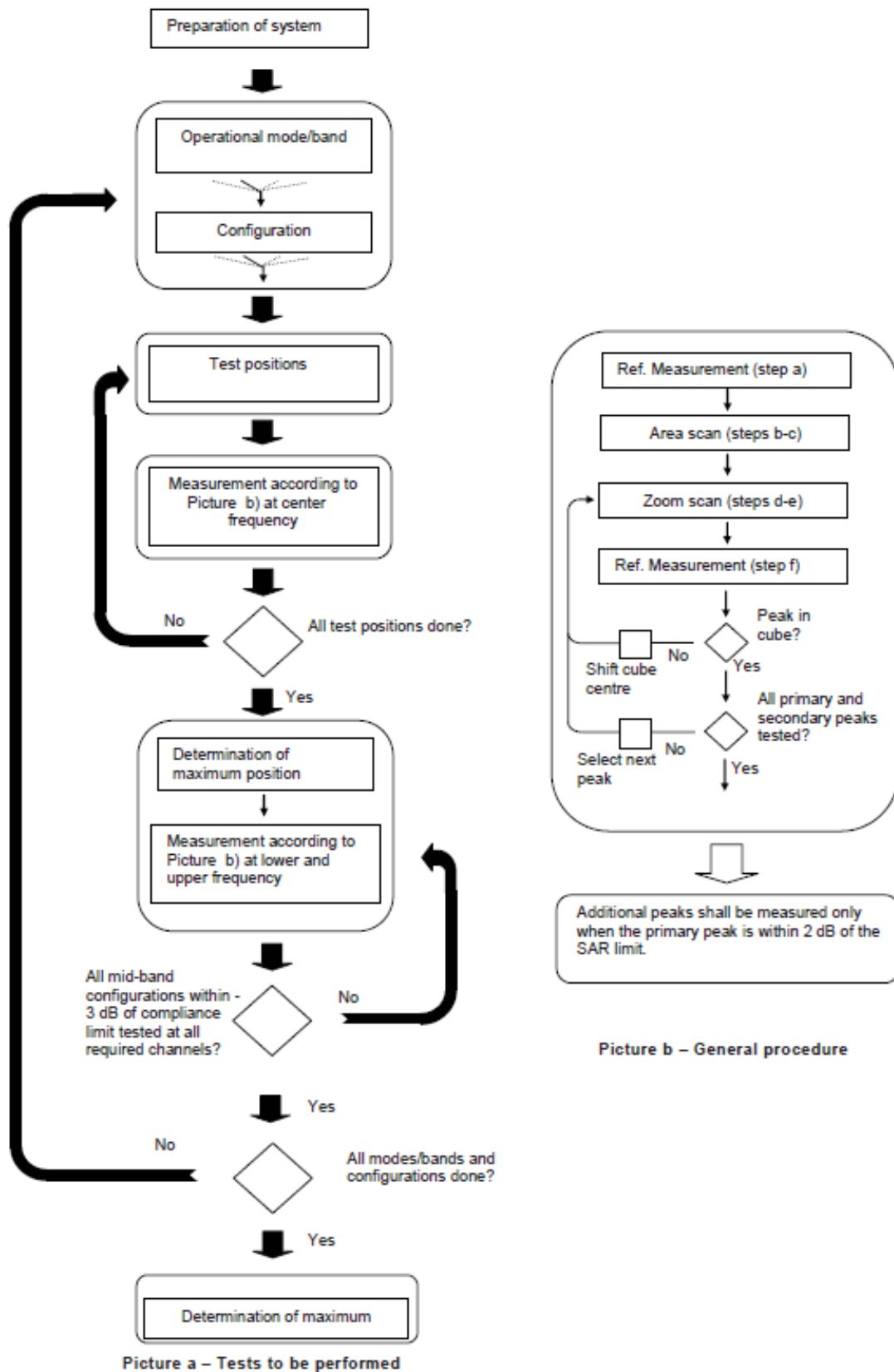

Picture 9.1 Block diagram of the tests to be performed

6 Specific Absorption Rate (SAR)

6.1 Introduction

SAR is related to the rate at which energy is absorbed per unit mass in an object exposed to a radio field. The SAR distribution in a biological body is complicated and is usually carried out by experimental techniques or numerical modeling. The standard recommends limits for two tiers of groups, occupational/controlled and general population/uncontrolled, based on a person's awareness and ability to exercise control over his or her exposure. In general, occupational/controlled exposure limits are higher than the limits for general population/uncontrolled.

6.2 SAR Definition

The SAR definition is the time derivative (rate) of the incremental energy (dW) absorbed by (dissipated in) an incremental mass (dm) contained in a volume element (dv) of a given density (ρ). The equation description is as below:

$$SAR = \frac{d}{dt} \left(\frac{dW}{dm} \right) = \frac{d}{dt} \left(\frac{dW}{\rho dv} \right)$$

SAR is expressed in units of Watts per kilogram (W/kg)

SAR measurement can be either related to the temperature elevation in tissue by

$$SAR = c \left(\frac{\delta T}{\delta t} \right)$$

Where: C is the specific heat capacity, δT is the temperature rise and δt is the exposure duration, or related to the electrical field in the tissue by

$$SAR = \frac{\sigma |E|^2}{\rho}$$

Where: σ is the conductivity of the tissue, ρ is the mass density of tissue and E is the RMS electrical field strength.

However for evaluating SAR of low power transmitter, electrical field measurement is typically applied.

9.2 General Measurement Procedure

The area and zoom scan resolutions specified in the table below must be applied to the SAR measurements and fully documented in SAR reports to qualify for TCB approval. Probe boundary effect error compensation is required for measurements with the probe tip closer than half a probe tip diameter to the phantom surface. Both the probe tip diameter and sensor offset distance must satisfy measurement protocols; to ensure probe boundary effect errors are minimized and the higher fields closest to the phantom surface can be correctly measured and extrapolated to the phantom surface for computing 1-g SAR. Tolerances of the post-processing algorithms must be verified by the test laboratory for the scan resolutions used in the SAR measurements, according to the reference distribution functions specified in IEEE Std 1528-2003. The results should be documented as part of the system validation records and may be requested to support test results when all the measurement parameters in the following table are not satisfied.

		≤ 3 GHz	> 3 GHz
Maximum distance from closest measurement point (geometric center of probe sensors) to phantom surface		5 ± 1 mm	$\frac{1}{2} \delta \cdot \ln(2) \pm 0.5$ mm
Maximum probe angle from probe axis to phantom surface normal at the measurement location		$30^\circ \pm 1^\circ$	$20^\circ \pm 1^\circ$
Maximum area scan spatial resolution: Δx_{Area} , Δy_{Area}		≤ 2 GHz: ≤ 15 mm 2 – 3 GHz: ≤ 12 mm	3 – 4 GHz: ≤ 12 mm 4 – 6 GHz: ≤ 10 mm
		When the x or y dimension of the test device, in the measurement plane orientation, is smaller than the above, the measurement resolution must be \leq the corresponding x or y dimension of the test device with at least one measurement point on the test device.	
Maximum zoom scan spatial resolution: Δx_{Zoom} , Δy_{Zoom}		≤ 2 GHz: ≤ 8 mm 2 – 3 GHz: ≤ 5 mm*	3 – 4 GHz: ≤ 5 mm* 4 – 6 GHz: ≤ 4 mm*
Maximum zoom scan spatial resolution, normal to phantom surface	uniform grid: $\Delta z_{Zoom}(n)$	≤ 5 mm	3 – 4 GHz: ≤ 4 mm 4 – 5 GHz: ≤ 3 mm 5 – 6 GHz: ≤ 2 mm
	graded grid $\Delta z_{Zoom}(1)$: between 1 st two points closest to phantom surface	≤ 4 mm	3 – 4 GHz: ≤ 3 mm 4 – 5 GHz: ≤ 2.5 mm 5 – 6 GHz: ≤ 2 mm
	$\Delta z_{Zoom}(n>1)$: between subsequent points	$\leq 1.5 \cdot \Delta z_{Zoom}(n-1)$	
Minimum zoom scan volume	x, y, z	≥ 30 mm	3 – 4 GHz: ≥ 28 mm 4 – 5 GHz: ≥ 25 mm 5 – 6 GHz: ≥ 22 mm
Note: δ is the penetration depth of a plane-wave at normal incidence to the tissue medium; see draft standard IEEE P1528-2011 for details. * When zoom scan is required and the <u>reported</u> SAR from the area scan based 1-g SAR estimation procedures of KDB 447498 is ≤ 1.4 W/kg, ≤ 8 mm, ≤ 7 mm and ≤ 5 mm zoom scan resolution may be applied, respectively, for 2 GHz to 3 GHz, 3 GHz to 4 GHz and 4 GHz to 6 GHz.			

9.3 WCDMA Measurement Procedures for SAR

The following procedures are applicable to WCDMA handsets operating under 3GPP Release99, Release 5 and Release 6. The default test configuration is to measure SAR with an established radio link between the DUT and a communication test set using a 12.2kbps RMC (reference measurement channel) configured in Test Loop Mode 1. SAR is selectively confirmed for other physical channel configurations (DPCCH & DPDCH_n), HSDPA and HSPA (HSUPA/HSDPA) modes according to output power, exposure conditions and device operating capabilities. Both uplink and downlink should be configured with the same RMC or AMR, when required. SAR for Release 5 HSDPA and Release 6 HSPA are measured using the applicable FRC (fixed reference channel) and E-DCH reference channel configurations. Maximum output power is verified according to applicable versions of 3GPP TS 34.121 and SAR must be measured according to these maximum output conditions. When Maximum Power Reduction (MPR) is not implemented according to Cubic Metric (CM) requirements for Release 6 HSPA, the following procedures do not apply.

For Release 5 HSDPA Data Devices:

Sub-test	β_c	β_d	β_d (SF)	β_c / β_d	β_{hs}	CM/dB
1	2/15	15/15	64	2/15	4/15	0.0
2	12/15	15/15	64	12/15	24/25	1.0
3	15/15	8/15	64	15/8	30/15	1.5
4	15/15	4/15	64	15/4	30/15	1.5

For Release 6 HSPA Data Devices

Sub-test	β_c	β_d	β_d (SF)	β_c / β_d	β_{hs}	β_{ec}	β_{ed}	β_{ed} (SF)	β_{ed} (codes)	CM (dB)	MPR (dB)	AG Index	E-TFCI
1	11/15	15/15	64	11/15	22/15	209/225	1039/225	4	1	1.5	1.5	20	75
2	6/15	15/15	64	6/15	12/15	12/15	12/15	4	1	1.5	1.5	12	67
3	15/15	9/15	64	15/9	30/15	30/15	$\beta_{ed1}:47/15$ $\beta_{ed2}:47/15$	4	2	1.5	1.5	15	92
4	2/15	15/15	64	2/15	4/15	4/15	56/75	4	1	1.5	1.5	17	71
5	15/15	15/15	64	15/15	24/15	30/15	134/15	4	1	1.5	1.5	21	81

Rel.8 DC-HSDPA (Cat 24)

SAR test exclusion for Rel.8 DC-HSDPA must satisfy the SAR test exclusion requirements of Rel.5 HSDPA. SAR test exclusion for DC-HSDPA devices is determined by power measurements according to the H-Set 12, Fixed Reference Channel (FRC) configuration in Table C.8.1.12 of 3GPP TS 34.121-1. A primary and a secondary serving HS-DSCH Cell are required to perform the power measurement and for the results to qualify for SAR test exclusion.

9.4 SAR Measurement for LTE

SAR tests for LTE are performed with a base station simulator, Rohde & Schwarz CMW500. Closed loop power control was used so the UE transmits with maximum output power during SAR testing. All powers were measured with the CMW 500.

It is performed for conducted power and SAR based on the KDB941225 D05.

SAR is evaluated separately according to the following procedures for the different test positions in each exposure condition – head, body, body-worn accessories and other use conditions. The procedures in the following subsections are applied separately to test each LTE frequency band.

1) QPSK with 1 RB allocation

Start with the largest channel bandwidth and measure SAR for QPSK with 1 RB allocation, using the RB offset and required test channel combination with the highest maximum output power among RB offsets at the upper edge, middle and lower edge of each required test channel. When the reported SAR is ≤ 0.8 W/kg, testing of the remaining RB offset configurations and required test channels is not required for 1 RB allocation; otherwise, SAR is required for the remaining required test channels and only for the RB offset configuration with the highest output power for that channel. When the reported SAR of a required test channel is > 1.45 W/kg, SAR is required for all three RB offset configurations for that required test channel.

2) QPSK with 50% RB allocation

The procedures required for 1 RB allocation in 1) are applied to measure the SAR for QPSK with 50% RB allocation.

3) QPSK with 100% RB allocation

For QPSK with 100% RB allocation, SAR is not required when the highest maximum output power for 100 % RB allocation is less than the highest maximum output power in 50% and 1 RB allocations and the highest reported SAR for 1 RB and 50% RB allocation in 1) and 2) are ≤ 0.8 W/kg. Otherwise, SAR is measured for the highest output power channel; and if the reported SAR is > 1.45 W/kg, the remaining required test channels must also be tested.

TDD test:

TDD testing is performed using guidance from FCC KDB 941225 D05 v02r05 and the SAR test guidance provided in April 2013 TCB works hop notes. TDD is tested at the highest duty factor using UL-DL configuration 0 with special subframe configuration 6 and applying the FDD LTE procedures in KDB 941225 D05 v02r05. SAR testing is performed using the extended cyclic prefix listed in 3GPP TS 36.211.

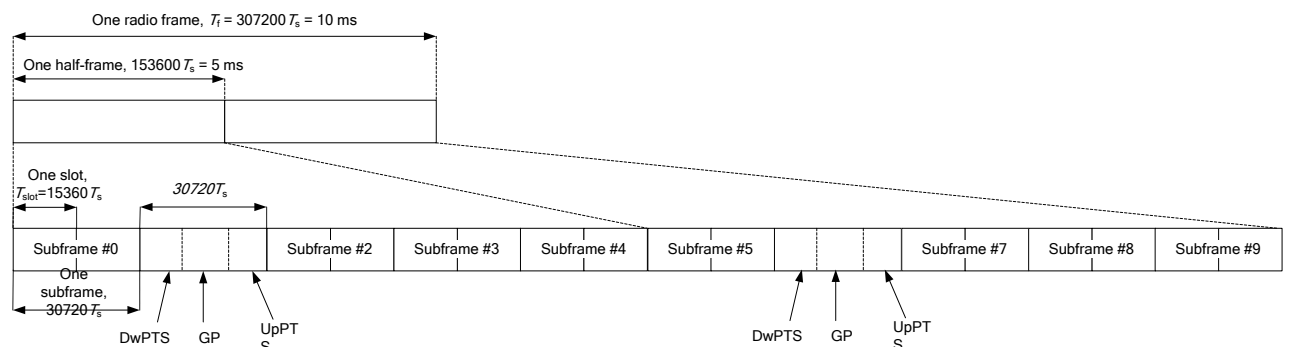

Figure 9.2: Frame structure type 2 (for 5 ms switch-point periodicity)

Table 9.1: Configuration of special subframe (lengths of DwPTS/GP/UpPTS)

Special subframe configuration	Normal cyclic prefix in downlink			Extended cyclic prefix in downlink		
	DwPTS	UpPTS		DwPTS	UpPTS	
		Normal cyclic prefix in uplink	Extended cyclic prefix in uplink		Normal cyclic prefix in uplink	Extended cyclic prefix in uplink
0	$6592 \cdot T_s$	$2192 \cdot T_s$	$2560 \cdot T_s$	$7680 \cdot T_s$	$2192 \cdot T_s$	$2560 \cdot T_s$
1	$19760 \cdot T_s$			$20480 \cdot T_s$		
2	$21952 \cdot T_s$			$23040 \cdot T_s$		
3	$24144 \cdot T_s$			$25600 \cdot T_s$		
4	$26336 \cdot T_s$	$4384 \cdot T_s$	$5120 \cdot T_s$	$7680 \cdot T_s$	$4384 \cdot T_s$	$5120 \cdot T_s$
5	$6592 \cdot T_s$			$20480 \cdot T_s$		
6	$19760 \cdot T_s$			$23040 \cdot T_s$		
7	$21952 \cdot T_s$			$12800 \cdot T_s$		
8	$24144 \cdot T_s$			-		
9	$13168 \cdot T_s$	-	-	-	-	-

Table 9.2: Uplink-downlink configurations

Uplink-downlink configuration	Downlink-to-Uplink Switch-point periodicity	Subframe number									
		0	1	2	3	4	5	6	7	8	9
0	5 ms	D	S	U	U	U	D	S	U	U	U
1	5 ms	D	S	U	U	D	D	S	U	U	D
2	5 ms	D	S	U	D	D	D	S	U	D	D
3	10 ms	D	S	U	U	U	D	D	D	D	D
4	10 ms	D	S	U	U	D	D	D	D	D	D
5	10 ms	D	S	U	D	D	D	D	D	D	D
6	5 ms	D	S	U	U	U	D	S	U	U	D

Duty factor is calculated by:

$$\begin{aligned}
 \text{Duty factor} &= \text{uplink frame} \cdot 6 + \text{UpPTS} \cdot 2 / \text{one frame length} \\
 &= (30720 \cdot T_s + 6 + 5120 \cdot T_s \cdot 2) / 307200 \cdot T_s \\
 &= 0.633
 \end{aligned}$$

According to the KDB 447498 D01, SAR should be evaluated at more than 3 frequencies for devices supporting transmit bands wider than 100MHz. Oct.2014 FCC-TCB conference notes (Dec. 2014 rev.) specifies the 5 test channels to use for 3GPP band 41 SAR evaluation.

9.5 Bluetooth & Wi-Fi Measurement Procedures for SAR

Normal network operating configurations are not suitable for measuring the SAR of 802.11 transmitters in general. Unpredictable fluctuations in network traffic and antenna diversity conditions can introduce undesirable variations in SAR results. The SAR for these devices should be measured using chipset based test mode software to ensure that the results are consistent and reliable.

Chipset based test mode software is hardware dependent and generally varies among manufacturers. The device operating parameters established in a test mode for SAR measurements must be identical to those programmed in production units, including output power levels, amplifier gain settings and other RF performance tuning parameters. The test frequencies should correspond to actual channel frequencies defined for domestic use. SAR for devices with switched diversity should be measured with only one antenna transmitting at a time during each SAR measurement, according to a fixed modulation and data rate. The same data pattern should be used for all measurements.

9.6 Power Drift

To control the output power stability during the SAR test, DASY4 system calculates the power drift by measuring the E-field at the same location at the beginning and at the end of the measurement for each test position. These drift values can be found in section 14 labeled as: (Power Drift [dB]). This ensures that the power drift during one measurement is within 5%.

10 Area Scan Based 1-g SAR

10.1 Requirement of KDB

According to the KDB447498 D01 v05, when the implementation is based the specific polynomial fit algorithm as presented at the 29th Bioelectromagnetics Society meeting (2007) and the estimated 1-gSAR is ≤ 1.2 W/kg, a zoom scan measurement is not required provided it is also not needed for any other purpose; for example, if the peak SAR location required for simultaneous transmission SAR test exclusion can be determined accurately by the SAR system or manually to discriminate between distinctive peaks and scattered noisy SAR distributions from area scans.

There must not be any warning or alert messages due to various measurement concerns identified by the SAR system; for example, noise in measurements, peaks too close to scan boundary, peaks are too sharp, spatial resolution and uncertainty issues etc. The SAR system verification must also demonstrate that the area scan estimated 1-g SAR is within 3% of the zoom scan 1-g SAR (See Annex B). When all the SAR results for each exposure condition in a frequency band and wireless mode are based on estimated 1-g SAR, the 1-g SAR for the highest SAR configuration must be determined by a zoom scan.

10.2 Fast SAR Algorithms

The approach is based on the area scan measurement applying a frequency dependent attenuation parameter. This attenuation parameter was empirically determined by analyzing a large number of phones. The MOTOROLA FAST SAR was developed and validated by the MOTOROLA Research Group in Ft. Lauderdale.

In the initial study, an approximation algorithm based on Linear fit was developed. The accuracy of the algorithm has been demonstrated across a broad frequency range (136-2450 MHz) and for both 1- and 10-g averaged SAR using a sample of 264 SAR measurements from 55 wireless handsets. For the sample size studied, the root-mean-squared errors of the algorithm are 1.2% and 5.8% for 1- and 10-g averaged SAR, respectively. The paper describing the algorithm in detail is expected to be published in August 2004 within the Special Issue of Transactions on MTT.

In the second step, the same research group optimized the fitting algorithm to an Polynomial fit whereby the frequency validity was extended to cover the range 30-6000MHz. Details of this study can be found in the BEMS 2007 Proceedings.

Both algorithms are implemented in DASY software.

11 Conducted Output Power

For Main antenna, there are two sets of tune-up power, Normal power and Low power (Hotspot on)

Normal power	Low Power-Hotspot on
Power Level A	Power Level B

For WiFi antenna, there are two sets of tune-up power, Normal power and Low power. Low power status is applied for head test, when the phone is in talking mode and receiver worked, then power reduction will be applied.

11.1 GSM Measurement result

During the process of testing, the EUT was controlled via Agilent Digital Radio Communication tester (E5515C) to ensure the maximum power transmission and proper modulation. This result contains conducted output power for the EUT. In all cases, the measured peak output power should be greater and within 5% than EMI measurement.

Table 11.1-1: The conducted power measurement results for GSM, GPRS and EGPRS-Level A

GSM 850 Speech (GMSK)	Measured Power (dBm)			Tune up	calculation	Averaged Power (dBm)		
	251	190	128			251	190	128
1 Txslot	31.65	31.74	32.09	33.3	/	/	/	/
GSM 850 GPRS (GMSK)	Measured Power (dBm)				calculation	Averaged Power (dBm)		
	251	190	128			251	190	128
1 Txslot	31.64	31.63	31.93	33.30	-9.03	22.61	22.60	22.90
2 Txslots	30.06	30.30	30.49	30.50	-6.02	24.04	24.28	24.47
3 Txslots	27.30	27.58	28.24	28.50	-4.26	23.04	23.32	23.98
4 Txslots	26.28	26.51	26.73	27.50	-3.01	23.27	23.50	23.72
GSM 850 EGPRS (GMSK)	Measured Power (dBm)				calculation	Averaged Power (dBm)		
	251	190	128			251	190	128
1 Txslot	31.63	31.63	31.93	33.30	-9.03	22.60	22.60	22.90
2 Txslots	30.06	29.98	30.49	30.50	-6.02	24.04	23.96	24.47
3 Txslots	27.29	27.59	28.25	28.50	-4.26	23.03	23.33	23.99
4 Txslots	26.29	26.52	26.73	27.50	-3.01	23.28	23.51	23.72
GSM 850 EGPRS (8PSK)	Measured Power (dBm)				calculation	Averaged Power (dBm)		
	251	190	128			251	190	128
1 Txslot	25.18	25.98	25.59	27.00	-9.03	16.15	16.95	17.47
2 Txslots	21.87	22.62	23.20	23.50	-6.02	15.85	16.60	17.18
3 Txslots	21.52	21.31	21.75	22.50	-4.26	17.26	17.05	17.69
4 Txslots	19.81	20.09	21.43	21.60	-3.01	16.80	17.08	18.42
PCS1900 Speech (GMSK)	Measured Power (dBm)			Tune up	calculation	Averaged Power (dBm)		
	810	661	512			810	661	512
1 Txslot	29.30	29.33	29.51	30.80	/	/	/	/
PCS1900 GPRS (GMSK)	Measured Power (dBm)				calculation	Averaged Power (dBm)		
	810	661	512			810	661	512

1 Txslot	29.48	29.86	29.57	30.80	-9.03	20.45	20.83	20.54
2 Txslots	26.44	26.60	26.60	27.50	-6.02	20.42	20.58	20.58
3 Txslots	24.78	24.90	24.80	26.00	-4.26	20.52	20.64	20.54
4 Txslots	23.66	23.67	23.57	25.00	-3.01	20.65	20.66	20.56
PCS1900 EGPRS (GMSK)	Measured Power (dBm)				calculation	Averaged Power (dBm)		
	810	661	512			810	661	512
1 Txslot	29.39	29.38	29.41	30.30	-9.03	20.36	20.35	20.38
2 Txslots	26.50	26.50	26.51	27.50	-6.02	20.48	20.48	20.49
3 Txslots	24.77	24.80	24.82	25.50	-4.26	20.51	20.54	20.56
4 Txslots	23.53	23.58	23.59	24.50	-3.01	20.52	20.57	20.58
PCS1900 EGPRS (8PSK)	Measured Power (dBm)				calculation	Averaged Power (dBm)		
	810	661	512			810	661	512
1 Txslot	25.04	24.60	24.78	26.00	-9.03	16.01	15.57	15.75
2 Txslots	22.91	23.18	22.91	24.00	-6.02	16.89	17.16	16.89
3 Txslots	20.10	20.22	20.14	21.80	-4.26	15.84	15.96	15.88
4 Txslots	19.75	19.79	19.83	21.50	-3.01	16.74	16.78	16.82

NOTES:

1) Division Factors

To average the power, the division factor is as follows:

1TX-slot = 1 transmit time slot out of 8 time slots=> conducted power divided by (8/1) => -9.03dB

2TX-slots = 2 transmit time slots out of 8 time slots=> conducted power divided by (8/2) => -6.02dB

3TX-slots = 3 transmit time slots out of 8 time slots=> conducted power divided by (8/3) => -4.26dB

4TX-slots = 4 transmit time slots out of 8 time slots=> conducted power divided by (8/4) => -3.01dB

According to the conducted power as above, the body measurements are performed with 2Txslots for GSM850 and 3Txslots for GSM1900.

Power-Level B

PCS1900 Speech (GMSK)	Measured Power (dBm)			Tune up	calculation	Averaged Power (dBm)		
	810	661	512			810	661	512
1 Txslot	25.94	26.00	26.10	27	!	!	!	!
PCS1900 GPRS (GMSK)	Measured Power (dBm)				calculation	Averaged Power (dBm)		
	810	661	512			810	661	512
1 Txslot	25.94	26.07	26.05	27.00	-9.03	16.91	17.04	17.02
2 Txslots	22.79	22.77	22.85	24.00	-6.02	16.77	16.75	16.83
3 Txslots	21.62	21.62	21.77	23.30	-4.26	17.36	17.36	17.51
4 Txslots	20.12	20.23	20.27	21.50	-3.01	17.11	17.22	17.26
PCS1900 EGPRS (GMSK)	Measured Power (dBm)				calculation	Averaged Power (dBm)		
	810	661	512			810	661	512
1 Txslot	25.97	26.04	26.13	27.00	-9.03	16.94	17.01	17.10
2 Txslots	22.74	22.74	22.83	24.00	-6.02	16.72	16.72	16.81
3 Txslots	21.59	21.60	21.76	23.30	-4.26	17.33	17.34	17.50

4 Txslots	20.10	20.22	20.27	21.50	-3.01	17.09	17.21	17.26
PCS1900 EGPRS (8PSK)	Measured Power (dBm)				calculation	Averaged Power (dBm)		
	810	661	512			810	661	512
1 Txslot	25.04	24.60	24.78	26.00	-9.03	16.01	15.57	15.75
2 Txslots	22.91	23.18	22.91	24.00	-6.02	16.89	17.16	16.89
3 Txslots	20.10	20.22	20.14	21.80	-4.26	15.84	15.96	15.88
4 Txslots	19.75	19.79	19.83	21.50	-3.01	16.74	16.78	16.82

NOTES:

1) Division Factors

To average the power, the division factor is as follows:

1TX-slot = 1 transmit time slot out of 8 time slots=> conducted power divided by (8/1) => -9.03dB

2TX-slots = 2 transmit time slots out of 8 time slots=> conducted power divided by (8/2) => -6.02dB

3TX-slots = 3 transmit time slots out of 8 time slots=> conducted power divided by (8/3) => -4.26dB

4TX-slots = 4 transmit time slots out of 8 time slots=> conducted power divided by (8/4) => -3.01dB

According to the conducted power as above, the body measurements are performed with 2Txslots for GSM1900.

11.2 WCDMA Measurement result

Table 11.2-1: The conducted Power for WCDMA-Level A

Item	band	FDDV result			
	ARFCN	4233 (846.6MHz)	4182 (836.4MHz)	4132 (826.4MHz)	Tune up
WCDMA	\	22.52	22.80	22.95	24
HSUPA	1	21.25	21.30	21.48	22
	2	19.28	19.37	19.43	21
	3	20.20	20.30	20.42	22
	4	19.31	19.33	19.51	21
	5	21.22	21.33	21.41	22
DC-HSDPA	1	21.16	21.41	21.51	23
	2	21.61	21.79	21.86	23
	3	21.63	21.78	21.87	23
	4	21.12	21.33	21.39	23
Item	band	FDDIV result			
	ARFCN	1513 (1752.6MHz)	1412 (1732.4MHz)	1312 (1712.4MHz)	
WCDMA	\	22.80	22.73	22.92	24
HSUPA	1	21.77	21.68	21.80	22
	2	19.89	19.78	19.88	21
	3	20.83	20.70	20.85	22
	4	19.81	19.67	19.85	21
	5	21.84	21.74	21.88	22
DC-HSDPA	1	21.23	21.23	21.44	23
	2	21.86	21.62	21.64	22

	3	21.89	21.61	21.69	22
	4	21.13	21.15	21.34	22
Item	band	FDDII result			
	ARFCN	9538 (1907.6MHz)	9400 (1880MHz)	9262 (1852.4MHz)	Tune up
WCDMA	\	22.77	22.63	22.53	23
HSUPA	1	21.87	21.57	21.41	22
	2	19.95	19.69	19.51	21
	3	20.82	20.59	20.49	22
	4	19.93	19.65	19.46	21
	5	21.89	21.64	21.51	22
DC-HSDPA	1	21.23	21.14	21.09	23
	2	21.56	21.52	21.48	22
	3	21.58	21.57	21.49	22
	4	21.08	21.07	21.01	22

Table 11.2-2: The conducted Power for WCDMA-Level B

Item	band	FDDIV result			
	ARFCN	1513 (1752.6MHz)	1412(1732.4MHz)	1312 (1712.4MHz)	Tune up
WCDMA	\	20.11	20.12	20.27	21
HSUPA	1	18.50	18.51	18.54	19.50
	2	16.47	16.41	16.48	18.00
	3	17.49	17.36	17.53	18.00
	4	16.48	16.40	16.47	18.00
	5	18.50	18.35	18.56	20.00
DC-HSDPA	1	18.04	18.00	18.09	20.00
	2	18.43	18.37	18.51	20.00
	3	18.47	18.38	18.55	20.00
	4	18.01	18.02	18.04	20.00
Item	band	FDDII result			
	ARFCN	9538 (1907.6MHz)	9400 (1880MHz)	9262 (1852.4MHz)	Tune up
WCDMA	\	20.20	20.01	19.96	21
HSUPA	1	18.56	18.33	18.18	20.50
	2	16.57	16.28	16.14	20.50
	3	17.51	17.28	17.17	20.00
	4	16.54	16.27	16.03	20.00
	5	18.51	18.25	18.11	20.00
DC-HSDPA	1	18.08	17.91	17.60	20.00
	2	18.37	18.25	18.08	20.00
	3	18.38	18.29	18.09	20.00
	4	17.91	17.83	17.62	20.00

11.3 CDMA Measurement result

Table 11.3-1: The conducted Power for CDMA-Level A

CDMA BC0	Conducted Power (dBm)			Tune up
	777 (848.31MHz)	384 (836.52MHz)	1013 (824.7MHz)	
SO55/RC3	24.35	24.16	23.92	25
SO55/RC1	24.34	24.15	23.91	25
SO32/RC3(FCH only)	24.34	24.14	23.91	25
SO32/RC3(FCH+SCH _n)	24.33	24.15	23.90	25
EVDO Rev.0	24.22	24.27	24.30	25
EVDO Rev.A	24.19	24.28	24.27	25
CDMA BC1	Conducted Power (dBm)			Tune up
	1175 (1908.75MHz)	600 (1880MHz)	25 (1851.25MHz)	
SO55/RC3	24.09	24.32	24.43	25
SO55/RC1	24.07	24.31	24.42	25
SO32/RC3(FCH only)	24.06	24.31	24.41	25
SO32/RC3(FCH+SCH _n)	24.08	24.30	24.41	25
EVDO Rev.0	24.72	24.61	24.36	25
EVDO Rev.A	24.76	24.57	24.35	25
CDMA BC10	Conducted Power (dBm)			Tune up
	684 (823.1MHz)	580 (820.5MHz)	476(817.9MHz)	
SO55/RC3	24.52	24.45	24.47	25
SO55/RC1	24.51	24.41	24.46	25
SO32/RC3(FCH only)	24.50	24.40	24.45	25
SO32/RC3(FCH+SCH _n)	24.50	24.42	24.44	25
EVDO Rev.0	24.76	24.82	24.84	25
EVDO Rev.A	24.75	24.77	24.83	25

Table 11.3-2: The conducted Power for CDMA-Level B

CDMA BC1	Conducted Power (dBm)			Tune up
	1175 (1908.75MHz)	600 (1880MHz)	25 (1851.25MHz)	
SO55/RC3	21.32	21.11	20.88	22
SO55/RC1	21.31	21.10	20.82	22
SO32/RC3(FCH only)	21.30	21.10	20.87	22
SO32/RC3(FCH+SCH _n)	21.31	21.09	20.86	22
EVDO Rev.0	21.38	21.27	20.89	22
EVDO Rev.A	21.37	21.24	20.87	22

11.4 LTE Measurement result

Table 11.4-1: Maximum Power Reduction (MPR) for LTE

Modulation	Channel bandwidth / Transmission bandwidth configuration [RB]						MPR (dB)
	1.4	3	5	10	15	20	
	MHz	MHz	MHz	MHz	MHz	MHz	
QPSK	> 5	> 4	> 8	> 12	> 16	> 18	1
16 QAM	≤ 5	≤ 4	≤ 8	≤ 12	≤ 16	≤ 18	1
16 QAM	> 5	> 4	> 8	> 12	> 16	> 18	2

Table 11.4-2: The tune up for LTE – Level A

Band	Tune up
LTE Band 7	23.5
LTE Band 12	23.5
LTE Band 13	24
LTE Band 25	24
LTE Band 26	24
LTE Band 41(PC2)	28
LTE Band 41(PC3)	24
LTE Band 66	24
LTE Band 71	24

Table 11.4-3: The tune up for LTE – Level B

Band	Tune up
LTE Band 7	18.5
LTE Band 25	19.5
LTE Band 41(PC2)	24
LTE Band 41(PC3)	20.3(Channel L/M)
LTE Band 41(PC3)	21(Channel H)
LTE Band 66	19.5

LTE B7-Level A					
BANDWIDTH	Number of RBs	Frequency	QPSK	16QAM	64QAM
5MHz	1RB-High (24)	2567.5 (21425)	22.42	21.51	21.51
		2535 (21100)	22.33	21.50	21.65
		2502.5 (20775)	22.09	21.61	21.32
	1RB-Middle (12)	2567.5 (21425)	22.43	21.51	21.54
		2535 (21100)	22.35	21.46	21.72
		2502.5 (20775)	22.08	21.62	21.34
	1RB-Low (0)	2567.5 (21425)	22.39	21.51	21.61
		2535 (21100)	22.33	21.45	21.73
		2502.5 (20775)	22.08	21.59	21.41
	12RB-High (13)	2567.5 (21425)	21.44	20.55	20.45
		2535 (21100)	21.32	20.48	20.62
		2502.5 (20775)	21.15	20.36	20.35
	12RB-Middle (6)	2567.5 (21425)	21.48	20.58	20.49
		2535 (21100)	21.31	20.54	20.69
		2502.5 (20775)	21.17	20.37	20.40
	12RB-Low (0)	2567.5 (21425)	21.43	20.55	20.47
		2535 (21100)	21.32	20.46	20.60
		2502.5 (20775)	21.14	20.35	20.30
25RB (0)	2567.5 (21425)	21.42	20.45	20.39	
	2535 (21100)	21.32	20.45	20.62	
	2502.5 (20775)	21.18	20.30	20.33	
10MHz	1RB-High (49)	2565 (21400)	22.29	21.37	21.47
		2535 (21100)	22.27	21.20	21.66
		2505 (20800)	22.20	21.51	21.42
	1RB-Middle (24)	2565 (21400)	22.29	21.43	21.62
		2535 (21100)	22.25	21.24	21.66
		2505 (20800)	22.09	21.44	21.34
	1RB-Low (0)	2565 (21400)	22.33	21.44	21.69
		2535 (21100)	22.15	21.16	21.68
		2505 (20800)	22.05	21.41	21.27
	25RB-High (25)	2565 (21400)	21.42	20.60	20.48
		2535 (21100)	21.31	20.46	20.64
		2505 (20800)	21.23	20.29	20.37
	25RB-Middle (12)	2565 (21400)	21.41	20.65	20.48
		2535 (21100)	21.33	20.44	20.68
		2505 (20800)	21.19	20.26	20.31
	25RB-Low (0)	2565 (21400)	21.39	20.58	20.52
		2535 (21100)	21.29	20.37	20.64
		2505 (20800)	21.10	20.23	20.29
50RB (0)	2565 (21400)	21.38	20.55	20.49	
	2535 (21100)	21.29	20.41	20.60	
	2505 (20800)	21.19	20.32	20.38	



15MHz	1RB-High (74)	2562.5 (21375)	22.36	21.77	21.56
		2535 (21100)	22.30	21.65	21.71
		2507.5 (20825)	22.13	21.09	21.39
	1RB-Middle (37)	2562.5 (21375)	22.43	21.81	21.65
		2535 (21100)	22.33	21.73	21.73
		2507.5 (20825)	22.05	21.01	21.33
	1RB-Low (0)	2562.5 (21375)	22.37	21.80	21.64
		2535 (21100)	22.25	21.64	21.69
		2507.5 (20825)	21.99	20.96	21.45
	36RB-High (38)	2562.5 (21375)	21.41	20.55	20.48
		2535 (21100)	21.29	20.40	20.64
		2507.5 (20825)	21.24	20.30	20.40
	36RB-Middle (19)	2562.5 (21375)	21.45	20.61	20.56
		2535 (21100)	21.32	20.39	20.64
		2507.5 (20825)	21.22	20.34	20.45
	36RB-Low (0)	2562.5 (21375)	21.40	20.54	20.57
		2535 (21100)	21.26	20.30	20.62
		2507.5 (20825)	21.08	20.19	20.30
	75RB (0)	2562.5 (21375)	21.41	20.50	20.51
		2535 (21100)	21.31	20.36	20.62
		2507.5 (20825)	21.22	20.27	20.31
20MHz	1RB-High (99)	2560 (21350)	22.18	21.85	21.40
		2535 (21100)	22.20	21.70	21.61
		2510 (20850)	22.11	21.54	21.49
	1RB-Middle (50)	2560 (21350)	22.27	21.96	21.65
		2535 (21100)	22.24	21.79	21.70
		2510 (20850)	22.07	21.50	21.51
	1RB-Low (0)	2560 (21350)	22.16	21.78	21.62
		2535 (21100)	22.00	21.53	21.50
		2510 (20850)	21.89	21.34	21.29
	50RB-High (50)	2560 (21350)	21.35	20.50	20.51
		2535 (21100)	21.34	20.43	20.58
		2510 (20850)	21.22	20.28	20.41
	50RB-Middle (25)	2560 (21350)	21.40	20.51	20.57
		2535 (21100)	21.37	20.50	20.60
		2510 (20850)	21.25	20.28	20.44
	50RB-Low (0)	2560 (21350)	21.37	20.43	20.61
		2535 (21100)	21.30	20.39	20.57
		2510 (20850)	21.16	20.19	20.38
	100RB (0)	2560 (21350)	21.35	20.50	20.56
		2535 (21100)	21.31	20.39	20.61
		2510 (20850)	21.15	20.21	20.35

LTEB7-Level B					
BANDWIDTH	Number of RBs	Frequency	QPSK	16QAM	Tune-up
5MHz	1RB-High (24)	2567.5 (21425)	17.82	17.88	18.01
		2535 (21100)	17.58	18.16	17.92
		2502.5 (20775)	17.44	17.61	17.69
	1RB-Middle (12)	2567.5 (21425)	17.84	17.89	17.98
		2535 (21100)	17.62	18.21	18.06
		2502.5 (20775)	17.47	17.62	17.67
	1RB-Low (0)	2567.5 (21425)	17.84	17.99	17.96
		2535 (21100)	17.54	18.14	17.92
		2502.5 (20775)	17.47	17.63	17.60
	12RB-High (13)	2567.5 (21425)	17.34	17.94	17.85
		2535 (21100)	17.38	17.86	17.92
		2502.5 (20775)	17.33	17.60	17.57
	12RB-Middle (6)	2567.5 (21425)	17.33	17.93	17.93
		2535 (21100)	17.65	17.85	17.91
		2502.5 (20775)	17.49	17.61	17.61
	12RB-Low (0)	2567.5 (21425)	17.78	17.92	17.90
		2535 (21100)	17.59	17.82	17.79
		2502.5 (20775)	17.46	17.59	17.60
	25RB (0)	2567.5 (21425)	17.77	17.86	17.87
		2535 (21100)	17.62	17.73	17.82
		2502.5 (20775)	17.45	17.49	17.54
10MHz	1RB-High (49)	2565 (21400)	17.56	17.70	17.82
		2535 (21100)	17.59	17.58	17.89
		2505 (20800)	17.51	17.87	17.73
	1RB-Middle (24)	2565 (21400)	17.59	17.75	18.02
		2535 (21100)	17.56	17.60	17.88
		2505 (20800)	17.45	17.86	17.63
	1RB-Low (0)	2565 (21400)	17.59	17.70	18.04
		2535 (21100)	17.47	17.54	17.93
		2505 (20800)	17.40	17.82	17.61
	25RB-High (25)	2565 (21400)	17.67	17.88	17.86
		2535 (21100)	17.60	17.73	17.82
		2505 (20800)	17.53	17.64	17.58
	25RB-Middle (12)	2565 (21400)	17.67	17.86	17.90
		2535 (21100)	17.60	17.76	17.88
		2505 (20800)	17.46	17.60	17.57
	25RB-Low (0)	2565 (21400)	17.62	17.89	17.95
		2535 (21100)	17.58	17.73	17.88
		2505 (20800)	17.45	17.56	17.56
	50RB (0)	2565 (21400)	17.67	17.78	17.87
		2535 (21100)	17.57	17.70	17.83
		2505 (20800)	17.50	17.65	17.62

15MHz	1RB-High (74)	2562.5 (21375)	17.68	17.72	17.80
		2535 (21100)	17.60	18.02	18.02
		2507.5 (20825)	17.50	17.88	17.67
	1RB-Middle (37)	2562.5 (21375)	17.73	17.75	18.05
		2535 (21100)	17.59	18.09	18.09
		2507.5 (20825)	17.50	17.85	17.64
	1RB-Low (0)	2562.5 (21375)	17.71	17.69	18.09
		2535 (21100)	17.54	17.98	17.96
		2507.5 (20825)	17.38	17.90	17.67
	36RB-High (38)	2562.5 (21375)	17.74	17.84	17.91
		2535 (21100)	17.60	17.76	17.91
		2507.5 (20825)	17.50	17.60	17.63
	36RB-Middle (19)	2562.5 (21375)	17.76	17.87	17.95
		2535 (21100)	17.59	17.81	17.91
		2507.5 (20825)	17.52	17.56	17.67
	36RB-Low (0)	2562.5 (21375)	17.73	17.83	18.00
		2535 (21100)	17.54	17.69	17.83
		2507.5 (20825)	17.40	17.45	17.52
75RB (0)	2562.5 (21375)	17.75	17.83	17.91	
	2535 (21100)	17.59	17.69	17.81	
	2507.5 (20825)	17.46	17.58	17.55	
20MHz	1RB-High (99)	2560 (21350)	17.66	18.28	17.87
		2535 (21100)	17.75	18.23	17.86
		2510 (20850)	17.64	18.12	17.67
	1RB-Middle (50)	2560 (21350)	17.81	18.40	17.96
		2535 (21100)	17.76	18.29	17.94
		2510 (20850)	17.70	18.09	17.64
	1RB-Low (0)	2560 (21350)	17.71	18.26	18.11
		2535 (21100)	17.56	18.14	17.69
		2510 (20850)	17.50	18.01	17.56
	50RB-High (50)	2560 (21350)	17.78	17.87	17.90
		2535 (21100)	17.81	17.92	17.78
		2510 (20850)	17.71	17.75	17.60
	50RB-Middle (25)	2560 (21350)	17.87	17.92	17.87
		2535 (21100)	17.85	17.95	17.98
		2510 (20850)	17.68	17.74	17.61
	50RB-Low (0)	2560 (21350)	17.80	17.90	17.95
		2535 (21100)	17.83	17.87	17.78
		2510 (20850)	17.68	17.77	17.61
100RB (0)	2560 (21350)	17.72	17.92	17.79	
	2535 (21100)	17.77	17.88	17.82	
	2510 (20850)	17.67	17.77	17.59	

LTE B12-LevelA						
BANDWIDTH	Number of RBs	Frequency	QPSK	16QAM	64QAM	
1.4MHz	1RB-High (5)	715.3 (23173)	22.77	21.67	21.02	
		707.5 (23095)	22.92	22.11	21.24	
		699.7 (23017)	22.98	21.89	21.35	
	1RB-Middle (3)	715.3 (23173)	22.26	21.71	21.07	
		707.5 (23095)	22.17	22.16	21.37	
		699.7 (23017)	22.19	21.96	21.56	
	1RB-Low (0)	715.3 (23173)	22.71	21.68	21.12	
		707.5 (23095)	22.95	22.10	21.28	
		699.7 (23017)	22.99	21.91	21.44	
	3RB-High (3)	715.3 (23173)	22.87	21.63	21.02	
		707.5 (23095)	22.26	21.87	21.24	
		699.7 (23017)	22.34	22.05	21.42	
	3RB-Middle (1)	715.3 (23173)	22.22	21.69	21.15	
		707.5 (23095)	22.27	22.00	21.29	
		699.7 (23017)	22.72	22.11	21.50	
	3RB-Low (0)	715.3 (23173)	22.19	21.66	21.06	
		707.5 (23095)	22.43	21.90	21.21	
		699.7 (23017)	22.38	22.01	21.42	
	6RB (0)	715.3 (23173)	22.25	20.80	20.00	
		707.5 (23095)	22.28	20.76	20.13	
		699.7 (23017)	22.26	21.10	20.35	
	3MHz	1RB-High (14)	714.5 (23165)	22.85	21.57	21.15
			707.5 (23095)	22.98	22.20	21.29
			700.5 (23025)	23.11	21.92	21.43
1RB-Middle (7)		714.5 (23165)	22.28	21.68	21.33	
		707.5 (23095)	22.21	22.27	21.42	
		700.5 (23025)	21.98	22.01	21.53	
1RB-Low (0)		714.5 (23165)	22.26	21.65	21.10	
		707.5 (23095)	22.32	22.20	21.37	
		700.5 (23025)	22.19	22.00	21.53	
8RB-High (7)		714.5 (23165)	22.14	20.88	20.06	
		707.5 (23095)	21.98	20.96	20.28	
		700.5 (23025)	22.26	21.03	20.44	
8RB-Middle (4)		714.5 (23165)	22.32	20.95	20.10	
		707.5 (23095)	22.19	21.04	20.29	
		700.5 (23025)	22.14	21.10	20.48	
8RB-Low (0)		714.5 (23165)	22.43	20.86	20.09	
		707.5 (23095)	22.47	21.00	20.30	
		700.5 (23025)	22.30	21.07	20.45	
15RB (0)		714.5 (23165)	22.33	20.81	20.09	
		707.5 (23095)	22.10	20.97	20.26	
		700.5 (23025)	22.36	20.99	20.44	

5MHz	1RB-High (24)	713.5 (23155)	22.63	21.77	20.98	
		707.5 (23095)	22.84	22.02	21.27	
		701.5 (23035)	23.05	22.40	21.36	
	1RB-Middle (12)	713.5 (23155)	22.61	21.82	21.19	
		707.5 (23095)	22.90	21.99	21.40	
		701.5 (23035)	22.98	22.44	21.46	
	1RB-Low (0)	713.5 (23155)	22.88	21.96	21.34	
		707.5 (23095)	22.96	22.04	21.38	
		701.5 (23035)	23.06	22.50	21.60	
	12RB-High (13)	713.5 (23155)	21.78	20.86	20.07	
		707.5 (23095)	21.89	21.01	20.26	
		701.5 (23035)	21.94	21.15	20.40	
	12RB-Middle (6)	713.5 (23155)	21.80	20.91	20.17	
		707.5 (23095)	21.94	21.05	20.32	
		701.5 (23035)	22.00	21.19	20.47	
	12RB-Low (0)	713.5 (23155)	21.88	20.99	20.26	
		707.5 (23095)	21.91	21.03	20.31	
		701.5 (23035)	22.02	21.19	20.45	
	25RB (0)	713.5 (23155)	21.86	20.85	20.23	
		707.5 (23095)	21.89	20.98	20.26	
		701.5 (23035)	21.95	21.09	20.42	
	10MHz	1RB-High (49)	711 (23130)	22.74	21.95	21.02
			707.5 (23095)	22.83	21.79	21.36
			704 (23060)	22.92	21.69	21.25
1RB-Middle (24)		711 (23130)	22.89	22.15	21.31	
		707.5 (23095)	22.97	21.76	21.34	
		704 (23060)	23.06	21.75	21.38	
1RB-Low (0)		711 (23130)	23.05	22.13	21.35	
		707.5 (23095)	23.06	21.84	21.42	
		704 (23060)	23.07	21.84	21.48	
25RB-High (25)		711 (23130)	21.79	20.90	20.16	
		707.5 (23095)	21.81	20.97	20.23	
		704 (23060)	21.85	20.94	20.34	
25RB-Middle (12)		711 (23130)	21.80	20.94	20.26	
		707.5 (23095)	21.84	21.02	20.30	
		704 (23060)	21.91	20.98	20.27	
25RB-Low (0)		711 (23130)	21.80	20.91	20.31	
		707.5 (23095)	21.90	21.01	20.33	
		704 (23060)	21.94	20.98	20.39	
50RB (0)		711 (23130)	21.79	20.89	20.23	
		707.5 (23095)	21.87	20.93	20.31	
		704 (23060)	21.91	20.96	20.36	

BANDWIDTH	Number of RBs	Frequency	QPSK	16QAM	64QAM
5MHz	1RB-High (24)	784.5 (23255)	23.10	22.03	21.60
		782 (23230)	23.06	21.95	21.48
		779.5 (23205)	22.95	22.39	21.61
	1RB-Middle (12)	784.5 (23255)	23.03	21.95	21.67
		782 (23230)	23.02	21.99	21.66
		779.5 (23205)	22.85	22.34	21.57
	1RB-Low (0)	784.5 (23255)	22.97	21.96	21.75
		782 (23230)	22.94	21.96	21.62
		779.5 (23205)	22.84	22.31	21.56
	12RB-High (13)	784.5 (23255)	21.96	21.00	20.56
		782 (23230)	21.84	20.92	20.57
		779.5 (23205)	21.87	21.01	20.55
	12RB-Middle (6)	784.5 (23255)	21.88	20.97	20.50
		782 (23230)	21.90	21.04	20.65
		779.5 (23205)	21.85	21.09	20.60
	12RB-Low (0)	784.5 (23255)	21.89	20.92	20.55
		782 (23230)	21.83	20.99	20.59
		779.5 (23205)	21.84	21.06	20.58
25RB (0)	784.5 (23255)	21.87	20.85	20.51	
	782 (23230)	21.93	20.95	20.54	
	779.5 (23205)	21.90	20.96	20.50	
10MHz	1RB-High (49)	782 (23230)	23.25	21.84	21.54
	1RB-Middle (24)	782 (23230)	23.06	21.81	21.68
	1RB-Low (0)	782 (23230)	22.84	21.78	21.57
	25RB-High (25)	782 (23230)	21.90	20.93	20.36
	25RB-Middle (12)	782 (23230)	21.98	21.06	20.61
	25RB-Low (0)	782 (23230)	21.99	21.05	20.65
	50RB (0)	782 (23230)	22.03	20.99	20.64

LTEB25-LevelA					
BANDWIDTH	Number of RBs	Frequency	QPSK	16QAM	64QAM
1.4MHz	1RB-High (5)	1914.3 (26683)	22.83	21.98	21.82
		1882.5 (26365)	22.75	21.66	21.05
		1850.7 (26047)	22.47	21.64	20.89
	1RB-Middle (3)	1914.3 (26683)	22.86	22.01	20.95
		1882.5 (26365)	22.79	21.75	21.11
		1850.7 (26047)	22.61	21.68	20.98
	1RB-Low (0)	1914.3 (26683)	22.82	22.00	20.94
		1882.5 (26365)	22.75	21.64	21.04
		1850.7 (26047)	22.51	21.59	20.92
	3RB-High (3)	1914.3 (26683)	22.54	21.74	20.82
		1882.5 (26365)	22.64	21.90	21.01
		1850.7 (26047)	22.55	21.63	20.86
	3RB-Middle (1)	1914.3 (26683)	22.56	21.79	20.86
		1882.5 (26365)	22.70	21.98	20.99
		1850.7 (26047)	22.60	21.69	20.98
	3RB-Low (0)	1914.3 (26683)	22.53	21.77	20.86
		1882.5 (26365)	22.67	21.91	21.05
		1850.7 (26047)	22.53	21.68	20.88
	6RB (0)	1914.3 (26683)	21.95	20.67	20.80
		1882.5 (26365)	21.64	20.90	20.90
		1850.7 (26047)	21.44	20.66	20.73
3MHz	1RB-High (14)	1913.5 (26675)	22.96	22.01	20.86
		1882.5 (26365)	22.76	21.73	21.17
		1851.5 (26055)	22.44	21.42	20.98
	1RB-Middle (7)	1913.5 (26675)	22.98	22.13	21.07
		1882.5 (26365)	22.94	21.88	21.25
		1851.5 (26055)	22.59	21.54	21.04
	1RB-Low (0)	1913.5 (26675)	22.83	22.09	21.00
		1882.5 (26365)	22.81	21.78	21.10
		1851.5 (26055)	22.48	21.42	20.83
	8RB-High (7)	1913.5 (26675)	21.87	20.88	20.79
		1882.5 (26365)	21.81	20.91	21.02
		1851.5 (26055)	21.55	20.72	20.83
	8RB-Middle (4)	1913.5 (26675)	21.92	20.95	20.88
		1882.5 (26365)	21.84	20.95	21.07
		1851.5 (26055)	21.58	20.77	20.86
	8RB-Low (0)	1913.5 (26675)	21.85	20.91	20.87
		1882.5 (26365)	21.80	20.93	21.01
		1851.5 (26055)	21.54	20.74	20.90
15RB (0)	1913.5 (26675)	21.82	20.87	20.87	
	1882.5 (26365)	21.76	20.85	21.01	
	1851.5 (26055)	21.56	20.63	20.82	



5MHz	1RB-High (24)	1912.5 (26665)	22.99	21.82	20.85	
		1882.5 (26365)	22.89	21.96	21.16	
		1852.5 (26065)	22.62	22.17	20.97	
	1RB-Middle (12)	1912.5 (26665)	22.90	21.84	20.91	
		1882.5 (26365)	22.99	22.00	21.25	
		1852.5 (26065)	22.56	22.13	21.06	
	1RB-Low (0)	1912.5 (26665)	22.81	21.84	20.97	
		1882.5 (26365)	22.98	21.94	21.06	
		1852.5 (26065)	22.50	22.05	20.87	
	12RB-High (13)	1912.5 (26665)	21.84	20.89	20.83	
		1882.5 (26365)	21.83	21.00	21.03	
		1852.5 (26065)	21.65	20.88	20.94	
	12RB-Middle (6)	1912.5 (26665)	21.91	20.94	20.93	
		1882.5 (26365)	21.88	21.05	21.07	
		1852.5 (26065)	21.60	20.82	20.85	
	12RB-Low (0)	1912.5 (26665)	21.83	20.94	20.91	
		1882.5 (26365)	21.82	20.98	21.12	
		1852.5 (26065)	21.57	20.79	20.85	
	25RB (0)	1912.5 (26665)	21.84	20.82	20.90	
		1882.5 (26365)	21.83	20.94	21.01	
		1852.5 (26065)	21.66	20.79	20.86	
	10MHz	1RB-High (49)	1910 (26640)	22.96	21.74	20.83
			1882.5 (26365)	22.91	21.77	21.17
			1855 (26090)	22.74	22.11	21.03
1RB-Middle (24)		1910 (26640)	22.76	21.81	20.94	
		1882.5 (26365)	22.90	21.75	21.08	
		1855 (26090)	22.71	22.15	21.10	
1RB-Low (0)		1910 (26640)	22.70	21.76	20.89	
		1882.5 (26365)	23.01	21.73	21.08	
		1855 (26090)	22.66	22.08	21.06	
25RB-High (25)		1910 (26640)	21.84	20.94	20.87	
		1882.5 (26365)	21.82	20.96	20.94	
		1855 (26090)	21.61	20.77	20.85	
25RB-Middle (12)		1910 (26640)	21.86	20.98	20.87	
		1882.5 (26365)	21.92	20.98	21.09	
		1855 (26090)	21.69	20.81	20.97	
25RB-Low (0)		1910 (26640)	21.77	20.98	20.88	
		1882.5 (26365)	21.86	20.91	20.96	
		1855 (26090)	21.70	20.83	20.95	
50RB (0)		1910 (26640)	21.78	20.91	20.89	
		1882.5 (26365)	21.87	20.92	21.05	
		1855 (26090)	21.65	20.79	20.93	



15MHz	1RB-High (74)	1907.5 (26615)	23.02	22.05	21.79
		1882.5 (26365)	22.77	21.70	21.09
		1857.5 (26115)	22.77	22.04	20.92
	1RB-Middle (37)	1907.5 (26615)	22.87	22.13	21.10
		1882.5 (26365)	22.91	21.78	21.17
		1857.5 (26115)	22.69	22.04	20.94
	1RB-Low (0)	1907.5 (26615)	22.79	22.04	20.96
		1882.5 (26365)	22.85	21.62	21.08
		1857.5 (26115)	22.58	21.96	20.94
	36RB-High (38)	1907.5 (26615)	21.91	20.91	20.96
		1882.5 (26365)	21.88	20.99	21.08
		1857.5 (26115)	21.81	20.92	20.93
	36RB-Middle (19)	1907.5 (26615)	21.84	20.88	20.92
		1882.5 (26365)	21.98	21.01	21.10
		1857.5 (26115)	21.72	20.86	20.92
	36RB-Low (0)	1907.5 (26615)	21.79	20.79	20.90
		1882.5 (26365)	21.88	20.95	20.99
		1857.5 (26115)	21.68	20.82	20.92
	75RB (0)	1907.5 (26615)	21.86	20.89	20.86
		1882.5 (26365)	21.89	20.98	21.01
		1857.5 (26115)	21.68	20.80	20.86
20MHz	1RB-High (99)	1905 (26590)	23.34	21.36	20.95
		1882.5 (26365)	23.55	21.56	21.18
		1860 (26140)	23.05	21.06	21.00
	1RB-Middle (50)	1905 (26590)	22.81	21.21	20.99
		1882.5 (26365)	22.97	21.30	21.32
		1860 (26140)	22.75	21.07	20.93
	1RB-Low (0)	1905 (26590)	22.84	21.24	21.06
		1882.5 (26365)	22.91	21.11	21.01
		1860 (26140)	22.62	21.09	21.02
	50RB-High (50)	1905 (26590)	21.92	21.00	20.94
		1882.5 (26365)	21.96	21.03	21.01
		1860 (26140)	21.85	20.88	20.91
	50RB-Middle (25)	1905 (26590)	21.92	20.98	20.91
		1882.5 (26365)	21.98	21.04	21.08
		1860 (26140)	21.88	20.92	20.96
	50RB-Low (0)	1905 (26590)	21.84	20.88	20.85
		1882.5 (26365)	21.95	20.91	21.02
		1860 (26140)	21.78	20.83	20.86
	100RB (0)	1905 (26590)	21.85	20.94	20.88
		1882.5 (26365)	21.96	21.02	21.00
		1860 (26140)	21.80	20.87	20.93

LTEB25-LevelB					
BANDWIDTH	Number of RBs	Frequency	QPSK	16QAM	64QAM
1.4MHz	1RB-High (5)	1914.3 (26683)	18.74	18.78	18.73
		1882.5 (26365)	18.73	18.82	18.94
		1850.7 (26047)	18.52	18.95	18.78
	1RB-Middle (3)	1914.3 (26683)	18.73	18.81	18.86
		1882.5 (26365)	18.76	18.91	19.02
		1850.7 (26047)	18.56	18.99	18.72
	1RB-Low (0)	1914.3 (26683)	18.70	18.76	18.81
		1882.5 (26365)	18.71	18.82	18.97
		1850.7 (26047)	18.49	18.94	18.68
	3RB-High (3)	1914.3 (26683)	18.72	18.95	18.76
		1882.5 (26365)	18.66	18.84	18.88
		1850.7 (26047)	18.50	18.79	18.69
	3RB-Middle (1)	1914.3 (26683)	18.83	19.07	18.77
		1882.5 (26365)	18.77	18.88	18.92
		1850.7 (26047)	18.62	18.90	18.70
	3RB-Low (0)	1914.3 (26683)	18.71	18.98	18.77
		1882.5 (26365)	18.70	18.81	18.84
		1850.7 (26047)	18.54	18.84	18.66
	6RB (0)	1914.3 (26683)	18.84	18.97	18.68
		1882.5 (26365)	18.67	18.86	18.78
		1850.7 (26047)	18.46	18.48	18.57
3MHz	1RB-High (14)	1913.5 (26675)	18.75	18.62	18.76
		1882.5 (26365)	18.78	19.21	19.10
		1851.5 (26055)	18.52	18.62	18.78
	1RB-Middle (7)	1913.5 (26675)	18.87	18.73	18.97
		1882.5 (26365)	18.92	19.31	19.07
		1851.5 (26055)	18.68	18.75	18.91
	1RB-Low (0)	1913.5 (26675)	18.74	18.68	18.84
		1882.5 (26365)	18.73	19.19	19.04
		1851.5 (26055)	18.57	18.62	18.76
	8RB-High (7)	1913.5 (26675)	18.81	18.94	18.77
		1882.5 (26365)	18.80	18.94	18.95
		1851.5 (26055)	18.53	18.63	18.68
	8RB-Middle (4)	1913.5 (26675)	18.90	18.99	18.86
		1882.5 (26365)	18.87	18.97	18.94
		1851.5 (26055)	18.60	18.72	18.74
	8RB-Low (0)	1913.5 (26675)	18.80	18.93	18.77
		1882.5 (26365)	18.83	18.96	18.95
		1851.5 (26055)	18.57	18.67	18.72
	15RB (0)	1913.5 (26675)	18.82	18.93	18.78
		1882.5 (26365)	18.80	18.93	18.92
		1851.5 (26055)	18.55	18.62	18.63



5MHz	1RB-High (24)	1912.5 (26665)	18.84	18.85	18.83	
		1882.5 (26365)	18.86	19.01	19.01	
		1852.5 (26065)	18.66	19.23	18.82	
	1RB-Middle (12)	1912.5 (26665)	18.81	18.89	18.94	
		1882.5 (26365)	18.96	19.04	19.10	
		1852.5 (26065)	18.57	19.21	18.84	
	1RB-Low (0)	1912.5 (26665)	18.76	18.89	18.85	
		1882.5 (26365)	18.89	19.03	19.06	
		1852.5 (26065)	18.58	19.13	18.79	
	12RB-High (13)	1912.5 (26665)	18.84	18.85	18.81	
		1882.5 (26365)	18.82	18.98	18.96	
		1852.5 (26065)	18.68	18.87	18.78	
	12RB-Middle (6)	1912.5 (26665)	18.90	18.93	18.86	
		1882.5 (26365)	18.85	19.02	18.95	
		1852.5 (26065)	18.62	18.82	18.75	
	12RB-Low (0)	1912.5 (26665)	18.85	18.89	18.79	
		1882.5 (26365)	18.87	18.97	18.95	
		1852.5 (26065)	18.61	18.80	18.76	
	25RB (0)	1912.5 (26665)	18.87	18.77	18.76	
		1882.5 (26365)	18.87	18.90	18.81	
		1852.5 (26065)	18.68	18.79	18.74	
	10MHz	1RB-High (49)	1910 (26640)	18.84	18.87	18.83
			1882.5 (26365)	18.87	18.85	19.13
			1855 (26090)	18.73	19.12	18.93
1RB-Middle (24)		1910 (26640)	18.78	18.86	18.97	
		1882.5 (26365)	18.87	18.80	19.04	
		1855 (26090)	18.73	19.17	18.89	
1RB-Low (0)		1910 (26640)	18.71	18.76	18.84	
		1882.5 (26365)	18.90	18.80	19.14	
		1855 (26090)	18.75	19.10	18.93	
25RB-High (25)		1910 (26640)	18.84	18.97	18.79	
		1882.5 (26365)	18.88	18.91	18.87	
		1855 (26090)	18.65	18.76	18.75	
25RB-Middle (12)		1910 (26640)	18.84	18.99	18.80	
		1882.5 (26365)	18.94	18.97	18.92	
		1855 (26090)	18.71	18.82	18.80	
25RB-Low (0)		1910 (26640)	18.80	18.95	18.75	
		1882.5 (26365)	18.87	18.94	18.91	
		1855 (26090)	18.71	18.80	18.77	
50RB (0)		1910 (26640)	18.83	18.86	18.75	
		1882.5 (26365)	18.91	18.90	18.89	
		1855 (26090)	18.68	18.79	18.78	



15MHz	1RB-High (74)	1907.5 (26615)	18.90	19.26	18.86
		1882.5 (26365)	18.78	18.77	18.97
		1857.5 (26115)	18.76	19.10	18.81
	1RB-Middle (37)	1907.5 (26615)	18.85	19.22	18.90
		1882.5 (26365)	18.90	18.88	19.07
		1857.5 (26115)	18.74	19.12	18.87
	1RB-Low (0)	1907.5 (26615)	18.79	19.17	18.81
		1882.5 (26365)	18.81	18.68	18.93
		1857.5 (26115)	18.64	19.07	18.89
	36RB-High (38)	1907.5 (26615)	18.87	18.94	18.77
		1882.5 (26365)	18.91	18.99	18.94
		1857.5 (26115)	18.83	18.92	18.77
	36RB-Middle (19)	1907.5 (26615)	18.81	18.86	18.81
		1882.5 (26365)	18.95	18.99	19.00
		1857.5 (26115)	18.74	18.85	18.82
	36RB-Low (0)	1907.5 (26615)	18.77	18.83	18.76
		1882.5 (26365)	18.86	18.95	18.88
		1857.5 (26115)	18.70	18.87	18.82
	75RB (0)	1907.5 (26615)	18.80	18.88	18.72
		1882.5 (26365)	18.92	19.00	18.86
		1857.5 (26115)	18.74	18.84	18.76
20MHz	1RB-High (99)	1905 (26590)	19.03	19.38	18.91
		1882.5 (26365)	18.87	19.34	18.97
		1860 (26140)	18.86	19.40	18.91
	1RB-Middle (50)	1905 (26590)	18.91	19.26	18.89
		1882.5 (26365)	18.98	19.40	19.04
		1860 (26140)	18.75	19.29	18.79
	1RB-Low (0)	1905 (26590)	18.90	19.33	18.86
		1882.5 (26365)	18.87	19.21	18.85
		1860 (26140)	18.67	19.31	18.92
	50RB-High (50)	1905 (26590)	18.95	19.00	18.82
		1882.5 (26365)	19.02	19.00	18.85
		1860 (26140)	18.87	18.92	18.76
	50RB-Middle (25)	1905 (26590)	18.89	18.99	18.77
		1882.5 (26365)	19.00	19.08	18.91
		1860 (26140)	18.89	18.93	18.87
	50RB-Low (0)	1905 (26590)	18.91	18.93	18.75
		1882.5 (26365)	18.94	18.93	18.87
		1860 (26140)	18.76	18.89	18.72
100RB (0)	1905 (26590)	18.87	18.96	18.74	
	1882.5 (26365)	18.97	18.97	18.91	
	1860 (26140)	18.87	18.97	18.83	

LTEB26-LevelA					
BANDWIDTH	Number of RBs	Frequency	QPSK	16QAM	64QAM
1.4MHz	1RB-High (5)	848.3 (27033)	22.35	21.43	20.79
		831.5 (26865)	22.43	21.81	20.92
		814.7 (26697)	22.60	21.64	21.24
	1RB-Middle (3)	848.3 (27033)	22.56	21.44	20.86
		831.5 (26865)	22.35	21.91	21.09
		814.7 (26697)	22.44	21.68	21.23
	1RB-Low (0)	848.3 (27033)	22.27	21.41	20.80
		831.5 (26865)	22.48	21.85	20.98
		814.7 (26697)	22.67	21.64	21.15
	3RB-High (3)	848.3 (27033)	22.57	21.38	20.78
		831.5 (26865)	22.69	21.67	21.01
		814.7 (26697)	22.85	21.79	21.16
	3RB-Middle (1)	848.3 (27033)	22.31	21.44	20.90
		831.5 (26865)	22.49	21.74	21.02
		814.7 (26697)	22.63	21.89	21.21
	3RB-Low (0)	848.3 (27033)	22.21	21.38	20.88
		831.5 (26865)	22.38	21.68	21.00
		814.7 (26697)	22.55	21.82	21.16
	6RB (0)	848.3 (27033)	21.33	20.51	19.78
		831.5 (26865)	21.47	20.41	19.94
		814.7 (26697)	21.60	20.86	20.04
3MHz	1RB-High (14)	847.5 (27025)	22.39	21.75	20.83
		831.5 (26865)	22.47	21.54	21.04
		815.5 (26705)	22.50	21.56	21.10
	1RB-Middle (7)	847.5 (27025)	22.89	21.81	21.05
		831.5 (26865)	22.78	21.63	21.22
		815.5 (26705)	22.59	21.61	21.22
	1RB-Low (0)	847.5 (27025)	22.41	21.78	20.95
		831.5 (26865)	22.55	21.61	21.06
		815.5 (26705)	22.50	21.59	21.09
	8RB-High (7)	847.5 (27025)	21.36	20.51	19.89
		831.5 (26865)	21.56	20.61	19.99
		815.5 (26705)	22.69	20.60	19.95
	8RB-Middle (4)	847.5 (27025)	22.78	20.55	19.93
		831.5 (26865)	22.49	20.66	20.05
		815.5 (26705)	22.54	20.67	20.02
	8RB-Low (0)	847.5 (27025)	22.56	20.55	19.90
		831.5 (26865)	22.67	20.63	20.06
		815.5 (26705)	22.36	20.61	20.03
	15RB (0)	847.5 (27025)	21.37	20.51	19.92
		831.5 (26865)	21.56	20.55	19.99
		815.5 (26705)	21.86	20.53	20.01

5MHz	1RB-High (24)	846.5 (27015)	22.32	21.52	20.85
		831.5 (26865)	22.42	21.72	21.08
		816.5 (26715)	22.63	22.21	21.32
	1RB-Middle (12)	846.5 (27015)	22.35	21.46	21.00
		831.5 (26865)	22.44	21.70	21.11
		816.5 (26715)	22.62	22.22	21.19
	1RB-Low (0)	846.5 (27015)	22.36	21.58	21.12
		831.5 (26865)	22.49	21.75	21.15
		816.5 (26715)	22.67	22.23	21.30
	12RB-High (13)	846.5 (27015)	21.36	20.53	19.91
		831.5 (26865)	21.52	20.69	19.99
		816.5 (26715)	21.65	20.87	20.16
	12RB-Middle (6)	846.5 (27015)	21.42	20.57	19.93
		831.5 (26865)	21.52	20.69	20.08
		816.5 (26715)	21.68	20.92	20.25
	12RB-Low (0)	846.5 (27015)	21.48	20.58	19.96
		831.5 (26865)	21.54	20.68	20.09
		816.5 (26715)	21.66	20.90	20.26
25RB (0)	846.5 (27015)	21.44	20.45	19.95	
	831.5 (26865)	21.53	20.63	20.04	
	816.5 (26715)	21.63	20.79	20.18	
10MHz	1RB-High (49)	844 (26990)	22.38	21.70	20.91
		831.5 (26865)	22.45	21.53	21.12
		820 (26750)	22.58	21.52	21.13
	1RB-Middle (24)	844 (26990)	22.33	21.80	21.11
		831.5 (26865)	22.54	21.55	21.10
		820 (26750)	22.67	21.53	21.21
	1RB-Low (0)	844 (26990)	22.39	21.85	21.12
		831.5 (26865)	22.57	21.59	21.16
		820 (26750)	22.43	21.58	21.35
	25RB-High (25)	844 (26990)	21.43	20.55	19.95
		831.5 (26865)	21.50	20.68	19.96
		820 (26750)	21.62	20.73	20.13
	25RB-Middle (12)	844 (26990)	21.46	20.60	19.96
		831.5 (26865)	21.57	20.69	20.01
		820 (26750)	21.64	20.73	20.19
	25RB-Low (0)	844 (26990)	21.46	20.57	19.95
		831.5 (26865)	21.54	20.72	20.06
		820 (26750)	21.69	20.79	20.19
50RB (0)	844 (26990)	21.41	20.56	19.91	
	831.5 (26865)	21.53	20.67	20.01	
	820 (26750)	21.64	20.70	20.12	
15MHz	1RB-High (74)	841.5 (26965)	22.38	21.70	20.97
		831.5 (26865)	22.40	21.89	21.09
		822.5 (26775)	22.50	21.46	21.08
	1RB-Middle (37)	841.5 (26965)	22.47	21.84	21.08
		831.5 (26865)	22.51	21.96	21.12
		822.5 (26775)	22.58	21.55	21.23
	1RB-Low (0)	841.5 (26965)	22.66	21.63	21.28
		831.5 (26865)	22.55	21.99	21.13
		822.5 (26775)	22.67	22.02	21.30
	36RB-High (38)	841.5 (26965)	21.45	20.55	19.99
		831.5 (26865)	21.48	20.57	20.04
		822.5 (26775)	21.60	20.70	20.04
	36RB-Middle (19)	841.5 (26965)	21.56	20.74	20.18
		831.5 (26865)	21.55	20.66	20.10
		822.5 (26775)	21.64	20.73	20.18
	36RB-Low (0)	841.5 (26965)	21.53	20.76	20.21
		831.5 (26865)	21.58	20.62	20.09
		822.5 (26775)	21.64	20.74	20.23
75RB (0)	841.5 (26965)	21.55	20.66	20.11	
	831.5 (26865)	21.51	20.62	20.04	
	822.5 (26775)	21.61	20.71	20.10	



LTE B41(PC3)-Level A					
BANDWIDTH	Number of RBs	Frequency	QPSK	16QAM	64QAM
5MHz	1RB-High (24)	2687.5 (41565)	22.19	22.33	22.16
		2640.3(41093)	22.25	22.42	22.20
		2593 (40620)	22.52	22.37	22.10
		2545.8(40148)	22.32	22.33	22.16
		2498.5 (39675)	22.24	22.43	22.02
	1RB-Middle (12)	2687.5 (41565)	22.22	22.33	22.17
		2640.3(41093)	22.29	22.46	22.22
		2593 (40620)	22.49	22.41	22.09
		2545.8(40148)	22.28	22.33	22.18
		2498.5 (39675)	22.23	22.43	22.02
	1RB-Low (0)	2687.5 (41565)	22.21	22.26	22.17
		2640.3(41093)	22.29	22.41	22.18
		2593 (40620)	22.50	22.46	22.09
		2545.8(40148)	22.30	22.27	22.20
		2498.5 (39675)	22.25	22.41	22.01
	12RB-High (13)	2687.5 (41565)	22.32	21.39	21.56
		2640.3(41093)	22.37	21.45	21.62
		2593 (40620)	22.52	21.56	21.52
		2545.8(40148)	22.38	21.39	21.62
		2498.5 (39675)	22.35	21.43	21.47
	12RB-Middle (6)	2687.5 (41565)	22.32	21.37	21.59
		2640.3(41093)	22.38	21.52	21.66
		2593 (40620)	22.57	21.57	21.53
		2545.8(40148)	22.41	21.41	21.66
		2498.5 (39675)	22.36	21.51	21.49
	12RB-Low (0)	2687.5 (41565)	22.27	21.35	21.57
		2640.3(41093)	22.34	21.50	21.62
		2593 (40620)	22.50	21.50	21.51
2545.8(40148)		22.39	21.32	21.61	
2498.5 (39675)		22.31	21.45	21.42	
25RB (0)	2687.5 (41565)	22.27	21.39	21.55	
	2640.3(41093)	22.36	21.41	21.63	
	2593 (40620)	22.50	21.51	21.53	
	2545.8(40148)	22.32	21.43	21.62	
	2498.5 (39675)	22.36	21.43	21.45	
10MHz	1RB-High (49)	2685 (41540)	22.76	22.84	22.73
		2639(41080)	22.28	22.47	22.16
		2593 (40620)	22.51	22.40	22.07
		2547(40160)	22.32	22.30	22.09
		2501 (39700)	22.29	22.42	22.01
	1RB-Middle (24)	2685 (41540)	22.30	22.31	22.17
		2639(41080)	22.34	22.50	22.20
		2593 (40620)	22.46	22.48	22.12
		2547(40160)	22.33	22.31	22.19
		2501 (39700)	22.25	22.44	21.97
	1RB-Low (0)	2685 (41540)	22.80	22.87	22.85
		2639(41080)	22.31	22.47	22.19
		2593 (40620)	22.35	22.37	22.02
		2547(40160)	22.27	22.26	22.18
		2501 (39700)	22.20	22.40	21.97
	25RB-High (25)	2685 (41540)	22.58	21.59	21.74
		2639(41080)	22.33	21.42	21.61
		2593 (40620)	22.49	21.53	21.48
		2547(40160)	22.36	21.42	21.60
		2501 (39700)	22.32	21.43	21.47
	25RB-Middle (12)	2685 (41540)	22.40	21.45	21.67
		2639(41080)	22.41	21.47	21.67
		2593 (40620)	22.52	21.54	21.53
		2547(40160)	22.41	21.45	21.65
		2501 (39700)	22.37	21.44	21.45
	25RB-Low (0)	2685 (41540)	22.47	21.54	21.78
		2639(41080)	22.36	21.42	21.65
		2593 (40620)	22.50	21.52	21.52
		2547(40160)	22.36	21.40	21.60
		2501 (39700)	22.31	21.37	21.44
	50RB (0)	2685 (41540)	22.52	21.62	21.77
		2639(41080)	22.38	21.44	21.60
2593 (40620)		22.47	21.53	21.50	
2547(40160)		22.36	21.43	21.59	
2501 (39700)		22.36	21.44	21.59	



15MHz	1RB-High (74)	2682.5 (41515)	22.20	22.20	22.11
		2637.8(41068)	22.28	22.36	22.19
		2593 (40620)	22.44	22.47	22.05
		2548.3(40173)	22.32	22.31	22.09
		2503.5 (39725)	22.23	22.35	22.00
	1RB-Middle (37)	2682.5 (41515)	22.37	22.32	22.21
		2637.8(41068)	22.36	22.49	22.23
		2593 (40620)	22.49	22.49	22.16
		2548.3(40173)	22.35	22.32	22.21
		2503.5 (39725)	22.33	22.39	22.01
	1RB-Low (0)	2682.5 (41515)	22.01	22.07	21.99
		2637.8(41068)	22.31	22.42	22.24
		2593 (40620)	22.39	22.41	22.09
		2548.3(40173)	22.27	22.24	22.17
		2503.5 (39725)	22.26	22.33	21.99
	36RB-High (38)	2682.5 (41515)	22.34	21.45	21.55
		2637.8(41068)	22.36	21.46	21.57
		2593 (40620)	22.50	21.58	21.46
		2548.3(40173)	22.37	21.43	21.58
		2503.5 (39725)	22.33	21.41	21.44
	36RB-Middle (19)	2682.5 (41515)	22.31	21.40	21.59
		2637.8(41068)	22.42	21.53	21.66
		2593 (40620)	22.55	21.59	21.49
		2548.3(40173)	22.39	21.39	21.61
		2503.5 (39725)	22.37	21.41	21.43
	36RB-Low (0)	2682.5 (41515)	22.16	21.22	21.47
		2637.8(41068)	22.38	21.49	21.59
		2593 (40620)	22.50	21.57	21.50
2548.3(40173)		22.29	21.32	21.57	
2503.5 (39725)		22.26	21.38	21.38	
75RB (0)	2682.5 (41515)	22.28	21.30	21.48	
	2637.8(41068)	22.39	21.47	21.64	
	2593 (40620)	22.51	21.60	21.50	
	2548.3(40173)	22.31	21.39	21.57	
	2503.5 (39725)	22.34	21.36	21.42	
20MHz	1RB-High (99)	2680 (41490)	23.30	22.43	22.21
		2636.5(41055)	23.30	22.26	22.10
		2593 (40620)	23.52	22.32	22.01
		2549.5(40185)	23.39	22.56	22.11
		2506 (39750)	23.34	22.30	22.00
	1RB-Middle (50)	2680 (41490)	23.24	22.37	22.19
		2636.5(41055)	23.40	22.31	22.17
		2593 (40620)	23.60	22.37	22.12
		2549.5(40185)	23.30	22.45	22.18
		2506 (39750)	23.33	22.27	22.00
	1RB-Low (0)	2680 (41490)	23.43	22.23	23.13
		2636.5(41055)	23.41	22.32	22.17
		2593 (40620)	23.98	23.22	22.02
		2549.5(40185)	23.18	22.35	22.12
		2506 (39750)	23.23	22.11	21.95
	50RB-High (50)	2680 (41490)	22.25	21.37	21.54
		2636.5(41055)	22.28	21.38	21.59
		2593 (40620)	22.51	21.56	21.44
		2549.5(40185)	22.48	21.56	21.58
		2506 (39750)	22.31	21.36	21.42
	50RB-Middle (25)	2680 (41490)	22.20	21.29	21.51
		2636.5(41055)	22.37	21.39	21.64
		2593 (40620)	22.52	21.55	21.49
		2549.5(40185)	22.37	21.48	21.56
		2506 (39750)	22.35	21.36	21.47
	50RB-Low (0)	2680 (41490)	22.16	21.28	21.51
		2636.5(41055)	22.34	21.35	21.60
		2593 (40620)	22.48	21.56	21.49
2549.5(40185)		22.26	21.39	21.55	
2506 (39750)		22.28	21.32	21.40	
100RB (0)	2680 (41490)	22.18	21.21	21.46	
	2636.5(41055)	22.30	21.38	21.58	
	2593 (40620)	22.47	21.54	21.47	
	2549.5(40185)	22.46	21.45	21.62	
	2506 (39750)	22.32	21.35	21.42	

LTE B41(PC3)-LevelB					
BANDWIDTH	Number of RBs	Frequency	QPSK	16QAM	64QAM
5MHz	1RB-High (24)	2687.5 (41565)	19.66	19.70	19.69
		2640.3(41093)	19.69	19.82	19.80
		2593 (40620)	19.87	19.76	19.65
		2545.8(40148)	19.70	19.66	19.75
		2498.5 (39675)	19.67	19.88	19.65
	1RB-Middle (12)	2687.5 (41565)	19.63	19.72	19.74
		2640.3(41093)	19.61	19.81	19.80
		2593 (40620)	19.86	19.79	19.69
		2545.8(40148)	19.62	19.66	19.79
		2498.5 (39675)	19.62	19.90	19.65
	1RB-Low (0)	2687.5 (41565)	19.63	19.71	19.71
		2640.3(41093)	19.63	19.79	19.80
		2593 (40620)	19.85	19.81	19.70
		2545.8(40148)	19.63	19.68	19.79
		2498.5 (39675)	19.59	19.87	19.63
	12RB-High (13)	2687.5 (41565)	19.72	19.79	19.84
		2640.3(41093)	19.70	19.79	19.92
		2593 (40620)	19.86	19.93	19.80
		2545.8(40148)	19.69	19.71	19.89
		2498.5 (39675)	19.75	19.87	19.76
	12RB-Middle (6)	2687.5 (41565)	19.75	19.80	19.80
		2640.3(41093)	19.74	19.84	19.91
		2593 (40620)	19.91	19.96	19.83
		2545.8(40148)	19.71	19.76	19.93
		2498.5 (39675)	19.74	19.90	19.77
	12RB-Low (0)	2687.5 (41565)	19.70	19.75	19.77
		2640.3(41093)	19.73	19.82	19.90
		2593 (40620)	19.87	19.91	19.80
		2545.8(40148)	19.64	19.73	19.88
		2498.5 (39675)	19.70	19.87	19.76
	25RB (0)	2687.5 (41565)	19.67	19.80	19.83
		2640.3(41093)	19.71	19.75	19.90
		2593 (40620)	19.84	19.89	19.79
		2545.8(40148)	19.68	19.80	19.91
		2498.5 (39675)	19.75	19.83	19.73
	10MHz	1RB-High (49)	2685 (41540)	20.25	20.28
2639(41080)			19.65	19.83	19.75
2593 (40620)			19.85	19.82	19.62
2547(40160)			19.64	19.66	19.75
2501 (39700)			19.63	19.86	19.63
1RB-Middle (24)		2685 (41540)	19.68	19.74	19.76
		2639(41080)	19.68	19.81	19.80
		2593 (40620)	19.85	19.81	19.70
		2547(40160)	19.66	19.67	19.82
		2501 (39700)	19.65	19.88	19.65
1RB-Low (0)		2685 (41540)	20.22	20.33	20.37
		2639(41080)	19.64	19.86	19.78
		2593 (40620)	19.69	19.69	19.63
		2547(40160)	19.64	19.64	19.82
		2501 (39700)	19.60	19.87	19.61
25RB-High (25)		2685 (41540)	19.90	20.01	20.01
		2639(41080)	19.70	19.76	19.90
		2593 (40620)	19.84	19.91	19.77
		2547(40160)	19.67	19.79	19.92
		2501 (39700)	19.73	19.83	19.76
25RB-Middle (12)		2685 (41540)	19.83	19.86	19.94
		2639(41080)	19.74	19.80	19.93
		2593 (40620)	19.87	19.94	19.85
		2547(40160)	19.73	19.76	19.95
		2501 (39700)	19.75	19.89	19.79
25RB-Low (0)		2685 (41540)	19.92	19.97	20.02
		2639(41080)	19.73	19.77	19.90
		2593 (40620)	19.84	19.89	19.83
		2547(40160)	19.67	19.75	19.96
		2501 (39700)	19.69	19.81	19.72
50RB (0)		2685 (41540)	19.95	19.87	19.99
		2639(41080)	19.71	19.78	19.85
		2593 (40620)	19.82	19.90	19.78
		2547(40160)	19.66	19.77	19.87
		2501 (39700)	19.72	19.86	19.80

15MHz	1RB-High (74)	2682.5 (41515)	19.59	19.62	19.57
		2637.8(41068)	19.66	19.72	19.78
		2593 (40620)	19.78	19.88	19.69
		2548.3(40173)	19.64	19.64	19.74
	1RB-Middle (37)	2503.5 (39725)	19.69	19.75	19.64
		2682.5 (41515)	19.70	19.72	19.80
		2637.8(41068)	19.74	19.80	19.82
		2593 (40620)	19.87	19.95	19.69
		2548.3(40173)	19.66	19.67	19.84
	1RB-Low (0)	2503.5 (39725)	19.70	19.78	19.63
		2682.5 (41515)	19.44	19.45	19.57
		2637.8(41068)	19.70	19.76	19.80
		2593 (40620)	19.76	19.83	19.72
	36RB-High (38)	2548.3(40173)	19.60	19.65	19.81
		2503.5 (39725)	19.68	19.71	19.62
		2682.5 (41515)	19.74	19.81	19.80
		2637.8(41068)	19.71	19.78	19.84
		2593 (40620)	19.90	19.94	19.74
	36RB-Middle (19)	2548.3(40173)	19.68	19.74	19.83
		2503.5 (39725)	19.70	19.80	19.71
		2682.5 (41515)	19.70	19.75	19.81
		2637.8(41068)	19.72	19.80	19.90
		2593 (40620)	19.91	19.97	19.77
	36RB-Low (0)	2548.3(40173)	19.71	19.78	19.90
		2503.5 (39725)	19.71	19.81	19.74
		2682.5 (41515)	19.58	19.65	19.74
		2637.8(41068)	19.69	19.75	19.88
		2593 (40620)	19.86	19.97	19.79
75RB (0)	2548.3(40173)	19.64	19.72	19.91	
	2503.5 (39725)	19.64	19.76	19.69	
	2682.5 (41515)	19.61	19.72	19.75	
	2637.8(41068)	19.74	19.82	19.88	
	2593 (40620)	19.85	19.95	19.78	
20MHz	1RB-High (99)	2548.3(40173)	19.68	19.75	19.86
		2503.5 (39725)	19.68	19.82	19.71
		2680 (41490)	19.76	19.79	19.74
		2636.5(41055)	19.66	19.65	19.75
		2593 (40620)	19.83	19.95	19.65
	1RB-Middle (50)	2549.5(40185)	19.79	19.80	19.82
		2506 (39750)	19.67	19.60	19.66
		2680 (41490)	19.79	19.70	19.81
		2636.5(41055)	19.76	19.60	19.84
		2593 (40620)	19.87	20.01	19.70
	1RB-Low (0)	2549.5(40185)	19.70	19.68	19.81
		2506 (39750)	19.68	19.60	19.67
		2680 (41490)	20.69	20.60	20.77
		2636.5(41055)	19.70	19.64	19.84
		2593 (40620)	19.67	19.88	19.71
	50RB-High (50)	2549.5(40185)	19.59	19.60	19.79
		2506 (39750)	19.59	19.57	19.58
		2680 (41490)	19.72	19.75	19.79
		2636.5(41055)	19.68	19.77	19.85
		2593 (40620)	19.83	19.96	19.77
	50RB-Middle (25)	2549.5(40185)	19.79	19.82	19.96
		2506 (39750)	19.73	19.80	19.74
		2680 (41490)	19.65	19.75	19.80
		2636.5(41055)	19.75	19.79	19.93
		2593 (40620)	19.86	19.99	19.82
	50RB-Low (0)	2549.5(40185)	19.68	19.74	19.90
		2506 (39750)	19.72	19.83	19.75
		2680 (41490)	19.65	19.66	19.80
2636.5(41055)		19.71	19.75	19.93	
2593 (40620)		19.82	19.94	19.84	
100RB (0)	2549.5(40185)	19.60	19.68	19.89	
	2506 (39750)	19.66	19.75	19.69	
	2680 (41490)	19.64	19.67	19.74	
	2636.5(41055)	19.69	19.78	19.91	
	2593 (40620)	19.82	19.90	19.79	
		2549.5(40185)	19.72	19.81	19.96
		2506 (39750)	19.67	19.77	19.75

LTE B41(PC2)-LevelA						
BANDWIDTH	Number of RBs	Frequency	QPSK	16QAM	64QAM	
5MHz	1RB-High (24)	2687.5 (41565)	26.90	25.84	25.31	
		2640.3(41093)	27.04	25.88	25.30	
		2593 (40620)	27.14	25.93	25.18	
		2545.8(40148)	26.93	25.89	25.33	
		2498.5 (39675)	26.96	25.98	25.13	
	1RB-Middle (12)	2687.5 (41565)	26.86	25.85	25.29	
		2640.3(41093)	27.00	25.87	25.31	
		2593 (40620)	27.11	25.92	25.21	
		2545.8(40148)	26.89	25.92	25.37	
	1RB-Low (0)	2498.5 (39675)	26.98	25.96	25.14	
		2687.5 (41565)	26.86	25.85	25.30	
		2640.3(41093)	27.06	25.83	25.27	
		2593 (40620)	27.16	25.94	25.22	
	12RB-High (13)	2545.8(40148)	26.90	25.91	25.33	
		2498.5 (39675)	26.97	25.94	25.13	
		2687.5 (41565)	25.93	24.75	24.48	
		2640.3(41093)	25.95	24.74	24.56	
	12RB-Middle (6)	2593 (40620)	26.09	24.92	24.44	
		2545.8(40148)	25.92	24.76	24.53	
		2498.5 (39675)	25.95	24.84	24.37	
		2687.5 (41565)	25.95	24.76	24.55	
	12RB-Low (0)	2640.3(41093)	25.98	24.77	24.57	
		2593 (40620)	26.12	24.93	24.49	
		2545.8(40148)	25.87	24.73	24.57	
		2498.5 (39675)	25.97	24.84	24.34	
	25RB (0)	2687.5 (41565)	25.89	24.64	24.53	
		2640.3(41093)	25.95	24.70	24.54	
		2593 (40620)	26.07	24.79	24.45	
		2545.8(40148)	25.88	24.74	24.50	
	10MHz	1RB-High (49)	2498.5 (39675)	25.92	24.70	24.34
			2498.5 (39675)	25.83	24.66	24.32
			2593 (40620)	26.08	24.81	24.44
			2545.8(40148)	25.81	24.78	24.50
			2685 (41540)	25.86	24.75	24.49
		1RB-Middle (24)	2640.3(41093)	25.94	24.62	24.56
			2593 (40620)	26.07	24.79	24.45
2545.8(40148)			25.88	24.74	24.50	
2501 (39700)			26.96	25.94	25.26	
2685 (41540)			26.93	25.97	25.33	
1RB-Low (0)		2639(41080)	26.98	25.88	25.24	
		2593 (40620)	27.19	25.97	25.16	
		2547(40160)	26.96	25.94	25.26	
		2501 (39700)	26.96	25.97	25.10	
		2685 (41540)	26.93	25.97	25.33	
25RB-High (25)		2639(41080)	26.87	25.88	25.29	
		2593 (40620)	27.12	25.96	25.22	
		2547(40160)	26.95	25.98	25.32	
		2501 (39700)	26.91	25.98	25.13	
		2685 (41540)	27.60	26.44	25.91	
25RB-Middle (12)		2639(41080)	27.00	25.89	25.31	
		2593 (40620)	27.08	25.82	25.16	
		2547(40160)	26.91	25.92	25.33	
		2501 (39700)	26.92	25.94	25.08	
		2685 (41540)	26.11	24.89	24.69	
25RB-Low (0)		2639(41080)	25.91	24.66	24.50	
		2593 (40620)	26.08	24.79	24.43	
		2547(40160)	25.89	24.70	24.52	
		2501 (39700)	25.94	24.70	24.34	
		2685 (41540)	26.00	24.79	24.60	
50RB (0)		2639(41080)	25.97	24.72	24.59	
		2593 (40620)	26.10	24.85	24.45	
		2547(40160)	25.94	24.68	24.55	
		2501 (39700)	25.93	24.74	24.34	
		2685 (41540)	26.10	24.87	24.76	
		2639(41080)	25.92	24.67	24.57	
	2593 (40620)	26.07	24.84	24.44		
	2547(40160)	25.90	24.64	24.52		
	2501 (39700)	25.91	24.73	24.34		
	2685 (41540)	26.08	24.91	24.68		
	2639(41080)	25.90	24.61	24.54		
	2593 (40620)	25.98	24.86	24.44		
	2547(40160)	25.86	24.73	24.49		
	2501 (39700)	25.91	24.77	24.50		
	2685 (41540)	26.08	24.91	24.68		

15MHz	1RB-High (74)	2682.5 (41515)	26.87	25.84	25.20
		2637.8(41068)	26.99	25.82	25.25
		2593 (40620)	27.12	25.86	25.15
		2548.3(40173)	26.99	25.94	25.23
	1RB-Middle (37)	2503.5 (39725)	26.97	25.91	25.14
		2682.5 (41515)	27.02	26.03	25.34
		2637.8(41068)	27.12	25.83	25.29
		2593 (40620)	27.24	26.03	25.23
	1RB-Low (0)	2548.3(40173)	27.00	26.01	25.34
		2503.5 (39725)	26.97	25.92	25.12
		2682.5 (41515)	26.69	25.71	25.13
		2637.8(41068)	26.98	25.91	25.29
	36RB-High (38)	2593 (40620)	26.98	25.88	25.18
		2548.3(40173)	26.99	25.93	25.35
		2503.5 (39725)	26.91	25.86	25.10
		2682.5 (41515)	26.00	24.82	24.48
	36RB-Middle (19)	2637.8(41068)	26.01	24.86	24.44
		2593 (40620)	26.14	24.92	24.36
		2548.3(40173)	25.96	24.80	24.43
		2503.5 (39725)	26.00	24.85	24.29
	36RB-Low (0)	2682.5 (41515)	25.98	24.80	24.50
		2637.8(41068)	26.05	24.91	24.49
		2593 (40620)	26.16	24.98	24.39
		2548.3(40173)	26.00	24.81	24.45
	75RB (0)	2503.5 (39725)	26.04	24.89	24.31
		2682.5 (41515)	25.83	24.66	24.39
		2637.8(41068)	26.02	24.83	24.51
		2593 (40620)	26.15	24.91	24.41
1RB-High (99)	2548.3(40173)	25.92	24.75	24.46	
	2503.5 (39725)	25.92	24.81	24.25	
	2682.5 (41515)	25.88	24.72	24.43	
	2637.8(41068)	26.02	24.81	24.53	
1RB-Middle (50)	2593 (40620)	26.14	24.92	24.41	
	2548.3(40173)	25.92	24.77	24.45	
	2503.5 (39725)	25.98	24.82	24.28	
	2680 (41490)	27.08	25.96	26.41	
1RB-Low (0)	2636.5(41055)	27.16	25.64	25.24	
	2593 (40620)	27.19	26.12	25.10	
	2549.5(40185)	27.17	25.96	25.29	
	2506 (39750)	27.06	25.79	25.15	
50RB-High (50)	2680 (41490)	26.99	25.97	-10.44	
	2636.5(41055)	27.14	25.71	25.27	
	2593 (40620)	27.12	26.11	25.22	
	2549.5(40185)	27.06	25.96	25.32	
50RB-Middle (25)	2506 (39750)	27.11	25.77	25.14	
	2680 (41490)	27.87	26.69	-38.82	
	2636.5(41055)	27.09	25.67	25.28	
	2593 (40620)	26.96	25.99	25.17	
50RB-Low (0)	2549.5(40185)	26.92	25.77	25.29	
	2506 (39750)	27.00	25.67	25.04	
	2680 (41490)	25.91	24.98	25.38	
	2636.5(41055)	25.87	24.67	24.51	
100RB (0)	2593 (40620)	26.00	24.83	24.38	
	2549.5(40185)	25.98	24.78	24.53	
	2506 (39750)	25.90	24.68	24.35	
	2680 (41490)	25.84	24.65	24.49	
100RB (0)	2636.5(41055)	25.95	24.69	24.61	
	2593 (40620)	26.04	24.84	24.44	
	2549.5(40185)	25.87	24.69	24.49	
	2506 (39750)	25.89	24.69	24.36	
100RB (0)	2680 (41490)	25.80	24.61	24.47	
	2636.5(41055)	25.90	24.66	24.57	
	2593 (40620)	26.01	24.82	24.45	
	2549.5(40185)	25.84	24.69	24.51	
100RB (0)	2506 (39750)	25.89	24.69	24.30	
	2680 (41490)	25.66	24.68	24.42	
	2636.5(41055)	25.83	24.71	24.55	
	2593 (40620)	26.04	24.81	24.42	
100RB (0)	2549.5(40185)	26.05	24.77	24.57	
	2506 (39750)	25.90	24.74	24.57	

LTE B41(PC2)-Level B						
BANDWIDTH	Number of RBs	Frequency	QPSK	16QAM	64QAM	
5MHz	1RB-High (24)	2687.5 (41565)	22.27	22.57	22.18	
		2640.3(41093)	22.31	22.70	22.20	
		2593 (40620)	22.46	22.69	22.08	
		2545.8(40148)	22.31	22.63	22.18	
		2498.5 (39675)	22.26	22.72	22.03	
	1RB-Middle (12)	2687.5 (41565)	22.23	22.60	22.15	
		2640.3(41093)	22.28	22.70	22.23	
		2593 (40620)	22.45	22.73	22.10	
		2545.8(40148)	22.31	22.64	22.19	
	1RB-Low (0)	2498.5 (39675)	22.26	22.74	22.04	
		2687.5 (41565)	22.21	22.60	22.18	
		2640.3(41093)	22.27	22.67	22.23	
		2593 (40620)	22.47	22.70	22.13	
	12RB-High (13)	2545.8(40148)	22.29	22.62	22.18	
		2498.5 (39675)	22.22	22.70	22.01	
		2687.5 (41565)	22.31	22.47	21.58	
		2640.3(41093)	22.37	22.45	21.65	
		2593 (40620)	22.54	22.65	21.51	
	12RB-Middle (6)	2545.8(40148)	22.40	22.45	21.64	
		2498.5 (39675)	22.35	22.50	21.46	
		2687.5 (41565)	22.36	22.45	21.61	
		2640.3(41093)	22.38	22.53	21.67	
	12RB-Low (0)	2593 (40620)	22.59	22.57	21.54	
		2545.8(40148)	22.44	22.46	21.64	
		2498.5 (39675)	22.43	22.51	21.48	
		2687.5 (41565)	22.32	22.44	21.55	
	25RB (0)	2640.3(41093)	22.33	22.50	21.64	
		2593 (40620)	22.50	22.60	21.53	
		2498.5 (39675)	22.32	22.50	21.45	
		2687.5 (41565)	22.32	22.43	21.61	
		2640.3(41093)	22.35	22.39	21.67	
	10MHz	1RB-High (49)	2593 (40620)	22.53	22.48	21.49
			2545.8(40148)	22.38	22.44	21.65
			2498.5 (39675)	22.37	22.46	21.45
			2685 (41540)	22.87	22.35	23.97
			2639(41080)	22.25	22.76	22.21
1RB-Middle (24)		2547(40160)	22.35	22.78	22.15	
		2501 (39700)	22.15	22.71	22.00	
		2685 (41540)	22.25	22.76	23.50	
		2639(41080)	22.27	22.71	22.23	
		2593 (40620)	22.48	22.70	22.16	
1RB-Low (0)		2547(40160)	22.31	22.74	22.22	
		2501 (39700)	22.28	22.76	22.02	
		2685 (41540)	22.74	22.25	24.07	
		2639(41080)	22.27	22.69	22.28	
		2593 (40620)	22.36	22.54	22.07	
25RB-High (25)	2547(40160)	22.30	22.77	22.21		
	2501 (39700)	22.09	22.74	21.98		
	2685 (41540)	22.48	22.60	21.79		
	2639(41080)	22.35	22.44	21.65		
	2593 (40620)	22.50	22.51	21.53		
25RB-Middle (12)	2547(40160)	22.38	22.46	21.63		
	2501 (39700)	22.36	22.42	21.47		
	2685 (41540)	22.38	22.47	21.71		
	2639(41080)	22.39	22.45	21.69		
	2593 (40620)	22.53	22.54	21.56		
25RB-Low (0)	2547(40160)	22.43	22.43	21.66		
	2501 (39700)	22.34	22.41	21.48		
	2685 (41540)	22.51	22.60	21.80		
	2639(41080)	22.38	22.42	21.65		
	2593 (40620)	22.50	22.50	21.55		
50RB (0)	2547(40160)	22.38	22.35	21.60		
	2501 (39700)	22.33	22.36	21.46		
	2685 (41540)	22.57	22.51	21.78		
	2639(41080)	22.31	22.46	21.65		
	2593 (40620)	22.42	22.52	21.55		
		2547(40160)	22.34	22.35	21.62	
		2501 (39700)	22.38	22.46		

15MHz	1RB-High (74)	2682.5 (41515)	22.25	22.74	22.09
		2637.8(41068)	22.15	22.68	22.18
		2593 (40620)	22.46	22.75	22.08
		2548.3(40173)	22.34	22.73	22.12
		2503.5 (39725)	22.28	22.55	22.04
	1RB-Middle (37)	2682.5 (41515)	22.32	22.82	22.24
		2637.8(41068)	22.26	22.77	22.26
		2593 (40620)	22.61	22.79	22.18
		2548.3(40173)	22.37	22.77	22.23
		2503.5 (39725)	22.24	22.58	22.04
	1RB-Low (0)	2682.5 (41515)	22.21	22.58	22.06
		2637.8(41068)	22.21	22.69	22.27
		2593 (40620)	22.48	22.72	22.12
		2548.3(40173)	22.31	22.79	22.23
		2503.5 (39725)	22.11	22.67	22.00
	36RB-High (38)	2682.5 (41515)	22.34	22.42	21.61
		2637.8(41068)	22.35	22.45	21.60
		2593 (40620)	22.55	22.59	21.48
		2548.3(40173)	22.34	22.45	21.60
		2503.5 (39725)	22.32	22.44	21.47
	36RB-Middle (19)	2682.5 (41515)	22.32	22.43	21.61
		2637.8(41068)	22.38	22.53	21.66
		2593 (40620)	22.55	22.64	21.54
		2548.3(40173)	22.38	22.41	21.63
		2503.5 (39725)	22.33	22.43	21.47
	36RB-Low (0)	2682.5 (41515)	22.17	22.22	21.52
		2637.8(41068)	22.36	22.48	21.61
		2593 (40620)	22.54	22.55	21.52
2548.3(40173)		22.30	22.37	21.60	
2503.5 (39725)		22.25	22.39	21.39	
75RB (0)	2682.5 (41515)	22.15	22.30	21.51	
	2637.8(41068)	22.38	22.44	21.67	
	2593 (40620)	22.54	22.61	21.54	
	2548.3(40173)	22.37	22.40	21.62	
	2503.5 (39725)	22.31	22.35	21.43	
20MHz	1RB-High (99)	2680 (41490)	22.40	22.60	22.27
		2636.5(41055)	22.26	22.50	22.14
		2593 (40620)	22.44	22.85	22.06
		2549.5(40185)	22.46	22.63	22.19
		2506 (39750)	22.31	22.48	22.08
	1RB-Middle (50)	2680 (41490)	22.25	22.70	22.32
		2636.5(41055)	22.43	22.55	22.27
		2593 (40620)	22.42	23.00	22.17
		2549.5(40185)	22.44	22.65	22.19
		2506 (39750)	22.31	22.53	22.06
	1RB-Low (0)	2680 (41490)	23.22	22.45	23.15
		2636.5(41055)	22.25	22.46	22.24
		2593 (40620)	22.30	22.81	22.08
		2549.5(40185)	22.25	22.52	22.22
		2506 (39750)	22.23	22.42	21.99
	50RB-High (50)	2680 (41490)	22.31	22.33	21.57
		2636.5(41055)	22.36	22.40	21.65
		2593 (40620)	22.50	22.61	21.51
		2549.5(40185)	22.44	22.47	21.67
		2506 (39750)	22.33	22.41	21.48
	50RB-Middle (25)	2680 (41490)	22.24	22.31	21.57
		2636.5(41055)	22.42	22.43	21.69
		2593 (40620)	22.52	22.62	21.55
		2549.5(40185)	22.34	22.37	21.62
		2506 (39750)	22.33	22.39	21.48
	50RB-Low (0)	2680 (41490)	22.19	22.29	21.58
		2636.5(41055)	22.38	22.40	21.70
		2593 (40620)	22.47	22.61	21.60
2549.5(40185)		22.29	22.36	21.64	
2506 (39750)		22.27	22.34	21.43	
100RB (0)	2680 (41490)	22.22	22.17	21.51	
	2636.5(41055)	22.35	22.34	21.66	
	2593 (40620)	22.51	22.58	21.53	
	2549.5(40185)	22.40	22.35	21.67	
	2506 (39750)	22.33	22.41	21.67	

LTE B66-LevelA					
BANDWIDTH	Number of RBs	Frequency	QPSK	16QAM	64QAM
1.4MHz	1RB-High (5)	1779.3 (132665)	22.98	22.26	21.38
		1745 (132322)	22.79	21.76	21.29
		1710.7 (131979)	22.90	21.85	21.50
	1RB-Middle (3)	1779.3 (132665)	22.49	22.33	21.55
		1745 (132322)	22.23	21.79	21.39
		1710.7 (131979)	22.31	21.92	21.57
	1RB-Low (0)	1779.3 (132665)	22.97	22.29	21.48
		1745 (132322)	22.20	21.73	21.36
		1710.7 (131979)	22.28	21.84	21.46
	3RB-High (3)	1779.3 (132665)	22.37	22.12	21.41
		1745 (132322)	22.50	21.91	21.36
		1710.7 (131979)	22.74	21.84	21.43
	3RB-Middle (1)	1779.3 (132665)	22.97	22.23	21.51
		1745 (132322)	22.74	21.96	21.37
		1710.7 (131979)	22.89	21.95	21.50
	3RB-Low (0)	1779.3 (132665)	22.90	22.20	21.40
		1745 (132322)	22.69	21.92	21.35
		1710.7 (131979)	22.80	21.88	21.46
	6RB (0)	1779.3 (132665)	21.94	20.90	20.30
		1745 (132322)	21.70	21.01	20.31
		1710.7 (131979)	21.87	21.00	20.42
3MHz	1RB-High (14)	1778.5 (132657)	23.08	22.38	21.46
		1745 (132322)	22.86	21.82	21.44
		1711.5 (131987)	22.92	21.77	21.54
	1RB-Middle (7)	1778.5 (132657)	22.50	22.46	21.62
		1745 (132322)	22.36	21.89	21.47
		1711.5 (131987)	22.32	21.82	21.74
	1RB-Low (0)	1778.5 (132657)	23.05	22.41	21.57
		1745 (132322)	22.88	21.85	21.40
		1711.5 (131987)	23.03	21.75	21.53
	8RB-High (7)	1778.5 (132657)	22.43	21.12	20.42
		1745 (132322)	22.38	20.90	20.36
		1711.5 (131987)	22.25	21.06	20.54
	8RB-Middle (4)	1778.5 (132657)	22.05	21.16	20.47
		1745 (132322)	21.84	20.96	20.33
		1711.5 (131987)	21.95	21.08	20.54
	8RB-Low (0)	1778.5 (132657)	22.00	21.15	20.38
		1745 (132322)	21.80	20.94	20.35
		1711.5 (131987)	21.91	21.06	20.51
	15RB (0)	1778.5 (132657)	22.03	21.13	20.47
		1745 (132322)	21.81	20.84	20.34
		1711.5 (131987)	21.94	21.03	20.47



5MHz	1RB-High (24)	1777.5 (132647)	23.06	22.16	22.51	
		1745 (132322)	22.81	22.02	21.40	
		1712.5 (131997)	22.96	22.45	21.63	
	1RB-Middle (12)	1777.5 (132647)	22.99	22.15	21.53	
		1745 (132322)	22.80	21.95	21.39	
		1712.5 (131997)	22.87	22.41	21.55	
	1RB-Low (0)	1777.5 (132647)	23.06	22.20	21.61	
		1745 (132322)	22.86	22.02	21.50	
		1712.5 (131997)	23.04	22.40	21.57	
	12RB-High (13)	1777.5 (132647)	22.05	21.17	20.44	
		1745 (132322)	21.83	20.98	20.39	
		1712.5 (131997)	21.97	21.17	20.59	
	12RB-Middle (6)	1777.5 (132647)	22.07	21.20	20.48	
		1745 (132322)	21.90	21.05	20.39	
		1712.5 (131997)	21.99	21.16	20.53	
	12RB-Low (0)	1777.5 (132647)	22.08	21.20	20.50	
		1745 (132322)	21.90	21.03	20.40	
		1712.5 (131997)	21.97	21.18	20.58	
	25RB (0)	1777.5 (132647)	22.08	21.06	20.44	
		1745 (132322)	21.85	20.95	20.31	
		1712.5 (131997)	21.94	21.09	20.49	
	10MHz	1RB-High (49)	1775 (132622)	23.01	22.41	21.53
			1745 (132322)	22.86	21.88	21.46
			1715 (132022)	22.84	21.93	21.73
1RB-Middle (24)		1775 (132622)	22.88	22.39	21.47	
		1745 (132322)	22.67	21.82	21.48	
		1715 (132022)	22.79	21.86	21.68	
1RB-Low (0)		1775 (132622)	23.03	22.35	21.56	
		1745 (132322)	22.97	21.83	21.52	
		1715 (132022)	23.06	21.81	21.62	
25RB-High (25)		1775 (132622)	22.26	21.14	20.41	
		1745 (132322)	22.29	21.05	20.39	
		1715 (132022)	22.43	21.09	20.55	
25RB-Middle (12)		1775 (132622)	22.33	21.18	20.48	
		1745 (132322)	22.24	21.04	20.35	
		1715 (132022)	22.26	21.10	20.56	
25RB-Low (0)		1775 (132622)	22.26	21.06	20.40	
		1745 (132322)	22.45	21.03	20.39	
		1715 (132022)	22.29	21.05	20.59	
50RB (0)		1775 (132622)	22.55	21.08	20.33	
		1745 (132322)	22.40	20.94	20.41	
		1715 (132022)	22.40	21.03	20.57	



15MHz	1RB-High (74)	1772.5 (132597)	23.03	22.01	21.56
		1745 (132322)	22.89	22.34	21.58
		1717.5 (132047)	22.96	22.52	21.66
	1RB-Middle (37)	1772.5 (132597)	23.05	21.97	21.54
		1745 (132322)	22.92	22.21	21.45
		1717.5 (132047)	22.91	22.39	21.67
	1RB-Low (0)	1772.5 (132597)	23.02	22.07	21.60
		1745 (132322)	23.03	22.25	21.64
		1717.5 (132047)	22.98	22.30	21.75
	36RB-High (38)	1772.5 (132597)	22.09	21.20	20.45
		1745 (132322)	21.91	20.99	20.39
		1717.5 (132047)	21.93	21.06	20.52
	36RB-Middle (19)	1772.5 (132597)	21.98	21.08	20.39
		1745 (132322)	21.91	21.03	20.37
		1717.5 (132047)	21.96	21.05	20.60
	36RB-Low (0)	1772.5 (132597)	22.01	21.12	20.46
		1745 (132322)	21.89	21.06	20.47
		1717.5 (132047)	22.00	21.05	20.60
	75RB (0)	1772.5 (132597)	22.01	21.06	20.43
		1745 (132322)	21.91	20.99	20.36
		1717.5 (132047)	21.95	21.11	20.58
20MHz	1RB-High (99)	1770 (132572)	22.54	22.15	21.55
		1745 (132322)	22.48	22.08	21.67
		1720 (132072)	22.43	21.87	21.50
	1RB-Middle (50)	1770 (132572)	22.41	22.00	21.42
		1745 (132322)	22.39	21.79	21.42
		1720 (132072)	22.36	21.97	21.69
	1RB-Low (0)	1770 (132572)	22.55	22.24	21.73
		1745 (132322)	22.50	21.85	21.58
		1720 (132072)	22.65	21.89	21.69
	50RB-High (50)	1770 (132572)	21.53	20.64	20.37
		1745 (132322)	21.52	20.56	20.35
		1720 (132072)	21.48	20.53	20.46
	50RB-Middle (25)	1770 (132572)	21.57	20.66	20.47
		1745 (132322)	21.49	20.60	20.39
		1720 (132072)	21.58	20.73	20.56
	50RB-Low (0)	1770 (132572)	21.58	20.71	20.49
		1745 (132322)	21.51	20.55	20.47
		1720 (132072)	21.64	20.68	20.63
	100RB (0)	1770 (132572)	21.52	20.68	20.41
		1745 (132322)	21.49	20.55	20.40
		1720 (132072)	21.51	20.58	20.44

LTE B66-LevelB					
BANDWIDTH	Number of RBs	Frequency	QPSK	16QAM	64QAM
1.4MHz	1RB-High (5)	1779.3 (132665)	18.53	18.65	18.65
		1745 (132322)	18.53	18.58	18.58
		1710.7 (131979)	18.70	19.02	18.71
	1RB-Middle (3)	1779.3 (132665)	18.60	18.65	18.64
		1745 (132322)	18.57	18.65	18.64
		1710.7 (131979)	18.77	19.07	18.84
	1RB-Low (0)	1779.3 (132665)	18.54	18.60	18.63
		1745 (132322)	18.55	18.58	18.66
		1710.7 (131979)	18.73	18.99	18.84
	3RB-High (3)	1779.3 (132665)	18.53	18.79	18.67
		1745 (132322)	18.42	18.52	18.56
		1710.7 (131979)	18.70	18.85	18.70
	3RB-Middle (1)	1779.3 (132665)	18.58	18.83	18.77
		1745 (132322)	18.48	18.56	18.68
		1710.7 (131979)	18.77	18.91	18.75
	3RB-Low (0)	1779.3 (132665)	18.55	18.78	18.71
		1745 (132322)	18.41	18.50	18.55
		1710.7 (131979)	18.72	18.84	18.68
6RB (0)	1779.3 (132665)	18.49	18.82	18.63	
	1745 (132322)	18.25	18.67	18.50	
	1710.7 (131979)	18.39	18.69	18.63	
3MHz	1RB-High (14)	1778.5 (132657)	18.59	18.70	18.76
		1745 (132322)	18.55	18.44	18.69
		1711.5 (131987)	18.80	19.15	18.84
	1RB-Middle (7)	1778.5 (132657)	18.66	18.77	18.92
		1745 (132322)	18.63	18.55	18.77
		1711.5 (131987)	18.91	19.21	18.90
	1RB-Low (0)	1778.5 (132657)	18.64	18.72	18.77
		1745 (132322)	18.55	18.44	18.64
		1711.5 (131987)	18.81	19.11	18.88
	8RB-High (7)	1778.5 (132657)	18.62	18.67	18.63
		1745 (132322)	18.56	18.65	18.58
		1711.5 (131987)	18.80	18.85	18.74
	8RB-Middle (4)	1778.5 (132657)	18.69	18.74	18.71
		1745 (132322)	18.59	18.68	18.62
		1711.5 (131987)	18.84	18.90	18.76
	8RB-Low (0)	1778.5 (132657)	18.63	18.70	18.71
		1745 (132322)	18.56	18.67	18.60
		1711.5 (131987)	18.77	18.85	18.67
15RB (0)	1778.5 (132657)	18.63	18.65	18.68	
	1745 (132322)	18.56	18.61	18.57	
	1711.5 (131987)	18.78	18.82	18.75	



5MHz	1RB-High (24)	1777.5 (132647)	18.71	18.84	18.83	
		1745 (132322)	18.56	19.09	18.71	
		1712.5 (131997)	18.84	18.95	18.88	
	1RB-Middle (12)	1777.5 (132647)	18.70	18.80	18.72	
		1745 (132322)	18.51	19.03	18.73	
		1712.5 (131997)	18.81	18.86	18.90	
	1RB-Low (0)	1777.5 (132647)	18.79	18.86	18.83	
		1745 (132322)	18.62	19.07	18.68	
		1712.5 (131997)	18.87	18.92	18.79	
	12RB-High (13)	1777.5 (132647)	18.60	18.76	18.67	
		1745 (132322)	18.53	18.73	18.61	
		1712.5 (131997)	18.81	18.88	18.79	
	12RB-Middle (6)	1777.5 (132647)	18.68	18.79	18.70	
		1745 (132322)	18.64	18.76	18.62	
		1712.5 (131997)	18.84	18.88	18.79	
	12RB-Low (0)	1777.5 (132647)	18.66	18.78	18.72	
		1745 (132322)	18.62	18.74	18.56	
		1712.5 (131997)	18.82	18.87	18.78	
	25RB (0)	1777.5 (132647)	18.68	18.69	18.70	
		1745 (132322)	18.59	18.64	18.57	
		1712.5 (131997)	18.79	18.80	18.76	
	10MHz	1RB-High (49)	1775 (132622)	18.60	18.67	18.75
			1745 (132322)	18.52	18.46	18.69
			1715 (132022)	18.77	19.16	18.96
1RB-Middle (24)		1775 (132622)	18.62	18.67	18.87	
		1745 (132322)	18.49	18.45	18.64	
		1715 (132022)	18.73	19.14	18.91	
1RB-Low (0)		1775 (132622)	18.60	18.61	18.73	
		1745 (132322)	18.60	18.48	18.69	
		1715 (132022)	18.84	19.14	18.91	
25RB-High (25)		1775 (132622)	18.68	18.75	18.68	
		1745 (132322)	18.55	18.60	18.64	
		1715 (132022)	18.81	18.91	18.74	
25RB-Middle (12)		1775 (132622)	18.67	18.79	18.74	
		1745 (132322)	18.59	18.62	18.62	
		1715 (132022)	18.82	18.94	18.75	
25RB-Low (0)		1775 (132622)	18.59	18.70	18.63	
		1745 (132322)	18.58	18.61	18.61	
		1715 (132022)	18.85	18.93	18.79	
50RB (0)		1775 (132622)	18.56	18.62	18.61	
		1745 (132322)	18.55	18.59	18.63	
		1715 (132022)	18.79	18.86	18.78	

15MHz	1RB-High (74)	1772.5 (132597)	18.75	19.09	18.87
		1745 (132322)	18.54	18.54	18.79
		1717.5 (132047)	18.78	19.16	18.91
	1RB-Middle (37)	1772.5 (132597)	18.77	19.03	18.68
		1745 (132322)	18.54	18.45	18.69
		1717.5 (132047)	18.77	19.18	18.93
	1RB-Low (0)	1772.5 (132597)	18.77	19.13	18.98
		1745 (132322)	18.68	18.57	18.80
		1717.5 (132047)	18.89	19.28	18.98
	36RB-High (38)	1772.5 (132597)	18.71	18.70	18.74
		1745 (132322)	18.53	18.63	18.60
		1717.5 (132047)	18.76	18.90	18.76
	36RB-Middle (19)	1772.5 (132597)	18.65	18.62	18.65
		1745 (132322)	18.59	18.61	18.63
		1717.5 (132047)	18.80	18.88	18.81
	36RB-Low (0)	1772.5 (132597)	18.68	18.66	18.66
		1745 (132322)	18.64	18.64	18.66
		1717.5 (132047)	18.82	18.91	18.81
	75RB (0)	1772.5 (132597)	18.64	18.63	18.63
		1745 (132322)	18.60	18.62	18.65
		1717.5 (132047)	18.78	18.86	18.76
20MHz	1RB-High (99)	1770 (132572)	18.91	19.42	18.80
		1745 (132322)	18.95	19.41	18.82
		1720 (132072)	18.87	19.27	18.82
	1RB-Middle (50)	1770 (132572)	18.81	19.37	18.64
		1745 (132322)	18.85	19.22	18.73
		1720 (132072)	18.94	19.40	18.91
	1RB-Low (0)	1770 (132572)	18.92	19.49	18.97
		1745 (132322)	18.95	19.35	18.87
		1720 (132072)	19.12	19.48	18.98
	50RB-High (50)	1770 (132572)	18.86	18.87	18.64
		1745 (132322)	18.89	18.95	18.64
		1720 (132072)	18.95	18.95	18.69
	50RB-Middle (25)	1770 (132572)	18.88	18.92	18.66
		1745 (132322)	18.92	18.96	18.66
		1720 (132072)	19.01	19.06	18.79
	50RB-Low (0)	1770 (132572)	18.92	19.02	18.72
		1745 (132322)	18.97	18.91	18.73
		1720 (132072)	19.08	19.09	18.79
	100RB (0)	1770 (132572)	18.86	18.90	18.71
		1745 (132322)	18.91	18.94	18.65
		1720 (132072)	18.94	19.00	18.69

LTE B71-Level A					
BANDWIDTH	Number of RBs	Frequency	QPSK	16QAM	64QAM
5MHz	1RB-High (24)	695.5 (133447)	23.06	22.71	21.68
		680.5 (133297)	22.78	21.97	22.43
		665.5 (133147)	22.40	21.54	21.05
	1RB-Middle (12)	695.5 (133447)	23.14	22.70	21.73
		680.5 (133297)	22.81	21.94	22.43
		665.5 (133147)	22.41	21.58	20.96
	1RB-Low (0)	695.5 (133447)	23.06	22.61	21.67
		680.5 (133297)	22.73	21.88	22.20
		665.5 (133147)	22.39	21.52	20.93
	12RB-High (13)	695.5 (133447)	22.17	21.41	20.61
		680.5 (133297)	21.83	21.01	20.32
		665.5 (133147)	21.53	20.66	20.06
	12RB-Middle (6)	695.5 (133447)	22.12	21.36	20.54
		680.5 (133297)	21.89	20.98	20.46
		665.5 (133147)	21.64	20.79	20.11
	12RB-Low (0)	695.5 (133447)	22.12	21.33	20.53
		680.5 (133297)	21.88	20.89	20.41
		665.5 (133147)	21.53	20.67	19.98
25RB (0)	695.5 (133447)	22.11	21.21	20.46	
	680.5 (133297)	21.85	20.78	20.34	
	665.5 (133147)	21.57	20.68	20.03	
10MHz	1RB-High (49)	693 (132422)	23.09	22.47	21.07
		680.5 (133297)	22.81	21.87	21.44
		668 (133172)	22.48	21.42	21.12
	1RB-Middle (24)	693 (132422)	23.05	22.36	21.04
		680.5 (133297)	22.71	21.78	21.46
		668 (133172)	22.44	21.37	21.13
	1RB-Low (0)	693 (132422)	22.95	22.24	21.11
		680.5 (133297)	22.54	21.62	21.31
		668 (133172)	22.38	21.20	20.95
	25RB-High (25)	693 (132422)	21.97	21.10	19.99
		680.5 (133297)	21.73	20.93	20.33
		668 (133172)	21.49	20.61	20.01
	25RB-Middle (12)	693 (132422)	22.01	21.11	20.00
		680.5 (133297)	21.78	20.96	20.38
		668 (133172)	21.55	20.59	20.08
	25RB-Low (0)	693 (132422)	21.89	21.04	20.02
		680.5 (133297)	21.71	20.84	20.33
		668 (133172)	21.46	20.56	20.06
50RB (0)	693 (132422)	21.96	21.09	19.99	
	680.5 (133297)	21.76	20.91	20.37	
	668 (133172)	21.50	20.55	20.05	

15MHz	1RB-High (74)	690.5 (133397)	23.14	22.55	21.64
		680.5 (133297)	22.89	22.31	21.45
		670.5 (133197)	22.64	21.61	21.24
	1RB-Middle (37)	690.5 (133397)	23.13	22.43	21.65
		680.5 (133297)	22.79	22.20	21.45
		670.5 (133197)	22.55	21.45	21.26
	1RB-Low (0)	690.5 (133397)	22.97	22.38	21.57
		680.5 (133297)	22.60	22.01	21.40
		670.5 (133197)	22.37	21.27	21.07
	36RB-High (38)	690.5 (133397)	22.07	21.24	20.48
		680.5 (133297)	21.81	20.89	20.31
		670.5 (133197)	21.60	20.73	20.14
	36RB-Middle (19)	690.5 (133397)	21.97	21.14	20.44
		680.5 (133297)	21.84	20.91	20.34
		670.5 (133197)	21.58	20.66	20.08
	36RB-Low (0)	690.5 (133397)	21.94	21.11	20.48
		680.5 (133297)	21.73	20.85	20.36
		670.5 (133197)	21.59	20.62	20.09
75RB (0)	690.5 (133397)	21.93	21.09	20.42	
	680.5 (133297)	21.84	20.94	20.36	
	670.5 (133197)	21.56	20.61	20.07	
20MHz	1RB-High (99)	688 (133372)	23.04	22.46	21.69
		683 (133322)	23.01	22.18	21.54
		673 (133222)	22.71	22.00	22.40
	1RB-Middle (50)	688 (133372)	22.83	22.23	21.50
		683 (133322)	22.73	21.96	21.42
		673 (133222)	22.45	21.71	22.03
	1RB-Low (0)	688 (133372)	22.64	22.05	21.42
		683 (133322)	22.57	21.80	21.40
		673 (133222)	22.39	21.59	22.11
	50RB-High (50)	688 (133372)	21.98	21.10	20.47
		683 (133322)	21.86	20.90	20.41
		673 (133222)	21.72	20.80	21.24
	50RB-Middle (25)	688 (133372)	21.87	21.00	20.46
		683 (133322)	21.76	20.81	20.38
		673 (133222)	21.59	20.72	21.15
	50RB-Low (0)	688 (133372)	21.74	20.88	20.37
		683 (133322)	21.71	20.71	20.32
		673 (133222)	21.47	20.52	21.03
100RB (0)	688 (133372)	21.88	20.94	20.42	
	683 (133322)	21.75	20.83	20.34	
	673 (133222)	21.61	20.67	21.13	

The conducted power measurement results of downlink LTE CA Conduced Power are as below (3CA):

DL LTE CA Class	Level A															Power		
	PCC Band	PCC Bandwidth (MHz)	PCC UL RB size	PCC UL RB offset	PCC DL RB size	PCC DL RB offset	PCC UL Channel	PCC DL Channel	SCC Band	SCC Bandwidth (MHz)	SCC DL Channel	SCC	SCC Band	SCC Bandwidth (MHz)	SCC DL Channel	Rel 8 LTE Tx Power(dBm)	LTE CA Tx Power(dBm)	Tune-up
12A-2A-2A	12	3	1	14	15	0	23025	5025	2	20	700	2	20	1100	23.11	23.01	23.5	
12A-2A-4A	12	3	1	14	15	0	23025	5025	2	20	900	4	20	2175	23.11	23.04	23.5	
12A-4A-4A	12	3	1	14	15	0	23025	5025	4	20	2050	4	20	2300	23.11	23.03	23.5	
66A-2A-5A	66	10	1	49	50	0	132622	67086	2	20	900	5	10	2525	23.11	22.98	24	
66A-2A-12A	66	10	1	49	50	0	132622	67086	2	20	900	12	10	5095	23.11	23.07	24	
66A-2A-71A	66	10	1	49	50	0	132622	67086	2	20	900	71	20	68786	23.11	23.07	24	
66A-2A-2A	66	10	1	49	50	0	132622	67086	2	20	700	2	20	1100	23.11	22.96	24	
66A-2C	66	10	1	49	50	0	132622	67086	2	20	902	2	20	1100	23.11	23.02	24	
66C-2A	66	10	1	49	50	0	132622	67086	66	15	67206	2	20	900	23.11	23.03	24	
66C-12A	66	10	1	49	50	0	132622	67086	66	15	67206	12	10	5095	23.11	22.99	24	
66C-71A	66	10	1	49	50	0	132622	67086	66	15	67206	71	20	68786	23.11	22.96	24	
66A-66A-2A	66	10	1	49	50	0	132622	67086	66	5	66461	2	20	900	23.11	22.96	24	
66A-66A-71A	66	10	1	49	50	0	132622	67086	66	5	66461	71	20	68786	23.11	23.02	24	
71A-2A-4A	71	15	1	74	75	0	133397	68861	2	20	900	4	20	2175	23.14	23.01	24	
71A-2A-66A	71	15	1	74	75	0	133397	68861	2	20	900	66	20	68886	23.14	23.03	24	
71A-66A-66A	71	15	1	74	75	0	133397	68861	66	20	66536	66	20	67036	23.14	23.01	24	
71A-4A-4A	71	15	1	74	75	0	133397	68861	4	20	2050	4	20	2300	23.14	23.07	24	
71A-66C	71	15	1	74	75	0	133397	68861	66	20	66838	66	20	67036	23.14	23	24	
71A-2A-2A	71	15	1	74	75	0	133397	68861	2	20	700	2	20	1100	23.14	23.04	24	

DL LTE CA Class	Level B															Power		
	PCC								SCC1			SCC2			Rel 8 LTE Tx Power(dBm)	Rel 10 DL LTE CA Tx Power(dBm)	Tune-up	
	PCC Band	PCC Bandwidth (MHz)	PCC UL RB size	PCC UL RB offset	PCC DL RB size	PCC DL RB offset	PCC UL Channel	PCC DL Channel	SCC Band	SCC Bandwidth (MHz)	DL Channel	SCC Band	SCC Bandwidth (MHz)	DL Channel				
66A-2A-5A	66	20	1	0	100	0	132072	66536	2	20	900	5	10	2525	19.12	18.97	19.5	
66A-2A-12A	66	20	1	0	100	0	132072	66536	2	20	900	12	10	5095	19.12	19.06	19.5	
66A-2A-2A	66	20	1	0	100	0	132072	66536	2	20	700	2	20	1100	19.12	18.98	19.5	
66A-66A-2A	66	20	1	0	100	0	132072	66536	66	20	67036	2	20	900	19.12	18.97	19.5	
66C-2A	66	20	1	0	100	0	132072	66536	66	20	66734	2	20	900	19.12	19.08	19.5	
66C-12A	66	20	1	0	100	0	132072	66536	66	20	66734	12	10	5095	19.12	19.02	19.5	
66A-2C	66	20	1	0	100	0	132072	66536	2	20	900	2	20	1100	19.12	19.07	19.5	
66A-2A-71A	66	20	1	0	100	0	132072	66536	2	20	900	71	20	68786	19.12	18.97	19.5	
66A-66A-71A	66	20	1	0	100	0	132072	66536	66	20	67036	71	20	68786	19.12	19.01	19.5	
66C-71A	66	20	1	0	100	0	132072	66536	66	20	66734	71	20	68786	19.12	19.05	19.5	

Note: Testing is not required in bands or modes not intended/allowed for US operation.

11.4 Wi-Fi and BT Measurement result

The maximum output power of BT is 7.59dBm.

The maximum tune up of BT is 8dBm.

Normal Power

The average conducted power for Wi-Fi is as following:

802.11b				
Channel\data rate	1Mbps	2Mbps	5.5Mbps	11Mbps
11(2462MHz)	20.74	/	/	20.72
6(2437(MHz)	21.36	/	/	21.32
1(2412MHz)	21.46	21.42	21.33	21.47
tuneup	22.00	22.00	22.00	22.40

802.11g								
Channel\data rate	6Mbps	9Mbps	12Mbps	18Mbps	24Mbps	36Mbps	48Mbps	54Mbps
11(2462MHz)	18.50	/	/	/	/	/	/	/
6(2437(MHz)	18.95	/	/	/	/	/	/	/
1(2412MHz)	19.11	18.14	18.08	17.85	16.48	16.45	15.85	14.97
tuneup	20.00	19.00	19.00	19.00	18.00	18.00	17.00	16.00

802.11n-20MHz								
Channel\data rate	MCS0	MCS1	MCS2	MCS3	MCS4	MCS5	MCS6	MCS7
11(2462MHz)	17.25	/	/	/	/	/	/	/
6(2437(MHz)	17.63	/	/	/	/	/	/	/
1(2412MHz)	18.16	17.07	16.89	15.89	15.88	15.78	15.77	15.69
tuneup	19.00	19.00	18.50	17.00	17.00	17.00	17.00	17.00

802.11n-40MHz								
Channel\data rate	MCS0	MCS1	MCS2	MCS3	MCS4	MCS5	MCS6	MCS7
9(2452MHz)	17.83	/	/	/	/	/	/	/
6(2437MHz)	17.92	/	/	/	/	/	/	/
3(2422MHz)	18.30	17.25	17.18	16.93	16.65	15.95	15.39	14.68
tuneup	19.00	18.30	18.30	17.50	17.00	17.00	16.20	16.20



802.11a (5GHz)								
Channel\data rate	6Mbps	9Mbps	12Mbps	18Mbps	24Mbps	36Mbps	48Mbps	54Mbps
36(5180 MHz)	17.50	15.76	15.77	15.31	15.10	14.87	14.90	15.00
40(5200 MHz)	17.14	/	/	/	/	/	/	/
44(5220 MHz)	17.30	/	/	/	/	/	/	/
48(5240 MHz)	17.14	/	/	/	/	/	/	/
Tune up	18.70	16.50	16.50	16.50	16.50	16.50	16.50	16.50
52(5260 MHz)	18.28	18.27	18.23	15.34	15.15	14.98	15.02	14.99
56(5280 MHz)	17.96	/	/	/	/	/	/	/
60(5300 MHz)	17.51	/	/	/	/	/	/	/
64(5320 MHz)	17.16	/	/	/	/	/	/	/
Tune up	18.70	18.70	18.70	16.50	16.50	16.50	16.50	16.50
100(5500 MHz)	16.72	/	/	/	/	/	/	/
104(5520 MHz)	17.48	/	/	/	/	/	/	/
108(5540 MHz)	17.17	/	/	/	/	/	/	/
112(5560 MHz)	17.38	/	/	/	/	/	/	/
116(5580 MHz)	17.75	/	/	/	/	/	/	/
120(5600 MHz)	17.55	/	/	/	/	/	/	/
124(5620 MHz)	17.26	/	/	/	/	/	/	/
128(5640 MHz)	17.78	/	/	/	/	/	/	/
132(5660 MHz)	17.78	/	/	/	/	/	/	/
136(5680 MHz)	18.08	15.86	15.83	15.57	15.37	15.33	15.36	15.34
140(5700 MHz)	17.40	/	/	/	/	/	/	/
144(5720 MHz)	17.69	/	/	/	/	/	/	/
Tune up	18.70	16.50	16.50	16.50	16.50	16.50	16.50	16.50
149(5745 MHz)	17.83	/	/	/	/	/	/	/
153(5765 MHz)	18.26	17.71	17.69	17.52	17.33	17.19	17.22	17.18
155(5775 MHz)	17.92	/	/	/	/	/	/	/
161(5805 MHz)	16.86	/	/	/	/	/	/	/
165(5825 MHz)	16.81	/	/	/	/	/	/	/
Tune up	18.70	18.00	18.00	18.00	18.00	18.00	18.00	18.00

Low Power

802.11b				
Channel\data rate	1Mbps	2Mbps	5.5Mbps	11Mbps
11(2462MHz)	16.10	/	16.13	/
6(2437(MHz)	16.19	/	16.24	/
1(2412MHz)	16.79	16.85	16.90	16.83
tuneup	17.50	17.50	17.50	17.50

802.11g								
Channel\data rate	6Mbps	9Mbps	12Mbps	18Mbps	24Mbps	36Mbps	48Mbps	54Mbps
11(2462MHz)	13.70	/	/	/	/	/	/	/



6(2437(MHz)	14.07	/	/	/	/	/	/	/
1(2412MHz)	14.62	/	/	/	/	/	/	/
tuneup	15.50	15.50	15.50	15.50	15.50	15.50	15.50	15.50
802.11n-20MHz								
Channel\data rate	MCS0	MCS1	MCS2	MCS3	MCS4	MCS5	MCS6	MCS7
11(2462MHz)	13.52	/	/	/	/	/	/	/
6(2437(MHz)	13.91	/	/	/	/	/	/	/
1(2412MHz)	14.52	/	/	/	/	/	/	/
tuneup	15.00	15.00	15.00	15.00	15.00	15.00	15.00	15.00
802.11n-40MHz								
Channel\data rate	MCS0	MCS1	MCS2	MCS3	MCS4	MCS5	MCS6	MCS7
9(2452MHz)	14.14	/	/	/	/	/	/	/
6(2437MHz)	14.55	/	/	/	/	/	/	/
3(2422MHz)	14.72	/	/	/	/	/	/	/
tuneup	15.00	15.00	15.00	15.00	15.00	15.00	15.00	15.00

802.11a (5GHz)								
Channel\data rate	6Mbps	9Mbps	12Mbps	18Mbps	24Mbps	36Mbps	48Mbps	54Mbps
36(5180 MHz)	13.39	/	/	/	/	/	/	/
40(5200 MHz)	13.67	/	/	/	/	/	/	/
44(5220 MHz)	14.02	12.83	12.79	13.57	13.14	13.36	13.41	13.37
48(5240 MHz)	13.92	/	/	/	/	/	/	/
Tune up	14.50	14.50	14.50	14.50	14.50	14.50	14.50	14.50
52(5260 MHz)	13.40	12.50	12.50	14.24	13.07	12.77	12.76	12.72
56(5280 MHz)	12.95	/	/	/	/	/	/	/
60(5300 MHz)	12.51	/	/	/	/	/	/	/
64(5320 MHz)	12.50	/	/	/	/	/	/	/
Tune up	14.50	14.50	14.50	14.50	14.50	14.50	14.50	14.50
100(5500 MHz)	12.76	/	/	/	/	/	/	/
104(5520 MHz)	13.44	/	/	/	/	/	/	/
108(5540 MHz)	14.46	/	/	/	/	/	/	/
Tune up	14.60	/	/	/	/	/	/	/
112(5560 MHz)	15.14	/	/	/	/	/	/	/
116(5580 MHz)	15.06	/	/	/	/	/	/	/
120(5600 MHz)	14.73	/	/	/	/	/	/	/
124(5620 MHz)	13.90	/	/	/	/	/	/	/
128(5640 MHz)	13.41	/	/	/	/	/	/	/
132(5660 MHz)	13.25	/	/	/	/	/	/	/
136(5680 MHz)	13.86	/	/	/	/	/	/	/
140(5700 MHz)	14.72	/	/	/	/	/	/	/
Tune up	15.20	/	/	/	/	/	/	/
144(5720 MHz)	15.29	14.24	14.21	14.98	14.78	14.73	14.77	14.75



No.I20Z60553-SEM05

Tune up	15.50	14.70	14.70	15.00	15.00	15.00	15.00	15.00
149(5745 MHz)	15.94	14.82	14.79	15.59	15.40	15.33	15.34	15.35
153(5765 MHz)	15.74	/	/	/	/	/	/	/
157(5785 MHz)	15.15	/	/	/	/	/	/	/
161(5805 MHz)	14.47	/	/	/	/	/	/	/
165(5825 MHz)	14.28	/	/	/	/	/	/	/
Tune up	16.10	16.10	16.10	15.00	15.00	15.00	15.00	15.00

12 Simultaneous TX SAR Considerations

12.1 Introduction

The following procedures adopted from “FCC SAR Considerations for Cell Phones with Multiple Transmitters” are applicable to handsets with built-in unlicensed transmitters such as 802.11 a/b/g and Bluetooth devices which may simultaneously transmit with the licensed transmitter. For this device, the BT and Wi-Fi can transmit simultaneous with other transmitters.

12.2 Transmit Antenna Separation Distances

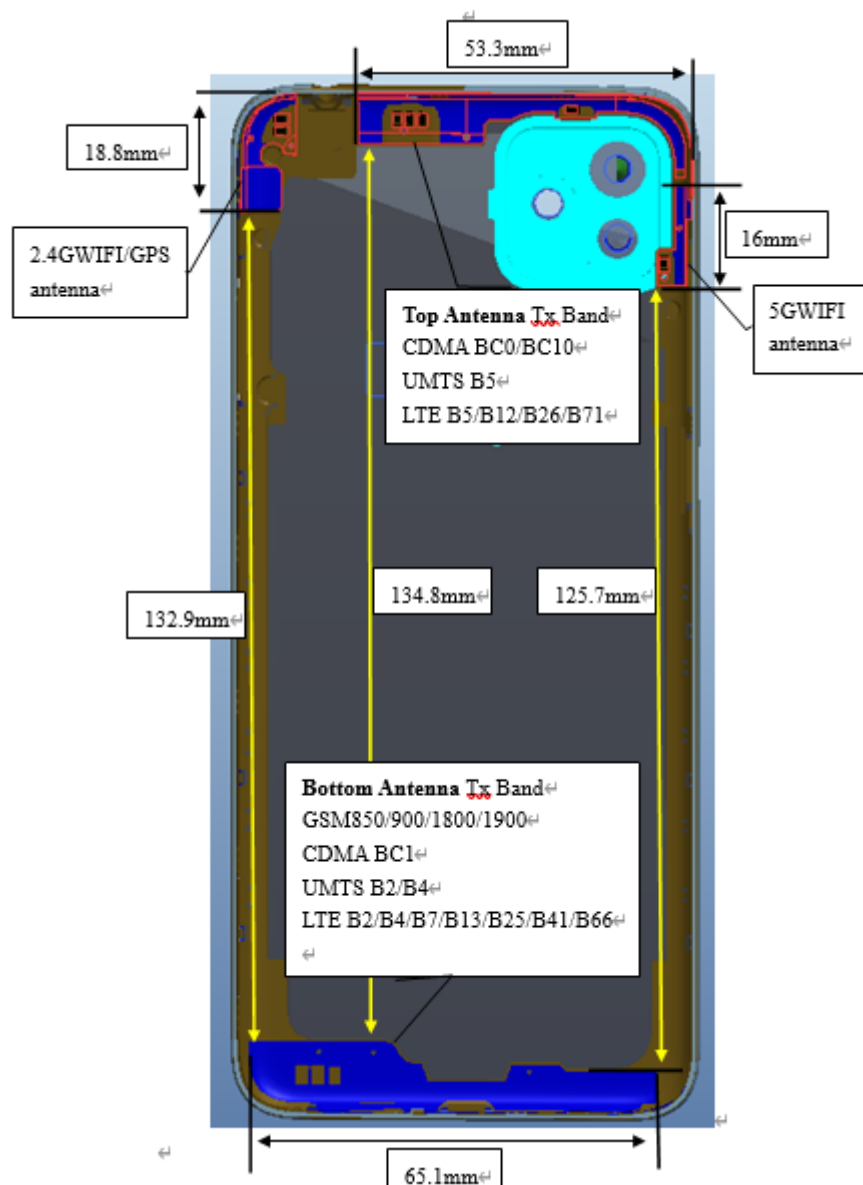

Picture 12.1 Antenna Locations

12.3 SAR Measurement Positions

According to the KDB941225 D06 Hot Spot SAR v01, the edges with less than 2.5 cm distance to the antennas need to be tested for SAR.

SAR measurement positions						
Mode	Front	Rear	Left edge	Right edge	Top edge	Bottom edge
Main antenna- Bottom antenna	Yes	Yes	Yes	Yes	No	Yes
Main antenna- Top antenna	Yes	Yes	Yes	Yes	Yes	No
WLAN 2.4G	Yes	Yes	Yes	No	Yes	No
WLAN 5G	Yes	Yes	No	Yes	Yes	No

12.4 Standalone SAR Test Exclusion Considerations

Standalone 1-g head or body SAR evaluation by measurement or numerical simulation is not required when the corresponding SAR Exclusion Threshold condition, listed below, is satisfied. The 1-g SAR test exclusion threshold for 100 MHz to 6 GHz at test separation distances ≤ 50 mm are determined by:

$$\left[\frac{(\text{max. power of channel, including tune-up tolerance, mW})}{(\text{min. test separation distance, mm})} \right] \cdot \sqrt{f(\text{GHz})} \leq 3.0$$
 for 1-g SAR, where

- $f(\text{GHz})$ is the RF channel transmit frequency in GHz
- Power and distance are rounded to the nearest mW and mm before calculation
- The result is rounded to one decimal place for comparison

Table 12.1: Standalone SAR test exclusion considerations

Band/Mode	F(GHz)	Position	SAR test exclusion threshold(mW)	RF output power		SAR test exclusion
				dBm	mW	
Bluetooth	2.441	Head	9.60	8	6.31	Yes
		Body	19.20	8	6.31	Yes
2.4GHz WLAN	2.45	Head	9.58	22.4	173.78	No
		Body	19.17	22.4	173.78	No
5GHz WLAN	5.2	Head	6.58	18.5	70.79	No
		Body	13.16	18.5	70.79	No
	5.3	Head	6.52	18.5	70.79	No
		Body	13.03	18.5	70.79	No
	5.6	Head	6.34	18.5	70.79	No
		Body	12.68	18.5	70.79	No
	5.8	Head	6.23	18.5	70.79	No
		Body	12.46	18.5	70.79	No

13 Evaluation of Simultaneous

Table 13.1: The sum of reported SAR values for main antenna and WiFi2.4G

	Position	Main antenna	WiFi	Sum
Highest reported SAR value for Head	Left head, Cheek (LTE B26)	1.02	0.19	1.21
Highest reported SAR value for Head	Right head, Cheek (WCDMA BC10)	0.99	0.44	1.43
Highest reported SAR value for Hotspot	Rear 10mm (LTE B41(PC2))	0.75	0.47	1.22
Highest reported SAR value for Body	Rear 15mm (LTE Band66)	0.47	0.47 ^[1]	0.94

[1] – the wifi value with 10mm is used to evaluate the sum value with 15mm

Table 13.2: The sum of reported SAR values for main antenna and WiFi5G

	Position	Main antenna	WiFi	Sum
Highest reported SAR value for Head	Left head, Cheek (LTE B26)	1.02	0.33	1.35
Highest reported SAR value for Hotspot	Bottom10mm (LTE B41(PC3))	1.34	0.00	1.34
Highest reported SAR value for Body	Rear 15mm (LTE Band66)	0.47	0.55	1.02

Table 13.3: The sum of reported SAR values for main antenna and BT

	Position	Main antenna	BT	Sum
Maximum reported SAR value for Head	Left head, Cheek (LTE B26)	1.02	0.26 ^[1]	1.28
Maximum reported SAR value for Hotspot	Bottom 10mm (LTE B7)	1.34	0.13 ^[1]	1.47
Highest reported SAR value for Body	Rear 15mm (LTE Band66)	0.47	0.09 ^[1]	0.56

[1] - Estimated SAR for Bluetooth (see the table 13.4)

Table 13.4: Estimated SAR for Bluetooth

Mode/Band	F (GHz)	Position	Distance (mm)	Upper limit of power *		Estimated _{1g} (W/kg)
				dBm	mW	
Bluetooth	2.441	Head	5	8	6.3	0.26
Bluetooth	2.441	Body	10	8	6.3	0.13



* - Maximum possible output power declared by manufacturer

When standalone SAR test exclusion applies to an antenna that transmits simultaneously with other antennas, the standalone SAR must be estimated according to following to determine simultaneous transmission SAR test exclusion:

(max. power of channel, including tune-up tolerance, mW)/(min. test separation distance,mm) x [$\sqrt{f(\text{GHz})}$]/x] W/kg for test separation distances ≤ 50 mm;
where $x = 7.5$ for 1-g SAR.

When the minimum test separation distance is < 5 mm, a distance of 5 mm is applied to determine SAR test exclusion

Conclusion:

According to the above tables, the sum of reported SAR values is < 1.6 W/kg. So the simultaneous transmission SAR with volume scans is not required.

14 SAR Test Result

It is determined by user manual for the distance between the EUT and the phantom bottom. The distance is 10 mm or 15mm and just applied to the condition of body worn accessory.

It is performed for all SAR measurements with area scan based 1-g SAR estimation (Fast SAR). A zoom scan measurement is added when the estimated 1-gSAR is the highest measured SAR in each exposure configuration, wireless mode and frequency band combination or more than 1.2W/kg.

The calculated SAR is obtained by the following formula:

$$\text{Reported SAR} = \text{Measured SAR} \times 10^{(P_{\text{Target}} - P_{\text{Measured}})/10}$$

Where P_{Target} is the power of manufacturing upper limit;

P_{Measured} is the measured power in chapter 11.

Table 14.1: Duty Cycle

Mode	Duty Cycle
Speech for GSM850	1:4
Speech for GSM1900	1:2
GPRS&EGPRS for GSM850- Normal Power	1:4
GPRS&EGPRS for GSM1900-Normal Power	1:2
GPRS&EGPRS for GSM1900-Low Power	1:2.67
WCDMA<E FDD	1:1
LTE B41	1:1.58

14.1 SAR results for Fast SAR

Table 14.1-1: SAR Values (GSM 850 MHz Band - Head)

Ambient Temperature: 22.9 °C						Liquid Temperature: 22.5 °C					
Frequency		Side	Test Position	Figure No.	Conducted Power (dBm)	Max. tune-up Power (dBm)	Measured SAR(10g) (W/kg)	Reported SAR(10g) (W/kg)	Measured SAR(1g) (W/kg)	Reported SAR(1g) (W/kg)	Power Drift (dB)
Ch.	MHz										
190	836.6	Left	Touch	/	29.97	30.5	0.034	0.04	0.067	0.08	-0.14
190	836.6	Left	Tilt	/	29.97	30.5	0.048	0.05	0.057	0.06	0.07
251	848.8	Right	Touch	/	30.06	30.5	0.077	0.09	0.098	0.11	0.09
190	836.6	Right	Touch	/	29.97	30.5	0.082	0.09	0.105	0.12	0.01
128	824.2	Right	Touch	Fig.1	30.49	30.5	0.102	0.10	0.13	0.13	0.15
190	836.6	Right	Tilt	/	29.97	30.5	0.041	0.05	0.052	0.06	-0.16

Note: the head SAR of GSM850 is tested with GPRS (2Txslots) mode because of VoIP.

Table 14.1-2: SAR Values (GSM 850 MHz Band - Body)

Ambient Temperature: 22.9 °C						Liquid Temperature: 22.5 °C					
Frequency		Mode (number of timeslots)	Test Position	Figure No.	Conducted Power (dBm)	Max. tune-up Power (dBm)	Measured SAR(10g) (W/kg)	Reported SAR(10g) (W/kg)	Measured SAR(1g) (W/kg)	Reported SAR(1g) (W/kg)	Power Drift (dB)
Ch.	MHz										
190	836.6	GPRS (2)	Front	/	29.97	30.5	0.094	0.11	0.13	0.15	-0.02
251	848.8	GPRS (2)	Rear	/	30.06	30.5	0.143	0.16	0.253	0.28	0.00
190	836.6	GPRS (2)	Rear	/	29.97	30.5	0.16	0.18	0.294	0.33	0.08
128	824.2	GPRS (2)	Rear	Fig.2	30.49	30.5	0.17	0.17	0.307	0.31	0.09
190	836.6	GPRS (2)	Left	/	29.97	30.5	0.046	0.05	0.07	0.08	-0.12
190	836.6	GPRS (2)	Right	/	29.97	30.5	0.089	0.10	0.13	0.15	-0.14
190	836.6	GPRS (2)	Bottom	/	29.97	30.5	0.076	0.09	0.142	0.16	-0.16
128	824.2	EGPRS (2)	Rear	/	30.49	30.5	0.169	0.17	0.305	0.31	0.16

Note: The distance between the EUT and the phantom bottom is 10mm.

Table 14.1-3: SAR Values (GSM 1900 MHz Band - Head)

Ambient Temperature: 22.9 °C						Liquid Temperature: 22.5 °C					
Frequency		Side	Test Position	Figure No.	Conducted Power (dBm)	Max. tune-up Power (dBm)	Measured SAR(10g) (W/kg)	Reported SAR(10g) (W/kg)	Measured SAR(1g) (W/kg)	Reported SAR(1g) (W/kg)	Power Drift (dB)
Ch.	MHz										
661	1880	Left	Touch	/	23.67	25	0.002	0.00	0.004	0.01	0.14
661	1880	Left	Tilt	/	23.67	25	0.001	0.00	0.003	0.00	0.10
810	1909.8	Right	Touch	/	23.66	25	0.002	0.00	0.004	0.01	0.00
661	1880	Right	Touch	Fig.3	23.67	25	0.002	0.00	0.005	0.01	0.00
512	1850.2	Right	Touch	/	23.57	25	0.002	0.00	0.004	0.01	0.14

661	1880	Right	Tilt	/	23.67	25	0.002	0.00	0.004	0.01	-0.09
-----	------	-------	------	---	-------	----	-------	------	-------	------	-------

Note: the head SAR of GSM1900 is tested with GPRS (4Txslots) mode because of VoIP.

Table 14.1-4: SAR Values (GSM 1900 MHz Band - Body)

Ambient Temperature: 22.9 °C Liquid Temperature: 22.5 °C											
Frequency		Mode (number of timeslots)	Test Position	Figure No.	Conducted Power (dBm)	Max. tune-up Power (dBm)	Measured SAR(10g) (W/kg)	Reported SAR(10g) (W/kg)	Measured SAR(1g) (W/kg)	Reported SAR(1g) (W/kg)	Power Drift (dB)
Ch.	MHz										
661	1880	GPRS (4)	Front	/	21.62	23.3	0.102	0.15	0.19	0.28	0.10
661	1880	GPRS (4)	Rear	/	21.62	23.3	0.112	0.16	0.205	0.30	-0.13
661	1880	GPRS (4)	Left	/	21.62	23.3	0.032	0.05	0.054	0.08	0.03
661	1880	GPRS (4)	Right	/	21.62	23.3	<0.01	<0.01	<0.01	<0.01	/
810	1909.8	GPRS (4)	Bottom	Fig.4	21.62	23.3	0.203	0.30	0.393	0.58	0.09
661	1880	GPRS (4)	Bottom	/	21.62	23.3	0.16	0.24	0.302	0.44	-0.04
512	1850.2	GPRS (4)	Bottom	/	21.62	23.3	0.139	0.20	0.26	0.38	0.04
810	1909.8	EGPRS (4)	Bottom	/	21.59	23.3	0.201	0.30	0.391	0.58	0.01

Note1: The distance between the EUT and the phantom bottom is 10mm

Table 14.1-5: SAR Values (GSM 1900 MHz Band - Body)

Ambient Temperature: 22.9 °C Liquid Temperature: 22.5 °C											
Frequency		Mode (number of timeslots)	Test Position	Figure No.	Conducted Power (dBm)	Max. tune-up Power (dBm)	Measured SAR(10g) (W/kg)	Reported SAR(10g) (W/kg)	Measured SAR(1g) (W/kg)	Reported SAR(1g) (W/kg)	Power Drift (dB)
Ch.	MHz										
661	1880	GPRS (4)	Front	/	23.57	25	0.047	0.07	0.084	0.12	0.12
810	1909.8	GPRS (4)	Rear	Fig.5	23.67	25	0.053	0.07	0.091	0.12	0.08
661	1880	GPRS (4)	Rear	/	23.57	25	0.049	0.07	0.082	0.11	-0.07
512	1850.2	GPRS (4)	Rear	/	23.67	25	0.042	0.06	0.074	0.10	0.05

Note1: The distance between the EUT and the phantom bottom is 15mm

Table 14.1-6: SAR Values (WCDMA 1900 MHz Band - Head)

Ambient Temperature: 22.9 °C Liquid Temperature: 22.5 °C											
Frequency		Side	Test Position	Figure No.	Conducted Power (dBm)	Max. tune-up Power (dBm)	Measured SAR(10g) (W/kg)	Reported SAR(10g) (W/kg)	Measured SAR(1g) (W/kg)	Reported SAR(1g) (W/kg)	Power Drift (dB)
Ch.	MHz										
9400	1880	Left	Touch	/	22.63	23	0.039	0.04	0.069	0.08	-0.01
9400	1880	Left	Tilt	/	22.63	23	0.029	0.03	0.053	0.06	-0.08
9400	1880	Right	Touch	/	22.63	23	0.042	0.05	0.073	0.08	0.06
9538	1907.6	Right	Tilt	/	22.77	23	0.044	0.05	0.081	0.09	0.07
9400	1880	Right	Tilt	/	22.63	23	0.044	0.05	0.082	0.09	-0.09
9262	1852.4	Right	Tilt	Fig.6	22.53	23	0.047	0.05	0.086	0.10	0.16

Table 14.1-7: SAR Values (WCDMA 1900 MHz Band - Body)

Frequency		Test Position	Figure No.	Conduct ed Power (dBm)	Max. tune-up Power (dBm)	Ambient Temperature: 22.9 °C		Liquid Temperature: 22.5°C		Power Drift (dB)
Ch.	MHz					Measured SAR(10g) (W/kg)	Reported SAR(10g) (W/kg)	Measured SAR(1g) (W/kg)	Reported SAR(1g) (W/kg)	
9400	1880	Front	/	20.01	21	0.215	0.27	0.405	0.51	0.04
9400	1880	Rear	/	20.01	21	0.225	0.28	0.4	0.50	-0.11
9400	1880	Left	/	20.01	21	0.06	0.08	0.105	0.13	-0.14
9400	1880	Right	/	20.01	21	0.039	0.05	0.066	0.08	0.16
9538	1907.6	Bottom	Fig.7	20.20	21	0.403	0.48	0.769	0.92	0.14
9400	1880	Bottom	/	20.01	21	0.366	0.46	0.698	0.88	0.09
9262	1852.4	Bottom	/	19.96	21	0.337	0.43	0.639	0.81	-0.03

Note: The distance between the EUT and the phantom bottom is 10mm

Table 14.1-8: SAR Values (WCDMA 1900 MHz Band - Limb)

Frequency		Test Position	Figure No.	Conduct ed Power (dBm)	Max. tune-up Power (dBm)	Ambient Temperature: 22.9 °C		Liquid Temperature: 22.5°C		Power Drift (dB)
Ch.	MHz					Measured SAR(10g) (W/kg)	Reported SAR(10g) (W/kg)	Measured SAR(1g) (W/kg)	Reported SAR(1g) (W/kg)	
9538	1907.6	Bottom	/	22.77	23	3.46	3.65	8.7	9.17	-0.09
9400	1880	Bottom	/	22.63	23	3.15	3.43	8.26	8.99	0.07
9262	1852.4	Bottom	/	22.53	23	3.03	3.38	7.91	8.81	0.01

Note: The distance between the EUT and the phantom bottom is 0mm

Table 14.1-9: SAR Values (WCDMA 1900 MHz Band - Body)

Frequency		Test Position	Figure No.	Conduct ed Power (dBm)	Max. tune-up Power (dBm)	Ambient Temperature: 22.9 °C		Liquid Temperature: 22.5°C		Power Drift (dB)
Ch.	MHz					Measured SAR(10g) (W/kg)	Reported SAR(10g) (W/kg)	Measured SAR(1g) (W/kg)	Reported SAR(1g) (W/kg)	
9400	1880	Front	/	22.63	24	0.11	0.15	0.193	0.26	0.08
9538	1907.6	Rear	Fig.8	22.77	24	0.125	0.17	0.215	0.29	0.08
9400	1880	Rear	/	22.63	24	0.115	0.16	0.198	0.27	-0.07
9262	1852.4	Rear	/	22.53	24	0.11	0.15	0.187	0.26	-0.04

Note: The distance between the EUT and the phantom bottom is 15mm

Table 14.1-10: SAR Values (WCDMA 1700 MHz Band - Head)

Frequency		Side	Test Position	Figure No.	Conducte d Power (dBm)	Max. tune-up Power (dBm)	Ambient Temperature: 22.9 °C		Liquid Temperature: 22.5°C		Powe r Drift (dB)
Ch.	MHz						Measure d SAR(10g) (W/kg)	Reporte d SAR(10g) (W/kg)	Measure d SAR(1g) (W/kg)	Reporte d SAR(1g) (W/kg)	
1412	1732.4	Left	Touch	/	22.73	24	0.089	0.12	0.143	0.19	-0.09
1412	1732.4	Left	Tilt	/	22.73	24	0.048	0.06	0.077	0.10	-0.06
1412	1732.4	Right	Touch	/	22.80	24	0.085	0.11	0.134	0.18	0.04
1513	1752.6	Right	Touch	/	22.73	24	0.1	0.13	0.155	0.21	-0.13

1412	1732.4	Right	Touch	Fig.9	22.92	24	0.104	0.13	0.167	0.21	0.12
1312	1712.4	Right	Tilt	/	22.73	24	0.086	0.12	0.141	0.19	0.10

Table 14.1-11: SAR Values (WCDMA 1700 MHz Band - Body)

Ambient Temperature: 22.9 °C						Liquid Temperature: 22.5 °C					
Frequency		Test Position	Figure No.	Conducted Power (dBm)	Max. tune-up Power (dBm)	Measured SAR(10g) (W/kg)	Reported SAR(10g) (W/kg)	Measured SAR(1g) (W/kg)	Reported SAR(1g) (W/kg)	Power Drift (dB)	
Ch.	MHz										
1412	1732.4	Front	/	20.12	21	0.172	0.21	0.309	0.38	0.07	
1412	1732.4	Rear	/	20.12	21	0.198	0.24	0.351	0.43	0.11	
1412	1732.4	Left	/	20.12	21	0.052	0.06	0.084	0.10	0.03	
1412	1732.4	Right	/	20.12	21	0.042	0.05	0.072	0.09	-0.16	
1513	1752.6	Bottom	Fig.10	20.11	21	0.225	0.28	0.427	0.52	0.18	
1412	1732.4	Bottom	/	20.12	21	0.217	0.27	0.411	0.50	-0.02	
1312	1712.4	Bottom	/	20.27	21	0.209	0.25	0.394	0.47	0.08	

Note: The distance between the EUT and the phantom bottom is 10mm

Table 14.1-12: SAR Values (WCDMA 1700 MHz Band - Body)

Ambient Temperature: 22.9 °C						Liquid Temperature: 22.5 °C					
Frequency		Test Position	Figure No.	Conducted Power (dBm)	Max. tune-up Power (dBm)	Measured SAR(10g) (W/kg)	Reported SAR(10g) (W/kg)	Measured SAR(1g) (W/kg)	Reported SAR(1g) (W/kg)	Power Drift (dB)	
Ch.	MHz										
1412	1732.5	Front	/	22.73	24	0.104	0.14	0.185	0.25	-0.07	
1513	1752.6	Rear	/	22.80	24	0.111	0.15	0.194	0.26	-0.07	
1412	1732.5	Rear	Fig.11	22.73	24	0.114	0.15	0.199	0.27	0.06	
1312	1712.4	Rear	/	22.92	24	0.114	0.15	0.196	0.25	0.09	

Note: The distance between the EUT and the phantom bottom is 15mm

Table 14.1-13: SAR Values (WCDMA 850 MHz Band - Head)

Ambient Temperature: 22.9 °C						Liquid Temperature: 22.5 °C					
Frequency		Side	Test Position	Figure No.	Conducted Power (dBm)	Max. tune-up Power (dBm)	Measured SAR(10g) (W/kg)	Reported SAR(10g) (W/kg)	Measured SAR(1g) (W/kg)	Reported SAR(1g) (W/kg)	Power Drift (dB)
Ch.	MHz										
4183	836.6	Left	Touch	/	22.80	24	0.234	0.31	0.327	0.43	0.15
4183	836.6	Left	Tilt	/	22.80	24	0.14	0.18	0.255	0.34	0.05
4183	836.6	Right	Touch	/	22.80	24	0.233	0.31	0.362	0.48	0.12
4233	846.6	Right	Touch	/	22.52	24	0.199	0.28	0.36	0.51	-0.03
4183	836.6	Right	Touch	/	22.80	24	0.221	0.29	0.399	0.53	-0.08
4132	826.4	Right	Tilt	Fig.12	22.95	24	0.236	0.30	0.429	0.55	-0.12

Table 14.1-14: SAR Values (WCDMA 850 MHz Band - Body)

Frequency		Test Position	Figure No.	Conducted Power (dBm)	Max. tune-up Power (dBm)	Ambient Temperature: 22.9 °C		Liquid Temperature: 22.5 °C		Power Drift (dB)
Ch.	MHz					Measured SAR(10g) (W/kg)	Reported SAR(10g) (W/kg)	Measured SAR(1g) (W/kg)	Reported SAR(1g) (W/kg)	
4183	836.6	Front	/	22.80	24	0.102	0.13	0.164	0.22	-0.10
4233	846.6	Rear	/	22.52	24	0.104	0.15	0.162	0.23	0.03
4183	836.6	Rear	/	22.80	24	0.09	0.12	0.174	0.23	-0.14
4132	826.4	Rear	Fig.13	22.95	24	0.119	0.15	0.184	0.23	0.04
4183	836.6	Left	/	22.80	24	0.068	0.09	0.116	0.15	-0.01
4183	836.6	Right	/	22.80	24	0.096	0.13	0.168	0.22	-0.03
4183	836.6	Top	/	22.80	24	0.063	0.08	0.131	0.17	0.12

Note: The distance between the EUT and the phantom bottom is 10mm.

Table 14.1-15: SAR Values (CDMA BC0 Band - Head)

Frequency		Side	Test Position	Figure No./ Note	Conducted Power (dBm)	Max. tune-up Power (dBm)	Ambient Temperature: 22.9 °C		Liquid Temperature: 22.5 °C		Power Drift (dB)
Ch.	MHz						Measured SAR(10g) (W/kg)	Reported SAR(10g) (W/kg)	Measured SAR(1g) (W/kg)	Reported SAR(1g) (W/kg)	
777	848.31	Left	Touch	/	24.35	25	0.404	0.40	0.593	0.69	0.11
384	836.52	Left	Touch	Fig.14	24.16	25	0.466	0.57	0.685	0.83	0.02
1013	824.7	Left	Touch	/	23.92	25	0.346	0.44	0.497	0.64	0.14
384	836.52	Left	Tilt	/	24.16	25	0.209	0.25	0.358	0.43	-0.04
384	836.52	Right	Touch	/	24.16	25	0.440	0.53	0.649	0.79	0.16
384	836.52	Right	Tilt	/	24.16	25	0.336	0.41	0.574	0.70	0.11

Table 14.1-16: SAR Values (CDMA BC0 Band - Body)

Frequency		Test Position	Figure No./ Note	Conducted Power (dBm)	Max. tune-up Power (dBm)	Ambient Temperature: 22.9 °C		Liquid Temperature: 22.5 °C		Power Drift (dB)
Ch.	MHz					Measured SAR(10g) (W/kg)	Reported SAR(10g) (W/kg)	Measured SAR(1g) (W/kg)	Reported SAR(1g) (W/kg)	
777	848.31	Front	/	24.35	25	0.175	0.20	0.226	0.26	0.03
384	836.52	Front	/	24.16	25	0.186	0.23	0.242	0.29	0.05
1013	824.7	Front	Fig.15	23.92	25	0.198	0.25	0.258	0.33	0.01
384	836.52	Rear	/	24.16	25	0.134	0.16	0.209	0.25	-0.07
384	836.52	Left	/	24.16	25	0.127	0.15	0.179	0.22	0.06
384	836.52	Right	/	24.16	25	0.174	0.21	0.241	0.29	-0.04
384	836.52	Top	/	24.16	25	0.113	0.14	0.199	0.24	-0.12

Note: The distance between the EUT and the phantom bottom is 10mm.

Table 14.1-17: SAR Values (CDMA BC1 Band - Head)

Frequency		Side	Test Position	Figure No./ Note	Conduct ed Power (dBm)	Max. tune-up Power (dBm)	Measure d SAR(10g)(W/kg)	Reported SAR(10g)(W/kg)	Measure d SAR(1g)(W/kg)	Reporte d SAR(1g)(W/kg)	Power Drift (dB)
Ch.	MHz										
Ambient Temperature: 22.9 °C Liquid Temperature: 22.5 °C											
600	1880	Left	Touch	/	24.32	25	0.025	0.03	0.038	0.04	0.13
600	1880	Left	Tilt	/	24.32	25	0.019	0.02	0.029	0.03	0.10
1175	1908.75	Right	Touch	Fig.16	24.09	25	0.032	0.04	0.05	0.06	0.17
600	1880	Right	Touch	/	24.32	25	0.029	0.03	0.046	0.05	0.15
25	1851.25	Right	Touch	/	24.43	25	0.031	0.04	0.048	0.05	0.16
600	1880	Right	Tilt	/	24.32	25	0.027	0.03	0.044	0.05	-0.01

Table 14.1-18: SAR Values (CDMA BC1 Band - Body)

Frequency		Test Position	Figure No./Note	Conduct ed Power (dBm)	Max. tune-up Power (dBm)	Measured SAR(10g)(W/kg)	Reported SAR(10g)(W/kg)	Measure d SAR(1g)(W/kg)	Reported SAR(1g)(W/kg)	Power Drift (dB)
Ch.	MHz									
Ambient Temperature: 22.9 °C Liquid Temperature: 22.5 °C										
600	1880	Front	/	21.11	22	0.092	0.11	0.169	0.21	-0.02
600	1880	Rear	/	21.11	22	0.101	0.12	0.174	0.21	-0.10
600	1880	Left	/	21.11	22	0.028	0.03	0.047	0.06	0.00
600	1880	Right	/	21.11	22	0.019	0.02	0.03	0.04	0.04
1175	1908.75	Bottom	Fig.17	21.32	22	0.304	0.36	0.582	0.68	-0.16
600	1880	Bottom	/	21.11	22	0.26	0.32	0.497	0.61	-0.14
25	1851.25	Bottom	/	20.88	22	0.211	0.27	0.401	0.52	-0.01

Note1: The distance between the EUT and the phantom bottom is 10mm.

Table 14.1-19: SAR Values (CDMA BC1 Band - Limb)

Frequency		Test Position	Figure No./Note	Conduct ed Power (dBm)	Max. tune-up Power (dBm)	Measured SAR(10g)(W/kg)	Reported SAR(10g)(W/kg)	Measure d SAR(1g)(W/kg)	Reported SAR(1g)(W/kg)	Power Drift (dB)
Ch.	MHz									
Ambient Temperature: 22.9 °C Liquid Temperature: 22.5 °C										
1175	1908.75	Bottom	/	24.09	25	0.903	1.11	3.22	3.97	0.03

Note1: The distance between the EUT and the phantom bottom is 0mm.

Table 14.1-20: SAR Values (CDMA BC1 Band - Body)

Frequency		Test Position	Figure No./Note	Conducted Power (dBm)	Max. tune-up Power (dBm)	Measured SAR(10g) (W/kg)	Reported SAR(10g) (W/kg)	Measured SAR(1g) (W/kg)	Reported SAR(1g) (W/kg)	Power Drift (dB)
Ch.	MHz									
Ambient Temperature: 22.9 °C Liquid Temperature: 22.5 °C										
600	1880	Front	/	24.32	25	0.174	0.20	0.306	0.36	-0.12
1175	1908.75	Rear	Fig.18	24.09	25	0.207	0.26	0.355	0.44	-0.14
600	1880	Rear	/	24.32	25	0.186	0.22	0.321	0.38	0.12
25	1851.25	Rear	/	24.43	25	0.174	0.20	0.296	0.34	0.16

Note1: The distance between the EUT and the phantom bottom is 15mm.

Table 14.1-21: SAR Values (CDMA BC10 Band - Head)

Frequency		Side	Test Position	Figure No./Note	Conducted Power (dBm)	Max. tune-up Power (dBm)	Measured SAR(10g) (W/kg)	Reported SAR(10g) (W/kg)	Measured SAR(1g) (W/kg)	Reported SAR(1g) (W/kg)	Power Drift (dB)
Ch.	MHz										
Ambient Temperature: 22.9 °C Liquid Temperature: 22.5 °C											
580	820.5	Left	Touch	/	24.45	25	0.398	0.45	0.595	0.68	-0.14
580	820.5	Left	Tilt	/	24.45	25	0.124	0.14	0.214	0.24	-0.06
684	823.1	Right	Touch		24.52	25	0.518	0.58	0.818	0.91	0.01
580	820.5	Right	Touch	Fig.19	24.45	25	0.548	0.62	0.869	0.99	0.13
476	817.9	Right	Touch	/	24.47	25	0.505	0.57	0.795	0.90	-0.11
580	820.5	Right	Tilt	/	24.45	25	0.362	0.41	0.619	0.70	-0.14

Table 14.1-22: SAR Values (CDMA BC10 Band - Body)

Frequency		Test Position	Figure No./Note	Conducted Power (dBm)	Max. tune-up Power (dBm)	Measured SAR(10g) (W/kg)	Reported SAR(10g) (W/kg)	Measured SAR(1g) (W/kg)	Reported SAR(1g) (W/kg)	Power Drift (dB)
Ch.	MHz									
Ambient Temperature: 22.9 °C Liquid Temperature: 22.5 °C										
684	823.1	Front	Fig.20	24.52	25	0.17	0.19	0.222	0.25	0.03
580	820.5	Front	/	24.45	25	0.167	0.19	0.217	0.25	0.01
476	817.9	Front	/	24.47	25	0.169	0.19	0.221	0.25	0.16
580	820.5	Rear	/	24.45	25	0.118	0.13	0.182	0.21	0.07
580	820.5	Left	/	24.45	25	0.067	0.08	0.095	0.11	-0.08
580	820.5	Right	/	24.45	25	0.151	0.17	0.212	0.24	-0.09
580	820.5	Top	/	24.45	25	0.091	0.10	0.166	0.19	0.07
684	823.1	Front	/	24.52	25	0.165	0.18	0.217	0.24	0.10

Note: The distance between the EUT and the phantom bottom is 10mm.

Table 14.1-23: SAR Values (LTE Band7 - Head)

Frequency		Ambient Temperature: 22.9 °C					Liquid Temperature: 22.5°C					
Ch.	MHz	Mode	Side	Test Position	Figure No.	Conducted Power (dBm)	Max. tune-up Power (dBm)	Measured SAR(10g) (W/kg)	Reported SAR(10g)(W/kg)	Measured SAR(1g) (W/kg)	Reported SAR(1g) (W/kg)	Power Drift (dB)
21350	2560	1RB_Mid	Left	Touch	Fig.21	22.27	23.5	0.036	0.05	0.063	0.08	0.18
21350	2560	1RB_Mid	Left	Tilt	/	22.27	23.5	0.023	0.03	0.039	0.05	-0.04
21350	2560	1RB_Mid	Right	Touch	/	22.27	23.5	0.022	0.03	0.037	0.05	0.15
21350	2560	1RB_Mid	Right	Tilt	/	22.27	23.5	0.026	0.03	0.046	0.06	0.15
21350	2560	50RB_Mid	Left	Touch	/	21.40	22.5	0.03	0.04	0.053	0.07	0.15
21350	2560	50RB_Mid	Left	Tilt	/	21.40	22.5	0.018	0.02	0.03	0.04	-0.10
21350	2560	50RB_Mid	Right	Touch	/	21.40	22.5	0.018	0.02	0.031	0.04	0.01
21350	2560	50RB_Mid	Right	Tilt	/	21.40	22.5	0.021	0.03	0.038	0.05	-0.12

Note1: The LTE mode is QPSK_20MHz.

Table 14.1-24: SAR Values (LTE Band7 - Body)

Frequency		Ambient Temperature: 22.9 °C					Liquid Temperature: 22.5°C					
Ch.	MHz	Mode	Test Position	Figure No.	Conducted Power (dBm)	Max. tune-up Power (dBm)	Measured SAR(10g) (W/kg)	Reported SAR(10g)(W/kg)	Measured SAR(1g) (W/kg)	Reported SAR(1g) (W/kg)	Power Drift (dB)	
21350	2560	1RB_Mid	Front	/	17.81	18.5	0.231	0.27	0.483	0.57	-0.04	
21350	2560	1RB_Mid	Rear	/	17.81	18.5	0.257	0.30	0.544	0.64	-0.09	
21350	2560	1RB_Mid	Left	/	17.81	18.5	0.048	0.06	0.082	0.10	-0.05	
21350	2560	1RB_Mid	Right	/	17.81	18.5	0.021	0.02	0.039	0.05	-0.04	
21350	2560	1RB_Mid	Bottom	/	17.81	18.5	0.425	0.50	0.946	1.11	-0.14	
21100	2535	1RB_Mid	Bottom	/	17.76	18.5	0.399	0.47	0.888	1.05	0.05	
20850	2510	1RB_Mid	Bottom	/	17.70	18.5	0.367	0.44	0.818	0.98	0.01	
21350	2560	50RB_Mid	Front	/	17.87	18.5	0.252	0.29	0.524	0.61	0.06	
21350	2560	50RB_Mid	Rear	/	17.87	18.5	0.282	0.33	0.601	0.69	-0.03	
21350	2560	50RB_Mid	Left	/	17.87	18.5	0.053	0.06	0.094	0.11	-0.07	
21350	2560	50RB_Mid	Right	/	17.87	18.5	0.019	0.02	0.036	0.04	-0.10	
21350	2560	50RB_Mid	Bottom	Fig.22	17.87	18.5	0.468	0.54	1.02	1.18	-0.14	
21100	2535	50RB_Mid	Bottom	/	17.85	18.5	0.457	0.53	0.997	1.16	0.09	
20850	2510	50RB_Mid	Bottom	/	17.71	18.5	0.382	0.46	0.832	1.00	-0.04	
21100	2535	100RB	Bottom	/	17.77	18.5	0.414	0.49	0.903	1.07	0.15	

Note1: The distance between the EUT and the phantom bottom is 10mm

Note2: The LTE mode is QPSK_20MHz.

Table 14.1-25: SAR Values (LTE Band7 - Limb)

Frequency		Mode	Test Position	Figure No.	Conducted Power (dBm)	Max. tune-up Power (dBm)	Measured SAR(10g) (W/kg)	Reported SAR(10g)(W/kg)	Measured SAR(1g) (W/kg)	Reported SAR(1g) (W/kg)	Power Drift (dB)
Ch.	MHz										
21350	2560	1RB_Mid	Bottom	/	22.27	23.5	2.09	2.77	6.09	8.08	-0.21
21100	2535	1RB_Mid	Bottom	/	22.24	23.5	2.69	3.59	7.72	10.31	0.03
20850	2510	1RB_Mid	Bottom	/	22.07	23.5	2.58	3.58	7.389	10.26	0.06
21350	2560	1RB_Mid	Bottom	/	21.35	22.5	1.73	2.26	4.64	6.05	0.08

Note1: The distance between the EUT and the phantom bottom is 0mm

Note2: The LTE mode is QPSK_20MHz.

Table 14.1-26: SAR Values (LTE Band7 -Limb)

Frequency		Mode	Test Position	Figure No.	Conducted Power (dBm)	Max. tune-up Power (dBm)	Measured SAR(10g) (W/kg)	Reported SAR(10g)(W/kg)	Measured SAR(1g) (W/kg)	Reported SAR(1g) (W/kg)	Power Drift (dB)
Ch.	MHz										
21350	2560	1RB_Mid	Bottom	/	22.27	23.5	2.09	2.77	6.09	8.08	-0.21
21100	2535	1RB_Mid	Bottom	/	22.24	23.5	2.69	3.59	7.72	10.31	0.03
20850	2510	1RB_Mid	Bottom	/	22.07	23.5	2.58	3.58	7.389	10.26	0.06
21350	2560	100RB	Bottom	/	21.35	22.5	1.73	2.26	4.64	6.05	0.08

Note1: The distance between the EUT and the phantom bottom is 0mm

Note2: The LTE mode is QPSK_20MHz.

Table 14.1-27: SAR Values (LTE Band7 -Body)

Frequency		Mode	Test Position	Figure No.	Conducted Power (dBm)	Max. tune-up Power (dBm)	Measured SAR(10g) (W/kg)	Reported SAR(10g)(W/kg)	Measured SAR(1g) (W/kg)	Reported SAR(1g) (W/kg)	Power Drift (dB)
Ch.	MHz										
21350	2560	1RB_Mid	Front	/	22.27	23.5	0.125	0.17	0.264	0.35	0.03
21350	2560	1RB_Mid	Rear	Fig.23	22.27	23.5	0.164	0.22	0.334	0.44	-0.17
21350	2560	50RB_Mid	Front	/	21.40	22.5	0.109	0.14	0.229	0.30	-0.12
21350	2560	50RB_Mid	Rear	/	21.40	22.5	0.143	0.18	0.291	0.37	0.07

Note1: The distance between the EUT and the phantom bottom is 15mm

Note2: The LTE mode is QPSK_20MHz.

Table 14.1-28: SAR Values (LTE Band12 - Head)

Frequency		Mode	Side	Test Position	Figure No.	Conducted Power (dBm)	Max. tune-up Power (dBm)	Measured SAR(10g) (W/kg)	Reported SAR(10g)(W/kg)	Measured SAR(1g) (W/kg)	Reported SAR(1g) (W/kg)	Power Drift (dB)
Ch.	MHz											
23060	704	1RB-Low	Left	Touch	Fig.24	23.07	23.5	0.288	0.32	0.472	0.52	-0.08
23060	704	1RB-Low	Left	Tilt	/	23.07	23.5	0.288	0.32	0.393	0.43	-0.16
23060	704	1RB-Low	Right	Touch	/	23.07	23.5	0.215	0.24	0.43	0.47	-0.05
23060	704	1RB-Low	Right	Tilt	/	23.07	23.5	0.254	0.28	0.37	0.41	-0.16
23060	704	25RB-Low	Left	Touch	/	21.94	22.5	0.205	0.23	0.382	0.43	0.03
23060	704	25RB-Low	Left	Tilt	/	21.94	22.5	0.236	0.27	0.345	0.39	-0.14
23060	704	25RB-Low	Right	Touch	/	21.94	22.5	0.187	0.21	0.342	0.39	-0.12
23060	704	25RB-Low	Right	Tilt	/	21.94	22.5	0.202	0.23	0.294	0.33	0.05

Note1: The LTE mode is QPSK_10MHz.

Table 14.1-29: SAR Values (LTE Band12 - Body)

Frequency		Mode	Test Position	Figure No.	Conducted Power (dBm)	Max. tune-up Power (dBm)	Measured SAR(10g) (W/kg)	Reported SAR(10g) (W/kg)	Measured SAR(1g) (W/kg)	Reported SAR(1g) (W/kg)	Power Drift (dB)
Ch.	MHz										
23060	704	1RB_Low	Front	/	23.07	23.5	0.062	0.07	0.082	0.09	0.09
23060	704	1RB_Low	Rear	/	23.07	23.5	0.085	0.09	0.114	0.13	0.15
23060	704	1RB_Low	Left	/	23.07	23.5	0.055	0.06	0.077	0.09	0.09
23060	704	1RB_Low	Right	Fig.25	23.07	23.5	0.091	0.10	0.13	0.14	0.00
23060	704	1RB_Low	Bottom	/	23.07	23.5	<0.01	<0.01	<0.01	<0.01	/
23060	704	25RB_Low	Front	/	21.94	22.5	0.05	0.06	0.065	0.07	0.01
23060	704	25RB_Low	Rear	/	21.94	22.5	0.069	0.08	0.091	0.10	-0.03
23060	704	25RB_Low	Left	/	21.94	22.5	0.044	0.05	0.064	0.07	0.01
23060	704	25RB_Low	Right	/	21.94	22.5	0.073	0.08	0.104	0.12	-0.09
23060	704	25RB_Low	Bottom	/	21.94	22.5	<0.01	<0.01	<0.01	<0.01	/

Note1: The distance between the EUT and the phantom bottom is 10mm.

Note2: The LTE mode is QPSK_10MHz.

Table 14.1-30: SAR Values (LTE Band13 - Head)

Frequency		Mode	Side	Test Position	Figure No.	Conducted Power (dBm)	Max. tune-up Power (dBm)	Measured SAR(10g) (W/kg)	Reported SAR(10g) (W/kg)	Measured SAR(1g) (W/kg)	Reported SAR(1g) (W/kg)	Power Drift (dB)
Ch.	MHz											
Ambient Temperature: 22.9°C		Liquid Temperature: 22.5°C										
23230	782	1RB-High	Left	Touch	/	23.25	24	0.077	0.09	0.096	0.11	0.11
23230	782	1RB-High	Left	Tilt	/	23.25	24	0.059	0.07	0.073	0.09	0.01
23230	782	1RB-High	Right	Touch	Fig.26	23.25	24	0.086	0.10	0.111	0.13	0.19
23230	782	1RB-High	Right	Tilt	/	23.25	24	0.058	0.07	0.073	0.09	0.15
23230	782	25RB-Low	Left	Touch	/	21.99	23	0.059	0.07	0.074	0.09	0.03
23230	782	25RB-Low	Left	Tilt	/	21.99	23	0.047	0.06	0.06	0.08	-0.14
23230	782	25RB-Low	Right	Touch	/	21.99	23	0.069	0.09	0.089	0.11	0.10
23230	782	25RB-Low	Right	Tilt	/	21.99	23	0.045	0.06	0.057	0.07	-0.14

Note1: The LTE mode is QPSK_10MHz.

Table 14.1-31: SAR Values (LTE Band13 - Body)

Frequency		Mode	Test Position	Figure No.	Conducted Power (dBm)	Max. tune-up Power (dBm)	Measured SAR(10g) (W/kg)	Reported SAR(10g) (W/kg)	Measured SAR(1g) (W/kg)	Reported SAR(1g) (W/kg)	Power Drift (dB)	
Ch.	MHz											
Ambient Temperature: 22.9°C		Liquid Temperature: 22.5°C										
23230	782	1RB_High	Front	/	23.25	24	0.12	0.14	0.165	0.20	-0.15	
23230	782	1RB_High	Rear	Fig.27	23.25	24	0.143	0.17	0.258	0.31	-0.09	
23230	782	1RB_High	Left	/	23.25	24	0.076	0.09	0.114	0.14	0.15	
23230	782	1RB_High	Right	/	23.25	24	0.126	0.15	0.188	0.22	0.01	
23230	782	1RB_High	Bottom	/	23.25	24	0.066	0.08	0.137	0.16	0.07	
23230	782	25RB_Low	Front	/	21.99	23	0.096	0.12	0.132	0.17	0.03	
23230	782	25RB_Low	Rear	/	21.99	23	0.111	0.14	0.199	0.25	-0.13	
23230	782	25RB_Low	Left	/	21.99	23	0.065	0.08	0.099	0.12	0.12	
23230	782	25RB_Low	Right	/	21.99	23	0.103	0.13	0.153	0.19	0.14	
23230	782	25RB_Low	Bottom	/	21.99	23	0.05	0.06	0.105	0.13	-0.11	

Note1: The distance between the EUT and the phantom bottom is 10mm.

Note2: The LTE mode is QPSK_10MHz.

Table 14.1-32: SAR Values (LTE Band25 - Head)

Ambient Temperature: 22.9 °C Liquid Temperature: 22.5 °C												
Frequency		Mode	Side	Test Position	Figure No.	Conducted Power (dBm)	tune-up Power (dBm)	Measured SAR(10g) (W/kg)	Reported SAR(10g) (W/kg)	Measured SAR(1g) (W/kg)	Reported SAR(1g) (W/kg)	Power Drift (dB)
Ch.	MHz											
26365	1882.5	1RB_High	Left	Touch	/	23.55	24	0.04	0.04	0.069	0.08	-0.11
26365	1882.5	1RB_High	Left	Tilt	/	23.55	24	0.038	0.04	0.068	0.08	0.14
26365	1882.5	1RB_High	Right	Touch	/	23.55	24	0.041	0.05	0.075	0.08	0.05
26365	1882.5	1RB_High	Right	Tilt	Fig.28	23.55	24	0.041	0.05	0.076	0.08	-0.13
26365	1882.5	50RB_Mid	Left	Touch	/	21.98	23	0.032	0.04	0.056	0.07	0.03
26365	1882.5	50RB_Mid	Left	Tilt	/	21.98	23	0.032	0.04	0.059	0.07	0.03
26365	1882.5	50RB_Mid	Right	Touch	/	21.98	23	0.034	0.04	0.062	0.08	-0.10
26365	1882.5	50RB_Mid	Right	Tilt	/	21.98	23	0.031	0.04	0.058	0.07	-0.13

Note1: The LTE mode is QPSK_20MHz.

Table 14.1-33: SAR Values (LTE Band25 - Body)

Ambient Temperature: 22.9 °C Liquid Temperature: 22.5 °C												
Frequency		Mode	Test Position	Figure No.	Conducted Power (dBm)	tune-up Power (dBm)	Measured SAR(10g) (W/kg)	Reported SAR(10g) (W/kg)	Measured SAR(1g) (W/kg)	Reported SAR(1g) (W/kg)	Power Drift (dB)	
Ch.	MHz											
26590	1905	1RB_Mid	Front	/	19.03	19.5	0.163	0.18	0.3	0.33	-0.01	
26591	1906	1RB_Mid	Rear	/	19.03	19.5	0.173	0.19	0.305	0.34	0.02	
26592	1907	1RB_Mid	Left	/	19.03	19.5	0.042	0.05	0.072	0.08	-0.13	
26593	1908	1RB_Mid	Right	/	19.03	19.5	0.032	0.04	0.052	0.06	0.09	
26594	1909	1RB_Mid	Bottom	/	19.03	19.5	0.271	0.30	0.522	0.58	-0.03	
26365	1882.5	50RB_Mid	Front	/	19.02	19.5	0.165	0.18	0.302	0.34	-0.06	
26365	1882.5	50RB_Mid	Rear	/	19.02	19.5	0.173	0.19	0.307	0.34	-0.10	
26365	1882.5	50RB_Mid	Left	/	19.02	19.5	0.042	0.05	0.071	0.08	-0.05	
26365	1882.5	50RB_Mid	Right	/	19.02	19.5	0.032	0.04	0.053	0.06	0.07	
26365	1882.5	50RB_Mid	Bottom	Fig.29	19.02	19.5	0.273	0.30	0.526	0.59	0.16	

Note1: The distance between the EUT and the phantom bottom is 10mm

Note2: The LTE mode is QPSK_20MHz.

Table 14.1-34: SAR Values (LTE Band25 - Limb)

Frequency		Mode	Test Position	Figure No.	Conducted Power (dBm)	tune-up Power (dBm)	Measured SAR(10g) (W/kg)	Reported SAR(10g) (W/kg)	Measured SAR(1g) (W/kg)	Reported SAR(1g) (W/kg)	Power Drift (dB)
Ch.	MHz										
Ambient Temperature: 22.9 °C Liquid Temperature: 22.5 °C											
26365	1882.5	1RB_High	Bottom	/	23.55	24	2.99	3.31	7.55	8.37	-0.06
26590	1905	1RB_High	Bottom	/	23.34	24	3.31	3.86	8.44	9.84	0.17
26140	1860	1RB_High	Bottom	/	23.05	24	2.59	3.22	6.5	8.09	-0.06
26365	1882.5	100RB	Bottom	/	21.96	23	2.18	2.77	5.26	6.69	0.13

Note1: The distance between the EUT and the phantom bottom is 0mm

Note2: The LTE mode is QPSK_20MHz.

Table 14.1-35: SAR Values (LTE Band25 - Body)

Frequency		Mode	Test Position	Figure No.	Conducted Power (dBm)	tune-up Power (dBm)	Measured SAR(10g) (W/kg)	Reported SAR(10g) (W/kg)	Measured SAR(1g) (W/kg)	Reported SAR(1g) (W/kg)	Power Drift (dB)
Ch.	MHz										
Ambient Temperature: 22.9 °C Liquid Temperature: 22.5 °C											
26365	1882.5	1RB_High	Bottom	/	23.55	24	0.068	0.08	0.12	0.13	0.05
26365	1882.5	1RB_High	Bottom	Fig.30	23.55	24	0.073	0.08	0.125	0.14	-0.07
26365	1882.5	50RB_Mid	Bottom	/	21.51	23	0.056	0.08	0.098	0.14	0.14
26365	1882.5	50RB_Mid	Bottom	/	21.51	23	0.059	0.08	0.1	0.14	0.01

Note1: The distance between the EUT and the phantom bottom is 15mm

Note2: The LTE mode is QPSK_20MHz.

Table 14.1-36: SAR Values (LTE Band26 - Head)

Frequency		Mode	Side	Test Position	Figure No.	Conducted Power (dBm)	tune-up Power (dBm)	Measured SAR(10g) (W/kg)	Reported SAR(10g) (W/kg)	Measured SAR(1g) (W/kg)	Reported SAR(1g) (W/kg)	Power Drift (dB)
Ch.	MHz											
Ambient Temperature: 22.9 °C Liquid Temperature: 22.5 °C												
26965	841.5	1RB-Low	Left	Touch	/	22.66	24	0.461	0.63	0.737	1.00	0.09
26865	831.5	1RB-Low	Left	Touch	/	22.55	24	0.392	0.55	0.619	0.86	0.06
26775	822.5	1RB-Low	Left	Touch	Fig.31	22.67	24	0.471	0.64	0.751	1.02	-0.14
26775	822.5	1RB-Low	Left	Tilt	/	22.67	24	0.275	0.37	0.513	0.70	0.13
26965	841.5	1RB-Low	Right	Touch	/	22.66	24	0.423	0.58	0.649	0.88	0.07
26865	831.5	1RB-Low	Right	Touch	/	22.55	24	0.35	0.49	0.54	0.75	-0.04
26775	822.5	1RB-Low	Right	Touch	/	22.67	24	0.432	0.59	0.662	0.90	-0.02
26775	822.5	1RB-Low	Right	Tilt	/	22.67	24	0.303	0.41	0.55	0.75	0.15
26965	841.5	36RB-Middle	Left	Touch	/	21.56	23	0.324	0.45	0.518	0.72	0.03
26865	831.5	36RB-Low	Left	Touch	/	21.58	23	0.338	0.47	0.535	0.74	-0.06
26775	822.5	36RB-Low	Left	Touch	/	21.64	23	0.376	0.51	0.595	0.81	-0.06
26775	822.5	36RB-Low	Left	Tilt	/	21.64	23	0.221	0.30	0.414	0.57	-0.05

26775	822.5	36RB-Low	Right	Touch	/	21.64	23	0.346	0.47	0.53	0.72	-0.01
26775	822.5	36RB-Low	Right	Tilt	/	21.64	23	0.244	0.33	0.444	0.61	-0.15
26775	822.5	100RB	Left	Touch	/	21.61	22	0.456	0.50	0.73	0.80	-0.02
26775	822.5	100RB	Right	Touch	/	21.61	22	0.413	0.45	0.634	0.69	0.03

Note1: The LTE mode is QPSK_15MHz.

Table 14.1-37: SAR Values (LTE Band26 - Body)

Ambient Temperature: 22.9 °C Liquid Temperature: 22.5 °C												
Frequency		Mode	Test Position	Figure No.	Conducted Power (dBm)	tune-up Power (dBm)	Measured SAR(10g) (W/kg)	Reported SAR(10g) (W/kg)	Measured SAR(1g) (W/kg)	Reported SAR(1g) (W/kg)	Power Drift (dB)	
Ch.	MHz											
26775	822.5	1RB_Low	Front	/	22.67	24	0.1	0.14	0.126	0.17	-0.13	
26775	822.5	1RB_Low	Rear	Fig.32	22.67	24	0.099	0.13	0.153	0.21	0.01	
26775	822.5	1RB_Low	Left	/	22.67	24	0.065	0.09	0.089	0.12	0.05	
26775	822.5	1RB_Low	Right	/	22.67	24	0.086	0.12	0.117	0.16	0.15	
26775	822.5	1RB_Low	Top	/	22.67	24	0.05	0.07	0.082	0.11	0.14	
26775	822.5	36RB_Low	Front	/	21.64	23	0.083	0.11	0.105	0.14	0.13	
26775	822.5	36RB_Low	Rear	/	21.64	23	0.085	0.12	0.129	0.18	-0.16	
26775	822.5	36RB_Low	Left	/	21.64	23	0.053	0.07	0.072	0.10	0.03	
26775	822.5	36RB_Low	Right	/	21.64	23	0.073	0.10	0.099	0.14	0.04	
26775	822.5	36RB_Low	Top	/	21.64	23	0.042	0.06	0.069	0.09	-0.06	

Note1: The distance between the EUT and the phantom bottom is 10mm

Note2: The LTE mode is QPSK_15MHz.

Table 14.1-38: SAR Values (LTE Band41 PC3 - Head)

Ambient Temperature: 22.9 °C Liquid Temperature: 22.5 °C												
Frequency		Mode	Side	Test Position	Figure No.	Conducted Power (dBm)	tune-up Power (dBm)	Measured SAR(10g) (W/kg)	Reported SAR(10g) (W/kg)	Measured SAR(1g) (W/kg)	Reported SAR(1g) (W/kg)	Power Drift (dB)
Ch.	MHz											
40620	2593	1RB-Low	Left	Touch	Fig.33	23.98	24	0.027	0.03	0.069	0.07	-0.11
40620	2593	1RB-Low	Left	Tilt	/	23.98	24	0.021	0.02	0.052	0.05	0.15
40620	2593	1RB-Low	Right	Touch	/	23.98	24	0.015	0.02	0.038	0.04	0.11
40620	2593	1RB-Low	Right	Tilt	/	23.98	24	0.018	0.02	0.047	0.05	0.03
40620	2593	50RB-Middle	Left	Touch	/	22.52	23	0.023	0.03	0.059	0.07	-0.08
40620	2593	50RB-Middle	Left	Tilt	/	22.52	23	0.017	0.02	0.044	0.05	0.11
40620	2593	50RB-Middle	Right	Touch	/	22.52	23	0.012	0.01	0.031	0.03	-0.10
40620	2593	50RB-Middle	Right	Tilt	/	22.52	23	0.016	0.02	0.04	0.04	0.05

Note1: The LTE mode is QPSK_20MHz.

Table 14.1-39: SAR Values (LTE Band41 PC3- Body)

Frequency		Mode	Test Position	Figure No.	Conducted Power (dBm)	tune-up Power (dBm)	Measured SAR(10g) (W/kg)	Reported SAR(10g) (W/kg)	Measured SAR(1g) (W/kg)	Reported SAR(1g) (W/kg)	Power Drift (dB)
Ch.	MHz										
Ambient Temperature: 22.9 °C Liquid Temperature: 22.5°C											
41490	2680	1RB_Low	Front	/	20.69	21	0.244	0.26	0.531	0.57	-0.10
41490	2680	1RB_Low	Rear	/	20.69	21	0.257	0.28	0.555	0.60	-0.06
41490	2680	1RB_Low	Left	/	20.69	21	0.056	0.06	0.104	0.11	0.08
41490	2680	1RB_Low	Right	/	20.69	21	0.022	0.02	0.045	0.05	-0.15
41490	2680	1RB_Low	Bottom	/	20.69	21	0.353	0.38	0.813	0.87	-0.04
41055	2636.5	1RB_Mid	Bottom	/	19.76	21	0.308	0.41	0.729	0.97	-0.03
40620	2593	1RB_Mid	Bottom	/	19.87	20.3	0.414	0.46	0.969	1.07	-0.01
40185	2549.5	1RB_Mid	Bottom	Fig.34	19.79	20.3	0.534	0.60	1.19	1.34	-0.09
39750	2506	1RB_Mid	Bottom	/	19.68	20.3	0.527	0.61	1.13	1.30	-0.04
40620	2593	50RB_Mid	Front	/	19.86	20.3	0.19	0.21	0.412	0.46	-0.05
40620	2593	50RB_Mid	Rear	/	19.86	20.3	0.201	0.22	0.437	0.48	-0.10
40620	2593	50RB_Mid	Left	/	19.86	20.3	0.045	0.05	0.084	0.09	-0.12
40620	2593	50RB_Mid	Right	/	19.86	20.3	0.02	0.02	0.038	0.04	0.11
40620	2593	50RB_Mid	Bottom	/	19.86	20.3	0.274	0.30	0.611	0.68	-0.03
40620	2593	100RB	Bottom	/	19.82	20.3	0.414	0.46	0.974	1.09	-0.08

Note1: The distance between the EUT and the phantom bottom is 10mm.

Note6: The LTE mode is QPSK_20MHz.

Table 14.1-40: SAR Values (LTE Band41 PC3- Limb)

Frequency		Mode	Test Position	Figure No.	Conducted Power (dBm)	tune-up Power (dBm)	Measured SAR(10g) (W/kg)	Reported SAR(10g) (W/kg)	Measured SAR(1g) (W/kg)	Reported SAR(1g) (W/kg)	Power Drift (dB)
Ch.	MHz										
Ambient Temperature: 22.9 °C Liquid Temperature: 22.5°C											
40185	2549.5	1RB-High	Bottom	/	23.98	24	1.39	1.40	4.00	4.02	-0.06
40620	2593	1RB-Low	Bottom	/	23.98	24	1.26	1.27	3.80	3.82	0.20

Note1: The distance between the EUT and the phantom bottom is 0mm.

Note2: The LTE mode is QPSK_20MHz.

Table 14.1-41: SAR Values (LTE Band41 PC3- Body)

Frequency		Mode	Test Position	Figure No.	Conducted Power (dBm)	tune-up Power (dBm)	Measured SAR(10g) (W/kg)	Reported SAR(10g) (W/kg)	Measured SAR(1g) (W/kg)	Reported SAR(1g) (W/kg)	Power Drift (dB)
Ch.	MHz										
Ambient Temperature: 22.9 °C Liquid Temperature: 22.5°C											
40620	2593	1RB_Low	Front	/	23.98	24	0.2	0.20	0.423	0.42	-0.03
40620	2593	1RB_Low	Rear	Fig.35	23.98	24	0.219	0.22	0.446	0.45	-0.14
40620	2593	50RB_Mid	Front	/	23.98	24	0.157	0.16	0.331	0.33	-0.07
40620	2593	50RB_Mid	Rear	/	23.98	24	0.173	0.17	0.349	0.35	0.00