

Table 14.1-24: SAR Values (LTE Band17 - Body)

Frequency		Mode	Test Position	Figure No.	Conducted Power (dBm)	tune-up Power (dBm)	Measured SAR(10g) (W/kg)	Reported SAR(10g) (W/kg)	Measured SAR(1g) (W/kg)	Reported SAR(1g) (W/kg)	Power Drift (dB)	
Ch.	MHz											
		Ambient Temperature: 22.9 °C						Liquid Temperature: 22.5 °C				
23780	709	1RB_Mid	Front	/	23.18	24	0.080	0.10	0.103	0.12	0.13	
23780	709	1RB_Mid	Rear	Fig.24	23.18	24	0.139	0.17	0.183	0.22	-0.12	
23780	709	1RB_Mid	Left	/	23.18	24	0.123	0.15	0.173	0.21	0.04	
23780	709	1RB_Mid	Right	/	23.18	24	0.049	0.06	0.069	0.08	0.13	
23780	709	1RB_Mid	Bottom	/	23.18	24	0.037	0.04	0.062	0.07	-0.10	
23780	709	25RB_Low	Front	/	22.00	23	0.063	0.08	0.081	0.10	0.05	
23780	709	25RB_Low	Rear	/	22.00	23	0.107	0.13	0.140	0.18	0.04	
23780	709	25RB_Low	Left	/	22.00	23	0.092	0.12	0.130	0.16	-0.12	
23780	709	25RB_Low	Right	/	22.00	23	0.037	0.05	0.051	0.06	0.09	
23780	709	25RB_Low	Bottom	/	22.00	23	0.028	0.04	0.047	0.06	-0.03	
23780	709	1RB_Mid	Rear	B2	23.18	24	0.124	0.15	0.176	0.21	0.07	

Note1: The distance between the EUT and the phantom bottom is 10mm.

Note2: The LTE mode is QPSK_10MHz.

Table 14.1-25: SAR Values (LTE Band66 - Head)

Frequency		Mode	Side	Test Position	Figure No.	Conducted Power (dBm)	Max. tune-up Power (dBm)	Measured SAR(10g) (W/kg)	Reported SAR(10g) (W/kg)	Measured SAR(1g) (W/kg)	Reported SAR(1g) (W/kg)	Power Drift (dB)
Ch.	MHz											
		Ambient Temperature: 22.9 °C						Liquid Temperature: 22.5 °C				
132572	1770	1RB_Mid	Left	Touch	Fig.25	22.89	24	0.168	0.22	0.273	0.35	0.02
132572	1770	1RB_Mid	Left	Tilt	/	22.89	24	0.127	0.16	0.194	0.25	-0.09
132572	1770	1RB_Mid	Right	Touch	/	22.89	24	0.154	0.20	0.249	0.32	0.02
132572	1770	1RB_Mid	Right	Tilt	/	22.89	24	0.085	0.11	0.137	0.18	0.11
132072	1720	50RB_Mid	Left	Touch	/	21.95	23	0.137	0.17	0.220	0.28	-0.01
132072	1720	50RB_Mid	Left	Tilt	/	21.95	23	0.053	0.07	0.079	0.10	0.01
132072	1720	50RB_Mid	Right	Touch	/	21.95	23	0.118	0.15	0.186	0.24	-0.05
132072	1720	50RB_Mid	Right	Tilt	/	21.95	23	0.067	0.09	0.113	0.14	-0.13
132572	1770	1RB_Mid	Left	Touch	B2	22.89	24	0.142	0.18	0.261	0.34	0.04

Note1: The LTE mode is QPSK_20MHz.

Table 14.1-26: SAR Values (LTE Band66 - Body)

Ambient Temperature: 22.9 °C						Liquid Temperature: 22.5 °C					
Frequency		Mode	Test Position	Figure No.	Conducted Power (dBm)	Max. tune-up Power (dBm)	Measured SAR(10g) (W/kg)	Reported SAR(10g) (W/kg)	Measured SAR(1g) (W/kg)	Reported SAR(1g) (W/kg)	Power Drift (dB)
Ch.	MHz										
132072	1720	1RB_Mid	Front	/	19.05	20	0.105	0.13	0.168	0.21	-0.02
132572	1770	1RB_Mid	Rear	Fig.26	19.05	20	0.162	0.20	0.300	0.37	0.02
132072	1720	1RB_Mid	Left	/	19.05	20	0.030	0.04	0.049	0.06	0.06
132072	1720	1RB_Mid	Right	/	19.05	20	0.038	0.05	0.063	0.08	-0.03
132322	1745	1RB_Mid	Bottom	/	19.05	20	0.119	0.15	0.220	0.27	-0.12
132072	1720	50RB_High	Front	/	18.89	20	0.100	0.13	0.158	0.20	-0.01
132072	1720	50RB_High	Rear	/	18.89	20	0.143	0.18	0.257	0.33	0.00
132072	1720	50RB_High	Left	/	18.89	20	0.030	0.04	0.050	0.06	-0.03
132072	1720	50RB_High	Right	/	18.89	20	0.027	0.03	0.046	0.06	-0.07
132072	1720	50RB_High	Bottom	/	18.89	20	0.119	0.15	0.223	0.29	0.01
132072	1720	50RB_High	Rear	B2	19.05	20	0.147	0.18	0.286	0.36	0.01

Note1: The distance between the EUT and the phantom bottom is 10mm

Note2: The LTE mode is QPSK_20MHz.

Table 14.1-27: SAR Values (LTE Band66 - Body)

Ambient Temperature: 22.9 °C						Liquid Temperature: 22.5 °C					
Frequency		Mode	Test Position	Figure No.	Conducted Power (dBm)	Max. tune-up Power (dBm)	Measured SAR(10g) (W/kg)	Reported SAR(10g) (W/kg)	Measured SAR(1g) (W/kg)	Reported SAR(1g) (W/kg)	Power Drift (dB)
Ch.	MHz										
132572	1770	1RB_Mid	Front	/	22.89	24	0.181	0.23	0.279	0.36	0.04
132572	1770	1RB_Mid	Rear	Fig.27	22.89	24	0.236	0.30	0.406	0.52	0.03
132072	1720	50RB_High	Front	/	21.95	23	0.142	0.18	0.216	0.28	0.07
132072	1720	50RB_High	Rear	/	21.95	23	0.185	0.24	0.310	0.40	0.00
132572	1770	1RB_Mid	Rear	B2	22.89	24	0.218	0.28	0.397	0.51	0.04

Note1: The distance between the EUT and the phantom bottom is 15mm

Note2: The LTE mode is QPSK_20MHz.

14.2 SAR results for Standard procedure

There is zoom scan measurement to be added for the highest measured SAR in each exposure configuration/band.

Table 14.2-1: SAR Values (GSM 850 MHz Band - Head)

Ambient Temperature: 22.9 °C						Liquid Temperature: 22.5°C					
Frequency		Side	Test Position	Figure No.	Conducted Power (dBm)	Max. tune-up Power (dBm)	Measured SAR(10g) (W/kg)	Reported SAR(10g) (W/kg)	Measured SAR(1g) (W/kg)	Reported SAR(1g) (W/kg)	Power Drift (dB)
Ch.	MHz										
251	848.8	Left	Touch	Fig.1	31.80	33.3	0.319	0.45	0.423	0.60	0.09

Table 14.1-2: SAR Values (GSM 850 MHz Band - Body)

Ambient Temperature: 22.9 °C						Liquid Temperature: 22.5°C					
Frequency		Mode (number of timeslots)	Test Position	Figure No.	Conducted Power (dBm)	Max. tune-up Power (dBm)	Measured SAR(10g) (W/kg)	Reported SAR(10g) (W/kg)	Measured SAR(1g) (W/kg)	Reported SAR(1g) (W/kg)	Power Drift (dB)
Ch.	MHz										
251	848.8	GPRS (2)	Rear	Fig.2	29.16	30.5	0.241	0.33	0.434	0.59	-0.07

Note: The distance between the EUT and the phantom bottom is 10mm.

Table 14.1-3: SAR Values (GSM 1900 MHz Band - Head)

Ambient Temperature: 22.9 °C						Liquid Temperature: 22.5°C					
Frequency		Side	Test Position	Figure No.	Conducted Power (dBm)	Max. tune-up Power (dBm)	Measured SAR(10g) (W/kg)	Reported SAR(10g) (W/kg)	Measured SAR(1g) (W/kg)	Reported SAR(1g) (W/kg)	Power Drift (dB)
Ch.	MHz										
512	1850.2	Left	Touch	Fig.3	28.72	30.3	0.065	0.09	0.105	0.15	-0.06

Table 14.1-4: SAR Values (GSM 1900 MHz Band - Body)

Ambient Temperature: 22.9 °C						Liquid Temperature: 22.5°C					
Frequency		Mode (number of timeslots)	Test Position	Figure No.	Conducted Power (dBm)	Max. tune-up Power (dBm)	Measured SAR(10g) (W/kg)	Reported SAR(10g) (W/kg)	Measured SAR(1g) (W/kg)	Reported SAR(1g) (W/kg)	Power Drift (dB)
Ch.	MHz										
512	1850.2	GPRS (2)	Bottom	Fig.4	26.94	28	0.315	0.40	0.615	0.78	-0.01

Note1: The distance between the EUT and the phantom bottom is 10mm

Table 14.1-5: SAR Values (WCDMA 1900 MHz Band - Head)

Frequency		Side	Test Position	Figure No.	Conducted Power (dBm)	Max. tune-up Power (dBm)	Measured SAR(10g) (W/kg)	Reported SAR(10g) (W/kg)	Measured SAR(1g) (W/kg)	Reported SAR(1g) (W/kg)	Power Drift (dB)
Ch.	MHz										
		Ambient Temperature: 22.9 °C					Liquid Temperature: 22.5 °C				
9800	1880	Left	Touch	Fig.5	22.48	24	0.135	0.19	0.215	0.31	0.02

Table 14.1-6: SAR Values (WCDMA 1900 MHz Band - Body)

Frequency		Test Position	Figure No.	Conducted Power (dBm)	Max. tune-up Power (dBm)	Measured SAR(10g) (W/kg)	Reported SAR(10g) (W/kg)	Measured SAR(1g) (W/kg)	Reported SAR(1g) (W/kg)	Power Drift (dB)	
Ch.	MHz										
		Ambient Temperature: 22.9 °C					Liquid Temperature: 22.5 °C				
9938	1907.6	Bottom	Fig.6	19.23	20	0.274	0.33	0.543	0.65	-0.06	

Note1: The distance between the EUT and the phantom bottom is 10mm

Table 14.1-7: SAR Values (WCDMA 1900 MHz Band - Body)

Frequency		Test Position	Figure No.	Conducted Power (dBm)	Max. tune-up Power (dBm)	Measured SAR(10g) (W/kg)	Reported SAR(10g) (W/kg)	Measured SAR(1g) (W/kg)	Reported SAR(1g) (W/kg)	Power Drift (dB)	
Ch.	MHz										
		Ambient Temperature: 22.9 °C					Liquid Temperature: 22.5 °C				
9662	1852.4	Rear	Fig.7	22.59	24	0.257	0.36	0.447	0.62	-0.03	

Note1: The distance between the EUT and the phantom bottom is 15mm

Table 14.1-8: SAR Values (WCDMA 1700 MHz Band - Head)

Frequency		Side	Test Position	Figure No.	Conducted Power (dBm)	Max. tune-up Power (dBm)	Measured SAR(10g) (W/kg)	Reported SAR(10g) (W/kg)	Measured SAR(1g) (W/kg)	Reported SAR(1g) (W/kg)	Power Drift (dB)
Ch.	MHz										
		Ambient Temperature: 22.9 °C					Liquid Temperature: 22.5 °C				
1513	1752.6	Left	Touch	Fig.8	22.68	24	0.185	0.25	0.293	0.40	0.06

Table 14.1-9: SAR Values (WCDMA 1700 MHz Band - Body)

Frequency		Test Position	Figure No.	Conducted Power (dBm)	Max. tune-up Power (dBm)	Measured SAR(10g) (W/kg)	Reported SAR(10g) (W/kg)	Measured SAR(1g) (W/kg)	Reported SAR(1g) (W/kg)	Power Drift (dB)	
Ch.	MHz										
		Ambient Temperature: 22.9 °C					Liquid Temperature: 22.5 °C				
1513	1752.6	Rear	Fig.9	19.11	20	0.141	0.17	0.257	0.32	0.11	

Note1: The distance between the EUT and the phantom bottom is 10mm

Table 14.2-10: SAR Values (WCDMA 1700 MHz Band - Body)

Ambient Temperature: 22.9 °C						Liquid Temperature: 22.5 °C				
Frequency		Test Position	Figure No.	Conducted Power (dBm)	Max. tune-up Power (dBm)	Measured SAR(10g) (W/kg)	Reported SAR(10g) (W/kg)	Measured SAR(1g) (W/kg)	Reported SAR(1g) (W/kg)	Power Drift (dB)
Ch.	MHz									
1513	1752.6	Rear	Fig.10	22.68	24	0.253	0.34	0.432	0.59	-0.09

Note1: The distance between the EUT and the phantom bottom is 15mm

Table 14.2-11: SAR Values (WCDMA 850 MHz Band - Head)

Ambient Temperature: 22.9 °C						Liquid Temperature: 22.5 °C					
Frequency		Side	Test Position	Figure No.	Conducted Power (dBm)	Max. tune-up Power (dBm)	Measured SAR(10g) (W/kg)	Reported SAR(10g) (W/kg)	Measured SAR(1g) (W/kg)	Reported SAR(1g) (W/kg)	Power Drift (dB)
Ch.	MHz										
4132	826.4	Left	Touch	Fig.11	22.60	24	0.235	0.32	0.309	0.43	0.05

Table 14.2-12: SAR Values (WCDMA 850 MHz Band - Body)

Ambient Temperature: 22.9 °C						Liquid Temperature: 22.5 °C				
Frequency		Test Position	Figure No.	Conducted Power (dBm)	Max. tune-up Power (dBm)	Measured SAR(10g) (W/kg)	Reported SAR(10g) (W/kg)	Measured SAR(1g) (W/kg)	Reported SAR(1g) (W/kg)	Power Drift (dB)
Ch.	MHz									
4233	846.6	Rear	Fig.12	22.63	24	0.384	0.53	0.463	0.63	-0.09

Note: The distance between the EUT and the phantom bottom is 10mm.

Table 14.2-13: SAR Values (LTE Band2 - Head)

Ambient Temperature: 22.9 °C						Liquid Temperature: 22.5 °C						
Frequency		Mode	Side	Test Position	Figure No.	Conducted Power (dBm)	Max. tune-up Power (dBm)	Measured SAR(10g) (W/kg)	Reported SAR(10g) (W/kg)	Measured SAR(1g) (W/kg)	Reported SAR(1g) (W/kg)	Power Drift (dB)
Ch.	MHz											
19100	1900	1RB_Mid	Right	Touch	Fig.13	23.07	24	0.144	0.18	0.236	0.29	0.01

Note1: The LTE mode is QPSK_20MHz.

Table 14.2-14: SAR Values (LTE Band2 - Body)

Ambient Temperature: 22.9 °C						Liquid Temperature: 22.5 °C					
Frequency		Mode	Test Position	Figure No.	Conducted Power (dBm)	Max. tune-up Power (dBm)	Measured SAR(10g) (W/kg)	Reported SAR(10g) (W/kg)	Measured SAR(1g) (W/kg)	Reported SAR(1g) (W/kg)	Power Drift (dB)
Ch.	MHz										
19100	1900	50RB_Mid	Bottom	Fig.14	18.82	20	0.253	0.33	0.498	0.65	0.00

Note1: The distance between the EUT and the phantom bottom is 10mm

Note2: The LTE mode is QPSK_20MHz.

Table 14.2-15: SAR Values (LTE Band2 - Body)

Ambient Temperature: 22.9°C						Liquid Temperature: 22.5°C					
Frequency		Mode	Test Position	Figure No.	Conducted Power (dBm)	Max. tune-up Power (dBm)	Measured SAR(10g) (W/kg)	Reported SAR(10g) (W/kg)	Measured SAR(1g) (W/kg)	Reported SAR(1g) (W/kg)	Power Drift (dB)
Ch.	MHz										
19100	1900	1RB_Mid	Rear	Fig.15	23.07	24	0.271	0.34	0.473	0.59	-0.01

Note1: The distance between the EUT and the phantom bottom is 15mm

Note2: The LTE mode is QPSK_20MHz.

Table 14.2-16: SAR Values (LTE Band5 - Head)

Ambient Temperature: 22.9°C						Liquid Temperature: 22.5°C						
Frequency		Mode	Side	Test Position	Figure No.	Conducted Power (dBm)	Max. tune-up Power (dBm)	Measured SAR(10g) (W/kg)	Reported SAR(10g) (W/kg)	Measured SAR(1g) (W/kg)	Reported SAR(1g) (W/kg)	Power Drift (dB)
Ch.	MHz											
20450	829	1RB_Mid	Left	Touch	Fig.16	22.72	24	0.251	0.34	0.330	0.44	0.07

Note1: The LTE mode is QPSK_10MHz.

Table 14.2-17: SAR Values (LTE Band5 - Body)

Ambient Temperature: 22.9°C						Liquid Temperature: 22.5°C					
Frequency		Mode	Test Position	Figure No.	Conducted Power (dBm)	Max. tune-up Power (dBm)	Measured SAR(10g) (W/kg)	Reported SAR(10g) (W/kg)	Measured SAR(1g) (W/kg)	Reported SAR(1g) (W/kg)	Power Drift (dB)
Ch.	MHz										
20450	829	1RB_Mid	Rear	Fig.17	22.72	24	0.238	0.32	0.420	0.56	-0.04

Note1: The distance between the EUT and the phantom bottom is 10mm.

Note2: The LTE mode is QPSK_10MHz.

Table 14.2-18: SAR Values (LTE Band7 - Head)

Ambient Temperature: 22.9°C						Liquid Temperature: 22.5°C						
Frequency		Mode	Side	Test Position	Figure No.	Conducted Power (dBm)	Max. tune-up Power (dBm)	Measured SAR(10g) (W/kg)	Reported SAR(10g) (W/kg)	Measured SAR(1g) (W/kg)	Reported SAR(1g) (W/kg)	Power Drift (dB)
Ch.	MHz											
21100	2535	1RB_Mid	Right	Touch	Fig.18	22.67	24	0.033	0.04	0.068	0.09	0.08

Note1: The LTE mode is QPSK_20MHz.

Table 14.2-19: SAR Values (LTE Band7 - Body)

Ambient Temperature: 22.9°C						Liquid Temperature: 22.5°C					
Frequency		Mode	Test Position	Figure No.	Conducted Power (dBm)	Max. tune-up Power (dBm)	Measured SAR(10g) (W/kg)	Reported SAR(10g) (W/kg)	Measured SAR(1g) (W/kg)	Reported SAR(1g) (W/kg)	Power Drift (dB)
Ch.	MHz										
21100	2535	50RB_Mid	Bottom	Fig.19	18.51	19.5	0.336	0.42	0.715	0.90	-0.13

Note1: The distance between the EUT and the phantom bottom is 10mm

Note2: The LTE mode is QPSK_20MHz.

Table 14.1-20: SAR Values (LTE Band7 - Body)

Ambient Temperature: 22.9 °C						Liquid Temperature: 22.5 °C					
Frequency		Mode	Test Position	Figure No.	Conduct ed Power (dBm)	Max. tune-up Power (dBm)	Measured SAR(10g) (W/kg)	Reported SAR(10g) (W/kg)	Measured SAR(1g) (W/kg)	Reported SAR(1g) (W/kg)	Power Drift (dB)
Ch.	MHz										
21350	2560	1RB_Mid	Rear	Fig.20	22.62	24	0.485	0.67	0.958	1.32	-0.04

Note1: The distance between the EUT and the phantom bottom is 15mm

Note2: The LTE mode is QPSK_20MHz.

Table 14.1-21: SAR Values (LTE Band13 - Head)

Ambient Temperature: 22.9 °C						Liquid Temperature: 22.5 °C						
Frequency		Mode	Side	Test Position	Figure No.	Conduc ted Power (dBm)	tune-up Power (dBm)	Measured SAR(10g) (W/kg)	Reported SAR(10g) (W/kg)	Measured SAR(1g) (W/kg)	Reporte d SAR(1g) (W/kg)	Powe r Drift (dB)
Ch.	MHz											
23230	782	1RB_Mid	Left	Touch	Fig.21	22.95	24	0.178	0.23	0.232	0.30	-0.04

Note1: The LTE mode is QPSK_10MHz.

Table 14.1-22: SAR Values (LTE Band13 - Body)

Ambient Temperature: 22.9 °C						Liquid Temperature: 22.5 °C					
Frequency		Mode	Test Position	Figure No.	Conduct ed Power (dBm)	tune-up Power (dBm)	Measured SAR(10g) (W/kg)	Reported SAR(10g) (W/kg)	Measured SAR(1g) (W/kg)	Reported SAR(1g) (W/kg)	Power Drift (dB)
Ch.	MHz										
23230	782	1RB_Mid	Rear	Fig.22	22.95	24	0.335	0.43	0.439	0.56	-0.04

Note1: The distance between the EUT and the phantom bottom is 10mm.

Note2: The LTE mode is QPSK_10MHz.

Table 14.1-23: SAR Values (LTE Band17 - Head)

Ambient Temperature: 22.9 °C						Liquid Temperature: 22.5 °C						
Frequency		Mode	Side	Test Position	Figure No.	Conduc ted Power (dBm)	tune-up Power (dBm)	Measured SAR(10g) (W/kg)	Reported SAR(10g) (W/kg)	Measured SAR(1g) (W/kg)	Reporte d SAR(1g) (W/kg)	Powe r Drift (dB)
Ch.	MHz											
23780	709	1RB_Mid	Left	Touch	Fig.23	23.18	24	0.088	0.11	0.115	0.14	-0.06

Note1: The LTE mode is QPSK_10MHz.

Table 14.1-24: SAR Values (LTE Band17 - Body)

Ambient Temperature: 22.9 °C						Liquid Temperature: 22.5 °C					
Frequency		Mode	Test Position	Figure No.	Conduct ed Power (dBm)	tune-up Power (dBm)	Measured SAR(10g) (W/kg)	Reported SAR(10g) (W/kg)	Measured SAR(1g) (W/kg)	Reported SAR(1g) (W/kg)	Power Drift (dB)
Ch.	MHz										
23780	709	1RB_Mid	Rear	Fig.24	23.18	24	0.139	0.17	0.183	0.22	-0.12

Note1: The distance between the EUT and the phantom bottom is 10mm.

Note2: The LTE mode is QPSK_10MHz.

Table 14.1-25: SAR Values (LTE Band66 - Head)

Ambient Temperature: 22.9°C						Liquid Temperature: 22.5°C						
Frequency		Mode	Side	Test Position	Figure No.	Conducted Power (dBm)	Max. tune-up Power (dBm)	Measured SAR(10g) (W/kg)	Reported SAR(10g) (W/kg)	Measured SAR(1g) (W/kg)	Reported SAR(1g) (W/kg)	Power Drift (dB)
Ch.	MHz											
132572	1770	1RB_Mid	Left	Touch	Fig.25	22.89	24	0.168	0.22	0.273	0.35	0.02

Note1: The LTE mode is QPSK_20MHz.

Table 14.1-26: SAR Values (LTE Band66 - Body)

Ambient Temperature: 22.9°C						Liquid Temperature: 22.5°C					
Frequency		Mode	Test Position	Figure No.	Conducted Power (dBm)	Max. tune-up Power (dBm)	Measured SAR(10g) (W/kg)	Reported SAR(10g) (W/kg)	Measured SAR(1g) (W/kg)	Reported SAR(1g) (W/kg)	Power Drift (dB)
Ch.	MHz										
132572	1770	1RB_Mid	Rear	Fig.26	19.05	20	0.162	0.20	0.300	0.37	0.02

Note1: The distance between the EUT and the phantom bottom is 10mm

Note2: The LTE mode is QPSK_20MHz.

Table 14.1-27: SAR Values (LTE Band66 - Body)

Ambient Temperature: 22.9°C						Liquid Temperature: 22.5°C					
Frequency		Mode	Test Position	Figure No.	Conducted Power (dBm)	Max. tune-up Power (dBm)	Measured SAR(10g) (W/kg)	Reported SAR(10g) (W/kg)	Measured SAR(1g) (W/kg)	Reported SAR(1g) (W/kg)	Power Drift (dB)
Ch.	MHz										
132572	1770	1RB_Mid	Rear	Fig.27	22.89	24	0.236	0.30	0.406	0.52	0.03

Note1: The distance between the EUT and the phantom bottom is 15mm

Note2: The LTE mode is QPSK_20MHz.

14.3 WLAN Evaluation for 2.4G

According to the KDB248227 D01, SAR is measured for 2.4GHz 802.11b DSSS using the initial test position procedure.

Head Evaluation

Table 14.3-1: SAR Values (WLAN - Head)– 802.11b (Fast SAR)

Ambient Temperature: 22.9°C						Liquid Temperature: 22.5°C					
Frequency		Side	Test Position	Figure No.	Conducted Power (dBm)	Max. tune-up Power (dBm)	Measured SAR(10g) (W/kg)	Reported SAR(10g) (W/kg)	Measured SAR(1g) (W/kg)	Reported SAR(1g) (W/kg)	Power Drift (dB)
MHz	Ch.										
2437	6	Left	Touch	/	16.96	17.5	0.078	0.09	0.189	0.21	0.00
2437	6	Left	Tilt	/	16.96	17.5	0.102	0.12	0.250	0.28	-0.12

2437	6	Right	Touch	/	16.96	17.5	0.106	0.12	0.268	0.30	-0.04
2437	6	Right	Tilt	/	16.96	17.5	0.139	0.16	0.358	0.41	0.07

As shown above table, the initial test position for head is “Right Tilt”. So the head SAR of WLAN is presented as below:

Table 14.3-2: SAR Values (WLAN - Head)– 802.11b (Full SAR)

Ambient Temperature: 22.9 °C					Liquid Temperature: 22.5 °C						
Frequency		Side	Test Position	Figure No.	Conducted Power (dBm)	Max. tune-up Power (dBm)	Measured SAR(10g) (W/kg)	Reported SAR(10g) (W/kg)	Measured SAR(1g) (W/kg)	Reported SAR(1g)(W/kg)	Power Drift (dB)
MHz	Ch.										
2437	6	Right	Touch	/	16.96	17.5	0.120	0.14	0.315	0.36	-0.04
2437	6	Right	Tilt	Fig.28	16.96	17.5	0.142	0.16	0.363	0.41	0.07

Note1: When the reported SAR of the initial test position is > 0.4 W/kg, SAR is repeated for the 802.11 transmission mode configuration tested in the initial test position using subsequent highest estimated 1-g SAR conditions determined by area scans, on the highest maximum output power channel, until the reported SAR is \leq 0.8 W/kg.

Note2: For all positions/configurations tested using the initial test position and subsequent test positions, when the reported SAR is > 0.8 W/kg, SAR is measured for these test positions/configurations on the subsequent next highest measured output power channel until the reported SAR is \leq 1.2 W/kg or all required channels are tested.

According to the KDB248227 D01, The reported SAR must be scaled to 100% transmission duty factor to determine compliance at the maximum tune-up tolerance limit. The scaled reported SAR is presented as below.

Table 14.3-3: SAR Values (WLAN - Head) – 802.11b (Scaled Reported SAR)

Ambient Temperature: 22.9 °C					Liquid Temperature: 22.5 °C		
Frequency		Side	Test Position	Actual duty factor	maximum duty factor	Reported SAR (1g)(W/kg)	Scaled reported SAR (1g)(W/kg)
MHz	Ch.						
2437	6	Right	Tilt	100%	100%	0.41	0.41

SAR is not required for OFDM because the 802.11b adjusted SAR \leq 1.2 W/kg.

Body Evaluation

Table 14.3-4: SAR Values (WLAN - Body)– 802.11b (Fast SAR)

Ambient Temperature: 22.9 °C					Liquid Temperature: 22.5 °C						
Frequency		Test Position	Figure No.	Conducted Power (dBm)	Max. tune-up Power (dBm)	Measured SAR(10g) (W/kg)	Reported SAR(10g) (W/kg)	Measured SAR(1g) (W/kg)	Reported SAR(1g)(W/kg)	Power Drift (dB)	
MHz	Ch.										
2437	6	Front	/	16.96	17.5	0.034	0.04	0.072	0.08	0.11	
2437	6	Rear	/	16.96	17.5	0.072	0.08	0.150	0.17	0.13	
2437	6	Left	/	16.96	17.5	0.069	0.08	0.142	0.16	-0.08	
2437	6	Top	/	16.96	17.5	0.090	0.10	0.200	0.23	0.01	

As shown above table, the initial test position for body is “Top”. So the body SAR of WLAN is presented as below:

Table 14.3-5: SAR Values (WLAN - Body)– 802.11b (Full SAR)

Frequency		Test Position	Figure No.	Ambient Temperature: 22.9 °C		Liquid Temperature: 22.5 °C				Power Drift (dB)
MHz	Ch.			Conducted Power (dBm)	Max. tune-up Power (dBm)	Measured SAR(10g) (W/kg)	Reported SAR(10g) (W/kg)	Measured SAR(1g) (W/kg)	Reported SAR(1g) (W/kg)	
2437	6	Top	Fig.29	16.96	17.5	0.088	0.10	0.194	0.22	0.01
2437	6	Rear	Note3	16.96	17.5	0.036	0.04	0.073	0.08	0.02

Note1: When the reported SAR of the initial test position is > 0.4 W/kg, SAR is repeated for the 802.11 transmission mode configuration tested in the initial test position using subsequent highest estimated 1-g SAR conditions determined by area scans, on the highest maximum output power channel, until the reported SAR is \leq 0.8 W/kg.

Note2: For all positions/configurations tested using the initial test position and subsequent test positions, when the reported SAR is > 0.8 W/kg, SAR is measured for these test positions/configurations on the subsequent next highest measured output power channel until the reported SAR is \leq 1.2 W/kg or all required channels are tested.

Note3: he distance between the EUT and the phantom bottom is 15mm.

According to the KDB248227 D01, The reported SAR must be scaled to 100% transmission duty factor to determine compliance at the maximum tune-up tolerance limit. The scaled reported SAR is presented as below.

Table 14.3-6: SAR Values (WLAN - Body) – 802.11b (Scaled Reported SAR)

Frequency		Test Position	Ambient Temperature: 22.9 °C		Liquid Temperature: 22.5 °C	
MHz	Ch.		Actual duty factor	maximum duty factor	Reported SAR (1g)(W/kg)	Scaled reported SAR (1g)(W/kg)
2437	6	Top	100%	100%	0.22	0.22

SAR is not required for OFDM because the 802.11b adjusted SAR \leq 1.2 W/kg.

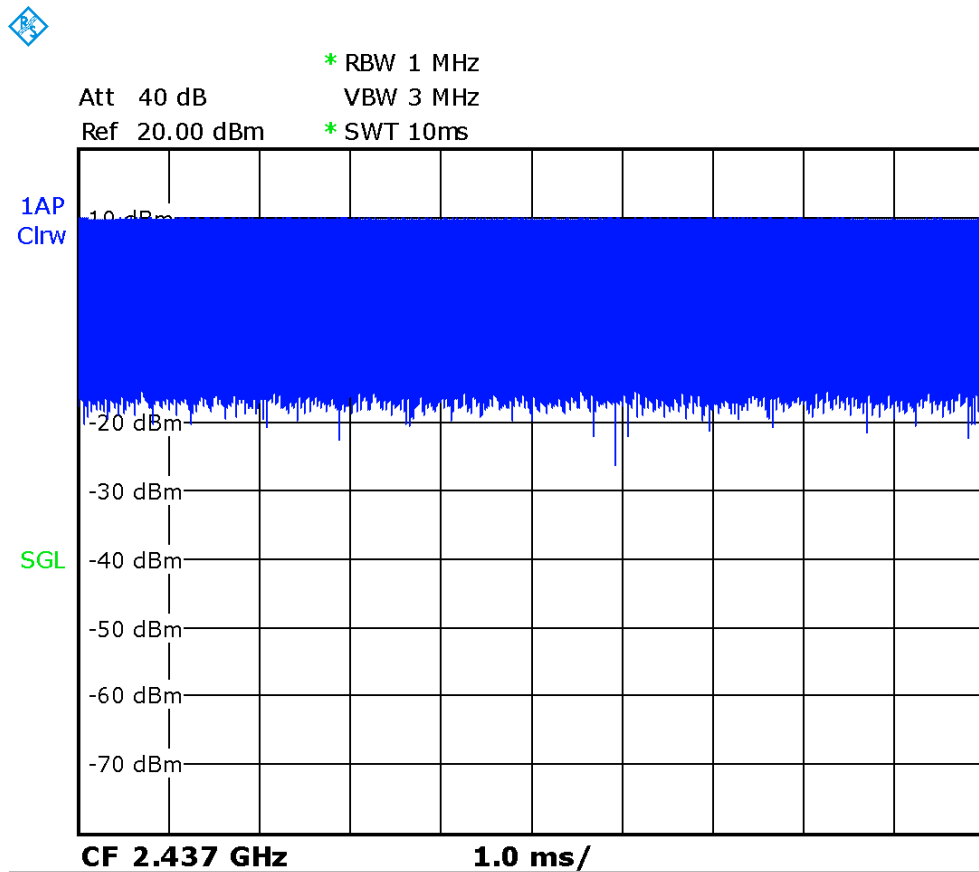

Picture 14.1 Duty factor plot

14.4 BT Evaluation

Table 14.5-1: SAR Values (Bluetooth - Head)

Frequency		Side	Test Position	Figure No.	Conducted Power (dBm)	Max. tune-up Power (dBm)	Measured SAR(10g) (W/kg)	Reported SAR(10g) (W/kg)	Measured SAR(1g) (W/kg)	Reported SAR(1g) (W/kg)	Power Drift (dB)
Ch.	MHz										
78	2480	Left	Touch	Fig.37	11.84	12	< 0.01	< 0.01	< 0.01	< 0.01	/
78	2480	Left	Tilt	/	11.84	12	< 0.01	< 0.01	< 0.01	< 0.01	/
78	2480	Right	Touch	/	11.84	12	< 0.01	< 0.01	< 0.01	< 0.01	/
78	2480	Right	Tilt	/	11.84	12	< 0.01	< 0.01	< 0.01	< 0.01	/

15 SAR Measurement Variability

SAR measurement variability must be assessed for each frequency band, which is determined by the SAR probe calibration point and tissue-equivalent medium used for the device measurements. When both head and body tissue-equivalent media are required for SAR measurements in a frequency band, the variability measurement procedures should be applied to the tissue medium with the highest measured SAR, using the highest measured SAR configuration for that tissue-equivalent medium.

The following procedures are applied to determine if repeated measurements are required.

- 1) Repeated measurement is not required when the original highest measured SAR is < 0.80 W/kg; steps 2) through 4) do not apply.
- 2) When the original highest measured SAR is ≥ 0.80 W/kg, repeat that measurement once.
- 3) Perform a second repeated measurement only if the ratio of largest to smallest SAR for the original and first repeated measurements is > 1.20 or when the original or repeated measurement is ≥ 1.45 W/kg ($\sim 10\%$ from the 1-g SAR limit).
- 4) Perform a third repeated measurement only if the original, first or second repeated measurement is ≥ 1.5 W/kg and the ratio of largest to smallest SAR for the original, first and second repeated measurements is > 1.20 .

Table 15.7: SAR Measurement Variability for Body LTE B7 (1g)

Frequency		Test Position	Spacing (mm)	Original SAR (W/kg)	First Repeated SAR (W/kg)	The Ratio	Second Repeated SAR (W/kg)
Ch.	MHz						
21350	2560	Rear	15	0.958	0.908	1.06	/

16 Measurement Uncertainty

16.1 Measurement Uncertainty for Normal SAR Tests (300MHz~3GHz)

No.	Error Description	Type	Uncertainty value	Probably Distribution	Div.	(Ci) 1g	(Ci) 10g	Std. Unc. (1g)	Std. Unc. (10g)	Degree of freedom
Measurement system										
1	Probe calibration	B	6.0	N	1	1	1	6.0	6.0	∞
2	Isotropy	B	4.7	R	$\sqrt{3}$	0.7	0.7	1.9	1.9	∞
3	Boundary effect	B	1.0	R	$\sqrt{3}$	1	1	0.6	0.6	∞
4	Linearity	B	4.7	R	$\sqrt{3}$	1	1	2.7	2.7	∞
5	Detection limit	B	1.0	N	1	1	1	0.6	0.6	∞
6	Readout electronics	B	0.3	R	$\sqrt{3}$	1	1	0.3	0.3	∞
7	Response time	B	0.8	R	$\sqrt{3}$	1	1	0.5	0.5	∞
8	Integration time	B	2.6	R	$\sqrt{3}$	1	1	1.5	1.5	∞
9	RF ambient conditions-noise	B	0	R	$\sqrt{3}$	1	1	0	0	∞
10	RFambient conditions-reflection	B	0	R	$\sqrt{3}$	1	1	0	0	∞
11	Probe positioned mech. restrictions	B	0.4	R	$\sqrt{3}$	1	1	0.2	0.2	∞
12	Probe positioning with respect to phantom shell	B	2.9	R	$\sqrt{3}$	1	1	1.7	1.7	∞
13	Post-processing	B	1.0	R	$\sqrt{3}$	1	1	0.6	0.6	∞
Test sample related										
14	Test sample positioning	A	3.3	N	1	1	1	3.3	3.3	71
15	Device holder uncertainty	A	3.4	N	1	1	1	3.4	3.4	5
16	Drift of output power	B	5.0	R	$\sqrt{3}$	1	1	2.9	2.9	∞
Phantom and set-up										
17	Phantom uncertainty	B	4.0	R	$\sqrt{3}$	1	1	2.3	2.3	∞
18	Liquid conductivity (target)	B	5.0	R	$\sqrt{3}$	0.64	0.43	1.8	1.2	∞
19	Liquid conductivity (meas.)	A	2.06	N	1	0.64	0.43	1.32	0.89	43
20	Liquid permittivity (target)	B	5.0	R	$\sqrt{3}$	0.6	0.49	1.7	1.4	∞
21	Liquid permittivity (meas.)	A	1.6	N	1	0.6	0.49	1.0	0.8	521

Combined standard uncertainty	$u_c = \sqrt{\sum_{i=1}^{21} c_i^2 u_i^2}$						9.55	9.43	257
Expanded uncertainty (confidence interval of 95 %)	$u_e = 2u_c$						19.1	18.9	

16.2 Measurement Uncertainty for Normal SAR Tests (3~6GHz)

No.	Error Description	Type	Uncertainty value	Probably Distribution	Div.	(Ci) 1g	(Ci) 10g	Std. Unc. (1g)	Std. Unc. (10g)	Degree of freedom
Measurement system										
1	Probe calibration	B	6.55	N	1	1	1	6.55	6.55	∞
2	Isotropy	B	4.7	R	$\sqrt{3}$	0.7	0.7	1.9	1.9	∞
3	Boundary effect	B	2.0	R	$\sqrt{3}$	1	1	1.2	1.2	∞
4	Linearity	B	4.7	R	$\sqrt{3}$	1	1	2.7	2.7	∞
5	Detection limit	B	1.0	R	$\sqrt{3}$	1	1	0.6	0.6	∞
6	Readout electronics	B	0.3	R	$\sqrt{3}$	1	1	0.3	0.3	∞
7	Response time	B	0.8	R	$\sqrt{3}$	1	1	0.5	0.5	∞
8	Integration time	B	2.6	R	$\sqrt{3}$	1	1	1.5	1.5	∞
9	RF ambient conditions-noise	B	0	R	$\sqrt{3}$	1	1	0	0	∞
10	RFambient conditions-reflection	B	0	R	$\sqrt{3}$	1	1	0	0	∞
11	Probe positioned mech. restrictions	B	0.8	R	$\sqrt{3}$	1	1	0.5	0.5	∞
12	Probe positioning with respect to phantom shell	B	6.7	R	$\sqrt{3}$	1	1	3.9	3.9	∞
13	Post-processing	B	4.0	R	$\sqrt{3}$	1	1	2.3	2.3	∞
Test sample related										
14	Test sample positioning	A	3.3	N	1	1	1	3.3	3.3	71
15	Device holder uncertainty	A	3.4	N	1	1	1	3.4	3.4	5
16	Drift of output power	B	5.0	R	$\sqrt{3}$	1	1	2.9	2.9	∞
Phantom and set-up										
17	Phantom uncertainty	B	4.0	R	$\sqrt{3}$	1	1	2.3	2.3	∞
18	Liquid conductivity (target)	B	5.0	R	$\sqrt{3}$	0.64	0.43	1.8	1.2	∞
19	Liquid conductivity (meas.)	A	2.06	N	1	0.64	0.43	1.32	0.89	43
20	Liquid permittivity (target)	B	5.0	R	$\sqrt{3}$	0.6	0.49	1.7	1.4	∞

21	Liquid permittivity (meas.)	A	1.6	N	1	0.6	0.49	1.0	0.8	521
Combined standard uncertainty		$u_c = \sqrt{\sum_{i=1}^{21} c_i^2 u_i^2}$						10.7	10.6	257
Expanded uncertainty (confidence interval of 95 %)		$u_e = 2u_c$						21.4	21.1	

16.3 Measurement Uncertainty for Fast SAR Tests (300MHz~3GHz)

No.	Error Description	Type	Uncertainty value	Probably Distribution	Div.	(Ci) 1g	(Ci) 10g	Std. Unc. (1g)	Std. Unc. (10g)	Degree of freedom
Measurement system										
1	Probe calibration	B	6.0	N	1	1	1	6.0	6.0	∞
2	Isotropy	B	4.7	R	$\sqrt{3}$	0.7	0.7	1.9	1.9	∞
3	Boundary effect	B	1.0	R	$\sqrt{3}$	1	1	0.6	0.6	∞
4	Linearity	B	4.7	R	$\sqrt{3}$	1	1	2.7	2.7	∞
5	Detection limit	B	1.0	R	$\sqrt{3}$	1	1	0.6	0.6	∞
6	Readout electronics	B	0.3	R	$\sqrt{3}$	1	1	0.3	0.3	∞
7	Response time	B	0.8	R	$\sqrt{3}$	1	1	0.5	0.5	∞
8	Integration time	B	2.6	R	$\sqrt{3}$	1	1	1.5	1.5	∞
9	RF ambient conditions-noise	B	0	R	$\sqrt{3}$	1	1	0	0	∞
10	RFambient conditions-reflection	B	0	R	$\sqrt{3}$	1	1	0	0	∞
11	Probe positioned mech. Restrictions	B	0.4	R	$\sqrt{3}$	1	1	0.2	0.2	∞
12	Probe positioning with respect to phantom shell	B	2.9	R	$\sqrt{3}$	1	1	1.7	1.7	∞
13	Post-processing	B	1.0	R	$\sqrt{3}$	1	1	0.6	0.6	∞
14	Fast SAR z-Approximation	B	7.0	R	$\sqrt{3}$	1	1	4.0	4.0	∞
Test sample related										
15	Test sample positioning	A	3.3	N	1	1	1	3.3	3.3	71
16	Device holder uncertainty	A	3.4	N	1	1	1	3.4	3.4	5
17	Drift of output power	B	5.0	R	$\sqrt{3}$	1	1	2.9	2.9	∞
Phantom and set-up										
18	Phantom uncertainty	B	4.0	R	$\sqrt{3}$	1	1	2.3	2.3	∞
19	Liquid conductivity (target)	B	5.0	R	$\sqrt{3}$	0.64	0.43	1.8	1.2	∞

20	Liquid conductivity (meas.)	A	2.06	N	1	0.64	0.43	1.32	0.89	43
21	Liquid permittivity (target)	B	5.0	R	$\sqrt{3}$	0.6	0.49	1.7	1.4	∞
22	Liquid permittivity (meas.)	A	1.6	N	1	0.6	0.49	1.0	0.8	521
Combined standard uncertainty		$u_c = \sqrt{\sum_{i=1}^{22} c_i^2 u_i^2}$						10.4	10.3	257
Expanded uncertainty (confidence interval of 95 %)		$u_e = 2u_c$						20.8	20.6	

16.4 Measurement Uncertainty for Fast SAR Tests (3~6GHz)

No.	Error Description	Type	Uncertainty value	Probably Distribution	Div.	(Ci) 1g	(Ci) 10g	Std. Unc. (1g)	Std. Unc. (10g)	Degree of freedom
Measurement system										
1	Probe calibration	B	6.55	N	1	1	1	6.55	6.55	∞
2	Isotropy	B	4.7	R	$\sqrt{3}$	0.7	0.7	1.9	1.9	∞
3	Boundary effect	B	2.0	R	$\sqrt{3}$	1	1	1.2	1.2	∞
4	Linearity	B	4.7	R	$\sqrt{3}$	1	1	2.7	2.7	∞
5	Detection limit	B	1.0	R	$\sqrt{3}$	1	1	0.6	0.6	∞
6	Readout electronics	B	0.3	R	$\sqrt{3}$	1	1	0.3	0.3	∞
7	Response time	B	0.8	R	$\sqrt{3}$	1	1	0.5	0.5	∞
8	Integration time	B	2.6	R	$\sqrt{3}$	1	1	1.5	1.5	∞
9	RF ambient conditions-noise	B	0	R	$\sqrt{3}$	1	1	0	0	∞
10	RFambient conditions-reflection	B	0	R	$\sqrt{3}$	1	1	0	0	∞
11	Probe positioned mech. Restrictions	B	0.8	R	$\sqrt{3}$	1	1	0.5	0.5	∞
12	Probe positioning with respect to phantom shell	B	6.7	R	$\sqrt{3}$	1	1	3.9	3.9	∞
13	Post-processing	B	1.0	R	$\sqrt{3}$	1	1	0.6	0.6	∞
14	Fast SAR z-Approximation	B	14.0	R	$\sqrt{3}$	1	1	8.1	8.1	∞
Test sample related										
15	Test sample positioning	A	3.3	N	1	1	1	3.3	3.3	71
16	Device holder uncertainty	A	3.4	N	1	1	1	3.4	3.4	5

17	Drift of output power	B	5.0	R	$\sqrt{3}$	1	1	2.9	2.9	∞
Phantom and set-up										
18	Phantom uncertainty	B	4.0	R	$\sqrt{3}$	1	1	2.3	2.3	∞
19	Liquid conductivity (target)	B	5.0	R	$\sqrt{3}$	0.64	0.43	1.8	1.2	∞
20	Liquid conductivity (meas.)	A	2.06	N	1	0.64	0.43	1.32	0.89	43
21	Liquid permittivity (target)	B	5.0	R	$\sqrt{3}$	0.6	0.49	1.7	1.4	∞
22	Liquid permittivity (meas.)	A	1.6	N	1	0.6	0.49	1.0	0.8	521
Combined standard uncertainty		$u_c = \sqrt{\sum_{i=1}^{22} c_i^2 u_i^2}$						13.5	13.4	257
Expanded uncertainty (confidence interval of 95 %)		$u_e = 2u_c$						27.0	26.8	

17 MAIN TEST INSTRUMENTS

Table 17.1: List of Main Instruments

No.	Name	Type	Serial Number	Calibration Date	Valid Period
01	Network analyzer	E5071C	MY46110673	January 24, 2019	One year
02	Power meter	NRP2	106277	September 4, 2019	One year
03	Power sensor	NRP8S	104291		
04	Signal Generator	E4438C	MY49070393	January 4, 2019	One Year
05	Amplifier	60S1G4	0331848	No Calibration Requested	
06	BTS	E5515C	MY50263375	January 17, 2019	One year
07	BTS	CMW500	159890	January 3, 2019	One year
08	E-field Probe	SPEAG EX3DV4	3617	January 31, 2019	One year
09	DAE	SPEAG DAE4	771	January 11, 2019	One year
10	Dipole Validation Kit	SPEAG D750V3	1017	July 18, 2019	One year
11	Dipole Validation Kit	SPEAG D835V2	4d069	July 18, 2019	One year
12	Dipole Validation Kit	SPEAG D1750V2	1003	July 16, 2019	One year
13	Dipole Validation Kit	SPEAG D1900V2	5d101	July 17, 2019	One year
14	Dipole Validation Kit	SPEAG D2450V2	853	July 17, 2019	One year
15	Dipole Validation Kit	SPEAG D2600V2	1012	July 17, 2019	One year

END OF REPORT BODY

ANNEX A Graph Results

GSM850_CH251 Left Cheek

Date: 11/20/2019

Electronics: DAE4 Sn771

Medium: head 835 MHz

Medium parameters used: $f = 848.8$; $\sigma = 0.914$ mho/m; $\epsilon_r = 41.58$; $\rho = 1000$ kg/m³

Ambient Temperature: 22.5°C, Liquid Temperature: 22.3°C

Communication System: GSM850 848.8 Duty Cycle: 1: 8.3

Probe: EX3DV4 – SN3617 ConvF(9.75,9.75,9.75)

Area Scan (71x121x1): Interpolated grid: dx=1.000 mm, dy=1.000 mm

Maximum value of SAR (interpolated) = 0.505 W/kg

Zoom Scan (7x7x7)/Cube 0: Measurement grid: dx=5mm, dy=5mm, dz=5mm

Reference Value = 6.688 V/m; Power Drift = 0.09 dB

Peak SAR (extrapolated) = 0.543 W/kg

SAR(1 g) = 0.423 W/kg; SAR(10 g) = 0.319 W/kg

Maximum value of SAR (measured) = SAR W/kg

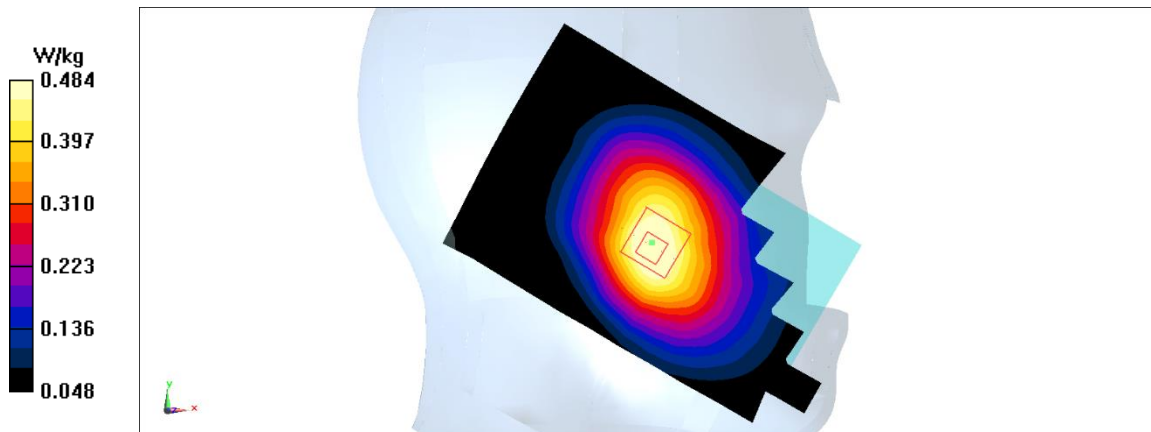

Fig A.1

GSM850_CH251 Rear

Date: 11/20/2019

Electronics: DAE4 Sn771

Medium: head 835 MHz

Medium parameters used: $f = 848.8$; $\sigma = 0.914$ mho/m; $\epsilon_r = 41.58$; $\rho = 1000$ kg/m³

Ambient Temperature: 22.5°C, Liquid Temperature: 22.3°C

Communication System: GSM850 848.8 Duty Cycle: 1: 4

Probe: EX3DV4 – SN3617 ConvF(9.75,9.75,9.75)

Area Scan (71x121x1): Interpolated grid: dx=1.000 mm, dy=1.000 mm

Maximum value of SAR (interpolated) = 0.572 W/kg

Zoom Scan (7x7x7)/Cube 0: Measurement grid: dx=5mm, dy=5mm, dz=5mm

Reference Value = 20.59 V/m; Power Drift = -0.07 dB

Peak SAR (extrapolated) = 0.823 W/kg

SAR(1 g) = 0.434 W/kg; SAR(10 g) = 0.241 W/kg

Maximum value of SAR (measured) = points W/kg

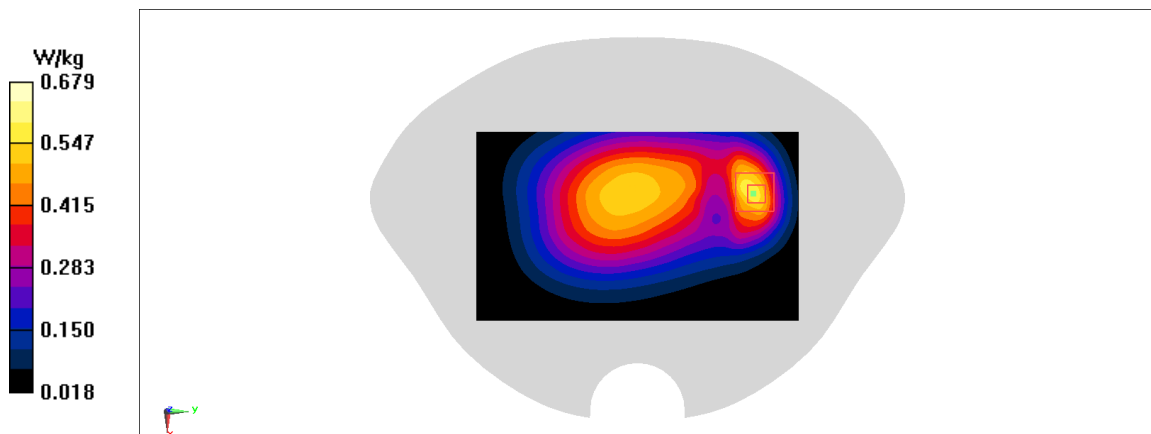

Fig A.2

PCS1900_CH512 Left Cheek

Date: 11/22/2019

Electronics: DAE4 Sn771

Medium: head 1900 MHz

Medium parameters used: $f = 1850.2$; $\sigma = 1.342$ mho/m; $\epsilon_r = 39.61$; $\rho = 1000$ kg/m³

Ambient Temperature: 22.5°C, Liquid Temperature: 22.3°C

Communication System: PCS1900 1850.2 Duty Cycle: 1: 8.3

Probe: EX3DV4 – SN3617 ConvF(8.14,8.14,8.14)

Area Scan (71x121x1): Interpolated grid: dx=1.000 mm, dy=1.000 mm

Maximum value of SAR (interpolated) = 0.142 W/kg

Zoom Scan (7x7x7)/Cube 0: Measurement grid: dx=5mm, dy=5mm, dz=5mm

Reference Value = 2.545 V/m; Power Drift = -0.06 dB

Peak SAR (extrapolated) = 0.167 W/kg

SAR(1 g) = 0.105 W/kg; SAR(10 g) = 0.065 W/kg

Maximum value of SAR (measured) = points W/kg

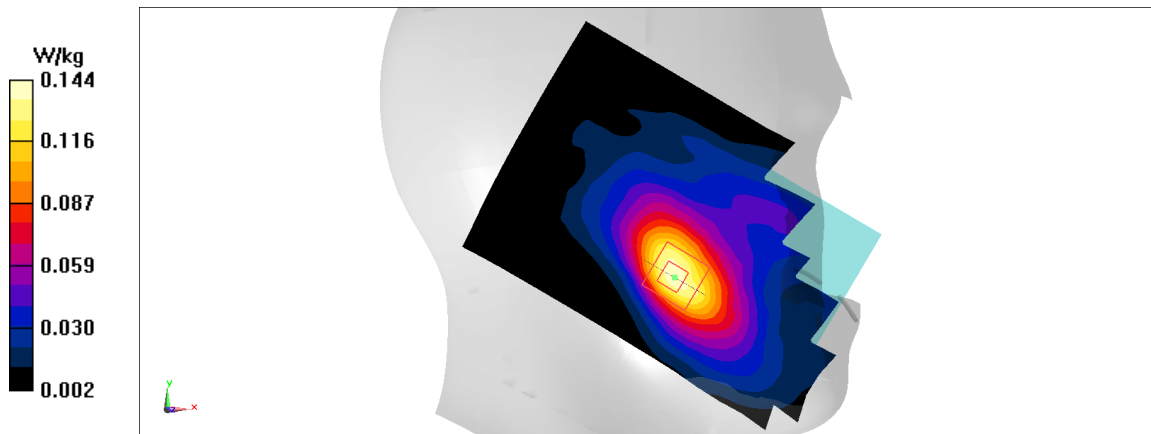

Fig A.3

PCS1900_CH512 Bottom

Date: 11/22/2019

Electronics: DAE4 Sn771

Medium: head 1900 MHz

Medium parameters used: $f = 1850.2$; $\sigma = 1.342$ mho/m; $\epsilon_r = 39.61$; $\rho = 1000$ kg/m³

Ambient Temperature: 22.5°C, Liquid Temperature: 22.3°C

Communication System: PCS1900 1850.2 Duty Cycle: 1: 4

Probe: EX3DV4 – SN3617 ConvF(8.14,8.14,8.14)

Area Scan (71x121x1): Interpolated grid: dx=1.000 mm, dy=1.000 mm

Maximum value of SAR (interpolated) = 0.896 W/kg

Zoom Scan (7x7x7)/Cube 0: Measurement grid: dx=5mm, dy=5mm, dz=5mm

Reference Value = 18.41 V/m; Power Drift = -0.01 dB

Peak SAR (extrapolated) = 1.17 W/kg

SAR(1 g) = 0.615 W/kg; SAR(10 g) = 0.315 W/kg

Maximum value of SAR (measured) = points W/kg

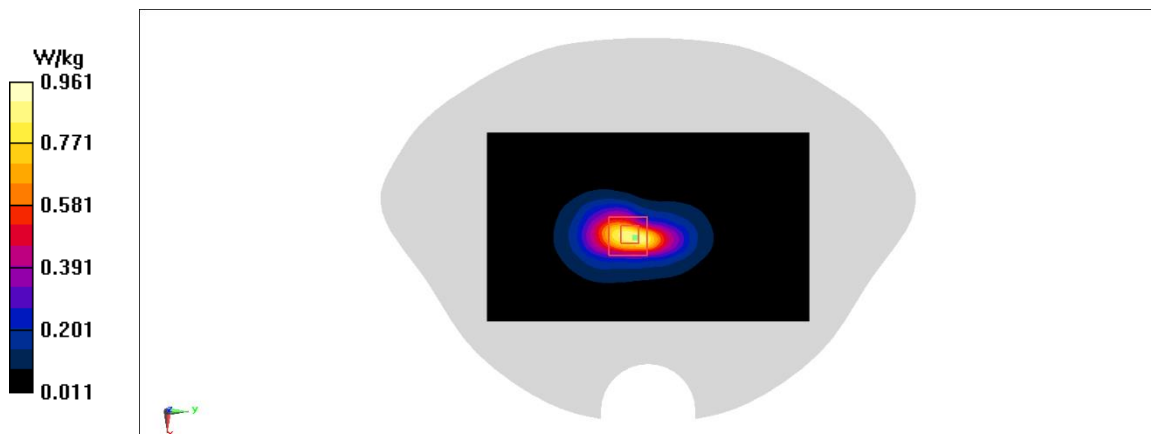

Fig A.4

WCDMA1900-BII_CH9400 Left Cheek

Date: 11/22/2019

Electronics: DAE4 Sn771

Medium: head 1900 MHz

Medium parameters used: $f = 1880$; $\sigma = 1.371$ mho/m; $\epsilon_r = 39.57$; $\rho = 1000$ kg/m³

Ambient Temperature: 22.5°C, Liquid Temperature: 22.3°C

Communication System: WCDMA1900-BII 1880 Duty Cycle: 1: 1

Probe: EX3DV4 – SN3617 ConvF(8.14,8.14,8.14)

Area Scan (71x121x1): Interpolated grid: dx=1.000 mm, dy=1.000 mm

Maximum value of SAR (interpolated) = 0.276 W/kg

Zoom Scan (7x7x7)/Cube 0: Measurement grid: dx=5mm, dy=5mm, dz=5mm

Reference Value = 3.431 V/m; Power Drift = 0.02 dB

Peak SAR (extrapolated) = 0.331 W/kg

SAR(1 g) = 0.215 W/kg; SAR(10 g) = 0.135 W/kg

Maximum value of SAR (measured) = points W/kg

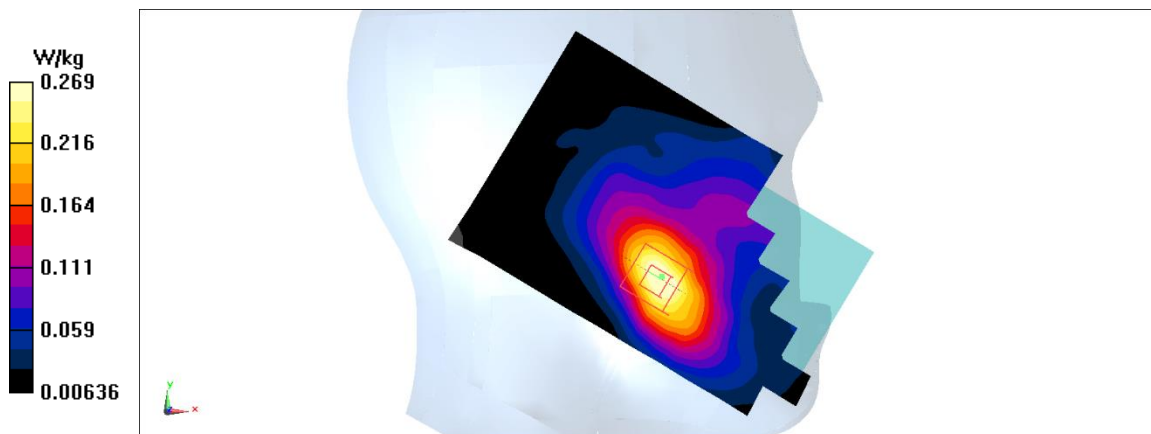

Fig A.5

WCDMA1900-BII_CH9538 Bottom

Date: 11/22/2019

Electronics: DAE4 Sn771

Medium: head 1900 MHz

Medium parameters used: $f = 1907.6$; $\sigma = 1.398$ mho/m; $\epsilon_r = 39.54$; $\rho = 1000$ kg/m³

Ambient Temperature: 22.5°C, Liquid Temperature: 22.3°C

Communication System: WCDMA1900-BII 1907.6 Duty Cycle: 1: 1

Probe: EX3DV4 – SN3617 ConvF(8.14,8.14,8.14)

Area Scan (71x121x1): Interpolated grid: dx=1.000 mm, dy=1.000 mm

Maximum value of SAR (interpolated) = 0.85 W/kg

Zoom Scan (7x7x7)/Cube 0: Measurement grid: dx=5mm, dy=5mm, dz=5mm

Reference Value = 16.49 V/m; Power Drift = -0.06 dB

Peak SAR (extrapolated) = 1.03 W/kg

SAR(1 g) = 0.543 W/kg; SAR(10 g) = 0.274 W/kg

Maximum value of SAR (measured) = points W/kg

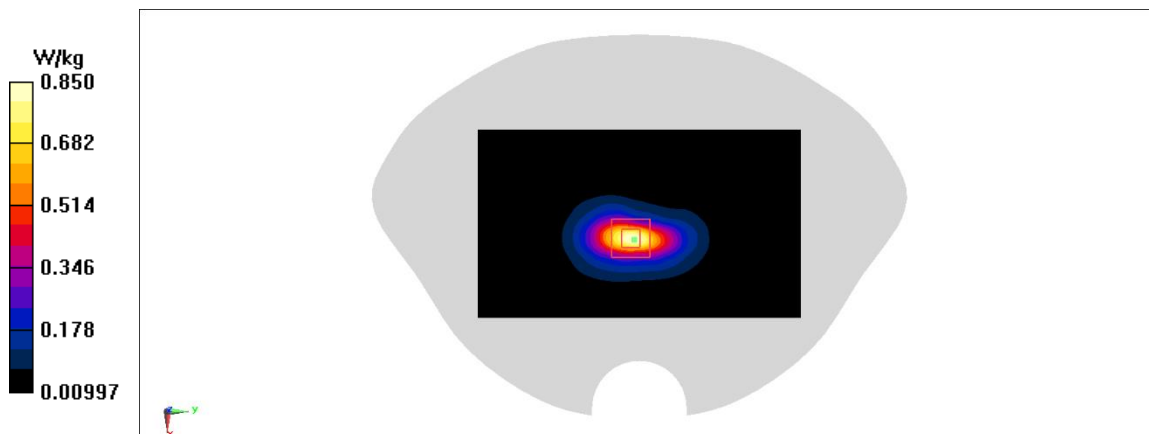

Fig A.6

WCDMA1900-BII_CH9262 Rear

Date: 11/22/2019

Electronics: DAE4 Sn771

Medium: head 1900 MHz

Medium parameters used: $f = 1852.4$; $\sigma = 1.344$ mho/m; $\epsilon_r = 39.61$; $\rho = 1000$ kg/m³

Ambient Temperature: 22.5°C, Liquid Temperature: 22.3°C

Communication System: WCDMA1900-BII 1852.4 Duty Cycle: 1: 1

Probe: EX3DV4 – SN3617 ConvF(8.14,8.14,8.14)

Area Scan (71x121x1): Interpolated grid: dx=1.000 mm, dy=1.000 mm

Maximum value of SAR (interpolated) = 0.645 W/kg

Zoom Scan (7x7x7)/Cube 0: Measurement grid: dx=5mm, dy=5mm, dz=5mm

Reference Value = 7.639 V/m; Power Drift = -0.03 dB

Peak SAR (extrapolated) = 0.782 W/kg

SAR(1 g) = 0.447 W/kg; SAR(10 g) = 0.257 W/kg

Maximum value of SAR (measured) = points W/kg

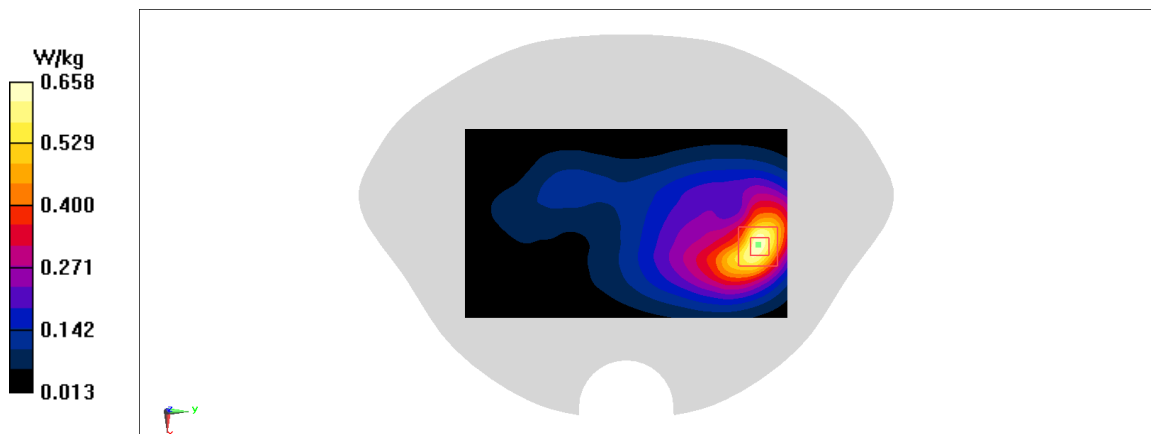
**Fig A.7**

WCDMA1700-BIV_CH1513 Left Cheek

Date: 11/21/2019

Electronics: DAE4 Sn771

Medium: head 1750 MHz

Medium parameters used: $f = 1752.6$; $\sigma = 1.383$ mho/m; $\epsilon_r = 40.68$; $\rho = 1000$ kg/m³

Ambient Temperature: 22.5°C, Liquid Temperature: 22.3°C

Communication System: WCDMA1700-BIV 1752.6 Duty Cycle: 1: 1

Probe: EX3DV4 – SN3617 ConvF(8.38,8.38,8.38)

Area Scan (71x121x1): Interpolated grid: dx=1.000 mm, dy=1.000 mm

Maximum value of SAR (interpolated) = 0.383 W/kg

Zoom Scan (7x7x7)/Cube 0: Measurement grid: dx=5mm, dy=5mm, dz=5mm

Reference Value = 5.101 V/m; Power Drift = 0.06 dB

Peak SAR (extrapolated) = 0.44 W/kg

SAR(1 g) = 0.293 W/kg; SAR(10 g) = 0.185 W/kg

Maximum value of SAR (measured) = points W/kg

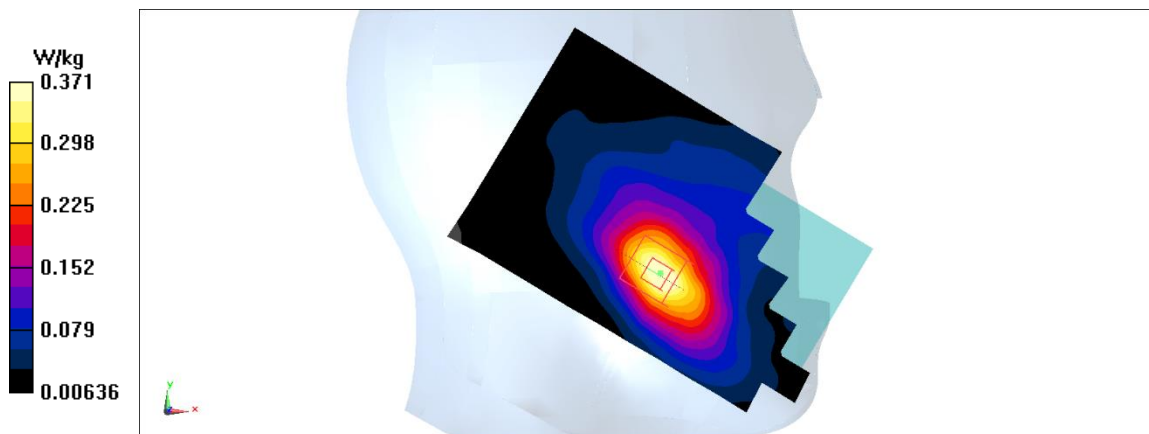

Fig A.8

WCDMA1700-BIV_CH1513 Rear

Date: 11/21/2019

Electronics: DAE4 Sn771

Medium: head 1750 MHz

Medium parameters used: $f = 1752.6$; $\sigma = 1.383$ mho/m; $\epsilon_r = 40.68$; $\rho = 1000$ kg/m³

Ambient Temperature: 22.5°C, Liquid Temperature: 22.3°C

Communication System: WCDMA1700-BIV 1752.6 Duty Cycle: 1: 1

Probe: EX3DV4 – SN3617 ConvF(8.38,8.38,8.38)

Area Scan (71x121x1): Interpolated grid: dx=1.000 mm, dy=1.000 mm

Maximum value of SAR (interpolated) = 0.388 W/kg

Zoom Scan (7x7x7)/Cube 0: Measurement grid: dx=5mm, dy=5mm, dz=5mm

Reference Value = 4.706 V/m; Power Drift = 0.11 dB

Peak SAR (extrapolated) = 0.469 W/kg

SAR(1 g) = 0.257 W/kg; SAR(10 g) = 0.141 W/kg

Maximum value of SAR (measured) = points W/kg

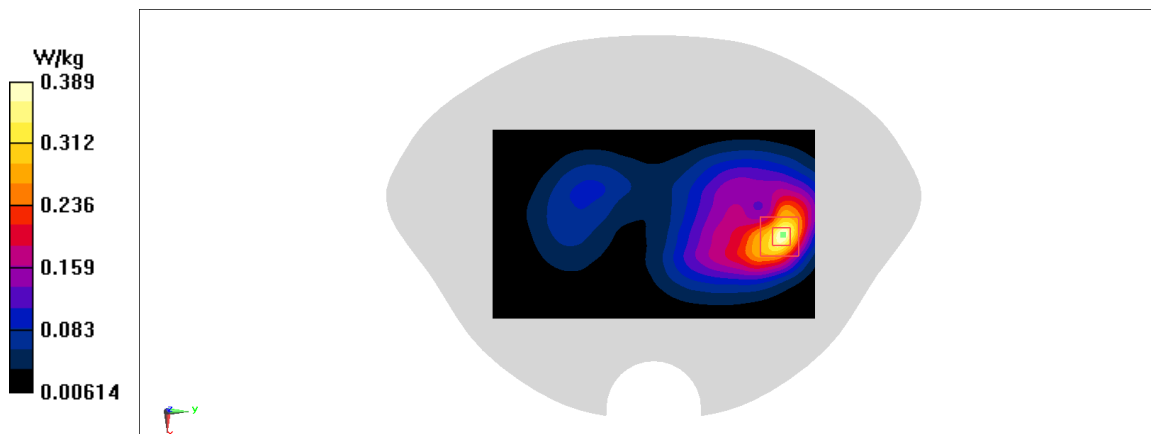

Fig A.9

WCDMA1700-BIV_CH1513 Rear

Date: 11/21/2019

Electronics: DAE4 Sn771

Medium: head 1750 MHz

Medium parameters used: $f = 1752.6$; $\sigma = 1.383$ mho/m; $\epsilon_r = 40.68$; $\rho = 1000$ kg/m³

Ambient Temperature: 22.5°C, Liquid Temperature: 22.3°C

Communication System: WCDMA1700-BIV 1752.6 Duty Cycle: 1: 1

Probe: EX3DV4 – SN3617 ConvF(8.38,8.38,8.38)

Area Scan (71x121x1): Interpolated grid: dx=1.000 mm, dy=1.000 mm

Maximum value of SAR (interpolated) = 0.58 W/kg

Zoom Scan (7x7x7)/Cube 0: Measurement grid: dx=5mm, dy=5mm, dz=5mm

Reference Value = 6.497 V/m; Power Drift = -0.09 dB

Peak SAR (extrapolated) = 0.751 W/kg

SAR(1 g) = 0.432 W/kg; SAR(10 g) = 0.253 W/kg

Maximum value of SAR (measured) = points W/kg

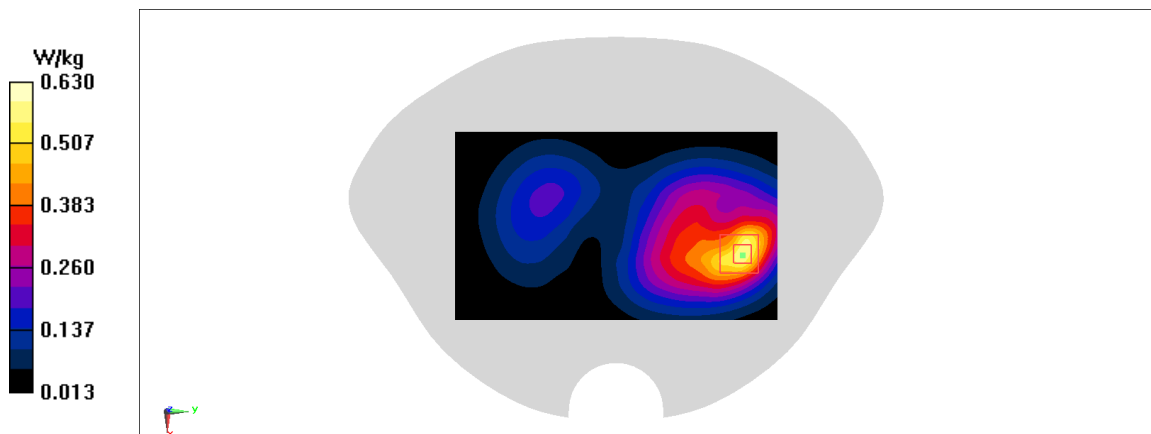

Fig A.10

WCDMA850-BV_CH4132 Left Cheek

Date: 11/20/2019

Electronics: DAE4 Sn771

Medium: head 835 MHz

Medium parameters used: $f = 826.4$; $\sigma = 0.892$ mho/m; $\epsilon_r = 41.61$; $\rho = 1000$ kg/m³

Ambient Temperature: 22.5°C, Liquid Temperature: 22.3°C

Communication System: WCDMA850-BV 826.4 Duty Cycle: 1: 1

Probe: EX3DV4 – SN3617 ConvF(9.75,9.75,9.75)

Area Scan (71x121x1): Interpolated grid: dx=1.000 mm, dy=1.000 mm

Maximum value of SAR (interpolated) = 0.359 W/kg

Zoom Scan (7x7x7)/Cube 0: Measurement grid: dx=5mm, dy=5mm, dz=5mm

Reference Value = 4.683 V/m; Power Drift = 0.05 dB

Peak SAR (extrapolated) = 0.393 W/kg

SAR(1 g) = 0.309 W/kg; SAR(10 g) = 0.235 W/kg

Maximum value of SAR (measured) = SAR W/kg

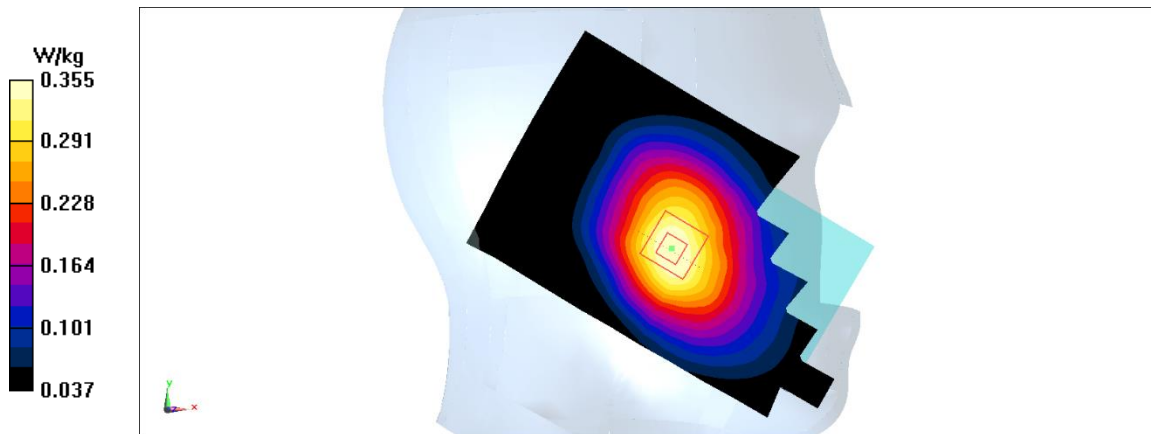

Fig A.11

WCDMA850-BV_CH4233 Rear

Date: 11/20/2019

Electronics: DAE4 Sn771

Medium: head 835 MHz

Medium parameters used: $f = 846.6$; $\sigma = 0.912$ mho/m; $\epsilon_r = 41.59$; $\rho = 1000$ kg/m³

Ambient Temperature: 22.5°C, Liquid Temperature: 22.3°C

Communication System: WCDMA850-BV 846.6 Duty Cycle: 1: 1

Probe: EX3DV4 – SN3617 ConvF(9.75,9.75,9.75)

Area Scan (71x121x1): Interpolated grid: dx=1.000 mm, dy=1.000 mm

Maximum value of SAR (interpolated) = 0.549 W/kg

Zoom Scan (7x7x7)/Cube 0: Measurement grid: dx=5mm, dy=5mm, dz=5mm

Reference Value = 22.3 V/m; Power Drift = -0.09 dB

Peak SAR (extrapolated) = 0.63 W/kg

SAR(1 g) = 0.463 W/kg; SAR(10 g) = 0.348 W/kg

Maximum value of SAR (measured) = SAR W/kg

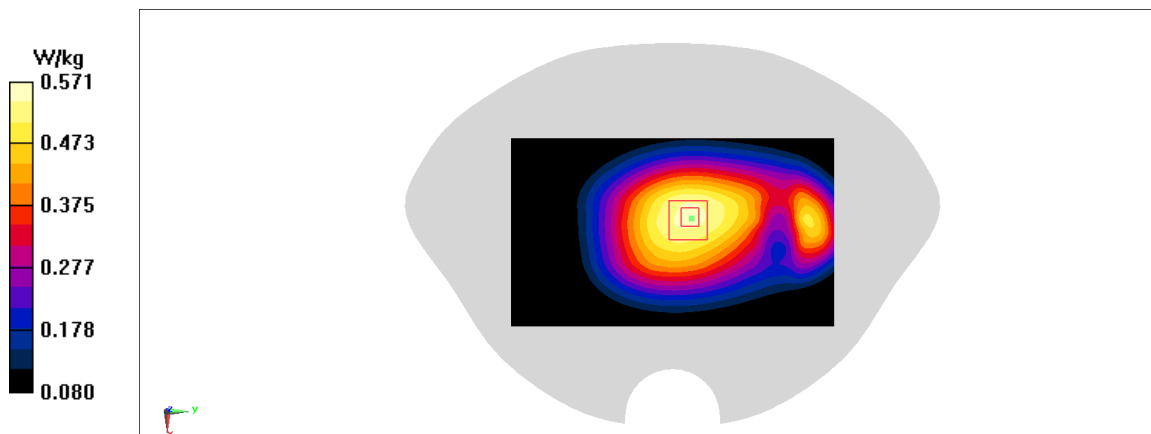

Fig A.12

LTE1900-FDD2_CH19100 Right Cheek

Date: 11/22/2019

Electronics: DAE4 Sn771

Medium: head 1900 MHz

Medium parameters used: $f = 1900$ MHz; $\sigma = 1.39$ mho/m; $\epsilon_r = 39.55$; $\rho = 1000$ kg/m³

Ambient Temperature: 22.5°C, Liquid Temperature: 22.3°C

Communication System: LTE1900-FDD2 1900 MHz Duty Cycle: 1: 1

Probe: EX3DV4 – SN3617 ConvF(8.14,8.14,8.14)

Area Scan (71x121x1): Interpolated grid: dx=1.000 mm, dy=1.000 mm

Maximum value of SAR (interpolated) = 0.329 W/kg

Zoom Scan (7x7x7)/Cube 0: Measurement grid: dx=5mm, dy=5mm, dz=5mm

Reference Value = 3.549 V/m; Power Drift = 0.01 dB

Peak SAR (extrapolated) = 0.378 W/kg

SAR(1 g) = 0.236 W/kg; SAR(10 g) = 0.144 W/kg

Maximum value of SAR (measured) = points W/kg

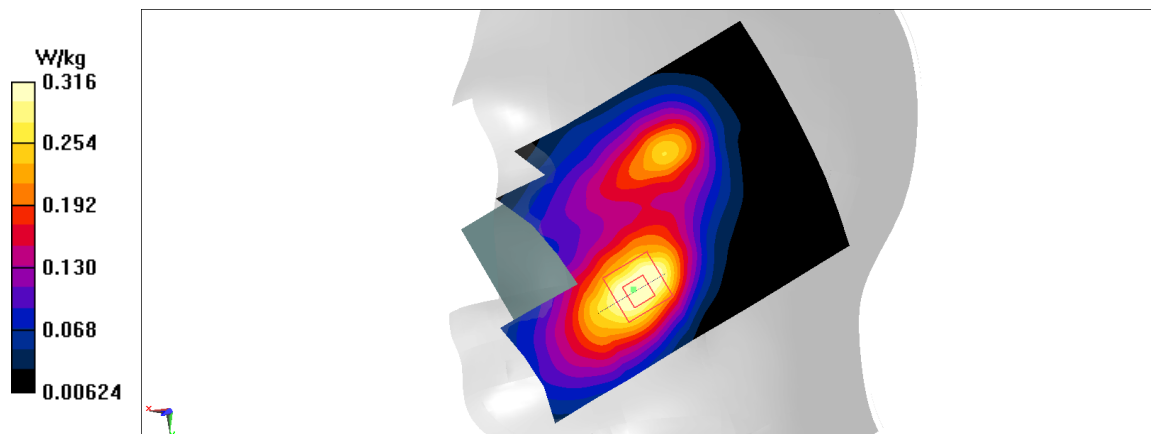

Fig A.13

LTE1900-FDD2_CH19100 Bottom

Date: 11/22/2019

Electronics: DAE4 Sn771

Medium: head 1900 MHz

Medium parameters used: $f = 1900$ MHz; $\sigma = 1.39$ mho/m; $\epsilon_r = 39.55$; $\rho = 1000$ kg/m³

Ambient Temperature: 22.5°C, Liquid Temperature: 22.3°C

Communication System: LTE1900-FDD2 1900 MHz Duty Cycle: 1: 1

Probe: EX3DV4 – SN3617 ConvF(8.14,8.14,8.14)

Area Scan (71x121x1): Interpolated grid: dx=1.000 mm, dy=1.000 mm

Maximum value of SAR (interpolated) = 0.779 W/kg

Zoom Scan (7x7x7)/Cube 0: Measurement grid: dx=5mm, dy=5mm, dz=5mm

Reference Value = 16.36 V/m; Power Drift = 0 dB

Peak SAR (extrapolated) = 0.939 W/kg

SAR(1 g) = 0.498 W/kg; SAR(10 g) = 0.253 W/kg

Maximum value of SAR (measured) = points W/kg

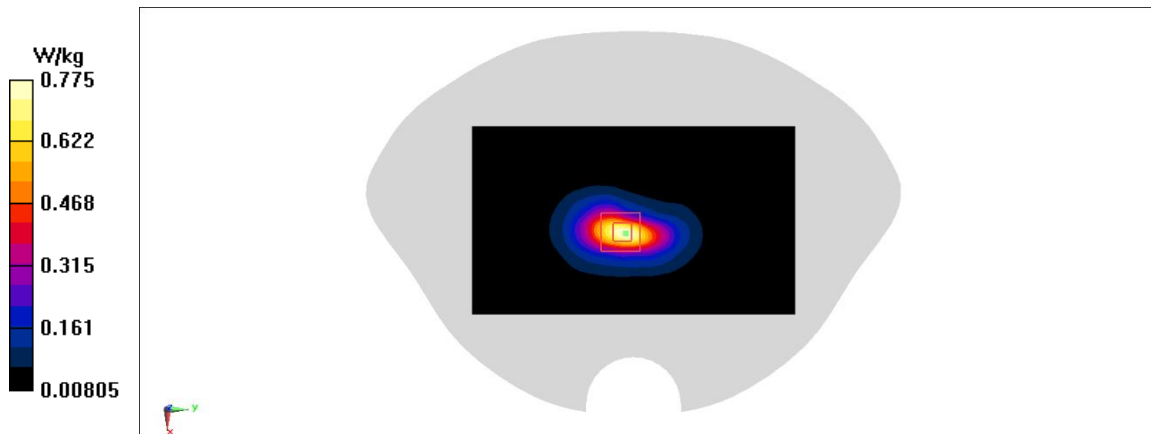

Fig A.14

LTE1900-FDD2_CH19100 Rear

Date: 11/22/2019

Electronics: DAE4 Sn771

Medium: head 1900 MHz

Medium parameters used: $f = 1900$ MHz; $\sigma = 1.39$ mho/m; $\epsilon_r = 39.55$; $\rho = 1000$ kg/m³

Ambient Temperature: 22.5°C, Liquid Temperature: 22.3°C

Communication System: LTE1900-FDD2 1900 MHz Duty Cycle: 1: 1

Probe: EX3DV4 – SN3617 ConvF(8.14,8.14,8.14)

Area Scan (71x121x1): Interpolated grid: dx=1.000 mm, dy=1.000 mm

Maximum value of SAR (interpolated) = 0.69 W/kg

Zoom Scan (7x7x7)/Cube 0: Measurement grid: dx=5mm, dy=5mm, dz=5mm

Reference Value = 7.058 V/m; Power Drift = -0.01 dB

Peak SAR (extrapolated) = 0.802 W/kg

SAR(1 g) = 0.473 W/kg; SAR(10 g) = 0.271 W/kg

Maximum value of SAR (measured) = points W/kg

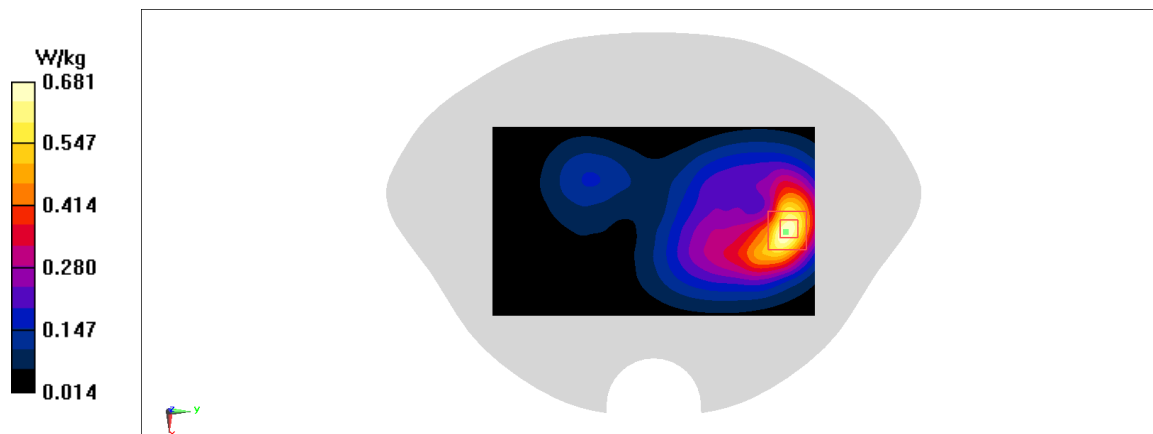

Fig A.15

LTE850-FDD5_CH20450 Left Cheek

Date: 11/20/2019

Electronics: DAE4 Sn771

Medium: head 835 MHz

Medium parameters used: $f = 829$ MHz; $\sigma = 0.895$ mho/m; $\epsilon_r = 41.61$; $\rho = 1000$ kg/m³

Ambient Temperature: 22.5°C, Liquid Temperature: 22.3°C

Communication System: LTE850-FDD5 829 MHz Duty Cycle: 1: 1

Probe: EX3DV4 – SN3617 ConvF(9.75,9.75,9.75)

Area Scan (71x121x1): Interpolated grid: dx=1.000 mm, dy=1.000 mm

Maximum value of SAR (interpolated) = 0.383 W/kg

Zoom Scan (7x7x7)/Cube 0: Measurement grid: dx=5mm, dy=5mm, dz=5mm

Reference Value = 4.799 V/m; Power Drift = 0.07 dB

Peak SAR (extrapolated) = 0.419 W/kg

SAR(1 g) = 0.33 W/kg; SAR(10 g) = 0.251 W/kg

Maximum value of SAR (measured) = SAR W/kg

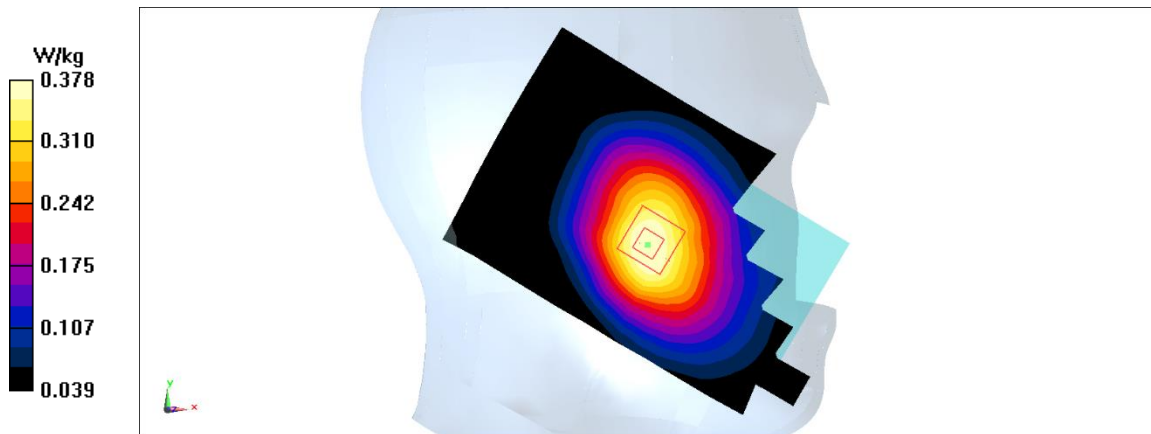

Fig A.16

LTE850-FDD5_CH20450 Rear

Date: 11/20/2019

Electronics: DAE4 Sn771

Medium: head 835 MHz

Medium parameters used: $f = 829$ MHz; $\sigma = 0.895$ mho/m; $\epsilon_r = 41.61$; $\rho = 1000$ kg/m³

Ambient Temperature: 22.5°C, Liquid Temperature: 22.3°C

Communication System: LTE850-FDD5 829 MHz Duty Cycle: 1: 1

Probe: EX3DV4 – SN3617 ConvF(9.75,9.75,9.75)

Area Scan (71x121x1): Interpolated grid: dx=1.000 mm, dy=1.000 mm

Maximum value of SAR (interpolated) = 0.665 W/kg

Zoom Scan (7x7x7)/Cube 0: Measurement grid: dx=5mm, dy=5mm, dz=5mm

Reference Value = 23.9 V/m; Power Drift = -0.04 dB

Peak SAR (extrapolated) = 0.793 W/kg

SAR(1 g) = 0.42 W/kg; SAR(10 g) = 0.238 W/kg

Maximum value of SAR (measured) = points W/kg

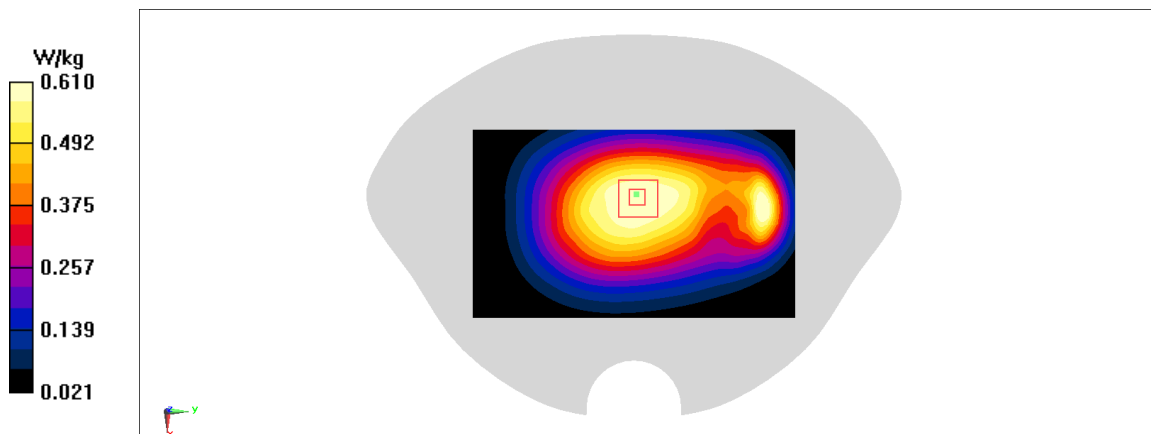

Fig A.17

LTE2500-FDD7_CH21100 Right Cheek

Date: 11/23/2019

Electronics: DAE4 Sn771

Medium: head 2600 MHz

Medium parameters used: $f = 2535$ MHz; $\sigma = 1.904$ mho/m; $\epsilon_r = 39.65$; $\rho = 1000$ kg/m³

Ambient Temperature: 22.5°C, Liquid Temperature: 22.3°C

Communication System: LTE2500-FDD7 2535 MHz Duty Cycle: 1: 1

Probe: EX3DV4 – SN3617 ConvF(7.19,7.19,7.19)

Area Scan (71x121x1): Interpolated grid: dx=1.000 mm, dy=1.000 mm

Maximum value of SAR (interpolated) = 0.152 W/kg

Zoom Scan (7x7x7)/Cube 0: Measurement grid: dx=5mm, dy=5mm, dz=5mm

Reference Value = 0 V/m; Power Drift = 0.08 dB

Peak SAR (extrapolated) = 0.137 W/kg

SAR(1 g) = 0.069 W/kg; SAR(10 g) = 0.033 W/kg

Maximum value of SAR (measured) = points W/kg

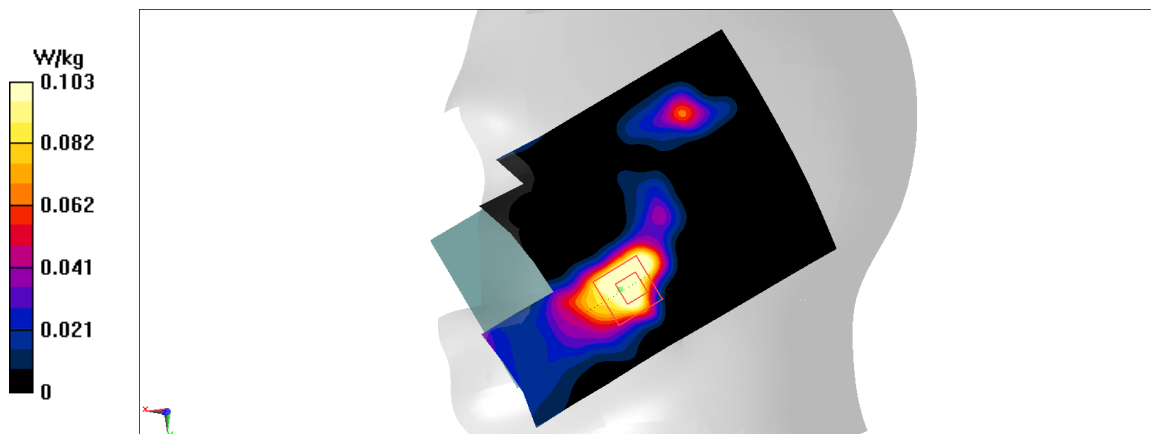

Fig A.18

LTE2500-FDD7_CH21100 Bottom

Date: 11/23/2019

Electronics: DAE4 Sn771

Medium: head 2600 MHz

Medium parameters used: $f = 2535$ MHz; $\sigma = 1.904$ mho/m; $\epsilon_r = 39.65$; $\rho = 1000$ kg/m³

Ambient Temperature: 22.5°C, Liquid Temperature: 22.3°C

Communication System: LTE2500-FDD7 2535 MHz Duty Cycle: 1: 1

Probe: EX3DV4 – SN3617 ConvF(7.19,7.19,7.19)

Area Scan (71x121x1): Interpolated grid: dx=1.000 mm, dy=1.000 mm

Maximum value of SAR (interpolated) = 1.24 W/kg

Zoom Scan (7x7x7)/Cube 0: Measurement grid: dx=5mm, dy=5mm, dz=5mm

Reference Value = 18.54 V/m; Power Drift = -0.13 dB

Peak SAR (extrapolated) = 1.48 W/kg

SAR(1 g) = 0.715 W/kg; SAR(10 g) = 0.336 W/kg

Maximum value of SAR (measured) = points W/kg

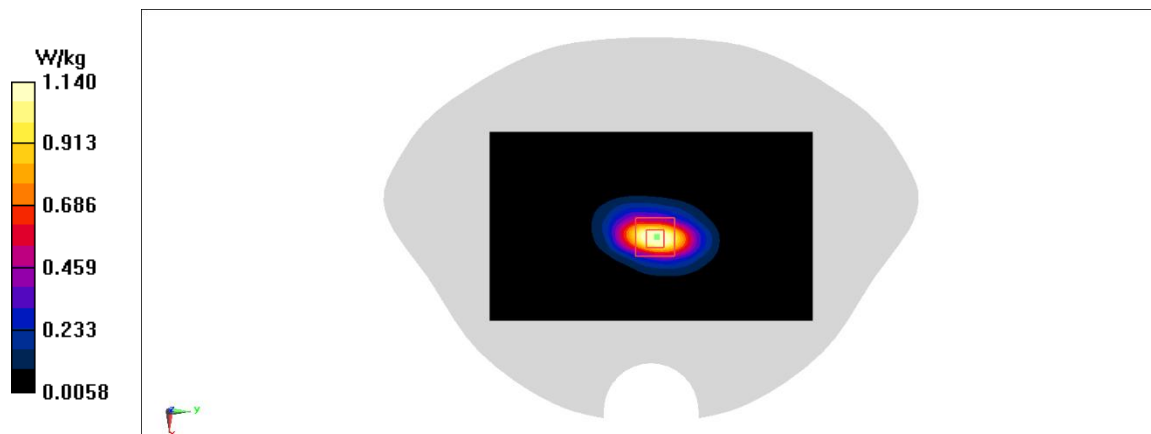

Fig A.19

LTE2500-FDD7_CH21350 Rear

Date: 11/23/2019

Electronics: DAE4 Sn771

Medium: head 2600 MHz

Medium parameters used: $f = 2560$ MHz; $\sigma = 1.928$ mho/m; $\epsilon_r = 39.62$; $\rho = 1000$ kg/m³

Ambient Temperature: 22.5°C, Liquid Temperature: 22.3°C

Communication System: LTE2500-FDD7 2560 MHz Duty Cycle: 1: 1

Probe: EX3DV4 – SN3617 ConvF(7.19,7.19,7.19)

Area Scan (71x121x1): Interpolated grid: dx=1.000 mm, dy=1.000 mm

Maximum value of SAR (interpolated) = 1.42 W/kg

Zoom Scan (7x7x7)/Cube 0: Measurement grid: dx=5mm, dy=5mm, dz=5mm

Reference Value = 2.133 V/m; Power Drift = -0.04 dB

Peak SAR (extrapolated) = 1.88 W/kg

SAR(1 g) = 0.958 W/kg; SAR(10 g) = 0.485 W/kg

Maximum value of SAR (measured) = points W/kg

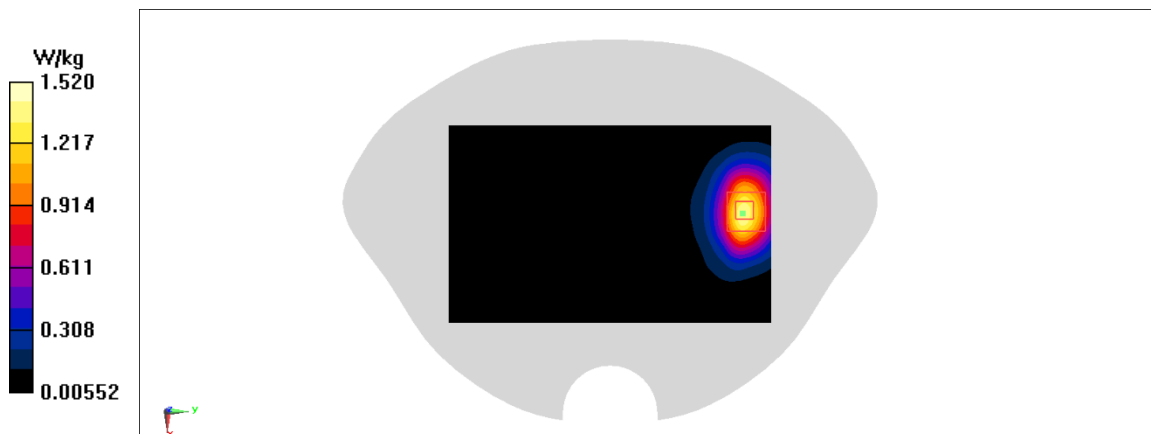
**Fig A.20**

LTE750-FDD13_CH23230 Left Cheek

Date: 11/19/2019

Electronics: DAE4 Sn771

Medium: head 750 MHz

Medium parameters used: $f = 782 \text{ MHz}$; $\sigma = 0.928 \text{ mho/m}$; $\epsilon_r = 41.66$; $\rho = 1000 \text{ kg/m}^3$

Ambient Temperature: 22.5°C , Liquid Temperature: 22.3°C

Communication System: LTE750-FDD13 782 MHz Duty Cycle: 1: 1

Probe: EX3DV4 – SN3617 ConvF(10.03,10.03,10.03)

Area Scan (71x121x1): Interpolated grid: $dx=1.000 \text{ mm}$, $dy=1.000 \text{ mm}$

Maximum value of SAR (interpolated) = 0.266 W/kg

Zoom Scan (7x7x7)/Cube 0: Measurement grid: $dx=5\text{mm}$, $dy=5\text{mm}$, $dz=5\text{mm}$

Reference Value = 3.96 V/m ; Power Drift = -0.04 dB

Peak SAR (extrapolated) = 0.296 W/kg

SAR(1 g) = 0.232 W/kg ; SAR(10 g) = 0.178 W/kg

Maximum value of SAR (measured) = SAR W/kg

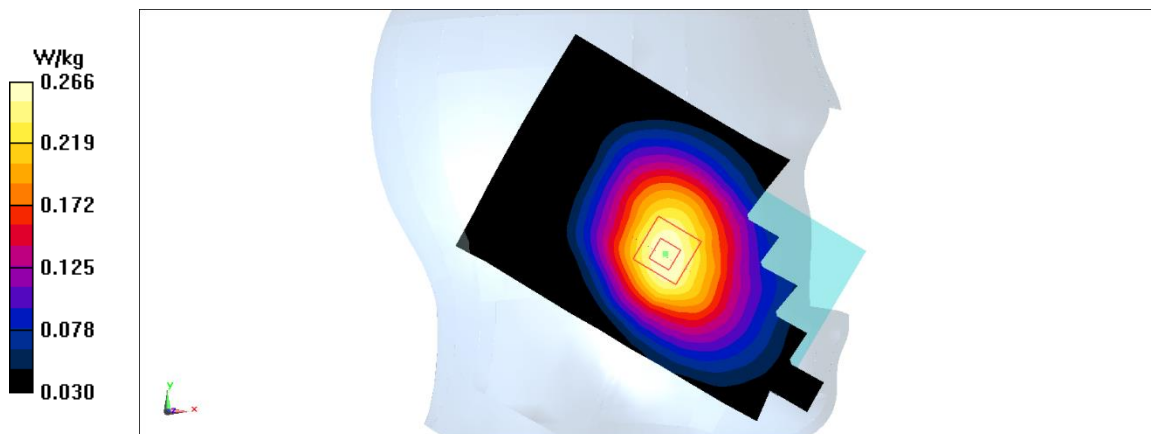

Fig A.21

LTE750-FDD13_CH23230 Rear

Date: 11/19/2019

Electronics: DAE4 Sn771

Medium: head 750 MHz

Medium parameters used: $f = 782$ MHz; $\sigma = 0.928$ mho/m; $\epsilon_r = 41.66$; $\rho = 1000$ kg/m³

Ambient Temperature: 22.5°C, Liquid Temperature: 22.3°C

Communication System: LTE750-FDD13 782 MHz Duty Cycle: 1: 1

Probe: EX3DV4 – SN3617 ConvF(10.03,10.03,10.03)

Area Scan (71x121x1): Interpolated grid: dx=1.000 mm, dy=1.000 mm

Maximum value of SAR (interpolated) = 0.547 W/kg

Zoom Scan (7x7x7)/Cube 0: Measurement grid: dx=5mm, dy=5mm, dz=5mm

Reference Value = 23.27 V/m; Power Drift = -0.04 dB

Peak SAR (extrapolated) = 0.607 W/kg

SAR(1 g) = 0.439 W/kg; SAR(10 g) = 0.335 W/kg

Maximum value of SAR (measured) = SAR W/kg

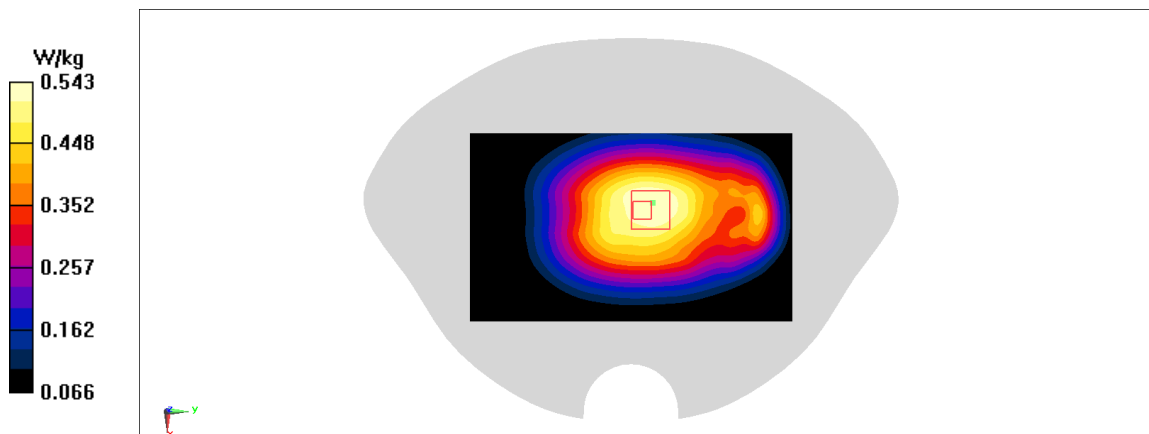

Fig A.22

LTE700-FDD17_CH23780 Left Cheek

Date: 11/19/2019

Electronics: DAE4 Sn771

Medium: head 750 MHz

Medium parameters used: $f = 709$ MHz; $\sigma = 0.859$ mho/m; $\epsilon_r = 41.75$; $\rho = 1000$ kg/m³

Ambient Temperature: 22.5°C, Liquid Temperature: 22.3°C

Communication System: LTE700-FDD17 709 MHz Duty Cycle: 1: 1

Probe: EX3DV4 – SN3617 ConvF(10.03,10.03,10.03)

Area Scan (71x121x1): Interpolated grid: dx=1.000 mm, dy=1.000 mm

Maximum value of SAR (interpolated) = 0.13 W/kg

Zoom Scan (7x7x7)/Cube 0: Measurement grid: dx=5mm, dy=5mm, dz=5mm

Reference Value = 3.101 V/m; Power Drift = -0.06 dB

Peak SAR (extrapolated) = 0.145 W/kg

SAR(1 g) = 0.115 W/kg; SAR(10 g) = 0.088 W/kg

Maximum value of SAR (measured) = SAR W/kg

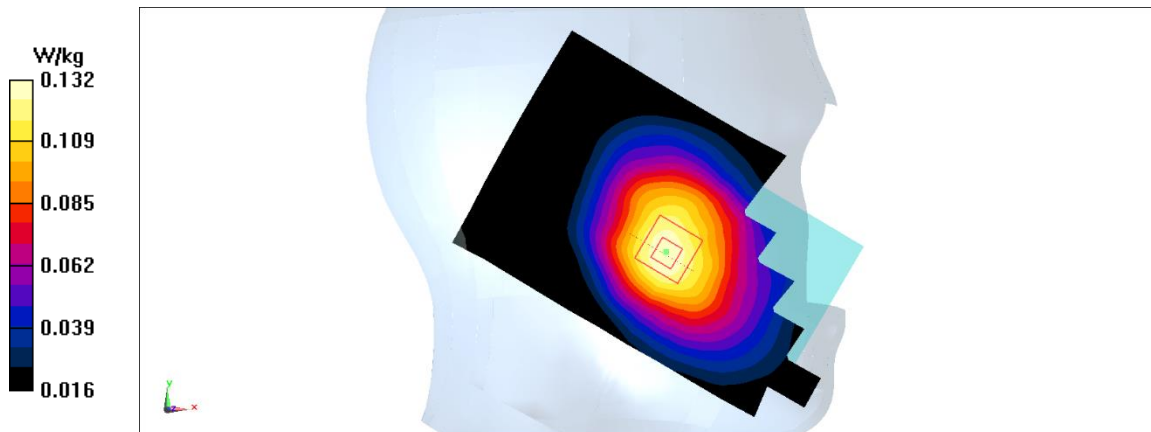

Fig A.23

LTE700-FDD17_CH23780 Rear

Date: 11/19/2019

Electronics: DAE4 Sn771

Medium: head 750 MHz

Medium parameters used: $f = 709$ MHz; $\sigma = 0.859$ mho/m; $\epsilon_r = 41.75$; $\rho = 1000$ kg/m³

Ambient Temperature: 22.5°C, Liquid Temperature: 22.3°C

Communication System: LTE700-FDD17 709 MHz Duty Cycle: 1: 1

Probe: EX3DV4 – SN3617 ConvF(10.03,10.03,10.03)

Area Scan (71x121x1): Interpolated grid: dx=1.000 mm, dy=1.000 mm

Maximum value of SAR (interpolated) = 0.227 W/kg

Zoom Scan (7x7x7)/Cube 0: Measurement grid: dx=5mm, dy=5mm, dz=5mm

Reference Value = 14.49 V/m; Power Drift = -0.12 dB

Peak SAR (extrapolated) = 0.248 W/kg

SAR(1 g) = 0.183 W/kg; SAR(10 g) = 0.139 W/kg

Maximum value of SAR (measured) = SAR W/kg

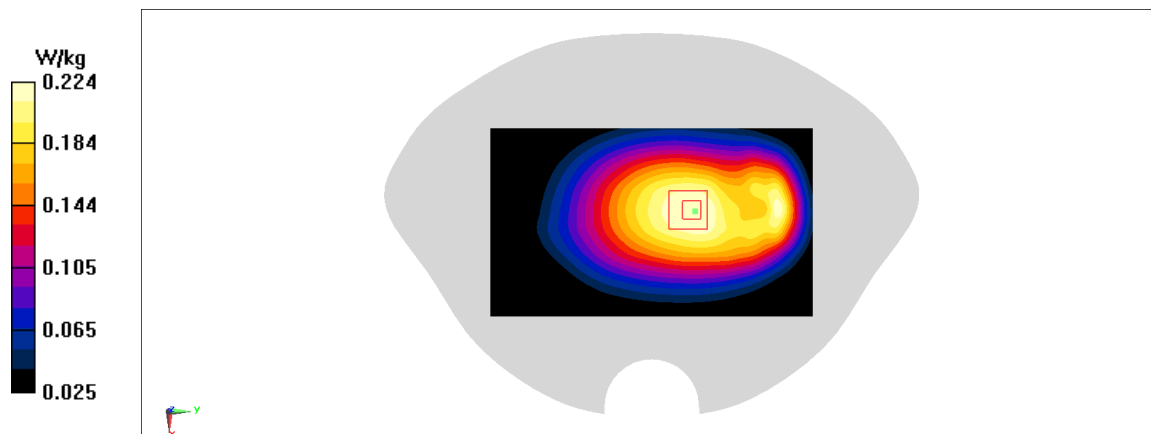

Fig A.24

LTE1700-FDD66_CH132572 Left Cheek

Date: 11/21/2019

Electronics: DAE4 Sn771

Medium: head 1750 MHz

Medium parameters used: $f = 709$ MHz; $\sigma = 0.391$ mho/m; $\epsilon_r = 41.93$; $\rho = 1000$ kg/m³

Ambient Temperature: 22.5°C, Liquid Temperature: 22.3°C

Communication System: LTE1700-FDD66 709 MHz Duty Cycle: 1: 1

Probe: EX3DV4 – SN3617 ConvF(8.38,8.38,8.38)

Area Scan (71x121x1): Interpolated grid: dx=1.000 mm, dy=1.000 mm

Maximum value of SAR (interpolated) = 0.352 W/kg

Zoom Scan (7x7x7)/Cube 0: Measurement grid: dx=5mm, dy=5mm, dz=5mm

Reference Value = 5.912 V/m; Power Drift = 0.02 dB

Peak SAR (extrapolated) = 0.425 W/kg

SAR(1 g) = 0.273 W/kg; SAR(10 g) = 0.168 W/kg

Maximum value of SAR (measured) = points W/kg

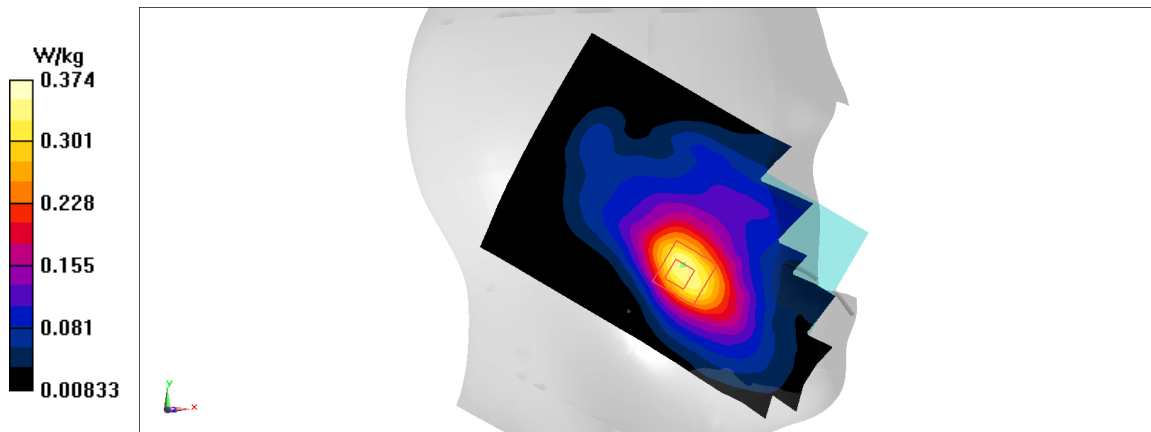

Fig A.25

LTE1700-FDD66_CH132322 Rear

Date: 11/21/2019

Electronics: DAE4 Sn771

Medium: head 1750 MHz

Medium parameters used: $f = 709$ MHz; $\sigma = 0.391$ mho/m; $\epsilon_r = 41.93$; $\rho = 1000$ kg/m³

Ambient Temperature: 22.5°C, Liquid Temperature: 22.3°C

Communication System: LTE1700-FDD66 709 MHz Duty Cycle: 1: 1

Probe: EX3DV4 – SN3617 ConvF(8.38,8.38,8.38)

Area Scan (71x121x1): Interpolated grid: dx=1.000 mm, dy=1.000 mm

Maximum value of SAR (interpolated) = 0.431 W/kg

Zoom Scan (7x7x7)/Cube 0: Measurement grid: dx=5mm, dy=5mm, dz=5mm

Reference Value = 5.471 V/m; Power Drift = 0.02 dB

Peak SAR (extrapolated) = 0.556 W/kg

SAR(1 g) = 0.3 W/kg; SAR(10 g) = 0.162 W/kg

Maximum value of SAR (measured) = points W/kg

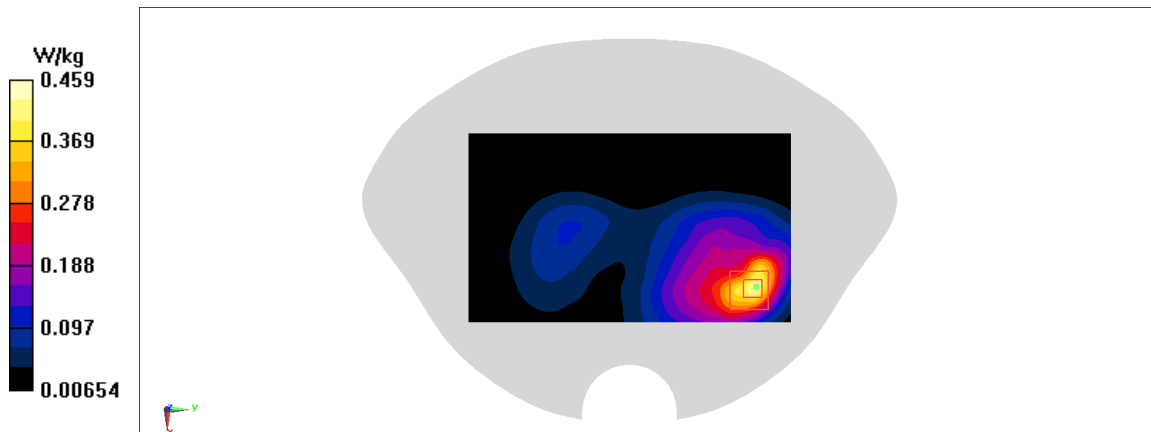

Fig A.26

LTE1700-FDD66_CH132572 Rear

Date: 11/21/2019

Electronics: DAE4 Sn771

Medium: head 1750 MHz

Medium parameters used: $f = 709$ MHz; $\sigma = 0.391$ mho/m; $\epsilon_r = 41.93$; $\rho = 1000$ kg/m³

Ambient Temperature: 22.5°C, Liquid Temperature: 22.3°C

Communication System: LTE1700-FDD66 709 MHz Duty Cycle: 1: 1

Probe: EX3DV4 – SN3617 ConvF(8.38,8.38,8.38)

Area Scan (71x121x1): Interpolated grid: dx=1.000 mm, dy=1.000 mm

Maximum value of SAR (interpolated) = 0.555 W/kg

Zoom Scan (7x7x7)/Cube 0: Measurement grid: dx=5mm, dy=5mm, dz=5mm

Reference Value = 8.95 V/m; Power Drift = 0.03 dB

Peak SAR (extrapolated) = 0.709 W/kg

SAR(1 g) = 0.406 W/kg; SAR(10 g) = 0.236 W/kg

Maximum value of SAR (measured) = points W/kg

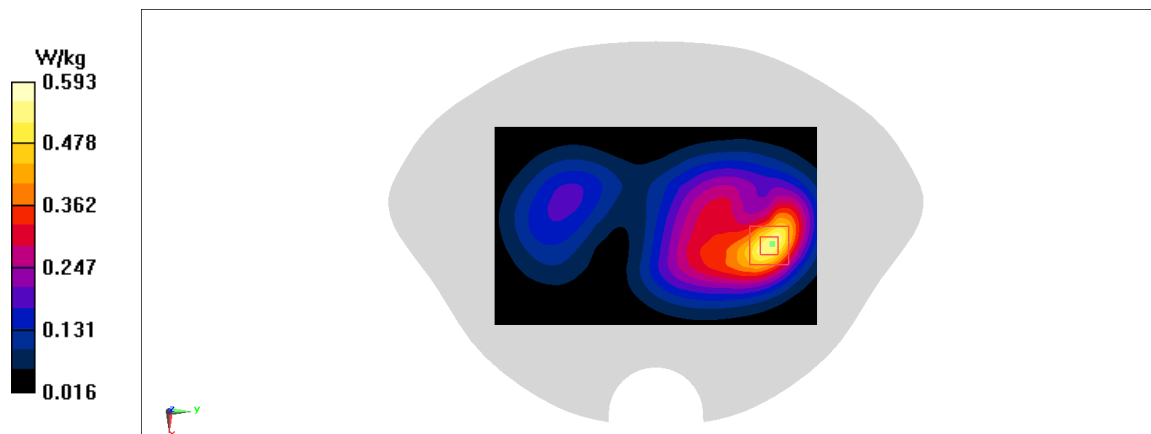

Fig A.27

WLAN2450_CH6 Left Tilt

Date: 11/23/2019

Electronics: DAE4 Sn771

Medium: head 2450 MHz

Medium parameters used: $f = 2437$; $\sigma = 1.772$ mho/m; $\epsilon_r = 39.07$; $\rho = 1000$ kg/m³

Ambient Temperature: 22.5°C, Liquid Temperature: 22.3°C

Communication System: WLAN2450 2437 Duty Cycle: 1: 1

Probe: EX3DV4 – SN3617 ConvF(7.62,7.62,7.62)

Area Scan (71x121x1): Interpolated grid: dx=1.000 mm, dy=1.000 mm

Maximum value of SAR (interpolated) = 0.662 W/kg

Zoom Scan (7x7x7)/Cube 0: Measurement grid: dx=5mm, dy=5mm, dz=5mm

Reference Value = 7.908 V/m; Power Drift = 0.07 dB

Peak SAR (extrapolated) = 0.831 W/kg

SAR(1 g) = 0.363 W/kg; SAR(10 g) = 0.142 W/kg

Maximum value of SAR (measured) = 0.617 W/kg

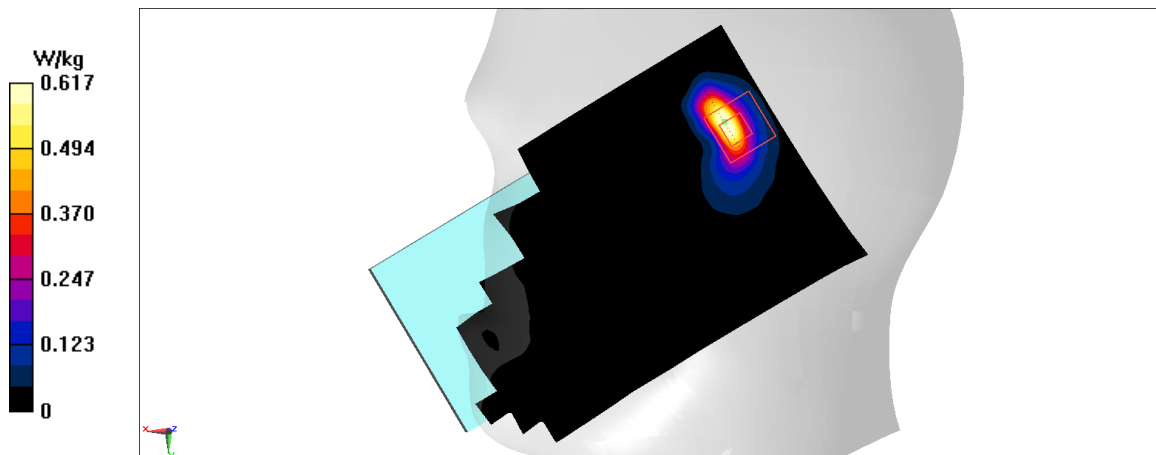

Fig A.28

WLAN2450_CH6 Top

Date: 11/23/2019

Electronics: DAE4 Sn771

Medium: head 2450 MHz

Medium parameters used: $f = 2437$; $\sigma = 1.772$ mho/m; $\epsilon_r = 39.07$; $\rho = 1000$ kg/m³

Ambient Temperature: 22.5°C, Liquid Temperature: 22.3°C

Communication System: WLAN2450 2437 Duty Cycle: 1: 1

Probe: EX3DV4 – SN3617 ConvF(7.62,7.62,7.62)

Area Scan (71x121x1): Interpolated grid: dx=1.000 mm, dy=1.000 mm

Maximum value of SAR (interpolated) = 0.323 W/kg

Zoom Scan (7x7x7)/Cube 0: Measurement grid: dx=5mm, dy=5mm, dz=5mm

Reference Value = 6.228 V/m; Power Drift = 0.01 dB

Peak SAR (extrapolated) = 0.408 W/kg

SAR(1 g) = 0.194 W/kg; SAR(10 g) = 0.088 W/kg

Maximum value of SAR (measured) = 0.323 W/kg

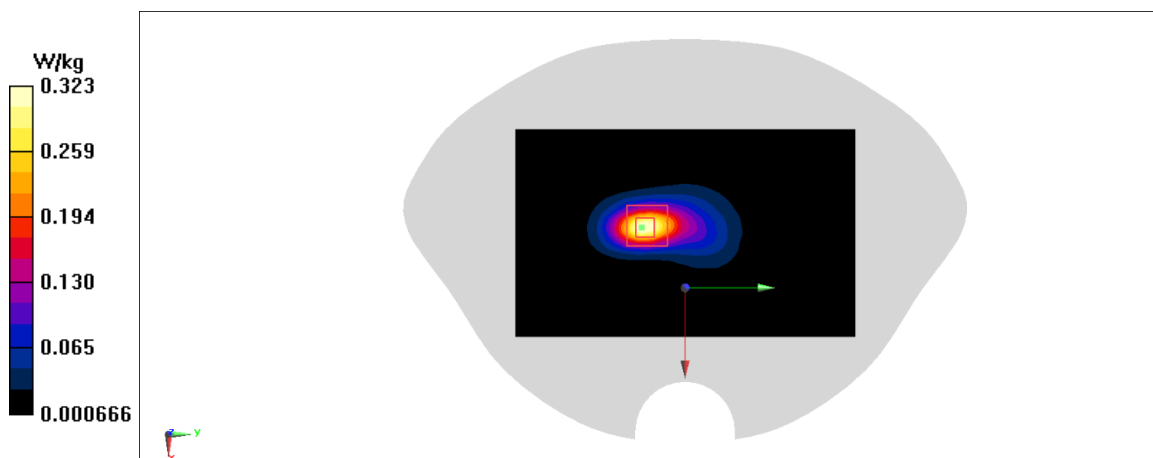

Fig A.29

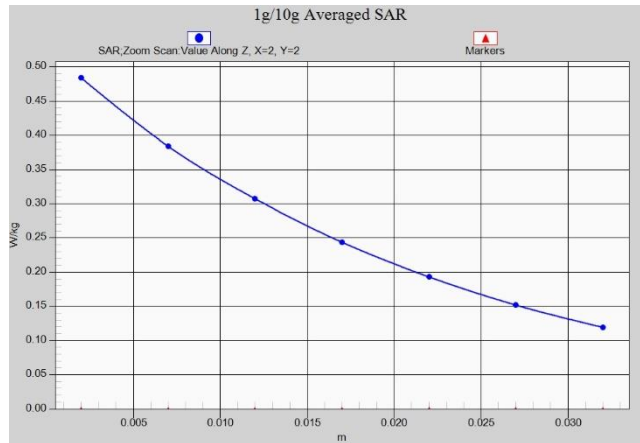

Fig. 1-1 Z-Scan at power reference point (GSM850)

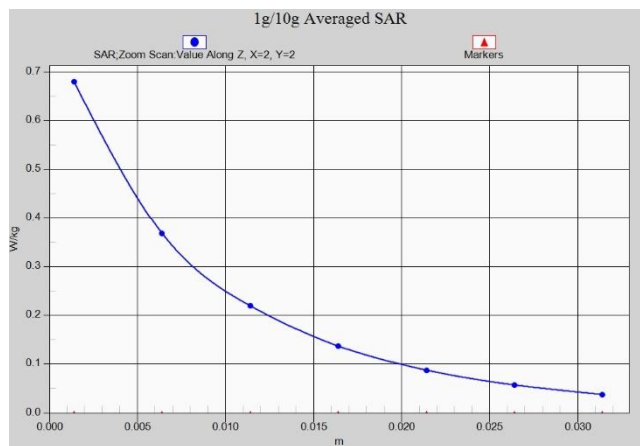

Fig. 1-2 Z-Scan at power reference point (GSM850)

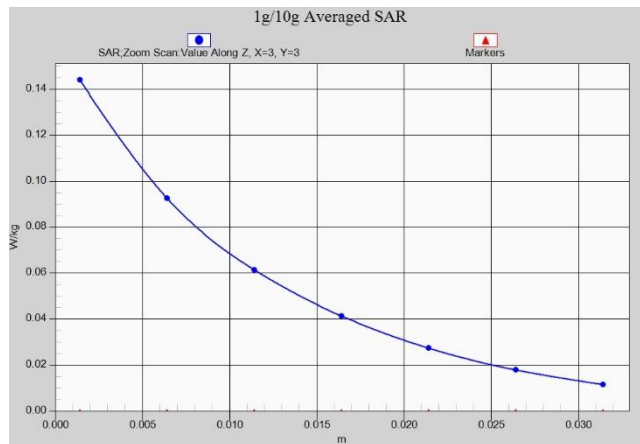

Fig. 1-3 Z-Scan at power reference point (PCS1900)

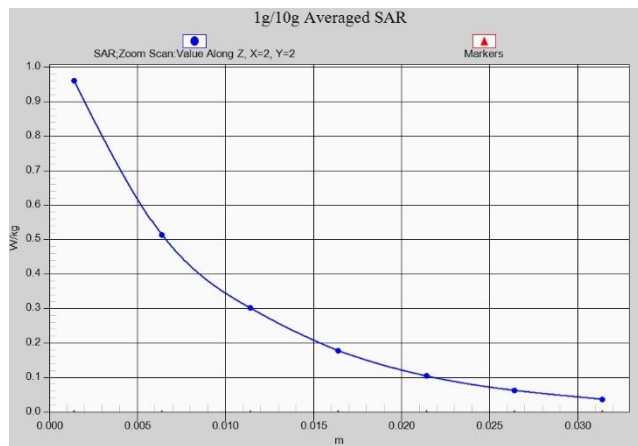

Fig. 1-4 Z-Scan at power reference point (PCS1900)

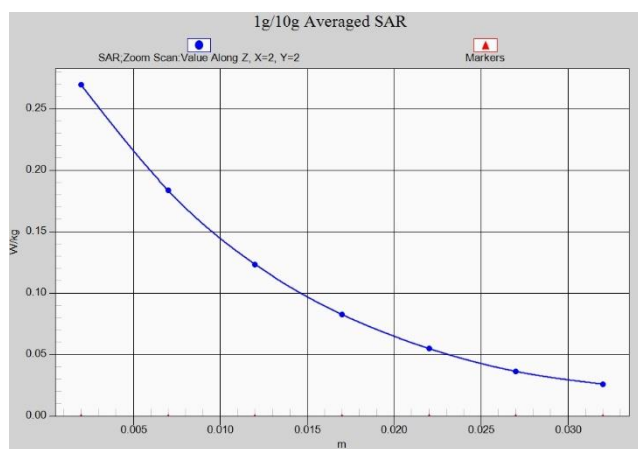

Fig. 1-5 Z-Scan at power reference point (WCDMA1900)

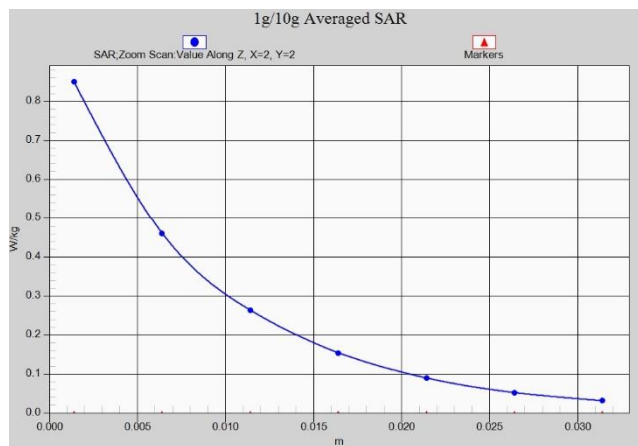

Fig. 1-6 Z-Scan at power reference point (WCDMA1900)

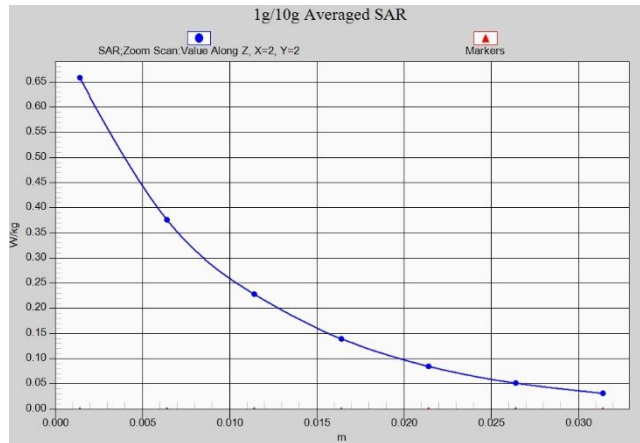

Fig. 1-7 Z-Scan at power reference point (WCDMA1900)

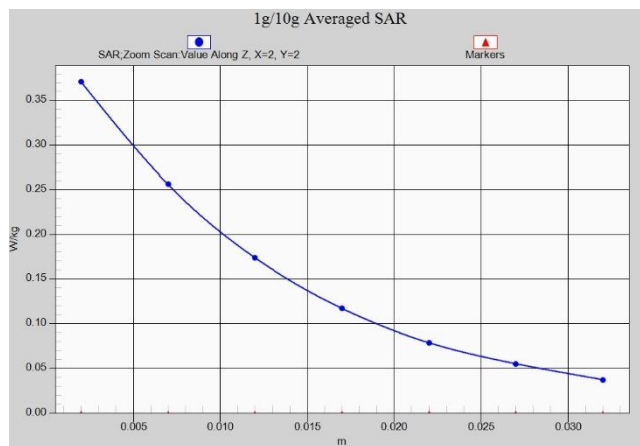

Fig. 1-8 Z-Scan at power reference point (WCDMA1700)

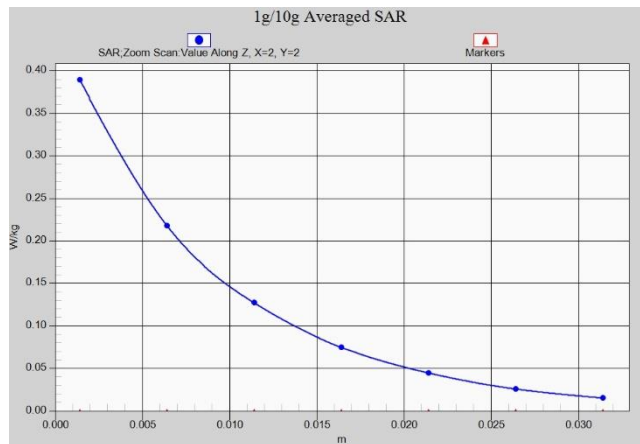

Fig. 1-9 Z-Scan at power reference point (WCDMA1700)

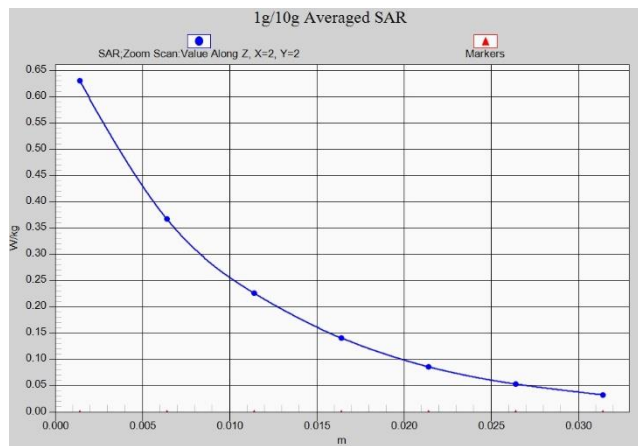

Fig. 1-10 Z-Scan at power reference point (WCDMA1700)

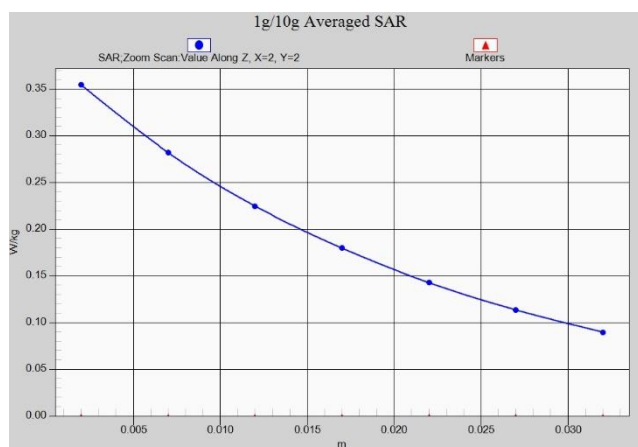

Fig. 1-11 Z-Scan at power reference point (WCDMA850)



Fig. 1-12 Z-Scan at power reference point (WCDMA850)

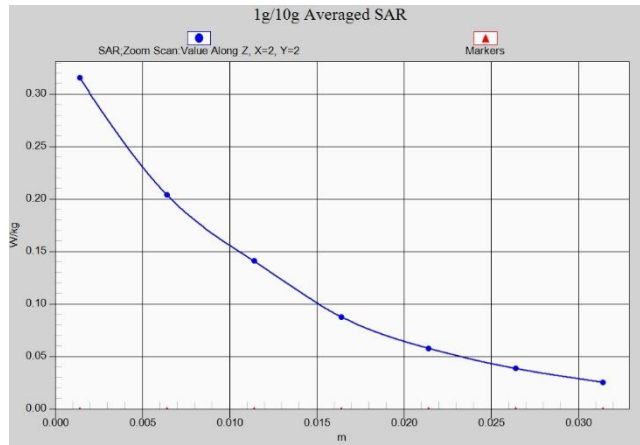

Fig. 1-13 Z-Scan at power reference point (LTE Band2)

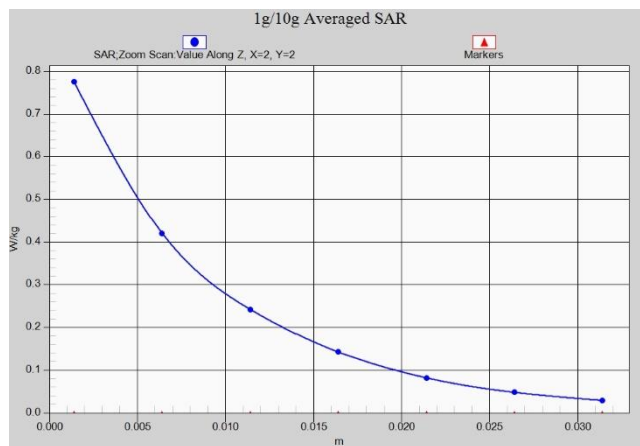

Fig. 1-14 Z-Scan at power reference point (LTE Band2)

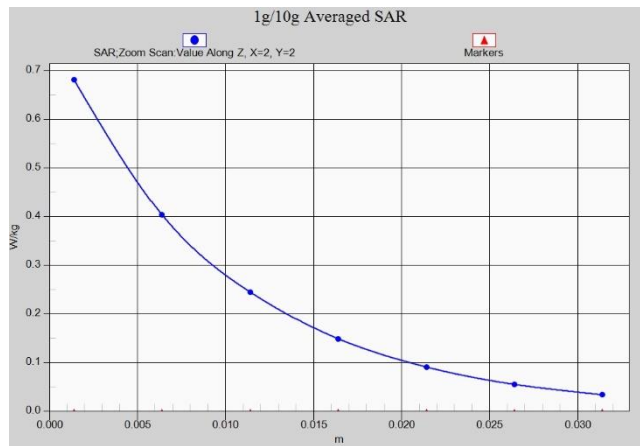

Fig. 1-15 Z-Scan at power reference point (LTE Band2)

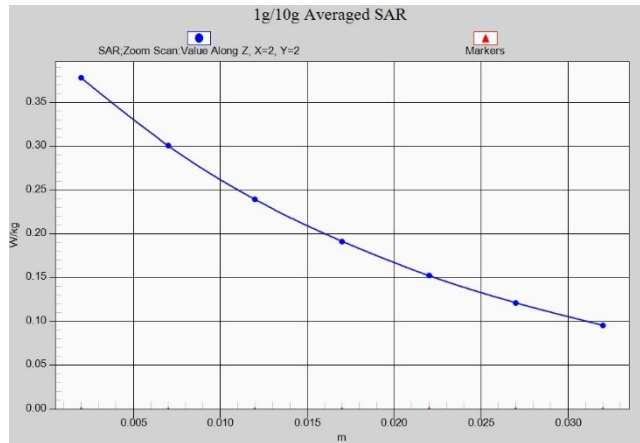

Fig. 1-16 Z-Scan at power reference point (LTE Band5)



Fig. 1-17 Z-Scan at power reference point (LTE Band5)

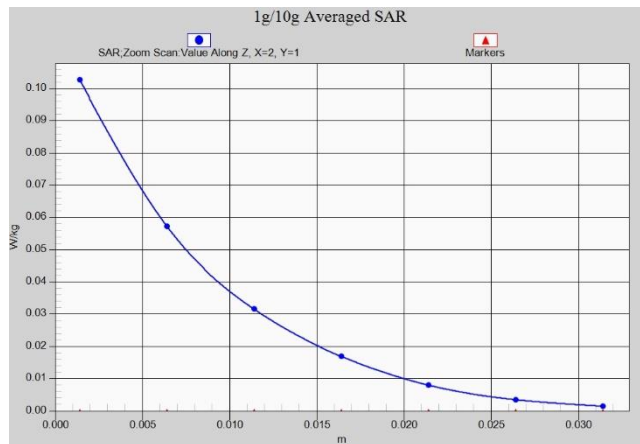

Fig. 1-18 Z-Scan at power reference point (LTE Band7)

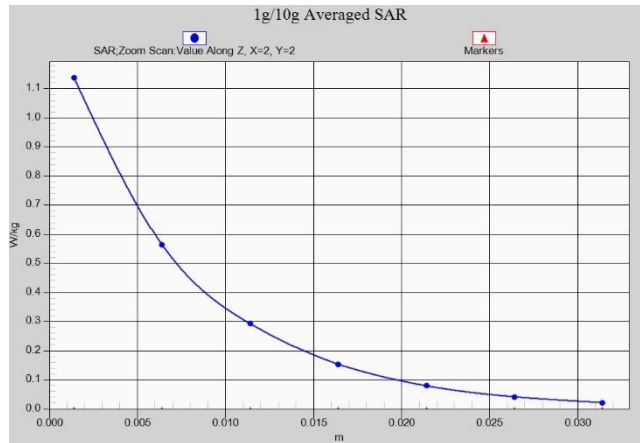

Fig. 1-19 Z-Scan at power reference point (LTE Band7)

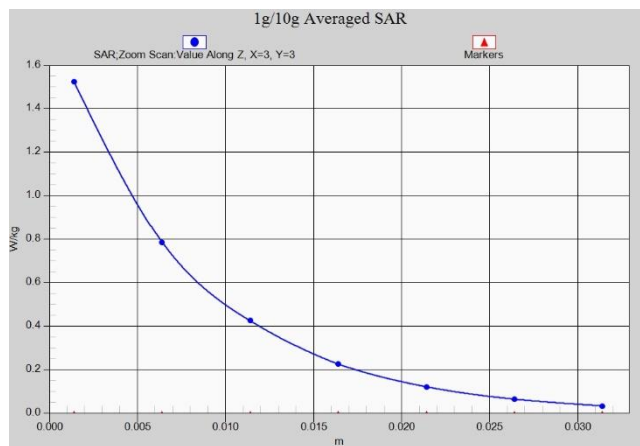

Fig. 1-20 Z-Scan at power reference point (LTE Band7)

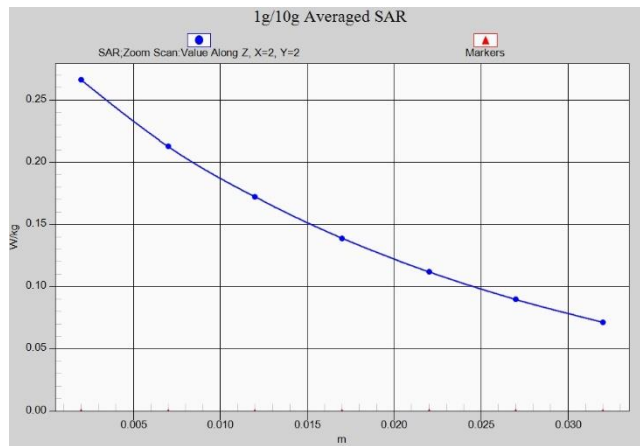

Fig. 1-21 Z-Scan at power reference point (LTE Band13)

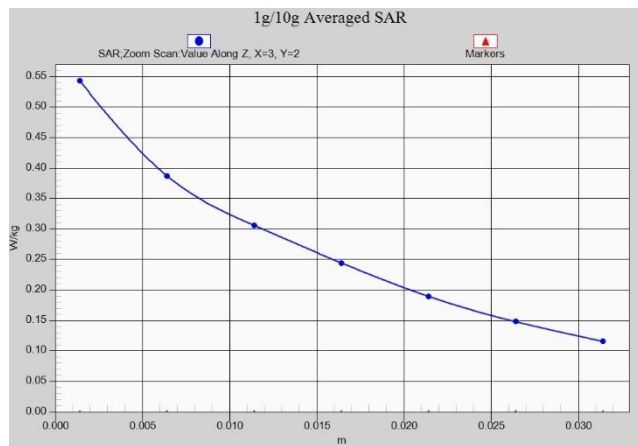

Fig. 1-22 Z-Scan at power reference point (LTE Band13)

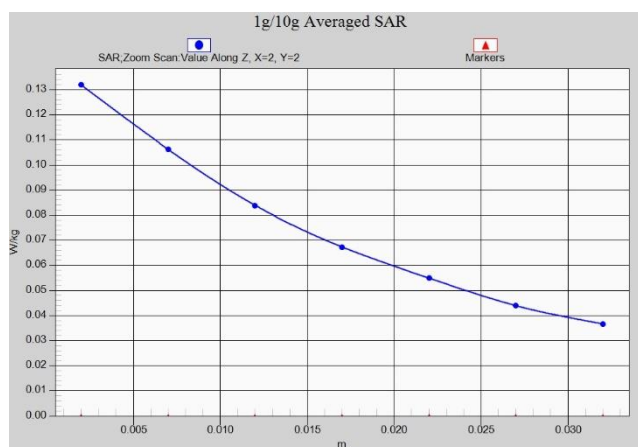

Fig. 1-23 Z-Scan at power reference point (LTE Band17)



Fig. 1-24 Z-Scan at power reference point (LTE Band17)

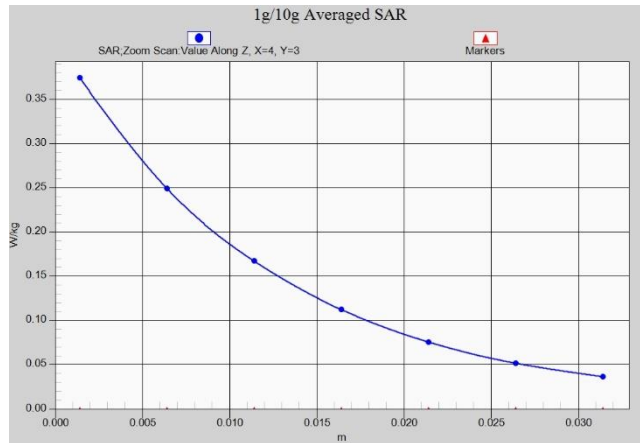

Fig. 1-25 Z-Scan at power reference point (LTE Band66)

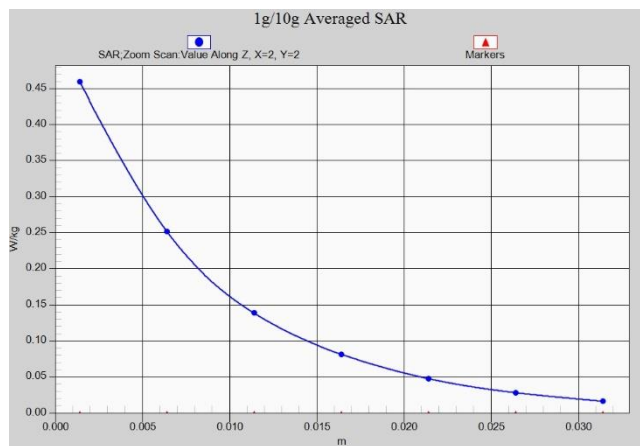

Fig. 1-26 Z-Scan at power reference point (LTE Band66)

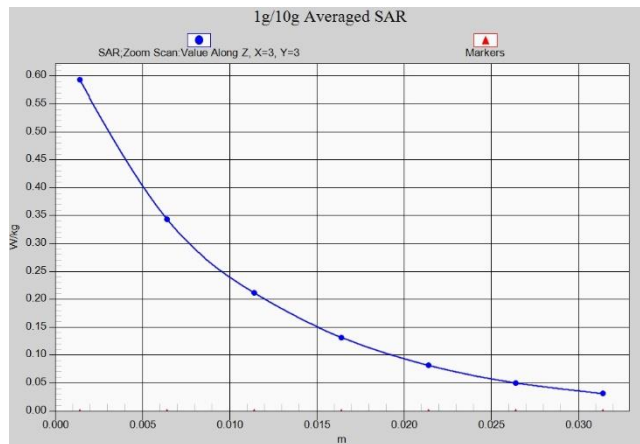

Fig. 1-27 Z-Scan at power reference point (LTE Band66)

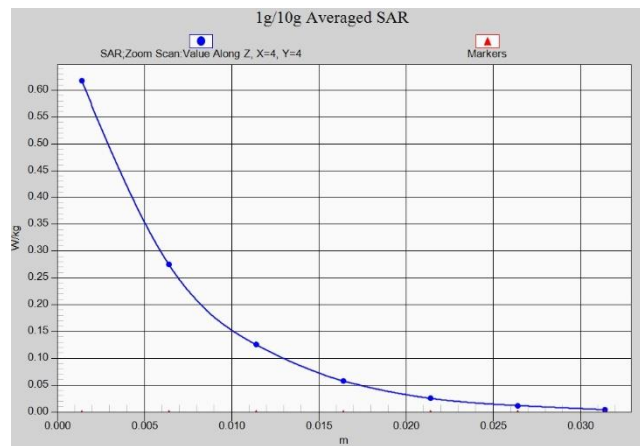

Fig. 1-28 Z-Scan at power reference point (2450 MHz)

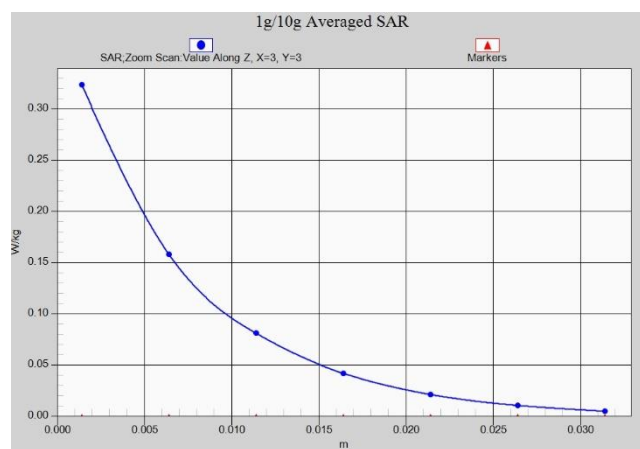

Fig. 1-29 Z-Scan at power reference point (2450 MHz)

ANNEX B System Verification Results

750 MHz

Date: 11/19/2019

Electronics: DAE4 Sn771

Medium: Head 750 MHz

Medium parameters used: $f = 750 \text{ MHz}$; $\sigma = 0.898 \text{ mho/m}$; $\epsilon_r = 41.7$; $\rho = 1000 \text{ kg/m}^3$

Ambient Temperature: 22.5°C Liquid Temperature: 22.3°C

Communication System: CW Frequency: 750 MHz Duty Cycle: 1:1

Probe: EX3DV4 – SN3617 ConvF(10.03,10.03,10.03)

System Validation /Area Scan (81x191x1): Interpolated grid: $dx=1.000 \text{ mm}$, $dy=1.000 \text{ mm}$

Reference Value = 60.78 V/m ; Power Drift = 0.03

Fast SAR: SAR(1 g) = 2.11 W/kg ; SAR(10 g) = 1.42 W/kg

Maximum value of SAR (interpolated) = 2.78 W/kg

System Validation /Zoom Scan (7x7x7)/Cube 0: Measurement grid: $dx=5\text{mm}$, $dy=5\text{mm}$, $dz=5\text{mm}$

Reference Value = 60.78 V/m ; Power Drift = 0.03 dB

Peak SAR (extrapolated) = 3.16 W/kg

SAR(1 g) = 2.14 W/kg ; SAR(10 g) = 1.38 W/kg

Maximum value of SAR (measured) = 2.83 W/kg

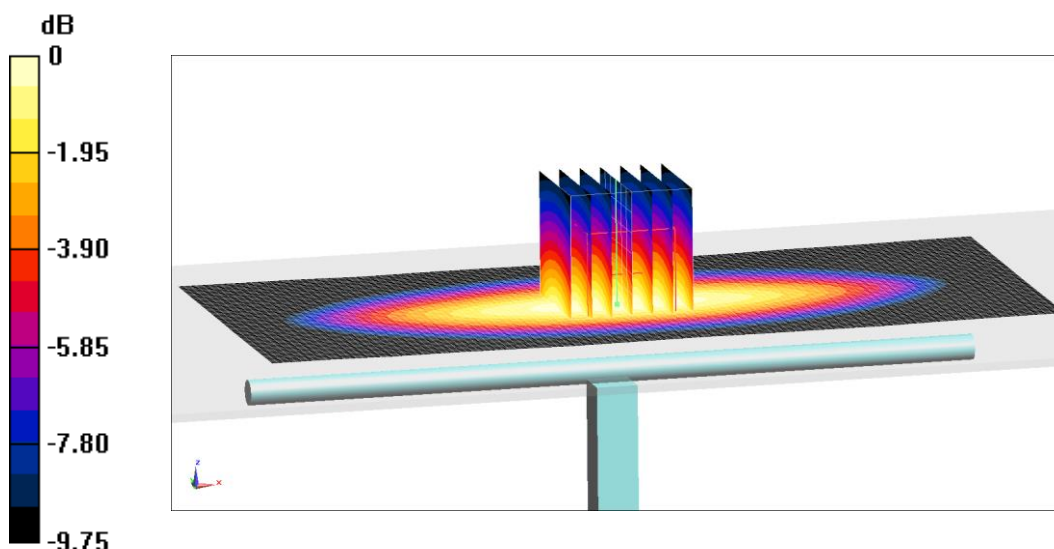

0 dB = $2.83 \text{ W/kg} = 4.52 \text{ dB W/kg}$

Fig.B.1 validation 750 MHz 250mW

835 MHz

Date: 11/20/2019

Electronics: DAE4 Sn771

Medium: Head 835 MHz

Medium parameters used: $f = 835 \text{ MHz}$; $\sigma = 0.901 \text{ mho/m}$; $\epsilon_r = 41.6$; $\rho = 1000 \text{ kg/m}^3$

Ambient Temperature: 22.5°C Liquid Temperature: 22.3°C

Communication System: CW Frequency: 835 MHz Duty Cycle: 1:1

Probe: EX3DV4 – SN3617 ConvF(9.75,9.75,9.75)

System Validation /Area Scan (81x191x1): Interpolated grid: $dx=1.000 \text{ mm}$, $dy=1.000 \text{ mm}$

Reference Value = 63.88 V/m; Power Drift = 0.04

Fast SAR: SAR(1 g) = 2.42 W/kg; SAR(10 g) = 1.56 W/kg

Maximum value of SAR (interpolated) = 3.16 W/kg

System Validation /Zoom Scan (7x7x7)/Cube 0: Measurement grid: $dx=5\text{mm}$, $dy=5\text{mm}$, $dz=5\text{mm}$

Reference Value = 63.88 V/m; Power Drift = 0.04 dB

Peak SAR (extrapolated) = 3.62 W/kg

SAR(1 g) = 2.45 W/kg; SAR(10 g) = 1.57 W/kg

Maximum value of SAR (measured) = 3.26 W/kg

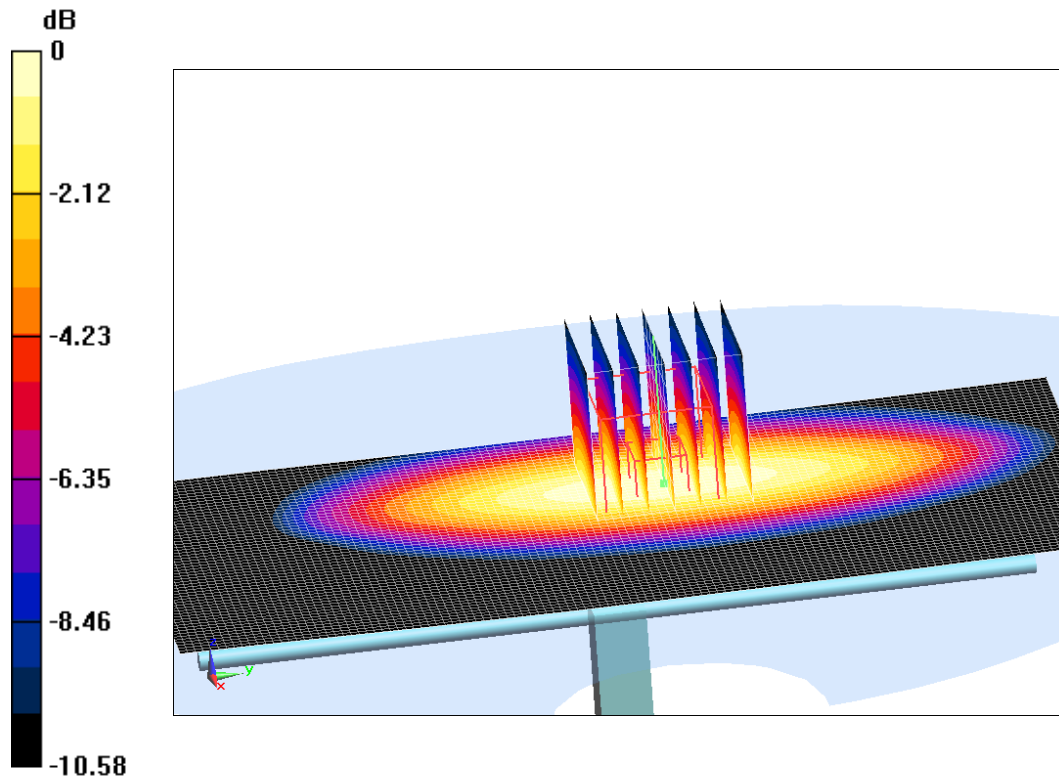

0 dB = 3.26 W/kg = 5.13 dB W/kg

Fig.B.2 validation 835 MHz 250mW

1750 MHz

Date: 11/21/2019

Electronics: DAE4 Sn771

Medium: Head 1750 MHz

Medium parameters used: $f = 1750$ MHz; $\sigma = 1.38$ mho/m; $\epsilon_r = 40.68$; $\rho = 1000$ kg/m³

Ambient Temperature: 22.5°C Liquid Temperature: 22.3°C

Communication System: CW Frequency: 1750 MHz Duty Cycle: 1:1

Probe: EX3DV4 – SN3617 ConvF(8.38,8.38,8.38)

System Validation /Area Scan (81x191x1): Interpolated grid: dx=1.000 mm, dy=1.000 mm

Reference Value = 104.5 V/m; Power Drift = 0.06

Fast SAR: SAR(1 g) = 9.03 W/kg; SAR(10 g) = 4.83 W/kg

Maximum value of SAR (interpolated) = 14.31 W/kg

System Validation /Zoom Scan (7x7x7)/Cube 0: Measurement grid: dx=5mm, dy=5mm, dz=5mm

Reference Value = 104.5 V/m; Power Drift = 0.06 dB

Peak SAR (extrapolated) = 16.53 W/kg

SAR(1 g) = 9.01 W/kg; SAR(10 g) = 4.85 W/kg

Maximum value of SAR (measured) = 13.9 W/kg

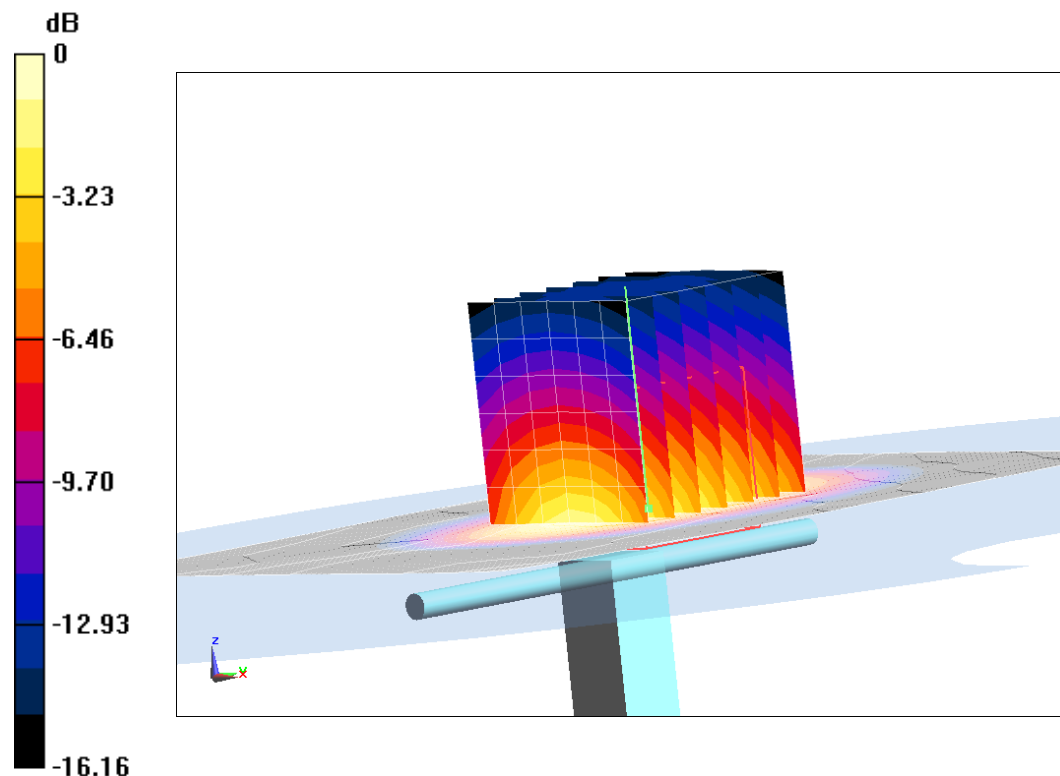

0 dB = 13.9 W/kg = 11.43 dB W/kg

Fig.B.3 validation 1750 MHz 250mW

1900 MHz

Date: 11/22/2019

Electronics: DAE4 Sn771

Medium: Head 1900 MHz

Medium parameters used: $f = 1900$ MHz; $\sigma = 1.39$ mho/m; $\epsilon_r = 39.55$; $\rho = 1000$ kg/m³

Ambient Temperature: 22.5°C Liquid Temperature: 22.3°C

Communication System: CW Frequency: 1900 MHz Duty Cycle: 1:1

Probe: EX3DV4 – SN3617 ConvF(8.14,8.14,8.14)

System Validation /Area Scan (81x191x1): Interpolated grid: dx=1.000 mm, dy=1.000 mm

Reference Value = 107.26 V/m; Power Drift = 0.02

Fast SAR: SAR(1 g) = 9.96 W/kg; SAR(10 g) = 5.2 W/kg

Maximum value of SAR (interpolated) = 15.34 W/kg

System Validation /Zoom Scan (7x7x7)/Cube 0: Measurement grid: dx=5mm, dy=5mm, dz=5mm

Reference Value = 107.26 V/m; Power Drift = 0.02 dB

Peak SAR (extrapolated) = 17.52 W/kg

SAR(1 g) = 10.07 W/kg; SAR(10 g) = 5.15 W/kg

Maximum value of SAR (measured) = 14.81 W/kg

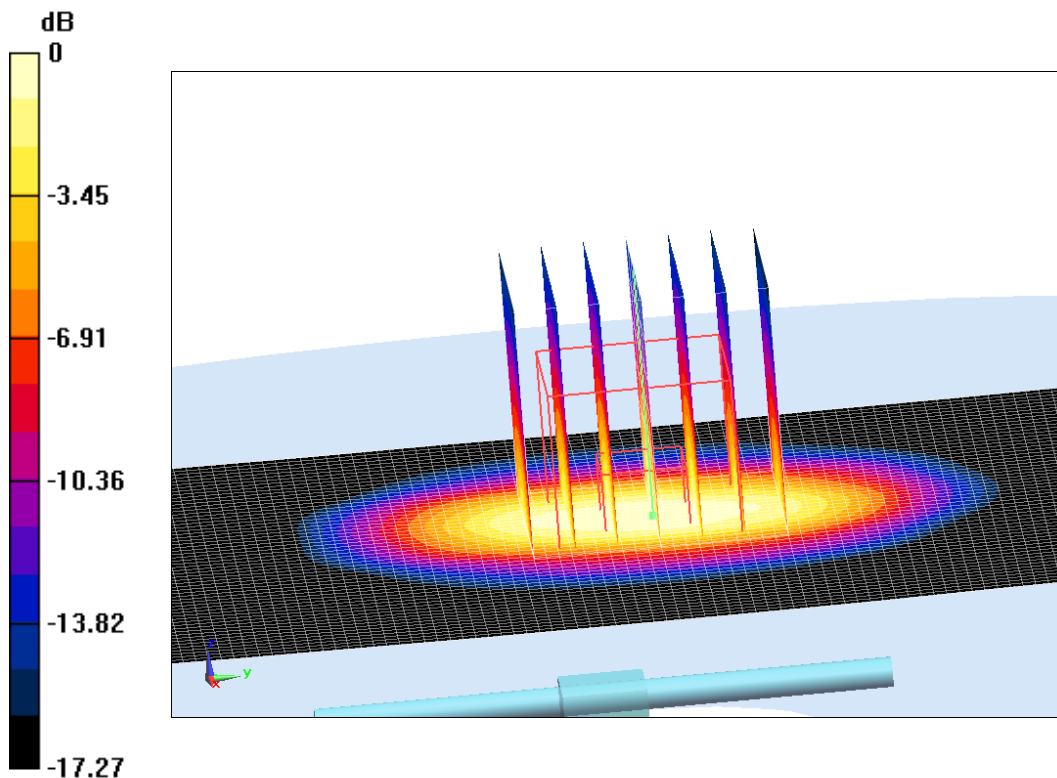

0 dB = 14.81 W/kg = 11.71 dB W/kg

Fig.B.4 validation 1900 MHz 250mW

2450 MHz

Date: 11/23/2019

Electronics: DAE4 Sn771

Medium: Head 2450 MHz

Medium parameters used: $f = 2450$ MHz; $\sigma = 1.784$ mho/m; $\epsilon_r = 39.05$; $\rho = 1000$ kg/m³

Ambient Temperature: 22.5°C Liquid Temperature: 22.3°C

Communication System: CW Frequency: 2450 MHz Duty Cycle: 1:1

Probe: EX3DV4 – SN3617 ConvF(7.62,7.62,7.62)

System Validation /Area Scan (81x191x1): Interpolated grid: dx=1.000 mm, dy=1.000 mm

Reference Value = 116.72 V/m; Power Drift = -0.08

Fast SAR: SAR(1 g) = 12.8 W/kg; SAR(10 g) = 5.97 W/kg

Maximum value of SAR (interpolated) = 21.99 W/kg

System Validation /Zoom Scan (7x7x7)/Cube 0: Measurement grid: dx=5mm, dy=5mm, dz=5mm

Reference Value = 116.72 V/m; Power Drift = -0.08 dB

Peak SAR (extrapolated) = 25.53 W/kg

SAR(1 g) = 13.14 W/kg; SAR(10 g) = 6.16 W/kg

Maximum value of SAR (measured) = 21.92 W/kg

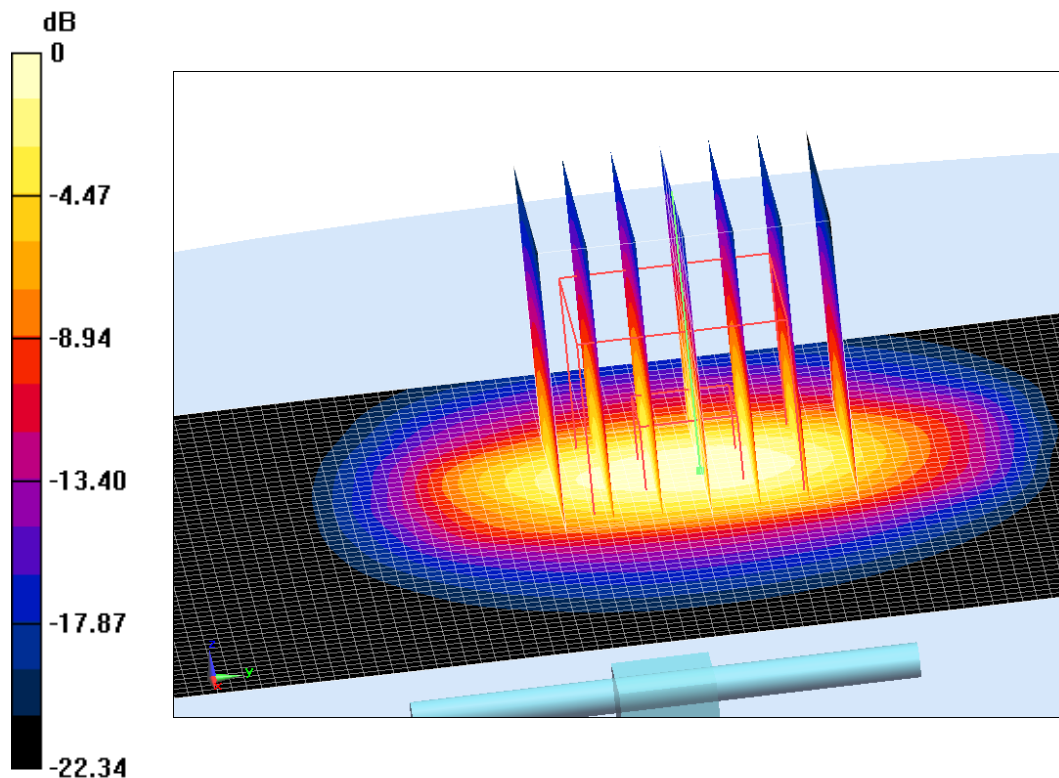

0 dB = 21.92 W/kg = 13.41 dB W/kg

Fig.B.5 validation 2450 MHz 250mW

2600 MHz

Date: 11/23/2019

Electronics: DAE4 Sn771

Medium: Head 2600 MHz

Medium parameters used: $f = 2600$ MHz; $\sigma = 1.966$ mho/m; $\epsilon_r = 39.57$; $\rho = 1000$ kg/m³

Ambient Temperature: 22.5°C Liquid Temperature: 22.3°C

Communication System: CW Frequency: 2600 MHz Duty Cycle: 1:1

Probe: EX3DV4 – SN3617 ConvF(7.19,7.19,7.19)

System Validation /Area Scan (81x191x1): Interpolated grid: dx=1.000 mm, dy=1.000 mm

Reference Value = 118.31 V/m; Power Drift = -0.05

Fast SAR: SAR(1 g) = 13.82 W/kg; SAR(10 g) = 6.2 W/kg

Maximum value of SAR (interpolated) = 25.14 W/kg

System Validation /Zoom Scan (7x7x7)/Cube 0: Measurement grid: dx=5mm, dy=5mm, dz=5mm

Reference Value = 118.31 V/m; Power Drift = -0.05 dB

Peak SAR (extrapolated) = 28.68 W/kg

SAR(1 g) = 14.17 W/kg; SAR(10 g) = 6.31 W/kg

Maximum value of SAR (measured) = 23.74 W/kg

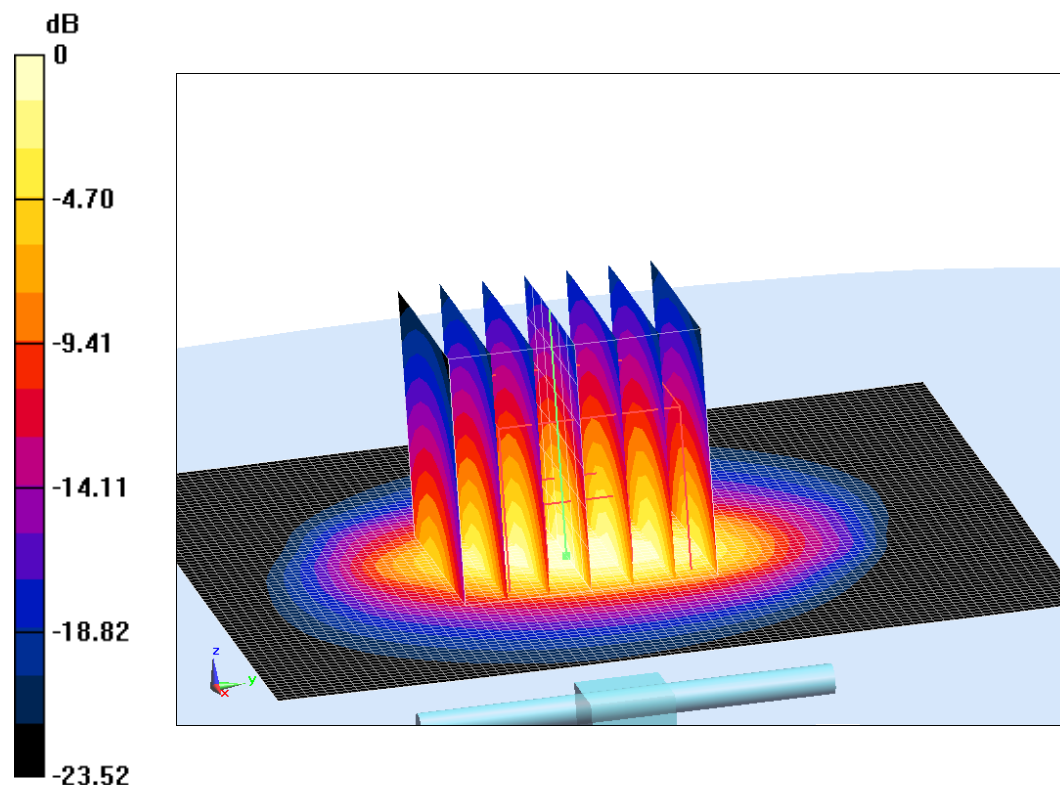

0 dB = 23.74 W/kg = 13.75 dB W/kg

Fig.B.6 validation 2600 MHz 250mW



The SAR system verification must be required that the area scan estimated 1-g SAR is within 3% of the zoom scan 1-g SAR.

Table B.1 Comparison between area scan and zoom scan for system verification

Date	Band	Position	Area scan (1g)	Zoom scan (1g)	Drift (%)
2019-11-19	750	Head	2.11	2.14	-1.40
2019-11-20	835	Head	2.42	2.45	-1.22
2019-11-21	1750	Head	9.03	9.01	0.22
2019-11-22	1900	Head	9.96	10.07	-1.09
2019-11-23	2300	Head	12.8	13.14	-2.59
2019-11-23	2450	Head	13.82	14.17	-2.47

ANNEX C SAR Measurement Setup

C.1 Measurement Set-up

The Dasy4 or DASY5 system for performing compliance tests is illustrated above graphically. This system consists of the following items:

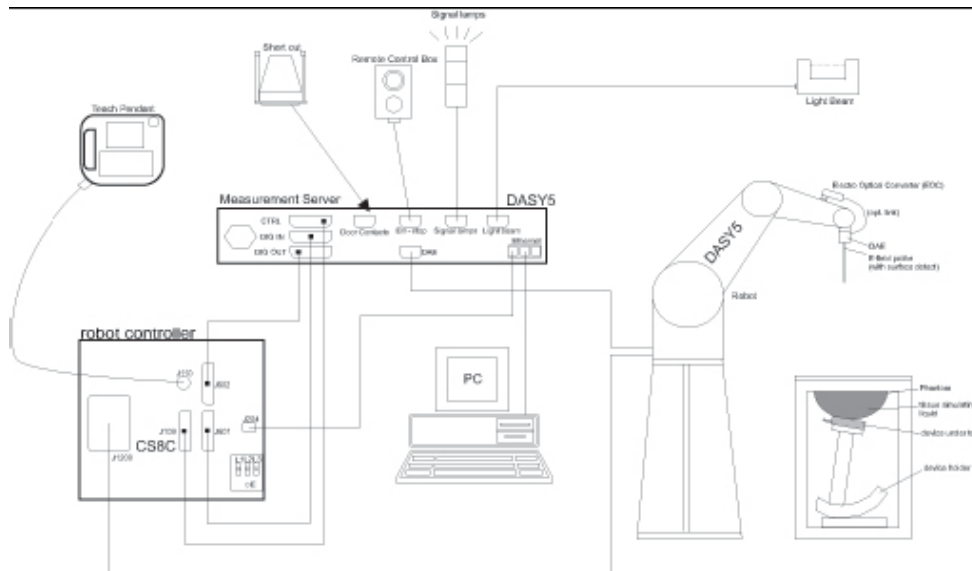

Picture C.1 SAR Lab Test Measurement Set-up

- A standard high precision 6-axis robot (Stäubli TX=RX family) with controller, teach pendant and software. An arm extension for accommodating the data acquisition electronics (DAE).
- An isotropic field probe optimized and calibrated for the targeted measurement.
- A data acquisition electronics (DAE) which performs the signal amplification, signal multiplexing, AD-conversion, offset measurements, mechanical surface detection, collision detection, etc. The unit is battery powered with standard or rechargeable batteries. The signal is optically transmitted to the EOC.
- The Electro-optical converter (EOC) performs the conversion from optical to electrical signals for the digital communication to the DAE. To use optical surface detection, a special version of the EOC is required. The EOC signal is transmitted to the measurement server.
- The function of the measurement server is to perform the time critical tasks such as signal filtering, control of the robot operation and fast movement interrupts.
- The Light Beam used is for probe alignment. This improves the (absolute) accuracy of the probe positioning.
- A computer running WinXP and the DASY4 or DASY5 software.
- Remote control and teach pendant as well as additional circuitry for robot safety such as
- warning lamps, etc.
- The phantom, the device holder and other accessories according to the targeted measurement.

C.2 Dasy4 or DASY5 E-field Probe System

The SAR measurements were conducted with the dosimetric probe designed in the classical triangular configuration and optimized for dosimetric evaluation. The probe is constructed using the thick film technique; with printed resistive lines on ceramic substrates. The probe is equipped with an optical multifiber line ending at the front of the probe tip. It is connected to the EOC box on the robot arm and provides an automatic detection of the phantom surface. Half of the fibers are connected to a pulsed infrared transmitter, the other half to a synchronized receiver. As the probe approaches the surface, the reflection from the surface produces a coupling from the transmitting to the receiving fibers. This reflection increases first during the approach, reaches maximum and then decreases. If the probe is flatly touching the surface, the coupling is zero. The distance of the coupling maximum to the surface is independent of the surface reflectivity and largely independent of the surface to probe angle. The DASY4 or DASY5 software reads the reflection during a software approach and looks for the maximum using 2nd ord curve fitting. The approach is stopped at reaching the maximum.

Probe Specifications:

Model:	ES3DV3, EX3DV4
Frequency	10MHz — 6.0GHz(EX3DV4)
Range:	10MHz — 4GHz(ES3DV3)
Calibration:	In head and body simulating tissue at Frequencies from 835 up to 5800MHz
Linearity:	± 0.2 dB(30 MHz to 6 GHz) for EX3DV4 ± 0.2 dB(30 MHz to 4 GHz) for ES3DV3
DynamicRange:	10 mW/kg — 100W/kg
Probe Length:	330 mm
Probe Tip	
Length:	20 mm
Body Diameter:	12 mm
Tip Diameter:	2.5 mm (3.9 mm for ES3DV3)
Tip-Center:	1 mm (2.0mm for ES3DV3)
Application:	SAR Dosimetry Testing Compliance tests of mobile phones Dosimetry in strong gradient fields



Picture C.2 Near-field Probe



Picture C.3 E-field Probe

C.3 E-field Probe Calibration

Each E-Probe/Probe Amplifier combination has unique calibration parameters. A TEM cell calibration procedure is conducted to determine the proper amplifier settings to enter in the probe parameters. The amplifier settings are determined for a given frequency by subjecting the probe to a known E-field density (1 mW/cm²) using an RF Signal generator, TEM cell, and RF Power Meter.

The free space E-field from amplified probe outputs is determined in a test chamber. This calibration can be performed in a TEM cell if the frequency is below 1 GHz and in a waveguide or

other methodologies above 1 GHz for free space. For the free space calibration, the probe is placed in the volumetric center of the cavity and at the proper orientation with the field. The probe is then rotated 360 degrees until the three channels show the maximum reading. The power density readings equates to 1 mW/cm².

E-field temperature correlation calibration is performed in a flat phantom filled with the appropriate simulated brain tissue. The E-field in the medium correlates with the temperature rise in the dielectric medium. For temperature correlation calibration a RF transparent thermistor-based temperature probe is used in conjunction with the E-field probe.

$$SAR = C \frac{\Delta T}{\Delta t}$$

Where:

Δt = Exposure time (30 seconds),

C = Heat capacity of tissue (brain or muscle),

ΔT = Temperature increase due to RF exposure.

$$SAR = \frac{|E|^2 \cdot \sigma}{\rho}$$

Where:

σ = Simulated tissue conductivity,

ρ = Tissue density (kg/m³).

C.4 Other Test Equipment

C.4.1 Data Acquisition Electronics(DAE)

The data acquisition electronics consist of a highly sensitive electrometer-grade preamplifier with auto-zeroing, a channel and gain-switching multiplexer, a fast 16 bit AD-converter and a command decoder with a control logic unit. Transmission to the measurement server is accomplished through an optical downlink for data and status information, as well as an optical uplink for commands and the clock.

The mechanical probe mounting device includes two different sensor systems for frontal and sideways probe contacts. They are used for mechanical surface detection and probe collision detection.

The input impedance of the DAE is 200 MOhm; the inputs are symmetrical and floating. Common mode rejection is above 80 dB.



PictureC.4: DAE

C.4.2 Robot

The SPEAG DASY system uses the high precision robots (DASY4: RX90XL; DASY5: RX160L) type from Stäubli SA (France). For the 6-axis controller system, the robot controller version from Stäubli is used. The Stäubli robot series have many features that are important for our application:

- High precision (repeatability 0.02mm)
- High reliability (industrial design)
- Low maintenance costs (virtually maintenance free due to direct drive gears; no belt drives)
- Jerk-free straight movements (brushless synchron motors; no stepper motors)
- Low ELF interference (motor control fields shielded via the closed metallic construction shields)



Picture C.5 DASY 4



Picture C.6 DASY 5

C.4.3 Measurement Server

The Measurement server is based on a PC/104 CPU board with CPU (dasy4: 166 MHz, Intel Pentium; DASY5: 400 MHz, Intel Celeron), chipdisk (DASY4: 32 MB; DASY5: 128MB), RAM (DASY4: 64 MB, DASY5: 128MB). The necessary circuits for communication with the DAE electronic box, as well as the 16 bit AD converter system for optical detection and digital I/O interface are contained on the DASY I/O board, which is directly connected to the PC/104 bus of the CPU board.

The measurement server performs all real-time data evaluation of field measurements and surface detection, controls robot movements and handles safety operation. The PC operating system cannot interfere with these time critical processes. All connections are supervised by a watchdog, and disconnection of any of the cables to the measurement server will automatically disarm the robot and disable all program-controlled robot movements. Furthermore, the measurement server is equipped with an expansion port which is reserved for future applications. Please note that this expansion port does not have a standardized pinout, and therefore only devices provided by SPEAG can be connected. Devices from any other supplier could seriously damage the measurement server.



Picture C.7 Server for DASY 4



Picture C.8 Server for DASY 5

C.4.4 Device Holder for Phantom

The SAR in the phantom is approximately inversely proportional to the square of the distance between the source and the liquid surface. For a source at 5mm distance, a positioning uncertainty of $\pm 0.5\text{mm}$ would produce a SAR uncertainty of $\pm 20\%$. Accurate device positioning is therefore crucial for accurate and repeatable measurements. The positions in which the devices must be measured are defined by the standards.

The DASY device holder is designed to cope with the different positions given in the standard. It has two scales for device rotation (with respect to the body axis) and device inclination (with respect to the line between the ear reference points). The rotation centers for both scales are the ear reference point (ERP). Thus the device needs no repositioning when changing the angles. The DASY device holder is constructed of low-loss POM material having the following dielectric parameters: relative permittivity $\epsilon = 3$ and loss tangent $\delta = 0.02$. The amount of dielectric material has been reduced in the closest vicinity of the device, since measurements have suggested that the influence of the clamp on the test results could thus be lowered.

<Laptop Extension Kit>

The extension is lightweight and made of POM, acrylic glass and foam. It fits easily on the upper part of the Mounting Device in place of the phone positioner. The extension is fully compatible with the Twin-SAM and ELI phantoms.



Picture C.9-1: Device Holder

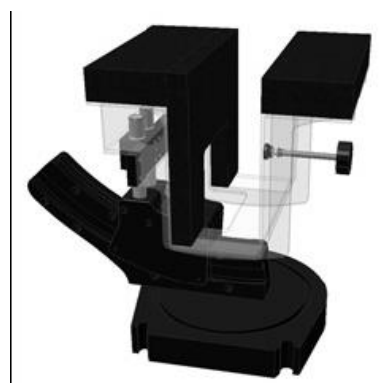

Picture C.9-2: Laptop Extension Kit

C.4.5 Phantom

The SAM Twin Phantom V4.0 is constructed of a fiberglass shell integrated in a table. The shape of the shell is based on data from an anatomical study designed to represent the 90th percentile of the population. The phantom enables the dissymmetric evaluation

of SAR for both left and right handed handset usage, as well as body-worn usage using the flat phantom region. Reference markings on the Phantom allow the complete setup of all predefined phantom positions and measurement grids by manually teaching three points in the robot. The shell phantom has a 2mm shell thickness (except the ear region where shell thickness increases to 6 mm).

Shell Thickness: 2 ± 0.2 mm

Filling Volume: Approx. 25 liters

Dimensions: 810 x 1000 x 500 mm (H x L x W)

Available: Special



Picture C.10: SAM Twin Phantom

ANNEX D Position of the wireless device in relation to the phantom

D.1 General considerations

This standard specifies two handset test positions against the head phantom – the “cheek” position and the “tilt” position.

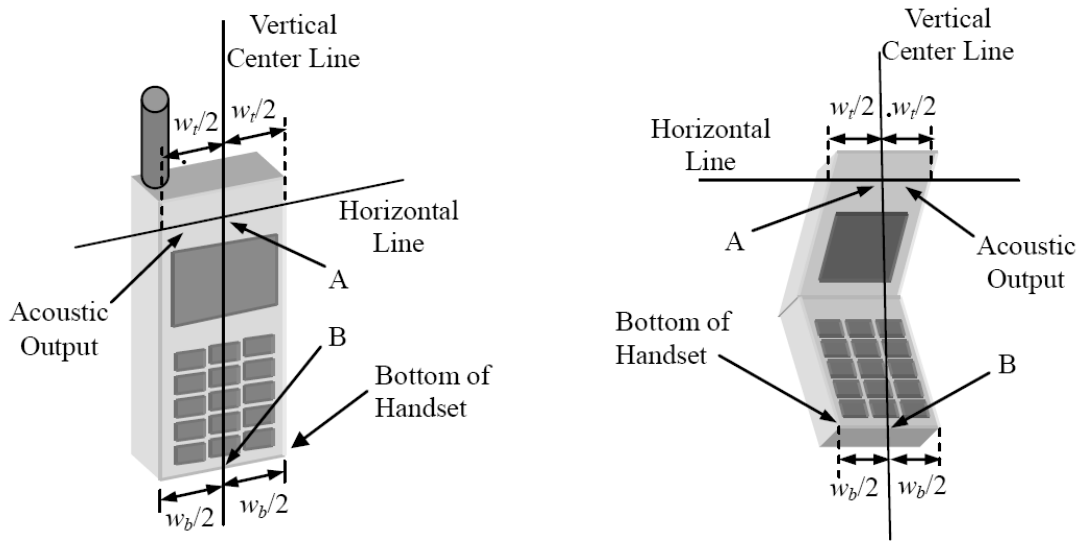

- w_t Width of the handset at the level of the acoustic
- w_b Width of the bottom of the handset
- A Midpoint of the width w_t of the handset at the level of the acoustic output
- B Midpoint of the width w_b of the bottom of the handset

Picture D.1-a Typical “fixed” case handset Picture D.1-b Typical “clam-shell” case handset

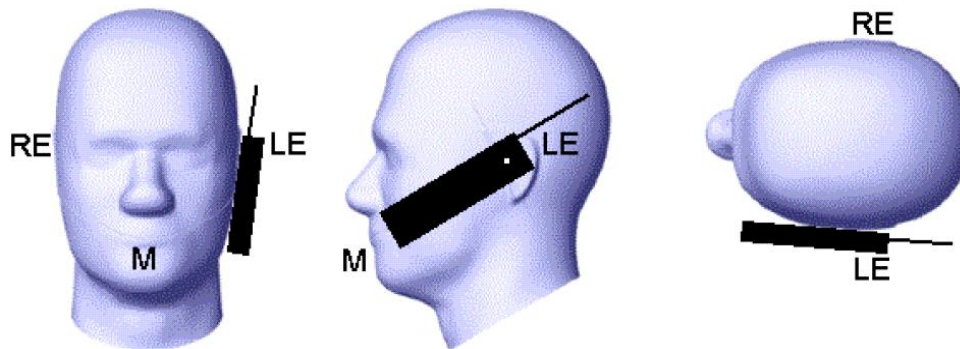

Picture D.2 Cheek position of the wireless device on the left side of SAM

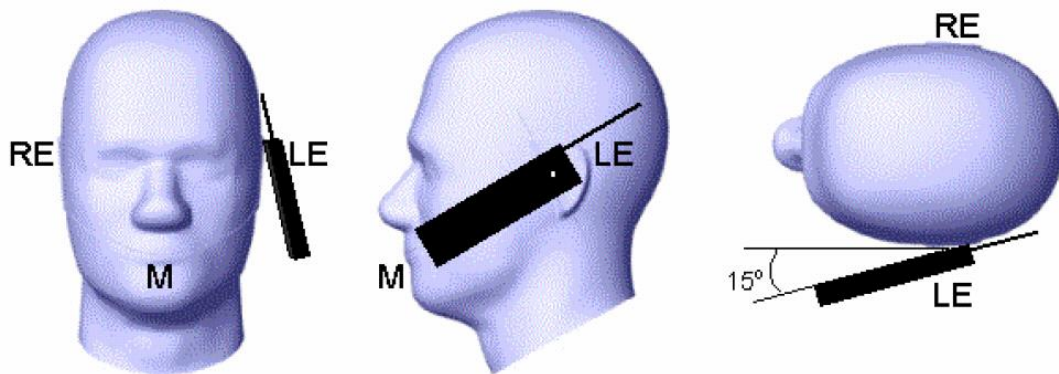

Picture D.3 Tilt position of the wireless device on the left side of SAM

D.2 Body-worn device

A typical example of a body-worn device is a mobile phone, wireless enabled PDA or other battery operated wireless device with the ability to transmit while mounted on a person's body using a carry accessory approved by the wireless device manufacturer.

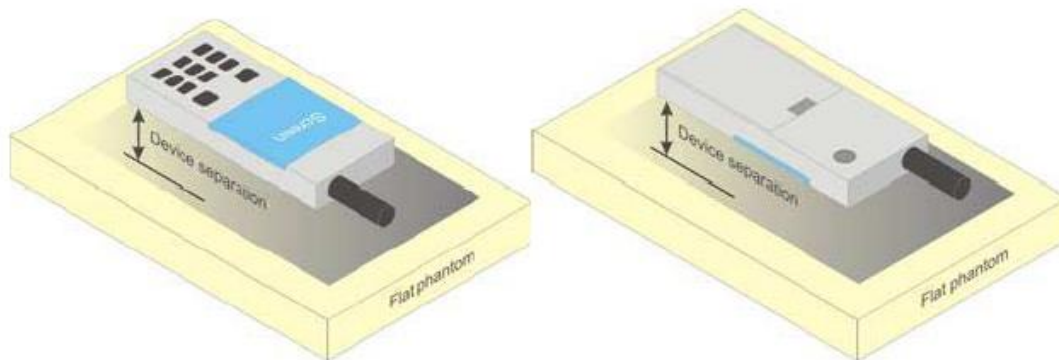

Picture D.4 Test positions for body-worn devices

D.3 Desktop device

A typical example of a desktop device is a wireless enabled desktop computer placed on a table or desk when used.

The DUT shall be positioned at the distance and in the orientation to the phantom that corresponds to the intended use as specified by the manufacturer in the user instructions. For devices that employ an external antenna with variable positions, tests shall be performed for all antenna positions specified. Picture 8.5 show positions for desktop device SAR tests. If the intended use is not specified, the device shall be tested directly against the flat phantom.

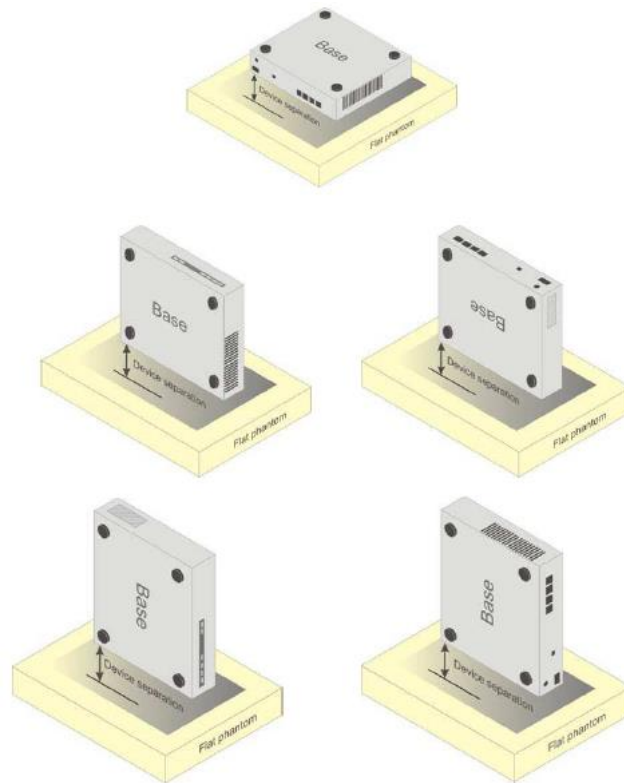

Picture D.5 Test positions for desktop devices

D.4 DUT Setup Photos



Picture D.6

ANNEX E Equivalent Media Recipes

The liquid used for the frequency range of 800-3000 MHz consisted of water, sugar, salt, preventol, glycol monobutyl and Cellulose. The liquid has been previously proven to be suited for worst-case. The Table E.1 shows the detail solution. It's satisfying the latest tissue dielectric parameters requirements proposed by the IEEE 1528 and IEC 62209.

TableE.1: Composition of the Tissue Equivalent Matter

Frequency (MHz)	835Head	835Body	1900 Head	1900 Body	2450 Head	2450 Body	5800 Head	5800 Body
Ingredients (% by weight)								
Water	41.45	52.5	55.242	69.91	58.79	72.60	65.53	65.53
Sugar	56.0	45.0	\	\	\	\	\	\
Salt	1.45	1.4	0.306	0.13	0.06	0.18	\	\
Preventol	0.1	0.1	\	\	\	\	\	\
Cellulose	1.0	1.0	\	\	\	\	\	\
Glycol Monobutyl	\	\	44.452	29.96	41.15	27.22	\	\
Diethylenglycol monohexylether	\	\	\	\	\	\	17.24	17.24
Triton X-100	\	\	\	\	\	\	17.24	17.24
Dielectric Parameters Target Value	$\epsilon=41.5$ $\sigma=0.90$	$\epsilon=55.2$ $\sigma=0.97$	$\epsilon=40.0$ $\sigma=1.40$	$\epsilon=53.3$ $\sigma=1.52$	$\epsilon=39.2$ $\sigma=1.80$	$\epsilon=52.7$ $\sigma=1.95$	$\epsilon=35.3$ $\sigma=5.27$	$\epsilon=48.2$ $\sigma=6.00$

Note: There are a little adjustment respectively for 750, 1750, 2600, 5200, 5300 and 5600 based on the recipe of closest frequency in table E.1.

ANNEX F System Validation

The SAR system must be validated against its performance specifications before it is deployed. When SAR probes, system components or software are changed, upgraded or recalibrated, these must be validated with the SAR system(s) that operates with such components.

Table F.1: System Validation for 3617

Probe SN.	Liquid name	Validation date	Frequency point	Status (OK or Not)
3617	Head 750MHz	Feb.14,2019	750 MHz	OK
3617	Head 850MHz	Feb.14,2019	835 MHz	OK
3617	Head 900MHz	Feb.14,2019	900 MHz	OK
3617	Head 1750MHz	Feb.14,2019	1750 MHz	OK
3617	Head 1810MHz	Feb.14,2019	1810 MHz	OK
3617	Head 1900MHz	Feb.15,2019	1900 MHz	OK
3617	Head 2000MHz	Feb.15,2019	2000 MHz	OK
3617	Head 2100MHz	Feb.15,2019	2100 MHz	OK
3617	Head 2300MHz	Feb.15,2019	2300 MHz	OK
3617	Head 2450MHz	Feb.15,2019	2450 MHz	OK
3617	Head 2600MHz	Feb.16,2019	2600 MHz	OK
3617	Head 3500MHz	Feb.16,2019	3500 MHz	OK
3617	Head 3700MHz	Feb.16,2019	3700 MHz	OK
3617	Head 5200MHz	Feb.16,2019	5250 MHz	OK
3617	Head 5500MHz	Feb.16,2019	5600 MHz	OK
3617	Head 5800MHz	Feb.16,2019	5800 MHz	OK
3617	Body 750MHz	Feb.16,2019	750 MHz	OK
3617	Body 850MHz	Feb.13,2019	835 MHz	OK
3617	Body 900MHz	Feb.13,2019	900 MHz	OK
3617	Body 1750MHz	Feb.13,2019	1750 MHz	OK
3617	Body 1810MHz	Feb.13,2019	1810 MHz	OK
3617	Body 1900MHz	Feb.13,2019	1900 MHz	OK
3617	Body 2000MHz	Feb.17,2019	2000 MHz	OK
3617	Body 2100MHz	Feb.17,2019	2100 MHz	OK
3617	Body 2300MHz	Feb.17,2019	2300 MHz	OK
3617	Body 2450MHz	Feb.17,2019	2450 MHz	OK
3617	Body 2600MHz	Feb.17,2019	2600 MHz	OK
3617	Body 3500MHz	Feb.12,2019	3500 MHz	OK
3617	Body 3700MHz	Feb.12,2019	3700 MHz	OK
3617	Body 5200MHz	Feb.12,2019	5250 MHz	OK
3617	Body 5500MHz	Feb.12,2019	5600 MHz	OK
3617	Body 5800MHz	Feb.12,2019	5800 MHz	OK