



## ***RF-Emission Test Report***

**Report No:** ZR/2019/B0003  
**Applicant:** TCL Communication Ltd.  
**Manufacturer:** TCL Communication Ltd.  
**Product Name:** LTE/WCDMA/GSM mobile phone  
**Model No.(EUT):** 5028D  
**Trade Mark:** alcatel  
**FCC ID:** 2ACCJH117  
**Standards:** ANSI C63.19-2011  
CFR 47 FCC Part 20  
**Date of Receipt:** 2019-11-20  
**Date of Test:** 2019-11-24 to 2019-11-24  
**Date of Issue:** 2019-12-14  
**Test conclusion:** **PASS \***

\* In the configuration tested, the EUT detailed in this report complied with the standards specified above.

Authorized Signature:

Derek Yang

Wireless Laboratory Manager

The manufacturer should ensure that all products in series production are in conformity with the product sample detailed in this report.

If the product in this report is used in any configuration other than that detailed in the report, the manufacturer must ensure the new system complies with all relevant standards. Any mention of SGS International Electrical Approvals or testing done by SGS International Electrical Approvals in connection with, distribution or use of the product described in this report must be approved by SGS International Electrical Approvals in writing.



## REVISION HISTORY

Revision Record				
Version	Chapter	Date	Modifier	Remark
01		2019-12-14		Original

## TEST SUMMARY

Frequency Band	HAC RF Emission Test result*		M-rating
GSM850	E-Field dB(V/m)	42.20	M3
GSM1900	E-Field dB(V/m)	28.28	M4
WCDMA Band II	E-Field dB(V/m)	/	M4
WCDMA Band V	E-Field dB(V/m)	/	M4
LTE Band 5	E-Field dB(V/m)	/	M4
LTE Band 7	E-Field dB(V/m)	/	M4
LTE Band 38	E-Field dB(V/m)	24.53	M4
WiFi 2.4G	E-Field dB(V/m)	/	M4
<b>HAC Rate Category: M3</b>			

**Note:**

- 1) This portable wireless equipment has been shown to be hearing-aid compatible under the above rated category, specified in ANSI/IEEE Std.C63.19-2011 and had been tested in accordance with the specified measurement procedures, Hear-Aid Compatibility is based on the assumption that all production units will be designed electrically identical to the device tested in this report. Test results reported herein relate only to the item(s) tested and are for North American Bands only.
- 2) \*- HAC RF Emission Test for low power exemption according to ANSI C63.19-2011 and HAC RF Emission rating is M4 (Refer to Section 9.3 for details).

**Approved & Released by**

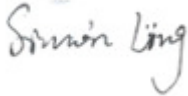

Simon Ling

SAR Manager

**Tested by**

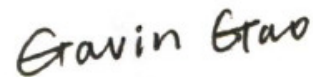

Gavin Gao

SAR Engineer



## CONTENTS

<b>1</b>	<b>General Information</b>	<b>5</b>
1.1	Introduction	5
1.2	Details of Client	5
1.3	Test Location	6
1.4	Test Facility	6
1.5	General Description of EUT	7
1.5.1	DUT Antenna Locations	8
1.5.2	List of air interfaces/frequency bands	9
1.6	Test Specification	10
1.7	ANSI C63.19-2011 limits	10
<b>2</b>	<b>Calibration certificate</b>	<b>10</b>
<b>3</b>	<b>HAC (T Coil) Measurement System</b>	<b>11</b>
3.1	Measurement System Diagram for SPEAG Robotic	11
3.2	E-Field Probe	12
3.3	Test Arch	12
3.4	Phone Holder	12
<b>4</b>	<b>Measurement uncertainty evaluation</b>	<b>13</b>
<b>5</b>	<b>RF Emission Measurements Reference and Plane</b>	<b>14</b>
<b>6</b>	<b>System Verification Procedure</b>	<b>15</b>
6.1	System Check	15
6.2	System Check Result	15
<b>7</b>	<b>Modulation Interference Factor</b>	<b>16</b>
<b>8</b>	<b>HAC Measurement Procedure</b>	<b>17</b>
<b>9</b>	<b>HAC RF Measurement Results</b>	<b>18</b>
9.1	Max Tune-up	18
9.2	Conducted RF Output Power	19
9.3	Low-power Exemption	20
9.4	HAC RF Emission Test Results	21
<b>10</b>	<b>Equipment list</b>	<b>22</b>
<b>11</b>	<b>Calibration certificate</b>	<b>23</b>
<b>12</b>	<b>Photographs</b>	<b>23</b>
	<b>Appendix A: Detailed System Check Results</b>	<b>23</b>
	<b>Appendix B: Detailed Test Results</b>	<b>23</b>
	<b>Appendix C: Calibration certificate</b>	<b>23</b>
	<b>Appendix D: Photographs</b>	<b>23</b>

## 1 General Information

### 1.1 Introduction

The purpose of the Hearing Aid Compatibility is to enable measurements of the near electric fields generated by wireless communication devices in the region controlled for use by a hearing aid in accordance with ANSI-C63.19-2011

The purpose of this standard is to establish categories for hearing aids and for WD (wireless communications devices) that can indicate to health care practitioners and hearing aid users which hearing aids are compatible with which WD, and to provide tests that can be used to assess the electromagnetic characteristics of hearing aids and WD and assign them to these categories. The various parameters required, in order to demonstrate compatibility and accessibility are measured. The design of the standard is such that when a hearing aid and WD achieve one of the categories specified, as measured by the methodology of this standard, the indicated performance is realized.

In order to provide for the usability of a hearing aid with a WD, several factors must be coordinated:

a) Radio frequency (RF) measurements of the near-field electric fields emitted by a WD to categorize these emissions for correlation with the RF immunity of a hearing aid.

Hence, the following are measurements made for the WD:  
RF E-Field emissions

The measurement plane is parallel to, and 1.5cm in front of, the reference plane.

Applications for certification of equipment operation under part 20, that a manufacturer is seeking to certify as hearing aid compatible, as set forth in §20.19 of that part, shall include a statement indication compliance with the test requirements of §20.19 and indicating the appropriate U-rating for the equipment. The manufacturer of the equipment shall be responsible for maintaining the test results.

### 1.2 Details of Client

Applicant:	TCL Communication Ltd.
Address:	5/F, Building 22E, 22 Science Park East Avenue, Hong Kong Science Park, Shatin, NT, Hong Kong
Manufacturer:	TCL Communication Ltd.
Address:	5/F, Building 22E, 22 Science Park East Avenue, Hong Kong Science Park, Shatin, NT, Hong Kong

### 1.3 Test Location

Company: SGS-CSTC Standards Technical Services Co., Ltd. Xian Branch  
Address: Unit D, Building 1, Kanghong Orange Science Park, 137 Keyuan Third Road, Fengdong New Town, Xi'an  
Post code: 710086  
Telephone: +86 512 36836182  
Fax: +86 512 36836182

### 1.4 Test Facility

The test facility is recognized, certified, or accredited by the following organizations:

- **A2LA (Certificate No. 4854.01)**

SGS-CSTC Standards Technical Services Co., Ltd., Xi'an Branch is accredited by the American Association for Laboratory Accreditation(A2LA). Certificate No. 4854.01.

- **FCC –Designation Number: CN1271**

SGS-CSTC Standards Technical Services Co., Ltd., Xi'an Branch has been recognized as an accredited testing laboratory.

Designation Number: CN1271. Test Firm Registration Number: 637380.

- **Innovation, Science and Economic Development Canada**

SGS-CSTC Standards Technical Services Co., Ltd., Xi'an Branch has been recognized by ISED as an accredited testing laboratory.

CAB identifier: CN0095

ISED#: 25613.

## 1.5 General Description of EUT

Device Type :	portable device		
Exposure Category:	uncontrolled environment / general population		
Product Name:	LTE/WCDMA/GSM mobile phone		
Model No.(EUT):	5028D		
Trade Mark:	alcatel		
Product Phase:	production unit		
FCC ID:	2ACCJH117		
SN:	HQ9TTCPB7LXC65V8		
Hardware Version:	PIO		
Software Version:	v4F58		
Antenna Type:	Inner Antenna		
Device Operating Configurations :			
Modulation Mode:	<b>GSM:</b> GMSK, 8PSK; <b>WCDMA:</b> QPSK, 16QAM(HSPA+); <b>LTE:</b> QPSK,16QAM <b>WIFI:</b> DSSS, OFDM <b>BT:</b> GFSK, $\pi/4$ DQPSK,8DPSK		
Device Class:	B		
GPRS Multi-slots Class:	12	EGPRS Multi-slots Class:	12
HSDPA UE Category:	14	HSUPA UE Category	7
DC-HSDPA UE Category:	24		
Power Class	4, tested with power level 5(GSM850)		
	1, tested with power level 0(GSM1900)		
	3, tested with power control "all 1"(WCDMA Band II/V)		
	3, tested with power control Max Power(LTE Band 5/7/38)		
Frequency Bands:	Band	Tx (MHz)	Rx (MHz)
	GSM850	824 - 849	869 - 894
	GSM1900	1850-1910	1930-1990
	WCDMA Band V	824 - 849	869 - 894
	WCDMA Band II	1850-1910	1930-1990
	LTE Band 5	824 - 849	869 - 894
	LTE Band 7	2500-2570	2620-2690
	LTE Band 38	2570~2620	2570~2620
	WIFI 2.4G	2412~2462	2412~2462
BT	2402~2480	2402~2480	
Battery Information:	Model:	CAC3860024C1	
	Normal Voltage:	3.85V	
	Rated capacity:	3860mAh	
	Manufacturer:	Shenzhen BYD Lithium Battery Company Limited	
	Model:	CAC3860025C7	
	Normal Voltage:	3.85V	
	Rated capacity:	3860mAh	
	Manufacturer:	Ningbo Veken Battery Co., Ltd.	
Remark:	The data in the report is the worst battery.		

### 1.5.1 DUT Antenna Locations

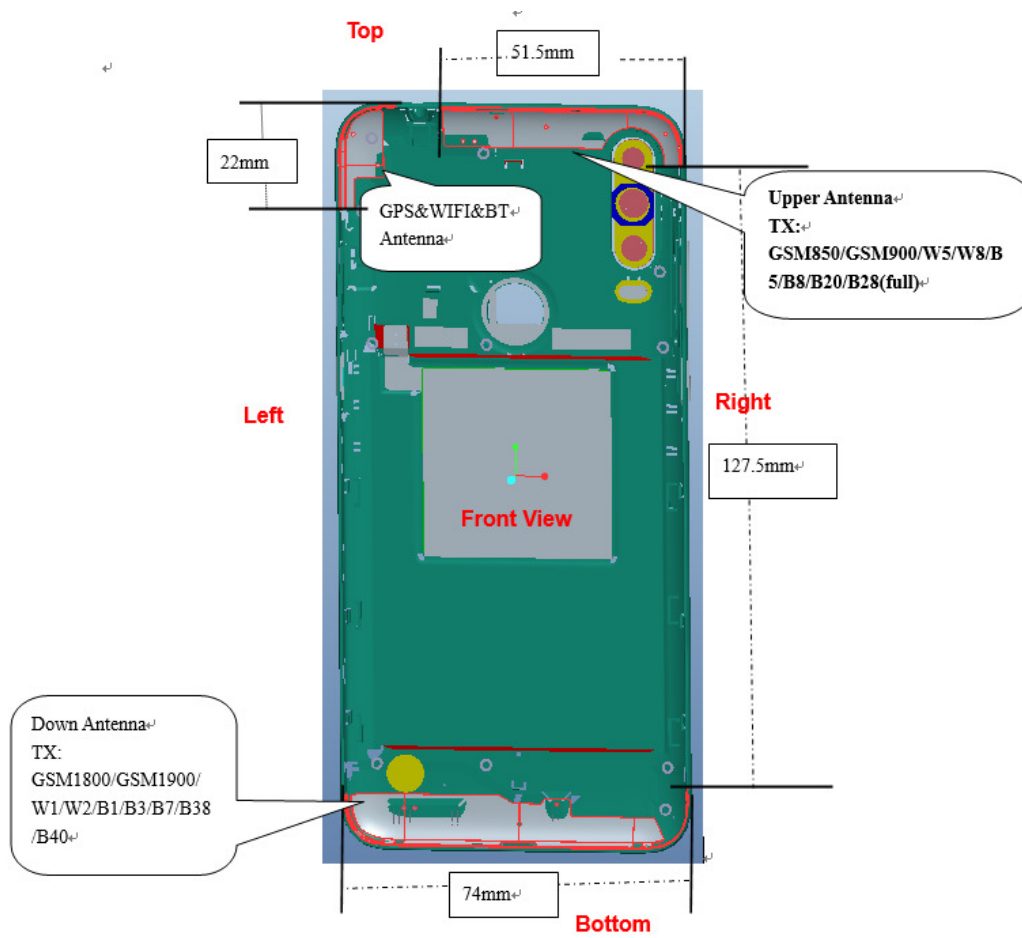



**1.5.2 List of air interfaces/frequency bands**

Air- Interface	Band (MHZ)	Type	ANSI C63.19 Tested	Simultaneous Transmitter	Name of Voice Service	Power Reduction
GSM	850	VO	Yes	BT or Wi-Fi	NA	NA
	1900					
	GPRS/EGPRS	VD	Yes	BT or Wi-Fi	No	
WCDMA	Band II	VO	Yes	BT or Wi-Fi	NA	NA
	Band V					
	HSPA	VD	Yes	BT or Wi-Fi	No	
LTE FDD	5	VD	Yes	BT or Wi-Fi	NA	NA
	7					
LTE TDD	38	VD	Yes	BT or Wi-Fi	NA	NA
Wi-Fi	2450	VD	Yes	WWAN	NA	NA
BT	2450	DT	NA	WWAN	NA	NA

VO: Legacy Cellular Voice Service from Table 7.1 in 7.4.2.1 of ANSI C63.19-2011

DT: Digital Transport (no voice)

VD: IP Voice Service over Digital Transport

**Remark:**

The air interface is exempted from testing by low power exemption that its average antenna input power plus its MIF is  $\leq 17$  dBm and is rated as M4.



## 1.6 Test Specification

Identity	Document Title
CFR 47 FCC Part 20	§20.19 Hearing aid-compatible mobile handsets.
ANSI C63.19-2011	American National Standard for Methods of Measurement of Compatibility between Wireless Communication Devices
KDB 285076 D01	HAC Guidance v05
KDB 285076 D02	T-Coil testing v03
KDB 285076 D03	HAC FAQ v01

## 1.7 ANSI C63.19-2011 limits

Emission Categories	E-field emissions dB(V/m)	
	< 960 MHz	> 960 MHz
Category M1	50-55	40-45
Category M2	45-50	35-40
Category M3	40-45	30-45
Category M4	<40	<30

Table 1: Telephone near-field categories in linear units

## 2 Calibration certificate

Temperature	Min. = 18°C, Max. = 25 °C
Relative humidity	Min. = 30%, Max. = 70%

Table 2: The Ambient Conditions

### 3 HAC (T Coil) Measurement System

#### 3.1 Measurement System Diagram for SPEAG Robotic

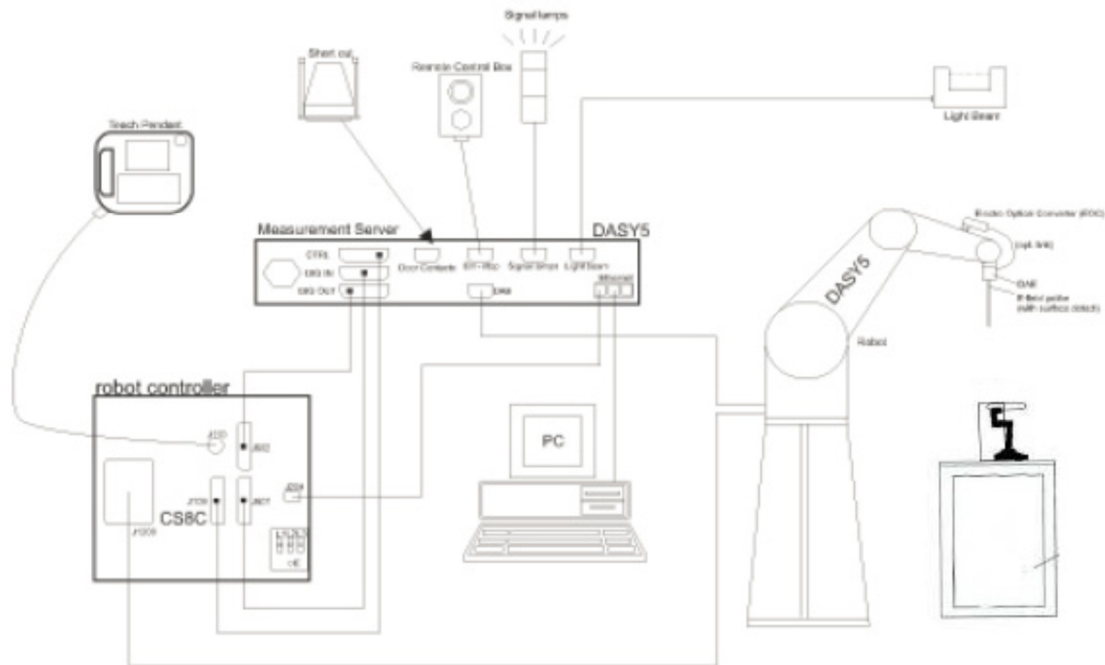



Fig. 1. The SPEAG Robotic Diagram

The DASY5 system for performing compliance tests consists of the following items:

- A standard high precision 6-axis robot (Stabile RX family) with controller, teach pendant and software. An arm extension is for accommodating the data acquisition electronics (DAE).
- An Audio Magnetic probe.
- A data acquisition electronics (DAE) which performs the signal amplification, signal multiplexing, AD-conversion, offset measurements, mechanical surface detection, collision detection, etc. The unit is battery powered with standard or rechargeable batteries. The signal is optically transmitted to the EOC.
- The Electro-optical converter (EOC) performs the conversion between optical and electrical of the signals for the digital communication to the DAE and for the analog signal from the optical surface detection. The EOC is connected to the measurement server.
- The function of the measurement server is to perform the time critical tasks such as signal filtering, control of the robot operation and fast movement interrupts.
- A probe alignment unit which improves the (absolute) accuracy of the probe positioning.
- A computer operating Windows 7.
- DASY5 software.
- Remote control with teach pendant and additional circuitry for robot safety such as warning lamps, etc.
- The Test Arch SAM phantom
- The device holder for handheld mobile phones.
- Validation dipole kits allowing to validate the proper functioning of the system.

### 3.2 E-Field Probe

Construction	One dipole parallel, two dipoles normal to probe axis Built-in shielding against static charges PEEK enclosure material	 <p>EF3DV3 E-Field Probe</p>
Calibration	In air from 100 MHz to 6.0 GHz (absolute accuracy $\pm 6.0\%$ , $k=2$ )	
Frequency	(extended to 20 MHz for MRI), Linearity: $\pm 0.2$ dB (100 MHz to 6 GHz)	
Directivity	$\pm 0.2$ dB in air (rotation around probe axis) $\pm 0.4$ dB in air (rotation normal to probe axis)	
Dynamic Range	2 V/m to > 1000 V/m; Linearity: $\pm 0.2$ dB	
Dimensions	Tip diameter: 8 mm Distance from probe tip to dipole centers: 2.5 mm	

### 3.3 Test Arch

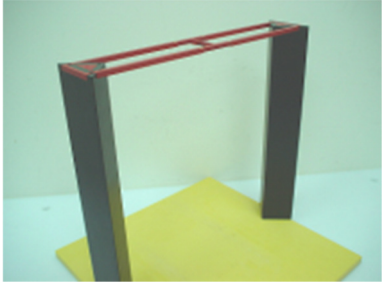
Description	Enables easy and well defined positioning of the phone and validation dipoles as well as simple teaching of the robot.	 <p>Test Arch</p>
Dimensions	length: 370 mm width: 370 mm height: 370 mm	

### 3.4 Phone Holder

Description	Supports accurate and reliable positioning of any phone Effect on near field $< \pm 0.5$ dB	 <p>Phone Holder</p>
-------------	------------------------------------------------------------------------------------------------	-----------------------------------------------------------------------------------------------------------

#### 4 Measurement uncertainty evaluation

Uncertainty Component	Uncertainty Value (%)	Probability Distribution	Divisor	ci (E)	Standard Uncertainty (E) (%)
<b>Measurement system</b>					
Probe calibration	±5.1	N	1	1	±5.1
Axial isotropy	±4.7	R	$\sqrt{3}$	1	±2.7
Sensor position	±16.5	R	$\sqrt{3}$	1	±9.5
Boundary effect	±2.4	R	$\sqrt{3}$	1	±1.4
Phantom Boundary Effect	±7.2	R	$\sqrt{3}$	1	±4.1
Linearity	±4.7	R	$\sqrt{3}$	1	±2.7
Scaling with PMR calibration	±10.0	R	$\sqrt{3}$	1	±5.8
System Detection limit	±1.0	R	$\sqrt{3}$	1	±0.6
Readout Electronics	±0.3	N	1	1	±0.3
Response time	±0.8	R	$\sqrt{3}$	1	±0.5
Integration time	±2.6	R	$\sqrt{3}$	1	±1.5
RF ambient conditions	±3.0	R	$\sqrt{3}$	1	±1.7
RF reflection	±12.0	R	$\sqrt{3}$	1	±6.9
Probe positioner	±1.2	R	$\sqrt{3}$	1	±0.7
Probe positioning	±4.7	R	$\sqrt{3}$	1	±2.7
Extrapolation and interpolation	±1.0	R	$\sqrt{3}$	1	±0.6
<b>Related to test samples</b>					
Device Positioning Vertical	±4.7	R	$\sqrt{3}$	1	±2.7
Device Positioning Lateral	±1.0	R	$\sqrt{3}$	1	±0.6
Device Holder and Phantom	±2.4	R	$\sqrt{3}$	1	±1.4
Power drift	±5.0	R	$\sqrt{3}$	1	±2.9
<b>Phantom and Setup Related</b>					
Phantom Thickness	±2.4	R	$\sqrt{3}$	1	±1.4
Combined Std. Uncertainty	$u_c = \sqrt{\sum_{i=1}^{21} c_i^2 u_i^2}$				±16.3
Expanded Std. Uncertainty on Power (K=2)					±32.6
Expanded Std. Uncertainty on Field (K=2)					±16.3

Table 3: Measurement uncertainties for RF

## 5 RF Emission Measurements Reference and Plane

Fig.3 illustrate the references and reference plane that shall be used in a typical EUT emissions measurement. The principle of this section is applied to EUT with similar geometry. Please refer to Appendix C for the setup photographs.

- ◆ The area is 5 cm by 5 cm.
- ◆ The area is centered on the audio frequency output transducer of the EUT.
- ◆ The area is in a reference plane, which is defined as the planar area that contains the highest point in the area of the phone that normally rests against the user's ear. It is parallel to the centerline of the receiver area of the phone and is defined by the points of the receiver-end of the EUT handset, which, in normal handset use, rest against the ear.
- ◆ The measurement plane is parallel to, and 10 mm in front of, the reference plane.



Fig.3 WD reference and plane for RF emission measurements

## 6 System Verification Procedure

### 6.1 System Check

Place a dipole antenna meeting the requirements given in ANSI C63.19-2011 in the position normally occupied by the WD. The dipole antenna serves as a known source for an electrical and magnetic output. Position the E-field probe so that the following occurs:

- The probes and their cables are parallel to the coaxial feed of the dipole antenna
- The probe cables and the coaxial feed of the dipole antenna approach the measurement area from opposite directions
- The center point of the probe element(s) are 15 mm from the closest surface of the dipole elements.

Scan the length of the dipole with the E-field probe and record the two maximum values found near the dipole ends. Average the two readings and compare the reading to the expected value in the calibration certificate or the expected value in this standard.

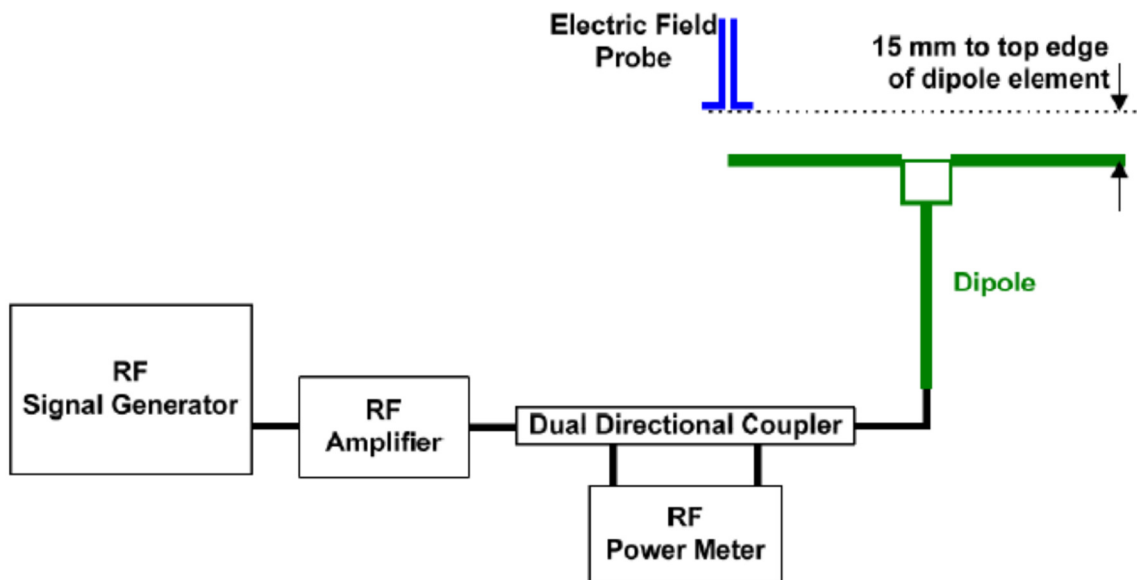

Fig.4 System verification

### 6.2 System Check Result

Frequency (MHz)	Input Power (mW)	E-Field Value 1 (V/m)	E-Field Value 2 (V/m)	Averaged Measured* Value(V/m)	Target** Value (V/m)	Deviation*** (%)	Limit**** (%)	Test Date
835	20	110.5	121.1	105.5	115.80	9.76	±18%	2019/11/24
1880	20	91.77	94.57	87.20	93.17	6.85	±18%	2019/11/24
2600	20	83.85	91.33	83.90	87.59	4.40	±18%	2019/11/24

**Note:**

\* Please refer to the appendix A for detailed measurement data and plot.

\*\* Target value is provided by SPEAD in the calibration certificate of specific dipoles.

\*\*\* Deviation (%) =  $100 \times (\text{Measured value} - \text{Target value}) / \text{Target value}$ .

\*\*\*\* ANSI C63.19 requires values within  $\pm 18\%$  are acceptable.



## 7 Modulation Interference Factor

The HAC Standard ANSI C63.19-2011 defines a new scaling using the Modulation Interference Factor (MIF). For any specific fixed and repeatable modulated signal, a modulation interference factor (MIF, expressed in dB) may be developed that relates its interference potential to its steady-state rms signal level or average power level. This factor is a function only of the audio-frequency amplitude modulation characteristics of the signal and is the same for field-strength and conducted power measurements. It is important to emphasize that the MIF is valid only for a specific repeatable audio-frequency amplitude modulation characteristic. Any change in modulation characteristic requires determination and application of a new MIF

The Modulation Interference factor (MIF, in dB) is added to the measured average E-field (in dBV/m) and converts it to the RF Audio Interference level (in dBV/m). This level considers the audible amplitude modulation components in the RF E-field. CW fields without amplitude modulation are assumed to not interfere with the hearing aid electronics.

Modulations without time slots and low fluctuations at low frequencies have low MIF values, TDMA modulations with narrow transmission and repetition rates of few 100 Hz have high MIF values and give similar classifications as ANSI C63.19-2011.

ER3D, EF3D and EU2D E-field probes have a bandwidth <10 kHz and can therefore not evaluate the RF envelope in the full audio band. DASY52 is therefore using the indirect measurement method according to ANSI C63.19-2011 which is the primary method. These near field probes read the averaged E-field measurement. Especially for the new high peak-to-average (PAR) signal types, the probes shall be linearized by PMR calibration in order to not overestimate the field reading. Probe Modulation Response (PMR) calibration linearizes the probe response over its dynamic range for specific modulations which are characterized by their UID and result in an uncertainty specified in the probe calibration certificate. The MIF is characteristic for a given waveform envelope and can be used as a constant conversion factor if the probe has been PMR calibrated.

The evaluation method for the MIF is defined in ANSI C63.19-2011 section D.7. An RMS demodulated RF signal is fed to a spectral filter (similar to an A weighting filter) and forwarded to a temporal filter acting as a quasi-peak detector. The averaged output of these filtering is scaled to a 1 kHz 80% AM signal as reference. MIF measurement requires additional instrumentation and is not well suited for evaluation by the end user with reasonable uncertainty.

It may alliteratively be determined through analysis and simulation, because it is constant and characteristic for a communication signal. DASY52 uses well-defined signals for PMR calibration. The MIF of these signals has been determined by simulation and it is automatically applied.

The MIF measurement uncertainty is estimated as follows, declared by HAC equipment provider SPEAG, for modulation frequencies from slotted waveforms with fundamental frequency and at least 2 harmonics within 10 kHz:

1. 0.2 dB for MIF: -7 to +5 dB
2. 0.5 dB for MIF: -13 to +11 dB
3. 1 dB for MIF: > -20 dB

MIF values applied in this test report were provided by the HAC equipment provider of SPEAG, and the worst values for all air interface are listed below to be determine the Low-power Exemption.

SPEAG UID	UID version	Communication system	MIF(dB)
10021	DAC	GSM-FDD (TDMA, GMSK)	3.63
10025	DAC	EDGE-FDD (TDMA, 8PSK, TN 0)	3.75
10460	AAA	UMTS-FDD (WCDMA, AMR)	-25.43
10225	AAA	UMTS-FDD (HSPA+)	-20.39
10169	CAE	LTE-FDD (SC-FDMA, 1 RB, 20 MHz, QPSK)	-15.63
10170	CAE	LTE-FDD (SC-FDMA, 1RB, 20 MHz, 16-QAM)	-9.76
10172	CAG	LTE-TDD (SC-FDMA, 1 RB, 20 MHz, QPSK)	-1.62
10173	CAG	LTE-TDD (SC-FDMA, 1RB, 20 MHz, 16-QAM)	-1.44
10061	CAB	IEEE 802.11b WiFi 2.4 GHz (DSSS, 11 Mbps)	-2.02
10077	CAB	IEEE 802.11g WiFi 2.4 GHz (DSSS-OFDM, 54 Mbps)	0.12
10427	AAB	IEEE 802.11n (HT Green eld, 150 Mbps, 64-QAM)	-13.44



## 8 HAC Measurement Procedure

**The evaluation was performed with the following procedure:**

- a) Confirm the proper operation of the field probe, probe measurement system, and other instrumentation and the positioning system.
  - b) Position the WD in its intended test position.
  - c) Set the WD to transmit a fixed and repeatable combination of signal power and modulation characteristic that is representative of the worst case (highest interference potential) encountered in normal use. Transiently occurring start-up, changeover, or termination conditions, or other operations likely to occur less than 1% of the time during normal operation, may be excluded from consideration.
  - d) The center subgrid shall be centered on the T-Coil mode perpendicular measurement point or the acoustic output, as appropriate. Locate the field probe at the initial test position in the 50 mm by 50 mm grid, which is contained in the measurement plane, refer to illustrated in Figure 3. If the field alignment method is used, align the probe for maximum field reception.
  - e) Record the reading at the output of the measurement system.
  - f) Scan the entire 50 mm by 50 mm region in equally spaced increments and record the reading at each measurement point. The distance between measurement points shall be sufficient to assure the identification of the maximum reading.
  - g) Identify the five contiguous subgrids around the center subgrid whose maximum reading is the lowest of all available choices. This eliminates the three subgrids with the maximum readings. Thus, the six areas to be used to determine the WD's highest emissions are identified.
  - h) Identify the maximum reading within the nonexcluded subgrids identified in step g).
  - i) Convert the maximum reading identified in step h) to RF audio interference level, in, V/m, by taking the square root of the reading and then dividing it by the measurement system transfer function, established in 5.5.1.1. Convert the result to dB(V/m) by taking the base-10 logarithm and multiplying it by 20.
- Indirect measurement method
- Replacing step i) of 5.5.1.2, the RF audio interference level in dB(V/m) is obtained by adding the MIF (in dB) to the maximum steady-state rms field-strength reading, in dB(V/m), from step h). Use this result to determine the category rating.
- j) Compare this RF audio interference level with the categories in Clause 8 and record the resulting WD category rating.
  - k) For the T-Coil mode M-rating assessment, determine whether the chosen perpendicular measurement point is contained in an included subgrid of the first scan. If so, then a second scan is not necessary. The first scan and resultant category rating may be used for the T-Coil mode M rating. Otherwise, repeat step a) through step i), with the grid shifted so that it is centered on the perpendicular measurement point. Record the WD category rating.

## 9 HAC RF Measurement Results

### 9.1 Max Tune-up

Frequency Band		Average Power (dBm)	
GSM	GSM850	32.80	
	EDGE850	27.00	
	GSM1900	29.80	
	EDGE1900	26.00	
WCDMA	Band V	23.50	
	Band II	23.50	
	HSPA	22.50	
FDD LTE	Band 5	23.50	
	Band 7	23.50	
TDD LTE	Band 38	QPSK	23.50
		16QAM	22.50
2.4GHz WLAN	802.11b	18.50	
	802.11g	16.00	
	802.11n-HT20	15.00	
	802.11n-HT40	11.00	

## 9.2 Conducted RF Output Power

GSM 850				
Burst Output Power(dBm)				Tune up
Channel	128	190	251	
GSM (GMSK, 1 Tx slot)	<b>32.56</b>	<b>32.57</b>	<b>32.45</b>	32.80
GSM 1900				
Burst Output Power(dBm)				Tune up
Channel	512	661	810	
GSM (GMSK, 1 Tx slot)	<b>29.75</b>	<b>29.78</b>	<b>29.74</b>	29.80

LTE Band 38 Receiver On				Conducted Power(dBm)			
Bandwidth	Modulation	RB size	RB offset	Channel	Channel	Channel	Tune up
				37850	38000	38150	
20MHz	QPSK	1	0	22.48	22.30	22.19	23.50
		1	50	<b>22.72</b>	<b>22.55</b>	<b>22.47</b>	23.50
		1	99	22.22	22.06	22.10	23.50
		50	0	21.79	21.54	21.45	22.50
		50	25	21.67	21.48	21.29	22.50
		50	50	21.63	21.45	21.20	22.50
		100	0	21.71	21.57	21.43	22.50
	16QAM	1	0	21.67	21.52	21.34	22.50
		1	50	21.81	21.58	21.56	22.50
		1	99	21.38	21.19	21.18	22.50
		50	0	20.88	20.60	20.46	21.50
		50	25	20.76	20.51	20.39	21.50
		50	50	20.74	20.48	20.35	21.50
		100	0	20.77	20.53	20.42	21.50

### 9.3 Low-power Exemption

According to ANSI C63.19-2011, a RF air interface technology of a device is exempt from testing when its average antenna input power plus its MIF is  $\leq 17$  dBm for any of its operation modes.

Air Interface		Max Average Antenna Input Power (dBm)	Worst Case MIF (dB)	Power + MIF(dB)	C63.19 test required
GSM850		32.80	3.63	36.43	Yes
EDGE850		27.00	3.75	30.75	No
GSM1900		29.80	3.63	33.43	Yes
EDGE1900		26.00	3.75	29.75	No
WCDMA		23.50	-25.43	-1.93	No
WCDMA - HSPA		22.50	-20.39	2.11	No
LTE - FDD		23.50	-9.76	13.74	No
LTE - TDD	QPSK	23.50	-1.62	21.88	Yes
	16QAM	22.50	-1.44	21.06	No
802.11b		18.50	-2.02	16.48	No
802.11g		16.00	0.12	16.12	No
802.11n-HT20		15.00	-13.44	1.56	No
802.11n-HT40		11.00	-13.44	-2.44	No

**General Note:**

- EDGE data modes and 16QAM is not necessary due the GSM Voice mode and QPSK is the worst case.
- According to ANSI C63.19 2011-version, for the air interface technology of a device is exempt from testing when its average antenna input power plus its MIF is  $\leq 17$  dBm for any of its operating modes.
- HAC RF rating is M4 for the air interface which meets the low power exemption.

## 9.4 HAC RF Emission Test Results

Band	Test Mode	Channel	Frequency (MHz)	MIF (dB)	Audio Interference Level (dBV/m)	Power Drift (dB)	Category
GSM850	GSM Voice	128	824.2	3.63	41.42	-0.01	M3
GSM850	GSM Voice	190	836.6	3.63	41.88	-0.01	M3
GSM850	GSM Voice	251	848.8	3.63	42.20	-0.01	M3
GSM1900	GSM Voice	512	1850.2	3.63	28.28	-0.04	M4
GSM1900	GSM Voice	661	1880	3.63	28.07	0.01	M4
GSM1900	GSM Voice	810	1909.8	3.63	27.68	-0.03	M4
LTE Band 38	20M QPSK 1RB_50	37850	2580	-1.62	24.29	0.00	M4
LTE Band 38	20M QPSK 1RB_50	38000	2595	-1.62	24.39	0.03	M4
LTE Band 38	20M QPSK 1RB_50	38150	2610	-1.62	24.53	-0.04	M4

**Remark:**

1. The detail RF Emission results please refer to appendix B.

## 10 Equipment list

Equipment	Manufacturer	Model	Serial Number	Calibration Date	Due date of calibration
<input checked="" type="checkbox"/> Software	SPEAG	DASY52 52.8.8	NA	NCR	NCR
<input checked="" type="checkbox"/> DAE	SPEAG	DAE3	896	2019-09-18	2020-09-17
<input checked="" type="checkbox"/> E-Field Probe	SPEAG	EF3DV3	4051	2019-06-18	2020-06-17
<input checked="" type="checkbox"/> Validation Kits	SPEAG	CD835V3	1052	2019-06-21	2020-06-20
<input checked="" type="checkbox"/> Validation Kits	SPEAG	CD1880V3	1044	2019-06-21	2020-06-20
<input checked="" type="checkbox"/> Validation Kits	SPEAG	CD2600V3	1021	2019-09-03	2020-09-02
<input checked="" type="checkbox"/> Test Arch SD HAC	SPEAG	NA	NA	NCR	NCR
<input checked="" type="checkbox"/> Universal Radio Communication Tester	R&S	CMU200	123090	2019-06-25	2020-06-24
<input checked="" type="checkbox"/> Universal Radio Communication Tester	R&S	CMW500	103990	2019-04-09	2020-04-08
<input checked="" type="checkbox"/> Signal Generator	Agilent	N5171B	MY53050736	2019-04-12	2020-04-11
<input checked="" type="checkbox"/> Preamplifier	Mini-Circuits	ZHL-42W	15542	NCR	NCR
<input checked="" type="checkbox"/> Preamplifier	Compliance Directions Systems Inc.	AMP28-3W	073501433	NCR	NCR
<input checked="" type="checkbox"/> Power Meter	Agilent	E4416A	GB41292095	2019-04-12	2020-04-11
<input checked="" type="checkbox"/> Power Sensor	Agilent	8481H	MY41091234	2019-04-12	2020-04-11
<input checked="" type="checkbox"/> Power Sensor	R&S	NRP-Z92	100025	2019-04-12	2020-04-11
<input checked="" type="checkbox"/> Attenuator	SHX	TS2-3dB	30704	NCR	NCR
<input checked="" type="checkbox"/> Coaxial low pass filter	Mini-Circuits	VLF-2500(+)	NA	NCR	NCR
<input checked="" type="checkbox"/> Coaxial low pass filter	Microlab Fxr	LA-F13	NA	NCR	NCR
<input checked="" type="checkbox"/> DC POWER SUPPLY	SAKO	SK1730SL5A	NA	NCR	NCR
<input checked="" type="checkbox"/> Humidity and Temperature Indicator	KIMTOKA	KIMTOKA	NA	2019-04-15	2020-04-14

Note:

1. All the equipments are within the valid period when the tests are performed.
2. NCR: "No-Calibration Required".



**11 Calibration certificate**

Please see the Appendix B

**12 Photographs**

Please see the Appendix C

**Appendix A: Detailed System Check Results**

**Appendix B: Detailed Test Results**

**Appendix C: Calibration certificate**

**Appendix D: Photographs**

**---END---**

---