



SAR TEST REPORT

No. I19Z61867-SEM03

For

TCL Communication Ltd.

LTE/UMTS/GSM mobile phone

Model Name: A508DL

with

Hardware Version: PIO

Software Version: vC41

FCC ID: 2ACCJH112

Issued Date: 2019-11-19

Note:

The test results in this test report relate only to the devices specified in this report. This report shall not be reproduced except in full without the written approval of CTTL.

The report must not be used by the client to claim product certification, approval, or endorsement by NVLAP, NIST, or any agency of the U.S. Government.

Test Laboratory:

CTTL, Telecommunication Technology Labs, CAICT

No. 51, Xueyuan Road, Haidian District, Beijing, P. R. China 100191.

Tel:+86(0)10-62304633-2512, Fax:+86(0)10-62304633-2504

Email: ctl_terminals@caict.ac.cn, website: www.caict.ac.cn

©Copyright. All rights reserved by CTTL.



REPORT HISTORY

Report Number	Revision	Issue Date	Description
I19Z61867-SEM03	Rev.0	2019-11-8	Initial creation of test report
I19Z61867-SEM03	Rev.1	2019-11-11	Update table 2.3 on page 7 and table 4.1 on page 9.
I19Z61867-SEM03	Rev.2	2019-11-19	Update the typo on page 29. Added WCDMA band5, LTE bands12/26 measurement data at top position.

TABLE OF CONTENT

1 TEST LABORATORY	5
1.1 TESTING LOCATION	5
1.2 TESTING ENVIRONMENT.....	5
1.3 PROJECT DATA	5
1.4 SIGNATURE.....	5
2 STATEMENT OF COMPLIANCE	6
3 CLIENT INFORMATION	8
3.1 APPLICANT INFORMATION	8
3.2 MANUFACTURER INFORMATION	8
4 EQUIPMENT UNDER TEST (EUT) AND ANCILLARY EQUIPMENT (AE).....	9
4.1 ABOUT EUT	9
4.2 INTERNAL IDENTIFICATION OF EUT USED DURING THE TEST	9
4.3 INTERNAL IDENTIFICATION OF AE USED DURING THE TEST	9
5 TEST METHODOLOGY	10
5.1 APPLICABLE LIMIT REGULATIONS	10
5.2 APPLICABLE MEASUREMENT STANDARDS.....	10
6 SPECIFIC ABSORPTION RATE (SAR).....	11
6.1 INTRODUCTION.....	11
6.2 SAR DEFINITION.....	11
7 TISSUE SIMULATING LIQUIDS	12
7.1 TARGETS FOR TISSUE SIMULATING LIQUID	12
7.2 DIELECTRIC PERFORMANCE	12
8 SYSTEM VERIFICATION	19
8.1 SYSTEM SETUP.....	19
8.2 SYSTEM VERIFICATION.....	20
9 MEASUREMENT PROCEDURES	21
9.1 TESTS TO BE PERFORMED	21
9.2 GENERAL MEASUREMENT PROCEDURE.....	23
9.3 WCDMA MEASUREMENT PROCEDURES FOR SAR	24
9.4 SAR MEASUREMENT FOR LTE.....	25
9.5 BLUETOOTH & WI-FI MEASUREMENT PROCEDURES FOR SAR	27
9.6 POWER DRIFT.....	27
10 AREA SCAN BASED 1-G SAR.....	28
10.1 REQUIREMENT OF KDB.....	28
10.2 FAST SAR ALGORITHMS	28

11 CONDUCTED OUTPUT POWER.....	29
11.1 GSM MEASUREMENT RESULT	29
11.2 WCDMA MEASUREMENT RESULT.....	31
11.3 LTE MEASUREMENT RESULT	33
11.5 WI-FI AND BT MEASUREMENT RESULT	58
12 SIMULTANEOUS TX SAR CONSIDERATIONS.....	59
12.1 INTRODUCTION.....	59
12.2 TRANSMIT ANTENNA SEPARATION DISTANCES	59
12.3 SAR MEASUREMENT POSITIONS	60
12.4 STANDALONE SAR TEST EXCLUSION CONSIDERATIONS	60
13 EVALUATION OF SIMULTANEOUS.....	61
14 SAR TEST RESULT	62
14.1 SAR RESULTS FOR FAST SAR.....	63
14.2 SAR RESULTS FOR STANDARD PROCEDURE.....	71
15 SAR MEASUREMENT VARIABILITY.....	72
14.3 WLAN EVALUATION FOR 2.4G	74
16 MEASUREMENT UNCERTAINTY	77
16.1 MEASUREMENT UNCERTAINTY FOR NORMAL SAR TESTS (300MHZ~3GHZ)	77
16.2 MEASUREMENT UNCERTAINTY FOR NORMAL SAR TESTS (3~6GHZ)	78
16.3 MEASUREMENT UNCERTAINTY FOR FAST SAR TESTS (300MHZ~3GHZ)	79
16.4 MEASUREMENT UNCERTAINTY FOR FAST SAR TESTS (3~6GHZ).....	80
17 MAIN TEST INSTRUMENTS.....	82
ANNEX A GRAPH RESULTS.....	83
ANNEX B SYSTEM VERIFICATION RESULTS	126
ANNEX C SAR MEASUREMENT SETUP	139
ANNEX D POSITION OF THE WIRELESS DEVICE IN RELATION TO THE PHANTOM	145
ANNEX E EQUIVALENT MEDIA RECIPES	148
ANNEX F SYSTEM VALIDATION	149
ANNEX G PROBE CALIBRATION CERTIFICATE.....	150
ANNEX H DIPOLE CALIBRATION CERTIFICATE	169
ANNEX J ACCREDITATION CERTIFICATE.....	217

1 Test Laboratory

1.1 Testing Location

Company Name:	CTTL(Shouxiang)
Address:	No. 51 Shouxiang Science Building, Xueyuan Road, Haidian District, Beijing, P. R. China100191

1.2 Testing Environment

Temperature:	18°C~25°C,
Relative humidity:	30%~ 70%
Ground system resistance:	< 0.5 Ω
Ambient noise & Reflection:	< 0.012 W/kg

1.3 Project Data

Project Leader:	Qi Dianyuan
Test Engineer:	Lin Xiaojun
Testing Start Date:	November 1, 2019
Testing End Date:	November 7, 2019

1.4 Signature



Lin Xiaojun
(Prepared this test report)

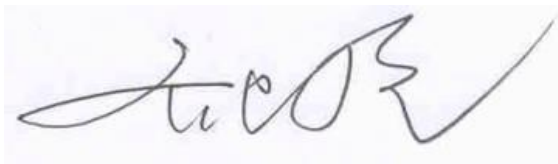

Qi Dianyuan
(Reviewed this test report)

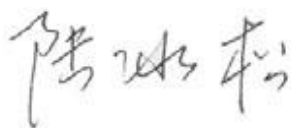

Lu Bingsong
Deputy Director of the laboratory
(Approved this test report)

2 Statement of Compliance

The maximum results of Specific Absorption Rate (SAR) found during testing for TCL Communication Ltd. LTE/UMTS/GSM mobile phone A508DL is as follows:

Table 2.1: Highest Reported SAR (1g)

Exposure Configuration	Technology Band	Highest Reported SAR 1g(W/kg)	Equipment Class
Head (Separation Distance 0mm)	GSM850	0.27	PCE
	GSM1900	0.12	
	WCDMA1900	0.15	
	WCDMA1700	0.31	
	WCDMA 850	0.65	
	LTE Band12	0.70	
	LTE Band13	0.36	
	LTE Band25	0.20	
	LTE Band26	0.87	
	LTE Band41	0.25	
	LTE Band41	0.17	
	LTE Band66	0.27	
	LTE Band71	0.70	
	WLAN	0.44	DTS
	Bluetooth	0.21	DSS
Hotspot (Separation Distance 10mm)	GSM850	0.68	PCE
	GSM1900	1.16	
	WCDMA1900	1.39	
	WCDMA1700	0.85	
	WCDMA 850	0.40	
	LTE Band12	0.51	
	LTE Band13	0.46	
	LTE Band25	1.38	
	LTE Band26	0.47	
	LTE Band41	1.03	
	LTE Band41	0.69	
	LTE Band66	1.26	
	LTE Band71	0.45	
	WLAN	0.46	DTS
	Bluetooth	0.10	DSS
Body-worn (Separation Distance 15mm)	GSM1900	0.65	PCE
	WCDMA1900	0.69	
	WCDMA1700	0.75	
	LTE Band25	0.92	
	LTE Band66	0.76	

The SAR values found for the Mobile Phone are below the maximum recommended levels of 1.6 W/kg as averaged over any 1g tissue according to the ANSI C95.1-1992.

For body operation, this device has been tested and meets FCC RF exposure guidelines when used with any accessory that contains no metal and which provides a minimum separation distance of

10/15 mm between this device and the body of the user. Use of other accessories may not ensure compliance with FCC RF exposure guidelines.

The EUT battery must be fully charged and checked periodically during the test to ascertain uniform power output.

The measurement together with the test system set-up is described in annex C of this test report. A detailed description of the equipment under test can be found in chapter 4 of this test report. The highest reported SAR value is obtained at the case of **(Table 2.1)**, and the values are: **1.39 W/kg(1g)**.

Table 2.2: 0mm Reported SAR for phablet

Exposure Configuration	Technology Band	Highest Reported SAR 10g(W/kg)	Equipment Class	Limited SAR 10g(W/kg)
Hotspot (Separation Distance 0mm)	GSM1900	1.74	PCE	4.0
	WCDMA1900	0.94		
	WCDMA1700	1.28		
	LTE Band25	1.49		
	LTE Band66	1.65		

Table 2.3: The sum of reported SAR values for main antenna and WIFI

	Position	Main antenna	WIFI	Sum
Highest reported SAR value for Head	Right hand,Touch cheek	0.78	0.44	1.22
Highest reported SAR value for Body	Bottom 10mm	1.39	/	1.39
Highest reported SAR value for Body	Rear 10mm	1.03	0.46	1.49

Table 2.4: The sum of reported SAR values for main antenna and BT

	Position	Main antenna	BT	Sum
Highest reported SAR value for Head	Right hand,Touch cheek	0.78	0.21	1.22
Highest reported SAR value for Body	Bottom 10mm	1.39	0.10	1.49

[1] - Estimated SAR for Bluetooth (see the table 13.3)

According to the above tables, the highest sum of reported SAR values is **1.49 W/kg (1g)**. The detail for simultaneous transmission consideration is described in chapter 13.

3 Client Information

3.1 Applicant Information

Company Name:	TCL Communication Ltd.
Address/Post:	5/F, Building 22E, 22 Science Park East Avenue, Hong Kong Science Park, Shatin, NT, Hong Kong
Contact Person:	Gong Zhizhou
Contact Email:	hizhou.gong@tcl.com
Telephone:	0086-755-36611722
Fax	0086-755-36612000-81722

3.2 Manufacturer Information

Company Name:	TCL Communication Ltd.
Address/Post:	5/F, Building 22E, 22 Science Park East Avenue, Hong Kong Science Park, Shatin, NT, Hong Kong
Contact Person:	Gong Zhizhou
Contact Email:	zhizhou.gong@tcl.com
Telephone:	0086-755-36611722
Fax	0086-755-36612000-81722

4 Equipment Under Test (EUT) and Ancillary Equipment (AE)

4.1 About EUT

Description:	TCL Communication Ltd.
Model name:	A508DL
Operating mode(s):	GSM850/900/1800/1900, WCDMA B2/B4/B5 LTE Band 2/4/5/12/13/25/26/41/66/71, BT, Wi-Fi(2.4G)
Tested Tx Frequency:	824 – 849 MHz (GSM 850)
	1850 – 1910 MHz (GSM 1900)
	824 – 849 MHz (WCDMA 850 Band V)
	1850 – 1910 MHz (WCDMA1700 Band II)
	1710-1755 MHz (WCDMA1900 Band IV)
	699.7 – 715.3 MHz (LTE Band 12)
	779.5 –784.5 MHz (LTE Band 13)
	1850 – 1915 MHz (LTE Band 25)
	814 – 849 MHz (LTE Band 26)
	2498.5 – 2687.5 MHz (LTE Band41)
	1710.7 –1779.3 MHz (LTE Band 66)
	665.5 – 695.5 MHz (LTE Band 71)
	2412 – 2462 MHz (Wi-Fi 2.4G)
2400 – 2483.5 MHz (Bluetooth)	
GPRS/EGPRS Multislot Class:	12
Test device Production information:	Production unit
Device type:	Portable device
Antenna type:	Integrated antenna
Hotspot mode:	Support

4.2 Internal Identification of EUT used during the test

EUT ID*	IMEI	HW Version	SW Version
EUT1	015592000017987	PIO	vC41
EUT2	015592000017151	PIO	vC41
EUT3	015592000017300	PIO	vC41

*EUT ID: is used to identify the test sample in the lab internally.

Note: It is performed to do SAR with the EUT2~3 and conducted power with the EUT1.

4.3 Internal Identification of AE used during the test

AE ID*	Description	Model	SN	Manufacturer
AE1	Battery	CAC3400011C1	/	BYD

*AE ID: is used to identify the test sample in the lab internally.

5 TEST METHODOLOGY

5.1 Applicable Limit Regulations

ANSI C95.1–1992:IEEE Standard for Safety Levels with Respect to Human Exposure to Radio Frequency Electromagnetic Fields, 3 kHz to 300 GHz.

It specifies the maximum exposure limit of **1.6 W/kg** as averaged over any 1 gram of tissue for portable devices being used within 20 cm of the user in the uncontrolled environment.

5.2 Applicable Measurement Standards

IEEE 1528–2013: Recommended Practice for Determining the Peak Spatial-Average Specific Absorption Rate (SAR) in the Human Head from Wireless Communications Devices: Measurement Techniques.

KDB447498 D01: General RF Exposure Guidance v06: Mobile and Portable Devices RF Exposure Procedures and Equipment Authorization Policies.

KDB648474 D04 Handset SAR v01r03: SAR Evaluation Considerations for Wireless Handsets.

KDB941225 D01 SAR test for 3G devices v03r01: SAR Measurement Procedures for 3G Devices

KDB941225 D05 SAR for LTE Devices v02r05: SAR Evaluation Considerations for LTE Devices

KDB941225 D06 Hotspot Mode SAR v02r01: SAR Evaluation Procedures for Portable Devices with Wireless Router Capabilities

KDB248227 D01 802.11 Wi-Fi SAR v02r02: SAR GUIDANCE FOR IEEE 802.11 (Wi-Fi) TRANSMITTERS

KDB865664 D01 SAR measurement 100 MHz to 6 GHz v01r04: SAR Measurement Requirements for 100 MHz to 6 GHz.

KDB865664 D02 RF Exposure Reporting v01r02: RF Exposure Compliance Reporting and Documentation Considerations

6 Specific Absorption Rate (SAR)

6.1 Introduction

SAR is related to the rate at which energy is absorbed per unit mass in an object exposed to a radio field. The SAR distribution in a biological body is complicated and is usually carried out by experimental techniques or numerical modeling. The standard recommends limits for two tiers of groups, occupational/controlled and general population/uncontrolled, based on a person's awareness and ability to exercise control over his or her exposure. In general, occupational/controlled exposure limits are higher than the limits for general population/uncontrolled.

6.2 SAR Definition

The SAR definition is the time derivative (rate) of the incremental energy (dW) absorbed by (dissipated in) an incremental mass (dm) contained in a volume element (dv) of a given density (ρ). The equation description is as below:

$$SAR = \frac{d}{dt} \left(\frac{dW}{dm} \right) = \frac{d}{dt} \left(\frac{dW}{\rho dv} \right)$$

SAR is expressed in units of Watts per kilogram (W/kg)

SAR measurement can be either related to the temperature elevation in tissue by

$$SAR = c \left(\frac{\delta T}{\delta t} \right)$$

Where: C is the specific heat capacity, δT is the temperature rise and δt is the exposure duration, or related to the electrical field in the tissue by

$$SAR = \frac{\sigma |E|^2}{\rho}$$

Where: σ is the conductivity of the tissue, ρ is the mass density of tissue and E is the RMS electrical field strength.

However for evaluating SAR of low power transmitter, electrical field measurement is typically applied.

7 Tissue Simulating Liquids

7.1 Targets for tissue simulating liquid

Table 7.1: Targets for tissue simulating liquid

Frequency(MHz)	Liquid Type	Conductivity(σ)	$\pm 5\%$ Range	Permittivity(ϵ)	$\pm 5\%$ Range
750	Head	0.89	0.85~0.93	41.94	39.8~44.0
750	Body	0.96	0.91~1.01	55.5	52.7~58.3
835	Head	0.90	0.86~0.95	41.5	39.4~43.6
835	Body	0.97	0.92~1.02	55.2	52.4~58.0
1750	Head	1.37	1.30~1.44	40.08	38.1~42.1
1750	Body	1.49	1.42~1.56	53.4	50.7~56.1
1900	Head	1.40	1.33~1.47	40.0	38.0~42.0
1900	Body	1.52	1.44~1.60	53.3	50.6~56.0
2450	Head	1.67	1.59~1.75	39.47	37.5~41.4
2450	Body	1.95	1.85~2.05	52.7	50.1~55.3
2600	Head	1.96	1.86~2.06	39.01	37.1~41.0
2600	Body	2.16	2.05~2.27	52.5	49.9~55.1

7.2 Dielectric Performance

Table 7.2: Dielectric Performance of Tissue Simulating Liquid

Measurement Date (yyyy-mm-dd)	Type	Frequency	Permittivity ϵ	Drift (%)	Conductivity σ (S/m)	Drift (%)
2019-11-1	Head	750 MHz	41.7	-0.57	0.898	0.90
	Body	750 MHz	55.35	-0.27	0.951	-0.94
2019-11-2	Head	835 MHz	41.6	0.24	0.901	0.11
	Body	835 MHz	56.1	1.63	0.988	1.86
2019-11-3	Head	1750 MHz	40.68	1.50	1.38	0.73
	Body	1750 MHz	53.22	-0.34	1.514	1.61
2019-11-4	Head	1900 MHz	39.55	-1.13	1.39	-0.71
	Body	1900 MHz	53.19	-0.21	1.536	1.05
2019-11-5	Head	2450 MHz	39.05	-0.38	1.784	-0.89
	Body	2450 MHz	53.36	1.25	1.966	0.82
2019-11-6	Head	2600 MHz	39.57	1.44	1.966	0.31
	Body	2600 MHz	51.61	-1.70	2.138	-1.02

Note: The liquid temperature is 22.0°C

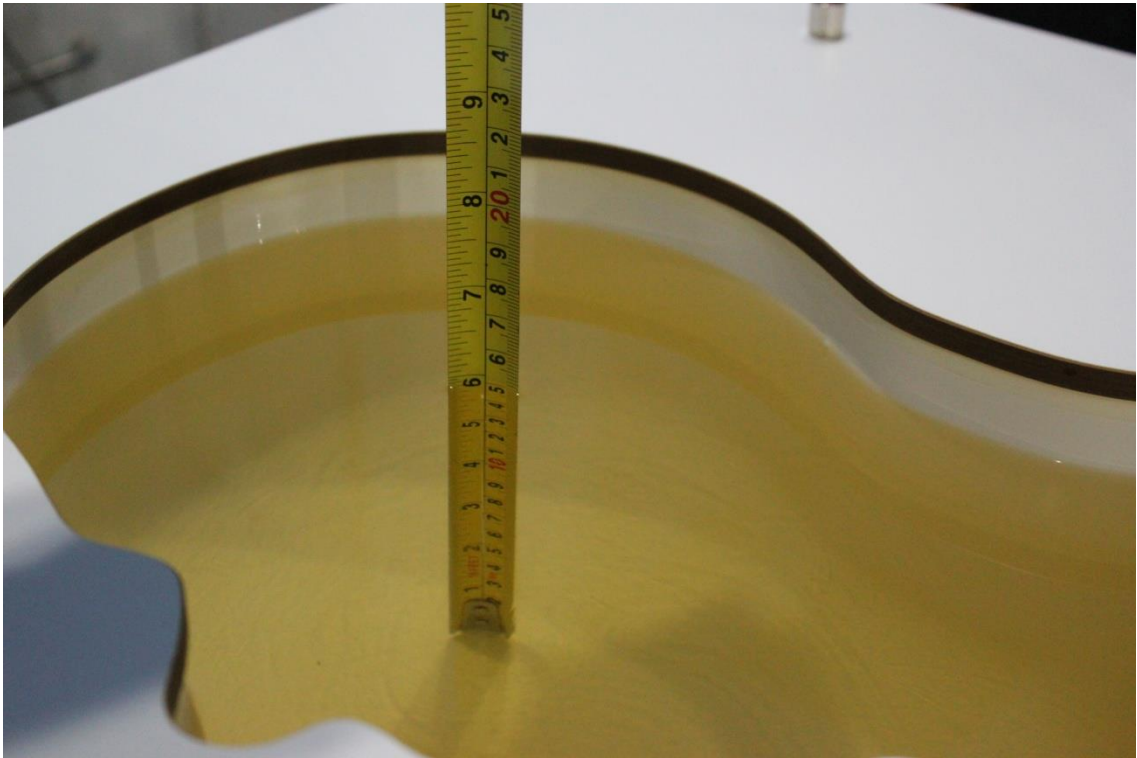

Picture 7-1 Liquid depth in the Head Phantom (750MHz)



Picture 7-2 Liquid depth in the Flat Phantom (750MHz)

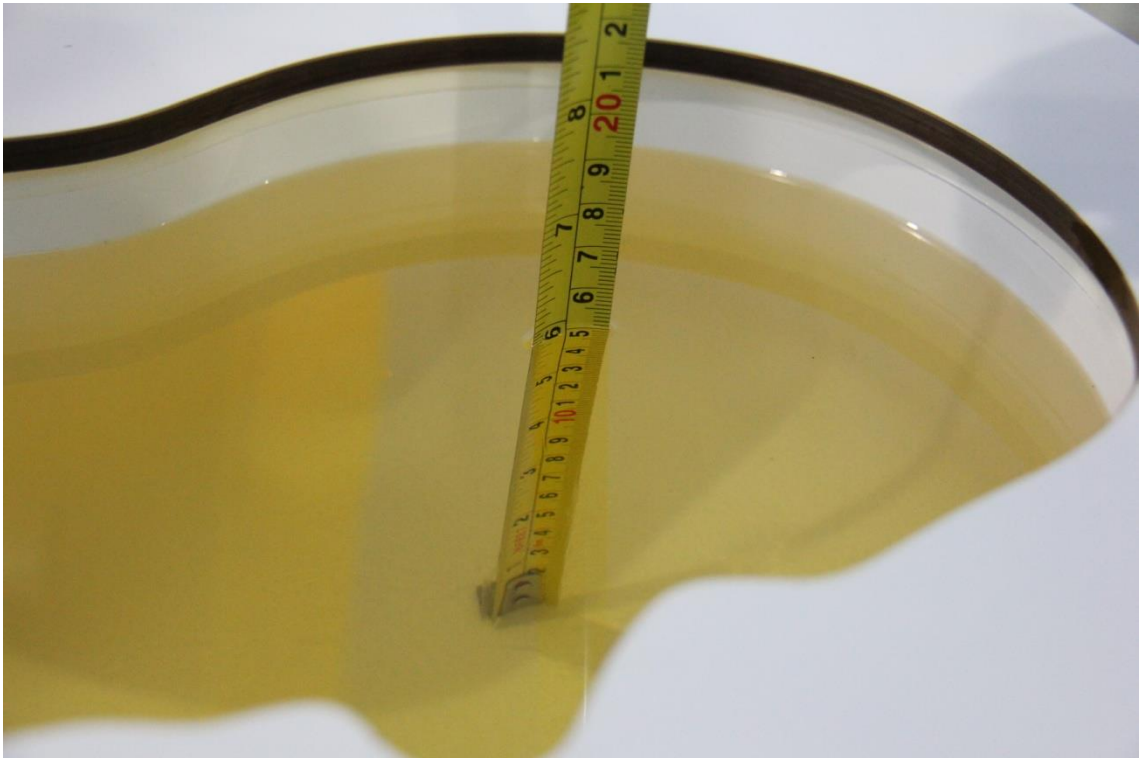

Picture 7-3 Liquid depth in the Head Phantom (835 MHz)

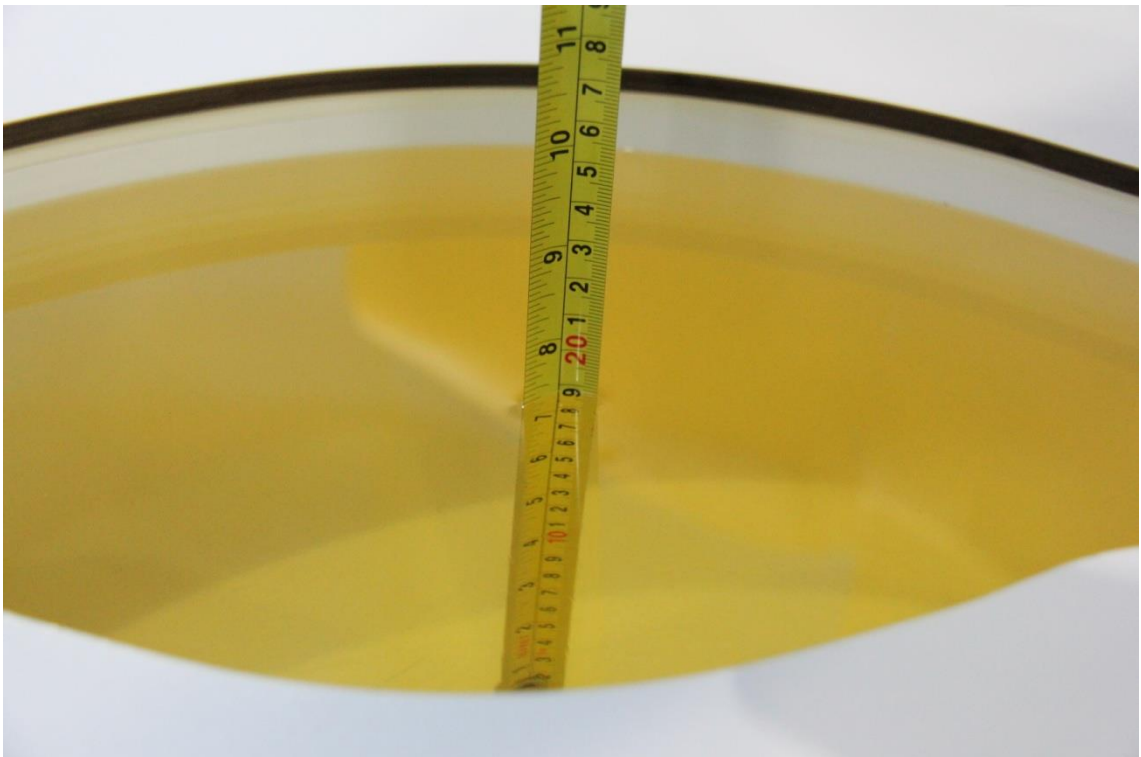

Picture 7-4 Liquid depth in the Flat Phantom (835 MHz)



Picture 7-5 Liquid depth in the Head Phantom (1750 MHz)

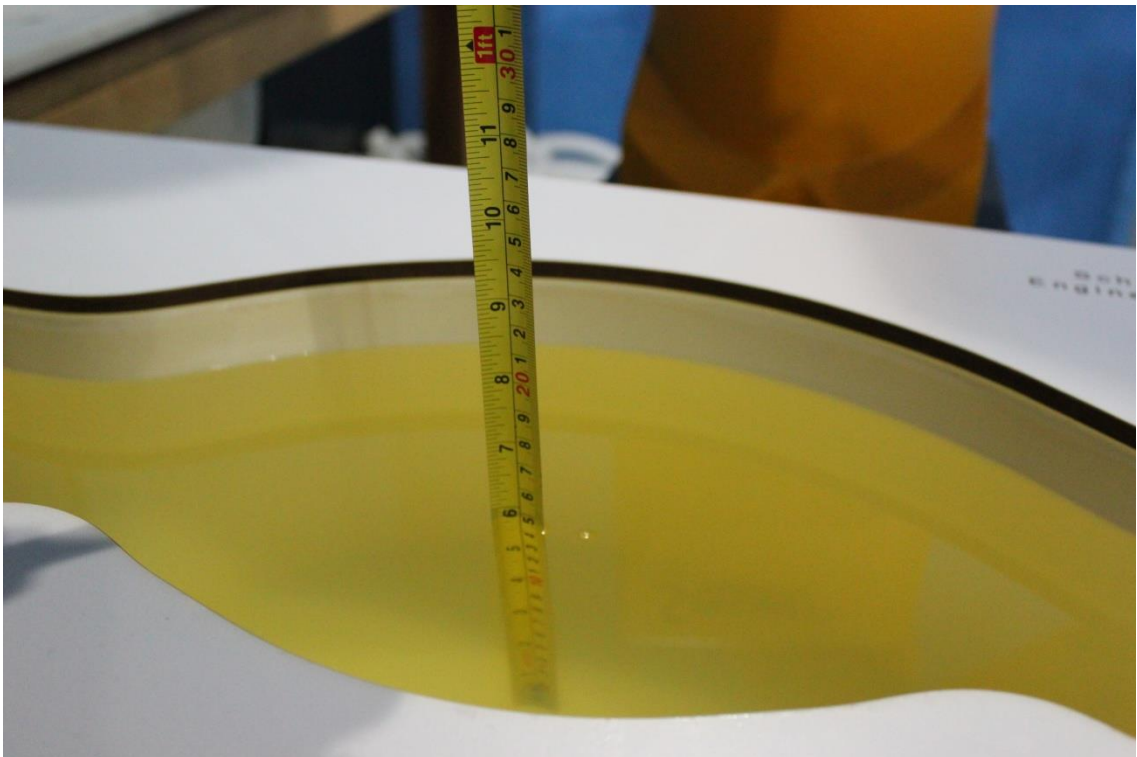

Picture 7-6 Liquid depth in the Flat Phantom (1750MHz)

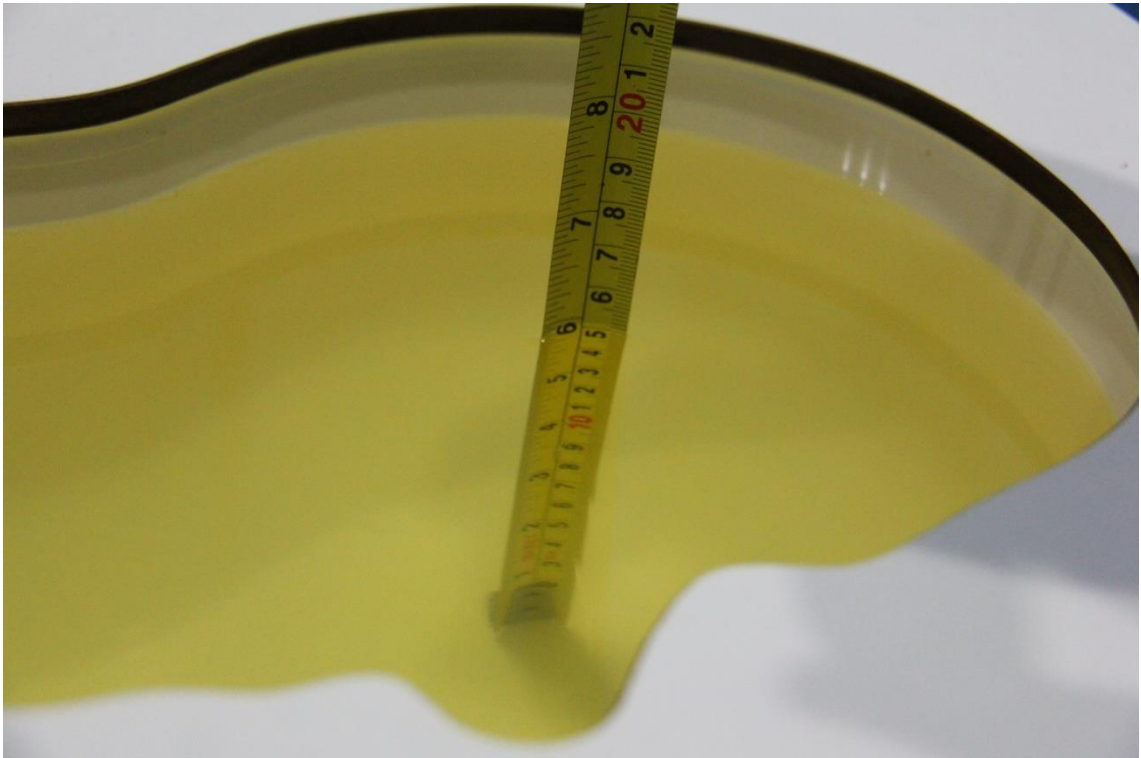

Picture 7-7 Liquid depth in the Head Phantom (1900 MHz)

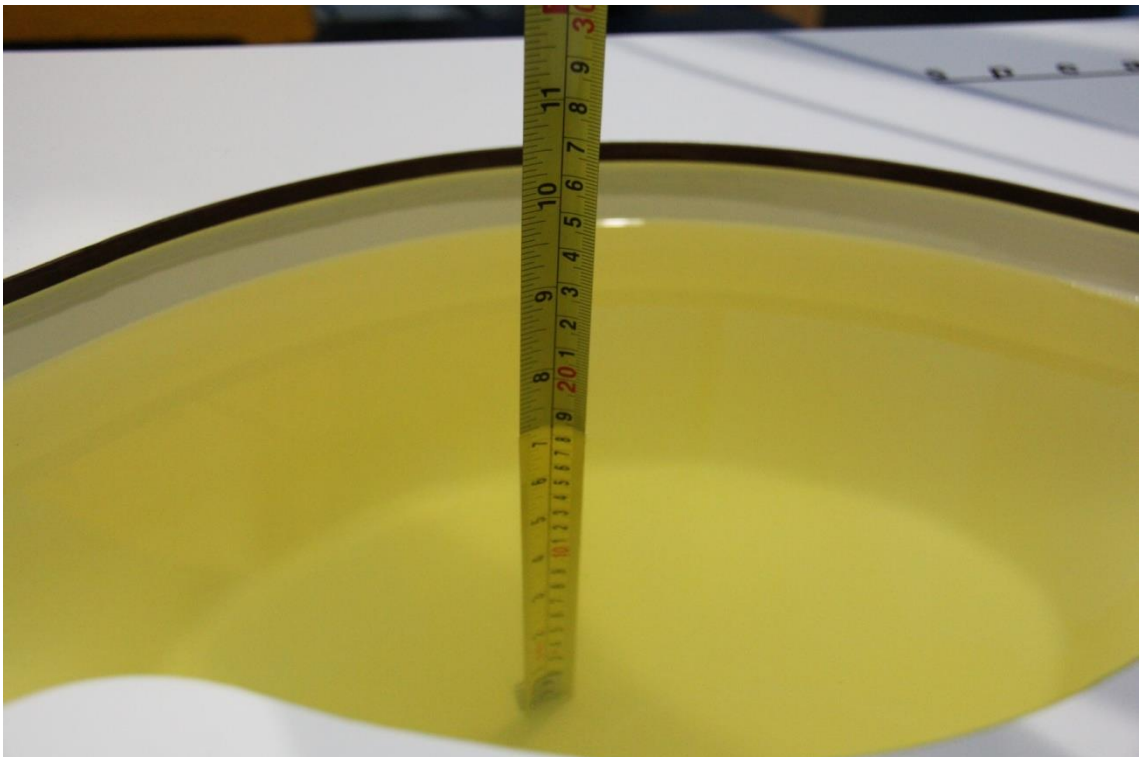

Picture 7-8 Liquid depth in the Flat Phantom (1900MHz)

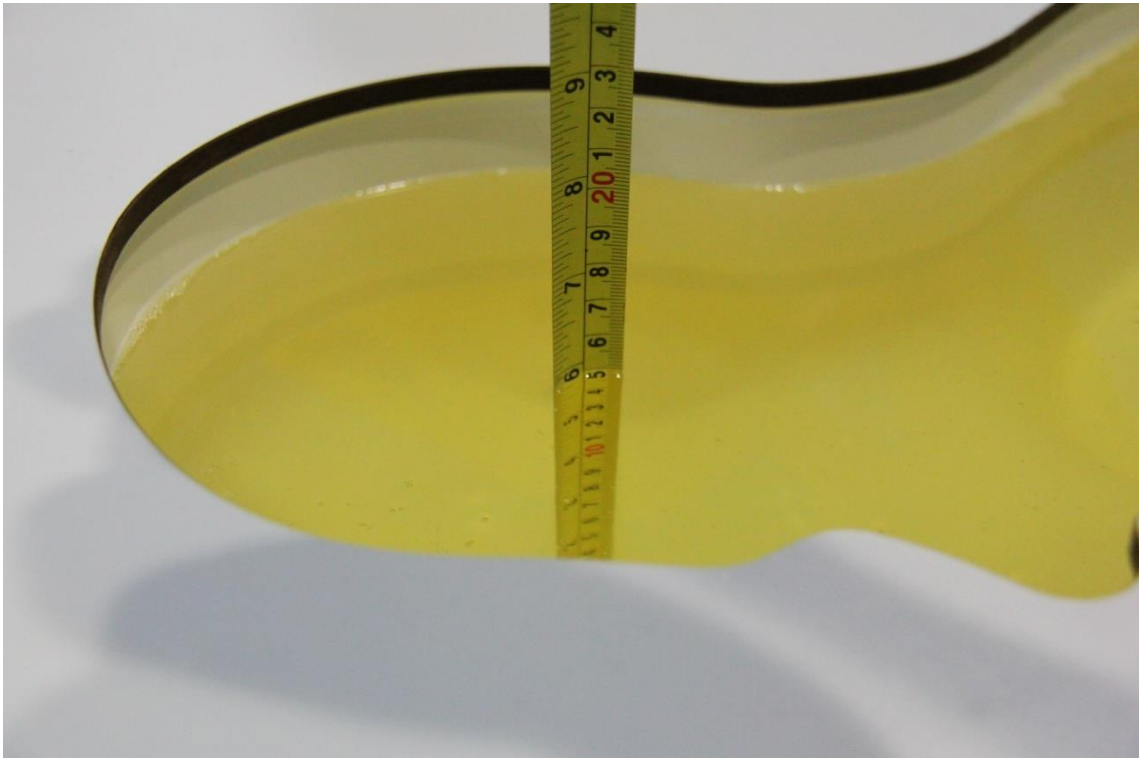

Picture 7-9 Liquid depth in the Head Phantom (2450MHz)

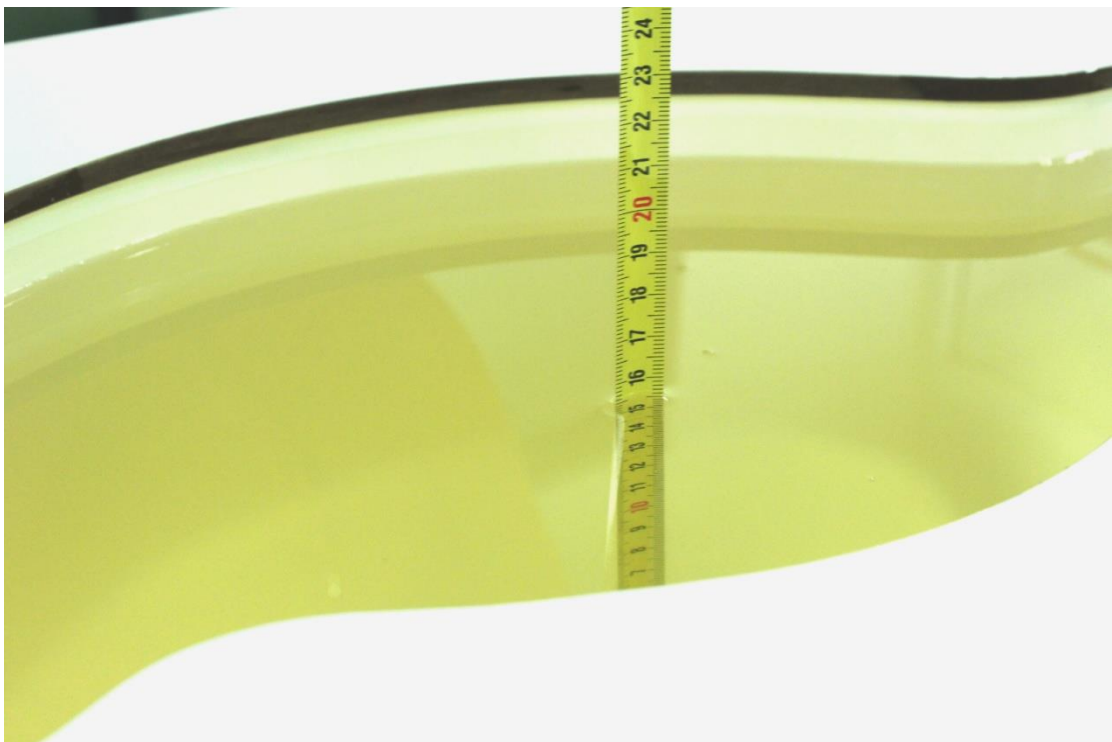

Picture 7-10 Liquid depth in the Flat Phantom (2450MHz)



Picture 7-11 Liquid depth in the Head Phantom (2600 MHz)

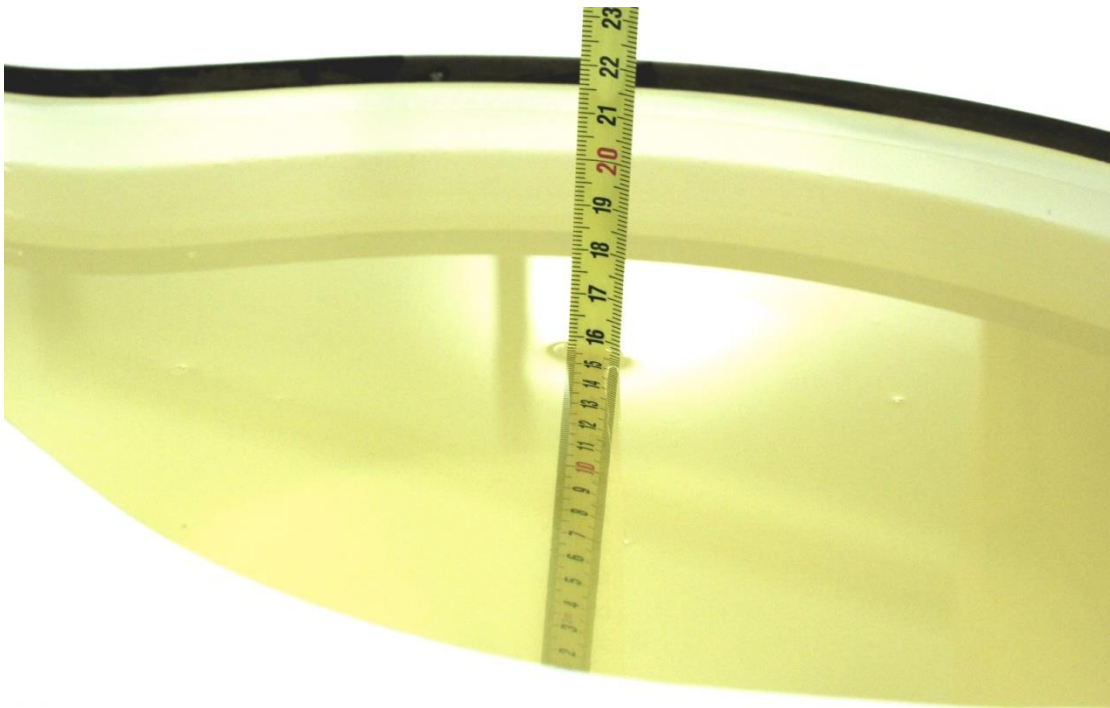

Picture 7-12 Liquid depth in the Flat Phantom (2600MHz)

8 System verification

8.1 System Setup

In the simplified setup for system evaluation, the DUT is replaced by a calibrated dipole and the power source is replaced by a continuous wave that comes from a signal generator. The calibrated dipole must be placed beneath the flat phantom section of the SAM twin phantom with the correct distance holder. The distance holder should touch the phantom surface with a light pressure at the reference marking and be oriented parallel to the long side of the phantom. The equipment setup is shown below:

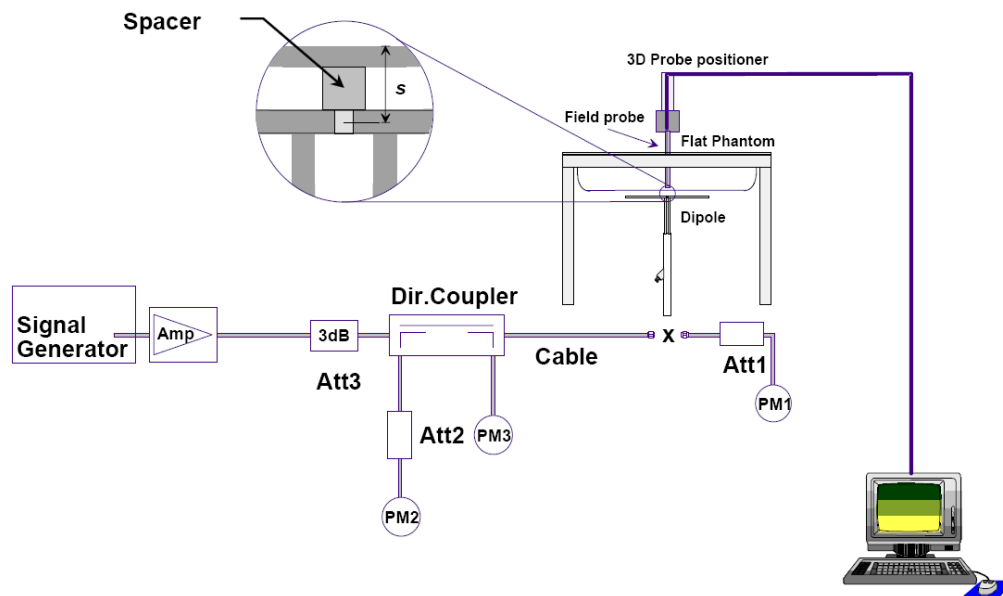

Picture 8.1 System Setup for System Evaluation



Picture 8.2 Photo of Dipole Setup

8.2 System Verification

SAR system verification is required to confirm measurement accuracy, according to the tissue dielectric media, probe calibration points and other system operating parameters required for measuring the SAR of a test device. The system verification must be performed for each frequency band and within the valid range of each probe calibration point required for testing the device.

The system verification results are required that the area scan estimated 1-g SAR is within 3% of the zoom scan 1-g SAR. The details are presented in annex B.

Table 8.1: System Verification of Head

Measurement Date (yyyy-mm-dd)	Frequency	Target value (W/kg)		Measured value(W/kg)		Deviation	
		10 g Average	1 g Average	10 g Average	1 g Average	10 g Average	1 g Average
2019-11-1	750 MHz	5.57	8.57	5.52	8.56	-0.90%	-0.12%
2019-11-2	835 MHz	6.29	9.70	6.28	9.8	-0.16%	1.03%
2019-11-3	1750 MHz	19.3	36.6	19.4	36.04	0.52%	-1.53%
2019-11-4	1900 MHz	20.8	39.7	20.6	40.28	-0.96%	1.46%
2019-11-6	2450 MHz	24.2	51.6	24.64	52.56	1.82%	1.86%
2019-11-7	2600 MHz	25.1	55.8	25.24	56.68	0.56%	1.58%

Table 8.2: System Verification of Body

Measurement Date (yyyy-mm-dd)	Frequency	Target value (W/kg)		Measured value (W/kg)		Deviation	
		10 g Average	1 g Average	10 g Average	1 g Average	10 g Average	1 g Average
2019-11-1	750 MHz	5.63	8.55	5.6	8.72	-0.53%	1.99%
2019-11-2	835 MHz	6.32	9.68	6.4	9.52	1.27%	-1.65%
2019-11-3	1750 MHz	19.5	36.8	19.76	36.48	1.33%	-0.87%
2019-11-4	1900 MHz	20.9	39.7	20.64	39.32	-1.24%	-0.96%
2019-11-6	2450 MHz	24.5	52.3	24.12	51.76	-1.55%	-1.03%
2019-11-7	2600 MHz	24.8	55	25.2	54.16	1.61%	-1.53%

9 Measurement Procedures

9.1 Tests to be performed

In order to determine the highest value of the peak spatial-average SAR of a handset, all device positions, configurations and operational modes shall be tested for each frequency band according to steps 1 to 3 below. A flowchart of the test process is shown in picture 9.1.

Step 1: The tests described in 9.2 shall be performed at the channel that is closest to the centre of the transmit frequency band (f_c) for:

- a) all device positions (cheek and tilt, for both left and right sides of the SAM phantom, as described in annex D),
- b) all configurations for each device position in a), e.g., antenna extended and retracted, and
- c) all operational modes, e.g., analogue and digital, for each device position in a) and configuration in b) in each frequency band.

If more than three frequencies need to be tested according to 11.1 (i.e., $N_c > 3$), then all frequencies, configurations and modes shall be tested for all of the above test conditions.

Step 2: For the condition providing highest peak spatial-average SAR determined in Step 1, perform all tests described in 9.2 at all other test frequencies, i.e., lowest and highest frequencies. In addition, for all other conditions (device position, configuration and operational mode) where the peak spatial-average SAR value determined in Step 1 is within 3 dB of the applicable SAR limit, it is recommended that all other test frequencies shall be tested as well.

Step 3: Examine all data to determine the highest value of the peak spatial-average SAR found in Steps 1 to 2.

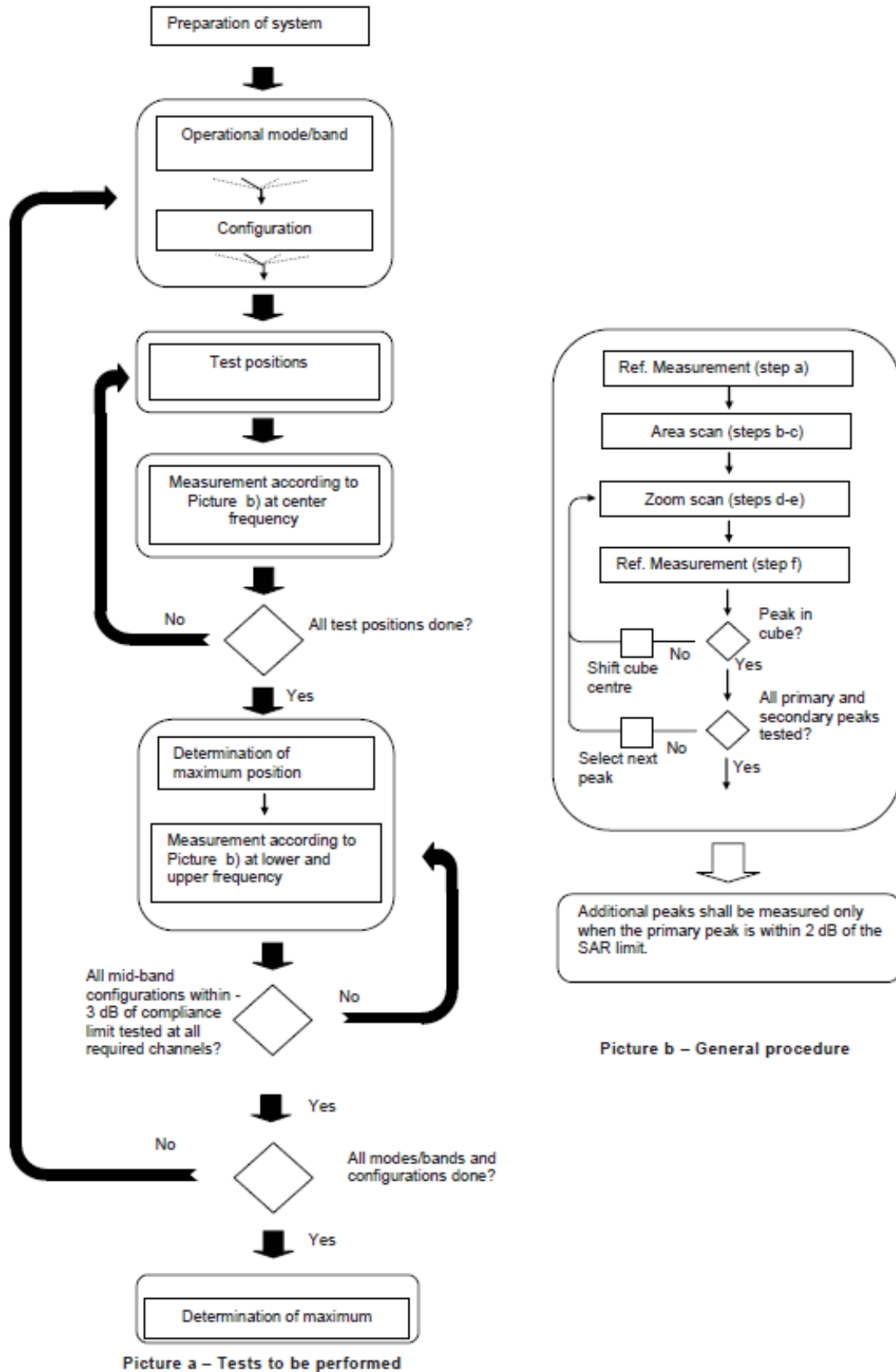

Picture 9.1 Block diagram of the tests to be performed

9.2 General Measurement Procedure

The area and zoom scan resolutions specified in the table below must be applied to the SAR measurements and fully documented in SAR reports to qualify for TCB approval. Probe boundary effect error compensation is required for measurements with the probe tip closer than half a probe tip diameter to the phantom surface. Both the probe tip diameter and sensor offset distance must satisfy measurement protocols; to ensure probe boundary effect errors are minimized and the higher fields closest to the phantom surface can be correctly measured and extrapolated to the phantom surface for computing 1-g SAR. Tolerances of the post-processing algorithms must be verified by the test laboratory for the scan resolutions used in the SAR measurements, according to the reference distribution functions specified in IEEE Std 1528-2003. The results should be documented as part of the system validation records and may be requested to support test results when all the measurement parameters in the following table are not satisfied.

		≤ 3 GHz	> 3 GHz	
Maximum distance from closest measurement point (geometric center of probe sensors) to phantom surface		5 ± 1 mm	$\frac{1}{2} \cdot \delta \cdot \ln(2) \pm 0.5$ mm	
Maximum probe angle from probe axis to phantom surface normal at the measurement location		$30^\circ \pm 1^\circ$	$20^\circ \pm 1^\circ$	
Maximum area scan spatial resolution: Δx_{Area} , Δy_{Area}		≤ 2 GHz: ≤ 15 mm 2 – 3 GHz: ≤ 12 mm	3 – 4 GHz: ≤ 12 mm 4 – 6 GHz: ≤ 10 mm	
		When the x or y dimension of the test device, in the measurement plane orientation, is smaller than the above, the measurement resolution must be \leq the corresponding x or y dimension of the test device with at least one measurement point on the test device.		
Maximum zoom scan spatial resolution: Δx_{Zoom} , Δy_{Zoom}		≤ 2 GHz: ≤ 8 mm 2 – 3 GHz: ≤ 5 mm*	3 – 4 GHz: ≤ 5 mm* 4 – 6 GHz: ≤ 4 mm*	
Maximum zoom scan spatial resolution, normal to phantom surface	uniform grid: $\Delta z_{Zoom}(n)$	≤ 5 mm	3 – 4 GHz: ≤ 4 mm 4 – 5 GHz: ≤ 3 mm 5 – 6 GHz: ≤ 2 mm	
	graded grid	$\Delta z_{Zoom}(1)$: between 1 st two points closest to phantom surface	≤ 4 mm	3 – 4 GHz: ≤ 3 mm 4 – 5 GHz: ≤ 2.5 mm 5 – 6 GHz: ≤ 2 mm
		$\Delta z_{Zoom}(n>1)$: between subsequent points	$\leq 1.5 \cdot \Delta z_{Zoom}(n-1)$	
Minimum zoom scan volume	x, y, z	≥ 30 mm	3 – 4 GHz: ≥ 28 mm 4 – 5 GHz: ≥ 25 mm 5 – 6 GHz: ≥ 22 mm	
Note: δ is the penetration depth of a plane-wave at normal incidence to the tissue medium; see draft standard IEEE P1528-2011 for details. * When zoom scan is required and the <i>reported</i> SAR from the area scan based 1-g SAR estimation procedures of KDB 447498 is ≤ 1.4 W/kg, ≤ 8 mm, ≤ 7 mm and ≤ 5 mm zoom scan resolution may be applied, respectively, for 2 GHz to 3 GHz, 3 GHz to 4 GHz and 4 GHz to 6 GHz.				

9.3 WCDMA Measurement Procedures for SAR

The following procedures are applicable to WCDMA handsets operating under 3GPP Release99, Release 5 and Release 6. The default test configuration is to measure SAR with an established radio link between the DUT and a communication test set using a 12.2kbps RMC (reference measurement channel) configured in Test Loop Mode 1. SAR is selectively confirmed for other physical channel configurations (DPCCH & DPDCH_n), HSDPA and HSPA (HSUPA/HSDPA) modes according to output power, exposure conditions and device operating capabilities. Both uplink and downlink should be configured with the same RMC or AMR, when required. SAR for Release 5 HSDPA and Release 6 HSPA are measured using the applicable FRC (fixed reference channel) and E-DCH reference channel configurations. Maximum output power is verified according to applicable versions of 3GPP TS 34.121 and SAR must be measured according to these maximum output conditions. When Maximum Power Reduction (MPR) is not implemented according to Cubic Metric (CM) requirements for Release 6 HSPA, the following procedures do not apply.

For Release 5 HSDPA Data Devices:

Sub-test	β_c	β_d	β_d (SF)	β_c / β_d	β_{hs}	CM/dB
1	2/15	15/15	64	2/15	4/15	0.0
2	12/15	15/15	64	12/15	24/25	1.0
3	15/15	8/15	64	15/8	30/15	1.5
4	15/15	4/15	64	15/4	30/15	1.5

For Release 6 HSPA Data Devices

Sub-test	β_c	β_d	β_d (SF)	β_c / β_d	β_{hs}	β_{ec}	β_{ed}	β_{ed} (SF)	β_{ed} (codes)	CM (dB)	MPR (dB)	AG Index	E-TFCI
1	11/15	15/15	64	11/15	22/15	209/225	1039/225	4	1	1.5	1.5	20	75
2	6/15	15/15	64	6/15	12/15	12/15	12/15	4	1	1.5	1.5	12	67
3	15/15	9/15	64	15/9	30/15	30/15	$\beta_{ed1}:47/15$ $\beta_{ed2}:47/15$	4	2	1.5	1.5	15	92
4	2/15	15/15	64	2/15	4/15	4/15	56/75	4	1	1.5	1.5	17	71
5	15/15	15/15	64	15/15	24/15	30/15	134/15	4	1	1.5	1.5	21	81

Rel.8 DC-HSDPA (Cat 24)

SAR test exclusion for Rel.8 DC-HSDPA must satisfy the SAR test exclusion requirements of Rel.5 HSDPA. SAR test exclusion for DC-HSDPA devices is determined by power measurements according to the H-Set 12, Fixed Reference Channel (FRC) configuration in Table C.8.1.12 of 3GPP TS 34.121-1. A primary and a secondary serving HS-DSCH Cell are required to perform the power measurement and for the results to qualify for SAR test exclusion.

9.4 SAR Measurement for LTE

SAR tests for LTE are performed with a base station simulator, Rohde & Schwarz CMW500. Closed loop power control was used so the UE transmits with maximum output power during SAR testing. All powers were measured with the CMW 500.

It is performed for conducted power and SAR based on the KDB941225 D05.

SAR is evaluated separately according to the following procedures for the different test positions in each exposure condition – head, body, body-worn accessories and other use conditions. The procedures in the following subsections are applied separately to test each LTE frequency band.

1) QPSK with 1 RB allocation

Start with the largest channel bandwidth and measure SAR for QPSK with 1 RB allocation, using the RB offset and required test channel combination with the highest maximum output power among RB offsets at the upper edge, middle and lower edge of each required test channel. When the reported SAR is ≤ 0.8 W/kg, testing of the remaining RB offset configurations and required test channels is not required for 1 RB allocation; otherwise, SAR is required for the remaining required test channels and only for the RB offset configuration with the highest output power for that channel. When the reported SAR of a required test channel is > 1.45 W/kg, SAR is required for all three RB offset configurations for that required test channel.

2) QPSK with 50% RB allocation

The procedures required for 1 RB allocation in 1) are applied to measure the SAR for QPSK with 50% RB allocation.

3) QPSK with 100% RB allocation

For QPSK with 100% RB allocation, SAR is not required when the highest maximum output power for 100 % RB allocation is less than the highest maximum output power in 50% and 1 RB allocations and the highest reported SAR for 1 RB and 50% RB allocation in 1) and 2) are ≤ 0.8 W/kg. Otherwise, SAR is measured for the highest output power channel; and if the reported SAR is > 1.45 W/kg, the remaining required test channels must also be tested.

TDD test:

TDD testing is performed using guidance from FCC KDB 941225 D05 and the SAR test guidance provided in April 2013 TCB works hop notes. TDD is tested at the highest duty factor using UL-DL configuration 0 with special subframe configuration 6 and applying the FDD LTE procedures in KDB 941225 D05. SAR testing is performed using the extended cyclic prefix listed in 3GPP TS 36.211.

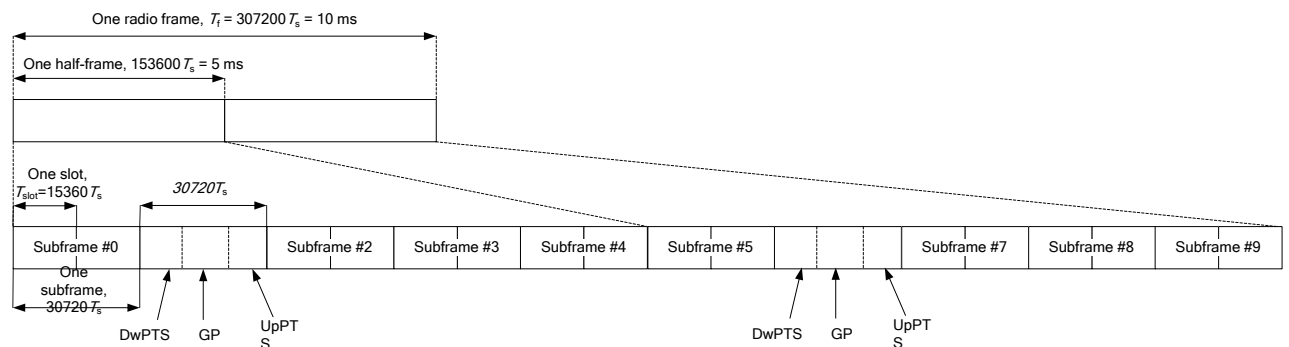

Figure 9.2: Frame structure type 2 (for 5 ms switch-point periodicity)

Table 9.1: Configuration of special subframe (lengths of DwPTS/GP/UpPTS)

Special subframe configuration	Normal cyclic prefix in downlink			Extended cyclic prefix in downlink		
	DwPTS	UpPTS		DwPTS	UpPTS	
		Normal cyclic prefix in uplink	Extended cyclic prefix in uplink		Normal cyclic prefix in uplink	Extended cyclic prefix in uplink
0	$6592 \cdot T_s$	$2192 \cdot T_s$	$2560 \cdot T_s$	$7680 \cdot T_s$	$2192 \cdot T_s$	$2560 \cdot T_s$
1	$19760 \cdot T_s$			$20480 \cdot T_s$		
2	$21952 \cdot T_s$			$23040 \cdot T_s$		
3	$24144 \cdot T_s$			$25600 \cdot T_s$		
4	$26336 \cdot T_s$			$7680 \cdot T_s$		
5	$6592 \cdot T_s$	$4384 \cdot T_s$	$5120 \cdot T_s$	$20480 \cdot T_s$	$4384 \cdot T_s$	$5120 \cdot T_s$
6	$19760 \cdot T_s$			$23040 \cdot T_s$		
7	$21952 \cdot T_s$			$12800 \cdot T_s$		
8	$24144 \cdot T_s$			-		
9	$13168 \cdot T_s$			-		

Table 9.2: Uplink-downlink configurations

Uplink-downlink configuration	Downlink-to-Uplink Switch-point periodicity	Subframe number									
		0	1	2	3	4	5	6	7	8	9
0	5 ms	D	S	U	U	U	D	S	U	U	U
1	5 ms	D	S	U	U	D	D	S	U	U	D
2	5 ms	D	S	U	D	D	D	S	U	D	D
3	10 ms	D	S	U	U	U	D	D	D	D	D
4	10 ms	D	S	U	U	D	D	D	D	D	D
5	10 ms	D	S	U	D	D	D	D	D	D	D
6	5 ms	D	S	U	U	U	D	S	U	U	D

Duty factor is calculated by:

Duty factor = uplink frame*6+UpPTS*2/one frame length

$$= (30720 \cdot T_s * 6 + 5120 \cdot T_s * 2) / 307200 \cdot T_s$$

$$= 0.633$$

9.5 Bluetooth & Wi-Fi Measurement Procedures for SAR

Normal network operating configurations are not suitable for measuring the SAR of 802.11 transmitters in general. Unpredictable fluctuations in network traffic and antenna diversity conditions can introduce undesirable variations in SAR results. The SAR for these devices should be measured using chipset based test mode software to ensure that the results are consistent and reliable.

Chipset based test mode software is hardware dependent and generally varies among manufacturers. The device operating parameters established in a test mode for SAR measurements must be identical to those programmed in production units, including output power levels, amplifier gain settings and other RF performance tuning parameters. The test frequencies should correspond to actual channel frequencies defined for domestic use. SAR for devices with switched diversity should be measured with only one antenna transmitting at a time during each SAR measurement, according to a fixed modulation and data rate. The same data pattern should be used for all measurements.

9.6 Power Drift

To control the output power stability during the SAR test, DASY4 system calculates the power drift by measuring the E-field at the same location at the beginning and at the end of the measurement for each test position. These drift values can be found in section 14 labeled as: (Power Drift [dB]). This ensures that the power drift during one measurement is within 5%.

10 Area Scan Based 1-g SAR

10.1 Requirement of KDB

According to the KDB447498 D01, when the implementation is based the specific polynomial fit algorithm as presented at the 29th Bioelectromagnetics Society meeting (2007) and the estimated 1-gSAR is ≤ 1.2 W/kg, a zoom scan measurement is not required provided it is also not needed for any other purpose; for example, if the peak SAR location required for simultaneous transmission SAR test exclusion can be determined accurately by the SAR system or manually to discriminate between distinctive peaks and scattered noisy SAR distributions from area scans.

There must not be any warning or alert messages due to various measurement concerns identified by the SAR system; for example, noise in measurements, peaks too close to scan boundary, peaks are too sharp, spatial resolution and uncertainty issues etc. The SAR system verification must also demonstrate that the area scan estimated 1-g SAR is within 3% of the zoom scan 1-g SAR (See Annex B). When all the SAR results for each exposure condition in a frequency band and wireless mode are based on estimated 1-g SAR, the 1-g SAR for the highest SAR configuration must be determined by a zoom scan.

10.2 Fast SAR Algorithms

The approach is based on the area scan measurement applying a frequency dependent attenuation parameter. This attenuation parameter was empirically determined by analyzing a large number of phones. The MOTOROLA FAST SAR was developed and validated by the MOTOROLA Research Group in Ft. Lauderdale.

In the initial study, an approximation algorithm based on Linear fit was developed. The accuracy of the algorithm has been demonstrated across a broad frequency range (136-2450 MHz) and for both 1- and 10-g averaged SAR using a sample of 264 SAR measurements from 55 wireless handsets. For the sample size studied, the root-mean-squared errors of the algorithm are 1.2% and 5.8% for 1- and 10-g averaged SAR, respectively. The paper describing the algorithm in detail is expected to be published in August 2004 within the Special Issue of Transactions on MTT.

In the second step, the same research group optimized the fitting algorithm to an Polynomial fit whereby the frequency validity was extended to cover the range 30-6000MHz. Details of this study can be found in the BEMS 2007 Proceedings.

Both algorithms are implemented in DASY software.

11 Conducted Output Power

There are three sets of tune-up power, Normal power and Low power (Receiver on / Hotspot)

For WWAN, when the phone hotspot worked, then power reduction will be implemented immediately at GSM850/1900, WCDMA2/B4, and LTEB25/B66.

For WLAN, when the phone is in talking mode and receiver worked, then power reduction will be applied.

11.1 GSM Measurement result

During the process of testing, the EUT was controlled via Agilent Digital Radio Communication tester (E5515C) to ensure the maximum power transmission and proper modulation. This result contains conducted output power for the EUT. In all cases, the measured peak output power should be greater and within 5% than EMI measurement.

Table 11.1-1: The conducted power measurement results for GSM850/1900-Normal power

GSM 850 Speech (GMSK)	Measured Power (dBm)			Tune up	calculation	Averaged Power (dBm)		
	251	190	128			251	190	128
1 Txslot	32.24	32.22	32.07	33.3	/	/	/	/
GSM 850 GPRS (GMSK)	Measured Power (dBm)				calculation	Averaged Power (dBm)		
	251	190	128			251	190	128
1 Txslot	32.22	32.2	32.03	33.3	-9.03	23.19	23.17	23
2 Txslots	29.98	29.91	29.73	30.5	-6.02	23.96	23.89	23.71
3Txslots	27.95	27.85	27.65	28.5	-4.26	23.69	23.59	23.39
4 Txslots	26.61	26.51	26.26	27.5	-3.01	23.6	23.5	23.25
GSM 850 EGPRS (GMSK)	Measured Power (dBm)				calculation	Averaged Power (dBm)		
	251	190	128			251	190	128
1 Txslot	32.25	32.22	32.06	33.3	-9.03	23.22	23.19	23.03
2 Txslots	30.01	29.93	29.75	30.5	-6.02	23.99	23.91	23.73
3Txslots	27.97	27.86	27.68	28.5	-4.26	23.71	23.6	23.42
4 Txslots	26.6	26.5	26.28	27.5	-3.01	23.59	23.49	23.27
GSM 850 EGPRS (8PSK)	Measured Power (dBm)				calculation	Averaged Power (dBm)		
	251	190	128			251	190	128
1 Txslot	27.17	27.33	27.46	27.8	-9.03	18.14	18.3	18.43
2 Txslots	24.34	24.46	24.64	25.5	-6.02	18.32	18.44	18.62
3Txslots	23.28	23.38	23.58	24	-4.26	19.02	19.12	19.32
4 Txslots	21.53	21.62	22.03	22.5	-3.01	18.52	18.61	19.02
PCS1900 Speech (GMSK)	Measured Power (dBm)			Tune up	calculation	Averaged Power (dBm)		
	810	661	512			810	661	512
1 Txslot	29.73	29.8	29.83	30.3				
PCS1900 GPRS (GMSK)	Measured Power (dBm)				calculation	Averaged Power (dBm)		
	810	661	512			810	661	512

1 Txslot	29.74	29.8	29.86	30.3	-9.03	20.71	20.77	20.83
2 Txslots	28.01	28.04	28.11	28.5	-6.02	21.99	22.02	22.09
3Txslots	25.57	25.6	25.58	26	-4.26	21.31	21.34	21.32
4 Txslots	24.5	24.55	24.55	25	-3.01	21.49	21.54	21.54
PCS1900	Measured Power (dBm)				calculation	Averaged Power (dBm)		
EGPRS (GMSK)	810	661	512			810	661	512
1 Txslot	29.74	29.82	29.88	30.3	-9.03	20.71	20.79	20.85
2 Txslots	28.01	28.03	28.11	28.5	-6.02	21.99	22.01	22.09
3Txslots	25.58	25.58	25.58	26	-4.26	21.32	21.32	21.32
4 Txslots	24.49	24.52	24.54	25	-3.01	21.48	21.51	21.53
PCS1900	Measured Power (dBm)				calculation	Averaged Power (dBm)		
EGPRS (8PSK)	810	661	512			810	661	512
1 Txslot	26.63	26.64	26.87	27.3	-9.03	17.6	17.61	17.84
2 Txslots	24.5	24.41	24.6	25	-6.02	18.48	18.39	18.58
3Txslots	23.35	23.22	23.51	24	-4.26	19.09	18.96	19.25
4 Txslots	22.12	22.11	22.34	22.8	-3.01	19.11	19.1	19.33

NOTES:

1) Division Factors

To average the power, the division factor is as follows:

1TX-slot = 1 transmit time slot out of 8 time slots=> conducted power divided by (8/1) => -9.03dB

2TX-slots = 2 transmit time slots out of 8 time slots=> conducted power divided by (8/2) => -6.02dB

3TX-slots = 3 transmit time slots out of 8 time slots=> conducted power divided by (8/3) => -4.26dB

4TX-slots = 4 transmit time slots out of 8 time slots=> conducted power divided by (8/4) => -3.01dB

According to the conducted power as above, the body measurements are performed with 2Txslots for GSM850 and GSM1900.

Table 11.1-2: The conducted power measurement results for GSM850/1900–Low power

PCS1900	Measured Power (dBm)			Tune up	calculation	Averaged Power (dBm)		
Speech (GMSK)	810	661	512			810	661	512
1 Txslot	28.00	27.95	28.02	28.50	/	/	/	/
PCS1900	Measured Power (dBm)				calculation	Averaged Power (dBm)		
GPRS (GMSK)	810	661	512			810	661	512
1 Txslot	28.02	27.95	28.03	28.50	-9.03	18.99	18.92	19.00
2 Txslots	25.65	25.54	25.59	26.00	-6.02	19.63	19.52	19.57
3Txslots	23.88	23.77	23.81	24.30	-4.26	19.62	19.51	19.55
4 Txslots	22.78	22.67	22.75	23.30	-3.01	19.77	19.66	19.74
PCS1900	Measured Power (dBm)				calculation	Averaged Power (dBm)		
EGPRS (GMSK)	810	661	512			810	661	512
1 Txslot	27.98	27.94	28.00	28.50	-9.03	18.95	18.91	18.97
2 Txslots	25.62	25.53	25.56	26.00	-6.02	19.60	19.51	19.54
3Txslots	23.84	23.77	23.71	24.30	-4.26	19.58	19.51	19.45
4 Txslots	22.75	22.67	22.72	23.30	-3.01	19.74	19.66	19.71

NOTES:

1) Division Factors

To average the power, the division factor is as follows:

1TX-slot = 1 transmit time slot out of 8 time slots=> conducted power divided by (8/1) => -9.03dB

2TX-slots = 2 transmit time slots out of 8 time slots=> conducted power divided by (8/2) => -6.02dB

3TX-slots = 3 transmit time slots out of 8 time slots=> conducted power divided by (8/3) => -4.26dB

4TX-slots = 4 transmit time slots out of 8 time slots=> conducted power divided by (8/4) => -3.01dB

According to the conducted power as above, the body measurements are performed with 2Txslots for GSM850 and GSM1900.

11.2 WCDMA Measurement result

Table 11.2-1: The conducted Power for WCDMA Normal power

WCDMA Part				
WCDMA850	FDDV result (dBm)			TUNEUP
	4233/4458	4183/4408	4132/4357	
	(846.6MHz)	(836.6MHz)	(826.4MHz)	
	23.83	23.75	23.68	24.00
HSUPA	22.01	21.96	21.88	22.00
	22.04	21.91	21.88	22.00
	21.52	21.44	20.90	22.00
	22.03	20.94	21.92	22.00
	20.99	20.91	20.89	22.00
DC-HSDPA	21.9	21.93	21.87	23.00
	21.38	21.39	21.33	23.00
	21.09	21.01	21.05	23.00
	21.04	21.08	21.05	23.00
WCDMA1900	FDDII result (dBm)			TUNEUP
	9538/9938	9400/9800	9262/9662	
	(1907.6MHz)	(1880MHz)	(1852.4MHz)	
	23.20	23.14	23.46	24.00
HSUPA	20.84	20.83	20.95	22.00
	20.73	20.76	20.91	22.00
	20.28	20.29	20.36	22.00
	20.78	20.73	20.86	22.00
	19.75	19.73	19.88	21.00
DC-HSDPA	20.62	20.68	20.84	22.00
	19.66	19.76	19.96	21.00
	19.3	19.38	19.50	21.00
	19.28	19.35	19.49	21.00
WCDMA1700	FDDIV result (dBm)			TUNEUP
	1513/1738	1412/1637	1312/1537	
	(1752.6MHz)	(1732.4MHz)	(1712.4MHz)	
	23.47	23.54	23.43	24.00
HSUPA	20.79	20.91	20.99	22.00
	20.76	20.96	20.95	22.00
	20.3	20.43	20.46	22.00
	20.8	20.83	20.91	22.00
	20.03	20.04	20.01	22.00
DC-HSDPA	20.7	20.81	20.87	22.00
	19.78	19.96	19.90	21.00
	19.35	19.49	19.54	21.00
	19.36	19.45	19.53	21.00

Table 11.2-2: The conducted Power for WCDMA Low power

WCDMA Part				
WCDMA1900	FDDII result (dBm)			TUNEUP
	9538/9938 (1907.6MHz)	9400/9800 (1880MHz)	9262/9662 (1852.4MHz)	
	19.75	19.66	19.83	20.50
	19.7	19.67	19.80	20.50
HSUPA	19.71	19.65	19.80	20.50
	19.28	19.19	18.88	20.00
	19.73	19.66	19.83	20.00
	18.72	18.65	18.82	20.00
DC-HSDPA	19.64	19.67	19.80	20.00
	18.8	19.85	19.03	20.00
	18.37	19.40	18.56	20.00
	18.31	18.36	18.52	20.00
WCDMA1700	FDDIV result (dBm)			TUNEUP
	1513/1738 (1752.6MHz)	1412/1637 (1732.4MHz)	1312/1537 (1712.4MHz)	
	21.17	21.24	21.21	21.50
	20.47	20.59	20.67	21.00
HSUPA	20.44	20.64	20.63	21.00
	19.99	20.12	20.15	21.00
	20.48	20.51	20.59	21.00
	19.43	19.54	19.51	21.00
DC-HSDPA	21.01	21.02	21.08	21.50
	20.17	20.35	20.29	21.00
	19.73	19.87	19.92	21.00
	19.74	19.83	19.91	21.00

11.3 LTE Measurement result

Table 11.3-1: Tune up for LTE Normal power

Band	Tune up (dBm)	
	Normal power	Low power
Band 12	24	/
Band 13	24	/
Band 25	24	20.5
Band 26	24	/
Band 41 PC2	27	/
Band 41 PC3	24	/
Band 66	24	20.8
Band 71	24	/

Table 11.3-2: Maximum Power Reduction (MPR) for LTE Normal power

Modulation	Channel bandwidth / Transmission bandwidth configuration [RB]						MPR (dB)
	1.4 MHz	3 MHz	5 MHz	10 MHz	15 MHz	20 MHz	
QPSK	> 5	> 4	> 8	> 12	> 16	> 18	1
16 QAM	≤ 5	≤ 4	≤ 8	≤ 12	≤ 16	≤ 18	1
16 QAM	> 5	> 4	> 8	> 12	> 16	> 18	2
64 QAM	≤ 5	≤ 4	≤ 8	≤ 12	≤ 16	≤ 18	2
64 QAM	> 5	> 4	> 8	> 12	> 16	> 18	3

LTEband12

Bandwidth (MHz)	RB allocation	Frequency (MHz)	Actual output power (dBm)	
	RB offset		QPSK	16QAM
1.4MHz	1RB-High (5)	715.3	23.19	22.27
		707.5	23.03	22.16
		699.7	22.96	22.07
	1RB-Middle (3)	715.3	23.07	22.36
		707.5	23.06	22.23
		699.7	23.08	22.17
	1RB-Low (0)	715.3	23.12	22.17
		707.5	23.02	22.16
		699.7	22.91	22.02
	3RB-High (3)	715.3	23.09	22.21
		707.5	23.12	22.08
		699.7	23.06	21.97
	3RB-Middle (1)	715.3	23.13	22.22
		707.5	23.19	22.13
		699.7	23.08	22.03
	3RB-Low (0)	715.3	23.12	22.15
		707.5	23.13	22.11
		699.7	23.01	21.99
	6RB (0)	715.3	22.24	21.19
		707.5	22.14	21.12
		699.7	22.04	21.07
3MHz	1RB-High (14)	714.5	23.02	22.29
		707.5	23.09	22.20
		700.5	22.94	22.03
	1RB-Middle (7)	714.5	23.02	22.36
		707.5	23.16	22.29
		700.5	23.05	22.20
	1RB-Low (0)	714.5	23.04	22.18
		707.5	22.97	22.09
		700.5	22.92	21.99
	8RB-High (7)	714.5	22.17	21.13
		707.5	22.06	21.05
		700.5	21.97	21.03
	8RB-Middle (4)	714.5	22.20	21.14
		707.5	22.09	21.08
		700.5	22.01	21.08
	8RB-Low (0)	714.5	22.14	21.08
		707.5	22.04	21.01
		700.5	21.93	21.04
	15RB (0)	714.5	22.15	21.09
		707.5	22.05	21.01
		700.5	21.98	21.01

5MHz	1RB-High (24)	713.5	23.09	22.19
		707.5	23.01	22.15
		701.5	22.86	22.09
	1RB-Middle (12)	713.5	23.09	22.35
		707.5	23.05	22.26
		701.5	23.10	22.17
	1RB-Low (0)	713.5	22.94	22.08
		707.5	22.88	22.00
		701.5	22.79	21.95
	12RB-High (13)	713.5	22.11	21.06
		707.5	22.12	21.07
		701.5	21.98	21.04
	12RB-Middle (6)	713.5	22.15	21.08
		707.5	22.09	21.01
		701.5	22.06	21.08
	12RB-Low (0)	713.5	22.09	21.02
		707.5	22.03	21.05
		701.5	21.99	21.02
25RB (0)	713.5	22.12	21.10	
	707.5	22.09	21.05	
	701.5	21.96	20.93	
10MHz	1RB-High (49)	711	23.17	22.29
		707.5	23.08	22.25
		704	23.02	22.20
	1RB-Middle (24)	711	23.14	22.34
		707.5	23.12	22.24
		704	23.04	22.15
	1RB-Low (0)	711	22.91	22.03
		707.5	22.86	21.98
		704	22.84	21.98
	25RB-High (25)	711	22.12	21.10
		707.5	22.21	21.18
		704	22.14	21.10
	25RB-Middle (12)	711	22.14	21.10
		707.5	22.11	21.10
		704	22.09	21.05
	25RB-Low (0)	711	22.04	21.04
		707.5	22.02	21.02
		704	22.05	21.04
50RB (0)	711	22.06	21.06	
	707.5	22.14	21.10	
	704	22.13	21.08	

LTEband13

Bandwidth (MHz)	RB allocation	Frequency (MHz)	Actual output power (dBm)	
	RB offset		QPSK	16QAM
5MHz	1RB-High (24)	784.5 (23255)	22.82	21.98
		782 (23230)	22.85	22.03
		779.5 (23205)	22.89	22.38
	1RB-Middle (12)	784.5 (23255)	23.04	22.26
		782 (23230)	23.04	22.27
		779.5 (23205)	23.08	22.61
	1RB-Low (0)	784.5 (23255)	22.85	21.99
		782 (23230)	22.86	22.03
		779.5 (23205)	22.92	22.24
	12RB-High (13)	784.5 (23255)	21.93	20.97
		782 (23230)	21.99	21.00
		779.5 (23205)	22.01	21.13
	12RB-Middle (6)	784.5 (23255)	22.04	21.10
		782 (23230)	22.04	21.07
		779.5 (23205)	22.00	21.14
	12RB-Low (0)	784.5 (23255)	21.98	21.02
		782 (23230)	21.87	20.96
		779.5 (23205)	21.84	20.97
	25RB (0)	784.5 (23255)	21.95	20.93
		782 (23230)	21.92	20.96
		779.5 (23205)	21.94	21.00
10MHz	1RB-High (49)	782 (23230)	23.04	22.33
	1RB-Middle (24)	782 (23230)	23.13	22.36
	1RB-Low (0)	782 (23230)	22.99	22.23
	25RB-High (25)	782 (23230)	21.93	21.00
	25RB-Middle (12)	782 (23230)	22.03	21.07
	25RB-Low (0)	782 (23230)	21.84	20.89
	50RB (0)	782 (23230)	21.92	20.93

LTEband25

Bandwidth (MHz)	RB allocation	Frequency (MHz)	Actual output power (dBm)		
	RB offset		QPSK	16QAM	
1.4MHz	1RB-High (5)	1914.3 (26683)	22.64	21.78	
		1882.5 (26365)	22.64	21.85	
		1850.7 (26047)	22.76	22.18	
	1RB-Middle (3)	1914.3 (26683)	22.90	21.88	
		1882.5 (26365)	22.78	21.96	
		1850.7 (26047)	22.89	22.35	
	1RB-Low (0)	1914.3 (26683)	22.67	21.75	
		1882.5 (26365)	22.63	21.82	
		1850.7 (26047)	22.74	22.15	
	3RB-High (3)	1914.3 (26683)	22.92	22.02	
		1882.5 (26365)	22.78	21.80	
		1850.7 (26047)	22.87	22.06	
	3RB-Middle (1)	1914.3 (26683)	22.87	22.05	
		1882.5 (26365)	22.79	21.86	
		1850.7 (26047)	22.95	22.09	
	3RB-Low (0)	1914.3 (26683)	22.80	21.98	
		1882.5 (26365)	22.74	21.82	
		1850.7 (26047)	22.87	22.08	
	6RB (0)	1914.3 (26683)	21.77	20.95	
		1882.5 (26365)	21.70	20.84	
		1850.7 (26047)	21.75	20.68	
	3MHz	1RB-High (14)	1913.5 (26675)	22.76	22.18
			1882.5 (26365)	22.68	21.78
			1851.5 (26055)	22.83	21.79
1RB-Middle (7)		1913.5 (26675)	22.92	22.34	
		1882.5 (26365)	22.81	21.95	
		1851.5 (26055)	22.94	21.90	
1RB-Low (0)		1913.5 (26675)	22.78	22.19	
		1882.5 (26365)	22.71	21.85	
		1851.5 (26055)	22.82	21.77	
8RB-High (7)		1913.5 (26675)	21.77	20.86	
		1882.5 (26365)	21.74	20.79	
		1851.5 (26055)	21.77	20.93	
8RB-Middle (4)		1913.5 (26675)	21.86	20.94	
		1882.5 (26365)	21.78	20.84	
		1851.5 (26055)	21.82	20.95	
8RB-Low (0)		1913.5 (26675)	21.83	20.95	
		1882.5 (26365)	21.75	20.79	
		1851.5 (26055)	21.79	20.96	
15RB (0)		1913.5 (26675)	21.80	20.82	
		1882.5 (26365)	21.77	20.73	
		1851.5 (26055)	21.84	20.91	

5MHz	1RB-High (24)	1912.5 (26665)	22.73	21.84	
		1882.5 (26365)	22.71	21.85	
		1852.5 (26065)	22.75	22.34	
	1RB-Middle (12)	1912.5 (26665)	22.99	22.06	
		1882.5 (26365)	22.93	22.12	
		1852.5 (26065)	22.95	22.53	
	1RB-Low (0)	1912.5 (26665)	22.72	21.80	
		1882.5 (26365)	22.73	21.87	
		1852.5 (26065)	22.72	22.29	
	12RB-High (13)	1912.5 (26665)	21.70	20.79	
		1882.5 (26365)	21.76	20.82	
		1852.5 (26065)	21.83	20.98	
	12RB-Middle (6)	1912.5 (26665)	21.86	20.87	
		1882.5 (26365)	21.79	20.89	
		1852.5 (26065)	21.86	21.07	
	12RB-Low (0)	1912.5 (26665)	21.79	20.85	
		1882.5 (26365)	21.74	20.83	
		1852.5 (26065)	21.79	20.97	
	25RB (0)	1912.5 (26665)	21.79	20.72	
		1882.5 (26365)	21.73	20.78	
		1852.5 (26065)	21.81	20.92	
	10MHz	1RB-High (49)	1910 (26640)	22.70	21.76
			1882.5 (26365)	22.64	21.65
			1855 (26090)	22.83	22.19
1RB-Middle (24)		1910 (26640)	22.78	21.84	
		1882.5 (26365)	22.82	21.83	
		1855 (26090)	22.95	22.38	
1RB-Low (0)		1910 (26640)	22.63	21.80	
		1882.5 (26365)	22.67	21.69	
		1855 (26090)	22.76	22.16	
25RB-High (25)		1910 (26640)	21.72	20.80	
		1882.5 (26365)	21.80	20.84	
		1855 (26090)	21.87	20.96	
25RB-Middle (12)		1910 (26640)	21.79	20.93	
		1882.5 (26365)	21.85	20.83	
		1855 (26090)	21.93	20.97	
25RB-Low (0)		1910 (26640)	21.81	20.95	
		1882.5 (26365)	21.80	20.86	
		1855 (26090)	21.88	20.95	
50RB (0)		1910 (26640)	21.75	20.84	
		1882.5 (26365)	21.82	20.79	
		1855 (26090)	21.91	20.94	

15MHz	1RB-High (74)	1907.5 (26615)	22.67	22.12
		1882.5 (26365)	22.63	21.55
		1857.5 (26115)	22.72	22.05
	1RB-Middle (37)	1907.5 (26615)	22.83	22.26
		1882.5 (26365)	22.70	21.71
		1857.5 (26115)	22.91	22.30
	1RB-Low (0)	1907.5 (26615)	22.71	22.20
		1882.5 (26365)	22.63	21.66
		1857.5 (26115)	22.78	22.12
	36RB-High (38)	1907.5 (26615)	21.76	20.71
		1882.5 (26365)	21.73	20.72
		1857.5 (26115)	21.89	20.90
	36RB-Middle (19)	1907.5 (26615)	21.82	20.77
		1882.5 (26365)	21.77	20.75
		1857.5 (26115)	21.84	20.92
	36RB-Low (0)	1907.5 (26615)	21.82	20.78
		1882.5 (26365)	21.77	20.72
		1857.5 (26115)	21.89	20.88
75RB (0)	1907.5 (26615)	21.78	20.75	
	1882.5 (26365)	21.76	20.75	
	1857.5 (26115)	21.87	20.91	
20MHz	1RB-High (99)	1905 (26590)	22.60	22.08
		1882.5 (26365)	22.49	21.99
		1860 (26140)	22.55	22.21
	1RB-Middle (50)	1905 (26590)	22.91	22.46
		1882.5 (26365)	22.83	22.33
		1860 (26140)	22.92	22.52
	1RB-Low (0)	1905 (26590)	22.56	22.13
		1882.5 (26365)	22.53	22.03
		1860 (26140)	22.56	22.18
	50RB-High (50)	1905 (26590)	21.65	20.70
		1882.5 (26365)	21.72	20.69
		1860 (26140)	21.75	20.81
	50RB-Middle (25)	1905 (26590)	21.80	20.89
		1882.5 (26365)	21.77	20.74
		1860 (26140)	21.85	20.93
	50RB-Low (0)	1905 (26590)	21.83	20.87
		1882.5 (26365)	21.80	20.79
		1860 (26140)	21.80	20.84
100RB (0)	1905 (26590)	21.77	20.78	
	1882.5 (26365)	21.74	20.76	
	1860 (26140)	21.80	20.84	

LTE band25 Low power

Bandwidth (MHz)	RB allocation	Frequency (MHz)	Actual output power (dBm)		
	RB offset		QPSK	16QAM	
1.4MHz	1RB-High (5)	1914.3 (26683)	19.77	20.14	
		1882.5 (26365)	19.71	20.07	
		1850.7 (26047)	19.82	20.22	
	1RB-Middle (3)	1914.3 (26683)	20.08	20.30	
		1882.5 (26365)	19.93	20.24	
		1850.7 (26047)	20.03	20.29	
	1RB-Low (0)	1914.3 (26683)	19.88	20.14	
		1882.5 (26365)	19.80	20.11	
		1850.7 (26047)	19.91	20.19	
	3RB-High (3)	1914.3 (26683)	19.97	20.09	
		1882.5 (26365)	19.92	20.01	
		1850.7 (26047)	20.01	20.13	
	3RB-Middle (1)	1914.3 (26683)	20.03	20.12	
		1882.5 (26365)	19.96	20.07	
		1850.7 (26047)	20.08	20.20	
	3RB-Low (0)	1914.3 (26683)	19.99	20.08	
		1882.5 (26365)	19.91	19.99	
		1850.7 (26047)	20.03	20.18	
	6RB (0)	1914.3 (26683)	20.07	20.04	
		1882.5 (26365)	19.91	19.97	
		1850.7 (26047)	19.73	20.08	
	3MHz	1RB-High (14)	1913.5 (26675)	19.98	20.20
			1882.5 (26365)	19.89	20.13
			1851.5 (26055)	20.05	20.31
		1RB-Middle (7)	1913.5 (26675)	20.17	20.38
			1882.5 (26365)	20.05	20.33
			1851.5 (26055)	20.17	20.40
1RB-Low (0)		1913.5 (26675)	19.93	20.14	
		1882.5 (26365)	19.87	20.12	
		1851.5 (26055)	20.02	20.26	
8RB-High (7)		1913.5 (26675)	19.99	20.04	
		1882.5 (26365)	19.92	19.97	
		1851.5 (26055)	20.05	20.13	
8RB-Middle (4)		1913.5 (26675)	20.04	20.10	
		1882.5 (26365)	19.96	20.02	
		1851.5 (26055)	20.05	20.14	
8RB-Low (0)		1913.5 (26675)	20.00	20.10	
		1882.5 (26365)	19.91	19.98	
		1851.5 (26055)	20.02	20.12	
15RB (0)		1913.5 (26675)	19.97	19.99	
		1882.5 (26365)	19.90	19.93	
		1851.5 (26055)	20.06	20.07	

3MHz	1RB-High (14)	1913.5 (26675)	19.98	20.20
		1882.5 (26365)	19.89	20.13
		1851.5 (26055)	20.05	20.31
	1RB-Middle (7)	1913.5 (26675)	20.17	20.38
		1882.5 (26365)	20.05	20.33
		1851.5 (26055)	20.17	20.40
	1RB-Low (0)	1913.5 (26675)	19.93	20.14
		1882.5 (26365)	19.87	20.12
		1851.5 (26055)	20.02	20.26
	8RB-High (7)	1913.5 (26675)	19.99	20.04
		1882.5 (26365)	19.92	19.97
		1851.5 (26055)	20.05	20.13
	8RB-Middle (4)	1913.5 (26675)	20.04	20.10
		1882.5 (26365)	19.96	20.02
		1851.5 (26055)	20.05	20.14
	8RB-Low (0)	1913.5 (26675)	20.00	20.10
		1882.5 (26365)	19.91	19.98
		1851.5 (26055)	20.02	20.12
	15RB (0)	1913.5 (26675)	19.97	19.99
		1882.5 (26365)	19.90	19.93
		1851.5 (26055)	20.06	20.07
5MHz	1RB-High (24)	1912.5 (26665)	19.89	20.13
		1882.5 (26365)	19.79	20.02
		1852.5 (26065)	19.96	20.17
	1RB-Middle (12)	1912.5 (26665)	20.12	20.35
		1882.5 (26365)	20.04	20.31
		1852.5 (26065)	20.22	20.39
	1RB-Low (0)	1912.5 (26665)	19.83	20.07
		1882.5 (26365)	19.79	20.09
		1852.5 (26065)	19.92	20.15
	12RB-High (13)	1912.5 (26665)	19.95	19.96
		1882.5 (26365)	19.94	19.95
		1852.5 (26065)	20.07	20.08
	12RB-Middle (6)	1912.5 (26665)	20.08	20.07
		1882.5 (26365)	19.99	19.99
		1852.5 (26065)	20.13	20.15
	12RB-Low (0)	1912.5 (26665)	20.00	20.01
		1882.5 (26365)	19.91	19.95
		1852.5 (26065)	20.06	20.05
	25RB (0)	1912.5 (26665)	19.99	20.06
		1882.5 (26365)	19.94	19.98
		1852.5 (26065)	20.06	20.13

15MHz	1RB-High (74)	1907.5 (26615)	19.90	20.15
		1882.5 (26365)	19.83	20.07
		1857.5 (26115)	19.91	20.16
	1RB-Middle (37)	1907.5 (26615)	20.13	20.41
		1882.5 (26365)	20.06	20.32
		1857.5 (26115)	20.22	20.45
	1RB-Low (0)	1907.5 (26615)	19.87	20.11
		1882.5 (26365)	19.81	20.07
		1857.5 (26115)	19.96	20.22
	36RB-High (38)	1907.5 (26615)	20.01	20.02
		1882.5 (26365)	19.95	19.95
		1857.5 (26115)	20.15	20.13
	36RB-Middle (19)	1907.5 (26615)	20.03	20.02
		1882.5 (26365)	19.96	19.98
		1857.5 (26115)	20.14	20.13
	36RB-Low (0)	1907.5 (26615)	20.00	20.02
		1882.5 (26365)	19.98	19.97
		1857.5 (26115)	20.13	20.14
75RB (0)	1907.5 (26615)	19.98	20.03	
	1882.5 (26365)	19.93	19.98	
	1857.5 (26115)	20.12	20.14	
20MHz	1RB-High (99)	1905 (26590)	19.87	20.07
		1882.5 (26365)	19.77	20.00
		1860 (26140)	19.67	19.91
	1RB-Middle (50)	1905 (26590)	20.06	20.35
		1882.5 (26365)	20.02	20.25
		1860 (26140)	20.03	20.26
	1RB-Low (0)	1905 (26590)	19.76	19.99
		1882.5 (26365)	19.75	19.99
		1860 (26140)	19.83	20.06
	50RB-High (50)	1905 (26590)	19.90	19.94
		1882.5 (26365)	19.89	19.92
		1860 (26140)	19.93	19.97
	50RB-Middle (25)	1905 (26590)	20.12	20.05
		1882.5 (26365)	19.98	19.99
		1860 (26140)	19.94	19.99
	50RB-Low (0)	1905 (26590)	20.02	20.04
		1882.5 (26365)	19.96	19.97
		1860 (26140)	19.91	19.95
100RB (0)	1905 (26590)	19.97	20.01	
	1882.5 (26365)	19.92	19.97	
	1860 (26140)	19.95	19.98	

LTE band26

Bandwidth (MHz)	RB allocation	Frequency (MHz)	Actual output power (dBm)	
	RB offset		QPSK	16QAM
1.4MHz	1RB-High (5)	848.3 (27033)	22.94	22.06
		831.5 (26865)	22.87	22.08
		814.7 (26697)	22.90	22.06
	1RB-Middle (3)	848.3 (27033)	23.09	22.18
		831.5 (26865)	23.00	22.23
		814.7 (26697)	23.01	22.18
	1RB-Low (0)	848.3 (27033)	22.95	22.14
		831.5 (26865)	22.87	22.04
		814.7 (26697)	22.88	22.12
	3RB-High (3)	848.3 (27033)	23.06	22.05
		831.5 (26865)	23.00	22.03
		814.7 (26697)	23.00	22.07
	3RB-Middle (1)	848.3 (27033)	23.09	22.11
		831.5 (26865)	23.05	22.09
		814.7 (26697)	23.08	22.11
	3RB-Low (0)	848.3 (27033)	23.05	22.06
		831.5 (26865)	23.00	22.03
		814.7 (26697)	23.00	22.05
	6RB (0)	848.3 (27033)	22.34	22.85
		831.5 (26865)	22.27	22.51
		814.7 (26697)	22.52	22.76
3MHz	1RB-High (14)	847.5 (27025)	22.95	22.10
		831.5 (26865)	22.95	22.10
		815.5 (26705)	22.95	22.15
	1RB-Middle (7)	847.5 (27025)	23.18	22.31
		831.5 (26865)	23.06	22.26
		815.5 (26705)	23.11	22.37
	1RB-Low (0)	847.5 (27025)	22.95	22.11
		831.5 (26865)	22.92	22.14
		815.5 (26705)	22.90	22.11
	8RB-High (7)	847.5 (27025)	22.03	21.02
		831.5 (26865)	21.98	20.99
		815.5 (26705)	21.98	20.99
	8RB-Middle (4)	847.5 (27025)	22.06	21.06
		831.5 (26865)	22.02	21.04
		815.5 (26705)	21.97	21.00
	8RB-Low (0)	847.5 (27025)	22.03	21.05
		831.5 (26865)	21.94	20.96
		815.5 (26705)	21.92	20.98
15RB (0)	847.5 (27025)	22.03	20.98	
	831.5 (26865)	21.96	20.94	
	815.5 (26705)	21.93	20.91	

5MHz	1RB-High (24)	846.5 (27015)	22.88	22.06
		831.5 (26865)	22.86	22.01
		816.5 (26715)	22.86	22.05
	1RB-Middle (12)	846.5 (27015)	23.13	22.27
		831.5 (26865)	23.09	22.28
		816.5 (26715)	23.09	22.35
	1RB-Low (0)	846.5 (27015)	22.82	21.98
		831.5 (26865)	22.80	21.95
		816.5 (26715)	22.77	21.98
	12RB-High (13)	846.5 (27015)	21.97	20.93
		831.5 (26865)	21.96	20.92
		816.5 (26715)	21.92	20.92
	12RB-Middle (6)	846.5 (27015)	22.09	21.03
		831.5 (26865)	22.05	21.02
		816.5 (26715)	22.01	21.02
	12RB-Low (0)	846.5 (27015)	22.03	20.99
		831.5 (26865)	21.91	20.86
		816.5 (26715)	21.90	20.88
25RB (0)	846.5 (27015)	22.03	21.00	
	831.5 (26865)	21.95	20.94	
	816.5 (26715)	21.96	20.96	
10MHz	1RB-High (49)	844 (26990)	23.00	22.18
		831.5 (26865)	22.96	22.12
		820 (26750)	22.95	22.20
	1RB-Middle (24)	844 (26990)	23.09	22.26
		831.5 (26865)	23.06	22.23
		820 (26750)	23.06	22.24
	1RB-Low (0)	844 (26990)	22.87	22.05
		831.5 (26865)	22.84	22.07
		820 (26750)	22.86	22.09
	25RB-High (25)	844 (26990)	22.00	20.97
		831.5 (26865)	21.98	21.01
		820 (26750)	22.01	21.02
	25RB-Middle (12)	844 (26990)	22.05	21.06
		831.5 (26865)	22.02	21.01
		820 (26750)	22.01	21.02
	25RB-Low (0)	844 (26990)	22.04	21.02
		831.5 (26865)	21.95	20.94
		820 (26750)	22.01	21.01
50RB (0)	844 (26990)	22.01	20.98	
	831.5 (26865)	21.97	20.96	
	820 (26750)	22.02	20.99	

15MHz	1RB-High (74)	841.5 (26965)	23.01	22.15
		831.5 (26865)	22.98	22.12
		822.5 (26775)	22.88	22.12
	1RB-Middle (37)	841.5 (26965)	23.13	22.34
		831.5 (26865)	23.12	22.29
		822.5 (26775)	23.12	22.36
	1RB-Low (0)	841.5 (26965)	22.79	22.01
		831.5 (26865)	22.78	21.96
		822.5 (26775)	22.80	22.00
	36RB-High (38)	841.5 (26965)	22.02	20.97
		831.5 (26865)	22.01	20.96
		822.5 (26775)	22.04	20.99
	36RB-Middle (19)	841.5 (26965)	22.07	21.03
		831.5 (26865)	22.02	20.98
		822.5 (26775)	22.02	20.99
	36RB-Low (0)	841.5 (26965)	22.02	20.97
		831.5 (26865)	21.92	20.86
		822.5 (26775)	22.00	20.95
	75RB (0)	841.5 (26965)	22.05	21.01
		831.5 (26865)	21.94	20.92
		822.5 (26775)	22.02	21.00

LTE band41 (PC2)

Bandwidth (MHz)	RB allocation RB offset	Frequency (MHz)	Actual output power (dBm)		
			QPSK	16QAM	
5MHz	1RB-High (24)	2687.5 (41565)	25.95	25.06	
		2640.3(41093)	26.17	25.33	
		2593 (40620)	26.17	25.28	
		2545.8(40148)	25.96	25.04	
	1RB-Middle (12)	2498.5 (39675)	25.89	24.97	
		2687.5 (41565)	25.93	25.05	
		2640.3(41093)	26.12	25.27	
		2593 (40620)	26.08	25.19	
	1RB-Low (0)	2545.8(40148)	25.84	24.93	
		2498.5 (39675)	25.81	24.93	
		2687.5 (41565)	26.02	25.13	
		2640.3(41093)	26.22	25.28	
	12RB-High (13)	2593 (40620)	26.15	25.32	
		2545.8(40148)	25.96	25.05	
		2498.5 (39675)	25.95	25.04	
		2687.5 (41565)	25.09	24.05	
	12RB-Middle (6)	2640.3(41093)	25.27	24.17	
		2593 (40620)	25.27	24.20	
		2545.8(40148)	25.00	23.95	
		2498.5 (39675)	25.02	23.92	
	12RB-Low (0)	2687.5 (41565)	25.10	24.08	
		2640.3(41093)	25.29	24.21	
		2593 (40620)	25.28	24.21	
		2545.8(40148)	25.02	23.97	
	25RB (0)	2498.5 (39675)	25.02	23.91	
		2687.5 (41565)	25.11	24.11	
		2640.3(41093)	25.27	24.20	
		2593 (40620)	25.26	24.19	
	10MHz	1RB-High (49)	2545.8(40148)	25.00	23.96
			2498.5 (39675)	25.07	23.90
			2687.5 (41565)	25.07	24.15
			2640.3(41093)	25.23	24.27
		1RB-Middle (24)	2593 (40620)	25.25	24.29
			2545.8(40148)	25.00	24.08
			2498.5 (39675)	25.08	24.03
			2685 (41540)	25.93	25.07
		1RB-Low (0)	2639(41080)	26.16	25.24
			2593 (40620)	26.20	25.29
			2547(40160)	25.97	25.06
			2501 (39700)	25.87	24.98
	25RB-High (25)	2685 (41540)	26.00	25.18	
		2639(41080)	26.25	25.40	
		2593 (40620)	26.27	25.27	
		2547(40160)	26.05	25.06	
	25RB-Middle (12)	2501 (39700)	26.04	25.12	
		2685 (41540)	26.09	25.16	
		2639(41080)	26.28	25.32	
		2593 (40620)	26.20	25.33	
25RB-Low (0)	2547(40160)	25.95	25.09		
	2501 (39700)	25.95	25.08		
	2685 (41540)	25.12	24.20		
	2639(41080)	25.28	24.33		
50RB (0)	2593 (40620)	25.34	24.38		
	2547(40160)	25.07	24.13		
	2501 (39700)	25.09	24.11		
	2685 (41540)	25.17	24.25		
50RB (0)	2639(41080)	25.31	24.33		
	2593 (40620)	25.31	24.35		
	2547(40160)	25.07	24.11		
	2501 (39700)	25.04	24.08		
50RB (0)	2685 (41540)	25.18	24.26		
	2639(41080)	25.31	24.33		
	2593 (40620)	25.28	24.32		
	2547(40160)	25.03	24.09		
50RB (0)	2501 (39700)	25.04	24.01		
	2685 (41540)	25.13	24.14		
	2639(41080)	25.31	24.24		
	2593 (40620)	25.34	24.25		
50RB (0)	2547(40160)	25.06	24.01		
	2501 (39700)	25.04	23.97		

15MHz	1RB-High (74)	2682.5 (41515)	25.89	25.00
		2637.8(41068)	26.08	25.13
		2593 (40620)	26.14	25.26
		2548.3(40173)	25.96	25.05
	1RB-Middle (37)	2503.5 (39725)	25.84	24.95
		2682.5 (41515)	25.92	25.04
		2637.8(41068)	26.13	25.26
		2593 (40620)	26.22	25.18
	1RB-Low (0)	2548.3(40173)	25.92	24.97
		2503.5 (39725)	25.94	24.87
		2682.5 (41515)	26.04	25.17
		2637.8(41068)	26.33	25.31
	36RB-High (38)	2593 (40620)	26.13	25.21
		2548.3(40173)	25.94	25.00
		2503.5 (39725)	25.91	25.01
		2682.5 (41515)	25.10	24.10
	36RB-Middle (19)	2637.8(41068)	25.27	24.23
		2593 (40620)	25.34	24.26
		2548.3(40173)	25.06	24.00
		2503.5 (39725)	25.08	23.93
36RB-Low (0)	2682.5 (41515)	25.13	24.14	
	2637.8(41068)	25.31	24.23	
	2593 (40620)	25.31	24.24	
	2548.3(40173)	25.03	24.01	
75RB (0)	2503.5 (39725)	25.04	23.98	
	2682.5 (41515)	25.16	24.17	
	2637.8(41068)	25.34	24.27	
	2593 (40620)	25.24	24.20	
20MHz	1RB-High (99)	2548.3(40173)	25.03	23.98
		2503.5 (39725)	25.08	23.91
		2682.5 (41515)	25.12	24.15
		2637.8(41068)	25.28	24.26
	1RB-Middle (50)	2593 (40620)	25.28	24.26
		2548.3(40173)	25.02	24.01
		2503.5 (39725)	25.09	23.95
		2682.5 (41515)	25.09	23.95
	1RB-Low (0)	2680 (41490)	25.87	24.87
		2636.5(41055)	26.10	25.14
		2593 (40620)	26.15	25.25
		2549.5(40185)	25.93	24.98
	50RB-High (50)	2506 (39750)	25.81	24.89
		2680 (41490)	26.09	25.13
		2636.5(41055)	26.13	25.27
		2593 (40620)	26.50	25.21
	50RB-Middle (25)	2549.5(40185)	25.98	25.03
		2506 (39750)	25.93	24.93
		2680 (41490)	26.11	25.23
		2636.5(41055)	26.18	25.28
50RB-Low (0)	2593 (40620)	26.12	25.19	
	2549.5(40185)	25.96	25.03	
	2506 (39750)	25.90	25.04	
	2680 (41490)	25.07	24.06	
100RB (0)	2636.5(41055)	25.25	24.18	
	2593 (40620)	25.33	24.28	
	2549.5(40185)	25.04	23.99	
	2506 (39750)	25.08	23.85	
	2680 (41490)	25.15	24.14	
	2636.5(41055)	25.31	24.22	
	2593 (40620)	25.29	24.22	
	2549.5(40185)	25.04	23.99	
	2506 (39750)	25.02	23.93	
	2680 (41490)	25.18	24.18	
	2636.5(41055)	25.30	24.23	
	2593 (40620)	25.18	24.14	
	2549.5(40185)	25.07	23.94	
	2506 (39750)	25.09	23.84	
	2680 (41490)	25.15	24.21	
	2636.5(41055)	25.28	24.28	
	2593 (40620)	25.29	24.30	
	2549.5(40185)	25.02	24.05	
	2506 (39750)	25.06	23.98	

LTE band41 (PC3)

Bandwidth (MHz)	RB allocation RB offset	Frequency (MHz)	Actual output power (dBm)		
			QPSK	16QAM	
5MHz	1RB-High (24)	2687.5 (41565)	23.11	21.94	
		2640.3(41093)	23.30	22.16	
		2593 (40620)	23.30	22.18	
		2545.8(40148)	23.02	21.86	
		2498.5 (39675)	23.03	21.88	
	1RB-Middle (12)	2687.5 (41565)	23.28	22.17	
		2640.3(41093)	23.47	22.32	
		2593 (40620)	23.49	22.33	
		2545.8(40148)	23.24	22.07	
		2498.5 (39675)	23.22	22.09	
	1RB-Low (0)	2687.5 (41565)	23.17	22.00	
		2640.3(41093)	23.37	22.22	
		2593 (40620)	23.31	22.15	
		2545.8(40148)	23.08	21.91	
		2498.5 (39675)	23.08	21.77	
	12RB-High (13)	2687.5 (41565)	22.17	21.07	
		2640.3(41093)	22.36	21.28	
		2593 (40620)	22.37	21.29	
		2545.8(40148)	22.11	21.05	
		2498.5 (39675)	22.14	21.08	
	12RB-Middle (6)	2687.5 (41565)	22.21	21.10	
		2640.3(41093)	22.40	21.34	
		2593 (40620)	22.40	21.32	
		2545.8(40148)	22.16	21.07	
		2498.5 (39675)	22.12	21.09	
	12RB-Low (0)	2687.5 (41565)	22.20	21.11	
		2640.3(41093)	22.34	21.30	
		2593 (40620)	22.36	21.30	
		2545.8(40148)	22.10	21.02	
		2498.5 (39675)	22.08	21.04	
	25RB (0)	2687.5 (41565)	22.18	21.15	
		2640.3(41093)	22.35	21.40	
		2593 (40620)	22.37	21.39	
		2545.8(40148)	22.12	21.16	
		2498.5 (39675)	22.13	21.17	
	10MHz	1RB-High (49)	2685 (41540)	23.11	21.95
			2639(41080)	23.30	22.16
			2593 (40620)	23.37	22.21
			2547(40160)	23.09	21.95
			2501 (39700)	22.99	21.82
1RB-Middle (24)		2685 (41540)	23.22	22.05	
		2639(41080)	23.43	22.28	
		2593 (40620)	23.43	22.22	
		2547(40160)	23.12	22.00	
		2501 (39700)	23.09	21.91	
1RB-Low (0)		2685 (41540)	23.23	22.06	
		2639(41080)	23.43	22.25	
		2593 (40620)	23.32	22.14	
		2547(40160)	23.09	21.93	
		2501 (39700)	23.11	21.93	
25RB-High (25)		2685 (41540)	22.24	21.19	
		2639(41080)	22.39	21.42	
		2593 (40620)	22.46	21.47	
		2547(40160)	22.19	21.21	
		2501 (39700)	22.19	21.24	
25RB-Middle (12)		2685 (41540)	22.25	21.24	
		2639(41080)	22.44	21.45	
		2593 (40620)	22.43	21.45	
		2547(40160)	22.16	21.19	
		2501 (39700)	22.16	21.22	
25RB-Low (0)		2685 (41540)	22.30	21.26	
		2639(41080)	22.41	21.43	
		2593 (40620)	22.40	21.39	
		2547(40160)	22.15	21.17	
		2501 (39700)	22.10	21.14	
50RB (0)		2685 (41540)	22.22	21.12	
		2639(41080)	22.39	21.34	
		2593 (40620)	22.41	21.34	
		2547(40160)	22.15	21.08	
		2501 (39700)	22.14	21.10	

15MHz	1RB-High (74)	2682.5 (41515)	23.07	21.88
		2637.8(41068)	23.24	22.11
		2593 (40620)	23.33	22.18
		2548.3(40173)	23.02	21.88
	1RB-Middle (37)	2503.5 (39725)	22.98	21.83
		2682.5 (41515)	23.26	22.11
		2637.8(41068)	23.47	22.31
		2593 (40620)	23.44	22.29
	1RB-Low (0)	2548.3(40173)	23.23	22.06
		2503.5 (39725)	23.17	21.94
		2682.5 (41515)	23.21	22.03
		2637.8(41068)	23.36	22.23
	36RB-High (38)	2593 (40620)	23.27	22.13
		2548.3(40173)	23.07	21.87
		2503.5 (39725)	23.05	21.89
		2682.5 (41515)	22.20	21.14
	36RB-Middle (19)	2637.8(41068)	22.38	21.35
		2593 (40620)	22.42	21.37
		2548.3(40173)	22.15	21.12
		2503.5 (39725)	22.09	21.05
	36RB-Low (0)	2682.5 (41515)	22.21	21.17
		2637.8(41068)	22.41	21.35
		2593 (40620)	22.40	21.36
		2548.3(40173)	22.16	21.11
	75RB (0)	2503.5 (39725)	22.11	21.07
		2682.5 (41515)	22.24	21.19
		2637.8(41068)	22.41	21.37
		2593 (40620)	22.34	21.30
20MHz	1RB-High (99)	2548.3(40173)	22.12	21.09
		2503.5 (39725)	22.08	21.05
		2682.5 (41515)	22.19	21.16
		2637.8(41068)	22.37	21.35
	1RB-Middle (50)	2593 (40620)	22.37	21.36
		2548.3(40173)	22.11	21.12
		2637.8(41068)	22.41	21.37
		2680 (41490)	23.03	21.85
	1RB-Low (0)	2636.5(41055)	23.24	22.04
		2593 (40620)	23.33	22.17
		2549.5(40185)	23.06	21.87
		2506 (39750)	22.89	21.76
	50RB-High (50)	2680 (41490)	23.25	22.10
		2636.5(41055)	23.45	22.26
		2593 (40620)	23.43	22.25
		2549.5(40185)	23.19	21.98
	50RB-Middle (25)	2506 (39750)	23.09	21.93
		2680 (41490)	23.24	22.04
		2636.5(41055)	23.31	22.18
		2593 (40620)	23.25	22.02
	50RB-Low (0)	2549.5(40185)	22.97	21.82
		2506 (39750)	22.98	21.83
		2680 (41490)	22.17	21.11
		2636.5(41055)	22.34	21.29
	100RB (0)	2593 (40620)	22.41	21.37
		2549.5(40185)	22.13	21.10
		2506 (39750)	22.04	20.98
		2680 (41490)	22.23	21.15
100RB (0)	2636.5(41055)	22.37	21.33	
	2593 (40620)	22.38	21.32	
	2549.5(40185)	22.15	21.06	
	2506 (39750)	22.10	21.04	
100RB (0)	2680 (41490)	22.30	21.19	
	2636.5(41055)	22.41	21.34	
	2593 (40620)	22.30	21.23	
	2549.5(40185)	22.07	21.02	
100RB (0)	2506 (39750)	21.99	20.95	
	2680 (41490)	22.26	21.25	
	2636.5(41055)	22.40	21.39	
	2593 (40620)	22.41	21.40	
100RB (0)	2549.5(40185)	22.13	21.14	
	2506 (39750)	22.05	21.06	

LTE band66

Bandwidth (MHz)	RB allocation	Frequency (MHz)	Actual output power (dBm)	
	RB offset		QPSK	16QAM
1.4MHz	1RB-High (5)	1779.3 (132665)	22.94	22.16
		1745 (132322)	22.66	22.05
		1710.7 (131979)	22.43	21.48
	1RB-Middle (3)	1779.3 (132665)	23.20	22.36
		1745 (132322)	22.85	22.24
		1710.7 (131979)	22.49	21.69
	1RB-Low (0)	1779.3 (132665)	22.99	22.15
		1745 (132322)	22.62	22.02
		1710.7 (131979)	22.39	21.47
	3RB-High (3)	1779.3 (132665)	23.07	22.14
		1745 (132322)	22.76	21.94
		1710.7 (131979)	22.55	21.68
	3RB-Middle (1)	1779.3 (132665)	22.93	22.17
		1745 (132322)	22.80	22.02
		1710.7 (131979)	22.59	21.69
	3RB-Low (0)	1779.3 (132665)	22.94	22.15
		1745 (132322)	22.76	21.96
		1710.7 (131979)	22.53	21.63
	6RB (0)	1779.3 (132665)	22.02	21.21
		1745 (132322)	21.66	20.62
		1710.7 (131979)	21.52	20.70
3MHz	1RB-High (14)	1778.5 (132657)	22.96	21.92
		1745 (132322)	22.69	22.01
		1711.5 (131987)	22.41	21.46
	1RB-Middle (7)	1778.5 (132657)	22.98	22.10
		1745 (132322)	22.84	22.25
		1711.5 (131987)	22.60	21.66
	1RB-Low (0)	1778.5 (132657)	22.91	21.91
		1745 (132322)	22.66	22.01
		1711.5 (131987)	22.42	21.57
	8RB-High (7)	1778.5 (132657)	21.97	21.12
		1745 (132322)	21.63	20.75
		1711.5 (131987)	21.44	20.48
	8RB-Middle (4)	1778.5 (132657)	22.04	21.17
		1745 (132322)	21.67	20.80
		1711.5 (131987)	21.52	20.52
	8RB-Low (0)	1778.5 (132657)	21.97	21.11
		1745 (132322)	21.61	20.73
		1711.5 (131987)	21.43	20.48
	15RB (0)	1778.5 (132657)	22.03	21.04
		1745 (132322)	21.62	20.65
		1711.5 (131987)	21.45	20.41

5MHz	1RB-High (24)	1777.5 (132647)	22.90	22.06	
		1745 (132322)	22.55	22.04	
		1712.5 (131997)	22.37	21.44	
	1RB-Middle (12)	1777.5 (132647)	23.02	22.32	
		1745 (132322)	22.85	22.34	
		1712.5 (131997)	22.68	21.75	
	1RB-Low (0)	1777.5 (132647)	22.88	22.02	
		1745 (132322)	22.52	22.03	
		1712.5 (131997)	22.37	21.47	
	12RB-High (13)	1777.5 (132647)	21.97	21.04	
		1745 (132322)	21.71	20.77	
		1712.5 (131997)	21.47	20.43	
	12RB-Middle (6)	1777.5 (132647)	22.01	21.13	
		1745 (132322)	21.69	20.81	
		1712.5 (131997)	21.50	20.54	
	12RB-Low (0)	1777.5 (132647)	21.98	21.08	
		1745 (132322)	21.63	20.70	
		1712.5 (131997)	21.42	20.47	
	25RB (0)	1777.5 (132647)	21.99	21.01	
		1745 (132322)	21.65	20.71	
		1712.5 (131997)	21.44	20.38	
	10MHz	1RB-High (49)	1775 (132622)	22.91	21.90
			1745 (132322)	22.69	21.99
			1715 (132022)	22.32	21.42
1RB-Middle (24)		1775 (132622)	23.06	22.03	
		1745 (132322)	22.84	22.16	
		1715 (132022)	22.55	21.56	
1RB-Low (0)		1775 (132622)	22.80	21.81	
		1745 (132322)	22.58	21.98	
		1715 (132022)	22.36	21.41	
25RB-High (25)		1775 (132622)	22.02	21.03	
		1745 (132322)	21.75	20.78	
		1715 (132022)	21.47	20.54	
25RB-Middle (12)		1775 (132622)	22.03	21.04	
		1745 (132322)	21.72	20.76	
		1715 (132022)	21.51	20.57	
25RB-Low (0)		1775 (132622)	22.00	21.04	
		1745 (132322)	21.62	20.70	
		1715 (132022)	21.45	20.57	
50RB (0)		1775 (132622)	21.99	20.96	
		1745 (132322)	21.67	20.67	
		1715 (132022)	21.49	20.49	

15MHz	1RB-High (74)	1772.5 (132597)	22.84	21.83	
		1745 (132322)	22.60	21.94	
		1717.5 (132047)	22.39	21.84	
	1RB-Middle (37)	1772.5 (132597)	22.93	21.92	
		1745 (132322)	22.73	22.09	
		1717.5 (132047)	22.48	21.85	
	1RB-Low (0)	1772.5 (132597)	22.76	21.67	
		1745 (132322)	22.58	21.91	
		1717.5 (132047)	22.39	21.77	
	36RB-High (38)	1772.5 (132597)	22.03	20.96	
		1745 (132322)	21.70	20.74	
		1717.5 (132047)	21.46	20.42	
	36RB-Middle (19)	1772.5 (132597)	22.00	20.97	
		1745 (132322)	21.65	20.66	
		1717.5 (132047)	21.50	20.43	
	36RB-Low (0)	1772.5 (132597)	22.06	20.99	
		1745 (132322)	21.58	20.61	
		1717.5 (132047)	21.51	20.43	
	75RB (0)	1772.5 (132597)	22.01	20.97	
		1745 (132322)	21.65	20.63	
		1717.5 (132047)	21.51	20.42	
	20MHz	1RB-High (99)	1770 (132572)	22.79	22.31
			1745 (132322)	22.52	21.96
			1720 (132072)	22.40	21.93
		1RB-Middle (50)	1770 (132572)	23.03	22.51
			1745 (132322)	22.74	22.28
			1720 (132072)	22.59	22.08
1RB-Low (0)		1770 (132572)	22.56	22.06	
		1745 (132322)	22.36	21.88	
		1720 (132072)	22.28	21.78	
50RB-High (50)		1770 (132572)	21.82	20.88	
		1745 (132322)	21.67	20.66	
		1720 (132072)	21.40	20.46	
50RB-Middle (25)		1770 (132572)	21.94	20.95	
		1745 (132322)	21.66	20.57	
		1720 (132072)	21.48	20.47	
50RB-Low (0)		1770 (132572)	21.91	20.90	
		1745 (132322)	21.55	20.54	
		1720 (132072)	21.46	20.48	
100RB (0)		1770 (132572)	21.92	20.93	
		1745 (132322)	21.60	20.63	
		1720 (132072)	21.44	20.49	

LTEband66 Low power

Bandwidth (MHz)	RB allocation	Frequency (MHz)	Actual output power (dBm)	
	RB offset		QPSK	16QAM
1.4MHz	1RB-High (5)	1779.3 (132665)	20.01	20.43
		1745 (132322)	19.89	20.17
		1710.7 (131979)	19.57	19.85
	1RB-Middle (3)	1779.3 (132665)	20.03	20.60
		1745 (132322)	20.04	20.29
		1710.7 (131979)	19.72	19.99
	1RB-Low (0)	1779.3 (132665)	20.18	20.40
		1745 (132322)	19.90	20.18
		1710.7 (131979)	19.61	19.83
	3RB-High (3)	1779.3 (132665)	20.03	20.43
		1745 (132322)	20.02	20.13
		1710.7 (131979)	19.70	19.81
	3RB-Middle (1)	1779.3 (132665)	20.07	20.44
		1745 (132322)	20.08	20.17
		1710.7 (131979)	19.77	19.84
	3RB-Low (0)	1779.3 (132665)	20.08	20.38
		1745 (132322)	20.01	20.11
		1710.7 (131979)	19.70	19.79
	6RB (0)	1779.3 (132665)	20.02	20.37
		1745 (132322)	20.02	20.08
		1710.7 (131979)	19.69	19.74
3MHz	1RB-High (14)	1778.5 (132657)	20.01	20.47
		1745 (132322)	19.93	20.17
		1711.5 (131987)	19.62	19.89
	1RB-Middle (7)	1778.5 (132657)	20.03	20.60
		1745 (132322)	20.12	20.38
		1711.5 (131987)	19.79	20.04
	1RB-Low (0)	1778.5 (132657)	20.03	20.43
		1745 (132322)	19.90	20.13
		1711.5 (131987)	19.65	19.84
	8RB-High (7)	1778.5 (132657)	20.02	20.33
		1745 (132322)	20.01	20.06
		1711.5 (131987)	19.68	19.70
	8RB-Middle (4)	1778.5 (132657)	20.33	20.35
		1745 (132322)	20.04	20.11
		1711.5 (131987)	19.73	19.78
	8RB-Low (0)	1778.5 (132657)	20.30	20.31
		1745 (132322)	19.99	20.02
		1711.5 (131987)	19.67	19.72
	15RB (0)	1778.5 (132657)	20.26	20.26
		1745 (132322)	19.96	19.94
		1711.5 (131987)	19.66	19.66

5MHz	1RB-High (24)	1777.5 (132647)	20.12	20.31
		1745 (132322)	19.85	20.05
		1712.5 (131997)	19.52	19.71
	1RB-Middle (12)	1777.5 (132647)	20.48	20.63
		1745 (132322)	20.18	20.35
		1712.5 (131997)	19.86	20.04
	1RB-Low (0)	1777.5 (132647)	20.12	20.36
		1745 (132322)	19.79	20.05
		1712.5 (131997)	19.56	19.72
	12RB-High (13)	1777.5 (132647)	20.24	20.25
		1745 (132322)	19.98	20.01
		1712.5 (131997)	19.67	19.65
	12RB-Middle (6)	1777.5 (132647)	20.35	20.35
		1745 (132322)	20.01	20.04
		1712.5 (131997)	19.74	19.72
	12RB-Low (0)	1777.5 (132647)	20.28	20.28
		1745 (132322)	19.96	19.93
		1712.5 (131997)	19.69	19.65
25RB (0)	1777.5 (132647)	20.29	20.31	
	1745 (132322)	19.95	20.02	
	1712.5 (131997)	19.69	19.70	
10MHz	1RB-High (49)	1775 (132622)	20.21	20.41
		1745 (132322)	19.92	20.14
		1715 (132022)	19.62	19.81
	1RB-Middle (24)	1775 (132622)	20.41	20.63
		1745 (132322)	20.12	20.34
		1715 (132022)	19.82	19.98
	1RB-Low (0)	1775 (132622)	20.23	20.41
		1745 (132322)	19.91	20.10
		1715 (132022)	19.66	19.84
	25RB-High (25)	1775 (132622)	20.31	20.35
		1745 (132322)	20.07	20.11
		1715 (132022)	19.74	19.73
	25RB-Middle (12)	1775 (132622)	20.34	20.37
		1745 (132322)	20.06	20.08
		1715 (132022)	19.76	19.77
	25RB-Low (0)	1775 (132622)	20.33	20.40
		1745 (132322)	19.99	20.02
		1715 (132022)	19.75	19.79
50RB (0)	1775 (132622)	20.34	20.32	
	1745 (132322)	20.01	20.02	
	1715 (132022)	19.73	19.74	

15MHz	1RB-High (74)	1772.5 (132597)	20.18	20.39
		1745 (132322)	19.89	20.07
		1717.5 (132047)	19.64	19.84
	1RB-Middle (37)	1772.5 (132597)	20.26	20.73
		1745 (132322)	20.18	20.39
		1717.5 (132047)	19.84	20.05
	1RB-Low (0)	1772.5 (132597)	20.17	20.33
		1745 (132322)	19.87	20.07
		1717.5 (132047)	19.64	19.84
	36RB-High (38)	1772.5 (132597)	20.13	20.32
		1745 (132322)	20.04	20.05
		1717.5 (132047)	19.74	19.70
	36RB-Middle (19)	1772.5 (132597)	20.06	20.34
		1745 (132322)	20.02	20.00
		1717.5 (132047)	19.76	19.74
	36RB-Low (0)	1772.5 (132597)	20.39	20.36
		1745 (132322)	19.95	19.94
		1717.5 (132047)	19.75	19.74
	75RB (0)	1772.5 (132597)	20.31	20.33
		1745 (132322)	19.99	19.99
		1717.5 (132047)	19.72	19.74
20MHz	1RB-High (99)	1770 (132572)	20.08	20.34
		1745 (132322)	19.86	20.1
		1720 (132072)	19.66	19.89
	1RB-Middle (50)	1770 (132572)	20.39	20.57
		1745 (132322)	20.11	20.34
		1720 (132072)	19.81	20.03
	1RB-Low (0)	1770 (132572)	20.04	20.26
		1745 (132322)	19.73	19.96
		1720 (132072)	19.59	19.82
	50RB-High (50)	1770 (132572)	20.23	20.25
		1745 (132322)	20.04	20.03
		1720 (132072)	19.69	19.75
	50RB-Middle (25)	1770 (132572)	20.35	20.36
		1745 (132322)	20.02	20.04
		1720 (132072)	19.76	19.78
	50RB-Low (0)	1770 (132572)	20.36	20.35
		1745 (132322)	19.89	19.92
		1720 (132072)	19.82	19.8
	100RB (0)	1770 (132572)	20.3	20.32
		1745 (132322)	19.97	19.99
		1720 (132072)	19.78	19.77

LTE band71

Bandwidth (MHz)	RB allocation	Frequency (MHz)	Actual output power (dBm)	
	RB offset		QPSK	16QAM
5MHz	1RB-High (24)	695.5 (133447)	23.01	22.11
		680.5 (133297)	22.97	22.09
		665.5 (133147)	23.28	22.74
	1RB-Middle (12)	695.5 (133447)	23.26	22.27
		680.5 (133297)	23.22	22.31
		665.5 (133147)	23.24	22.17
	1RB-Low (0)	695.5 (133447)	22.98	22.09
		680.5 (133297)	23.01	22.10
		665.5 (133147)	23.27	22.98
	12RB-High (13)	695.5 (133447)	22.10	21.11
		680.5 (133297)	21.97	21.03
		665.5 (133147)	22.36	21.52
	12RB-Middle (6)	695.5 (133447)	22.08	21.12
		680.5 (133297)	22.06	21.14
		665.5 (133147)	22.52	21.65
	12RB-Low (0)	695.5 (133447)	22.01	21.05
		680.5 (133297)	22.03	21.10
		665.5 (133147)	22.41	21.56
	25RB (0)	695.5 (133447)	22.07	21.03
		680.5 (133297)	22.01	21.03
		665.5 (133147)	22.41	21.48
10MHz	1RB-High (49)	693 (132422)	23.12	22.46
		680.5 (133297)	23.00	22.01
		668 (133172)	23.22	22.10
	1RB-Middle (24)	693 (132422)	23.26	22.75
		680.5 (133297)	23.10	22.18
		668 (133172)	23.15	22.31
	1RB-Low (0)	693 (132422)	23.41	22.94
		680.5 (133297)	23.06	22.16
		668 (133172)	23.28	22.49
	25RB-High (25)	693 (132422)	22.34	21.35
		680.5 (133297)	22.00	21.09
		668 (133172)	22.28	21.32
	25RB-Middle (12)	693 (132422)	22.33	21.50
		680.5 (133297)	22.11	21.19
		668 (133172)	22.44	21.45
	25RB-Low (0)	693 (132422)	22.45	21.52
		680.5 (133297)	22.08	21.19
		668 (133172)	22.45	21.49
	50RB (0)	693 (132422)	22.44	21.42
		680.5 (133297)	22.04	21.07
		668 (133172)	22.40	21.37

15MHz	1RB-High (74)	2682.5 (41515)	25.89	25.00
		2637.8(41068)	26.08	25.13
		2593 (40620)	26.14	25.26
		2548.3(40173)	25.96	25.05
		2503.5 (39725)	25.84	24.95
	1RB-Middle (37)	2682.5 (41515)	25.92	25.04
		2637.8(41068)	26.13	25.26
		2593 (40620)	26.22	25.18
		2548.3(40173)	25.92	24.97
		2503.5 (39725)	25.94	24.87
	1RB-Low (0)	2682.5 (41515)	26.04	25.17
		2637.8(41068)	26.33	25.31
		2593 (40620)	26.13	25.21
		2548.3(40173)	25.94	25.00
		2503.5 (39725)	25.91	25.01
	36RB-High (38)	2682.5 (41515)	25.10	24.10
		2637.8(41068)	25.27	24.23
		2593 (40620)	25.34	24.26
		2548.3(40173)	25.06	24.00
		2503.5 (39725)	25.08	23.93
	36RB-Middle (19)	2682.5 (41515)	25.13	24.14
		2637.8(41068)	25.31	24.23
		2593 (40620)	25.31	24.24
		2548.3(40173)	25.03	24.01
		2503.5 (39725)	25.04	23.98
	36RB-Low (0)	2682.5 (41515)	25.16	24.17
		2637.8(41068)	25.34	24.27
		2593 (40620)	25.24	24.20
2548.3(40173)		25.03	23.98	
2503.5 (39725)		25.08	23.91	
75RB (0)	2682.5 (41515)	25.12	24.15	
	2637.8(41068)	25.28	24.26	
	2593 (40620)	25.28	24.26	
	2548.3(40173)	25.02	24.01	
	2503.5 (39725)	25.09	23.95	
20MHz	1RB-High (99)	2680 (41490)	25.87	24.87
		2636.5(41055)	26.10	25.14
		2593 (40620)	26.15	25.25
		2549.5(40185)	25.93	24.98
		2506 (39750)	25.81	24.89
	1RB-Middle (50)	2680 (41490)	26.09	25.13
		2636.5(41055)	26.13	25.27
		2593 (40620)	26.70	25.21
		2549.5(40185)	26.20	25.03
		2506 (39750)	26.13	24.93
	1RB-Low (0)	2680 (41490)	26.11	25.23
		2636.5(41055)	26.18	25.28
		2593 (40620)	26.12	25.19
		2549.5(40185)	25.96	25.03
		2506 (39750)	25.90	25.04
	50RB-High (50)	2680 (41490)	25.07	24.06
		2636.5(41055)	25.25	24.18
		2593 (40620)	25.33	24.28
		2549.5(40185)	25.04	23.99
		2506 (39750)	25.08	23.85
	50RB-Middle (25)	2680 (41490)	25.15	24.14
		2636.5(41055)	25.31	24.22
		2593 (40620)	25.29	24.22
		2549.5(40185)	25.04	23.99
		2506 (39750)	25.02	23.93
	50RB-Low (0)	2680 (41490)	25.18	24.18
		2636.5(41055)	25.30	24.23
		2593 (40620)	25.18	24.14
2549.5(40185)		25.07	23.94	
2506 (39750)		25.09	23.84	
100RB (0)	2680 (41490)	25.15	24.21	
	2636.5(41055)	25.28	24.28	
	2593 (40620)	25.29	24.30	
	2549.5(40185)	25.02	24.05	
	2506 (39750)	25.06	23.98	

11.5 Wi-Fi and BT Measurement result

The maximum output power of BT antenna is 5.42dBm.

The maximum tune up of BT antenna is 7dBm.

The average conducted power for Wi-Fi 2.4G is as following:

For WLAN, when the phone is in talking mode and receiver worked, then power reduction will be implemented immediately at WIFI 2.4G.

Table 11.5-1: The conducted Power for WIFI 2.4G Normal power

802.11b(dBm)									
Channel\data rate	1Mbps	2Mbps	5.5Mbps	11Mbps					
11(2462MHz)	21.27	/	21.30	/					
6(2437MHz)	20.73	21.40	21.46	21.38					
1(2412MHz)	20.10	/	19.92	/					
TUNEUP	21.50	21.50	21.50	21.50					
802.11g(dBm)									
Channel\data rate	6Mbps	9Mbps	12Mbps	18Mbps	24Mbps	36Mbps	48Mbps	54Mbps	
11(2462MHz)	18.40	/	/	/	/	/	/	/	/
6(2437MHz)	18.55	18.40	18.36	18.27	18.17	18.05	17.46	17.40	
1(2412MHz)	18.45	/	/	/	/	/	/	/	/
TUNEUP	19.00	19.00	19.00	19.00	19.00	19.00	18.00	18.00	
802.11n(dBm)-20MHz									
Channel\data rate	MCS0	MCS1	MCS2	MCS3	MCS4	MCS5	MCS6	MCS7	
11(2462MHz)	16.70	16.55	16.43	16.40	16.23	15.65	15.60	15.52	
6(2437MHz)	16.48	/	/	/	/	/	/	/	/
1(2412MHz)	17.30	/	/	/	/	/	/	/	/
TUNEUP	17.50	17.50	17.50	17.50	17.50	17.50	17.50	17.50	17.50
802.11n(dBm)-40MHz									
Channel\data rate	MCS0	MCS1	MCS2	MCS3	MCS4	MCS5	MCS6	MCS7	
9(2452MHz)	17.10	17.05	16.97	16.90	16.80	16.30	16.25	16.20	
6(2437MHz)	16.60	/	/	/	/	/	/	/	/
3(2422MHz)	16.50	/	/	/	/	/	/	/	/
TUNEUP	17.50	17.50	17.50	17.50	17.50	17.50	17.50	17.50	17.50

Table 11.5-2: The conducted Power for WIFI 2.4G Low power

802.11b	Channel\data	1Mbps	2Mbps	5.5Mbps	11Mbps				
WLAN2450	11(2462MHz)	16.56	17.20	/	/				
	6(2437(MHz)	16.72	16.87	16.82	16.73				
	1(2412MHz)	16.62	17.26	/	/				
TUNEUP	TUNEUP	18.00	18.00	18.00	18.00				
802.11g	Channel\data	6Mbps	9Mbps	12Mbps	18Mbps	24Mbps	36Mbps	48Mbps	54Mbps
WLAN2450	11(2462MHz)	17.68	/	/	/	/	/	/	/
	6(2437(MHz)	17.50	/	/	/	/	/	/	/
	1(2412MHz)	17.48	17.56	17.59	17.58	17.59	17.57	17.35	17.40
TUNEUP	TUNEUP	18.00	18.00	18.00	18.00	18.00	18.00	18.00	18.00
802.11n-20MHz	Channel\data	MCS0	MCS1	MCS2	MCS3	MCS4	MCS5	MCS6	MCS7
WLAN2450	11(2462MHz)	16.70	/	/	/	/	/	/	/
	6(2437(MHz)	16.48	16.38	16.35	16.26	17.48	16.93	16.86	16.80
	1(2412MHz)	17.30	/	/	/	/	/	/	/
TUNEUP	TUNEUP	17.50	17.50	17.50	17.50	17.50	17.50	17.50	17.50
802.11n-40MHz	Channel\data	MCS0	MCS1	MCS2	MCS3	MCS4	MCS5	MCS6	MCS7
WLAN2450	9(2452MHz)	17.10	17.05	16.97	16.90	16.80	16.30	16.25	16.20
	6(2437MHz)	16.60	/	/	/	/	/	/	/
	3(2422MHz)	16.50	/	/	/	/	/	/	/
TUNEUP	TUNEUP	17.50	17.50	17.50	17.50	17.50	17.50	17.50	17.50

12 Simultaneous TX SAR Considerations

12.1 Introduction

The following procedures adopted from “FCC SAR Considerations for Cell Phones with Multiple Transmitters” are applicable to handsets with built-in unlicensed transmitters such as 802.11 a/b/g and Bluetooth devices which may simultaneously transmit with the licensed transmitter.

For this device, the BT and Wi-Fi can transmit simultaneous with other transmitters.

12.2 Transmit Antenna Separation Distances

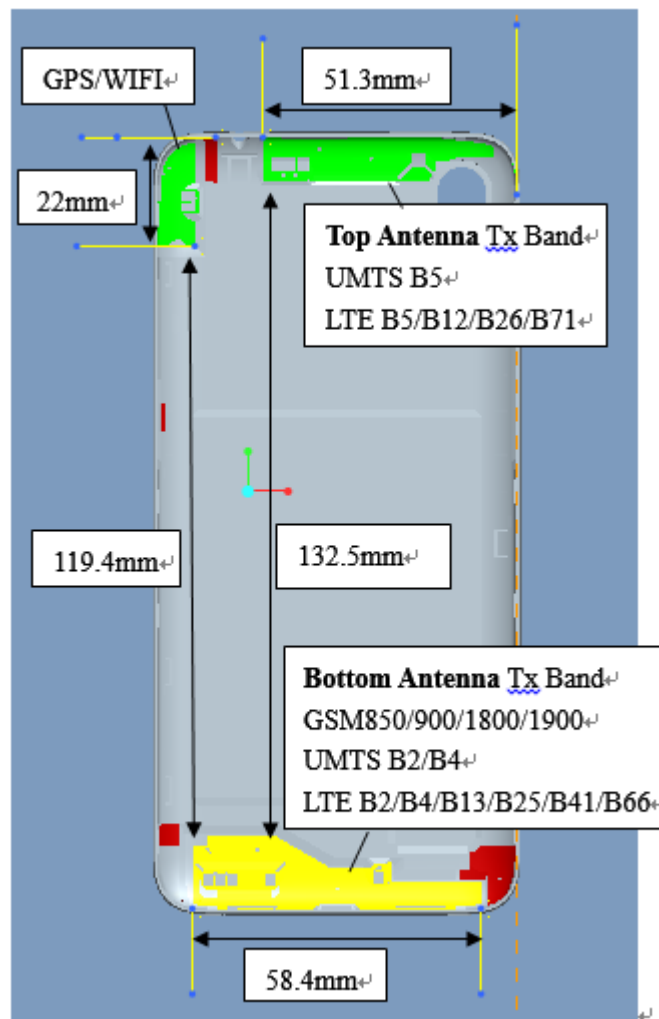

Picture 12.1 Antenna Locations

12.3 SAR Measurement Positions

According to the KDB941225 D06 Hot Spot SAR, the edges with less than 2.5 cm distance to the antennas need to be tested for SAR.

SAR measurement positions						
Mode	Front	Rear	Left edge	Right edge	Top edge	Bottom edge
Top Antenna	Yes	Yes	Yes	Yes	Yes	No
Bottom Antenna	Yes	Yes	Yes	Yes	No	Yes
WLAN2.4G	Yes	Yes	Yes	No	Yes	No

12.4 Standalone SAR Test Exclusion Considerations

Standalone 1-g head or body SAR evaluation by measurement or numerical simulation is not required when the corresponding SAR Exclusion Threshold condition, listed below, is satisfied. The 1-g SAR test exclusion threshold for 100 MHz to 6 GHz at test separation distances ≤ 50 mm are determined by:

$[(\text{max. power of channel, including tune-up tolerance, mW}) / (\text{min. test separation distance, mm})] \cdot [\sqrt{f(\text{GHz})}] \leq 3.0$ for 1-g SAR, where

- $f(\text{GHz})$ is the RF channel transmit frequency in GHz
- Power and distance are rounded to the nearest mW and mm before calculation
- The result is rounded to one decimal place for comparison

Table 12.1: Standalone SAR test exclusion considerations

Band/Mode	F(GHz)	Position	SAR test exclusion threshold(mW)	RF output power		SAR test exclusion
				dBm	mW	
Bluetooth	2.441	Head	9.60	7	5.01	Yes
		Body	19.20	7	5.01	Yes
2.4GHz WLAN	2.45	Head	9.58	18	63.1	No
		Body	19.17	21.5	141	No

13 Evaluation of Simultaneous

Table 13.1: The sum of reported SAR values for main antenna and WIFI

	Position	Main antenna	WIFI	Sum
Highest reported SAR value for Head	Right hand,Touch cheek	0.78	0.44	1.22
Highest reported SAR value for Body	Bottom 10mm	1.39	/	1.39
Highest reported SAR value for Body	Rear 10m	1.03	0.46	1.49

Table 13.2: The sum of reported SAR values for main antenna and BT

	Position	Main antenna	BT	Sum
Highest reported SAR value for Head	Right hand,Touch cheek	0.78	0.21	1.22
Highest reported SAR value for Body	Bottom 10mm	1.39	0.10	1.49

[1] - Estimated SAR for Bluetooth (see the table 13.3)

Table 13.3: Estimated SAR for Bluetooth

Mode/Band	F (GHz)	Position	Distance (mm)	Upper limit of power *		Estimated _{1g} (W/kg)
				dBm	mW	
Bluetooth	2.441	Head	5	7	5.01	0.21
Bluetooth	2.441	Body	10	7	5.01	0.10

* - Maximum possible output power declared by manufacturer

When standalone SAR test exclusion applies to an antenna that transmits simultaneously with other antennas, the standalone SAR must be estimated according to following to determine simultaneous transmission SAR test exclusion:

(max. power of channel, including tune-up tolerance, mW)/(min. test separation distance,mm) $\cdot\sqrt{f(\text{GHz})/x}$ W/kg for test separation distances ≤ 50 mm;

where $x = 7.5$ for 1-g SAR.

When the minimum test separation distance is < 5 mm, a distance of 5 mm is applied to determine SAR test exclusion

Conclusion:

According to the above tables, the sum of reported SAR values is < 1.6 W/kg. So the simultaneous transmission SAR with volume scans is not required.

14 SAR Test Result

It is determined by user manual for the distance between the EUT and the phantom bottom. The distance is 10 mm and just applied to the condition of body worn accessory.

It is performed for all SAR measurements with area scan based 1-g SAR estimation (Fast SAR). A zoom scan measurement is added when the estimated 1-g SAR is the highest measured SAR in each exposure configuration, wireless mode and frequency band combination or more than 1.2W/kg.

The calculated SAR is obtained by the following formula:

$$\text{Reported SAR} = \text{Measured SAR} \times 10^{(P_{\text{Target}} - P_{\text{Measured}})/10}$$

Where P_{Target} is the power of manufacturing upper limit;

P_{Measured} is the measured power in chapter 11.

Table 14.1: Duty Cycle

Mode	Duty Cycle
GSM850/1900	1:4
WCDMA<E FDD	1:1
LTE TDD	1:1.58

14.1 SAR results for Fast SAR

H: Headset

Table 14.1-1: SAR Values (GSM 850 MHz Band - Head)

Test Position	Phantom position L/R/F	Frequency Band	Channel Number	Frequency (MHz)	Figure No./Note	EUT Measured Power (dBm)	Tune up (dBm)	Measured SAR 1g (W/kg)	Calculated SAR 1g (W/kg)	Measured SAR 10g (W/kg)	Calculated SAR 10g (W/kg)	Power Drift
Cheek	Left	GSM850	190	836.6	/	32.22	33.3	0.138	0.18	0.108	0.14	0.01
Tilt	Left	GSM850	190	836.6	/	32.22	33.3	0.091	0.12	0.071	0.09	0.06
Cheek	Right	GSM850	251	848.8	/	32.24	33.3	0.178	0.23	0.133	0.17	-0.07
Cheek	Right	GSM850	190	836.6	Fig.1	32.22	33.3	0.213	0.27	0.157	0.20	0.19
Cheek	Right	GSM850	128	824.2	/	32.07	33.3	0.203	0.27	0.152	0.20	0.04
Tilt	Right	GSM850	190	836.6	/	32.22	33.3	0.089	0.11	0.070	0.09	-0.12

Table 14.1-2: SAR Values (GSM 850 MHz Band - Body)

Frequency Band	Channel Number	Frequency (MHz)	Figure No./Note	Mode	EUT Measured Power (dBm)	Tune up (dBm)	Measured SAR 1g (W/kg)	Calculated SAR 1g (W/kg)	Measured SAR 10g (W/kg)	Calculated SAR 10g (W/kg)	Power Drift
GSM850	190	836.6	/	Front GPRS 2TX	29.91	30.5	0.219	0.25	0.155	0.18	-0.01
GSM850	251	848.8	/	Rear GPRS 2TX	29.98	30.5	0.560	0.63	0.298	0.34	0.04
GSM850	190	836.6	Fig.2	Rear GPRS 2TX	29.91	30.5	0.594	0.68	0.326	0.37	0.06
GSM850	128	824.2	/	Rear GPRS 2TX	29.73	30.5	0.514	0.61	0.281	0.34	-0.07
GSM850	190	836.6	/	Left Edge GPRS 2TX	29.91	30.5	0.100	0.11	0.069	0.08	-0.05
GSM850	190	836.6	/	Right Edge GPRS 2TX	29.91	30.5	0.142	0.16	0.101	0.12	-0.10
GSM850	190	836.6	/	Bottom Edge GPRS 2TX	29.91	30.5	0.187	0.21	0.109	0.12	0.08
GSM850	190	836.6	/	Rear EGPRS 2TX	29.93	30.5	0.578	0.66	0.318	0.36	0.07

Note: The distance between the EUT and the phantom bottom is 10mm.

Table 14.1-3: SAR Values (GSM 1900 MHz Band - Head)

Test Position	Phantom position L/R/F	Frequency Band	Channel Number	Frequency (MHz)	Figure No./Note	EUT Measured Power (dBm)	Tune up (dBm)	Measured SAR 1g (W/kg)	Calculated SAR 1g (W/kg)	Measured SAR 10g (W/kg)	Calculated SAR 10g (W/kg)	Power Drift
Cheek	Left	GSM1900	810	1909.8	/	29.73	30.3	0.055	0.06	0.034	0.04	-0.08
Cheek	Left	GSM1900	661	1880	/	29.8	30.3	0.071	0.08	0.047	0.05	0.05
Cheek	Left	GSM1900	512	1850.2	Fig.3	29.83	30.3	0.105	0.12	0.064	0.07	0.15
Tilt	Left	GSM1900	661	1880	/	29.8	30.3	0.068	0.08	0.040	0.04	0.01
Cheek	Right	GSM1900	661	1880	/	29.8	30.3	0.090	0.10	0.055	0.06	0.04
Tilt	Right	GSM1900	661	1880	/	29.8	30.3	0.068	0.08	0.039	0.04	0.06

Table 14.1-4: SAR Values (GSM 1900 MHz Band - Body)

Frequency Band	Channel Number	Frequency (MHz)	Figure No./Note	Mode	EUT Measured Power (dBm)	Tune up (dBm)	Measured SAR 1g (W/kg)	Calculated SAR 1g (W/kg)	Measured SAR 10g (W/kg)	Calculated SAR 10g (W/kg)	Power Drift
GSM1900	661	1880	/	Front GPRS 2tx	25.54	26.00	0.418	0.46	0.207	0.23	-0.08
GSM1900	661	1880	/	Rear GPRS 2tx	25.54	26.00	0.425	0.47	0.215	0.24	0.08
GSM1900	661	1880	/	Left Edge GPRS 2tx	25.54	26.00	0.029	0.03	0.017	0.02	-0.12
GSM1900	661	1880	/	Right Edge GPRS 2tx	25.54	26.00	0.035	0.04	0.018	0.02	-0.10
GSM1900	810	1909.8	/	Bottom Edge GPRS 2tx	25.65	26.00	0.744	0.81	0.339	0.37	0.09
GSM1900	661	1880	Fig.4	Bottom Edge GPRS 2tx	25.54	26.00	1.040	1.16	0.468	0.52	-0.03
GSM1900	512	1850.2	/	Bottom Edge GPRS 2tx	25.59	26.00	0.926	1.02	0.437	0.48	0.12
GSM1900	661	1880	/	Bottom Edge EGPRS 2tx	25.53	26.00	0.986	1.10	0.449	0.50	0.08
GSM1900	661	1880	note2	Bottom Edge GPRS 2tx	25.54	26.00	3.960	4.40	1.566	1.74	0.09

Note: The distance between the EUT and the phantom bottom is 10mm.

Note2: The distance between the EUT and the phantom bottom is 0mm.

Table 14.1-5: SAR Values (GSM1900–Body)

Frequency Band	Channel Number	Frequency (MHz)	Figure No./Note	Mode	EUT Measured Power (dBm)	Tune up (dBm)	Measured SAR 1g (W/kg)	Calculated SAR 1g (W/kg)	Measured SAR 10g (W/kg)	Calculated SAR 10g (W/kg)	Power Drift
GSM1900	661	1880	/	Front GPRS	28.04	30.3	0.260	0.44	0.148	0.25	0.07
GSM1900	810	1909.8	/	Rear GPRS	28.01	30.3	0.247	0.42	0.145	0.25	0.10
GSM1900	661	1880	/	Rear GPRS	28.04	30.3	0.288	0.48	0.173	0.29	0.11
GSM1900	512	1850.2	Fig.5	Rear GPRS	28.11	30.3	0.395	0.65	0.236	0.39	-0.06
GSM1900	512	1850.2	/	Rear EGPRS	28.11	30.3	0.377	0.62	0.214	0.35	0.09

Note: The distance between the EUT and the phantom bottom is 15mm.

Table 14.1-6: SAR Values (WCDMA 1900 MHz Band - Head)

Test Position	Phantom position L/R/F	Frequency Band	Channel Number	Frequency (MHz)	Figure No./Note	EUT Measured Power (dBm)	Tune up (dBm)	Measured SAR 1g (W/kg)	Calculated SAR 1g (W/kg)	Measured SAR 10g (W/kg)	Calculated SAR 10g (W/kg)	Power Drift
Cheek	Left	WCDMA1900	9400	1880	/	23.14	24.00	0.097	0.12	0.060	0.07	0.05
Tilt	Left	WCDMA1900	9538	1907.6	/	23.20	24.00	0.121	0.15	0.073	0.09	-0.12
Tilt	Left	WCDMA1900	9400	1880	Fig.6	23.14	24.00	0.123	0.15	0.075	0.09	-0.14
Tilt	Left	WCDMA1900	9262	1852.4	/	23.46	24.00	0.114	0.13	0.071	0.08	0.11
Cheek	Right	WCDMA1900	9400	1880	/	23.14	24.00	0.085	0.10	0.051	0.06	-0.05
Tilt	Right	WCDMA1900	9400	1880	/	23.14	24.00	0.107	0.13	0.062	0.08	-0.12

Table 14.1-7: SAR Values (WCDMA 1900 MHz Band - Body)

Frequency Band	Channel Number	Frequency (MHz)	Figure No./Note	Mode	EUT Measured Power (dBm)	Tune up (dBm)	Measured SAR 1g (W/kg)	Calculated SAR 1g (W/kg)	Measured SAR 10g (W/kg)	Calculated SAR 10g (W/kg)	Power Drift
WCDMA1900	9400	1880	/	Front	19.66	20.5	0.500	0.61	0.276	0.34	-0.01
WCDMA1900	9400	1880	/	Rear	19.66	20.5	0.569	0.69	0.319	0.39	0.10
WCDMA1900	9400	1880	/	Left Edge	19.66	20.5	0.065	0.08	0.043	0.05	-0.09
WCDMA1900	9400	1880	/	Right Edge	19.66	20.5	0.071	0.09	0.045	0.05	-0.01
WCDMA1900	9538	1907.6	Fig.7	Bottom Edge	19.75	20.5	1.170	1.39	0.588	0.70	0.18
WCDMA1900	9400	1880	/	Bottom Edge	19.66	20.5	1.012	1.23	0.507	0.61	-0.09
WCDMA1900	9262	1852.4	/	Bottom Edge	19.83	20.5	1.127	1.31	0.573	0.67	-0.04
WCDMA1900	9538	1907.6	note2	Bottom Edge	19.75	20.5	2.310	2.75	0.793	0.94	0.05
WCDMA1900	9538	1907.6	H	Bottom Edge	19.75	20.5	1.110	1.32	0.359	0.43	-0.08

Note: The distance between the EUT and the phantom bottom is 10mm.

Note2: The distance between the EUT and the phantom bottom is 0mm.

Table 14.1-8: SAR Values (WCDMA 1900 MHz Band - Body)

Frequency Band	Channel Number	Frequency (MHz)	Figure No./Note	Mode	EUT Measured Power (dBm)	Tune up (dBm)	Measured SAR 1g (W/kg)	Calculated SAR 1g (W/kg)	Measured SAR 10g (W/kg)	Calculated SAR 10g (W/kg)	Power Drift
WCDMA1900	9400	1880	/	Front	23.14	24.00	0.463	0.56	0.257	0.31	0.06
WCDMA1900	9538	1907.6	/	Rear	23.20	24.00	0.576	0.69	0.333	0.40	0.03
WCDMA1900	9400	1880	/	Rear	23.14	24.00	0.525	0.64	0.302	0.37	-0.06
WCDMA1900	9262	1852.4	Fig.8	Rear	23.46	24.00	0.603	0.68	0.356	0.40	-0.01

Note: The distance between the EUT and the phantom bottom is 15mm.

Table 14.1-9: SAR Values (WCDMA 1700 MHz Band -Head)

Test Position	Phantom position L/R/F	Frequency Band	Channel Number	Frequency (MHz)	Figure No./Note	EUT Measured Power (dBm)	Tune up (dBm)	Measured SAR 1g (W/kg)	Calculated SAR 1g (W/kg)	Measured SAR 10g (W/kg)	Calculated SAR 10g (W/kg)	Power Drift
Cheek	Left	WCDMA1700	1412	1732.4	/	23.54	24.00	0.189	0.21	0.124	0.14	0.12
Tilt	Left	WCDMA1700	1412	1732.4	/	23.54	24.00	0.138	0.15	0.089	0.10	-0.01
Cheek	Right	WCDMA1700	1513	1752.6	/	23.47	24.00	0.169	0.19	0.108	0.12	-0.03
Cheek	Right	WCDMA1700	1412	1732.4	Fig.9	23.54	24.00	0.276	0.31	0.176	0.20	0.09
Cheek	Right	WCDMA1700	1312	1712.4	/	23.43	24.00	0.243	0.28	0.155	0.18	0.01
Tilt	Right	WCDMA1700	1412	1732.4	/	23.54	24.00	0.121	0.13	0.077	0.09	0.03

Table 14.1-10: SAR Values (WCDMA 1700 MHz Band -Body)

Frequency Band	Channel Number	Frequency (MHz)	Figure No./Note	Mode	EUT Measured Power (dBm)	Tune up (dBm)	Measured SAR 1g (W/kg)	Calculated SAR 1g (W/kg)	Measured SAR 10g (W/kg)	Calculated SAR 10g (W/kg)	Power Drift
WCDMA1700	1412	1732.5	/	Front	21.24	21.50	0.384	0.41	0.222	0.24	-0.09
WCDMA1700	1412	1732.5	/	Rear	21.24	21.50	0.423	0.45	0.251	0.27	-0.04
WCDMA1700	1412	1732.5	/	Left Edge	21.24	21.50	0.061	0.06	0.037	0.04	-0.05
WCDMA1700	1412	1732.5	/	Right Edge	21.24	21.50	0.086	0.09	0.054	0.06	0.03
WCDMA1700	1513	1752.6	Fig.24	Bottom Edge	21.17	21.50	0.785	0.85	0.404	0.44	0.03
WCDMA1700	1412	1732.5	/	Bottom Edge	21.24	21.50	0.731	0.78	0.377	0.40	0.09
WCDMA1700	1312	1712.4	/	Bottom Edge	21.21	21.50	0.685	0.73	0.353	0.38	-0.06
WCDMA1700	1513	1752.6	note2	Bottom Edge	21.17	21.50	3.110	3.36	1.190	1.28	0.09
WCDMA1700	1513	1752.6	H	Bottom Edge	21.17	21.50	0.782	0.84	0.401	0.43	0.05

Note: The distance between the EUT and the phantom bottom is 10mm.

Note2: The distance between the EUT and the phantom bottom is 0mm.

Table 14.1-11: SAR Values (WCDMA 1700 MHz Band -Body)

Frequency Band	Channel Number	Frequency (MHz)	Figure No./Note	Mode	EUT Measured Power (dBm)	Tune up (dBm)	Measured SAR 1g (W/kg)	Calculated SAR 1g (W/kg)	Measured SAR 10g (W/kg)	Calculated SAR 10g (W/kg)	Power Drift
WCDMA1700	1513	1752.6	/	Front	23.47	24.00	0.605	0.68	0.361	0.41	-0.06
WCDMA1700	1412	1732.5	/	Front	23.54	24.00	0.677	0.75	0.404	0.45	0.13
WCDMA1700	1312	1712.4	Fig.11	Front	23.43	24.00	0.610	0.70	0.364	0.42	0.11
WCDMA1700	1312	1712.4	/	Rear	23.43	24.00	0.579	0.66	0.362	0.41	0.08

Note: The distance between the EUT and the phantom bottom is 15mm.

Table 14.1-12: SAR Values (WCDMA 850 MHz Band -Head)

Test Position	Phantom position L/R/F	Frequency Band	Channel Number	Frequency (MHz)	Figure No./Note	EUT Measured Power (dBm)	Tune up (dBm)	Measured SAR 1g (W/kg)	Calculated SAR 1g (W/kg)	Measured SAR 10g (W/kg)	Calculated SAR 10g (W/kg)	Power Drift
Cheek	Left	WCDMA 850	4233	846.6	/	23.83	24.00	0.521	0.54	0.367	0.38	-0.02
Cheek	Left	WCDMA 850	4183	836.6	/	23.75	24.00	0.547	0.58	0.377	0.40	0.12
Cheek	Left	WCDMA 850	4132	826.4	Fig.12	23.68	24.00	0.602	0.65	0.422	0.45	0.02
Tilt	Left	WCDMA 850	4183	836.6	/	23.75	24.00	0.432	0.46	0.258	0.27	-0.03
Cheek	Right	WCDMA 850	4183	836.6	/	23.75	24.00	0.499	0.53	0.287	0.30	0.05
Tilt	Right	WCDMA 850	4183	836.6	/	23.75	24.00	0.452	0.48	0.249	0.26	0.00

Table 14.1-13: SAR Values (WCDMA 850 MHz Band -Body)

Frequency Band	Channel Number	Frequency (MHz)	Figure No./Note	Mode	EUT Measured Power (dBm)	Tune up (dBm)	Measured SAR 1g (W/kg)	Calculated SAR 1g (W/kg)	Measured SAR 10g (W/kg)	Calculated SAR 10g (W/kg)	Power Drift
WCDMA 850	4183	836.6	/	Front	23.75	24.00	0.236	0.25	0.127	0.13	-0.02
WCDMA 850	4233	846.6	Fig.13	Rear	23.83	24.00	0.386	0.40	0.235	0.24	0.00
WCDMA 850	4183	836.6	/	Rear	23.75	24.00	0.324	0.34	0.160	0.17	0.10
WCDMA 850	4132	826.4	/	Rear	23.68	24.00	0.354	0.38	0.180	0.19	0.03
WCDMA 850	4183	836.6	/	Left Edge	23.75	24.00	0.195	0.21	0.110	0.12	0.12
WCDMA 850	4183	836.6	/	Right Edge	23.75	24.00	0.336	0.36	0.186	0.20	-0.08
WCDMA 850	4183	836.6	/	Top Edge	23.75	24.00	0.25	0.26	0.139	0.15	-0.11

Note: The distance between the EUT and the phantom bottom is 10mm.

Table 14.1-14: SAR Values (LTE Band12 -Head)

Test Position	Phantom position L/R/F	Frequency Band	Channel Number	Frequency (MHz)	Figure No./Note	Mode	EUT Measured Power (dBm)	Tune up (dBm)	Measured SAR 1g (W/kg)	Calculated SAR 1g (W/kg)	Measured SAR 10g (W/kg)	Calculated SAR 10g (W/kg)	Power Drift
Cheek	Left	LTE Band12	23130	711	/	1RB-High	23.17	24	0.483	0.58	0.594	0.72	-0.01
Tilt	Left	LTE Band12	23130	711	Fig.14	1RB-High	23.17	24	0.582	0.70	0.321	0.39	-0.02
Cheek	Right	LTE Band12	23130	711	/	1RB-High	23.17	24	0.509	0.62	0.586	0.71	0.03
Tilt	Right	LTE Band12	23130	711	/	1RB-High	23.17	24	0.520	0.63	0.544	0.66	0.02
Cheek	Left	LTE Band12	23095	707.5	/	25RB-High	22.21	23	0.350	0.42	0.449	0.54	-0.09
Tilt	Left	LTE Band12	23095	707.5	/	25RB-High	22.21	23	0.470	0.56	0.529	0.63	0.01
Cheek	Right	LTE Band12	23095	707.5	/	25RB-High	22.21	23	0.311	0.37	0.383	0.46	0.02
Tilt	Right	LTE Band12	23095	707.5	/	25RB-High	22.21	23	0.440	0.53	0.502	0.60	0.09

Note: The LTE mode is QPSK_10MHz.

Table 14.1-15: SAR Values (LTE Band12 - Body)

Frequency Band	Channel Number	Frequency (MHz)	Figure No./Note	Mode	EUT Measured Power (dBm)	Tune up (dBm)	Measured SAR 1g (W/kg)	Calculated SAR 1g (W/kg)	Measured SAR 10g (W/kg)	Calculated SAR 10g (W/kg)	Power Drift
LTE Band12	23130	711	/	1RB-High Front	23.17	24	0.264	0.32	0.203	0.25	0.02
LTE Band12	23130	711	/	1RB-High Rear 10mm	23.17	24	0.361	0.44	0.275	0.33	0.04
LTE Band12	23130	711	/	1RB-High Left Edge	23.17	24	0.284	0.34	0.200	0.24	-0.01
LTE Band12	23130	711	Fig.15	1RB-High Right Edge	23.17	24	0.422	0.51	0.298	0.36	0.01
LTE Band12	23130	711	/	1RB-High Top	23.17	24	0.296	0.36	0.207	0.25	0.05
LTE Band12	23095	707.5	/	25RB-High Front	22.21	23	0.197	0.24	0.150	0.18	0.09
LTE Band12	23095	707.5	/	25RB-High Rear	22.21	23	0.277	0.33	0.212	0.25	0.05
LTE Band12	23095	707.5	/	25RB-High Left Edge	22.21	23	0.118	0.14	0.081	0.10	0.08
LTE Band12	23095	707.5	/	25RB-High Right Edge	22.21	23	0.221	0.27	0.148	0.18	0.04
LTE Band12	23095	707.5	/	25RB-High Top	22.21	23	0.171	0.21	0.107	0.13	0.12

Note: The LTE mode is QPSK_10MHz.

Note1: The distance between the EUT and the phantom bottom is 10mm.

Table 14.1-16: SAR Values (LTE Band13 - Head)

Test Position	Phantom position L/R/F	Frequency Band	Channel Number	Frequency (MHz)	Figure No./Note	Mode	EUT Measured Power (dBm)	Tune up (dBm)	Measured SAR 1g (W/kg)	Calculated SAR 1g (W/kg)	Measured SAR 10g (W/kg)	Calculated SAR 10g (W/kg)	Power Drift
Cheek	Left	LTE Band13	23230	782	/	1RB-Middle	23.13	24	0.231	0.28	0.183	0.22	-0.04
Tilt	Left	LTE Band13	23230	782	/	1RB-Middle	23.13	24	0.155	0.19	0.124	0.15	-0.03
Cheek	Right	LTE Band13	23230	782	Fig.16	1RB-Middle	23.13	24	0.299	0.36	0.226	0.28	0.10
Tilt	Right	LTE Band13	23230	782	/	1RB-Middle	23.13	24	0.220	0.27	0.178	0.22	-0.03
Cheek	Left	LTE Band13	23230	782	/	25RB-Middle	22.03	23	0.176	0.22	0.139	0.17	0.07
Tilt	Left	LTE Band13	23230	782	/	25RB-Middle	22.03	23	0.117	0.15	0.095	0.12	-0.03
Cheek	Right	LTE Band13	23230	782	/	25RB-Middle	22.03	23	0.227	0.28	0.172	0.21	-0.03
Tilt	Right	LTE Band13	23230	782	/	25RB-Middle	22.03	23	0.165	0.21	0.134	0.17	-0.07

Note: The LTE mode is QPSK_10MHz.

Table 14.1-17: SAR Values (LTE Band13 - Body)

Frequency Band	Channel Number	Frequency (MHz)	Figure No./Note	Mode	EUT Measured Power (dBm)	Tune up (dBm)	Measured SAR 1g (W/kg)	Calculated SAR 1g (W/kg)	Measured SAR 10g (W/kg)	Calculated SAR 10g (W/kg)	Power Drift
LTE Band13	23230	782	/	1RB-Middle Front	23.13	24	0.333	0.41	0.185	0.23	-0.06
LTE Band13	23230	782	Fig.17	1RB-Middle Rear	23.13	24	0.374	0.46	0.207	0.25	-0.09
LTE Band13	23230	782	/	1RB-Middle Left Edge	23.13	24	0.245	0.30	0.123	0.15	0.04
LTE Band13	23230	782	/	1RB-Middle Right Edge	23.13	24	0.293	0.36	0.151	0.18	0.10
LTE Band13	23230	782	/	1RB-Middle Bottom Edge	23.13	24	0.132	0.16	0.053	0.06	0.03
LTE Band13	23230	782	/	25RB-Middle Front	22.03	23	0.253	0.32	0.140	0.17	0.10
LTE Band13	23230	782	/	25RB-Middle Rear	22.03	23	0.284	0.35	0.157	0.20	-0.06
LTE Band13	23230	782	/	25RB-Middle Left Edge	22.03	23	0.186	0.23	0.094	0.12	0.11
LTE Band13	23230	782	/	25RB-Middle Right Edge	22.03	23	0.225	0.28	0.115	0.14	-0.02
LTE Band13	23230	782	/	25RB-Middle Bottom Edge	22.03	23	0.100	0.12	0.040	0.05	-0.04

Note: The LTE mode is QPSK_10MHz.

Note1: The distance between the EUT and the phantom bottom is 10mm.

Table 14.1-18: SAR Values (LTE Band25 - Head)

Test Position	Phantom position L/R/F	Frequency Band	Channel Number	Frequency (MHz)	Figure No./Note	Mode	EUT Measured Power (dBm)	Tune up (dBm)	Measured SAR 1g (W/kg)	Calculated SAR 1g (W/kg)	Measured SAR 10g (W/kg)	Calculated SAR 10g (W/kg)	Power Drift
Cheek	Left	LTE Band25	26140	1860	Fig.18	1RB-Middle	22.92	24	0.153	0.20	0.093	0.12	0.09
Tilt	Left	LTE Band25	26140	1860	/	1RB-Middle	22.92	24	0.145	0.19	0.090	0.12	-0.09
Cheek	Right	LTE Band25	26140	1860	/	1RB-Middle	22.92	24	0.141	0.18	0.084	0.11	-0.11
Tilt	Right	LTE Band25	26140	1860	/	1RB-Middle	22.92	24	0.145	0.19	0.082	0.11	-0.01
Cheek	Left	LTE Band25	26140	1860	/	50RB-Middle	21.85	23	0.120	0.16	0.073	0.10	0.02
Tilt	Left	LTE Band25	26140	1860	/	50RB-Middle	21.85	23	0.112	0.15	0.069	0.09	0.04
Cheek	Right	LTE Band25	26140	1860	/	50RB-Middle	21.85	23	0.109	0.14	0.064	0.08	-0.01
Tilt	Right	LTE Band25	26140	1860	/	50RB-Middle	21.85	23	0.118	0.15	0.065	0.08	0.10

Note: The LTE mode is QPSK_20MHz.

Table 14.1-19: SAR Values (LTE Band25 – Body)

Frequency Band	Channel Number	Frequency (MHz)	Figure No./Note	Mode	EUT Measured Power (dBm)	Tune up (dBm)	Measured SAR 1g (W/kg)	Calculated SAR 1g (W/kg)	Measured SAR 10g (W/kg)	Calculated SAR 10g (W/kg)	Power Drift
LTE Band25	26590	1905	/	1RB-Middle Front	20.06	20.5	0.536	0.59	0.266	0.29	-0.04
LTE Band25	26590	1905	/	1RB-Middle Rear	20.06	20.5	0.577	0.64	0.301	0.33	0.02
LTE Band25	26590	1905	/	1RB-Middle Left Edge	20.06	20.5	0.045	0.05	0.027	0.03	-0.05
LTE Band25	26590	1905	/	1RB-Middle Right Edge	20.06	20.5	0.038	0.04	0.023	0.03	0.07
LTE Band25	26590	1905	Fig.19	1RB-Middle Bottom Edge	20.06	20.5	1.250	1.38	0.619	0.69	0.01
LTE Band25	26590	1905	/	50RB-Middle Front	20.12	20.5	0.408	0.45	0.206	0.22	0.06
LTE Band25	26590	1905	/	50RB-Middle Rear	20.12	20.5	0.444	0.48	0.234	0.26	0.03
LTE Band25	26590	1905	/	50RB-Middle Left Edge	20.12	20.5	0.036	0.04	0.022	0.02	-0.12
LTE Band25	26590	1905	/	50RB-Middle Right Edge	20.12	20.5	0.031	0.03	0.018	0.02	-0.05
LTE Band25	26590	1905	/	50RB-Middle Bottom Edge	20.12	20.5	0.891	0.97	0.445	0.49	-0.04
LTE Band25	26590	1905	0mm	1RB-Middle Bottom Edge	20.06	20.5	3.180	3.52	1.350	1.49	0.07
LTE Band25	26590	1905	H	1RB-Middle Bottom Edge	20.06	20.5	1.230	1.36	0.616	0.68	0.04

Note: The LTE mode is QPSK_20MHz.

Note1: The distance between the EUT and the phantom bottom is 10mm.

Table 14.1-20: SAR Values (LTE Band25 – Body)

Frequency Band	Channel Number	Frequency (MHz)	Figure No./Note	Mode	EUT Measured Power (dBm)	Tune up (dBm)	Measured SAR 1g (W/kg)	Calculated SAR 1g (W/kg)	Measured SAR 10g (W/kg)	Calculated SAR 10g (W/kg)	Power Drift
LTE Band25	26140	1860	/	1RB-Middle Front	22.92	24	0.627	0.80	0.364	0.47	-0.04
LTE Band25	26140	1860	Fig.20	1RB-Middle Rear	22.92	24	0.719	0.92	0.424	0.54	0.02
LTE Band25	26140	1860	/	50RB-Middle Front	21.85	23	0.499	0.65	0.288	0.38	0.06
LTE Band25	26140	1860	/	50RB-Middle Rear	21.85	23	0.564	0.73	0.333	0.43	0.03

Note: The LTE mode is QPSK_20MHz.

Note1: The distance between the EUT and the phantom bottom is 15mm.

Table 14.1-21: SAR Values (LTE Band26 – Head)

Test Position	Phantom position L/R/F	Frequency Band	Channel Number	Frequency (MHz)	Figure No./Note	Mode	EUT Measured Power (dBm)	Tune up (dBm)	Measured SAR 1g (W/kg)	Calculated SAR 1g (W/kg)	Measured SAR 10g (W/kg)	Calculated SAR 10g (W/kg)	Power Drift
Cheek	Left	LTE Band26	26965	841.5	/	1RB-Middle	23.13	24	0.553	0.68	0.378	0.46	0.11
Tilt	Left	LTE Band26	26965	841.5	/	1RB-Middle	23.13	24	0.491	0.60	0.262	0.32	-0.04
Cheek	Right	LTE Band26	26965	841.5	/	1RB-Middle	23.13	24	0.636	0.78	0.406	0.50	-0.07
Tilt	Right	LTE Band26	26965	841.5	Fig.21	1RB-Middle	23.13	24	0.711	0.87	0.397	0.49	-0.01
Cheek	Left	LTE Band26	26965	841.5	/	36RB-Middle	22.07	23	0.520	0.64	0.353	0.44	-0.01
Tilt	Left	LTE Band26	26965	841.5	/	36RB-Middle	22.07	23	0.455	0.56	0.249	0.31	0.07
Cheek	Right	LTE Band26	26965	841.5	/	36RB-Middle	22.07	23	0.477	0.59	0.303	0.38	-0.11
Tilt	Right	LTE Band26	26965	841.5	/	36RB-Middle	22.07	23	0.553	0.69	0.307	0.38	0.11

Note: The LTE mode is QPSK_10MHz.

Note1: The distance between the EUT and the phantom bottom is 10mm.

Table 14.1-22: SAR Values (LTE Band26 – Body)

Frequency Band	Channel Number	Frequency (MHz)	Figure No./Note	Mode	EUT Measured Power (dBm)	Tune up (dBm)	Measured SAR 1g (W/kg)	Calculated SAR 1g (W/kg)	Measured SAR 10g (W/kg)	Calculated SAR 10g (W/kg)	Power Drift
LTE Band26	26965	841.5	/	1RB-Middle Front	23.13	24	0.312	0.38	0.192	0.23	-0.05
LTE Band26	26965	841.5	Fig.22	1RB-Middle Rear	23.13	24	0.382	0.47	0.234	0.29	0.01
LTE Band26	26965	841.5	/	1RB-Middle Left Edge	23.13	24	0.224	0.27	0.125	0.15	0.04
LTE Band26	26965	841.5	/	1RB-Middle Right Edge	23.13	24	0.363	0.44	0.200	0.24	0.01
LTE Band26	26965	841.5	/	1RB-Middle Top	23.13	24	0.275	0.34	0.180	0.22	0.08
LTE Band26	26965	841.5	/	36RB-Middle Front	22.07	23	0.250	0.31	0.153	0.19	0.02
LTE Band26	26965	841.5	/	36RB-Middle Rear	22.07	23	0.311	0.39	0.190	0.24	-0.06
LTE Band26	26965	841.5	/	36RB-Middle Left Edge	22.07	23	0.177	0.22	0.098	0.12	-0.11
LTE Band26	26965	841.5	/	36RB-Middle Right Edge	22.07	23	0.294	0.36	0.162	0.20	-0.11
LTE Band26	26965	841.5	/	36RB-Middle Top	22.07	23	0.264	0.33	0.203	0.25	0.09

Note: The LTE mode is QPSK_10MHz.

Table 14.1-23: SAR Values (LTE Band41 – Head) PC2

Test Position	Phantom position L/R/F	Frequency Band	Channel Number	Frequency (MHz)	Figure No./Note	Mode	EUT Measured Power (dBm)	Tune up (dBm)	Measured SAR 1g (W/kg)	Calculated SAR 1g (W/kg)	Measured SAR 10g (W/kg)	Calculated SAR 10g (W/kg)	Power Drift
Cheek	Left	LTE Band41	40620	2593	/	1RB-Middle	26.50	27	0.092	0.10	0.043	0.05	-0.05
Tilt	Left	LTE Band41	40620	2593	/	1RB-Middle	26.50	27	0.099	0.11	0.046	0.05	0.12
Cheek	Right	LTE Band41	40620	2593	Fig.23	1RB-Middle	26.50	27	0.234	0.26	0.111	0.12	0.13
Tilt	Right	LTE Band41	40620	2593	/	1RB-Middle	26.50	27	0.122	0.14	0.053	0.06	-0.12
Cheek	Left	LTE Band41	40620	2593	/	50RB-High	25.33	26	0.069	0.08	0.033	0.04	-0.09
Tilt	Left	LTE Band41	40620	2593	/	50RB-High	25.33	26	0.079	0.09	0.038	0.04	-0.04
Cheek	Right	LTE Band41	40620	2593	/	50RB-High	25.33	26	0.130	0.15	0.061	0.07	0.09
Tilt	Right	LTE Band41	40620	2593	/	50RB-High	25.33	26	0.143	0.17	0.063	0.07	-0.11

Note: The LTE mode is QPSK_20MHz.

Note1: The distance between the EUT and the phantom bottom is 10mm.

Table 14.1-24: SAR Values (LTE Band41 – Body) PC2

Frequency Band	Channel Number	Frequency (MHz)	Figure No./Note	Mode	EUT Measured Power (dBm)	Tune up (dBm)	Measured SAR 1g (W/kg)	Calculated SAR 1g (W/kg)	Measured SAR 10g (W/kg)	Calculated SAR 10g (W/kg)	Power Drift
LTE Band41	40620	2593	/	1RB-Middle Front	26.70	27	0.932	1.00	0.479	0.51	0.05
LTE Band41	40620	2593	Fig.24	1RB-Middle Rear	26.70	27	0.965	1.03	0.508	0.54	0.07
LTE Band41	40620	2593	/	1RB-Middle Left Edge	26.70	27	0.255	0.27	0.128	0.14	-0.10
LTE Band41	40620	2593	/	1RB-Middle Right Edge	26.70	27	0.318	0.34	0.178	0.19	-0.09
LTE Band41	40620	2593	/	1RB-Middle Bottom Edge	26.70	27	0.703	0.75	0.342	0.37	0.01
LTE Band41	40620	2593	/	50RB-High Front	25.33	26	0.703	0.82	0.362	0.42	-0.02
LTE Band41	40620	2593	/	50RB-High Rear	25.33	26	0.728	0.85	0.381	0.44	0.06
LTE Band41	40620	2593	/	50RB-High Left Edge	25.33	26	0.193	0.23	0.097	0.11	-0.02
LTE Band41	40620	2593	/	50RB-High Right Edge	25.33	26	0.239	0.28	0.135	0.16	0.07
LTE Band41	40620	2593	/	50RB-High Bottom Edge	25.33	26	0.526	0.61	0.256	0.30	0.12

Note: The LTE mode is QPSK_20MHz.

Note1: The distance between the EUT and the phantom bottom is 10mm.

Table 14.1-25: SAR Values (LTE Band41– Head) PC3

Test Position	Phantom position L/R/F	Frequency Band	Channel Number	Frequency (MHz)	Figure No./Note	Mode	EUT Measured Power (dBm)	Tune up (dBm)	Measured SAR 1g (W/kg)	Calculated SAR 1g (W/kg)	Measured SAR 10g (W/kg)	Calculated SAR 10g (W/kg)	Power Drift
Cheek	Left	LTE Band41	41055	2636.5	/	1RB-Middle	23.45	24	0.074	0.08	0.040	0.05	-0.07
Tilt	Left	LTE Band41	41055	2636.5	/	1RB-Middle	23.45	24	0.074	0.08	0.040	0.05	-0.12
Cheek	Right	LTE Band41	41055	2636.5	/	1RB-Middle	23.45	24	0.088	0.10	0.046	0.05	-0.11
Tilt	Right	LTE Band41	41055	2636.5	Fig.25	1RB-Middle	23.45	24	0.150	0.17	0.073	0.08	0.19
Cheek	Left	LTE Band41	41055	2636.5	/	50RB-Low	22.41	23	0.061	0.07	0.033	0.04	0.12
Tilt	Left	LTE Band41	41055	2636.5	/	50RB-Low	22.41	23	0.053	0.06	0.028	0.03	0.08
Cheek	Right	LTE Band41	41055	2636.5	/	50RB-Low	22.41	23	0.068	0.08	0.035	0.04	0.05
Tilt	Right	LTE Band41	41055	2636.5	/	50RB-Low	22.41	23	0.108	0.12	0.053	0.06	0.06

Note: The LTE mode is QPSK_20MHz.

Table 14.1-26: SAR Values (LTE Band41 – Body) PC3

Frequency Band	Channel Number	Frequency (MHz)	Mode	Figure No./Note	EUT Measured Power (dBm)	Tune up (dBm)	Measured SAR 1g (W/kg)	Calculated SAR 1g (W/kg)	Measured SAR 10g (W/kg)	Calculated SAR 10g (W/kg)	Power Drift
LTE Band14	23330	793	1RB-Low Front	/	23.41	24.3	0.207	0.25	0.146	0.18	0.11
LTE Band14	23330	793	1RB-Low Rear	/	23.41	24.3	0.427	0.52	0.277	0.34	-0.05
LTE Band14	23330	793	1RB-Low Left Edge	Fig.36	23.41	24.3	0.518	0.64	0.333	0.41	-0.04
LTE Band14	23330	793	25RB-High Front	/	22.95	23.3	0.144	0.16	0.101	0.11	-0.09
LTE Band14	23330	793	25RB-High Rear	/	22.95	23.3	0.363	0.39	0.235	0.25	0.04
LTE Band14	23330	793	25RB-High Left Edge	/	22.95	23.3	0.422	0.46	0.27	0.29	0.01
LTE Band14	23330	793	1RB-Low Left Edge	B2	23.41	24.3	0.495	0.61	0.308	0.38	0.04

Note: The LTE mode is QPSK_10MHz.

Note: The distance between the EUT and the phantom bottom is 10mm.

Table 14.1-27: SAR Values (LTE Band66 – Head)

Test Position	Phantom position L/R/F	Frequency Band	Channel Number	Frequency (MHz)	Figure No./Note	Mode	EUT Measured Power (dBm)	Tune up (dBm)	Measured SAR 1g (W/kg)	Calculated SAR 1g (W/kg)	Measured SAR 10g (W/kg)	Calculated SAR 10g (W/kg)	Power Drift
Cheek	Left	LTE Band66	132572	1770	/	1RB-Middle	23.03	24	0.183	0.23	0.117	0.15	-0.02
Tilt	Left	LTE Band66	132572	1770	/	1RB-Middle	23.03	24	0.139	0.17	0.091	0.11	-0.08
Cheek	Right	LTE Band66	132572	1770	Fig.27	1RB-Middle	23.03	24	0.219	0.27	0.139	0.17	0.02
Tilt	Right	LTE Band66	132572	1770	/	1RB-Middle	23.03	24	0.121	0.15	0.072	0.09	-0.06
Cheek	Left	LTE Band66	132572	1770	/	50RB-Middle	21.94	23	0.143	0.18	0.092	0.12	0.10
Tilt	Left	LTE Band66	132572	1770	/	50RB-Middle	21.94	23	0.118	0.15	0.075	0.10	0.06
Cheek	Right	LTE Band66	132572	1770	/	50RB-Middle	21.94	23	0.169	0.22	0.107	0.14	0.11
Tilt	Right	LTE Band66	132572	1770	/	50RB-Middle	21.94	23	0.091	0.12	0.054	0.07	-0.09

Note: The LTE mode is QPSK_10MHz.

Table 14.1-28: SAR Values (LTE Band66 –Body)

Frequency Band	Channel Number	Frequency (MHz)	Figure No./Note	Mode	EUT Measured Power (dBm)	Tune up (dBm)	Measured SAR 1g (W/kg)	Calculated SAR 1g (W/kg)	Measured SAR 10g (W/kg)	Calculated SAR 10g (W/kg)	Power Drift
LTE Band66	132572	1770	/	1RB-Middle Front	20.39	20.8	0.666	0.73	0.376	0.41	-0.09
LTE Band66	132572	1770	/	1RB-Middle Rear	20.39	20.8	0.581	0.64	0.352	0.39	0.06
LTE Band66	132572	1770	/	1RB-Middle Left Edge	20.39	20.8	0.050	0.05	0.030	0.03	0.05
LTE Band66	132572	1770	/	1RB-Middle Right Edge	20.39	20.8	0.079	0.09	0.052	0.06	-0.08
LTE Band66	132572	1770	/	1RB-Middle Bottom Edge	20.39	20.8	1.080	1.19	0.564	0.62	-0.09
LTE Band66	132322	1745	/	1RB-Middle Bottom Edge	20.39	20.8	0.987	1.08	0.528	0.58	-0.02
LTE Band66	132072	1720	/	1RB-Middle Bottom Edge	20.39	20.8	0.947	1.04	0.518	0.57	-0.11
LTE Band66	132572	1770	/	50RB-Low Front	20.36	20.8	0.693	0.77	0.390	0.43	-0.06
LTE Band66	132572	1770	/	50RB-Low Rear	20.36	20.8	0.609	0.67	0.368	0.41	0.10
LTE Band66	132572	1770	/	50RB-Low Left Edge	20.36	20.8	0.073	0.08	0.047	0.05	-0.05
LTE Band66	132572	1770	/	50RB-Low Right Edge	20.36	20.8	0.079	0.09	0.051	0.06	0.11
LTE Band66	132572	1770	Fig.28	50RB-Low Bottom Edge	20.36	20.8	1.140	1.26	0.591	0.65	-0.05
LTE Band66	132322	1745	/	50RB-High Bottom Edge	20.36	20.8	1.010	1.12	0.545	0.60	0.08
LTE Band66	132072	1720	/	50RB-Middle Bottom Edge	20.36	20.8	0.931	1.03	0.510	0.56	-0.06
LTE Band66	132572	1770	H	50RB-Low Bottom Edge	20.36	20.8	1.010	1.12	0.556	0.62	0.08
LTE Band66	132572	1770	note2	50RB-Low Bottom Edge	20.36	20.8	3.960	4.38	1.490	1.65	0.07

Note: The LTE mode is QPSK_20MHz.

Note1: The distance between the EUT and the phantom bottom is 10mm.

Note: The distance between the EUT and the phantom bottom is 0mm.

Table 14.1-29: SAR Values (LTE Band71 –Head)

Test Position	Phantom position L/R/F	Frequency Band	Channel Number	Frequency (MHz)	Figure No./Note	Mode	EUT Measured Power (dBm)	Tune up (dBm)	Measured SAR 1g (W/kg)	Calculated SAR 1g (W/kg)	Measured SAR 10g (W/kg)	Calculated SAR 10g (W/kg)	Power Drift
Cheek	Left	LTE Band71	133222	673	Fig.29	1RB-Low	23.41	24	0.610	0.70	0.457	0.52	-0.04
Tilt	Left	LTE Band71	133222	673	/	1RB-Low	23.41	24	0.603	0.69	0.399	0.46	-0.10
Cheek	Right	LTE Band71	133222	673	/	1RB-Low	23.41	24	0.533	0.61	0.406	0.47	-0.09
Tilt	Right	LTE Band71	133222	673	/	1RB-Low	23.41	24	0.525	0.60	0.366	0.42	0.06
Cheek	Left	LTE Band71	133222	673	/	50RB-Low	22.34	23	0.426	0.50	0.333	0.39	-0.12
Tilt	Left	LTE Band71	133222	673	/	50RB-Low	22.34	23	0.443	0.52	0.291	0.34	-0.06
Cheek	Right	LTE Band71	133222	673	/	50RB-Low	22.34	23	0.396	0.46	0.300	0.35	0.11
Tilt	Right	LTE Band71	133222	673	/	50RB-Low	22.34	23	0.393	0.46	0.274	0.32	0.07

Note: The LTE mode is QPSK_20MHz.

Table 14.1-30: SAR Values (LTE Band71 –Body)

Frequency Band	Channel Number	Frequency (MHz)	Figure No./Note	Mode	EUT Measured Power (dBm)	Tune up (dBm)	Measured SAR 1g (W/kg)	Calculated SAR 1g (W/kg)	Measured SAR 10g (W/kg)	Calculated SAR 10g (W/kg)	Power Drift
LTE Band71	133222	673	/	1RB-Low Front	23.41	24	0.283	0.32	0.222	0.25	0.00
LTE Band71	133222	673	Fig.30	1RB-Low Rear	23.41	24	0.395	0.45	0.308	0.35	-0.04
LTE Band71	133222	673	/	1RB-Low Left Edge	23.41	24	0.196	0.23	0.138	0.16	-0.04
LTE Band71	133222	673	/	1RB-Low Right Edge	23.41	24	0.343	0.39	0.240	0.27	-0.12
LTE Band71	133222	673	/	1RB-Low Top Edge	23.41	24	0.134	0.15	0.078	0.09	0.13
LTE Band71	133222	673	/	50RB-Low Front	22.34	23	0.209	0.24	0.164	0.19	0.05
LTE Band71	133222	673	/	50RB-Low Rear	22.34	23	0.283	0.33	0.221	0.26	0.11
LTE Band71	133222	673	/	50RB-Low Left Edge	22.34	23	0.147	0.17	0.103	0.12	0.00
LTE Band71	133222	673	/	50RB-Low Right Edge	22.34	23	0.256	0.30	0.180	0.21	0.13
LTE Band71	133222	673	/	50RB-Low Top Edge	22.34	23	0.105	0.12	0.061	0.07	-0.08

Note: The LTE mode is QPSK_20MHz.

Note1: The distance between the EUT and the phantom bottom is 10mm.

14.2 SAR results for Standard procedure

There is zoom scan measurement to be added for the highest measured SAR in each exposure configuration/band.

Test Band	Channel	Frequency	Tune-Up	Measured Power	Test Position	Measured 10g SAR	Measured 1g SAR	Reported 10g SAR	Reported 1g SAR	Power Drift	Figure
GSM850	190	836.6	33.3	32.22	Right Cheek	0.157	0.213	0.20	0.27	0.19	Fig A.1
GSM850	190	836.6	30.5	29.91	Rear 10mm	0.326	0.594	0.37	0.68	0.06	Fig A.2
PCS1900	512	1850.2	30.3	29.83	Left Cheek	0.064	0.105	0.07	0.12	0.15	Fig A.3
PCS1900	661	1880	26	25.54	Bottom	0.468	1.04	0.52	1.16	-0.03	Fig A.4
PCS1900	512	1850.2	30.3	29.83	Rear 15mm	0.236	0.395	0.26	0.44	0.06	Fig A.5
WCDMA1900-B11	9400	1880	24	23.14	Left Tilt	0.075	0.123	0.09	0.15	-0.14	Fig A.6
WCDMA1900-B11	9538	1907.6	20.5	19.75	Bottom 10mm	0.588	1.17	0.70	1.39	0.18	Fig A.7
WCDMA1900-B11	9262	1852.4	24	23.46	Rear 15mm	0.356	0.603	0.40	0.68	0.11	Fig A.8
WCDMA1700-B1V	1412	1732.4	24	23.54	Right Cheek	0.176	0.276	0.20	0.31	0.09	Fig A.9
WCDMA1700-B1V	1513	1752.6	21.5	21.17	Bottom 10mm	0.404	0.785	0.44	0.85	0.03	Fig A.10
WCDMA1700-B1V	1412	1732.5	24	23.54	Rear 15mm	0.404	0.677	0.45	0.75	0.13	Fig A.11
WCDMA850-BV	4132	826.4	24	23.68	Left Cheek	0.422	0.602	0.45	0.65	0.02	Fig A.12
WCDMA850-BV	4233	846.6	24	23.83	Rear 10mm	0.235	0.386	0.24	0.40	0	Fig A.13
LTE700-FDD12	23130	711 MHz	24	23.17	Left Tilt	0.321	0.582	0.39	0.70	-0.02	Fig A.14
LTE700-FDD12	23130	711 MHz	24	23.17	Right Edge 10	0.298	0.422	0.36	0.51	0.01	Fig A.15
LTE750-FDD13	23230	782 MHz	24	23.13	Right Cheek	0.226	0.299	0.28	0.36	0.1	Fig A.16
LTE750-FDD13	23230	782 MHz	24	23.13	Rear 10mm	0.207	0.374	0.25	0.46	-0.09	Fig A.17
LTE1900-FDD25	26140	1860 MHz	24	22.92	Left Cheek	0.093	0.153	0.12	0.20	0.09	Fig A.18
LTE1900-FDD25	26590	1905 MHz	20.5	20.06	Bottom Edge 10	0.619	1.25	0.69	1.38	0.01	Fig A.19
LTE1900-FDD25	26140	1860 MHz	24	22.92	Rear 15mm	0.424	0.719	0.54	0.92	0.02	Fig A.20
LTE850-FDD26	26965	841.5 MHz	24	23.13	Right Tilt	0.397	0.711	0.49	0.87	-0.01	Fig A.21
LTE850-FDD26	26965	841.5 MHz	24	23.13	Rear 10mm	0.234	0.382	0.29	0.47	0.01	Fig A.22
LTE2500-TDD41	40620	2593 MHz	27	26.70	Right Cheek	0.111	0.234	0.12	0.25	0.13	Fig A.23
LTE2500-TDD41	40620	2593 MHz	27	26.70	Rear 10mm	0.508	0.965	0.54	1.03	0.07	Fig A.24
LTE2500-TDD41	41055	2636.5 MHz	24	23.45	Right Tilt	0.073	0.15	0.08	0.17	0.19	Fig A.25
LTE2500-TDD41	41055	2636.5 MHz	24	23.45	Front 10mm	0.321	0.609	0.36	0.69	0.02	Fig A.26
LTE1700-FDD66	132572	2636.5 MHz	24	23.03	Right Cheek	0.139	0.219	0.17	0.27	0.02	Fig A.27
LTE1700-FDD66	132572	2636.5 MHz	20.8	20.39	Bottom Edge 10	0.564	1.08	0.62	1.19	-0.09	Fig A.28
LTE1700-FDD66	132572	2636.5 MHz	24	23.03	Rear 15mm	0.368	0.608	0.46	0.76	0.06	Fig A.29
LTE700-FDD71	133222	2636.5 MHz	24	23.41	Left Cheek	0.457	0.61	0.52	0.70	0.12	Fig A.30
LTE700-FDD71	133222	2636.5 MHz	24	23.41	Rear 10mm	0.308	0.395	0.35	0.45	0.09	Fig A.31
WLAN2450	6	2412	18	17.26	Right Tilt	0.18	0.374	0.21	0.44	0.05	Fig A.32
WLAN2450	6	2412	21.5	21.46	Rear 10mm	0.218	0.46	0.22	0.46	0.05	Fig A.33

15 SAR Measurement Variability

SAR measurement variability must be assessed for each frequency band, which is determined by the SAR probe calibration point and tissue-equivalent medium used for the device measurements. When both head and body tissue-equivalent media are required for SAR measurements in a frequency band, the variability measurement procedures should be applied to the tissue medium with the highest measured SAR, using the highest measured SAR configuration for that tissue-equivalent medium.

The following procedures are applied to determine if repeated measurements are required.

- 1) Repeated measurement is not required when the original highest measured SAR is < 0.80 W/kg; steps 2) through 4) do not apply.
- 2) When the original highest measured SAR is ≥ 0.80 W/kg, repeat that measurement once.
- 3) Perform a second repeated measurement only if the ratio of largest to smallest SAR for the original and first repeated measurements is > 1.20 or when the original or repeated measurement is ≥ 1.45 W/kg ($\sim 10\%$ from the 1-g SAR limit).
- 4) Perform a third repeated measurement only if the original, first or second repeated measurement is ≥ 1.5 W/kg and the ratio of largest to smallest SAR for the original, first and second repeated measurements is > 1.20 .

Table 15.1: SAR Measurement Variability for Body LTEB66 (1g)

Frequency		Test Position	Mode	Spacing (mm)	Original SAR (W/kg)	First Repeated SAR (W/kg)	The Ratio	Second Repeated SAR (W/kg)
Ch.	MHz							
661	1880	Bottom	/	10	1.16	1.02	1.14	/
512	1850.2	Bottom	/	10	1.02	0.98	1.04	/
661	1880	Bottom	/	10	1.10	0.99	1.11	/
1513	1752.6	Bottom	/	10	0.89	0.81	1.10	/
1412	1732.5	Bottom	/	10	0.81	0.74	1.09	/
26590	1905	Bottom	/	10	1.38	1.17	1.18	/
26965	841.5	Bottom	/	10	0.87	0.80	1.09	/
9538	1907.6	Bottom	/	10	1.17	1.06	1.10	/
9400	1880	Front	/	10	1.01	0.96	1.05	/
9262	1852.4	Rear	/	10	1.13	1.01	1.12	/
40620	2593	Front	/	10	0.82	0.79	1.04	/
40620	2593	Rear	/	10	0.85	0.79	1.08	/
132572	1770	Bottom	/	10	1.19	1.01	1.18	/
132322	1745	Bottom	/	10	1.08	0.99	1.09	/
132072	1720	Bottom	/	10	1.04	0.95	1.09	/
132572	1770	Bottom	/	10	1.26	1.08	1.17	/
132322	1745	Bottom	/	10	1.12	1.03	1.09	/



132072	1720	Bottom	/	10	1.03	0.95	1.08	/
132572	1770	Bottom	/	10	1.12	0.97	1.15	/

14.3 WLAN Evaluation for 2.4G

According to the KDB248227 D01, SAR is measured for 2.4GHz 802.11b DSSS using the initial test position procedure.

When the phone is in talking mode and receiver worked, then power reduction will be implemented immediately at WIFI 2.4G.

Head Evaluation

Table 14.3-1: SAR Values (WLAN - Head)– 802.11b (Fast SAR)

Frequency		Side	Test Position	Figure No./ Note	Conducted Power (dBm)	Max. tune-up Power (dBm)	Measured SAR(1g) (W/kg)	Reported SAR(1g) (W/kg)	Measured SAR(10g) (W/kg)	Reported SAR(10g) (W/kg)	Power Drift (dB)
MHz	Ch.										
Ambient Temperature: 22.9 °C Liquid Temperature: 22.5 °C											
2412	1	Left	Cheek	/	17.26	18.00	0.152	0.18	0.085	0.10	0.01
2412	1	Left	Tilt	/	17.26	18.00	0.193	0.23	0.097	0.12	-0.19
2412	1	Right	Cheek	/	17.26	18.00	0.366	0.43	0.176	0.21	0.15
2412	1	Right	Tilt	/	17.26	18.00	0.336	0.40	0.149	0.18	-0.04

As shown above table, the initial test position for head is “Right Touch”. So the head SAR of WLAN is presented as below:

Table 14.3-2: SAR Values (WLAN - Head)– 802.11b (Full SAR)

Frequency		Side	Test Position	Figure No./ Note	Conducte d Power (dBm)	Max. tune-up Power (dBm)	Measured SAR(1g) (W/kg)	Reported SAR(1g) (W/kg)	Measured SAR(10g) (W/kg)	Reported SAR(10g) (W/kg)	Power Drift (dB)
MHz	Ch.										
Ambient Temperature: 22.9 °C Liquid Temperature: 22.5 °C											
2412	1	Right	Cheek	Fig.31	17.26	18.00	0.374	0.44	0.180	0.21	0.05

Note1: When the reported SAR of the initial test position is > 0.4 W/kg, SAR is repeated for the 802.11 transmission mode configuration tested in the initial test position using subsequent highest estimated 1-g SAR conditions determined by area scans, on the highest maximum output power channel, until the reported SAR is \leq 0.8 W/kg.
 Note2: For all positions/configurations tested using the initial test position and subsequent test positions, when the reported SAR is > 0.8 W/kg, SAR is measured for these test positions/configurations on the subsequent next highest measured output power channel until the reported SAR is \leq 1.2 W/kg or all required channels are tested.

According to the KDB248227 D01, The reported SAR must be scaled to 100% transmission duty factor to determine compliance at the maximum tune-up tolerance limit. The scaled reported SAR is presented as below.

Table 14.3-3: SAR Values (WLAN - Head) – 802.11b (Scaled Reported SAR)

Frequency		Side	Test Position	Actual duty factor	maximum duty factor	Reported SAR (1g)(W/kg)	Scaled reported SAR (1g)(W/kg)
MHz	Ch.						
Ambient Temperature: 22.9 °C Liquid Temperature: 22.5 °C							
2412	1	Right	Cheek	100%	100%	0.44	0.44

SAR is not required for OFDM because the 802.11b adjusted SAR \leq 1.2 W/kg.

Body Evaluation
Table 14.3-4: SAR Values (WLAN - Body)– 802.11b (Fast SAR)

Frequency		Test Position	Figure No./ Note	Conducted Power (dBm)	Max. tune-up Power (dBm)	Measured SAR(1g) (W/kg)	Reported SAR(1g) (W/kg)	Measured SAR(10g) (W/kg)	Reported SAR(10g) (W/kg)	Power Drift (dB)
MHz	Ch.									
2437	6	Front	/	21.46	21.50	0.201	0.20	0.105	0.11	0.05
2437	6	Rear	/	21.46	21.50	0.445	0.45	0.200	0.20	0.08
2437	6	Left	/	21.46	21.50	0.264	0.27	0.147	0.15	-0.10
2437	6	Top	/	21.46	21.50	0.212	0.21	0.103	0.10	0.11

As shown above table, the initial test position for body is “Rear”. So the body SAR of WLAN is presented as below:

Table 14.3-5: SAR Values (WLAN - Body)– 802.11b (Full SAR)

Frequency		Test Position	Figure No./ Note	Conducted Power (dBm)	Max. tune-up Power (dBm)	Measured SAR(1g) (W/kg)	Reported SAR(1g) (W/kg)	Measured SAR(10g) (W/kg)	Reported SAR(10g) (W/kg)	Power Drift (dB)
MHz	Ch.									
2437	6	Rear	Fig.32	21.46	21.50	0.460	0.46	0.218	0.22	0.05

Note1: When the reported SAR of the initial test position is > 0.4 W/kg, SAR is repeated for the 802.11 transmission mode configuration tested in the initial test position using subsequent highest estimated 1-g SAR conditions determined by area scans, on the highest maximum output power channel, until the reported SAR is \leq 0.8 W/kg.

Note2: For all positions/configurations tested using the initial test position and subsequent test positions, when the reported SAR is > 0.8 W/kg, SAR is measured for these test positions/configurations on the subsequent next highest measured output power channel until the reported SAR is \leq 1.2 W/kg or all required channels are tested.

According to the KDB248227 D01, The reported SAR must be scaled to 100% transmission duty factor to determine compliance at the maximum tune-up tolerance limit. The scaled reported SAR is presented as below.

Table 14.3-6: SAR Values (WLAN - Body) – 802.11b (Scaled Reported SAR)

Frequency		Test Position	Actual duty factor	maximum duty factor	Reported SAR (1g)(W/kg)	Scaled reported SAR (1g)(W/kg)
MHz	Ch.					
6	2437	Rear	100%	100%	0.46	0.46

SAR is not required for OFDM because the 802.11b adjusted SAR \leq 1.2 W/kg.

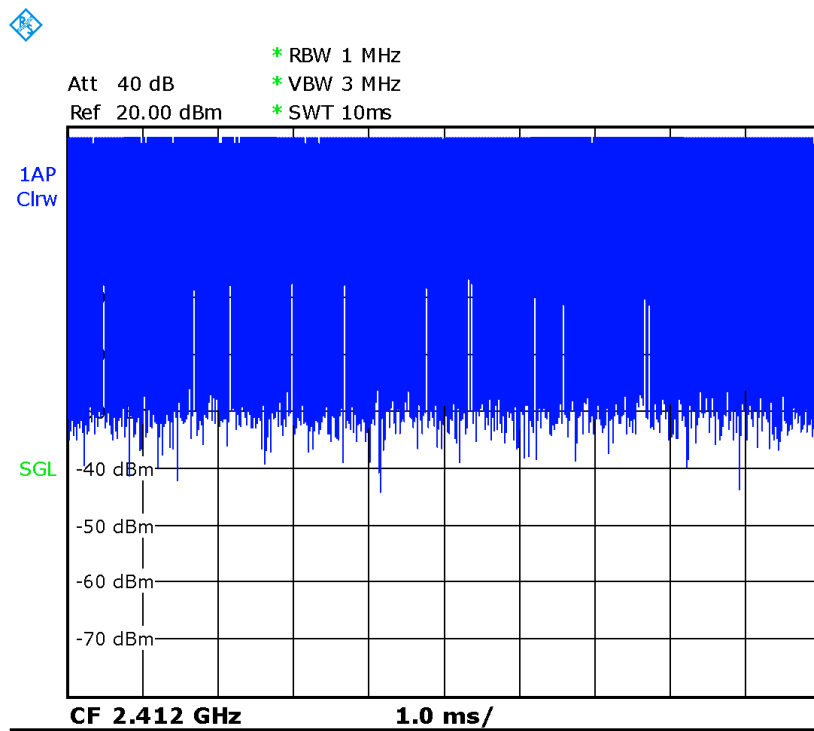

Picture 14.1 Duty factor plot

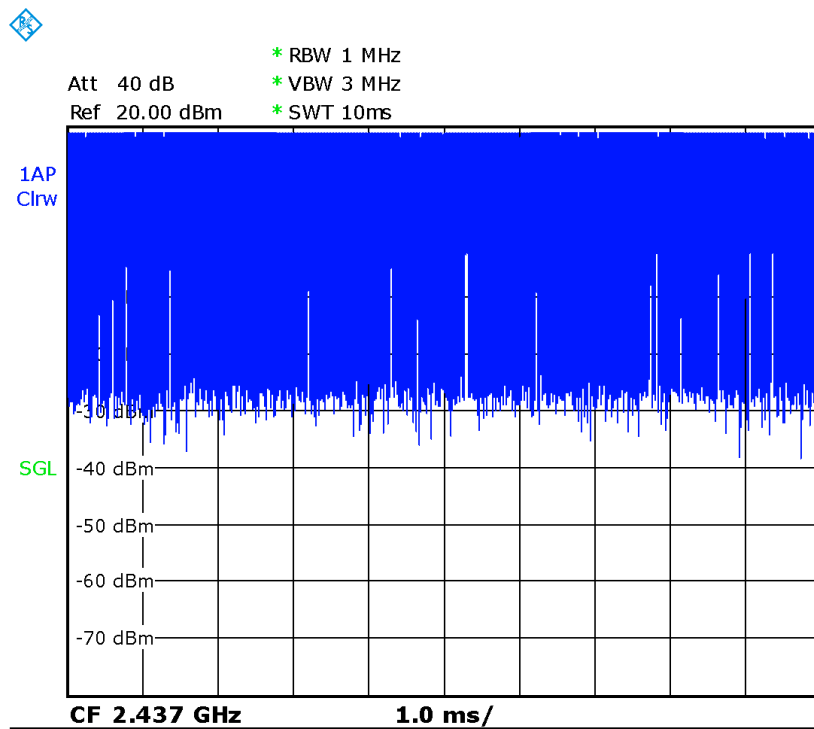

Picture 14.2 Duty factor plot

16 Measurement Uncertainty

16.1 Measurement Uncertainty for Normal SAR Tests (300MHz~3GHz)

No.	Error Description	Type	Uncertainty value	Probably Distribution	Div.	(Ci) 1g	(Ci) 10g	Std. Unc. (1g)	Std. Unc. (10g)	Degree of freedom
Measurement system										
1	Probe calibration	B	6.0	N	1	1	1	6.0	6.0	∞
2	Isotropy	B	4.7	R	$\sqrt{3}$	0.7	0.7	1.9	1.9	∞
3	Boundary effect	B	1.0	R	$\sqrt{3}$	1	1	0.6	0.6	∞
4	Linearity	B	4.7	R	$\sqrt{3}$	1	1	2.7	2.7	∞
5	Detection limit	B	1.0	N	1	1	1	0.6	0.6	∞
6	Readout electronics	B	0.3	R	$\sqrt{3}$	1	1	0.3	0.3	∞
7	Response time	B	0.8	R	$\sqrt{3}$	1	1	0.5	0.5	∞
8	Integration time	B	2.6	R	$\sqrt{3}$	1	1	1.5	1.5	∞
9	RF ambient conditions-noise	B	0	R	$\sqrt{3}$	1	1	0	0	∞
10	RF ambient conditions-reflection	B	0	R	$\sqrt{3}$	1	1	0	0	∞
11	Probe positioned mech. restrictions	B	0.4	R	$\sqrt{3}$	1	1	0.2	0.2	∞
12	Probe positioning with respect to phantom shell	B	2.9	R	$\sqrt{3}$	1	1	1.7	1.7	∞
13	Post-processing	B	1.0	R	$\sqrt{3}$	1	1	0.6	0.6	∞
Test sample related										
14	Test sample positioning	A	3.3	N	1	1	1	3.3	3.3	71
15	Device holder uncertainty	A	3.4	N	1	1	1	3.4	3.4	5
16	Drift of output power	B	5.0	R	$\sqrt{3}$	1	1	2.9	2.9	∞
Phantom and set-up										
17	Phantom uncertainty	B	4.0	R	$\sqrt{3}$	1	1	2.3	2.3	∞
18	Liquid conductivity (target)	B	5.0	R	$\sqrt{3}$	0.64	0.43	1.8	1.2	∞
19	Liquid conductivity (meas.)	A	2.06	N	1	0.64	0.43	1.32	0.89	43
20	Liquid permittivity (target)	B	5.0	R	$\sqrt{3}$	0.6	0.49	1.7	1.4	∞
21	Liquid permittivity (meas.)	A	1.6	N	1	0.6	0.49	1.0	0.8	521

Combined standard uncertainty	$u_c = \sqrt{\sum_{i=1}^{21} c_i^2 u_i^2}$							9.55	9.43	257
Expanded uncertainty (confidence interval of 95 %)	$u_e = 2u_c$							19.1	18.9	

16.2 Measurement Uncertainty for Normal SAR Tests (3~6GHz)

No.	Error Description	Type	Uncertainty value	Probably Distribution	Div.	(Ci) 1g	(Ci) 10g	Std. Unc. (1g)	Std. Unc. (10g)	Degree of freedom
Measurement system										
1	Probe calibration	B	6.55	N	1	1	1	6.55	6.55	∞
2	Isotropy	B	4.7	R	$\sqrt{3}$	0.7	0.7	1.9	1.9	∞
3	Boundary effect	B	2.0	R	$\sqrt{3}$	1	1	1.2	1.2	∞
4	Linearity	B	4.7	R	$\sqrt{3}$	1	1	2.7	2.7	∞
5	Detection limit	B	1.0	R	$\sqrt{3}$	1	1	0.6	0.6	∞
6	Readout electronics	B	0.3	R	$\sqrt{3}$	1	1	0.3	0.3	∞
7	Response time	B	0.8	R	$\sqrt{3}$	1	1	0.5	0.5	∞
8	Integration time	B	2.6	R	$\sqrt{3}$	1	1	1.5	1.5	∞
9	RF ambient conditions-noise	B	0	R	$\sqrt{3}$	1	1	0	0	∞
10	RFambient conditions-reflection	B	0	R	$\sqrt{3}$	1	1	0	0	∞
11	Probe positioned mech. restrictions	B	0.8	R	$\sqrt{3}$	1	1	0.5	0.5	∞
12	Probe positioning with respect to phantom shell	B	6.7	R	$\sqrt{3}$	1	1	3.9	3.9	∞
13	Post-processing	B	4.0	R	$\sqrt{3}$	1	1	2.3	2.3	∞
Test sample related										
14	Test sample positioning	A	3.3	N	1	1	1	3.3	3.3	71
15	Device holder uncertainty	A	3.4	N	1	1	1	3.4	3.4	5
16	Drift of output power	B	5.0	R	$\sqrt{3}$	1	1	2.9	2.9	∞
Phantom and set-up										
17	Phantom uncertainty	B	4.0	R	$\sqrt{3}$	1	1	2.3	2.3	∞
18	Liquid conductivity (target)	B	5.0	R	$\sqrt{3}$	0.64	0.43	1.8	1.2	∞
19	Liquid conductivity (meas.)	A	2.06	N	1	0.64	0.43	1.32	0.89	43
20	Liquid permittivity (target)	B	5.0	R	$\sqrt{3}$	0.6	0.49	1.7	1.4	∞

21	Liquid permittivity (meas.)	A	1.6	N	1	0.6	0.49	1.0	0.8	521
Combined standard uncertainty		$u_c = \sqrt{\sum_{i=1}^{21} c_i^2 u_i^2}$						10.7	10.6	257
Expanded uncertainty (confidence interval of 95 %)		$u_e = 2u_c$						21.4	21.1	

16.3 Measurement Uncertainty for Fast SAR Tests (300MHz~3GHz)

No.	Error Description	Type	Uncertainty value	Probably Distribution	Div.	(Ci) 1g	(Ci) 10g	Std. Unc. (1g)	Std. Unc. (10g)	Degree of freedom
Measurement system										
1	Probe calibration	B	6.0	N	1	1	1	6.0	6.0	∞
2	Isotropy	B	4.7	R	$\sqrt{3}$	0.7	0.7	1.9	1.9	∞
3	Boundary effect	B	1.0	R	$\sqrt{3}$	1	1	0.6	0.6	∞
4	Linearity	B	4.7	R	$\sqrt{3}$	1	1	2.7	2.7	∞
5	Detection limit	B	1.0	R	$\sqrt{3}$	1	1	0.6	0.6	∞
6	Readout electronics	B	0.3	R	$\sqrt{3}$	1	1	0.3	0.3	∞
7	Response time	B	0.8	R	$\sqrt{3}$	1	1	0.5	0.5	∞
8	Integration time	B	2.6	R	$\sqrt{3}$	1	1	1.5	1.5	∞
9	RF ambient conditions-noise	B	0	R	$\sqrt{3}$	1	1	0	0	∞
10	RFambient conditions-reflection	B	0	R	$\sqrt{3}$	1	1	0	0	∞
11	Probe positioned mech. Restrictions	B	0.4	R	$\sqrt{3}$	1	1	0.2	0.2	∞
12	Probe positioning with respect to phantom shell	B	2.9	R	$\sqrt{3}$	1	1	1.7	1.7	∞
13	Post-processing	B	1.0	R	$\sqrt{3}$	1	1	0.6	0.6	∞
14	Fast SAR z-Approximation	B	7.0	R	$\sqrt{3}$	1	1	4.0	4.0	∞
Test sample related										
15	Test sample positioning	A	3.3	N	1	1	1	3.3	3.3	71
16	Device holder uncertainty	A	3.4	N	1	1	1	3.4	3.4	5
17	Drift of output power	B	5.0	R	$\sqrt{3}$	1	1	2.9	2.9	∞
Phantom and set-up										
18	Phantom uncertainty	B	4.0	R	$\sqrt{3}$	1	1	2.3	2.3	∞
19	Liquid conductivity (target)	B	5.0	R	$\sqrt{3}$	0.64	0.43	1.8	1.2	∞

20	Liquid conductivity (meas.)	A	2.06	N	1	0.64	0.43	1.32	0.89	43
21	Liquid permittivity (target)	B	5.0	R	$\sqrt{3}$	0.6	0.49	1.7	1.4	∞
22	Liquid permittivity (meas.)	A	1.6	N	1	0.6	0.49	1.0	0.8	521
Combined standard uncertainty		$u_c = \sqrt{\sum_{i=1}^{22} c_i^2 u_i^2}$						10.4	10.3	257
Expanded uncertainty (confidence interval of 95 %)		$u_e = 2u_c$						20.8	20.6	

16.4 Measurement Uncertainty for Fast SAR Tests (3~6GHz)

No.	Error Description	Type	Uncertainty value	Probably Distribution	Div.	(Ci) 1g	(Ci) 10g	Std. Unc. (1g)	Std. Unc. (10g)	Degree of freedom
Measurement system										
1	Probe calibration	B	6.55	N	1	1	1	6.55	6.55	∞
2	Isotropy	B	4.7	R	$\sqrt{3}$	0.7	0.7	1.9	1.9	∞
3	Boundary effect	B	2.0	R	$\sqrt{3}$	1	1	1.2	1.2	∞
4	Linearity	B	4.7	R	$\sqrt{3}$	1	1	2.7	2.7	∞
5	Detection limit	B	1.0	R	$\sqrt{3}$	1	1	0.6	0.6	∞
6	Readout electronics	B	0.3	R	$\sqrt{3}$	1	1	0.3	0.3	∞
7	Response time	B	0.8	R	$\sqrt{3}$	1	1	0.5	0.5	∞
8	Integration time	B	2.6	R	$\sqrt{3}$	1	1	1.5	1.5	∞
9	RF ambient conditions-noise	B	0	R	$\sqrt{3}$	1	1	0	0	∞
10	RF ambient conditions-reflection	B	0	R	$\sqrt{3}$	1	1	0	0	∞
11	Probe positioned mech. Restrictions	B	0.8	R	$\sqrt{3}$	1	1	0.5	0.5	∞
12	Probe positioning with respect to phantom shell	B	6.7	R	$\sqrt{3}$	1	1	3.9	3.9	∞
13	Post-processing	B	1.0	R	$\sqrt{3}$	1	1	0.6	0.6	∞
14	Fast SAR z-Approximation	B	14.0	R	$\sqrt{3}$	1	1	8.1	8.1	∞
Test sample related										
15	Test sample positioning	A	3.3	N	1	1	1	3.3	3.3	71
16	Device holder uncertainty	A	3.4	N	1	1	1	3.4	3.4	5

17	Drift of output power	B	5.0	R	$\sqrt{3}$	1	1	2.9	2.9	∞
Phantom and set-up										
18	Phantom uncertainty	B	4.0	R	$\sqrt{3}$	1	1	2.3	2.3	∞
19	Liquid conductivity (target)	B	5.0	R	$\sqrt{3}$	0.64	0.43	1.8	1.2	∞
20	Liquid conductivity (meas.)	A	2.06	N	1	0.64	0.43	1.32	0.89	43
21	Liquid permittivity (target)	B	5.0	R	$\sqrt{3}$	0.6	0.49	1.7	1.4	∞
22	Liquid permittivity (meas.)	A	1.6	N	1	0.6	0.49	1.0	0.8	521
Combined standard uncertainty		$u_c = \sqrt{\sum_{i=1}^{22} c_i^2 u_i^2}$						13.5	13.4	257
Expanded uncertainty (confidence interval of 95 %)		$u_e = 2u_c$						27.0	26.8	

17 MAIN TEST INSTRUMENTS

Table 17.1: List of Main Instruments

No.	Name	Type	Serial Number	Calibration Date	Valid Period
01	Network analyzer	E5071C	MY46110673	January 24, 2019	One year
02	Power meter	NRVD	102083	October 24, 2018	One year
03	Power sensor	NRV-Z5	100542		
04	Power sensor	NRP6A	101369	April 11, 2019	One Year
05	Signal Generator	E4438C	MY49070393	January 4, 2019	One Year
06	Amplifier	60S1G4	0331848	No Calibration Requested	
07	Directional Coupler	778D	MY48220584	No Calibration Requested	
08	Directional Coupler	772D	MY46151265	No Calibration Requested	
09	BTS	E5515C	MY50263375	January 17, 2019	One year
10	BTS	CMW500	159890	January 3, 2019	One year
11	E-field Probe	SPEAG EX3DV4	3617	January 31, 2019	One year
12	DAE	SPEAG DAE4	771	January 11,2019	One year
13	Dipole Validation Ki	SPEAG D750V3	1017	July 18, 2019	One year
14	Dipole Validation Ki	SPEAG D835V2	4d069	July 18, 2019	One year
15	Dipole Validation Ki	SPEAG D1750V2	1003	July 16, 2019	One year
16	Dipole Validation Ki	SPEAG D1900V2	5d101	July 17, 2019	One year
17	Dipole Validation Ki	SPEAG D2450V2	853	July 17, 2019	One year
18	Dipole Validation Ki	SPEAG D2600V2	1012	July 17, 2019	One year

END OF REPORT BODY

ANNEX A Graph Results

GSM850_CH190 Right Cheek

Date: 11/2/2019

Electronics: DAE4 Sn771

Medium: head 835 MHz

Medium parameters used: $f = 836.6$; $\sigma = 0.903$ mho/m; $\epsilon_r = 41.6$; $\rho = 1000$ kg/m³

Ambient Temperature: 22.5°C, Liquid Temperature: 22.3°C

Communication System: GSM850 836.6 Duty Cycle:1:8.3

Probe: EX3DV4 – SN3617 ConvF(9.75,9.75,9.75)

Area Scan (71x121x1): Interpolated grid: dx=1.000 mm, dy=1.000 mm

Maximum value of SAR (interpolated) = 0.231 W/kg

Zoom Scan (7x7x7)/Cube 0: Measurement grid: dx=5mm, dy=5mm, dz=5mm

Reference Value = 5.521 V/m; Power Drift = 0.19 dB

Peak SAR (extrapolated) = 0.298 W/kg

SAR(1 g) = 0.213 W/kg; SAR(10 g) = 0.157 W/kg

Maximum value of SAR (measured) = 0.248 W/kg

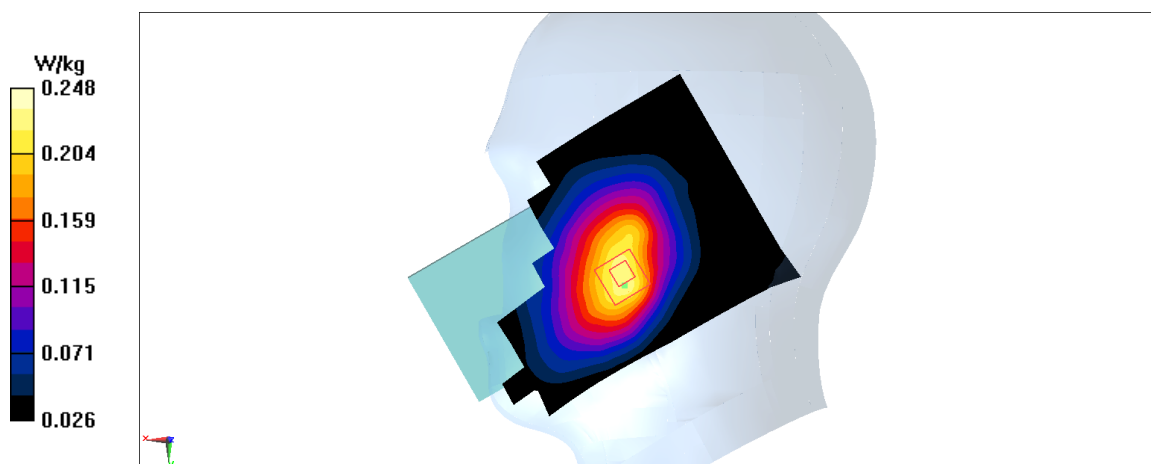

Fig A.1

GSM850_CH190 Rear 10mm

Date: 11/2/2019

Electronics: DAE4 Sn771

Medium: body 835 MHz

Medium parameters used: $f = 836.6$; $\sigma = 0.99$ mho/m; $\epsilon_r = 56.1$; $\rho = 1000$ kg/m³

Ambient Temperature: 22.5°C, Liquid Temperature: 22.3°C

Communication System: GSM850 836.6 Duty Cycle:1:4

Probe: EX3DV4 – SN3617 ConvF(9.61,9.61,9.61)

Area Scan (71x121x1): Interpolated grid: dx=1.000 mm, dy=1.000 mm

Maximum value of SAR (interpolated) = 0.649 W/kg

Zoom Scan (7x7x7)/Cube 0: Measurement grid: dx=5mm, dy=5mm, dz=5mm

Reference Value = 14.34 V/m; Power Drift = 0.06 dB

Peak SAR (extrapolated) = 1.1 W/kg

SAR(1 g) = 0.594 W/kg; SAR(10 g) = 0.326 W/kg

Maximum value of SAR (measured) = 0.725 W/kg

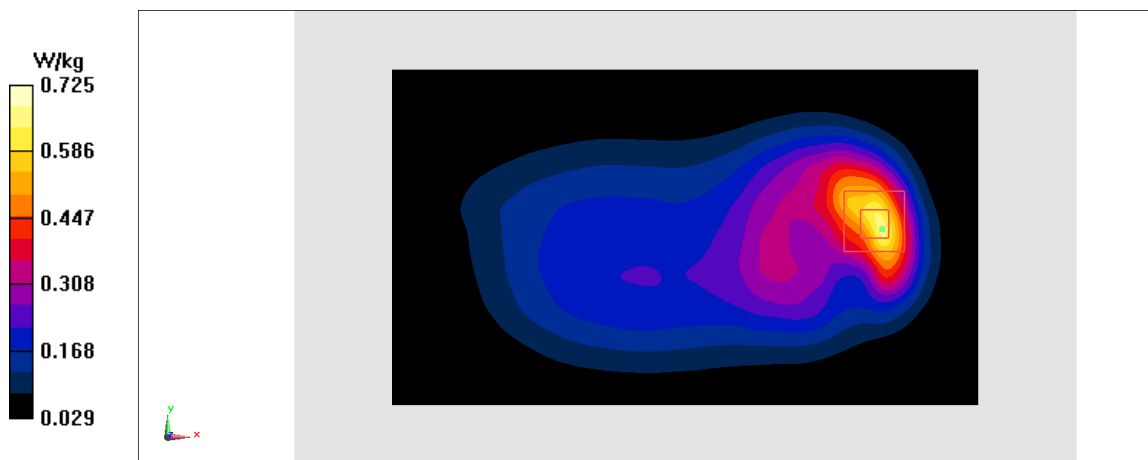
**Fig A.2**

PCS1900_CH512 Left Cheek

Date: 11/4/2019

Electronics: DAE4 Sn771

Medium: head 1900 MHz

Medium parameters used: $f = 1850.2$; $\sigma = 1.342$ mho/m; $\epsilon_r = 39.61$; $\rho = 1000$ kg/m³

Ambient Temperature: 22.5°C, Liquid Temperature: 22.3°C

Communication System: PCS1900 1850.2 Duty Cycle:1:8.3

Probe: EX3DV4 – SN3617 ConvF(8.14,8.14,8.14)

Area Scan (71x121x1): Interpolated grid: dx=1.000 mm, dy=1.000 mm

Maximum value of SAR (interpolated) = 0.135 W/kg

Zoom Scan (7x7x7)/Cube 0: Measurement grid: dx=5mm, dy=5mm, dz=5mm

Reference Value = 3.403 V/m; Power Drift = 0.15 dB

Peak SAR (extrapolated) = 0.163 W/kg

SAR(1 g) = 0.105 W/kg; SAR(10 g) = 0.064 W/kg

Maximum value of SAR (measured) = 0.123 W/kg

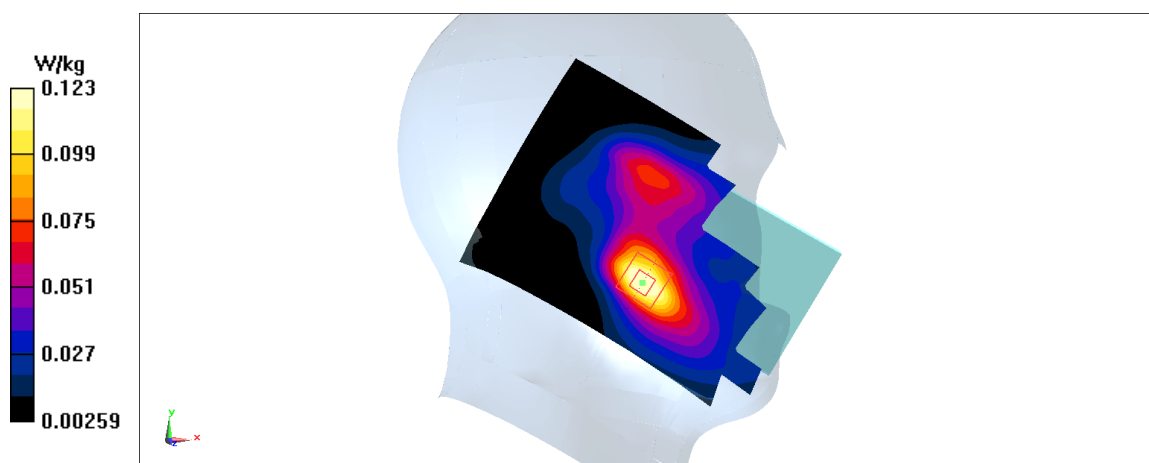
**Fig A.3**

PCS1900_CH661 Bottom

Date: 11/4/2019

Electronics: DAE4 Sn771

Medium: body 1900 MHz

Medium parameters used: $f = 1880$; $\sigma = 1.517$ mho/m; $\epsilon_r = 53.21$; $\rho = 1000$ kg/m³

Ambient Temperature: 22.5°C, Liquid Temperature: 22.3°C

Communication System: PCS1900 1880 Duty Cycle:1:4

Probe: EX3DV4 – SN3617 ConvF(7.78,7.78,7.78)

Area Scan (71x121x1): Interpolated grid: dx=1.000 mm, dy=1.000 mm

Maximum value of SAR (interpolated) = 2.64 W/kg

Zoom Scan (7x7x7)/Cube 0: Measurement grid: dx=5mm, dy=5mm, dz=5mm

Reference Value = 36.17 V/m; Power Drift = -0.03 dB

Peak SAR (extrapolated) = 3.52 W/kg

SAR(1 g) = 1.04 W/kg; SAR(10 g) = 0.468 W/kg

Maximum value of SAR (measured) = 2.54 W/kg

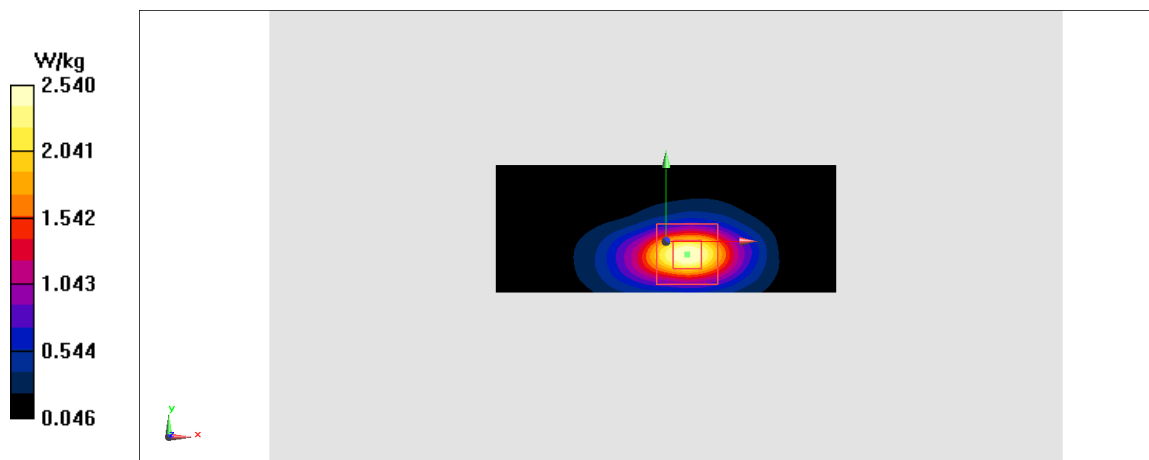
**Fig A.4**

PCS1900_CH512 Rear 15mm

Date: 11/4/2019

Electronics: DAE4 Sn771

Medium: body 1900 MHz

Medium parameters used: $f = 1850.2$; $\sigma = 1.488$ mho/m; $\epsilon_r = 53.25$; $\rho = 1000$ kg/m³

Ambient Temperature: 22.5°C, Liquid Temperature: 22.3°C

Communication System: PCS1900 1850.2 Duty Cycle: 1:4

Probe: EX3DV4 – SN3617 ConvF(7.78,7.78,7.78)

Area Scan (71x121x1): Interpolated grid: dx=1.000 mm, dy=1.000 mm

Maximum value of SAR (interpolated) = 0.490 W/kg

Zoom Scan (7x7x7)/Cube 0: Measurement grid: dx=5mm, dy=5mm, dz=5mm

Reference Value = 4.613 V/m; Power Drift = 0.06 dB

Peak SAR (extrapolated) = 0.617 W/kg

SAR(1 g) = 0.395 W/kg; SAR(10 g) = 0.236 W/kg

Maximum value of SAR (measured) = 0.517 W/kg

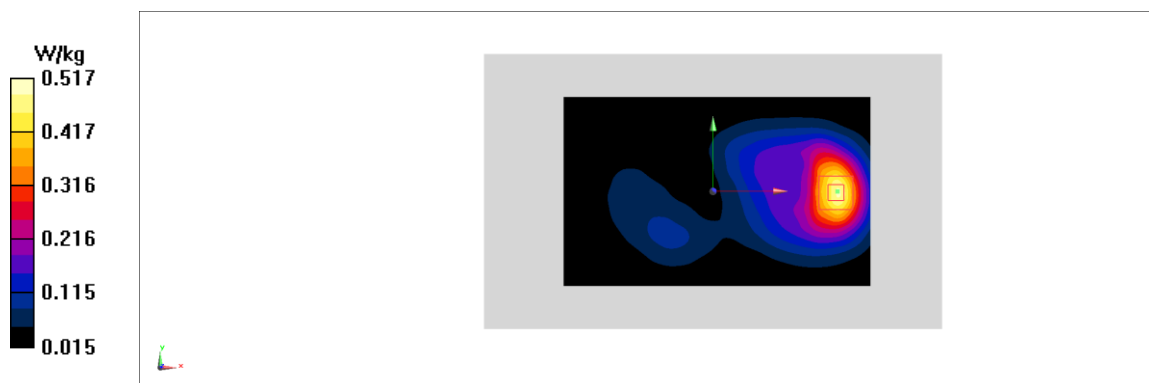
**Fig A.5**

WCDMA1900-BII_CH9400 Left Tilt

Date: 11/4/2019

Electronics: DAE4 Sn771

Medium: head 1900 MHz

Medium parameters used: $f = 1880$; $\sigma = 1.371$ mho/m; $\epsilon_r = 39.57$; $\rho = 1000$ kg/m³

Ambient Temperature: 22.5°C, Liquid Temperature: 22.3°C

Communication System: WCDMA1900-BII 1880 Duty Cycle:1:1

Probe: EX3DV4 – SN3617 ConvF(8.14,8.14,8.14)

Area Scan (71x121x1): Interpolated grid: dx=1.000 mm, dy=1.000 mm

Maximum value of SAR (interpolated) = 0.16 W/kg

Zoom Scan (7x7x7)/Cube 0: Measurement grid: dx=5mm, dy=5mm, dz=5mm

Reference Value = 8.792 V/m; Power Drift = -0.14 dB

Peak SAR (extrapolated) = 0.196 W/kg

SAR(1 g) = 0.123 W/kg; SAR(10 g) = 0.075 W/kg

Maximum value of SAR (measured) = 0.145 W/kg

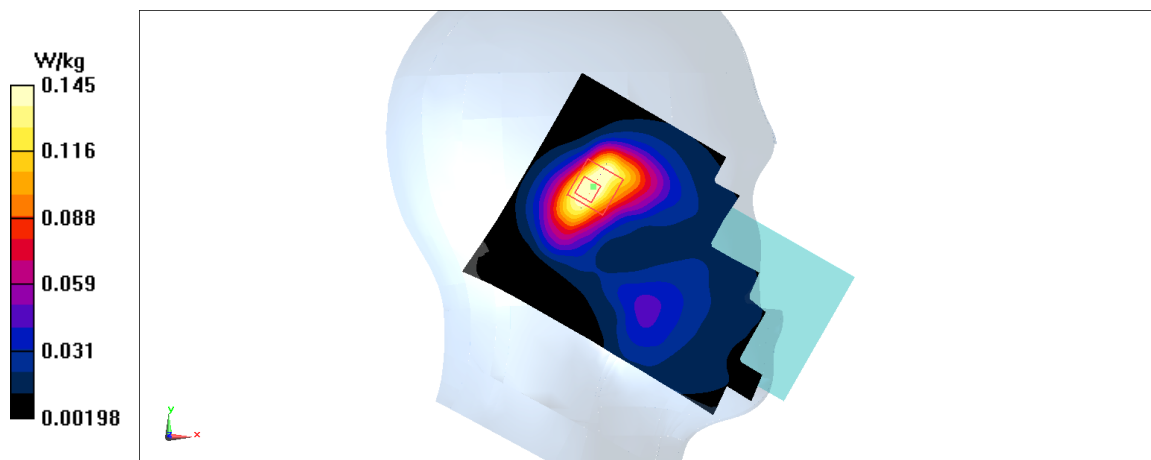

Fig A.6

WCDMA1900-BII_CH9538 Bottom 10mm

Date: 11/4/2019

Electronics: DAE4 Sn771

Medium: body 1900 MHz

Medium parameters used: $f = 1907.6$; $\sigma = 1.544$ mho/m; $\epsilon_r = 53.18$; $\rho = 1000$ kg/m³

Ambient Temperature: 22.5°C, Liquid Temperature: 22.3°C

Communication System: WCDMA1900-BII 1907.6 Duty Cycle:1:1

Probe: EX3DV4 – SN3617 ConvF(7.78,7.78,7.78)

Area Scan (71x121x1): Interpolated grid: dx=1.000 mm, dy=1.000 mm

Maximum value of SAR (interpolated) = 2.4 W/kg

Zoom Scan (7x7x7)/Cube 0: Measurement grid: dx=5mm, dy=5mm, dz=5mm

Reference Value = 33.73 V/m; Power Drift = 0.18 dB

Peak SAR (extrapolated) = 3.17 W/kg

SAR(1 g) = 0.728 W/kg; SAR(10 g) = 0.362 W/kg

Maximum value of SAR (measured) = 2.28 W/kg

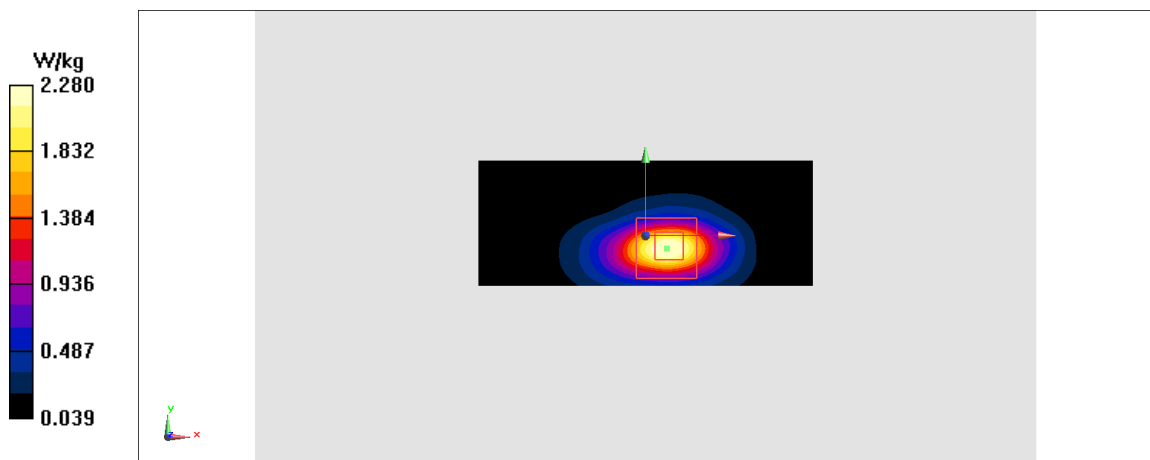

Fig A.7

WCDMA1900-BII_CH9262 Rear 15mm

Date: 11/4/2019

Electronics: DAE4 Sn771

Medium: body 1900 MHz

Medium parameters used: $f = 1852.4$; $\sigma = 1.49$ mho/m; $\epsilon_r = 53.25$; $\rho = 1000$ kg/m³

Ambient Temperature: 22.5°C, Liquid Temperature: 22.3°C

Communication System: WCDMA1900-BII 1852.4 Duty Cycle: 1:1

Probe: EX3DV4 – SN3617 ConvF(7.78,7.78,7.78)

Area Scan (71x121x1): Interpolated grid: dx=1.000 mm, dy=1.000 mm

Maximum value of SAR (interpolated) = 0.723 W/kg

Zoom Scan (7x7x7)/Cube 0: Measurement grid: dx=5mm, dy=5mm, dz=5mm

Reference Value = 9.37 V/m; Power Drift = 0.11 dB

Peak SAR (extrapolated) = 0.941 W/kg

SAR(1 g) = 0.603 W/kg; SAR(10 g) = 0.356 W/kg

Maximum value of SAR (measured) = 0.721 W/kg

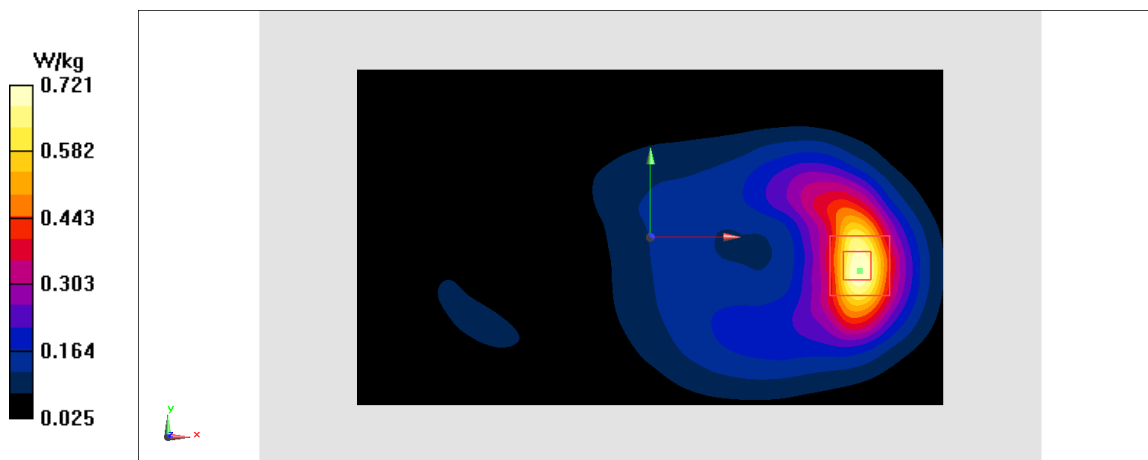

Fig A.8

WCDMA1700-BIV_CH1412 Right Cheek

Date: 11/3/2019

Electronics: DAE4 Sn771

Medium: head 1750 MHz

Medium parameters used: $f = 1732.4$; $\sigma = 1.363$ mho/m; $\epsilon_r = 40.7$; $\rho = 1000$ kg/m³

Ambient Temperature: 22.5°C, Liquid Temperature: 22.3°C

Communication System: WCDMA1700-BIV 1732.4 Duty Cycle:1:1

Probe: EX3DV4 – SN3617 ConvF(8.38,8.38,8.38)

Area Scan (71x121x1): Interpolated grid: dx=1.000 mm, dy=1.000 mm

Maximum value of SAR (interpolated) = 0.342 W/kg

Zoom Scan (7x7x7)/Cube 0: Measurement grid: dx=5mm, dy=5mm, dz=5mm

Reference Value = 7.884 V/m; Power Drift = 0.09 dB

Peak SAR (extrapolated) = 0.409 W/kg

SAR(1 g) = 0.276 W/kg; SAR(10 g) = 0.176 W/kg

Maximum value of SAR (measured) = 0.317 W/kg

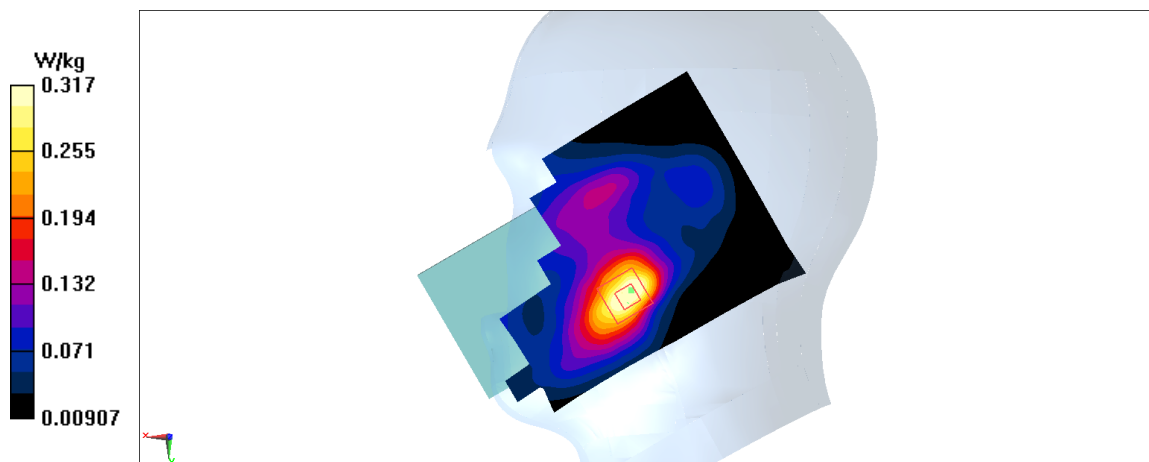

Fig A.9

WCDMA1700-BIV_CH1513 Bottom 10mm

Date: 11/3/2019

Electronics: DAE4 Sn771

Medium: body 1750 MHz

Medium parameters used: $f = 1752.6$; $\sigma = 1.517$ mho/m; $\epsilon_r = 53.22$; $\rho = 1000$ kg/m³

Ambient Temperature: 22.5°C, Liquid Temperature: 22.3°C

Communication System: WCDMA1700-BIV 1752.6 Duty Cycle:1:1

Probe: EX3DV4 – SN3617 ConvF(8.03,8.03,8.03)

Area Scan (71x121x1): Interpolated grid: dx=1.000 mm, dy=1.000 mm

Maximum value of SAR (interpolated) = 1.72 W/kg

Zoom Scan (7x7x7)/Cube 0: Measurement grid: dx=5mm, dy=5mm, dz=5mm

Reference Value = 32.27 V/m; Power Drift = 0.03 dB

Peak SAR (extrapolated) = 2.33 W/kg

SAR(1 g) = 0.785 W/kg; SAR(10 g) = 0.404 W/kg

Maximum value of SAR (measured) = 1.68 W/kg

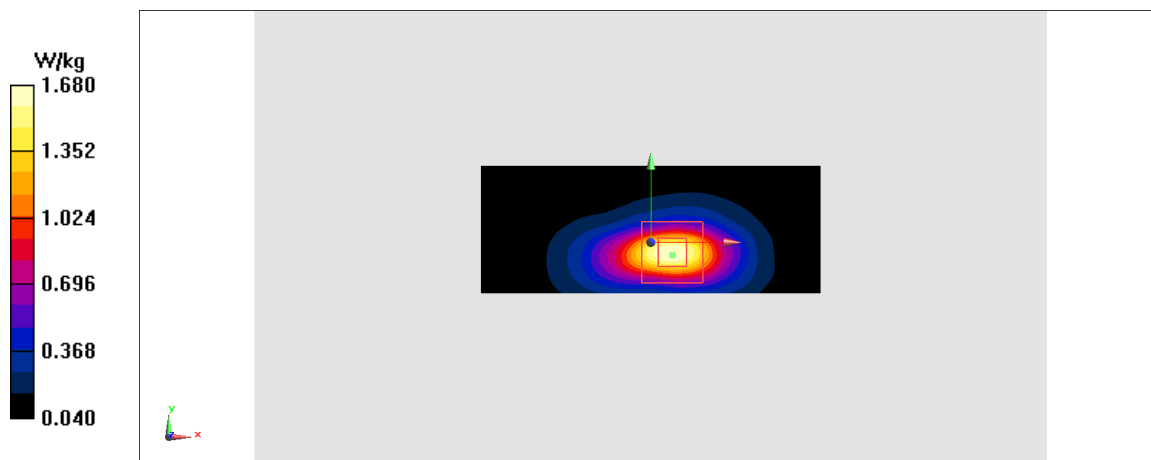

Fig A.10

WCDMA1700-BIV_CH1412 Rear 15mm

Date: 11/3/2019

Electronics: DAE4 Sn771

Medium: body 1750 MHz

Medium parameters used: $f = 1732.5$; $\sigma = 1.497$ mho/m; $\epsilon_r = 53.24$; $\rho = 1000$ kg/m³

Ambient Temperature: 22.5°C, Liquid Temperature: 22.3°C

Communication System: WCDMA1700-BIV 1732.5 Duty Cycle:1:1

Probe: EX3DV4 – SN3617 ConvF(8.03,8.03,8.03)

Area Scan (71x121x1): Interpolated grid: dx=1.000 mm, dy=1.000 mm

Maximum value of SAR (interpolated) = 0.797 W/kg

Zoom Scan (7x7x7)/Cube 0: Measurement grid: dx=5mm, dy=5mm, dz=5mm

Reference Value = 8.19 V/m; Power Drift = 0.13 dB

Peak SAR (extrapolated) = 1.05 W/kg

SAR(1 g) = 0.677 W/kg; SAR(10 g) = 0.404 W/kg

Maximum value of SAR (measured) = 0.8 W/kg

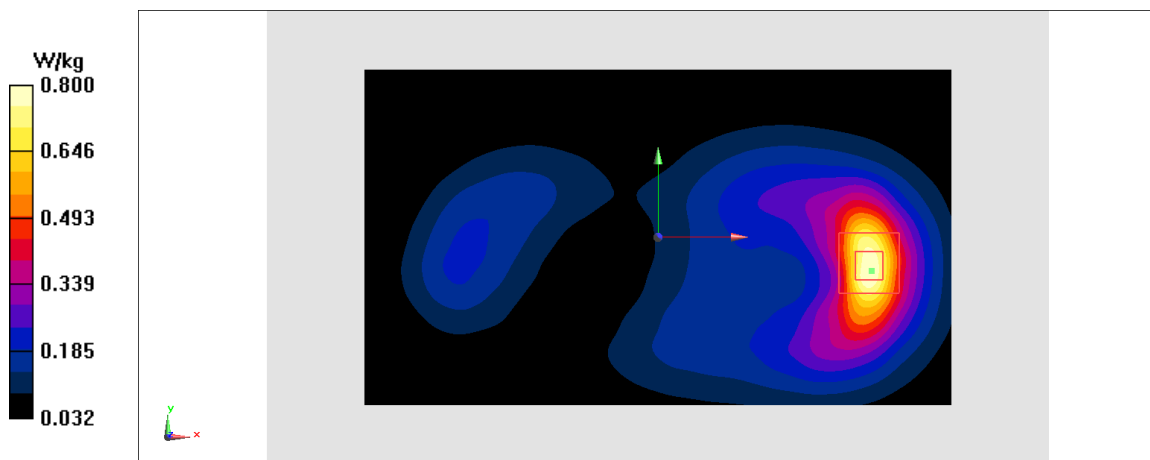

Fig A.11

WCDMA850-BV_CH4132 Left Cheek

Date: 11/2/2019

Electronics: DAE4 Sn771

Medium: head 835 MHz

Medium parameters used: $f = 826.4$; $\sigma = 0.892$ mho/m; $\epsilon_r = 41.61$; $\rho = 1000$ kg/m³

Ambient Temperature: 22.5°C, Liquid Temperature: 22.3°C

Communication System: WCDMA850-BV 826.4 Duty Cycle:1:1

Probe: EX3DV4 – SN3617 ConvF(9.75,9.75,9.75)

Area Scan (71x121x1): Interpolated grid: dx=1.000 mm, dy=1.000 mm

Maximum value of SAR (interpolated) = 0.231 W/kg

Zoom Scan (7x7x7)/Cube 0: Measurement grid: dx=5mm, dy=5mm, dz=5mm

Reference Value = 5.521 V/m; Power Drift = 0.02 dB

Peak SAR (extrapolated) = 0.298 W/kg

SAR(1 g) = 0.602 W/kg; SAR(10 g) = 0.422 W/kg

Maximum value of SAR (measured) = 0.248 W/kg

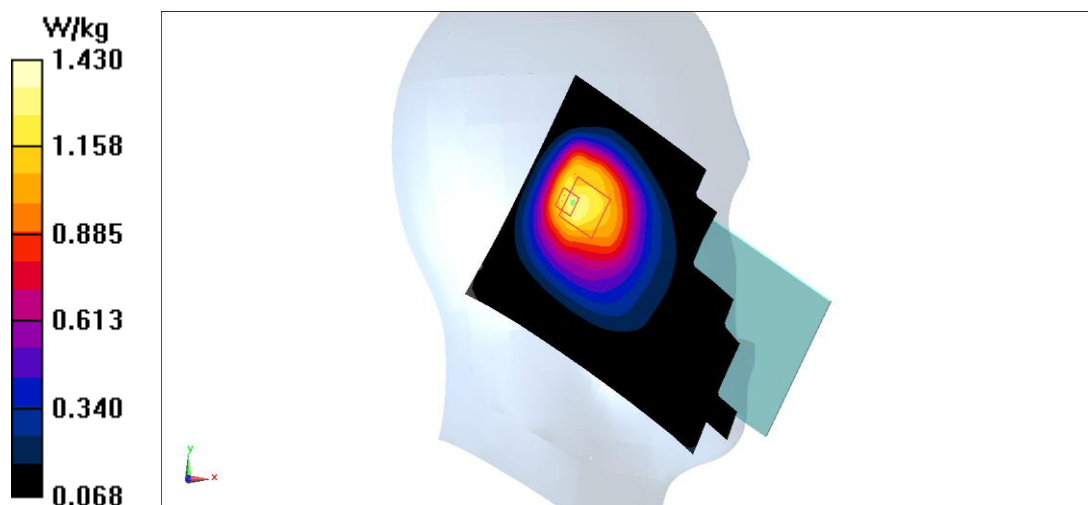

Fig A.12

WCDMA850-BV_CH4233 Rear 10mm

Date: 11/2/2019

Electronics: DAE4 Sn771

Medium: body 835 MHz

Medium parameters used: $f = 846.6$; $\sigma = 0.999$ mho/m; $\epsilon_r = 56.09$; $\rho = 1000$ kg/m³

Ambient Temperature: 22.5°C, Liquid Temperature: 22.3°C

Communication System: WCDMA850-BV 846.6 Duty Cycle: 1:1

Probe: EX3DV4 – SN3617 ConvF(9.61,9.61,9.61)

Area Scan (71x121x1): Interpolated grid: dx=1.000 mm, dy=1.000 mm

Maximum value of SAR (interpolated) = 0.649 W/kg

Zoom Scan (7x7x7)/Cube 0: Measurement grid: dx=5mm, dy=5mm, dz=5mm

Reference Value = 14.34 V/m; Power Drift = 0 dB

Peak SAR (extrapolated) = 1.1 W/kg

SAR(1 g) = 0.386 W/kg; SAR(10 g) = 0.235 W/kg

Maximum value of SAR (measured) = 0.725 W/kg

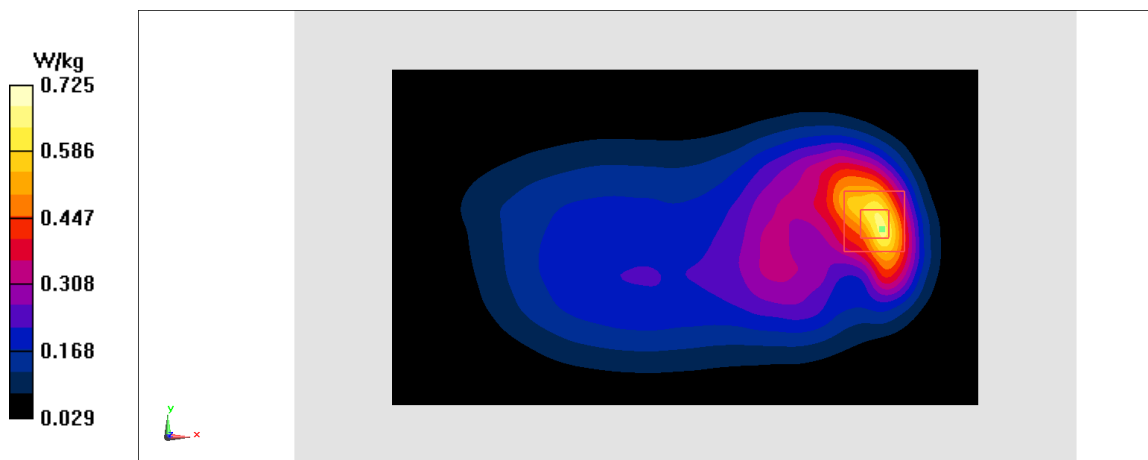
**Fig A.13**

LTE700-FDD12_CH23130 Left Tilt

Date: 11/1/2019

Electronics: DAE4 Sn771

Medium: head 750 MHz

Medium parameters used: $f = 711 \text{ MHz}$; $\sigma = 0.861 \text{ mho/m}$; $\epsilon_r = 41.75$; $\rho = 1000 \text{ kg/m}^3$

Ambient Temperature: 22.5°C , Liquid Temperature: 22.3°C

Communication System: LTE700-FDD12 711 MHz Duty Cycle:1:1

Probe: EX3DV4 – SN3617 ConvF(10.03,10.03,10.03)

Area Scan (71x121x1): Interpolated grid: $dx=1.000 \text{ mm}$, $dy=1.000 \text{ mm}$

Maximum value of SAR (interpolated) = 0.627 W/kg

Zoom Scan (7x7x7)/Cube 0: Measurement grid: $dx=5\text{mm}$, $dy=5\text{mm}$, $dz=5\text{mm}$

Reference Value = 30.23 V/m ; Power Drift = -0.02 dB

Peak SAR (extrapolated) = 1.7 W/kg

SAR(1 g) = 0.582 W/kg ; SAR(10 g) = 0.321 W/kg

Maximum value of SAR (measured) = 0.78 W/kg

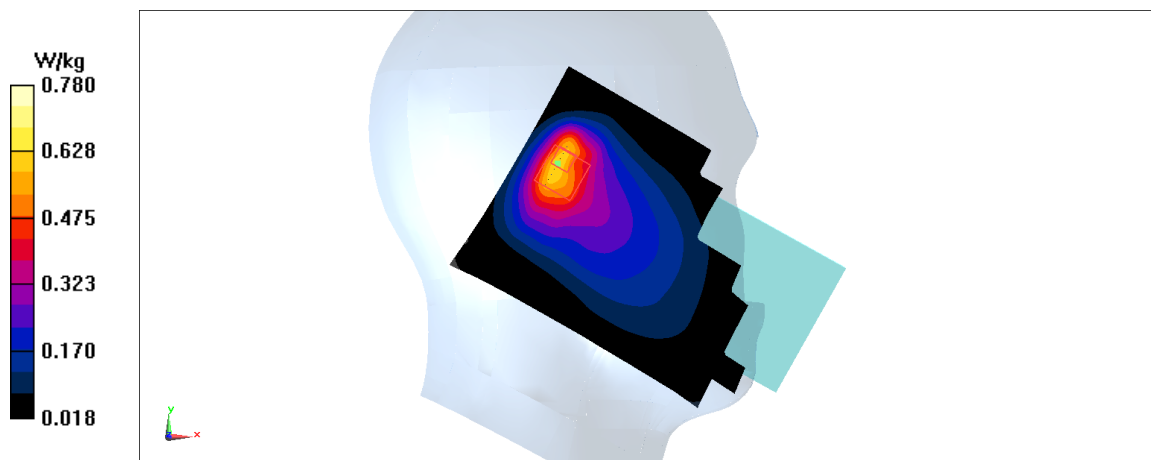

Fig A.14

LTE700-FDD12_CH23130 Right Edge 10mm

Date: 11/1/2019

Electronics: DAE4 Sn771

Medium: body 750 MHz

Medium parameters used: $f = 711 \text{ MHz}$; $\sigma = 0.914 \text{ mho/m}$; $\epsilon_r = 55.4$; $\rho = 1000 \text{ kg/m}^3$

Ambient Temperature: 22.5°C , Liquid Temperature: 22.3°C

Communication System: LTE700-FDD12 711 MHz Duty Cycle1:1:

Probe: EX3DV4 – SN3617 ConvF(9.85,9.85,9.85)

Area Scan (71x121x1): Interpolated grid: $dx=1.000 \text{ mm}$, $dy=1.000 \text{ mm}$

Maximum value of SAR (interpolated) = 0.479 W/kg

Zoom Scan (7x7x7)/Cube 0: Measurement grid: $dx=5\text{mm}$, $dy=5\text{mm}$, $dz=5\text{mm}$

Reference Value = 22.6 V/m ; Power Drift = 0.01 dB

Peak SAR (extrapolated) = 0.597 W/kg

SAR(1 g) = 0.422 W/kg ; SAR(10 g) = 0.298 W/kg

Maximum value of SAR (measured) = 0.481 W/kg

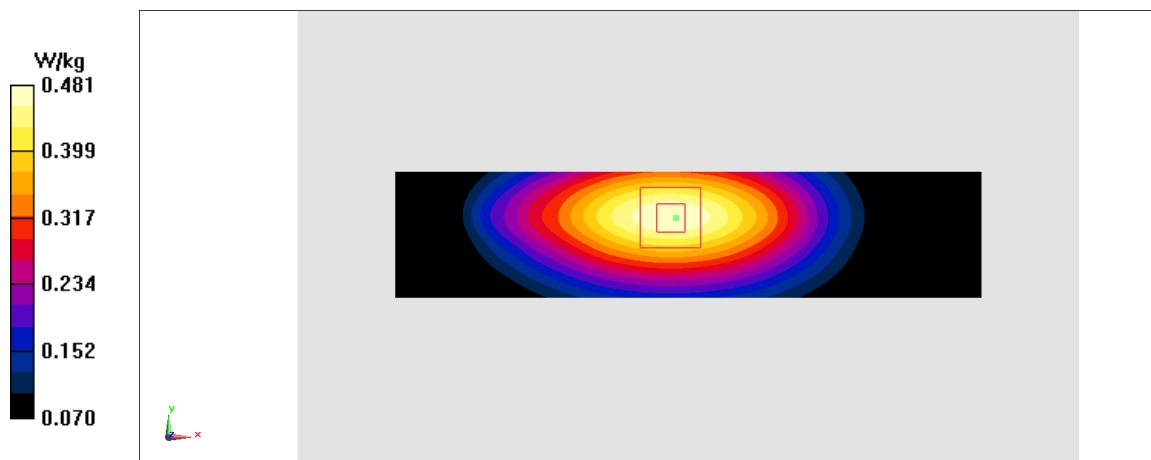

Fig A.15

LTE750-FDD13_CH23230 Right Cheek

Date: 11/1/2019

Electronics: DAE4 Sn771

Medium: head 750 MHz

Medium parameters used: $f = 782 \text{ MHz}$; $\sigma = 0.928 \text{ mho/m}$; $\epsilon_r = 41.66$; $\rho = 1000 \text{ kg/m}^3$

Ambient Temperature: 22.5°C , Liquid Temperature: 22.3°C

Communication System: LTE750-FDD13 782 MHz Duty Cycle:1:1

Probe: EX3DV4 – SN3617 ConvF(10.03,10.03,10.03)

Area Scan (71x121x1): Interpolated grid: $dx=1.000 \text{ mm}$, $dy=1.000 \text{ mm}$

Maximum value of SAR (interpolated) = 0.331 W/kg

Zoom Scan (7x7x7)/Cube 0: Measurement grid: $dx=5\text{mm}$, $dy=5\text{mm}$, $dz=5\text{mm}$

Reference Value = 6.879 V/m ; Power Drift = 0.1 dB

Peak SAR (extrapolated) = 0.405 W/kg

SAR(1 g) = 0.299 W/kg ; SAR(10 g) = 0.226 W/kg

Maximum value of SAR (measured) = 0.34 W/kg

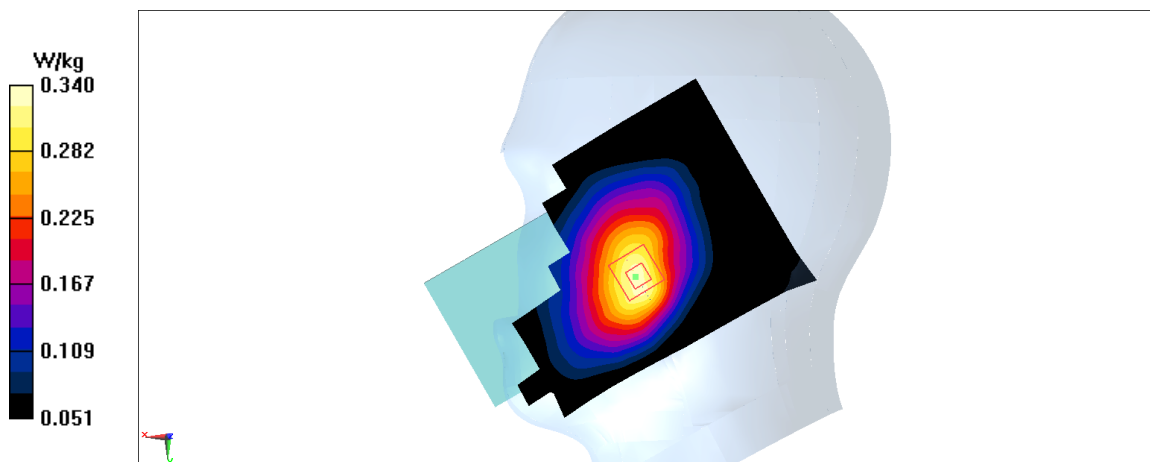

Fig A.16

LTE750-FDD13_CH23230 Rear 10mm

Date: 11/1/2019

Electronics: DAE4 Sn771

Medium: body 750 MHz

Medium parameters used: $f = 782 \text{ MHz}$; $\sigma = 0.981 \text{ mho/m}$; $\epsilon_r = 55.31$; $\rho = 1000 \text{ kg/m}^3$

Ambient Temperature: 22.5°C, Liquid Temperature: 22.3°C

Communication System: LTE750-FDD13 782 MHz Duty Cycle: 1:1

Probe: EX3DV4 – SN3617 ConvF(9.85,9.85,9.85)

Area Scan (71x121x1): Interpolated grid: $dx=1.000 \text{ mm}$, $dy=1.000 \text{ mm}$

Maximum value of SAR (interpolated) = 0.424 W/kg

Zoom Scan (7x7x7)/Cube 0: Measurement grid: $dx=5\text{mm}$, $dy=5\text{mm}$, $dz=5\text{mm}$

Reference Value = 20.03 V/m; Power Drift = -0.09 dB

Peak SAR (extrapolated) = 0.701 W/kg

SAR(1 g) = 0.374 W/kg; SAR(10 g) = 0.207 W/kg

Maximum value of SAR (measured) = 0.458 W/kg

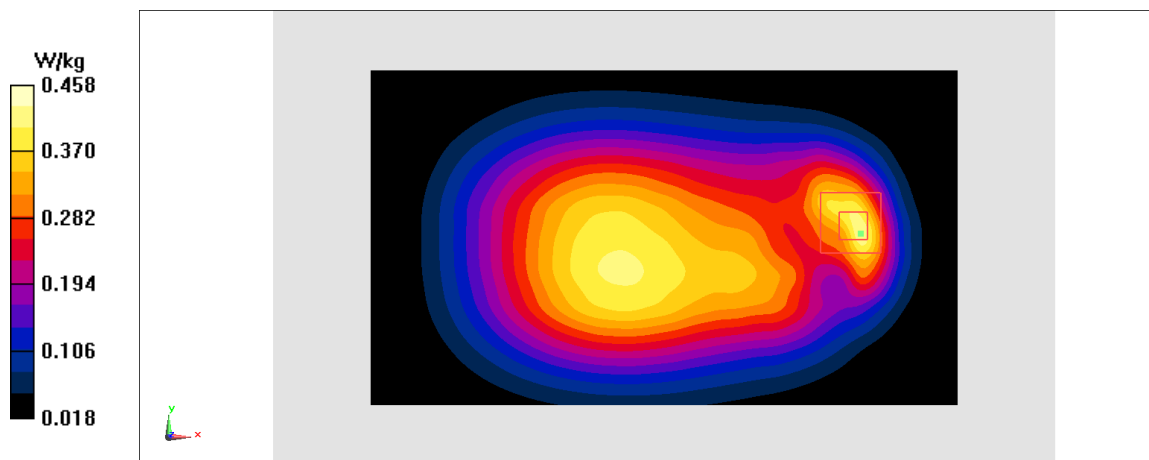
**Fig A.17**

LTE1900-FDD25_CH26140 Left Cheek

Date: 11/4/2019

Electronics: DAE4 Sn771

Medium: head 1900 MHz

Medium parameters used: $f = 1860$ MHz; $\sigma = 1.415$ mho/m; $\epsilon_r =$; $\rho = 1000$ kg/m³

Ambient Temperature: 22.5°C, Liquid Temperature: 22.3°C

Communication System: LTE1900-FDD25 1860 MHz Duty Cycle: 1:1

Probe: EX3DV4 – SN3617 ConvF(8.14,8.14,8.14)

Area Scan (71x121x1): Interpolated grid: dx=1.000 mm, dy=1.000 mm

Maximum value of SAR (interpolated) = 0.201 W/kg

Zoom Scan (7x7x7)/Cube 0: Measurement grid: dx=5mm, dy=5mm, dz=5mm

Reference Value = 4.117 V/m; Power Drift = 0.09 dB

Peak SAR (extrapolated) = 0.239 W/kg

SAR(1 g) = 0.153 W/kg; SAR(10 g) = 0.093 W/kg

Maximum value of SAR (measured) = 0.179 W/kg

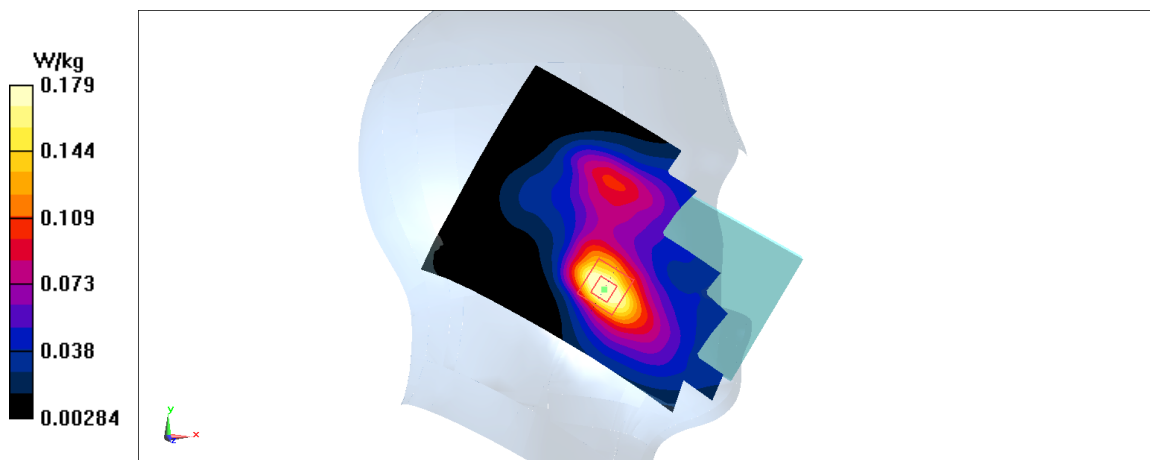

Fig A.18

LTE1900-FDD25_CH26590 Bottom Edge 10mm

Date: 11/4/2019

Electronics: DAE4 Sn771

Medium: body 1900 MHz

Medium parameters used: $f = 1905$ MHz; $\sigma = 1.57$ mho/m; $\epsilon_r = 53.312$; $\rho = 1000$ kg/m³

Ambient Temperature: 22.5°C, Liquid Temperature: 22.3°C

Communication System: LTE1900-FDD25 1905 MHz Duty Cycle: 1:1

Probe: EX3DV4 – SN3617 ConvF(7.78,7.78,7.78)

Area Scan (71x121x1): Interpolated grid: dx=1.000 mm, dy=1.000 mm

Maximum value of SAR (interpolated) = 3.22 W/kg

Zoom Scan (7x7x7)/Cube 0: Measurement grid: dx=5mm, dy=5mm, dz=5mm

Reference Value = 27.66 V/m; Power Drift = 0.01 dB

Peak SAR (extrapolated) = 4.16 W/kg

SAR(1 g) = 1.25 W/kg; SAR(10 g) = 0.619 W/kg

Maximum value of SAR (measured) = 3.39 W/kg

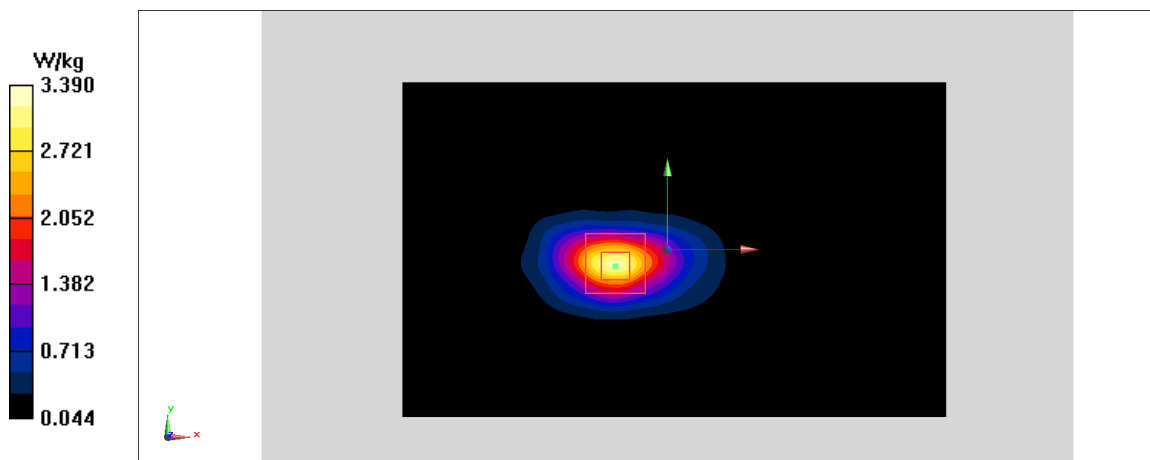

Fig A.19

LTE1900-FDD25_CH26140 Rear 15mm

Date: 11/4/2019

Electronics: DAE4 Sn771

Medium: body 1900 MHz

Medium parameters used: $f = 1860$ MHz; $\sigma = 1.543$ mho/m; $\epsilon_r = 53.369$; $\rho = 1000$ kg/m³

Ambient Temperature: 22.5°C, Liquid Temperature: 22.3°C

Communication System: LTE1900-FDD25 1860 MHz Duty Cycle: 1:1

Probe: EX3DV4 – SN3617 ConvF(7.78,7.78,7.78)

Area Scan (71x121x1): Interpolated grid: dx=1.000 mm, dy=1.000 mm

Maximum value of SAR (interpolated) = 0.912 W/kg

Zoom Scan (7x7x7)/Cube 0: Measurement grid: dx=5mm, dy=5mm, dz=5mm

Reference Value = 8.659 V/m; Power Drift = 0.02 dB

Peak SAR (extrapolated) = 1.13 W/kg

SAR(1 g) = 0.719 W/kg; SAR(10 g) = 0.424 W/kg

Maximum value of SAR (measured) = 0.942 W/kg

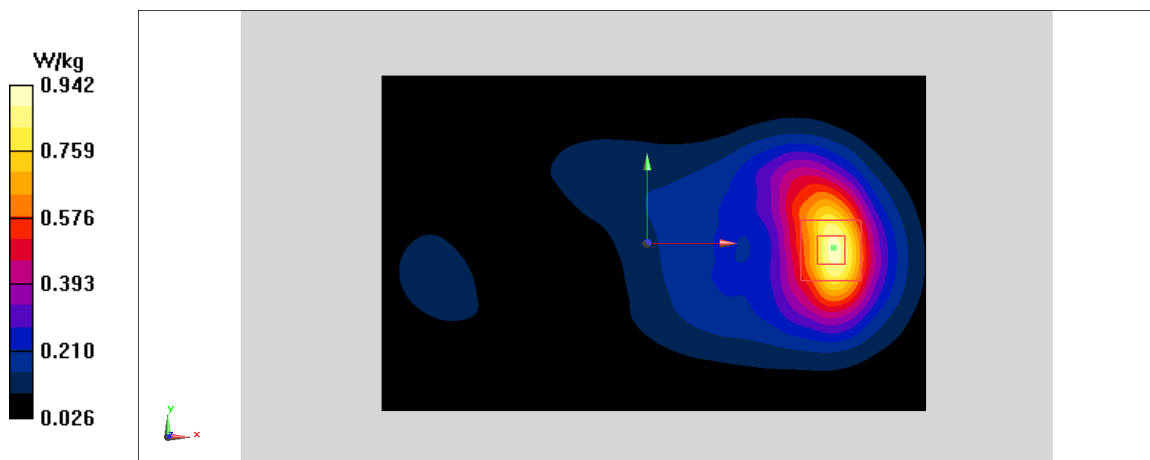

Fig A.20

LTE850-FDD26_CH26965 Right Tilt

Date: 11/2/2019

Electronics: DAE4 Sn771

Medium: head 750 MHz

Medium parameters used: $f = 841.5$ MHz; $\sigma = 0.904$ mho/m; $\epsilon_r = 40.75$; $\rho = 1000$ kg/m³

Ambient Temperature: 22.5°C, Liquid Temperature: 22.3°C

Communication System: LTE850-FDD26 841.5 MHz Duty Cycle:

Probe: EX3DV4 – SN3617 ConvF(9.75,9.75,9.75)

Area Scan (71x121x1): Interpolated grid: dx=1.000 mm, dy=1.000 mm

Maximum value of SAR (interpolated) = 1.45 W/kg

Zoom Scan (7x7x7)/Cube 0: Measurement grid: dx=5mm, dy=5mm, dz=5mm

Reference Value = 37.68 V/m; Power Drift = -0.01 dB

Peak SAR (extrapolated) = 2.04 W/kg

SAR(1 g) = 0.711 W/kg; SAR(10 g) = 0.397 W/kg

Maximum value of SAR (measured) = 1.33 W/kg

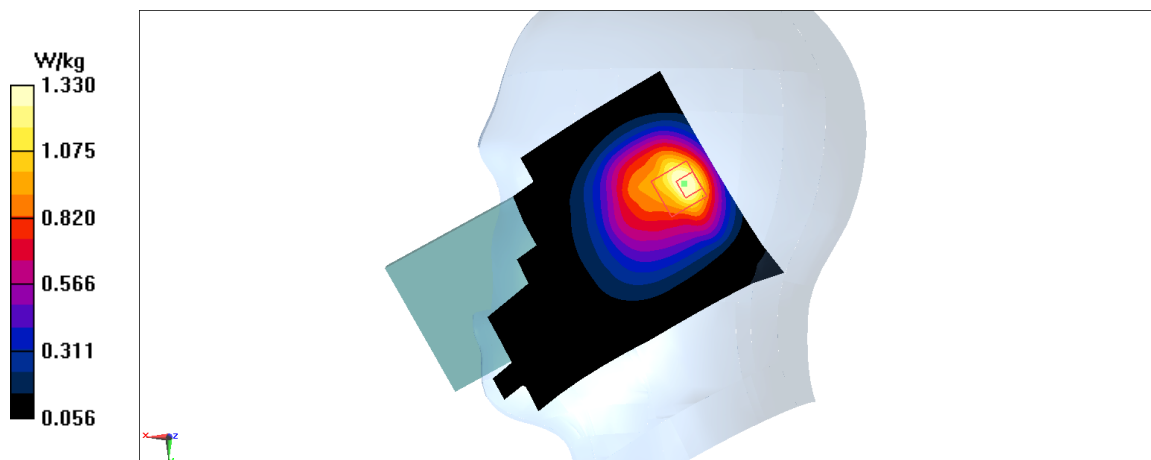

Fig A.21

LTE850-FDD26_CH26965 Rear 10mm

Date: 11/2/2019

Electronics: DAE4 Sn771

Medium: body 750 MHz

Medium parameters used: $f = 841.5$ MHz; $\sigma = 1.003$ mho/m; $\epsilon_r = 53.592$; $\rho = 1000$ kg/m³

Ambient Temperature: 22.5°C, Liquid Temperature: 22.3°C

Communication System: LTE850-FDD26 841.5 MHz Duty Cycle: 1:1

Probe: EX3DV4 – SN3617 ConvF(9.61,9.61,9.61)

Area Scan (71x121x1): Interpolated grid: dx=1.000 mm, dy=1.000 mm

Maximum value of SAR (interpolated) = 0.418 W/kg

Zoom Scan (7x7x7)/Cube 0: Measurement grid: dx=5mm, dy=5mm, dz=5mm

Reference Value = 19.57 V/m; Power Drift = 0.01 dB

Peak SAR (extrapolated) = 0.617 W/kg

SAR(1 g) = 0.382 W/kg; SAR(10 g) = 0.234 W/kg

Maximum value of SAR (measured) = 0.461 W/kg

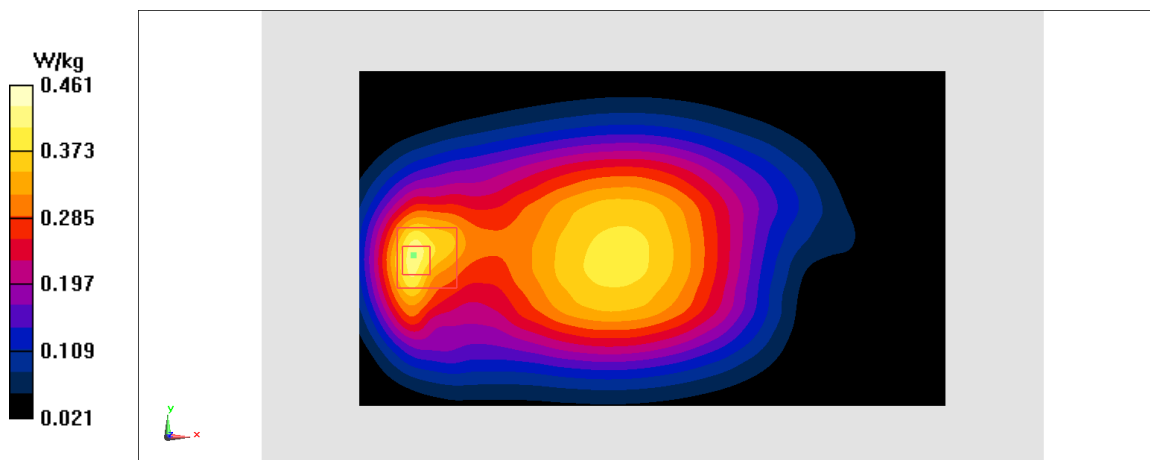

Fig A.22

LTE2500-TDD41_CH40620 Right Cheek

Date: 11/6/2019

Electronics: DAE4 Sn771

Medium: head 2600 MHz

Medium parameters used: $f = 2593$ MHz; $\sigma = 1.959$ mho/m; $\epsilon_r = 39.58$; $\rho = 1000$ kg/m³

Ambient Temperature: 22.5°C, Liquid Temperature: 22.3°C

Communication System: LTE2500-TDD41 2593 MHz Duty Cycle:1:1.58

Probe: EX3DV4 – SN3617 ConvF(7.19,7.19,7.19)

Area Scan (71x121x1): Interpolated grid: dx=1.000 mm, dy=1.000 mm

Maximum value of SAR (interpolated) = 0.297 W/kg

Zoom Scan (7x7x7)/Cube 0: Measurement grid: dx=5mm, dy=5mm, dz=5mm

Reference Value = 2.955 V/m; Power Drift = 0.13 dB

Peak SAR (extrapolated) = 0.473 W/kg

SAR(1 g) = 0.234 W/kg; SAR(10 g) = 0.111 W/kg

Maximum value of SAR (measured) = 0.294 W/kg

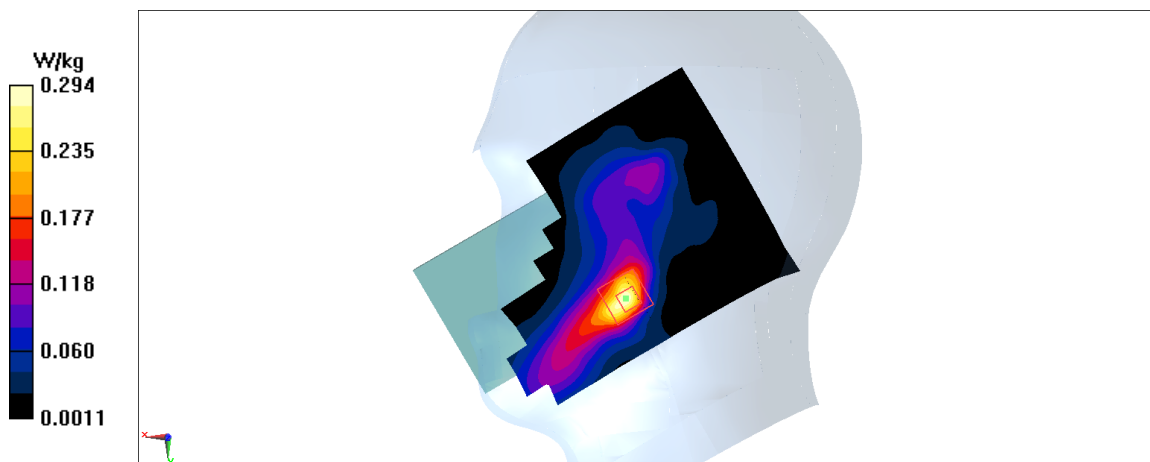

Fig A.23

LTE2500-TDD41_CH40620 Rear 10mm

Date: 11/6/2019

Electronics: DAE4 Sn771

Medium: body 2600 MHz

Medium parameters used: $f = 2593$ MHz; $\sigma = 2.131$ mho/m; $\epsilon_r = 51.62$; $\rho = 1000$ kg/m³

Ambient Temperature: 22.5°C, Liquid Temperature: 22.3°C

Communication System: LTE2500-TDD41 2593 MHz Duty Cycle:1:1.58

Probe: EX3DV4 – SN3617 ConvF(7.49,7.49,7.49)

Area Scan (71x121x1): Interpolated grid: dx=1.000 mm, dy=1.000 mm

Maximum value of SAR (interpolated) = 1.22 W/kg

Zoom Scan (7x7x7)/Cube 0: Measurement grid: dx=5mm, dy=5mm, dz=5mm

Reference Value = 5.509 V/m; Power Drift = 0.07 dB

Peak SAR (extrapolated) = 1.9 W/kg

SAR(1 g) = 0.965 W/kg; SAR(10 g) = 0.508 W/kg

Maximum value of SAR (measured) = 1.21 W/kg

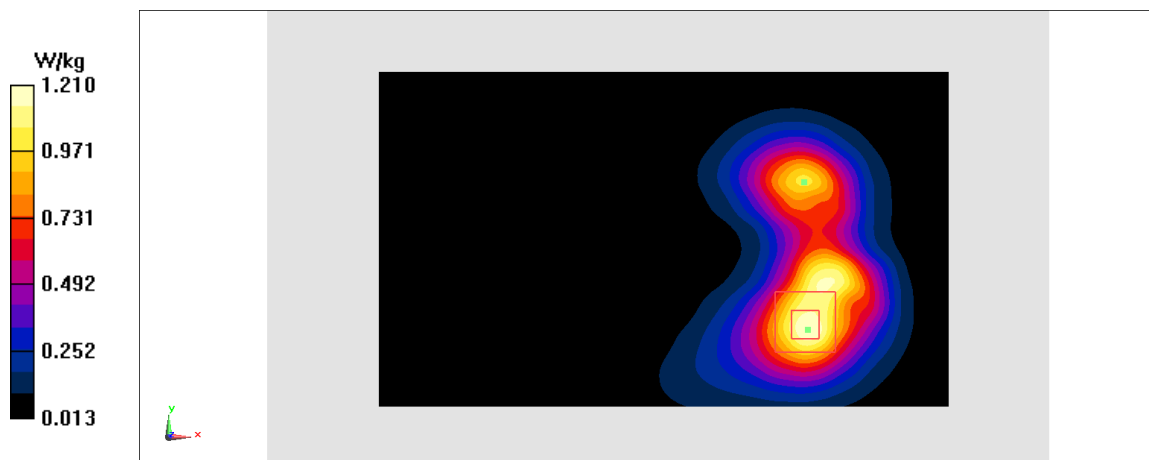

Fig A.24

LTE2500-TDD41_CH41055 Right Tilt

Date: 11/6/2019

Electronics: DAE4 Sn771

Medium: head 2600 MHz

Medium parameters used: $f = 2636.5$ MHz; $\sigma = 2$ mho/m; $\epsilon_r = 39.53$; $\rho = 1000$ kg/m³

Ambient Temperature: 22.5°C, Liquid Temperature: 22.3°C

Communication System: LTE2500-TDD41 2636.5 MHz Duty Cycle: 1:1.58

Probe: EX3DV4 – SN3617 ConvF(7.19,7.19,7.19)

Area Scan (71x121x1): Interpolated grid: dx=1.000 mm, dy=1.000 mm

Maximum value of SAR (interpolated) = 0.207 W/kg

Zoom Scan (7x7x7)/Cube 0: Measurement grid: dx=5mm, dy=5mm, dz=5mm

Reference Value = 5.199 V/m; Power Drift = 0.19 dB

Peak SAR (extrapolated) = 0.293 W/kg

SAR(1 g) = 0.15 W/kg; SAR(10 g) = 0.073 W/kg

Maximum value of SAR (measured) = 0.193 W/kg

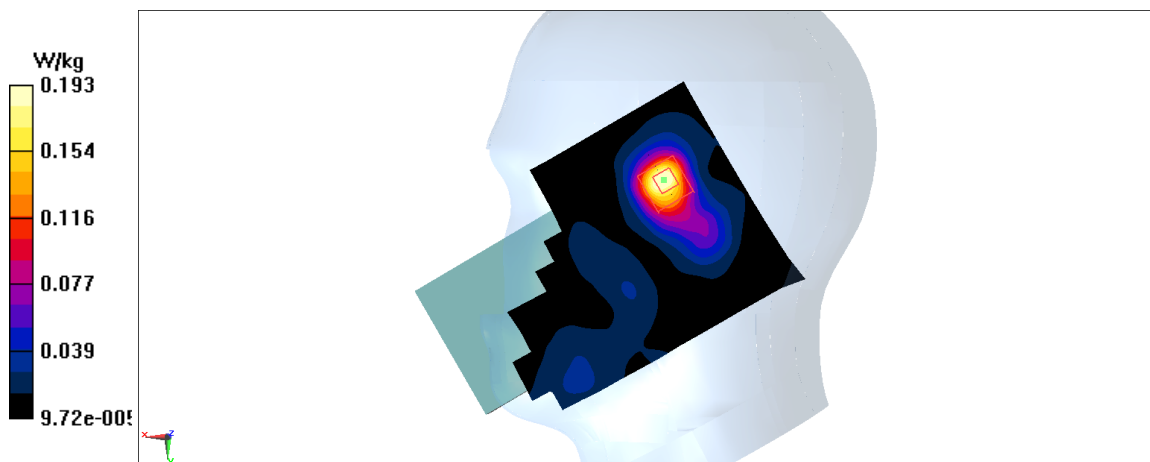

Fig A.25

LTE2500-TDD41_CH41055 Front 10mm

Date: 11/6/2019

Electronics: DAE4 Sn771

Medium: body 2600 MHz

Medium parameters used: $f = 2636.5$ MHz; $\sigma = 2.172$ mho/m; $\epsilon_r = 51.57$; $\rho = 1000$ kg/m³

Ambient Temperature: 22.5°C, Liquid Temperature: 22.3°C

Communication System: LTE2500-TDD41 2636.5 MHz Duty Cycle: 1:1.58

Probe: EX3DV4 – SN3617 ConvF(7.49,7.49,7.49)

Area Scan (71x121x1): Interpolated grid: dx=1.000 mm, dy=1.000 mm

Maximum value of SAR (interpolated) = 0.765 W/kg

Zoom Scan (7x7x7)/Cube 0: Measurement grid: dx=5mm, dy=5mm, dz=5mm

Reference Value = 2.222 V/m; Power Drift = 0.02 dB

Peak SAR (extrapolated) = 1.21 W/kg

SAR(1 g) = 0.609 W/kg; SAR(10 g) = 0.321 W/kg

Maximum value of SAR (measured) = 0.769 W/kg

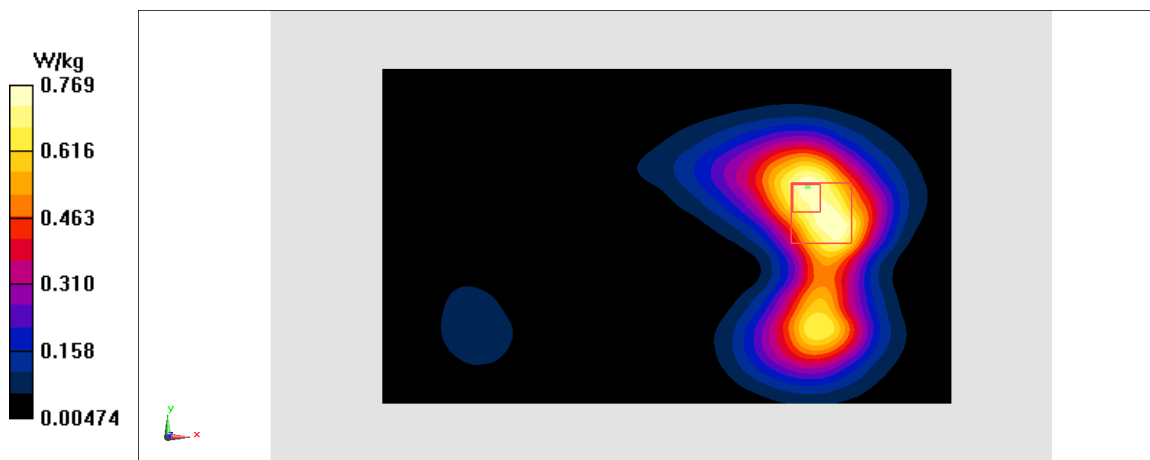

Fig A.26

LTE1700-FDD66_CH132572 Right Cheek

Date: 11/3/2019

Electronics: DAE4 Sn771

Medium: head 1750 MHz

Medium parameters used: $f = 2636.5$ MHz; $\sigma = 2.222$ mho/m; $\epsilon_r = 39.62$; $\rho = 1000$ kg/m³

Ambient Temperature: 22.5°C, Liquid Temperature: 22.3°C

Communication System: LTE1700-FDD66 2636.5 MHz Duty Cycle: 1:1

Probe: EX3DV4 – SN3617 ConvF(8.38,8.38,8.38)

Area Scan (71x121x1): Interpolated grid: dx=1.000 mm, dy=1.000 mm

Maximum value of SAR (interpolated) = 0.263 W/kg

Zoom Scan (7x7x7)/Cube 0: Measurement grid: dx=5mm, dy=5mm, dz=5mm

Reference Value = 6.969 V/m; Power Drift = 0.02 dB

Peak SAR (extrapolated) = 0.333 W/kg

SAR(1 g) = 0.219 W/kg; SAR(10 g) = 0.139 W/kg

Maximum value of SAR (measured) = 0.255 W/kg

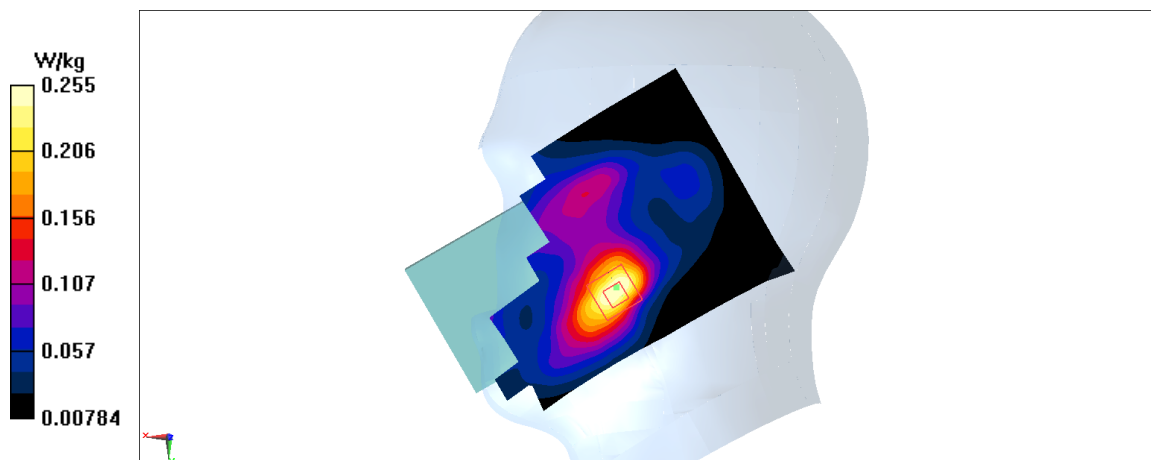

Fig A.27

LTE1700-FDD66_CH132572 Bottom Edge 10mm

Date: 11/3/2019

Electronics: DAE4 Sn771

Medium: body 1750 MHz

Medium parameters used: $f = 2636.5$ MHz; $\sigma = 2.356$ mho/m; $\epsilon_r = 52.16$; $\rho = 1000$ kg/m³

Ambient Temperature: 22.5°C, Liquid Temperature: 22.3°C

Communication System: LTE1700-FDD66 2636.5 MHz Duty Cycle: 1:1

Probe: EX3DV4 – SN3617 ConvF(8.03,8.03,8.03)

Area Scan (71x121x1): Interpolated grid: dx=1.000 mm, dy=1.000 mm

Maximum value of SAR (interpolated) = 1.46 W/kg

Zoom Scan (7x7x7)/Cube 0: Measurement grid: dx=5mm, dy=5mm, dz=5mm

Reference Value = 29.23 V/m; Power Drift = -0.09 dB

Peak SAR (extrapolated) = 1.99 W/kg

SAR(1 g) = 1.08 W/kg; SAR(10 g) = 0.564 W/kg

Maximum value of SAR (measured) = 1.43 W/kg

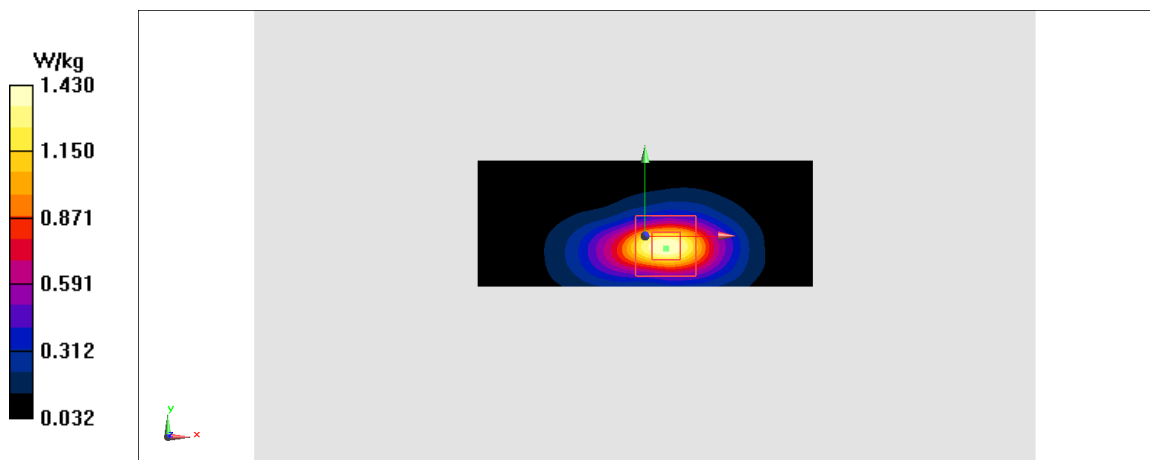

Fig A.28

LTE1700-FDD66_CH132572 Rear 15mm

Date: 11/3/2019

Electronics: DAE4 Sn771

Medium: body 1750 MHz

Medium parameters used: $f = 2636.5$ MHz; $\sigma = 2.356$ mho/m; $\epsilon_r = 52.16$; $\rho = 1000$ kg/m³

Ambient Temperature: 22.5°C, Liquid Temperature: 22.3°C

Communication System: LTE1700-FDD66 2636.5 MHz Duty Cycle: 1:1

Probe: EX3DV4 – SN3617 ConvF(8.03,8.03,8.03)

Area Scan (71x121x1): Interpolated grid: dx=1.000 mm, dy=1.000 mm

Maximum value of SAR (interpolated) = 0.72 W/kg

Zoom Scan (7x7x7)/Cube 0: Measurement grid: dx=5mm, dy=5mm, dz=5mm

Reference Value = 9.697 V/m; Power Drift = 0.06 dB

Peak SAR (extrapolated) = 0.932 W/kg

SAR(1 g) = 0.608 W/kg; SAR(10 g) = 0.368 W/kg

Maximum value of SAR (measured) = 0.724 W/kg

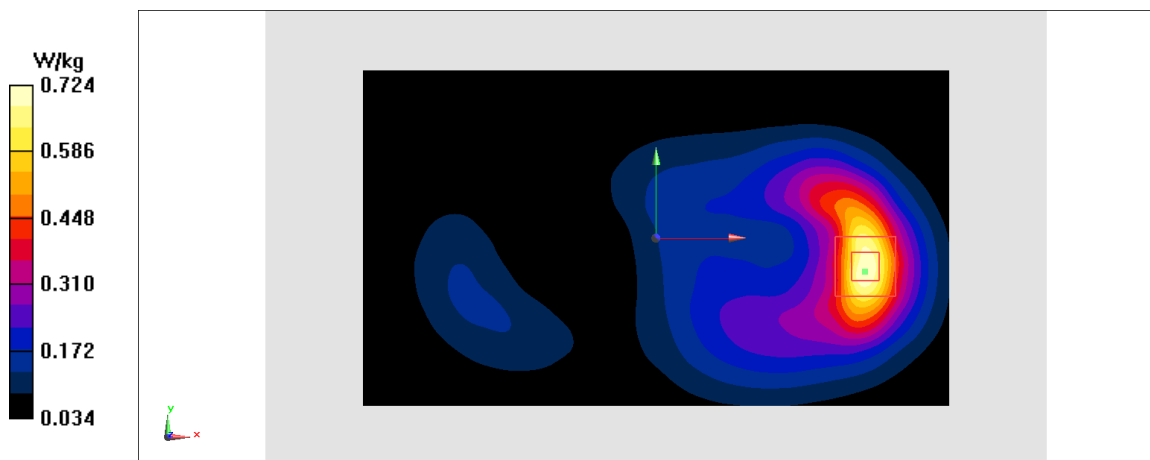

Fig A.29

LTE700-FDD71_CH133222 Left Cheek

Date: 11/1/2019

Electronics: DAE4 Sn771

Medium: head 750 MHz

Medium parameters used: $f = 2636.5$ MHz; $\sigma = 2.69$ mho/m; $\epsilon_r = 39.44$; $\rho = 1000$ kg/m³

Ambient Temperature: 22.5°C, Liquid Temperature: 22.3°C

Communication System: LTE700-FDD71 2636.5 MHz Duty Cycle:1:1

Probe: EX3DV4 – SN3617 ConvF(10.03,10.03,10.03)

Area Scan (71x121x1): Interpolated grid: dx=1.000 mm, dy=1.000 mm

Maximum value of SAR (interpolated) = 0.921 W/kg

Zoom Scan (7x7x7)/Cube 0: Measurement grid: dx=5mm, dy=5mm, dz=5mm

Reference Value = 32.73 V/m; Power Drift = 0.12 dB

Peak SAR (extrapolated) = 1.22 W/kg

SAR(1 g) = 0.61 W/kg; SAR(10 g) = 0.457 W/kg

Maximum value of SAR (measured) = 0.797 W/kg

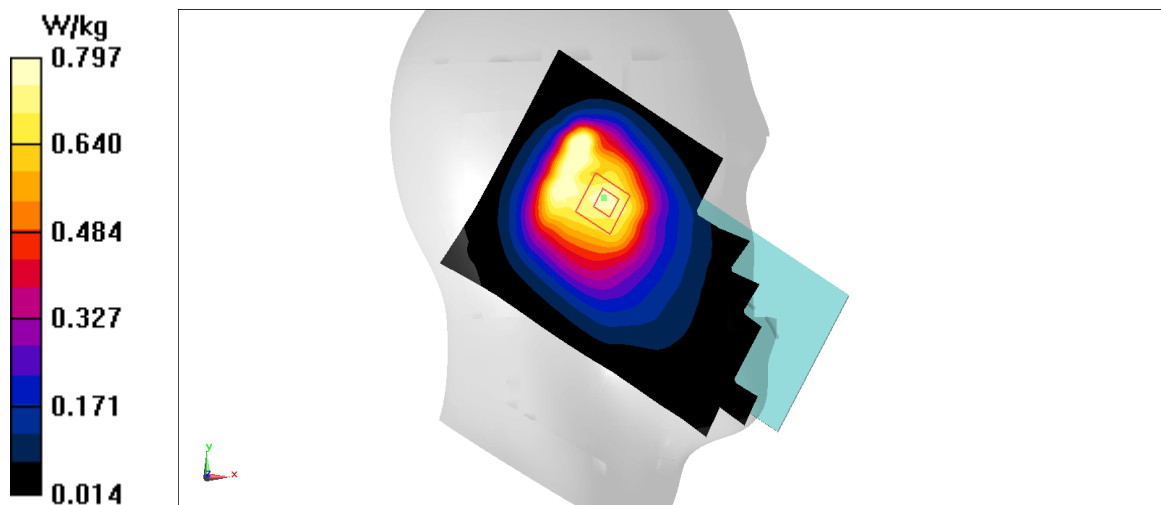

Fig A.30

LTE700-FDD71_CH133222 Rear 10mm

Date: 11/1/2019

Electronics: DAE4 Sn771

Medium: body 750 MHz

Medium parameters used: $f = 2636.5$ MHz; $\sigma = 2.743$ mho/m; $\epsilon_r = 53.09$; $\rho = 1000$ kg/m³

Ambient Temperature: 22.5°C, Liquid Temperature: 22.3°C

Communication System: LTE700-FDD71 2636.5 MHz Duty Cycle:1:1

Probe: EX3DV4 – SN3617 ConvF(9.85,9.85,9.85)

Area Scan (71x121x1): Interpolated grid: dx=1.000 mm, dy=1.000 mm

Maximum value of SAR (interpolated) = 0.477 W/kg

Zoom Scan (7x7x7)/Cube 0: Measurement grid: dx=5mm, dy=5mm, dz=5mm

Reference Value = 23.82 V/m; Power Drift = 0.09 dB

Peak SAR (extrapolated) = 0.529 W/kg

SAR(1 g) = 0.395 W/kg; SAR(10 g) = 0.308 W/kg

Maximum value of SAR (measured) = 0.477 W/kg

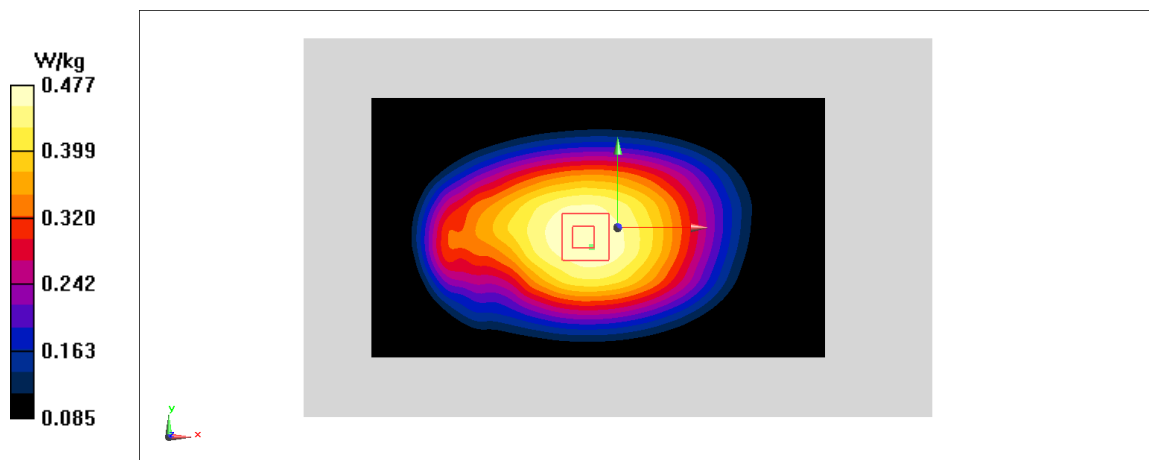
**Fig A.31**

WLAN2450_CH6 Right Tilt

Date: 11/5/2019

Electronics: DAE4 Sn771

Medium: head 2450 MHz

Medium parameters used: $f = 2412$; $\sigma = 1.748$ mho/m; $\epsilon_r = 39.1$; $\rho = 1000$ kg/m³

Ambient Temperature: 22.5°C, Liquid Temperature: 22.3°C

Communication System: WLAN2450 2412 Duty Cycle:1:1

Probe: EX3DV4 – SN3617 ConvF(7.62,7.62,7.62)

Area Scan (71x121x1): Interpolated grid: dx=1.000 mm, dy=1.000 mm

Maximum value of SAR (interpolated) = 0.517 W/kg

Zoom Scan (7x7x7)/Cube 0: Measurement grid: dx=5mm, dy=5mm, dz=5mm

Reference Value = 8.92 V/m; Power Drift = 0.05 dB

Peak SAR (extrapolated) = 0.739 W/kg

SAR(1 g) = 0.374 W/kg; SAR(10 g) = 0.18 W/kg

Maximum value of SAR (measured) = 0.536 W/kg

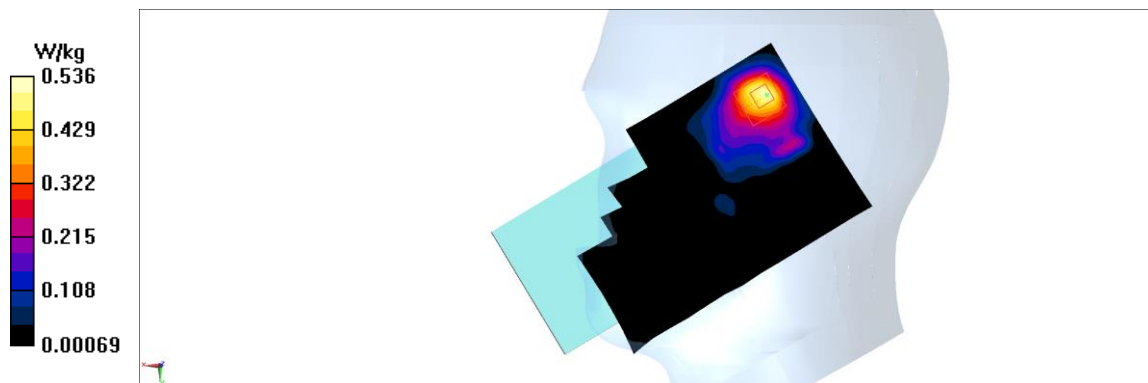

Fig A.32

WLAN2450_CH6 Rear 10mm

Date: 11/5/2019

Electronics: DAE4 Sn771

Medium: body 2450 MHz

Medium parameters used: $f = 2412$; $\sigma = 1.93$ mho/m; $\epsilon_r = 53.41$; $\rho = 1000$ kg/m³

Ambient Temperature: 22.5°C, Liquid Temperature: 22.3°C

Communication System: WLAN2450 2412 Duty Cycle:1:1

Probe: EX3DV4 – SN3617 ConvF(7.79,7.79,7.79)

Area Scan (71x121x1): Interpolated grid: dx=1.000 mm, dy=1.000 mm

Maximum value of SAR (interpolated) = 0.678 W/kg

Zoom Scan (7x7x7)/Cube 0: Measurement grid: dx=5mm, dy=5mm, dz=5mm

Reference Value = 6.732 V/m; Power Drift = 0.05 dB

Peak SAR (extrapolated) = 1.07 W/kg

SAR(1 g) = 0.46 W/kg; SAR(10 g) = 0.218 W/kg

Maximum value of SAR (measured) = 0.752 W/kg

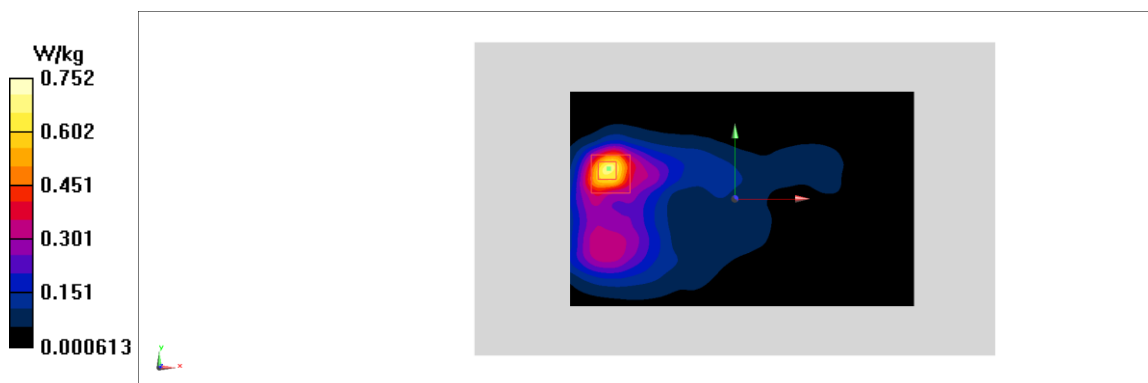
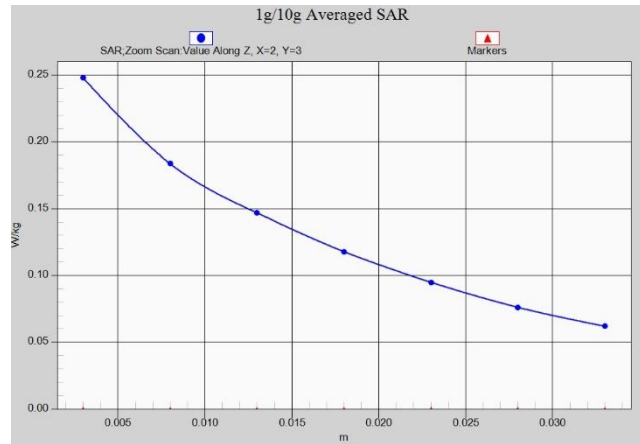
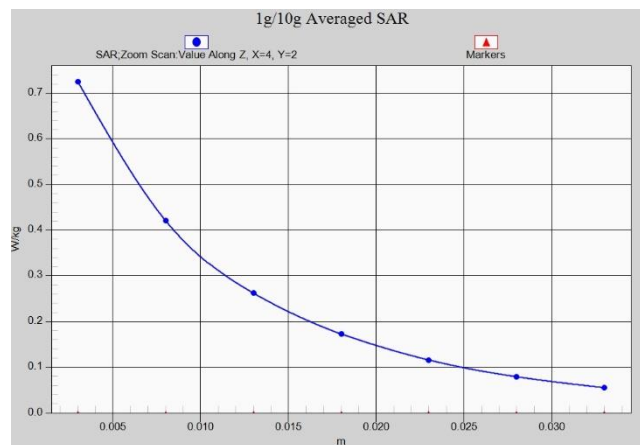

Fig A.33



Z-Scan at power reference point (GSM850)



Z-Scan at power reference point (GSM850)

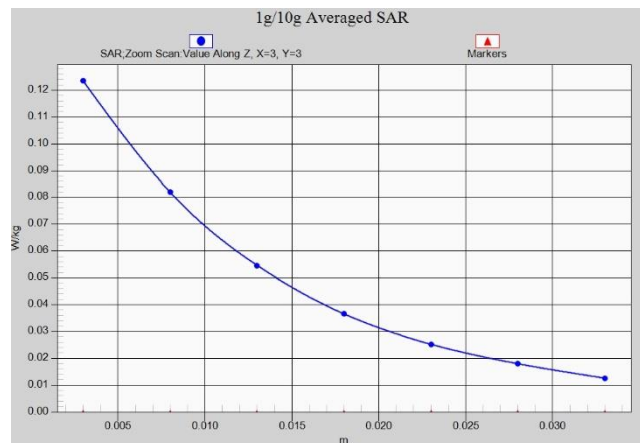

Z-Scan at power reference point (GSM1900)

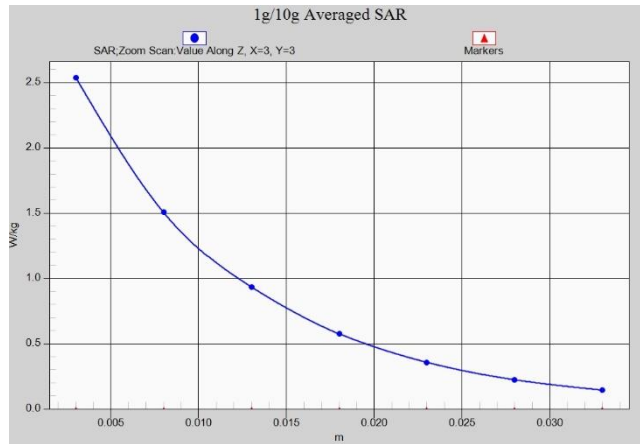

Z-Scan at power reference point (GSM1900)

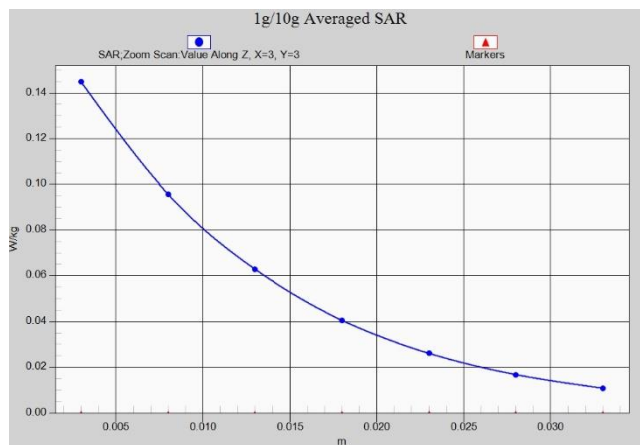

Z-Scan at power reference point (WCDMA1900)

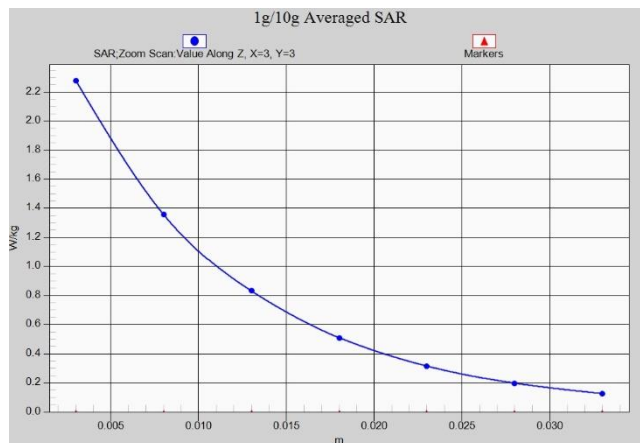

Z-Scan at power reference point (WCDMA1900)

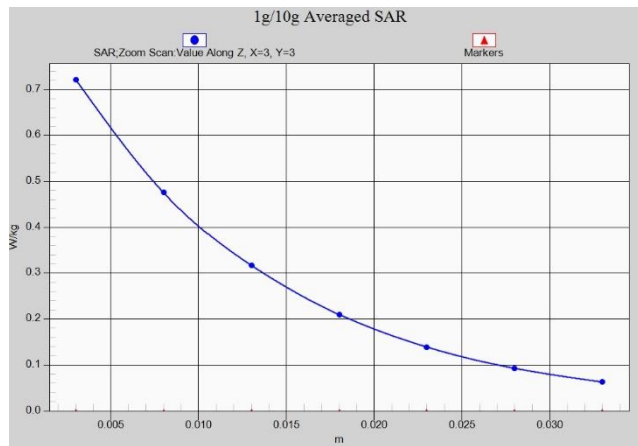

Z-Scan at power reference point (WCDMA1900)

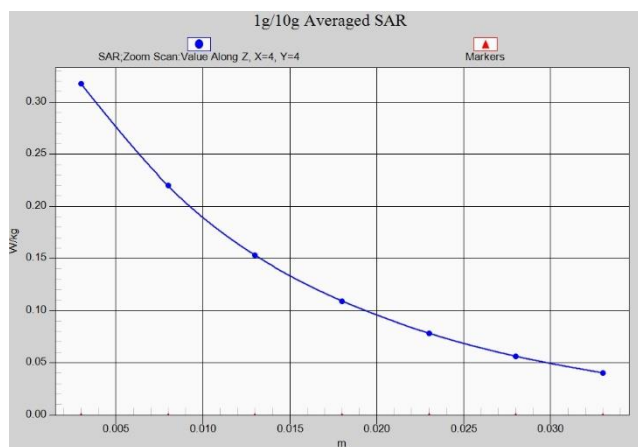

Z-Scan at power reference point (WCDMA1700)

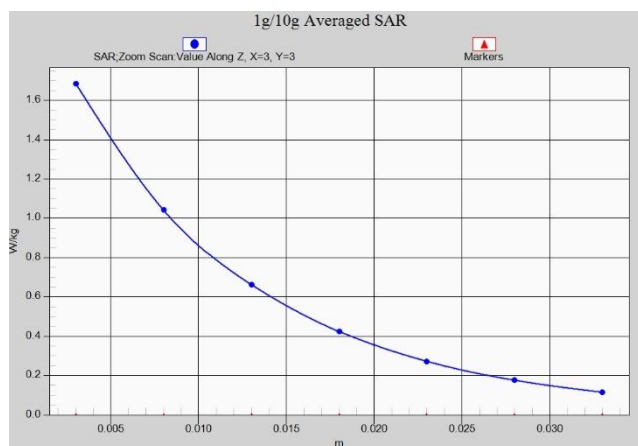

Z-Scan at power reference point (WCDMA1700)

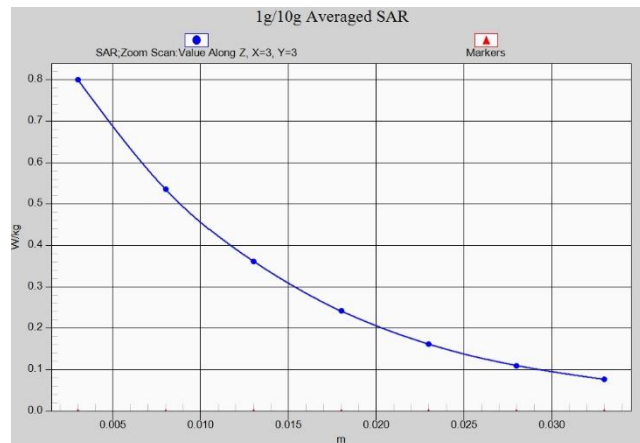

Z-Scan at power reference point (WCDMA1700)

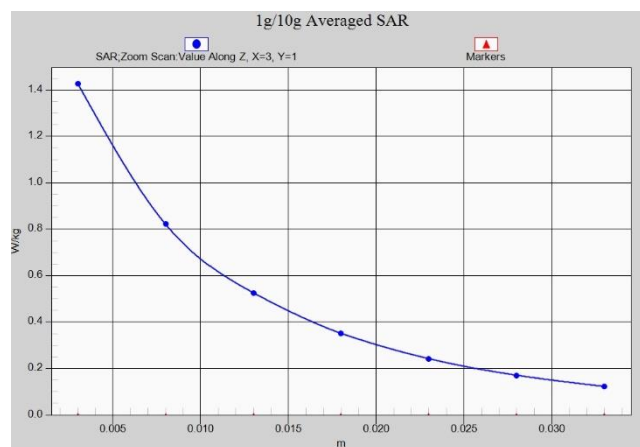

Z-Scan at power reference point (WCDMA850)

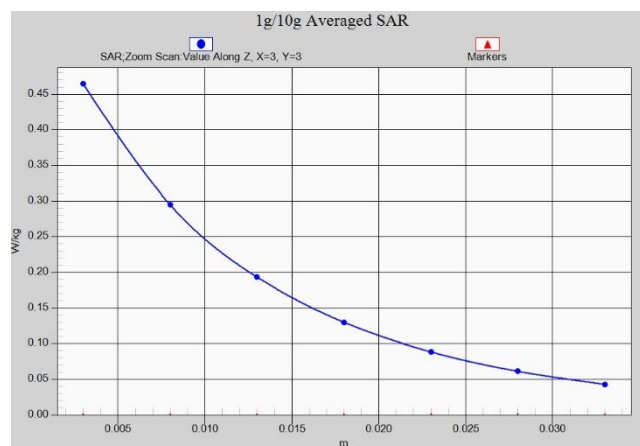

Z-Scan at power reference point (WCDMA850)

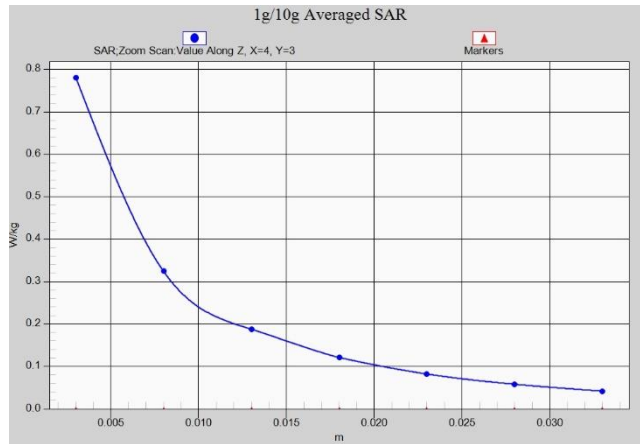

Z-Scan at power reference point (LTEB12)

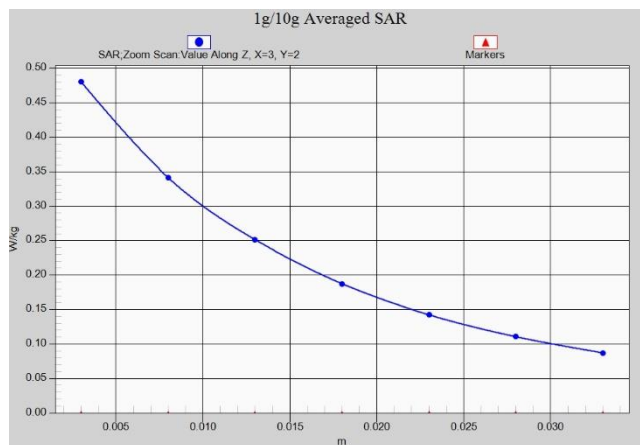

Z-Scan at power reference point (LTEB12)

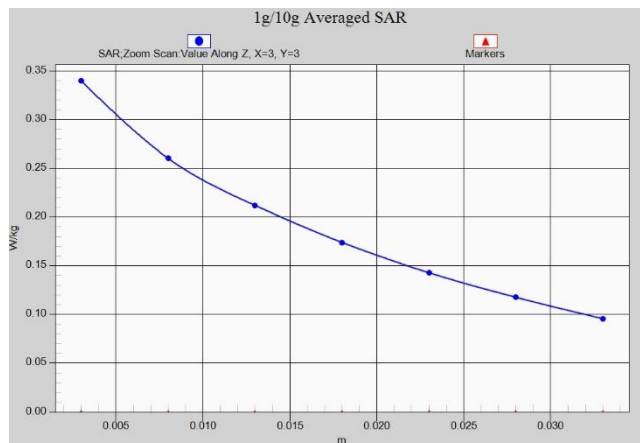

Z-Scan at power reference point (LTEB13)

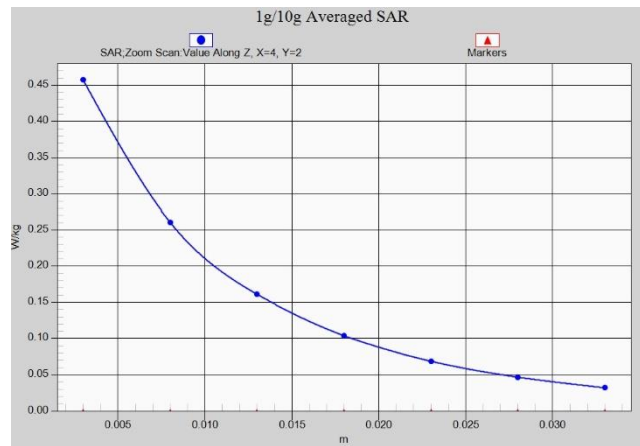

Z-Scan at power reference point (LTEB13)

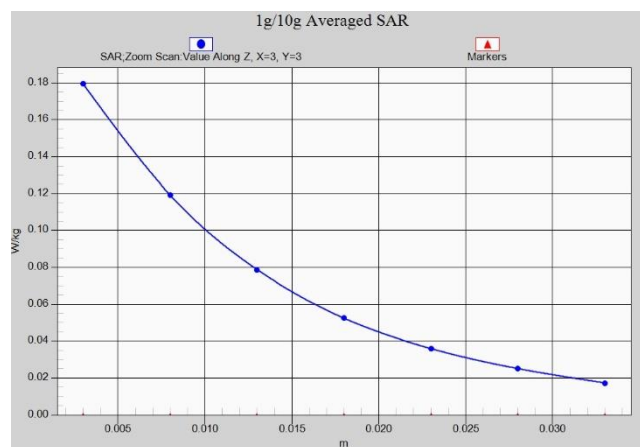

Z-Scan at power reference point (LTEB25)

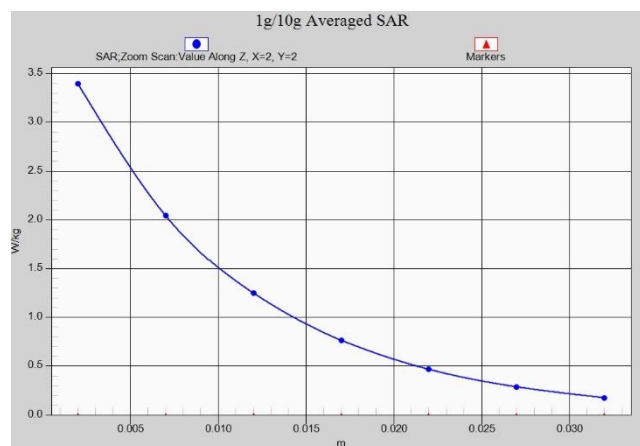

Z-Scan at power reference point (LTEB25)

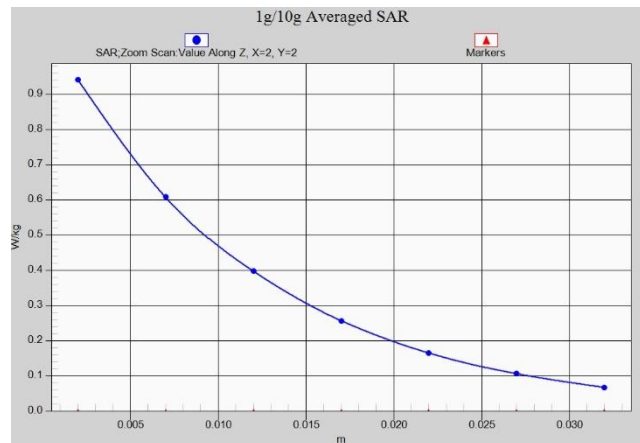

Z-Scan at power reference point (LTEB25)

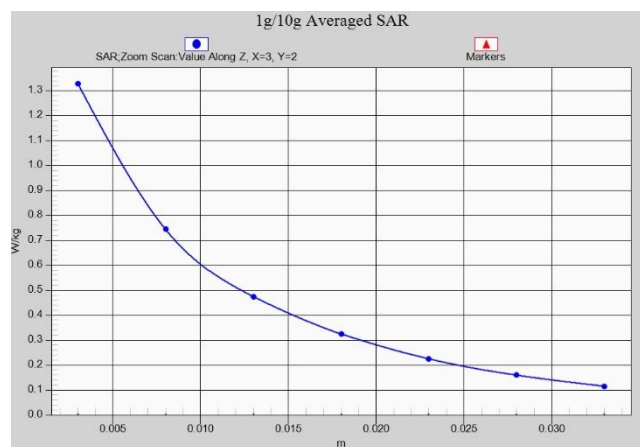

Z-Scan at power reference point (LTEB26)

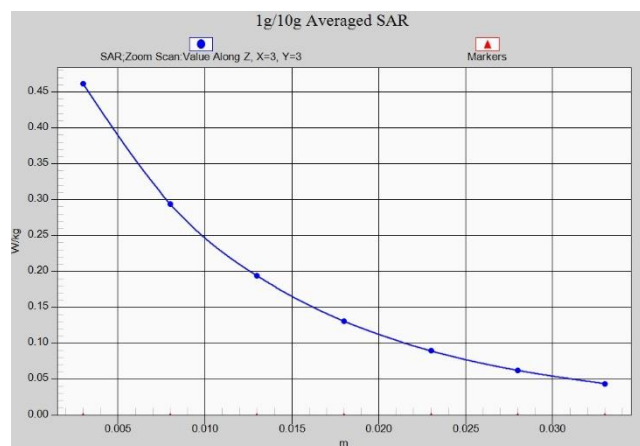

Z-Scan at power reference point (LTEB26)

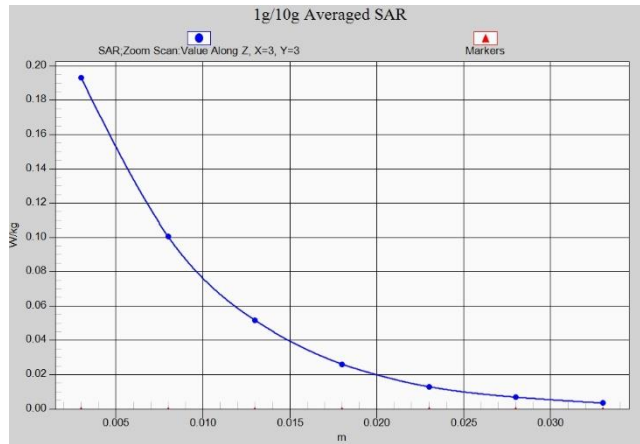

Z-Scan at power reference point (LTEB41)

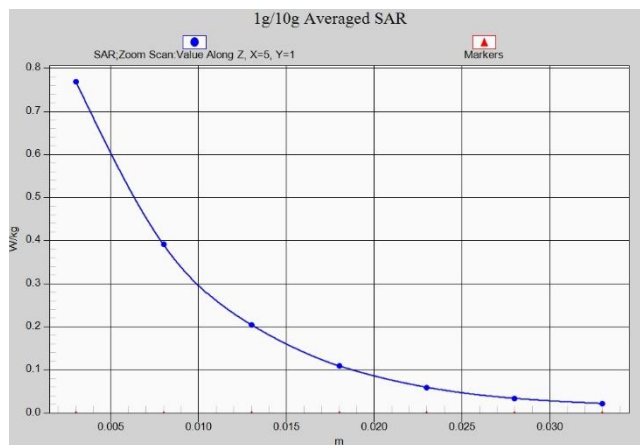

Z-Scan at power reference point (LTEB41)

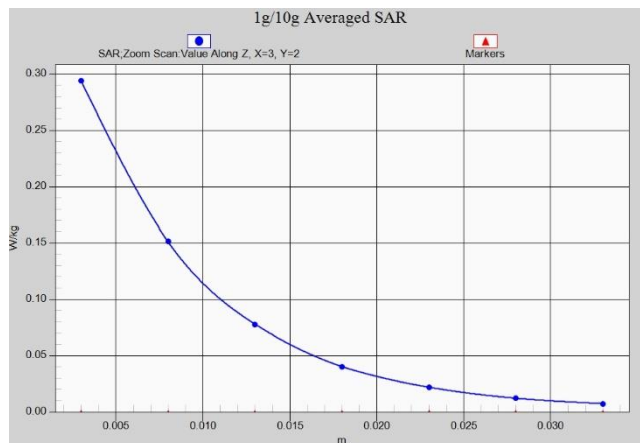

Z-Scan at power reference point (LTEB41)

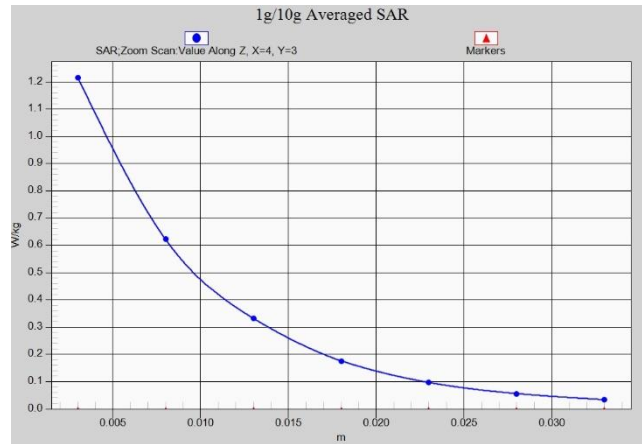

Z-Scan at power reference point (LTEB41)

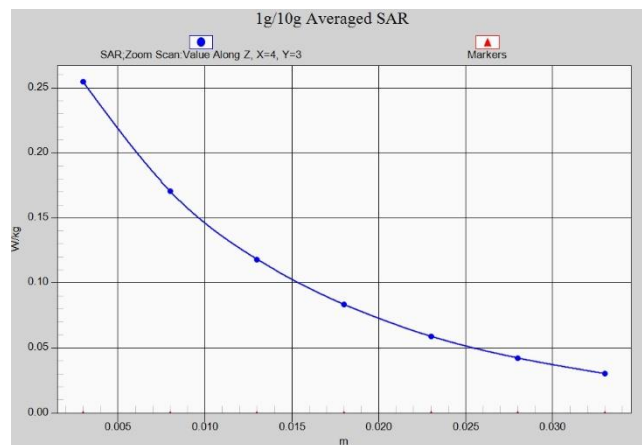

Z-Scan at power reference point (LTEB66)

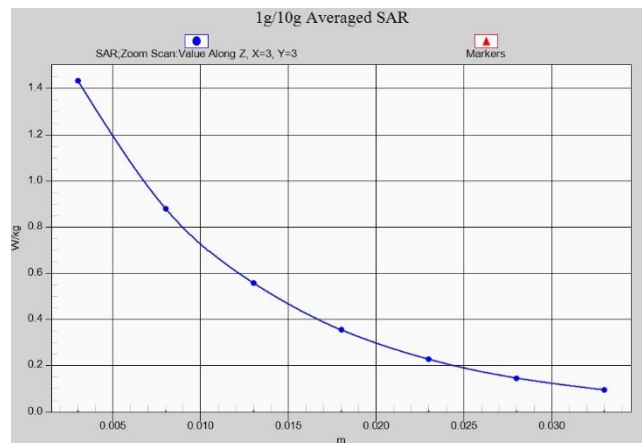

Z-Scan at power reference point (LTEB66)

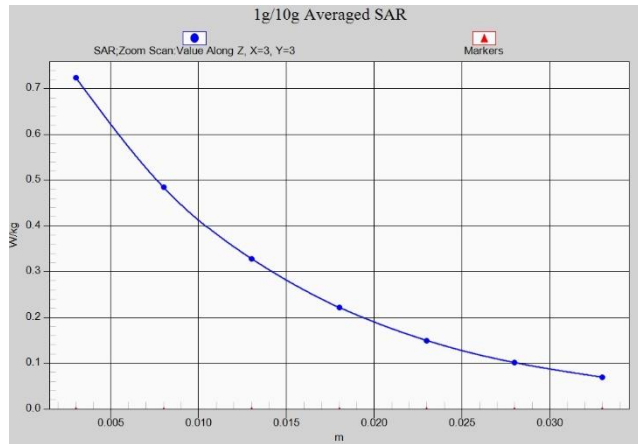

Z-Scan at power reference point (LTEB66)

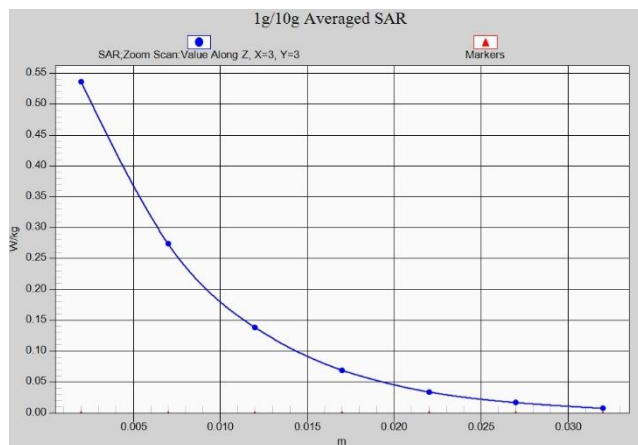

Z-Scan at power reference point (WIFI2.4G)

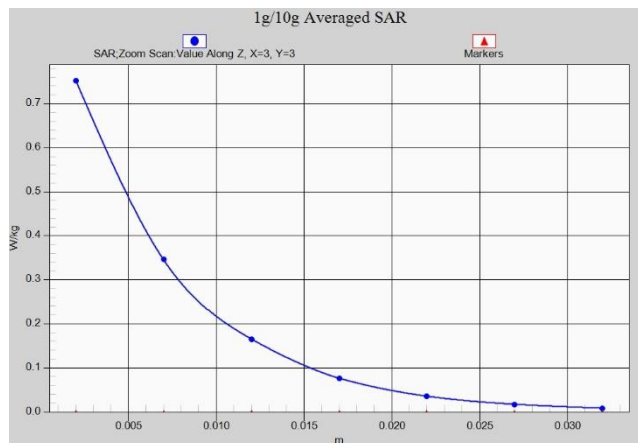

Z-Scan at power reference point (WIFI2.4G)

ANNEX B System Verification Results

750 MHz

Date: 11/1/2019

Electronics: DAE4 Sn771

Medium: Head 750 MHz

Medium parameters used: $f = 750 \text{ MHz}$; $\sigma = 0.898 \text{ mho/m}$; $\epsilon_r = 41.7$; $\rho = 1000 \text{ kg/m}^3$

Ambient Temperature: 22.5°C Liquid Temperature: 22.3°C

Communication System: CW Frequency: 750 MHz Duty Cycle: 1:1

Probe: EX3DV4 – SN3617 ConvF(10.03,10.03,10.03)

System Validation /Area Scan (81x191x1): Interpolated grid: $dx=1.000 \text{ mm}$, $dy=1.000 \text{ mm}$

Reference Value = 60.78 V/m ; Power Drift = 0.03

Fast SAR: SAR(1 g) = 2.11 W/kg ; SAR(10 g) = 1.42 W/kg

Maximum value of SAR (interpolated) = 2.78 W/kg

System Validation /Zoom Scan (7x7x7)/Cube 0: Measurement grid: $dx=5\text{mm}$, $dy=5\text{mm}$, $dz=5\text{mm}$

Reference Value = 60.78 V/m ; Power Drift = 0.03 dB

Peak SAR (extrapolated) = 3.16 W/kg

SAR(1 g) = 2.14 W/kg ; SAR(10 g) = 1.38 W/kg

Maximum value of SAR (measured) = 2.83 W/kg

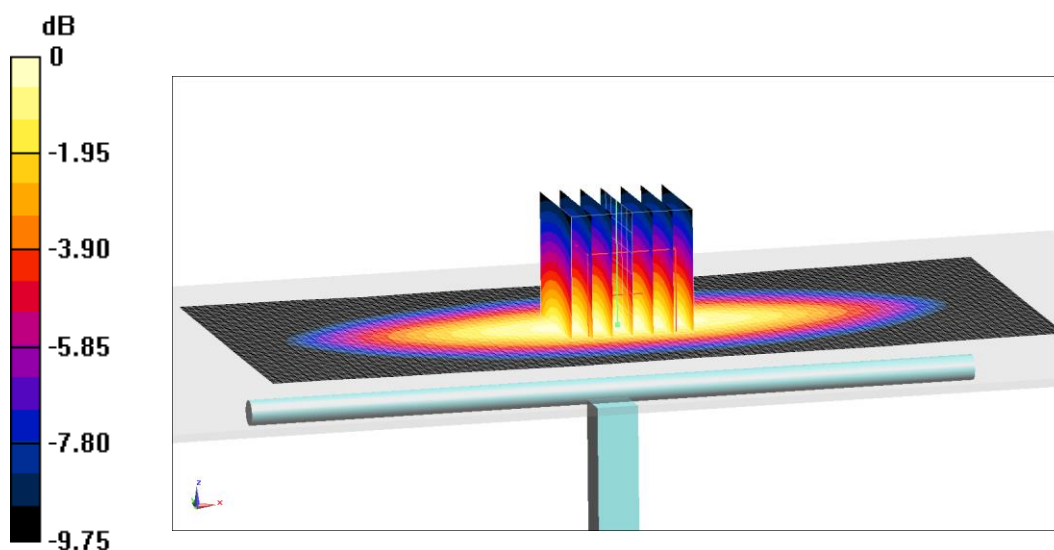

0 dB = $2.83 \text{ W/kg} = 4.52 \text{ dB W/kg}$

Fig.B.1 validation 750 MHz 250Mw

750 MHz

Date: 11/1/2019

Electronics: DAE4 Sn771

Medium: Body 750 MHz

Medium parameters used: $f = 750 \text{ MHz}$; $\sigma = 0.951 \text{ mho/m}$; $\epsilon_r = 55.35$; $\rho = 1000 \text{ kg/m}^3$

Ambient Temperature: 22.5°C Liquid Temperature: 22.3°C

Communication System: CW Frequency: 750 MHz Duty Cycle: 1:1

Probe: EX3DV4 – SN3617 ConvF(9.85,9.85,9.85)

System Validation /Area Scan (81x191x1): Interpolated grid: $dx=1.000 \text{ mm}$, $dy=1.000 \text{ mm}$

Reference Value = 58.82 V/m ; Power Drift = -0.03

Fast SAR: SAR(1 g) = 2.13 W/kg ; SAR(10 g) = 1.41 W/kg

Maximum value of SAR (interpolated) = 3.07 W/kg

System Validation /Zoom Scan (7x7x7)/Cube 0: Measurement grid: $dx=5\text{mm}$, $dy=5\text{mm}$, $dz=5\text{mm}$

Reference Value = 58.82 V/m ; Power Drift = -0.03 dB

Peak SAR (extrapolated) = 3.17 W/kg

SAR(1 g) = 2.18 W/kg ; SAR(10 g) = 1.4 W/kg

Maximum value of SAR (measured) = 2.82 W/kg

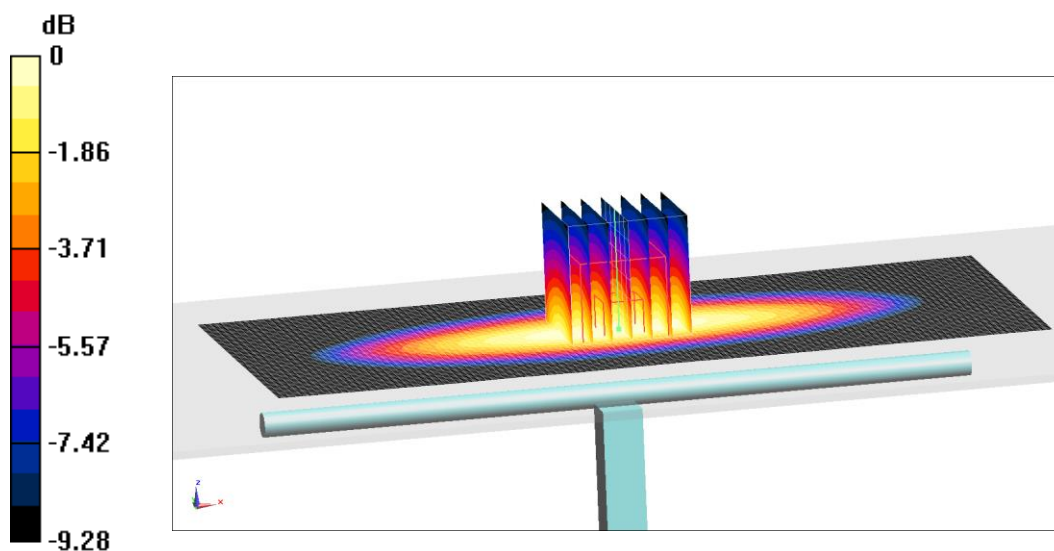

0 dB = 2.82 W/kg = 4.5 dB W/kg

Fig.B.2 validation 750 MHz 250mW

835 MHz

Date: 11/2/2019

Electronics: DAE4 Sn771

Medium: Head 835 MHz

Medium parameters used: $f = 835 \text{ MHz}$; $\sigma = 0.901 \text{ mho/m}$; $\epsilon_r = 41.6$; $\rho = 1000 \text{ kg/m}^3$

Ambient Temperature: 22.5°C Liquid Temperature: 22.3°C

Communication System: CW Frequency: 835 MHz Duty Cycle: 1:1

Probe: EX3DV4 – SN3617 ConvF(9.75,9.75,9.75)

System Validation /Area Scan (81x191x1): Interpolated grid: $dx=1.000 \text{ mm}$, $dy=1.000 \text{ mm}$

Reference Value = 63.88 V/m ; Power Drift = 0.04

Fast SAR: SAR(1 g) = 2.42 W/kg ; SAR(10 g) = 1.56 W/kg

Maximum value of SAR (interpolated) = 3.16 W/kg

System Validation /Zoom Scan (7x7x7)/Cube 0: Measurement grid: $dx=5\text{mm}$, $dy=5\text{mm}$, $dz=5\text{mm}$

Reference Value = 63.88 V/m ; Power Drift = 0.04 dB

Peak SAR (extrapolated) = 3.62 W/kg

SAR(1 g) = 2.45 W/kg ; SAR(10 g) = 1.57 W/kg

Maximum value of SAR (measured) = 3.26 W/kg

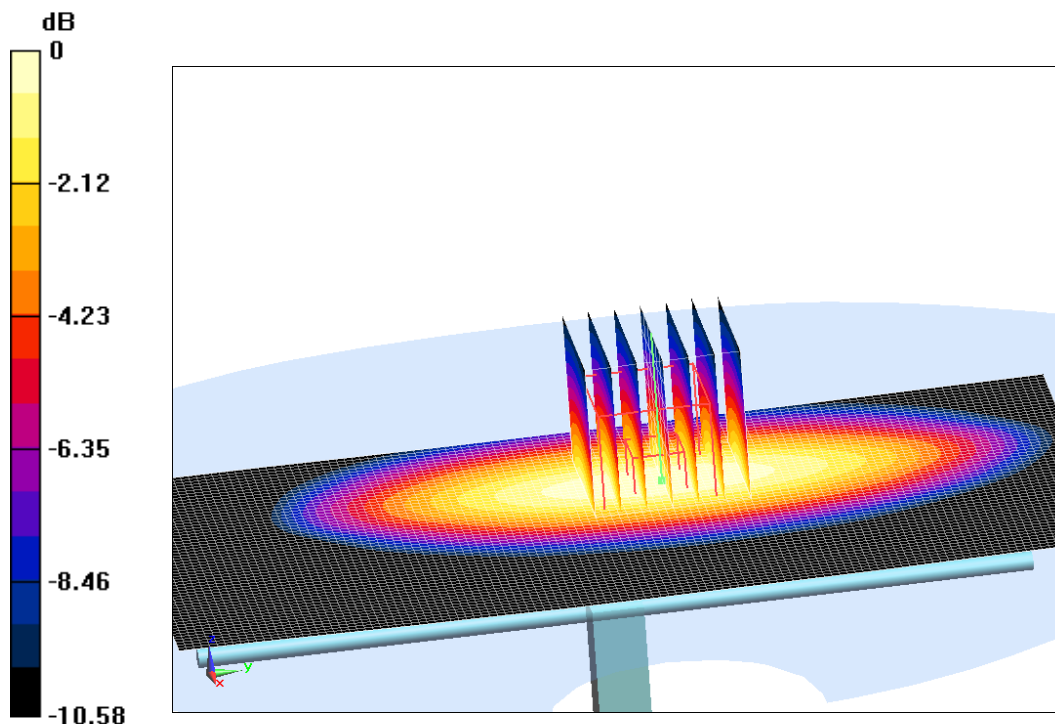

0 dB = $3.26 \text{ W/kg} = 5.13 \text{ dB W/kg}$

Fig.B.3 validation 835 MHz 250mW

835 MHz

Date: 11/2/2019

Electronics: DAE4 Sn771

Medium: Body 835 MHz

Medium parameters used: $f = 835 \text{ MHz}$; $\sigma = 0.988 \text{ mho/m}$; $\epsilon_r = 56.1$; $\rho = 1000 \text{ kg/m}^3$

Ambient Temperature: 22.5°C Liquid Temperature: 22.3°C

Communication System: CW Frequency: 835 MHz Duty Cycle: 1:1

Probe: EX3DV4 – SN3617 ConvF(9.61,9.61,9.61)

System Validation /Area Scan (81x191x1): Interpolated grid: $dx=1.000 \text{ mm}$, $dy=1.000 \text{ mm}$

Reference Value = 57.67 V/m ; Power Drift = -0.09

Fast SAR: SAR(1 g) = 2.39 W/kg ; SAR(10 g) = 1.57 W/kg

Maximum value of SAR (interpolated) = 3.45 W/kg

System Validation /Zoom Scan (7x7x7)/Cube 0: Measurement grid: $dx=5\text{mm}$, $dy=5\text{mm}$, $dz=5\text{mm}$

Reference Value = 57.67 V/m ; Power Drift = -0.09 dB

Peak SAR (extrapolated) = 3.68 W/kg

SAR(1 g) = 2.38 W/kg ; SAR(10 g) = 1.6 W/kg

Maximum value of SAR (measured) = 3.26 W/kg

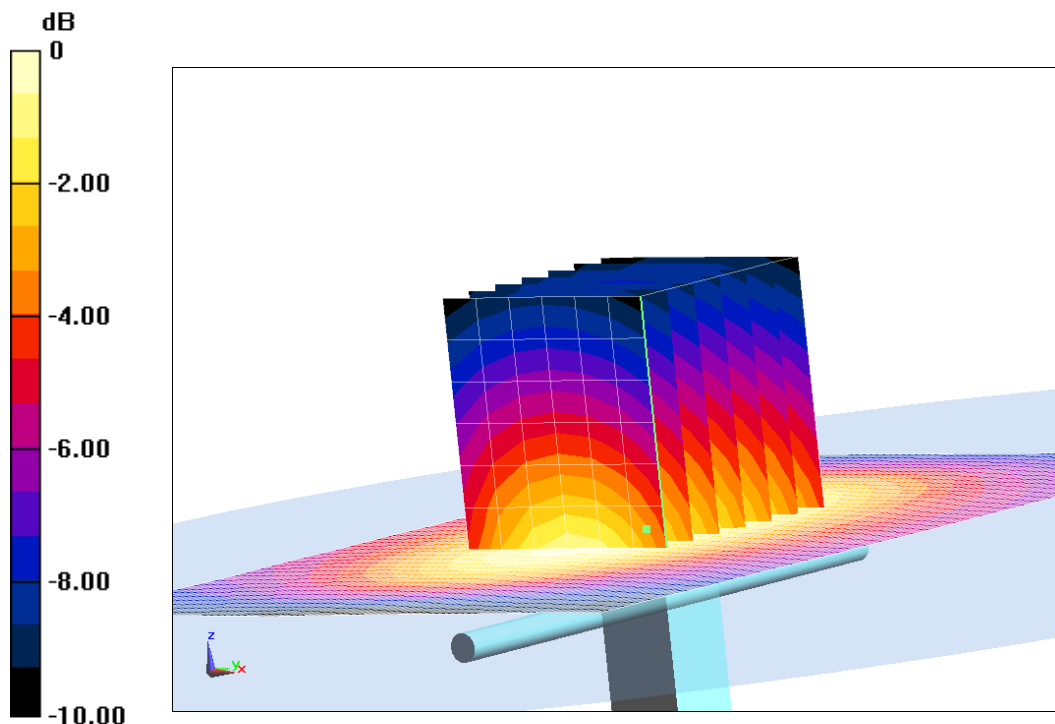

$0 \text{ dB} = 3.26 \text{ W/kg} = 5.13 \text{ dB W/kg}$

Fig.B.4 validation 835 MHz 250mW

1750 MHz

Date: 11/3/2019

Electronics: DAE4 Sn771

Medium: Head 1750 MHz

Medium parameters used: $f = 1750 \text{ MHz}$; $\sigma = 1.38 \text{ mho/m}$; $\epsilon_r = 40.68$; $\rho = 1000 \text{ kg/m}^3$

Ambient Temperature: 22.5°C Liquid Temperature: 22.3°C

Communication System: CW Frequency: 1750 MHz Duty Cycle: 1:1

Probe: EX3DV4 – SN3617 ConvF(8.38,8.38,8.38)

System Validation /Area Scan (81x191x1): Interpolated grid: $dx=1.000 \text{ mm}$, $dy=1.000 \text{ mm}$

Reference Value = 104.5 V/m ; Power Drift = 0.06

Fast SAR: SAR(1 g) = 9.03 W/kg ; SAR(10 g) = 4.83 W/kg

Maximum value of SAR (interpolated) = 14.31 W/kg

System Validation /Zoom Scan (7x7x7)/Cube 0: Measurement grid: $dx=5\text{mm}$, $dy=5\text{mm}$, $dz=5\text{mm}$

Reference Value = 104.5 V/m ; Power Drift = 0.06 dB

Peak SAR (extrapolated) = 16.53 W/kg

SAR(1 g) = 9.01 W/kg ; SAR(10 g) = 4.85 W/kg

Maximum value of SAR (measured) = 13.9 W/kg

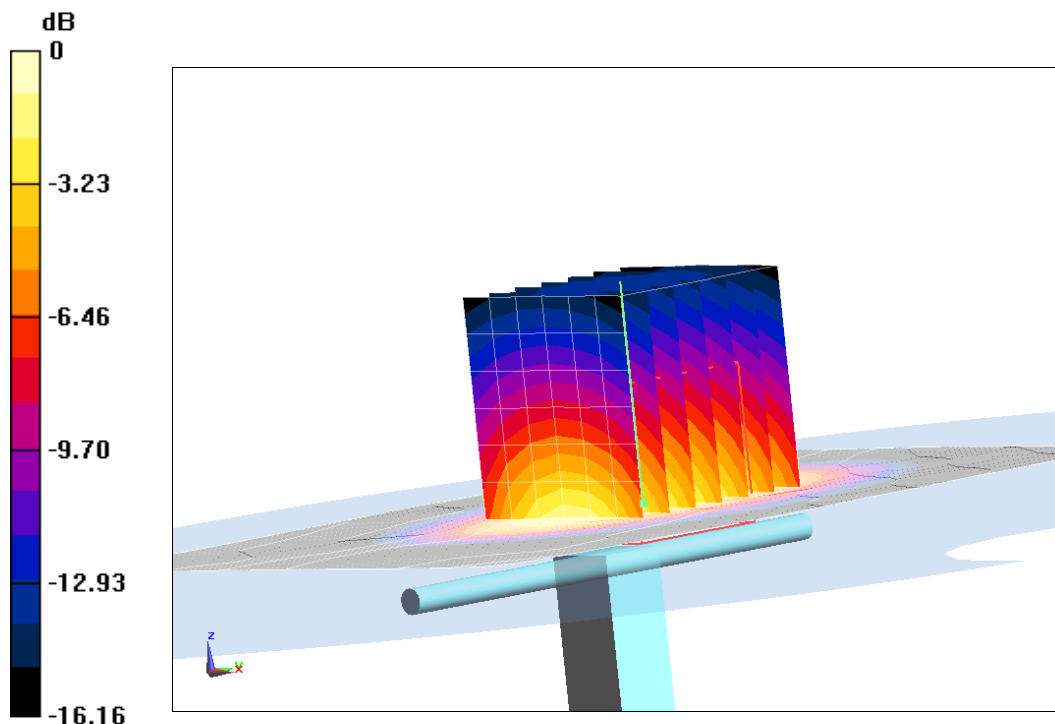

0 dB = $13.9 \text{ W/kg} = 11.43 \text{ dB W/kg}$

Fig.B.5 validation 1750 MHz 250mW

1750 MHz

Date: 11/3/2019

Electronics: DAE4 Sn771

Medium: Body 1750 MHz

Medium parameters used: $f = 1750$ MHz; $\sigma = 1.514$ mho/m; $\epsilon_r = 53.22$; $\rho = 1000$ kg/m³

Ambient Temperature: 22.5°C Liquid Temperature: 22.3°C

Communication System: CW Frequency: 1750 MHz Duty Cycle: 1:1

Probe: EX3DV4 – SN3617 ConvF(8.03,8.03,8.03)

System Validation /Area Scan (81x191x1): Interpolated grid: dx=1.000 mm, dy=1.000 mm

Reference Value = 103.14 V/m; Power Drift = 0.04

Fast SAR: SAR(1 g) = 9.08 W/kg; SAR(10 g) = 4.86 W/kg

Maximum value of SAR (interpolated) = 15.22 W/kg

System Validation /Zoom Scan (7x7x7)/Cube 0: Measurement grid: dx=5mm, dy=5mm, dz=5mm

Reference Value =103.14 V/m; Power Drift = 0.04 dB

Peak SAR (extrapolated) = 15.69 W/kg

SAR(1 g) = 9.12 W/kg; SAR(10 g) = 4.94 W/kg

Maximum value of SAR (measured) = 13.43 W/kg

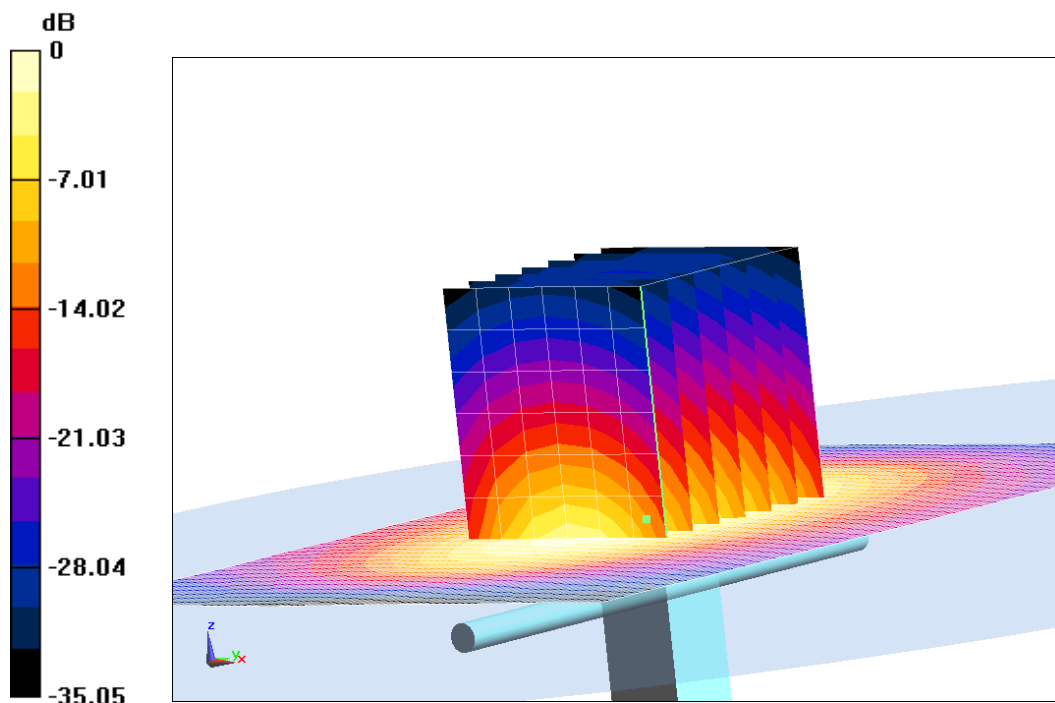

0 dB = 13.43 W/kg = 11.28 dB W/kg

Fig.B.6 validation 1750 MHz 250mW

1900 MHz

Date: 11/4/2019

Electronics: DAE4 Sn771

Medium: Head 1900 MHz

Medium parameters used: $f = 1900 \text{ MHz}$; $\sigma = 1.39 \text{ mho/m}$; $\epsilon_r = 39.55$; $\rho = 1000 \text{ kg/m}^3$

Ambient Temperature: 22.5°C Liquid Temperature: 22.3°C

Communication System: CW Frequency: 1900 MHz Duty Cycle: 1:1

Probe: EX3DV4 – SN3617 ConvF(8.14,8.14,8.14)

System Validation /Area Scan (81x191x1): Interpolated grid: $dx=1.000 \text{ mm}$, $dy=1.000 \text{ mm}$

Reference Value = 107.26 V/m ; Power Drift = 0.02

Fast SAR: SAR(1 g) = 9.96 W/kg ; SAR(10 g) = 5.2 W/kg

Maximum value of SAR (interpolated) = 15.34 W/kg

System Validation /Zoom Scan (7x7x7)/Cube 0: Measurement grid: $dx=5\text{mm}$, $dy=5\text{mm}$, $dz=5\text{mm}$

Reference Value = 107.26 V/m ; Power Drift = 0.02 dB

Peak SAR (extrapolated) = 17.52 W/kg

SAR(1 g) = 10.07 W/kg ; SAR(10 g) = 5.15 W/kg

Maximum value of SAR (measured) = 14.81 W/kg

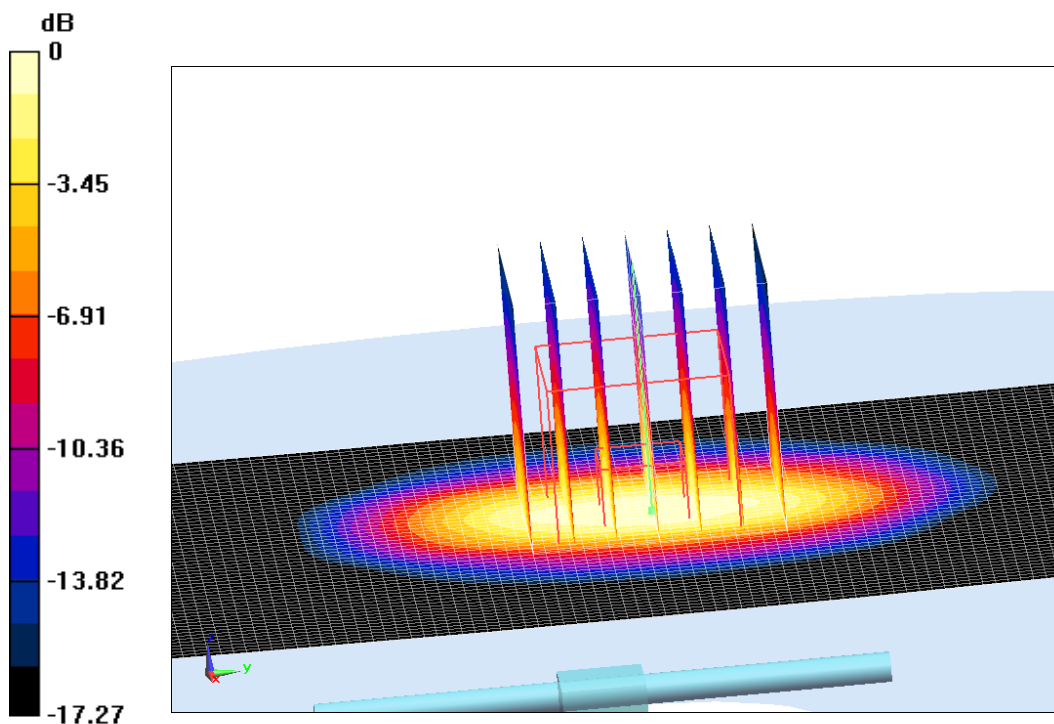

$0 \text{ dB} = 14.81 \text{ W/kg} = 11.71 \text{ dB W/kg}$

Fig.B.7 validation 1900 MHz 250mW

1900 MHz

Date: 11/4/2019

Electronics: DAE4 Sn771

Medium: Body 1900 MHz

Medium parameters used: $f = 1900$ MHz; $\sigma = 1.536$ mho/m; $\epsilon_r = 53.19$; $\rho = 1000$ kg/m³

Ambient Temperature: 22.5°C Liquid Temperature: 22.3°C

Communication System: CW Frequency: 1900 MHz Duty Cycle: 1:1

Probe: EX3DV4 – SN3617ConvF(7.78,7.78,7.78)

System Validation /Area Scan (81x191x1): Interpolated grid: dx=1.000 mm, dy=1.000 mm

Reference Value = 105.88 V/m; Power Drift = -0.03

Fast SAR: SAR(1 g) = 10.1 W/kg; SAR(10 g) = 5.19 W/kg

Maximum value of SAR (interpolated) = 17.03 W/kg

System Validation /Zoom Scan (7x7x7)/Cube 0: Measurement grid: dx=5mm, dy=5mm, dz=5mm

Reference Value =105.88 V/m; Power Drift = -0.03 dB

Peak SAR (extrapolated) = 17.55 W/kg

SAR(1 g) = 9.83 W/kg; SAR(10 g) = 5.16 W/kg

Maximum value of SAR (measured) = 14.41 W/kg

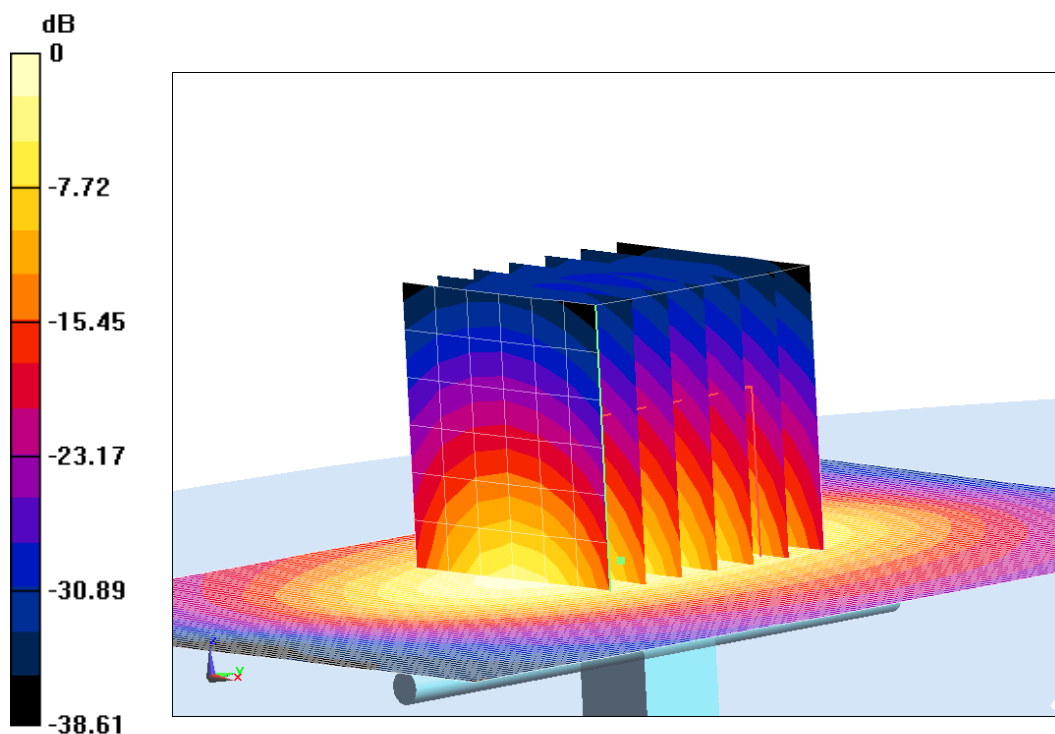

0 dB = 14.41 W/kg = 11.59 dB W/kg

Fig.B.8 validation 1900 MHz 250mW