



# HAC RF TEST REPORT

No. I19Z61825-SEM04

For

**TCL Communication Ltd.**

**LTE/UMTS/GSM mobile phone**

**Model name: A507DL**

**With**

**Hardware Version: PIO**

**Software Version: vD41**

**FCC ID: 2ACCJH111**

**Results Summary: M Category = M4**

**Issued Date: 2019-11-4**

**Note:**

The test results in this test report relate only to the devices specified in this report. This report shall not be reproduced except in full without the written approval of CTTL.

The report must not be used by the client to claim product certification, approval, or endorsement by NVLAP, NIST, or any agency of the U.S.Government.

**Test Laboratory:**

**CTTL, Telecommunication Technology Labs, CAICT**

No. 51, Xueyuan Road, Haidian District, Beijing, P. R. China 100191.

Tel:+86(0)10-62304633-2512, Fax:+86(0)10-62304633-2504

Email: [cttl\\_terminals@caict.ac.cn](mailto:cttl_terminals@caict.ac.cn), website: [www.caict.ac.cn](http://www.caict.ac.cn)



No.I19Z61825-SEM04

## **REPORT HISTORY**

<b>Report Number</b>	<b>Revision</b>	<b>Issue Date</b>	<b>Description</b>
I19Z61825-SEM04	Rev.0	2019-11-4	Initial creation of test report

## TABLE OF CONTENT

<b>1 TEST LABORATORY .....</b>	<b>5</b>
1.1 TESTING LOCATION .....	5
1.2 TESTING ENVIRONMENT.....	5
1.3 PROJECT DATA .....	5
1.4 SIGNATURE.....	5
<b>2 CLIENT INFORMATION .....</b>	<b>6</b>
2.1 APPLICANT INFORMATION .....	6
2.2 MANUFACTURER INFORMATION .....	6
<b>3 EQUIPMENT UNDER TEST (EUT) AND ANCILLARY EQUIPMENT (AE) .....</b>	<b>7</b>
3.1 ABOUT EUT .....	7
3.2 INTERNAL IDENTIFICATION OF EUT USED DURING THE TEST .....	7
3.3 INTERNAL IDENTIFICATION OF AE USED DURING THE TEST .....	7
3.4 AIR INTERFACES / BANDS INDICATING OPERATING MODES .....	8
<b>4 MAXIMUM OUTPUT POWER .....</b>	<b>9</b>
<b>5 REFERENCE DOCUMENTS.....</b>	<b>10</b>
5.1 REFERENCE DOCUMENTS FOR TESTING .....	10
<b>6 OPERATIONAL CONDITIONS DURING TEST .....</b>	<b>11</b>
6.1 HAC MEASUREMENT SET-UP.....	11
6.2 PROBE SPECIFICATION .....	12
6.3 TEST ARCH PHANTOM & PHONE POSITIONER .....	13
6.4 ROBOTIC SYSTEM SPECIFICATIONS .....	13
<b>7 EUT ARRANGEMENT .....</b>	<b>14</b>
7.1 WD RF EMISSION MEASUREMENTS REFERENCE AND PLANE .....	14
<b>8 SYSTEM VALIDATION .....</b>	<b>15</b>
8.1 VALIDATION PROCEDURE .....	15
8.2 VALIDATION RESULT .....	15
<b>9 EVALUATION OF MIF .....</b>	<b>16</b>
9.1 INTRODUCTION.....	16
9.2 MIF MEASUREMENT WITH THE AIA .....	17
9.3 TEST EQUIPMENT FOR THE MIF MEASUREMENT .....	17
9.4 TEST SIGNAL VALIDATION.....	17
9.5 DUT MIF RESULTS.....	18
<b>10 EVALUATION FOR LOW-POWER EXEMPTION .....</b>	<b>20</b>
10.1 PRODUCT TESTING THRESHOLD .....	20
10.2 CONDUCTED POWER.....	21
10.3 CONCLUSION .....	21



11 RF TEST PROCEDURES..... 22

12 MEASUREMENT RESULTS (E-FIELD)..... 23

13 ANSIC 63.19-2011 LIMITS ..... 24

14 MEASUREMENT UNCERTAINTY ..... 25

15 MAIN TEST INSTRUMENTS..... 26

16 CONCLUSION ..... 26

ANNEX A TEST LAYOUT ..... 27

ANNEX B TEST PLOTS ..... 28

ANNEX C SYSTEM VALIDATION RESULT..... 80

ANNEX D PROBE CALIBRATION CERTIFICATE ..... 83

ANNEX E DIPOLE CALIBRATION CERTIFICATE..... 92

## 1 Test Laboratory

### 1.1 Testing Location

CompanyName:	CTTL(Shouxiang)
Address:	No. 51 Shouxiang Science Building, Xueyuan Road, Haidian District, Beijing, P. R. China100191

### 1.2 Testing Environment

Temperature:	18°C~25°C,
Relative humidity:	30%~ 70%
Ground system resistance:	< 0.5 Ω
Ambient noise is checked and found very low and in compliance with requirement of standards. Reflection of surrounding objects is minimized and in compliance with requirement of standards.	

### 1.3 Project Data

Project Leader:	Qi Dianyuan
Test Engineer:	Lin Hao
Testing Start Date:	October 29, 2019
Testing End Date:	October 30, 2019

### 1.4 Signature



Lin Xiaojun  
(Prepared this test report)

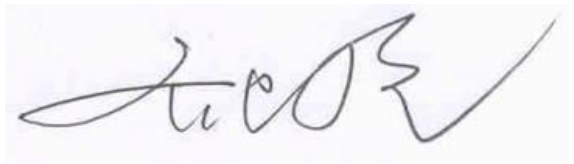

Qi Dianyuan  
(Reviewed this test report)

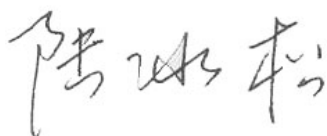

Lu Bingsong  
Deputy Director of the laboratory  
(Approved this test report)



## 2 Client Information

### 2.1 Applicant Information

Company Name:	TCL Communication Ltd.
Address /Post:	5/F, Building 22E, 22 Science Park East Avenue, Hong Kong Science Park, Shatin, NT, Hong Kong
Contact:	Gong Zhizhou
Email:	zhizhou.gong@tcl.com
Telephone:	0086-755-36611722
Fax:	\

### 2.2 Manufacturer Information

Company Name:	TCL Communication Ltd.
Address /Post:	5/F, Building 22E, 22 Science Park East Avenue, Hong Kong Science Park, Shatin, NT, Hong Kong
Contact:	Gong Zhizhou
Email:	zhizhou.gong@tcl.com
Telephone:	0086-755-36611722
Fax:	\

### 3 Equipment Under Test (EUT) and Ancillary Equipment (AE)

#### 3.1 About EUT

Description:	LTE/UMTS/GSM mobile phone
Model name:	A507DL
Operating mode(s):	GSM 850/900/1800/1900, UMTS FDD 2/4/5, BT, Wi-Fi LTE Band 2/4/5/12/13/25/26/41/66/71

#### 3.2 Internal Identification of EUT used during the test

EUT ID*	IMEI	HW Version	SW Version
EUT1	015591000213265	PIO	vD41
EUT2	015591000213257	PIO	vD41
EUT3	015591000213166	PIO	vD41

\*EUT ID: is used to identify the test sample in the lab internally.

**Note:** It is performed to test HAC with the EUT1&2 and conducted power with the EUT3.

#### 3.3 Internal Identification of AE used during the test

AE ID*	Description	Model	SN	Manufacturer
AE1	Battery	CAC2900019C1	/	BYD

\*AE ID: is used to identify the test sample in the lab internally.

### 3.4 Air Interfaces / Bands Indicating Operating Modes

Air-interface	Band(MHz)	Type	C63.19/tested	Simultaneous Transmission s	OTT
GSM	850	VO	Yes	BT, WLAN	NA
	1900				
GPRS/EDGE	850	DT	Yes	BT, WLAN	Google duo
	1900				
WCDMA (UMTS)	850	VO	Yes	BT, WLAN	NA
	1700				
	1900				
	HSPA	DT	Yes	BT, WLAN	Google duo
LTE TDD	Band41	V/D	Yes	BT, WLAN	Google duo
LTE FDD	Band12/13/25/26/66/71	V/D	Yes	BT, WLAN	Google duo
BT	2450	DT	NA	GSM,WCDMA, LTE	NA
WLAN	2450	V/D	Yes	GSM,WCDMA, LTE	Google duo

NA: Not Applicable VO: Voice Only V/D: CMRS and IP Voice Service over Digital Transport  
DT: Digital Transport

\* HAC Rating was not based on concurrent voice and data modes, Non current mode was found to represent worst case rating for both M and T rating

Note1 = No Associated T-Coil measurement has been made in accordance with 285076 D02 T-Coil testing for CMRS IP



#### 4 Maximum Output Power

<b>GSM 850MHz</b>	<b>Tune up(dBm)</b>		
	<b>Channel 251(848.8MHz)</b>	<b>Channel 190(836.6MHz)</b>	<b>Channel 128(824.2MHz)</b>
Voice	33.3	33.3	33.3
EDGE	31	31	31
<b>GSM 1900MHz</b>	<b>Tune up(dBm)</b>		
	<b>Channel 810(1909.8MHz)</b>	<b>Channel 661(1880MHz)</b>	<b>Channel 512(1850.2MHz)</b>
Voice	30.3	30.3	30.3
EDGE	28	28	28
<b>WCDMA 850MHz</b>	<b>Tune up(dBm)</b>		
	<b>Channel 4233(846.6MHz)</b>	<b>Channel 4182(836.4MHz)</b>	<b>Channel 4132(826.4MHz)</b>
RMC	24	24	24
HSPA	21	21	21
<b>WCDMA 1700MHz</b>	<b>Tune up(dBm)</b>		
	<b>Channel 1513 (1752.6MHz)</b>	<b>Channel 1412 (1732.4MHz)</b>	<b>Channel 1312 (1712.4MHz)</b>
RMC	24	24	24
HSPA	21	21	21
<b>WCDMA 1900MHz</b>	<b>Tune up(dBm)</b>		
	<b>Channel 9538(1907.6MHz)</b>	<b>Channel 9400(1880MHz)</b>	<b>Channel 9262(1852.4MHz)</b>
RMC	24	24	24
HSPA	21	21	21
<b>LTE Band12</b>	<b>Tune up(dBm)</b>		
	<b>Channel 23130(711MHz)</b>	<b>Channel 23095(707.5MHz)</b>	<b>Channel23060(704MHz)</b>
QPSK	24	24	24
16QAM	23	23	23
<b>LTE Band13</b>	<b>Tune up(dBm)</b>		
	<b>Channel 23230(782MHz)</b>		
QPSK	24		
16QAM	23		
<b>LTE Band25</b>	<b>Tune up(dBm)</b>		
	<b>Channel 26590(1905MHz)</b>	<b>Channel 26365(1883MHz)</b>	<b>Channel 26140(1860MHz)</b>
QPSK	24	24	24
16QAM	23	23	23
<b>LTE Band26</b>	<b>Tune up(dBm)</b>		
	<b>Channel 26965(841.5MHz)</b>	<b>Channel 26865(831.5MHz)</b>	<b>Channel 26775(822.5MHz)</b>
QPSK	24	24	24
16QAM	23	23	23
<b>LTE Band41</b>	<b>Tune up(dBm)</b>		

<b>Power Class 2</b>	<b>Channel 41490(2680MHz)</b>	<b>Channel 40620(2593MHz)</b>	<b>Channel 39750(2506MHz)</b>
QPSK	27	27	27
16QAM	26	26	26
<b>LTE Band41</b>	<b>Tune up(dBm)</b>		
<b>Power Class 3</b>	<b>Channel 41490(2680MHz)</b>	<b>Channel 40620(2593MHz)</b>	<b>Channel 39750(2506MHz)</b>
QPSK	24	24	24
16QAM	23	23	23
<b>LTE Band66</b>	<b>Tune up(dBm)</b>		
	<b>Channel 132572(1770MHz)</b>	<b>Channel 132322(1745MHz)</b>	<b>Channel 133072(1720MHz)</b>
QPSK	24	24	24
16QAM	23	23	23
<b>LTE Band71</b>	<b>Tune up(dBm)</b>		
	<b>Channel 133372(688MHz)</b>	<b>Channel 133322(683MHz)</b>	<b>Channel 133222(673MHz)</b>
QPSK	24	24	24
16QAM	23	23	23
<b>2.4GHz 802.11b 1M</b>	<b>Tune up(dBm)</b>		
	<b>Channel 11 (2462MHz)</b>	<b>Channel 6 (2437MHz)</b>	<b>Channel 1 (2412MHz)</b>
	21	21	20

Note: For LTE Band 41, UL-DL Configuration 1 was used to evaluate Power Class 2 and UL-DL Configuration 4 was used to evaluate Power Class 3.

## 5 Reference Documents

### 5.1 Reference Documents for testing

The following document listed in this section is referred for testing.

Reference	Title	Version
ANSI C63.19-2011	American National Standard for Methods of Measurement of Compatibility between Wireless Communication Devices and Hearing Aids	2011 Edition
FCC 47 CFR §20.19	Hearing Aid Compatible Mobile Headsets	2015 Edition
KDB 285076 D01	Equipment Authorization Guidance for Hearing Aid Compatibility	v05

## 6 OPERATIONAL CONDITIONS DURING TEST

### 6.1 HAC MEASUREMENT SET-UP

These measurements are performed using the DASY5 NEO automated dosimetric assessment system. It is made by Schmid & Partner Engineering AG (SPEAG) in Zurich, Switzerland. It consists of high precision robotics system (Stäubli), robot controller, Intel Core2 computer, near-field probe, probe alignment sensor. The robot is a six-axis industrial robot performing precise movements. A cell controller system contains the power supply, robot controller, teach pendant (Joystick), and remote control, is used to drive the robot motors. The PC consists of the HP Intel Core21.86 GHz computer with Windows XP system and HAC Measurement Software DASY5 NEO, A/D interface card, monitor, mouse, and keyboard. The Stäubli Robot is connected to the cell controller to allow software manipulation of the robot. A data acquisition electronic (DAE) circuit performs the signal amplification, signal multiplexing, AD-conversion, offset measurements, mechanical surface detection, collision detection, etc. is connected to the Electro-optical coupler (EOC). The EOC performs the conversion from the optical into digital electric signal of the DAE and transfers data to the PC plug-in card.

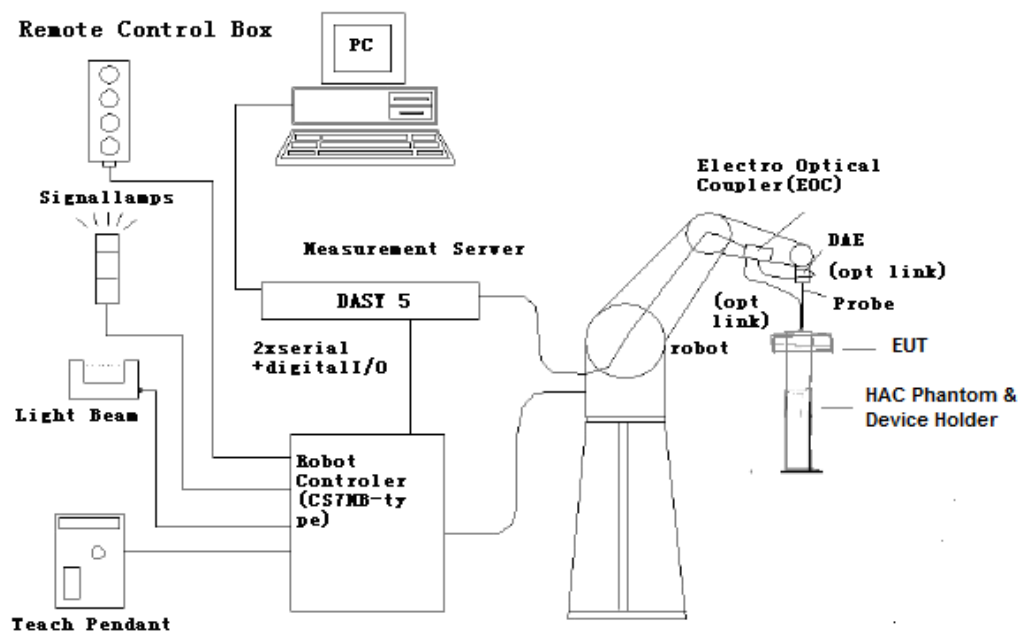

**Fig. 1 HAC Test Measurement Set-up**

The DAE4 consists of a highly sensitive electrometer-grade preamplifier with auto-zeroing, a channel and gain-switching multiplexer, a fast 16 bit AD-converter and a command decoder and control logic unit. Transmission to the PC-card is accomplished through an optical downlink for data and status information and an optical uplink for commands and clock lines. The mechanical probe mounting device includes two different sensor systems for frontal and sidewise probe contacts. They are also used for mechanical surface detection and probe collision detection. The robot uses its own controller with a built in VME-bus computer.

## 6.2 Probe Specification

### E-Field Probe Description

Construction	One dipole parallel, two dipoles normal to probe axis Built-in shielding against static charges PEEK enclosure material
Calibration	In air from 100 MHz to 3.0 GHz (absolute accuracy $\pm 6.0\%$ , $k=2$ )
Frequency	40 MHz to > 6 GHz (can be extended to < 20 MHz) Linearity: $\pm 0.2$ dB (100 MHz to 3 GHz)
Directivity	$\pm 0.2$ dB in air (rotation around probe axis) $\pm 0.4$ dB in air (rotation normal to probe axis)
Dynamic Range	2 V/m to > 1000 V/m; Linearity: $\pm 0.2$ dB
Dimensions	Overall length: 330 mm (Tip: 16 mm) Tip diameter: 8 mm (Body: 12 mm) Distance from probe tip to dipole centers: 2.5 mm
Application	General near-field measurements up to 6 GHz Field component measurements Fast automatic scanning in phantoms

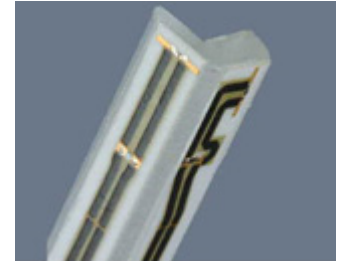

**[ER3DV6]**

### 6.3 Test Arch Phantom & Phone Positioner

The Test Arch phantom should be positioned horizontally on a stable surface. Reference markings on the Phantom allow the complete setup of all predefined phantom positions and measurement grids by manually teaching three points in the robot. It enables easy and well defined positioning of the phone and validation dipoles as well as simple teaching of the robot (Dimensions: 370 x 370 x 370 mm).

The Phone Positioner supports accurate and reliable positioning of any phone with effect on near field  $< \pm 0.5$  dB.

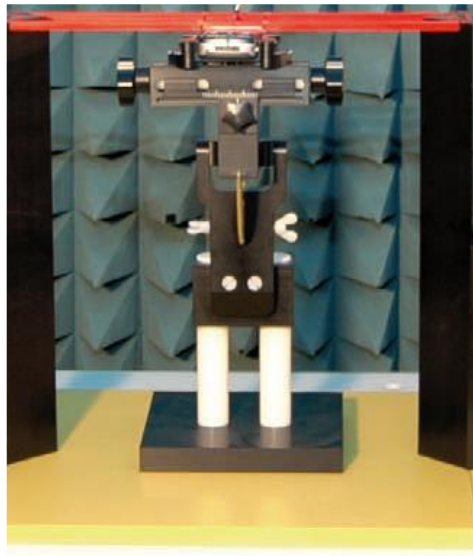

Fig. 2 HAC Phantom & Device Holder

### 6.4 Robotic System Specifications

#### Specifications

**Positioner:** Stäubli Unimation Corp. Robot Model: RX160L

**Repeatability:**  $\pm 0.02$  mm

**No. of Axis:** 6

#### Data Acquisition Electronic (DAE) System

##### Cell Controller

**Processor:** Intel Core2

**Clock Speed:** 1.86GHz

**Operating System:** Windows XP

##### Data Converter

**Features:** Signal Amplifier, multiplexer, A/D converter, and control logic

**Software:** DASY5 software

**Connecting Lines:** Optical downlink for data and status info.

Optical uplink for commands and clock

## 7 EUT ARRANGEMENT

### 7.1 WD RF Emission Measurements Reference and Plane

Figure 4 illustrates the references and reference plane that shall be used in the WD emissions measurement.

- The grid is 5 cm by 5 cm area that is divided into 9 evenly sized blocks or sub-grids.
- The grid is centered on the audio frequency output transducer of the WD (speaker or T-coil).
- The grid is located by reference to a reference plane. This reference plane is the planar area that contains the highest point in the area of the WD that normally rests against the user's ear
- The measurement plane is located parallel to the reference plane and 15 mm from it, out from the phone. The grid is located in the measurement plane.

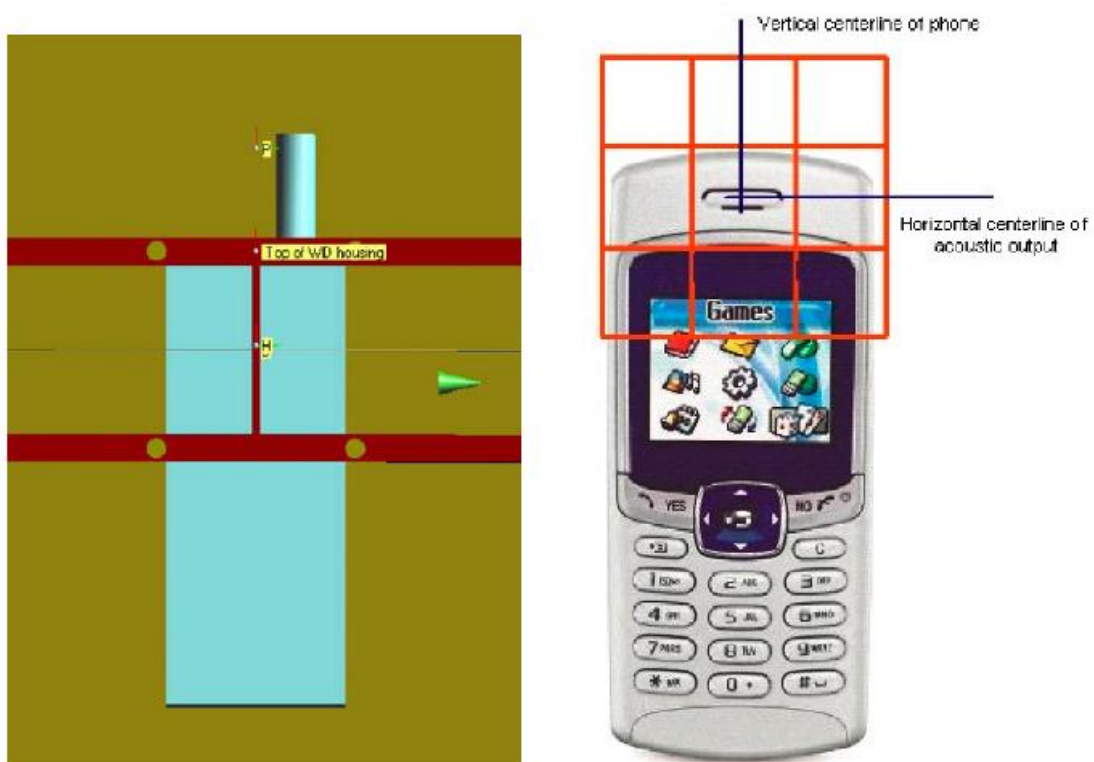

Fig. 3 WD reference and plane for RF emission measurements

## 8 SYSTEM VALIDATION

### 8.1 Validation Procedure

Place a dipole antenna meeting the requirements given in ANSI C63.19 in the position normally occupied by the WD. The dipole antenna serves as a known source for an electrical output. Position the E-field probes so that:

- The probes and their cables are parallel to the coaxial feed of the dipole antenna
- The probe cables and the coaxial feed of the dipole antenna approach the measurement area from opposite directions
- The center point of the probe element(s) are 15 mm from the closest surface of the dipole elements.

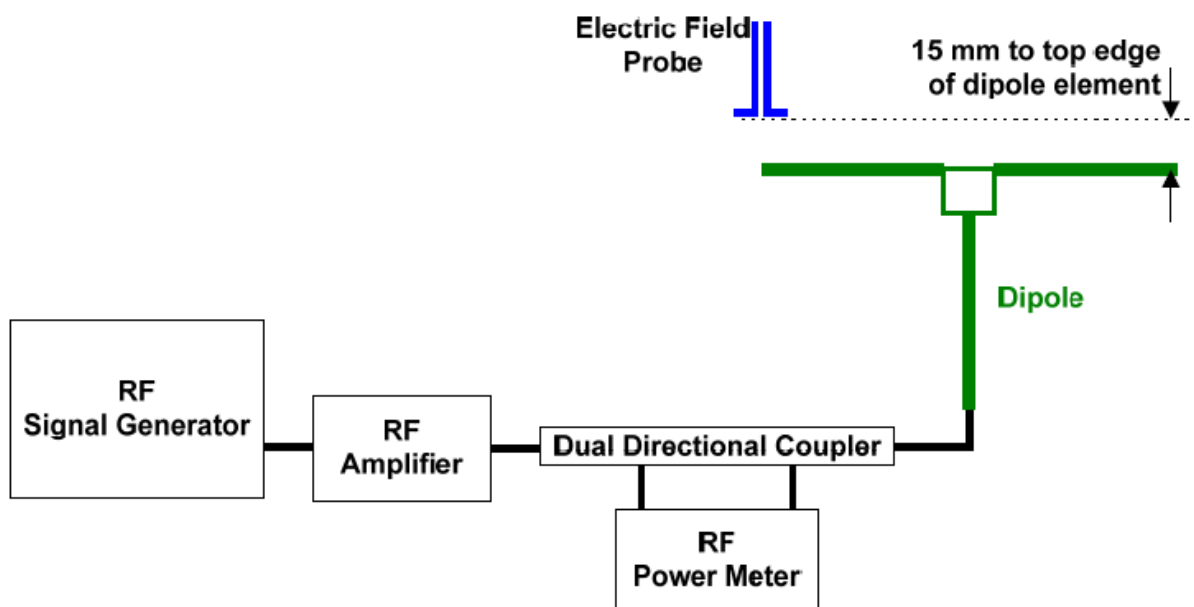

Fig. 4 Dipole Validation Setup

### 8.2 Validation Result

E-Field Scan						
Mode	Frequency (MHz)	Input Power (mW)	Measured <sup>1</sup> Value(dBV/m)	Target <sup>2</sup> Value(dBV/m)	Deviation <sup>3</sup> (%)	Limit <sup>4</sup> (%)
CW	835	100	40.73	40.56	1.98	±25
CW	1880	100	39.02	38.89	1.51	±25
CW	2600	100	38.61	38.57	0.46	±25

Notes:

1. Please refer to the attachment for detailed measurement data and plot.
2. Target value is provided by SPEAD in the calibration certificate of specific dipoles.
3. Deviation (%) =  $100 * (\text{Measured value minus Target value}) / \text{Target value}$ .
4. ANSI C63.19 requires values within  $\pm 25\%$  are acceptable, of which 12% is deviation and 13% is measurement uncertainty. Values independently validated for the dipole actually used in the measurements should be used, when available.

## 9 Evaluation of MIF

### 9.1 Introduction

The MIF (Modulation Interference Factor) is used to classify E-field emission to determine Hearing Aid Compatibility (HAC). It scales the power-averaged signal to the RF audio interference level and is characteristic to a modulation scheme. The HAC standard preferred "indirect" measurement method is based on average field measurement with separate scaling by the MIF. With an Audio Interference Analyzer (AIA) designed by SPEAG specifically for the MIF measurement, these values have been verified by practical measurements on an RF signal modulated with each of the waveforms. The resulting deviations from the simulated values are within the requirements of the HAC standard.

The AIA (Audio Interference Analyzer) is a USB powered electronic sensor to evaluate signals in the frequency range 698MHz - 6 GHz. It contains RMS detector and audio frequency circuits for sampling of the RF envelope.

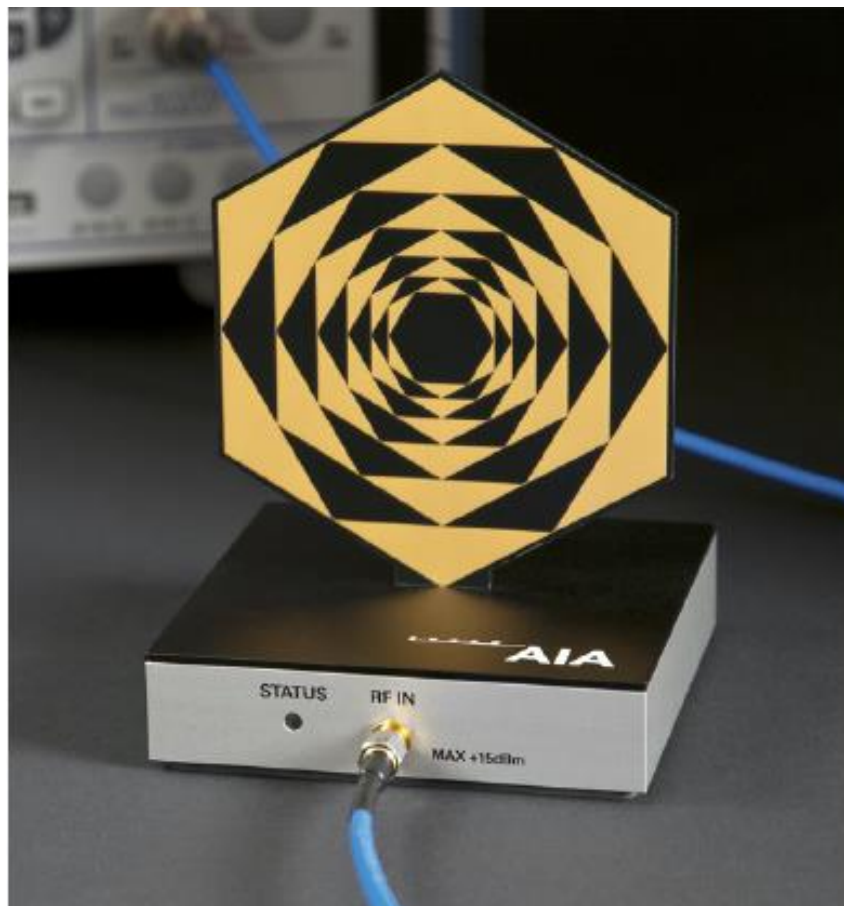

Fig. 5 AIA Front View



## 9.2 MIF measurement with the AIA

The MIF is measured with the AIA as follows:

1. Connect the AIA via USB to the DASY5 PC and verify the configuration settings.
2. Couple the RF signal to be evaluated to an AIA via cable or antenna.
3. Generate a MIF measurement job for the unknown signal and select the measurement port and timing settings.
4. Document the results via the post processor in a report.

## 9.3 Test equipment for the MIF measurement

No.	Name	Type	Serial Number	Manufacturer
01	Signal Generator	E4438C	MY49071430	Agilent
02	AIA	SE UMS 170 CB	1029	SPEAG
03	BTS	E5515C	MY50263375	Agilent

## 9.4 Test signal validation

The signal generator (E4438C) is used to generate a 1GHz signal with different modulation in the below table based on the ANSI C63.19-2011. The measured MIF with AIA are compared with the target values given in ANSI C63.19-2011 table D.3, D.4 and D5.

<b>Pulse modulation</b>	<b>Target MIF</b>	<b>Measured MIF</b>	<b>Deviation</b>
0.5ms pulse, 1000Hz repetition rate	-0.9 dB	-0.9 dB	0 dB
1ms pulse, 100Hz repetition rate	+3.9 dB	+3.7 dB	0.2 dB
0.1ms pulse, 100Hz repetition rate	+10.1 dB	+10.0 dB	0.1 dB
10ms pulse, 10Hz repetition rate	+1.6 dB	+1.7 dB	0.1 dB
<b>Sine-wave modulation</b>	<b>Target MIF</b>	<b>Measured MIF</b>	<b>Deviation</b>
1 kHz, 80% AM	-1.2 dB	-1.3 dB	0.1 dB
1 kHz, 10% AM	-9.1 dB	-9.0 dB	0.1 dB
1 kHz, 1% AM	-19.1 dB	-18.9 dB	0.2 dB
100 Hz, 10% AM	-16.1 dB	-16.0 dB	0.1 dB
10 kHz, 10% AM	-21.5 dB	-21.6 dB	0.1 dB
<b>Transmission protocol</b>	<b>Target MIF</b>	<b>Measured MIF</b>	<b>Deviation</b>
GSM; full-rate version 2; speech codec/handset low	+3.5 dB	+3.47 dB	0.03 dB
WCDMA; speech; speech codec low; AMR 12.2 kb/s	-20.0 dB	-19.8 dB	0.2 dB
CDMA; speech; SO3; RC3; full frame rate; 8kEVRC	-19.0 dB	-19.1 dB	0.1 dB
CDMA; speech; SO3; RC1; 1/8 <sup>th</sup> frame rate; 8kEVRC	+3.3 dB	+3.44 dB	0.14 dB

### 9.5 DUT MIF results

Typical MIF levels in ANSI C63.19-2011	
Transmission protocol	Modulation interference factor
GSM; full-rate version 2; speech codec/handset low	+3.5 dB
EDGE-FDD (TDMA, 8PSK, TN 0-1-2)	-0.52dB
EDGE-FDD (TDMA, 8PSK, TN 0-1-2-3)	-2.05dB
WCDMA; speech; speech codec low; AMR 12.2 kb/s	-20.0 dB
UMTS-FDD (HSPA)	-20.75dB
LTE-FDD (SC-FDMA, 1RB, 20MHz, QPSK)	-15.63 dB
LTE-FDD (SC-FDMA, 1RB, 20MHz, 16QAM)	-9.76 dB
LTE-FDD (SC-FDMA, 1RB, 20MHz, 64QAM)	-9.93 dB
LTE-TDD (SC-FDMA, 1RB, 20MHz, QPSK)	-1.62 dB
LTE-TDD (SC-FDMA, 1RB, 20MHz, 16QAM)	-1.44 dB
LTE-TDD (SC-FDMA, 1RB, 20MHz, 64QAM)	-1.54 dB
CDMA; speech; SO3; RC1; 1/8 <sup>th</sup> frame rate; 8kEVRC	+3.3 dB

Measured MIF for GSM							
Band		GSM 850 2TX			GSM 1900 2TX		
Channel		251	190	128	810	661	512
Mode	Voice	3.48	3.49	3.43	3.5	3.42	3.51
	EDGE	1.36	1.32	1.29	1.41	1.36	1.33

Measured MIF for WCDMA										
Band		WCDMA 850			WCDMA 1700			WCDMA 1900		
Channel		4458	4407	4357	1738	1637	1537	9938	9800	9662
Mode	RMC	-23.78	-23.56	-22.59	-22.71	-23.05	-22.69	-23.13	-23.37	-22.89
	HSUPA	-22.81	-23.26	-22.42	-23.46	-22.08	-23.30	-22.99	-22.43	-22.93

**QPSK**

Measured MIF levels		
Band	Channel	Modulation interference factor
Band12	23130	-13.97
	23095	-14.08
	23060	-14.11
Band13	23230	-14.38
Band25	26590	-13.79
	26365	-13.22
	26140	-14.78
Band26	26965	-13.02
	26865	-14.64
	26775	-14.59
Band66	132572	-14.01
	132322	-13.73
	132072	-13.13
Band71	133372	-14.96
	133322	-14.85
	133222	-13.39
Band41 (PC2)	41490	-1.71
	41055	-1.78
	40620	-1.73
	40185	-1.73
	39750	-1.75
Band41(PC3)	41490	-2.37
	41055	-2.44
	40620	-2.39
	40185	-2.37
	39750	-2.43

Note: For LTE Band 41, UL-DL Configuration 1 was used to evaluate Power Class 2 and UL-DL Configuration 4 was used to evaluate Power Class 3.

**16QAM**

Measured MIF levels		
Band	Channel	Modulation interference factor
Band12	23130	-11.05
	23095	-11.62
	23060	-11.43
Band13	23230	-11.85
Band25	26590	-11.88

	26365	-10.74
	26140	-10.72
Band26	26965	-11.75
	26865	-11.04
	26775	-11.26
Band66	132572	-11.21
	132322	-10.83
	132072	-10.68
Band71	133372	-11.26
	133322	-11.77
	133222	-11.46
Band41 (PC2)	41490	-1.8
	41055	-1.76
	40620	-1.65
	40185	-1.82
	39750	-1.58
Band41(PC3)	41490	-2.28
	41055	-2.24
	40620	-2.41
	40185	-2.21
	39750	-2.17

Note: For LTE Band 41, UL-DL Configuration 1 was used to evaluate Power Class 2 and UL-DL Configuration 4 was used to evaluate Power Class 3.

### WiFi

2.4GHz	11	-7.94
802.11b	6	-8.21
1M	1	-8.85

## 10 Evaluation for low-power exemption

### 10.1 Product testing threshold

There are two methods for exempting an RF air interface technology from testing. The first method requires evaluation of the MIF for the worst-case operating mode. An RF air interface technology of a device is exempt from testing when its average antenna input power plus its MIF is  $\leq 17$  dBm for any of its operating modes. The second method does not require determination of the MIF. The RF emissions testing exemption shall be applied to an RF air interface technology in a device whose peak antenna input power, averaged over intervals  $\leq 50 \mu s$ , is  $\leq 23$  dBm. An RF air interface technology that is exempted from testing by either method shall be rated as M4.

The first method is used to be exempt from testing for the RF air interface technology in this report.

## 10.2 Conducted power

Band	Average power (dBm)	MIF (dB)	Sum (dBm)	C63.19 Tested
GSM 850 - Voice	33.3	3.49	36.79	Yes
GSM 850 - EDGE	31	1.36	32.36	Yes*
GSM 1900 - Voice	30.3	3.51	33.81	Yes
GSM 1900 - EDGE	28	1.41	29.41	Yes*
WCDMA 850 - RMC	24	-22.59	1.41	No
WCDMA 850 - HSPA	21	-22.26	-1.26	No
WCDMA 1700 - RMC	24	-22.69	1.31	No
WCDMA 1700 - HSPA	21	-22.08	-1.08	No
WCDMA 1900 - RMC	24	-22.89	1.11	No
WCDMA 1900 - HSPA	21	-22.43	-1.43	No
LTE Band 12 QPSK	24	-13.97	10.03	No
LTE Band 13 QPSK	24	-14.38	9.62	No
LTE Band 25 QPSK	24	-13.22	10.78	No
LTE Band 26 QPSK	24	-13.02	10.98	No
LTE Band 66 QPSK	24	-13.13	10.87	No
LTE Band 71 QPSK	24	-13.39	10.61	No
LTE Band 41 Power Class 2 QPSK	27	-1.71	25.29	Yes
LTE Band 41 Power Class 3 QPSK	24	-2.37	21.63	Yes
LTE Band 12 16QAM	23	-11.05	11.95	No
LTE Band 13 16QAM	23	-11.85	11.15	No
LTE Band 25 16QAM	23	-10.72	12.28	No
LTE Band 26 16QAM	23	-11.04	11.96	No
LTE Band 66 16QAM	23	-10.68	12.32	No
LTE Band 71 16QAM	23	-11.26	11.74	No
LTE Band 41 Power Class 2 16QAM	26	-1.58	24.42	Yes
LTE Band 41 Power Class 3 16QAM	23	-2.17	20.83	Yes
WiFi-2.4G	21	-7.94	13.06	No

\*Note: For GSM bands, EDGE modes were not evaluated as Voice modes were found to be the worst-case modes for the GSM air interface.

## 10.3 Conclusion

According to the above table, the sums of average power and MIF for WCDMA, LTE FDD and WiFi are less than 17dBm. So it is measured for GSM and LTE TDD bands. The WCDMA, LTE FDD and WiFi are exempt from testing and rated as M4.

## 11 RF TEST PROCEDURES

**The evaluation was performed with the following procedure:**

- 1) Confirm proper operation of the field probe, probe measurement system and other instrumentation and the positioning system.
- 2) Position the WD in its intended test position. The gauge block can simplify this positioning.
- 3) Configure the WD normal operation for maximum rated RF output power, at the desired channel and other operating parameters (e.g., test mode), as intended for the test.
- 4) The center sub-grid shall be centered on the center of the T-Coil mode axial measurement point or the acoustic output, as appropriate. Locate the field probe at the initial test position in the 50 mm by 50 mm grid, which is contained in the measurement plane. If the field alignment method is used, align the probe for maximum field reception.
- 5) Record the reading.
- 6) Scan the entire 50 mm by 50 mm region in equally spaced increments and record the reading at each measurement point. The distance between measurement points shall be sufficient to assure the identification of the maximum reading.
- 7) Identify the five contiguous sub-grids around the center sub-grid whose maximum reading is the lowest of all available choices. This eliminates the three sub-grids with the maximum readings. Thus, the six areas to be used to determine the WD's highest emissions are identified.
- 8) Identify the maximum field reading within the non-excluded sub-grids identified in Step 7)
- 9) Evaluate the MIF and add to the maximum steady-state rms field-strength reading to obtain the RF audio interference level..
- 10) Compare this RF audio interference level with the categories and record the resulting WD category rating.

## 12 Measurement Results (E-Field)

Frequency		Measured Value(dBV/m)	Power Drift (dB)	Category
MHz	Channel			
<b>GSM 850</b>				
848.8	251	33.16	0	<b>M4</b> (see Fig B.1)
836.6	190	32.66	0.06	<b>M4</b> (see Fig B.2)
824.2	128	33.69	-0.02	<b>M4</b> (see Fig B.3)
<b>GSM 1900</b>				
1909.8	810	25.37	0.03	<b>M4</b> (see Fig B.4)
1880	661	24.76	0.17	<b>M4</b> (see Fig B.5)
1850.2	512	24.24	0.05	<b>M4</b> (see Fig B.6)
<b>LTE Band 41 QPSK Power Class 2</b>				
2680	41490	19.99	-0.11	<b>M4</b> (see Fig B.7)
2636.5	41055	21.27	-0.04	<b>M4</b> (see Fig B.8)
2593	40620	21.50	-0.03	<b>M4</b> (see Fig B.9)
2549.5	40185	21.52	-0.08	<b>M4</b> (see Fig B.10)
2506	39750	20.56	-0.04	<b>M4</b> (see Fig B.11)
<b>LTE Band 41 16QAM Power Class 2</b>				
2680	41490	20.11	-0.09	<b>M4</b> (see Fig B.12)
2636.5	41055	21.40	-0.08	<b>M4</b> (see Fig B.13)
2593	40620	21.74	-0.03	<b>M4</b> (see Fig B.14)
2549.5	40185	21.54	-0.07	<b>M4</b> (see Fig B.15)
2506	39750	20.78	0.02	<b>M4</b> (see Fig B.16)
<b>LTE Band 41 QPSK Power Class 3</b>				
2680	41490	20.02	-0.02	<b>M4</b> (see Fig B.17)
2636.5	41055	21.40	-0.08	<b>M4</b> (see Fig B.18)
2593	40620	21.68	-0.08	<b>M4</b> (see Fig B.19)
2549.5	40185	21.50	-0.14	<b>M4</b> (see Fig B.20)
2506	39750	20.72	-0.06	<b>M4</b> (see Fig B.21)
<b>LTE Band 41 16QAM Power Class 3</b>				
2680	41490	19.27	-0.02	<b>M4</b> (see Fig B.22)
2636.5	41055	20.48	-0.05	<b>M4</b> (see Fig B.23)
2593	40620	20.82	-0.13	<b>M4</b> (see Fig B.24)
2549.5	40185	20.68	-0.07	<b>M4</b> (see Fig B.25)
2506	39750	19.85	-0.07	<b>M4</b> (see Fig B.26)

Note: For LTE Band 41, UL-DL Configuration 1 was used to evaluate Power Class 2 and UL-DL Configuration 4 was used to evaluate Power Class 3.

### 13 ANSIC 63.19-2011 LIMITS

#### WD RF audio interference level categories in logarithmic units

<b>Emission categories</b>	<b>&lt; 960 MHz</b>	<b>E-field emissions</b>
Category M1	50 to 55	dB (V/m)
Category M2	45 to 50	dB (V/m)
Category M3	40 to 45	dB (V/m)
Category M4	< 40	dB (V/m)
<b>Emission categories</b>	<b>&gt; 960 MHz</b>	<b>E-field emissions</b>
Category M1	40 to 45	dB (V/m)
Category M2	35 to 40	dB (V/m)
Category M3	30 to 35	dB (V/m)
Category M4	< 30	dB (V/m)



## 14 MEASUREMENT UNCERTAINTY

No.	Error source	Type	Uncertainty Value(%)	Prob. Dist.	k	c <sub>i</sub> E	Standard Uncertainty (%) u <sub>i</sub> (%)E	Degree of freedom V <sub>eff</sub> or v <sub>i</sub>
<b>Measurement System</b>								
1	Probe Calibration	B	5.	N	1	1	5.1	∞
2	Axial Isotropy	B	4.7	R	$\sqrt{3}$	1	2.7	∞
3	Sensor Displacement	B	16.5	R	$\sqrt{3}$	1	9.5	∞
4	Boundary Effects	B	2.4	R	$\sqrt{3}$	1	1.4	∞
5	Linearity	B	4.7	R	$\sqrt{3}$	1	2.7	∞
6	Scaling to Peak Envelope Power	B	2.0	R	$\sqrt{3}$	1	1.2	∞
7	System Detection Limit	B	1.0	R	$\sqrt{3}$	1	0.6	∞
8	Readout Electronics	B	0.3	N	1	1	0.3	∞
9	Response Time	B	0.8	R	$\sqrt{3}$	1	0.5	∞
10	Integration Time	B	2.6	R	$\sqrt{3}$	1	1.5	∞
11	RF Ambient Conditions	B	3.0	R	$\sqrt{3}$	1	1.7	∞
12	RF Reflections	B	12.0	R	$\sqrt{3}$	1	6.9	∞
13	Probe Positioner	B	1.2	R	$\sqrt{3}$	1	0.7	∞
14	Probe Positioning	A	4.7	R	$\sqrt{3}$	1	2.7	∞
15	Extra. And Interpolation	B	1.0	R	$\sqrt{3}$	1	0.6	∞
<b>Test Sample Related</b>								
16	Device Positioning Vertical	B	4.7	R	$\sqrt{3}$	1	2.7	∞
17	Device Positioning Lateral	B	1.0	R	$\sqrt{3}$	1	0.6	∞
18	Device Holder and Phantom	B	2.4	R	$\sqrt{3}$	1	1.4	∞
19	Power Drift	B	5.0	R	$\sqrt{3}$	1	2.9	∞

20	AIA measurement	B	12	R	$\sqrt{3}$	1	6.9	$\infty$
<b>Phantom and Setup related</b>								
21	Phantom Thickness	B	2.4	R	$\sqrt{3}$	1	1.4	$\infty$
Combined standard uncertainty(%)							16.2	
Expanded uncertainty (confidence interval of 95 %)		$u_e = 2u_c$		N	k=2		32.4	

## 15 MAIN TEST INSTRUMENTS

**Table 1: List of Main Instruments**

No.	Name	Type	Serial Number	Calibration Date	Valid Period
01	Signal Generator	E4438C	MY49071430	January 23, 2019	One Year
02	Power meter	NRP2	106277	September 4, 2019	One year
03	Power sensor	NRP8S	104291		
04	Amplifier	60S1G4	0331848	No Calibration Requested	
05	E-Field Probe	EF3DV3	4060	May 17, 2019	One year
06	DAE	SPEAG DAE4	771	January 11, 2019	One year
07	HAC Dipole	CD835V3	1023	August 26, 2019	One year
08	HAC Dipole	CD1880V3	1018	August 26, 2019	One year
09	HAC Dipole	CD2600V3	1017	August 23, 2019	One year
10	BTS	E5515C	MY50263375	January 17, 2019	One year
11	AIA	SE UMS 170 CB	1029	No Calibration Requested	

## 16 CONCLUSION

The HAC measurement indicates that the EUT complies with the HAC limits of the ANSIC63.19-2011. The total M-rating is **M4**.

\*\*\*END OF REPORT BODY\*\*\*

## ANNEX A TEST LAYOUT

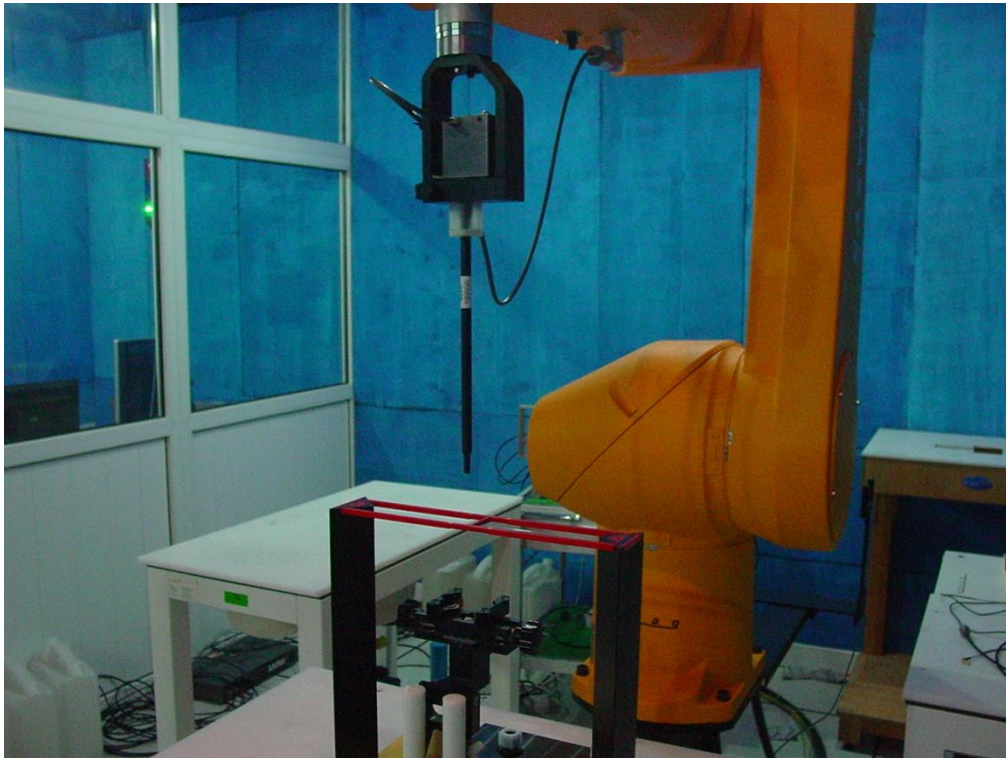

Picture A1:HAC RF System Layout

## ANNEX B TEST PLOTS

### HAC RF E-Field GSM 850 High

Date: 2019-10-29

Electronics: DAE4 Sn771

Medium: Air

Medium parameters used:  $\sigma = 0$  mho/m,  $\epsilon_r = 1$ ;  $\rho = 1000$  kg/m<sup>3</sup>

Ambient Temperature: 22.0°C

Communication System: GSM 850; Frequency: 848.8 MHz; Duty Cycle: 1:8.3

Probe: EF3DV3 - SN4060;ConvF(1, 1, 1)

GSM850/E Scan - ER3DV6 - 2011: 15 mm from Probe Center to the

Device/Hearing Aid Compatibility Test (101x101x1): Interpolated grid:

dx=0.5000 mm, dy=0.5000 mm

Device Reference Point: 0, 0, -6.3 mm

Reference Value = 41.30 V/m; Power Drift = -0.00 dB

Applied MIF = 3.48 dB

RF audio interference level = 33.16 dBV/m

Emission category: **M4**

MIF scaled E-field

Grid 1 <b>M4</b> 32.25 dBV/m	Grid 2 <b>M4</b> 32.61 dBV/m	Grid 3 <b>M4</b> 32.14 dBV/m
Grid 4 <b>M4</b> 32.81 dBV/m	Grid 5 <b>M4</b> 33.16 dBV/m	Grid 6 <b>M4</b> 32.58 dBV/m
Grid 7 <b>M4</b> 32.85 dBV/m	Grid 8 <b>M4</b> 33.24 dBV/m	Grid 9 <b>M4</b> 32.56 dBV/m

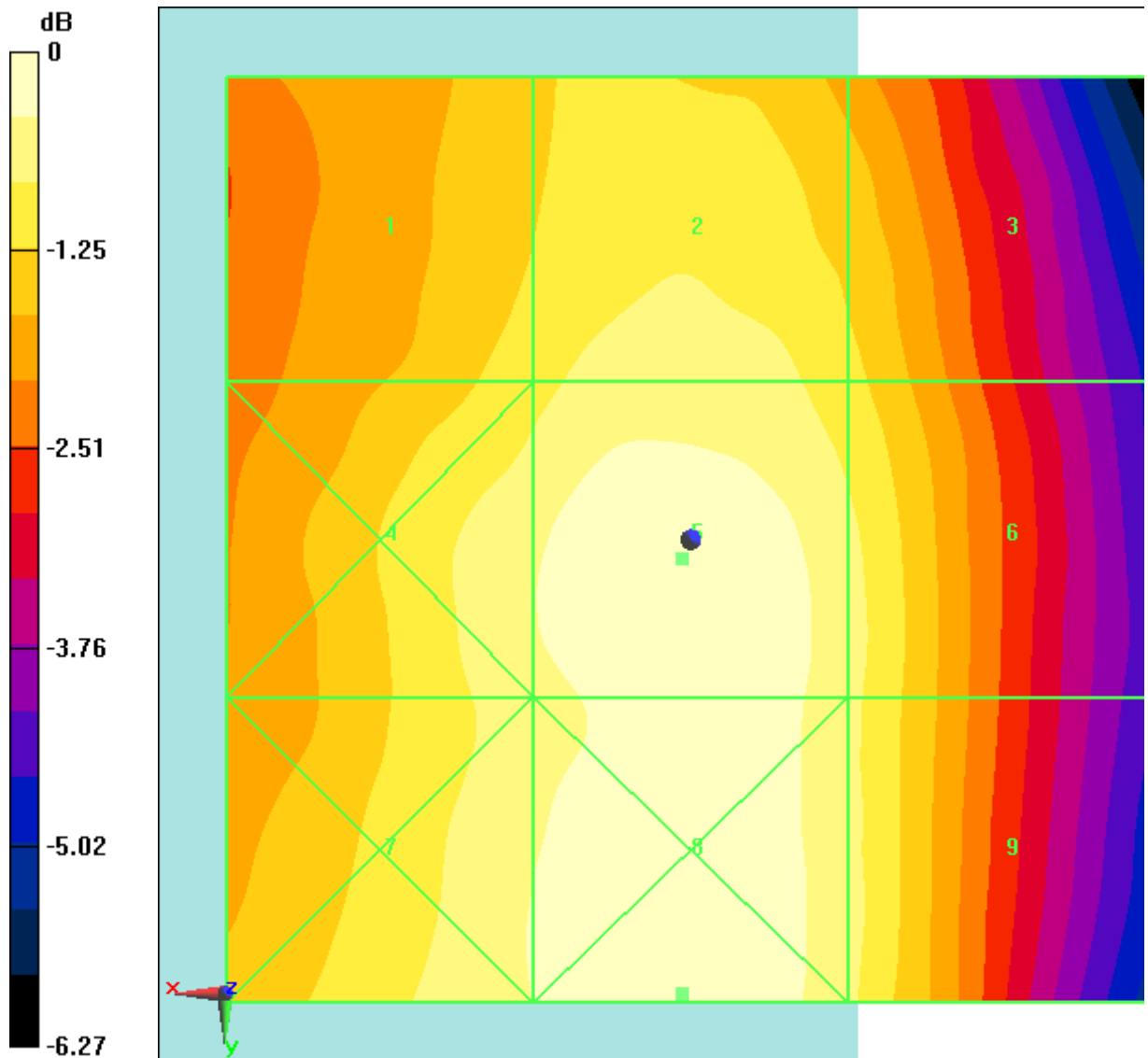

0 dB = 45.91 V/m = 33.24 dBV/m

**Fig B.1 HAC RF E-Field GSM 850 High**

**HAC RF E-Field GSM 850 Middle**

**Date: 2019-10-29**

Electronics: DAE4 Sn771

Medium: Air

Medium parameters used:  $\sigma = 0$  mho/m,  $\epsilon_r = 1$ ;  $\rho = 1000$  kg/m<sup>3</sup>

Ambient Temperature: 22.0°C

Communication System: GSM 850; Frequency: 836.6 MHz; Duty Cycle: 1:8.3

Probe: EF3DV3 - SN4060;ConvF(1, 1, 1)

GSM850/E Scan - ER3DV6 - 2011: 15 mm from Probe Center to the Device

2/Hearing Aid Compatibility Test (101x101x1): Interpolated grid:

dx=0.5000 mm, dy=0.5000 mm

Device Reference Point: 0, 0, -6.3 mm

Reference Value = 38.82 V/m; Power Drift = 0.06 dB

Applied MIF = 3.49 dB

RF audio interference level = 32.66 dBV/m

**Emission category: M4**

MIF scaled E-field

Grid 1 M4 31.79 dBV/m	Grid 2 M4 32.16 dBV/m	Grid 3 M4 31.68 dBV/m
Grid 4 M4 32.24 dBV/m	Grid 5 M4 32.66 dBV/m	Grid 6 M4 32.06 dBV/m
Grid 7 M4 32.36 dBV/m	Grid 8 M4 32.78 dBV/m	Grid 9 M4 32.1 dBV/m

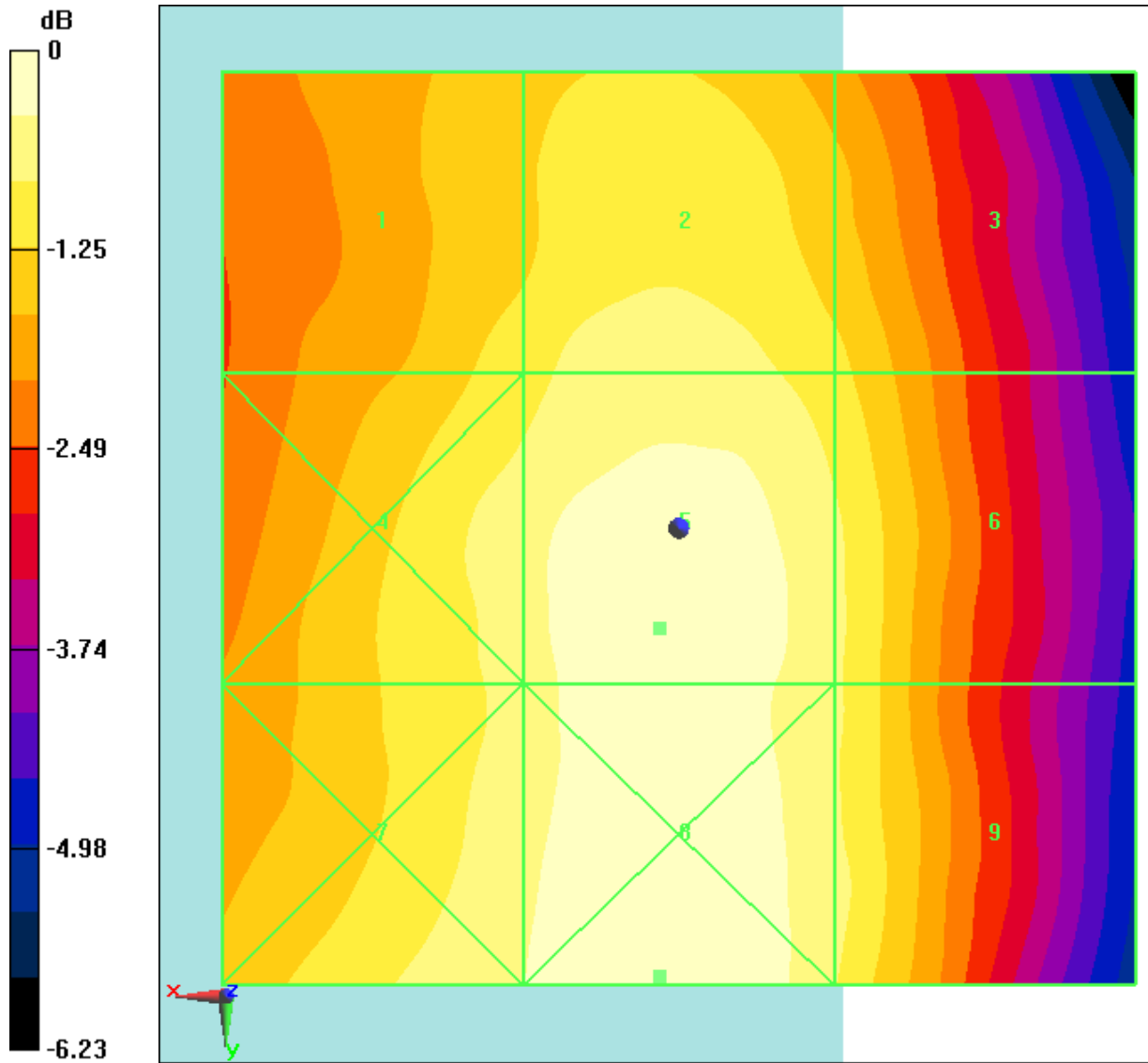

0 dB = 43.55 V/m = 32.78 dBV/m

**Fig B.2 HAC RF E-Field GSM 850 Middle**

**HAC RF E-Field GSM 850 Low**

**Date: 2019-10-29**

Electronics: DAE4 Sn771

Medium: Air

Medium parameters used:  $\sigma = 0$  mho/m,  $\epsilon_r = 1$ ;  $\rho = 1000$  kg/m<sup>3</sup>

Ambient Temperature: 22.0°C

Communication System: GSM 850; Frequency: 824.2 MHz; Duty Cycle: 1:8.3

Probe: EF3DV3 - SN4060;ConvF(1, 1, 1)

GSM850/E Scan - ER3DV6 - 2011: 15 mm from Probe Center to the Device

3/Hearing Aid Compatibility Test (101x101x1): Interpolated grid:

dx=0.5000 mm, dy=0.5000 mm

Device Reference Point: 0, 0, -6.3 mm

Reference Value = 44.31 V/m; Power Drift = -0.02 dB

Applied MIF = 3.43 dB

RF audio interference level = 33.69 dBV/m

**Emission category: M4**

MIF scaled E-field

Grid 1 M4 32.67 dBV/m	Grid 2 M4 33.26 dBV/m	Grid 3 M4 32.8 dBV/m
Grid 4 M4 33.15 dBV/m	Grid 5 M4 33.69 dBV/m	Grid 6 M4 33.12 dBV/m
Grid 7 M4 33.2 dBV/m	Grid 8 M4 33.65 dBV/m	Grid 9 M4 33.09 dBV/m



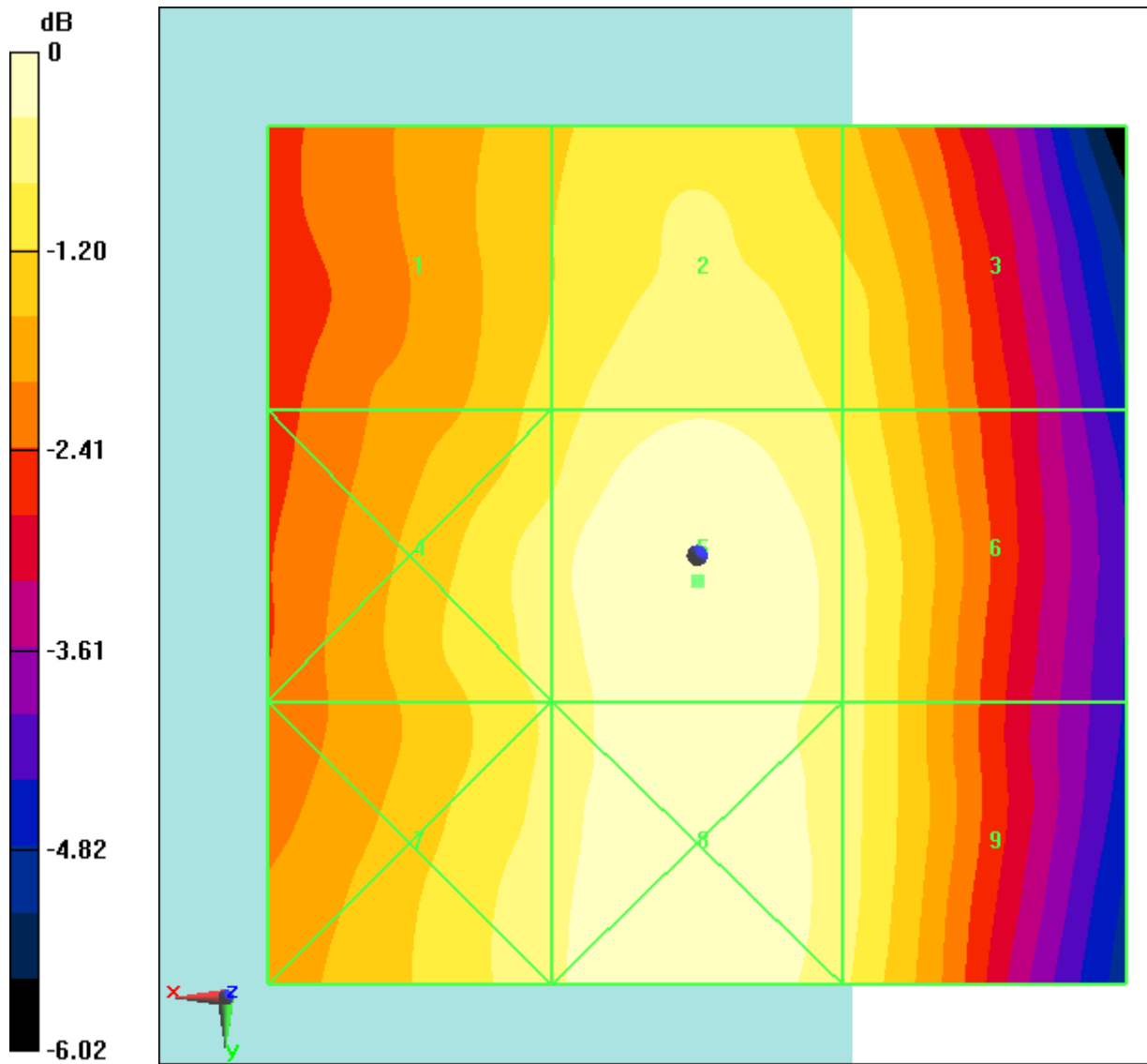

0 dB = 48.36 V/m = 33.69 dBV/m

**Fig B.3 HAC RF E-Field GSM 850 Low**

**HAC RF E-Field GSM 1900 High**

**Date: 2019-10-29**

Electronics: DAE4 Sn771

Medium: Air

Medium parameters used:  $\sigma = 0$  mho/m,  $\epsilon_r = 1$ ;  $\rho = 1000$  kg/m<sup>3</sup>

Ambient Temperature: 22.0°C

Communication System: PCS 1900; Frequency: 1909.8 MHz; Duty Cycle: 1:8.3

Probe: EF3DV3 - SN4060;ConvF(1, 1, 1)

GSM1900/E Scan - ER3DV6 - 2011: 15 mm from Probe Center to the

Device/Hearing Aid Compatibility Test (101x101x1): Interpolated grid:

dx=0.5000 mm, dy=0.5000 mm

Device Reference Point: 0, 0, -6.3 mm

Reference Value = 13.24 V/m; Power Drift = 0.03 dB

Applied MIF = 3.50 dB

RF audio interference level = 25.37 dBV/m

**Emission category: M4**

MIF scaled E-field

Grid 1 M4 22.83 dBV/m	Grid 2 M4 21.73 dBV/m	Grid 3 M4 22.52 dBV/m
Grid 4 M4 24.21 dBV/m	Grid 5 M4 25.37 dBV/m	Grid 6 M4 24.86 dBV/m
Grid 7 M4 26.23 dBV/m	Grid 8 M4 26.53 dBV/m	Grid 9 M4 25.65 dBV/m

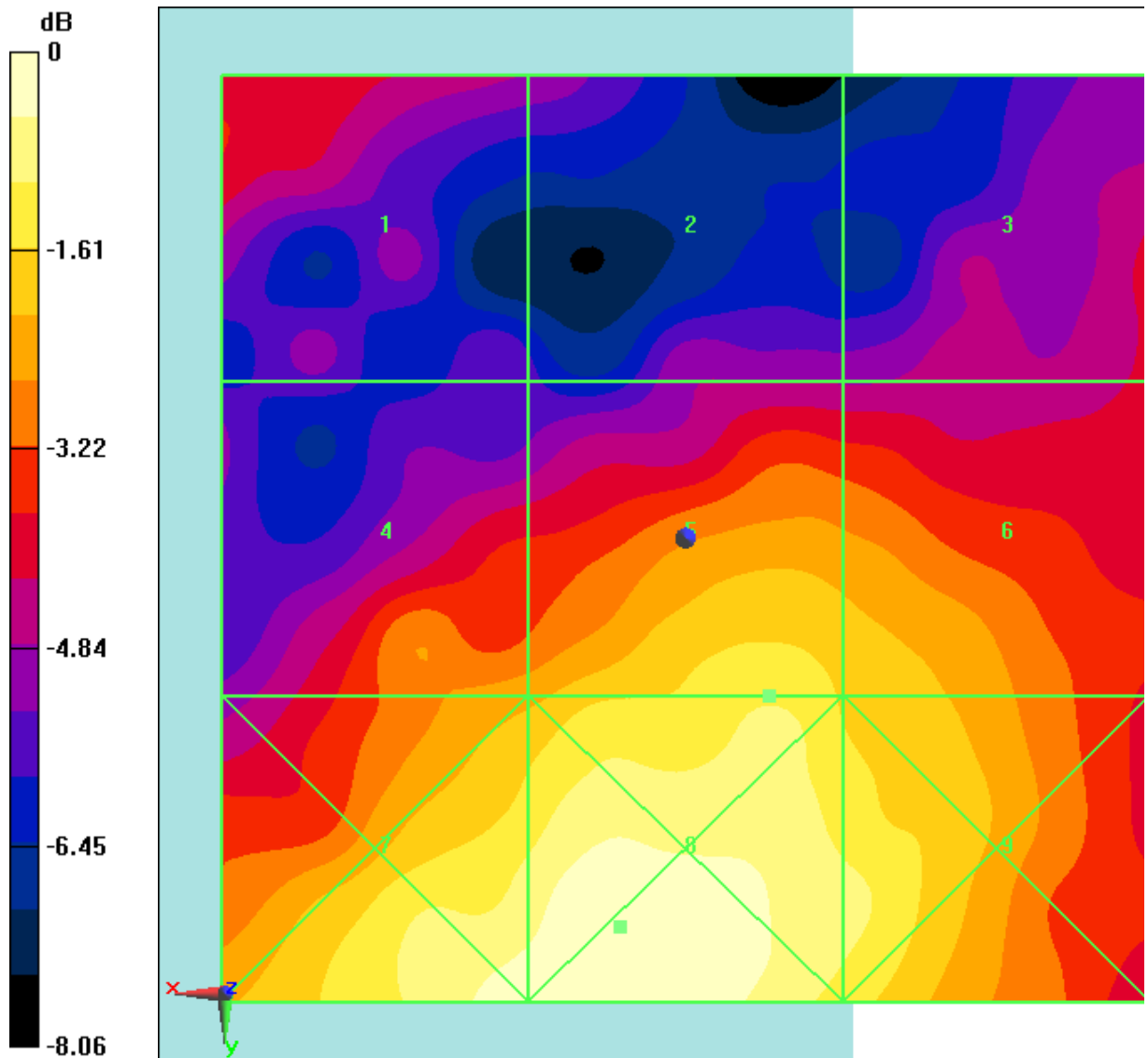

0 dB = 21.21 V/m = 26.53 dBV/m

**Fig B.4 HAC RF E-Field GSM 1900 High**

**HAC RF E-Field GSM 1900 Middle**

**Date: 2019-10-29**

Electronics: DAE4 Sn771

Medium: Air

Medium parameters used:  $\sigma = 0$  mho/m,  $\epsilon_r = 1$ ;  $\rho = 1000$  kg/m<sup>3</sup>

Ambient Temperature: 22.0°C

Communication System: PCS 1900; Frequency: 1880 MHz; Duty Cycle: 1:8.3

Probe: EF3DV3 - SN4060;ConvF(1, 1, 1)

GSM1900/E Scan – ER3DV6 – 2011: 15 mm from Probe Center to the Device

2/Hearing Aid Compatibility Test (101x101x1): Interpolated grid:

dx=0.5000 mm, dy=0.5000 mm

Device Reference Point: 0, 0, -6.3 mm

Reference Value = 13.10 V/m; Power Drift = 0.17 dB

Applied MIF = 3.42 dB

RF audio interference level = 24.76 dBV/m

**Emission category: M4**

MIF scaled E-field

Grid 1 M4 22.05 dBV/m	Grid 2 M4 22.1 dBV/m	Grid 3 M4 22.3 dBV/m
Grid 4 M4 24.41 dBV/m	Grid 5 M4 24.76 dBV/m	Grid 6 M4 24.76 dBV/m
Grid 7 M4 26.3 dBV/m	Grid 8 M4 26.36 dBV/m	Grid 9 M4 25.17 dBV/m

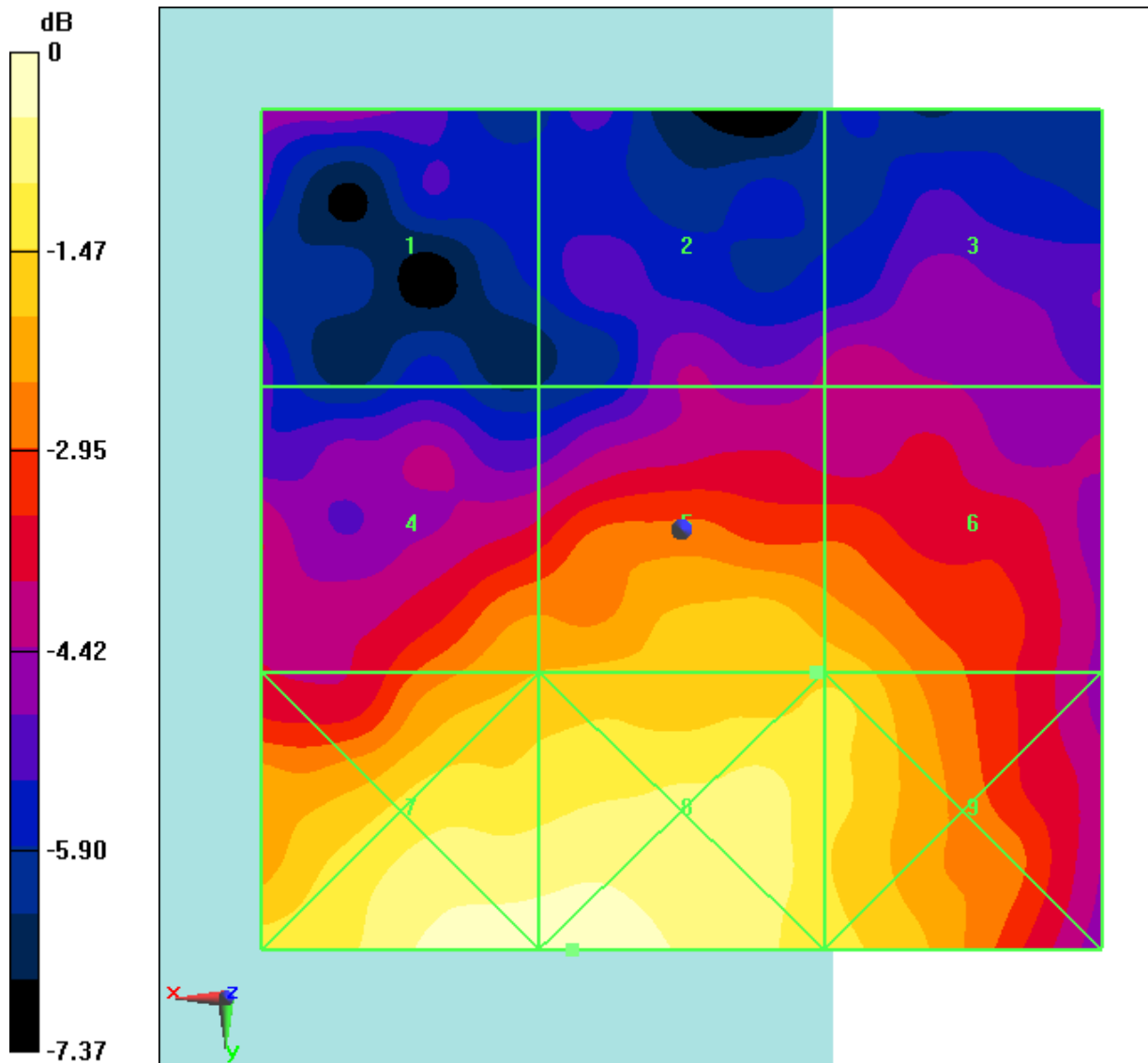

0 dB = 20.81 V/m = 26.37 dBV/m

**Fig B.5 HAC RF E-Field GSM 1900 Middle**

**HAC RF E-Field GSM 1900 Low**

**Date: 2019-10-29**

Electronics: DAE4 Sn771

Medium: Air

Medium parameters used:  $\sigma = 0$  mho/m,  $\epsilon_r = 1$ ;  $\rho = 1000$  kg/m<sup>3</sup>

Ambient Temperature: 22.0°C

Communication System: PCS 1900; Frequency: 1850.2 MHz; Duty Cycle: 1:8.3

Probe: EF3DV3 - SN4060;ConvF(1, 1, 1)

GSM1900/E Scan – ER3DV6 – 2011: 15 mm from Probe Center to the Device

3/Hearing Aid Compatibility Test (101x101x1): Interpolated grid:

dx=0.5000 mm, dy=0.5000 mm

Device Reference Point: 0, 0, -6.3 mm

Reference Value = 11.88 V/m; Power Drift = 0.25 dB

Applied MIF = 3.51 dB

RF audio interference level = 24.24 dBV/m

**Emission category: M4**

MIF scaled E-field

Grid 1 M4 21.92 dBV/m	Grid 2 M4 22.13 dBV/m	Grid 3 M4 22.03 dBV/m
Grid 4 M4 24.11 dBV/m	Grid 5 M4 24.24 dBV/m	Grid 6 M4 24.04 dBV/m
Grid 7 M4 25.75 dBV/m	Grid 8 M4 25.76 dBV/m	Grid 9 M4 25.11 dBV/m

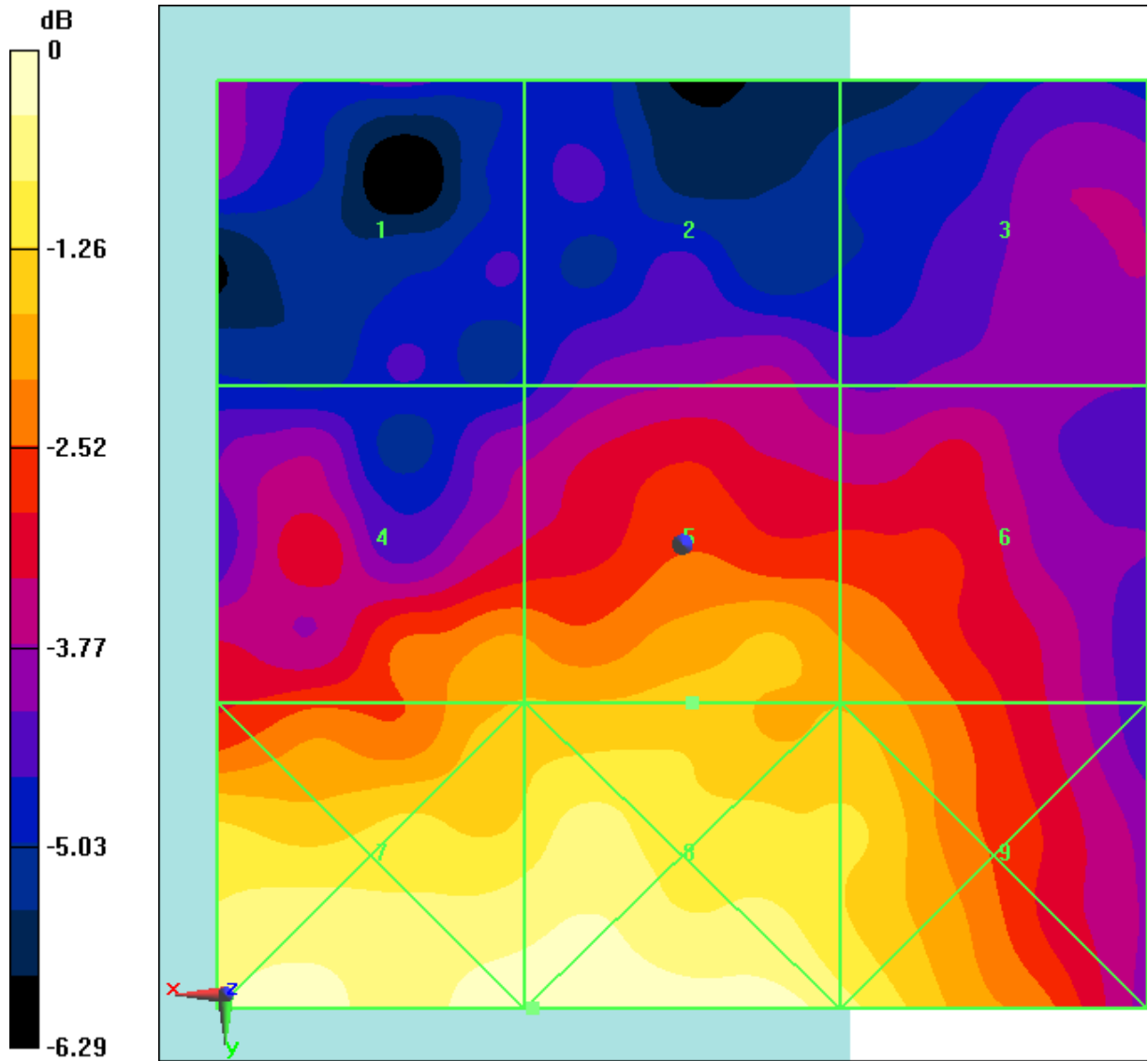

0 dB = 19.40 V/m = 25.76 dBV/m

**Fig B.6 HAC RF E-Field GSM 1900 Low**

**HAC RF E-Field LTE Band41 Power Class 2 QPSK CH41490**

**Date: 2019-10-30**

Electronics: DAE4 Sn771

Medium: Air

Medium parameters used:  $\sigma = 0$  mho/m,  $\epsilon_r = 1$ ;  $\rho = 1000$  kg/m<sup>3</sup>

Ambient Temperature: 22.0°C

Communication System: LTE Band41; Frequency: 2680 MHz; Duty Cycle: 1:1.58

Probe: EF3DV3 - SN4060;ConvF(1, 1, 1)

**B41/E Scan – ER3DV6 – 2011: 15 mm from Probe Center to the Device/Hearing**

**Aid Compatibility Test (101x101x1):** Interpolated grid: dx=0.5000 mm,  
dy=0.5000 mm

Device Reference Point: 0, 0, -6.3 mm

Reference Value = 10.67 V/m; Power Drift = -0.11 dB

Applied MIF = -1.71 dB

RF audio interference level = 19.99 dBV/m

**Emission category: M4**

MIF scaled E-field

Grid 1 M4 19.59 dBV/m	Grid 2 M4 19.8 dBV/m	Grid 3 M4 18.25 dBV/m
Grid 4 M4 16.13 dBV/m	Grid 5 M4 19.99 dBV/m	Grid 6 M4 20.05 dBV/m
Grid 7 M4 19.36 dBV/m	Grid 8 M4 20.59 dBV/m	Grid 9 M4 20.62 dBV/m



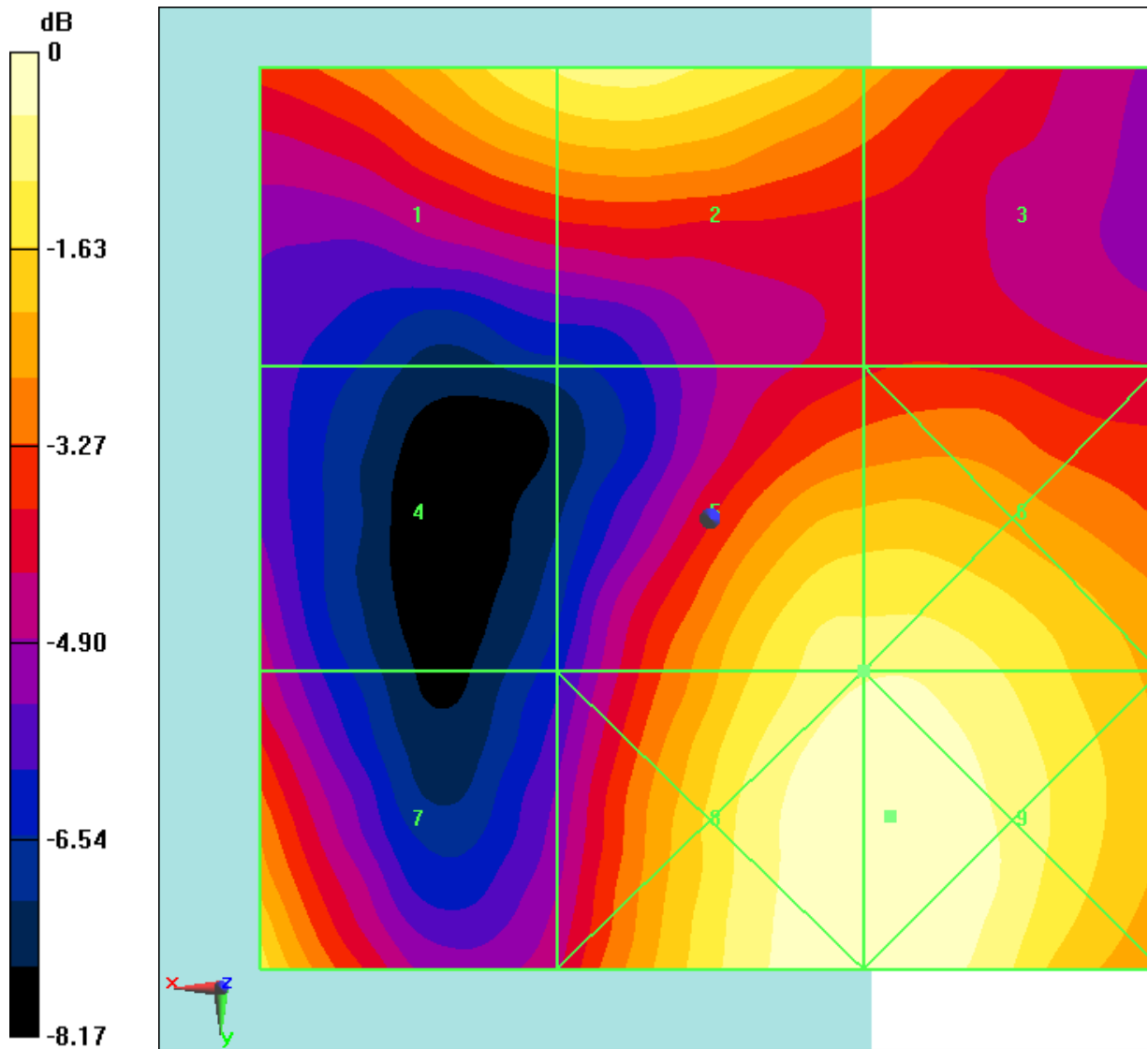

0 dB = 10.74 V/m = 20.62 dBV/m

**Fig B.7 HAC RF E-Field LTE Band41 Power Class 2 QPSK CH41490**

**HAC RF E-Field LTE Band41 Power Class 2 QPSK CH41055**

**Date: 2019-10-30**

Electronics: DAE4 Sn771

Medium: Air

Medium parameters used:  $\sigma = 0$  mho/m,  $\epsilon_r = 1$ ;  $\rho = 1000$  kg/m<sup>3</sup>

Ambient Temperature: 22.0°C

Communication System: LTE Band41; Frequency: 2636.5 MHz; Duty Cycle: 1:1.58

Probe: EF3DV3 - SN4060;ConvF(1, 1, 1)

B41/E Scan - ER3DV6 - 2011: 15 mm from Probe Center to the Device

2/Hearing Aid Compatibility Test (101x101x1): Interpolated grid:

$dx=0.5000$  mm,  $dy=0.5000$  mm

Device Reference Point: 0, 0, -6.3 mm

Reference Value = 10.28 V/m; Power Drift = -0.04 dB

Applied MIF = -1.78 dB

RF audio interference level = 21.27 dBV/m

Emission category: **M4**

MIF scaled E-field

Grid 1 M4 21.59 dBV/m	Grid 2 M4 21.67 dBV/m	Grid 3 M4 19.86 dBV/m
Grid 4 M4 16.85 dBV/m	Grid 5 M4 20.29 dBV/m	Grid 6 M4 20.34 dBV/m
Grid 7 M4 18.88 dBV/m	Grid 8 M4 21.27 dBV/m	Grid 9 M4 21.21 dBV/m

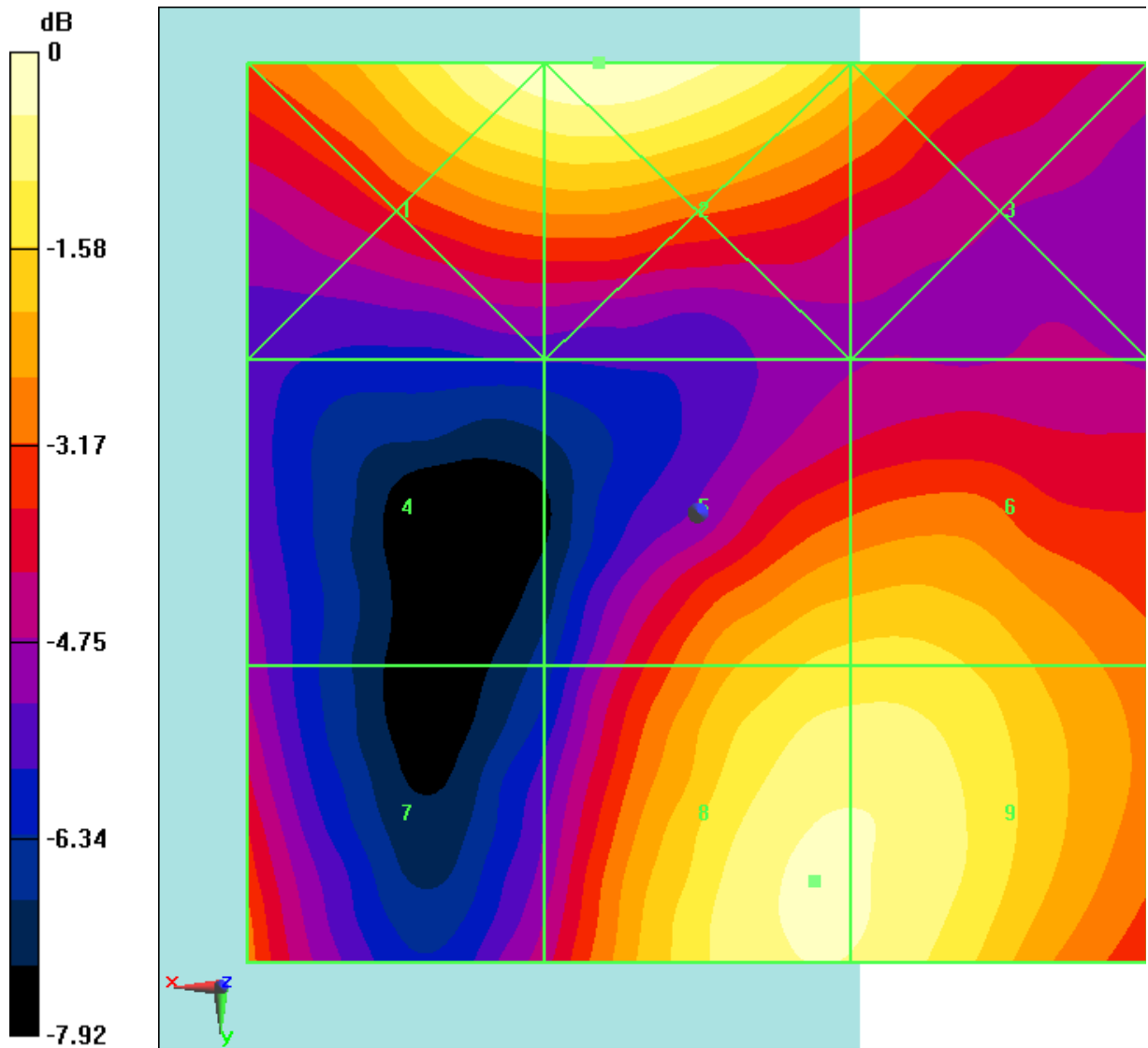

0 dB = 12.12 V/m = 21.67 dBV/m

**Fig B.8 HAC RF E-Field LTE Band41 Power Class 2 QPSK CH41055**

**HAC RF E-Field LTE Band41 Power Class 2 QPSK CH40620**
**Date: 2019-10-30**

Electronics: DAE4 Sn771

Medium: Air

 Medium parameters used:  $\sigma = 0$  mho/m,  $\epsilon_r = 1$ ;  $\rho = 1000$  kg/m<sup>3</sup>

Ambient Temperature: 22.0°C

Communication System: LTE Band41; Frequency: 2593 MHz; Duty Cycle: 1:1.58

Probe: EF3DV3 - SN4060;ConvF(1, 1, 1)

B41/E Scan - ER3DV6 - 2011: 15 mm from Probe Center to the Device

**3/Hearing Aid Compatibility Test (101x101x1):** Interpolated grid:

dx=0.5000 mm, dy=0.5000 mm

Device Reference Point: 0, 0, -6.3 mm

Reference Value = 9.585 V/m; Power Drift = -0.03 dB

Applied MIF = -1.73 dB

RF audio interference level = 21.50 dBV/m

**Emission category: M4**

MIF scaled E-field

Grid 1 M4 21.81 dBV/m	Grid 2 M4 21.78 dBV/m	Grid 3 M4 18.55 dBV/m
Grid 4 M4 17.68 dBV/m	Grid 5 M4 20.18 dBV/m	Grid 6 M4 20.21 dBV/m
Grid 7 M4 18.29 dBV/m	Grid 8 M4 21.5 dBV/m	Grid 9 M4 21.38 dBV/m

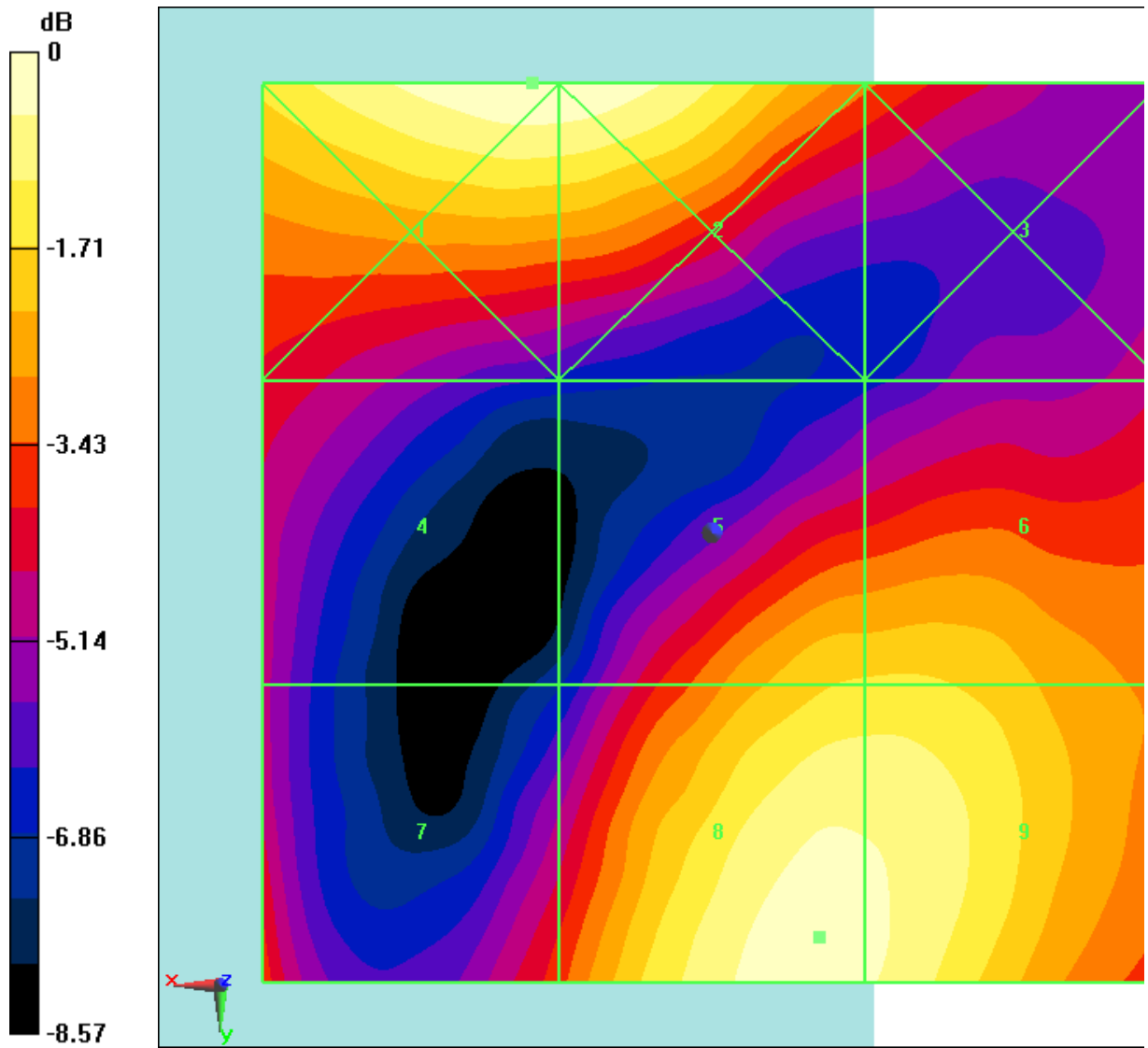

0 dB = 12.31 V/m = 21.81 dBV/m

**Fig B.9 HAC RF E-Field LTE Band41 Power Class 2 QPSK CH40620**

**HAC RF E-Field LTE Band41 Power Class 2 QPSK CH40185**
**Date: 2019-10-30**

Electronics: DAE4 Sn771

Medium: Air

 Medium parameters used:  $\sigma = 0$  mho/m,  $\epsilon_r = 1$ ;  $\rho = 1000$  kg/m<sup>3</sup>

Ambient Temperature: 22.0°C

Communication System: LTE Band41; Frequency: 2549.5 MHz; Duty Cycle: 1:1.58

Probe: EF3DV3 - SN4060;ConvF(1, 1, 1)

B41/E Scan - ER3DV6 - 2011: 15 mm from Probe Center to the Device 3

**3/Hearing Aid Compatibility Test (101x101x1):** Interpolated grid:

dx=0.5000 mm, dy=0.5000 mm

Device Reference Point: 0, 0, -6.3 mm

Reference Value = 8.920 V/m; Power Drift = -0.08 dB

Applied MIF = -1.73 dB

RF audio interference level = 21.52 dBV/m

**Emission category: M4**

MIF scaled E-field

Grid 1 M4 21.52 dBV/m	Grid 2 M4 21.12 dBV/m	Grid 3 M4 18.01 dBV/m
Grid 4 M4 17.92 dBV/m	Grid 5 M4 19.67 dBV/m	Grid 6 M4 19.74 dBV/m
Grid 7 M4 19.13 dBV/m	Grid 8 M4 21.52 dBV/m	Grid 9 M4 21.15 dBV/m

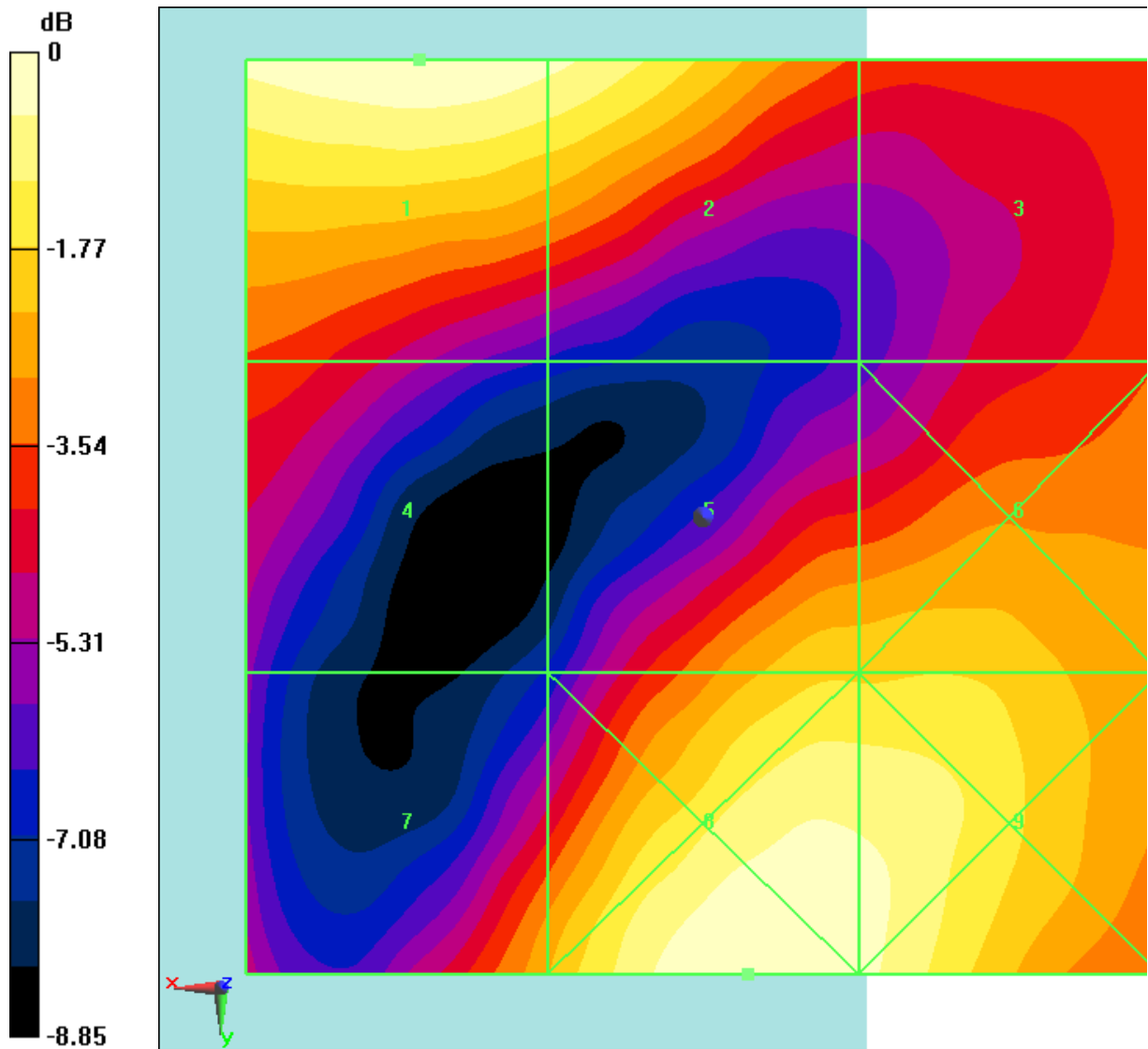

0 dB = 11.91 V/m = 21.52 dBV/m

**Fig B.10 HAC RF E-Field LTE Band41 Power Class 2 QPSK CH40185**

**HAC RF E-Field LTE Band41 Power Class 2 QPSK CH39750**

**Date: 2019-10-30**

Electronics: DAE4 Sn771

Medium: Air

Medium parameters used:  $\sigma = 0$  mho/m,  $\epsilon_r = 1$ ;  $\rho = 1000$  kg/m<sup>3</sup>

Ambient Temperature: 22.0°C

Communication System: LTE Band41; Frequency: 2506 MHz; Duty Cycle: 1:1.58

Probe: EF3DV3 - SN4060;ConvF(1, 1, 1)

B41/E Scan - ER3DV6 - 2011: 15 mm from Probe Center to the Device 3

2/Hearing Aid Compatibility Test (101x101x1): Interpolated grid:

dx=0.5000 mm, dy=0.5000 mm

Device Reference Point: 0, 0, -6.3 mm

Reference Value = 7.862 V/m; Power Drift = -0.04 dB

Applied MIF = -1.75 dB

RF audio interference level = 20.56 dBV/m

Emission category: **M4**

MIF scaled E-field

Grid 1 M4 21.88 dBV/m	Grid 2 M4 19.66 dBV/m	Grid 3 M4 17.3 dBV/m
Grid 4 M4 18.66 dBV/m	Grid 5 M4 19.1 dBV/m	Grid 6 M4 19.2 dBV/m
Grid 7 M4 19.21 dBV/m	Grid 8 M4 20.56 dBV/m	Grid 9 M4 19.87 dBV/m



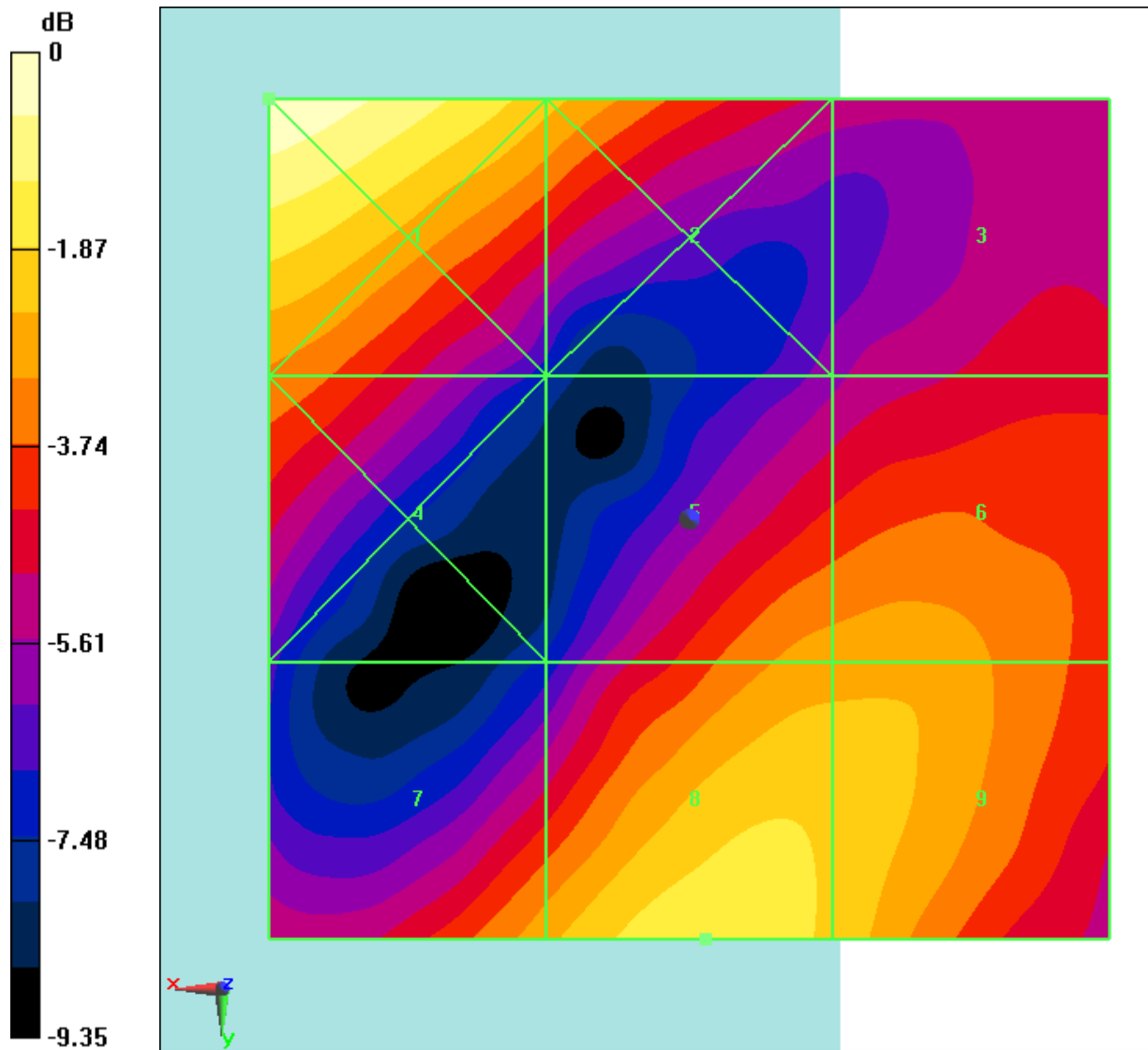

0 dB = 12.41 V/m = 21.88 dBV/m

**Fig B.11 HAC RF E-Field LTE Band41 Power Class 2 QPSK CH39750**

**HAC RF E-Field LTE Band41 Power Class 2 16QAM CH41490**

**Date: 2019-10-30**

Electronics: DAE4 Sn771

Medium: Air

Medium parameters used:  $\sigma = 0$  mho/m,  $\epsilon_r = 1$ ;  $\rho = 1000$  kg/m<sup>3</sup>

Ambient Temperature: 22.0°C

Communication System: LTE Band41; Frequency: 2680 MHz; Duty Cycle: 1:1.58

Probe: EF3DV3 - SN4060;ConvF(1, 1, 1)

**B41/E Scan – ER3DV6 – 2011: 15 mm from Probe Center to the Device/Hearing**

**Aid Compatibility Test (101x101x1):** Interpolated grid: dx=0.5000 mm,  
dy=0.5000 mm

Device Reference Point: 0, 0, -6.3 mm

Reference Value = 10.93 V/m; Power Drift = -0.09 dB

Applied MIF = -1.80 dB

RF audio interference level = 20.11 dBV/m

**Emission category: M4**

MIF scaled E-field

Grid 1 M4 19.76 dBV/m	Grid 2 M4 19.99 dBV/m	Grid 3 M4 18.48 dBV/m
Grid 4 M4 16.3 dBV/m	Grid 5 M4 20.11 dBV/m	Grid 6 M4 20.19 dBV/m
Grid 7 M4 19.45 dBV/m	Grid 8 M4 20.81 dBV/m	Grid 9 M4 20.81 dBV/m

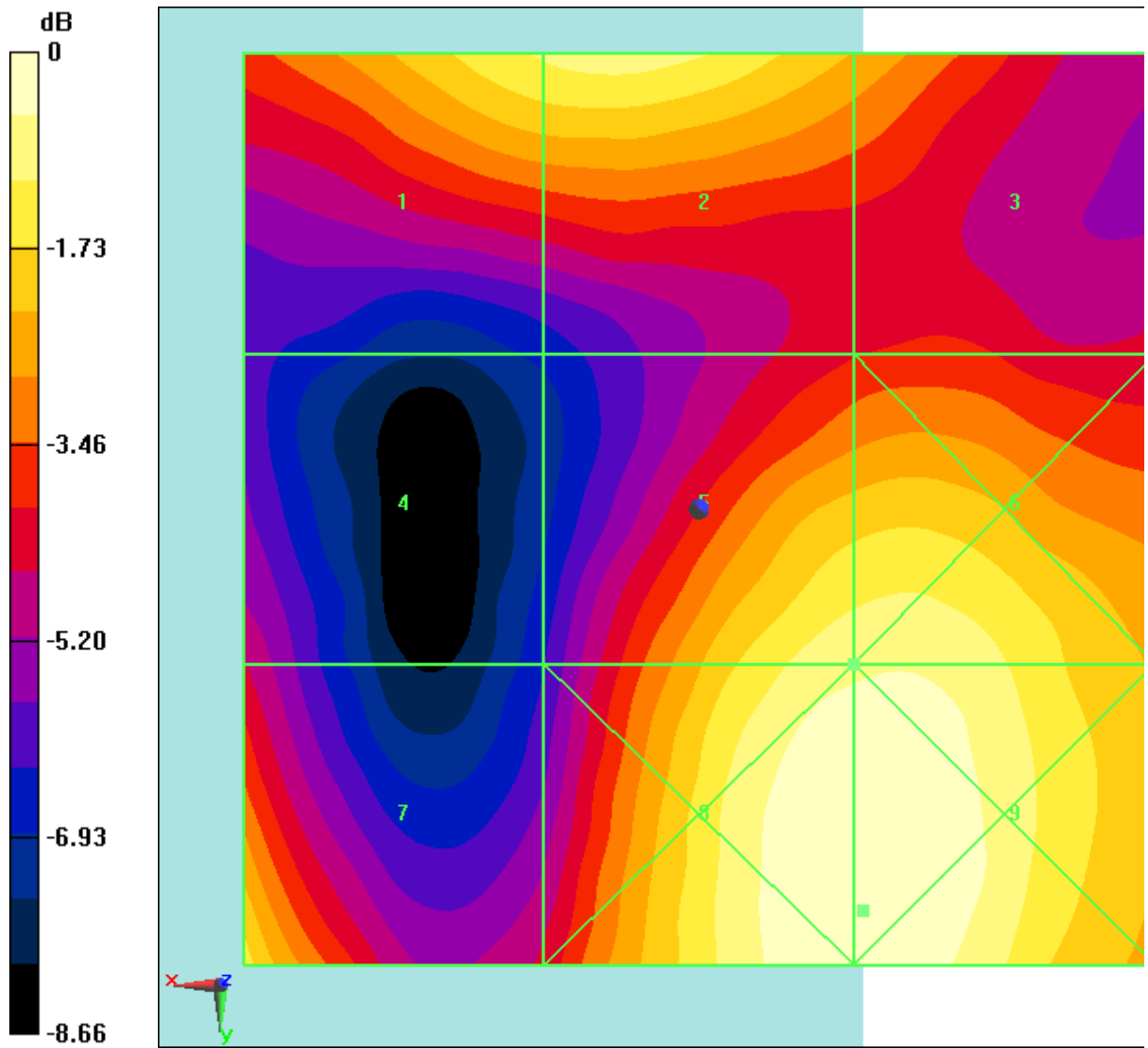

0 dB = 10.98 V/m = 20.81 dBV/m

**Fig B.12 HAC RF E-Field LTE Band41 Power Class 2 16QAM CH41490**

**HAC RF E-Field LTE Band41 Power Class 2 16QAM CH41055**

**Date: 2019-10-30**

Electronics: DAE4 Sn771

Medium: Air

Medium parameters used:  $\sigma = 0$  mho/m,  $\epsilon_r = 1$ ;  $\rho = 1000$  kg/m<sup>3</sup>

Ambient Temperature: 22.0°C

Communication System: LTE Band41; Frequency: 2636.5 MHz; Duty Cycle: 1:1.58

Probe: EF3DV3 - SN4060;ConvF(1, 1, 1)

B41/E Scan - ER3DV6 - 2011: 15 mm from Probe Center to the Device

2/Hearing Aid Compatibility Test (101x101x1): Interpolated grid:

dx=0.5000 mm, dy=0.5000 mm

Device Reference Point: 0, 0, -6.3 mm

Reference Value = 10.28 V/m; Power Drift = -0.08 dB

Applied MIF = -1.76 dB

RF audio interference level = 21.40 dBV/m

Emission category: **M4**

MIF scaled E-field

Grid 1 M4 21.74 dBV/m	Grid 2 M4 21.84 dBV/m	Grid 3 M4 19.93 dBV/m
Grid 4 M4 16.81 dBV/m	Grid 5 M4 20.36 dBV/m	Grid 6 M4 20.4 dBV/m
Grid 7 M4 19.15 dBV/m	Grid 8 M4 21.4 dBV/m	Grid 9 M4 21.39 dBV/m

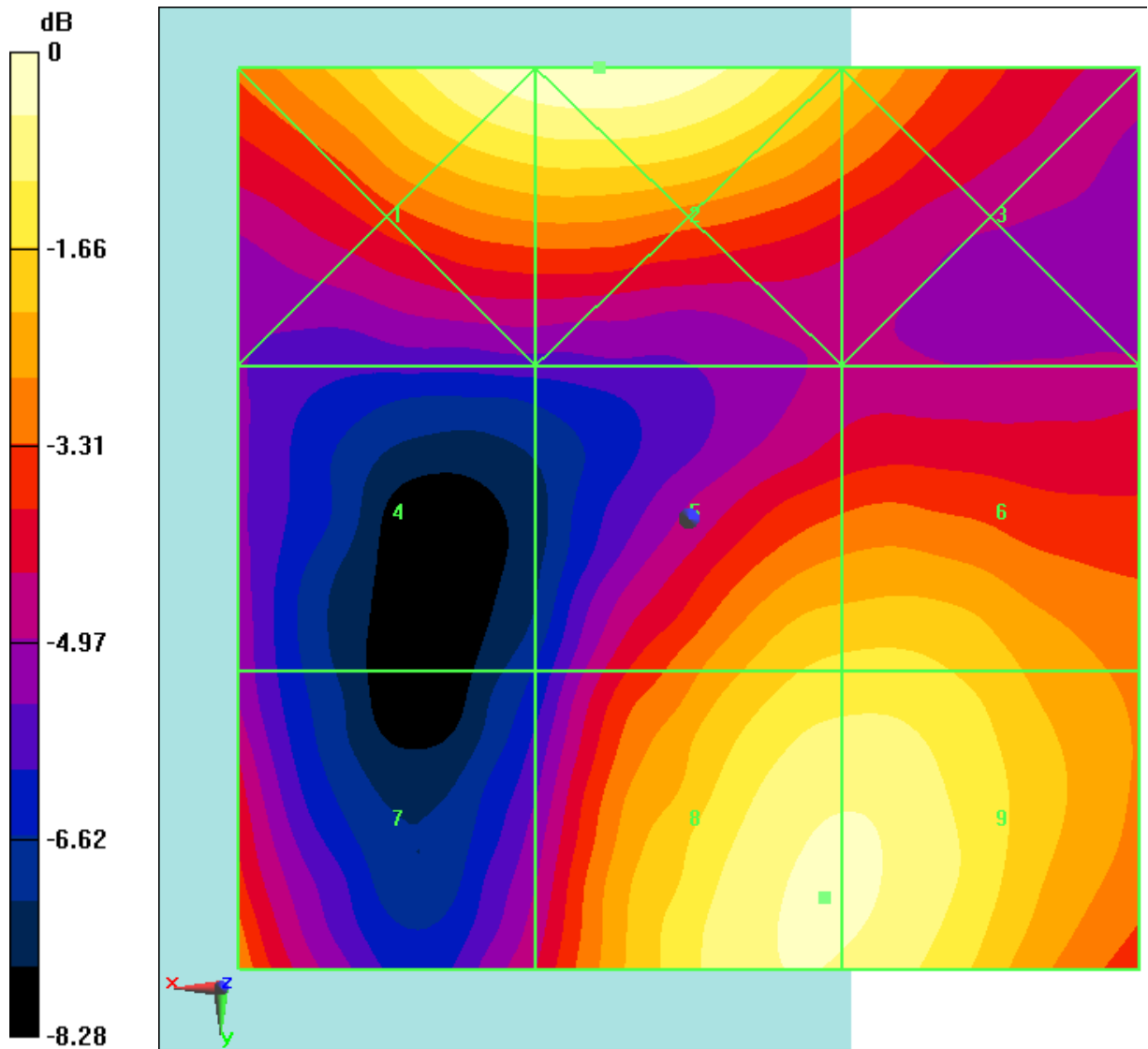

0 dB = 12.36 V/m = 21.84 dBV/m

**Fig B.13 HAC RF E-Field LTE Band41 Power Class 2 16QAM CH41055**

**HAC RF E-Field LTE Band41 Power Class 2 16QAM CH40620**
**Date: 2019-10-30**

Electronics: DAE4 Sn771

Medium: Air

 Medium parameters used:  $\sigma = 0$  mho/m,  $\epsilon_r = 1$ ;  $\rho = 1000$  kg/m<sup>3</sup>

Ambient Temperature: 22.0°C

Communication System: LTE Band41; Frequency: 2593 MHz; Duty Cycle: 1:1.58

Probe: EF3DV3 - SN4060;ConvF(1, 1, 1)

B41/E Scan - ER3DV6 - 2011: 15 mm from Probe Center to the Device

**3/Hearing Aid Compatibility Test (101x101x1):** Interpolated grid:

dx=0.5000 mm, dy=0.5000 mm

Device Reference Point: 0, 0, -6.3 mm

Reference Value = 9.923 V/m; Power Drift = -0.03 dB

Applied MIF = -1.65 dB

RF audio interference level = 21.74 dBV/m

**Emission category: M4**

MIF scaled E-field

Grid 1 M4 22.01 dBV/m	Grid 2 M4 21.99 dBV/m	Grid 3 M4 18.83 dBV/m
Grid 4 M4 17.92 dBV/m	Grid 5 M4 20.45 dBV/m	Grid 6 M4 20.5 dBV/m
Grid 7 M4 18.68 dBV/m	Grid 8 M4 21.74 dBV/m	Grid 9 M4 21.64 dBV/m

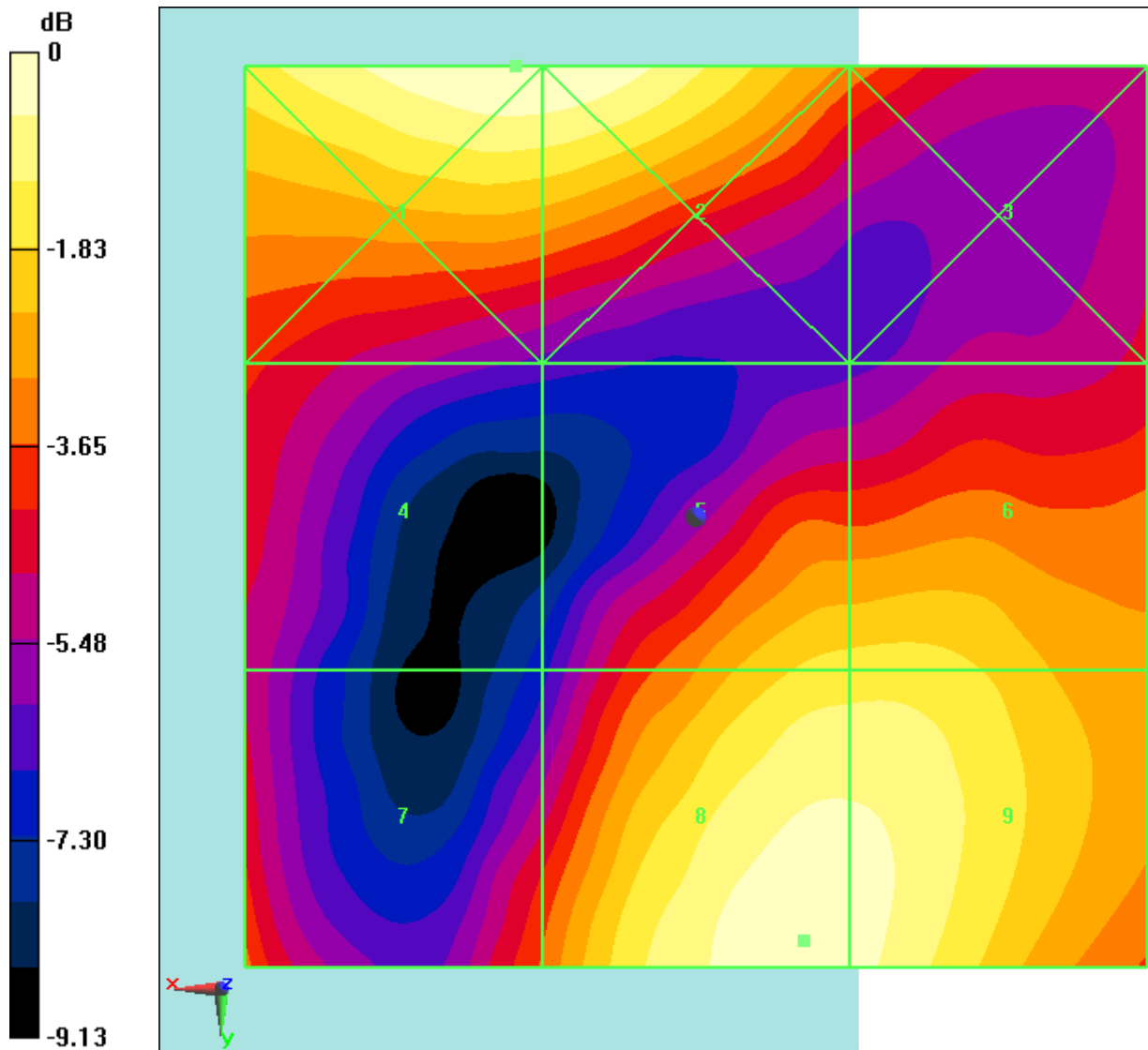

0 dB = 12.60 V/m = 22.01 dBV/m

**Fig B.14 HAC RF E-Field LTE Band41 Power Class 2 16QAM CH40620**

**HAC RF E-Field LTE Band41 Power Class 2 16QAM CH40185**
**Date: 2019-10-30**

Electronics: DAE4 Sn771

Medium: Air

 Medium parameters used:  $\sigma = 0$  mho/m,  $\epsilon_r = 1$ ;  $\rho = 1000$  kg/m<sup>3</sup>

Ambient Temperature: 22.0°C

Communication System: LTE Band41; Frequency: 2549.5 MHz; Duty Cycle: 1:1.58

Probe: EF3DV3 - SN4060;ConvF(1, 1, 1)

B41/E Scan - ER3DV6 - 2011: 15 mm from Probe Center to the Device 3

**3/Hearing Aid Compatibility Test (101x101x1):** Interpolated grid:

dx=0.5000 mm, dy=0.5000 mm

Device Reference Point: 0, 0, -6.3 mm

Reference Value = 8.933 V/m; Power Drift = -0.07 dB

Applied MIF = -1.82 dB

RF audio interference level = 21.54 dBV/m

**Emission category: M4**

MIF scaled E-field

Grid 1 M4 21.54 dBV/m	Grid 2 M4 21.32 dBV/m	Grid 3 M4 18.19 dBV/m
Grid 4 M4 18.12 dBV/m	Grid 5 M4 19.87 dBV/m	Grid 6 M4 19.96 dBV/m
Grid 7 M4 19.31 dBV/m	Grid 8 M4 21.55 dBV/m	Grid 9 M4 21.23 dBV/m



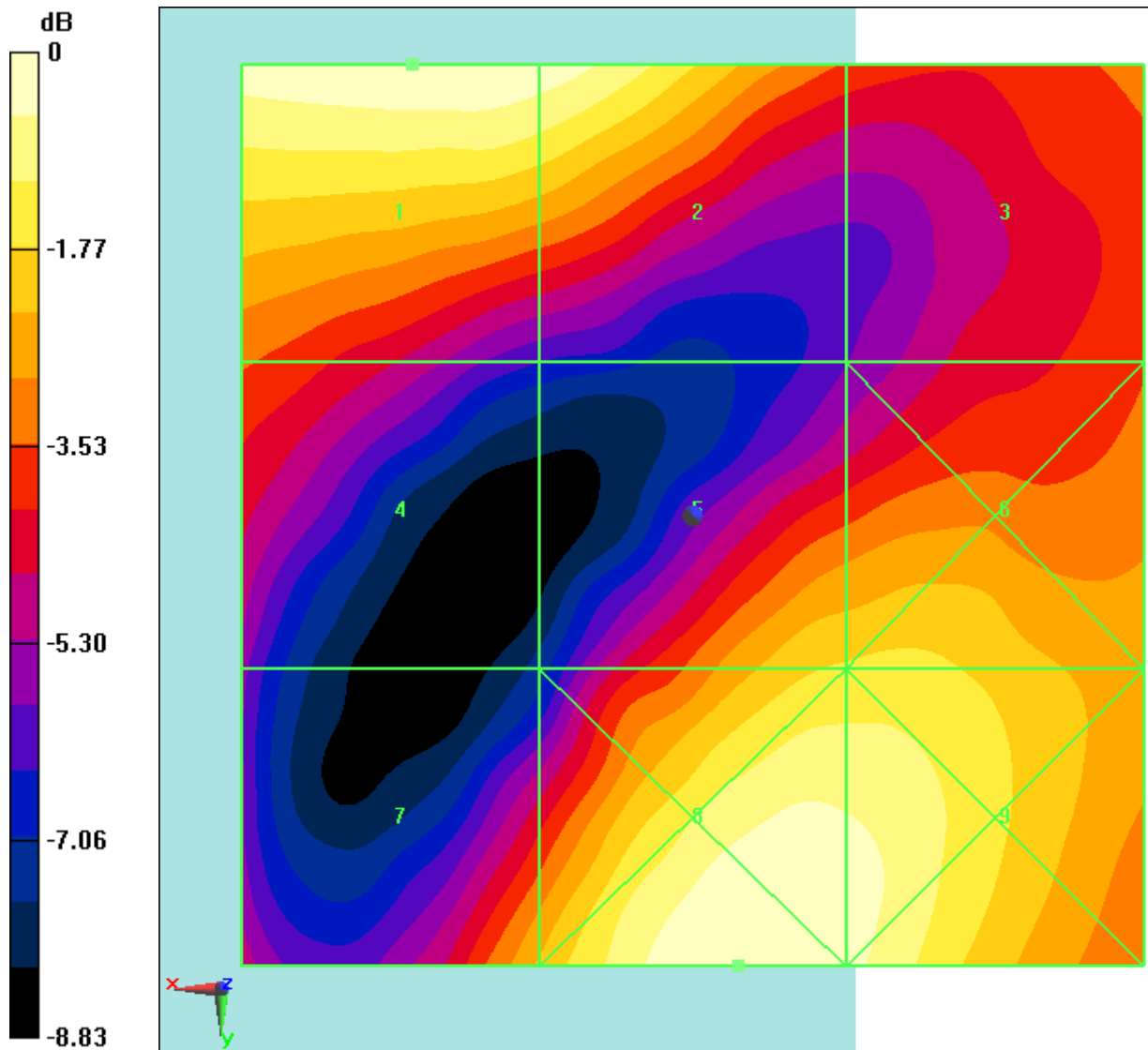

0 dB = 11.96 V/m = 21.55 dBV/m

**Fig B.15 HAC RF E-Field LTE Band41 Power Class 2 16QAM CH40185**

**HAC RF E-Field LTE Band41 Power Class 2 16QAM CH39750**

**Date: 2019-10-30**

Electronics: DAE4 Sn771

Medium: Air

Medium parameters used:  $\sigma = 0$  mho/m,  $\epsilon_r = 1$ ;  $\rho = 1000$  kg/m<sup>3</sup>

Ambient Temperature: 22.0°C

Communication System: LTE Band41; Frequency: 2506 MHz; Duty Cycle: 1:1.58

Probe: EF3DV3 - SN4060;ConvF(1, 1, 1)

B41/E Scan - ER3DV6 - 2011: 15 mm from Probe Center to the Device 3

2/Hearing Aid Compatibility Test (101x101x1): Interpolated grid:

dx=0.5000 mm, dy=0.5000 mm

Device Reference Point: 0, 0, -6.3 mm

Reference Value = 7.657 V/m; Power Drift = 0.02 dB

Applied MIF = -1.58 dB

RF audio interference level = 20.78 dBV/m

Emission category: **M4**

MIF scaled E-field

Grid 1 M4 22.13 dBV/m	Grid 2 M4 19.93 dBV/m	Grid 3 M4 17.79 dBV/m
Grid 4 M4 19.03 dBV/m	Grid 5 M4 19.4 dBV/m	Grid 6 M4 19.49 dBV/m
Grid 7 M4 19.51 dBV/m	Grid 8 M4 20.78 dBV/m	Grid 9 M4 20.23 dBV/m

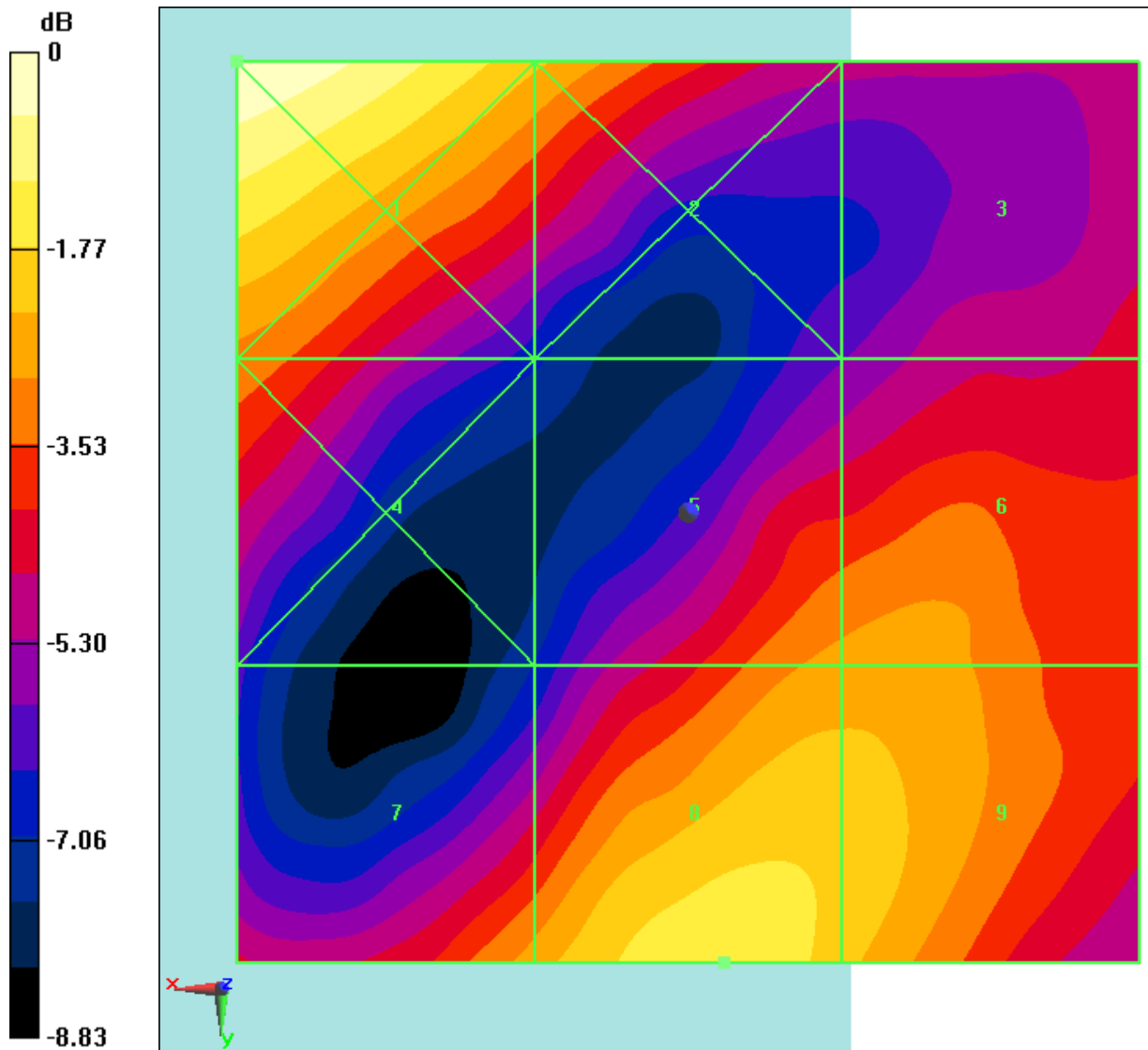

0 dB = 12.78 V/m = 22.13 dBV/m

**Fig B.16 HAC RF E-Field LTE Band41 Power Class 2 16QAM CH39750**

**HAC RF E-Field LTE Band41 Power Class 3 QPSK CH41490**

**Date: 2019-10-30**

Electronics: DAE4 Sn771

Medium: Air

Medium parameters used:  $\sigma = 0$  mho/m,  $\epsilon_r = 1$ ;  $\rho = 1000$  kg/m<sup>3</sup>

Ambient Temperature: 22.0°C

Communication System: LTE Band41; Frequency: 2680 MHz; Duty Cycle: 1:1.58

Probe: EF3DV3 - SN4060;ConvF(1, 1, 1)

**B41/E Scan – ER3DV6 – 2011: 15 mm from Probe Center to the Device/Hearing**

**Aid Compatibility Test (101x101x1):** Interpolated grid: dx=0.5000 mm,  
dy=0.5000 mm

Device Reference Point: 0, 0, -6.3 mm

Reference Value = 11.53 V/m; Power Drift = -0.02 dB

Applied MIF = -2.37 dB

RF audio interference level = 20.02 dBV/m

**Emission category: M4**

MIF scaled E-field

Grid 1 M4 19.61 dBV/m	Grid 2 M4 19.84 dBV/m	Grid 3 M4 18.42 dBV/m
Grid 4 M4 16.44 dBV/m	Grid 5 M4 20.02 dBV/m	Grid 6 M4 20.07 dBV/m
Grid 7 M4 19.47 dBV/m	Grid 8 M4 20.71 dBV/m	Grid 9 M4 20.72 dBV/m

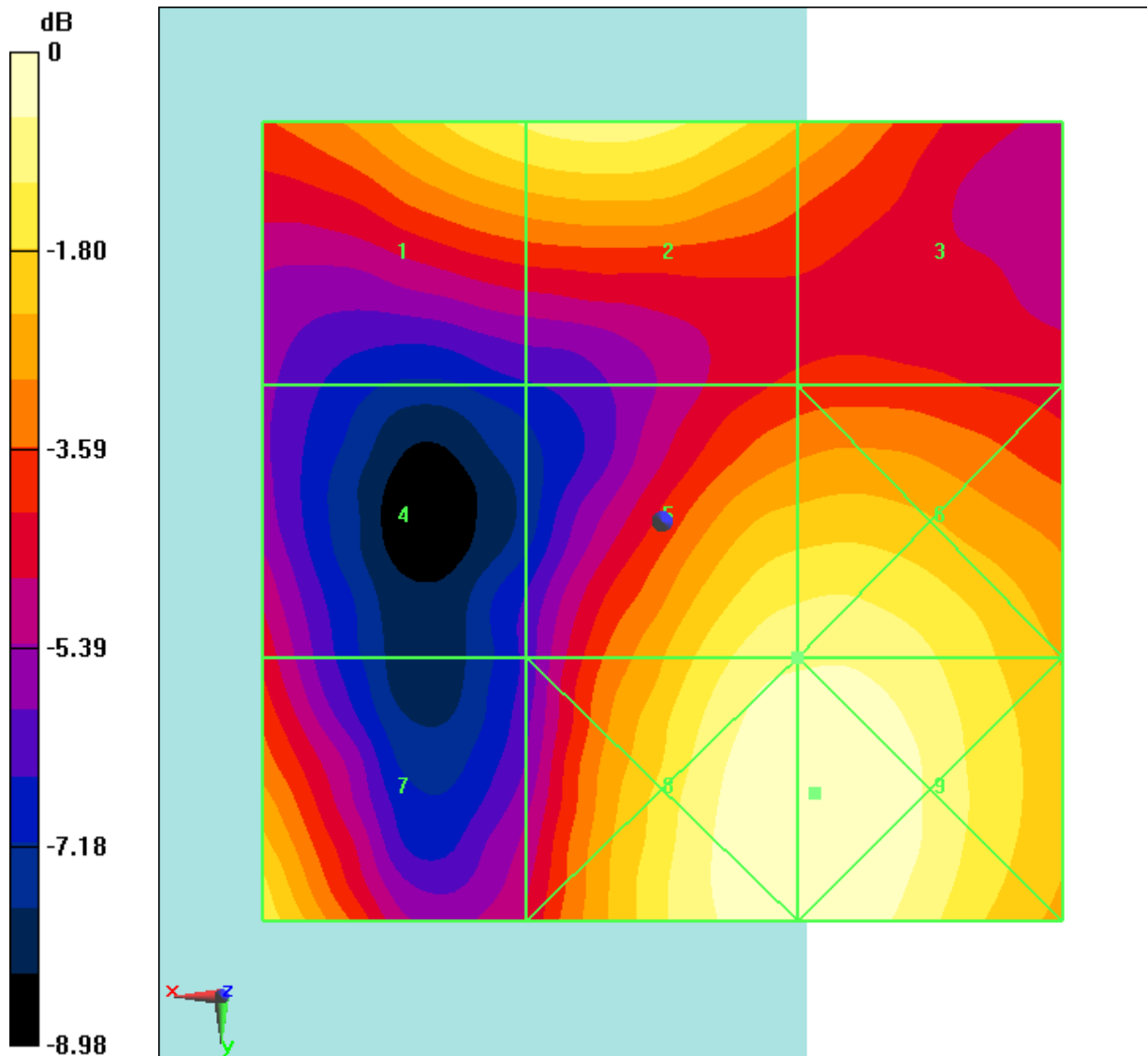

0 dB = 10.86 V/m = 20.72 dBV/m

**Fig B.17 HAC RF E-Field LTE Band41 Power Class 3 QPSK CH41490**

**HAC RF E-Field LTE Band41 Power Class 3 QPSK CH41055**

**Date: 2019-10-30**

Electronics: DAE4 Sn771

Medium: Air

Medium parameters used:  $\sigma = 0$  mho/m,  $\epsilon_r = 1$ ;  $\rho = 1000$  kg/m<sup>3</sup>

Ambient Temperature: 22.0°C

Communication System: LTE Band41; Frequency: 2636.5 MHz; Duty Cycle: 1:1.58

Probe: EF3DV3 - SN4060;ConvF(1, 1, 1)

B41/E Scan - ER3DV6 - 2011: 15 mm from Probe Center to the Device

2/Hearing Aid Compatibility Test (101x101x1): Interpolated grid:

dx=0.5000 mm, dy=0.5000 mm

Device Reference Point: 0, 0, -6.3 mm

Reference Value = 11.16 V/m; Power Drift = -0.08 dB

Applied MIF = -2.44 dB

RF audio interference level = 21.40 dBV/m

Emission category: **M4**

MIF scaled E-field

Grid 1 M4 21.79 dBV/m	Grid 2 M4 21.89 dBV/m	Grid 3 M4 20.1 dBV/m
Grid 4 M4 17.01 dBV/m	Grid 5 M4 20.47 dBV/m	Grid 6 M4 20.54 dBV/m
Grid 7 M4 19.17 dBV/m	Grid 8 M4 21.4 dBV/m	Grid 9 M4 21.38 dBV/m

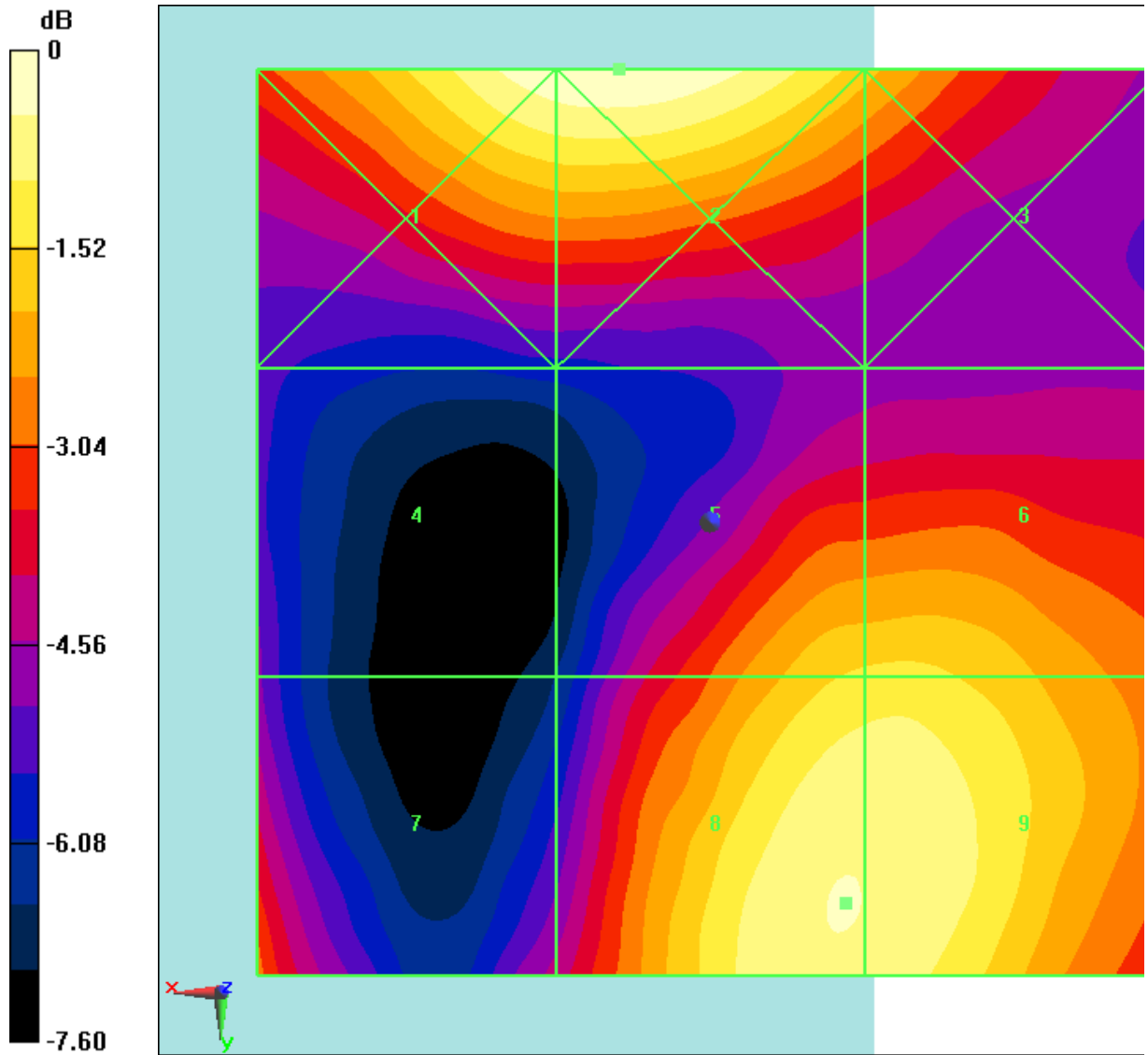

0 dB = 12.43 V/m = 21.89 dBV/m

**Fig B.18 HAC RF E-Field LTE Band41 Power Class 3 QPSK CH41055**

**HAC RF E-Field LTE Band41 Power Class 3 QPSK CH40620**
**Date: 2019-10-30**

Electronics: DAE4 Sn771

Medium: Air

 Medium parameters used:  $\sigma = 0$  mho/m,  $\epsilon_r = 1$ ;  $\rho = 1000$  kg/m<sup>3</sup>

Ambient Temperature: 22.0°C

Communication System: LTE Band41; Frequency: 2593 MHz; Duty Cycle: 1:1.58

Probe: EF3DV3 - SN4060;ConvF(1, 1, 1)

B41/E Scan - ER3DV6 - 2011: 15 mm from Probe Center to the Device

**3/Hearing Aid Compatibility Test (101x101x1):** Interpolated grid:

dx=0.5000 mm, dy=0.5000 mm

Device Reference Point: 0, 0, -6.3 mm

Reference Value = 10.47 V/m; Power Drift = -0.08 dB

Applied MIF = -2.39 dB

RF audio interference level = 21.68 dBV/m

**Emission category: M4**

MIF scaled E-field

Grid 1 M4 21.94 dBV/m	Grid 2 M4 21.91 dBV/m	Grid 3 M4 18.63 dBV/m
Grid 4 M4 17.86 dBV/m	Grid 5 M4 20.34 dBV/m	Grid 6 M4 20.37 dBV/m
Grid 7 M4 18.59 dBV/m	Grid 8 M4 21.68 dBV/m	Grid 9 M4 21.55 dBV/m



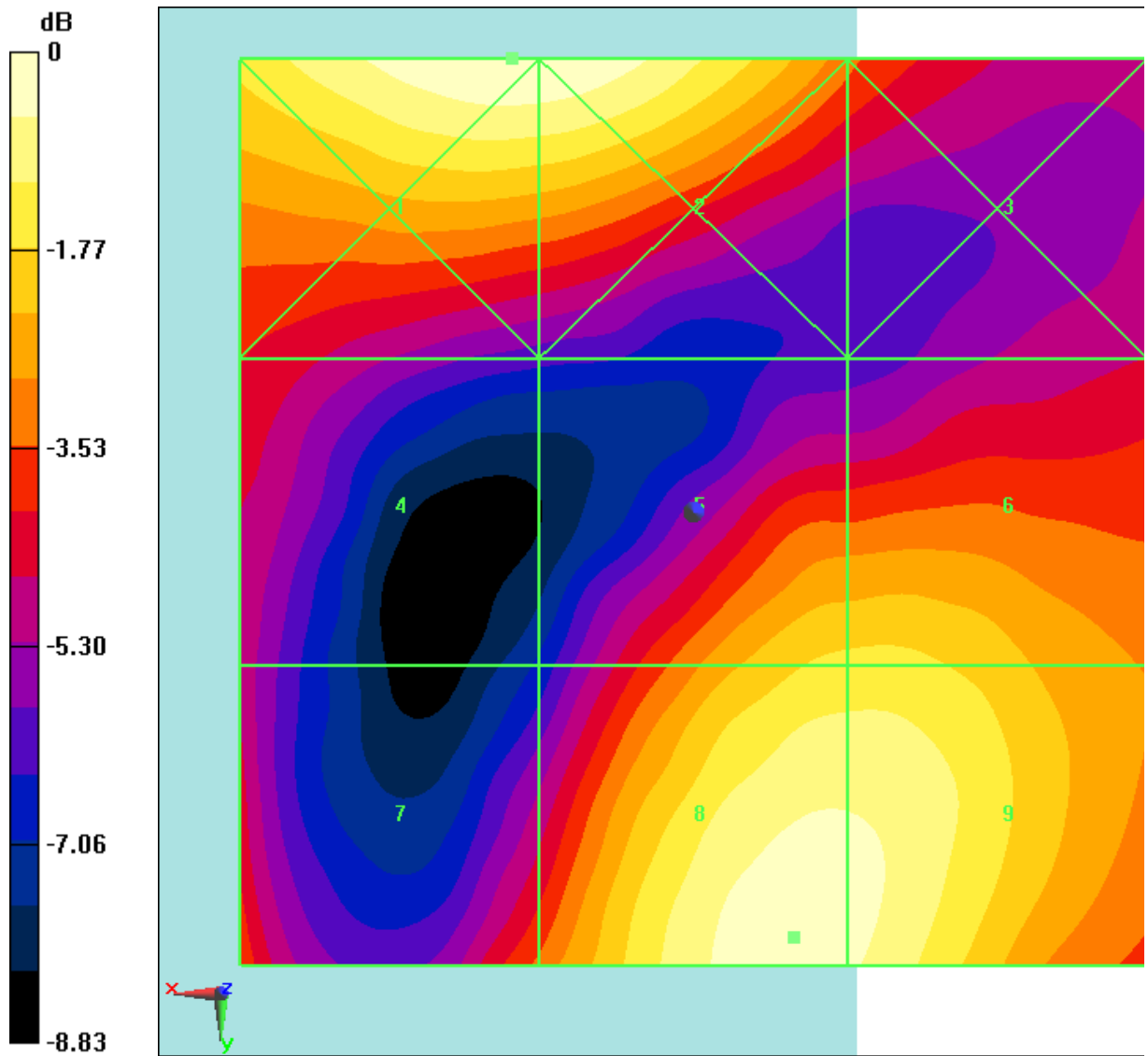

0 dB = 12.50 V/m = 21.94 dBV/m

**Fig B.19 HAC RF E-Field LTE Band41 Power Class 3 QPSK CH40620**

**HAC RF E-Field LTE Band41 Power Class 3 QPSK CH40185**

**Date: 2019-10-30**

Electronics: DAE4 Sn771

Medium: Air

Medium parameters used:  $\sigma = 0$  mho/m,  $\epsilon_r = 1$ ;  $\rho = 1000$  kg/m<sup>3</sup>

Ambient Temperature: 22.0°C

Communication System: LTE Band41; Frequency: 2549.5 MHz; Duty Cycle: 1:1.58

Probe: EF3DV3 - SN4060;ConvF(1, 1, 1)

B41/E Scan - ER3DV6 - 2011: 15 mm from Probe Center to the Device 3

3/Hearing Aid Compatibility Test (101x101x1): Interpolated grid:

dx=0.5000 mm, dy=0.5000 mm

Device Reference Point: 0, 0, -6.3 mm

Reference Value = 9.047 V/m; Power Drift = -0.14 dB

Applied MIF = -2.37 dB

RF audio interference level = 21.50 dBV/m

Emission category: **M4**

MIF scaled E-field

Grid 1 M4 21.51 dBV/m	Grid 2 M4 21.27 dBV/m	Grid 3 M4 17.95 dBV/m
Grid 4 M4 17.89 dBV/m	Grid 5 M4 19.8 dBV/m	Grid 6 M4 19.89 dBV/m
Grid 7 M4 19.29 dBV/m	Grid 8 M4 21.5 dBV/m	Grid 9 M4 21.2 dBV/m

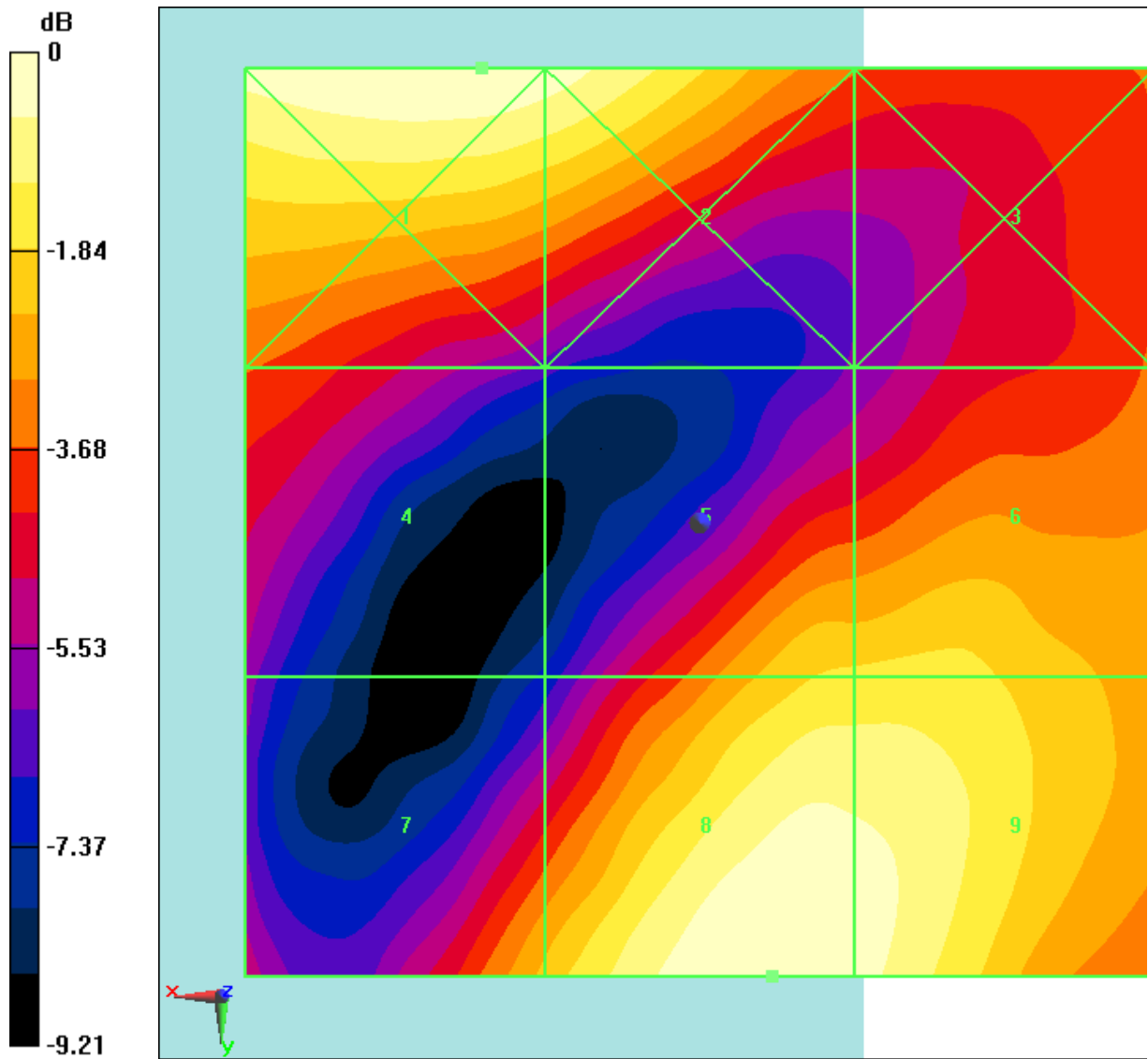

0 dB = 11.90 V/m = 21.51 dBV/m

**Fig B.20 HAC RF E-Field LTE Band41 Power Class 3 QPSK CH40185**

**HAC RF E-Field LTE Band41 Power Class 3 QPSK CH39750**

**Date: 2019-10-30**

Electronics: DAE4 Sn771

Medium: Air

Medium parameters used:  $\sigma = 0$  mho/m,  $\epsilon_r = 1$ ;  $\rho = 1000$  kg/m<sup>3</sup>

Ambient Temperature: 22.0°C

Communication System: LTE Band41; Frequency: 2506 MHz; Duty Cycle: 1:1.58

Probe: EF3DV3 - SN4060;ConvF(1, 1, 1)

B41/E Scan - ER3DV6 - 2011: 15 mm from Probe Center to the Device 3

2/Hearing Aid Compatibility Test (101x101x1): Interpolated grid:

dx=0.5000 mm, dy=0.5000 mm

Device Reference Point: 0, 0, -6.3 mm

Reference Value = 8.583 V/m; Power Drift = -0.06 dB

Applied MIF = -2.43 dB

RF audio interference level = 20.72 dBV/m

Emission category: **M4**

MIF scaled E-field

Grid 1 M4 22.02 dBV/m	Grid 2 M4 19.85 dBV/m	Grid 3 M4 17.33 dBV/m
Grid 4 M4 18.92 dBV/m	Grid 5 M4 19.32 dBV/m	Grid 6 M4 19.41 dBV/m
Grid 7 M4 19.38 dBV/m	Grid 8 M4 20.72 dBV/m	Grid 9 M4 20.09 dBV/m

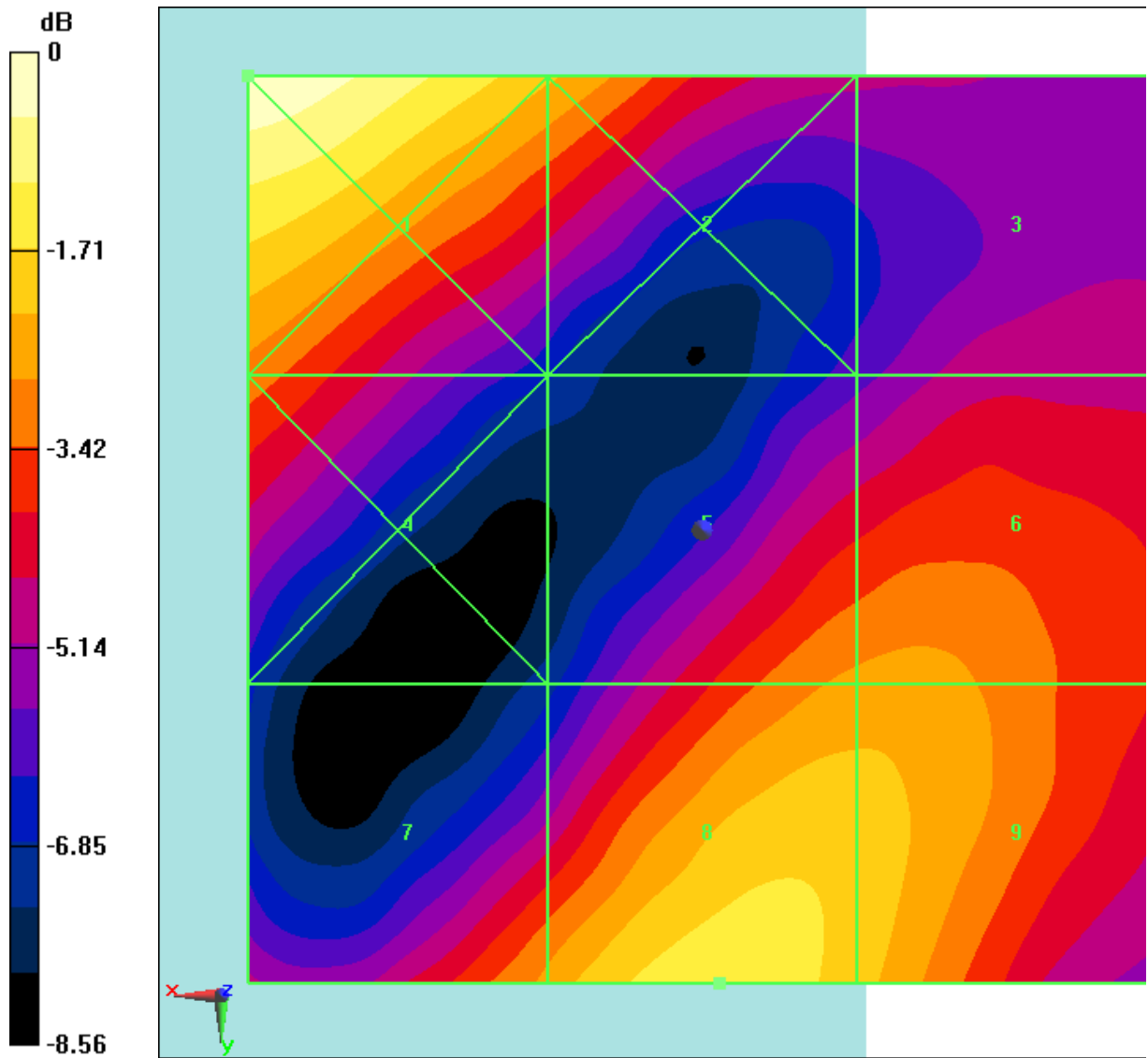

0 dB = 12.61 V/m = 22.01 dBV/m

**Fig B.21 HAC RF E-Field LTE Band41 Power Class 3 QPSK CH39750**

**HAC RF E-Field LTE Band41 Power Class 3 16QAM CH41490****Date: 2019-10-30**

Electronics: DAE4 Sn771

Medium: Air

Medium parameters used:  $\sigma = 0$  mho/m,  $\epsilon_r = 1$ ;  $\rho = 1000$  kg/m<sup>3</sup>

Ambient Temperature: 22.0°C

Communication System: LTE Band41; Frequency: 2680 MHz; Duty Cycle: 1:1.58

Probe: EF3DV3 - SN4060;ConvF(1, 1, 1)

B41/E Scan – ER3DV6 – 2011: 15 mm from Probe Center to the Device/Hearing

**Aid Compatibility Test (101x101x1):** Interpolated grid: dx=0.5000 mm,

dy=0.5000 mm

Device Reference Point: 0, 0, -6.3 mm

Reference Value = 10.68 V/m; Power Drift = -0.02 dB

Applied MIF = -2.28 dB

RF audio interference level = 19.27 dBV/m

**Emission category: M4**

MIF scaled E-field

Grid 1 M4 18.84 dBV/m	Grid 2 M4 19.09 dBV/m	Grid 3 M4 17.57 dBV/m
Grid 4 M4 15.42 dBV/m	Grid 5 M4 19.27 dBV/m	Grid 6 M4 19.34 dBV/m
Grid 7 M4 18.72 dBV/m	Grid 8 M4 19.93 dBV/m	Grid 9 M4 19.94 dBV/m

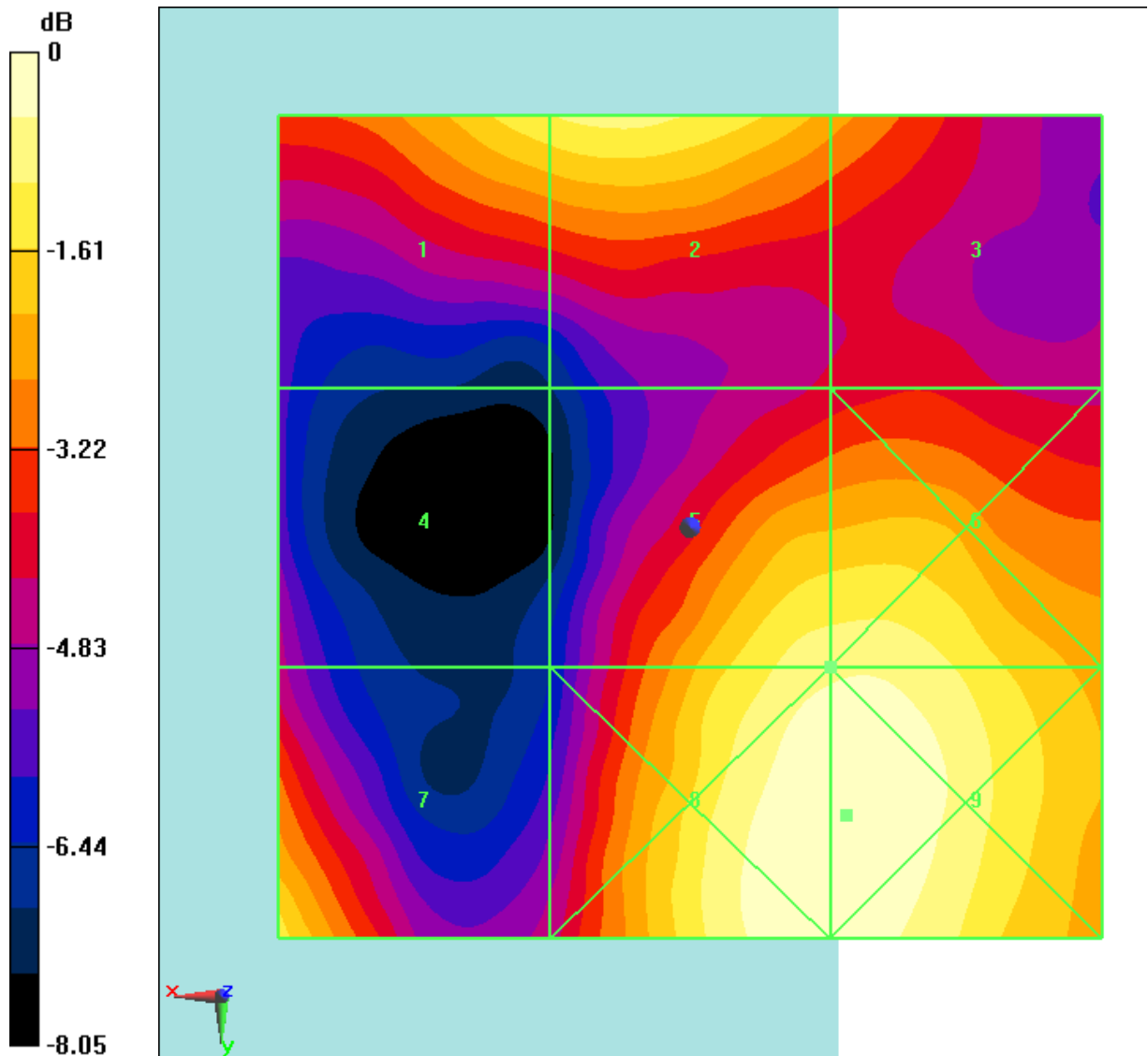

$0 \text{ dB} = 9.932 \text{ V/m} = 19.94 \text{ dBV/m}$

**Fig B.22 HAC RF E-Field LTE Band41 Power Class 3 16QAM CH41490**

**HAC RF E-Field LTE Band41 Power Class 3 16QAM CH41055**

**Date: 2019-10-30**

Electronics: DAE4 Sn771

Medium: Air

Medium parameters used:  $\sigma = 0$  mho/m,  $\epsilon_r = 1$ ;  $\rho = 1000$  kg/m<sup>3</sup>

Ambient Temperature: 22.0°C

Communication System: LTE Band41; Frequency: 2636.5 MHz; Duty Cycle: 1:1.58

Probe: EF3DV3 - SN4060;ConvF(1, 1, 1)

B41/E Scan - ER3DV6 - 2011: 15 mm from Probe Center to the Device

2/Hearing Aid Compatibility Test (101x101x1): Interpolated grid:

dx=0.5000 mm, dy=0.5000 mm

Device Reference Point: 0, 0, -6.3 mm

Reference Value = 9.957 V/m; Power Drift = -0.05 dB

Applied MIF = -2.24 dB

RF audio interference level = 20.48 dBV/m

Emission category: **M4**

MIF scaled E-field

Grid 1 M4 21 dBV/m	Grid 2 M4 21.09 dBV/m	Grid 3 M4 19.24 dBV/m
Grid 4 M4 15.72 dBV/m	Grid 5 M4 19.52 dBV/m	Grid 6 M4 19.56 dBV/m
Grid 7 M4 18.09 dBV/m	Grid 8 M4 20.48 dBV/m	Grid 9 M4 20.48 dBV/m



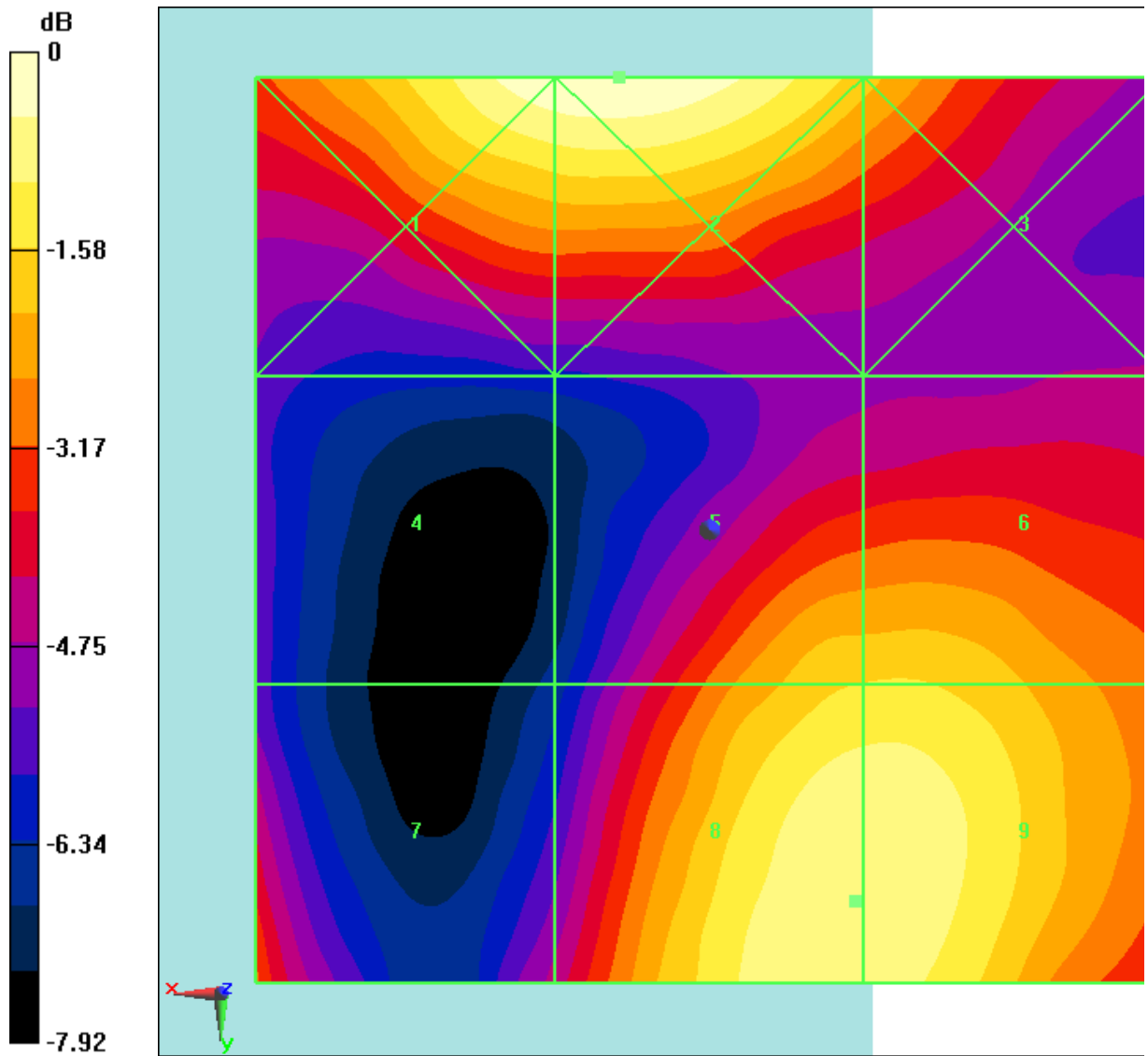

0 dB = 11.33 V/m = 21.08 dBV/m

**Fig B.23 HAC RF E-Field LTE Band41 Power Class 3 16QAM CH41055**

**HAC RF E-Field LTE Band41 Power Class 3 16QAM CH40620**

**Date: 2019-10-30**

Electronics: DAE4 Sn771

Medium: Air

Medium parameters used:  $\sigma = 0$  mho/m,  $\epsilon_r = 1$ ;  $\rho = 1000$  kg/m<sup>3</sup>

Ambient Temperature: 22.0°C

Communication System: LTE Band41; Frequency: 2593 MHz; Duty Cycle: 1:1.58

Probe: EF3DV3 - SN4060;ConvF(1, 1, 1)

B41/E Scan - ER3DV6 - 2011: 15 mm from Probe Center to the Device

3/Hearing Aid Compatibility Test (101x101x1): Interpolated grid:

dx=0.5000 mm, dy=0.5000 mm

Device Reference Point: 0, 0, -6.3 mm

Reference Value = 9.491 V/m; Power Drift = -0.13 dB

Applied MIF = -2.41 dB

RF audio interference level = 20.82 dBV/m

Emission category: **M4**

MIF scaled E-field

Grid 1 M4 21 dBV/m	Grid 2 M4 20.98 dBV/m	Grid 3 M4 17.7 dBV/m
Grid 4 M4 17.01 dBV/m	Grid 5 M4 19.5 dBV/m	Grid 6 M4 19.55 dBV/m
Grid 7 M4 17.69 dBV/m	Grid 8 M4 20.82 dBV/m	Grid 9 M4 20.7 dBV/m

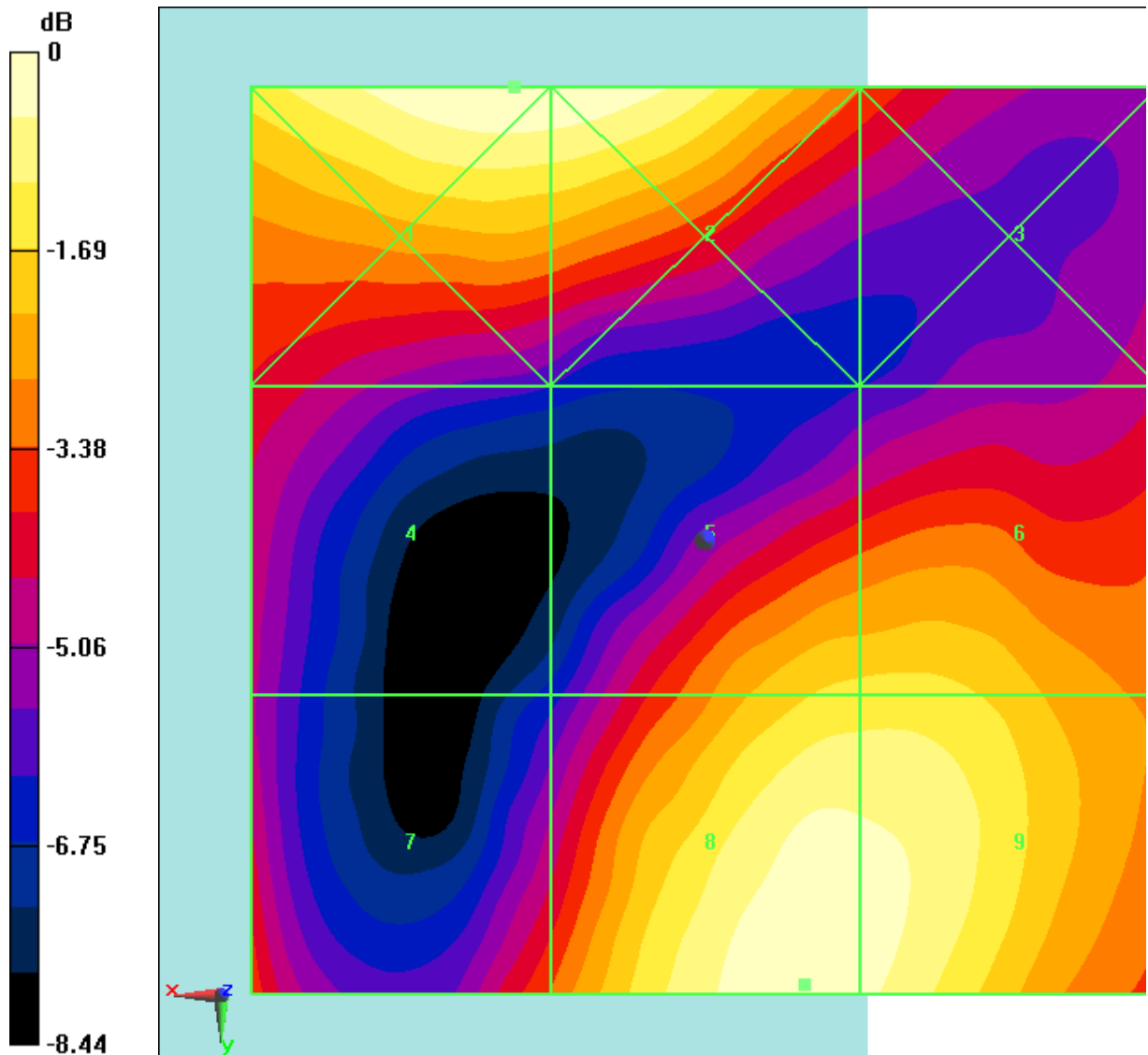

0 dB = 11.22 V/m = 21.00 dBV/m

**Fig B.24 HAC RF E-Field LTE Band41 Power Class 3 16QAM CH40620**

**HAC RF E-Field LTE Band41 Power Class 3 16QAM CH40185**
**Date: 2019-10-30**

Electronics: DAE4 Sn771

Medium: Air

 Medium parameters used:  $\sigma = 0$  mho/m,  $\epsilon_r = 1$ ;  $\rho = 1000$  kg/m<sup>3</sup>

Ambient Temperature: 22.0°C

Communication System: LTE Band41; Frequency: 2549.5 MHz; Duty Cycle: 1:1.58

Probe: EF3DV3 - SN4060;ConvF(1, 1, 1)

B41/E Scan - ER3DV6 - 2011: 15 mm from Probe Center to the Device 3

**3/Hearing Aid Compatibility Test (101x101x1):** Interpolated grid:

dx=0.5000 mm, dy=0.5000 mm

Device Reference Point: 0, 0, -6.3 mm

Reference Value = 8.290 V/m; Power Drift = -0.07 dB

Applied MIF = -2.21 dB

RF audio interference level = 20.68 dBV/m

**Emission category: M4**

MIF scaled E-field

Grid 1 M4 20.68 dBV/m	Grid 2 M4 20.41 dBV/m	Grid 3 M4 17.19 dBV/m
Grid 4 M4 17.19 dBV/m	Grid 5 M4 19.04 dBV/m	Grid 6 M4 19.13 dBV/m
Grid 7 M4 18.41 dBV/m	Grid 8 M4 20.72 dBV/m	Grid 9 M4 20.35 dBV/m

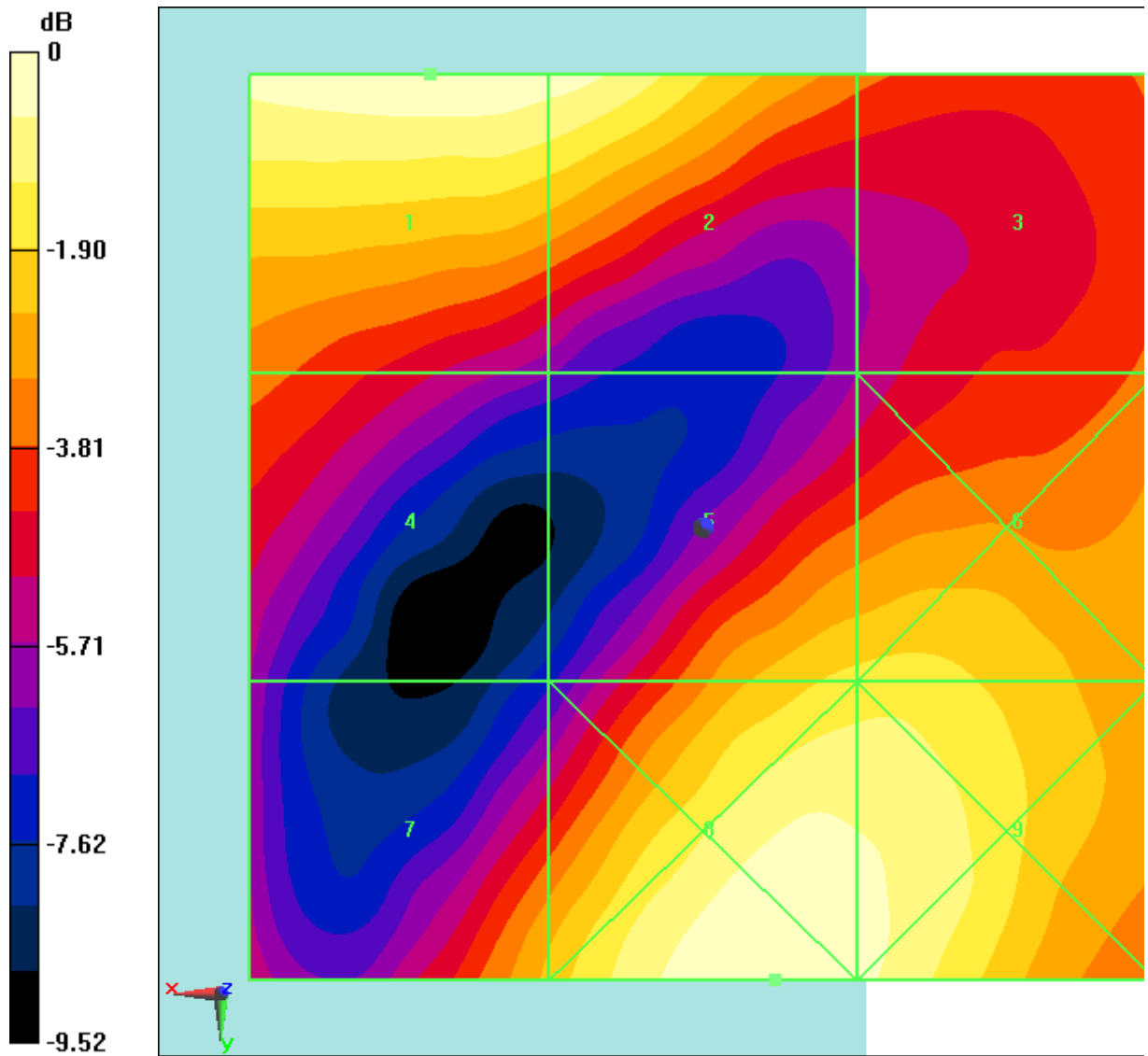

$0 \text{ dB} = 10.87 \text{ V/m} = 20.72 \text{ dBV/m}$

**Fig B.25 HAC RF E-Field LTE Band41 Power Class 3 16QAM CH40185**

**HAC RF E-Field LTE Band41 Power Class 3 16QAM CH39750**
**Date: 2019-10-30**

Electronics: DAE4 Sn771

Medium: Air

 Medium parameters used:  $\sigma = 0$  mho/m,  $\epsilon_r = 1$ ;  $\rho = 1000$  kg/m<sup>3</sup>

Ambient Temperature: 22.0°C

Communication System: LTE Band41; Frequency: 2506 MHz; Duty Cycle: 1:1.58

Probe: EF3DV3 - SN4060;ConvF(1, 1, 1)

B41/E Scan - ER3DV6 - 2011: 15 mm from Probe Center to the Device 3

2/Hearing Aid Compatibility Test (101x101x1): Interpolated grid:

 $dx=0.5000$  mm,  $dy=0.5000$  mm

Device Reference Point: 0, 0, -6.3 mm

Reference Value = 7.360 V/m; Power Drift = -0.07 dB

Applied MIF = -2.17 dB

RF audio interference level = 19.85 dBV/m

**Emission category: M4**

MIF scaled E-field

Grid 1 M4 21.28 dBV/m	Grid 2 M4 19.06 dBV/m	Grid 3 M4 16.64 dBV/m
Grid 4 M4 18.19 dBV/m	Grid 5 M4 18.41 dBV/m	Grid 6 M4 18.45 dBV/m
Grid 7 M4 18.51 dBV/m	Grid 8 M4 19.85 dBV/m	Grid 9 M4 19.19 dBV/m

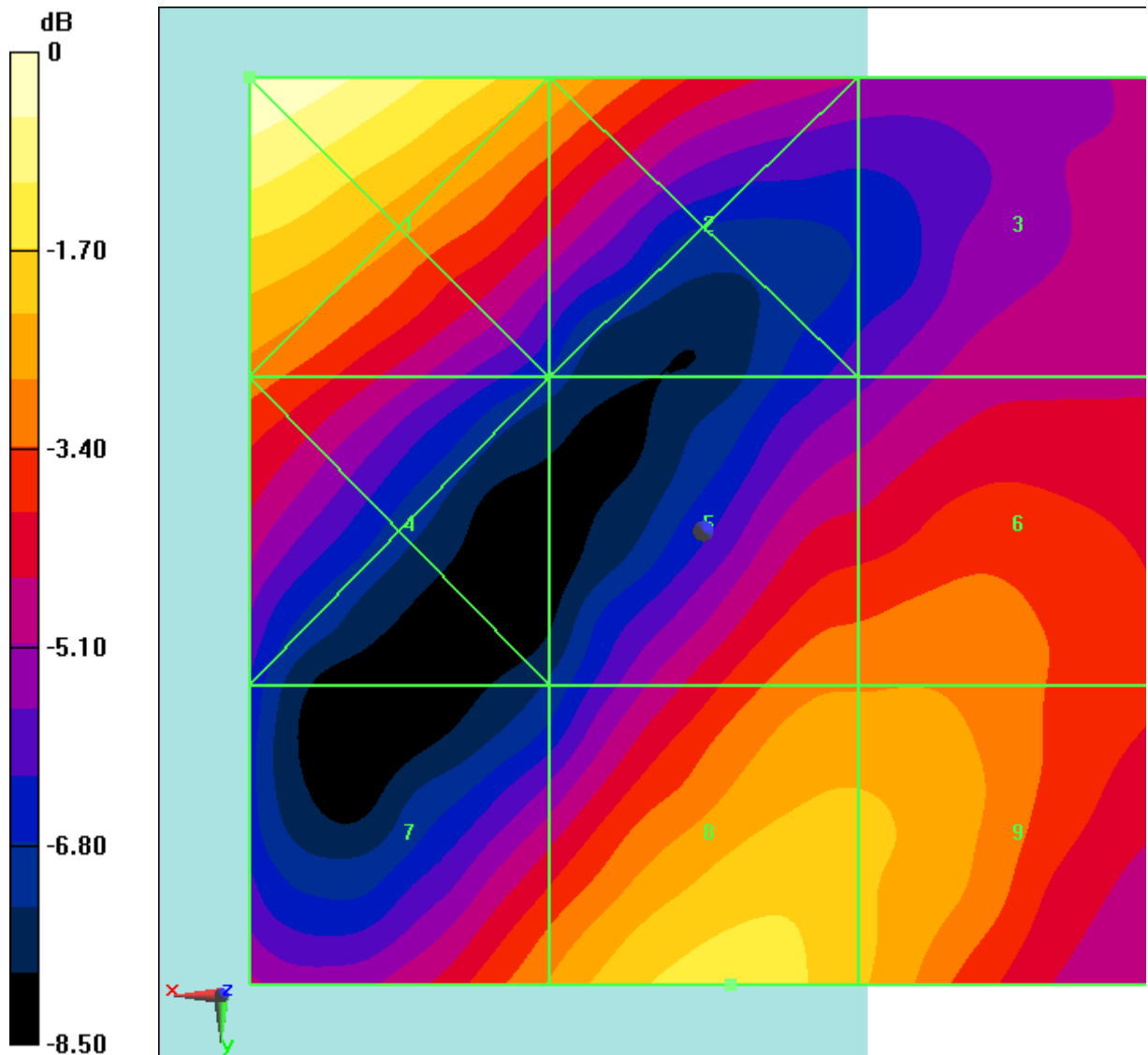

$0 \text{ dB} = 11.58 \text{ V/m} = 21.27 \text{ dBV/m}$

**Fig B.26 HAC RF E-Field LTE Band41 Power Class 3 16QAM CH39750**

## ANNEX C SYSTEM VALIDATION RESULT

### E SCAN of Dipole 835 MHz

Date: 2019-10-29

Electronics: DAE4 Sn771

Medium: Air

Medium parameters used:  $\sigma = 0$  mho/m,  $\epsilon_r = 1$ ;  $\rho = 1000$  kg/m<sup>3</sup>

Communication System: CW; Frequency: 835 MHz; Duty Cycle: 1:1

Probe: EF3DV3 - SN4060;ConvF(1, 1, 1)

**E Scan - measurement distance from the probe sensor center to CD835 Dipole = 15mm/Hearing Aid Compatibility Test (41x361x1):** Interpolated grid: dx=0.5000 mm, dy=0.5000 mm

Device Reference Point: 0, 0, -6.3 mm

Reference Value = 134.3 V/m; Power Drift = 0.07 dB

Applied MIF = 0.00 dB

RF audio interference level = 40.73 dBV/m

**Emission category: M3**

MIF scaled E-field

Grid 1 M3 40.28 dBV/m	Grid 2 M3 40.73 dBV/m	Grid 3 M3 40.85 dBV/m
Grid 4 M4 35.52 dBV/m	Grid 5 M4 35.87 dBV/m	Grid 6 M4 35.89 dBV/m
Grid 7 M3 40.48 dBV/m	Grid 8 M3 40.87 dBV/m	Grid 9 M3 40.78 dBV/m

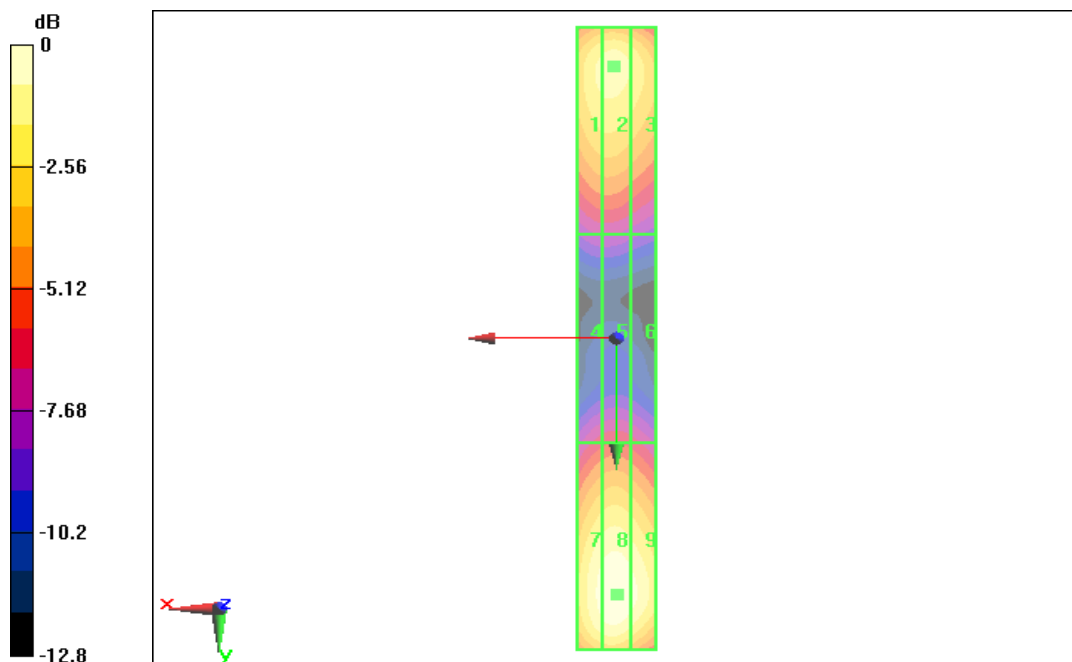

0 dB = 40.73 dBV/m



**E SCAN of Dipole 1880 MHz**

**Date: 2019-10-29**

Electronics: DAE4 Sn771

Medium: Air

Medium parameters used:  $\sigma = 0$  mho/m,  $\epsilon_r = 1$ ;  $\rho = 1000$  kg/m<sup>3</sup>

Communication System: CW; Frequency: 1880 MHz; Duty Cycle: 1:1

Probe: EF3DV3 - SN4060;ConvF(1, 1, 1)

**E Scan - measurement distance from the probe sensor center to CD1880 Dipole = 15mm/Hearing Aid Compatibility Test (41x181x1):** Interpolated grid: dx=0.5000 mm, dy=0.5000 mm

Device Reference Point: 0, 0, -6.3 mm

Reference Value = 154.2 V/m; Power Drift = 0.06 dB

Applied MIF = 0.00 dB

RF audio interference level = 39.02 dBV/m

**Emission category: M2**

MIF scaled E-field

Grid 1 M2 38.88 dBV/m	Grid 2 M2 39.02 dBV/m	Grid 3 M2 38.96 dBV/m
Grid 4 M2 36.14 dBV/m	Grid 5 M2 36.05 dBV/m	Grid 6 M2 36.27 dBV/m
Grid 7 M2 38.71 dBV/m	Grid 8 M2 39.01 dBV/m	Grid 9 M2 38.83 dBV/m

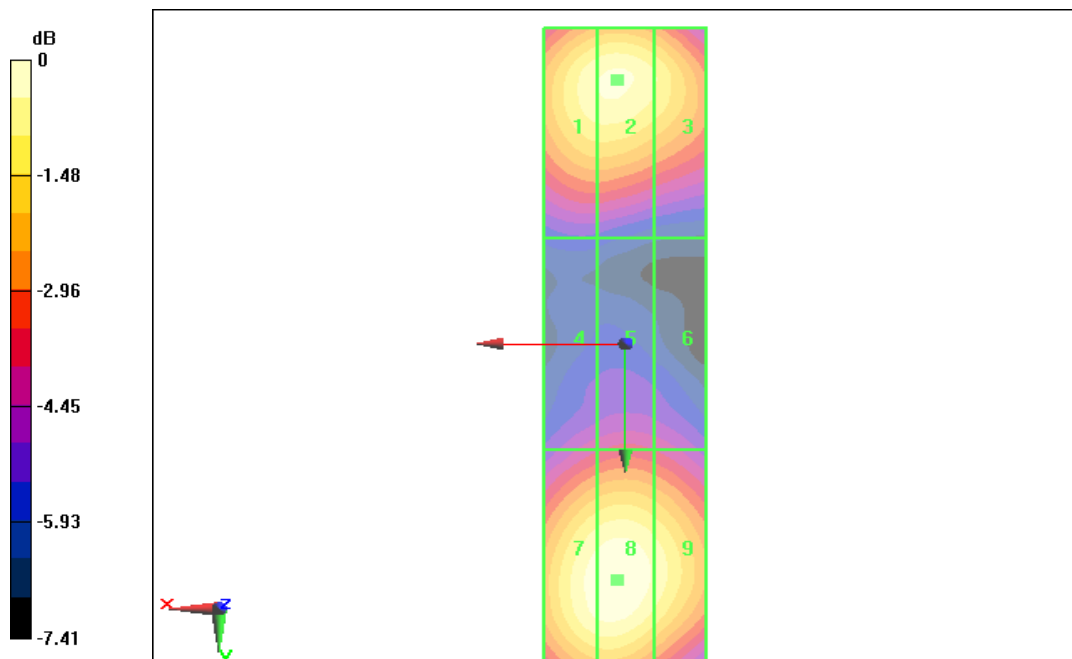

0 dB = 39.02 dBV/m

**E SCAN of Dipole 2600 MHz**
**Date: 2019-10-30**

Electronics: DAE4 Sn771

Medium: Air

 Medium parameters used:  $\sigma = 0$  mho/m,  $\epsilon_r = 1$ ;  $\rho = 1000$  kg/m<sup>3</sup>

Communication System: CW; Frequency: 2600 MHz; Duty Cycle: 1:1

Probe: EF3DV3 - SN4060;ConvF(1, 1, 1)

**E Scan - measurement distance from the probe sensor center to CD2600 Dipole = 15mm/Hearing Aid Compatibility Test (41x181x1):** Interpolated grid: dx=0.5000 mm, dy=0.5000 mm

Device Reference Point: 0, 0, -6.3 mm

Reference Value = 62.35 V/m; Power Drift = 0.04 dB

Applied MIF = 0.00 dB

RF audio interference level = 38.61 dBV/m

**Emission category: M2**

MIF scaled E-field

Grid 1M2 38.25 dBV/m	Grid 2M2 38.49 dBV/m	Grid 3M2 38.48 dBV/m
Grid 4M2 37.75 dBV/m	Grid 5M2 38.06 dBV/m	Grid 6M2 37.98 dBV/m
Grid 7M2 38.47 dBV/m	Grid 8M2 38.61 dBV/m	Grid 9M2 38.51 dBV/m

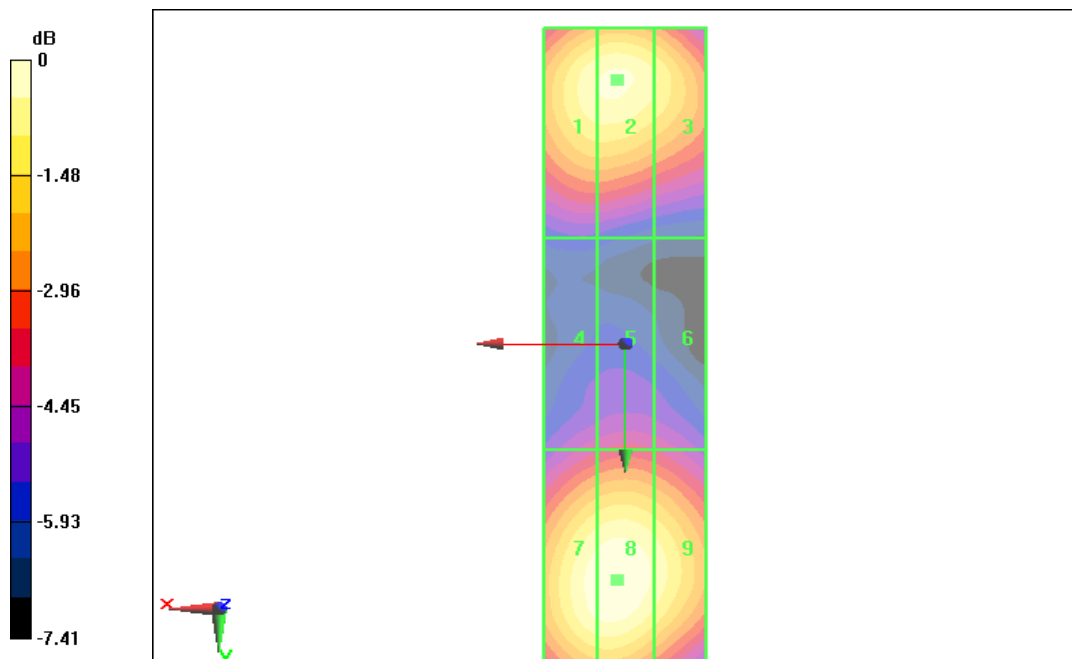

0 dB = 38.61 dBV/m

**ANNEX D PROBE CALIBRATION CERTIFICATE**

**Calibration Laboratory of  
Schmid & Partner  
Engineering AG**  
Zeughausstrasse 43, 8004 Zurich, Switzerland



**S** Schweizerischer Kalibrierdienst  
**C** Service suisse d'étalonnage  
**S** Servizio svizzero di taratura  
Swiss Calibration Service

Accredited by the Swiss Accreditation Service (SAS)  
The Swiss Accreditation Service is one of the signatories to the EA  
Multilateral Agreement for the recognition of calibration certificates

Accreditation No.: **SCS 0108**

Client **CTTL (Auden)**

Certificate No: **EF3-4060\_May19**

**CALIBRATION CERTIFICATE**

Object **EF3DV3- SN:4060**

Calibration procedure(s) **QA CAL-02.v9, QA CAL-25.v7  
Calibration procedure for E-field probes optimized for close near field  
evaluations in air**

Calibration date: **May 17, 2019**

This calibration certificate documents the traceability to national standards, which realize the physical units of measurements (SI).  
The measurements and the uncertainties with confidence probability are given on the following pages and are part of the certificate.

All calibrations have been conducted in the closed laboratory facility: environment temperature (22 ± 3)°C and humidity < 70%.

Calibration Equipment used (M&TE critical for calibration)

Primary Standards	ID	Cal Date (Certificate No.)	Scheduled Calibration
Power meter NRP	SN: 104778	03-Apr-19 (No. 217-02892/02893)	Apr-20
Power sensor NRP-Z91	SN: 103244	03-Apr-19 (No. 217-02892)	Apr-20
Power sensor NRP-Z91	SN: 103245	03-Apr-19 (No. 217-02893)	Apr-20
Reference 20 dB Attenuator	SN: S5277 (20x)	04-Apr-19 (No. 217-02894)	Apr-20
DAE4	SN: 789	14-Jan-19 (No. DAE4-789_Jan19)	Jan-20
Reference Probe ER3DV6	SN: 2328	09-Oct-18 (No. ER3-2328_Oct18)	Oct-19
Secondary Standards	ID	Check Date (in house)	Scheduled Check
Power meter E4419B	SN: GB41293874	06-Apr-16 (in house check Jun-18)	In house check: Jun-20
Power sensor E4412A	SN: MY41498087	06-Apr-16 (in house check Jun-18)	In house check: Jun-20
Power sensor E4412A	SN: 000110210	06-Apr-16 (in house check Jun-18)	In house check: Jun-20
RF generator HP 8648C	SN: US3642U01700	04-Aug-99 (in house check Jun-18)	In house check: Jun-20
Network Analyzer E8358A	SN: US41080477	31-Mar-14 (in house check Oct-18)	In house check: Oct-19

	Name	Function	Signature
Calibrated by:	Jeton Kastrati	Laboratory Technician	
Approved by:	Katja Pokovic	Technical Manager	

Issued: May 20, 2019

This calibration certificate shall not be reproduced except in full without written approval of the laboratory.

**Calibration Laboratory of**  
Schmid & Partner  
Engineering AG  
Zeughausstrasse 43, 8004 Zurich, Switzerland



**S** Schweizerischer Kalibrierdienst  
**C** Service suisse d'étalonnage  
**S** Servizio svizzero di taratura  
**S** Swiss Calibration Service

Accredited by the Swiss Accreditation Service (SAS)  
The Swiss Accreditation Service is one of the signatories to the EA  
Multilateral Agreement for the recognition of calibration certificates

Accreditation No.: **SCS 0108**

**Glossary:**

NORM <sub>x,y,z</sub>	sensitivity in free space
DCP	diode compression point
CF	crest factor (1/duty_cycle) of the RF signal
A, B, C, D	modulation dependent linearization parameters
En	incident E-field orientation normal to probe axis
Ep	incident E-field orientation parallel to probe axis
Polarization $\varphi$	$\varphi$ rotation around probe axis
Polarization $\vartheta$	$\vartheta$ rotation around an axis that is in the plane normal to probe axis (at measurement center), i.e., $\vartheta = 0$ is normal to probe axis
Connector Angle	information used in DASY system to align probe sensor X to the robot coordinate system

**Calibration is Performed According to the Following Standards:**

- IEEE Std 1309-2005, " IEEE Standard for calibration of electromagnetic field sensors and probes, excluding antennas, from 9 kHz to 40 GHz", December 2005
- CTIA Test Plan for Hearing Aid Compatibility, Rev 3.1.1, May 2017

**Methods Applied and Interpretation of Parameters:**

- NORM<sub>x,y,z</sub>*: Assessed for E-field polarization  $\vartheta = 0$  for XY sensors and  $\vartheta = 90$  for Z sensor ( $f \leq 900$  MHz in TEM-cell;  $f > 1800$  MHz: R22 waveguide).
- NORM(f)<sub>x,y,z</sub>* = *NORM<sub>x,y,z</sub>* \* *frequency\_response* (see Frequency Response Chart).
- DCP<sub>x,y,z</sub>*: DCP are numerical linearization parameters assessed based on the data of power sweep with CW signal (no uncertainty required). DCP does not depend on frequency nor media.
- PAR*: PAR is the Peak to Average Ratio that is not calibrated but determined based on the signal characteristics
- A<sub>x,y,z</sub>*; *B<sub>x,y,z</sub>*; *C<sub>x,y,z</sub>*; *D<sub>x,y,z</sub>*; *VR<sub>x,y,z</sub>*; *A, B, C, D* are numerical linearization parameters assessed based on the data of power sweep for specific modulation signal. The parameters do not depend on frequency nor media. *VR* is the maximum calibration range expressed in RMS voltage across the diode.
- Spherical isotropy (3D deviation from isotropy)*: in a locally homogeneous field realized using an open waveguide setup.
- Sensor Offset*: The sensor offset corresponds to the offset of virtual measurement center from the probe tip (on probe axis). No tolerance required.
- Connector Angle*: The angle is assessed using the information gained by determining the *NORM<sub>x</sub>* (no uncertainty required).



EF3DV3 – SN:4060

May 17, 2019

**DASY/EASY - Parameters of Probe: EF3DV3 - SN:4060****Basic Calibration Parameters**

	Sensor X	Sensor Y	Sensor Z	Unc (k=2)
Norm ( $\mu\text{V}/(\text{V}/\text{m})^2$ )	0.79	0.74	1.28	$\pm 10.1\%$
DCP (mV) <sup>B</sup>	98.2	95.5	93.6	

**Calibration results for Frequency Response (30 MHz – 6 GHz)**

Frequency MHz	Target E-Field V/m	Measured E-field (En) V/m	Deviation E-normal in %	Measured E-field (Ep) V/m	Deviation E-normal in %	Unc (k=2) %
30	77.2	77.3	0.2%	77.4	0.3%	$\pm 5.1\%$
100	77.3	78.3	1.3%	78.6	1.7%	$\pm 5.1\%$
450	77.1	78.1	1.3%	78.2	1.4%	$\pm 5.1\%$
600	77.1	77.6	0.7%	77.6	0.7%	$\pm 5.1\%$
750	77.2	77.6	0.5%	77.4	0.3%	$\pm 5.1\%$
1800	143.1	139.1	-2.8%	139.3	-2.6%	$\pm 5.1\%$
2000	135.1	131.5	-2.6%	131.6	-2.6%	$\pm 5.1\%$
2200	127.5	123.4	-3.2%	124.8	-2.1%	$\pm 5.1\%$
2500	125.5	122.5	-2.3%	123.6	-1.5%	$\pm 5.1\%$
3000	79.4	75.9	-4.5%	76.8	-3.3%	$\pm 5.1\%$
3500	256.2	247.1	-3.5%	244.6	-4.5%	$\pm 5.1\%$
3700	249.5	238.4	-4.4%	237.2	-4.9%	$\pm 5.1\%$
5200	50.7	51.2	0.9%	51.5	1.6%	$\pm 5.1\%$
5500	49.7	49.4	-0.6%	48.2	-3.0%	$\pm 5.1\%$
5800	48.8	48.7	-0.3%	49.6	1.6%	$\pm 5.1\%$

The reported uncertainty of measurement is stated as the standard uncertainty of measurement multiplied by the coverage factor k=2, which for a normal distribution corresponds to a coverage probability of approximately 95%.

<sup>B</sup> Numerical linearization parameter: uncertainty not required.

<sup>E</sup> Uncertainty is determined using the max. deviation from linear response applying rectangular distribution and is expressed for the square of the field value.



EF3DV3 – SN:4060

May 17, 2019

## DASY/EASY - Parameters of Probe: EF3DV3 - SN:4060

### Calibration Results for Modulation Response

UID	Communication System Name		A dB	B dB $\sqrt{\mu V}$	C	D dB	VR mV	Max dev.	Max Unc <sup>E</sup> (k=2)
0	CW	X	0.00	0.00	1.00	0.00	171.1	± 3.5 %	± 4.7 %
		Y	0.00	0.00	1.00		164.2		
		Z	0.00	0.00	1.00		172.8		
10352-AAA	Pulse Waveform (200Hz, 10%)	X	2.72	65.67	9.66	10.00	60.0	± 3.2 %	± 9.6 %
		Y	6.00	74.00	13.00		60.0		
		Z	2.66	66.07	9.64		60.0		
10353-AAA	Pulse Waveform (200Hz, 20%)	X	1.27	62.48	7.17	6.99	80.0	± 1.3 %	± 9.6 %
		Y	1.38	63.43	7.77		80.0		
		Z	1.30	63.08	7.35		80.0		
10354-AAA	Pulse Waveform (200Hz, 40%)	X	0.57	60.93	5.43	3.98	95.0	± 0.9 %	± 9.6 %
		Y	0.70	62.08	6.24		95.0		
		Z	0.61	61.44	5.61		95.0		
10355-AAA	Pulse Waveform (200Hz, 60%)	X	0.31	60.48	4.52	2.22	120.0	± 0.9 %	± 9.6 %
		Y	0.35	60.82	4.90		120.0		
		Z	0.42	61.46	4.70		120.0		
10387-AAA	QPSK Waveform, 1 MHz	X	0.52	60.58	6.63	0.00	150.0	± 2.6 %	± 9.6 %
		Y	0.46	60.00	5.71		150.0		
		Z	0.44	60.00	5.37		150.0		
10388-AAA	QPSK Waveform, 10 MHz	X	2.47	70.93	17.56	0.00	150.0	± 1.0 %	± 9.6 %
		Y	2.22	69.08	16.44		150.0		
		Z	2.44	71.07	17.65		150.0		
10396-AAA	64-QAM Waveform, 100 kHz	X	1.74	65.32	17.52	3.01	150.0	± 3.3 %	± 9.6 %
		Y	1.82	65.53	17.41		150.0		
		Z	2.13	67.57	17.98		150.0		
10399-AAA	64-QAM Waveform, 40 MHz	X	3.57	67.84	16.46	0.00	150.0	± 1.8 %	± 9.6 %
		Y	3.41	67.03	15.92		150.0		
		Z	3.54	67.84	16.52		150.0		
10414-AAA	WLAN CCDF, 64-QAM, 40MHz	X	4.80	66.13	16.05	0.00	150.0	± 3.4 %	± 9.6 %
		Y	4.67	65.67	15.72		150.0		
		Z	4.77	66.19	16.15		150.0		

Note: For details on UID parameters see Appendix

The reported uncertainty of measurement is stated as the standard uncertainty of measurement multiplied by the coverage factor  $k=2$ , which for a normal distribution corresponds to a coverage probability of approximately 95%.

<sup>B</sup> Numerical linearization parameter: uncertainty not required.

<sup>E</sup> Uncertainty is determined using the max. deviation from linear response applying rectangular distribution and is expressed for the square of the field value.



EF3DV3 – SN:4060

May 17, 2019

**DASY/EASY - Parameters of Probe: EF3DV3 - SN:4060****Sensor Frequency Model Parameters**

	Sensor X	Sensor Y	Sensor Z
Frequency Corr. (LF)	0.22	0.21	4.59
Frequency Corr. (HF)	2.82	2.82	2.82

**Sensor Model Parameters**

	C1 fF	C2 fF	$\alpha$ V <sup>-1</sup>	T1 ms.V <sup>-2</sup>	T2 ms.V <sup>-1</sup>	T3 ms	T4 V <sup>-2</sup>	T5 V <sup>-1</sup>	T6
X	36.7	244.56	37.42	5.96	0.18	4.95	0.00	0.00	1.01
Y	35.1	235.07	37.62	8.08	0.00	4.99	0.00	0.06	1.01
Z	33.6	228.28	38.82	7.28	0.00	4.99	0.00	0.19	1.00

**Other Probe Parameters**

Sensor Arrangement	Rectangular
Connector Angle (°)	-36.4
Mechanical Surface Detection Mode	enabled
Optical Surface Detection Mode	disabled
Probe Overall Length	337 mm
Probe Body Diameter	12 mm
Tip Length	25 mm
Tip Diameter	4 mm
Probe Tip to Sensor X Calibration Point	1.5 mm
Probe Tip to Sensor Y Calibration Point	1.5 mm
Probe Tip to Sensor Z Calibration Point	1.5 mm

EF3DV3 – SN:4060

May 17, 2019

### Receiving Pattern ( $\phi$ ), $\vartheta = 0^\circ$

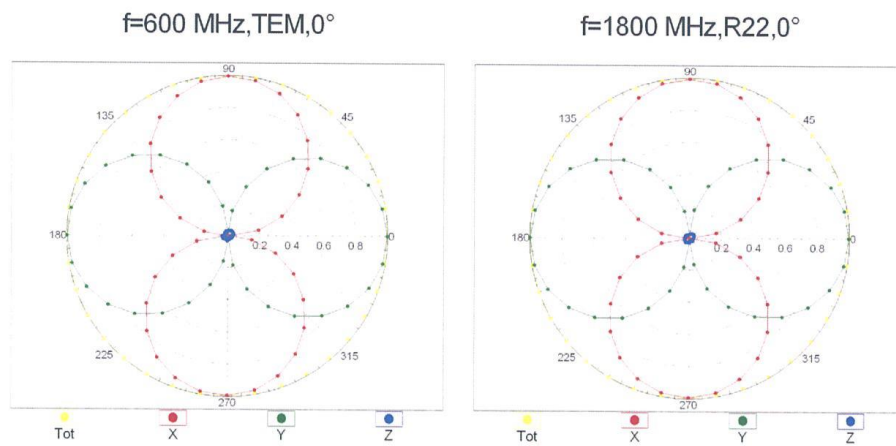

### Receiving Pattern ( $\phi$ ), $\vartheta = 90^\circ$

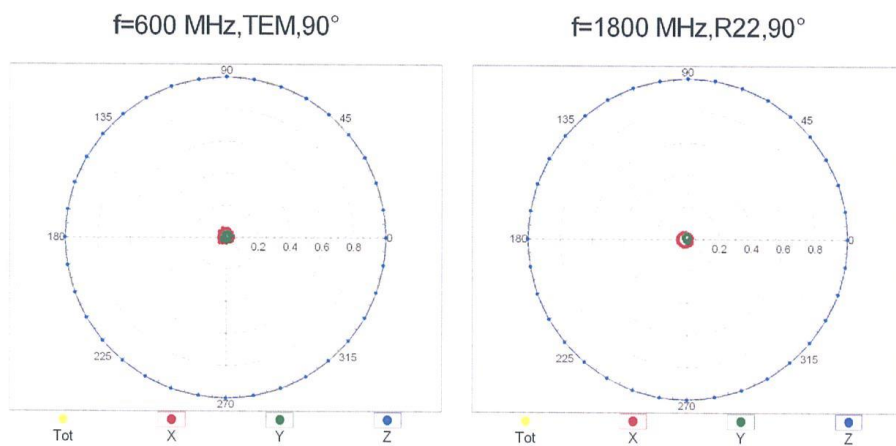



EF3DV3 – SN:4060

May 17, 2019

### Receiving Pattern ( $\phi$ ), $\vartheta = 0^\circ$

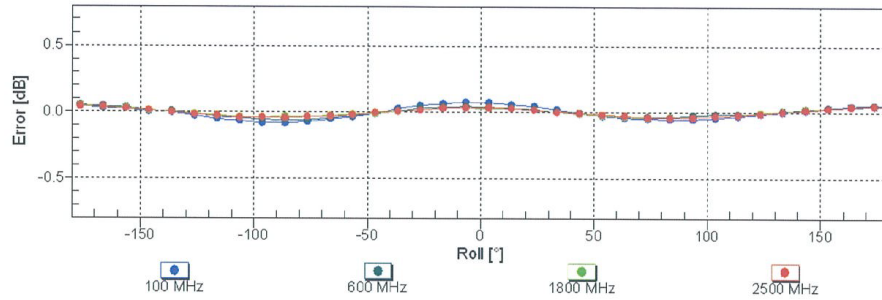
Uncertainty of Axial Isotropy Assessment:  $\pm 0.5\%$  (k=2)

### Receiving Pattern ( $\phi$ ), $\vartheta = 90^\circ$

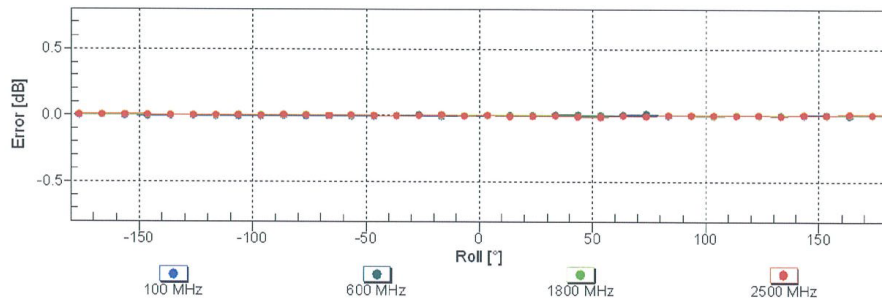
Uncertainty of Axial Isotropy Assessment:  $\pm 0.5\%$  (k=2)

### Dynamic Range f(E-field) (TEM cell, f = 900 MHz)

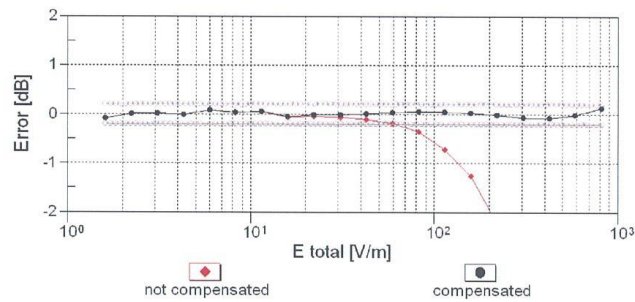
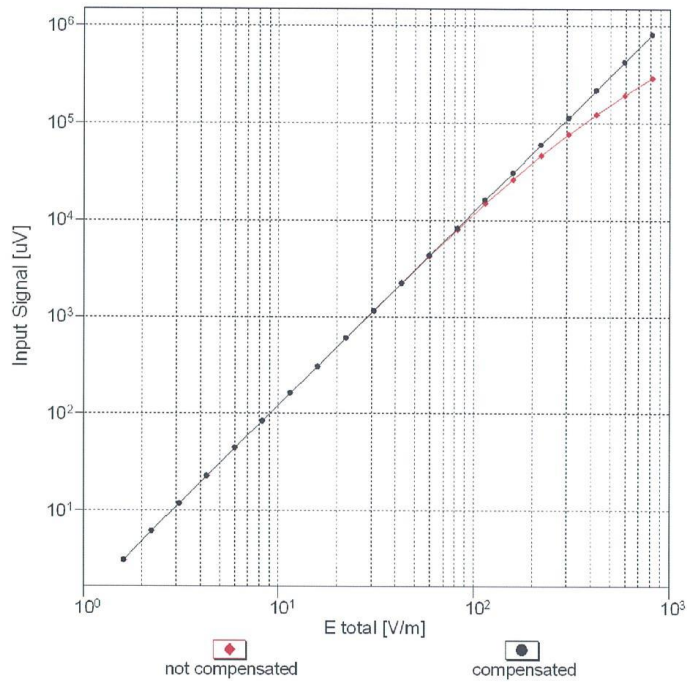

Uncertainty of Linearity Assessment:  $\pm 0.6\%$  (k=2)

### Deviation from Isotropy in Air Error ( $\phi$ , $\theta$ ), $f = 900$ MHz

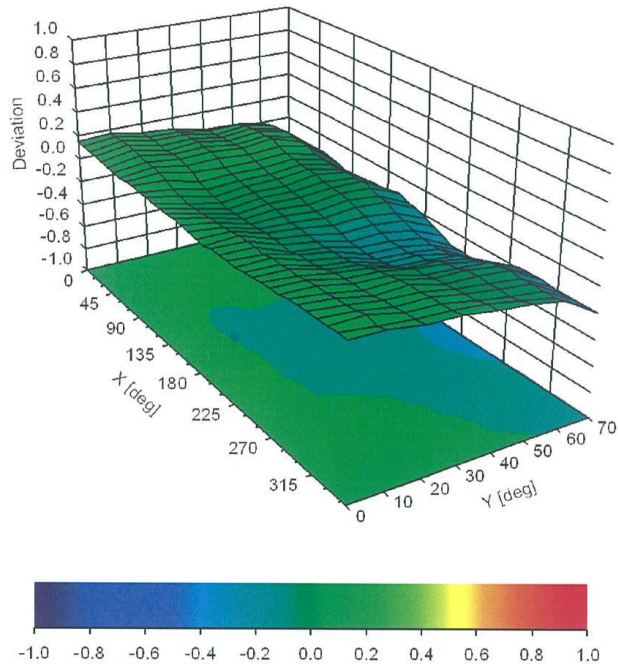

Uncertainty of Spherical Isotropy Assessment:  $\pm 2.6\%$  ( $k=2$ )

# ANNEX E DIPOLE CALIBRATION CERTIFICATE

## Dipole 835 MHz

**Calibration Laboratory of  
 Schmid & Partner  
 Engineering AG**  
 Zeughausstrasse 43, 8004 Zurich, Switzerland



**S** Schweizerischer Kalibrierdienst  
**C** Service suisse d'étalonnage  
**S** Servizio svizzero di taratura  
**S** Swiss Calibration Service

Accredited by the Swiss Accreditation Service (SAS)  
 The Swiss Accreditation Service is one of the signatories to the EA  
 Multilateral Agreement for the recognition of calibration certificates

Accreditation No.: **SCS 0108**

Client **CTTL (Auden)**

Certificate No: **CD835V3-1023\_Aug19**

CALIBRATION CERTIFICATE			
Object	CD835V3 - SN: 1023		
Calibration procedure(s)	QA CAL-20.v7 Calibration Procedure for Validation Sources in air		
Calibration date:	August 26, 2019		
This calibration certificate documents the traceability to national standards, which realize the physical units of measurements (SI). The measurements and the uncertainties with confidence probability are given on the following pages and are part of the certificate.			
All calibrations have been conducted in the closed laboratory facility: environment temperature (22 ± 3)°C and humidity < 70%.			
Calibration Equipment used (M&TE critical for calibration)			
Primary Standards	ID #	Cal Date (Certificate No.)	Scheduled Calibration
Power meter NRP	SN: 104778	03-Apr-19 (No. 217-02892/02893)	Apr-20
Power sensor NRP-Z91	SN: 103244	03-Apr-19 (No. 217-02892)	Apr-20
Power sensor NRP-Z91	SN: 103245	03-Apr-19 (No. 217-02893)	Apr-20
Reference 20 dB Attenuator	SN: 5058 (20k)	04-Apr-19 (No. 217-02894)	Apr-20
Type-N mismatch combination	SN: 5047.2 / 06327	04-Apr-19 (No. 217-02895)	Apr-20
Probe EF3DV3	SN: 4013	03-Jan-19 (No. EF3-4013_Jan19)	Jan-20
DAE4	SN: 781	09-Jan-19 (No. DAE4-781_Jan19)	Jan-20
Secondary Standards	ID #	Check Date (in house)	Scheduled Check
Power meter Agilent 4419B	SN: GB42420191	09-Oct-09 (in house check Oct-17)	In house check: Oct-20
Power sensor HP E4412A	SN: US38485102	05-Jan-10 (in house check Oct-17)	In house check: Oct-20
Power sensor HP 8482A	SN: US37295597	09-Oct-09 (in house check Oct-17)	In house check: Oct-20
RF generator R&S SMT-06	SN: 837633/005	10-Jan-19 (in house check Jan-19)	In house check: Oct-22
Network Analyzer Agilent E8358A	SN: US41080477	31-Mar-14 (in house check Oct-18)	In house check: Oct-19
Calibrated by:	Name Leif Klysner	Function Laboratory Technician	Signature 
Approved by:	Name Katja Pokovic	Function Technical Manager	Signature 
			Issued: August 27, 2019
This calibration certificate shall not be reproduced except in full without written approval of the laboratory.			