



FCC TEST REPORT

Application No.: ZR/2019/50026
Applicant: TCL Communication Ltd.
Address of Applicant: 7/F, Block F4, TCL Communication Technology Building, TCL International E City, Zhong Shan Yuan Road, Nanshan District, Shenzhen, Guangdong, P.R. China 518052
Manufacturer: TCL Communication Ltd.
Address of Manufacturer: 7/F, Block F4, TCL Communication Technology Building, TCL International E City, Zhong Shan Yuan Road, Nanshan District, Shenzhen, Guangdong, P.R. China 518052
EUT Description: HSUPA/HSDPA/UMTS quad band /GSM quad band mobile phone
Model No.: 4034T
Trade Mark: alcatel
FCC ID: 2ACCJH106
Standards: 47 CFR Part 2
 47 CFR Part 22 subpart H
 47 CFR Part 24 subpart E
 47 CFR Part 27 subpart C
Test Method: FCC KDB 971168 D01 Power Meas License Digital Systems V03r01 C63.26 (2015)
Date of Receipt: 2019/5/21
Date of Test: 2019/5/22 to 2019/6/10
Date of Issue: 2019/6/10

| | |
|---------------------|---------------|
| Test Result: | PASS * |
|---------------------|---------------|

* In the configuration tested, the EUT detailed in this report complied with the standards specified above.

Authorized Signature:

Derek Yang
Wireless Laboratory Manager



Unless otherwise agreed in writing, this document is issued by the Company subject to its General Conditions of Service printed overleaf, available on request or accessible at <http://www.sgs.com/en/Terms-and-Conditions.aspx> and, for electronic format documents, subject to Terms and Conditions for Electronic Documents at <http://www.sgs.com/en/terms-and-conditions/Terms-e-Documents.aspx>. Attention is drawn to the limitation of liability, indemnification and jurisdiction issues defined therein. Any holder of this document is advised that information contained hereon reflects the Company's findings at the time of its intervention only and within the limits of Client's instructions, if any. The Company's sole responsibility is to its Client and this document does not exonerate parties to a transaction from exercising all their rights and obligations under the transaction documents. This document cannot be reproduced except in full, without prior written approval of the Company. Any unauthorized alteration, forgery or falsification of the content or appearance of this document is unlawful and offenders may be prosecuted to the fullest extent of the law. Unless otherwise stated the results shown in this test report refer only to the sample(s) tested and such sample(s) are retained for 30 days only.
 Attention: To check the authenticity of testing /inspection report & certificate, please contact us at telephone: (86-755) 8307 1443, or email: CN.Doccheck@sgs.com

1 Version

| Revision Record | | | | |
|-----------------|---------|-----------|----------|----------|
| Version | Chapter | Date | Modifier | Remark |
| 00 | | 2019/6/10 | | Original |
| | | | | |
| | | | | |

| | | | |
|---------------------------------|--|--|--------------------------------|
| Authorized for issue by: | | | |
| Tested By | |  <hr/> (Mike Hu) /Project Engineer | 2019/6/10 <hr/> Date |
| Checked By | |  <hr/> (David Chen) /Reviewer | 2019/6/10 <hr/> Date |



Unless otherwise agreed in writing, this document is issued by the Company subject to its General Conditions of Service printed overleaf, available on request or accessible at <http://www.sgs.com/en/Terms-and-Conditions.aspx> and, for electronic format documents, subject to Terms and Conditions for Electronic Documents at <http://www.sgs.com/en/terms-and-conditions/terms-e-document.aspx>. Attention is drawn to the limitation of liability, indemnification and jurisdiction issues defined therein. Any holder of this document is advised that information contained hereon reflects the Company's findings at the time of its intervention only and within the limits of Client's instructions, if any. The Company's sole responsibility is to its Client and this document does not exonerate parties to a transaction from exercising all their rights and obligations under the transaction documents. This document cannot be reproduced except in full, without prior written approval of the Company. Any unauthorized alteration, forgery or falsification of the content or appearance of this document is unlawful and offenders may be prosecuted to the fullest extent of the law. Unless otherwise stated the results shown in this test report refer only to the sample(s) tested and such sample(s) are retained for 30 days only.
 Attention: To check the authenticity of testing /inspection report & certificate, please contact us at telephone: (86-755) 8307 1443, or email: CN.Doccheck@sgs.com

Content

| | | |
|----------|---|-----------|
| 1 | VERSION | 2 |
| 2 | TEST SUMMARY | 5 |
| 2.1 | GSM850/UMTS BAND 5 | 5 |
| 2.2 | GSM 1900/UMTS BAND 2 | 5 |
| 3 | GENERAL INFORMATION | 6 |
| 3.1 | CLIENT INFORMATION | 6 |
| 3.2 | TEST LOCATION | 6 |
| 3.3 | TEST FACILITY | 7 |
| 3.4 | GENERAL DESCRIPTION OF EUT | 8 |
| 3.5 | TEST MODE | 8 |
| 3.6 | TEST ENVIRONMENT | 8 |
| 3.7 | TECHNICAL SPECIFICATION | 9 |
| 3.8 | TEST FREQUENCIES | 10 |
| 4 | DESCRIPTION OF TESTS | 11 |
| 4.1 | CONDUCTED OUTPUT POWER | 11 |
| 4.2 | EFFECTIVE (ISOTROPIC) RADIATED POWER OF TRANSMITTER | 11 |
| 4.3 | OCCUPIED BANDWIDTH | 12 |
| 4.4 | BAND EDGE AT ANTENNA TERMINALS | 13 |
| 4.5 | SPURIOUS AND HARMONIC EMISSIONS AT ANTENNA TERMINAL | 13 |
| 4.6 | PEAK-AVERAGE RATIO | 14 |
| 4.7 | FIELD STRENGTH OF SPURIOUS RADIATION | 15 |
| 4.8 | FREQUENCY STABILITY / TEMPERATURE VARIATION | 15 |
| 4.9 | TEST SETUPS | 17 |
| 4.9.1 | Test Setup 1 | 17 |
| 4.9.2 | Test Setup 2 | 17 |
| 4.9.3 | Test Setup 3 | 18 |
| 4.9.4 | Test Setup 4 | 19 |
| 4.10 | TEST CONDITIONS | 20 |
| 5 | MAIN TEST INSTRUMENTS | 22 |



Unless otherwise agreed in writing, this document is issued by the Company subject to its General Conditions of Service printed overleaf, available on request or accessible at <http://www.sgs.com/en/Terms-and-Conditions.aspx> and, for electronic format documents, subject to Terms and Conditions for Electronic Documents at <http://www.sgs.com/en/Terms-and-Conditions/Terms-e-Document.aspx>. Attention is drawn to the limitation of liability, indemnification and jurisdiction issues defined therein. Any holder of this document is advised that information contained hereon reflects the Company's findings at the time of its intervention only and within the limits of Client's instructions, if any. The Company's sole responsibility is to its Client and this document does not exonerate parties to a transaction from exercising all their rights and obligations under the transaction documents. This document cannot be reproduced except in full, without prior written approval of the Company. Any unauthorized alteration, forgery or falsification of the content or appearance of this document is unlawful and offenders may be prosecuted to the fullest extent of the law. Unless otherwise stated the results shown in this test report refer only to the sample(s) tested and such sample(s) are retained for 30 days only.

Attention: To check the authenticity of testing /inspection report & certificate, please contact us at telephone: (86-755) 8307 1443, or email: CN.Doccheck@sgs.com



6 MEASUREMENT UNCERTAINTY24

7 APPENDIXES.....24



Unless otherwise agreed in writing, this document is issued by the Company subject to its General Conditions of Service printed overleaf, available on request or accessible at <http://www.sgs.com/en/Terms-and-Conditions.aspx> and, for electronic format documents, subject to Terms and Conditions for Electronic Documents at <http://www.sgs.com/en/terms-and-conditions/Terms-e-Documents.aspx>. Attention is drawn to the limitation of liability, indemnification and jurisdiction issues defined therein. Any holder of this document is advised that information contained hereon reflects the Company's findings at the time of its intervention only and within the limits of Client's instructions, if any. The Company's sole responsibility is to its Client and this document does not exonerate parties to a transaction from exercising all their rights and obligations under the transaction documents. This document cannot be reproduced except in full, without prior written approval of the Company. Any unauthorized alteration, forgery or falsification of the content or appearance of this document is unlawful and offenders may be prosecuted to the fullest extent of the law. Unless otherwise stated the results shown in this test report refer only to the sample(s) tested and such sample(s) are retained for 30 days only.

Attention: To check the authenticity of testing /inspection report & certificate, please contact us at telephone: (86-755) 8307 1443, or email: CN.Doccheck@sgs.com

2 Test Summary

2.1 GSM850/UMTS Band 5

| Test Item | FCC Rule No. | Requirements | Test Result | Verdict |
|--|------------------|---|-------------------------|---------|
| Effective (Isotropic) Radiated Power Output Data | §2.1046, §22.913 | FCC: ERP ≤ 7 W | Section 1 of Appendix B | Pass |
| Peak-Average Ratio | --- | Limit ≤ 13 dB | Section 2 of Appendix B | Pass |
| Modulation Characteristics | §2.1047 | Digital modulation | Section 3 of Appendix B | Pass |
| Bandwidth | §2.1049 | OBW: No limit. EBW: No limit. | Section 4 of Appendix B | Pass |
| Band Edges Compliance | §2.1051, §22.917 | ≤ -13 dBm/1%*EBW, in 1 MHz bands immediately outside and adjacent to the frequency block. | Section 5 of Appendix B | Pass |
| Spurious Emission at Antenna Terminals | §2.1051, §22.917 | FCC: ≤ -13 dBm/100 kHz, from 9 kHz to 10th harmonics but outside authorized operating frequency ranges. | Section 6 of Appendix B | Pass |
| Field Strength of Spurious Radiation | §2.1053, §22.917 | FCC: ≤ -13 dBm/100 kHz. | Section 7 of Appendix B | Pass |
| Frequency Stability | §2.1055, §22.355 | ≤ ±2.5ppm. | Section 8 of Appendix B | Pass |

Remark: For the verdict, the "N/A" denotes "not applicable", the "N/T" denotes "not tested".

2.2 GSM 1900/UMTS Band 2

| Test Item | FCC Rule No. | Requirements | Test Result | Verdict |
|--|------------------|--|-------------------------|---------|
| Effective (Isotropic) Radiated Power Output Data | §2.1046, §24.232 | EIRP ≤ 2 W | Section 1 of Appendix B | Pass |
| Peak-Average Ratio | §2.1046, §24.232 | Limit ≤ 13 dB | Section 2 of Appendix B | Pass |
| Modulation Characteristics | §2.1047 | Digital modulation | Section 3 of Appendix B | Pass |
| Bandwidth | §2.1049 | OBW: No limit. EBW: No limit. | Section 4 of Appendix B | Pass |
| Band Edges Compliance | §2.1051, §24.238 | ≤ -13 dBm/1%*EBW, in 1 MHz bands immediately outside and adjacent to the frequency block. | Section 5 of Appendix B | Pass |
| Spurious Emission at Antenna Terminals | §2.1051, §24.238 | ≤ -13 dBm/1 MHz, from 9 kHz to 10 th harmonics but outside authorized operating frequency ranges. | Section 6 of Appendix B | Pass |
| Field Strength of Spurious Radiation | §2.1053, §24.238 | ≤ -13 dBm/1 MHz. | Section 7 of Appendix B | Pass |
| Frequency Stability | §2.1055, §24.235 | ≤ ±2.5 ppm. | Section 8 of Appendix B | Pass |

Remark: For the verdict, the "N/A" denotes "not applicable", the "N/T" denotes "not tested".



Unless otherwise agreed in writing, this document is issued by the Company subject to its General Conditions of Service printed overleaf, available on request or accessible at <http://www.sgs.com/en/Terms-and-Conditions.aspx> and, for electronic format documents, subject to Terms and Conditions for Electronic Documents at <http://www.sgs.com/en/terms-and-conditions/terms-e-document.aspx>. Attention is drawn to the limitation of liability, indemnification and jurisdiction issues defined therein. Any holder of this document is advised that information contained hereon reflects the Company's findings at the time of its intervention only and within the limits of Client's instructions, if any. The Company's sole responsibility is to its Client and this document does not exonerate parties to a transaction from exercising all their rights and obligations under the transaction documents. This document cannot be reproduced except in full, without prior written approval of the Company. Any unauthorized alteration, forgery or falsification of the content or appearance of this document is unlawful and offenders may be prosecuted to the fullest extent of the law. Unless otherwise stated the results shown in this test report refer only to the sample(s) tested and such sample(s) are retained for 30 days only.

Attention: To check the authenticity of testing/inspection report & certificate, please contact us at telephone: (86-755) 8307 1443, or email: CN.Doccheck@sgs.com

3 General Information

3.1 Client Information

| | |
|--------------------------|--|
| Applicant: | TCL Communication Ltd. |
| Address of Applicant: | 7/F, Block F4, TCL Communication Technology Building, TCL International E City, Zhong Shan Yuan Road, Nanshan District, Shenzhen, Guangdong, P.R. China 518052 |
| Manufacturer: | TCL Communication Ltd. |
| Address of Manufacturer: | 7/F, Block F4, TCL Communication Technology Building, TCL International E City, Zhong Shan Yuan Road, Nanshan District, Shenzhen, Guangdong, P.R. China 518052 |

3.2 Test Location

| | |
|------------|---|
| Company: | SGS-CSTC Standards Technical Services Co., Ltd. Shenzhen Branch |
| Address: | No. 1 Workshop, M-10, Middle section, Science & Technology Park, Shenzhen, Guangdong, China |
| Post code: | 518057 |
| Telephone: | +86 (0) 755 2601 2053 |
| Fax: | +86 (0) 755 2671 0594 |
| E-mail: | ee.shenzhen@sgs.com |



Unless otherwise agreed in writing, this document is issued by the Company subject to its General Conditions of Service printed overleaf, available on request or accessible at <http://www.sgs.com/en/Terms-and-Conditions.aspx> and, for electronic format documents, subject to Terms and Conditions for Electronic Documents at <http://www.sgs.com/en/terms-and-conditions/terms-e-document.aspx>. Attention is drawn to the limitation of liability, indemnification and jurisdiction issues defined therein. Any holder of this document is advised that information contained hereon reflects the Company's findings at the time of its intervention only and within the limits of Client's instructions, if any. The Company's sole responsibility is to its Client and this document does not exonerate parties to a transaction from exercising all their rights and obligations under the transaction documents. This document cannot be reproduced except in full, without prior written approval of the Company. Any unauthorized alteration, forgery or falsification of the content or appearance of this document is unlawful and offenders may be prosecuted to the fullest extent of the law. Unless otherwise stated the results shown in this test report refer only to the sample(s) tested and such sample(s) are retained for 30 days only.

Attention: To check the authenticity of testing /inspection report & certificate, please contact us at telephone: (86-755) 8307 1443, or email: CN.Doccheck@sgs.com



3.3 Test Facility

The test facility is recognized, certified, or accredited by the following organizations:

• **CNAS (No. CNAS L2929)**

CNAS has accredited SGS-CSTC Standards Technical Services Co., Ltd. Shenzhen Branch EMC Lab to ISO/IEC 17025:2005 General Requirements for the Competence of Testing and Calibration Laboratories (CNAS-CL01 Accreditation Criteria for the Competence of Testing and Calibration Laboratories) for the competence in the field of testing.

• **A2LA (Certificate No. 3816.01)**

SGS-CSTC Standards Technical Services Co., Ltd., Shenzhen EMC Laboratory is accredited by the American Association for Laboratory Accreditation(A2LA). Certificate No. 3816.01.

• **VCCI**

The 3m Fully-anechoic chamber for above 1GHz, 10m Semi-anechoic chamber for below 1GHz, Shielded Room for Mains Port Conducted Interference Measurement and Telecommunication Port Conducted Interference Measurement of SGS-CSTC Standards Technical Services Co., Ltd. have been registered in accordance with the Regulations for Voluntary Control Measures with Registration No.: G-20026, R-14188, C-12383 and T-11153 respectively.

• **FCC –Designation Number: CN1178**

SGS-CSTC Standards Technical Services Co., Ltd., Shenzhen EMC Laboratory has been recognized as an accredited testing laboratory.

Designation Number: CN1178. Test Firm Registration Number: 406779.

• **Industry Canada (IC)**

Two 3m Semi-anechoic chambers and the 10m Semi-anechoic chamber of SGS-CSTC Standards Technical Services Co., Ltd. Shenzhen Branch EMC Lab have been registered by Certification and Engineering Bureau of Industry Canada for radio equipment testing with Registration No.: 4620C-1, 4620C-2, 4620C-3.



Unless otherwise agreed in writing, this document is issued by the Company subject to its General Conditions of Service printed overleaf, available on request or accessible at <http://www.sgs.com/en/Terms-and-Conditions.aspx> and, for electronic format documents, subject to Terms and Conditions for Electronic Documents at <http://www.sgs.com/en/terms-and-conditions/terms-e-document.aspx>. Attention is drawn to the limitation of liability, indemnification and jurisdiction issues defined therein. Any holder of this document is advised that information contained hereon reflects the Company's findings at the time of its intervention only and within the limits of Client's instructions, if any. The Company's sole responsibility is to its Client and this document does not exonerate parties to a transaction from exercising all their rights and obligations under the transaction documents. This document cannot be reproduced except in full, without prior written approval of the Company. Any unauthorized alteration, forgery or falsification of the content or appearance of this document is unlawful and offenders may be prosecuted to the fullest extent of the law. Unless otherwise stated the results shown in this test report refer only to the sample(s) tested and such sample(s) are retained for 30 days only.
Attention: To check the authenticity of testing /inspection report & certificate, please contact us at telephone: (86-755) 8307 1443, or email: CN.Doccheck@sgs.com

3.4 General Description of EUT

| | |
|-------------------|--|
| EUT Description:: | HSUPA/HSDPA/UMTS quad band /GSM quad band mobile phone |
| Model No.: | 4034T |
| Trade Mark: | alcatel |
| Hardware Version: | PIO |
| Software Version: | vAK52 |
| Sample Type: | <input checked="" type="checkbox"/> Portable Device, <input type="checkbox"/> Module |
| Antenna Type: | <input type="checkbox"/> External, <input checked="" type="checkbox"/> Integrated |
| Antenna Gain: | GSM850: -1.9dBi; GSM1900:-1.4dBi WCDMA Band II:-1.5dBi WCDMA Band V:-2.2dBi |

3.5 Test Mode

| Test Mode | Test Modes Description |
|-----------|---------------------------------------|
| GSM/TM1 | GSM system, GSM/GPRS, GMSK modulation |
| UMTS/TM1 | UMTS system, WCDMA, QPSK modulation |
| UMTS/TM2 | UMTS system, WCDMA, 16QAM modulation |

Remark: The test mode(s) are selected according to relevant radio technology specifications.

3.6 Test Environment

| Environment Parameter | Selected Values During Tests | |
|-----------------------|------------------------------|-------|
| Relative Humidity | 52% | |
| Atmospheric Pressure: | 101.32 KPa | |
| Temperature | NT | 25 °C |
| | LV | 3.5V |
| Voltage: | NV | 3.8V |
| | HV | 4.2V |

Remark: LV= lower extreme test voltage; NV= nominal voltage
HV= upper extreme test voltage; NT= normal temperature



Unless otherwise agreed in writing, this document is issued by the Company subject to its General Conditions of Service printed overleaf, available on request or accessible at <http://www.sgs.com/en/Terms-and-Conditions.aspx> and, for electronic format documents, subject to Terms and Conditions for Electronic Documents at <http://www.sgs.com/en/Terms-and-Conditions/Terms-e-Document.aspx>. Attention is drawn to the limitation of liability, indemnification and jurisdiction issues defined therein. Any holder of this document is advised that information contained hereon reflects the Company's findings at the time of its intervention only and within the limits of Client's instructions, if any. The Company's sole responsibility is to its Client and this document does not exonerate parties to a transaction from exercising all their rights and obligations under the transaction documents. This document cannot be reproduced except in full, without prior written approval of the Company. Any unauthorized alteration, forgery or falsification of the content or appearance of this document is unlawful and offenders may be prosecuted to the fullest extent of the law. Unless otherwise stated the results shown in this test report refer only to the sample(s) tested and such sample(s) are retained for 30 days only.
Attention: To check the authenticity of testing /inspection report & certificate, please contact us at telephone: (86-755) 8307 1443, or email: CN.Doccheck@sgs.com

3.7 Technical Specification

| Characteristics | Description | | |
|---|--|---|------------------|
| Radio System Type | <input checked="" type="checkbox"/> GSM | | |
| | <input checked="" type="checkbox"/> UMTS | | |
| Supported Frequency Range | Band | TX | RX |
| | GSM850 | 824 to 849 MHz | 869 to 894 MHz |
| | GSM1900 | 1850 to 1910 MHz | 1930 to 1990 MHz |
| | UMTS Band II | 1850 to 1910 MHz | 1930 to 1990 MHz |
| | UMTS Band V | 824 to 849 MHz | 869 to 894 MHz |
| Target TX Output Power | GSM850:32.3 dBm GSM1900: 30.3dBm UMTS Band II: 24dBm UMTS Band V: 24dBm | | |
| Supported Channel Bandwidth | GSM system: | <input checked="" type="checkbox"/> 0.2 MHz | |
| | UMTS system: | <input checked="" type="checkbox"/> 5 MHz | |
| Characteristics | Description | | |
| Designation of Emissions (Remark: the necessary bandwidth of which is the worst value from the measured occupied bandwidths for each type of channel bandwidth configuration.) | GSM850 | 246KGXW; | |
| | GSM1900 | 246KGXW; | |
| | UMTS Band II | 4M18F9W; | |
| | UMTS Band V | 4M15F9W; | |



Unless otherwise agreed in writing, this document is issued by the Company subject to its General Conditions of Service printed overleaf, available on request or accessible at <http://www.sgs.com/en/Terms-and-Conditions.aspx> and, for electronic format documents, subject to Terms and Conditions for Electronic Documents at <http://www.sgs.com/en/Terms-and-Conditions/Terms-e-Documents.aspx>. Attention is drawn to the limitation of liability, indemnification and jurisdiction issues defined therein. Any holder of this document is advised that information contained hereon reflects the Company's findings at the time of its intervention only and within the limits of Client's instructions, if any. The Company's sole responsibility is to its Client and this document does not exonerate parties to a transaction from exercising all their rights and obligations under the transaction documents. This document cannot be reproduced except in full, without prior written approval of the Company. Any unauthorized alteration, forgery or falsification of the content or appearance of this document is unlawful and offenders may be prosecuted to the fullest extent of the law. Unless otherwise stated the results shown in this test report refer only to the sample(s) tested and such sample(s) are retained for 30 days only.
Attention: To check the authenticity of testing /inspection report & certificate, please contact us at telephone: (86-755) 8307 1443, or email: CN.Doccheck@sgs.com



3.8 Test Frequencies

| Test Mode | TX / RX | RF Channel | | |
|-----------|---------|-------------|-------------|-------------|
| | | Low (L) | Middle (M) | High (H) |
| GSM850 | TX | Channel 128 | Channel 190 | Channel 251 |
| | | 824.2MHz | 836.6 MHz | 848.8 MHz |
| | RX | Channel 128 | Channel 190 | Channel 251 |
| | | 869.2 MHz | 881.6 MHz | 893.8 MHz |

| Test Mode | TX / RX | RF Channel | | |
|-----------|---------|-------------|-------------|-------------|
| | | Low (L) | Middle (M) | High (H) |
| GSM1900 | TX | Channel 512 | Channel 661 | Channel 810 |
| | | 1850.2MHz | 1880.0 MHz | 1909.8 MHz |
| | RX | Channel 512 | Channel 661 | Channel 810 |
| | | 1930.2 MHz | 1960.0 MHz | 1989.8 MHz |

| Test Mode | TX / RX | RF Channel | | |
|---------------|---------|--------------|--------------|--------------|
| | | Low (L) | Middle (M) | High (H) |
| WCDMA Band II | TX | Channel 9262 | Channel 9400 | Channel 9538 |
| | | 1852.4 MHz | 1880.0 MHz | 1907.6 MHz |
| | RX | Channel 9662 | Channel 9800 | Channel 9938 |
| | | 1932.4 MHz | 1960.0 MHz | 1987.6 MHz |

| Test Mode | TX / RX | RF Channel | | |
|--------------|---------|--------------|--------------|--------------|
| | | Low (L) | Middle (M) | High (H) |
| WCDMA Band V | TX | Channel 4132 | Channel 4182 | Channel 4233 |
| | | 826.4MHz | 836.4 MHz | 846.6 MHz |
| | RX | Channel 4357 | Channel 4407 | Channel 4458 |
| | | 871.4 MHz | 881.4 MHz | 891.6 MHz |



Unless otherwise agreed in writing, this document is issued by the Company subject to its General Conditions of Service printed overleaf, available on request or accessible at <http://www.sgs.com/en/Terms-and-Conditions.aspx> and, for electronic format documents, subject to Terms and Conditions for Electronic Documents at <http://www.sgs.com/en/terms-and-conditions/terms-e-document.aspx>. Attention is drawn to the limitation of liability, indemnification and jurisdiction issues defined therein. Any holder of this document is advised that information contained hereon reflects the Company's findings at the time of its intervention only and within the limits of Client's instructions, if any. The Company's sole responsibility is to its Client and this document does not exonerate parties to a transaction from exercising all their rights and obligations under the transaction documents. This document cannot be reproduced except in full, without prior written approval of the Company. Any unauthorized alteration, forgery or falsification of the content or appearance of this document is unlawful and offenders may be prosecuted to the fullest extent of the law. Unless otherwise stated the results shown in this test report refer only to the sample(s) tested and such sample(s) are retained for 30 days only.

Attention: To check the authenticity of testing /inspection report & certificate, please contact us at telephone: (86-755) 8307 1443, or email: CN.Doccheck@sgs.com

4 Description of Tests

4.1 Conducted Output Power

Measurement Procedure: FCC KDB 971168 D01 V03r01

The transmitter output was connected to a calibrated coaxial cable, attenuator and power meter, the other end of which was connected to a Base Station Simulator. The Base Station Simulator was set to force the EUT to its maximum power setting. The power output at the transmitter antenna port was determined by adding the value of the cable insertion loss to the power reading. The tests were performed at three frequencies (low channel, middle channel and high channel) and on the highest power levels, which can be setup on the transmitters.

Remark: Reference test setup 1

4.2 Effective (Isotropic) Radiated Power of Transmitter

Measurement Procedure: FCC KDB 971168 D01 V03r01 ; C63.26 (2015)

Calculate power in dBm by the following formula:

ERP (dBm) = Conducted Power (dBm) + antenna gain (dBd)

EIRP(dBm) = Conducted Power (dBm) + antenna gain (dBi)

EIRP=ERP+2.15dB

Measurement Procedure: FCC KDB 971168 D01 V03r01 ; ANSI/C63.26 (2015)

Below 1GHz test procedure as below:

- 1). The EUT was powered ON and placed on a 0.8m high table in the chamber. The antenna of the transmitter was extended to its maximum length.
- 2). The disturbance of the transmitter was maximized on the test receiver display by raising and lowering from 1m to 4m the receive antenna and by rotating through 360° the turntable. After the fundamental emission was maximized, a field strength measurement was made.
- 3). Steps 1) and 2) were performed with the EUT and the receive antenna in both vertical and horizontal polarization.
- 4). The transmitter was then removed and replaced with another antenna. The center of the antenna was approximately at the same location as the center of the transmitter.
- 5). A signal at the disturbance was fed to the substitution antenna by means of a non-radiating cable. With both the substitution and the receive antennas horizontally polarized, the receive antenna was raised and lowered to obtain a maximum reading at the test receiver. The level of the signal generator was adjusted until the measured field strength level in step 2) is obtained for this set of conditions.
- 6). The output power into the substitution antenna was then measured.
- 7). Steps 5) and 6) were repeated with both antennas polarized.
- 8). Calculate power in dBm by the following formula:

ERP (dBm) = Pg(dBm) – cable loss (dB) + antenna gain (dBd)

Where:

Pg is the generator output power into the substitution antenna.

Above 1GHz test procedure as below:



Unless otherwise agreed in writing, this document is issued by the Company subject to its General Conditions of Service printed overleaf, available on request or accessible at <http://www.sgs.com/en/Terms-and-Conditions.aspx> and, for electronic format documents, subject to Terms and Conditions for Electronic Documents at <http://www.sgs.com/en/terms-and-conditions/Terms-e-Documents.aspx>. Attention is drawn to the limitation of liability, indemnification and jurisdiction issues defined therein. Any holder of this document is advised that information contained hereon reflects the Company's findings at the time of its intervention only and within the limits of Client's instructions, if any. The Company's sole responsibility is to its Client and this document does not exonerate parties to a transaction from exercising all their rights and obligations under the transaction documents. This document cannot be reproduced except in full, without prior written approval of the Company. Any unauthorized alteration, forgery or falsification of the content or appearance of this document is unlawful and offenders may be prosecuted to the fullest extent of the law. Unless otherwise stated the results shown in this test report refer only to the sample(s) tested and such sample(s) are retained for 30 days only.
Attention: To check the authenticity of testing /inspection report & certificate, please contact us at telephone: (86-755) 8307 1443, or email: CN.Doccheck@sgs.com

- 1). Different between above is the test site, change from Semi- Anechoic Chamber to fully Anechoic Chamber
- 2). Calculate power in dBm by the following formula:

$$\text{EIRP(dBm)} = \text{Pg(dBm)} - \text{cable loss (dB)} + \text{antenna gain (dBi)}$$

$$\text{EIRP} = \text{ERP} + 2.15\text{dB}$$
 Where:
 Pg is the generator output power into the substitution antenna.
- 3). Test the EUT in the lowest channel, the middle channel the Highest channel
- 4). The radiation measurements are performed in X, Y, Z axis positioning. And found the X axis positioning which it is worse case, Only the test worst case mode is recorded in the report.
- 5). Repeat above procedures until all frequencies measured was complete.

Remark: Reference test setup 2

4.3 Occupied Bandwidth

Measurement Procedure: FCC KDB 971168 D01 V03r01 Section 4.2

The occupied bandwidth, that is the frequency bandwidth such that, below its lower and above its upper frequency limits, the mean powers radiated are each equal to 0.5 percent of the total mean power radiated by a given emission shall be measured. The transmitter output was connected to a calibrated coaxial cable, attenuator and Spectrum analyser, the other end of which was connected to a Base Station Simulator. The Base Station Simulator was set to force the EUT to its maximum power setting. The tests were performed at three frequencies (low channel, middle channel and high channel). The span of the analyzer shall be set to capture all products of the modulation process, including the emission skirts. The resolution bandwidth shall be set to as close to 1 percent of the selected span as is possible without being below 1 percent. The video bandwidth shall be set to 3 times the resolution bandwidth. Video averaging is not permitted. Where practical, a sampling detector shall be used since a peak or, peak hold, may produce a wider bandwidth than actual. The trace data points are recovered and are directly summed in linear terms. The recovered amplitude data points, beginning at the lowest frequency, are placed in a running sum until 0.5 percent of the total is reached and that frequency recorded. The process is repeated for the highest frequency data points. This frequency is recorded. The span between the two recorded frequencies is the occupied bandwidth.

Remark: Reference test setup 1



Unless otherwise agreed in writing, this document is issued by the Company subject to its General Conditions of Service printed overleaf, available on request or accessible at <http://www.sgs.com/en/Terms-and-Conditions.aspx> and, for electronic format documents, subject to Terms and Conditions for Electronic Documents at <http://www.sgs.com/en/Terms-and-Conditions/Terms-e-Documents.aspx>. Attention is drawn to the limitation of liability, indemnification and jurisdiction issues defined therein. Any holder of this document is advised that information contained hereon reflects the Company's findings at the time of its intervention only and within the limits of Client's instructions, if any. The Company's sole responsibility is to its Client and this document does not exonerate parties to a transaction from exercising all their rights and obligations under the transaction documents. This document cannot be reproduced except in full, without prior written approval of the Company. Any unauthorized alteration, forgery or falsification of the content or appearance of this document is unlawful and offenders may be prosecuted to the fullest extent of the law. Unless otherwise stated the results shown in this test report refer only to the sample(s) tested and such sample(s) are retained for 30 days only.
 Attention: To check the authenticity of testing / inspection report & certificate, please contact us at telephone: (86-755) 8307 1443, or email: CN.Doccheck@sgs.com

Test Settings

1. The signal analyzer's automatic bandwidth measurement capability was used to perform the 99% occupied bandwidth and the 26dB bandwidth. The bandwidth measurement was not influenced by any intermediate power nulls in the fundamental emission.
2. RBW = 1 – 5% of the expected OBW
3. VBW \geq 3 x RBW
4. Detector = Peak
5. Trace mode = max hold
6. Sweep = auto couple
7. The trace was allowed to stabilize
8. If necessary, steps 2 – 7 were repeated after changing the RBW such that it would be within 1 – 5% of the 99% occupied bandwidth observed in Step 7

4.4 Band Edge at Antenna Terminals

Measurement Procedure: FCC KDB 971168 D01 V03r01 Section 6.0

The transmitter output was connected to a calibrated coaxial cable, attenuator and Spectrum analyser, the other end of which was connected to a Base Station Simulator. The Base Station Simulator was set to force the EUT to its maximum power setting. The tests were performed at two frequencies (low channel and high channel). in the 1MHz bands immediately outside and adjacent to the frequency block a resolution bandwidth of 100kHz or 1% of the emission bandwidth of the fundamental emission of the transmitter may be employed. The EUT emission bandwidth is measured as the width of the signal between two points, outside of which all emission are attenuated at least 26dB below the transmitter power. The video bandwidth of the spectrum analyzer was set at thrice the resolution bandwidth. Detector Mode was set to peak or peak hold power.

Remark: Reference test setup 1

Test Settings

1. Start and stop frequency were set such that the band edge would be placed in the center of the plot
2. Span was set large enough so as to capture all out of band emissions near the band edge
3. RBW \geq 1% of the emission bandwidth
4. VBW \geq 3 x RBW
5. Detector = RMS
6. Number of sweep points \geq 2 x Span/RBW
7. Trace mode = trace average for continuous emissions, max hold for pulse emissions
8. Sweep time = auto couple
9. The trace was allowed to stabilize

4.5 Spurious And Harmonic Emissions at Antenna Terminal

Measurement Procedure: FCC KDB 971168 D01 V03r01



Unless otherwise agreed in writing, this document is issued by the Company subject to its General Conditions of Service printed overleaf, available on request or accessible at <http://www.sgs.com/en/Terms-and-Conditions.aspx> and, for electronic format documents, subject to Terms and Conditions for Electronic Documents at <http://www.sgs.com/en/Terms-and-Conditions/Terms-e-Documents.aspx>. Attention is drawn to the limitation of liability, indemnification and jurisdiction issues defined therein. Any holder of this document is advised that information contained hereon reflects the Company's findings at the time of its intervention only and within the limits of Client's instructions, if any. The Company's sole responsibility is to its Client and this document does not exonerate parties to a transaction from exercising all their rights and obligations under the transaction documents. This document cannot be reproduced except in full, without prior written approval of the Company. Any unauthorized alteration, forgery or falsification of the content or appearance of this document is unlawful and offenders may be prosecuted to the fullest extent of the law. Unless otherwise stated the results shown in this test report refer only to the sample(s) tested and such sample(s) are retained for 30 days only.

Attention: To check the authenticity of testing / inspection report & certificate, please contact us at telephone: (86-755) 8307 1443, or email: CN.Doccheck@sgs.com
 No.1 Workshop, M-10, Middle Section, Science & Technology Park, Shenzhen, China 518057 t (86-755) 26012053 f (86-755) 26710594 www.sgs.com.cn
 中国·深圳·科技园中区M-10栋一号厂房 邮编: 518057 t (86-755) 26012053 f (86-755) 26710594 sgs.china@sgs.com

The transmitter output was connected to a calibrated coaxial cable, attenuator and Spectrum analyzer, the other end of which was connected to a Base Station Simulator. The Base Station Simulator was set to force the EUT to its maximum power setting. The tests were performed at three frequencies (low channel and high channel). The level of the carrier and the various conducted spurious and harmonic frequencies is measured by means of a calibrated spectrum analyzer. The spectrum is scanned from the lowest frequency generated in the equipment up to a frequency including its 10th harmonic. On any frequency outside a licensee's frequency block, the power of any emission shall be attenuated below the transmitter power (P) by at least $43 + 10 \log(P)$ dB. Compliance with these provisions is based on the use of measurement instrumentation employing a resolution bandwidth of 1 MHz or greater. However, in the 1 MHz bands immediately outside and adjacent to the frequency block a resolution bandwidth of at least one percent of the emission bandwidth of the fundamental emission of the transmitter may be employed. The emission bandwidth is defined as the width of the signal between two points, one below the carrier center frequency and one above the carrier center frequency, outside of which all emission are attenuated at least 26 dB below the transmitter power.

Remark: Reference test setup 1

Test Settings

1. Start frequency was set to 30MHz and stop frequency was set to at least $10 \times$ the fundamental frequency (separated into at least two plots per channel)
2. Detector = RMS
3. Trace mode = trace average for continuous emissions, max hold for pulse emissions
4. Sweep time = auto couple
5. The trace was allowed to stabilize
6. Please see test notes below for RBW and VBW settings

4.6 Peak-Average Ratio

Measurement Procedure: FCC KDB 971168 D01 V03r01 Section 5.7.1

A peak to average ratio measurement is performed at the conducted port of the EUT. For WCDMA signals, the spectrum analyzers Complementary Cumulative Distribution Function (CCDF) measurement profile is used to determine the largest deviation between the average and the peak power of the EUT in a given bandwidth. The CCDF curve shows how much time the peak waveform spends at or above a given average power level. The percent of time the signal spends at or above the level defines the probability for that particular power level. For GSM signals, an average and a peak trace are used on a spectrum analyzer to determine the largest deviation between the average and the peak power of the EUT in a bandwidth greater than the emission bandwidth. The traces are generated with the spectrum analyzer set to zero span mode.

Remark: Reference test setup 1

Test Settings

1. The signal analyzer's CCDF measurement profile is enabled
2. Frequency = carrier center frequency
3. Measurement BW > Emission bandwidth of signal
4. The signal analyzer was set to collect one million samples to generate the CCDF curve
5. The measurement interval was set depending on the type of signal analyzed. For continuous signals (>98% duty cycle), the measurement interval was set to 1ms. For burst transmissions, the spectrum analyzer is set to use an internal "RF Burst" trigger that is synced with an incoming pulse and the measurement interval is set to less than the duration of the "on time" of one burst to ensure that energy is only captured during a time in which the transmitter is operating at maximum power



Unless otherwise agreed in writing, this document is issued by the Company subject to its General Conditions of Service printed overleaf, available on request or accessible at <http://www.sgs.com/en/Terms-and-Conditions.aspx> and, for electronic format documents, subject to Terms and Conditions for Electronic Documents at <http://www.sgs.com/en/Terms-and-Conditions/Terms-e-Documents.aspx>. Attention is drawn to the limitation of liability, indemnification and jurisdiction issues defined therein. Any holder of this document is advised that information contained hereon reflects the Company's findings at the time of its intervention only and within the limits of Client's instructions, if any. The Company's sole responsibility is to its Client and this document does not exonerate parties to a transaction from exercising all their rights and obligations under the transaction documents. This document cannot be reproduced except in full, without prior written approval of the Company. Any unauthorized alteration, forgery or falsification of the content or appearance of this document is unlawful and offenders may be prosecuted to the fullest extent of the law. Unless otherwise stated the results shown in this test report refer only to the sample(s) tested and such sample(s) are retained for 30 days only.

Attention: To check the authenticity of testing / inspection report & certificate, please contact us at telephone: (86-755) 8307 1443, or email: CN.Doccheck@sgs.com

4.7 Field Strength of Spurious Radiation

Measurement Procedure: FCC KDB 971168 D01 V03r01

Below 1GHz test procedure as below:

- 1). The EUT was powered ON and placed on a 80cm high table in the chamber. The antenna of the transmitter was extended to its maximum length.
- 2). The disturbance of the transmitter was maximized on the test receiver display by raising and lowering from 1m to 4m (for the test frequency of below 30MHz, the antenna was tuned to heights 1 meter) the receive antenna and by rotating through 360° the turntable. After the fundamental emission was maximized, a field strength measurement was made.
- 3). Steps 1) and 2) were performed with the EUT and the receive antenna in both vertical and horizontal polarization.
- 4). The transmitter was then removed and replaced with another antenna. The center of the antenna was approximately at the same location as the center of the transmitter.
- 5). A signal at the disturbance was fed to the substitution antenna by means of a non-radiating cable. With both the substitution and the receive antennas horizontally polarized, the receive antenna was raised and lowered to obtain a maximum reading at the test receiver. The level of the signal generator was adjusted until the measured field strength level in step 2) is obtained for this set of conditions.
- 6). The output power into the substitution antenna was then measured.
- 7). Steps 5) and 6) were repeated with both antennas polarized.
- 8) Calculate power in dBm by the following formula:

$$\text{ERP(dBm)} = \text{Pg(dBm)} - \text{cable loss (dB)} + \text{antenna gain (dBd)}$$

Where:

P_d is the dipole equivalent power, P_g is the generator output into the substitution antenna, and the antenna gain is the gain of the substitute antenna used relative to either a half-wave dipole (dBd) or an isotropic source (dBi). The substitute level is equal to P_g [dBm] – cable loss [dB]. The calculated P_d levels are then compared to the absolute spurious emission limit of -13dBm which is equivalent to the required minimum attenuation of $43 + 10\log_{10}(\text{Power [Watts]})$.

Above 1GHz test procedure as below:

- 1) Different between above is the test site, change from Semi- Anechoic Chamber to fully Anechoic Chamber
- 2) Calculate power in dBm by the following formula:

$$\text{EIRP(dBm)} = \text{Pg(dBm)} - \text{cable loss (dB)} + \text{antenna gain (dBi)}$$

$$\text{EIRP} = \text{ERP} + 2.15\text{dB}$$

Where:

P_g is the generator output power into the substitution antenna.

3. Test the EUT in the lowest channel, the middle channel the Highest channel
4. The radiation measurements are performed in X, Y, Z axis positioning. And found the X axis positioning which it is worse case, Only the test worst case mode is recorded in the report.
5. Repeat above procedures until all frequencies measured was complete

Remark: Reference test setup 3

4.8 Frequency Stability / Temperature Variation



Unless otherwise agreed in writing, this document is issued by the Company subject to its General Conditions of Service printed overleaf, available on request or accessible at <http://www.sgs.com/en/Terms-and-Conditions.aspx> and, for electronic format documents, subject to Terms and Conditions for Electronic Documents at <http://www.sgs.com/en/Terms-and-Conditions/Terms-e-Documents.aspx>. Attention is drawn to the limitation of liability, indemnification and jurisdiction issues defined therein. Any holder of this document is advised that information contained hereon reflects the Company's findings at the time of its intervention only and within the limits of Client's instructions, if any. The Company's sole responsibility is to its Client and this document does not exonerate parties to a transaction from exercising all their rights and obligations under the transaction documents. This document cannot be reproduced except in full, without prior written approval of the Company. Any unauthorized alteration, forgery or falsification of the content or appearance of this document is unlawful and offenders may be prosecuted to the fullest extent of the law. Unless otherwise stated the results shown in this test report refer only to the sample(s) tested and such sample(s) are retained for 30 days only.

Attention: To check the authenticity of testing / inspection report & certificate, please contact us at telephone: (86-755) 8307 1443, or email: CN.Doccheck@sgs.com

SGS-CSTC Standards Technical Services Co., Ltd.
Shenzhen Branch / Inspection & Testing Services Laboratory

No.1 Workshop, M-10, Middle Section, Science & Technology Park, Shenzhen, China 518057 t (86-755) 26012053 f (86-755) 26710594 www.sgs.com.cn
中国·深圳·科技园中区M-10栋一号厂房 邮编: 518057 t (86-755) 26012053 f (86-755) 26710594 sgs.china@sgs.com

Measurement Procedure:

Frequency stability testing is performed in accordance with the guidelines of FCC KDB 971168 D01 V03r01; ANSI/C63.26 (2015)

. The frequency stability of the transmitter is measured by:

- a.) **Temperature:** The temperature is varied from -30°C to +50°C in 10°C increments using an environmental chamber.
- b.) **Primary Supply Voltage:** The primary supply voltage is varied from 85% to 115% of the nominal value for non hand-carried battery and AC powered equipment. For hand-carried, battery-powered equipment, primary supply voltage is reduced to the battery operating end point which shall be specified by the manufacturer.

Specification – The frequency stability shall be sufficient to ensure that the fundamental emission stays within the authorized frequency block. The frequency stability of the transmitter shall be maintained within $\pm 0.00025\%$ (± 2.5 ppm) of the center frequency.

Time Period and Procedure:

1. The carrier frequency of the transmitter is measured at room temperature (20°C to provide a reference).
2. The equipment is turned on in a “standby” condition for fifteen minutes before applying power to the transmitter. Measurement of the carrier frequency of the transmitter is made within one minute after applying power to the transmitter.
3. Frequency measurements are made at 10°C intervals ranging from -30°C to +50°C. A period of at least one half-hour is provided to allow stabilization of the equipment at each temperature level.

Remark: Reference test setup 4

Unless otherwise agreed in writing, this document is issued by the Company subject to its General Conditions of Service printed overleaf, available on request or accessible at <http://www.sgs.com/en/Terms-and-Conditions.aspx> and, for electronic format documents, subject to Terms and Conditions for Electronic Documents at <http://www.sgs.com/en/terms-and-conditions/terms-e-document.aspx>. Attention is drawn to the limitation of liability, indemnification and jurisdiction issues defined therein. Any holder of this document is advised that information contained hereon reflects the Company's findings at the time of its intervention only and within the limits of Client's instructions, if any. The Company's sole responsibility is to its Client and this document does not exonerate parties to a transaction from exercising all their rights and obligations under the transaction documents. This document cannot be reproduced except in full, without prior written approval of the Company. Any unauthorized alteration, forgery or falsification of the content or appearance of this document is unlawful and offenders may be prosecuted to the fullest extent of the law. Unless otherwise stated the results shown in this test report refer only to the sample(s) tested and such sample(s) are retained for 30 days only.
Attention: To check the authenticity of testing /inspection report & certificate, please contact us at telephone: (86-755) 8307 1443, or email: CN.Doccheck@sgs.com

4.9 Test Setups

4.9.1 Test Setup 1

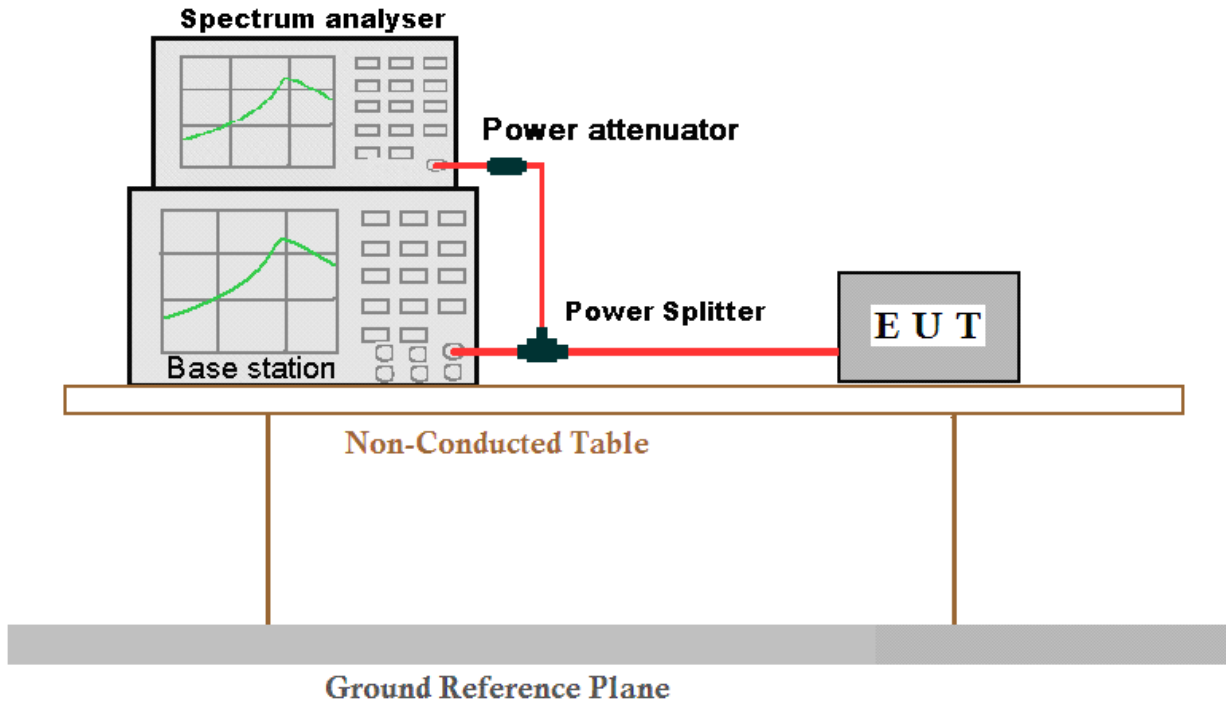

4.9.2 Test Setup 2

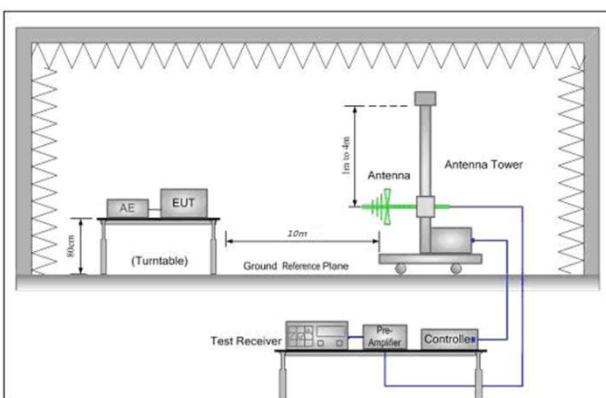

Figure 1. 30MHz to 1GHz

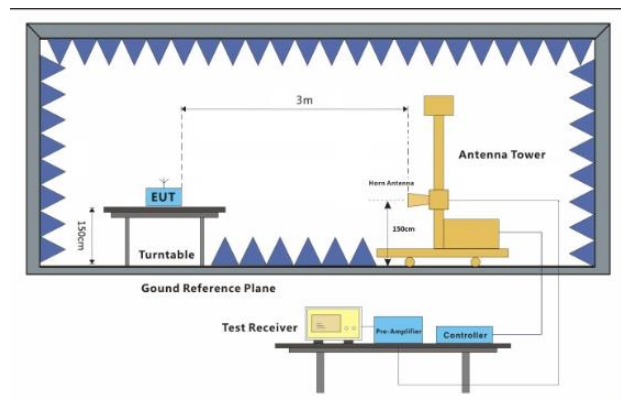

Figure 2. above 1GHz



Unless otherwise agreed in writing, this document is issued by the Company subject to its General Conditions of Service printed overleaf, available on request or accessible at <http://www.sgs.com/en/Terms-and-Conditions.aspx> and, for electronic format documents, subject to Terms and Conditions for Electronic Documents at <http://www.sgs.com/en/Terms-and-Conditions/Terms-e-Documents.aspx>. Attention is drawn to the limitation of liability, indemnification and jurisdiction issues defined therein. Any holder of this document is advised that information contained hereon reflects the Company's findings at the time of its intervention only and within the limits of Client's instructions, if any. The Company's sole responsibility is to its Client and this document does not exonerate parties to a transaction from exercising all their rights and obligations under the transaction documents. This document cannot be reproduced except in full, without prior written approval of the Company. Any unauthorized alteration, forgery or falsification of the content or appearance of this document is unlawful and offenders may be prosecuted to the fullest extent of the law. Unless otherwise stated the results shown in this test report refer only to the sample(s) tested and such sample(s) are retained for 30 days only.

4.9.3 Test Setup 3

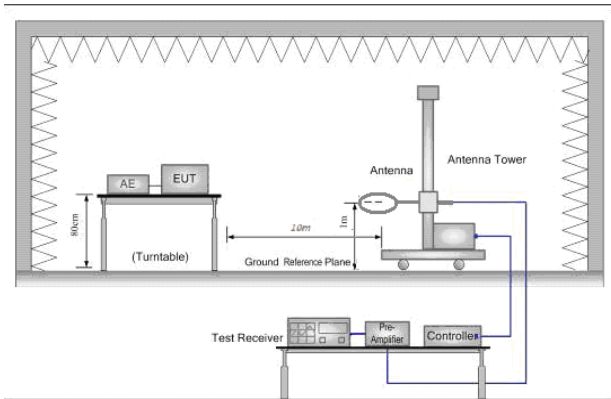

Figure 1. Below 30MHz

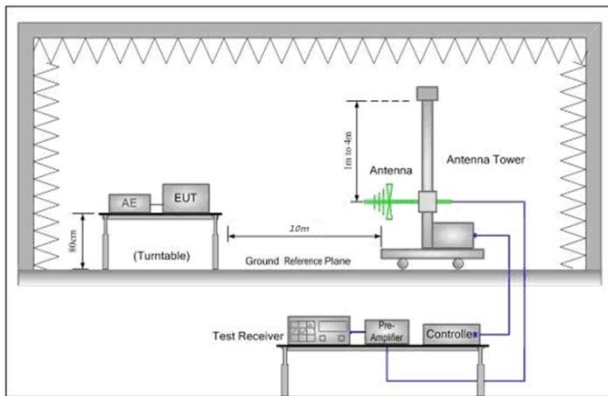

Figure 2. 30MHz to 1GHz

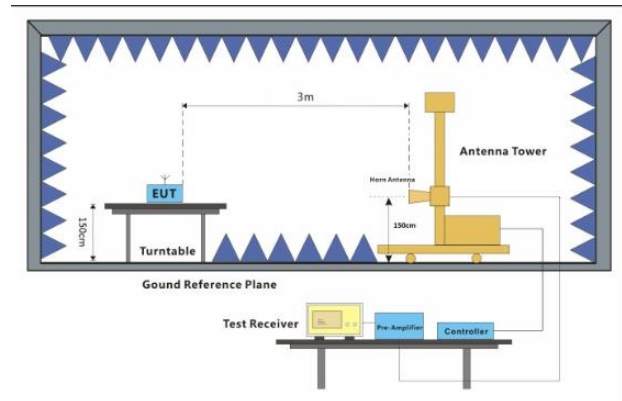
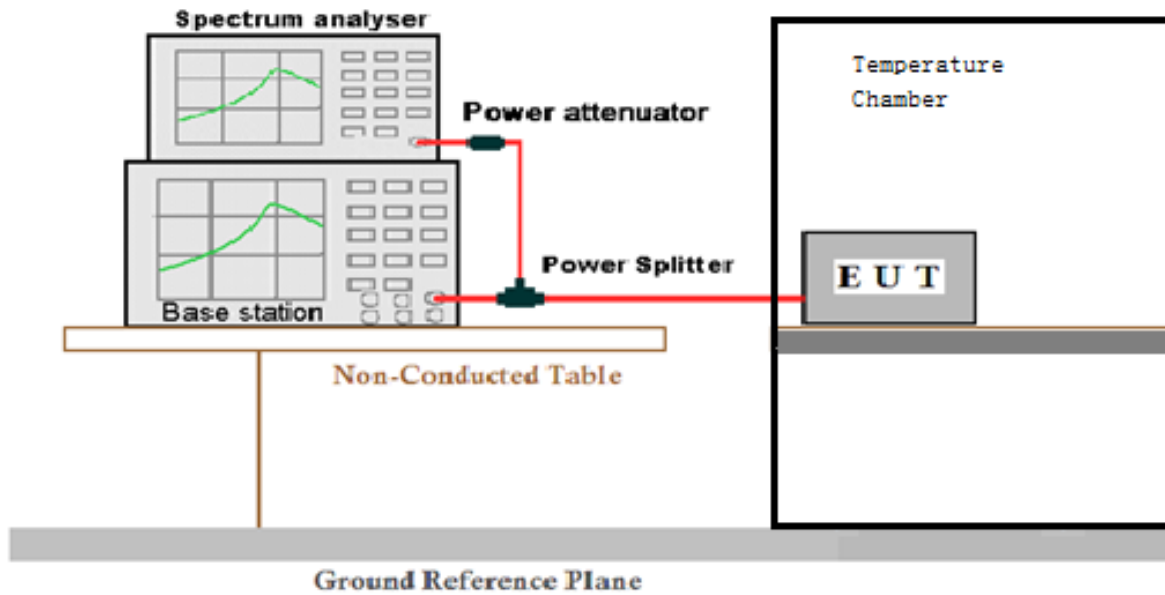

Figure 3. above 1GHz



Unless otherwise agreed in writing, this document is issued by the Company subject to its General Conditions of Service printed overleaf, available on request or accessible at <http://www.sgs.com/en/Terms-and-Conditions.aspx> and, for electronic format documents, subject to Terms and Conditions for Electronic Documents at <http://www.sgs.com/en/terms-and-conditions/terms-e-document.aspx>. Attention is drawn to the limitation of liability, indemnification and jurisdiction issues defined therein. Any holder of this document is advised that information contained hereon reflects the Company's findings at the time of its intervention only and within the limits of Client's instructions, if any. The Company's sole responsibility is to its Client and this document does not exonerate parties to a transaction from exercising all their rights and obligations under the transaction documents. This document cannot be reproduced except in full, without prior written approval of the Company. Any unauthorized alteration, forgery or falsification of the content or appearance of this document is unlawful and offenders may be prosecuted to the fullest extent of the law. Unless otherwise stated the results shown in this test report refer only to the sample(s) tested and such sample(s) are retained for 30 days only.

4.9.4 Test Setup 4



Unless otherwise agreed in writing, this document is issued by the Company subject to its General Conditions of Service printed overleaf, available on request or accessible at <http://www.sgs.com/en/Terms-and-Conditions.aspx> and, for electronic format documents, subject to Terms and Conditions for Electronic Documents at <http://www.sgs.com/en/terms-and-conditions/terms-e-document.aspx>. Attention is drawn to the limitation of liability, indemnification and jurisdiction issues defined therein. Any holder of this document is advised that information contained hereon reflects the Company's findings at the time of its intervention only and within the limits of Client's instructions, if any. The Company's sole responsibility is to its Client and this document does not exonerate parties to a transaction from exercising all their rights and obligations under the transaction documents. This document cannot be reproduced except in full, without prior written approval of the Company. Any unauthorized alteration, forgery or falsification of the content or appearance of this document is unlawful and offenders may be prosecuted to the fullest extent of the law. Unless otherwise stated the results shown in this test report refer only to the sample(s) tested and such sample(s) are retained for 30 days only.

Attention: To check the authenticity of testing / inspection report & certificate, please contact us at telephone: (86-755) 8307 1443, or email: CN.Doccheck@sgs.com

4.10 Test Conditions

| Test Case | | Test Conditions | |
|-------------------------------------|---|---|---|
| Transmit Output Power Data | Average Power, Total | Test Environment | Ambient Climate & Rated Voltage |
| | | Test Setup | Test Setup 1 |
| | | RF Channels (TX) | L, M, H (L= low channel, M= middle channel, H= high channel) |
| | | Test Mode | GSM/TM1;UMTS/TM1; UMTS/TM2; |
| | Average Power, Spectral Density (if required) | Test Environment | Ambient Climate & Rated Voltage |
| | | Test Setup | Test Setup 1 |
| | | RF Channels (TX) | L, M, H (L= low channel, M= middle channel, H= high channel) |
| | | Test Mode | GSM/TM1;UMTS/TM1; UMTS/TM2; |
| Peak-to-Average Ratio (if required) | Test Environment | Ambient Climate & Rated Voltage | |
| | Test Setup | Test Setup 1 | |
| | RF Channels (TX) | L, M, H (L= low channel, M= middle channel, H= high channel) | |
| | Test Mode | GSM/TM1;UMTS/TM1; UMTS/TM2; | |
| Modulation Characteristics | Test Environment | Ambient Climate & Rated Voltage | |
| | Test Setup | Test Setup 1 | |
| | RF Channels (TX) | M (M= middle channel) | |
| | Test Mode | GSM/TM1;UMTS/TM1; UMTS/TM2; | |
| Bandwidth | Occupied Bandwidth | Test Environment | Ambient Climate & Rated Voltage |
| | | Test Setup | Test Setup 1 |
| | | RF Channels (TX) | L, M, H (L= low channel, M= middle channel, H= high channel) |
| | | Test Mode | GSM/TM1;UMTS/TM1; UMTS/TM2; |
| | Emission Bandwidth (if required) | Test Environment | Ambient Climate & Rated Voltage |
| | | Test Setup | Test Setup 1 |
| | | RF Channels (TX) | L, M, H (L= low channel, M= middle channel, H= high channel) |
| | | Test Mode | GSM/TM1;UMTS/TM1; UMTS/TM2; |
| Band Edges Compliance | Test Environment | Ambient Climate & Rated Voltage | |
| | Test Setup | Test Setup 1 | |
| | RF Channels (TX) | L, H (L= low channel, H= high channel) | |
| | Test Mode | GSM/TM1;UMTS/TM1; UMTS/TM2; | |
| Spurious Emission at | Test Environment | Ambient Climate & Rated Voltage | |



Unless otherwise agreed in writing, this document is issued by the Company subject to its General Conditions of Service printed overleaf, available on request or accessible at <http://www.sgs.com/en/Terms-and-Conditions.aspx> and, for electronic format documents, subject to Terms and Conditions for Electronic Documents at <http://www.sgs.com/en/Terms-and-Conditions/Terms-e-Documents.aspx>. Attention is drawn to the limitation of liability, indemnification and jurisdiction issues defined therein. Any holder of this document is advised that information contained hereon reflects the Company's findings at the time of its intervention only and within the limits of Client's instructions, if any. The Company's sole responsibility is to its Client and this document does not exonerate parties to a transaction from exercising all their rights and obligations under the transaction documents. This document cannot be reproduced except in full, without prior written approval of the Company. Any unauthorized alteration, forgery or falsification of the content or appearance of this document is unlawful and offenders may be prosecuted to the fullest extent of the law. Unless otherwise stated the results shown in this test report refer only to the sample(s) tested and such sample(s) are retained for 30 days only.

Attention: To check the authenticity of testing/inspection report & certificate, please contact us at telephone: (86-755) 8307 1443, or email: CN.Doccheck@sgs.com

| | | |
|--------------------------------------|------------------|--|
| Antenna Terminals | Test Setup | Test Setup 1 |
| | RF Channels (TX) | L, M, H (L= low channel, M= middle channel, H= high channel) |
| | Test Mode | GSM/TM1;UMTS/TM1; |
| Field Strength of Spurious Radiation | Test Environment | Ambient Climate & Rated Voltage |
| | Test Setup | Test Setup 2 |
| | Test Mode | GSM/TM1;UMTS/TM1;UMTS/TM2; Remark: If applicable, the EUT conf. that has maximum power density (based on the equivalent power level) is selected. |
| | RF Channels (TX) | L, M, H (L= low channel, M= middle channel, H= high channel) |
| Frequency Stability | Test Environment | (1) -30 °C to +50 °C with step 10 °C at Rated Voltage; (2) VL, VN and VH of Rated Voltage at Ambient Climate. |
| | Test Setup | Test Setup 4 |
| | RF Channels (TX) | L, M, H (L= low channel, M= middle channel, H= high channel) |
| | Test Mode | GSM/TM1;UMTS/TM1; UMTS/TM2; |



Unless otherwise agreed in writing, this document is issued by the Company subject to its General Conditions of Service printed overleaf, available on request or accessible at <http://www.sgs.com/en/Terms-and-Conditions.aspx> and, for electronic format documents, subject to Terms and Conditions for Electronic Documents at <http://www.sgs.com/en/terms-and-conditions/terms-e-document.aspx>. Attention is drawn to the limitation of liability, indemnification and jurisdiction issues defined therein. Any holder of this document is advised that information contained hereon reflects the Company's findings at the time of its intervention only and within the limits of Client's instructions, if any. The Company's sole responsibility is to its Client and this document does not exonerate parties to a transaction from exercising all their rights and obligations under the transaction documents. This document cannot be reproduced except in full, without prior written approval of the Company. Any unauthorized alteration, forgery or falsification of the content or appearance of this document is unlawful and offenders may be prosecuted to the fullest extent of the law. Unless otherwise stated the results shown in this test report refer only to the sample(s) tested and such sample(s) are retained for 30 days only.
Attention: To check the authenticity of testing /inspection report & certificate, please contact us at telephone: (86-755) 8307 1443, or email: CN.Doccheck@sgs.com

5 Main Test Instruments

| RE in Chamber | | | | | |
|--|--|-------------------|---------------|--------------|---------------|
| Test Equipment | Manufacturer | Model No. | Inventory No. | Cal. date | Cal. Due date |
| | | | | (yyyy-mm-dd) | (yyyy-mm-dd) |
| 3m Semi-Anechoic Chamber | AUDIX | N/A | SEM001-02 | 2018/3/13 | 2021/3/12 |
| Spectrum Analyzer (20Hz-43GHz) | Rohde & Schwarz | FSU43 | SEM004-08 | 2019/3/2 | 2020/3/1 |
| BiConiLog Antenna (26-3000MHz) | ETS-Lindgren | 3142C | SEM003-01 | 2017/6/27 | 2020/6/26 |
| Horn Antenna (800MHz-18GHz) | Rohde & Schwarz | HF907 | SEM003-07 | 2018/4/13 | 2021/4/12 |
| Horn Antenna (15-40GHz) | Schwarzbeck | BBHA 9170 | SEM003-15 | 2017/10/17 | 2020/10/16 |
| Amplifier (0.1-1300MHz) | HP | 8447D | SEM005-02 | 2018/9/2 | 2019/9/2 |
| Low Noise Amplifier (100MHz-18GHz) | Black Diamond Series | BDLNA-0118-352810 | SEM005-05 | 2018/9/2 | 2019/9/2 |
| Pre-Amplifier (0.1-26.5GHz) | Compliance Directions Systems Inc. | PAP-0126 | EMC2063 | 2018/10/20 | 2019/10/19 |
| Pre-amplifier (26-40GHz) | Compliance Directions Systems Inc. | PAP-2640-50 | SEM005-08 | 2019/3/2 | 2020/3/1 |
| Band filter | N/A | N/A | N/A | N/A | N/A |
| Measurement Software | AUDIX | e3 V8.2014-6-27 | N/A | N/A | N/A |
| Coaxial Cable | SGS | N/A | SEM026-01 | 2018/7/12 | 2019/7/11 |
| Wideband Radio Communication Tester | Anristu | MT8821C | 6201462742 | 2019/4/3 | 2020/4/3 |
| Wideband Radio Communication Tester | Rohde & Schwarz | CMW500 | W005-02 | 2019/1/13 | 2020/1/12 |
| RF conducted test | | | | | |
| Test Equipment | Manufacturer | Model No. | Inventory No. | Cal. date | Cal. Due date |
| | | | | (yyyy-mm-dd) | (yyyy-mm-dd) |
| Dual Output Mobile Communication DC Source | Agilent Technologies Inc | 66311B | W009-09 | 2018/11/2 | 2019/11/1 |
| Signal Analyzer | Rohde & Schwarz | FSV | W005-02 | 2019/3/2 | 2020/3/1 |
| Coaxial Cable | SGS | N/A | SEM031-01 | 2018/7/12 | 2019/7/11 |
| Attenuator | Weinschel Associates | WA41 | SEM021-09 | N/A | N/A |
| Signal Generator | KEYSIGHT | N5173B | SEM006-05 | 2018/11/2 | 2019/11/1 |
| Humidity/ Temperature Indicator | Shanghai Meteorological Industry Factory | HTC-1 | W006-17 | 2018/11/2 | 2019/11/1 |
| Temperature Chamber | GIANT FORCE | ICT-150-40-CP-AR | W027-03 | 2018/11/2 | 2019/11/1 |
| Wideband Radio Communication Tester | Anristu | MT8821C | 6201462742 | 2019/3/2 | 2020/3/1 |
| Wideband Radio Communication Tester | Rohde & Schwarz | CMW500 | W005-02 | 2018/11/2 | 2019/11/1 |



Unless otherwise agreed in writing, this document is issued by the Company subject to its General Conditions of Service printed overleaf, available on request or accessible at <http://www.sgs.com/en/Terms-and-Conditions.aspx> and, for electronic format documents, subject to Terms and Conditions for Electronic Documents at <http://www.sgs.com/en/terms-and-conditions/terms-e-document.aspx>. Attention is drawn to the limitation of liability, indemnification and jurisdiction issues defined therein. Any holder of this document is advised that information contained hereon reflects the Company's findings at the time of its intervention only and within the limits of Client's instructions, if any. The Company's sole responsibility is to its Client and this document does not exonerate parties to a transaction from exercising all their rights and obligations under the transaction documents. This document cannot be reproduced except in full, without prior written approval of the Company. Any unauthorized alteration, forgery or falsification of the content or appearance of this document is unlawful and offenders may be prosecuted to the fullest extent of the law. Unless otherwise stated the results shown in this test report refer only to the sample(s) tested and such sample(s) are retained for 30 days only.

Attention: To check the authenticity of testing / inspection report & certificate, please contact us at telephone: (86-755) 8307 1443, or email: CN.Doccheck@sgs.com



| Test Equipment | Manufacturer | Model No. | Inventory No. | Cal. Date (yyyy-mm-dd) | Cal. Due date (yyyy-mm-dd) |
|---|------------------------------------|-----------------|---------------|------------------------|----------------------------|
| 3m Semi-Anechoic Chamber | AUDIX | N/A | SEM001-02 | 2018/3/13 | 2021/3/12 |
| Wideband Radio Communication Tester | Anristu | MT8821C | 6201462742 | 2019/4/3 | 2020/4/3 |
| Wideband Radio Communication Tester | Rohde & Schwarz | CMW500 | W005-02 | 2019/1/13 | 2020/1/12 |
| EXA Signal Analyzer (10Hz-26.5GHz) | Agilent Technologies Inc | N9010A | SEM004-09 | 2019/3/13 | 2020/3/12 |
| Spectrum Analyzer (20Hz-43GHz) | Rohde & Schwarz | FSU43 | SEM004-08 | 2019/3/2 | 2020/3/1 |
| BiConiLog Antenna (26-3000MHz) | ETS-Lindgren | 3142C | SEM003-01 | 2017/6/27 | 2020/6/26 |
| Horn Antenna (800MHz-18GHz) | Rohde & Schwarz | HF907 | SEM003-07 | 2018/4/13 | 2021/4/12 |
| Horn Antenna (15-40GHz) | Schwarzbeck | BBHA 9170 | SEM003-15 | 2017/10/17 | 2020/10/16 |
| Amplifier (0.1-1300MHz) | HP | 8447D | SEM005-02 | 2018/9/25 | 2019/9/24 |
| Pre-Amplifier (0.1-26.5GHz) | Compliance Directions Systems Inc. | PAP-0126 | SEM004-11 | 2018/9/27 | 2019/9/26 |
| Pre-amplifier (26-40GHz) | Compliance Directions Systems Inc. | PAP-2640-50 | SEM005-08 | 2019/3/2 | 2020/3/1 |
| Band filter | N/A | N/A | N/A | N/A | N/A |
| Coaxial Cable | SGS | N/A | SEM026-01 | 2018/7/12 | 2019/7/11 |
| Tunable Notch Filter WRCD1700/2000-0.2/40-10EEK | WAINRIGHT Instruments GMBH | N/A | N/A | N/A | N/A |
| Tunable Notch Filter WRCD800/960-0.2/40-10EEK | WAINRIGHT Instruments GMBH | N/A | N/A | N/A | N/A |
| HighPass Filter WHK1.2/15G-10SS | WAINRIGHT Instruments GMBH | N/A | N/A | N/A | N/A |
| HighPass Filter WHKX10-2700-3000-18000-40SS | WAINRIGHT Instruments GMBH | N/A | N/A | N/A | N/A |
| HighPass Filter WHKX7.0/26.5G-6SS | WAINRIGHT Instruments GMBH | N/A | N/A | N/A | N/A |
| Band Reject Filter WRCG 824/849-814/859-40/8SS | WAINRIGHT Instruments GMBH | N/A | N/A | N/A | N/A |
| Band Reject Filter WRCG 1850/1910-1835/1925-40/8SS | WAINRIGHT Instruments GMBH | N/A | N/A | N/A | N/A |
| Measurement Software | AUDIX | e3 V8.2014-6-27 | N/A | N/A | N/A |



Unless otherwise agreed in writing, this document is issued by the Company subject to its General Conditions of Service printed overleaf, available on request or accessible at <http://www.sgs.com/en/Terms-and-Conditions.aspx> and, for electronic format documents, subject to Terms and Conditions for Electronic Documents at <http://www.sgs.com/en/terms-and-conditions/terms-e-document.aspx>. Attention is drawn to the limitation of liability, indemnification and jurisdiction issues defined therein. Any holder of this document is advised that information contained hereon reflects the Company's findings at the time of its intervention only and within the limits of Client's instructions, if any. The Company's sole responsibility is to its Client and this document does not exonerate parties to a transaction from exercising all their rights and obligations under the transaction documents. This document cannot be reproduced except in full, without prior written approval of the Company. Any unauthorized alteration, forgery or falsification of the content or appearance of this document is unlawful and offenders may be prosecuted to the fullest extent of the law. Unless otherwise stated the results shown in this test report refer only to the sample(s) tested and such sample(s) are retained for 30 days only.

Attention: To check the authenticity of testing /inspection report & certificate, please contact us at telephone: (86-755) 8307 1443, or email: CN.Doccheck@sgs.com

6 Measurement Uncertainty

For a 95% confidence level ($k = 2$), the measurement expanded uncertainties for defined systems, in accordance with the recommendations of ISO 17025 as following:

| Test Item | Extended Uncertainty | Data |
|--------------------------------------|--------------------------|---|
| Transmit Output Power Data | Power [dBm] | $U = \pm 0.37$ dB |
| Bandwidth | Magnitude [%] | $U = \pm 0.2\%$ |
| Band Edge Compliance | Disturbance Power [dBm] | $U = \pm 2.0$ dB |
| Spurious Emissions, Conducted | Disturbance Power [dBm] | $U = \pm 2.0$ dB |
| Field Strength of Spurious Radiation | ERP[dBm]/EIRP [dBm] | For 3 m Chamber: $U = \pm 4.5$ dB (30 MHz to 1GHz) $U = \pm 3.3$ dB (above 1 GHz) For 10 m Chamber: $U = \pm 4.5$ dB (30 MHz to 1GHz) $U = \pm 3.2$ dB (above 1 GHz) |
| Frequency Stability | Frequency Accuracy [ppm] | $U = \pm 0.24$ ppm |

7 Appendixes

| | |
|--------------|---|
| Appendix A | Photographs of EUT Constructional Details for ZR201950026 |
| Appendix B.1 | GSM 850 & 1900 |
| Appendix B.2 | WCDMA Band II & V |

The End



Unless otherwise agreed in writing, this document is issued by the Company subject to its General Conditions of Service printed overleaf, available on request or accessible at <http://www.sgs.com/en/Terms-and-Conditions.aspx> and, for electronic format documents, subject to Terms and Conditions for Electronic Documents at <http://www.sgs.com/en/terms-and-conditions/terms-e-document.aspx>. Attention is drawn to the limitation of liability, indemnification and jurisdiction issues defined therein. Any holder of this document is advised that information contained hereon reflects the Company's findings at the time of its intervention only and within the limits of Client's instructions, if any. The Company's sole responsibility is to its Client and this document does not exonerate parties to a transaction from exercising all their rights and obligations under the transaction documents. This document cannot be reproduced except in full, without prior written approval of the Company. Any unauthorized alteration, forgery or falsification of the content or appearance of this document is unlawful and offenders may be prosecuted to the fullest extent of the law. Unless otherwise stated the results shown in this test report refer only to the sample(s) tested and such sample(s) are retained for 30 days only.
Attention: To check the authenticity of testing /inspection report & certificate, please contact us at telephone: (86-755) 8307 1443, or email: CN.Doccheck@sgs.com