

WCDMA1900-BII_CH9400 Left Cheek

Date: 6/18/2018

Electronics: DAE4 Sn1525

Medium: head 1900 MHz

Medium parameters used: $f = 1880$ MHz; $\sigma = 1.381$ mho/m; $\epsilon_r = 39.39$; $\rho = 1000$ kg/m³

Ambient Temperature: 22.5°C, Liquid Temperature: 22.3°C

Communication System: WCDMA1900-BII 1880 MHz Duty Cycle: 1:1

Probe: EX3DV4 – SN7464 ConvF(8.39,8.39,8.39)

Area Scan (71x121x1): Interpolated grid: dx=1.000 mm, dy=1.000 mm

Maximum value of SAR (interpolated) = 0.869 W/kg

Zoom Scan (7x7x7)/Cube 0: Measurement grid: dx=5mm, dy=5mm, dz=5mm

Reference Value = 3.26 V/m; Power Drift = 0.04 dB

Peak SAR (extrapolated) = 1.16 W/kg

SAR(1 g) = 0.721 W/kg; SAR(10 g) = 0.43 W/kg

Maximum value of SAR (measured) = 0.981 W/kg

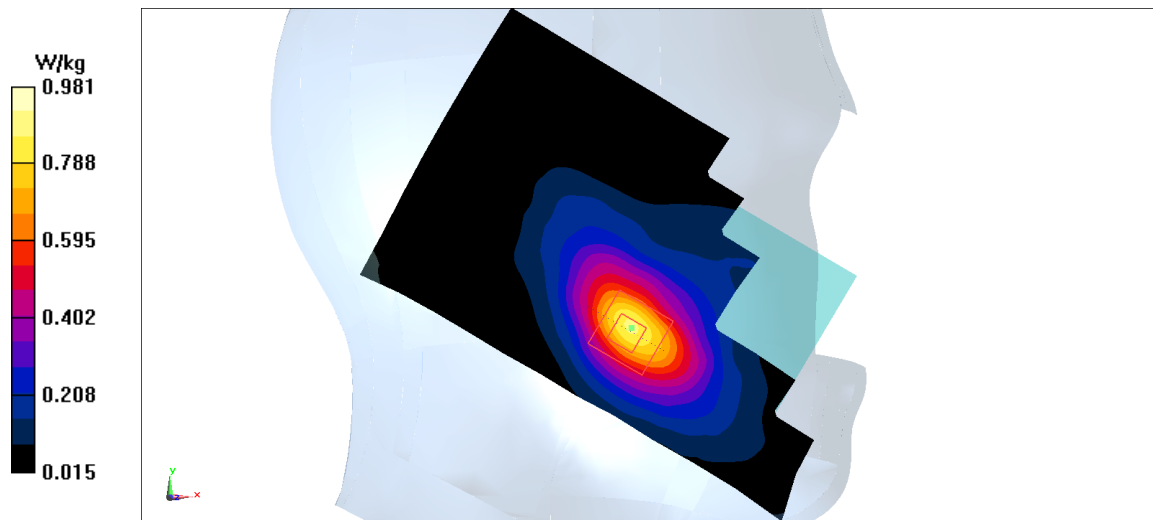

Fig A.5

WCDMA1900-BII_CH9400 Rear

Date: 6/18/2018

Electronics: DAE4 Sn1525

Medium: body 1900 MHz

Medium parameters used: $f = 1880$ MHz; $\sigma = 1.494$ mho/m; $\epsilon_r = 53.93$; $\rho = 1000$ kg/m³

Ambient Temperature: 22.5°C, Liquid Temperature: 22.3°C

Communication System: WCDMA1900-BII 1880 MHz Duty Cycle: 1:1

Probe: EX3DV4 – SN7464 ConvF(8.32,8.32,8.32)

Area Scan (71x121x1): Interpolated grid: dx=1.000 mm, dy=1.000 mm

Maximum value of SAR (interpolated) = 1.55 W/kg

Zoom Scan (7x7x7)/Cube 0: Measurement grid: dx=5mm, dy=5mm, dz=5mm

Reference Value = 10.58 V/m; Power Drift = -0.04 dB

Peak SAR (extrapolated) = 2.04 W/kg

SAR(1 g) = 1.2 W/kg; SAR(10 g) = 0.675 W/kg

Maximum value of SAR (measured) = 1.47 W/kg

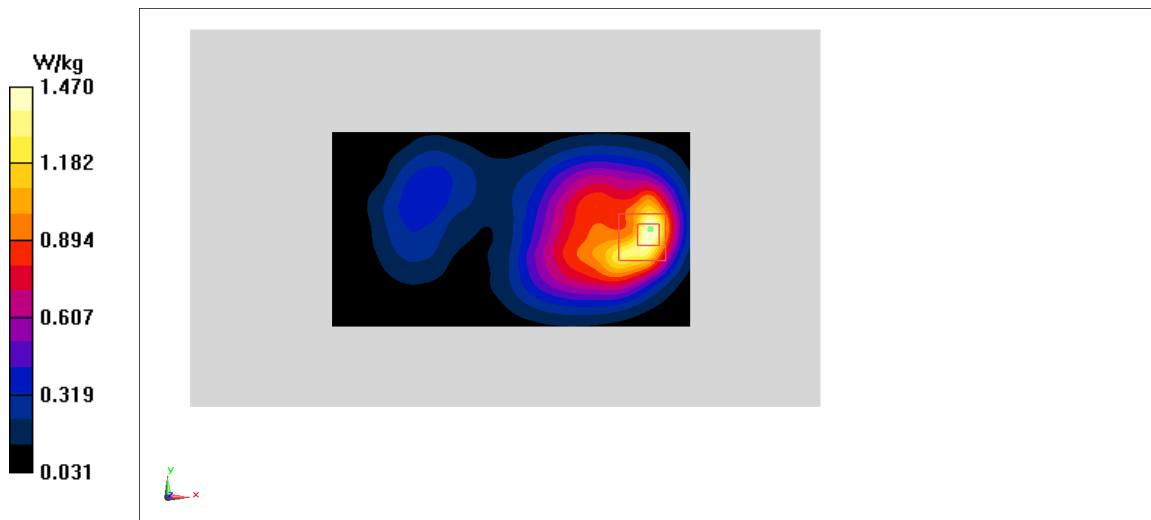

Fig A.6

WCDMA850-BV_CH4182 Left Cheek

Date: 6/17/2018

Electronics: DAE4 Sn1525

Medium: head 835 MHz

Medium parameters used: $f = 836.4$ MHz; $\sigma = 0.907$ mho/m; $\epsilon_r = 41.52$; $\rho = 1000$ kg/m³

Ambient Temperature: 22.5°C, Liquid Temperature: 22.3°C

Communication System: WCDMA850-BV 836.4 MHz Duty Cycle: 1:1

Probe: EX3DV4 – SN7464 ConvF(10.28,10.28,10.28)

Area Scan (71x121x1): Interpolated grid: $dx=1.000$ mm, $dy=1.000$ mm

Maximum value of SAR (interpolated) = 0.323 W/kg

Zoom Scan (7x7x7)/Cube 0: Measurement grid: $dx=5$ mm, $dy=5$ mm, $dz=5$ mm

Reference Value = 2.49 V/m; Power Drift = 0.09 dB

Peak SAR (extrapolated) = 0.367 W/kg

SAR(1 g) = 0.291 W/kg; SAR(10 g) = 0.219 W/kg

Maximum value of SAR (measured) = 0.32 W/kg

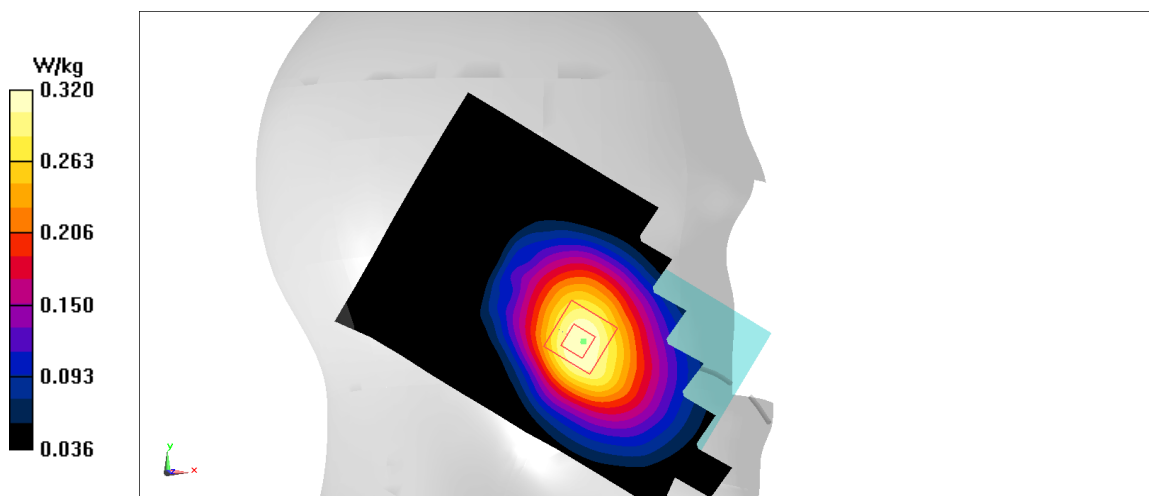

Fig A.7

WCDMA850-BV_CH4233 Rear

Date: 6/17/2018

Electronics: DAE4 Sn1525

Medium: body 835 MHz

Medium parameters used: $f = 846.6$ MHz; $\sigma = 0.981$ mho/m; $\epsilon_r = 55.11$; $\rho = 1000$ kg/m³

Ambient Temperature: 22.5°C, Liquid Temperature: 22.3°C

Communication System: WCDMA850-BV 846.6 MHz Duty Cycle: 1:1

Probe: EX3DV4 – SN7464 ConvF(10.21,10.21,10.21)

Area Scan (71x121x1): Interpolated grid: $dx=1.000$ mm, $dy=1.000$ mm

Maximum value of SAR (interpolated) = 0.393 W/kg

Zoom Scan (7x7x7)/Cube 0: Measurement grid: $dx=5$ mm, $dy=5$ mm, $dz=5$ mm

Reference Value = 19.05 V/m; Power Drift = -0.04 dB

Peak SAR (extrapolated) = 0.457 W/kg

SAR(1 g) = 0.357 W/kg; SAR(10 g) = 0.266 W/kg

Maximum value of SAR (measured) = 0.395 W/kg

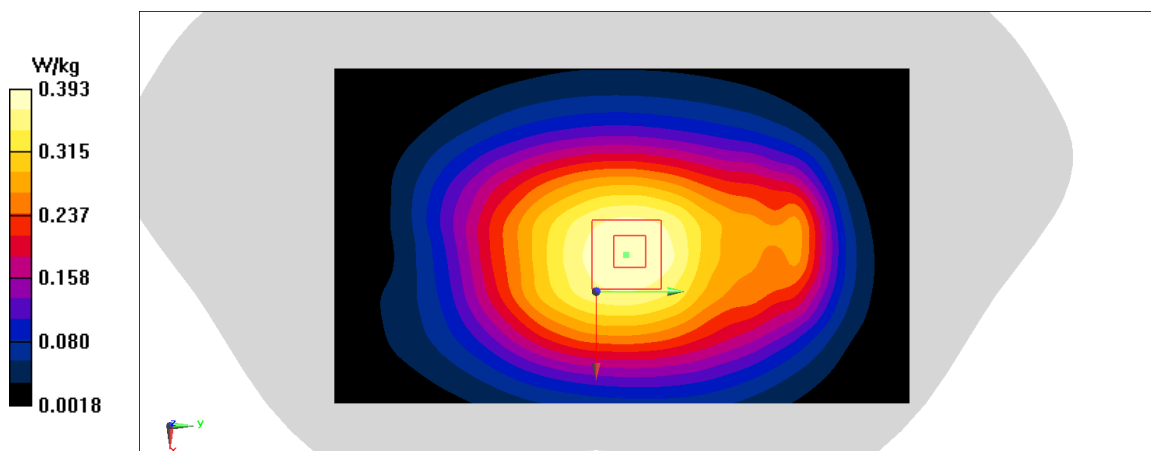

Fig A.8

LTE2500-FDD7_CH21350 Right Cheek

Date: 6/19/2018

Electronics: DAE4 Sn1525

Medium: head 2600 MHz

Medium parameters used: $f = 2560$ MHz; $\sigma = 1.904$ mho/m; $\epsilon_r = 38.68$; $\rho = 1000$ kg/m³

Ambient Temperature: 22.5°C, Liquid Temperature: 22.3°C

Communication System: LTE2500-FDD7 2560 MHz Duty Cycle: 1:1

Probe: EX3DV4 – SN7464 ConvF(7.76,7.76,7.76)

Area Scan (71x121x1): Interpolated grid: $dx=1.000$ mm, $dy=1.000$ mm

Maximum value of SAR (interpolated) = 0.104 W/kg

Zoom Scan (7x7x7)/Cube 0: Measurement grid: $dx=5$ mm, $dy=5$ mm, $dz=5$ mm

Reference Value = 1.646 V/m; Power Drift = 0.07 dB

Peak SAR (extrapolated) = 0.155 W/kg

SAR(1 g) = 0.284 W/kg; SAR(10 g) = 0.149 W/kg

Maximum value of SAR (measured) = 0.102 W/kg

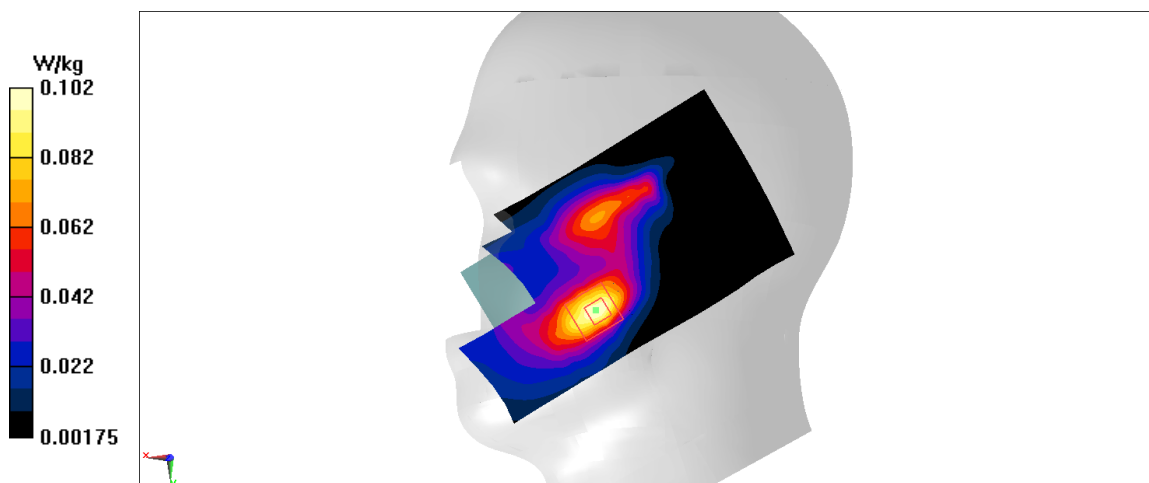

Fig A.9

LTE2500-FDD7_CH21350 Rear

Date: 6/19/2018

Electronics: DAE4 Sn1525

Medium: body 2600 MHz

Medium parameters used: $f = 2560$ MHz; $\sigma = 2.137$ mho/m; $\epsilon_r = 51.69$; $\rho = 1000$ kg/m³

Ambient Temperature: 22.5°C, Liquid Temperature: 22.3°C

Communication System: LTE2500-FDD7 2560 MHz Duty Cycle: 1:1

Probe: EX3DV4 – SN7464 ConvF(7.84,7.84,7.84)

Area Scan (71x121x1): Interpolated grid: dx=1.000 mm, dy=1.000 mm

Maximum value of SAR (interpolated) = 0.961 W/kg

Zoom Scan (7x7x7)/Cube 0: Measurement grid: dx=5mm, dy=5mm, dz=5mm

Reference Value = 4.165 V/m; Power Drift = 0.09 dB

Peak SAR (extrapolated) = 1.47 W/kg

SAR(1 g) = 0.776 W/kg; SAR(10 g) = 0.366 W/kg

Maximum value of SAR (measured) = 1.01 W/kg

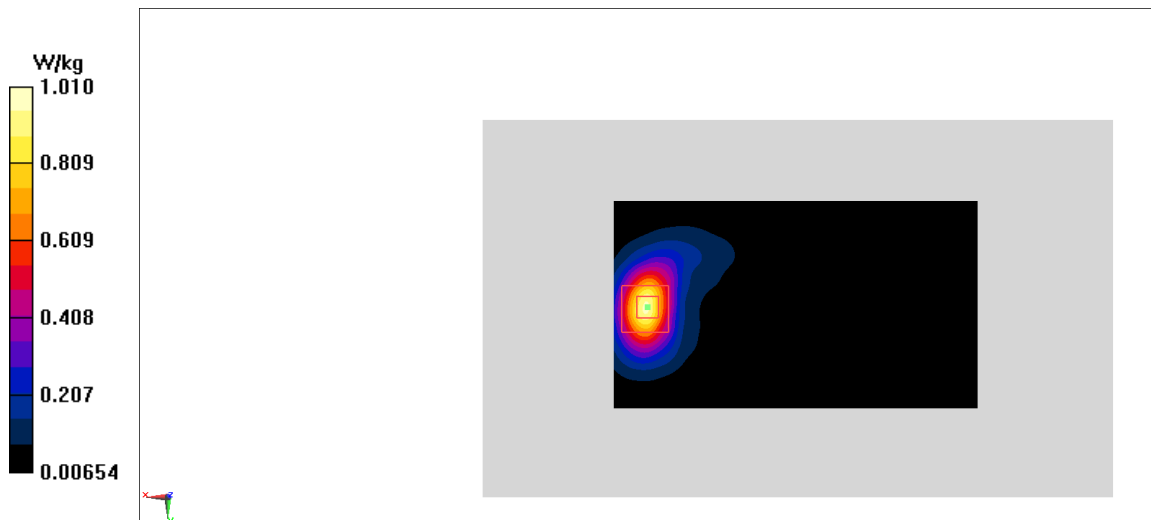

Fig A.10

WLAN2450_CH11 Right Cheek

Date: 6/19/2018

Electronics: DAE4 Sn1525

Medium: head 2450 MHz

Medium parameters used: $f = 2462$ MHz; $\sigma = 1.808$ mho/m; $\epsilon_r = 38.64$; $\rho = 1000$ kg/m³

Ambient Temperature: 22.5°C, Liquid Temperature: 22.3°C

Communication System: WLAN2450 2462 MHz Duty Cycle: 1:1

Probe: EX3DV4 – SN7464 ConvF(7.89,7.89,7.89)

Area Scan (71x121x1): Interpolated grid: $dx=1.000$ mm, $dy=1.000$ mm

Maximum value of SAR (interpolated) = 1.5 W/kg

Zoom Scan (7x7x7)/Cube 0: Measurement grid: $dx=5$ mm, $dy=5$ mm, $dz=5$ mm

Reference Value = 17.76 V/m; Power Drift = 0.02 dB

Peak SAR (extrapolated) = 2.11 W/kg

SAR(1 g) = 1.07 W/kg; SAR(10 g) = 0.56 W/kg

Maximum value of SAR (measured) = 1.34 W/kg

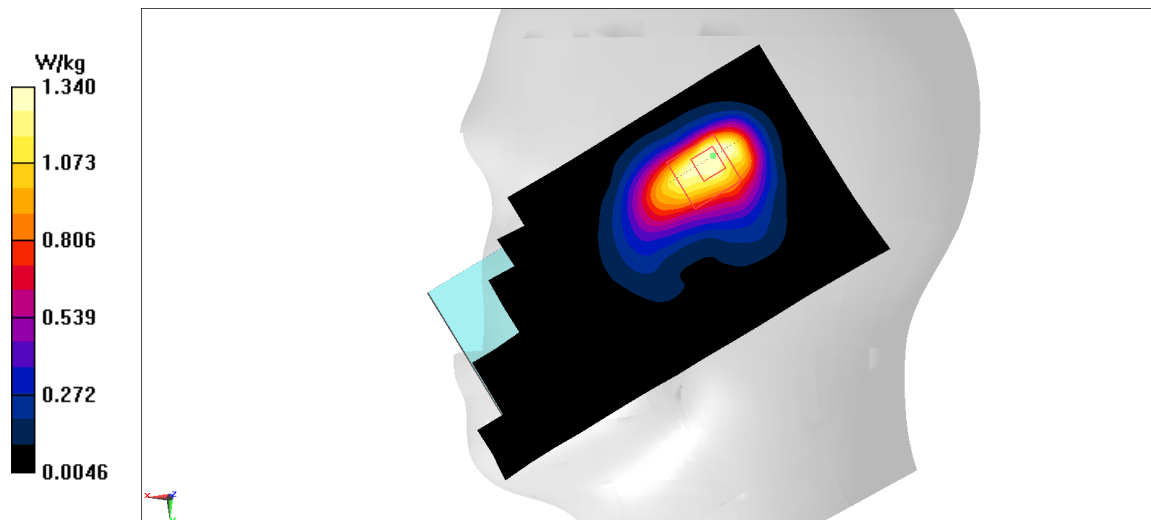

Fig A.11

WLAN2450_CH6 Front

Date: 6/19/2018

Electronics: DAE4 Sn1525

Medium: body 2450 MHz

Medium parameters used: $f = 2437$ MHz; $\sigma = 1.927$ mho/m; $\epsilon_r = 53.15$; $\rho = 1000$ kg/m³

Ambient Temperature: 22.5°C, Liquid Temperature: 22.3°C

Communication System: WLAN2450 2437 MHz Duty Cycle: 1:1

Probe: EX3DV4 – SN7464 ConvF(8.09,8.09,8.09)

Area Scan (71x121x1): Interpolated grid: dx=1.000 mm, dy=1.000 mm

Maximum value of SAR (interpolated) = 0.378 W/kg

Zoom Scan (7x7x7)/Cube 0: Measurement grid: dx=5mm, dy=5mm, dz=5mm

Reference Value = 8.569 V/m; Power Drift = -0.12 dB

Peak SAR (extrapolated) = 0.517 W/kg

SAR(1 g) = 0.297 W/kg; SAR(10 g) = 0.162 W/kg

Maximum value of SAR (measured) = 0.369 W/kg

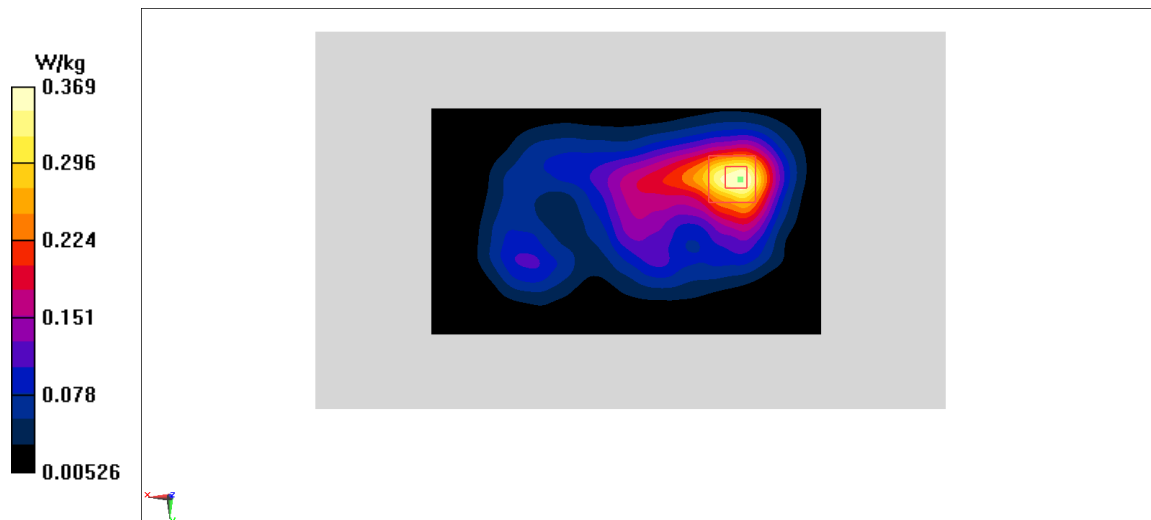

Fig A.12

LTE850-FDD5_CH20450 Left Cheek

Date: 8/1/2018

Electronics: DAE4 Sn1525

Medium: head 835 MHz

Medium parameters used: $f = 829$ MHz; $\sigma = 0.902$ mho/m; $\epsilon_r = 41.27$; $\rho = 1000$ kg/m³

Ambient Temperature: 22.4°C, Liquid Temperature: 22.2°C

Communication System: LTE850-FDD5 829 MHz Duty Cycle: 1:1

Probe: EX3DV4 – SN7464 ConvF(10.28,10.28,10.28)

Area Scan (71x121x1): Interpolated grid: $dx=1.000$ mm, $dy=1.000$ mm

Maximum value of SAR (interpolated) = 0.612 W/kg

Zoom Scan (7x7x7)/Cube 0: Measurement grid: $dx=5$ mm, $dy=5$ mm, $dz=5$ mm

Reference Value = 6.173 V/m; Power Drift = 0.14 dB

Peak SAR (extrapolated) = 0.695 W/kg

SAR(1 g) = 0.562 W/kg; SAR(10 g) = 0.436 W/kg

Maximum value of SAR (measured) = 0.614 W/kg

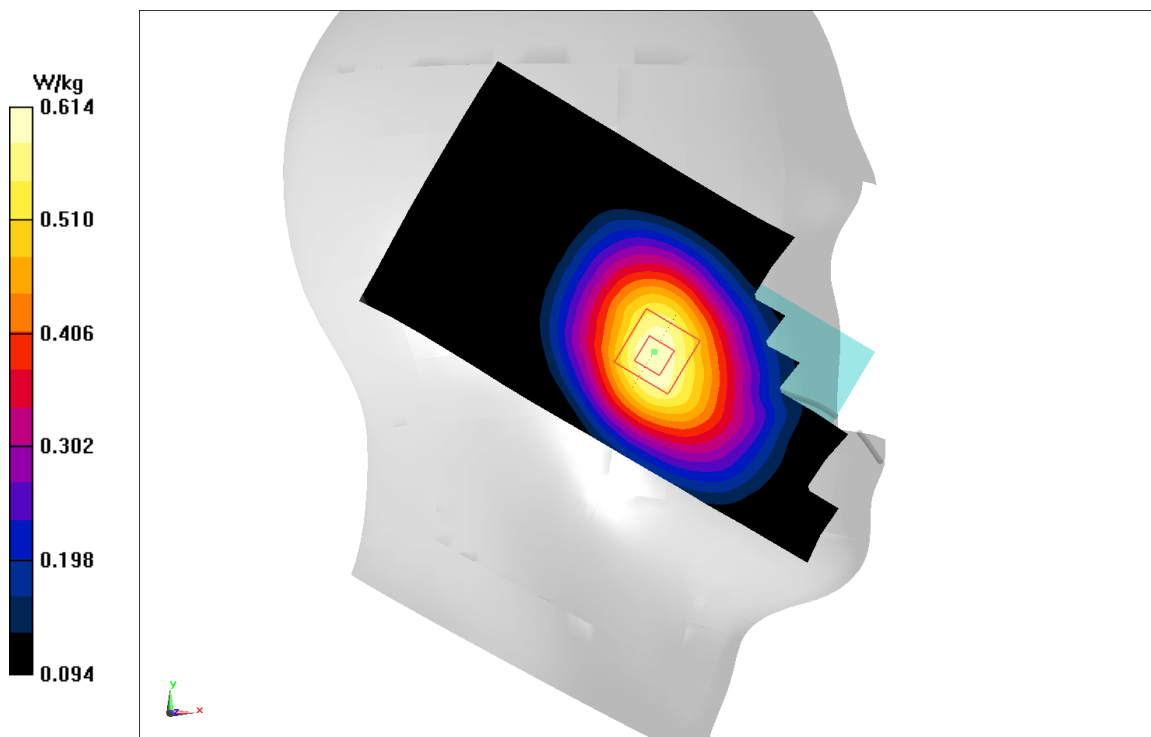

Fig A.13

LTE850-FDD5_CH20450 Rear

Date: 8/1/2018

Electronics: DAE4 Sn1525

Medium: body 835 MHz

Medium parameters used: $f = 829$ MHz; $\sigma = 0.955$ mho/m; $\epsilon_r = 55.06$; $\rho = 1000$ kg/m³

Ambient Temperature: 22.4°C, Liquid Temperature: 22.2°C

Communication System: LTE850-FDD5 829 MHz Duty Cycle: 1:1

Probe: EX3DV4 – SN7464 ConvF(10.21,10.21,10.21)

Area Scan (71x121x1): Interpolated grid: $dx=1.000$ mm, $dy=1.000$ mm

Maximum value of SAR (interpolated) = 0.738 W/kg

Zoom Scan (7x7x7)/Cube 0: Measurement grid: $dx=5$ mm, $dy=5$ mm, $dz=5$ mm

Reference Value = 26.04 V/m; Power Drift = -0.03 dB

Peak SAR (extrapolated) = 0.843 W/kg

SAR(1 g) = 0.674 W/kg; SAR(10 g) = 0.508 W/kg

Maximum value of SAR (measured) = 0.74 W/kg

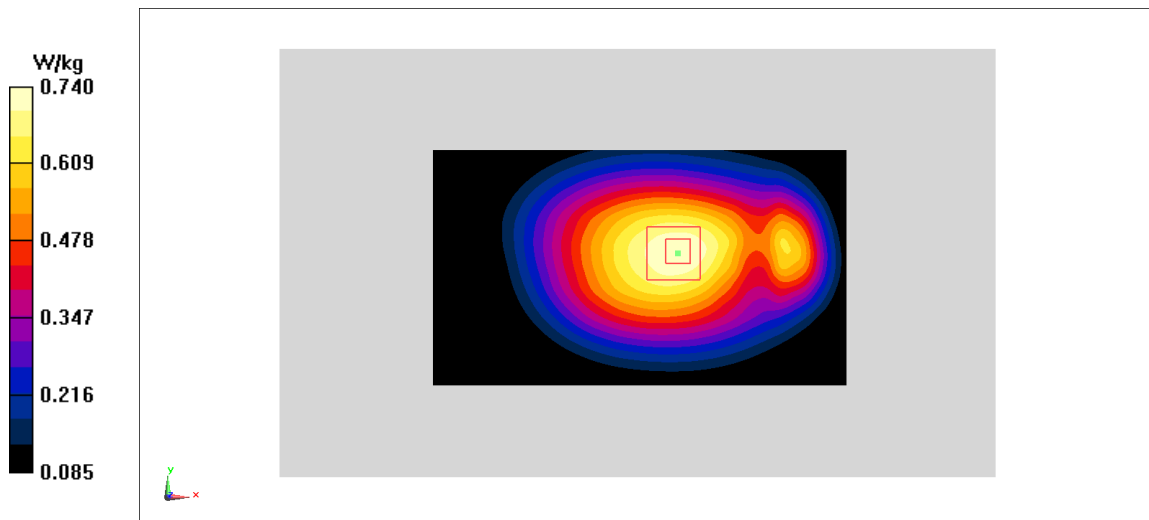

Fig A.14

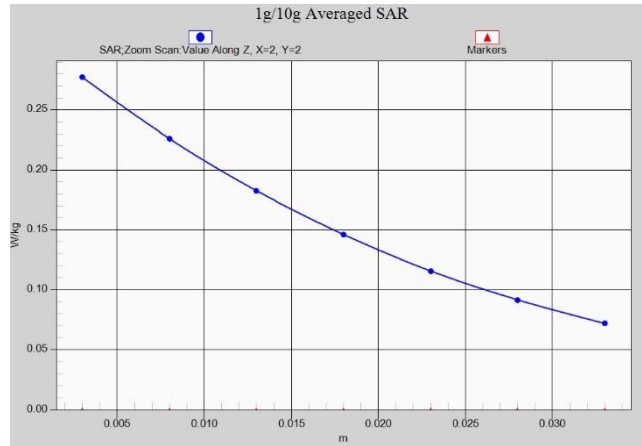

Fig.A.1- 1 Z-Scan at power reference point (GSM850)

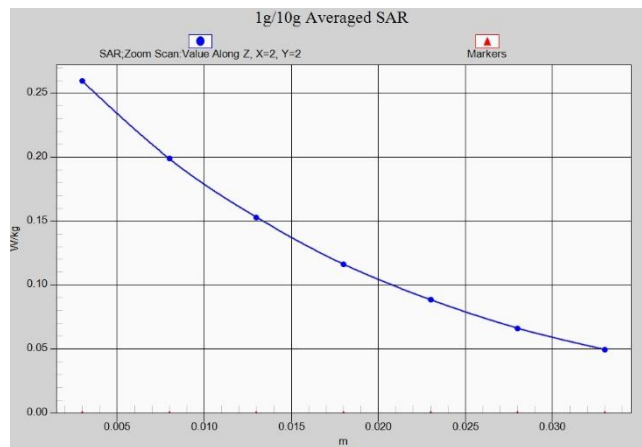

Fig.A.1- 2 Z-Scan at power reference point (GSM850)



Fig.A.1- 3 Z-Scan at power reference point (PCS1900)

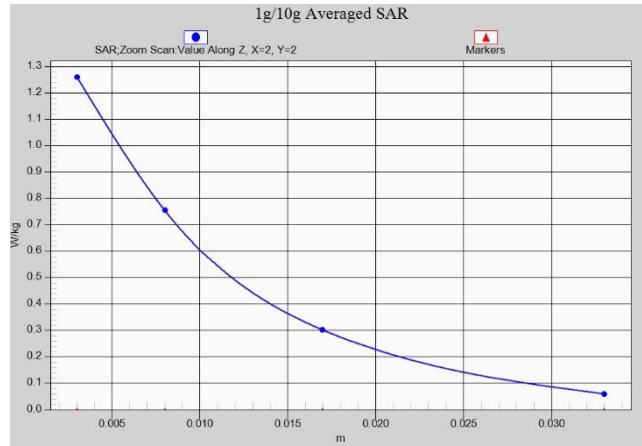

Fig.A.1- 4 Z-Scan at power reference point (PCS1900)

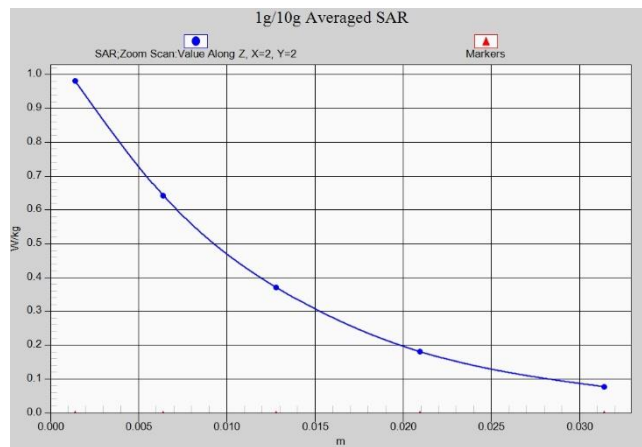

Fig.A.1- 5 Z-Scan at power reference point (W1900)

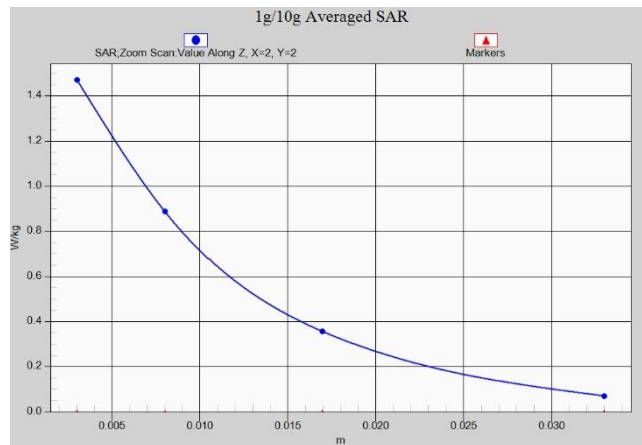

Fig.A.1- 6 Z-Scan at power reference point (W1900)

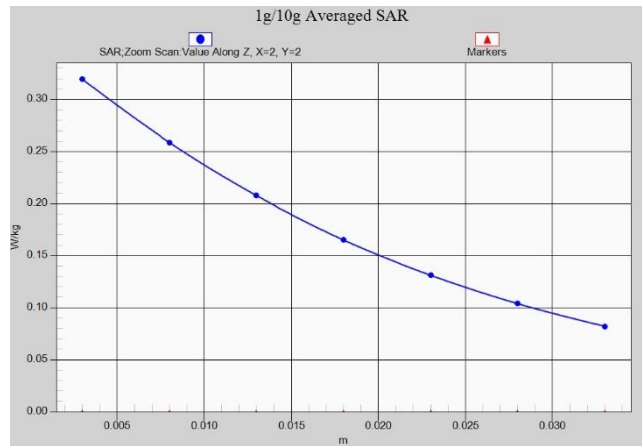

Fig.A.1- 7 Z-Scan at power reference point (W850)

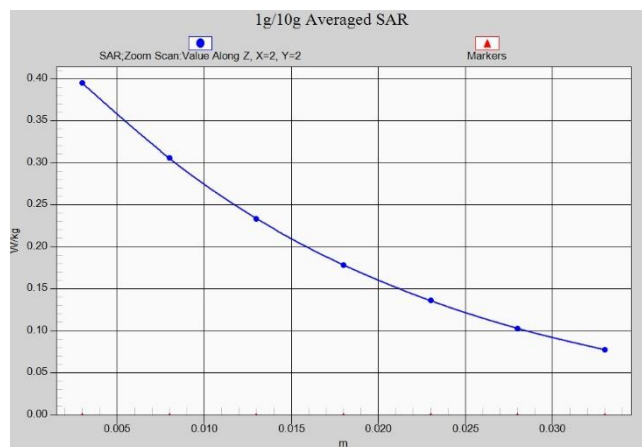

Fig.A.1- 8 Z-Scan at power reference point (W850)

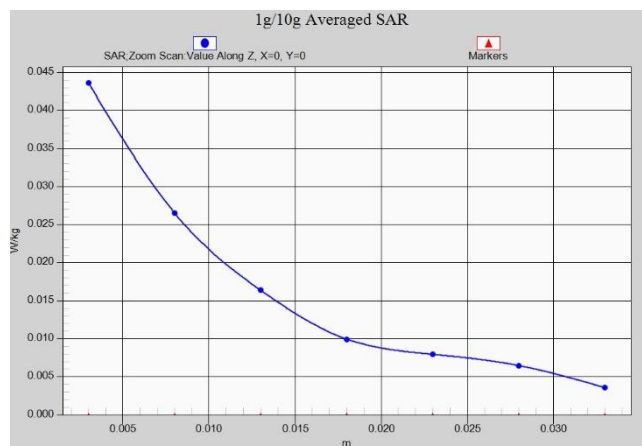

Fig.A.1- 9 Z-Scan at power reference point (LTE band7)

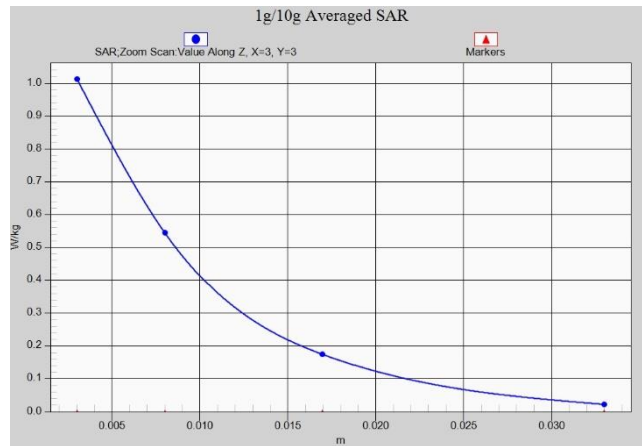

Fig.A.1- 10 Z-Scan at power reference point (LTE band7)

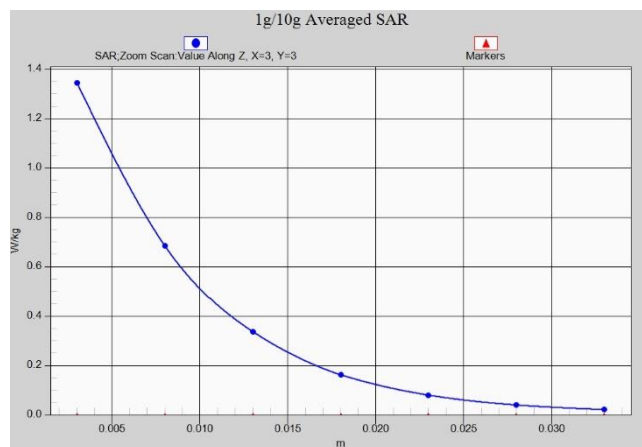

Fig.A.1- 11 Z-Scan at power reference point (Wifi2450)

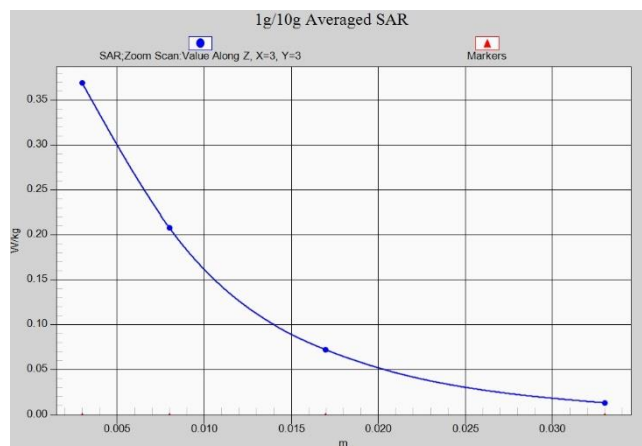

Fig.A.1- 12 Z-Scan at power reference point (Wifi2450)

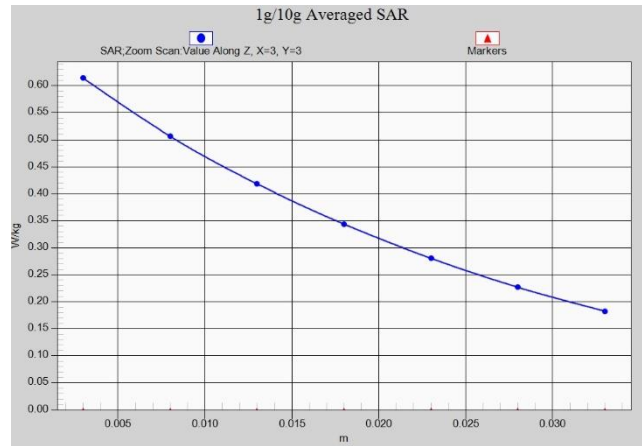

Fig.A.1- 13 Z-Scan at power reference point (LTE Band5)

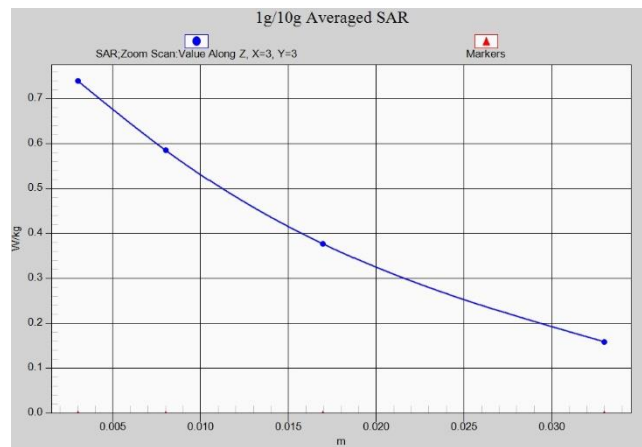

Fig.A.1- 14 Z-Scan at power reference point (LTE Band5)

ANNEX B System Verification Results

835 MHz

Date: 6/17/2018

Electronics: DAE4 Sn1525

Medium: Head 835 MHz

Medium parameters used: $f = 835$ MHz; $\sigma = 0.906$ mho/m; $\epsilon_r = 41.52$; $\rho = 1000$ kg/m³

Ambient Temperature: 22.5°C Liquid Temperature: 22.3°C

Communication System: CW Frequency: 835 MHz Duty Cycle: 1:1

Probe: EX3DV4 – SN7464 ConvF(10.28,10.28,10.28)

System Validation /Area Scan (81x191x1): Interpolated grid: dx=1.000 mm, dy=1.000 mm

Reference Value = 64.02 V/m; Power Drift = -0.05

Fast SAR: SAR(1 g) = 2.3 W/kg; SAR(10 g) = 1.51 W/kg

Maximum value of SAR (interpolated) = 3.8 W/kg

System Validation /Zoom Scan (7x7x7)/Cube 0: Measurement grid: dx=5mm, dy=5mm, dz=5mm

Reference Value =64.02 V/m; Power Drift = -0.05 dB

Peak SAR (extrapolated) = 4.04 W/kg

SAR(1 g) = 2.31 W/kg; SAR(10 g) = 1.5 W/kg

Maximum value of SAR (measured) = 3.6 W/kg

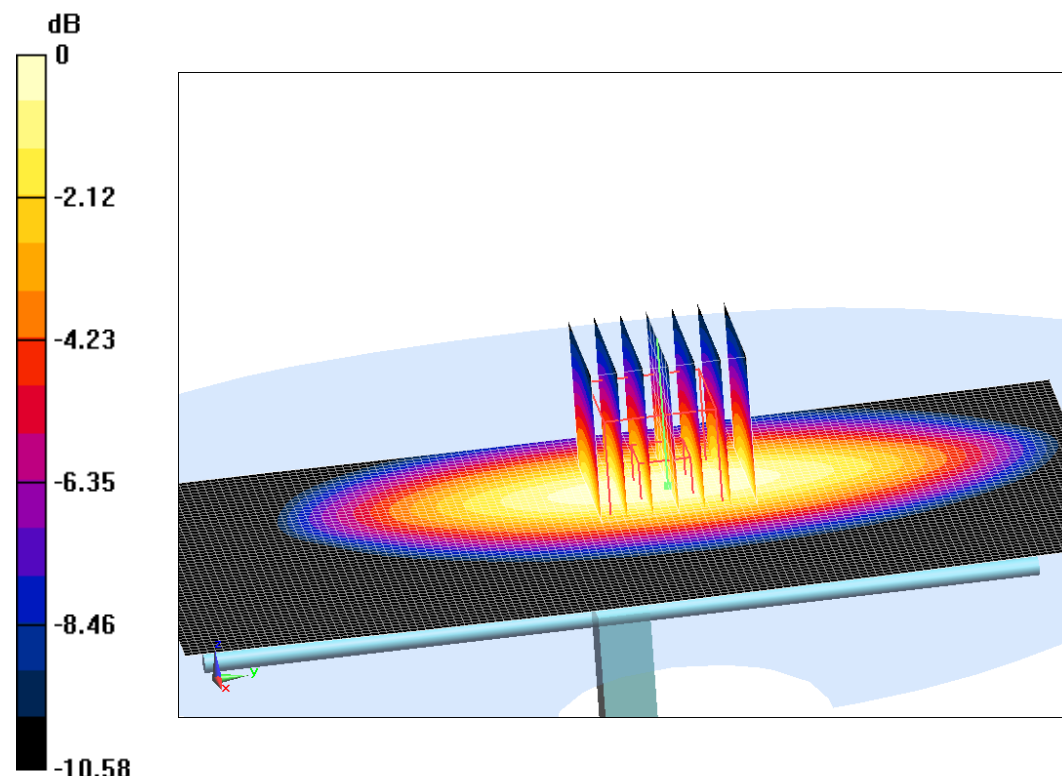

0 dB = 3.6 W/kg = 5.56 dB W/kg

Fig.B.1 validation 835 MHz 250mW

835 MHz

Date: 6/17/2018

Electronics: DAE4 Sn1525

Medium: Body 835 MHz

Medium parameters used: $f = 835 \text{ MHz}$; $\sigma = 0.97 \text{ mho/m}$; $\epsilon_r = 55.12$; $\rho = 1000 \text{ kg/m}^3$

Ambient Temperature: 22.5°C Liquid Temperature: 22.3°C

Communication System: CW Frequency: 835 MHz Duty Cycle: 1:1

Probe: EX3DV4 – SN7464 ConvF(10.21,10.21,10.21)

System Validation /Area Scan (81x191x1): Interpolated grid: $dx=1.000 \text{ mm}$, $dy=1.000 \text{ mm}$

Reference Value = 59.12 V/m; Power Drift = -0.09

Fast SAR: SAR(1 g) = 2.34 W/kg; SAR(10 g) = 1.53 W/kg

Maximum value of SAR (interpolated) = 3.56 W/kg

System Validation /Zoom Scan (7x7x7)/Cube 0: Measurement grid: $dx=5\text{mm}$, $dy=5\text{mm}$, $dz=5\text{mm}$

Reference Value =59.12 V/m; Power Drift = -0.09 dB

Peak SAR (extrapolated) = 3.74 W/kg

SAR(1 g) = 2.35 W/kg; SAR(10 g) = 1.54 W/kg

Maximum value of SAR (measured) = 3.18 W/kg

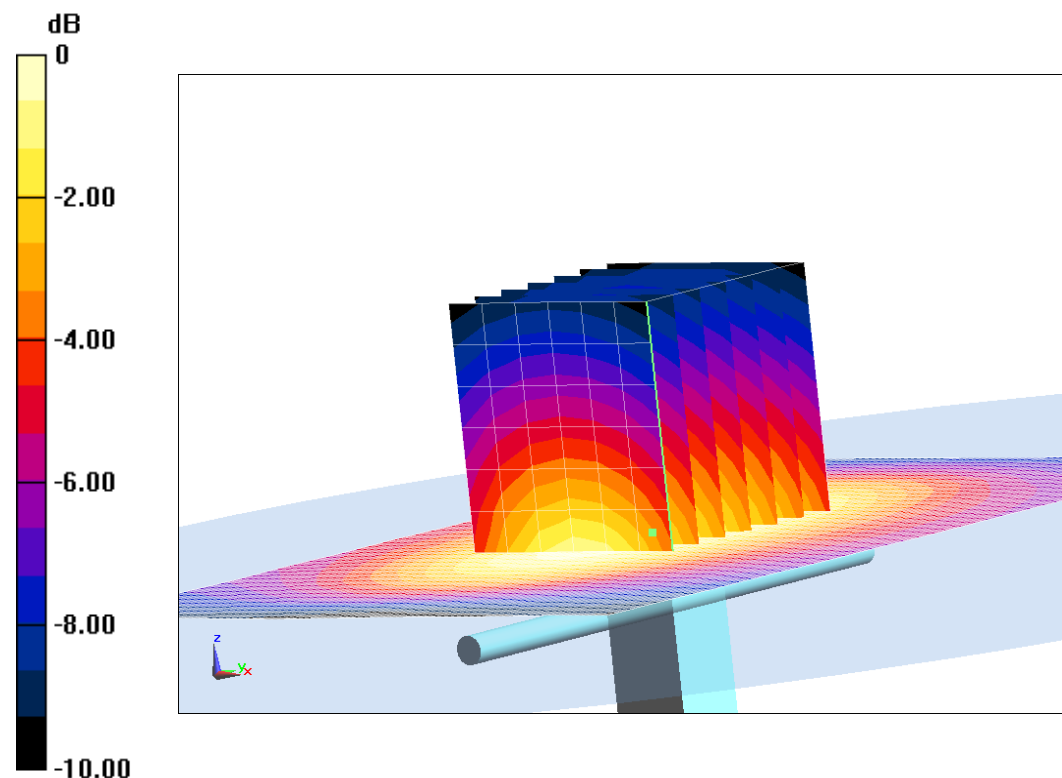

0 dB = 3.18 W/kg = 5.02 dB W/kg

Fig.B.2 validation 835 MHz 250mW

1900 MHz

Date: 6/18/2018

Electronics: DAE4 Sn1525

Medium: Head 1900 MHz

Medium parameters used: $f = 1900$ MHz; $\sigma = 1.4$ mho/m; $\epsilon_r = 39.37$; $\rho = 1000$ kg/m³

Ambient Temperature: 22.5°C Liquid Temperature: 22.3°C

Communication System: CW Frequency: 1900 MHz Duty Cycle: 1:1

Probe: EX3DV4 – SN7464 ConvF(8.39,8.39,8.39)

System Validation /Area Scan (81x191x1): Interpolated grid: dx=1.000 mm, dy=1.000 mm

Reference Value = 106.13 V/m; Power Drift = 0.02

Fast SAR: SAR(1 g) = 9.83 W/kg; SAR(10 g) = 5.21 W/kg

Maximum value of SAR (interpolated) = 14.63 W/kg

System Validation /Zoom Scan (7x7x7)/Cube 0: Measurement grid: dx=5mm, dy=5mm, dz=5mm

Reference Value = 106.13 V/m; Power Drift = 0.02 dB

Peak SAR (extrapolated) = 18.05 W/kg

SAR(1 g) = 9.8 W/kg; SAR(10 g) = 5.28 W/kg

Maximum value of SAR (measured) = 15.1 W/kg

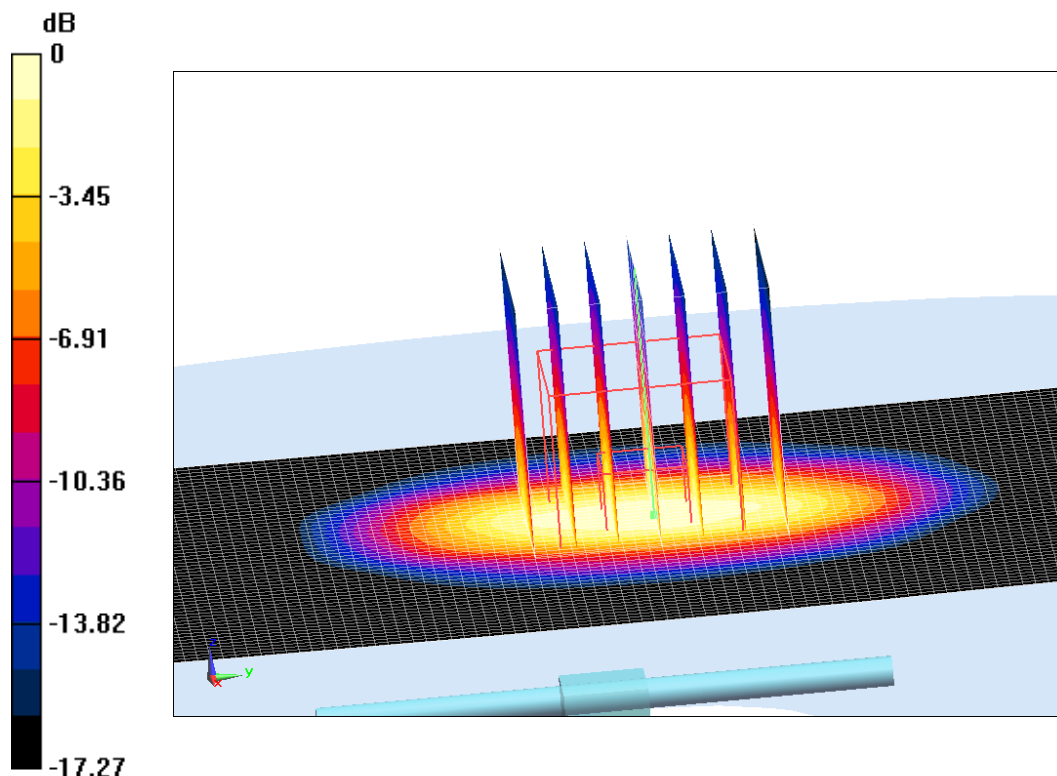

0 dB = 15.1 W/kg = 11.79 dB W/kg

Fig.B.3 validation 1900 MHz 250mW

1900 MHz

Date: 6/18/2018

Electronics: DAE4 Sn1525

Medium: Body 1900 MHz

Medium parameters used: $f = 1900$ MHz; $\sigma = 1.513$ mho/m; $\epsilon_r = 53.91$; $\rho = 1000$ kg/m³

Ambient Temperature: 22.5°C Liquid Temperature: 22.3°C

Communication System: CW Frequency: 1900 MHz Duty Cycle: 1:1

Probe: EX3DV4 – SN7464 ConvF(8.32,8.32,8.32)

System Validation /Area Scan (81x191x1): Interpolated grid: dx=1.000 mm, dy=1.000 mm

Reference Value = 102.83 V/m; Power Drift = 0.07

Fast SAR: SAR(1 g) = 9.97 W/kg; SAR(10 g) = 5.3 W/kg

Maximum value of SAR (interpolated) = 17.67 W/kg

System Validation /Zoom Scan (7x7x7)/Cube 0: Measurement grid: dx=5mm, dy=5mm, dz=5mm

Reference Value = 102.83 V/m; Power Drift = 0.07 dB

Peak SAR (extrapolated) = 17.4 W/kg

SAR(1 g) = 10.14 W/kg; SAR(10 g) = 5.38 W/kg

Maximum value of SAR (measured) = 14.16 W/kg

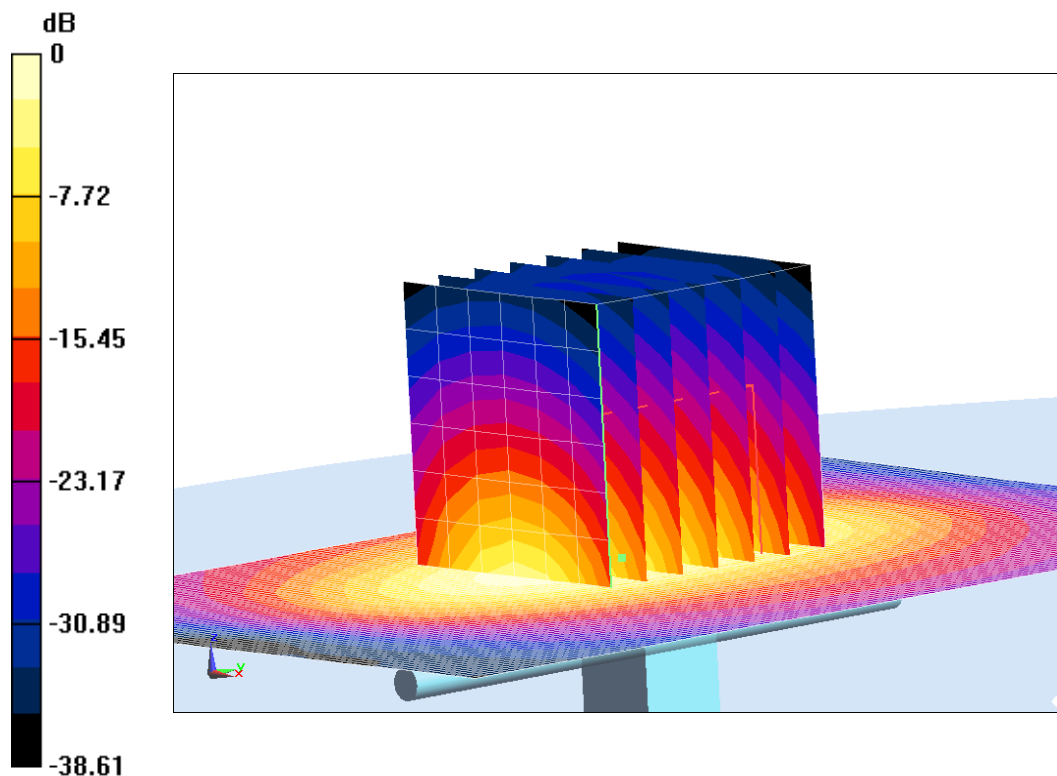

0 dB = 14.16 W/kg = 11.51 dB W/kg

Fig.B.4 validation 1900 MHz 250mW

2450 MHz

Date: 6/19/2018

Electronics: DAE4 Sn1525

Medium: Head 2450 MHz

Medium parameters used: $f = 2450$ MHz; $\sigma = 1.797$ mho/m; $\epsilon_r = 38.65$; $\rho = 1000$ kg/m³

Ambient Temperature: 22.5°C Liquid Temperature: 22.3°C

Communication System: CW Frequency: 2450 MHz Duty Cycle: 1:1

Probe: EX3DV4 – SN7464 ConvF(7.89,7.89,7.89)

System Validation /Area Scan (81x191x1): Interpolated grid: dx=1.000 mm, dy=1.000 mm

Reference Value = 114.63 V/m; Power Drift = -0.08

Fast SAR: SAR(1 g) = 13.05 W/kg; SAR(10 g) = 6.13 W/kg

Maximum value of SAR (interpolated) = 21.64 W/kg

System Validation /Zoom Scan (7x7x7)/Cube 0: Measurement grid: dx=5mm, dy=5mm, dz=5mm

Reference Value = 114.63 V/m; Power Drift = -0.08 dB

Peak SAR (extrapolated) = 26.89 W/kg

SAR(1 g) = 13.1 W/kg; SAR(10 g) = 6.28 W/kg

Maximum value of SAR (measured) = 21.45 W/kg

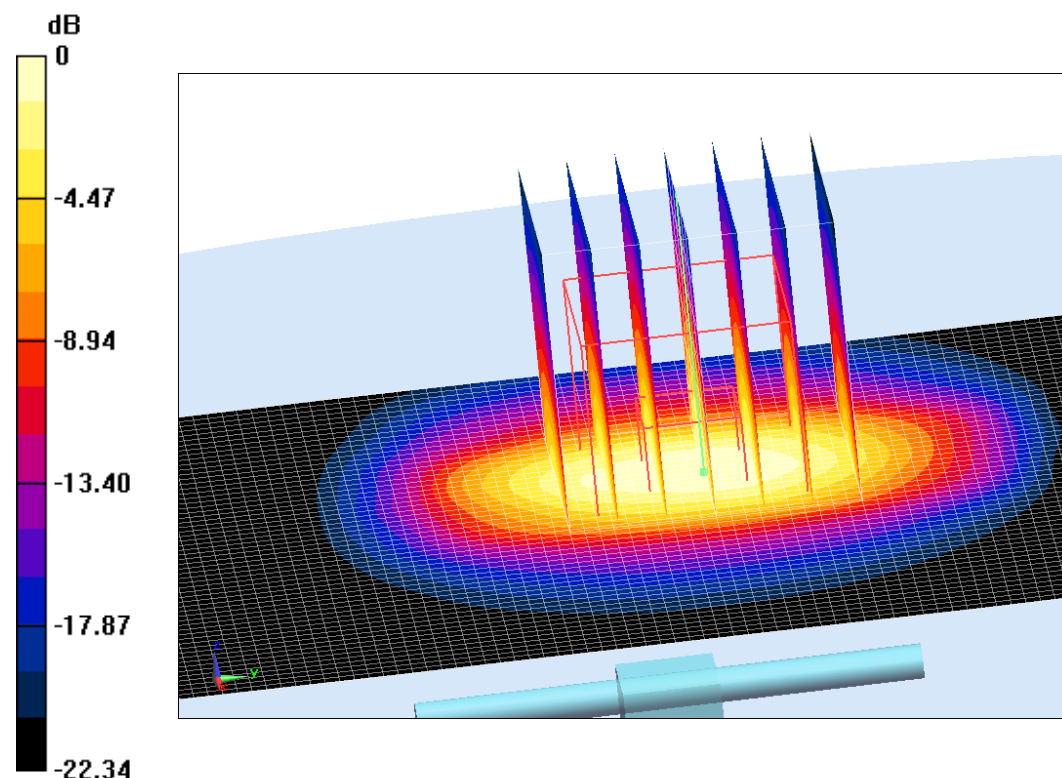

0 dB = 21.45 W/kg = 13.31 dB W/kg

Fig.B.5 validation 2450 MHz 250mW

2450 MHz

Date: 6/19/2018

Electronics: DAE4 Sn1525

Medium: Body 2450 MHz

Medium parameters used: $f = 2450$ MHz; $\sigma = 1.939$ mho/m; $\epsilon_r = 53.13$; $\rho = 1000$ kg/m³

Ambient Temperature: 22.5°C Liquid Temperature: 22.3°C

Communication System: CW Frequency: 2450 MHz Duty Cycle: 1:1

Probe: EX3DV4 – SN7464 ConvF(8.09,8.09,8.09)

System Validation /Area Scan (81x191x1): Interpolated grid: dx=1.000 mm, dy=1.000 mm

Reference Value = 104.23 V/m; Power Drift = 0.05

Fast SAR: SAR(1 g) = 12.45 W/kg; SAR(10 g) = 5.85 W/kg

Maximum value of SAR (interpolated) = 25.73 W/kg

System Validation /Zoom Scan (7x7x7)/Cube 0: Measurement grid: dx=5mm, dy=5mm, dz=5mm

Reference Value = 104.23 V/m; Power Drift = 0.05 dB

Peak SAR (extrapolated) = 25.46 W/kg

SAR(1 g) = 12.43 W/kg; SAR(10 g) = 5.85 W/kg

Maximum value of SAR (measured) = 19.82 W/kg

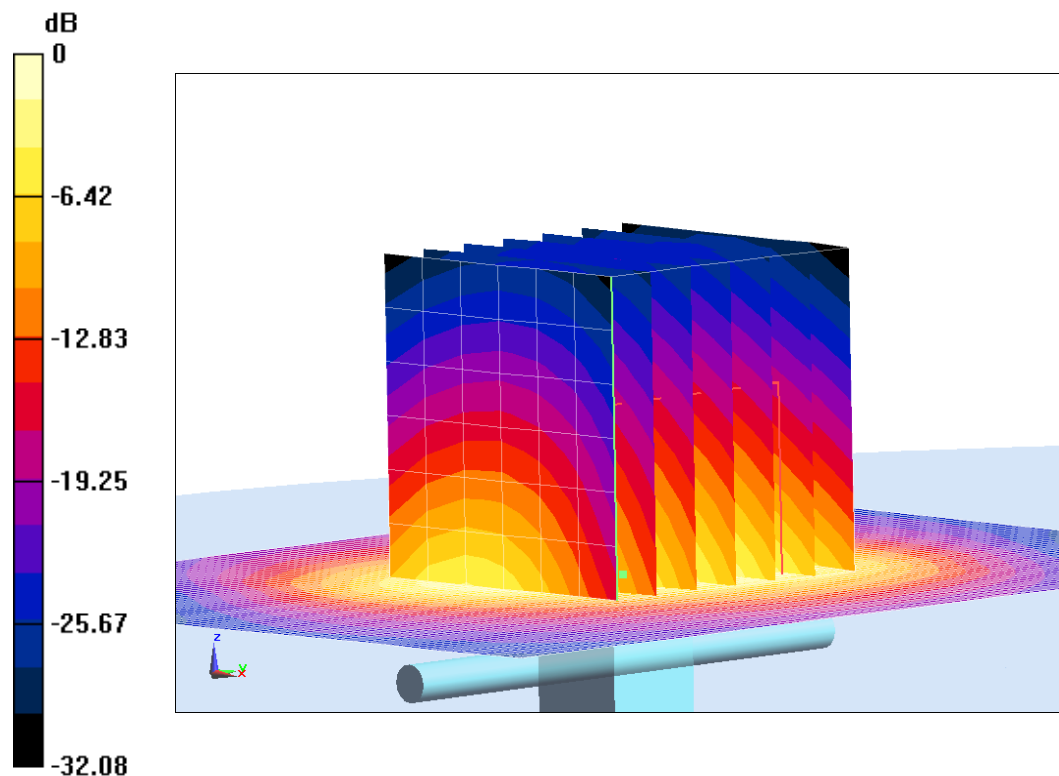

0 dB = 19.82 W/kg = 12.97 dB W/kg

Fig.B.6 validation 2450 MHz 250mW

2600 MHz

Date: 6/19/2018

Electronics: DAE4 Sn1525

Medium: Head 2600 MHz

Medium parameters used: $f = 2600$ MHz; $\sigma = 1.942$ mho/m; $\epsilon_r = 38.63$; $\rho = 1000$ kg/m³

Ambient Temperature: 22.5°C Liquid Temperature: 22.3°C

Communication System: CW Frequency: 2600 MHz Duty Cycle: 1:1

Probe: EX3DV4 – SN7464 ConvF(7.76,7.76,7.76)

System Validation /Area Scan (81x191x1): Interpolated grid: dx=1.000 mm, dy=1.000 mm

Reference Value = 111.47 V/m; Power Drift = 0.06

Fast SAR: SAR(1 g) = 14.33 W/kg; SAR(10 g) = 6.33 W/kg

Maximum value of SAR (interpolated) = 24.84 W/kg

System Validation /Zoom Scan (7x7x7)/Cube 0: Measurement grid: dx=5mm, dy=5mm, dz=5mm

Reference Value = 111.47 V/m; Power Drift = 0.06 dB

Peak SAR (extrapolated) = 31.96 W/kg

SAR(1 g) = 14.3 W/kg; SAR(10 g) = 6.47 W/kg

Maximum value of SAR (measured) = 25.43 W/kg

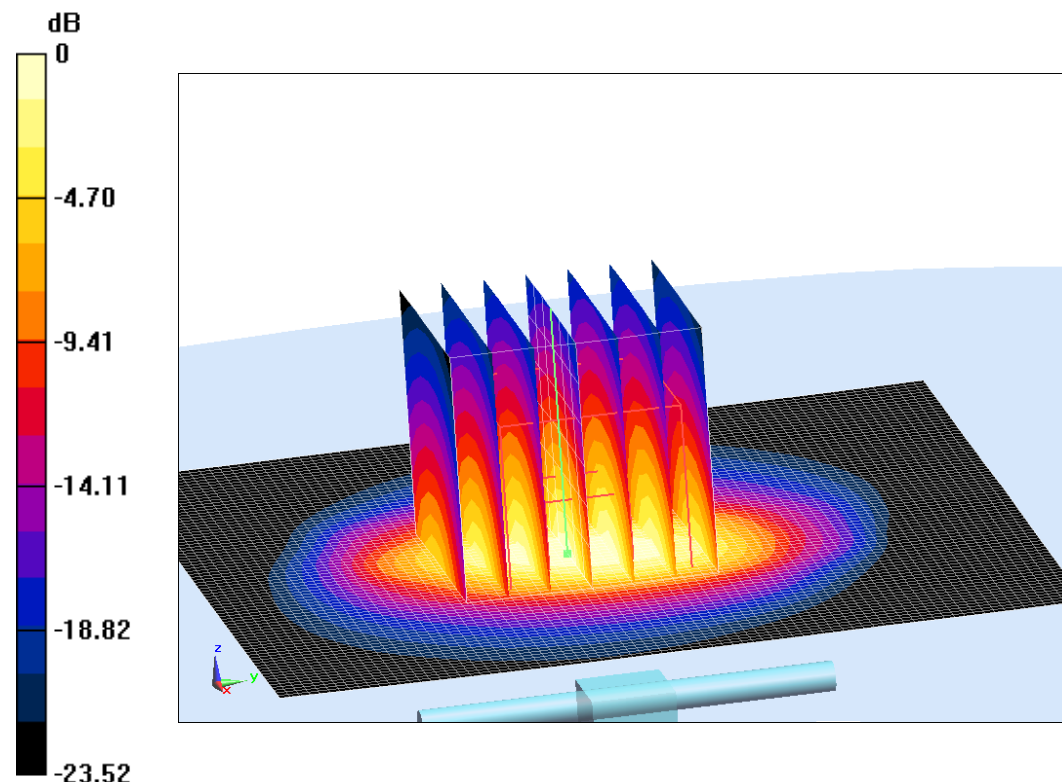

0 dB = 25.43 W/kg = 14.05 dB W/kg

Fig.B.7 validation 2600 MHz 250mW

2600 MHz

Date: 6/19/2018

Electronics: DAE4 Sn1525

Medium: Body 2600 MHz

Medium parameters used: $f = 2600$ MHz; $\sigma = 2.175$ mho/m; $\epsilon_r = 51.64$; $\rho = 1000$ kg/m³

Ambient Temperature: 22.5°C Liquid Temperature: 22.3°C

Communication System: CW Frequency: 2600 MHz Duty Cycle: 1:1

Probe: EX3DV4 – SN7464 ConvF(7.84,7.84,7.84)

System Validation /Area Scan (81x191x1): Interpolated grid: dx=1.000 mm, dy=1.000 mm

Reference Value = 105.84 V/m; Power Drift = -0.04

Fast SAR: SAR(1 g) = 13.79 W/kg; SAR(10 g) = 6.2 W/kg

Maximum value of SAR (interpolated) = 29.42 W/kg

System Validation /Zoom Scan (7x7x7)/Cube 0: Measurement grid: dx=5mm, dy=5mm, dz=5mm

Reference Value = 105.84 V/m; Power Drift = -0.04 dB

Peak SAR (extrapolated) = 30.08 W/kg

SAR(1 g) = 14.08 W/kg; SAR(10 g) = 6.26 W/kg

Maximum value of SAR (measured) = 23.24 W/kg

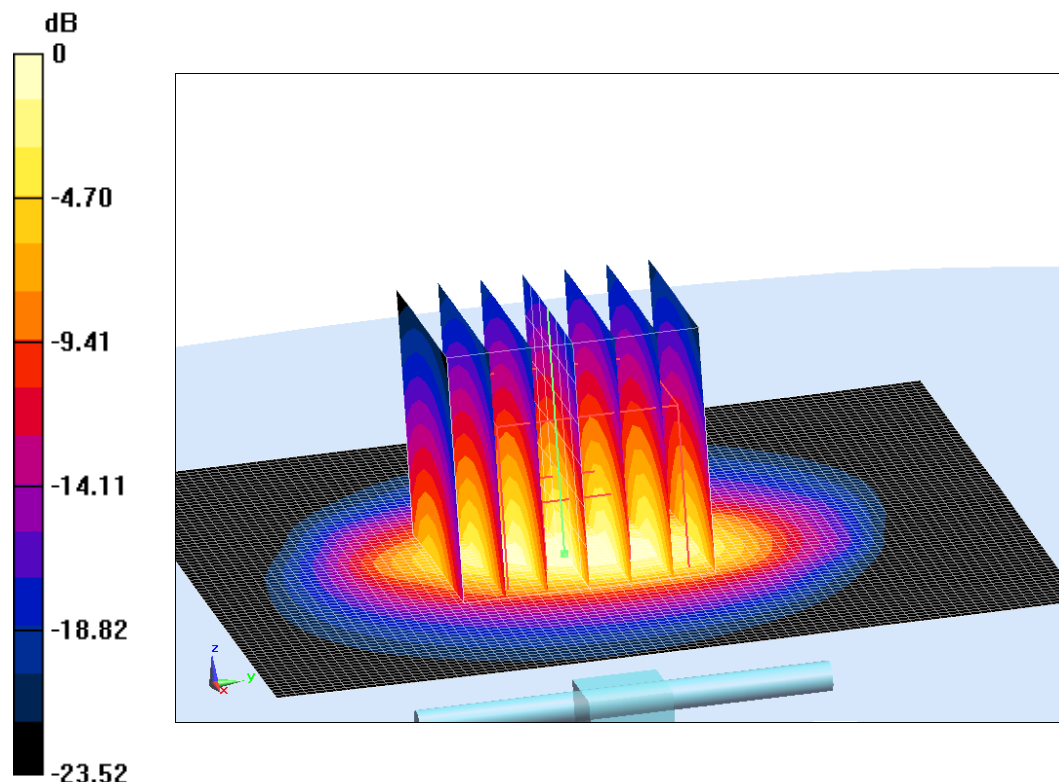

0 dB = 23.24 W/kg = 13.66 dB W/kg

Fig.B.8 validation 2600 MHz 250mW

835 MHz

Date: 8/1/2018

Electronics: DAE4 Sn1525

Medium: Head 835 MHz

Medium parameters used: $f = 835 \text{ MHz}$; $\sigma = 0.908 \text{ mho/m}$; $\epsilon_r = 41.26$; $\rho = 1000 \text{ kg/m}^3$

Ambient Temperature: 22.4°C Liquid Temperature: 22.2°C

Communication System: CW Frequency: 835 MHz Duty Cycle: 1:1

Probe: EX3DV4 – SN7464 ConvF(10.28,10.28,10.28)

System Validation /Area Scan (81x191x1): Interpolated grid: $dx=1.000 \text{ mm}$, $dy=1.000 \text{ mm}$

Reference Value = 65.55 V/m ; Power Drift = 0.03

Fast SAR: SAR(1 g) = 2.3 W/kg ; SAR(10 g) = 1.54 W/kg

Maximum value of SAR (interpolated) = 3.73 W/kg

System Validation /Zoom Scan (7x7x7)/Cube 0: Measurement grid: $dx=5\text{mm}$, $dy=5\text{mm}$, $dz=5\text{mm}$

Reference Value = 65.55 V/m ; Power Drift = 0.03 dB

Peak SAR (extrapolated) = 4.02 W/kg

SAR(1 g) = 2.34 W/kg ; SAR(10 g) = 1.5 W/kg

Maximum value of SAR (measured) = 3.58 W/kg

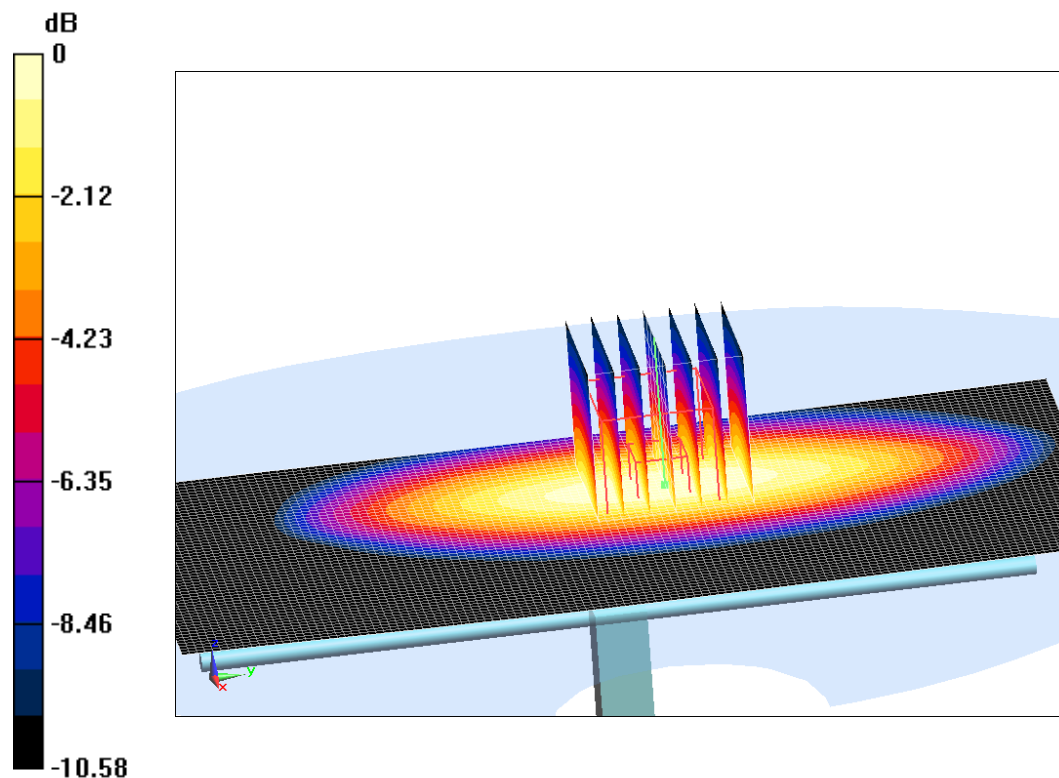

0 dB = 3.58 W/kg = 5.54 dB W/kg

Fig.B.9 validation 835 MHz 250mW

835 MHz

Date: 8/1/2018

Electronics: DAE4 Sn1525

Medium: Body 835 MHz

Medium parameters used: $f = 835 \text{ MHz}$; $\sigma = 0.961 \text{ mho/m}$; $\epsilon_r = 55.05$; $\rho = 1000 \text{ kg/m}^3$

Ambient Temperature: 22.4°C Liquid Temperature: 22.2°C

Communication System: CW Frequency: 835 MHz Duty Cycle: 1:1

Probe: EX3DV4 – SN7464 ConvF(10.21,10.21,10.21)

System Validation /Area Scan (81x191x1): Interpolated grid: $dx=1.000 \text{ mm}$, $dy=1.000 \text{ mm}$

Reference Value = 58.45 V/m ; Power Drift = -0.03

Fast SAR: SAR(1 g) = 2.35 W/kg ; SAR(10 g) = 1.53 W/kg

Maximum value of SAR (interpolated) = 3.49 W/kg

System Validation /Zoom Scan (7x7x7)/Cube 0: Measurement grid: $dx=5\text{mm}$, $dy=5\text{mm}$, $dz=5\text{mm}$

Reference Value = 58.45 V/m ; Power Drift = -0.03 dB

Peak SAR (extrapolated) = 3.62 W/kg

SAR(1 g) = 2.4 W/kg ; SAR(10 g) = 1.52 W/kg

Maximum value of SAR (measured) = 3.19 W/kg

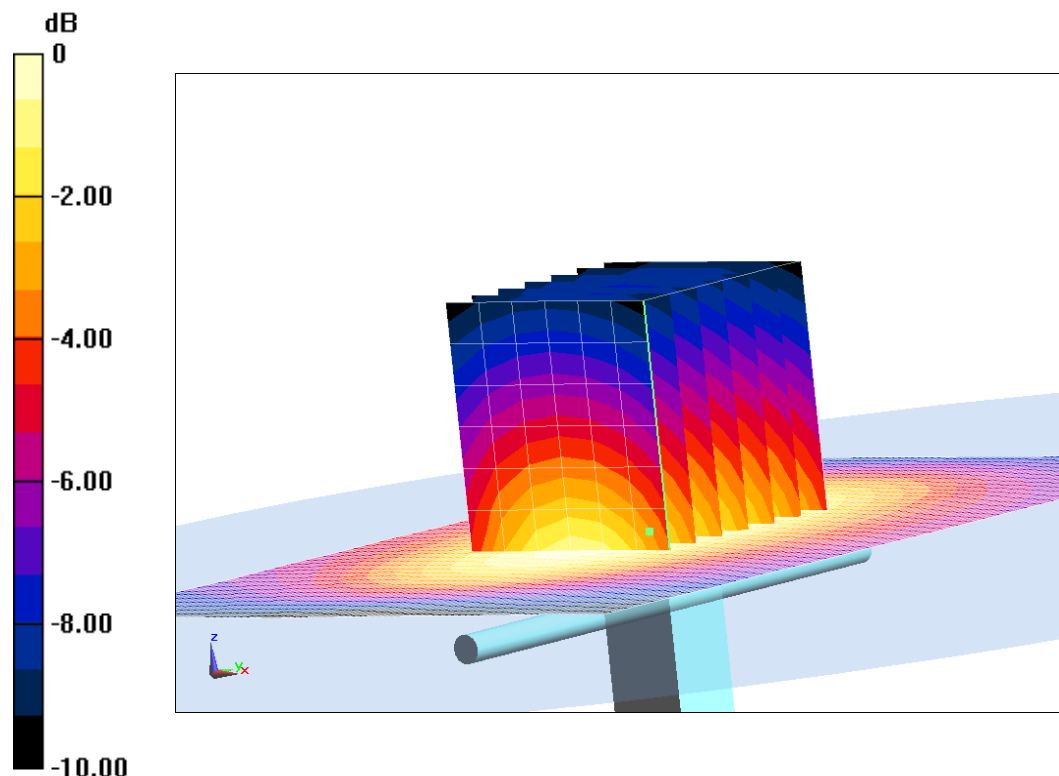

$0 \text{ dB} = 3.19 \text{ W/kg} = 5.04 \text{ dB W/kg}$

Fig.B.10 validation 835 MHz 250mW

1900 MHz

Date: 8/2/2018

Electronics: DAE4 Sn1525

Medium: Head 1900 MHz

Medium parameters used: $f = 1900$ MHz; $\sigma = 1.401$ mho/m; $\epsilon_r = 40.09$; $\rho = 1000$ kg/m³

Ambient Temperature: 22.4°C Liquid Temperature: 22.2°C

Communication System: CW Frequency: 1900 MHz Duty Cycle: 1:1

Probe: EX3DV4 – SN7464 ConvF(8.39,8.39,8.39)

System Validation /Area Scan (81x191x1): Interpolated grid: dx=1.000 mm, dy=1.000 mm

Reference Value = 106.97 V/m; Power Drift = 0.04

Fast SAR: SAR(1 g) = 10 W/kg; SAR(10 g) = 5.19 W/kg

Maximum value of SAR (interpolated) = 15.09 W/kg

System Validation /Zoom Scan (7x7x7)/Cube 0: Measurement grid: dx=5mm, dy=5mm, dz=5mm

Reference Value = 106.97 V/m; Power Drift = 0.04 dB

Peak SAR (extrapolated) = 18.59 W/kg

SAR(1 g) = 10.11 W/kg; SAR(10 g) = 5.25 W/kg

Maximum value of SAR (measured) = 15.08 W/kg

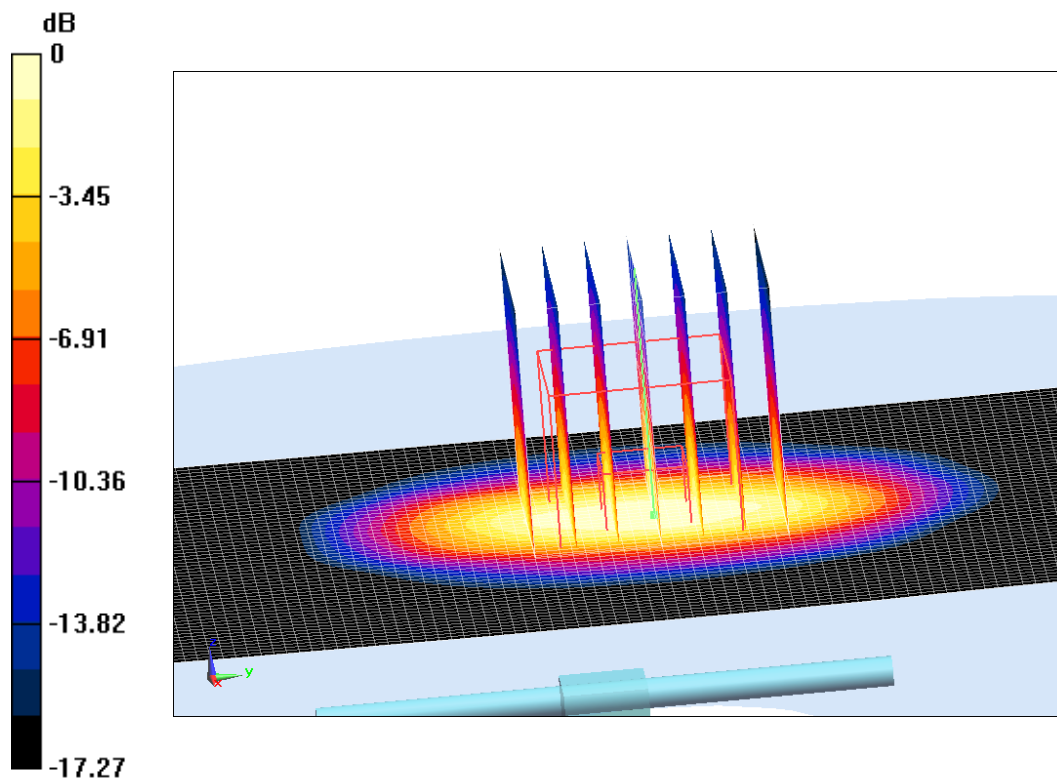

0 dB = 15.08 W/kg = 11.78 dB W/kg

Fig.B.11 validation 1900 MHz 250mW

1900 MHz

Date: 8/2/2018

Electronics: DAE4 Sn1525

Medium: Body 1900 MHz

Medium parameters used: $f = 1900$ MHz; $\sigma = 1.548$ mho/m; $\epsilon_r = 54.17$; $\rho = 1000$ kg/m³

Ambient Temperature: 22.4°C Liquid Temperature: 22.2°C

Communication System: CW Frequency: 1900 MHz Duty Cycle: 1:1

Probe: EX3DV4 – SN7464 ConvF(8.32,8.32,8.32)

System Validation /Area Scan (81x191x1): Interpolated grid: dx=1.000 mm, dy=1.000 mm

Reference Value = 101.56 V/m; Power Drift = -0.09

Fast SAR: SAR(1 g) = 9.99 W/kg; SAR(10 g) = 5.34 W/kg

Maximum value of SAR (interpolated) = 17.75 W/kg

System Validation /Zoom Scan (7x7x7)/Cube 0: Measurement grid: dx=5mm, dy=5mm, dz=5mm

Reference Value =101.56 V/m; Power Drift = -0.09 dB

Peak SAR (extrapolated) = 17.74 W/kg

SAR(1 g) = 9.94 W/kg; SAR(10 g) = 5.43 W/kg

Maximum value of SAR (measured) = 14.3 W/kg

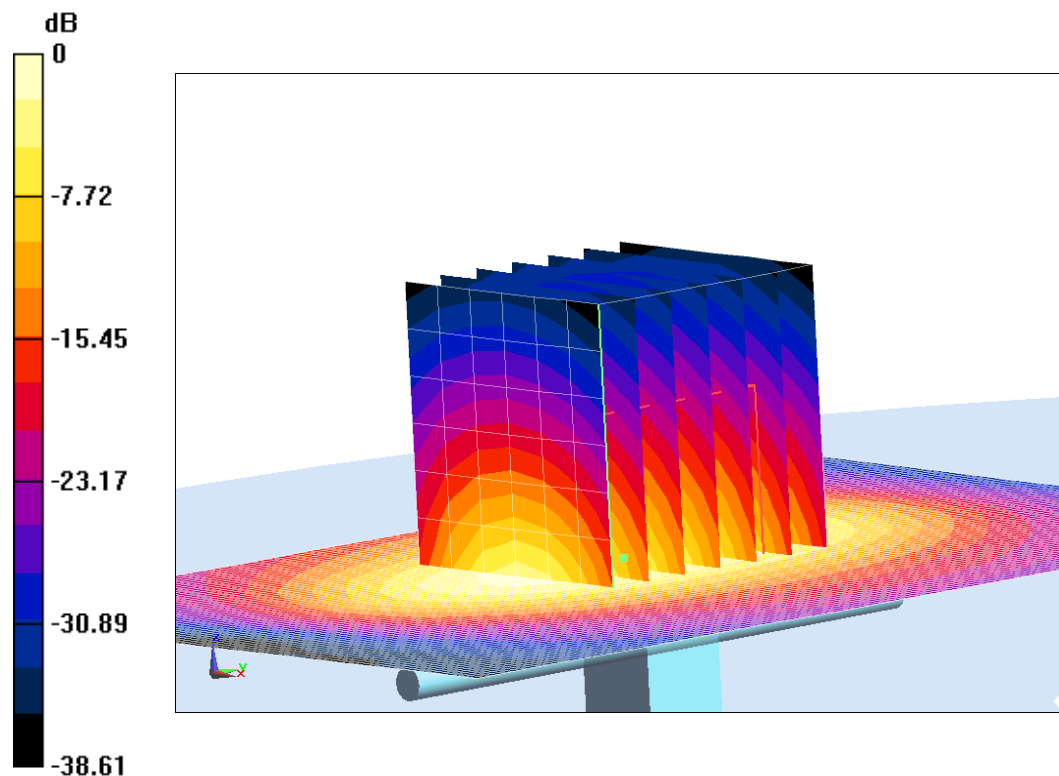

0 dB = 14.3 W/kg = 11.55 dB W/kg

Fig.B.12 validation 1900 MHz 250mW

2450 MHz

Date: 8/3/2018

Electronics: DAE4 Sn1525

Medium: Head 2450 MHz

Medium parameters used: $f = 2450$ MHz; $\sigma = 1.813$ mho/m; $\epsilon_r = 39.79$; $\rho = 1000$ kg/m³

Ambient Temperature: 22.4°C Liquid Temperature: 22.2°C

Communication System: CW Frequency: 2450 MHz Duty Cycle: 1:1

Probe: EX3DV4 – SN7464 ConvF(7.89,7.89,7.89)

System Validation /Area Scan (81x191x1): Interpolated grid: dx=1.000 mm, dy=1.000 mm

Reference Value = 111 V/m; Power Drift = 0.06

Fast SAR: SAR(1 g) = 12.88 W/kg; SAR(10 g) = 6.18 W/kg

Maximum value of SAR (interpolated) = 21.66 W/kg

System Validation /Zoom Scan (7x7x7)/Cube 0: Measurement grid: dx=5mm, dy=5mm, dz=5mm

Reference Value =111 V/m; Power Drift = 0.06 dB

Peak SAR (extrapolated) = 26.89 W/kg

SAR(1 g) = 12.84 W/kg; SAR(10 g) = 6.21 W/kg

Maximum value of SAR (measured) = 21.5 W/kg

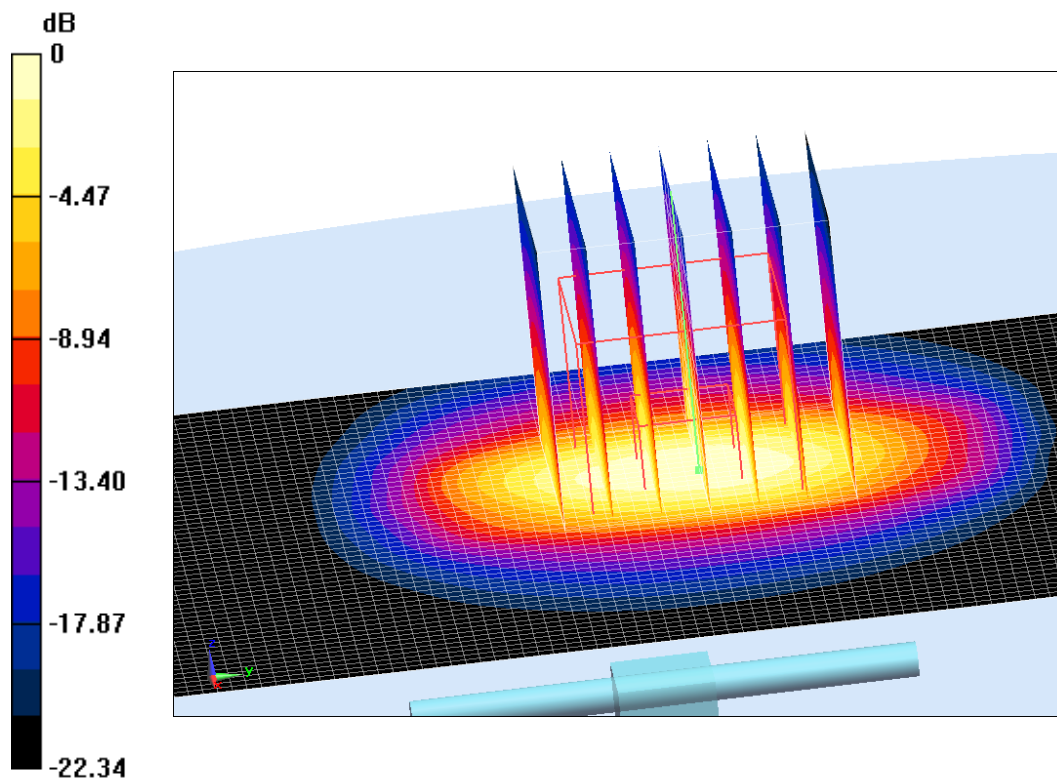

0 dB = 21.5 W/kg = 13.32 dB W/kg

Fig.B.13 validation 2450 MHz 250mW

2450 MHz

Date: 8/3/2018

Electronics: DAE4 Sn1525

Medium: Body 2450 MHz

Medium parameters used: $f = 2450$ MHz; $\sigma = 1.982$ mho/m; $\epsilon_r = 52.52$; $\rho = 1000$ kg/m³

Ambient Temperature: 22.4°C Liquid Temperature: 22.2°C

Communication System: CW Frequency: 2450 MHz Duty Cycle: 1:1

Probe: EX3DV4 – SN7464 ConvF(8.09,8.09,8.09)

System Validation /Area Scan (81x191x1): Interpolated grid: dx=1.000 mm, dy=1.000 mm

Reference Value = 105.99 V/m; Power Drift = 0.04

Fast SAR: SAR(1 g) = 12.43 W/kg; SAR(10 g) = 5.93 W/kg

Maximum value of SAR (interpolated) = 25.34 W/kg

System Validation /Zoom Scan (7x7x7)/Cube 0: Measurement grid: dx=5mm, dy=5mm, dz=5mm

Reference Value =105.99 V/m; Power Drift = 0.04 dB

Peak SAR (extrapolated) = 25.01 W/kg

SAR(1 g) = 12.49 W/kg; SAR(10 g) = 6.03 W/kg

Maximum value of SAR (measured) = 19.75 W/kg

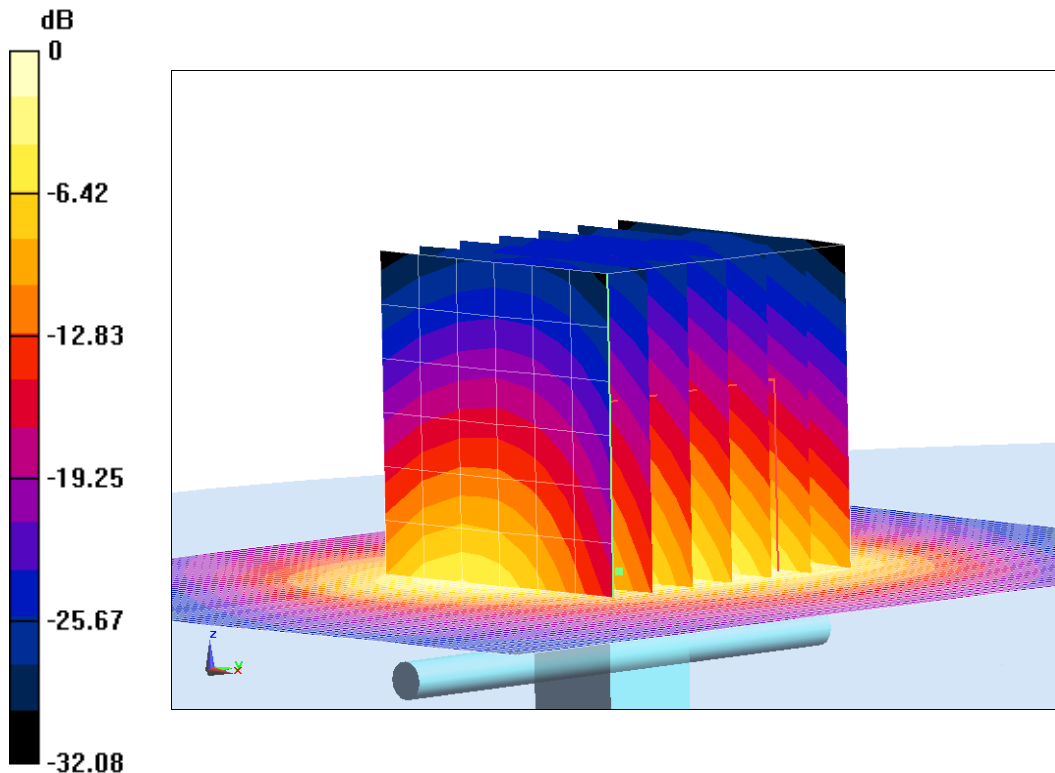

0 dB = 19.75 W/kg = 12.96 dB W/kg

Fig.B.14 validation 2450 MHz 250mW

2600 MHz

Date: 8/3/2018

Electronics: DAE4 Sn1525

Medium: Head 2600 MHz

Medium parameters used: $f = 2600$ MHz; $\sigma = 1.946$ mho/m; $\epsilon_r = 38.57$; $\rho = 1000$ kg/m³

Ambient Temperature: 22.4°C Liquid Temperature: 22.2°C

Communication System: CW Frequency: 2600 MHz Duty Cycle: 1:1

Probe: EX3DV4 – SN7464 ConvF(7.76,7.76,7.76)

System Validation /Area Scan (81x191x1): Interpolated grid: dx=1.000 mm, dy=1.000 mm

Reference Value = 112.4 V/m; Power Drift = 0.02

Fast SAR: SAR(1 g) = 14.52 W/kg; SAR(10 g) = 6.45 W/kg

Maximum value of SAR (interpolated) = 25.04 W/kg

System Validation /Zoom Scan (7x7x7)/Cube 0: Measurement grid: dx=5mm, dy=5mm, dz=5mm

Reference Value =112.4 V/m; Power Drift = 0.02 dB

Peak SAR (extrapolated) = 32.16 W/kg

SAR(1 g) = 14.69 W/kg; SAR(10 g) = 6.39 W/kg

Maximum value of SAR (measured) = 24.85 W/kg

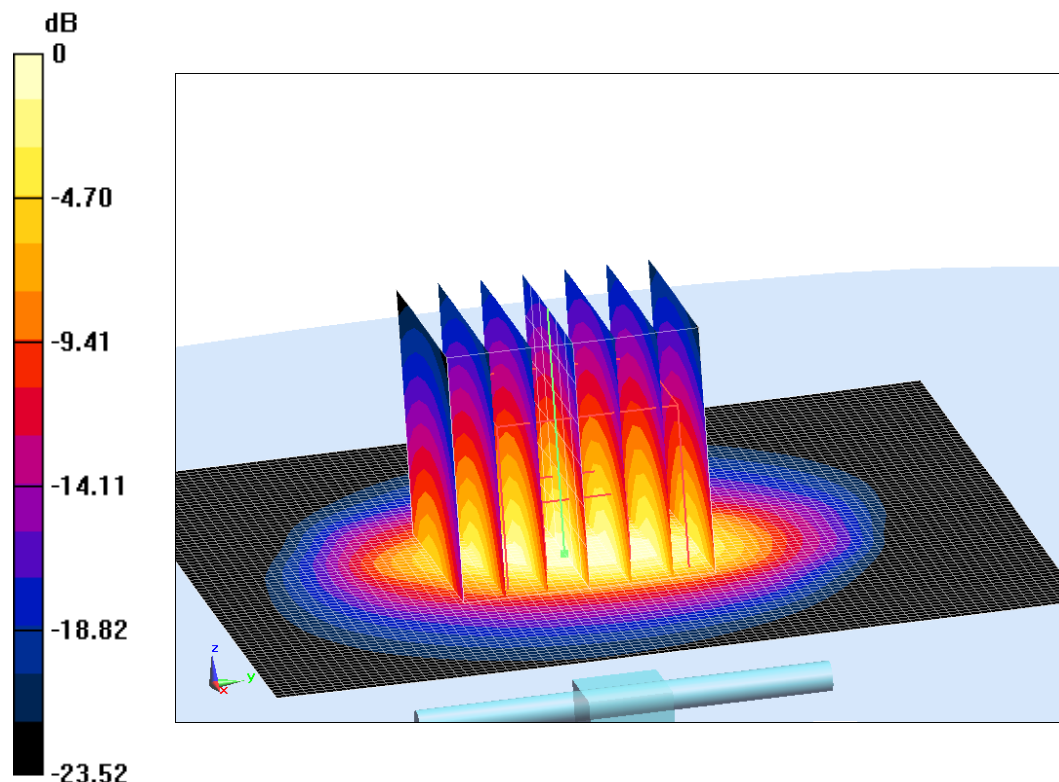

0 dB = 24.85 W/kg = 13.95 dB W/kg

Fig.B.15 validation 2600 MHz 250mW

2600 MHz

Date: 8/3/2018

Electronics: DAE4 Sn1525

Medium: Body 2600 MHz

Medium parameters used: $f = 2600$ MHz; $\sigma = 2.183$ mho/m; $\epsilon_r = 52.39$; $\rho = 1000$ kg/m³

Ambient Temperature: 22.4°C Liquid Temperature: 22.2°C

Communication System: CW Frequency: 2600 MHz Duty Cycle: 1:1

Probe: EX3DV4 – SN7464 ConvF(7.84,7.84,7.84)

System Validation /Area Scan (81x191x1): Interpolated grid: dx=1.000 mm, dy=1.000 mm

Reference Value = 108.21 V/m; Power Drift = -0.03

Fast SAR: SAR(1 g) = 14.11 W/kg; SAR(10 g) = 6.16 W/kg

Maximum value of SAR (interpolated) = 30.33 W/kg

System Validation /Zoom Scan (7x7x7)/Cube 0: Measurement grid: dx=5mm, dy=5mm, dz=5mm

Reference Value =108.21 V/m; Power Drift = -0.03 dB

Peak SAR (extrapolated) = 30.53 W/kg

SAR(1 g) = 13.74 W/kg; SAR(10 g) = 6.12 W/kg

Maximum value of SAR (measured) = 22.93 W/kg

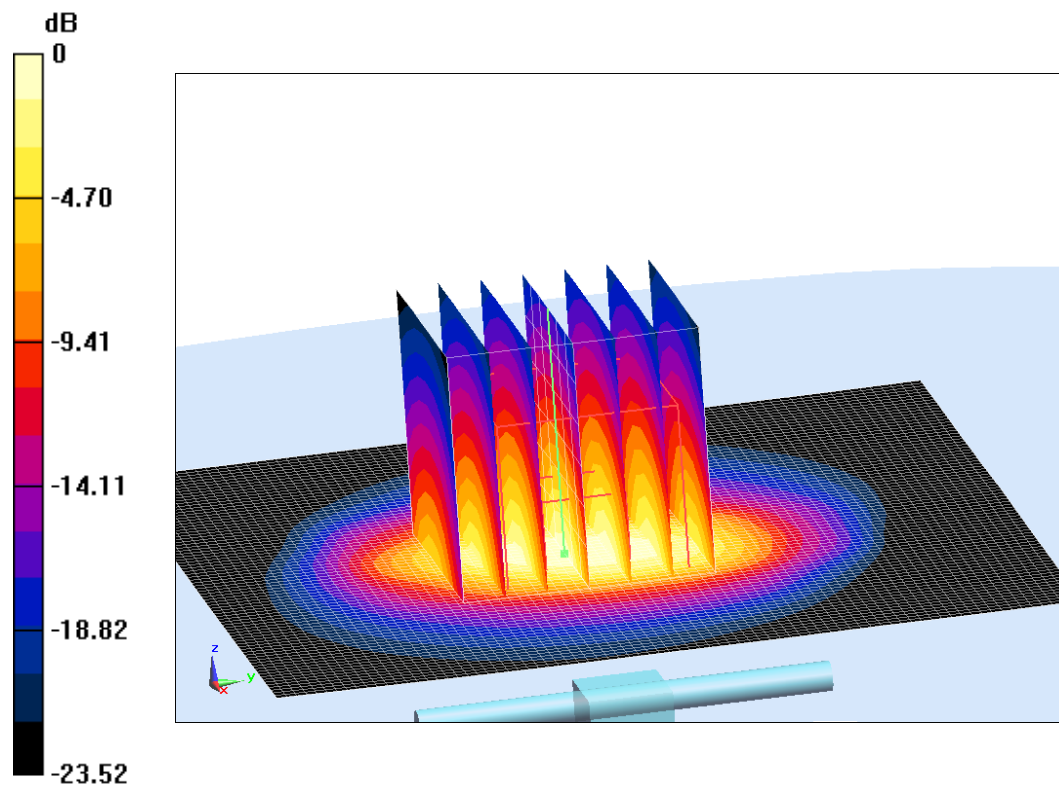

0 dB = 22.93 W/kg = 13.6 dB W/kg

Fig.B.16 validation 2600 MHz 250mW

The SAR system verification must be required that the area scan estimated 1-g SAR is within 3% of the zoom scan 1-g SAR.

Table B.1 Comparison between area scan and zoom scan for system verification

Date	Band	Position	Area scan (1g)	Zoom scan (1g)	Drift (%)
2018-6-17	835	Head	2.3	2.31	-0.43
	835	Body	2.34	2.35	-0.43
2018-6-18	1900	Head	9.83	9.8	0.31
	1900	Body	9.97	10.14	-1.68
2018-6-19	2450	Head	13.05	13.1	-0.38
	2450	Body	12.45	12.43	0.16
2018-6-19	2600	Head	14.33	14.3	0.21
	2600	Body	13.79	14.08	-2.06
2018/8/1	835	Head	2.3	2.34	-1.71
	835	Body	2.35	2.4	-2.08
2018/8/2	1900	Head	10	10.11	-1.09
	1900	Body	9.99	9.94	0.50
2018/8/3	2450	Head	12.88	12.84	0.31
	2450	Body	12.43	12.49	-0.48
2018/8/3	2600	Head	14.52	14.69	-1.16
	2600	Body	14.11	13.74	2.69

ANNEX C SAR Measurement Setup

C.1 Measurement Set-up

The Dasy4 or DASY5 system for performing compliance tests is illustrated above graphically. This system consists of the following items:

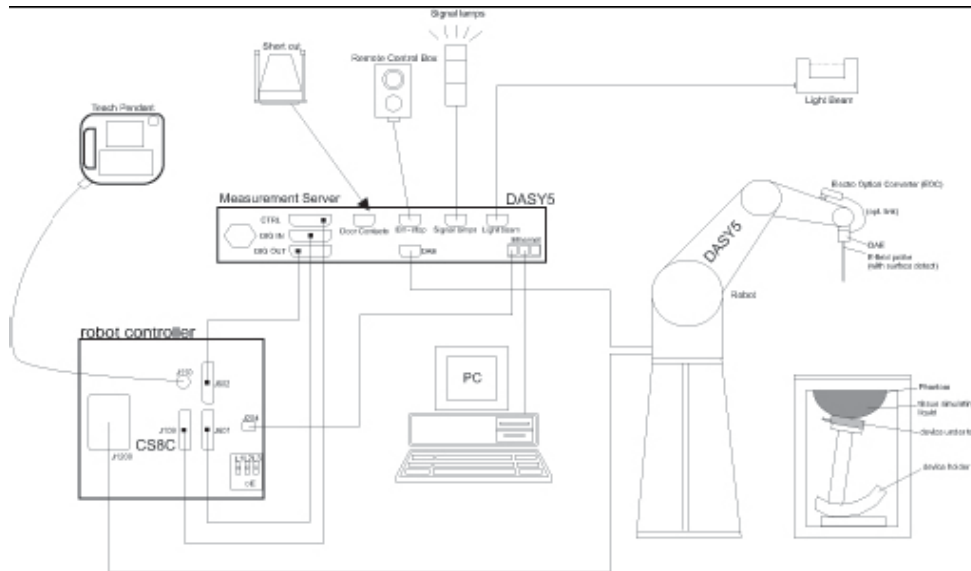

Picture C.1 SAR Lab Test Measurement Set-up

- A standard high precision 6-axis robot (Stäubli TX=RX family) with controller, teach pendant and software. An arm extension for accommodating the data acquisition electronics (DAE).
- An isotropic field probe optimized and calibrated for the targeted measurement.
- A data acquisition electronics (DAE) which performs the signal amplification, signal multiplexing, AD-conversion, offset measurements, mechanical surface detection, collision detection, etc. The unit is battery powered with standard or rechargeable batteries. The signal is optically transmitted to the EOC.
- The Electro-optical converter (EOC) performs the conversion from optical to electrical signals for the digital communication to the DAE. To use optical surface detection, a special version of the EOC is required. The EOC signal is transmitted to the measurement server.
- The function of the measurement server is to perform the time critical tasks such as signal filtering, control of the robot operation and fast movement interrupts.
- The Light Beam used is for probe alignment. This improves the (absolute) accuracy of the probe positioning.
- A computer running WinXP and the DASY4 or DASY5 software.
- Remote control and teach pendant as well as additional circuitry for robot safety such as
- warning lamps, etc.
- The phantom, the device holder and other accessories according to the targeted measurement.

C.2 Dasy4 or DASY5 E-field Probe System

The SAR measurements were conducted with the dosimetric probe designed in the classical triangular configuration and optimized for dosimetric evaluation. The probe is constructed using the thick film technique; with printed resistive lines on ceramic substrates. The probe is equipped with an optical multifiber line ending at the front of the probe tip. It is connected to the EOC box on the robot arm and provides an automatic detection of the phantom surface. Half of the fibers are connected to a pulsed infrared transmitter, the other half to a synchronized receiver. As the probe approaches the surface, the reflection from the surface produces a coupling from the transmitting to the receiving fibers. This reflection increases first during the approach, reaches maximum and then decreases. If the probe is flatly touching the surface, the coupling is zero. The distance of the coupling maximum to the surface is independent of the surface reflectivity and largely independent of the surface to probe angle. The DASY4 or DASY5 software reads the reflection during a software approach and looks for the maximum using 2nd order curve fitting. The approach is stopped at reaching the maximum.

Probe Specifications:

Model:	ES3DV3, EX3DV4
Frequency	10MHz — 6.0GHz(EX3DV4)
Range:	10MHz — 4GHz(ES3DV3)
Calibration:	In head and body simulating tissue at Frequencies from 835 up to 5800MHz
Linearity:	± 0.2 dB(30 MHz to 6 GHz) for EX3DV4 ± 0.2 dB(30 MHz to 4 GHz) for ES3DV3
Dynamic Range:	10 mW/kg — 100W/kg
Probe Length:	330 mm
Probe Tip	
Length:	20 mm
Body Diameter:	12 mm
Tip Diameter:	2.5 mm (3.9 mm for ES3DV3)
Tip-Center:	1 mm (2.0mm for ES3DV3)
Application:	SAR Dosimetry Testing Compliance tests of mobile phones Dosimetry in strong gradient fields



Picture C.2 Near-field Probe



Picture C.3 E-field Probe

C.3 E-field Probe Calibration

Each E-Probe/Probe Amplifier combination has unique calibration parameters. A TEM cell calibration procedure is conducted to determine the proper amplifier settings to enter in the probe parameters. The amplifier settings are determined for a given frequency by subjecting the probe to a known E-field density (1 mW/cm²) using an RF Signal generator, TEM cell, and RF Power Meter.

The free space E-field from amplified probe outputs is determined in a test chamber. This calibration can be performed in a TEM cell if the frequency is below 1 GHz and in a waveguide or other methodologies above 1 GHz for free space. For the free space calibration, the probe is placed

in the volumetric center of the cavity and at the proper orientation with the field. The probe is then rotated 360 degrees until the three channels show the maximum reading. The power density readings equates to 1 mW/ cm².

E-field temperature correlation calibration is performed in a flat phantom filled with the appropriate simulated brain tissue. The E-field in the medium correlates with the temperature rise in the dielectric medium. For temperature correlation calibration a RF transparent thermistor-based temperature probe is used in conjunction with the E-field probe.

$$SAR = C \frac{\Delta T}{\Delta t}$$

Where:

Δt = Exposure time (30 seconds),

C = Heat capacity of tissue (brain or muscle),

ΔT = Temperature increase due to RF exposure.

$$SAR = \frac{|E|^2 \cdot \sigma}{\rho}$$

Where:

σ = Simulated tissue conductivity,

ρ = Tissue density (kg/m³).

C.4 Other Test Equipment

C.4.1 Data Acquisition Electronics(DAE)

The data acquisition electronics consist of a highly sensitive electrometer-grade preamplifier with auto-zeroing, a channel and gain-switching multiplexer, a fast 16 bit AD-converter and a command decoder with a control logic unit. Transmission to the measurement server is accomplished through an optical downlink for data and status information, as well as an optical uplink for commands and the clock.

The mechanical probe mounting device includes two different sensor systems for frontal and sideways probe contacts. They are used for mechanical surface detection and probe collision detection.

The input impedance of the DAE is 200 MOhm; the inputs are symmetrical and floating. Common mode rejection is above 80 dB.



Picture C.4: DAE

C.4.2 Robot

The SPEAG DASY system uses the high precision robots (DASY4: RX90XL; DASY5: RX160L) type from Stäubli SA (France). For the 6-axis controller system, the robot controller version from Stäubli is used. The Stäubli robot series have many features that are important for our application:

- High precision (repeatability 0.02mm)
- High reliability (industrial design)
- Low maintenance costs (virtually maintenance free due to direct drive gears; no belt drives)
- Jerk-free straight movements (brushless synchron motors; no stepper motors)
- Low ELF interference (motor control fields shielded via the closed metallic construction shields)



Picture C.5 DASY 4



Picture C.6 DASY 5

C.4.3 Measurement Server

The Measurement server is based on a PC/104 CPU board with CPU (dasy4: 166 MHz, Intel Pentium; DASY5: 400 MHz, Intel Celeron), chipdisk (DASY4: 32 MB; DASY5: 128MB), RAM (DASY4: 64 MB, DASY5: 128MB). The necessary circuits for communication with the DAE electronic box, as well as the 16 bit AD converter system for optical detection and digital I/O interface are contained on the DASY I/O board, which is directly connected to the PC/104 bus of the CPU board.

The measurement server performs all real-time data evaluation of field measurements and surface detection, controls robot movements and handles safety operation. The PC operating system cannot interfere with these time critical processes. All connections are supervised by a watchdog, and disconnection of any of the cables to the measurement server will automatically disarm the robot and disable all program-controlled robot movements. Furthermore, the measurement server is equipped with an expansion port which is reserved for future applications. Please note that this expansion port does not have a standardized pinout, and therefore only devices provided by SPEAG can be connected. Devices from any other supplier could seriously damage the measurement server.



Picture C.7 Server for DASY 4



Picture C.8 Server for DASY 5

C.4.4 Device Holder for Phantom

The SAR in the phantom is approximately inversely proportional to the square of the distance between the source and the liquid surface. For a source at 5mm distance, a positioning uncertainty of ± 0.5 mm would produce a SAR uncertainty of $\pm 20\%$. Accurate device positioning is therefore crucial for accurate and repeatable measurements. The positions in which the devices must be measured are defined by the standards.

The DASY device holder is designed to cope with the different positions given in the standard. It has two scales for device rotation (with respect to the body axis) and device inclination (with respect to the line between the ear reference points). The rotation centers for both scales is the ear reference point (ERP). Thus the device needs no repositioning when changing the angles.

The DASY device holder is constructed of low-loss

POM material having the following dielectric

parameters: relative permittivity $\epsilon = 3$ and loss

tangent $\delta = 0.02$. The amount of dielectric material has been reduced in the closest vicinity of the device, since measurements have suggested that the influence of the clamp on the test results could thus be lowered.

<Laptop Extension Kit>

The extension is lightweight and made of POM, acrylic glass and foam. It fits easily on the upper part of the Mounting Device in place of the phone positioner. The extension is fully compatible with the Twin-SAM and ELI phantoms.



Picture C.9-1: Device Holder



Picture C.9-2: Laptop Extension Kit

C.4.5 Phantom

The SAM Twin Phantom V4.0 is constructed of a fiberglass shell integrated in a table. The shape of the shell is based on data from an anatomical study designed to

Represent the 90th percentile of the population. The phantom enables the dissymmetric evaluation of SAR for both left and right handed handset usage, as well as body-worn usage using the flat phantom region. Reference markings on the Phantom allow the complete setup of all predefined phantom positions and measurement grids by manually teaching three points in the robot. The shell phantom has a 2mm shell thickness (except the ear region where shell thickness increases to 6 mm).

Shell Thickness: 2 ± 0.2 mm

Filling Volume: Approx. 25 liters

Dimensions: 810 x 1000 x 500 mm (H x L x W)

Available: Special



Picture C.10: SAM Twin Phantom

ANNEX D Position of the wireless device in relation to the phantom

D.1 General considerations

This standard specifies two handset test positions against the head phantom – the “cheek” position and the “tilt” position.

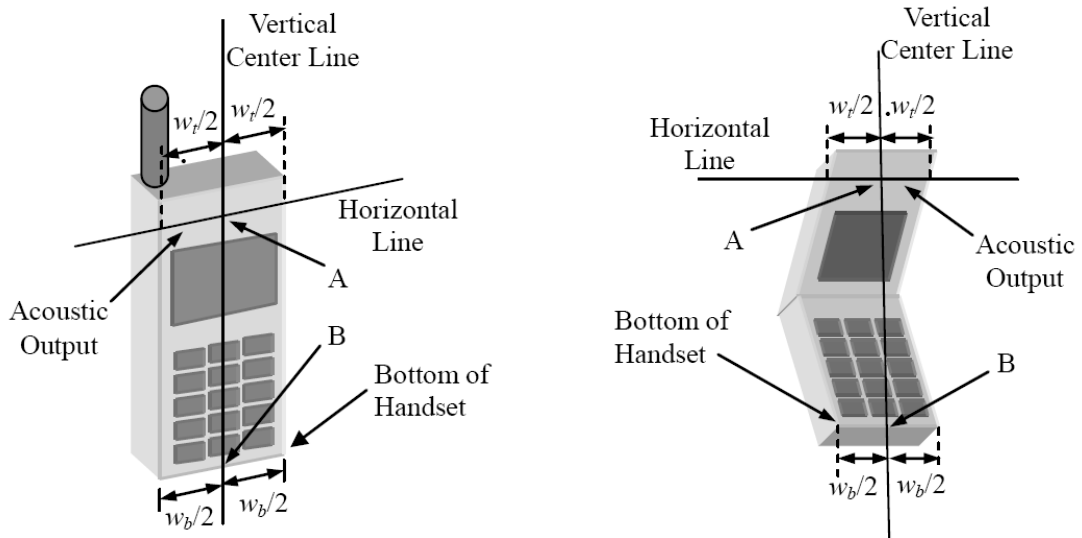

- w_t Width of the handset at the level of the acoustic
- w_b Width of the bottom of the handset
- A Midpoint of the width w_t of the handset at the level of the acoustic output
- B Midpoint of the width w_b of the bottom of the handset

Picture D.1-a Typical “fixed” case handset Picture D.1-b Typical “clam-shell” case handset

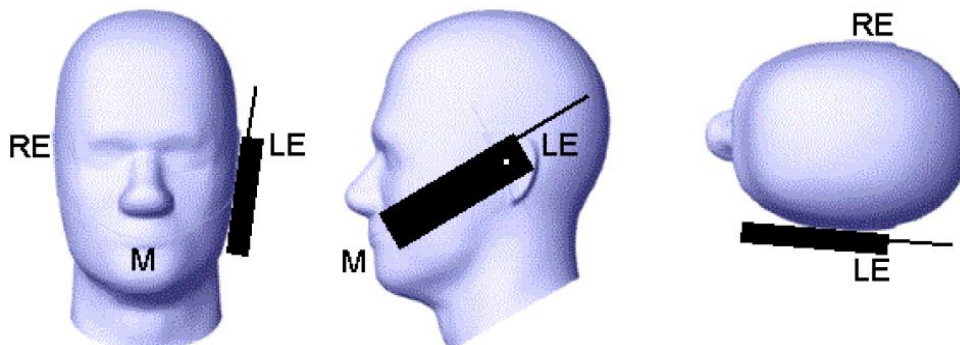

Picture D.2 Cheek position of the wireless device on the left side of SAM

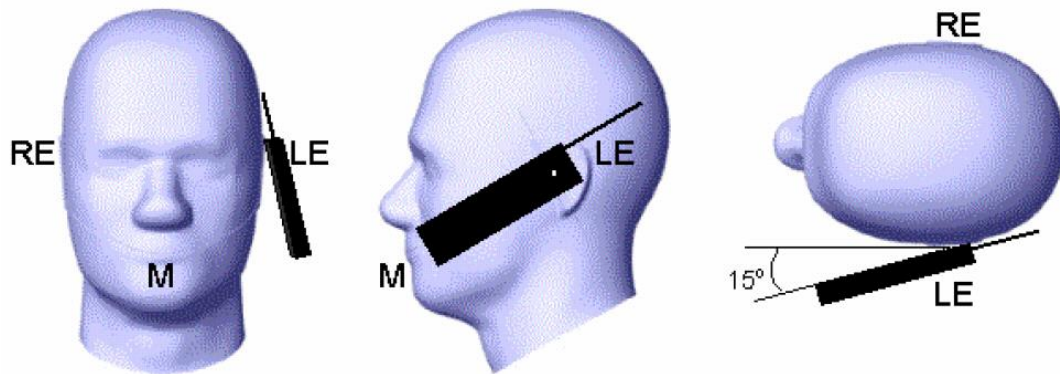

Picture D.3 Tilt position of the wireless device on the left side of SAM

D.2 Body-worn device

A typical example of a body-worn device is a mobile phone, wireless enabled PDA or other battery operated wireless device with the ability to transmit while mounted on a person's body using a carry accessory approved by the wireless device manufacturer.

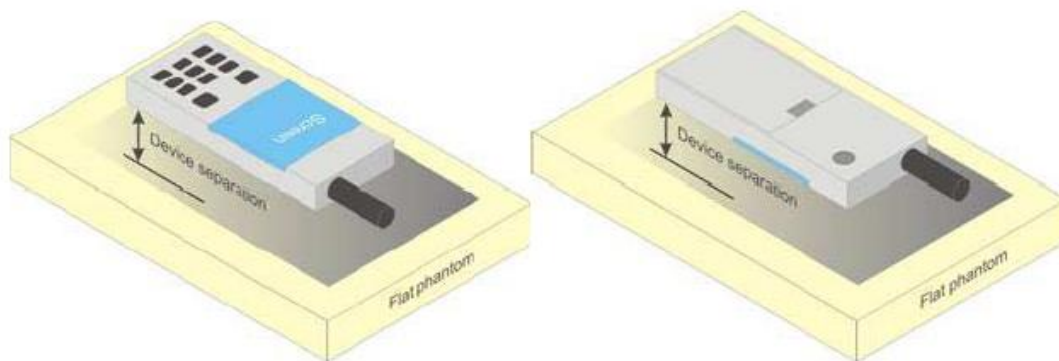

Picture D.4 Test positions for body-worn devices

D.3 Desktop device

A typical example of a desktop device is a wireless enabled desktop computer placed on a table or desk when used.

The DUT shall be positioned at the distance and in the orientation to the phantom that corresponds to the intended use as specified by the manufacturer in the user instructions. For devices that employ an external antenna with variable positions, tests shall be performed for all antenna positions specified. Picture 8.5 show positions for desktop device SAR tests. If the intended use is not specified, the device shall be tested directly against the flat phantom.

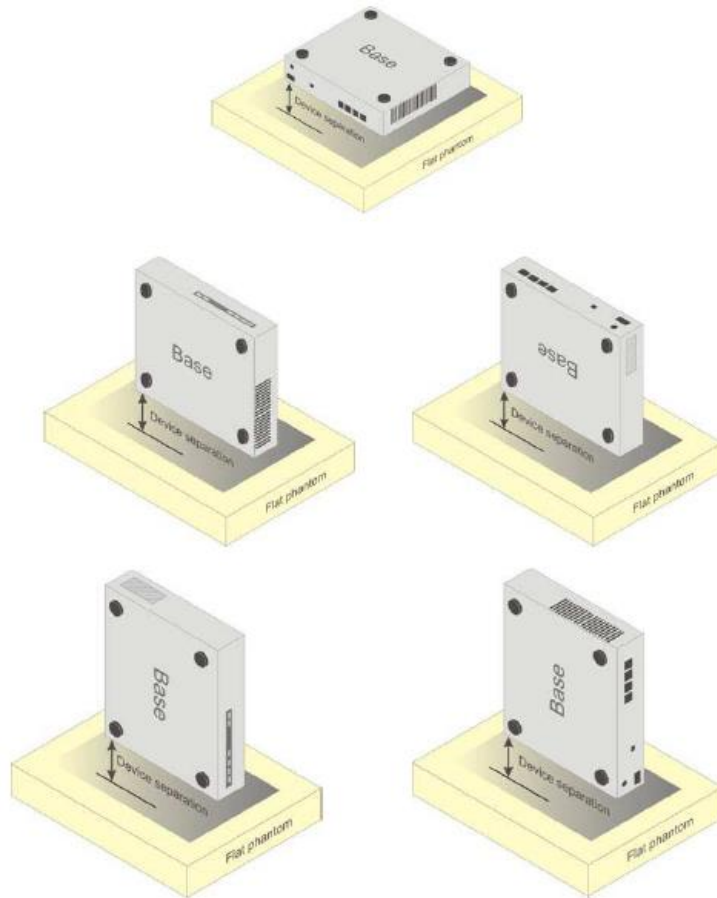

Picture D.5 Test positions for desktop devices

D.4 DUT Setup Photos



Picture D.6

ANNEX E Equivalent Media Recipes

The liquid used for the frequency range of 800-3000 MHz consisted of water, sugar, salt, preventol, glycol monobutyl and Cellulose. The liquid has been previously proven to be suited for worst-case. The Table E.1 shows the detail solution. It's satisfying the latest tissue dielectric parameters requirements proposed by the IEEE 1528 and IEC 62209.

Table E.1: Composition of the Tissue Equivalent Matter

Frequency (MHz)	835 Head	835 Body	1900 Head	1900 Body	2450 Head	2450 Body	5800 Head	5800 Body
Ingredients (% by weight)								
Water	41.45	52.5	55.242	69.91	58.79	72.60	65.53	65.53
Sugar	56.0	45.0	\	\	\	\	\	\
Salt	1.45	1.4	0.306	0.13	0.06	0.18	\	\
Preventol	0.1	0.1	\	\	\	\	\	\
Cellulose	1.0	1.0	\	\	\	\	\	\
Glycol Monobutyl	\	\	44.452	29.96	41.15	27.22	\	\
Diethylenglycol monohexylether	\	\	\	\	\	\	17.24	17.24
Triton X-100	\	\	\	\	\	\	17.24	17.24
Dielectric Parameters Target Value	$\epsilon=41.5$ $\sigma=0.90$	$\epsilon=55.2$ $\sigma=0.97$	$\epsilon=40.0$ $\sigma=1.40$	$\epsilon=53.3$ $\sigma=1.52$	$\epsilon=39.2$ $\sigma=1.80$	$\epsilon=52.7$ $\sigma=1.95$	$\epsilon=35.3$ $\sigma=5.27$	$\epsilon=48.2$ $\sigma=6.00$

Note: There are a little adjustment respectively for 750, 1750, 2600, 5200, 5300 and 5600 based on the recipe of closest frequency in table E.1.

ANNEX F System Validation

The SAR system must be validated against its performance specifications before it is deployed. When SAR probes, system components or software are changed, upgraded or recalibrated, these must be validated with the SAR system(s) that operates with such components.

Table F.1: System Validation for 7464

Probe SN.	Liquid name	Validation date	Frequency point	Status (OK or Not)
7464	Head 750MHz	Sep.26,2017	750 MHz	OK
7464	Head 850MHz	Sep.26,2017	850 MHz	OK
7464	Head 900MHz	Sep.26,2017	900 MHz	OK
7464	Head 1750MHz	Sep.26,2017	1750 MHz	OK
7464	Head 1810MHz	Sep.26,2017	1810 MHz	OK
7464	Head 1900MHz	Sep.27,2017	1900 MHz	OK
7464	Head 1950MHz	Sep.27,2017	1950 MHz	OK
7464	Head 2000MHz	Sep.27,2017	2000 MHz	OK
7464	Head 2100MHz	Sep.27,2017	2100 MHz	OK
7464	Head 2300MHz	Sep.27,2017	2300 MHz	OK
7464	Head 2450MHz	Sep.27,2017	2450 MHz	OK
7464	Head 2550MHz	Sep.28,2017	2550 MHz	OK
7464	Head 2600MHz	Sep.28,2017	2600 MHz	OK
7464	Head 3500MHz	Sep.28,2017	3500 MHz	OK
7464	Head 3700MHz	Sep.28,2017	3700 MHz	OK
7464	Head 5200MHz	Sep.28,2017	5200 MHz	OK
7464	Head 5500MHz	Sep.28,2017	5500 MHz	OK
7464	Head 5800MHz	Sep.28,2017	5800 MHz	OK
7464	Body 750MHz	Sep.28,2017	750 MHz	OK
7464	Body 850MHz	Sep.25,2017	850 MHz	OK
7464	Body 900MHz	Sep.25,2017	900 MHz	OK
7464	Body 1750MHz	Sep.25,2017	1750 MHz	OK
7464	Body 1810MHz	Sep.25,2017	1810 MHz	OK
7464	Body 1900MHz	Sep.25,2017	1900 MHz	OK
7464	Body 1950MHz	Sep.25,2017	1950 MHz	OK
7464	Body 2000MHz	Sep.29,2017	2000 MHz	OK
7464	Body 2100MHz	Sep.29,2017	2100 MHz	OK
7464	Body 2300MHz	Sep.29,2017	2300 MHz	OK
7464	Body 2450MHz	Sep.29,2017	2450 MHz	OK
7464	Body 2550MHz	Sep.29,2017	2550 MHz	OK
7464	Body 2600MHz	Sep.29,2017	2600 MHz	OK
7464	Body 3500MHz	Sep.24,2017	3500 MHz	OK
7464	Body 3700MHz	Sep.24,2017	3700 MHz	OK
7464	Body 5200MHz	Sep.24,2017	5200 MHz	OK
7464	Body 5500MHz	Sep.24,2017	5500 MHz	OK
7464	Body 5800MHz	Sep.24,2017	5800 MHz	OK

ANNEX G Probe Calibration Certificate

Probe 7464 Calibration Certificate

Calibration Laboratory of
Schmid & Partner
Engineering AG
Zeughausstrasse 43, 8004 Zurich, Switzerland



S Schweizerischer Kalibrierdienst
C Service suisse d'étalonnage
S Servizio svizzero di taratura
S Swiss Calibration Service

Accredited by the Swiss Accreditation Service (SAS)
The Swiss Accreditation Service is one of the signatories to the EA
Multilateral Agreement for the recognition of calibration certificates

Accreditation No.: SCS 0108

Client **CTTL-BJ (Auden)**

Certificate No: **EX3-7464_Sep17**

CALIBRATION CERTIFICATE

Object **EX3DV4 - SN:7464**

Calibration procedure(s) **QA CAL-01.v9, QA CAL-12.v9, QA CAL-14.v4, QA CAL-23.v5,
QA CAL-25.v6
Calibration procedure for dosimetric E-field probes**



Calibration date: **September 12, 2017**

This calibration certificate documents the traceability to national standards, which realize the physical units of measurements (SI).
The measurements and the uncertainties with confidence probability are given on the following pages and are part of the certificate.

All calibrations have been conducted in the closed laboratory facility: environment temperature (22 ± 3)°C and humidity < 70%.

Calibration Equipment used (M&TE critical for calibration)

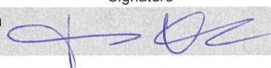
Primary Standards	ID	Cal Date (Certificate No.)	Scheduled Calibration
Power meter NRP	SN: 104778	04-Apr-17 (No. 217-02521/02522)	Apr-18
Power sensor NRP-Z91	SN: 103244	04-Apr-17 (No. 217-02521)	Apr-18
Power sensor NRP-Z91	SN: 103245	04-Apr-17 (No. 217-02525)	Apr-18
Reference 20 dB Attenuator	SN: S5277 (20x)	07-Apr-17 (No. 217-02528)	Apr-18
Reference Probe ES3DV2	SN: 3013	31-Dec-16 (No. ES3-3013_Dec16)	Dec-17
DAE4	SN: 660	7-Dec-16 (No. DAE4-660_Dec16)	Dec-17
Secondary Standards	ID	Check Date (in house)	Scheduled Check
Power meter E4419B	SN: GB41293874	06-Apr-16 (in house check Jun-16)	In house check: Jun-18
Power sensor E4412A	SN: MY41498087	06-Apr-16 (in house check Jun-16)	In house check: Jun-18
Power sensor E4412A	SN: 000110210	06-Apr-16 (in house check Jun-16)	In house check: Jun-18
RF generator HP 8648C	SN: US3642U01700	04-Aug-99 (in house check Jun-16)	In house check: Jun-18
Network Analyzer HP 8753E	SN: US37390585	18-Oct-01 (in house check Oct-16)	In house check: Oct-17

	Name	Function	Signature
Calibrated by:	Jeton Kastrati	Laboratory Technician	
Approved by:	Katja Pokovic	Technical Manager	

Issued: September 12, 2017

This calibration certificate shall not be reproduced except in full without written approval of the laboratory.