



SAR TEST REPORT

No. I18Z60981-SEM01

For

TCL Communication Ltd.

LTE / UMTS / GSM mobile phone

Model Name: 5033X

With

Hardware Version: 05

Software Version: v7LT8

FCC ID: 2ACCJH095

Issued Date: 2018-7-11



Note:

The test results in this test report relate only to the devices specified in this report. This report shall not be reproduced except in full without the written approval of CTTL.

The report must not be used by the client to claim product certification, approval, or endorsement by NVLAP, NIST, or any agency of the U.S. Government.

Test Laboratory:

CTTL, Telecommunication Technology Labs, CAICT

No. 51, Huayuan North Road, Haidian District, Beijing, P. R. China 100191.

Tel:+86(0)10-62304633-2512, Fax:+86(0)10-62304633-2504

Email: ctl_terminals@caict.ac.cn, website: www.caict.ac.cn



REPORT HISTORY

Report Number	Revision	Issue Date	Description
I18Z60981-SEM01	Rev.0	2018-7-11	Initial creation of test report



TABLE OF CONTENT

1	TEST LABORATORY	5
1.1	TESTING LOCATION	5
1.2	TESTING ENVIRONMENT	5
1.3	PROJECT DATA	5
1.4	SIGNATURE	5
2	STATEMENT OF COMPLIANCE	6
3	CLIENT INFORMATION	8
3.1	APPLICANT INFORMATION	8
3.2	MANUFACTURER INFORMATION	8
4	EQUIPMENT UNDER TEST (EUT) AND ANCILLARY EQUIPMENT (AE)	9
4.1	ABOUT EUT	9
4.2	INTERNAL IDENTIFICATION OF EUT USED DURING THE TEST	9
4.3	INTERNAL IDENTIFICATION OF AE USED DURING THE TEST	9
5	TEST METHODOLOGY	10
5.1	APPLICABLE LIMIT REGULATIONS	10
5.2	APPLICABLE MEASUREMENT STANDARDS	10
6	SPECIFIC ABSORPTION RATE (SAR)	11
6.1	INTRODUCTION	11
6.2	SAR DEFINITION	11
7	TISSUE SIMULATING LIQUIDS	12
7.1	TARGETS FOR TISSUE SIMULATING LIQUID	12
7.2	DIELECTRIC PERFORMANCE	12
8	SYSTEM VERIFICATION	17
8.1	SYSTEM SETUP	17
8.2	SYSTEM VERIFICATION	18
9	MEASUREMENT PROCEDURES	19
9.1	TESTS TO BE PERFORMED	19
9.2	GENERAL MEASUREMENT PROCEDURE	21
9.3	WCDMA MEASUREMENT PROCEDURES FOR SAR	22
9.4	SAR MEASUREMENT FOR LTE	23
9.5	BLUETOOTH & WI-FI MEASUREMENT PROCEDURES FOR SAR	23
9.6	POWER DRIFT	24
10	AREA SCAN BASED 1-G SAR	24
10.1	REQUIREMENT OF KDB	24
10.2	FAST SAR ALGORITHMS	24
11	CONDUCTED OUTPUT POWER	25



11.1	GSM MEASUREMENT RESULT	25
11.2	WCDMA MEASUREMENT RESULT.....	26
11.3	LTE MEASUREMENT RESULT	27
11.4	WI-FI AND BT MEASUREMENT RESULT	29
12	SIMULTANEOUS TX SAR CONSIDERATIONS	32
12.1	INTRODUCTION.....	32
12.2	TRANSMIT ANTENNA SEPARATION DISTANCES	32
12.3	SAR MEASUREMENT POSITIONS	33
12.4	STANDALONE SAR TEST EXCLUSION CONSIDERATIONS.....	33
13	EVALUATION OF SIMULTANEOUS.....	34
14	SAR TEST RESULT	35
14.1	SAR RESULTS	35
14.2	FULL SAR	42
14.3	WLAN EVALUATION	43
15	SAR MEASUREMENT VARIABILITY	46
16	MEASUREMENT UNCERTAINTY	47
16.1	MEASUREMENT UNCERTAINTY FOR NORMAL SAR TESTS (300MHZ~3GHZ)	47
16.2	MEASUREMENT UNCERTAINTY FOR NORMAL SAR TESTS (3~6GHZ).....	48
16.3	MEASUREMENT UNCERTAINTY FOR FAST SAR TESTS (300MHZ~3GHZ).....	49
16.4	MEASUREMENT UNCERTAINTY FOR FAST SAR TESTS (3~6GHZ).....	50
17	MAIN TEST INSTRUMENTS.....	52
ANNEX A	GRAPH RESULTS.....	53
ANNEX B	SYSTEM VERIFICATION RESULTS.....	69
ANNEX C	SAR MEASUREMENT SETUP	78
ANNEX D	POSITION OF THE WIRELESS DEVICE IN RELATION TO THE PHANTOM	84
ANNEX E	EQUIVALENT MEDIA RECIPES	87
ANNEX F	SYSTEM VALIDATION	88
ANNEX G	PROBE CALIBRATION CERTIFICATE	89
ANNEX H	DIPOLE CALIBRATION CERTIFICATE.....	100
ANNEX I	ACCREDITATION CERTIFICATE.....	132

1 Test Laboratory

1.1 Testing Location

Company Name:	CTTL(Shouxiang)
Address:	No. 51 Shouxiang Science Building, Xueyuan Road, Haidian District, Beijing, P. R. China100191

1.2 Testing Environment

Temperature:	18°C~25 °C,
Relative humidity:	30%~ 70%
Ground system resistance:	< 0.5 Ω
Ambient noise & Reflection:	< 0.012 W/kg

1.3 Project Data

Project Leader:	Qi Dianyuan
Test Engineer:	Lin Xiaojun
Testing Start Date:	June 17, 2018
Testing End Date:	June 19, 2018

1.4 Signature



Lin Xiaojun
(Prepared this test report)

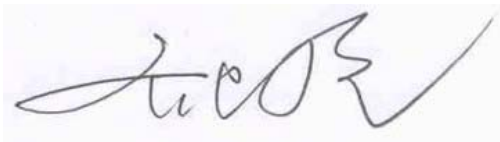

Qi Dianyuan
(Reviewed this test report)

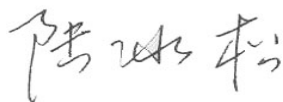

Lu Bingsong
Deputy Director of the laboratory
(Approved this test report)

2 Statement of Compliance

The maximum results of SAR found during testing for TCL Communication Ltd. LTE / UMTS / GSM mobile phone 5033X is as follows:

Table 2.1: Highest Reported SAR (1g)

Exposure Configuration	Technology Band	Highest Reported SAR 1g (W/Kg)	Equipment Class
Head (Separation Distance 0mm)	GSM 850	0.31	PCE
	PCS 1900	0.47	
	UMTS FDD 2	0.78	
	UMTS FDD 5	0.33	
	LTE Band 7	0.32	
	WLAN 2.4 GHz	1.21	DTS
Hotspot (Separation Distance 10mm)	GSM 850	0.26	PCE
	PCS 1900	1.17	
	UMTS FDD 2	1.30	
	UMTS FDD 5	0.42	
	LTE Band 7	0.88	
	WLAN 2.4 GHz	0.32	DTS

The SAR values found for the Mobile Phone are below the maximum recommended levels of 1.6 W/Kg as averaged over any 1g tissue according to the ANSI C95.1-1992.

For body worn operation, this device has been tested and meets FCC RF exposure guidelines when used with any accessory that contains no metal and which provides a minimum separation distance of 10 mm between this device and the body of the user. Use of other accessories may not ensure compliance with FCC RF exposure guidelines.

The EUT battery must be fully charged and checked periodically during the test to ascertain uniform power output.

The measurement together with the test system set-up is described in annex C of this test report. A detailed description of the equipment under test can be found in chapter 4 of this test report.

The highest reported SAR value is obtained at the case of **(Table 2.1)**, and the values are: **1.30 W/kg (1g)**.

Table 2.2: The sum of reported SAR values for main antenna and WiFi

	Position	Main antenna	WiFi	Sum
Highest reported SAR value for Head	Right hand, Touch cheek (LTE Band7)	0.32	1.21	1.53
Highest reported SAR value for Body	Rear (WCDMA 1900)	1.30	0.22	1.52

Table 2.3: The sum of reported SAR values for main antenna and BT

	Position	Main antenna	BT	Sum
Maximum reported SAR value for Head	Left hand, Touch cheek (WCDMA 1900)	0.78	0.21	0.99
Maximum reported SAR value for Body	Rear (WCDMA 1900)	1.30	0.10	1.40

[1] - Estimated SAR for Bluetooth (see the table 13.3)

According to the above tables, the highest sum of reported SAR values is **1.53 W/kg (1g)**. The detail for simultaneous transmission consideration is described in chapter 13.



3 Client Information

3.1 Applicant Information

Company Name:	TCL Communication Ltd.
Address /Post:	7/F, Block F4, TCL Communication Technology Building, TCL International E City, Zhong Shan Yuan Road, Nanshan District, Shenzhen, Guangdong, P.R. China 518052
City:	Shanghai
Postal Code:	201203
Country:	China
Contact Person:	Zhizhou Gong
E-mail:	zhizhou.gong@tcl.com
Telephone:	0086-755-36611722
Fax:	0086-755-36612000 ext: 81722

3.2 Manufacturer Information

Company Name:	TCL Communication Ltd.
Address /Post:	7/F, Block F4, TCL Communication Technology Building, TCL International E City, Zhong Shan Yuan Road, Nanshan District, Shenzhen, Guangdong, P.R. China 518052
City:	Shanghai
Postal Code:	201203
Country:	China
Contact Person:	Zhizhou Gong
E-mail:	zhizhou.gong@tcl.com
Telephone:	0086-755-36611722
Fax:	0086-755-36612000 ext: 81722

4 Equipment Under Test (EUT) and Ancillary Equipment (AE)

4.1 About EUT

Description:	LTE / UMTS / GSM mobile phone
Model name:	5033X
Operating mode(s):	GSM 850/900/1800/1900 WCDMA850/900/1900/2100 LTE B1/3/7/8/20, BT, WLAN
Tested Tx Frequency:	825 – 848.8 MHz (GSM 850)
	1850.2 – 1910 MHz (GSM 1900)
	826.4–846.6 MHz (WCDMA 850 Band V)
	1852.4–1907.6 MHz (WCDMA1900 Band II)
	2502.5 – 2567.5 MHz (LTE Band 7)
	2412 – 2462 MHz (Wi-Fi 2.4G)
GPRS/EGPRS Multislot Class:	12
GPRS capability Class:	B
Test device Production information:	Production unit
Device type:	Portable device
Antenna type:	Integrated antenna
Accessories/Body-worn configurations:	Headset
Hotspot mode:	Support
Product dimension	Long 137.6mm ;Wide 65.7mm ; Overall Diagonal 152.48mm

4.2 Internal Identification of EUT used during the test

EUT	IMEI	HW	SW
1	356270090200365	05	v7LT8
2	356270090200360	05	v7LT8
3	356270090200378	05	v7LT8

*EUT ID: is used to identify the test sample in the lab internally.

Note: It is performed to test SAR with the EUT1&2and conducted power with the EUT3.

4.3 Internal Identification of AE used during the test

AE ID	Description	Model	SN	Manufacturer
AE1	Battery	CAB1930000C7	/	Veken
AE2	Headset	CCB0046A10C4	/	Dongguan MeiHao Electronic Technology Co., Ltd.
AE3	Headset	CCB0046A10C1	/	HUIZHOU JUWEI ELECTRONICS CO.,LTD
AE4	Headset	CCB0049A10C1	/	HUIZHOU JUWEI ELECTRONICS CO.,LTD
AE5	Headset	CCB0049A10C4	/	Dongguan MeiHao Electronic Technology Co., Ltd.

*AE ID: is used to identify the test sample in the lab internally.



5 TEST METHODOLOGY

5.1 Applicable Limit Regulations

ANSI C95.1–1992: IEEE Standard for Safety Levels with Respect to Human Exposure to Radio Frequency Electromagnetic Fields, 3 kHz to 300 GHz.

It specifies the maximum exposure limit of **1.6 W/kg** as averaged over any 1 gram of tissue for portable devices being used within 20 cm of the user in the uncontrolled environment.

5.2 Applicable Measurement Standards

IEEE 1528–2013: Recommended Practice for Determining the Peak Spatial-Average Specific Absorption Rate (SAR) in the Human Head from Wireless Communications Devices: Measurement Techniques.

KDB447498 D01 General RF Exposure Guidance v06: Mobile and Portable Devices RF Exposure Procedures and Equipment Authorization Policies.

KDB648474 D04 Handset SAR v01r03: SAR Evaluation Considerations for Wireless Handsets.

KDB941225 D01 SAR test for 3G devices v03r01: SAR Measurement Procedures for 3G Devices

KDB941225 D06 Hotspot Mode SAR v02r01 SAR Evaluation Procedures for Portable Devices with Wireless Router Capabilities

KDB941225 D05 SAR for LTE Devices v02r05: SAR Evaluation Considerations for LTE Devices

KDB248227 D01 802.11 Wi-Fi SAR v02r02: SAR GUIDANCE FOR IEEE 802.11 (Wi-Fi) TRANSMITTERS

KDB865664 D01 SAR measurement 100 MHz to 6 GHz v01r04: SAR Measurement Requirements for 100 MHz to 6 GHz.

KDB865664 D02 RF Exposure Reporting v01r02: RF Exposure Compliance Reporting and Documentation Considerations

6 Specific Absorption Rate (SAR)

6.1 Introduction

SAR is related to the rate at which energy is absorbed per unit mass in an object exposed to a radio field. The SAR distribution in a biological body is complicated and is usually carried out by experimental techniques or numerical modeling. The standard recommends limits for two tiers of groups, occupational/controlled and general population/uncontrolled, based on a person's awareness and ability to exercise control over his or her exposure. In general, occupational/controlled exposure limits are higher than the limits for general population/uncontrolled.

6.2 SAR Definition

The SAR definition is the time derivative (rate) of the incremental energy (dW) absorbed by (dissipated in) an incremental mass (dm) contained in a volume element (dv) of a given density (ρ). The equation description is as below:

$$SAR = \frac{d}{dt} \left(\frac{dW}{dm} \right) = \frac{d}{dt} \left(\frac{dW}{\rho dv} \right)$$

SAR is expressed in units of Watts per kilogram (W/kg)

SAR measurement can be either related to the temperature elevation in tissue by

$$SAR = c \left(\frac{\delta T}{\delta t} \right)$$

Where: C is the specific heat capacity, δT is the temperature rise and δt is the exposure duration, or related to the electrical field in the tissue by

$$SAR = \frac{\sigma |E|^2}{\rho}$$

Where: σ is the conductivity of the tissue, ρ is the mass density of tissue and E is the RMS electrical field strength.

However for evaluating SAR of low power transmitter, electrical field measurement is typically applied.

7 Tissue Simulating Liquids

7.1 Targets for tissue simulating liquid

Table 7.1: Targets for tissue simulating liquid

Frequency(MHz)	Liquid Type	Conductivity(σ)	$\pm 5\%$ Range	Permittivity(ϵ)	$\pm 5\%$ Range
835	Head	0.90	0.86~0.95	41.5	39.4~43.6
835	Body	0.97	0.92~1.02	55.2	52.4~58.0
1900	Head	1.40	1.33~1.47	40.0	38.0~42.0
1900	Body	1.52	1.44~1.60	53.3	50.6~56.0
2450	Head	1.80	1.71~1.89	39.2	37.2~41.2
2450	Body	1.95	1.85~2.05	52.7	50.1~55.3
2600	Head	1.96	1.86~2.06	39.01	37.06~40.96
2600	Body	2.16	2.05~2.27	52.5	49.9~55.1

7.2 Dielectric Performance

Table 7.2: Dielectric Performance of Tissue Simulating Liquid

Measurement Date yyyy/mm/dd	Frequency	Type	Permittivity ϵ	Drift (%)	Conductivity σ (S/m)	Drift (%)
2018/6/17	835 MHz	Head	41.52	0.05	0.906	0.67
		Body	55.12	-0.14	0.97	0.00
2018/6/18	1900 MHz	Head	39.37	-1.58	1.4	0.00
		Body	53.91	1.14	1.513	-0.46
2018/6/19	2450 MHz	Head	38.65	-1.40	1.797	-0.17
		Body	53.13	0.82	1.939	-0.56
2018/6/19	2600 MHz	Head	38.63	-0.97	1.942	-0.92
		Body	51.64	-1.64	2.175	0.69

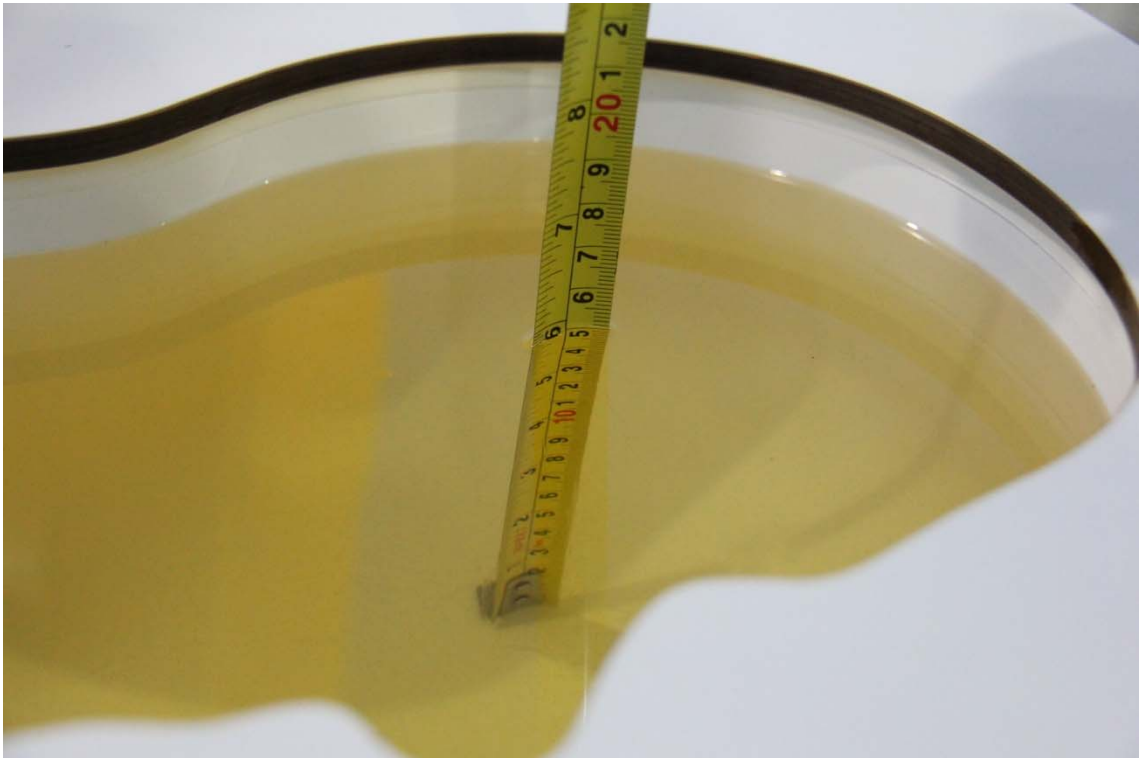

Picture 7-1 Liquid depth in the Head Phantom (835MHz)



Picture 7-2 Liquid depth in the Flat Phantom (835MHz)

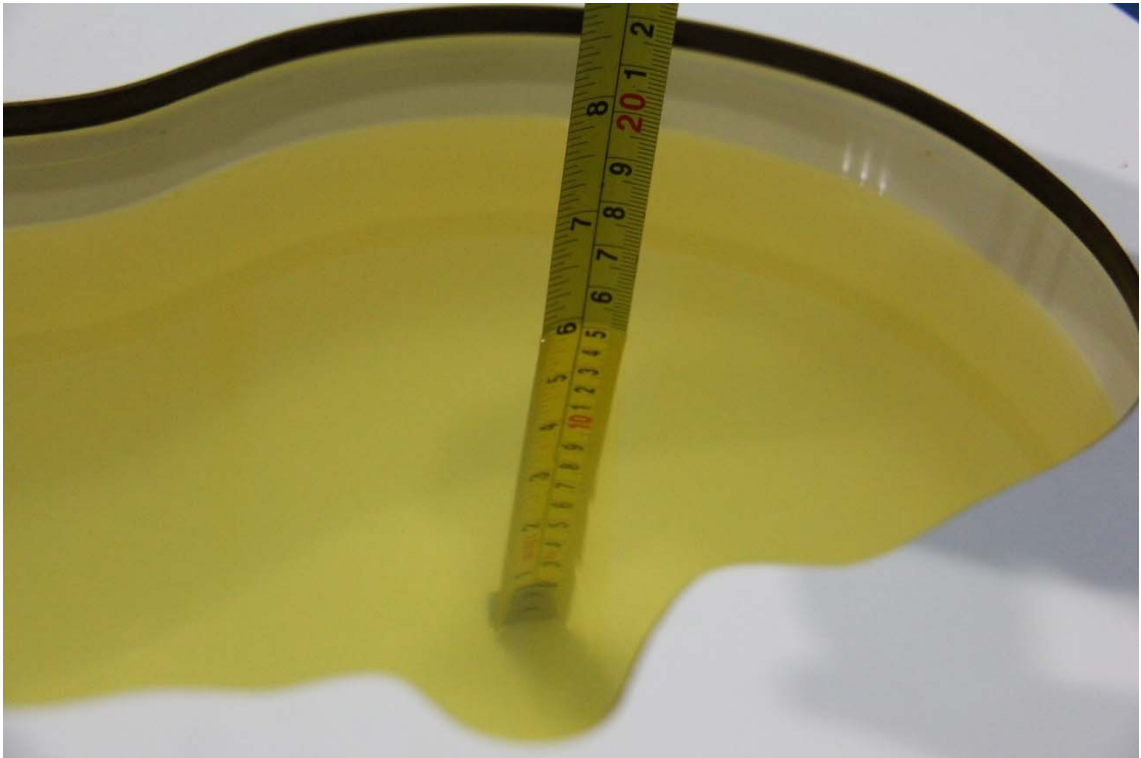

Picture 7-3 Liquid depth in the Head Phantom (1900 MHz)



Picture 7-4 Liquid depth in the Flat Phantom (1900MHz)

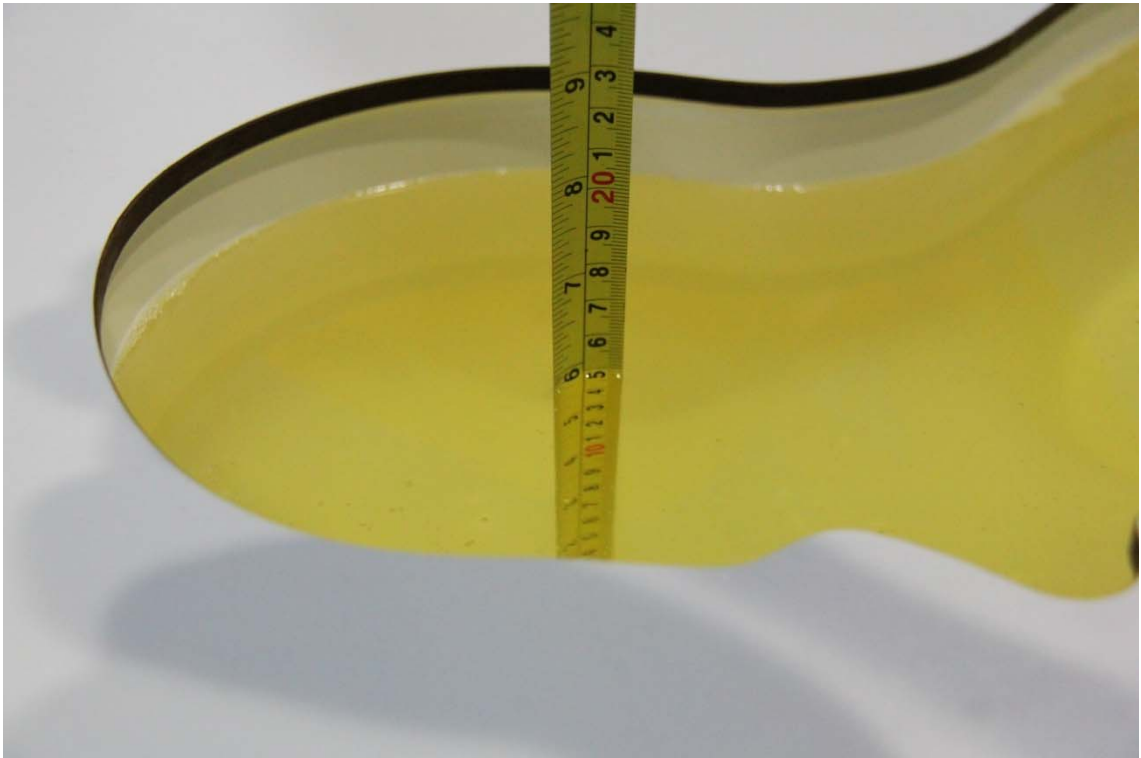

Picture 7-5 Liquid depth in the Head Phantom (2450MHz)

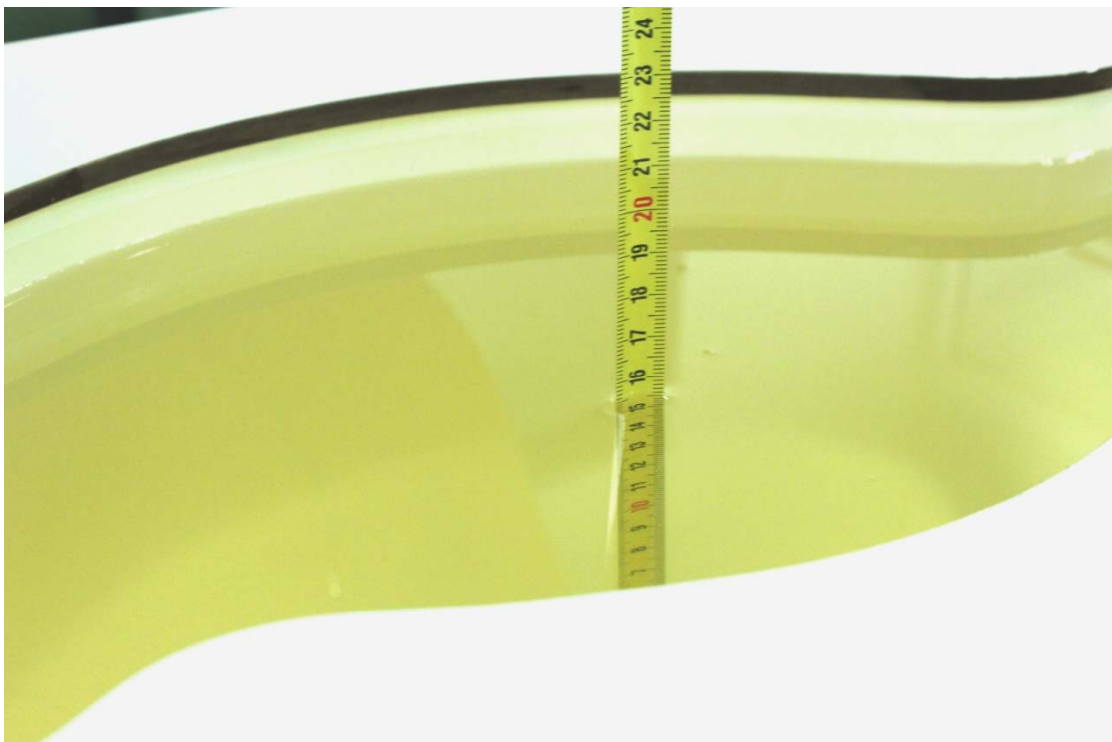

Picture 7-6 Liquid depth in the Flat Phantom (2450MHz)



Picture 7-7 Liquid depth in the Head Phantom (2600 MHz Head)

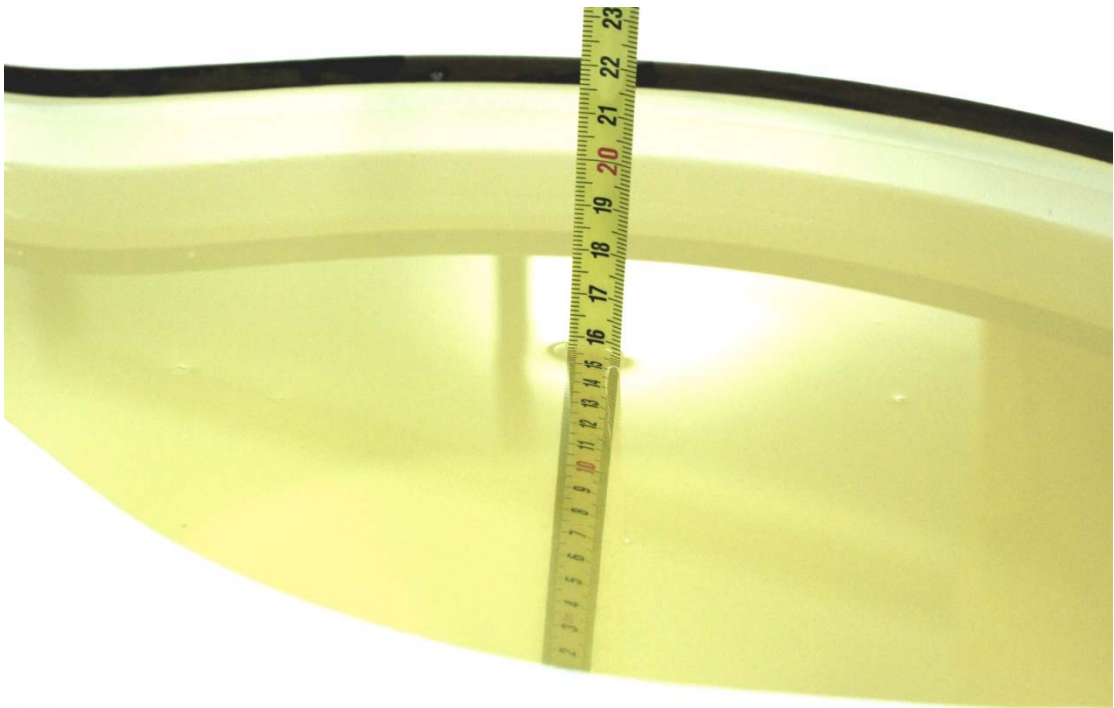

Picture 7-8 Liquid depth in the Flat Phantom (2600MHz)

8 System verification

8.1 System Setup

In the simplified setup for system evaluation, the DUT is replaced by a calibrated dipole and the power source is replaced by a continuous wave that comes from a signal generator. The calibrated dipole must be placed beneath the flat phantom section of the SAM twin phantom with the correct distance holder. The distance holder should touch the phantom surface with a light pressure at the reference marking and be oriented parallel to the long side of the phantom. The equipment setup is shown below:

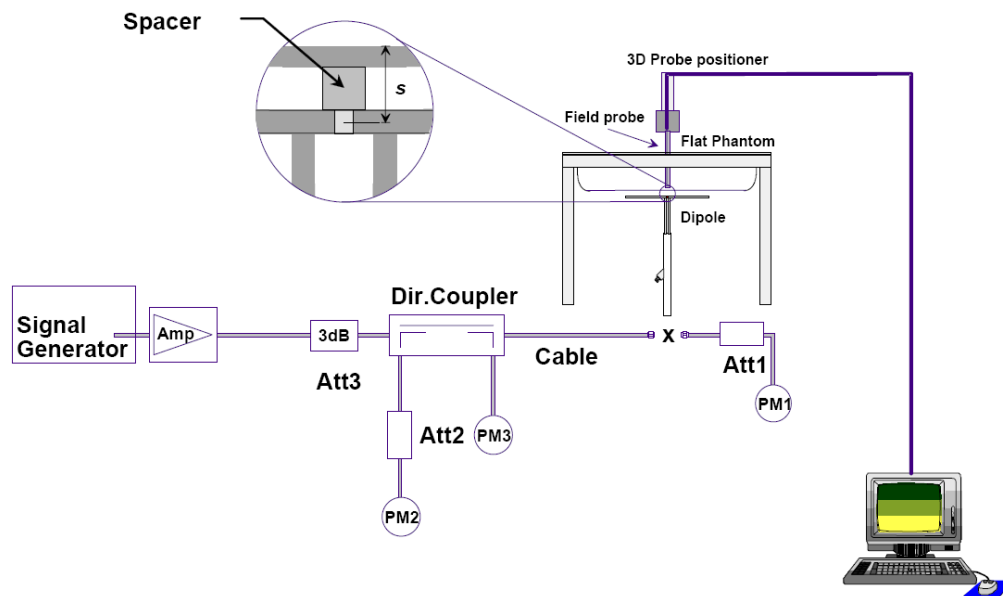

Picture 8.1 System Setup for System Evaluation



Picture 8.2 Photo of Dipole Setup

8.2 System Verification

SAR system verification is required to confirm measurement accuracy, according to the tissue dielectric media, probe calibration points and other system operating parameters required for measuring the SAR of a test device. The system verification must be performed for each frequency band and within the valid range of each probe calibration point required for testing the device.

The system verification results are required that the area scan estimated 1-g SAR is within 3% of the zoom scan 1-g SAR. The details are presented in annex B.

Table 8.1: System Verification of Head

Measurement Date (yyyy-mm-dd)	Frequency	Target value (W/kg)		Measured value (W/kg)		Deviation	
		10 g Average	1 g Average	10 g Average	1 g Average	10 g Average	1 g Average
2018/6/17	835 MHz	6.06	9.37	6	9.24	-0.99%	-1.39%
2018/6/18	1900 MHz	21.0	40.0	21.12	39.2	0.57%	-2.00%
2018/6/19	2450 MHz	24.7	52.2	25.12	52.4	1.70%	0.38%
2018/6/19	2600 MHz	25.8	57.9	25.88	57.2	0.31%	-1.21%

Table 8.2: System Verification of Body

Measurement Date (yyyy-mm-dd)	Frequency	Target value (W/kg)		Measured value (W/kg)		Deviation	
		10 g Average	1 g Average	10 g Average	1 g Average	10 g Average	1 g Average
2018/6/17	835 MHz	6.12	9.41	6.16	9.4	0.65%	-0.11%
2018/6/18	1900 MHz	21.5	40.5	21.52	40.56	0.09%	0.15%
2018/6/19	2450 MHz	23.8	50.4	23.4	49.72	-1.68%	-1.35%
2018/6/19	2600 MHz	24.8	55.5	25.04	56.32	0.97%	1.48%

9 Measurement Procedures

9.1 Tests to be performed

In order to determine the highest value of the peak spatial-average SAR of a handset, all device positions, configurations and operational modes shall be tested for each frequency band according to steps 1 to 3 below. A flowchart of the test process is shown in picture 9.1.

Step 1: The tests described in 9.2 shall be performed at the channel that is closest to the center of the transmit frequency band (f_c) for:

- a) all device positions (cheek and tilt, for both left and right sides of the SAM phantom, as described in annex D),
- b) all configurations for each device position in a), e.g., antenna extended and retracted, and
- c) all operational modes, e.g., analogue and digital, for each device position in a) and configuration in b) in each frequency band.

If more than three frequencies need to be tested according to 11.1 (i.e., $N_c > 3$), then all frequencies, configurations and modes shall be tested for all of the above test conditions.

Step 2: For the condition providing highest peak spatial-average SAR determined in Step 1, perform all tests described in 9.2 at all other test frequencies, i.e., lowest and highest frequencies. In addition, for all other conditions (device position, configuration and operational mode) where the peak spatial-average SAR value determined in Step 1 is within 3 dB of the applicable SAR limit, it is recommended that all other test frequencies shall be tested as well.

Step 3: Examine all data to determine the highest value of the peak spatial-average SAR found in Steps 1 to 2.

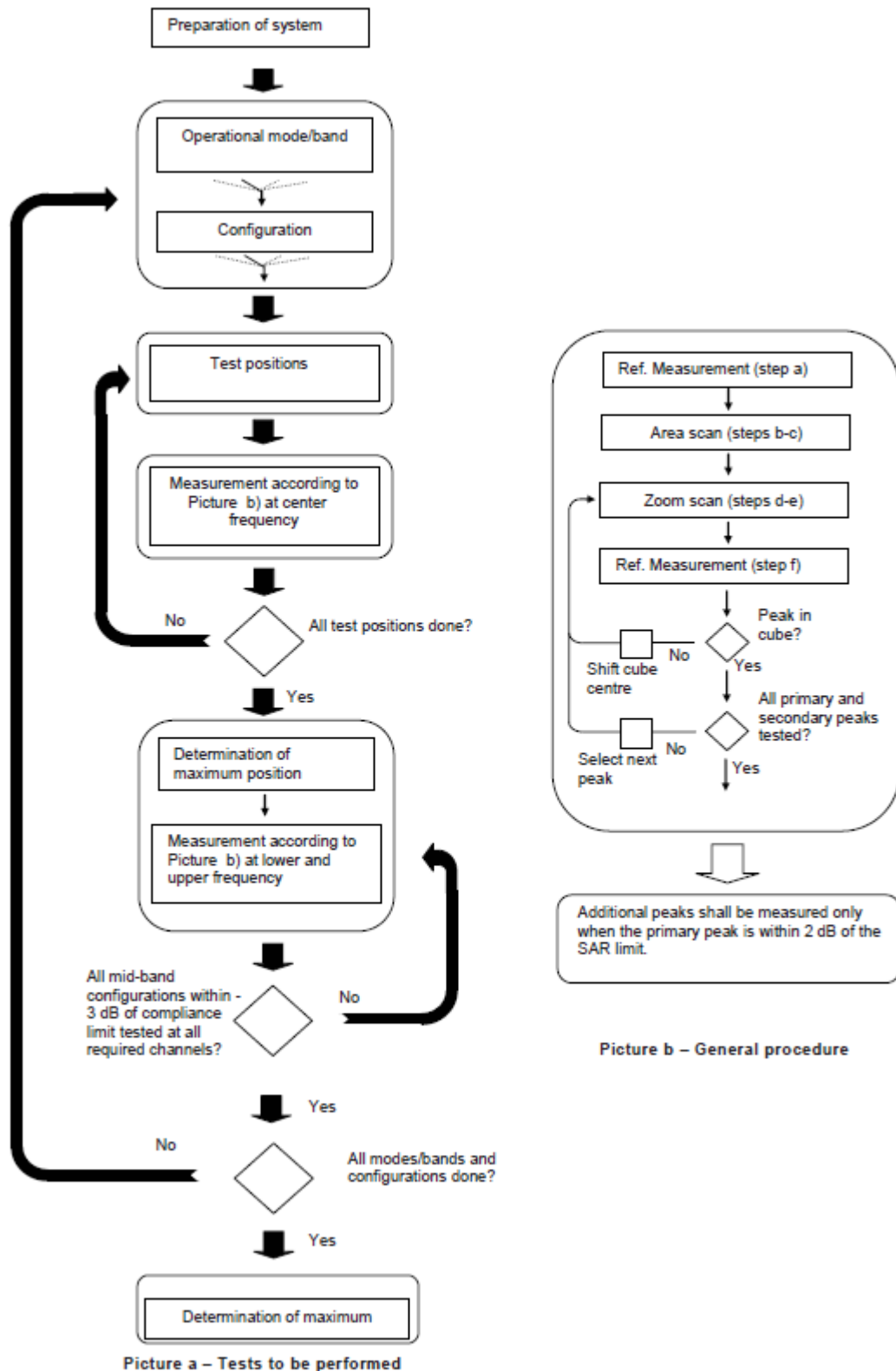

Picture 9.1 Block diagram of the tests to be performed

9.2 General Measurement Procedure

The area and zoom scan resolutions specified in the table below must be applied to the SAR measurements and fully documented in SAR reports to qualify for TCB approval. Probe boundary effect error compensation is required for measurements with the probe tip closer than half a probe tip diameter to the phantom surface. Both the probe tip diameter and sensor offset distance must satisfy measurement protocols; to ensure probe boundary effect errors are minimized and the higher fields closest to the phantom surface can be correctly measured and extrapolated to the phantom surface for computing 1-g SAR. Tolerances of the post-processing algorithms must be verified by the test laboratory for the scan resolutions used in the SAR measurements, according to the reference distribution functions specified in IEEE Std 1528-2013. The results should be documented as part of the system validation records and may be requested to support test results when all the measurement parameters in the following table are not satisfied.

		≤ 3 GHz	> 3 GHz	
Maximum distance from closest measurement point (geometric center of probe sensors) to phantom surface		5 ± 1 mm	$\frac{1}{2} \delta \cdot \ln(2) \pm 0.5$ mm	
Maximum probe angle from probe axis to phantom surface normal at the measurement location		$30^\circ \pm 1^\circ$	$20^\circ \pm 1^\circ$	
Maximum area scan spatial resolution: $\Delta x_{Area}, \Delta y_{Area}$		≤ 2 GHz: ≤ 15 mm 2 – 3 GHz: ≤ 12 mm	3 – 4 GHz: ≤ 12 mm 4 – 6 GHz: ≤ 10 mm	
		When the x or y dimension of the test device, in the measurement plane orientation, is smaller than the above, the measurement resolution must be \leq the corresponding x or y dimension of the test device with at least one measurement point on the test device.		
Maximum zoom scan spatial resolution: $\Delta x_{Zoom}, \Delta y_{Zoom}$		≤ 2 GHz: ≤ 8 mm 2 – 3 GHz: ≤ 5 mm*	3 – 4 GHz: ≤ 5 mm* 4 – 6 GHz: ≤ 4 mm*	
Maximum zoom scan spatial resolution, normal to phantom surface	uniform grid: $\Delta z_{Zoom}(n)$	≤ 5 mm	3 – 4 GHz: ≤ 4 mm 4 – 5 GHz: ≤ 3 mm 5 – 6 GHz: ≤ 2 mm	
	graded grid	$\Delta z_{Zoom}(1)$: between 1 st two points closest to phantom surface	≤ 4 mm	3 – 4 GHz: ≤ 3 mm 4 – 5 GHz: ≤ 2.5 mm 5 – 6 GHz: ≤ 2 mm
		$\Delta z_{Zoom}(n>1)$: between subsequent points	$\leq 1.5 \cdot \Delta z_{Zoom}(n-1)$	
Minimum zoom scan volume	x, y, z	≥ 30 mm	3 – 4 GHz: ≥ 28 mm 4 – 5 GHz: ≥ 25 mm 5 – 6 GHz: ≥ 22 mm	
Note: δ is the penetration depth of a plane-wave at normal incidence to the tissue medium; see draft standard IEEE P1528-2011 for details. * When zoom scan is required and the <i>reported</i> SAR from the area scan based 1-g SAR estimation procedures of KDB 447498 is ≤ 1.4 W/kg, ≤ 8 mm, ≤ 7 mm and ≤ 5 mm zoom scan resolution may be applied, respectively, for 2 GHz to 3 GHz, 3 GHz to 4 GHz and 4 GHz to 6 GHz.				

9.3 WCDMA Measurement Procedures for SAR

The following procedures are applicable to WCDMA handsets operating under 3GPP Release99, Release 5 and Release 6. The default test configuration is to measure SAR with an established radio link between the DUT and a communication test set using a 12.2kbps RMC (reference measurement channel) configured in Test Loop Mode 1. SAR is selectively confirmed for other physical channel configurations (DPCCH & DPDCH_n), HSDPA and HSPA (HSUPA/HSDPA) modes according to output power, exposure conditions and device operating capabilities. Both uplink and downlink should be configured with the same RMC or AMR, when required. SAR for Release 5 HSDPA and Release 6 HSPA are measured using the applicable FRC (fixed reference channel) and E-DCH reference channel configurations. Maximum output power is verified according to applicable versions of 3GPP TS 34.121 and SAR must be measured according to these maximum output conditions. When Maximum Power Reduction (MPR) is not implemented according to Cubic Metric (CM) requirements for Release 6 HSPA, the following procedures do not apply.

For Release 5 HSDPA Data Devices:

Sub-test	β_c	β_d	β_d (SF)	β_c / β_d	β_{hs}	CM/dB
1	2/15	15/15	64	2/15	4/15	0.0
2	12/15	15/15	64	12/15	24/25	1.0
3	15/15	8/15	64	15/8	30/15	1.5
4	15/15	4/15	64	15/4	30/15	1.5

For Release 6 HSPA Data Devices

Sub-test	β_c	β_d	β_d (SF)	β_c / β_d	β_{hs}	β_{ec}	β_{ed}	β_{ed} (SF)	β_{ed} (codes)	CM (dB)	MPR (dB)	AG Index	E-TFCI
1	11/15	15/15	64	11/15	22/15	209/225	1039/225	4	1	1.5	1.5	20	75
2	6/15	15/15	64	6/15	12/15	12/15	12/15	4	1	1.5	1.5	12	67
3	15/15	9/15	64	15/9	30/15	30/15	$\beta_{ed1}:47/15$ $\beta_{ed2}:47/15$	4	2	1.5	1.5	15	92
4	2/15	15/15	64	2/15	4/15	4/15	56/75	4	1	1.5	1.5	17	71
5	15/15	15/15	64	15/15	24/15	30/15	134/15	4	1	1.5	1.5	21	81

Rel.8 DC-HSDPA (Cat 24)

SAR test exclusion for Rel.8 DC-HSDPA must satisfy the SAR test exclusion requirements of Rel.5 HSDPA. SAR test exclusion for DC-HSDPA devices is determined by power measurements according to the H-Set 12, Fixed Reference Channel (FRC) configuration in Table C.8.1.12 of 3GPP TS 34.121-1. A primary and a secondary serving HS-DSCH Cell are required to perform the power measurement and for the results to qualify for SAR test exclusion.

9.4 SAR Measurement for LTE

SAR tests for LTE are performed with a base station simulator, Rohde & Schwarz CMW500. Closed loop power control was used so the UE transmits with maximum output power during SAR testing. All powers were measured with the CMW 500.

It is performed for conducted power and SAR based on the KDB941225 D05.

SAR is evaluated separately according to the following procedures for the different test positions in each exposure condition – head, body, body-worn accessories and other use conditions. The procedures in the following subsections are applied separately to test each LTE frequency band.

1) QPSK with 1 RB allocation

Start with the largest channel bandwidth and measure SAR for QPSK with 1 RB allocation, using the RB offset and required test channel combination with the highest maximum output power among RB offsets at the upper edge, middle and lower edge of each required test channel. When the reported SAR is ≤ 0.8 W/kg, testing of the remaining RB offset configurations and required test channels is not required for 1 RB allocation; otherwise, SAR is required for the remaining required test channels and only for the RB offset configuration with the highest output power for that channel. When the reported SAR of a required test channel is > 1.45 W/kg, SAR is required for all three RB offset configurations for that required test channel.

2) QPSK with 50% RB allocation

The procedures required for 1 RB allocation in 1) are applied to measure the SAR for QPSK with 50% RB allocation.

3) QPSK with 100% RB allocation

For QPSK with 100% RB allocation, SAR is not required when the highest maximum output power for 100 % RB allocation is less than the highest maximum output power in 50% and 1 RB allocations and the highest reported SAR for 1 RB and 50% RB allocation in 1) and 2) are ≤ 0.8 W/kg. Otherwise, SAR is measured for the highest output power channel; and if the reported SAR is > 1.45 W/kg, the remaining required test channels must also be tested.

9.5 Bluetooth & Wi-Fi Measurement Procedures for SAR

Normal network operating configurations are not suitable for measuring the SAR of 802.11 transmitters in general. Unpredictable fluctuations in network traffic and antenna diversity conditions can introduce undesirable variations in SAR results. The SAR for these devices should be measured using chipset based test mode software to ensure that the results are consistent and reliable.

Chipset based test mode software is hardware dependent and generally varies among manufacturers. The device operating parameters established in a test mode for SAR measurements must be identical to those programmed in production units, including output power levels, amplifier gain settings and other RF performance tuning parameters. The test frequencies should correspond to actual channel frequencies defined for domestic use. SAR for devices with switched diversity should be measured with only one antenna transmitting at a time during each SAR measurement, according to a fixed modulation and data rate. The same data pattern should be used for all measurements.

9.6 Power Drift

To control the output power stability during the SAR test, DASY4 system calculates the power drift by measuring the E-field at the same location at the beginning and at the end of the measurement for each test position. These drift values can be found in section 14 labeled as: (Power Drift [dB]). This ensures that the power drift during one measurement is within 5%.

10 Area Scan Based 1-g SAR

10.1 Requirement of KDB

According to the KDB447498 D01 v05, when the implementation is based the specific polynomial fit algorithm as presented at the 29th Bioelectromagnetics Society meeting (2007) and the estimated 1-g SAR is ≤ 1.2 W/kg, a zoom scan measurement is not required provided it is also not needed for any other purpose; for example, if the peak SAR location required for simultaneous transmission SAR test exclusion can be determined accurately by the SAR system or manually to discriminate between distinctive peaks and scattered noisy SAR distributions from area scans.

There must not be any warning or alert messages due to various measurement concerns identified by the SAR system; for example, noise in measurements, peaks too close to scan boundary, peaks are too sharp, spatial resolution and uncertainty issues etc. The SAR system verification must also demonstrate that the area scan estimated 1-g SAR is within 3% of the zoom scan 1-g SAR (See Annex B). When all the SAR results for each exposure condition in a frequency band and wireless mode are based on estimated 1-g SAR, the 1-g SAR for the highest SAR configuration must be determined by a zoom scan.

10.2 Fast SAR Algorithms

The approach is based on the area scan measurement applying a frequency dependent attenuation parameter. This attenuation parameter was empirically determined by analyzing a large number of phones. The MOTOROLA FAST SAR was developed and validated by the MOTOROLA Research Group in Ft. Lauderdale.

In the initial study, an approximation algorithm based on Linear fit was developed. The accuracy of the algorithm has been demonstrated across a broad frequency range (136-2450 MHz) and for both 1- and 10-g averaged SAR using a sample of 264 SAR measurements from 55 wireless handsets. For the sample size studied, the root-mean-squared errors of the algorithm are 1.2% and 5.8% for 1- and 10-g averaged SAR, respectively. The paper describing the algorithm in detail is expected to be published in August 2004 within the Special Issue of Transactions on MTT.

In the second step, the same research group optimized the fitting algorithm to an Polynomial fit whereby the frequency validity was extended to cover the range 30-6000MHz. Details of this study can be found in the BEMS 2007 Proceedings.

Both algorithms are implemented in DASY software.

11 Conducted Output Power

11.1 GSM Measurement result

During the process of testing, the EUT was controlled via Agilent Digital Radio Communication tester (E5515C) to ensure the maximum power transmission and proper modulation. This result contains conducted output power for the EUT. In all cases, the measured peak output power should be greater and within 5% than EMI measurement.

Table 11-1 GSM850 #1

GSM850 #1								
Config	Tune-up	Measured Power (dBm)			Calculation	Frame Burst Power (dBm)		
		CH251 848.8 MHz	CH190 836.6 MHz	CH128 824.2 MHz		CH251 848.8 MHz	CH190 836.6 MHz	CH128 824.2 MHz
GSM Speech	33.30	32.46	32.62	32.60				
GPRS 1 Txslot	33.30	32.51	32.65	32.60	-9.03	23.48	23.62	23.57
GPRS 2 Txslots	30.50	30.08	30.22	30.09	-6.02	24.06	24.20	24.07
GPRS 3 Txslots	28.50	27.88	28.02	27.86	-4.26	23.62	23.76	23.60
GPRS 4 Txslots	27.50	26.57	26.77	26.54	-3.01	23.56	23.76	23.53
EGPRS GMSK 1 Txslot	33.30	32.44	32.60	32.56	-9.03	23.41	23.57	23.53
EGPRS GMSK 2 Txslots	30.50	30.01	30.17	30.05	-6.02	23.99	24.15	24.03
EGPRS GMSK 3 Txslots	28.50	27.79	27.95	27.81	-4.26	23.53	23.69	23.55
EGPRS GMSK 4 Txslots	27.50	26.46	26.70	26.49	-3.01	23.45	23.69	23.48
EGPRS 8PSK 1 Txslot	27.00	26.27	26.06	26.25	-9.03	17.24	17.03	17.22
EGPRS 8PSK 2 Txslots	25.50	24.96	25.27	25.11	-6.02	18.94	19.25	19.09
EGPRS 8PSK 3 Txslots	24.00	23.58	23.64	23.85	-4.26	19.32	19.38	19.59
EGPRS 8PSK 4 Txslots	22.50	21.88	21.71	21.81	-3.01	18.87	18.70	18.80

Table 11-2 PCS1900 #1

PCS1900 #1								
Config	Tune-up	Measured Power (dBm)			Calculation	Frame Burst Power (dBm)		
		CH810 1909.8 MHz	CH661 1880 MHz	CH512 1850.2 MHz		CH810 1909.8 MHz	CH661 1880 MHz	CH512 1850.2 MHz
GSM Speech	30.30	30.26	30.04	30.03				
GPRS 1 Txslot	30.30	30.14	30.09	30.08	-9.03	21.11	21.06	21.05
GPRS 2 Txslots	28.00	27.91	27.90	27.57	-6.02	21.89	21.88	21.55
GPRS 3 Txslots	26.00	25.76	25.83	25.65	-4.26	21.50	21.57	21.39
GPRS 4 Txslots	25.00	24.71	24.76	24.64	-3.01	21.70	21.75	21.63
EGPRS GMSK 1 Txslot	30.30	30.15	30.13	30.11	-9.03	21.12	21.10	21.08
EGPRS GMSK 2 Txslots	28.00	27.91	27.93	27.59	-6.02	21.89	21.91	21.57
EGPRS GMSK 3 Txslots	26.00	25.76	25.85	25.67	-4.26	21.50	21.59	21.41
EGPRS GMSK 4 Txslots	25.00	24.69	24.78	24.66	-3.01	21.68	21.77	21.65
EGPRS 8PSK 1 Txslot	27.00	26.36	25.88	25.89	-9.03	17.33	16.85	16.86
EGPRS 8PSK 2 Txslots	25.00	24.96	24.62	24.50	-6.02	18.94	18.60	18.48
EGPRS 8PSK 3 Txslots	23.00	22.88	22.76	22.46	-4.26	18.62	18.50	18.20
EGPRS 8PSK 4 Txslots	22.00	21.85	21.71	21.44	-3.01	18.84	18.70	18.43

NOTES:

Division Factors

To average the power, the division factor is as follows:

1TX-slot = 1 transmit time slot out of 8 time slots=> conducted power divided by (8/1) => -9.03dB

2TX-slots = 2 transmit time slots out of 8 time slots=> conducted power divided by (8/2) => -6.02dB

3TX-slots = 3 transmit time slots out of 8 time slots=> conducted power divided by (8/3) => -4.26dB

4TX-slots = 4 transmit time slots out of 8 time slots=> conducted power divided by (8/4) => -3.01dB

According to the conducted power as above, the body measurements are performed with 2Txslots for 850MHz and 1900MHz.

11.2 WCDMA Measurement result

Table 11-3 WCDMA1900-BII #1

WCDMA1900-BII #1					
			Measured Power (dBm)		
Item		Tune-up	CH9538 1907.6 MHz	CH9400 1880 MHz	CH9262 1852.4 MHz
WCDMA	RMC	24.00	23.61	23.65	23.64
HSUPA	subtest1	22.00	21.93	21.95	21.94
	subtest2	23.00	21.99	22.05	21.95
	subtest3	22.00	21.54	21.56	21.49
	subtest4	22.00	21.92	21.93	21.96
	subtest5	22.00	21.94	21.98	21.97
HSPA+	\	22.00	21.82	21.85	21.83
DC-HSDPA	subtest1	23.00	22.78	22.81	22.86
	subtest2	23.00	22.81	22.84	22.85
	subtest3	23.00	22.31	22.32	22.33
	subtest4	23.00	22.30	22.31	22.34

Table 11-4 WCDMA850-BV #1

WCDMA850-BV #1					
			Measured Power (dBm)		
Item		Tune-up	CH4233 846.6 MHz	CH4182 836.4 MHz	CH4132 826.4 MHz
WCDMA	RMC	24.00	23.32	23.39	23.34
HSUPA	subtest1	22.00	21.48	21.47	21.44
	subtest2	22.00	21.44	21.46	21.42
	subtest3	21.00	20.95	20.96	20.98
	subtest4	22.00	21.49	21.51	21.46
	subtest5	22.00	21.46	21.51	21.48
HSPA+	\	22.00	21.45	21.43	21.41
DC-HSDPA	subtest1	23.00	22.39	22.46	22.38
	subtest2	23.00	22.42	22.45	22.37
	subtest3	23.00	21.96	21.91	21.84
	subtest4	23.00	21.93	21.93	21.86

11.3 LTE Measurement result

Table 11-5 LTE2500-FDD7 #1

LTE2500-FDD7 #1								
BandWidth	RB No./Start	Channel	Tune-up	Measured Power (dBm) & MPR				
				QPSK		16QAM		
				Measured Power	MPR	Measured Power	MPR	
5MHz	1H	21425	24.5	23.95	0	22.36	1	
		21100	24.5	23.24	0	22.40	1	
		20775	24.5	23.29	0	22.72	1	
	1M	21425	24.5	23.70	0	22.61	1	
		21100	24.5	23.48	0	22.60	1	
		20775	24.5	23.50	0	22.94	1	
	1L	21425	24.5	23.34	0	22.36	1	
		21100	24.5	23.25	0	22.39	1	
		20775	24.5	23.30	0	22.71	1	
	12H	21425	24.5	22.39	1	21.48	2	
		21100	24.5	22.34	1	21.43	2	
		20775	24.5	22.39	1	21.53	2	
	12M	21425	24.5	22.52	1	21.55	2	
		21100	24.5	22.41	1	21.45	2	
		20775	24.5	22.40	1	21.55	2	
	12L	21425	24.5	22.46	1	21.52	2	
		21100	24.5	22.34	1	21.38	2	
		20775	24.5	22.33	1	21.43	2	
	25	21425	24.5	22.47	1	21.40	2	
		21100	24.5	22.36	1	21.36	2	
		20775	24.5	22.40	1	21.41	2	
	10MHz	1H	21400	24.5	23.61	0	22.77	1
			21100	24.5	23.45	0	22.45	1
			20800	24.5	23.92	0	22.61	1
		1M	21400	24.5	23.74	0	22.83	1
			21100	24.5	23.51	0	22.30	1
			20800	24.5	23.49	0	22.75	1
1L		21400	24.5	23.93	0	22.75	1	
		21100	24.5	23.87	0	22.17	1	
		20800	24.5	23.85	0	22.57	1	
25H		21400	24.5	22.50	1	21.99	2	
		21100	24.5	22.48	1	21.74	2	
		20800	24.5	22.52	1	21.52	2	
25M		21400	24.5	21.60	1	21.99	2	
		21100	24.5	21.66	1	21.88	2	
		20800	24.5	22.86	1	21.43	2	
25L		21400	24.5	22.51	1	21.98	2	
		21100	24.5	22.41	1	21.56	2	
		20800	24.5	22.37	1	21.33	2	
50		21400	24.5	22.52	1	21.68	2	
		21100	24.5	22.47	1	21.61	2	
		20800	24.5	22.45	1	21.49	2	
15MHz		1H	21375	24.5	23.92	0	22.55	1
			21100	24.5	23.27	0	22.14	1
			20825	24.5	23.28	0	22.54	1
		1M	21375	24.5	24.02	0	22.68	1
			21100	24.5	23.37	0	22.19	1
			20825	24.5	23.42	0	22.66	1
	1L	21375	24.5	23.82	0	22.65	1	
		21100	24.5	23.30	0	22.08	1	
		20825	24.5	23.34	0	22.53	1	
	36H	21375	24.5	23.15	1	21.48	2	
		21100	24.5	22.47	1	21.41	2	
		20825	24.5	22.46	1	21.46	2	
	36M	21375	24.5	23.05	1	21.43	2	
		21100	24.5	22.52	1	21.40	2	
		20825	24.5	22.40	1	21.43	2	
	36L	21375	24.5	22.58	1	21.37	2	
		21100	24.5	22.56	1	21.33	2	
		20825	24.5	22.36	1	21.34	2	
	75	21375	24.5	22.51	1	21.43	2	
		21100	24.5	22.52	1	21.43	2	
		20825	24.5	22.46	1	21.37	2	



20MHz	1H	21350	24.5	23.61	0	23.04	1
		21100	24.5	23.51	0	22.81	1
		20850	24.5	23.51	0	22.58	1
	1M	21350	24.5	23.94	0	23.44	1
		21100	24.5	23.91	0	22.94	1
		20850	24.5	23.92	0	23.13	1
	1L	21350	24.5	23.51	0	23.04	1
		21100	24.5	23.47	0	22.46	1
		20850	24.5	23.47	0	22.42	1
	50H	21350	24.5	22.89	1	21.86	2
		21100	24.5	22.85	1	21.73	2
		20850	24.5	22.86	1	21.66	2
	50M	21350	24.5	22.91	1	21.94	2
		21100	24.5	22.88	1	21.88	2
		20850	24.5	22.82	1	21.77	2
	50L	21350	24.5	22.76	1	21.77	2
		21100	24.5	22.74	1	21.59	2
		20850	24.5	22.67	1	21.45	2
	100	21350	24.5	22.81	1	21.72	2
		21100	24.5	22.79	1	21.59	2
		20850	24.5	22.75	1	21.74	2

11.4 Wi-Fi and BT Measurement result

The output power of BT antenna is as following:

Table 11-6 Bluetooth Power

Bluetooth Power				
Mode	Channel	Frequency	Tune-up	Measured
GFSK	78	2480 MHz	7	5.39
	39	2441 MHz	7	5.2
	0	2402 MHz	7	6.21
EDR2M-4_DQPSK	78	2480 MHz	6	4.41
	39	2441 MHz	6	4.14
	0	2402 MHz	6	5.04
EDR3M-8DPSK	78	2480 MHz	6	4.47
	39	2441 MHz	6	4.19
	0	2402 MHz	6	5.11



The average conducted power for Wi-Fi is as following:

Table 11-7 WLAN2450 #1

WLAN2450 #1						
Band	Mode	Channel	Frequency	Data Rate	Tune-up	Measured
WLAN 2.4G 20M	802.11b	11	2462 MHz	1Mbps	18.50	17.95
		6	2437 MHz		18.50	18.21
		1	2412 MHz		18.50	17.79
		11	2462 MHz	2Mbps	/	/
		6	2437 MHz		18.50	18.09
		1	2412 MHz		/	/
		11	2462 MHz	5.5Mbps	/	/
		6	2437 MHz		18.50	18.18
		1	2412 MHz		/	/
		11	2462 MHz	11Mbps	/	/
		6	2437 MHz		18.50	18.08
		1	2412 MHz		/	/
	802.11g	6Mbps	11	2462 MHz	16.50	16.00
			6	2437 MHz	16.50	15.85
			1	2412 MHz	16.50	16.33
		9Mbps	11	2462 MHz	/	/
			6	2437 MHz	/	/
			1	2412 MHz	16.00	14.29
		12Mbps	11	2462 MHz	/	/
			6	2437 MHz	/	/
			1	2412 MHz	16.00	14.75
		18Mbps	11	2462 MHz	/	/
			6	2437 MHz	/	/
			1	2412 MHz	16.00	14.83
		24Mbps	11	2462 MHz	/	/
			6	2437 MHz	/	/
			1	2412 MHz	16.00	14.29
		36Mbps	11	2462 MHz	/	/
			6	2437 MHz	/	/
			1	2412 MHz	16.00	14.22
		48Mbps	11	2462 MHz	/	/
			6	2437 MHz	/	/
			1	2412 MHz	16.00	14.74
		54Mbps	11	2462 MHz	/	/
			6	2437 MHz	/	/
			1	2412 MHz	16.00	14.29
	802.11n 20M	MCS0	11	2462 MHz	15.50	14.75
			6	2437 MHz	15.50	14.96
			1	2412 MHz	15.50	14.94
		MCS1	11	2462 MHz	/	/
			6	2437 MHz	15.00	14.71
			1	2412 MHz	/	/
MCS2		11	2462 MHz	/	/	
		6	2437 MHz	15.00	14.83	
		1	2412 MHz	/	/	
MCS3		11	2462 MHz	/	/	
		6	2437 MHz	15.00	14.78	
		1	2412 MHz	/	/	
MCS4		11	2462 MHz	/	/	
		6	2437 MHz	15.00	14.76	
		1	2412 MHz	/	/	
MCS5		11	2462 MHz	/	/	
		6	2437 MHz	15.00	13.80	
		1	2412 MHz	/	/	
MCS6		11	2462 MHz	/	/	
		6	2437 MHz	15.00	13.83	
		1	2412 MHz	/	/	
MCS7	11	2462 MHz	/	/		
	6	2437 MHz	15.00	13.80		



		1	2412 MHz		/	/
WLAN 2.4G 40M	802.11n 40M	9	2452 MHz	MCS0	13.50	12.76
		6	2437 MHz		13.50	12.95
		3	2422 MHz		13.50	13.26
		9	2452 MHz	MCS1	/	/
		6	2437 MHz		/	/
		3	2422 MHz		13.50	13.03
		9	2452 MHz	MCS2	/	/
		6	2437 MHz		/	/
		3	2422 MHz		13.50	12.99
		9	2452 MHz	MCS3	/	/
		6	2437 MHz		/	/
		3	2422 MHz		13.50	12.94
		9	2452 MHz	MCS4	/	/
		6	2437 MHz		/	/
		3	2422 MHz		13.50	12.96
		9	2452 MHz	MCS5	/	/
		6	2437 MHz		/	/
		3	2422 MHz		13.50	12.04
		9	2452 MHz	MCS6	/	/
		6	2437 MHz		/	/
		3	2422 MHz		13.50	12.03
9	2452 MHz	MCS7	/	/		
6	2437 MHz		/	/		
3	2422 MHz		13.50	11.75		

12 Simultaneous TX SAR Considerations

12.1 Introduction

The following procedures adopted from “FCC SAR Considerations for Cell Phones with Multiple Transmitters” are applicable to handsets with built-in unlicensed transmitters such as 802.11 a/b/g and Bluetooth devices which may simultaneously transmit with the licensed transmitter. For this device, the BT and Wi-Fi can transmit simultaneous with other transmitters.

12.2 Transmit Antenna Separation Distances

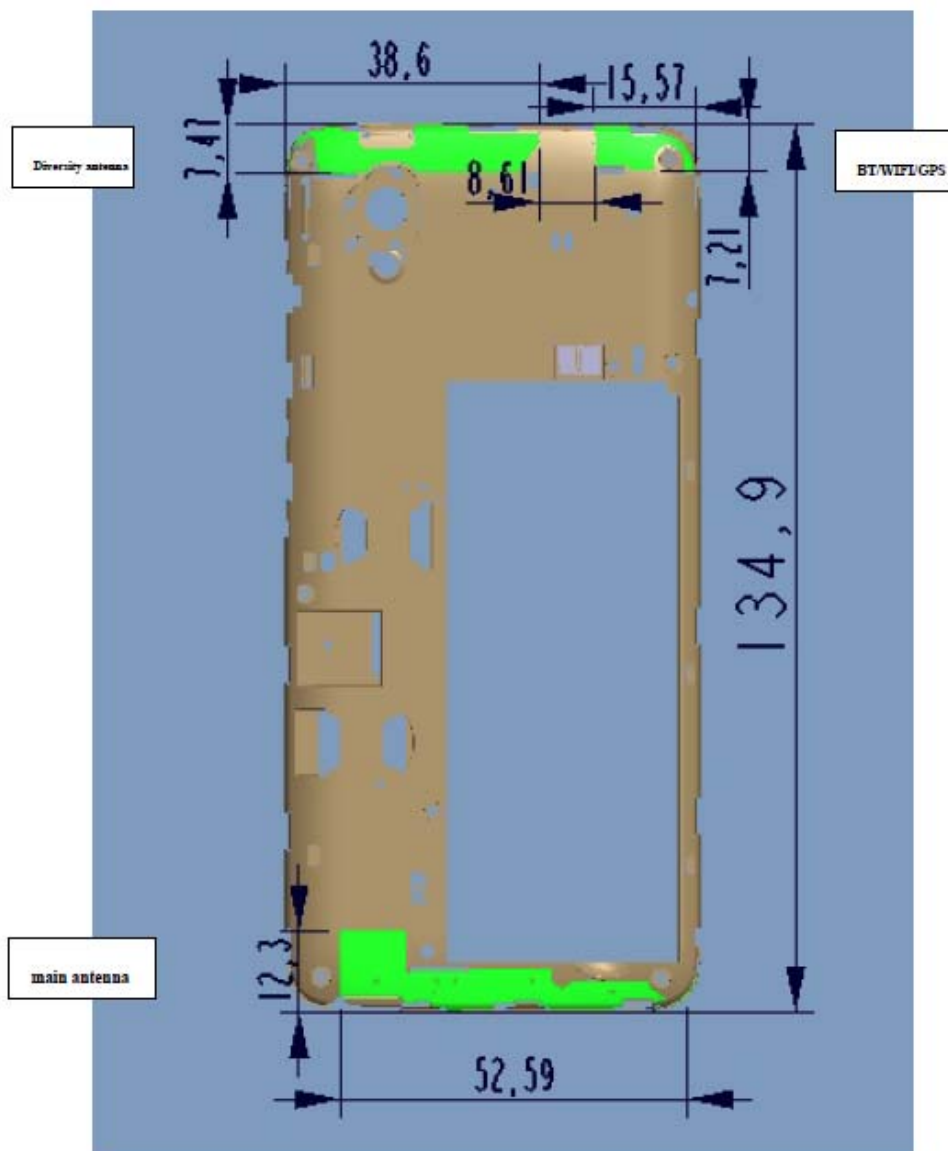

Picture 12.1 Antenna Locations

12.3 SAR Measurement Positions

According to the KDB941225 D06 Hot Spot SAR v01, the edges with less than 2.5 cm distance to the antennas need to be tested for SAR.

SAR measurement positions						
Mode	Front	Rear	Left edge	Right edge	Top edge	Bottom edge
Main antenna	Yes	Yes	Yes	Yes	No	Yes
WLAN	Yes	Yes	Yes	No	Yes	No

12.4 Standalone SAR Test Exclusion Considerations

Standalone 1-g head or body SAR evaluation by measurement or numerical simulation is not required when the corresponding SAR Exclusion Threshold condition, listed below, is satisfied. The 1-g SAR test exclusion threshold for 100 MHz to 6 GHz at test separation distances ≤ 50 mm are determined by:

$[(\text{max. power of channel, including tune-up tolerance, mW}) / (\text{min. test separation distance, mm})] \cdot [\sqrt{f(\text{GHz})}] \leq 3.0$ for 1-g SAR, where

- $f(\text{GHz})$ is the RF channel transmit frequency in GHz
- Power and distance are rounded to the nearest mW and mm before calculation
- The result is rounded to one decimal place for comparison

Table 12.1: Standalone SAR test exclusion considerations

Band/Mode	F(GHz)	Position	SAR test exclusion threshold (mW)	RF output power		SAR test exclusion
				dBm	mW	
Bluetooth	2.441	Head	9.6	7	5.01	Yes
		Body	19.2	7	5.01	Yes
2.4GHz WLAN 802.11 b	2.45	Head	9.58	18.5	70.79	No
		Body	19.17	18.5	70.79	No

13 Evaluation of Simultaneous

Table 13.1: The sum of reported SAR values for main antenna and WiFi

	Position	Main antenna	WiFi	Sum
Highest reported SAR value for Head	Right hand, Touch cheek (LTE Band7)	0.32	1.21	1.53
Highest reported SAR value for Body	Rear (WCDMA 1900)	1.30	0.22	1.52

Table 13.2: The sum of reported SAR values for main antenna and BT

	Position	Main antenna	BT	Sum
Maximum reported SAR value for Head	Left hand, Touch cheek (WCDMA 1900)	0.78	0.21	0.99
Maximum reported SAR value for Body	Rear (WCDMA 1900)	1.30	0.10	1.40

[1] - Estimated SAR for Bluetooth (see the table 13.3)

Table 13.3: Estimated SAR for Bluetooth

Mode/Band	F (GHz)	Position	Distance (mm)	Upper limit of power *		Estimated _{1g} (W/kg)
				dBm	mW	
Bluetooth	2.441	Head	5	7	5.01	0.21
Bluetooth	2.441	Body	10	7	5.01	0.10

* - Maximum possible output power declared by manufacturer

When standalone SAR test exclusion applies to an antenna that transmits simultaneously with other antennas, the standalone SAR must be estimated according to following to determine simultaneous transmission SAR test exclusion:

(max. power of channel, including tune-up tolerance, mW)/(min. test separation distance, mm) · [$\sqrt{f(\text{GHz})/x}$] W/kg for test separation distances ≤ 50 mm;

where $x = 7.5$ for 1-g SAR.

When the minimum test separation distance is < 5 mm, a distance of 5 mm is applied to determine SAR test exclusion

Conclusion:

According to the above tables, the sum of reported SAR values is < 1.6 W/kg. So the simultaneous transmission SAR with volume scans is not required.

14 SAR Test Result

It is determined by user manual for the distance between the EUT and the phantom bottom.

The distance is 10 mm and just applied to the condition of body worn accessory.

It is performed for all SAR measurements with area scan based 1-g SAR estimation (Fast SAR). A zoom scan measurement is added when the estimated 1-g SAR is the highest measured SAR in each exposure configuration, wireless mode and frequency band combination or more than 1.2W/kg.

The calculated SAR is obtained by the following formula:

$$\text{Reported SAR} = \text{Measured SAR} \times 10^{(P_{\text{Target}} - P_{\text{Measured}})/10}$$

Where P_{Target} is the power of manufacturing upper limit;

P_{Measured} is the measured power in chapter 11.

Mode	Duty Cycle
Speech for GSM850/1900	1:8.3
GPRS&EGPRS for GSM850/1900	1:4
WCDMA<E&WiFi	1:1

14.1 SAR results

Note: H1: CCB0046A10C4 H2: CCB0046A10C1 H3: CCB0049A10C1 H4: CCB0049A10C4

Table 14-1 GSM850 #1 Head

GSM850 #1 Head									
Ambient Temperature:			22.5			Liquid Temperature:			22.3
Mode	Device orientation	SAR measurement	Measured SAR [W/kg]			Reported SAR [W/kg]			
			CH251 848.8 MHz	CH190 836.6 MHz	CH128 824.2 MHz	CH251 848.8 MHz	CH190 836.6 MHz	CH128 824.2 MHz	
GSM	Tune-up		33.30	33.30	33.30	Scaling factor*			
	Slot Average Power [dBm]		32.46	32.62	32.60	1.21	1.17	1.18	
	Left Cheek	1g SAR	0.253	0.199	0.175	0.31	0.23	0.21	
		10g SAR	0.191	0.143	0.123	0.23	0.17	0.14	
		Deviation	-0.09	0.04	0.04	-0.09	0.04	0.04	
	Left Tilt	1g SAR		0.107			0.13		
		10g SAR		0.08			0.09		
		Deviation		0.01			0.01		
	Right Cheek	1g SAR		0.17			0.20		
		10g SAR		0.123			0.14		
		Deviation		0.06			0.06		
	Right Tilt	1g SAR		0.096			0.11		
		10g SAR		0.071			0.08		
		Deviation		0.08			0.08		

Table 14-2 GSM850 #1 Body

GSM850 #1 Body									
Ambient Temperature:			22.5			Liquid Temperature:			22.3
Mode	Device orientation	SAR measurement	Measured SAR [W/kg]			Reported SAR [W/kg]			
			CH251 848.8 MHz	CH190 836.6 MHz	CH128 824.2 MHz	CH251 848.8 MHz	CH190 836.6 MHz	CH128 824.2 MHz	
GPRS 2 Txslots	Tune-up		30.50	30.50	30.50	Scaling factor*			
	Slot Average Power [dBm]		30.08	30.22	30.09	1.10	1.07	1.10	
	Front	1g SAR		0.136			0.15		
		10g SAR		0.104			0.11		
		Deviation		0.09			0.09		
	Rear	1g SAR	0.234	0.166	0.182	0.26	0.18	0.20	
		10g SAR	0.174	0.126	0.138	0.19	0.13	0.15	
		Deviation	-0.12	0.07	-0.06	-0.12	0.07	-0.06	
	Left edge	1g SAR		0.089			0.09		
		10g SAR		0.061			0.07		
		Deviation		-0.19			-0.19		
	Right edge	1g SAR		0.087			0.09		
		10g SAR		0.063			0.07		
		Deviation		-0.12			-0.12		
	Bottom edge	1g SAR		0.055			0.06		
10g SAR			0.035			0.04			
Deviation			0.04			0.04			
EGPRS GMSK 2 Txslots	Tune-up		30.50	30.50	30.50	Scaling factor*			
	Slot Average Power [dBm]		30.01	30.17	30.05	1.12	1.08	1.11	
	Rear	1g SAR	0.23			0.26			
		10g SAR	0.169			0.19			
		Deviation	0.1			0.10			

Table 14-3 PCS1900 #1 Head

PCS1900 #1 Head									
Ambient Temperature:			22.5			Liquid Temperature:			22.3
Mode	Device orientation	SAR measurement	Measured SAR [W/kg]			Reported SAR [W/kg]			
			CH810 1909.8	CH661 1880 MHz	CH512 1850.2	CH810 1909.8	CH661 1880 MHz	CH512 1850.2	
GSM	Tune-up		30.30	30.30	30.30	Scaling factor*			
	Slot Average Power [dBm]		30.26	30.04	30.03	1.01	1.06	1.06	
	Left Cheek	1g SAR	0.362	0.442	0.432	0.37	0.47	0.46	
		10g SAR	0.213	0.266	0.253	0.22	0.28	0.27	
		Deviation	0.04	-0.09	0.08	0.04	-0.09	0.08	
	Left Tilt	1g SAR		0.161			0.17		
		10g SAR		0.105			0.11		
		Deviation		0.04			0.04		
	Right Cheek	1g SAR		0.276			0.29		
		10g SAR		0.177			0.19		
		Deviation		0.07			0.07		
	Right Tilt	1g SAR		0.162			0.17		
		10g SAR		0.104			0.11		
		Deviation		0.08			0.08		

Table 14-4 PCS1900 #1 Body

PCS1900 #1 Body									
Ambient Temperature:			22.5			Liquid Temperature:			22.3
Mode	Device orientation	SAR measurement	Measured SAR [W/kg]			Reported SAR [W/kg]			
			CH810 1909.8	CH661 1880 MHz	CH512 1850.2	CH810 1909.8	CH661 1880 MHz	CH512 1850.2	
GPRS 2 Txslots	Tune-up		28.00	28.00	28.00	Scaling factor*			
	Slot Average Power [dBm]		27.91	27.90	27.57	1.02	1.02	1.10	
	Front	1g SAR		0.739			0.76		
		10g SAR		0.449			0.46		
		Deviation		0.06			0.06		
	Rear	1g SAR	0.862	1.01	1.06	0.88	1.03	1.17	
		10g SAR	0.472	0.564	0.605	0.48	0.58	0.67	
		Deviation	0.05	-0.12	-0.14	0.05	-0.12	-0.14	
	Left edge	1g SAR		0.154			0.16		
		10g SAR		0.095			0.10		
		Deviation		0.03			0.03		
	Right edge	1g SAR		0.247			0.25		
		10g SAR		0.148			0.15		
		Deviation		0.09			0.09		
	Bottom edge	1g SAR	0.851	0.901	0.879	0.87	0.92	0.97	
10g SAR		0.438	0.046	0.423	0.45	0.05	0.47		
Deviation		0.04	0.02	0.01	0.04	0.02	0.01		
EGPRS GMSK 2 Txslots	Tune-up		28.00	28.00	28.00	Scaling factor*			
	Slot Average Power [dBm]		27.91	27.93	27.59	1.02	1.02	1.10	
	Rear	1g SAR			1.02			1.12	
		10g SAR			0.578			0.63	
		Deviation			0.03			0.03	

Table 14-5 WCDMA1900-BII #1Head

WCDMA1900-BII #1Head									
Ambient Temperature:			22.5			Liquid Temperature:			22.3
Mode	Device orientation	SAR measurement	Measured SAR [W/kg]			Reported SAR [W/kg]			
			CH9538 1907.6 MHz	CH9400 1880 MHz	CH9262 1852.4 MHz	CH9538 1907.6 MHz	CH9400 1880 MHz	CH9262 1852.4 MHz	
RMC	Tune-up		24.00	24.00	24.00	Scaling factor*			
	Slot Average Power [dBm]		23.61	23.65	23.64	1.09	1.08	1.09	
	Left Cheek	1g SAR	0.624	0.721	0.705	0.68	0.78	0.77	
		10g SAR	0.378	0.43	0.426	0.41	0.47	0.46	
		Deviation	0.06	0.04	0.07	0.06	0.04	0.07	
	Left Tilt	1g SAR		0.236			0.26		
		10g SAR		0.153			0.17		
		Deviation		0.06			0.06		
	Right Cheek	1g SAR		0.266			0.29		
		10g SAR		0.158			0.17		
		Deviation		0.04			0.04		
	Right Tilt	1g SAR		0.249			0.27		
		10g SAR		0.157			0.17		
		Deviation		0.02			0.02		

Table 14-6 WCDMA1900-BII #1Body

WCDMA1900-BII #1Body								
Ambient Temperature: 22.5			Liquid Temperature: 22.3					
Mode	Device orientation	SAR measurement	Measured SAR [W/kg]			Reported SAR [W/kg]		
			CH9538 1907.6 MHz	CH9400 1880 MHz	CH9262 1852.4 MHz	CH9538 1907.6 MHz	CH9400 1880 MHz	CH9262 1852.4 MHz
RMC	Tune-up		24.00	24.00	24.00	Scaling factor*		
	Slot Average Power [dBm]		23.61	23.65	23.64	1.09	1.08	1.09
	Front	1g SAR	0.795	0.902	0.909	0.87	0.98	0.99
		10g SAR	0.471	0.562	0.575	0.52	0.61	0.62
		Deviation	0.04	0.02	0.01	0.04	0.02	0.01
	Rear	1g SAR	1.12	1.2	1.15	1.23	1.30	1.25
		10g SAR	0.621	0.675	0.611	0.68	0.73	0.66
		Deviation	0.06	-0.04	0.04	0.06	-0.04	0.04
	Left edge	1g SAR		0.235			0.25	
		10g SAR		0.142			0.15	
		Deviation		0.06			0.06	
	Right edge	1g SAR		0.278			0.30	
		10g SAR		0.163			0.18	
		Deviation		0.07			0.07	
	Bottom edge	1g SAR	1.06	1.14	1.09	1.16	1.24	1.18
10g SAR		0.601	0.654	0.598	0.66	0.71	0.65	
Deviation		0.04	0.03	0.06	0.04	0.03	0.06	
RMC H1	Rear	1g SAR		1.07			1.16	
		10g SAR		0.61			0.66	
		Deviation		0.06			0.06	
RMC H2	Rear	1g SAR		1.05			1.14	
		10g SAR		0.602			0.65	
		Deviation		-0.02			-0.02	
RMC H3	Rear	1g SAR		1.1			1.19	
		10g SAR		0.624			0.68	
		Deviation		-0.06			-0.06	
RMC H4	Rear	1g SAR		1.07			1.16	
		10g SAR		0.607			0.66	
		Deviation		-0.07			-0.07	

Table 14-7 WCDMA850-BV #1Head

WCDMA850-BV #1Head								
Ambient Temperature: 22.5			Liquid Temperature: 22.3					
Mode	Device orientation	SAR measurement	Measured SAR [W/kg]			Reported SAR [W/kg]		
			CH4233 846.6 MHz	CH4182 836.4 MHz	CH4132 826.4 MHz	CH4233 846.6 MHz	CH4182 836.4 MHz	CH4132 826.4 MHz
RMC	Tune-up		24.00	24.00	24.00	Scaling factor*		
	Slot Average Power [dBm]		23.32	23.39	23.34	1.17	1.15	1.16
	Left Cheek	1g SAR	0.265	0.291	0.224	0.31	0.33	0.26
		10g SAR	0.192	0.219	0.162	0.22	0.25	0.19
		Deviation	0.04	0.09	0.06	0.04	0.09	0.06
	Left Tilt	1g SAR		0.174			0.20	
		10g SAR		0.129			0.15	
		Deviation		0.08			0.08	
	Right Cheek	1g SAR		0.209			0.24	
		10g SAR		0.153			0.18	
		Deviation		0.03			0.03	
	Right Tilt	1g SAR		0.13			0.15	
		10g SAR		0.097			0.11	
		Deviation		0.08			0.08	

Table 14-8 WCDMA850-BV #1Body

WCDMA850-BV #1Body								
Ambient Temperature: 22.5			Liquid Temperature: 22.3					
Mode	Device orientation	SAR measurement	Measured SAR [W/kg]			Reported SAR [W/kg]		
			CH4233 846.6 MHz	CH4182 836.4 MHz	CH4132 826.4 MHz	CH4233 846.6 MHz	CH4182 836.4 MHz	CH4132 826.4 MHz
RMC	Tune-up		24.00	24.00	24.00	Scaling factor*		
	Slot Average Power [dBm]		23.32	23.39	23.34	1.17	1.15	1.16
	Front	1g SAR		0.212			0.24	
		10g SAR		0.15			0.17	
		Deviation		0.05			0.05	
	Rear	1g SAR	0.357	0.287	0.34	0.42	0.33	0.40
		10g SAR	0.266	0.201	0.261	0.31	0.23	0.30
		Deviation	-0.04	0.06	-0.14	-0.04	0.06	-0.14
	Left edge	1g SAR		0.166			0.19	
		10g SAR		0.116			0.13	
		Deviation		-0.09			-0.09	
	Right edge	1g SAR		0.123			0.14	
		10g SAR		0.087			0.10	
		Deviation		-0.12			-0.12	
	Bottom edge	1g SAR		0.089			0.10	
		10g SAR		0.052			0.06	
		Deviation		0.04			0.04	



Table 14-9 LTE2500-FDD7 #1 Head

LTE2500-FDD7 #1 Head								
Ambient Temperature: 22.5			Liquid Temperature: 22.3					
Mode	Device orientation	SAR measurement	Measured SAR [W/kg]			Reported SAR [W/kg]		
			21350	21100	20850	21350	21100	20850
			M	M	M	M	M	M
20MHz QPSK1RB	Tune-up		24.50	24.50	24.50	Scaling factor*		
	Measured Power [dBm]		23.94	23.91	23.92	1.14	1.14	1.14
	Left Cheek	1g SAR	0.263			0.30		
		10g SAR	0.135			0.15		
		Deviation	0.07			0.07		
	Left Tilt	1g SAR	0.125			0.14		
		10g SAR	0.057			0.06		
		Deviation	-0.01			-0.01		
	Right Cheek	1g SAR	0.284			0.32		
		10g SAR	0.149			0.17		
		Deviation	0.07			0.07		
	Right Tilt	1g SAR	0.135			0.15		
		10g SAR	0.064			0.07		
		Deviation	0.07			0.07		
TRUE	Device orientation	SAR measurement	Measured SAR [W/kg]			Reported SAR [W/kg]		
			21350	21100	20850	21350	21100	20850
			M	M	H	M	M	H
20MHz QPSK50% RB	Tune-up		23.50	23.50	23.50	Scaling factor*		
	Measured Power [dBm]		22.91	22.88	22.86	1.15	1.15	1.16
	Left Cheek	1g SAR	0.201			0.23		
		10g SAR	0.103			0.12		
		Deviation	-0.04			-0.04		
	Left Tilt	1g SAR	0.097			0.11		
		10g SAR	0.046			0.05		
		Deviation	0.09			0.09		
	Right Cheek	1g SAR	0.218			0.25		
		10g SAR	0.114			0.13		
		Deviation	0.02			0.02		
	Right Tilt	1g SAR	0.104			0.12		
		10g SAR	0.05			0.06		
		Deviation	0.01			0.01		

Table 14-10 LTE2500-FDD7 #1 Body

LTE2500-FDD7 #1 Body								
Ambient Temperature: 22.5					Liquid Temperature: 22.3			
Mode	Device orientation	SAR measurement	Measured SAR [W/kg]			Reported SAR [W/kg]		
			21350	21100	20850	21350	21100	20850
			M	M	M	M	M	M
20MHz QPSK1RB	Tune-up		24.50	24.50	24.50	Scaling factor*		
	Measured Power [dBm]		23.94	23.91	23.92	1.14	1.14	1.14
	Front	1g SAR	0.29			0.33		
		10g SAR	0.148			0.17		
		Deviation	0.04			0.04		
	Rear	1g SAR	0.776	0.76	0.746	0.88	0.87	0.85
		10g SAR	0.366	0.365	0.358	0.42	0.42	0.41
		Deviation	0.09	0.11	0.09	0.09	0.11	0.09
	Left edge	1g SAR	0.056			0.06		
		10g SAR	0.034			0.04		
		Deviation	-0.03			-0.03		
	Right edge	1g SAR	0.061			0.07		
		10g SAR	0.032			0.04		
		Deviation	0.06			0.06		
	Bottom edge	1g SAR	0.729	0.714	0.732	0.83	0.82	0.84
10g SAR		0.343	0.336	0.342	0.39	0.38	0.39	
Deviation		0.04	0.04	0.06	0.04	0.04	0.06	
Mode	Device orientation	SAR measurement	Measured			Reported SAR [W/kg]		
			21350	21100	20850	21350	21100	20850
			M	M	H			
20MHz QPSK50% RB	Tune-up		23.50	23.50	23.50	Scaling factor*		
	Measured Power [dBm]		22.91	22.88	22.86	1.15	1.15	1.16
	Front	1g SAR	0.191			0.22		
		10g SAR	0.096			0.11		
		Deviation	0.03			0.03		
	Rear	1g SAR	0.573			0.66		
		10g SAR	0.273			0.31		
		Deviation	0.09			0.09		
	Left edge	1g SAR	0.031			0.04		
		10g SAR	0.019			0.02		
		Deviation	0.02			0.02		
	Right edge	1g SAR	0.038			0.04		
		10g SAR	0.022			0.03		
		Deviation	0.04			0.04		
	Bottom edge	1g SAR	0.583			0.67		
10g SAR		0.271			0.31			
Deviation		0.04			0.04			
Mode	Device orientation	SAR measurement	Measured SAR [W/kg]			Reported SAR [W/kg]		
			21350	21100	20850	21350	21100	20850
20MHz QPSK100% RB	Tune-up		23.50	23.50	23.50	Scaling factor*		
	Measured Power [dBm]		22.81	22.79	22.75	1.17	1.18	1.19
	Rear	1g SAR	0.56			0.66		
		10g SAR	0.266			0.31		
Deviation		0.04			0.04			
20MHz QPSK100% RB	Bottom edge	1g SAR	0.602			0.71		
		10g SAR	0.29			0.34		
		Deviation	0.04			0.04		



14.2 Full SAR

Test Band	Channel	Frequency	Tune-Up	Measured Power	Test Position	Measured 10g SAR	Measured 1g SAR	Reported 10g SAR	Reported 1g SAR	Power Drift	Figure
GSM850	251	848.8 MHz	33.3	32.46	Left Cheek	0.191	0.253	0.23	0.31	-0.09	Fig A.1
GSM850	251	848.8 MHz	30.5	30.08	Rear	0.174	0.234	0.19	0.26	-0.12	Fig A.2
PCS1900	661	1880 MHz	30.3	30.04	Left Cheek	0.266	0.442	0.28	0.47	-0.09	Fig A.3
PCS1900	512	1850.2 MHz	28	27.57	Rear	0.605	1.06	0.67	1.17	-0.14	Fig A.4
WCDMA1900-BII	9400	1880 MHz	24	23.65	Left Cheek	0.43	0.721	0.47	0.78	0.04	Fig A.5
WCDMA1900-BII	9400	1880 MHz	24	23.65	Rear	0.675	1.2	0.73	1.30	-0.04	Fig A.6
WCDMA850-BV	4182	836.4 MHz	24	23.39	Left Cheek	0.219	0.291	0.25	0.33	0.09	Fig A.7
WCDMA850-BV	4233	846.6 MHz	24	23.32	Rear	0.266	0.357	0.31	0.42	-0.04	Fig A.8
LTE2500-FDD7	21350	2560 MHz	24.5	23.94	Right Cheek	0.149	0.284	0.17	0.32	0.07	Fig A.9
LTE2500-FDD7	21350	2560 MHz	24.5	23.94	Rear	0.366	0.776	0.42	0.88	0.09	Fig A.10

14.3 WLAN Evaluation

According to the KDB248227 D01, SAR is measured for 802.11b DSSS using the initial test position procedure.

Note1: When the reported SAR of the initial test position is > 0.4 W/kg, SAR is repeated for the 802.11 transmission mode configuration tested in the initial test position using subsequent highest estimated 1-g SAR conditions determined by area scans, on the highest maximum output power channel, until the reported SAR is ≤ 0.8 W/kg.

Note2: For all positions/configurations tested using the initial test position and subsequent test positions, when the reported SAR is > 0.8 W/kg, SAR is measured for these test positions/configurations on the subsequent next highest measured output power channel until the reported SAR is ≤ 1.2 W/kg or all required channels are tested.

Note3: According to the KDB248227 D01, The reported SAR must be scaled to 100% transmission duty factor to determine compliance at the maximum tune-up tolerance limit.

Table 14-11 WLAN2450 #1 Head Fast SAR

WLAN2450 #1 Head Fast SAR								
Ambient Temperature: 22.5				Liquid Temperature: 22.3				
Rate	Device orientation	SAR measurement	Measured SAR [W/kg]			Reported SAR [W/kg]		
			11 2462 MHz	6 2437 MHz	1 2412 MHz	11	6	1
802.11b 1Mbps	Tune up		18.5	18.5	18.5	Scaling factor*		
	Slot Average Power [dBm]		17.95	18.21	17.79	1.14	1.07	1.18
	Left Cheek	1g Fast SAR		0.537			0.57	
		10g SAR		0.311			0.33	
		Deviation		-0.07			-0.07	
	Left Tilt	1g Fast SAR		0.442			0.47	
		10g SAR		0.237			0.25	
		Deviation		0.13			0.13	
	Right Cheek	1g Fast SAR	1.1	1.15	1.04	1.25	1.23	1.22
		10g SAR	0.577	0.587	0.539	0.65	0.63	0.63
		Deviation	0.02	-0.01	0.02	0.02	-0.01	0.02
	Right Tilt	1g Fast SAR		0.739			0.79	
		10g SAR		0.368			0.39	
		Deviation		0.06			0.06	

Table 14-12 WLAN2450 #1 Head Full SAR

WLAN2450 #1 Head Full SAR								
Ambient Temperature: 22.5				Liquid Temperature: 22.3				
Rate	Device orientation	SAR measurement	Measured SAR [W/kg]			Reported SAR [W/kg]		
			11 2462 MHz	6 2437 MHz	1 2412 MHz	11	6	1
802.11b 1Mbps	Tune up		18.5	18.5	18.5	Scaling factor*		
	Slot Average Power [dBm]		17.95	18.21	17.79	1.14	1.07	1.18
	Right Cheek	1g Full SAR	1.07	1.08	1.02	1.21	1.15	1.20
		10g SAR	0.56	0.565	0.527	0.64	0.60	0.62
		Deviation	0.02	-0.01	0.02	0.02	-0.01	0.02
	Right Tilt	1g Full SAR		0.661			0.71	
		10g SAR		0.336			0.36	
		Deviation		0.06			0.06	