

Table 14-18 LTE700-FDD12 #1 Body

LTE700-FDD12 #1 Body								
Ambient Temperature: 22.5				Liquid Temperature: 22.3				
Mode	Device orientation	SAR measurement	Measured SAR [W/kg]			Reported SAR [W/kg]		
			23130 M	23095 M	23060 M	23130 M	23095 M	23060 M
10MHz QPSK1RB	Tune-up		24.00	24.00	24.00	Scaling factor*		
	Measured Power [dBm]		23.23	23.26	23.23	1.19	1.18	1.20
	Front	1g SAR		0.119			0.14	
		10g SAR		0.093			0.11	
		Deviation		0.05			0.05	
	Rear	1g SAR		0.196			0.23	
		10g SAR		0.154			0.18	
		Deviation		0.02			0.02	
	Left edge	1g SAR		0.141			0.17	
		10g SAR		0.1			0.12	
		Deviation		0.14			0.14	
	Right edge	1g SAR		0.164			0.19	
		10g SAR		0.118			0.14	
		Deviation		0.16			0.16	
Bottom edge	1g SAR		0.053			0.06		
	10g SAR		0.036			0.04		
	Deviation		0.08			0.08		
Mode	Device orientation	SAR measurement	Measured SAR [W/kg]			Reported SAR [W/kg]		
			23130 M	23095 H	23060 H	23130	23095	23060
10MHz QPSK50% RB	Tune-up		23.00	23.00	23.00	Scaling factor*		
	Measured Power [dBm]		22.16	22.20	22.17	1.21	1.20	1.21
	Front	1g SAR		0.09			0.11	
		10g SAR		0.07			0.08	
		Deviation		0.18			0.18	
	Rear	1g SAR		0.149			0.18	
		10g SAR		0.116			0.14	
		Deviation		0.18			0.18	
	Left edge	1g SAR		0.105			0.13	
		10g SAR		0.075			0.09	
		Deviation		0.18			0.18	
	Right edge	1g SAR		0.123			0.15	
		10g SAR		0.089			0.11	
		Deviation		0.03			0.03	
Bottom edge	1g SAR		0.047			0.06		
	10g SAR		0.027			0.03		
	Deviation		0.03			0.03		
Mode	Device orientation	SAR measurement	Measured SAR [W/kg]			Reported SAR [W/kg]		
			23130	23095	23060	23130	23095	23060
10MHz QPSK100% RB	Tune-up		23.00	23.00	23.00	Scaling factor*		
	Measured Power [dBm]		22.16	22.26	22.15	1.21	1.19	1.22
	Rear	1g SAR						
		10g SAR						
Deviation								
10MHz QPSK1RB B2	Rear	1g SAR		0.176			0.21	
		10g SAR		0.143			0.17	
		Deviation		0.05			0.05	



Table 14-19 LTE750-FDD13 #1 Head

LTE750-FDD13 #1 Head								
Ambient Temperature: 22.5				Liquid Temperature: 22.3				
Mode	Device orientation	SAR measurement	Measured SAR [W/kg]			Reported SAR [W/kg]		
			H	M	23230	H	M	23230
			H	H	M	H	H	M
10MHz QPSK1RB	Tune-up		24.00	24.00	24.00	Scaling factor*		
	Measured Power [dBm]		0.00	0.00	23.23	251.19	251.19	1.19
	Left Cheek	1g SAR			0.086			0.10
		10g SAR			0.068			0.08
		Deviation			0.18			0.18
	Left Tilt	1g SAR			0.07			0.08
		10g SAR			0.057			0.07
		Deviation			0.19			0.19
	Right Cheek	1g SAR			0.104			0.12
		10g SAR			0.08			0.10
		Deviation			-0.02			-0.02
	Right Tilt	1g SAR			0.064			0.08
		10g SAR			0.05			0.06
		Deviation			0.17			0.17
	TRUE	Device orientation	SAR measurement	Measured SAR [W/kg]			Reported SAR [W/kg]	
H				M	23230	H	M	23230
			H	H	H	H	H	H
10MHz QPSK50% RB	Tune-up		23.00	23.00	24.00	Scaling factor*		
	Measured Power [dBm]		0.00	0.00	22.23	199.53	199.53	1.50
	Left Cheek	1g SAR			0.055			0.08
		10g SAR			0.044			0.07
		Deviation			0.14			0.14
	Left Tilt	1g SAR			0.05			0.08
		10g SAR			0.04			0.06
		Deviation			0.13			0.13
	Right Cheek	1g SAR			0.081			0.12
		10g SAR			0.062			0.09
		Deviation			0.17			0.17
	Right Tilt	1g SAR			0.058			0.09
		10g SAR			0.046			0.07
		Deviation			0.15			0.15
	Mode	Device orientation	SAR measurement	Measured SAR [W/kg]			Reported SAR [W/kg]	
H				M	23230	H	M	23230
10MHz QPSK100% RB	Tune-up		23.00	23.00	24.00	Scaling factor*		
	Measured Power [dBm]		0.00	0.00	22.24	199.53	199.53	1.50
	Left Cheek	1g SAR						
		10g SAR						
Deviation								
10MHz QPSK1RB B2	Right Cheek	1g SAR			0.098			0.12
		10g SAR			0.067			0.08
		Deviation			0.03			0.03

Table 14-20 LTE750-FDD13 #1 Body

LTE750-FDD13 #1 Body								
Ambient Temperature: 22.5				Liquid Temperature: 22.3				
Mode	Device orientation	SAR measurement	Measured SAR [W/kg]			Reported SAR [W/kg]		
			H	M	23230	H	M	23230
			H	H	M	H	H	M
10MHz QPSK1RB	Tune-up		24.00	24.00	24.00	Scaling factor*		
	Measured Power [dBm]		0.00	0.00	23.23	251.19	251.19	1.19
	Front	1g SAR			0.124			0.15
		10g SAR			0.092			0.11
		Deviation			0.04			0.04
	Rear	1g SAR			0.228			0.27
		10g SAR			0.126			0.15
		Deviation			-0.02			-0.02
	Left edge	1g SAR			0.13			0.16
		10g SAR			0.085			0.10
		Deviation			-0.09			-0.09
	Right edge	1g SAR			0.176			0.21
		10g SAR			0.121			0.14
		Deviation			-0.01			-0.01
	Bottom edge	1g SAR			0.096			0.11
10g SAR				0.052			0.06	
Deviation				0.05			0.05	
Mode	Device orientation	SAR measurement	Measured SAR [W/kg]			Reported SAR [W/kg]		
			H	M	23230	H	M	23230
			H	H	H			
10MHz QPSK50% RB	Tune-up		23.00	23.00	24.00	Scaling factor*		
	Measured Power [dBm]		0.00	0.00	22.23	199.53	199.53	1.50
	Front	1g SAR			0.098			0.15
		10g SAR			0.073			0.11
		Deviation			0.02			0.02
	Rear	1g SAR			0.171			0.26
		10g SAR			0.097			0.15
		Deviation			-0.06			-0.06
	Left edge	1g SAR			0.096			0.14
		10g SAR			0.063			0.09
		Deviation			-0.05			-0.05
	Right edge	1g SAR			0.134			0.20
		10g SAR			0.091			0.14
		Deviation			0.01			0.01
	Bottom edge	1g SAR			0.077			0.12
10g SAR				0.042			0.06	
Deviation				0.08			0.08	
Mode	Device orientation	SAR measurement	Measured SAR [W/kg]			Reported SAR [W/kg]		
			H	M	23230	H	M	23230
			H	H	H			
10MHz QPSK100% RB	Tune-up		23.00	23.00	24.00	Scaling factor*		
	Measured Power [dBm]		0.00	0.00	22.24	199.53	199.53	1.50
	Front	1g SAR						
		10g SAR						
Deviation								
10MHz QPSK1RB B2	Rear	1g SAR			0.206			0.25
		10g SAR			0.112			0.13
		Deviation			0.09			0.09



Table 14-21 LTE1700-FDD66 #1 Head

LTE1700-FDD66 #1 Head								
Ambient Temperature: 22.5				Liquid Temperature: 22.3				
Mode	Device orientation	SAR measurement	Measured SAR [W/kg]			Reported SAR [W/kg]		
			132572	132322	132072	132572	132322	132072
			M	M	M	M	M	M
20MHz QPSK1RB	Tune-up		24.50	24.50	24.50	Scaling factor*		
	Measured Power [dBm]		23.84	23.88	23.92	1.16	1.15	1.14
	Left Cheek	1g SAR			0.204			0.23
		10g SAR			0.137			0.16
		Deviation			0.03			0.03
	Left Tilt	1g SAR			0.173			0.20
		10g SAR			0.108			0.12
		Deviation			0.09			0.09
	Right Cheek	1g SAR			0.198			0.23
		10g SAR			0.127			0.15
		Deviation			0.11			0.11
	Right Tilt	1g SAR			0.175			0.20
		10g SAR			0.115			0.13
		Deviation			0.04			0.04
FALSE	Device orientation	SAR measurement	Measured SAR [W/kg]			Reported SAR [W/kg]		
			132572	132322	132072	132572	132322	132072
			L	M	M	L	M	M
20MHz QPSK50% RB	Tune-up		23.50	23.50	23.50	Scaling factor*		
	Measured Power [dBm]		22.88	22.79	22.79	1.15	1.18	1.18
	Left Cheek	1g SAR	0.219			0.25		
		10g SAR	0.142			0.16		
		Deviation	0.19			0.19		
	Left Tilt	1g SAR	0.128			0.15		
		10g SAR	0.077			0.09		
		Deviation	0.01			0.01		
	Right Cheek	1g SAR	0.206			0.24		
		10g SAR	0.13			0.15		
		Deviation	0.03			0.03		
	Right Tilt	1g SAR	0.121			0.14		
		10g SAR	0.08			0.09		
		Deviation	0.04			0.04		
Mode	Device orientation	SAR measurement	Measured SAR [W/kg]			Reported SAR [W/kg]		
			132572	132322	132072	132572	132322	132072
20MHz QPSK100% RB	Tune-up		23.50	23.50	23.50	Scaling factor*		
	Measured Power [dBm]		22.82	22.78	22.75	1.17	1.18	1.19
	Left Cheek	1g SAR						
		10g SAR						
Deviation								
20MHz QPSK50% RB B2	Left Cheek	1g SAR	0.211			0.24		
		10g SAR	0.137			0.16		
		Deviation	0.04			0.04		

Table 14-22 LTE1700-FDD66 #1 Body

LTE1700-FDD66 #1 Body								
Ambient Temperature: 22.5				Liquid Temperature: 22.3				
Mode	Device orientation	SAR measurement	Measured SAR [W/kg]			Reported SAR [W/kg]		
			132572	132322	132072	132572	132322	132072
			M	M	M	M	M	M
20MHz QPSK1RB	Tune-up		24.50	24.50	24.50	Scaling factor*		
	Measured Power [dBm]		23.84	23.88	23.92	1.16	1.15	1.14
	Front	1g SAR			0.462			0.53
		10g SAR			0.26			0.30
		Deviation			0.09			0.09
	Rear	1g SAR			0.648			0.74
		10g SAR			0.341			0.39
		Deviation			0.14			0.14
	Left edge	1g SAR			0.306			0.35
		10g SAR			0.175			0.20
		Deviation			0.02			0.02
	Right edge	1g SAR			0.127			0.15
		10g SAR			0.075			0.09
		Deviation			0.15			0.15
	Bottom edge	1g SAR			0.438			0.50
10g SAR				0.243			0.28	
Deviation				0.18			0.18	
Mode	Device orientation	SAR measurement	Measured SAR [W/kg]			Reported SAR [W/kg]		
			132572	132322	132072	132572	132322	132072
			L	M	M			
20MHz QPSK50% RB	Tune-up		23.50	23.50	23.50	Scaling factor*		
	Measured Power [dBm]		22.88	22.79	22.79	1.15	1.18	1.18
	Front	1g SAR	0.368			0.42		
		10g SAR	0.203			0.23		
		Deviation	0.05			0.05		
	Rear	1g SAR	0.476			0.55		
		10g SAR	0.249			0.29		
		Deviation	0.16			0.16		
	Left edge	1g SAR	0.215			0.25		
		10g SAR	0.123			0.14		
		Deviation	0.07			0.07		
	Right edge	1g SAR	0.089			0.10		
		10g SAR	0.052			0.06		
		Deviation	0.14			0.14		
	Bottom edge	1g SAR	0.324			0.37		
10g SAR		0.178			0.21			
Deviation		0.1			0.10			
Mode	Device orientation	SAR measurement	Measured SAR [W/kg]			Reported SAR [W/kg]		
			132572	132322	132072	132572	132322	132072
20MHz QPSK100% RB	Tune-up		23.50	23.50	23.50	Scaling factor*		
	Measured Power [dBm]		22.82	22.78	22.75	1.17	1.18	1.19
	Front	1g SAR						
		10g SAR						
Deviation								
20MHz QPSK1RB B2	Rear	1g SAR			0.621			0.71
		10g SAR			0.304			0.35
		Deviation			0.04			0.04



### 14.3 Full SAR

Test Band	Channel	Frequency	Tune-Up	Measured Power	Test Position	Measured 10g SAR	Measured 1g SAR	Reported 10g SAR	Reported 1g SAR	Power Drift	Figure
GSM850	251	848.8 MHz	33.8	32.94	Right Cheek	0.142	0.187	0.17	0.23	0.18	<a href="#">Fig A.1</a>
GSM850	190	836.6 MHz	30.5	30.49	Rear	0.115	0.215	0.12	0.22	0.04	<a href="#">Fig A.2</a>
PCS1900	512	1850.2 MHz	30.3	29.79	Left Cheek	0.094	0.149	0.11	0.17	0.11	<a href="#">Fig A.3</a>
PCS1900	661	1880 MHz	25	24.38	Rear	0.232	0.44	0.27	0.51	-0.06	<a href="#">Fig A.4</a>
WCDMA850-BV	4233	846.6 MHz	24	23.98	Right Cheek	0.157	0.207	0.16	0.21	0.17	<a href="#">Fig A.5</a>
WCDMA850-BV	4182	835.4 MHz	24	23.87	Rear	0.118	0.22	0.12	0.23	-0.02	<a href="#">Fig A.6</a>
WCDMA1700-BIV	1412	1732.4 MHz	24	23.57	Left Cheek	0.167	0.259	0.18	0.29	0.02	<a href="#">Fig A.7</a>
WCDMA1700-BIV	1412	1732.4 MHz	24	23.57	Rear	0.282	0.524	0.31	0.58	0.18	<a href="#">Fig A.8</a>
WCDMA1900-BII	9400	1880 MHz	24	23.62	Left Cheek	0.139	0.225	0.15	0.25	0.18	<a href="#">Fig A.9</a>
WCDMA1900-BII	9400	1880 MHz	24	23.62	Rear	0.305	0.573	0.33	0.63	0.16	<a href="#">Fig A.10</a>
LTE1900-FDD2	19100	1900 MHz	24	23.51	Left Cheek	0.119	0.189	0.13	0.21	-0.09	<a href="#">Fig A.11</a>
LTE1900-FDD2	19100	1900 MHz	24	23.51	Rear	0.345	0.658	0.39	0.74	0.19	<a href="#">Fig A.12</a>
LTE850-FDD5	20600	844 MHz	24.5	23.97	Right Cheek	0.144	0.189	0.16	0.21	0.1	<a href="#">Fig A.13</a>
LTE850-FDD5	20600	844 MHz	24.5	23.97	Rear	0.141	0.264	0.16	0.30	-0.02	<a href="#">Fig A.14</a>
LTE2500-FDD7	21350	2560 MHz	23.5	23.18	Left Cheek	0.147	0.275	0.16	0.30	0.05	<a href="#">Fig A.15</a>
LTE2500-FDD7	21350	2560 MHz	23.5	23.18	Bottom edge	0.431	1.03	0.46	1.11	0.07	<a href="#">Fig A.16</a>
LTE700-FDD12	23095	707.5 MHz	24	23.26	Left Cheek	0.064	0.08	0.08	0.09	0.08	<a href="#">Fig A.17</a>
LTE700-FDD12	23095	707.5 MHz	24	23.26	Rear	0.154	0.196	0.18	0.23	0.02	<a href="#">Fig A.18</a>
LTE750-FDD13	23230	782 MHz	24	23.23	Right Cheek	0.08	0.104	0.10	0.12	-0.02	<a href="#">Fig A.19</a>
LTE750-FDD13	23230	782 MHz	24	23.23	Rear	0.126	0.228	0.15	0.27	-0.02	<a href="#">Fig A.20</a>
LTE1700-FDD66	132572	782 MHz	24.5	23.84	Left Cheek	0.142	0.219	0.16	0.25	0.19	<a href="#">Fig A.21</a>
LTE1700-FDD66	132072	782 MHz	24.5	23.92	Rear	0.341	0.648	0.39	0.74	0.14	<a href="#">Fig A.22</a>

### 14.4 WLAN Evaluation

According to the KDB248227 D01, SAR is measured for 802.11b DSSS using the initial test position procedure.

Note1: When the reported SAR of the initial test position is > 0.4 W/kg, SAR is repeated for the 802.11 transmission mode configuration tested in the initial test position using subsequent highest estimated 1-g SAR conditions determined by area scans, on the highest maximum output power channel, until the reported SAR is ≤ 0.8 W/kg.

Note2: For all positions/configurations tested using the initial test position and subsequent test positions, when the reported SAR is > 0.8 W/kg, SAR is measured for these test positions/configurations on the subsequent next highest measured output power channel until the reported SAR is ≤ 1.2 W/kg or all required channels are tested.

Note3: According to the KDB248227 D01, The reported SAR must be scaled to 100% transmission duty factor to determine compliance at the maximum tune-up tolerance limit.

**Table 14-23 WLAN2450 #1 Head Fast SAR**

WLAN2450 #1 Head Fast SAR								
Ambient Temperature: 22.5				Liquid Temperature: 22.3				
Rate	Device orientation	SAR measurement	Measured SAR [W/kg]			Reported SAR [W/kg]		
			11 2462 MHz	6 2437 MHz	1 2412 MHz	11	6	1
802.11b 1Mbps	Tune up		18	18	18	Scaling factor*		
	Slot Average Power [dBm]		17.59	17.32	17.67	1.10	1.17	1.08
	Left Cheek	1g Fast SAR			0.11			0.12
		10g SAR			0.058			0.06
		Deviation			0.06			0.06
	Left Tilt	1g Fast SAR			0.117			0.13
		10g SAR			0.059			0.06
		Deviation			0.01			0.01
	Right Cheek	1g Fast SAR			0.198			0.21
		10g SAR			0.102			0.11
		Deviation			0.02			0.02
	Right Tilt	1g Fast SAR			0.207			0.22
		10g SAR			0.099			0.11
		Deviation			0.03			0.03
802.11b 1Mbps B2	Right Tilt	1g Fast SAR			0.198		0.21	
		10g SAR			0.087		0.09	
		Deviation			0.02		0.02	

**Table 14-24 WLAN2450 #1 Head Full SAR**

WLAN2450 #1 Head Full SAR								
Ambient Temperature: 22.5				Liquid Temperature: 22.3				
Rate	Device orientation	SAR measurement	Measured SAR [W/kg]			Reported SAR [W/kg]		
			11 2462 MHz	6 2437 MHz	1 2412 MHz	11	6	1
802.11b 1Mbps	Tune up		18	18	18	Scaling factor*		
	Slot Average Power [dBm]		17.59	17.32	17.67	1.10	1.17	1.08
	Right Tilt	1g Full SAR			0.201			0.22
		10g SAR			0.098			0.11
		Deviation			0.03			0.03

According to the KDB248227 D01, The reported SAR must be scaled to 100% transmission duty factor to determine compliance at the maximum tune-up tolerance limit. The scaled reported SAR is presented as below							
Frequency		Test Position	Actual duty factor	maximum duty factor	Reported SAR(1g)(W/kg)	Scaled reported SAR(1g)(W/kg)	Figure
MHz	Ch.						
2412 MHz	1	Right Tilt	100.00%	100%	0.22	0.22	Fig A.23

**Table 14-25 WLAN2450 #1 Body Fast SAR**

WLAN2450 #1 Body Fast SAR								
Ambient Temperature: 22.5				Liquid Temperature: 22.3				
Rate	Device orientation	SAR measurement	Measured SAR [W/kg]			Reported SAR [W/kg]		
			11 2462 MHz	6 2437 MHz	1 2412 MHz	11	6	1
802.11b 1Mbps	Tune up		18	18	18	Scaling factor*		
	Slot Average Power [dBm]		17.59	17.32	17.67	1.10	1.17	1.08
	Front	1g Fast SAR			0.043			0.05
		10g SAR			0.024			0.03
		Deviation			0.06			0.06
	Rear	1g Fast SAR			0.174			0.19
		10g SAR			0.067			0.07
		Deviation			-0.03			-0.03
	Top edge	1g Fast SAR			0.045			0.05
		10g SAR			0.022			0.02
		Deviation			0.05			0.05
	Left edge	1g Fast SAR			0.063			0.07
		10g SAR			0.03			0.03
		Deviation			0.08			0.08
	802.11b 1Mbps B2	Rear	1g Fast SAR			0.156		0.17
10g SAR					0.062		0.07	
Deviation					0.04		0.04	

**Table 14-26 WLAN2450 #1 Body Full SAR**

WLAN2450 #1 Body Full SAR								
Ambient Temperature: 22.5				Liquid Temperature: 22.3				
Rate	Device orientation	SAR measurement	Measured SAR [W/kg]			Reported SAR [W/kg]		
			11 2462 MHz	6 2437 MHz	1 2412 MHz	11	6	1
802.11b 1Mbps	Tune up		18	18	18	Scaling factor*		
	Slot Average Power [dBm]		17.59	17.32	17.67	1.10	1.17	1.08
	Rear	1g Full SAR			0.161			0.17
		10g SAR			0.066			0.07
		Deviation			-0.03			-0.03

According to the KDB248227 D01, The reported SAR must be scaled to 100% transmission duty factor to determine compliance at the maximum tune-up tolerance limit. The scaled reported SAR is presented as below							
Frequency		Test Position	Actual duty factor	maximum duty factor	Reported SAR(1g)(W/kg)	Scaled reported SAR(1g)(W/kg)	Figure
MHz	Ch.						
2412 MHz	1	Rear	100.00%	100%	0.17	0.17	Fig A.24

SAR is not required for OFDM because the 802.11b adjusted SAR  $\leq 1.2$  W/kg.



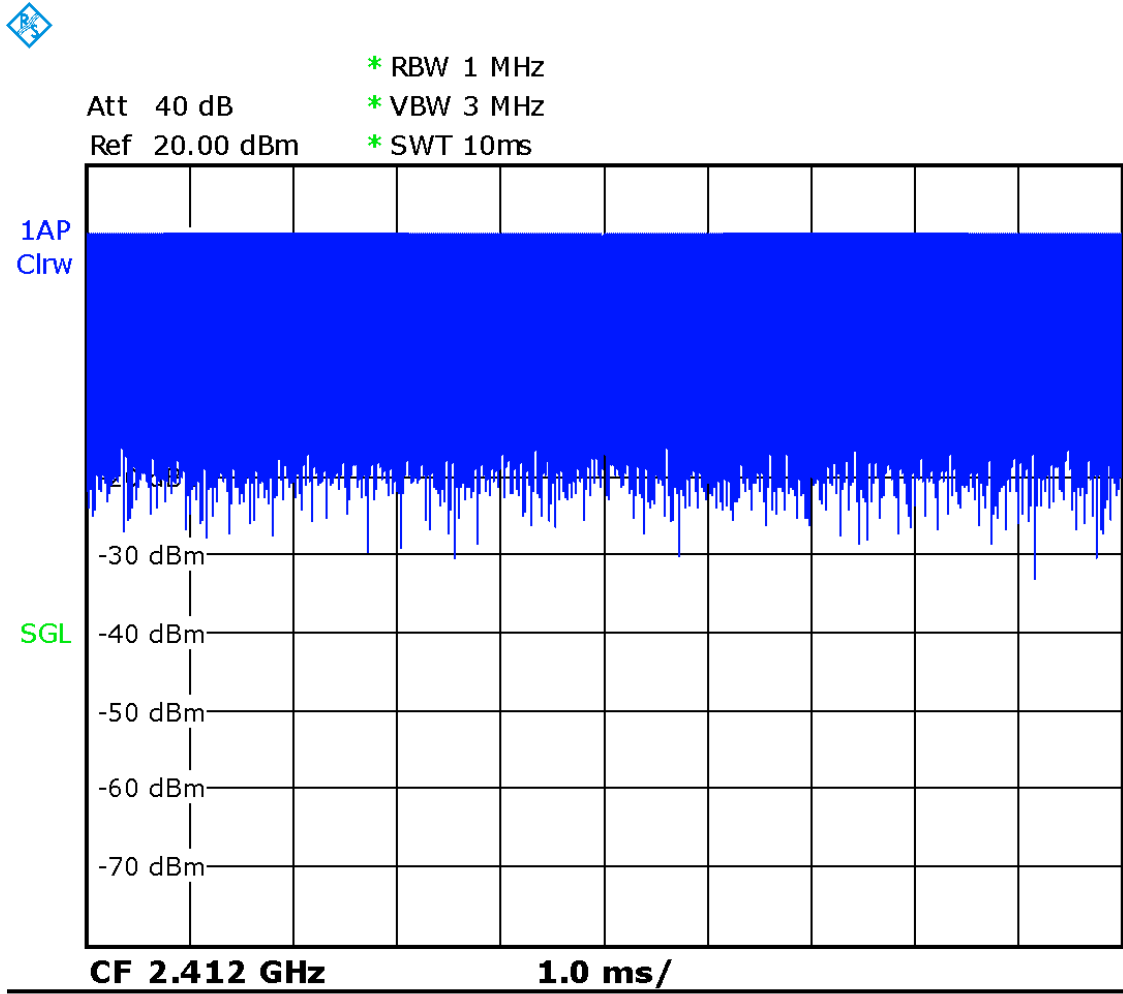

Picture 14.1 Duty factor plot

## 15 SAR Measurement Variability

SAR measurement variability must be assessed for each frequency band, which is determined by the SAR probe calibration point and tissue-equivalent medium used for the device measurements. When both head and body tissue-equivalent media are required for SAR measurements in a frequency band, the variability measurement procedures should be applied to the tissue medium with the highest measured SAR, using the highest measured SAR configuration for that tissue-equivalent medium.

The following procedures are applied to determine if repeated measurements are required.

- 1) Repeated measurement is not required when the original highest measured SAR is  $< 0.80$  W/kg; steps 2) through 4) do not apply.
- 2) When the original highest measured SAR is  $\geq 0.80$  W/kg, repeat that measurement once.
- 3) Perform a second repeated measurement only if the ratio of largest to smallest SAR for the original and first repeated measurements is  $> 1.20$  or when the original or repeated measurement is  $\geq 1.45$  W/kg ( $\sim 10\%$  from the 1-g SAR limit).
- 4) Perform a third repeated measurement only if the original, first or second repeated measurement is  $\geq 1.5$  W/kg and the ratio of largest to smallest SAR for the original, first and second repeated measurements is  $> 1.20$ .

Mode	CH	Freq	Test Poision	Original SAR (W/kg)	First Repeated SAR(W/kg)	The Ratio
LTE2500-FDD7	21350	2560 MHz	Bottom edge	1.03	1.02	1.01

## 16 Measurement Uncertainty

### 16.1 Measurement Uncertainty for Normal SAR Tests (300MHz~3GHz)

No.	Error Description	Type	Uncertainty value	Probably Distribution	Div.	(Ci) 1g	(Ci) 10g	Std. Unc. (1g)	Std. Unc. (10g)	Degree of freedom
<b>Measurement system</b>										
1	Probe calibration	B	6.0	N	1	1	1	6.0	6.0	∞
2	Isotropy	B	4.7	R	$\sqrt{3}$	0.7	0.7	1.9	1.9	∞
3	Boundary effect	B	1.0	R	$\sqrt{3}$	1	1	0.6	0.6	∞
4	Linearity	B	4.7	R	$\sqrt{3}$	1	1	2.7	2.7	∞
5	Detection limit	B	1.0	N	1	1	1	0.6	0.6	∞
6	Readout electronics	B	0.3	R	$\sqrt{3}$	1	1	0.3	0.3	∞
7	Response time	B	0.8	R	$\sqrt{3}$	1	1	0.5	0.5	∞
8	Integration time	B	2.6	R	$\sqrt{3}$	1	1	1.5	1.5	∞
9	RF ambient conditions-noise	B	0	R	$\sqrt{3}$	1	1	0	0	∞
10	RF ambient conditions-reflection	B	0	R	$\sqrt{3}$	1	1	0	0	∞
11	Probe positioned mech. restrictions	B	0.4	R	$\sqrt{3}$	1	1	0.2	0.2	∞
12	Probe positioning with respect to phantom shell	B	2.9	R	$\sqrt{3}$	1	1	1.7	1.7	∞
13	Post-processing	B	1.0	R	$\sqrt{3}$	1	1	0.6	0.6	∞
<b>Test sample related</b>										
14	Test sample positioning	A	3.3	N	1	1	1	3.3	3.3	71
15	Device holder uncertainty	A	3.4	N	1	1	1	3.4	3.4	5
16	Drift of output power	B	5.0	R	$\sqrt{3}$	1	1	2.9	2.9	∞
<b>Phantom and set-up</b>										
17	Phantom uncertainty	B	4.0	R	$\sqrt{3}$	1	1	2.3	2.3	∞
18	Liquid conductivity (target)	B	5.0	R	$\sqrt{3}$	0.64	0.43	1.8	1.2	∞
19	Liquid conductivity (meas.)	A	2.06	N	1	0.64	0.43	1.32	0.89	43
20	Liquid permittivity (target)	B	5.0	R	$\sqrt{3}$	0.6	0.49	1.7	1.4	∞
21	Liquid permittivity (meas.)	A	1.6	N	1	0.6	0.49	1.0	0.8	521

Combined standard uncertainty	$u_c = \sqrt{\sum_{i=1}^{21} c_i^2 u_i^2}$							9.55	9.43	257
Expanded uncertainty (confidence interval of 95 %)	$u_e = 2u_c$							19.1	18.9	

### 16.2 Measurement Uncertainty for Normal SAR Tests (3~6GHz)

No.	Error Description	Type	Uncertainty value	Probably Distribution	Div.	(Ci) 1g	(Ci) 10g	Std. Unc. (1g)	Std. Unc. (10g)	Degree of freedom
<b>Measurement system</b>										
1	Probe calibration	B	6.55	N	1	1	1	6.55	6.55	∞
2	Isotropy	B	4.7	R	$\sqrt{3}$	0.7	0.7	1.9	1.9	∞
3	Boundary effect	B	2.0	R	$\sqrt{3}$	1	1	1.2	1.2	∞
4	Linearity	B	4.7	R	$\sqrt{3}$	1	1	2.7	2.7	∞
5	Detection limit	B	1.0	R	$\sqrt{3}$	1	1	0.6	0.6	∞
6	Readout electronics	B	0.3	R	$\sqrt{3}$	1	1	0.3	0.3	∞
7	Response time	B	0.8	R	$\sqrt{3}$	1	1	0.5	0.5	∞
8	Integration time	B	2.6	R	$\sqrt{3}$	1	1	1.5	1.5	∞
9	RF ambient conditions-noise	B	0	R	$\sqrt{3}$	1	1	0	0	∞
10	RF ambient conditions-reflection	B	0	R	$\sqrt{3}$	1	1	0	0	∞
11	Probe positioned mech. restrictions	B	0.8	R	$\sqrt{3}$	1	1	0.5	0.5	∞
12	Probe positioning with respect to phantom shell	B	6.7	R	$\sqrt{3}$	1	1	3.9	3.9	∞
13	Post-processing	B	4.0	R	$\sqrt{3}$	1	1	2.3	2.3	∞
<b>Test sample related</b>										
14	Test sample positioning	A	3.3	N	1	1	1	3.3	3.3	71
15	Device holder uncertainty	A	3.4	N	1	1	1	3.4	3.4	5
16	Drift of output power	B	5.0	R	$\sqrt{3}$	1	1	2.9	2.9	∞
<b>Phantom and set-up</b>										
17	Phantom uncertainty	B	4.0	R	$\sqrt{3}$	1	1	2.3	2.3	∞
18	Liquid conductivity (target)	B	5.0	R	$\sqrt{3}$	0.64	0.43	1.8	1.2	∞
19	Liquid conductivity (meas.)	A	2.06	N	1	0.64	0.43	1.32	0.89	43
20	Liquid permittivity	B	5.0	R	$\sqrt{3}$	0.6	0.49	1.7	1.4	∞

	(target)									
21	Liquid permittivity (meas.)	A	1.6	N	1	0.6	0.49	1.0	0.8	521
Combined standard uncertainty		$u'_c = \sqrt{\sum_{i=1}^{21} c_i^2 u_i^2}$						10.7	10.6	257
Expanded uncertainty (confidence interval of 95 %)		$u_e = 2u_c$						21.4	21.1	

### 16.3 Measurement Uncertainty for Fast SAR Tests (300MHz~3GHz)

No.	Error Description	Type	Uncertainty value	Probably Distribution	Div.	(Ci) 1g	(Ci) 10g	Std. Unc. (1g)	Std. Unc. (10g)	Degree of freedom
<b>Measurement system</b>										
1	Probe calibration	B	6.0	N	1	1	1	6.0	6.0	∞
2	Isotropy	B	4.7	R	$\sqrt{3}$	0.7	0.7	1.9	1.9	∞
3	Boundary effect	B	1.0	R	$\sqrt{3}$	1	1	0.6	0.6	∞
4	Linearity	B	4.7	R	$\sqrt{3}$	1	1	2.7	2.7	∞
5	Detection limit	B	1.0	R	$\sqrt{3}$	1	1	0.6	0.6	∞
6	Readout electronics	B	0.3	R	$\sqrt{3}$	1	1	0.3	0.3	∞
7	Response time	B	0.8	R	$\sqrt{3}$	1	1	0.5	0.5	∞
8	Integration time	B	2.6	R	$\sqrt{3}$	1	1	1.5	1.5	∞
9	RF ambient conditions-noise	B	0	R	$\sqrt{3}$	1	1	0	0	∞
10	RF ambient conditions-reflection	B	0	R	$\sqrt{3}$	1	1	0	0	∞
11	Probe positioned mech. Restrictions	B	0.4	R	$\sqrt{3}$	1	1	0.2	0.2	∞
12	Probe positioning with respect to phantom shell	B	2.9	R	$\sqrt{3}$	1	1	1.7	1.7	∞
13	Post-processing	B	1.0	R	$\sqrt{3}$	1	1	0.6	0.6	∞
14	Fast SAR z-Approximation	B	7.0	R	$\sqrt{3}$	1	1	4.0	4.0	∞
<b>Test sample related</b>										
15	Test sample positioning	A	3.3	N	1	1	1	3.3	3.3	71
16	Device holder uncertainty	A	3.4	N	1	1	1	3.4	3.4	5
17	Drift of output power	B	5.0	R	$\sqrt{3}$	1	1	2.9	2.9	∞
<b>Phantom and set-up</b>										
18	Phantom uncertainty	B	4.0	R	$\sqrt{3}$	1	1	2.3	2.3	∞

19	Liquid conductivity (target)	B	5.0	R	$\sqrt{3}$	0.64	0.43	1.8	1.2	$\infty$
20	Liquid conductivity (meas.)	A	2.06	N	1	0.64	0.43	1.32	0.89	43
21	Liquid permittivity (target)	B	5.0	R	$\sqrt{3}$	0.6	0.49	1.7	1.4	$\infty$
22	Liquid permittivity (meas.)	A	1.6	N	1	0.6	0.49	1.0	0.8	521
Combined standard uncertainty		$u_c' = \sqrt{\sum_{i=1}^{22} c_i^2 u_i^2}$						10.4	10.3	257
Expanded uncertainty (confidence interval of 95 %)		$u_e = 2u_c$						20.8	20.6	

#### 16.4 Measurement Uncertainty for Fast SAR Tests (3~6GHz)

No.	Error Description	Type	Uncertainty value	Probably Distribution	Div.	(Ci) 1g	(Ci) 10g	Std. Unc. (1g)	Std. Unc. (10g)	Degree of freedom
<b>Measurement system</b>										
1	Probe calibration	B	6.55	N	1	1	1	6.55	6.55	$\infty$
2	Isotropy	B	4.7	R	$\sqrt{3}$	0.7	0.7	1.9	1.9	$\infty$
3	Boundary effect	B	2.0	R	$\sqrt{3}$	1	1	1.2	1.2	$\infty$
4	Linearity	B	4.7	R	$\sqrt{3}$	1	1	2.7	2.7	$\infty$
5	Detection limit	B	1.0	R	$\sqrt{3}$	1	1	0.6	0.6	$\infty$
6	Readout electronics	B	0.3	R	$\sqrt{3}$	1	1	0.3	0.3	$\infty$
7	Response time	B	0.8	R	$\sqrt{3}$	1	1	0.5	0.5	$\infty$
8	Integration time	B	2.6	R	$\sqrt{3}$	1	1	1.5	1.5	$\infty$
9	RF ambient conditions-noise	B	0	R	$\sqrt{3}$	1	1	0	0	$\infty$
10	RF ambient conditions-reflection	B	0	R	$\sqrt{3}$	1	1	0	0	$\infty$
11	Probe positioned mech. Restrictions	B	0.8	R	$\sqrt{3}$	1	1	0.5	0.5	$\infty$
12	Probe positioning with respect to phantom shell	B	6.7	R	$\sqrt{3}$	1	1	3.9	3.9	$\infty$
13	Post-processing	B	1.0	R	$\sqrt{3}$	1	1	0.6	0.6	$\infty$
14	Fast SAR z-Approximation	B	14.0	R	$\sqrt{3}$	1	1	8.1	8.1	$\infty$
<b>Test sample related</b>										
15	Test sample positioning	A	3.3	N	1	1	1	3.3	3.3	71

16	Device holder uncertainty	A	3.4	N	1	1	1	3.4	3.4	5
17	Drift of output power	B	5.0	R	$\sqrt{3}$	1	1	2.9	2.9	$\infty$
<b>Phantom and set-up</b>										
18	Phantom uncertainty	B	4.0	R	$\sqrt{3}$	1	1	2.3	2.3	$\infty$
19	Liquid conductivity (target)	B	5.0	R	$\sqrt{3}$	0.64	0.43	1.8	1.2	$\infty$
20	Liquid conductivity (meas.)	A	2.06	N	1	0.64	0.43	1.32	0.89	43
21	Liquid permittivity (target)	B	5.0	R	$\sqrt{3}$	0.6	0.49	1.7	1.4	$\infty$
22	Liquid permittivity (meas.)	A	1.6	N	1	0.6	0.49	1.0	0.8	521
Combined standard uncertainty		$u_c' = \sqrt{\sum_{i=1}^{22} c_i^2 u_i^2}$						13.5	13.4	257
Expanded uncertainty (confidence interval of 95 %)		$u_e = 2u_c$						27.0	26.8	

## 17 MAIN TEST INSTRUMENTS

**Table 17.1: List of Main Instruments**

No.	Name	Type	Serial Number	Calibration Date	Valid Period
01	Network analyzer	E5071C	MY46110673	January 24, 2018	One year
02	Power meter	NRVD	102083	November 01, 2017	One year
03	Power sensor	NRV-Z5	100542		
04	Signal Generator	E4438C	MY49071430	January 2, 2018	One Year
05	Amplifier	60S1G4	0331848	No Calibration Requested	
06	BTS	E5515C	MY50263375	January 23, 2018	One year
07	BTS	CMW500	149646	October 31, 2017	One year
08	E-field Probe	SPEAG EX3DV4	7464	September 12, 2017	One year
09	DAE	SPEAG DAE4	1525	October 2, 2017	One year
10	Dipole Validation Kit	SPEAG D750V3	1017	July 19, 2017	One year
11	Dipole Validation Kit	SPEAG D835V2	4d069	July 19, 2017	One year
12	Dipole Validation Kit	SPEAG D1750V2	1003	July 21, 2017	One year
13	Dipole Validation Kit	SPEAG D1900V2	5d101	July 26, 2017	One year
14	Dipole Validation Kit	SPEAG D2450V2	853	July 21, 2017	One year
15	Dipole Validation Kit	SPEAG D2600V2	1012	July 21, 2017	One year

\*\*\*END OF REPORT BODY\*\*\*



## ANNEX A Graph Results

### GSM850\_CH251 Right Cheek

Date: 6/2/2018

Electronics: DAE4 Sn1525

Medium: Head 835 MHz

Medium parameters used:  $f = 848.8$  MHz;  $\sigma = 0.914$  mho/m;  $\epsilon_r = 41.58$ ;  $\rho = 1000$  kg/m<sup>3</sup>

Ambient Temperature: 22.5°C, Liquid Temperature: 22.3°C

Communication System: GSM850 848.8 MHz Duty Cycle: 1:8.3

Probe: EX3DV4 – SN7464 ConvF(10.28,10.28,10.28)

**Area Scan (71x121x1):** Interpolated grid:  $dx=1.000$  mm,  $dy=1.000$  mm

Maximum value of SAR (interpolated) = 0.205 W/kg

**Zoom Scan (7x7x7)/Cube 0:** Measurement grid:  $dx=5$ mm,  $dy=5$ mm,  $dz=5$ mm

Reference Value = 5.208 V/m; Power Drift = 0.18 dB

Peak SAR (extrapolated) = 0.241 W/kg

**SAR(1 g) = 0.187 W/kg; SAR(10 g) = 0.142 W/kg**

Maximum value of SAR (measured) = 0.205 W/kg

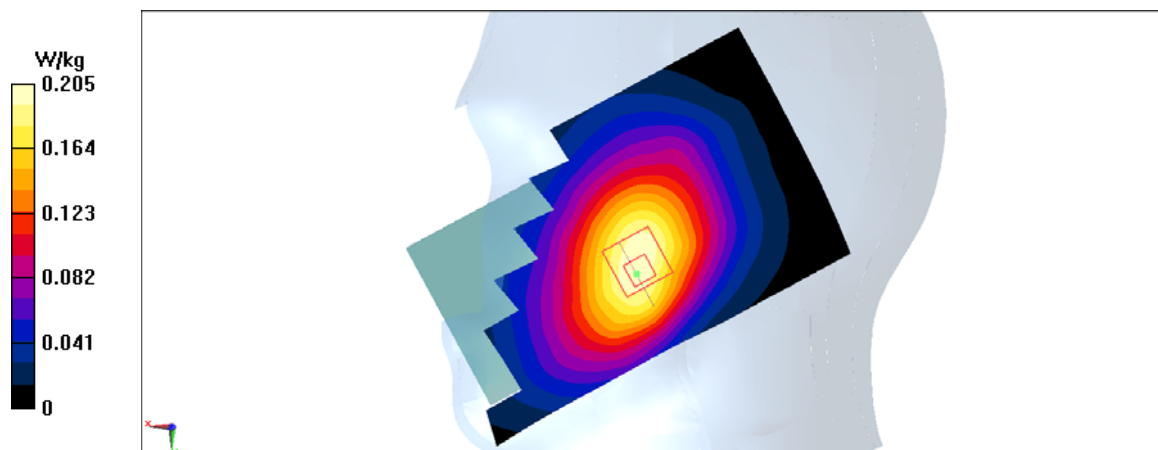

Fig A.1

**GSM850\_CH190 Rear**

Date: 6/2/2018

Electronics: DAE4 Sn1525

Medium: Head 835 MHz

Medium parameters used:  $f = 836.6$  MHz;  $\sigma = 0.99$  mho/m;  $\epsilon_r = 56.1$ ;  $\rho = 1000$  kg/m<sup>3</sup>

Ambient Temperature: 22.5°C, Liquid Temperature: 22.3°C

Communication System: GSM850 836.6 MHz Duty Cycle: 1:4

Probe: EX3DV4 – SN7464 ConvF(10.21,10.21,10.21)

**Area Scan (71x121x1):** Interpolated grid: dx=1.000 mm, dy=1.000 mm

Maximum value of SAR (interpolated) = 0.27 W/kg

**Zoom Scan (7x7x7)/Cube 0:** Measurement grid: dx=5mm, dy=5mm, dz=5mm

Reference Value = 12.9 V/m; Power Drift = 0.04 dB

Peak SAR (extrapolated) = 0.404 W/kg

**SAR(1 g) = 0.215 W/kg; SAR(10 g) = 0.115 W/kg**

Maximum value of SAR (measured) = 0.272 W/kg

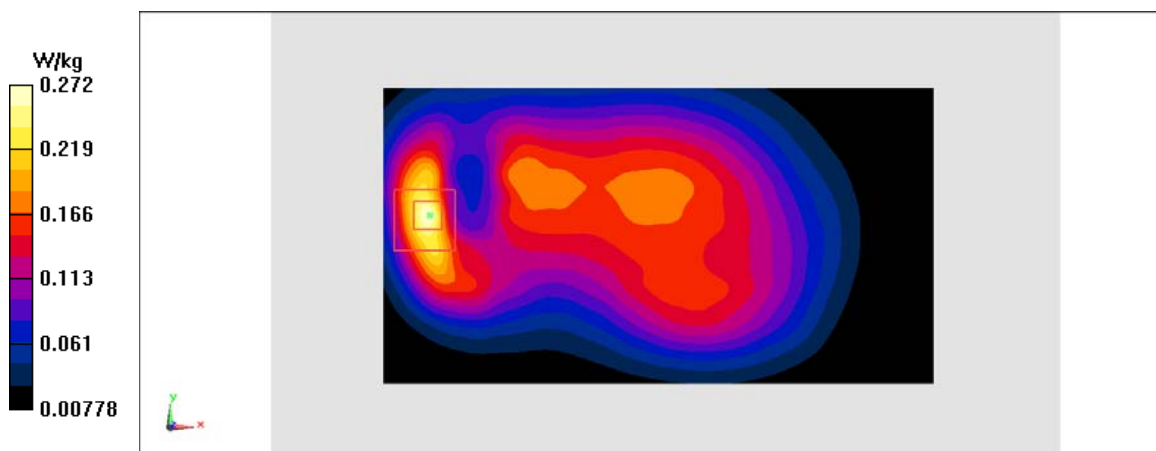

**Fig A.2**

### PCS1900\_CH512 Left Cheek

Date: 6/9/2018

Electronics: DAE4 Sn1525

Medium: Head 1900 MHz

Medium parameters used:  $f = 1850.2$  MHz;  $\sigma = 1.342$  mho/m;  $\epsilon_r = 39.61$ ;  $\rho = 1000$  kg/m<sup>3</sup>

Ambient Temperature: 22.5°C, Liquid Temperature: 22.3°C

Communication System: PCS1900 1850.2 MHz Duty Cycle: 1:8.3

Probe: EX3DV4 – SN7464 ConvF(8.39,8.39,8.39)

**Area Scan (71x121x1):** Interpolated grid:  $dx=1.000$  mm,  $dy=1.000$  mm

Maximum value of SAR (interpolated) = 0.175 W/kg

**Zoom Scan (7x7x7)/Cube 0:** Measurement grid:  $dx=5$ mm,  $dy=5$ mm,  $dz=5$ mm

Reference Value = 5.615 V/m; Power Drift = 0.11 dB

Peak SAR (extrapolated) = 0.227 W/kg

**SAR(1 g) = 0.149 W/kg; SAR(10 g) = 0.094 W/kg**

Maximum value of SAR (measured) = 0.176 W/kg

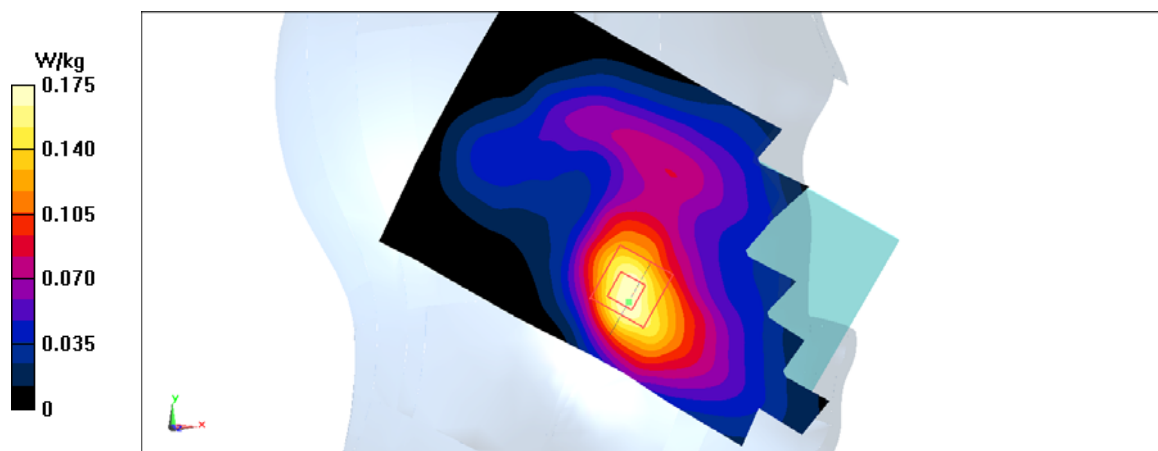

Fig A.3

**PCS1900\_CH661 Rear**

Date: 6/9/2018

Electronics: DAE4 Sn1525

Medium: Head 1900 MHz

Medium parameters used:  $f = 1880$  MHz;  $\sigma = 1.517$  mho/m;  $\epsilon_r = 53.21$ ;  $\rho = 1000$  kg/m<sup>3</sup>

Ambient Temperature: 22.5°C, Liquid Temperature: 22.3°C

Communication System: PCS1900 1880 MHz Duty Cycle: 1:2

Probe: EX3DV4 – SN7464 ConvF(8.32,8.32,8.32)

**Area Scan (71x121x1):** Interpolated grid: dx=1.000 mm, dy=1.000 mm

Maximum value of SAR (interpolated) = 0.561 W/kg

**Zoom Scan (7x7x7)/Cube 0:** Measurement grid: dx=5mm, dy=5mm, dz=5mm

Reference Value = 5.288 V/m; Power Drift = -0.06 dB

Peak SAR (extrapolated) = 0.794 W/kg

**SAR(1 g) = 0.44 W/kg; SAR(10 g) = 0.232 W/kg**

Maximum value of SAR (measured) = 0.546 W/kg

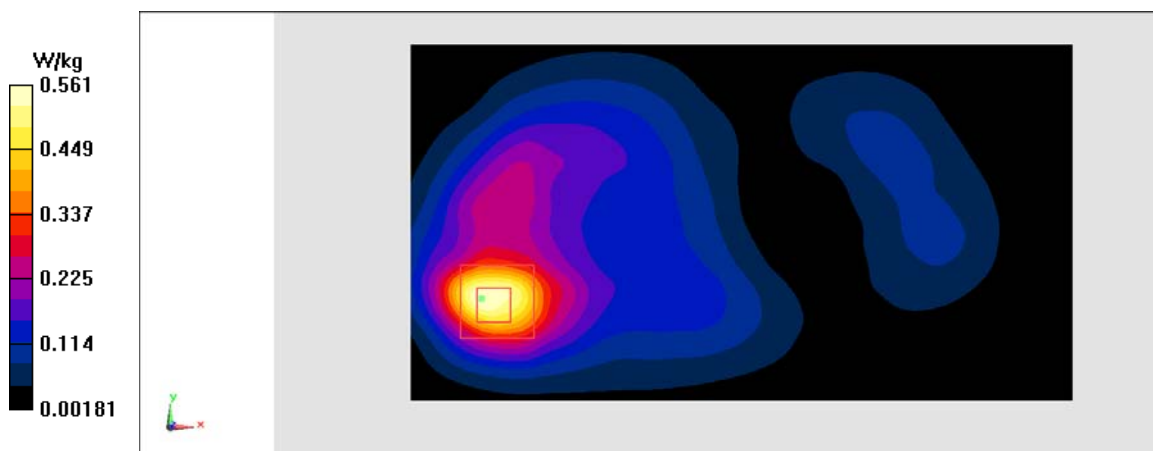

**Fig A.4**

### WCDMA850-BV\_CH4233 Right Cheek

Date: 6/2/2018

Electronics: DAE4 Sn1525

Medium: Head 835 MHz

Medium parameters used:  $f = 846.6$  MHz;  $\sigma = 0.912$  mho/m;  $\epsilon_r = 41.59$ ;  $\rho = 1000$  kg/m<sup>3</sup>

Ambient Temperature: 22.5°C, Liquid Temperature: 22.3°C

Communication System: WCDMA850-BV 846.6 MHz Duty Cycle: 1:1

Probe: EX3DV4 – SN7464 ConvF(10.28,10.28,10.28)

**Area Scan (71x121x1):** Interpolated grid:  $dx=1.000$  mm,  $dy=1.000$  mm

Maximum value of SAR (interpolated) = 0.23 W/kg

**Zoom Scan (7x7x7)/Cube 0:** Measurement grid:  $dx=5$ mm,  $dy=5$ mm,  $dz=5$ mm

Reference Value = 5.62 V/m; Power Drift = 0.17 dB

Peak SAR (extrapolated) = 0.261 W/kg

**SAR(1 g) = 0.207 W/kg; SAR(10 g) = 0.157 W/kg**

Maximum value of SAR (measured) = 0.227 W/kg

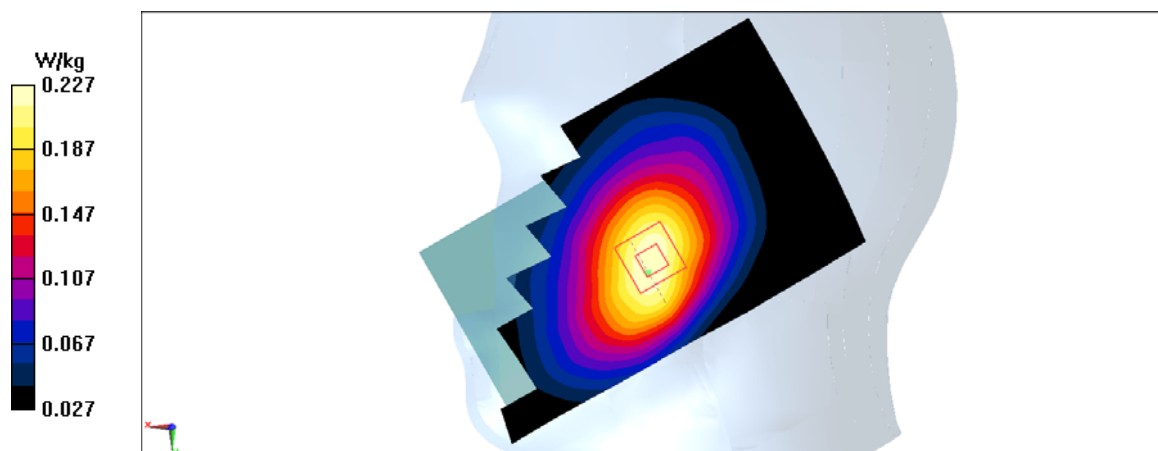

Fig A.5

**WCDMA850-BV\_CH4182 Rear**

Date: 6/2/2018

Electronics: DAE4 Sn1525

Medium: Head 835 MHz

Medium parameters used:  $f = 835.4$  MHz;  $\sigma = 0.988$  mho/m;  $\epsilon_r = 56.1$ ;  $\rho = 1000$  kg/m<sup>3</sup>

Ambient Temperature: 22.5°C, Liquid Temperature: 22.3°C

Communication System: WCDMA850-BV 835.4 MHz Duty Cycle: 1:1

Probe: EX3DV4 – SN7464 ConvF(10.21,10.21,10.21)

**Area Scan (71x121x1):** Interpolated grid: dx=1.000 mm, dy=1.000 mm

Maximum value of SAR (interpolated) = 0.276 W/kg

**Zoom Scan (7x7x7)/Cube 0:** Measurement grid: dx=5mm, dy=5mm, dz=5mm

Reference Value = 12.85 V/m; Power Drift = -0.02 dB

Peak SAR (extrapolated) = 0.414 W/kg

**SAR(1 g) = 0.22 W/kg; SAR(10 g) = 0.118 W/kg**

Maximum value of SAR (measured) = 0.281 W/kg

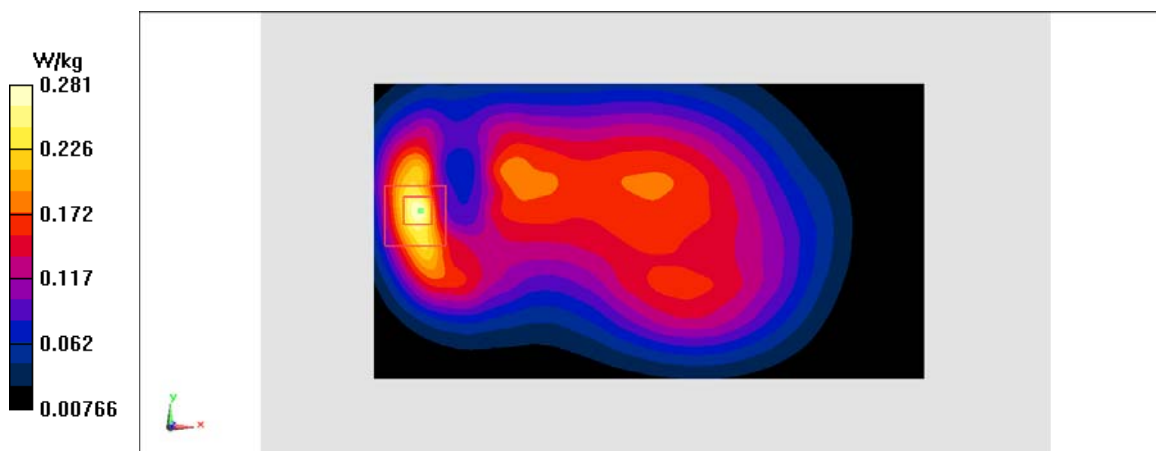

**Fig A.6**

### WCDMA1700-BIV\_CH1412 Left Cheek

Date: 6/3/2018

Electronics: DAE4 Sn1525

Medium: Head 1750 MHz

Medium parameters used:  $f = 1732.4$  MHz;  $\sigma = 1.363$  mho/m;  $\epsilon_r = 40.7$ ;  $\rho = 1000$  kg/m<sup>3</sup>

Ambient Temperature: 22.5°C, Liquid Temperature: 22.3°C

Communication System: WCDMA1700-BIV 1732.4 MHz Duty Cycle: 1:1

Probe: EX3DV4 – SN7464 ConvF(8.70,8.70,8.70)

**Area Scan (71x121x1):** Interpolated grid: dx=1.000 mm, dy=1.000 mm

Maximum value of SAR (interpolated) = 0.303 W/kg

**Zoom Scan (7x7x7)/Cube 0:** Measurement grid: dx=5mm, dy=5mm, dz=5mm

Reference Value = 7.832 V/m; Power Drift = 0.02 dB

Peak SAR (extrapolated) = 0.38 W/kg

**SAR(1 g) = 0.259 W/kg; SAR(10 g) = 0.167 W/kg**

Maximum value of SAR (measured) = 0.3 W/kg

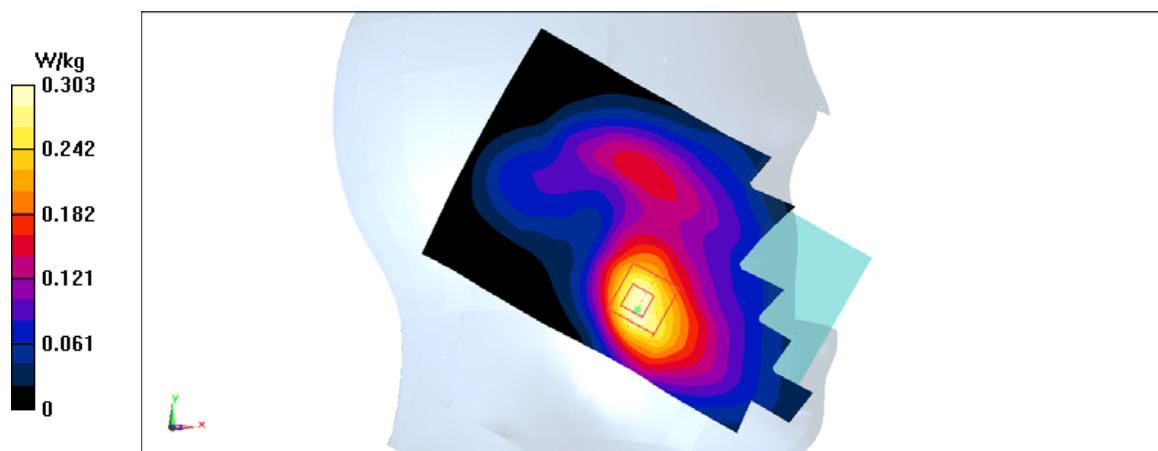

Fig A.7

**WCDMA1700-BIV\_CH1412 Rear**

Date: 6/3/2018

Electronics: DAE4 Sn1525

Medium: Head 1750 MHz

Medium parameters used:  $f = 1732.4$  MHz;  $\sigma = 1.497$  mho/m;  $\epsilon_r = 53.24$ ;  $\rho = 1000$  kg/m<sup>3</sup>

Ambient Temperature: 22.5°C, Liquid Temperature: 22.3°C

Communication System: WCDMA1700-BIV 1732.4 MHz Duty Cycle: 1:1

Probe: EX3DV4 – SN7464 ConvF(8.60,8.60,8.60)

**Area Scan (71x121x1):** Interpolated grid: dx=1.000 mm, dy=1.000 mm

Maximum value of SAR (interpolated) = 0.633 W/kg

**Zoom Scan (7x7x7)/Cube 0:** Measurement grid: dx=5mm, dy=5mm, dz=5mm

Reference Value = 6.847 V/m; Power Drift = 0.18 dB

Peak SAR (extrapolated) = 0.937 W/kg

**SAR(1 g) = 0.524 W/kg; SAR(10 g) = 0.282 W/kg**

Maximum value of SAR (measured) = 0.635 W/kg

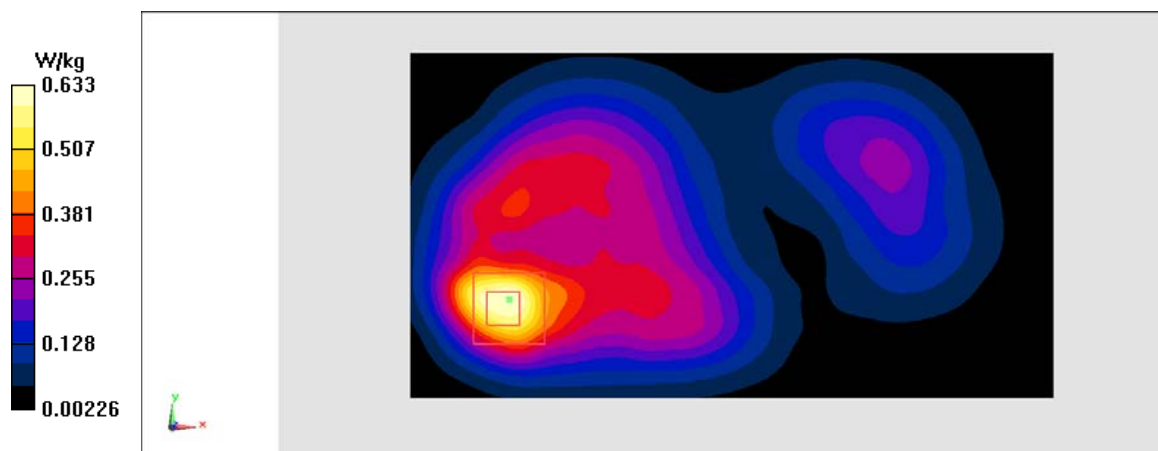

**Fig A.8**



### WCDMA1900-BII\_CH9400 Left Cheek

Date: 6/9/2018

Electronics: DAE4 Sn1525

Medium: Head 1900 MHz

Medium parameters used:  $f = 1880$  MHz;  $\sigma = 1.371$  mho/m;  $\epsilon_r = 39.57$ ;  $\rho = 1000$  kg/m<sup>3</sup>

Ambient Temperature: 22.5°C, Liquid Temperature: 22.3°C

Communication System: WCDMA1900-BII 1880 MHz Duty Cycle: 1:1

Probe: EX3DV4 – SN7464 ConvF(8.39,8.39,8.39)

**Area Scan (71x121x1):** Interpolated grid: dx=1.000 mm, dy=1.000 mm

Maximum value of SAR (interpolated) = 0.266 W/kg

**Zoom Scan (7x7x7)/Cube 0:** Measurement grid: dx=5mm, dy=5mm, dz=5mm

Reference Value = 6.83 V/m; Power Drift = 0.18 dB

Peak SAR (extrapolated) = 0.348 W/kg

**SAR(1 g) = 0.225 W/kg; SAR(10 g) = 0.139 W/kg**

Maximum value of SAR (measured) = 0.264 W/kg

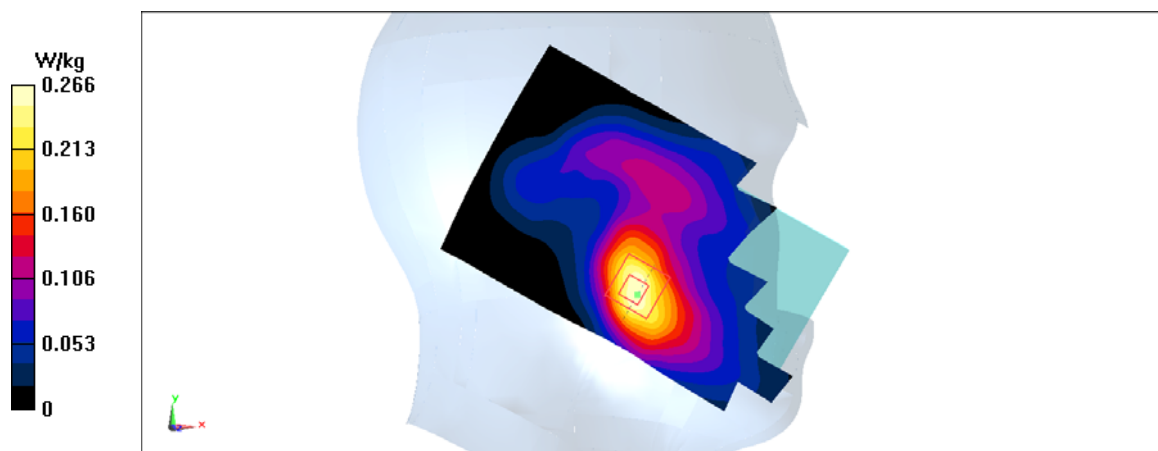

Fig A.9

### WCDMA1900-BII\_CH9400 Rear

Date: 6/9/2018

Electronics: DAE4 Sn1525

Medium: Head 1900 MHz

Medium parameters used:  $f = 1880$  MHz;  $\sigma = 1.517$  mho/m;  $\epsilon_r = 53.21$ ;  $\rho = 1000$  kg/m<sup>3</sup>

Ambient Temperature: 22.5°C, Liquid Temperature: 22.3°C

Communication System: WCDMA1900-BII 1880 MHz Duty Cycle: 1:1

Probe: EX3DV4 – SN7464 ConvF(8.32,8.32,8.32)

**Area Scan (71x121x1):** Interpolated grid: dx=1.000 mm, dy=1.000 mm

Maximum value of SAR (interpolated) = 0.688 W/kg

**Zoom Scan (7x7x7)/Cube 0:** Measurement grid: dx=5mm, dy=5mm, dz=5mm

Reference Value = 7.282 V/m; Power Drift = 0.16 dB

Peak SAR (extrapolated) = 1.03 W/kg

**SAR(1 g) = 0.573 W/kg; SAR(10 g) = 0.305 W/kg**

Maximum value of SAR (measured) = 0.706 W/kg

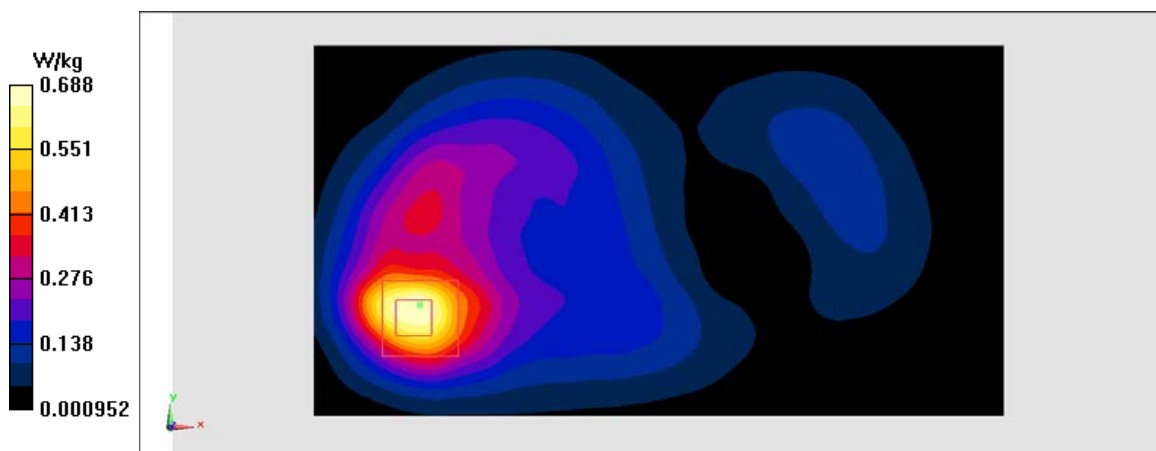

Fig A.10

**LTE1900-FDD2\_CH19100 Left Cheek**

Date: 6/9/2018

Electronics: DAE4 Sn1525

Medium: Head 1900 MHz

Medium parameters used:  $f = 1900$  MHz;  $\sigma = 1.39$  mho/m;  $\epsilon_r = 39.55$ ;  $\rho = 1000$  kg/m<sup>3</sup>

Ambient Temperature: 22.5°C, Liquid Temperature: 22.3°C

Communication System: LTE1900-FDD2 1900 MHz Duty Cycle: 1:1

Probe: EX3DV4 – SN7464 ConvF(8.39,8.39,8.39)

**Area Scan (71x121x1):** Interpolated grid: dx=1.000 mm, dy=1.000 mm

Maximum value of SAR (interpolated) = 0.22 W/kg

**Zoom Scan (7x7x7)/Cube 0:** Measurement grid: dx=5mm, dy=5mm, dz=5mm

Reference Value = 7.182 V/m; Power Drift = -0.09 dB

Peak SAR (extrapolated) = 0.281 W/kg

**SAR(1 g) = 0.189 W/kg; SAR(10 g) = 0.119 W/kg**

Maximum value of SAR (measured) = 0.221 W/kg

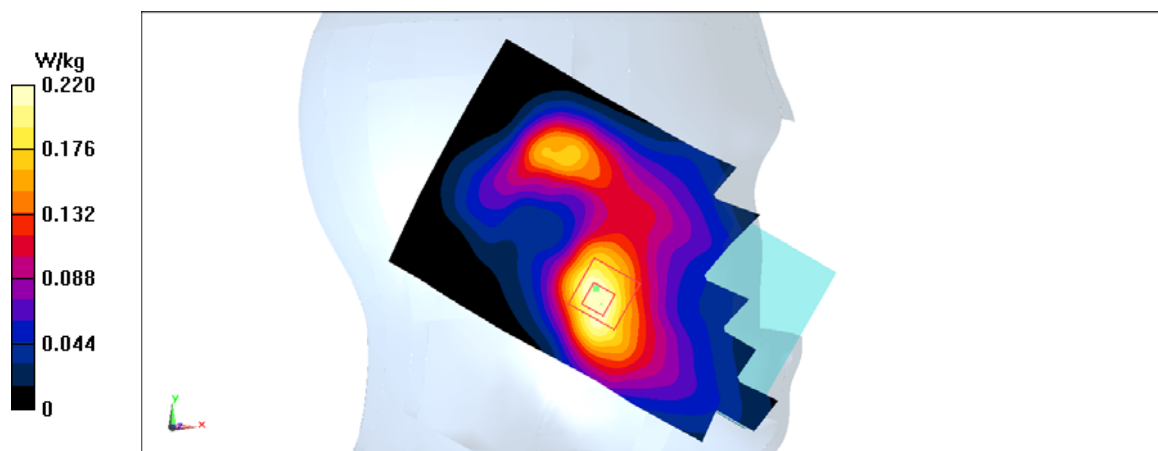

**Fig A.11**

**LTE1900-FDD2\_CH19100 Rear**

Date: 6/9/2018

Electronics: DAE4 Sn1525

Medium: Head 1900 MHz

Medium parameters used:  $f = 1900$  MHz;  $\sigma = 1.536$  mho/m;  $\epsilon_r = 53.19$ ;  $\rho = 1000$  kg/m<sup>3</sup>

Ambient Temperature: 22.5°C, Liquid Temperature: 22.3°C

Communication System: LTE1900-FDD2 1900 MHz Duty Cycle: 1:1

Probe: EX3DV4 – SN7464 ConvF(8.32,8.32,8.32)

**Area Scan (71x121x1):** Interpolated grid: dx=1.000 mm, dy=1.000 mm

Maximum value of SAR (interpolated) = 0.812 W/kg

**Zoom Scan (7x7x7)/Cube 0:** Measurement grid: dx=5mm, dy=5mm, dz=5mm

Reference Value = 8.053 V/m; Power Drift = 0.19 dB

Peak SAR (extrapolated) = 1.2 W/kg

**SAR(1 g) = 0.658 W/kg; SAR(10 g) = 0.345 W/kg**

Maximum value of SAR (measured) = 0.815 W/kg

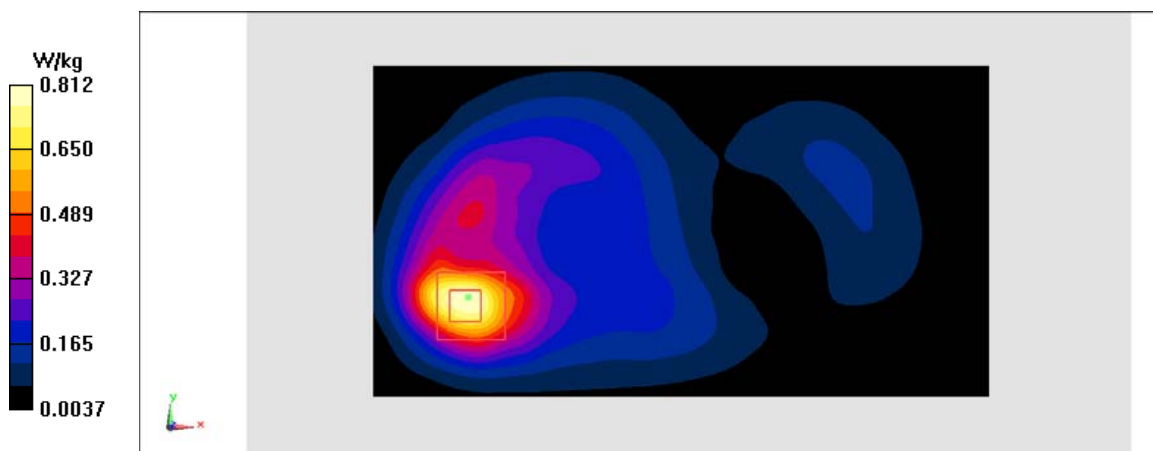

Fig A.12

**LTE850-FDD5\_CH20600 Right Cheek**

Date: 6/2/2018

Electronics: DAE4 Sn1525

Medium: Head 835 MHz

Medium parameters used:  $f = 844$  MHz;  $\sigma = 0.91$  mho/m;  $\epsilon_r = 41.59$ ;  $\rho = 1000$  kg/m<sup>3</sup>

Ambient Temperature: 22.5°C, Liquid Temperature: 22.3°C

Communication System: LTE850-FDD5 844 MHz Duty Cycle: 1:1

Probe: EX3DV4 – SN7464 ConvF(10.28,10.28,10.28)

**Area Scan (71x121x1):** Interpolated grid: dx=1.000 mm, dy=1.000 mm

Maximum value of SAR (interpolated) = 0.208 W/kg

**Zoom Scan (7x7x7)/Cube 0:** Measurement grid: dx=5mm, dy=5mm, dz=5mm

Reference Value = 5.846 V/m; Power Drift = 0.1 dB

Peak SAR (extrapolated) = 0.238 W/kg

**SAR(1 g) = 0.189 W/kg; SAR(10 g) = 0.144 W/kg**

Maximum value of SAR (measured) = 0.207 W/kg

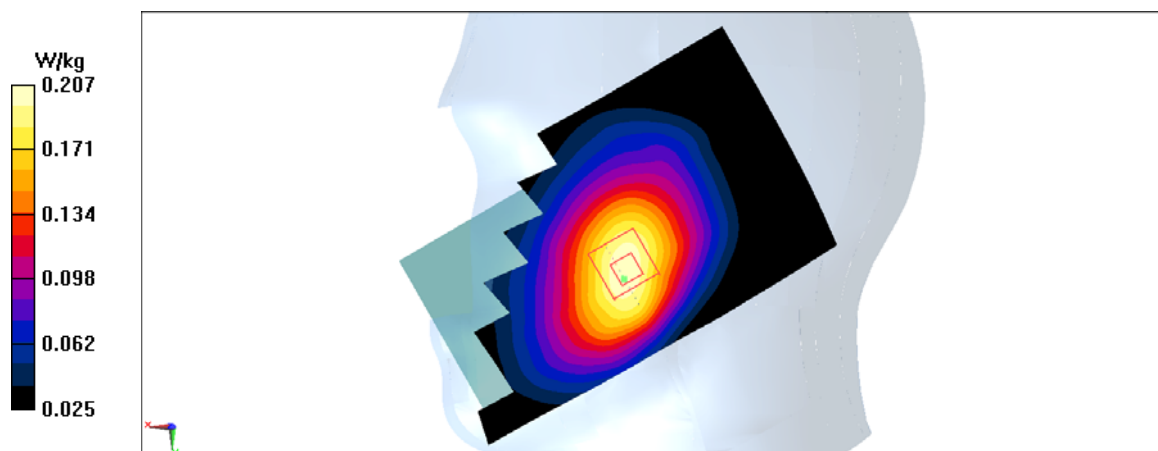

Fig A.13

**LTE850-FDD5\_CH20600 Rear**

Date: 6/2/2018

Electronics: DAE4 Sn1525

Medium: Head 835 MHz

Medium parameters used:  $f = 844$  MHz;  $\sigma = 0.997$  mho/m;  $\epsilon_r = 56.09$ ;  $\rho = 1000$  kg/m<sup>3</sup>

Ambient Temperature: 22.5°C, Liquid Temperature: 22.3°C

Communication System: LTE850-FDD5 844 MHz Duty Cycle: 1:1

Probe: EX3DV4 – SN7464 ConvF(10.21,10.21,10.21)

**Area Scan (71x121x1):** Interpolated grid: dx=1.000 mm, dy=1.000 mm

Maximum value of SAR (interpolated) = 0.329 W/kg

**Zoom Scan (7x7x7)/Cube 0:** Measurement grid: dx=5mm, dy=5mm, dz=5mm

Reference Value = 12.81 V/m; Power Drift = -0.02 dB

Peak SAR (extrapolated) = 0.495 W/kg

**SAR(1 g) = 0.264 W/kg; SAR(10 g) = 0.141 W/kg**

Maximum value of SAR (measured) = 0.33 W/kg

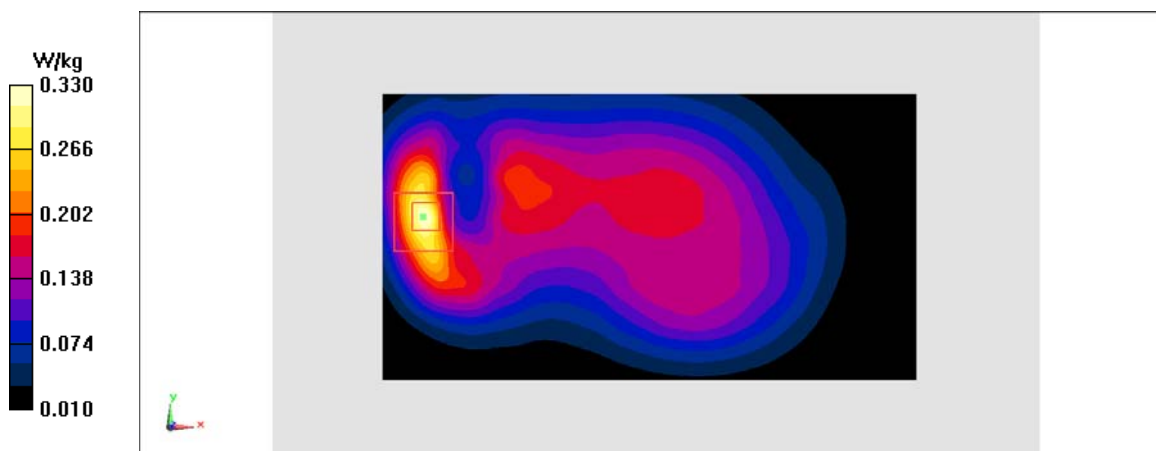

Fig A.14

**LTE2500-FDD7\_CH21350 Left Cheek**

Date: 6/11/2018

Electronics: DAE4 Sn1525

Medium: Head 2600 MHz

Medium parameters used:  $f = 2560$  MHz;  $\sigma = 1.928$  mho/m;  $\epsilon_r = 39.62$ ;  $\rho = 1000$  kg/m<sup>3</sup>

Ambient Temperature: 22.5°C, Liquid Temperature: 22.3°C

Communication System: LTE2500-FDD7 2560 MHz Duty Cycle: 1:1

Probe: EX3DV4 – SN7464 ConvF(7.76,7.76,7.76)

**Area Scan (71x121x1):** Interpolated grid:  $dx=1.000$  mm,  $dy=1.000$  mm

Maximum value of SAR (interpolated) = 0.357 W/kg

**Zoom Scan (7x7x7)/Cube 0:** Measurement grid:  $dx=5$ mm,  $dy=5$ mm,  $dz=5$ mm

Reference Value = 1.826 V/m; Power Drift = 0.05 dB

Peak SAR (extrapolated) = 0.515 W/kg

**SAR(1 g) = 0.275 W/kg; SAR(10 g) = 0.147 W/kg**

Maximum value of SAR (measured) = 0.345 W/kg

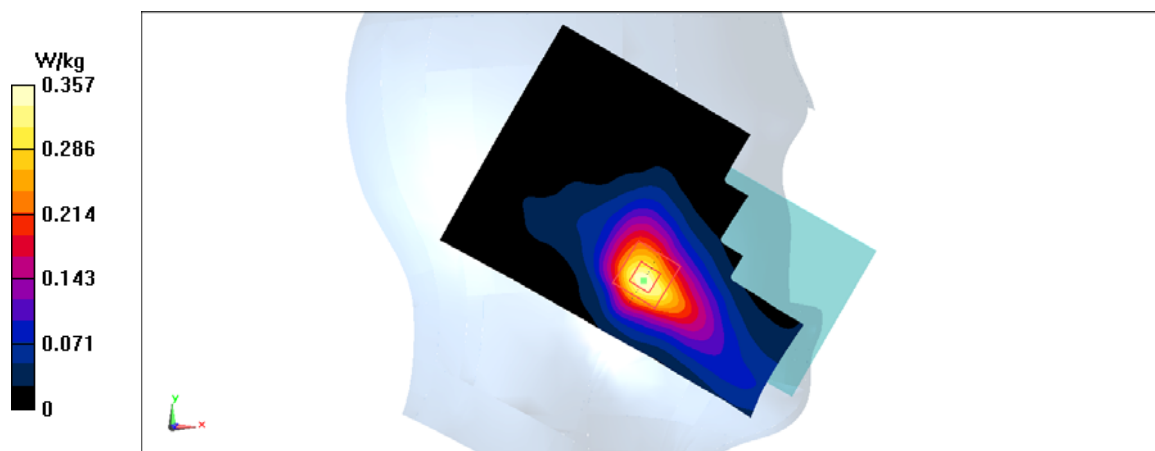

Fig A.15

**LTE2500-FDD7\_CH21350 Bottom edge**

Date: 6/11/2018

Electronics: DAE4 Sn1525

Medium: Head 2600 MHz

Medium parameters used:  $f = 2560$  MHz;  $\sigma = 2.1$  mho/m;  $\epsilon_r = 51.66$ ;  $\rho = 1000$  kg/m<sup>3</sup>

Ambient Temperature: 22.5°C, Liquid Temperature: 22.3°C

Communication System: LTE2500-FDD7 2560 MHz Duty Cycle: 1:1

Probe: EX3DV4 – SN7464 ConvF(7.84,7.84,7.84)

**Area Scan (71x121x1):** Interpolated grid:  $dx=1.000$  mm,  $dy=1.000$  mm

Maximum value of SAR (interpolated) = 1.38 W/kg

**Zoom Scan (7x7x7)/Cube 0:** Measurement grid:  $dx=5$ mm,  $dy=5$ mm,  $dz=5$ mm

Reference Value = 13.93 V/m; Power Drift = 0.07 dB

Peak SAR (extrapolated) = 2.12 W/kg

**SAR(1 g) = 1.03 W/kg; SAR(10 g) = 0.431 W/kg**

Maximum value of SAR (measured) = 1.41 W/kg

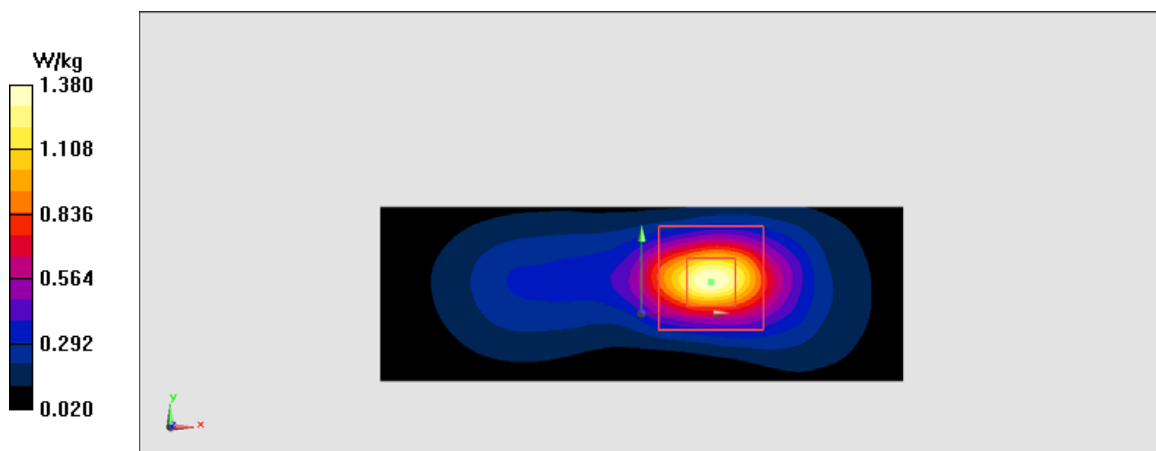

Fig A.16



**LTE700-FDD12\_CH23095 Left Cheek**

Date: 6/1/2018

Electronics: DAE4 Sn1525

Medium: Head 750 MHz

Medium parameters used:  $f = 707.5$  MHz;  $\sigma = 0.858$  mho/m;  $\epsilon_r = 41.75$ ;  $\rho = 1000$  kg/m<sup>3</sup>

Ambient Temperature: 22.5°C, Liquid Temperature: 22.3°C

Communication System: LTE700-FDD12 707.5 MHz Duty Cycle: 1:1

Probe: EX3DV4 – SN7464 ConvF(10.57,10.57,10.57)

**Area Scan (71x121x1):** Interpolated grid: dx=1.000 mm, dy=1.000 mm

Maximum value of SAR (interpolated) = 0.0855 W/kg

**Zoom Scan (7x7x7)/Cube 0:** Measurement grid: dx=5mm, dy=5mm, dz=5mm

Reference Value = 3.216 V/m; Power Drift = 0.08 dB

Peak SAR (extrapolated) = 0.097 W/kg

**SAR(1 g) = 0.08 W/kg; SAR(10 g) = 0.064 W/kg**

Maximum value of SAR (measured) = 0.0864 W/kg

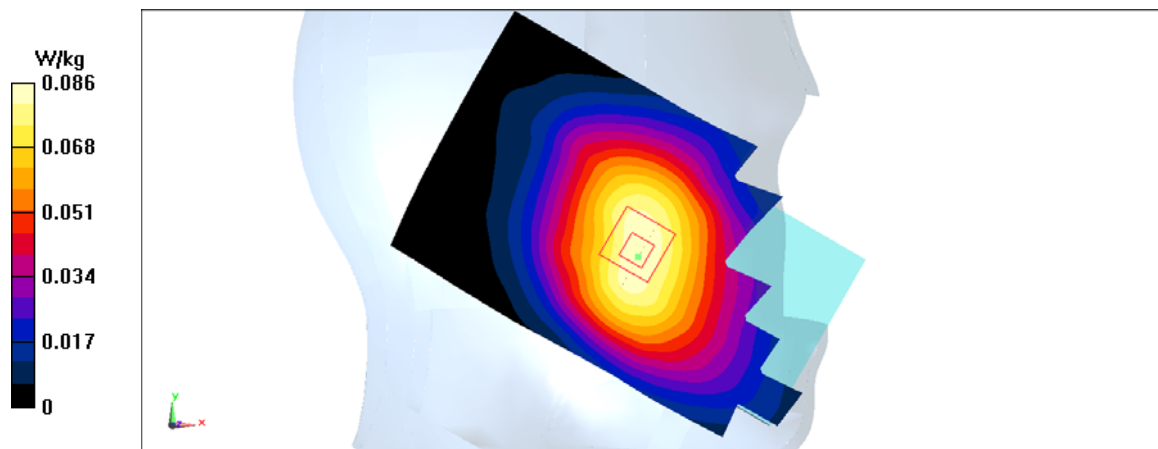

Fig A.17

**LTE700-FDD12\_CH23095 Rear**

Date: 6/1/2018

Electronics: DAE4 Sn1525

Medium: Head 750 MHz

Medium parameters used:  $f = 707.5$  MHz;  $\sigma = 0.911$  mho/m;  $\epsilon_r = 55.4$ ;  $\rho = 1000$  kg/m<sup>3</sup>

Ambient Temperature: 22.5°C, Liquid Temperature: 22.3°C

Communication System: LTE700-FDD12 707.5 MHz Duty Cycle: 1:1

Probe: EX3DV4 – SN7464 ConvF(10.63,10.63,10.63)

**Area Scan (71x121x1):** Interpolated grid: dx=1.000 mm, dy=1.000 mm

Maximum value of SAR (interpolated) = 0.214 W/kg

**Zoom Scan (7x7x7)/Cube 0:** Measurement grid: dx=5mm, dy=5mm, dz=5mm

Reference Value = 14.63 V/m; Power Drift = 0.02 dB

Peak SAR (extrapolated) = 0.241 W/kg

**SAR(1 g) = 0.196 W/kg; SAR(10 g) = 0.154 W/kg**

Maximum value of SAR (measured) = 0.213 W/kg

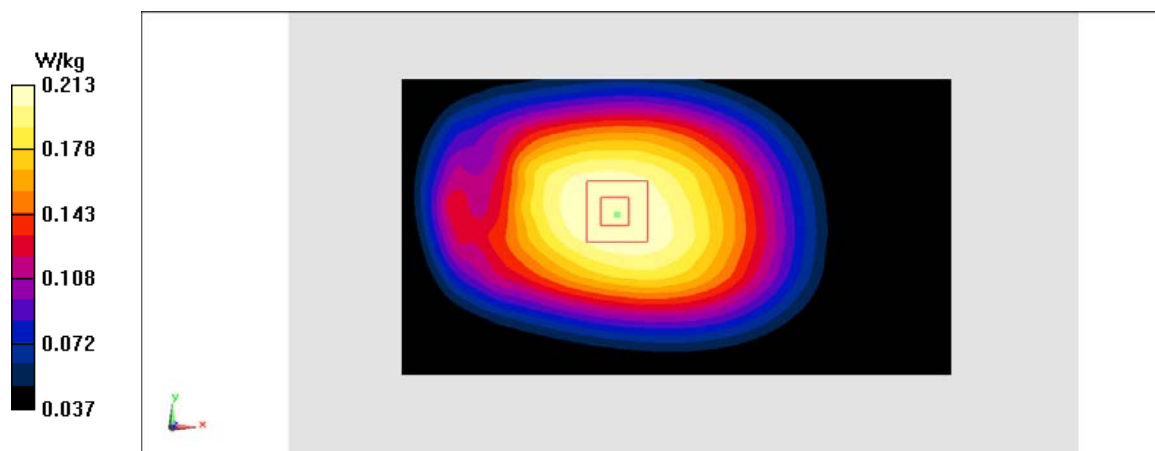

Fig A.18

### LTE750-FDD13\_CH23230 Right Cheek

Date: 6/1/2018

Electronics: DAE4 Sn1525

Medium: Head 750 MHz

Medium parameters used:  $f = 782$  MHz;  $\sigma = 0.928$  mho/m;  $\epsilon_r = 41.66$ ;  $\rho = 1000$  kg/m<sup>3</sup>

Ambient Temperature: 22.5°C, Liquid Temperature: 22.3°C

Communication System: LTE750-FDD13 782 MHz Duty Cycle: 1:1

Probe: EX3DV4 – SN7464 ConvF(10.57,10.57,10.57)

**Area Scan (71x121x1):** Interpolated grid:  $dx=1.000$  mm,  $dy=1.000$  mm

Maximum value of SAR (interpolated) = 0.105 W/kg

**Zoom Scan (7x7x7)/Cube 0:** Measurement grid:  $dx=5$ mm,  $dy=5$ mm,  $dz=5$ mm

Reference Value = 4.295 V/m; Power Drift = -0.02 dB

Peak SAR (extrapolated) = 0.13 W/kg

**SAR(1 g) = 0.104 W/kg; SAR(10 g) = 0.08 W/kg**

Maximum value of SAR (measured) = 0.114 W/kg

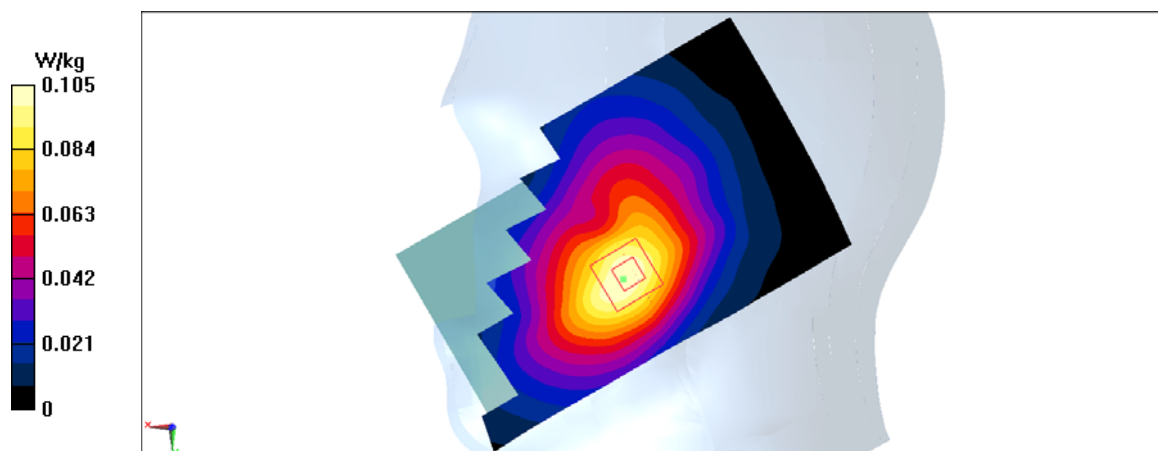

Fig A.19

**LTE750-FDD13\_CH23230 Rear**

Date: 6/1/2018

Electronics: DAE4 Sn1525

Medium: Head 750 MHz

Medium parameters used:  $f = 782$  MHz;  $\sigma = 0.981$  mho/m;  $\epsilon_r = 55.31$ ;  $\rho = 1000$  kg/m<sup>3</sup>

Ambient Temperature: 22.5°C, Liquid Temperature: 22.3°C

Communication System: LTE750-FDD13 782 MHz Duty Cycle: 1:1

Probe: EX3DV4 – SN7464 ConvF(10.63,10.63,10.63)

**Area Scan (71x121x1):** Interpolated grid: dx=1.000 mm, dy=1.000 mm

Maximum value of SAR (interpolated) = 0.289 W/kg

**Zoom Scan (7x7x7)/Cube 0:** Measurement grid: dx=5mm, dy=5mm, dz=5mm

Reference Value = 13.89 V/m; Power Drift = -0.02 dB

Peak SAR (extrapolated) = 0.415 W/kg

**SAR(1 g) = 0.228 W/kg; SAR(10 g) = 0.126 W/kg**

Maximum value of SAR (measured) = 0.288 W/kg

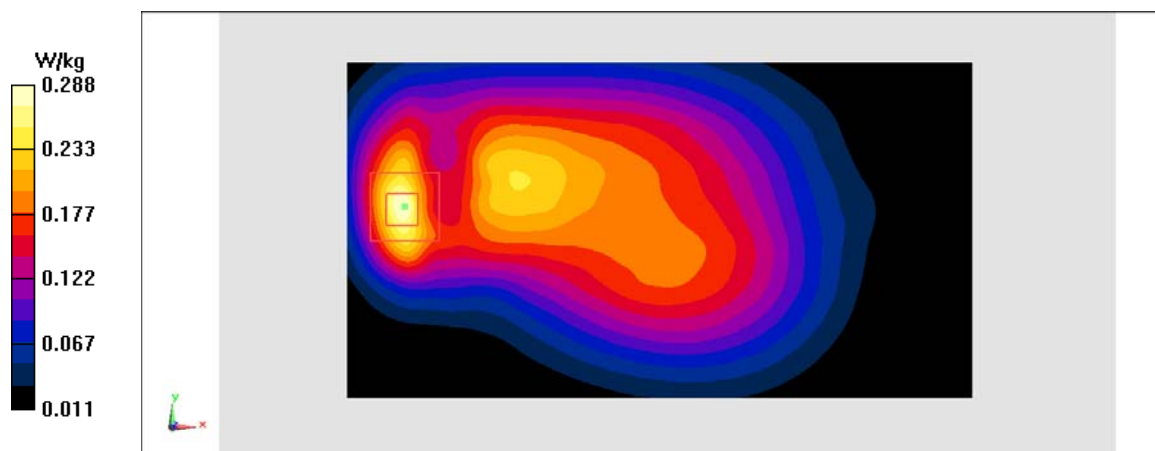

Fig A.20

**LTE1700-FDD66\_CH132572 Left Cheek**

Date: 6/3/2018

Electronics: DAE4 Sn1525

Medium: Head 1750 MHz

Medium parameters used:  $f = 782$  MHz;  $\sigma = 0.46$  mho/m;  $\epsilon_r = 41.84$ ;  $\rho = 1000$  kg/m<sup>3</sup>

Ambient Temperature: 22.5°C, Liquid Temperature: 22.3°C

Communication System: LTE1700-FDD66 782 MHz Duty Cycle: 1:1

Probe: EX3DV4 – SN7464 ConvF(8.70,8.70,8.70)

**Area Scan (71x121x1):** Interpolated grid: dx=1.000 mm, dy=1.000 mm

Maximum value of SAR (interpolated) = 0.235 W/kg

**Zoom Scan (7x7x7)/Cube 0:** Measurement grid: dx=5mm, dy=5mm, dz=5mm

Reference Value = 8.465 V/m; Power Drift = 0.19 dB

Peak SAR (extrapolated) = 0.319 W/kg

**SAR(1 g) = 0.219 W/kg; SAR(10 g) = 0.142 W/kg**

Maximum value of SAR (measured) = 0.252 W/kg

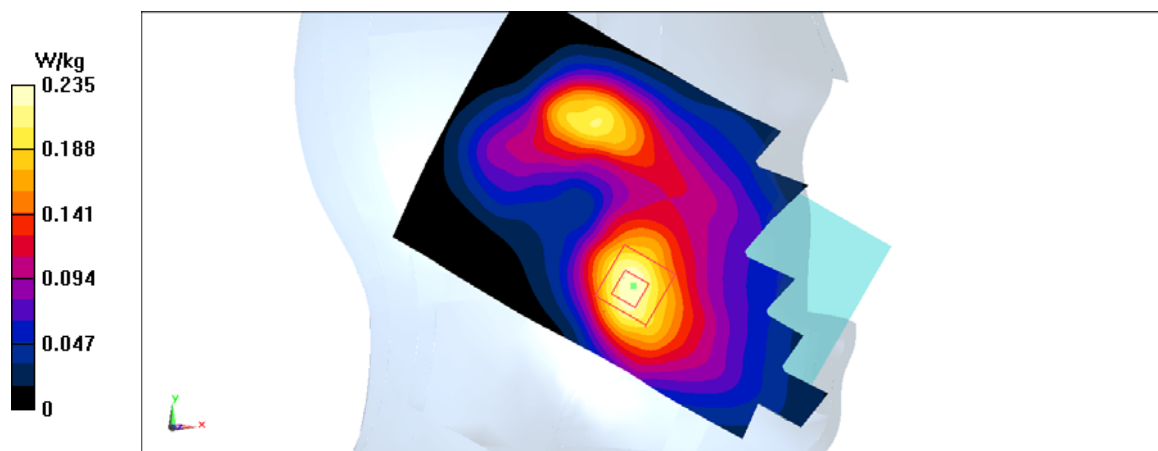

Fig A.21

**LTE1700-FDD66\_CH132072 Rear**

Date: 6/3/2018

Electronics: DAE4 Sn1525

Medium: Head 1750 MHz

Medium parameters used:  $f = 782$  MHz;  $\sigma = 0.594$  mho/m;  $\epsilon_r = 54.38$ ;  $\rho = 1000$  kg/m<sup>3</sup>

Ambient Temperature: 22.5°C, Liquid Temperature: 22.3°C

Communication System: LTE1700-FDD66 782 MHz Duty Cycle: 1:1

Probe: EX3DV4 – SN7464 ConvF(8.60,8.60,8.60)

**Area Scan (71x121x1):** Interpolated grid: dx=1.000 mm, dy=1.000 mm

Maximum value of SAR (interpolated) = 0.779 W/kg

**Zoom Scan (7x7x7)/Cube 0:** Measurement grid: dx=5mm, dy=5mm, dz=5mm

Reference Value = 7.764 V/m; Power Drift = 0.14 dB

Peak SAR (extrapolated) = 1.18 W/kg

**SAR(1 g) = 0.648 W/kg; SAR(10 g) = 0.341 W/kg**

Maximum value of SAR (measured) = 0.803 W/kg

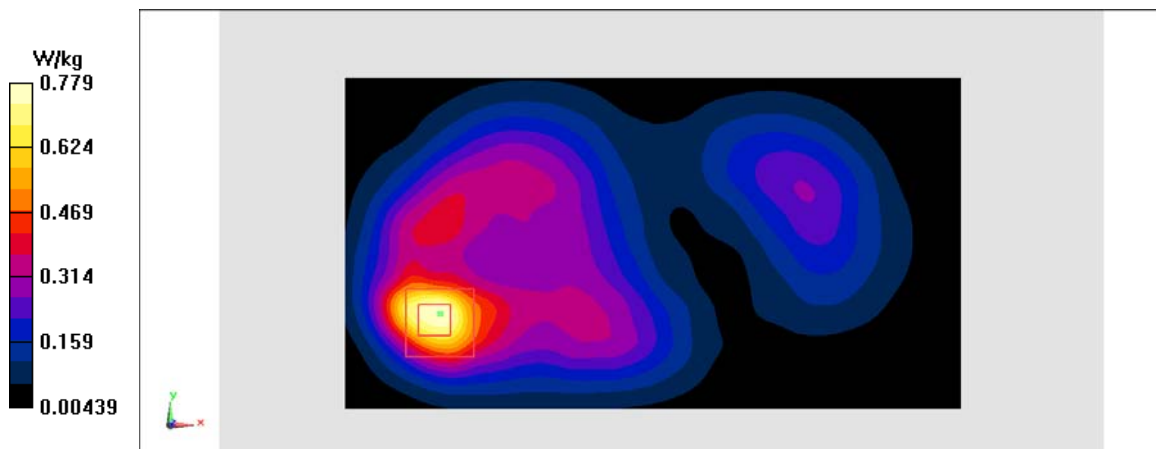

Fig A.22

### WLAN2450\_CH1 Right Tilt

Date: 6/10/2018

Electronics: DAE4 Sn1525

Medium: Head 2450 MHz

Medium parameters used:  $f = 2412$  MHz;  $\sigma = 1.748$  mho/m;  $\epsilon_r = 39.1$ ;  $\rho = 1000$  kg/m<sup>3</sup>

Ambient Temperature: 22.5°C, Liquid Temperature: 22.3°C

Communication System: WLAN2450 2412 MHz Duty Cycle: 1:1

Probe: EX3DV4 – SN7464 ConvF(7.89,7.89,7.89)

**Area Scan (71x121x1):** Interpolated grid:  $dx=1.000$  mm,  $dy=1.000$  mm

Maximum value of SAR (interpolated) = 0.286 W/kg

**Zoom Scan (7x7x7)/Cube 0:** Measurement grid:  $dx=5$ mm,  $dy=5$ mm,  $dz=5$ mm

Reference Value = 4.232 V/m; Power Drift = 0.03 dB

Peak SAR (extrapolated) = 0.448 W/kg

**SAR(1 g) = 0.201 W/kg; SAR(10 g) = 0.098 W/kg**

Maximum value of SAR (measured) = 0.26 W/kg

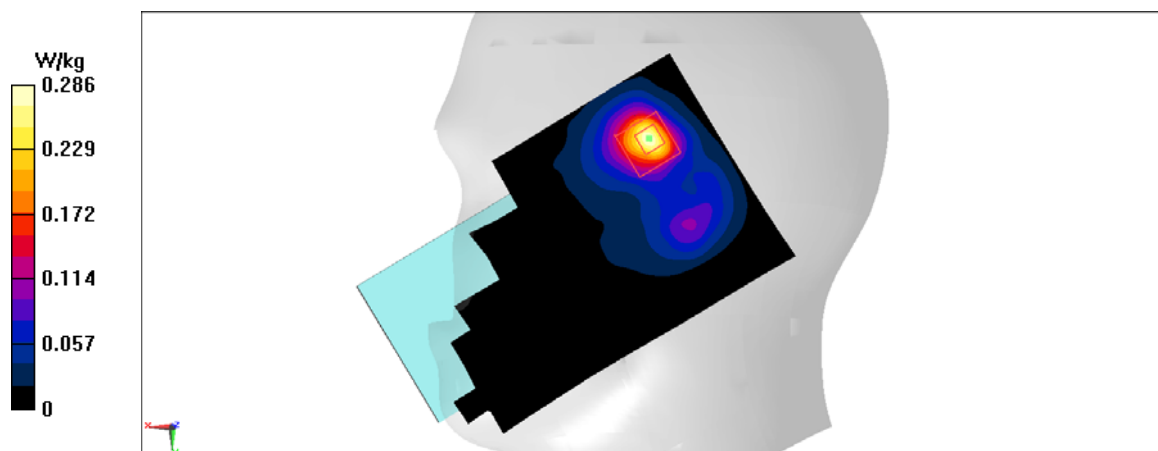

Fig A.23

**WLAN2450\_CH1 Rear**

Date: 6/10/2018

Electronics: DAE4 Sn1525

Medium: Head 2450 MHz

Medium parameters used:  $f = 2412$  MHz;  $\sigma = 1.93$  mho/m;  $\epsilon_r = 53.41$ ;  $\rho = 1000$  kg/m<sup>3</sup>

Ambient Temperature: 22.5°C, Liquid Temperature: 22.3°C

Communication System: WLAN2450 2412 MHz Duty Cycle: 1:1

Probe: EX3DV4 – SN7464 ConvF(8.09,8.09,8.09)

**Area Scan (71x121x1):** Interpolated grid:  $dx=1.000$  mm,  $dy=1.000$  mm

Maximum value of SAR (interpolated) = 0.285 W/kg

**Zoom Scan (7x7x7)/Cube 0:** Measurement grid:  $dx=5$ mm,  $dy=5$ mm,  $dz=5$ mm

Reference Value = 2.802 V/m; Power Drift = -0.03 dB

Peak SAR (extrapolated) = 0.37 W/kg

**SAR(1 g) = 0.161 W/kg; SAR(10 g) = 0.066 W/kg**

Maximum value of SAR (measured) = 0.217 W/kg

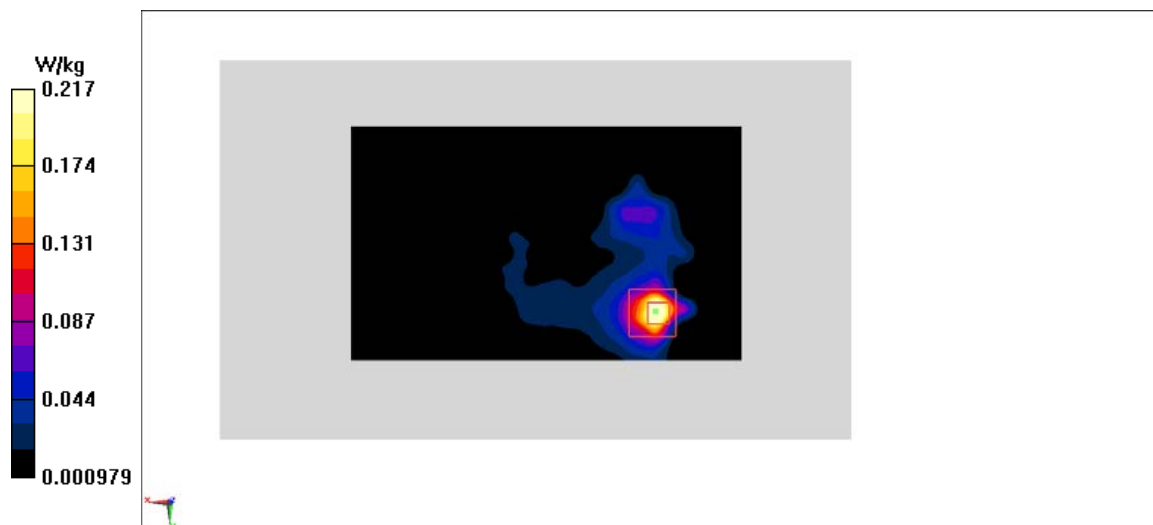
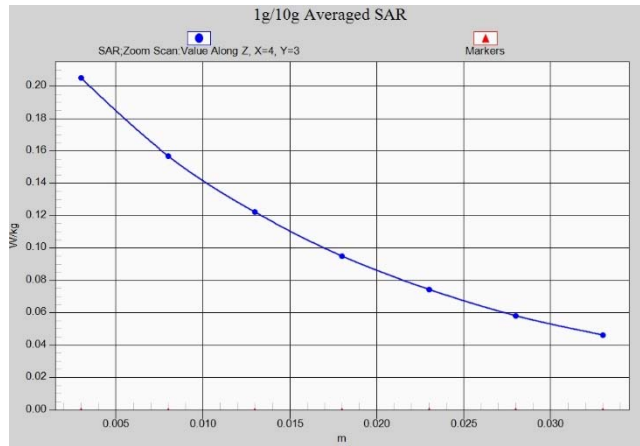
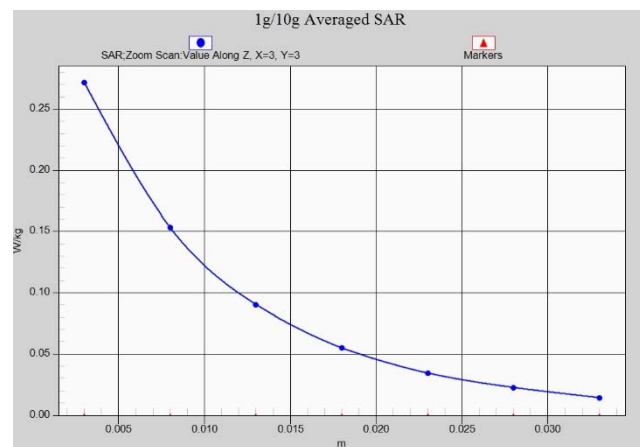

Fig A.24

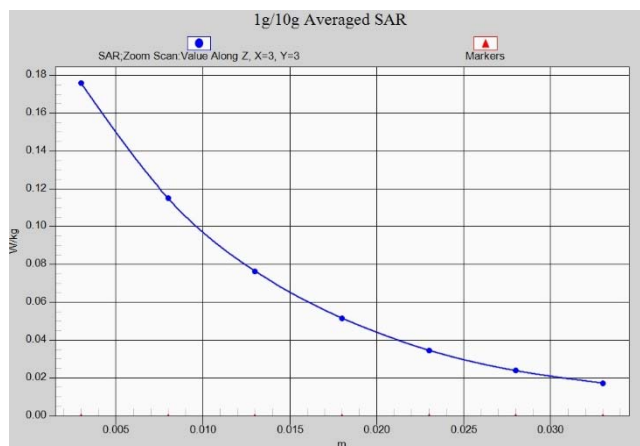



**Fig.A.1- 1 Z-Scan at power reference point (GSM850)**



**Fig.A.1- 2 Z-Scan at power reference point (GSM850)**



**Fig.A.1- 3 Z-Scan at power reference point (PCS1900)**

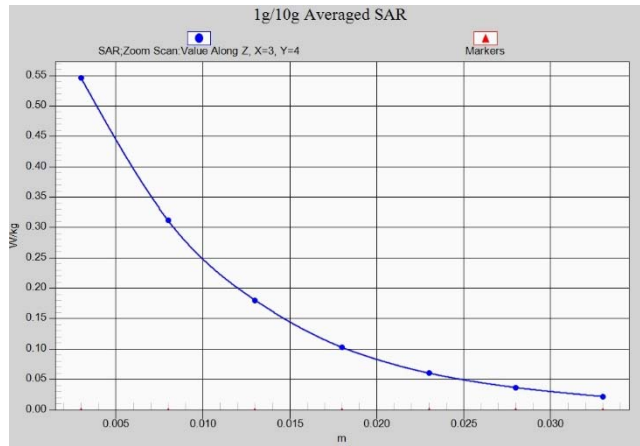

**Fig.A.1- 4 Z-Scan at power reference point (PCS1900)**

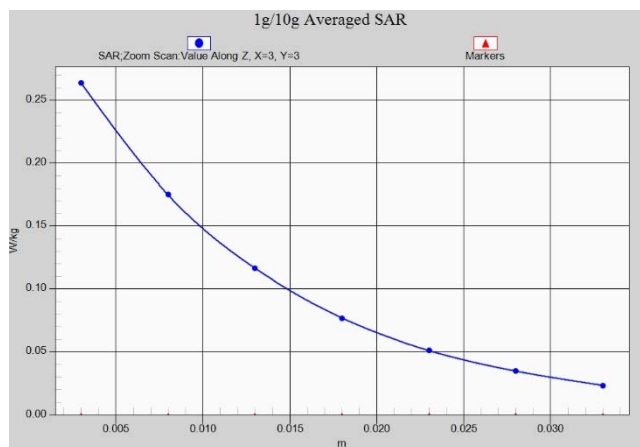

**Fig.A.1- 5 Z-Scan at power reference point (W1900)**

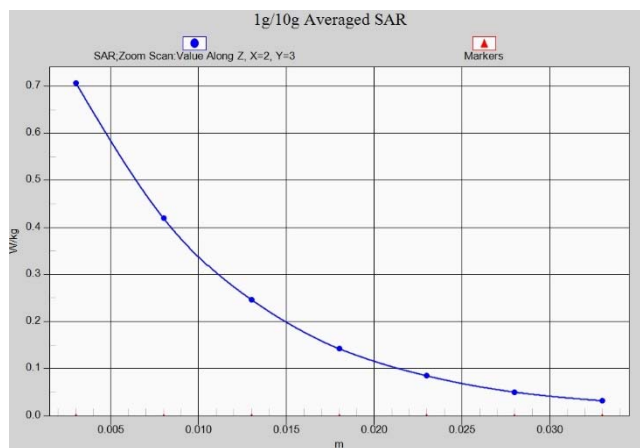

**Fig.A.1- 6 Z-Scan at power reference point (W1900)**

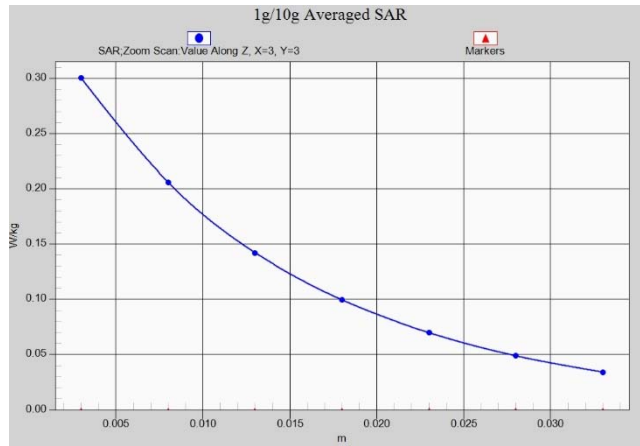

**Fig.A.1- 7 Z-Scan at power reference point (W1700)**



**Fig.A.1- 8 Z-Scan at power reference point (W1700)**

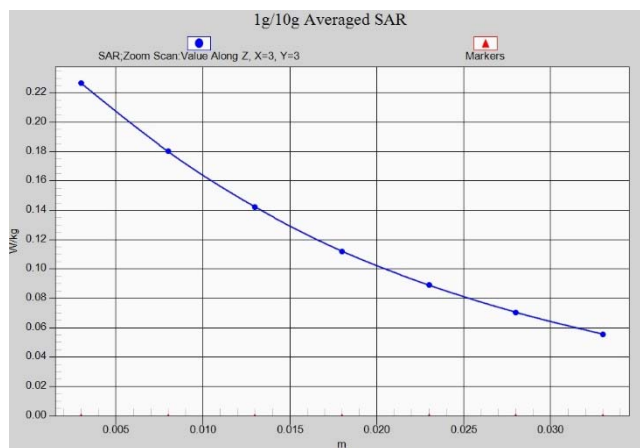

**Fig.A.1- 9 Z-Scan at power reference point (W850)**

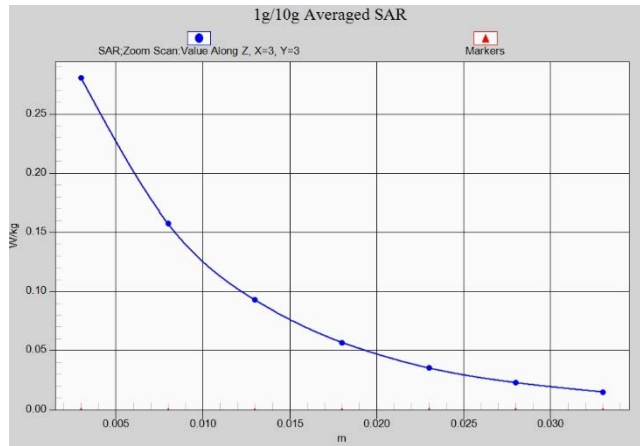

**Fig.A.1- 10 Z-Scan at power reference point (W850)**

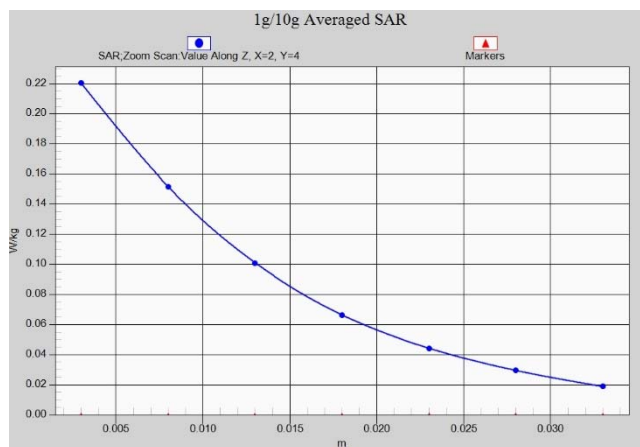

**Fig.A.1- 11 Z-Scan at power reference point (LTE band2)**

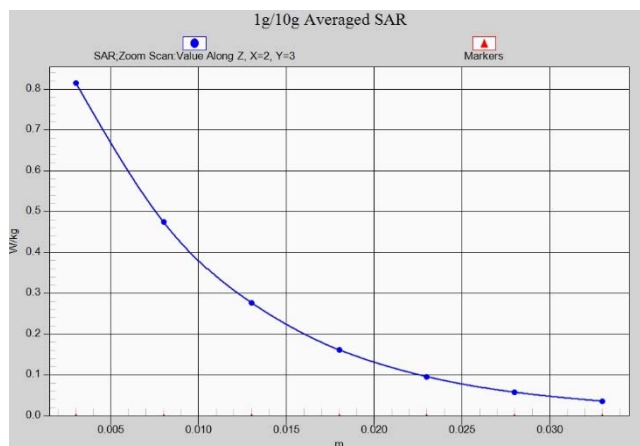

**Fig.A.1- 12 Z-Scan at power reference point (LTE band2)**

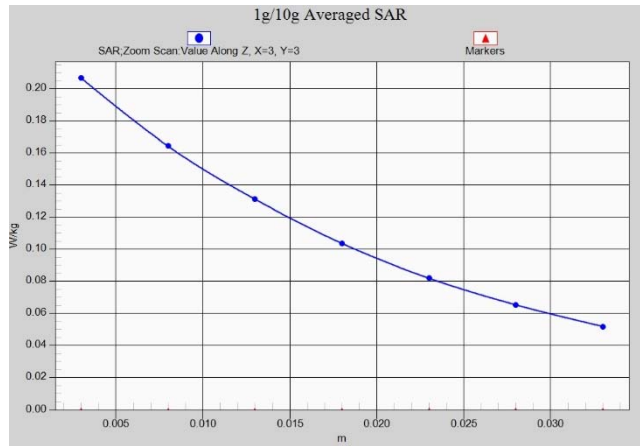

**Fig.A.1- 13 Z-Scan at power reference point (LTE band5)**

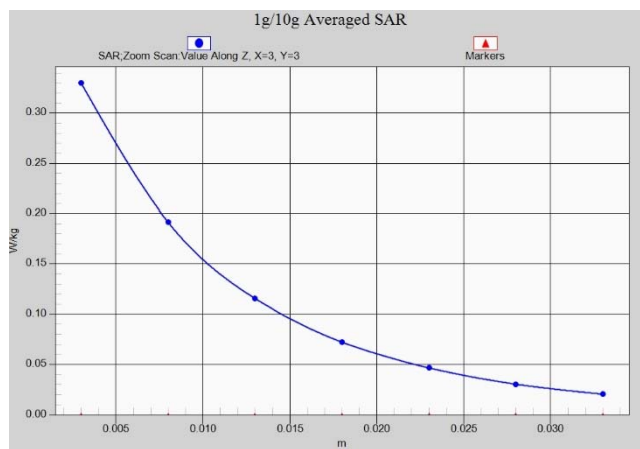

**Fig.A.1- 14 Z-Scan at power reference point (LTE band5)**

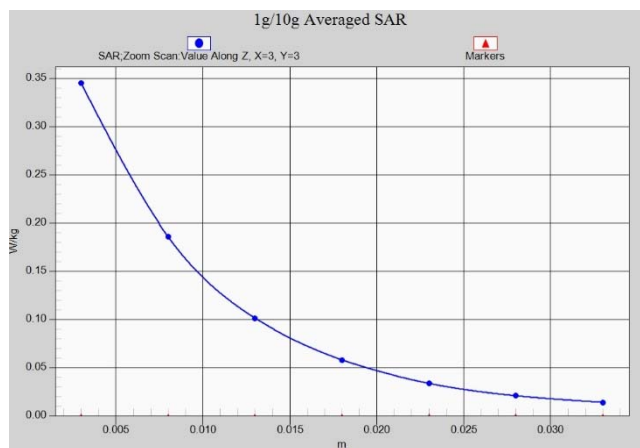

**Fig.A.1- 15 Z-Scan at power reference point (LTE band7)**

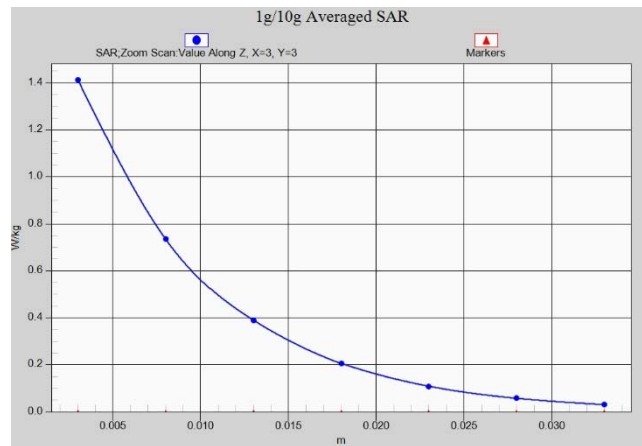

**Fig.A.1- 16 Z-Scan at power reference point (LTE band7)**

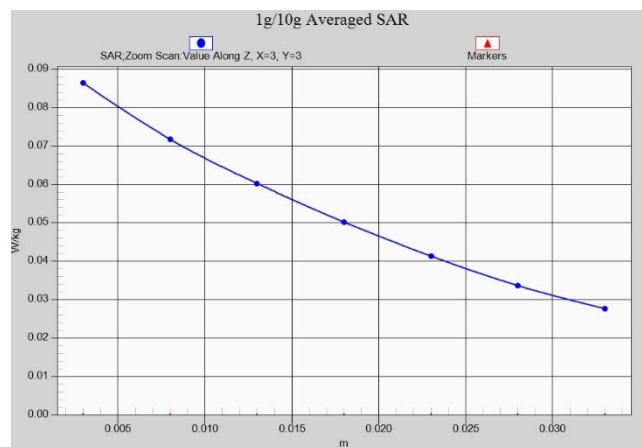

**Fig.A.1- 17 Z-Scan at power reference point (LTE band12)**

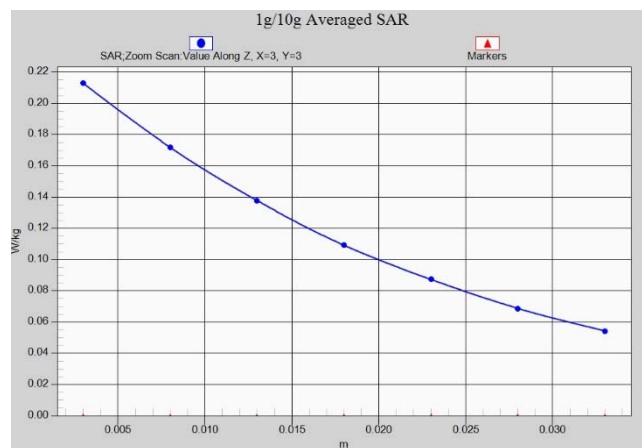

**Fig.A.1- 18 Z-Scan at power reference point (LTE band12)**

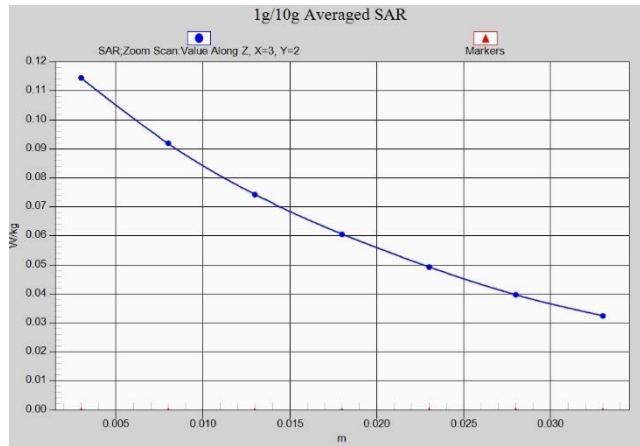

**Fig.A.1- 19 Z-Scan at power reference point (LTE band13)**

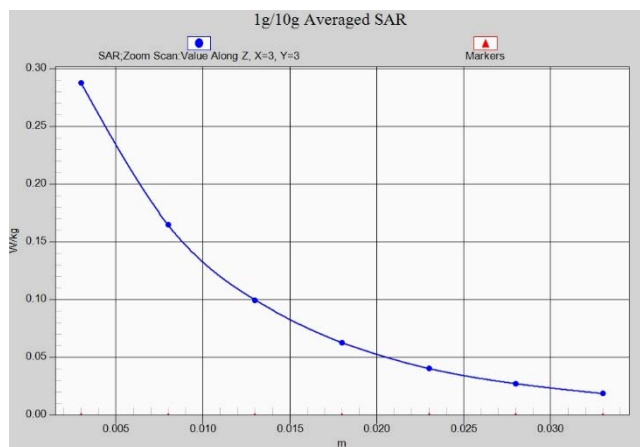

**Fig.A.1- 20 Z-Scan at power reference point (LTE band13)**

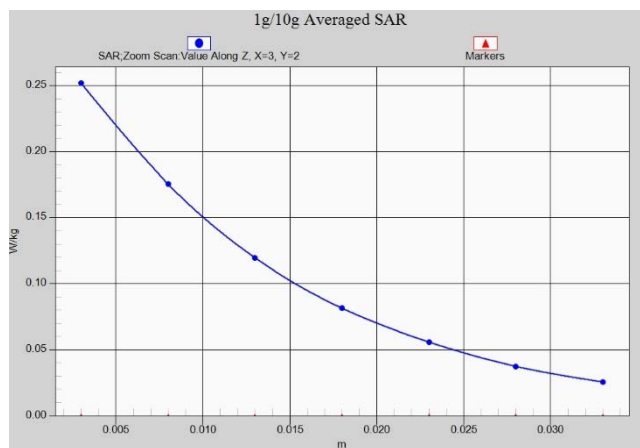

**Fig.A.1- 21 Z-Scan at power reference point (LTE band66)**

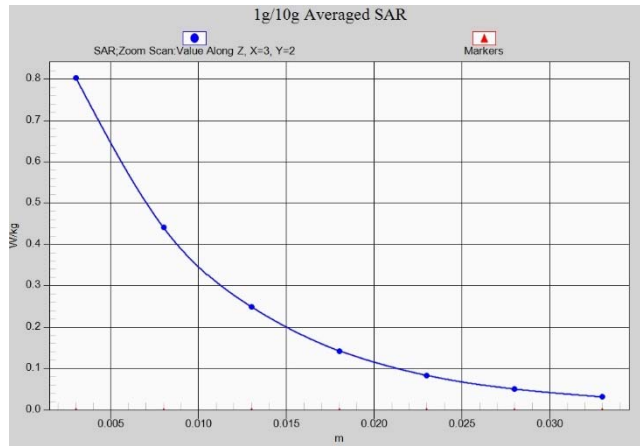

**Fig.A.1- 22 Z-Scan at power reference point (LTE band66)**

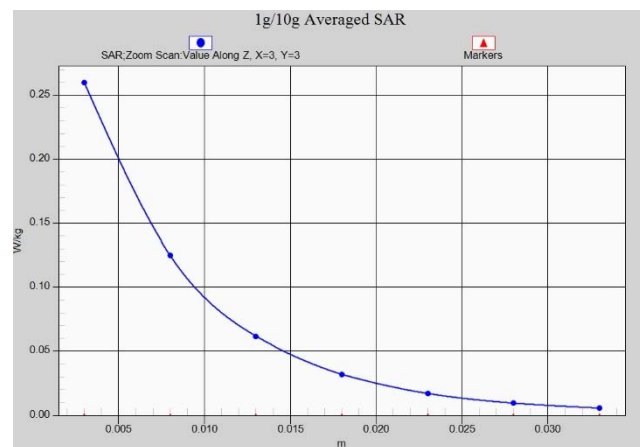

**Fig.A.1- 23 Z-Scan at power reference point (Wifi2450)**

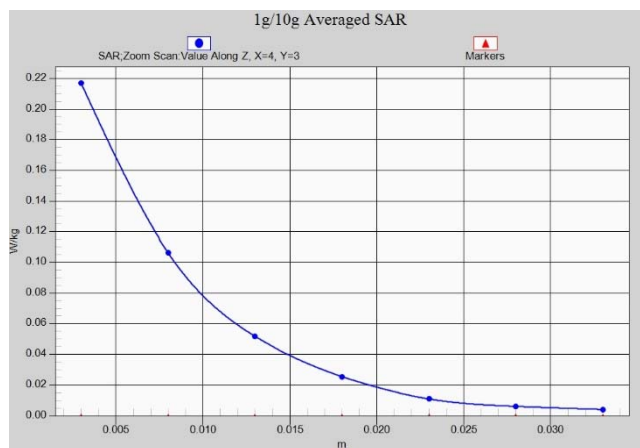

**Fig.A.1- 24 Z-Scan at power reference point (Wifi2450)**



## ANNEX B System Verification Results

### 750 MHz

Date: 6/1/2018

Electronics: DAE4 Sn1525

Medium: Head 750 MHz

Medium parameters used:  $f = 750$  MHz;  $\sigma = 0.898$  mho/m;  $\epsilon_r = 41.7$ ;  $\rho = 1000$  kg/m<sup>3</sup>

Ambient Temperature: 22.5°C Liquid Temperature: 22.3°C

Communication System: CW Frequency: 750 MHz Duty Cycle: 1:1

Probe: EX3DV4 – SN7464 ConvF(10.57,10.57,10.57)

**System Validation /Area Scan (81x191x1):** Interpolated grid: dx=1.000 mm, dy=1.000 mm

Reference Value = 59.9 V/m; Power Drift = 0.03

**Fast SAR: SAR(1 g) = 2.04 W/kg; SAR(10 g) = 1.38 W/kg**

Maximum value of SAR (interpolated) = 2.75 W/kg

**System Validation /Zoom Scan (7x7x7)/Cube 0:** Measurement grid: dx=5mm, dy=5mm, dz=5mm

Reference Value = 59.9 V/m; Power Drift = 0.03 dB

Peak SAR (extrapolated) = 3.17 W/kg

**SAR(1 g) = 2.08 W/kg; SAR(10 g) = 1.34 W/kg**

Maximum value of SAR (measured) = 2.82 W/kg

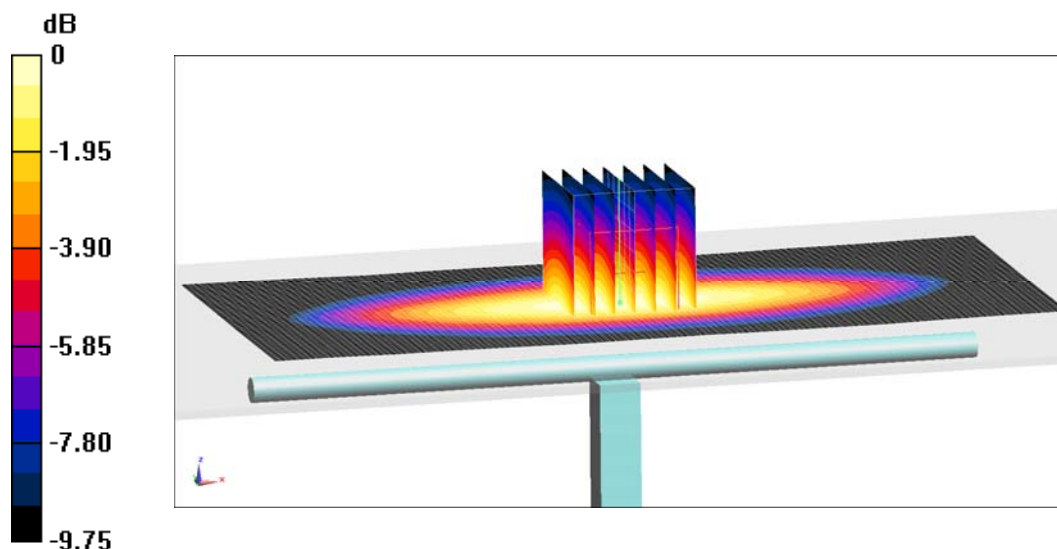

0 dB = 2.82 W/kg = 4.5 dB W/kg

**Fig.B.1 validation 750 MHz 250mW**

## 750 MHz

Date: 6/1/2018

Electronics: DAE4 Sn1525

Medium: Body 750 MHz

Medium parameters used:  $f = 750 \text{ MHz}$ ;  $\sigma = 0.951 \text{ mho/m}$ ;  $\epsilon_r = 55.35$ ;  $\rho = 1000 \text{ kg/m}^3$

Ambient Temperature:  $22.5^\circ\text{C}$  Liquid Temperature:  $22.3^\circ\text{C}$

Communication System: CW Frequency: 750 MHz Duty Cycle: 1:1

Probe: EX3DV4 – SN7464 ConvF(10.63,10.63,10.63)

**System Validation /Area Scan (81x191x1):** Interpolated grid:  $dx=1.000 \text{ mm}$ ,  $dy=1.000 \text{ mm}$

Reference Value =  $56.8 \text{ V/m}$ ; Power Drift =  $-0.03$

**Fast SAR: SAR(1 g) =  $2.16 \text{ W/kg}$ ; SAR(10 g) =  $1.42 \text{ W/kg}$**

Maximum value of SAR (interpolated) =  $3.23 \text{ W/kg}$

**System Validation /Zoom Scan (7x7x7)/Cube 0:** Measurement grid:  $dx=5\text{mm}$ ,  $dy=5\text{mm}$ ,  $dz=5\text{mm}$

Reference Value =  $56.8 \text{ V/m}$ ; Power Drift =  $-0.03 \text{ dB}$

Peak SAR (extrapolated) =  $3.3 \text{ W/kg}$

**SAR(1 g) =  $2.21 \text{ W/kg}$ ; SAR(10 g) =  $1.41 \text{ W/kg}$**

Maximum value of SAR (measured) =  $2.9 \text{ W/kg}$

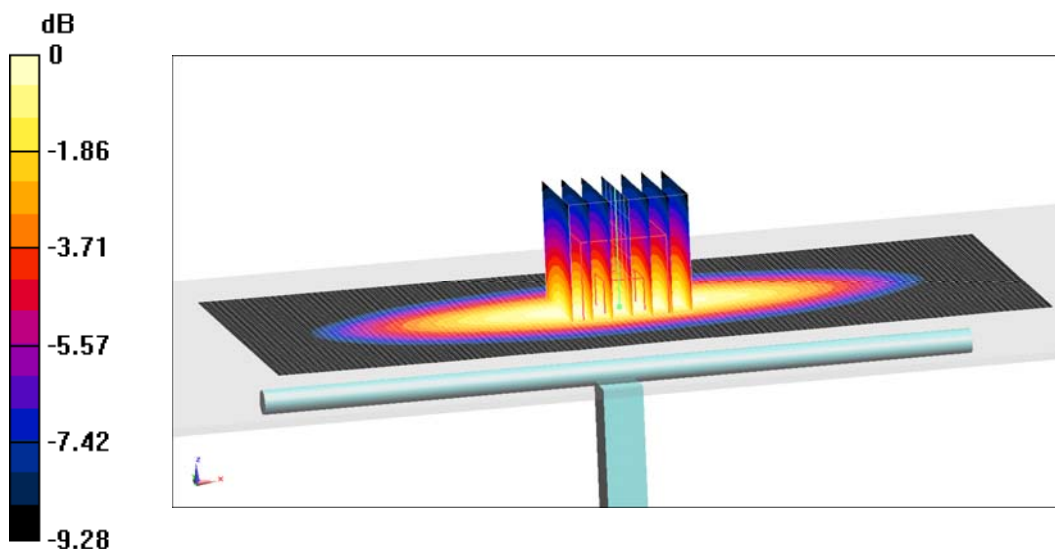

0 dB =  $2.9 \text{ W/kg}$  =  $4.62 \text{ dB W/kg}$

**Fig.B.2 validation 750 MHz 250mW**

## 835 MHz

Date: 6/2/2018

Electronics: DAE4 Sn1525

Medium: Head 835 MHz

Medium parameters used:  $f = 835 \text{ MHz}$ ;  $\sigma = 0.901 \text{ mho/m}$ ;  $\epsilon_r = 41.6$ ;  $\rho = 1000 \text{ kg/m}^3$

Ambient Temperature:  $22.5^\circ\text{C}$  Liquid Temperature:  $22.3^\circ\text{C}$

Communication System: CW Frequency: 835 MHz Duty Cycle: 1:1

Probe: EX3DV4 – SN7464 ConvF(10.28,10.28,10.28)

**System Validation /Area Scan (81x191x1):** Interpolated grid:  $dx=1.000 \text{ mm}$ ,  $dy=1.000 \text{ mm}$

Reference Value =  $64.81 \text{ V/m}$ ; Power Drift = 0.04

**Fast SAR: SAR(1 g) =  $2.34 \text{ W/kg}$ ; SAR(10 g) =  $1.5 \text{ W/kg}$**

Maximum value of SAR (interpolated) =  $3.8 \text{ W/kg}$

**System Validation /Zoom Scan (7x7x7)/Cube 0:** Measurement grid:  $dx=5\text{mm}$ ,  $dy=5\text{mm}$ ,  $dz=5\text{mm}$

Reference Value =  $64.81 \text{ V/m}$ ; Power Drift = 0.04 dB

Peak SAR (extrapolated) =  $4.12 \text{ W/kg}$

**SAR(1 g) =  $2.37 \text{ W/kg}$ ; SAR(10 g) =  $1.52 \text{ W/kg}$**

Maximum value of SAR (measured) =  $3.63 \text{ W/kg}$

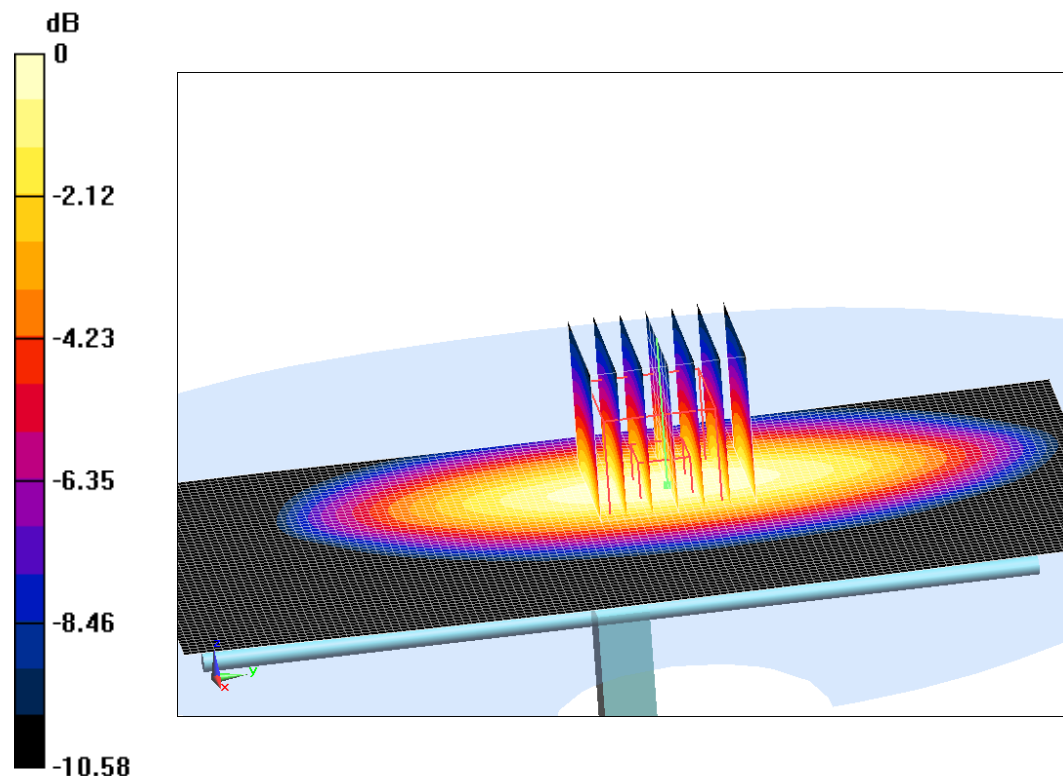

0 dB =  $3.63 \text{ W/kg} = 5.6 \text{ dB W/kg}$

**Fig.B.3 validation 835 MHz 250mW**

### 835 MHz

Date: 6/2/2018

Electronics: DAE4 Sn1525

Medium: Body 835 MHz

Medium parameters used:  $f = 835$  MHz;  $\sigma = 0.988$  mho/m;  $\epsilon_r = 56.1$ ;  $\rho = 1000$  kg/m<sup>3</sup>

Ambient Temperature: 22.5°C Liquid Temperature: 22.3°C

Communication System: CW Frequency: 835 MHz Duty Cycle: 1:1

Probe: EX3DV4 – SN7464 ConvF(10.21,10.21,10.21)

**System Validation /Area Scan (81x191x1):** Interpolated grid: dx=1.000 mm, dy=1.000 mm

Reference Value = 59.21 V/m; Power Drift = -0.09

**Fast SAR: SAR(1 g) = 2.32 W/kg; SAR(10 g) = 1.52 W/kg**

Maximum value of SAR (interpolated) = 3.58 W/kg

**System Validation /Zoom Scan (7x7x7)/Cube 0:** Measurement grid: dx=5mm, dy=5mm, dz=5mm

Reference Value =59.21 V/m; Power Drift = -0.09 dB

Peak SAR (extrapolated) = 3.7 W/kg

**SAR(1 g) = 2.31 W/kg; SAR(10 g) = 1.55 W/kg**

Maximum value of SAR (measured) = 3.2 W/kg

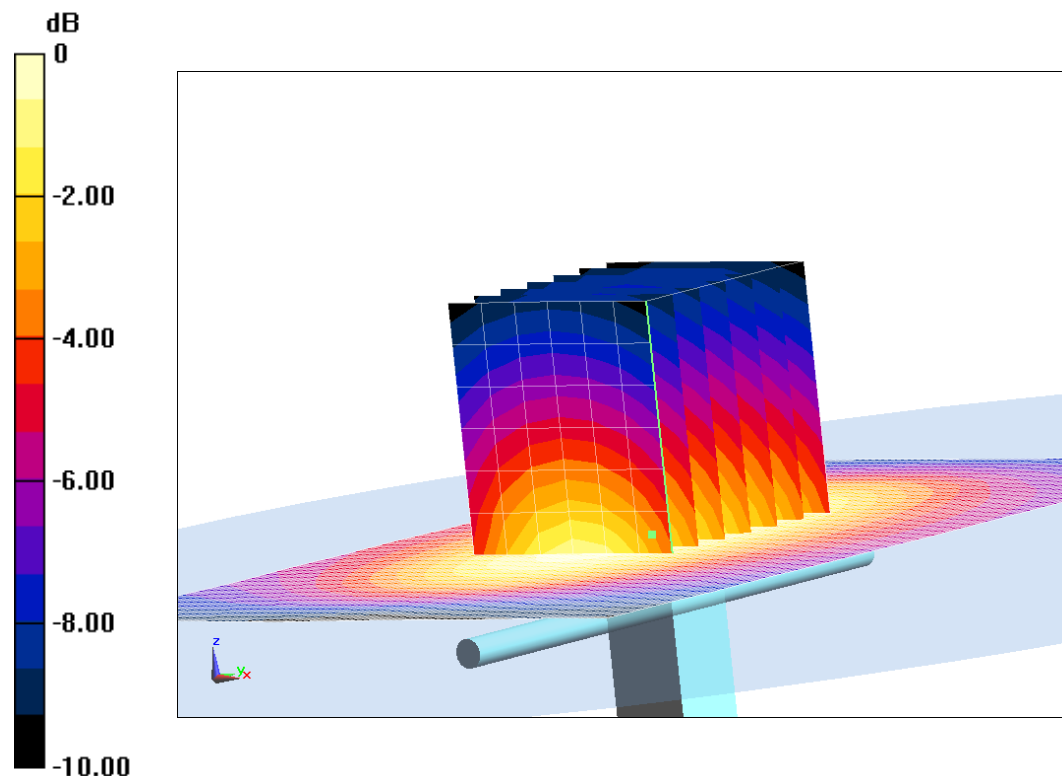

0 dB = 3.2 W/kg = 5.05 dB W/kg

**Fig.B.4 validation 835 MHz 250mW**

## 1750 MHz

Date: 6/3/2018

Electronics: DAE4 Sn1525

Medium: Head 1750 MHz

Medium parameters used:  $f = 1750$  MHz;  $\sigma = 1.38$  mho/m;  $\epsilon_r = 40.68$ ;  $\rho = 1000$  kg/m<sup>3</sup>

Ambient Temperature: 22.5°C Liquid Temperature: 22.3°C

Communication System: CW Frequency: 1750 MHz Duty Cycle: 1:1

Probe: EX3DV4 – SN7464 ConvF(8.70,8.70,8.70)

**System Validation /Area Scan (81x191x1):** Interpolated grid: dx=1.000 mm, dy=1.000 mm

Reference Value = 104.5 V/m; Power Drift = 0.06

**Fast SAR: SAR(1 g) = 9.05 W/kg; SAR(10 g) = 4.85 W/kg**

Maximum value of SAR (interpolated) = 14.9 W/kg

**System Validation /Zoom Scan (7x7x7)/Cube 0:** Measurement grid: dx=5mm, dy=5mm, dz=5mm

Reference Value = 104.5 V/m; Power Drift = 0.06 dB

Peak SAR (extrapolated) = 17.93 W/kg

**SAR(1 g) = 9.03 W/kg; SAR(10 g) = 4.88 W/kg**

Maximum value of SAR (measured) = 14.5 W/kg

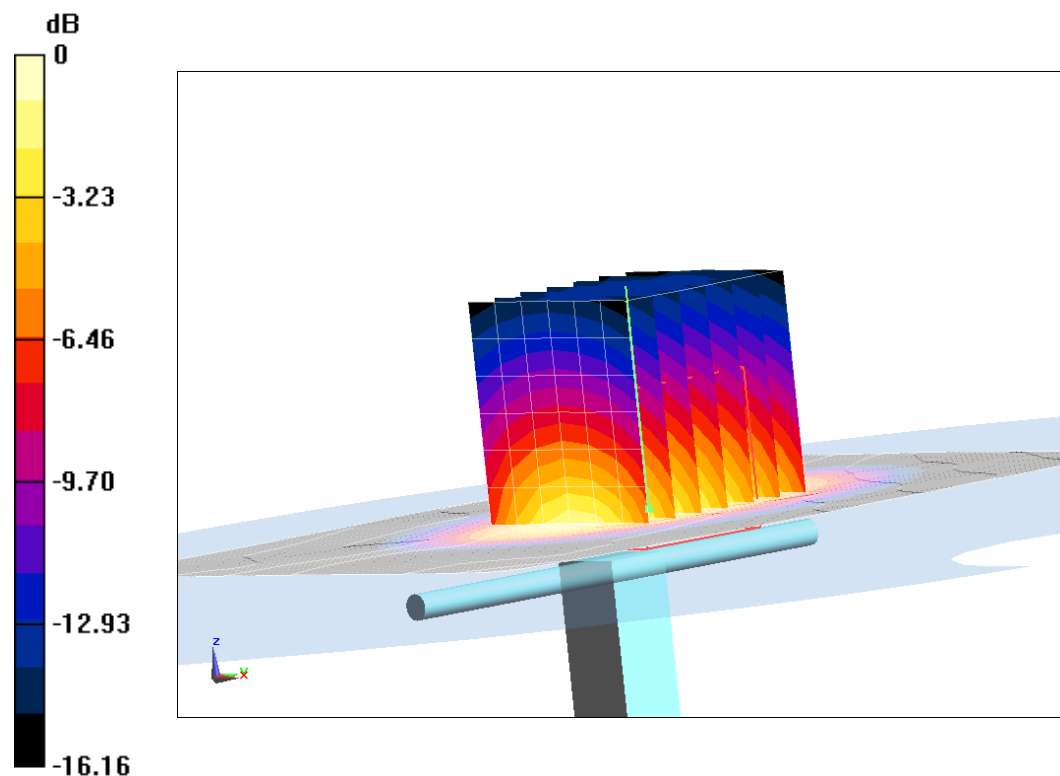

0 dB = 14.5 W/kg = 11.61 dB W/kg

**Fig.B.5 validation 1750 MHz 250mW**

## 1750 MHz

Date: 6/3/2018

Electronics: DAE4 Sn1525

Medium: Body 1750 MHz

Medium parameters used:  $f = 1750$  MHz;  $\sigma = 1.514$  mho/m;  $\epsilon_r = 53.22$ ;  $\rho = 1000$  kg/m<sup>3</sup>

Ambient Temperature: 22.5°C Liquid Temperature: 22.3°C

Communication System: CW Frequency: 1750 MHz Duty Cycle: 1:1

Probe: EX3DV4 – SN7464 ConvF(8.60,8.60,8.60)

**System Validation /Area Scan (81x191x1):** Interpolated grid: dx=1.000 mm, dy=1.000 mm

Reference Value = 101.14 V/m; Power Drift = 0.04

**Fast SAR: SAR(1 g) = 9.15 W/kg; SAR(10 g) = 4.93 W/kg**

Maximum value of SAR (interpolated) = 16.23 W/kg

**System Validation /Zoom Scan (7x7x7)/Cube 0:** Measurement grid: dx=5mm, dy=5mm, dz=5mm

Reference Value = 101.14 V/m; Power Drift = 0.04 dB

Peak SAR (extrapolated) = 16.08 W/kg

**SAR(1 g) = 9.19 W/kg; SAR(10 g) = 5.02 W/kg**

Maximum value of SAR (measured) = 13.23 W/kg

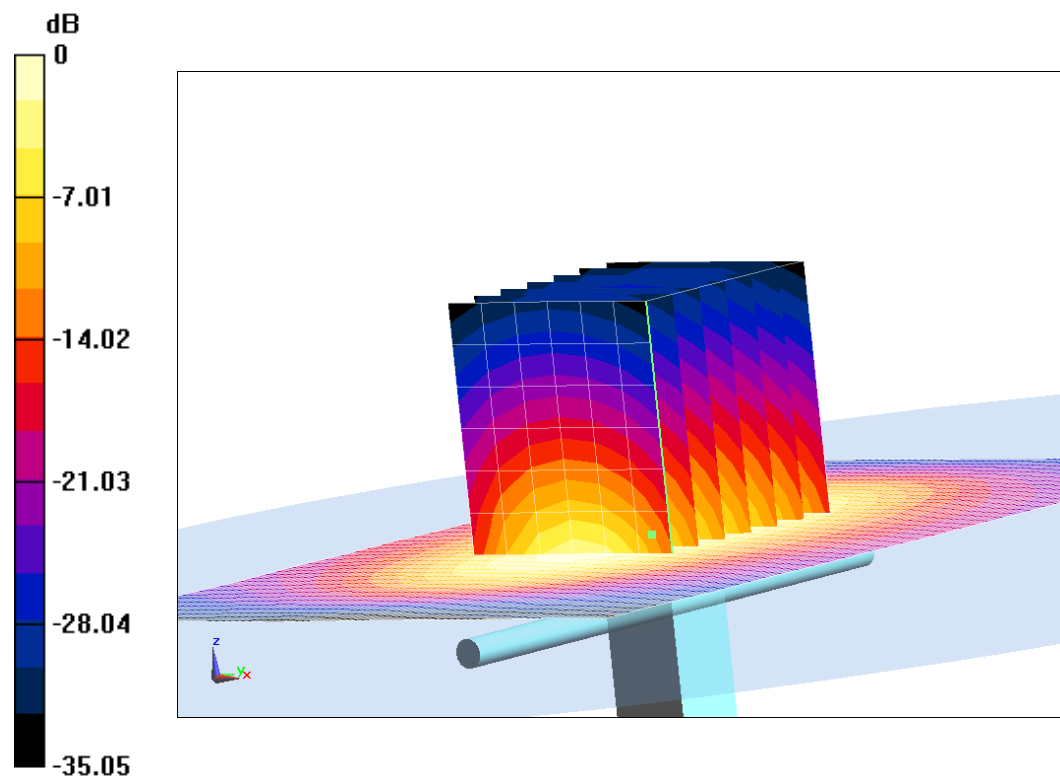

0 dB = 13.23 W/kg = 11.22 dB W/kg

**Fig.B.6 validation 1750 MHz 250mW**

## 1900 MHz

Date: 6/9/2018

Electronics: DAE4 Sn1525

Medium: Head 1900 MHz

Medium parameters used:  $f = 1900$  MHz;  $\sigma = 1.39$  mho/m;  $\epsilon_r = 39.55$ ;  $\rho = 1000$  kg/m<sup>3</sup>

Ambient Temperature: 22.5°C Liquid Temperature: 22.3°C

Communication System: CW Frequency: 1900 MHz Duty Cycle: 1:1

Probe: EX3DV4 – SN7464 ConvF(8.39,8.39,8.39)

**System Validation /Area Scan (81x191x1):** Interpolated grid: dx=1.000 mm, dy=1.000 mm

Reference Value = 105.18 V/m; Power Drift = 0.02

**Fast SAR: SAR(1 g) = 10.03 W/kg; SAR(10 g) = 5.25 W/kg**

Maximum value of SAR (interpolated) = 14.95 W/kg

**System Validation /Zoom Scan (7x7x7)/Cube 0:** Measurement grid: dx=5mm, dy=5mm, dz=5mm

Reference Value =105.18 V/m; Power Drift = 0.02 dB

Peak SAR (extrapolated) = 18.32 W/kg

**SAR(1 g) = 10.15 W/kg; SAR(10 g) = 5.2 W/kg**

Maximum value of SAR (measured) = 14.81 W/kg

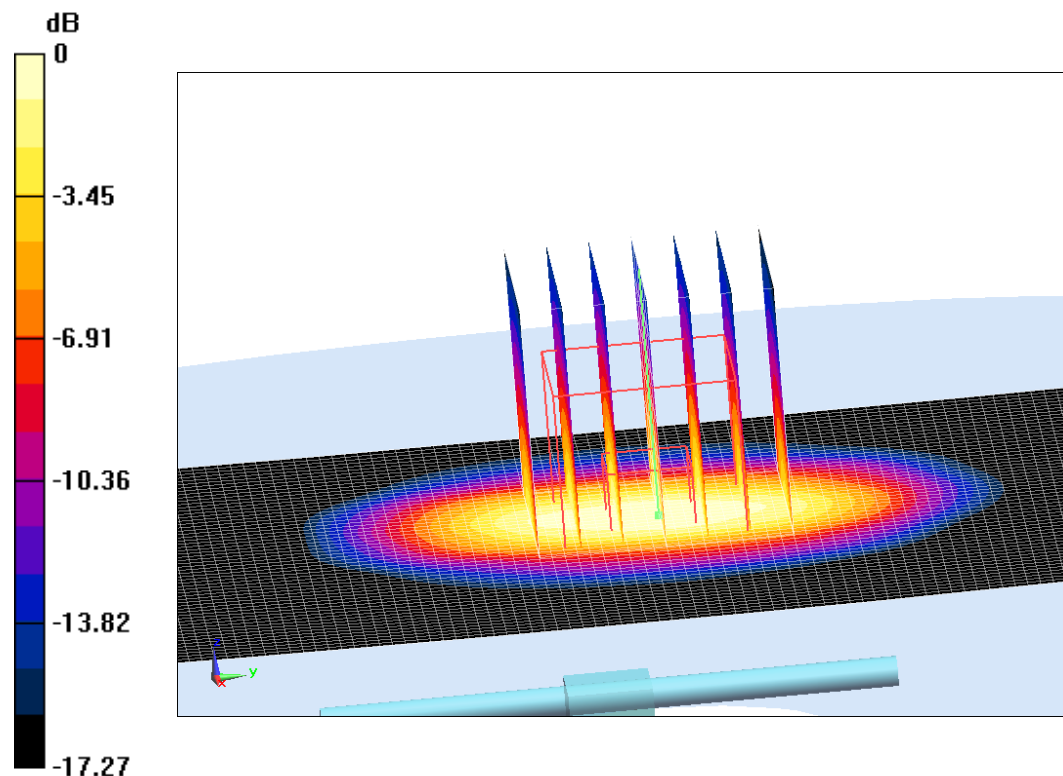

0 dB = 14.81 W/kg = 11.71 dB W/kg

**Fig.B.7 validation 1900 MHz 250mW**

## 1900 MHz

Date: 6/9/2018

Electronics: DAE4 Sn1525

Medium: Body 1900 MHz

Medium parameters used:  $f = 1900$  MHz;  $\sigma = 1.536$  mho/m;  $\epsilon_r = 53.19$ ;  $\rho = 1000$  kg/m<sup>3</sup>

Ambient Temperature: 22.5°C Liquid Temperature: 22.3°C

Communication System: CW Frequency: 1900 MHz Duty Cycle: 1:1

Probe: EX3DV4 – SN7464 ConvF(8.32,8.32,8.32)

**System Validation /Area Scan (81x191x1):** Interpolated grid: dx=1.000 mm, dy=1.000 mm

Reference Value = 103.34 V/m; Power Drift = -0.03

**Fast SAR: SAR(1 g) = 10.3 W/kg; SAR(10 g) = 5.34 W/kg**

Maximum value of SAR (interpolated) = 17.78 W/kg

**System Validation /Zoom Scan (7x7x7)/Cube 0:** Measurement grid: dx=5mm, dy=5mm, dz=5mm

Reference Value = 103.34 V/m; Power Drift = -0.03 dB

Peak SAR (extrapolated) = 17.85 W/kg

**SAR(1 g) = 10.03 W/kg; SAR(10 g) = 5.31 W/kg**

Maximum value of SAR (measured) = 14.11 W/kg

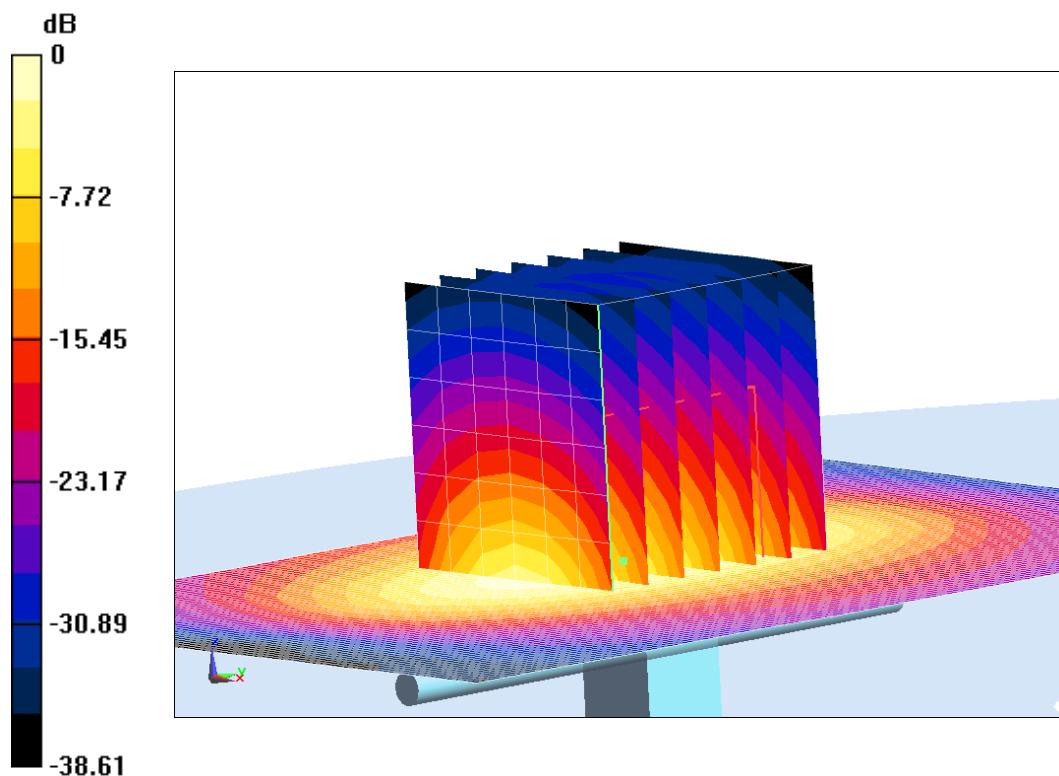

0 dB = 14.11 W/kg = 11.5 dB W/kg

**Fig.B.8 validation 1900 MHz 250mW**



## 2450 MHz

Date: 6/10/2018

Electronics: DAE4 Sn1525

Medium: Head 2450 MHz

Medium parameters used:  $f = 2450$  MHz;  $\sigma = 1.784$  mho/m;  $\epsilon_r = 39.05$ ;  $\rho = 1000$  kg/m<sup>3</sup>

Ambient Temperature: 22.5°C Liquid Temperature: 22.3°C

Communication System: CW Frequency: 2450 MHz Duty Cycle: 1:1

Probe: EX3DV4 – SN7464 ConvF(7.89,7.89,7.89)

**System Validation /Area Scan (81x191x1):** Interpolated grid: dx=1.000 mm, dy=1.000 mm

Reference Value = 113.79 V/m; Power Drift = -0.08

**Fast SAR: SAR(1 g) = 12.95 W/kg; SAR(10 g) = 6.09 W/kg**

Maximum value of SAR (interpolated) = 21.4 W/kg

**System Validation /Zoom Scan (7x7x7)/Cube 0:** Measurement grid: dx=5mm, dy=5mm, dz=5mm

Reference Value = 113.79 V/m; Power Drift = -0.08 dB

Peak SAR (extrapolated) = 26.83 W/kg

**SAR(1 g) = 13.29 W/kg; SAR(10 g) = 6.28 W/kg**

Maximum value of SAR (measured) = 21.92 W/kg

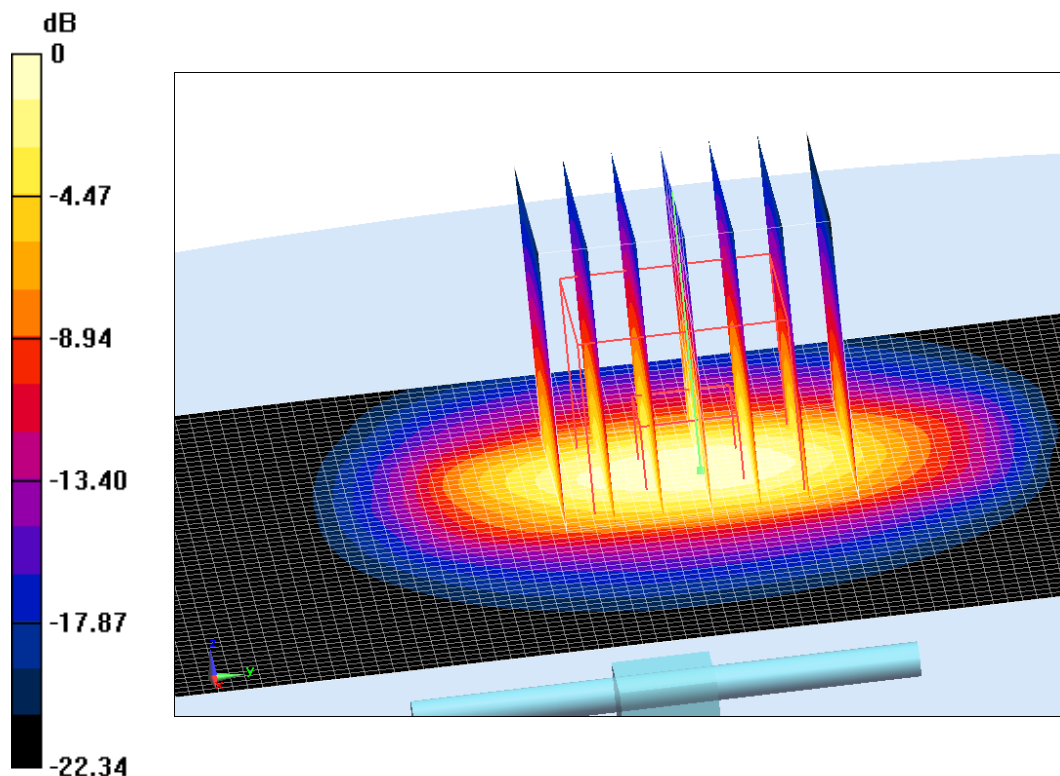

0 dB = 21.92 W/kg = 13.41 dB W/kg

**Fig.B.9 validation 2450 MHz 250mW**

## 2450 MHz

Date: 6/10/2018

Electronics: DAE4 Sn1525

Medium: Body 2450 MHz

Medium parameters used:  $f = 2450$  MHz;  $\sigma = 1.966$  mho/m;  $\epsilon_r = 53.36$ ;  $\rho = 1000$  kg/m<sup>3</sup>

Ambient Temperature: 22.5°C Liquid Temperature: 22.3°C

Communication System: CW Frequency: 2450 MHz Duty Cycle: 1:1

Probe: EX3DV4 – SN7464 ConvF(8.09,8.09,8.09)

**System Validation /Area Scan (81x191x1):** Interpolated grid: dx=1.000 mm, dy=1.000 mm

Reference Value = 103.84 V/m; Power Drift = -0.02

**Fast SAR: SAR(1 g) = 12.75 W/kg; SAR(10 g) = 5.97 W/kg**

Maximum value of SAR (interpolated) = 25.88 W/kg

**System Validation /Zoom Scan (7x7x7)/Cube 0:** Measurement grid: dx=5mm, dy=5mm, dz=5mm

Reference Value =103.84 V/m; Power Drift = -0.02 dB

Peak SAR (extrapolated) = 25.71 W/kg

**SAR(1 g) = 12.47 W/kg; SAR(10 g) = 5.86 W/kg**

Maximum value of SAR (measured) = 20.11 W/kg

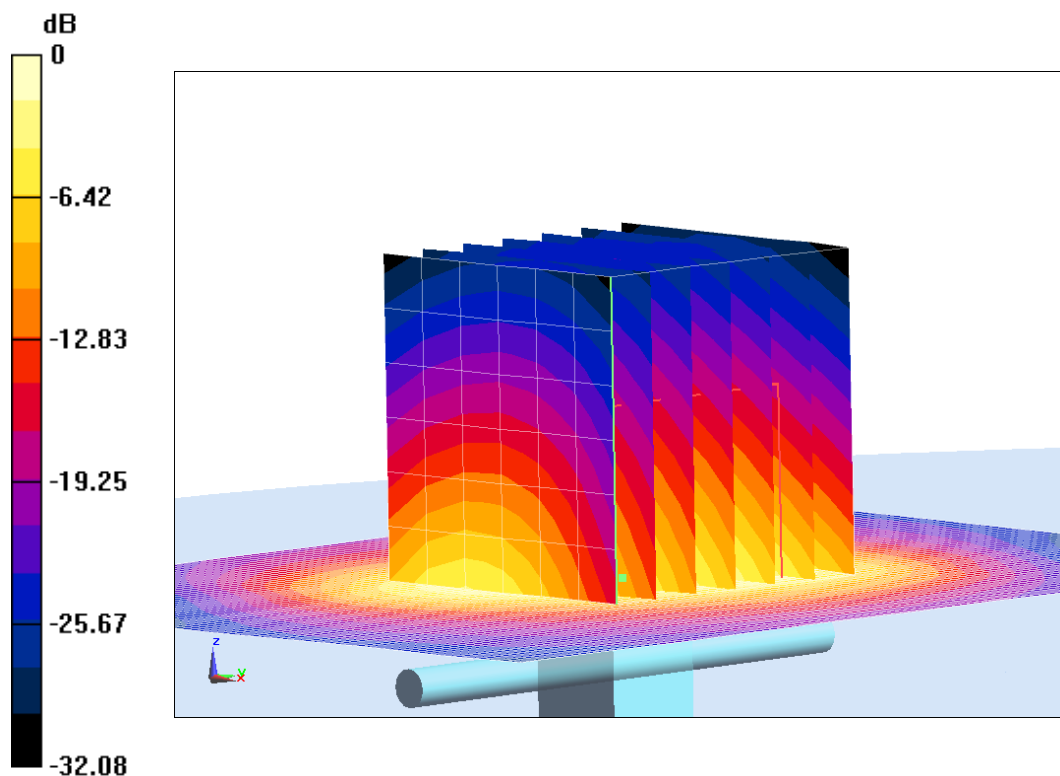

0 dB = 20.11 W/kg = 13.03 dB W/kg

**Fig.B.10 validation 2450 MHz 250mW**