

Appendix (Additional assessments outside the scope of SCS0108)
1. DC Voltage Linearity

High Range	Reading (μV)	Difference (μV)	Error (%)
Channel X + Input	200030.95	-2.42	-0.00
Channel X + Input	20004.11	-0.05	-0.00
Channel X - Input	-20003.75	2.02	-0.01
Channel Y + Input	200031.20	-2.23	-0.00
Channel Y + Input	20001.46	-2.74	-0.01
Channel Y - Input	-20005.92	-0.05	0.00
Channel Z + Input	200032.03	-1.05	-0.00
Channel Z + Input	20001.94	-2.11	-0.01
Channel Z - Input	-20006.15	-0.20	0.00

Low Range	Reading (μV)	Difference (μV)	Error (%)
Channel X + Input	2000.66	0.19	0.01
Channel X + Input	200.40	-0.18	-0.09
Channel X - Input	-198.67	0.81	-0.40
Channel Y + Input	2000.90	0.48	0.02
Channel Y + Input	199.98	-0.58	-0.29
Channel Y - Input	-200.18	-0.62	0.31
Channel Z + Input	2000.68	0.32	0.02
Channel Z + Input	199.07	-1.45	-0.72
Channel Z - Input	-201.14	-1.52	0.76

2. Common mode sensitivity

DASYS measurement parameters: Auto Zero Time: 3 sec; Measuring time: 3 sec

	Common mode Input Voltage (mV)	High Range Average Reading (μV)	Low Range Average Reading (μV)
Channel X	200	18.32	16.76
	- 200	-15.73	-17.08
Channel Y	200	-20.47	-20.86
	- 200	20.66	20.31
Channel Z	200	13.43	13.46
	- 200	-15.65	-15.97

3. Channel separation

DASYS measurement parameters: Auto Zero Time: 3 sec; Measuring time: 3 sec

	Input Voltage (mV)	Channel X (μV)	Channel Y (μV)	Channel Z (μV)
Channel X	200	-	0.08	-3.66
Channel Y	200	7.12	-	1.80
Channel Z	200	10.44	4.52	-

4. AD-Converter Values with inputs shorted

DASY measurement parameters: Auto Zero Time: 3 sec; Measuring time: 3 sec

	High Range (LSB)	Low Range (LSB)
Channel X	15817	15005
Channel Y	16329	14457
Channel Z	15576	15478

5. Input Offset Measurement

DASY measurement parameters: Auto Zero Time: 3 sec; Measuring time: 3 sec

 Input 10M Ω

	Average (μ V)	min. Offset (μ V)	max. Offset (μ V)	Std. Deviation (μ V)
Channel X	0.63	-0.54	2.27	0.51
Channel Y	-2.07	-3.42	-1.02	0.49
Channel Z	-0.89	-2.38	0.83	0.54

6. Input Offset Current

Nominal Input circuitry offset current on all channels: <25fA

7. Input Resistance (Typical values for information)

	Zeroing (kOhm)	Measuring (MOhm)
Channel X	200	200
Channel Y	200	200
Channel Z	200	200

8. Low Battery Alarm Voltage (Typical values for information)

Typical values	Alarm Level (VDC)
Supply (+ Vcc)	+7.9
Supply (- Vcc)	-7.6

9. Power Consumption (Typical values for information)

Typical values	Switched off (mA)	Stand by (mA)	Transmitting (mA)
Supply (+ Vcc)	+0.01	+6	+14
Supply (- Vcc)	-0.01	-8	-9

ANNEX J Spot Check

J.1 Dielectric Performance

Table J.1-1: Dielectric Performance of Tissue Simulating Liquid

Measurement Date yyyy/mm/dd	Frequency	Type	Permittivity ϵ	Drift (%)	Conductivity σ (S/m)	Drift (%)
2020/10/22	750 MHz	Head	41.7	-0.57	0.898	0.90
		Body	55.35	-0.27	0.951	-0.94
2020/10/22	835 MHz	Head	41.6	0.24	0.901	0.11
		Body	56.1	1.63	0.988	1.86
2020/10/22	1750 MHz	Head	40.68	1.50	1.38	0.73
		Body	53.22	-0.34	1.514	1.61
2020/10/23	1900 MHz	Head	39.55	-1.13	1.39	-0.71
		Body	53.19	-0.21	1.536	1.05
2020/10/23	2450 MHz	Head	39.05	-0.38	1.784	-0.89
		Body	53.36	1.25	1.966	0.82
2020/10/23	2600 MHz	Head	39.57	1.44	1.966	0.31
		Body	51.61	-1.70	2.138	-1.02

J.2 System Verification

Table J.2-1: System Verification of Head

Measurement Date (yyyy-mm- dd)	Frequency	Target value (W/kg)		Measured value (W/kg)		Deviation	
		10 g	1 g	10 g	1 g	10 g	1 g
		Average	Average	Average	Average	Average	Average
2020/10/22	750 MHz	5.53	8.47	5.48	8.48	-0.90%	0.12%
2020/10/22	835 MHz	6.25	9.60	6.24	9.72	-0.16%	1.25%
2020/10/22	1750 MHz	19.1	36.5	19.2	35.92	0.52%	-1.59%
2020/10/23	1900 MHz	20.6	39.6	20.4	40.2	-0.97%	1.52%
2020/10/23	2450 MHz	24.5	52.5	24.92	53.44	1.71%	1.79%
2020/10/23	2600 MHz	25.3	57.0	25.44	57.92	0.55%	1.61%

Table J.2-2: System Verification of Body

Measurement Date (yyyy-mm-dd)	Frequency	Target value (W/kg)		Measured value (W/kg)		Deviation	
		10 g Average	1 g Average	10 g Average	1 g Average	10 g Average	1 g Average
2020/10/22	750 MHz	5.84	8.85	5.8	9	-0.68%	1.69%
2020/10/22	835 MHz	6.39	9.74	6.44	9.56	0.78%	-1.85%
2020/10/22	1750 MHz	19.9	37.6	20.16	37.28	1.31%	-0.85%
2020/10/23	1900 MHz	20.8	39.5	20.52	39.12	-1.35%	-0.96%
2020/10/23	2450 MHz	24.6	52.4	24.24	51.88	-1.46%	-0.99%
2020/10/23	2600 MHz	24.6	55.1	25	54.24	1.63%	-1.56%

J.3 Conducted power of selected case

Table J.3-1: The conducted power results for 2G

GSM 850MHZ	Measured Power (dBm)		
		251	190
Speech	32.77	/	/
GPRS(2Tx)	/	30.48	/
GSM1900MHZ	Measured Power (dBm)		
		810	661
Speech	/	/	2958
GPRS(2Tx)	/	/	27.09

Table J.3-2: The conducted Power for WCDMA

Item	band	FDDII result		
		ARFCN	9538/9938	9400/9800
WCDMA	\	(1907.6MHz)	(1880MHz)	(1852.4MHz)
		/	/	23.11
Item	band	FDDIV result		
	ARFCN	1513/1738	1412/1637	1312/1537
WCDMA	\	(1752.6MHz)	(1732.4MHz)	(1712.4MHz)
		/	23.38	/
Item	band	FDDV result		
	ARFCN	4233/4458	4183/4408	4132/4357
WCDMA	\	(846.6MHz)	(836.6MHz)	(826.4MHz)
		23.44	23.38	/

Table J.3-3: The conducted Power for LTE

LTE Band2	1RB-Middle	1900 (19100)	23.11
LTE Band2	1RB-Middle	1860 (18700)	23.08
LTE Band4	1RB-Middle	1720 (20050)	23.11
LTE Band4	1RB-Middle	1745 (20300)	23.04

LTE Band5	1RB-Middle	829 (20450)	23.15
LTE Band7	1RB-Middle	2510 (20850)	21.70
LTE Band7	1RB-Middle	2560 (21350)	21.49
LTE Band12	1RB-Middle	704 (23060)	23.02
LTE Band13	1RB-Middle	782 (23230)	22.99

Table J.3-4: The conducted Power for WLAN

Mode / data rate	Channel	Measured Power (dBm)
2.4G-11b	6	15.71

J.4 Measurement results for spot check

Table J.4-1: The spot check results

Test Band	Channel	Frequency	Tune-Up	Measured Power	Test Position	Measured 10g SAR	Measured 1g SAR	Reported 10g SAR	Reported 1g SAR	Power Drift
GSM850	251	848.8 MHz	33.3	32.77	Left Cheek	0.302	0.399	0.34	0.45	-0.05
GSM850	190	836.6 MHz	30.5	30.48	Rear	0.428	0.546	0.43	0.55	-0.08
PCS1900	512	1850.2 MHz	30.3	29.58	Right Cheek	0.199	0.315	0.23	0.37	0.09
PCS1900	512	1850.2 MHz	28	27.09	Rear	0.453	0.791	0.13	0.98	-0.13
WCDMA1900-BII	9262	1852.4 MHz	23.5	23.11	Left Cheek	0.334	0.532	0.37	0.58	0.08
WCDMA1900-BII	9262	1852.4 MHz	23.5	23.11	Bottom edge	0.536	0.993	0.59	1.09	-0.06
WCDMA1700-BIV	1412	1732.4 MHz	23.5	23.38	Left Cheek	0.257	0.41	0.26	0.42	-0.12
WCDMA1700-BIV	1412	1732.4 MHz	23.5	23.38	Rear	0.451	0.765	0.46	0.79	0.08
WCDMA850-BV	4182	835.4 MHz	24	23.38	Left Cheek	0.286	0.379	0.33	0.44	0.06
WCDMA850-BV	4233	846.6 MHz	24	23.44	Rear	0.336	0.427	0.38	0.49	-0.1
LTE1900-FDD2	19100	1900 MHz	23.5	23.11	Left Cheek	0.269	0.429	0.29	0.47	-0.02
LTE1900-FDD2	18700	1860 MHz	23.5	23.08	Bottom edge	0.513	0.956	0.57	1.05	-0.07
LTE1700-FDD4	20050	1720 MHz	23.5	23.11	Left Cheek	0.2	0.318	0.22	0.35	-0.03
LTE1700-FDD4	20300	1745 MHz	23.5	23.04	Rear	0.514	0.889	0.57	0.99	0.08
LTE850-FDD5	20450	829 MHz	24	23.15	Left Cheek	0.255	0.333	0.31	0.40	0.01
LTE850-FDD5	20450	829 MHz	24	23.15	Rear	0.352	0.451	0.43	0.55	0.03
LTE2500-FDD7	20850	2510 MHz	22.2	21.7	Right Cheek	0.11	0.216	0.12	0.24	-0.06
LTE2500-FDD7	21350	2560 MHz	22.2	21.49	Bottom edge	0.494	1	0.58	1.18	-0.1
LTE700-FDD12	23060	704 MHz	24	23.02	Right Cheek	0.158	0.205	0.20	0.26	0.05
LTE700-FDD12	23060	704 MHz	24	23.02	Rear	0.175	0.228	0.22	0.29	0.02
LTE750-FDD13	23230	782 MHz	24	22.99	Left Cheek	0.211	0.274	0.27	0.35	-0.05
LTE750-FDD13	23230	782 MHz	24	22.99	Rear	0.232	0.296	0.29	0.37	-0.11
WLAN2450	6	2437 MHz	16.5	15.71	Right Cheek	0.397	0.764	0.48	0.92	0.11
WLAN2450	6	2437 MHz	16.5	15.71	Rear	0.0715	0.133	0.09	0.16	-0.06

J.5 Reported SAR Comparison

Exposure Configuration	Technology Band	Reported SAR 1g (W/Kg): original	Reported SAR 1g (W/Kg): spot check	
Head (Separation Distance 0mm)	GSM850	0.39	0.45	
	PCS1900	0.38	0.37	
	WCDMA1900-BII	0.23	0.58	
	WCDMA1700-BIV	0.46	0.42	
	WCDMA850-BV	0.39	0.44	
	LTE1900-FDD2	0.16	0.47	
	LTE1700-FDD4	0.33	0.35	
	LTE850-FDD5	0.36	0.40	
	LTE2500-FDD7	0.20	0.24	
	LTE700-FDD12	0.22	0.26	
	LTE750-FDD13	0.34	0.35	
	WLAN 2.4 GHz	0.99	0.92	
	Hotspot (Separation Distance 10mm)	GSM850	0.46	0.55
PCS1900		1.09	0.98	
WCDMA1900-BII		1.19	1.09	
WCDMA1700-BIV		1.18	0.79	
WCDMA850-BV		0.44	0.49	
LTE1900-FDD2		1.19	1.05	
LTE1700-FDD4		1.16	0.99	
LTE850-FDD5		0.41	0.55	
LTE2500-FDD7		1.19	1.18	
LTE700-FDD12		0.30	0.29	
LTE750-FDD13		0.37	0.37	
WLAN 2.4 GHz		0.16	0.16	DTS

Note: All the spot check results marked blue are larger than the original resultd. So it replace the original results and others are shared.

J.6 Evaluation of Simultaneous

Table K.6-1: The sum of reported SAR values for main antenna and WiFi

	Position	Main antenna	WiFi	Sum
Highest reported SAR value for Head	Right hand, Touch cheek	0.39	0.99	1.38
Highest reported SAR value for Body	Rear	1.18	0.19	1.37

Table K.6-2: The sum of reported SAR values for main antenna and BT

	Position	Main antenna	BT	Sum
Maximum reported SAR value for Head	Right hand, Touch cheek	0.39	0.21	0.60
Maximum reported SAR value for Body	Rear	1.18	0.10	1.28

J.7 List of Main Instruments

No.	Name	Type	Serial Number	Calibration Date	Valid Period
01	Network analyzer	N5239A	MY46110673	January 24, 2020	One year
02	Power meter	NRP2	101919	May 12, 2020	One year
03	Power sensor	NRP-Z91	101547		
04	Signal Generator	E4438C	MY49070393	January 4, 2020	One Year
05	Amplifier	60S1G4	0331848	No Calibration Requested	
06	BTS	CMW500	129942	February 10, 2020	One year
07	E-field Probe	SPEAG EX3DV4	3617	Jan 30, 2020	One year
08	DAE	SPEAG DAE4	777	January 8, 2020	One year
09	Dipole Validation Kit	SPEAG D750V3	1017	July 24,2020	One year
10	Dipole Validation Kit	SPEAG D835V2	4d069	July 24,,2020	One year
11	Dipole Validation Kit	SPEAG D1750V2	1003	July 24, 2020	One year
12	Dipole Validation Kit	SPEAG D1900V2	5d101	July 28,2020	One year
13	Dipole Validation Kit	SPEAG D2450V2	853	July 21,2020	One year
14	Dipole Validation Kit	SPEAG D2600V2	1012	July 21,2020	One year

J.8 Graph Results

GSM850_CH251 Left Cheek

Date: 10/22/2020

Electronics: DAE4 Sn777

Medium: head 835 MHz

Medium parameters used: $f = 848.8$ MHz; $\sigma = 0.914$ mho/m; $\epsilon_r = 41.58$; $\rho = 1000$ kg/m³

Ambient Temperature: 22.5°C, Liquid Temperature: 22.3°C

Communication System: GSM850 848.8 MHz Duty Cycle: 1: 8.3

Probe: EX3DV4 – SN3617 ConvF(9.66,9.66,9.66)

Area Scan (71x121x1): Interpolated grid: dx=1.000 mm, dy=1.000 mm
Maximum value of SAR (interpolated) = 0.492 W/kg

Zoom Scan (7x7x7)/Cube 0: Measurement grid: dx=5mm, dy=5mm, dz=5mm
Reference Value = 6.629 V/m; Power Drift = -0.05 dB
Peak SAR (extrapolated) = 0.522 W/kg
SAR(1 g) = 0.399 W/kg; SAR(10 g) = 0.302 W/kg
Maximum value of SAR (measured) = 0.476 W/kg

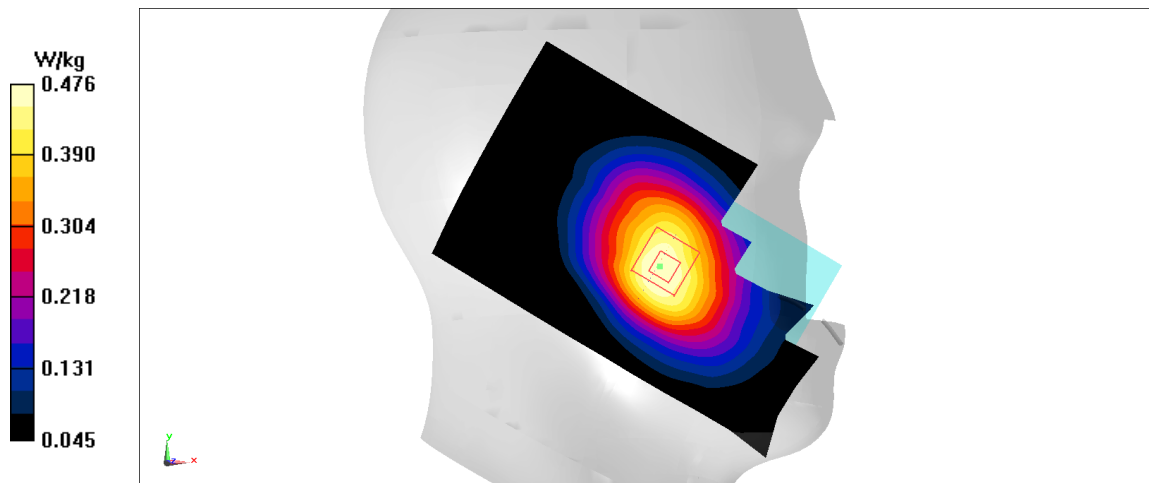

Fig A.1

GSM850_CH190 Rear

Date: 10/22/2020

Electronics: DAE4 Sn777

Medium: body 835 MHz

Medium parameters used: $f = 836.6$ MHz; $\sigma = 0.99$ mho/m; $\epsilon_r = 56.1$; $\rho = 1000$ kg/m³

Ambient Temperature: 22.5°C, Liquid Temperature: 22.3°C

Communication System: GSM850 836.6 MHz Duty Cycle: 1: 4

Probe: EX3DV4 – SN3617 ConvF(9.66,9.66,9.66)

Area Scan (71x121x1): Interpolated grid: dx=1.000 mm, dy=1.000 mm

Maximum value of SAR (interpolated) = 0.644 W/kg

Zoom Scan (7x7x7)/Cube 0: Measurement grid: dx=5mm, dy=5mm, dz=5mm

Reference Value = 22.46 V/m; Power Drift = -0.08 dB

Peak SAR (extrapolated) = 0.678 W/kg

SAR(1 g) = 0.546 W/kg; SAR(10 g) = 0.428 W/kg

Maximum value of SAR (measured) = 0.635 W/kg

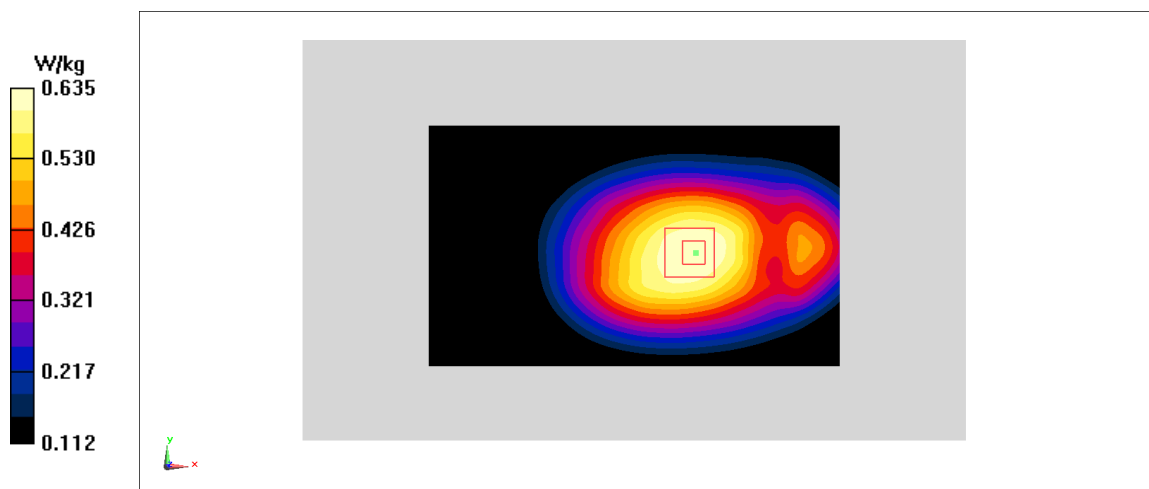

Fig A.2

PCS1900_CH512 Right Cheek

Date: 10/23/2020

Electronics: DAE4 Sn777

Medium: head 1900 MHz

Medium parameters used: $f = 1850.2$ MHz; $\sigma = 1.342$ mho/m; $\epsilon_r = 39.61$; $\rho = 1000$ kg/m³

Ambient Temperature: 22.5°C, Liquid Temperature: 22.3°C

Communication System: PCS1900 1850.2 MHz Duty Cycle: 1: 8.3

Probe: EX3DV4 – SN3617 ConvF(8.14,8.14,8.14)

Area Scan (71x121x1): Interpolated grid: dx=1.000 mm, dy=1.000 mm

Maximum value of SAR (interpolated) = 0.444 W/kg

Zoom Scan (7x7x7)/Cube 0: Measurement grid: dx=5mm, dy=5mm, dz=5mm

Reference Value = 3.768 V/m; Power Drift = 0.09 dB

Peak SAR (extrapolated) = 0.495 W/kg

SAR(1 g) = 0.315 W/kg; SAR(10 g) = 0.199 W/kg

Maximum value of SAR (measured) = 0.429 W/kg

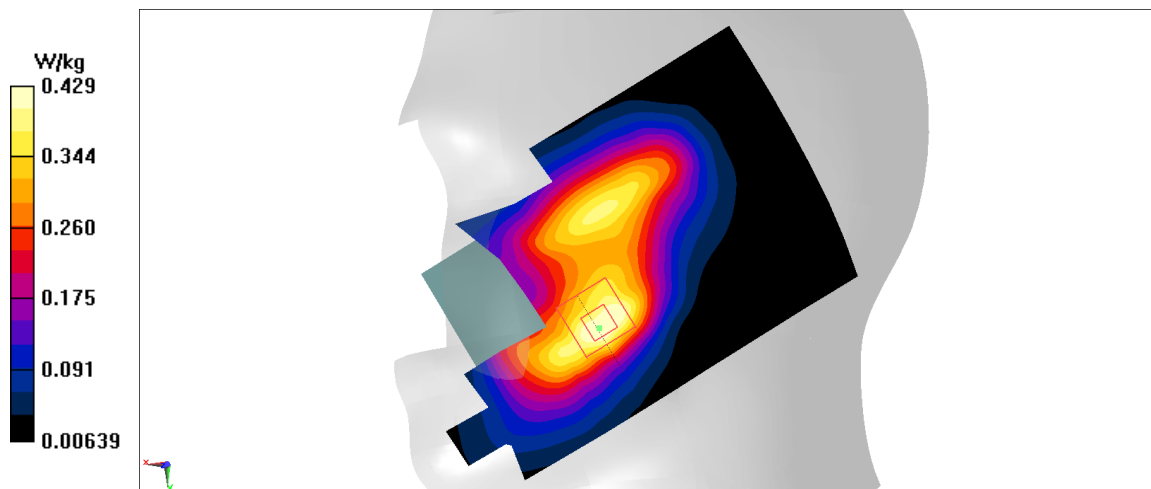

Fig A.3

PCS1900_CH512 Rear

Date: 10/23/2020

Electronics: DAE4 Sn777

Medium: body 1900 MHz

Medium parameters used: $f = 1850.2$ MHz; $\sigma = 1.488$ mho/m; $\epsilon_r = 53.25$; $\rho = 1000$ kg/m³

Ambient Temperature: 22.5°C, Liquid Temperature: 22.3°C

Communication System: PCS1900 1850.2 MHz Duty Cycle: 1: 4

Probe: EX3DV4 – SN3617 ConvF(8.14,8.14,8.14)

Area Scan (71x121x1): Interpolated grid: dx=1.000 mm, dy=1.000 mm

Maximum value of SAR (interpolated) = 1.2 W/kg

Zoom Scan (7x7x7)/Cube 0: Measurement grid: dx=5mm, dy=5mm, dz=5mm

Reference Value = 7.969 V/m; Power Drift = -0.13 dB

Peak SAR (extrapolated) = 1.38 W/kg

SAR(1 g) = 0.791 W/kg; SAR(10 g) = 0.453 W/kg

Maximum value of SAR (measured) = 1.13 W/kg

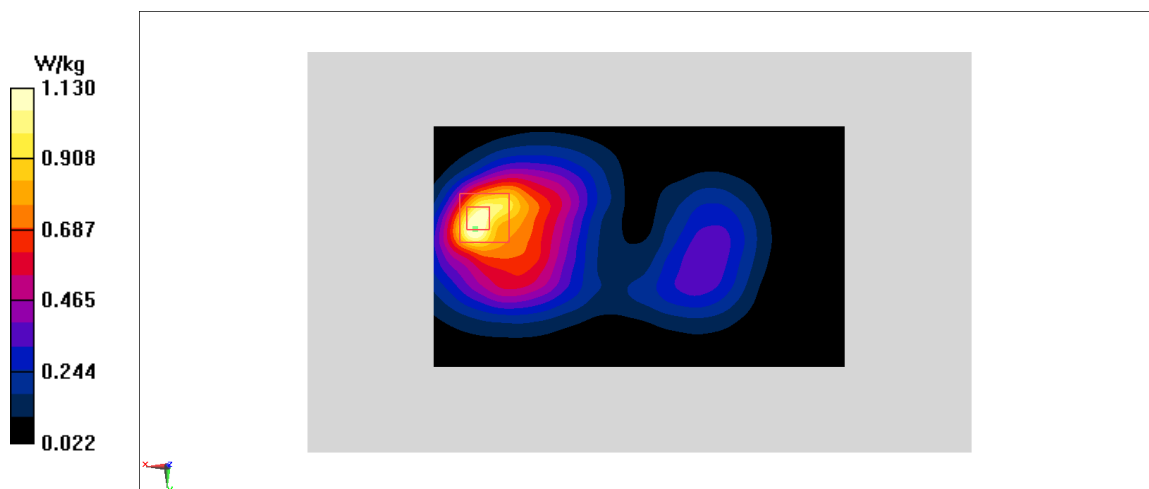

Fig A.4

WCDMA1900-BII_CH9262 Left Cheek

Date: 10/23/2020

Electronics: DAE4 Sn777

Medium: head 1900 MHz

Medium parameters used: $f = 1852.4$ MHz; $\sigma = 1.344$ mho/m; $\epsilon_r = 39.61$; $\rho = 1000$ kg/m³

Ambient Temperature: 22.5°C, Liquid Temperature: 22.3°C

Communication System: WCDMA1900-BII 1852.4 MHz Duty Cycle: 1: 1

Probe: EX3DV4 – SN3617 ConvF(8.14,8.14,8.14)

Area Scan (71x121x1): Interpolated grid: dx=1.000 mm, dy=1.000 mm

Maximum value of SAR (interpolated) = 0.753 W/kg

Zoom Scan (7x7x7)/Cube 0: Measurement grid: dx=5mm, dy=5mm, dz=5mm

Reference Value = 7.872 V/m; Power Drift = 0.08 dB

Peak SAR (extrapolated) = 0.841 W/kg

SAR(1 g) = 0.532 W/kg; SAR(10 g) = 0.334 W/kg

Maximum value of SAR (measured) = 0.727 W/kg

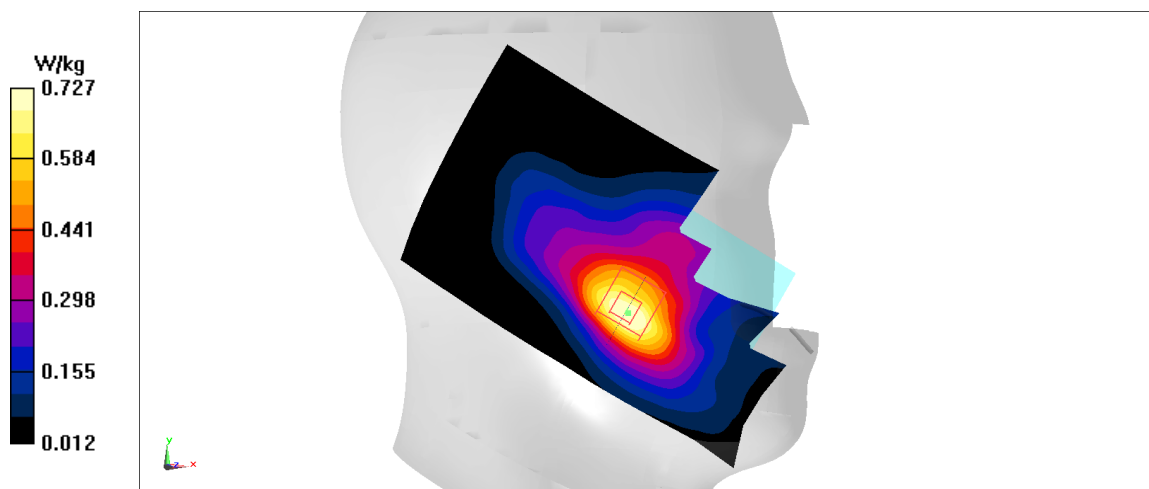

Fig A.5

WCDMA1900-BII_CH9262 Bottom edge

Date: 10/23/2020

Electronics: DAE4 Sn777

Medium: body 1900 MHz

Medium parameters used: $f = 1852.4$ MHz; $\sigma = 1.49$ mho/m; $\epsilon_r = 53.25$; $\rho = 1000$ kg/m³

Ambient Temperature: 22.5°C, Liquid Temperature: 22.3°C

Communication System: WCDMA1900-BII 1852.4 MHz Duty Cycle: 1: 1

Probe: EX3DV4 – SN3617 ConvF(8.14,8.14,8.14)

Area Scan (71x121x1): Interpolated grid: dx=1.000 mm, dy=1.000 mm

Maximum value of SAR (interpolated) = 1.48 W/kg

Zoom Scan (7x7x7)/Cube 0: Measurement grid: dx=5mm, dy=5mm, dz=5mm

Reference Value = 23.6 V/m; Power Drift = -0.06 dB

Peak SAR (extrapolated) = 1.75 W/kg

SAR(1 g) = 0.993 W/kg; SAR(10 g) = 0.536 W/kg

Maximum value of SAR (measured) = 1.48 W/kg

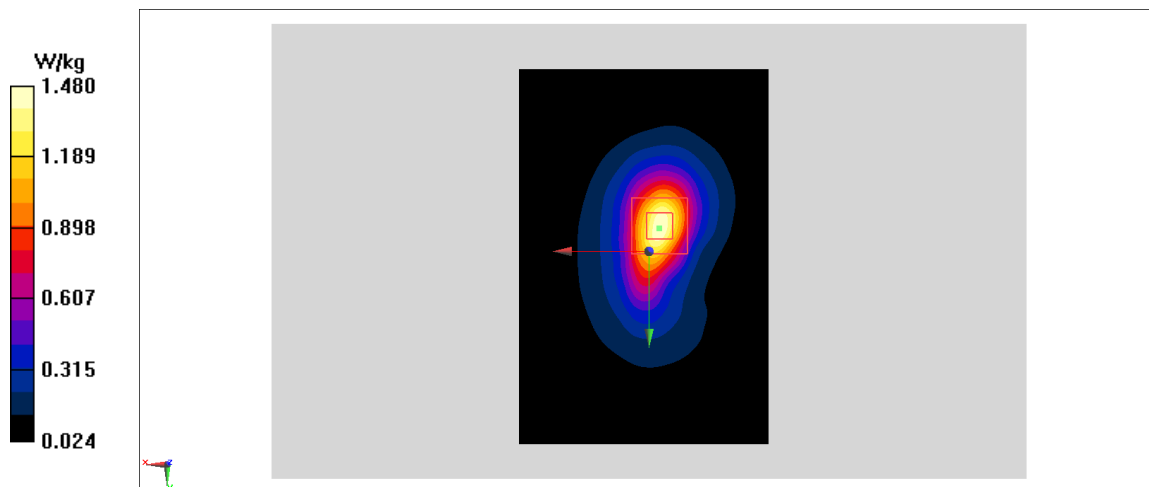

Fig A.6

WCDMA1700-BIV_CH1412 Left Cheek

Date: 10/22/2020

Electronics: DAE4 Sn777

Medium: head 1750 MHz

Medium parameters used: $f = 1732.4$ MHz; $\sigma = 1.363$ mho/m; $\epsilon_r = 40.7$; $\rho = 1000$ kg/m³

Ambient Temperature: 22.5°C, Liquid Temperature: 22.3°C

Communication System: WCDMA1700-BIV 1732.4 MHz Duty Cycle: 1: 1

Probe: EX3DV4 – SN3617 ConvF(8.41,8.41,8.41)

Area Scan (71x121x1): Interpolated grid: dx=1.000 mm, dy=1.000 mm

Maximum value of SAR (interpolated) = 0.558 W/kg

Zoom Scan (7x7x7)/Cube 0: Measurement grid: dx=5mm, dy=5mm, dz=5mm

Reference Value = 5.07 V/m; Power Drift = -0.12 dB

Peak SAR (extrapolated) = 0.645 W/kg

SAR(1 g) = 0.41 W/kg; SAR(10 g) = 0.257 W/kg

Maximum value of SAR (measured) = 0.559 W/kg

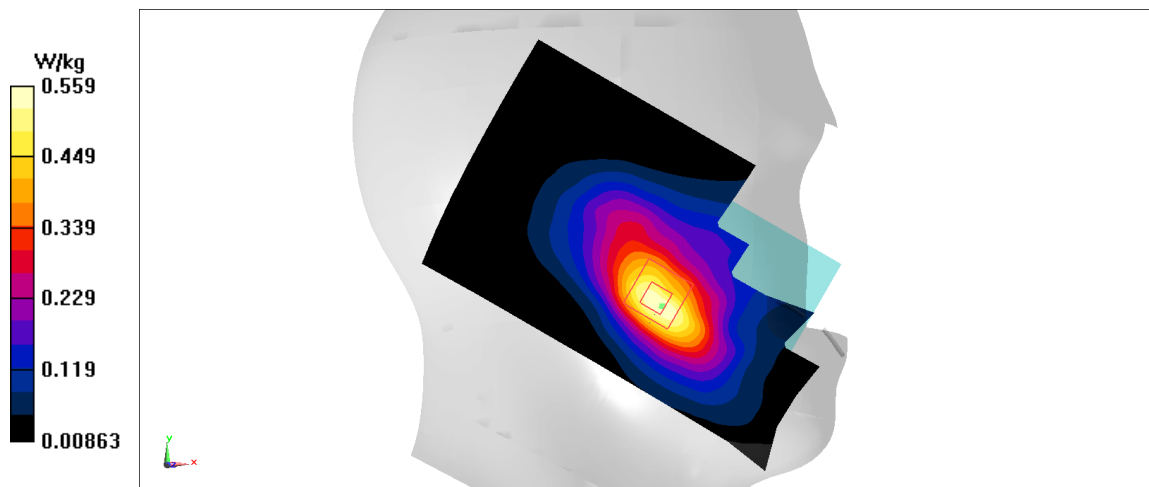

Fig A.7

WCDMA1700-BIV_CH1412 Rear

Date: 10/22/2020

Electronics: DAE4 Sn777

Medium: body 1750 MHz

Medium parameters used: $f = 1732.4$ MHz; $\sigma = 1.497$ mho/m; $\epsilon_r = 53.24$; $\rho = 1000$ kg/m³

Ambient Temperature: 22.5°C, Liquid Temperature: 22.3°C

Communication System: WCDMA1700-BIV 1732.4 MHz Duty Cycle: 1: 1

Probe: EX3DV4 – SN3617 ConvF(8.41,8.41,8.41)

Area Scan (71x121x1): Interpolated grid: dx=1.000 mm, dy=1.000 mm

Maximum value of SAR (interpolated) = 1.05 W/kg

Zoom Scan (7x7x7)/Cube 0: Measurement grid: dx=5mm, dy=5mm, dz=5mm

Reference Value = 12.41 V/m; Power Drift = 0.08 dB

Peak SAR (extrapolated) = 1.26 W/kg

SAR(1 g) = 0.765 W/kg; SAR(10 g) = 0.451 W/kg

Maximum value of SAR (measured) = 1.04 W/kg

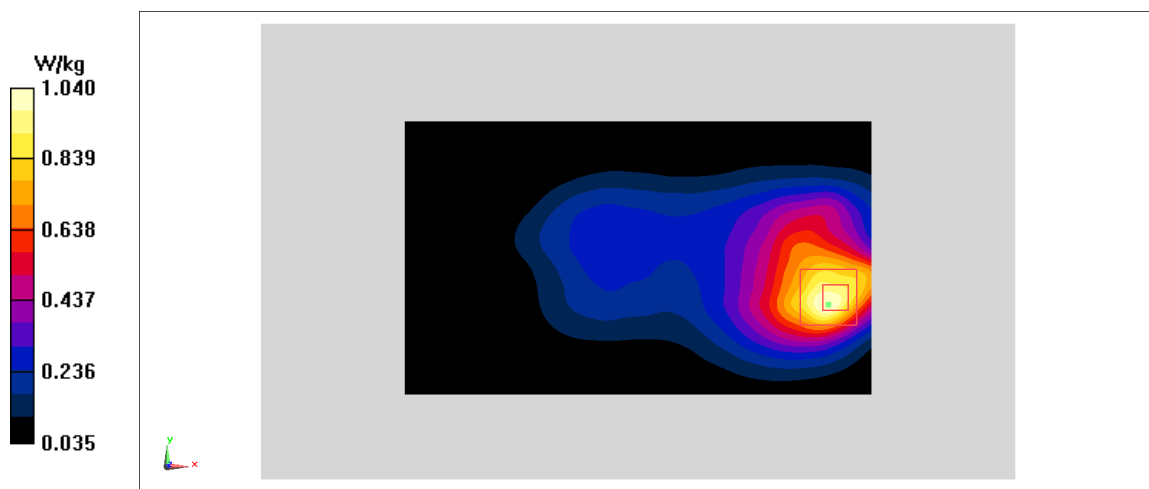

Fig A.8

WCDMA850-BV_CH4182 Left Cheek

Date: 10/22/2020

Electronics: DAE4 Sn777

Medium: head 835 MHz

Medium parameters used: $f = 835.4$ MHz; $\sigma = 0.901$ mho/m; $\epsilon_r = 41.6$; $\rho = 1000$ kg/m³

Ambient Temperature: 22.5°C, Liquid Temperature: 22.3°C

Communication System: WCDMA850-BV 835.4 MHz Duty Cycle: 1: 1

Probe: EX3DV4 – SN3617 ConvF(9.66,9.66,9.66)

Area Scan (71x121x1): Interpolated grid: dx=1.000 mm, dy=1.000 mm

Maximum value of SAR (interpolated) = 0.463 W/kg

Zoom Scan (7x7x7)/Cube 0: Measurement grid: dx=5mm, dy=5mm, dz=5mm

Reference Value = 3.222 V/m; Power Drift = 0.06 dB

Peak SAR (extrapolated) = 0.501 W/kg

SAR(1 g) = 0.379 W/kg; SAR(10 g) = 0.286 W/kg

Maximum value of SAR (measured) = 0.455 W/kg

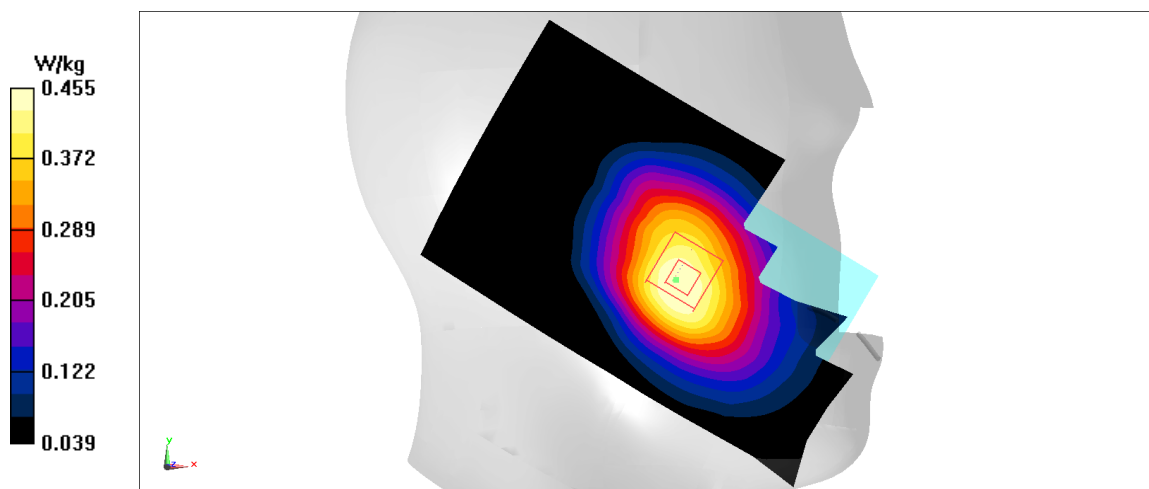

Fig A.9

WCDMA850-BV_CH4233 Rear

Date: 10/22/2020

Electronics: DAE4 Sn777

Medium: body 835 MHz

Medium parameters used: $f = 846.6$ MHz; $\sigma = 0.999$ mho/m; $\epsilon_r = 56.09$; $\rho = 1000$ kg/m³

Ambient Temperature: 22.5°C, Liquid Temperature: 22.3°C

Communication System: WCDMA850-BV 846.6 MHz Duty Cycle: 1: 1

Probe: EX3DV4 – SN3617 ConvF(9.66,9.66,9.66)

Area Scan (71x121x1): Interpolated grid: dx=1.000 mm, dy=1.000 mm

Maximum value of SAR (interpolated) = 0.505 W/kg

Zoom Scan (7x7x7)/Cube 0: Measurement grid: dx=5mm, dy=5mm, dz=5mm

Reference Value = 19.44 V/m; Power Drift = -0.1 dB

Peak SAR (extrapolated) = 0.531 W/kg

SAR(1 g) = 0.427 W/kg; SAR(10 g) = 0.336 W/kg

Maximum value of SAR (measured) = 0.495 W/kg

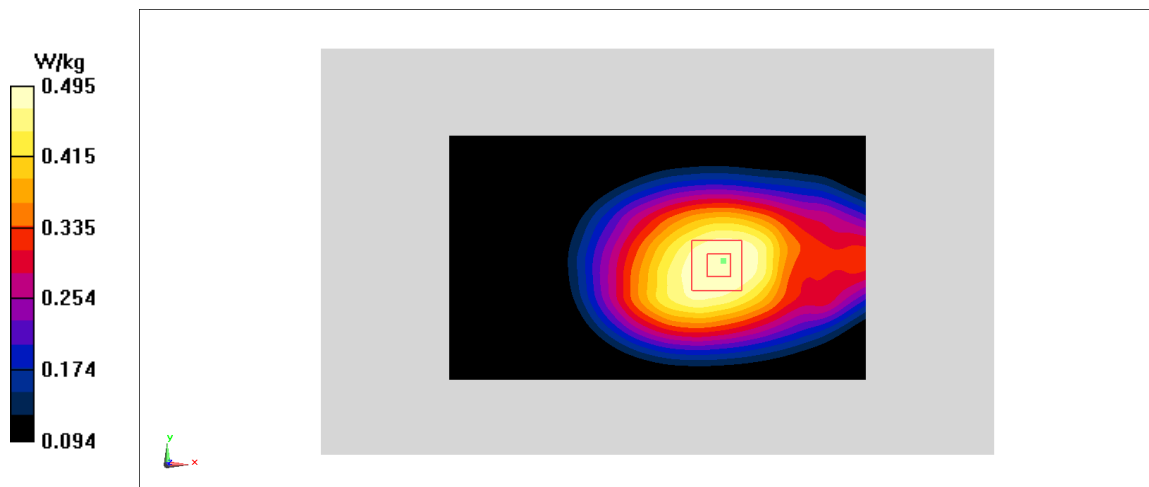

Fig A.10

LTE1900-FDD2_CH19100 Left Cheek

Date: 10/23/2020

Electronics: DAE4 Sn777

Medium: head 1900 MHz

Medium parameters used: $f = 1900$ MHz; $\sigma = 1.39$ mho/m; $\epsilon_r = 39.55$; $\rho = 1000$ kg/m³

Ambient Temperature: 22.5°C, Liquid Temperature: 22.3°C

Communication System: LTE1900-FDD2 1900 MHz Duty Cycle: 1: 1

Probe: EX3DV4 – SN3617 ConvF(8.14,8.14,8.14)

Area Scan (71x121x1): Interpolated grid: dx=1.000 mm, dy=1.000 mm

Maximum value of SAR (interpolated) = 0.604 W/kg

Zoom Scan (7x7x7)/Cube 0: Measurement grid: dx=5mm, dy=5mm, dz=5mm

Reference Value = 7.344 V/m; Power Drift = -0.02 dB

Peak SAR (extrapolated) = 0.682 W/kg

SAR(1 g) = 0.429 W/kg; SAR(10 g) = 0.269 W/kg

Maximum value of SAR (measured) = 0.587 W/kg

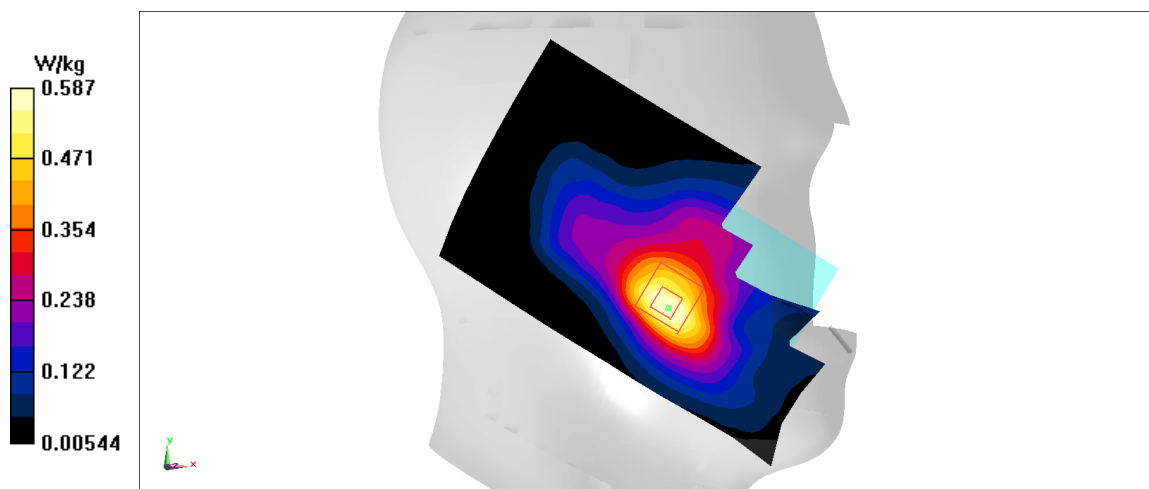

Fig A.11

LTE1900-FDD2_CH18700 Bottom edge

Date: 10/23/2020

Electronics: DAE4 Sn777

Medium: body 1900 MHz

Medium parameters used: $f = 1860$ MHz; $\sigma = 1.498$ mho/m; $\epsilon_r = 53.24$; $\rho = 1000$ kg/m³

Ambient Temperature: 22.5°C, Liquid Temperature: 22.3°C

Communication System: LTE1900-FDD2 1860 MHz Duty Cycle: 1: 1

Probe: EX3DV4 – SN3617 ConvF(8.14,8.14,8.14)

Area Scan (71x121x1): Interpolated grid: dx=1.000 mm, dy=1.000 mm

Maximum value of SAR (interpolated) = 1.45 W/kg

Zoom Scan (7x7x7)/Cube 0: Measurement grid: dx=5mm, dy=5mm, dz=5mm

Reference Value = 24.85 V/m; Power Drift = -0.07 dB

Peak SAR (extrapolated) = 1.69 W/kg

SAR(1 g) = 0.956 W/kg; SAR(10 g) = 0.513 W/kg

Maximum value of SAR (measured) = 1.43 W/kg

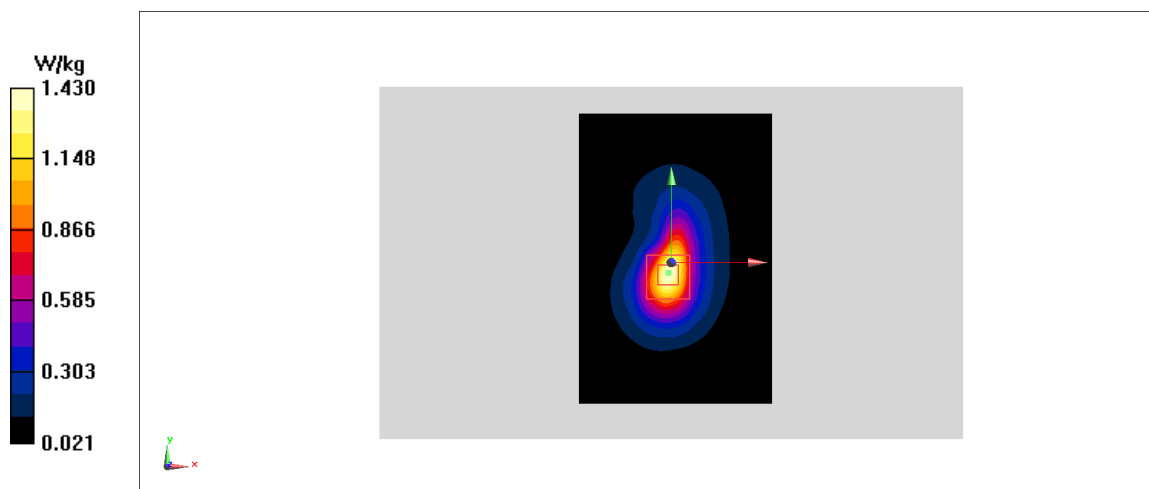

Fig A.12

LTE1700-FDD4_CH20050 Left Cheek

Date: 10/22/2020

Electronics: DAE4 Sn777

Medium: head 1750 MHz

Medium parameters used: $f = 1720$ MHz; $\sigma = 1.352$ mho/m; $\epsilon_r = 40.72$; $\rho = 1000$ kg/m³

Ambient Temperature: 22.5°C, Liquid Temperature: 22.3°C

Communication System: LTE1700-FDD4 1720 MHz Duty Cycle: 1: 1

Probe: EX3DV4 – SN3617 ConvF(8.41,8.41,8.41)

Area Scan (71x121x1): Interpolated grid: dx=1.000 mm, dy=1.000 mm

Maximum value of SAR (interpolated) = 0.43 W/kg

Zoom Scan (7x7x7)/Cube 0: Measurement grid: dx=5mm, dy=5mm, dz=5mm

Reference Value = 3.915 V/m; Power Drift = -0.03 dB

Peak SAR (extrapolated) = 0.5 W/kg

SAR(1 g) = 0.318 W/kg; SAR(10 g) = 0.2 W/kg

Maximum value of SAR (measured) = 0.436 W/kg

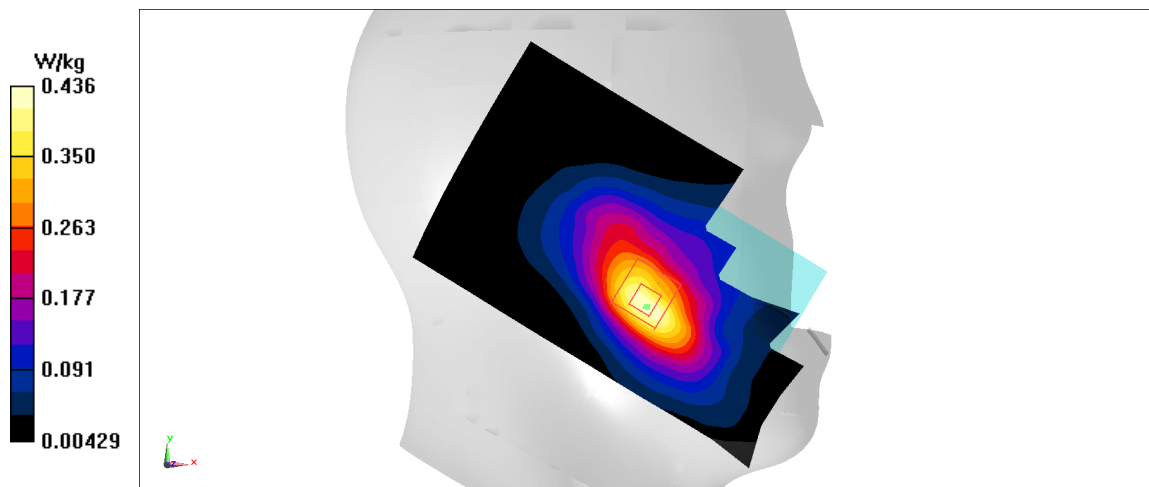

Fig A.13

LTE1700-FDD4_CH20300 Rear

Date: 10/22/2020

Electronics: DAE4 Sn777

Medium: body 1750 MHz

Medium parameters used: $f = 1745$ MHz; $\sigma = 1.509$ mho/m; $\epsilon_r = 53.23$; $\rho = 1000$ kg/m³

Ambient Temperature: 22.5°C, Liquid Temperature: 22.3°C

Communication System: LTE1700-FDD4 1745 MHz Duty Cycle: 1: 1

Probe: EX3DV4 – SN3617 ConvF(8.41,8.41,8.41)

Area Scan (71x121x1): Interpolated grid: dx=1.000 mm, dy=1.000 mm

Maximum value of SAR (interpolated) = 1.31 W/kg

Zoom Scan (7x7x7)/Cube 0: Measurement grid: dx=5mm, dy=5mm, dz=5mm

Reference Value = 12.11 V/m; Power Drift = 0.08 dB

Peak SAR (extrapolated) = 1.49 W/kg

SAR(1 g) = 0.889 W/kg; SAR(10 g) = 0.514 W/kg

Maximum value of SAR (measured) = 1.21 W/kg

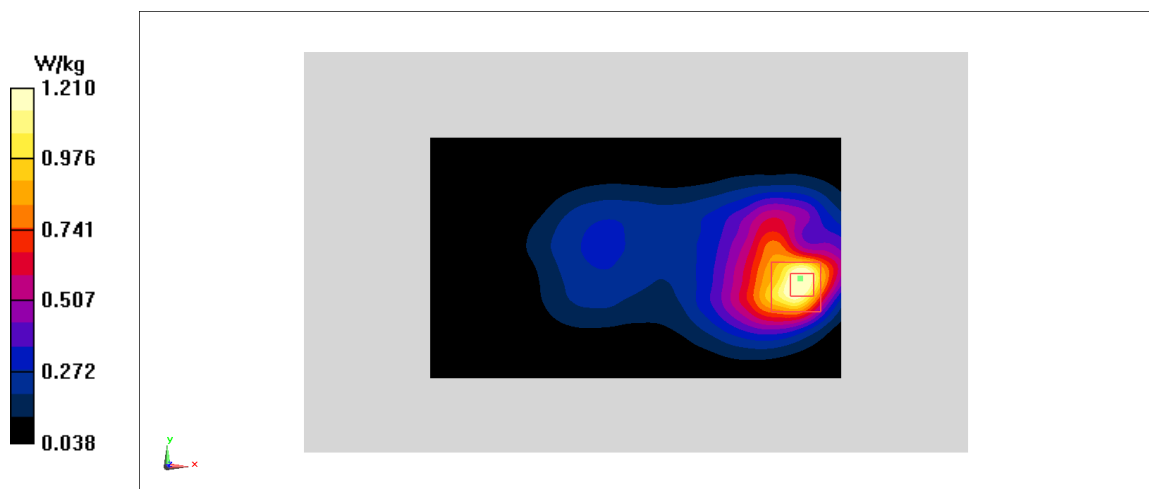

Fig A.14

LTE850-FDD5_CH20450 Left Cheek

Date: 10/22/2020

Electronics: DAE4 Sn777

Medium: head 835 MHz

Medium parameters used: $f = 829$ MHz; $\sigma = 0.895$ mho/m; $\epsilon_r = 41.61$; $\rho = 1000$ kg/m³

Ambient Temperature: 22.5°C, Liquid Temperature: 22.3°C

Communication System: LTE850-FDD5 829 MHz Duty Cycle: 1: 1

Probe: EX3DV4 – SN3617 ConvF(9.66,9.66,9.66)

Area Scan (71x121x1): Interpolated grid: dx=1.000 mm, dy=1.000 mm

Maximum value of SAR (interpolated) = 0.402 W/kg

Zoom Scan (7x7x7)/Cube 0: Measurement grid: dx=5mm, dy=5mm, dz=5mm

Reference Value = 7.092 V/m; Power Drift = 0.01 dB

Peak SAR (extrapolated) = 0.427 W/kg

SAR(1 g) = 0.333 W/kg; SAR(10 g) = 0.255 W/kg

Maximum value of SAR (measured) = 0.394 W/kg

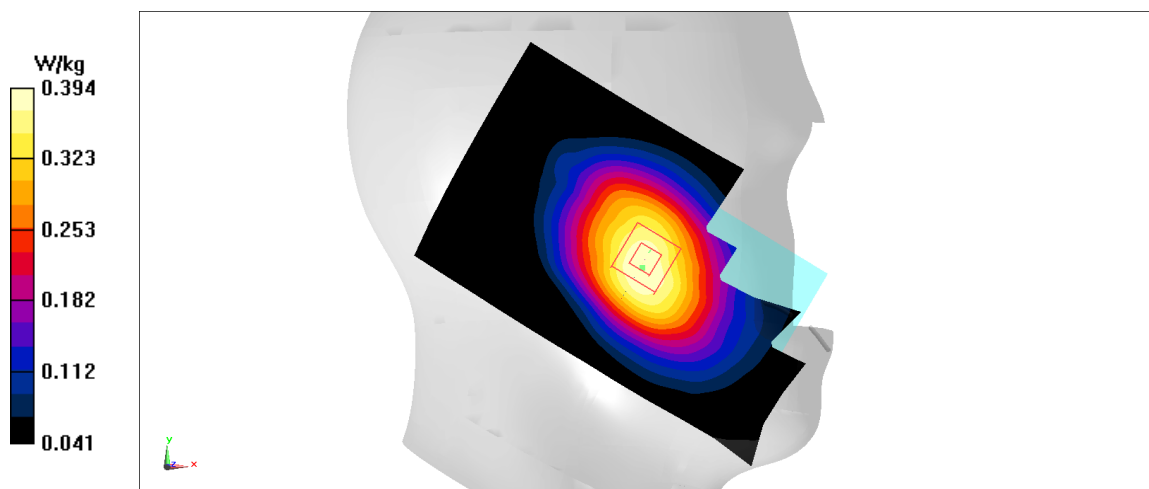

Fig A.15

LTE850-FDD5_CH20450 Rear

Date: 10/22/2020

Electronics: DAE4 Sn777

Medium: body 835 MHz

Medium parameters used: $f = 829$ MHz; $\sigma = 0.982$ mho/m; $\epsilon_r = 56.11$; $\rho = 1000$ kg/m³

Ambient Temperature: 22.5°C, Liquid Temperature: 22.3°C

Communication System: LTE850-FDD5 829 MHz Duty Cycle: 1: 1

Probe: EX3DV4 – SN3617 ConvF(9.66,9.66,9.66)

Area Scan (71x121x1): Interpolated grid: dx=1.000 mm, dy=1.000 mm

Maximum value of SAR (interpolated) = 0.526 W/kg

Zoom Scan (7x7x7)/Cube 0: Measurement grid: dx=5mm, dy=5mm, dz=5mm

Reference Value = 20.35 V/m; Power Drift = 0.03 dB

Peak SAR (extrapolated) = 0.562 W/kg

SAR(1 g) = 0.451 W/kg; SAR(10 g) = 0.352 W/kg

Maximum value of SAR (measured) = 0.524 W/kg

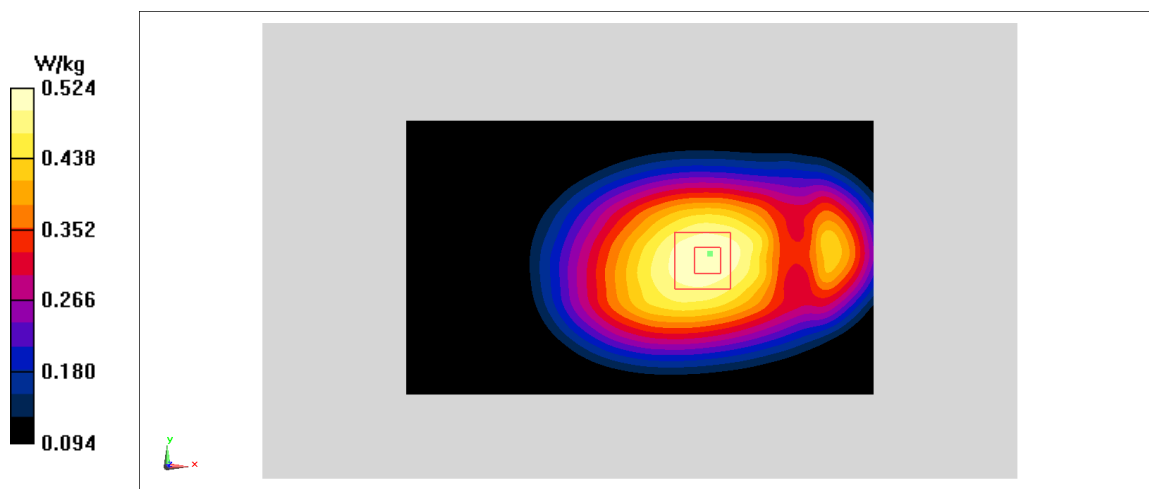

Fig A.16

LTE2500-FDD7_CH20850 Right Cheek

Date: 10/23/2020

Electronics: DAE4 Sn777

Medium: head 2600 MHz

Medium parameters used: $f = 2510$ MHz; $\sigma = 1.88$ mho/m; $\epsilon_r = 39.68$; $\rho = 1000$ kg/m³

Ambient Temperature: 22.5°C, Liquid Temperature: 22.3°C

Communication System: LTE2500-FDD7 2510 MHz Duty Cycle: 1: 1

Probe: EX3DV4 – SN3617 ConvF(7.52,7.52,7.52)

Area Scan (71x121x1): Interpolated grid: dx=1.000 mm, dy=1.000 mm

Maximum value of SAR (interpolated) = 0.35 W/kg

Zoom Scan (7x7x7)/Cube 0: Measurement grid: dx=5mm, dy=5mm, dz=5mm

Reference Value = 2.348 V/m; Power Drift = -0.06 dB

Peak SAR (extrapolated) = 0.399 W/kg

SAR(1 g) = 0.216 W/kg; SAR(10 g) = 0.11 W/kg

Maximum value of SAR (measured) = 0.329 W/kg

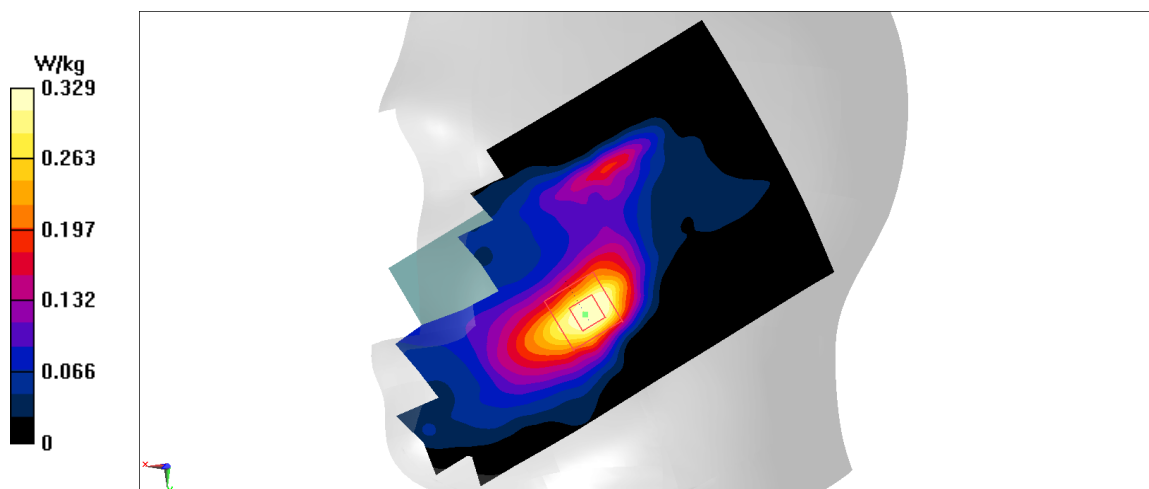

Fig A.17

LTE2500-FDD7_CH21350 Bottom edge

Date: 10/23/2020

Electronics: DAE4 Sn777

Medium: body 2600 MHz

Medium parameters used: $f = 2560$ MHz; $\sigma = 2.1$ mho/m; $\epsilon_r = 51.66$; $\rho = 1000$ kg/m³

Ambient Temperature: 22.5°C, Liquid Temperature: 22.3°C

Communication System: LTE2500-FDD7 2560 MHz Duty Cycle: 1: 1

Probe: EX3DV4 – SN3617 ConvF(7.65,7.65,7.65)

Area Scan (71x121x1): Interpolated grid: dx=1.000 mm, dy=1.000 mm

Maximum value of SAR (interpolated) = 1.67 W/kg

Zoom Scan (7x7x7)/Cube 0: Measurement grid: dx=5mm, dy=5mm, dz=5mm

Reference Value = 21.96 V/m; Power Drift = -0.1 dB

Peak SAR (extrapolated) = 1.97 W/kg

SAR(1 g) = 1 W/kg; SAR(10 g) = 0.494 W/kg

Maximum value of SAR (measured) = 1.6 W/kg

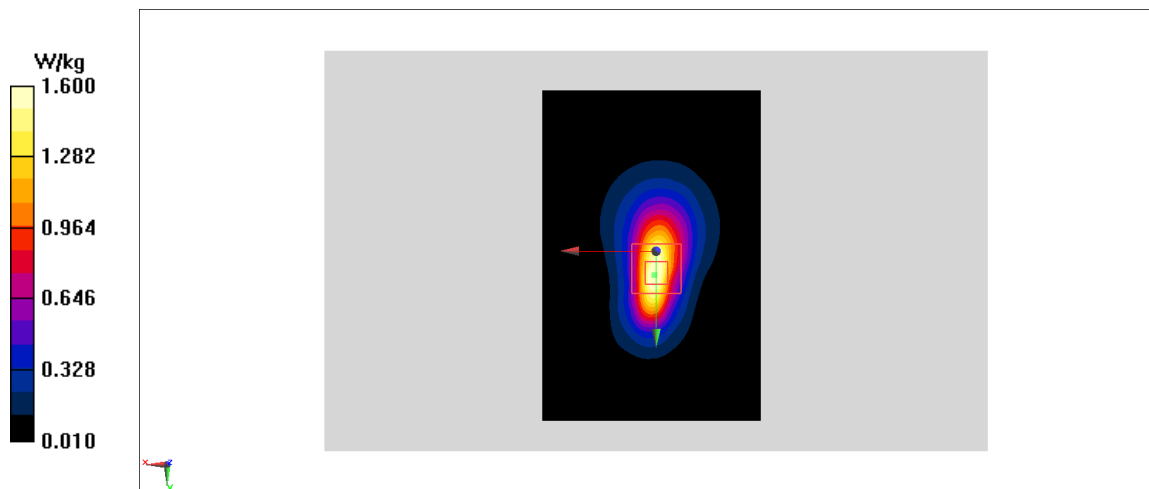

Fig A.18

LTE700-FDD12_CH23060 Right Cheek

Date: 10/22/2020

Electronics: DAE4 Sn777

Medium: head 750 MHz

Medium parameters used: $f = 704$ MHz; $\sigma = 0.854$ mho/m; $\epsilon_r = 41.76$; $\rho = 1000$ kg/m³

Ambient Temperature: 22.5°C, Liquid Temperature: 22.3°C

Communication System: LTE700-FDD12 704 MHz Duty Cycle: 1: 1

Probe: EX3DV4 – SN3617 ConvF(10.07,10.07,10.07)

Area Scan (71x121x1): Interpolated grid: dx=1.000 mm, dy=1.000 mm

Maximum value of SAR (interpolated) = 0.242 W/kg

Zoom Scan (7x7x7)/Cube 0: Measurement grid: dx=5mm, dy=5mm, dz=5mm

Reference Value = 5.551 V/m; Power Drift = 0.05 dB

Peak SAR (extrapolated) = 0.259 W/kg

SAR(1 g) = 0.205 W/kg; SAR(10 g) = 0.158 W/kg

Maximum value of SAR (measured) = 0.239 W/kg

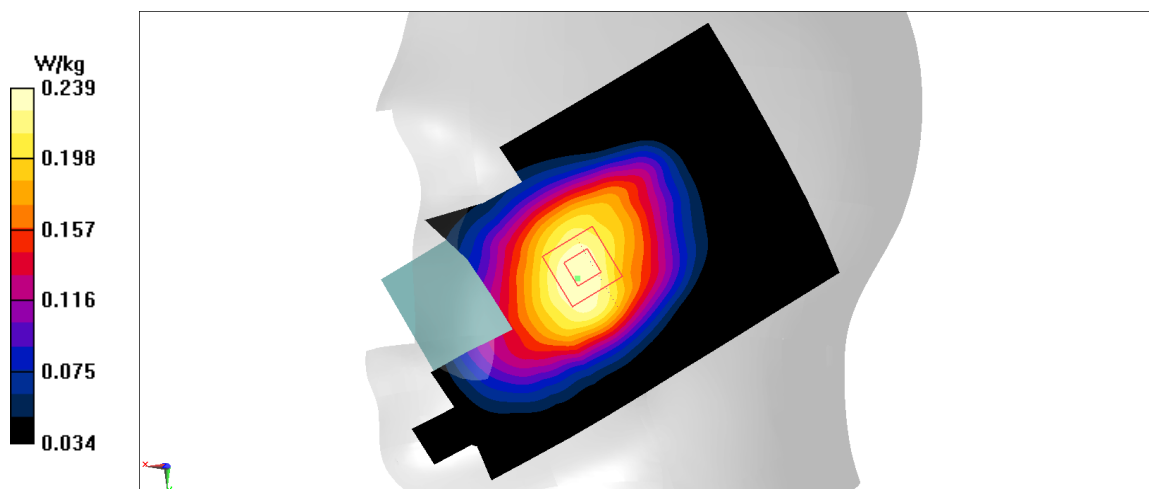

Fig A.19

LTE700-FDD12_CH23060 Rear

Date: 10/22/2020

Electronics: DAE4 Sn777

Medium: body 750 MHz

Medium parameters used: $f = 704$ MHz; $\sigma = 0.907$ mho/m; $\epsilon_r = 55.41$; $\rho = 1000$ kg/m³

Ambient Temperature: 22.5°C, Liquid Temperature: 22.3°C

Communication System: LTE700-FDD12 704 MHz Duty Cycle: 1: 1

Probe: EX3DV4 – SN3617 ConvF(10.07,10.07,10.07)

Area Scan (71x121x1): Interpolated grid: dx=1.000 mm, dy=1.000 mm

Maximum value of SAR (interpolated) = 0.324 W/kg

Zoom Scan (7x7x7)/Cube 0: Measurement grid: dx=5mm, dy=5mm, dz=5mm

Reference Value = 13.3 V/m; Power Drift = 0.02 dB

Peak SAR (extrapolated) = 0.383 W/kg

SAR(1 g) = 0.228 W/kg; SAR(10 g) = 0.175 W/kg

Maximum value of SAR (measured) = 0.315 W/kg

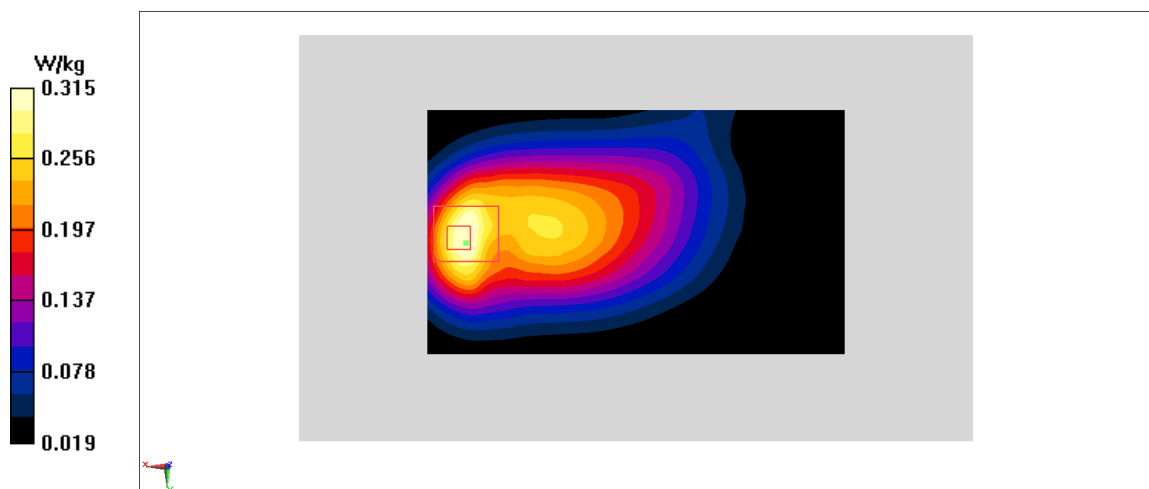

Fig A.20

LTE750-FDD13_CH23230 Left Cheek

Date: 10/22/2020

Electronics: DAE4 Sn777

Medium: head 750 MHz

Medium parameters used: $f = 782$ MHz; $\sigma = 0.928$ mho/m; $\epsilon_r = 41.66$; $\rho = 1000$ kg/m³

Ambient Temperature: 22.5°C, Liquid Temperature: 22.3°C

Communication System: LTE750-FDD13 782 MHz Duty Cycle: 1: 1

Probe: EX3DV4 – SN3617 ConvF(10.07,10.07,10.07)

Area Scan (71x121x1): Interpolated grid: dx=1.000 mm, dy=1.000 mm

Maximum value of SAR (interpolated) = 0.334 W/kg

Zoom Scan (7x7x7)/Cube 0: Measurement grid: dx=5mm, dy=5mm, dz=5mm

Reference Value = 3.185 V/m; Power Drift = -0.05 dB

Peak SAR (extrapolated) = 0.336 W/kg

SAR(1 g) = 0.274 W/kg; SAR(10 g) = 0.211 W/kg

Maximum value of SAR (measured) = 0.278 W/kg

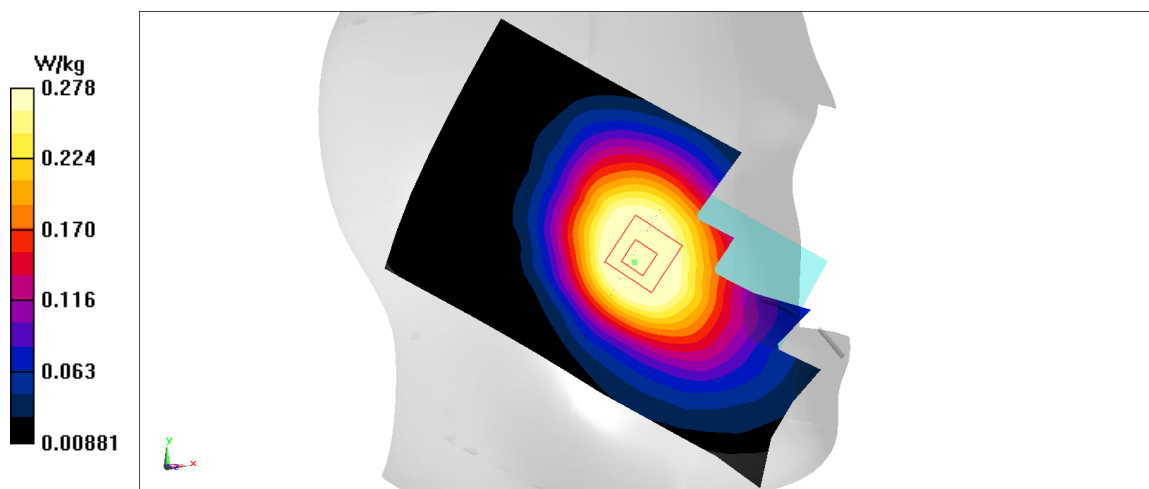

Fig A.21

LTE750-FDD13_CH23230 Rear

Date: 10/22/2020

Electronics: DAE4 Sn777

Medium: body 750 MHz

Medium parameters used: $f = 782 \text{ MHz}$; $\sigma = 0.981 \text{ mho/m}$; $\epsilon_r = 55.31$; $\rho = 1000 \text{ kg/m}^3$

Ambient Temperature: 22.5°C, Liquid Temperature: 22.3°C

Communication System: LTE750-FDD13 782 MHz Duty Cycle: 1: 1

Probe: EX3DV4 – SN3617 ConvF(10.07,10.07,10.07)

Area Scan (71x121x1): Interpolated grid: $dx=1.000 \text{ mm}$, $dy=1.000 \text{ mm}$

Maximum value of SAR (interpolated) = 0.35 W/kg

Zoom Scan (7x7x7)/Cube 0: Measurement grid: $dx=5\text{mm}$, $dy=5\text{mm}$, $dz=5\text{mm}$

Reference Value = 16.49 V/m; Power Drift = -0.11 dB

Peak SAR (extrapolated) = 0.366 W/kg

SAR(1 g) = 0.296 W/kg; SAR(10 g) = 0.232 W/kg

Maximum value of SAR (measured) = 0.344 W/kg

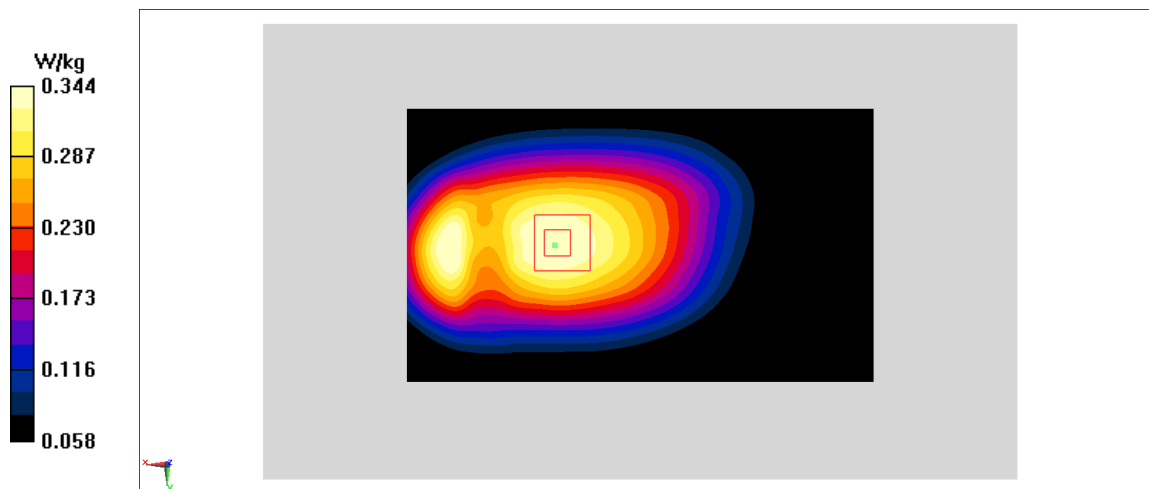

Fig A.22

WLAN2450_CH6 Right Cheek

Date: 10/23/2020

Electronics: DAE4 Sn777

Medium: head 2450 MHz

Medium parameters used: $f = 2437$ MHz; $\sigma = 1.772$ mho/m; $\epsilon_r = 39.07$; $\rho = 1000$ kg/m³

Ambient Temperature: 22.5°C, Liquid Temperature: 22.3°C

Communication System: WLAN2450 2437 MHz Duty Cycle: 1: 1

Probe: EX3DV4 – SN3617 ConvF(7.65,7.65,7.65)

Area Scan (71x121x1): Interpolated grid: dx=1.000 mm, dy=1.000 mm

Maximum value of SAR (interpolated) = 1.43 W/kg

Zoom Scan (7x7x7)/Cube 0: Measurement grid: dx=5mm, dy=5mm, dz=5mm

Reference Value = 14.72 V/m; Power Drift = 0.11 dB

Peak SAR (extrapolated) = 1.59 W/kg

SAR(1 g) = 0.764 W/kg; SAR(10 g) = 0.397 W/kg

Maximum value of SAR (measured) = 1.15 W/kg

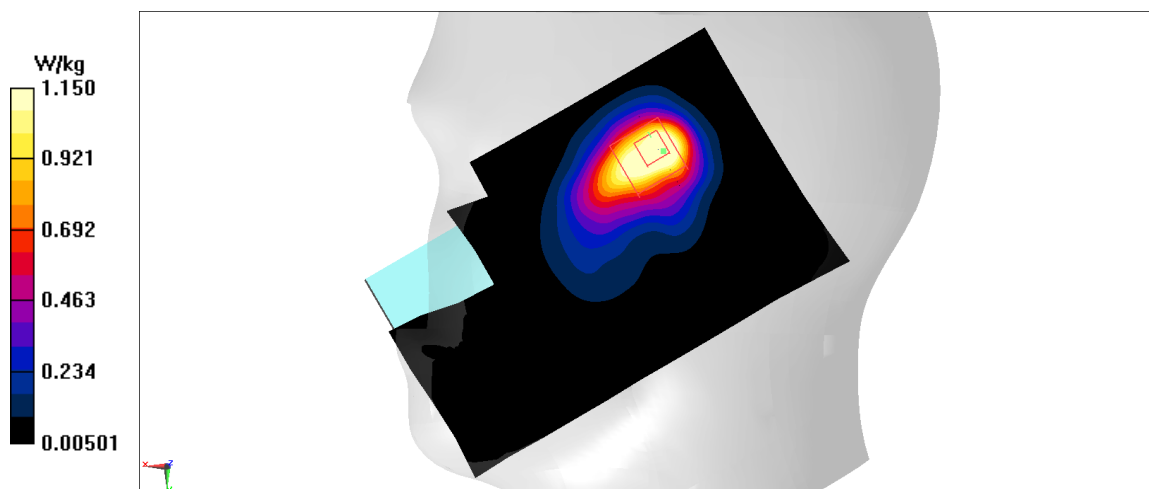

Fig A.23

WLAN2450_CH6 Rear

Date: 10/23/2020

Electronics: DAE4 Sn777

Medium: body 2450 MHz

Medium parameters used: $f = 2437$ MHz; $\sigma = 1.954$ mho/m; $\epsilon_r = 53.38$; $\rho = 1000$ kg/m³

Ambient Temperature: 22.5°C, Liquid Temperature: 22.3°C

Communication System: WLAN2450 2437 MHz Duty Cycle: 1: 1

Probe: EX3DV4 – SN3617 ConvF(7.65,7.65,7.65)

Area Scan (71x121x1): Interpolated grid: dx=1.000 mm, dy=1.000 mm

Maximum value of SAR (interpolated) = 0.249 W/kg

Zoom Scan (7x7x7)/Cube 0: Measurement grid: dx=5mm, dy=5mm, dz=5mm

Reference Value = 6.437 V/m; Power Drift = -0.06 dB

Peak SAR (extrapolated) = 0.261 W/kg

SAR(1 g) = 0.133 W/kg; SAR(10 g) = 0.0715 W/kg

Maximum value of SAR (measured) = 0.21 W/kg

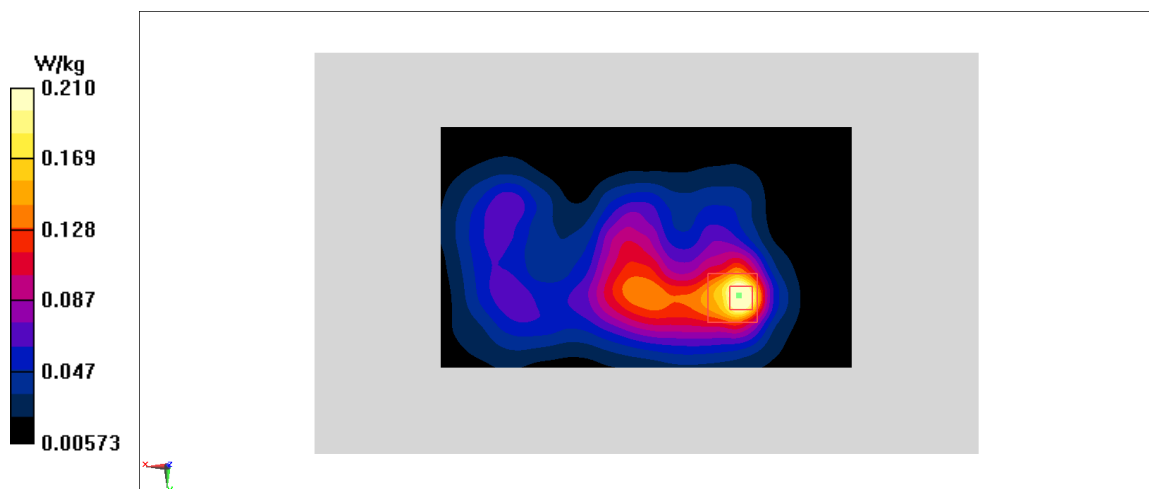

Fig A.24

J.9 System Verification Results

750 MHz

Date: 10/22/2020

Electronics: DAE4 Sn777

Medium: Head 750 MHz

Medium parameters used: $f = 750 \text{ MHz}$; $\sigma = 0.898 \text{ mho/m}$; $\epsilon_r = 41.7$; $\rho = 1000 \text{ kg/m}^3$

Ambient Temperature: 22.5°C Liquid Temperature: 22.3°C

Communication System: CW Frequency: 750 MHz Duty Cycle: 1:1

Probe: EX3DV4 – SN3617 ConvF(10.07,10.07,10.07)

System Validation /Area Scan (81x191x1): Interpolated grid: $dx=1.000 \text{ mm}$, $dy=1.000 \text{ mm}$

Reference Value = 60.52 V/m; Power Drift = 0.03

Fast SAR: SAR(1 g) = 2.08 W/kg; SAR(10 g) = 1.41 W/kg

Maximum value of SAR (interpolated) = 2.81 W/kg

System Validation /Zoom Scan (7x7x7)/Cube 0: Measurement grid: $dx=5\text{mm}$, $dy=5\text{mm}$, $dz=5\text{mm}$

Reference Value =60.52 V/m; Power Drift = 0.03 dB

Peak SAR (extrapolated) = 3.21 W/kg

SAR(1 g) = 2.12 W/kg; SAR(10 g) = 1.37 W/kg

Maximum value of SAR (measured) = 2.86 W/kg

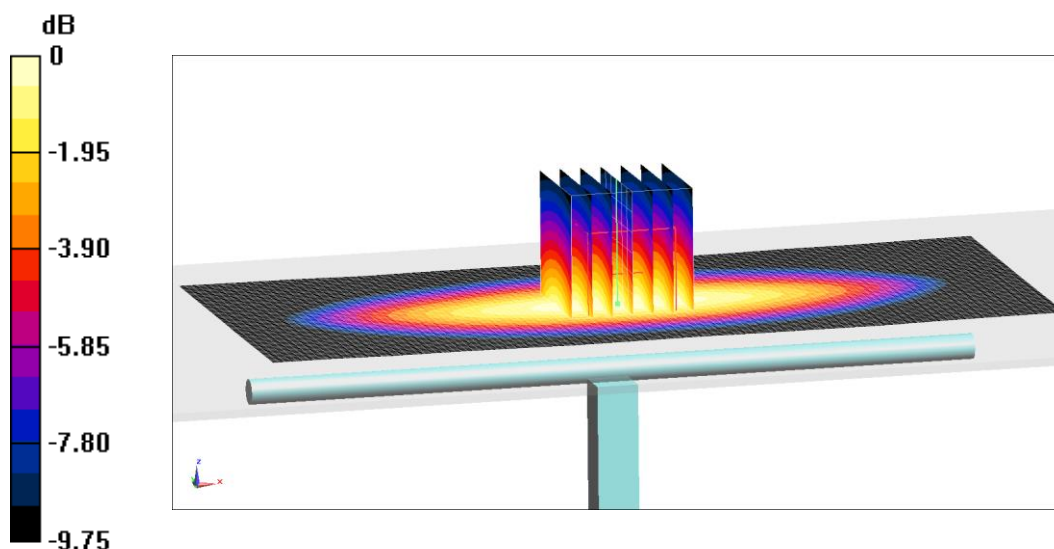

0 dB = 2.86 W/kg = 4.56 dB W/kg

Fig.B.1 validation 750 MHz 250mW

750 MHz

Date: 10/22/2020

Electronics: DAE4 Sn777

Medium: Body 750 MHz

Medium parameters used: $f = 750 \text{ MHz}$; $\sigma = 0.951 \text{ mho/m}$; $\epsilon_r = 55.35$; $\rho = 1000 \text{ kg/m}^3$

Ambient Temperature: 22.5°C Liquid Temperature: 22.3°C

Communication System: CW Frequency: 750 MHz Duty Cycle: 1:1

Probe: EX3DV4 – SN3617 ConvF(10.07,10.07,10.07)

System Validation /Area Scan (81x191x1): Interpolated grid: $dx=1.000 \text{ mm}$, $dy=1.000 \text{ mm}$

Reference Value = 54.69 V/m; Power Drift = -0.03

Fast SAR: SAR(1 g) = 2.21 W/kg; SAR(10 g) = 1.46 W/kg

Maximum value of SAR (interpolated) = 2.93 W/kg

System Validation /Zoom Scan (7x7x7)/Cube 0: Measurement grid: $dx=5\text{mm}$, $dy=5\text{mm}$, $dz=5\text{mm}$

Reference Value = 54.69 V/m; Power Drift = -0.03 dB

Peak SAR (extrapolated) = 3.27 W/kg

SAR(1 g) = 2.25 W/kg; SAR(10 g) = 1.45 W/kg

Maximum value of SAR (measured) = 2.92 W/kg

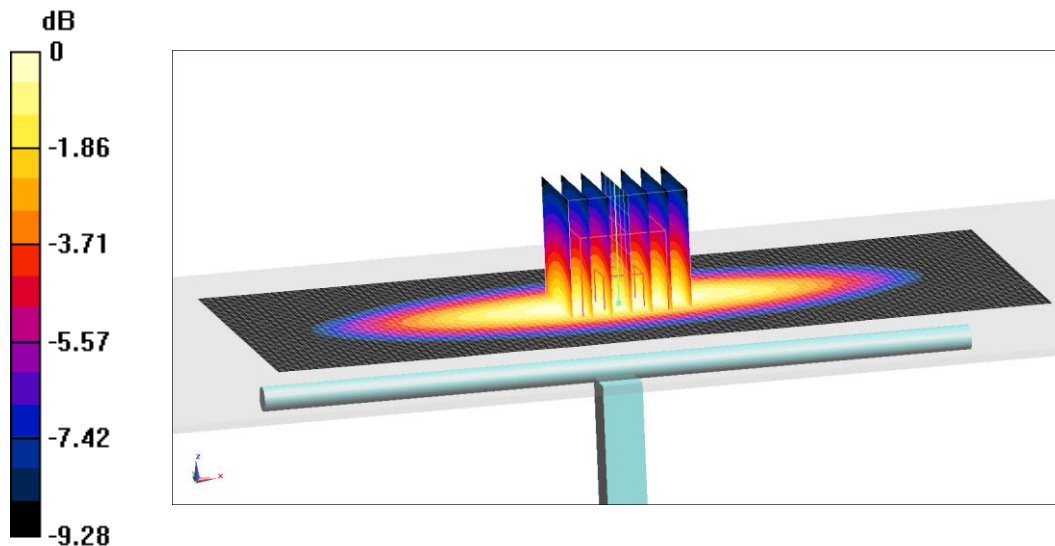

0 dB = 2.92 W/kg = 4.65 dB W/kg

Fig.B.2 validation 750 MHz 250mW

835 MHz

Date: 10/22/2020

Electronics: DAE4 Sn777

Medium: Head 835 MHz

Medium parameters used: $f = 835 \text{ MHz}$; $\sigma = 0.901 \text{ mho/m}$; $\epsilon_r = 41.6$; $\rho = 1000 \text{ kg/m}^3$

Ambient Temperature: 22.5°C Liquid Temperature: 22.3°C

Communication System: CW Frequency: 835 MHz Duty Cycle: 1:1

Probe: EX3DV4 – SN3617 ConvF(9.66,9.66,9.66)

System Validation /Area Scan (81x191x1): Interpolated grid: $dx=1.000 \text{ mm}$, $dy=1.000 \text{ mm}$

Reference Value = 63.54 V/m; Power Drift = 0.04

Fast SAR: SAR(1 g) = 2.4 W/kg; SAR(10 g) = 1.55 W/kg

Maximum value of SAR (interpolated) = 3.24 W/kg

System Validation /Zoom Scan (7x7x7)/Cube 0: Measurement grid: $dx=5\text{mm}$, $dy=5\text{mm}$, $dz=5\text{mm}$

Reference Value =63.54 V/m; Power Drift = 0.04 dB

Peak SAR (extrapolated) = 3.69 W/kg

SAR(1 g) = 2.43 W/kg; SAR(10 g) = 1.56 W/kg

Maximum value of SAR (measured) = 3.3 W/kg

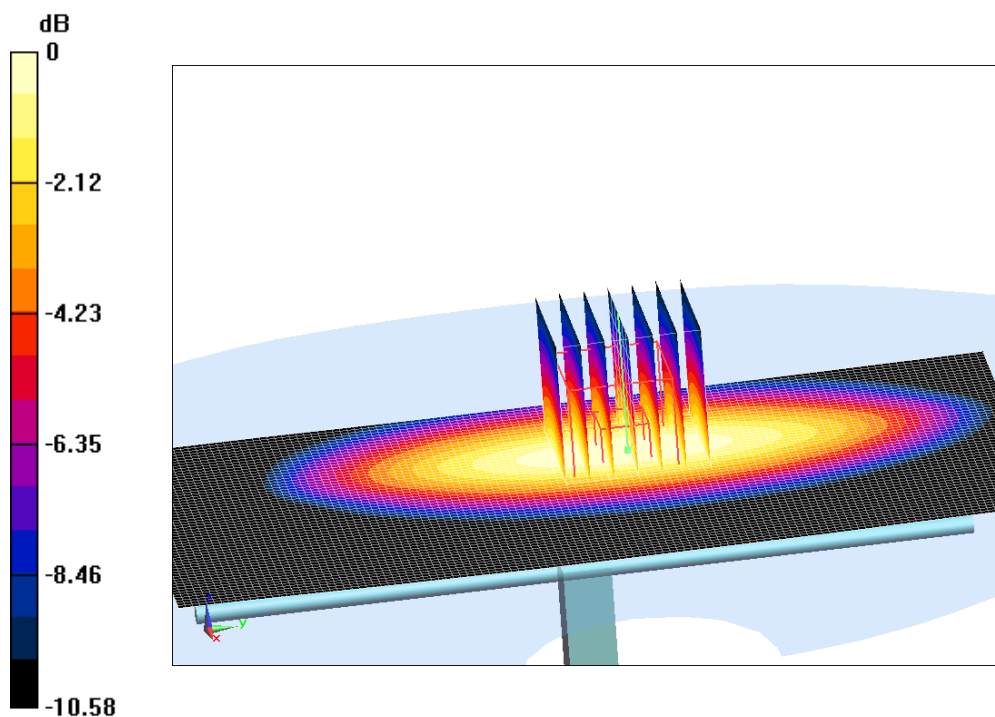

0 dB = 3.3 W/kg = 5.19 dB W/kg

Fig.B.3 validation 835 MHz 250mW

835 MHz

Date: 10/22/2020

Electronics: DAE4 Sn777

Medium: Body 835 MHz

Medium parameters used: $f = 835 \text{ MHz}$; $\sigma = 0.988 \text{ mho/m}$; $\epsilon_r = 56.1$; $\rho = 1000 \text{ kg/m}^3$

Ambient Temperature: 22.5°C Liquid Temperature: 22.3°C

Communication System: CW Frequency: 835 MHz Duty Cycle: 1:1

Probe: EX3DV4 – SN3617 ConvF(9.66,9.66,9.66)

System Validation /Area Scan (81x191x1): Interpolated grid: $dx=1.000 \text{ mm}$, $dy=1.000 \text{ mm}$

Reference Value = 57.46 V/m; Power Drift = -0.09

Fast SAR: SAR(1 g) = 2.4 W/kg; SAR(10 g) = 1.59 W/kg

Maximum value of SAR (interpolated) = 3.37 W/kg

System Validation /Zoom Scan (7x7x7)/Cube 0: Measurement grid: $dx=5\text{mm}$, $dy=5\text{mm}$, $dz=5\text{mm}$

Reference Value = 57.46 V/m; Power Drift = -0.09 dB

Peak SAR (extrapolated) = 3.71 W/kg

SAR(1 g) = 2.39 W/kg; SAR(10 g) = 1.61 W/kg

Maximum value of SAR (measured) = 3.28 W/kg

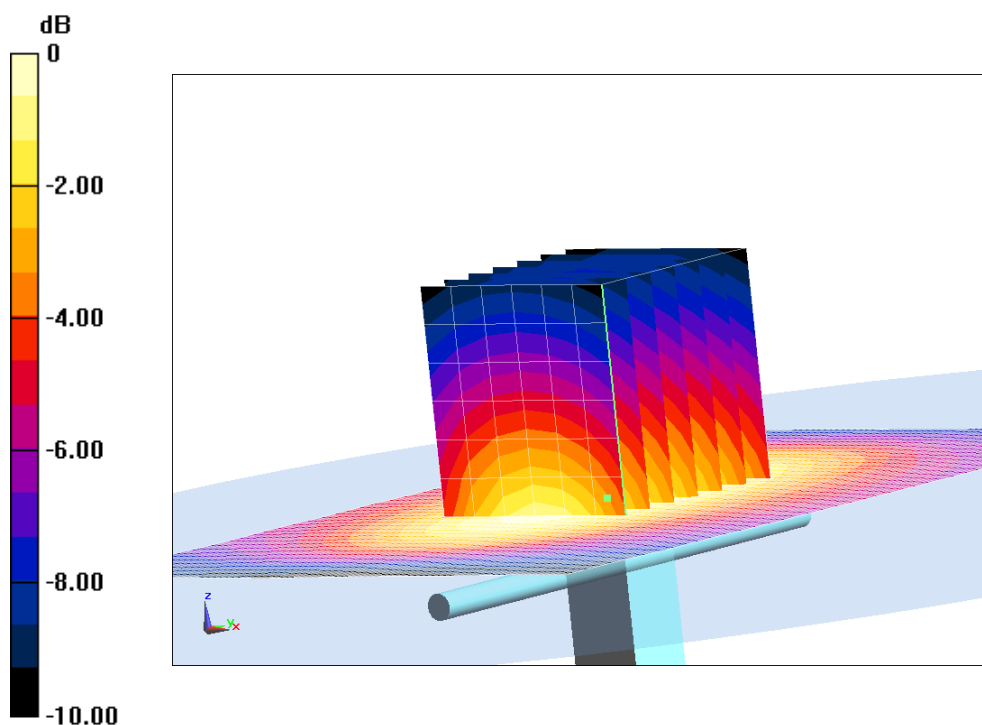

0 dB = 3.28 W/kg = 5.16 dB W/kg

Fig.B.4 validation 835 MHz 250mW

1750 MHz

Date: 10/22/2020

Electronics: DAE4 Sn777

Medium: Head 1750 MHz

Medium parameters used: $f = 1750$ MHz; $\sigma = 1.38$ mho/m; $\epsilon_r = 40.68$; $\rho = 1000$ kg/m³

Ambient Temperature: 22.5°C Liquid Temperature: 22.3°C

Communication System: CW Frequency: 1750 MHz Duty Cycle: 1:1

Probe: EX3DV4 – SN3617 ConvF(8.41,8.41,8.41)

System Validation /Area Scan (81x191x1): Interpolated grid: dx=1.000 mm, dy=1.000 mm

Reference Value = 104.5 V/m; Power Drift = 0.06

Fast SAR: SAR(1 g) = 9 W/kg; SAR(10 g) = 4.78 W/kg

Maximum value of SAR (interpolated) = 14.27 W/kg

System Validation /Zoom Scan (7x7x7)/Cube 0: Measurement grid: dx=5mm, dy=5mm, dz=5mm

Reference Value =104.5 V/m; Power Drift = 0.06 dB

Peak SAR (extrapolated) = 16.73 W/kg

SAR(1 g) = 8.98 W/kg; SAR(10 g) = 4.8 W/kg

Maximum value of SAR (measured) = 14.1 W/kg

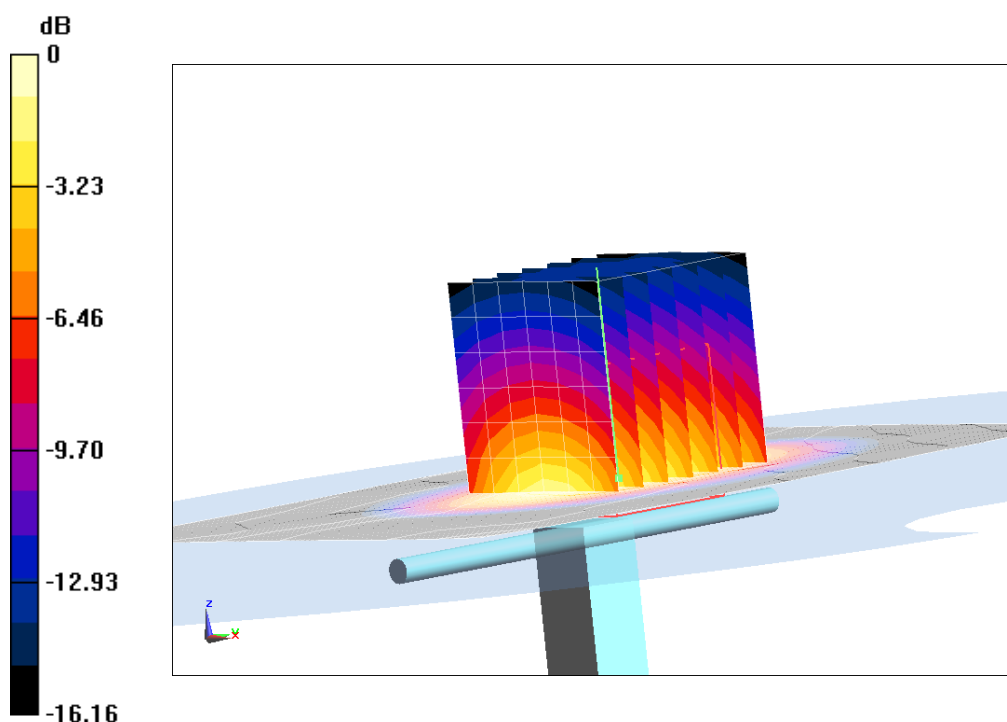

0 dB = 14.1 W/kg = 11.49 dB W/kg

Fig.B.5 validation 1750 MHz 250mW

1750 MHz

Date: 10/22/2020

Electronics: DAE4 Sn777

Medium: Body 1750 MHz

Medium parameters used: $f = 1750$ MHz; $\sigma = 1.514$ mho/m; $\epsilon_r = 53.22$; $\rho = 1000$ kg/m³

Ambient Temperature: 22.5°C Liquid Temperature: 22.3°C

Communication System: CW Frequency: 1750 MHz Duty Cycle: 1:1

Probe: EX3DV4 – SN3617 ConvF(8.41,8.41,8.41)

System Validation /Area Scan (81x191x1): Interpolated grid: dx=1.000 mm, dy=1.000 mm

Reference Value = 104.46 V/m; Power Drift = 0.04

Fast SAR: SAR(1 g) = 9.27 W/kg; SAR(10 g) = 4.96 W/kg

Maximum value of SAR (interpolated) = 13.83 W/kg

System Validation /Zoom Scan (7x7x7)/Cube 0: Measurement grid: dx=5mm, dy=5mm, dz=5mm

Reference Value = 104.46 V/m; Power Drift = 0.04 dB

Peak SAR (extrapolated) = 16.38 W/kg

SAR(1 g) = 9.32 W/kg; SAR(10 g) = 5.04 W/kg

Maximum value of SAR (measured) = 13.92 W/kg

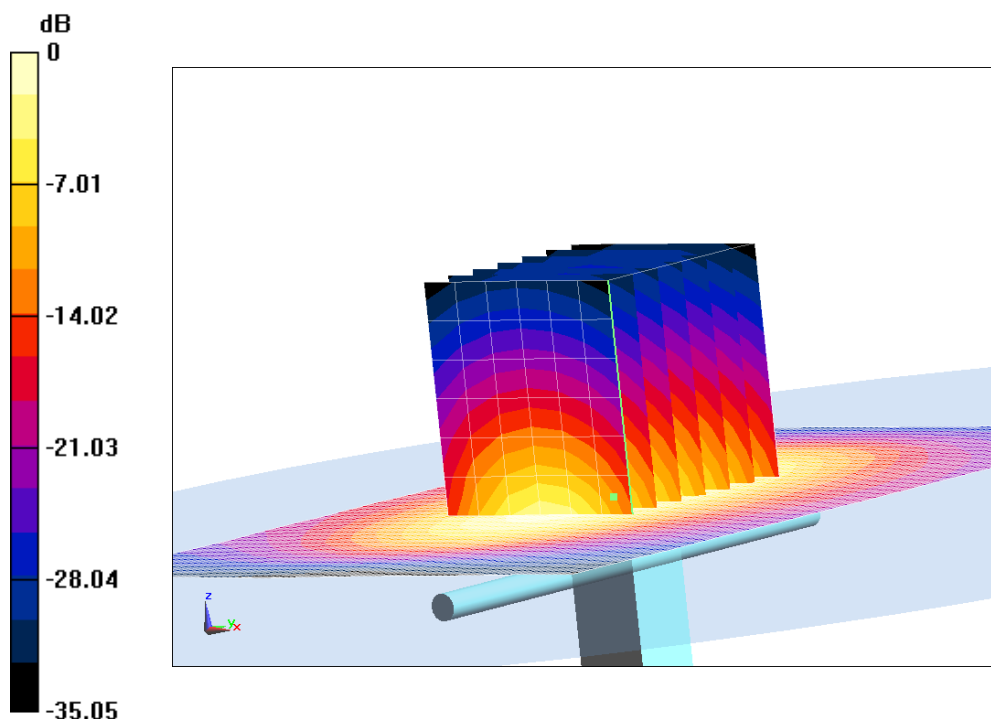

0 dB = 13.92 W/kg = 11.44 dB W/kg

Fig.B.6 validation 1750 MHz 250mW

1900 MHz

Date: 10/23/2020

Electronics: DAE4 Sn777

Medium: Head 1900 MHz

Medium parameters used: $f = 1900$ MHz; $\sigma = 1.39$ mho/m; $\epsilon_r = 39.55$; $\rho = 1000$ kg/m³

Ambient Temperature: 22.5°C Liquid Temperature: 22.3°C

Communication System: CW Frequency: 1900 MHz Duty Cycle: 1:1

Probe: EX3DV4 – SN3617 ConvF(8.14,8.14,8.14)

System Validation /Area Scan (81x191x1): Interpolated grid: dx=1.000 mm, dy=1.000 mm

Reference Value = 107.75 V/m; Power Drift = 0.02

Fast SAR: SAR(1 g) = 9.93 W/kg; SAR(10 g) = 5.15 W/kg

Maximum value of SAR (interpolated) = 15.31 W/kg

System Validation /Zoom Scan (7x7x7)/Cube 0: Measurement grid: dx=5mm, dy=5mm, dz=5mm

Reference Value = 107.75 V/m; Power Drift = 0.02 dB

Peak SAR (extrapolated) = 18.12 W/kg

SAR(1 g) = 10.05 W/kg; SAR(10 g) = 5.1 W/kg

Maximum value of SAR (measured) = 15.11 W/kg

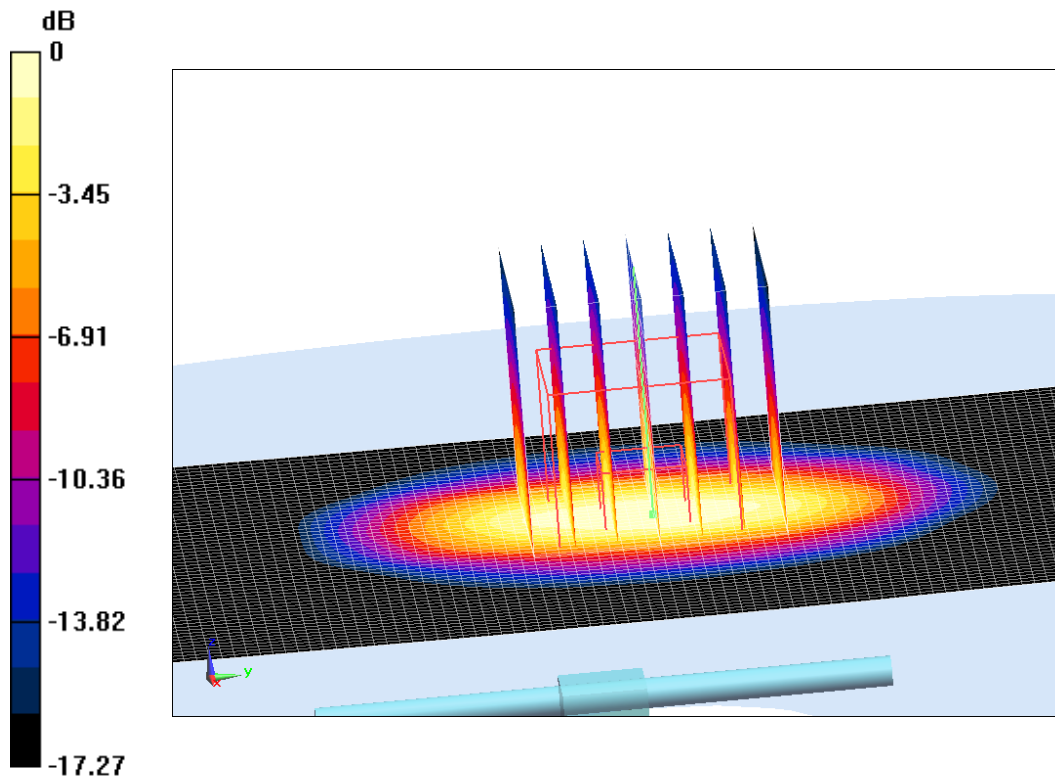

0 dB = 15.11 W/kg = 11.79 dB W/kg

Fig.B.7 validation 1900 MHz 250mW

1900 MHz

Date: 10/23/2020

Electronics: DAE4 Sn777

Medium: Body 1900 MHz

Medium parameters used: $f = 1900$ MHz; $\sigma = 1.536$ mho/m; $\epsilon_r = 53.19$; $\rho = 1000$ kg/m³

Ambient Temperature: 22.5°C Liquid Temperature: 22.3°C

Communication System: CW Frequency: 1900 MHz Duty Cycle: 1:1

Probe: EX3DV4 – SN3617 ConvF(8.14,8.14,8.14)

System Validation /Area Scan (81x191x1): Interpolated grid: dx=1.000 mm, dy=1.000 mm

Reference Value = 104.97 V/m; Power Drift = -0.03

Fast SAR: SAR(1 g) = 10.05 W/kg; SAR(10 g) = 5.16 W/kg

Maximum value of SAR (interpolated) = 14.19 W/kg

System Validation /Zoom Scan (7x7x7)/Cube 0: Measurement grid: dx=5mm, dy=5mm, dz=5mm

Reference Value = 104.97 V/m; Power Drift = -0.03 dB

Peak SAR (extrapolated) = 17.04 W/kg

SAR(1 g) = 9.78 W/kg; SAR(10 g) = 5.13 W/kg

Maximum value of SAR (measured) = 13.92 W/kg

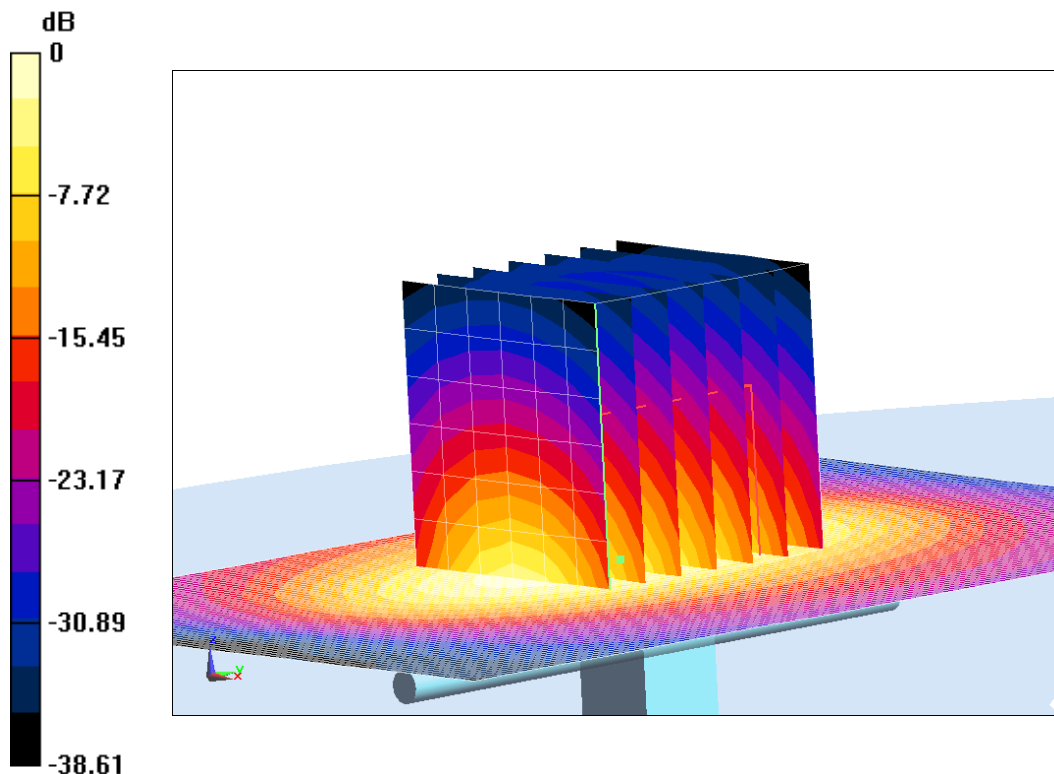

0 dB = 13.92 W/kg = 11.44 dB W/kg

Fig.B.8 validation 1900 MHz 250mW

2450 MHz

Date: 10/23/2020

Electronics: DAE4 Sn777

Medium: Head 2450 MHz

Medium parameters used: $f = 2450$ MHz; $\sigma = 1.784$ mho/m; $\epsilon_r = 39.05$; $\rho = 1000$ kg/m³

Ambient Temperature: 22.5°C Liquid Temperature: 22.3°C

Communication System: CW Frequency: 2450 MHz Duty Cycle: 1:1

Probe: EX3DV4 – SN3617 ConvF(7.65,7.65,7.65)

System Validation /Area Scan (81x191x1): Interpolated grid: dx=1.000 mm, dy=1.000 mm

Reference Value = 119.34 V/m; Power Drift = -0.08

Fast SAR: SAR(1 g) = 13.03 W/kg; SAR(10 g) = 6.04 W/kg

Maximum value of SAR (interpolated) = 21.8 W/kg

System Validation /Zoom Scan (7x7x7)/Cube 0: Measurement grid: dx=5mm, dy=5mm, dz=5mm

Reference Value = 119.34 V/m; Power Drift = -0.08 dB

Peak SAR (extrapolated) = 26.03 W/kg

SAR(1 g) = 13.36 W/kg; SAR(10 g) = 6.23 W/kg

Maximum value of SAR (measured) = 22.22 W/kg

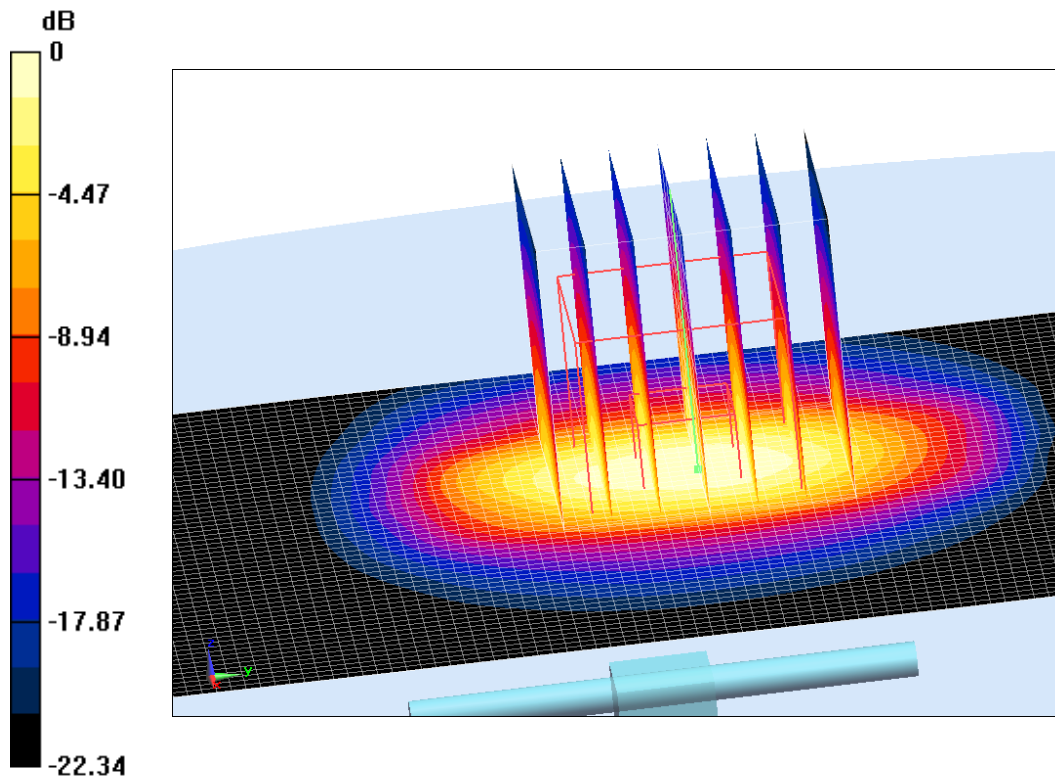

0 dB = 22.22 W/kg = 13.47 dB W/kg

Fig.B.9 validation 2450 MHz 250mW

2450 MHz

Date: 10/23/2020

Electronics: DAE4 Sn777

Medium: Body 2450 MHz

Medium parameters used: $f = 2450$ MHz; $\sigma = 1.966$ mho/m; $\epsilon_r = 53.36$; $\rho = 1000$ kg/m³

Ambient Temperature: 22.5°C Liquid Temperature: 22.3°C

Communication System: CW Frequency: 2450 MHz Duty Cycle: 1:1

Probe: EX3DV4 – SN3617 ConvF(7.65,7.65,7.65)

System Validation /Area Scan (81x191x1): Interpolated grid: dx=1.000 mm, dy=1.000 mm

Reference Value = 110.82 V/m; Power Drift = -0.02

Fast SAR: SAR(1 g) = 13.26 W/kg; SAR(10 g) = 6.17 W/kg

Maximum value of SAR (interpolated) = 21.74 W/kg

System Validation /Zoom Scan (7x7x7)/Cube 0: Measurement grid: dx=5mm, dy=5mm, dz=5mm

Reference Value = 110.82 V/m; Power Drift = -0.02 dB

Peak SAR (extrapolated) = 25.92 W/kg

SAR(1 g) = 12.97 W/kg; SAR(10 g) = 6.06 W/kg

Maximum value of SAR (measured) = 21.71 W/kg

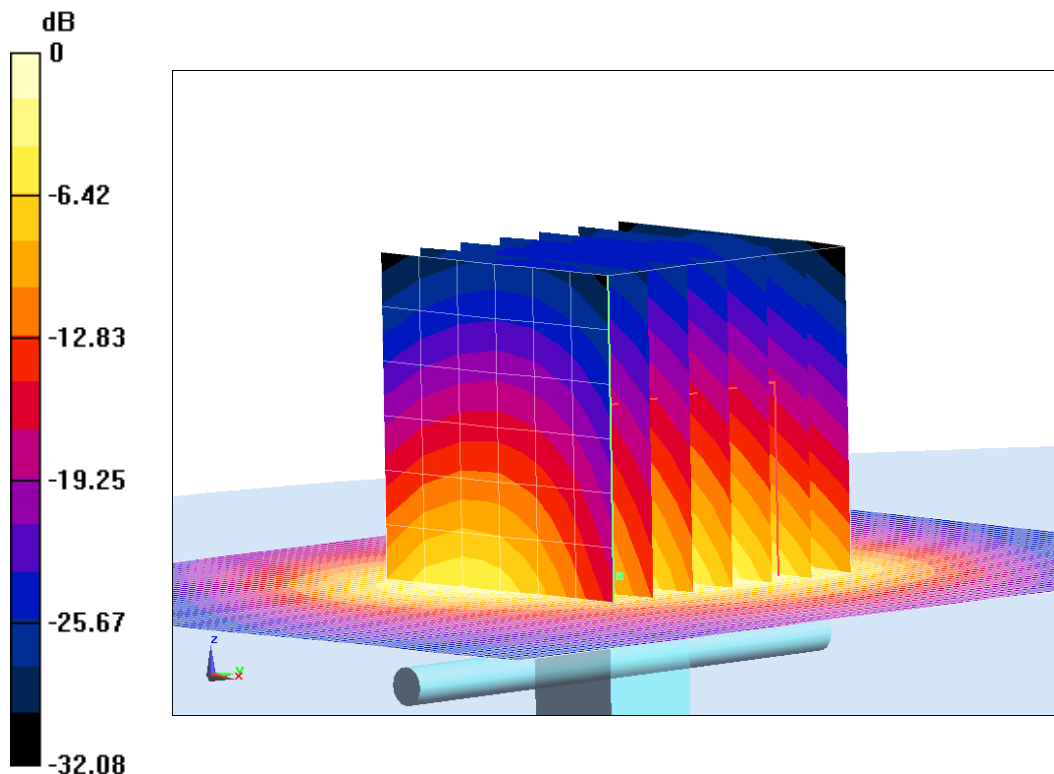

0 dB = 21.71 W/kg = 13.37 dB W/kg

Fig.B.10 validation 2450 MHz 250mW

2600 MHz

Date: 10/23/2020

Electronics: DAE4 Sn777

Medium: Head 2600 MHz

Medium parameters used: $f = 2600$ MHz; $\sigma = 1.966$ mho/m; $\epsilon_r = 39.57$; $\rho = 1000$ kg/m³

Ambient Temperature: 22.5°C Liquid Temperature: 22.3°C

Communication System: CW Frequency: 2600 MHz Duty Cycle: 1:1

Probe: EX3DV4 – SN3617 ConvF(7.52,7.52,7.52)

System Validation /Area Scan (81x191x1): Interpolated grid: dx=1.000 mm, dy=1.000 mm

Reference Value = 120.9 V/m; Power Drift = -0.05

Fast SAR: SAR(1 g) = 14.12 W/kg; SAR(10 g) = 6.25 W/kg

Maximum value of SAR (interpolated) = 24.65 W/kg

System Validation /Zoom Scan (7x7x7)/Cube 0: Measurement grid: dx=5mm, dy=5mm, dz=5mm

Reference Value = 120.9 V/m; Power Drift = -0.05 dB

Peak SAR (extrapolated) = 29.18 W/kg

SAR(1 g) = 14.48 W/kg; SAR(10 g) = 6.36 W/kg

Maximum value of SAR (measured) = 24.14 W/kg

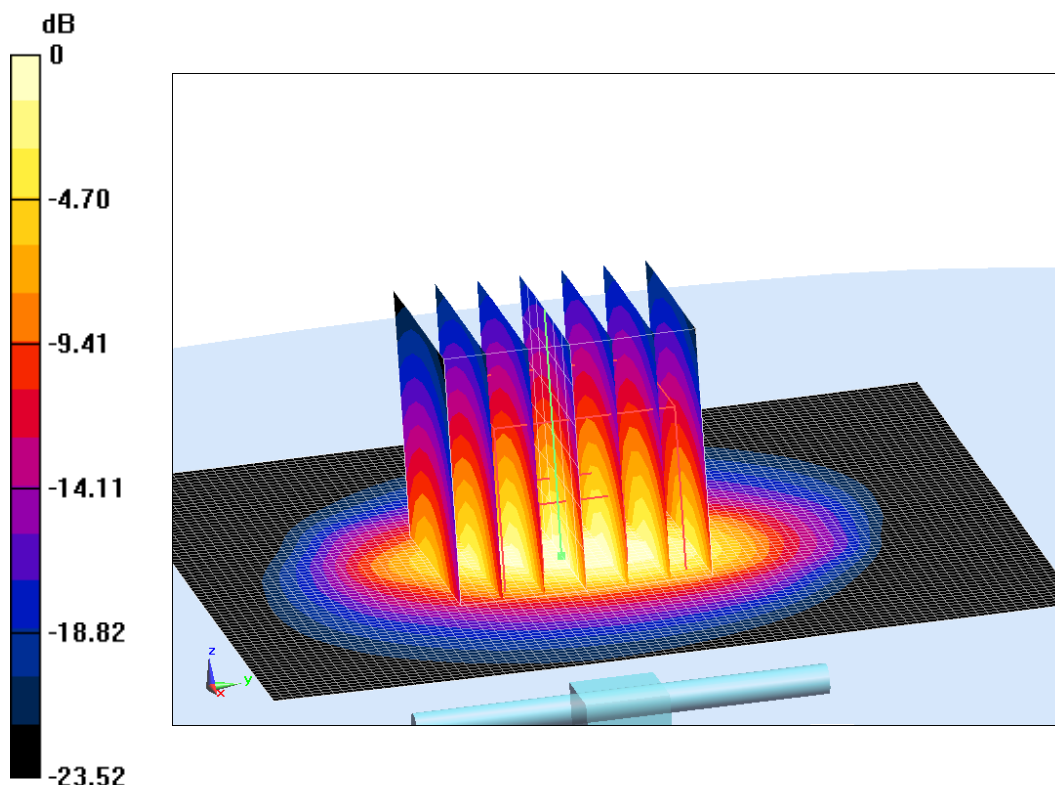

0 dB = 24.14 W/kg = 13.83 dB W/kg

Fig.B.11 validation 2600 MHz 250mW

2600 MHz

Date: 10/23/2020

Electronics: DAE4 Sn777

Medium: Body 2600 MHz

Medium parameters used: $f = 2600$ MHz; $\sigma = 2.138$ mho/m; $\epsilon_r = 51.61$; $\rho = 1000$ kg/m³

Ambient Temperature: 22.5°C Liquid Temperature: 22.3°C

Communication System: CW Frequency: 2600 MHz Duty Cycle: 1:1

Probe: EX3DV4 – SN3617 ConvF(7.52,7.52,7.52)

System Validation /Area Scan (81x191x1): Interpolated grid: dx=1.000 mm, dy=1.000 mm

Reference Value = 111.65 V/m; Power Drift = -0.02

Fast SAR: SAR(1 g) = 13.82 W/kg; SAR(10 g) = 6.05 W/kg

Maximum value of SAR (interpolated) = 22.45 W/kg

System Validation /Zoom Scan (7x7x7)/Cube 0: Measurement grid: dx=5mm, dy=5mm, dz=5mm

Reference Value = 111.65 V/m; Power Drift = -0.02 dB

Peak SAR (extrapolated) = 28.03 W/kg

SAR(1 g) = 13.56 W/kg; SAR(10 g) = 6.25 W/kg

Maximum value of SAR (measured) = 23.11 W/kg

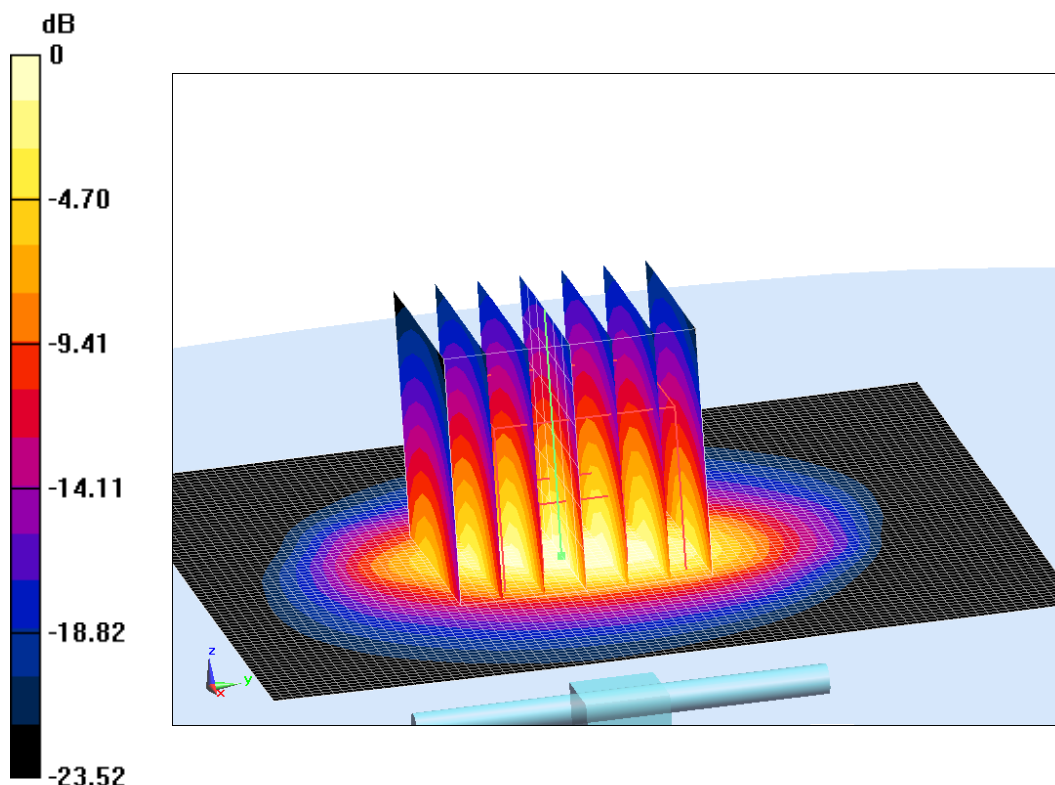

0 dB = 23.11 W/kg = 13.64 dB W/kg

Fig.B.12 validation 2600 MHz 250mW

J.10 Probe Calibration Certificate

Probe 3617 Calibration Certificate

Calibration Laboratory of
Schmid & Partner
Engineering AG
Zeughausstrasse 43, 8004 Zurich, Switzerland



S Schweizerischer Kalibrierdienst
C Service suisse d'étalonnage
S Servizio svizzero di taratura
S Swiss Calibration Service

Accredited by the Swiss Accreditation Service (SAS)
The Swiss Accreditation Service is one of the signatories to the EA
Multilateral Agreement for the recognition of calibration certificates

Accreditation No.: SCS 0108

Client **CTTL (Auden)**

Certificate No: EX3-3617_Jan20/2

CALIBRATION CERTIFICATE (Replacement of No: EX3-3617_Jan20)

Object: EX3DV4 - SN:3617

Calibration procedure(s): QA CAL-01.v9, QA CAL-12.v9, QA CAL-14.v5, QA CAL-23.v5, QA CAL-25.v7
Calibration procedure for dosimetric E-field probes

Calibration date: January 30, 2020

This calibration certificate documents the traceability to national standards, which realize the physical units of measurements (SI).
The measurements and the uncertainties with confidence probability are given on the following pages and are part of the certificate.

All calibrations have been conducted in the closed laboratory facility: environment temperature (22 ± 3)°C and humidity < 70%.

Calibration Equipment used (M&TE critical for calibration)

Primary Standards	ID	Cal Date (Certificate No.)	Scheduled Calibration
Power meter NRP	SN: 104778	03-Apr-19 (No. 217-02892/02893)	Apr-20
Power sensor NRP-Z91	SN: 103244	03-Apr-19 (No. 217-02892)	Apr-20
Power sensor NRP-Z91	SN: 103245	03-Apr-19 (No. 217-02893)	Apr-20
Reference 20 dB Attenuator	SN: S5277 (20x)	04-Apr-19 (No. 217-02894)	Apr-20
DAE4	SN: 660	27-Dec-19 (No. DAE4-660_Dec19)	Dec-20
Reference Probe ES3DV2	SN: 3013	31-Dec-19 (No. ES3-3013_Dec19)	Dec-20
Secondary Standards	ID	Check Date (in house)	Scheduled Check
Power meter E4419B	SN: GB41293874	06-Apr-16 (in house check Jun-18)	In house check: Jun-20
Power sensor E4412A	SN: MY41498087	06-Apr-16 (in house check Jun-18)	In house check: Jun-20
Power sensor E4412A	SN: 000110210	06-Apr-16 (in house check Jun-18)	In house check: Jun-20
RF generator HP 8648C	SN: US3642U01700	04-Aug-99 (in house check Jun-18)	In house check: Jun-20
Network Analyzer E8358A	SN: US41080477	31-Mar-14 (in house check Oct-19)	In house check: Oct-20

Calibrated by:	Name Claudio Leubler	Function Laboratory Technician	Signature
Approved by:	Name Katja Pokovic	Function Technical Manager	Signature

Issued: April 7, 2020

This calibration certificate shall not be reproduced except in full without written approval of the laboratory.

**Calibration Laboratory of
Schmid & Partner
Engineering AG**
Zeughausstrasse 43, 8004 Zurich, Switzerland



S Schweizerischer Kalibrierdienst
C Service suisse d'étalonnage
S Servizio svizzero di taratura
S Swiss Calibration Service

Accredited by the Swiss Accreditation Service (SAS)
The Swiss Accreditation Service is one of the signatories to the EA
Multilateral Agreement for the recognition of calibration certificates

Accreditation No.: **SCS 0108**

Glossary:

TSL	tissue simulating liquid
NORM _{x,y,z}	sensitivity in free space
ConvF	sensitivity in TSL / NORM _{x,y,z}
DCP	diode compression point
CF	crest factor (1/duty_cycle) of the RF signal
A, B, C, D	modulation dependent linearization parameters
Polarization φ	φ rotation around probe axis
Polarization ϑ	ϑ rotation around an axis that is in the plane normal to probe axis (at measurement center), i.e., $\vartheta = 0$ is normal to probe axis
Connector Angle	information used in DASY system to align probe sensor X to the robot coordinate system

Calibration is Performed According to the Following Standards:

- a) IEEE Std 1528-2013, "IEEE Recommended Practice for Determining the Peak Spatial-Averaged Specific Absorption Rate (SAR) in the Human Head from Wireless Communications Devices: Measurement Techniques", June 2013
- b) IEC 62209-1, "Measurement procedure for the assessment of Specific Absorption Rate (SAR) from hand-held and body-mounted devices used next to the ear (frequency range of 300 MHz to 6 GHz)", July 2016
- c) IEC 62209-2, "Procedure to determine the Specific Absorption Rate (SAR) for wireless communication devices used in close proximity to the human body (frequency range of 30 MHz to 6 GHz)", March 2010
- d) KDB 865664, "SAR Measurement Requirements for 100 MHz to 6 GHz"

Methods Applied and Interpretation of Parameters:

- **NORM_{x,y,z}**: Assessed for E-field polarization $\vartheta = 0$ ($f \leq 900$ MHz in TEM-cell; $f > 1800$ MHz: R22 waveguide). NORM_{x,y,z} are only intermediate values, i.e., the uncertainties of NORM_{x,y,z} does not affect the E^2 -field uncertainty inside TSL (see below *ConvF*).
- **NORM(f)_{x,y,z} = NORM_{x,y,z} * frequency_response** (see Frequency Response Chart). This linearization is implemented in DASY4 software versions later than 4.2. The uncertainty of the frequency response is included in the stated uncertainty of *ConvF*.
- **DCP_{x,y,z}**: DCP are numerical linearization parameters assessed based on the data of power sweep with CW signal (no uncertainty required). DCP does not depend on frequency nor media.
- **PAR**: PAR is the Peak to Average Ratio that is not calibrated but determined based on the signal characteristics
- **A_{x,y,z}; B_{x,y,z}; C_{x,y,z}; D_{x,y,z}; VR_{x,y,z}**: A, B, C, D are numerical linearization parameters assessed based on the data of power sweep for specific modulation signal. The parameters do not depend on frequency nor media. VR is the maximum calibration range expressed in RMS voltage across the diode.
- **ConvF and Boundary Effect Parameters**: Assessed in flat phantom using E-field (or Temperature Transfer Standard for $f \leq 800$ MHz) and inside waveguide using analytical field distributions based on power measurements for $f > 800$ MHz. The same setups are used for assessment of the parameters applied for boundary compensation (alpha, depth) of which typical uncertainty values are given. These parameters are used in DASY4 software to improve probe accuracy close to the boundary. The sensitivity in TSL corresponds to NORM_{x,y,z} * ConvF whereby the uncertainty corresponds to that given for ConvF. A frequency dependent ConvF is used in DASY version 4.4 and higher which allows extending the validity from ± 50 MHz to ± 100 MHz.
- **Spherical isotropy (3D deviation from isotropy)**: in a field of low gradients realized using a flat phantom exposed by a patch antenna.
- **Sensor Offset**: The sensor offset corresponds to the offset of virtual measurement center from the probe tip (on probe axis). No tolerance required.
- **Connector Angle**: The angle is assessed using the information gained by determining the NORM_x (no uncertainty required).

EX3DV4 – SN:3617

January 30, 2020

DASY/EASY - Parameters of Probe: EX3DV4 - SN:3617

Basic Calibration Parameters

	Sensor X	Sensor Y	Sensor Z	Unc (k=2)
Norm ($\mu\text{V}/(\text{V}/\text{m})^2$) ^A	0.35	0.21	0.32	± 10.1 %
DCP (mV) ^B	104.3	93.8	97.1	

Calibration Results for Modulation Response

UID	Communication System Name		A dB	B dB $\sqrt{\mu\text{V}}$	C	D dB	VR mV	Max dev.	Max Unc ^E (k=2)
0	CW	X	0.00	0.00	1.00	0.00	130.5	± 3.5 %	± 4.7 %
		Y	0.00	0.00	1.00		137.4		
		Z	0.00	0.00	1.00		129.2		
10352-AAA	Pulse Waveform (200Hz, 10%)	X	5.74	74.31	15.16	10.00	60.0	± 2.6 %	± 9.6 %
		Y	20.00	84.63	18.23		60.0		
		Z	20.00	90.64	20.98		60.0		
10353-AAA	Pulse Waveform (200Hz, 20%)	X	11.18	82.57	16.62	6.99	80.0	± 1.6 %	± 9.6 %
		Y	11.60	81.13	15.97		80.0		
		Z	20.00	91.54	20.06		80.0		
10354-AAA	Pulse Waveform (200Hz, 40%)	X	20.00	88.75	16.93	3.98	95.0	± 1.0 %	± 9.6 %
		Y	1.22	64.13	8.17		95.0		
		Z	20.00	94.77	20.04		95.0		
10355-AAA	Pulse Waveform (200Hz, 60%)	X	20.00	90.94	16.71	2.22	120.0	± 1.3 %	± 9.6 %
		Y	0.41	60.00	4.32		120.0		
		Z	20.00	99.77	20.92		120.0		
10387-AAA	QPSK Waveform, 1 MHz	X	0.73	63.23	9.65	0.00	150.0	± 4.1 %	± 9.6 %
		Y	0.47	60.00	5.82		150.0		
		Z	0.73	63.00	9.63		150.0		
10388-AAA	QPSK Waveform, 10 MHz	X	2.46	70.66	17.17	0.00	150.0	± 1.7 %	± 9.6 %
		Y	2.10	68.37	15.67		150.0		
		Z	2.45	70.34	17.05		150.0		
10396-AAA	64-QAM Waveform, 100 kHz	X	3.34	72.82	19.20	3.01	150.0	± 1.6 %	± 9.6 %
		Y	3.57	72.45	19.52		150.0		
		Z	3.45	73.00	19.94		150.0		
10399-AAA	64-QAM Waveform, 40 MHz	X	3.61	68.21	16.41	0.00	150.0	± 3.8 %	± 9.6 %
		Y	3.40	67.13	15.82		150.0		
		Z	3.62	68.06	16.39		150.0		
10414-AAA	WLAN CCDF, 64-QAM, 40MHz	X	4.88	66.26	15.89	0.00	150.0	± 6.6 %	± 9.6 %
		Y	4.57	64.95	15.35		150.0		
		Z	4.92	66.18	15.92		150.0		

Note: For details on UID parameters see Appendix

The reported uncertainty of measurement is stated as the standard uncertainty of measurement multiplied by the coverage factor k=2, which for a normal distribution corresponds to a coverage probability of approximately 95%.

^A The uncertainties of Norm X,Y,Z do not affect the E²-field uncertainty inside TSL (see Pages 5 and 6).

^B Numerical linearization parameter: uncertainty not required.

^E Uncertainty is determined using the max. deviation from linear response applying rectangular distribution and is expressed for the square of the field value.



EX3DV4- SN:3617

January 30, 2020

DASY/EASY - Parameters of Probe: EX3DV4 - SN:3617**Sensor Model Parameters**

	C1 fF	C2 fF	α V ⁻¹	T1 ms.V ⁻²	T2 ms.V ⁻¹	T3 ms	T4 V ⁻²	T5 V ⁻¹	T6
X	41.2	299.64	34.06	12.13	0.82	5.00	1.88	0.20	1.00
Y	42.0	334.64	39.96	9.91	1.46	5.06	0.00	0.82	1.01
Z	42.8	318.14	35.45	11.95	0.73	5.04	1.02	0.40	1.01

Other Probe Parameters

Sensor Arrangement	Triangular
Connector Angle (°)	13
Mechanical Surface Detection Mode	enabled
Optical Surface Detection Mode	disabled
Probe Overall Length	337 mm
Probe Body Diameter	10 mm
Tip Length	9 mm
Tip Diameter	2.5 mm
Probe Tip to Sensor X Calibration Point	1 mm
Probe Tip to Sensor Y Calibration Point	1 mm
Probe Tip to Sensor Z Calibration Point	1 mm
Recommended Measurement Distance from Surface	1.4 mm



EX3DV4- SN:3617

January 30, 2020

DASY/EASY - Parameters of Probe: EX3DV4 - SN:3617**Calibration Parameter Determined in Head Tissue Simulating Media**

f (MHz) ^C	Relative Permittivity ^F	Conductivity (S/m) ^F	ConvF X	ConvF Y	ConvF Z	Alpha ^G	Depth ^G (mm)	Unc (k=2)
64	54.2	0.75	12.37	12.37	12.37	0.00	1.00	± 13.3 %
150	52.3	0.76	11.63	11.63	11.63	0.00	1.00	± 13.3 %
300	45.3	0.87	11.41	11.41	11.41	0.08	1.20	± 13.3 %
450	43.5	0.87	10.84	10.84	10.84	0.12	1.40	± 13.3 %
750	41.9	0.89	10.07	10.07	10.07	0.61	0.80	± 12.0 %
835	41.5	0.90	9.66	9.66	9.66	0.54	0.84	± 12.0 %
900	41.5	0.97	9.56	9.56	9.56	0.54	0.80	± 12.0 %
1450	40.5	1.20	8.72	8.72	8.72	0.45	0.80	± 12.0 %
1640	40.2	1.31	8.50	8.50	8.50	0.25	0.80	± 12.0 %
1750	40.1	1.37	8.41	8.41	8.41	0.30	0.80	± 12.0 %
1810	40.0	1.40	8.20	8.20	8.20	0.15	1.26	± 12.0 %
1900	40.0	1.40	8.14	8.14	8.14	0.31	0.80	± 12.0 %
2000	40.0	1.40	8.25	8.25	8.25	0.40	0.81	± 12.0 %
2100	39.8	1.49	8.16	8.16	8.16	0.28	0.80	± 12.0 %
2300	39.5	1.67	7.95	7.95	7.95	0.35	0.86	± 12.0 %
2450	39.2	1.80	7.65	7.65	7.65	0.33	0.90	± 12.0 %
2600	39.0	1.96	7.52	7.52	7.52	0.38	0.90	± 12.0 %
3300	38.2	2.71	7.07	7.07	7.07	0.30	1.20	± 13.1 %
3500	37.9	2.91	7.02	7.02	7.02	0.35	1.30	± 13.1 %
3700	37.7	3.12	6.77	6.77	6.77	0.35	1.30	± 13.1 %
3900	37.5	3.32	6.62	6.62	6.62	0.40	1.60	± 13.1 %
4100	37.2	3.53	6.60	6.60	6.60	0.40	1.60	± 13.1 %
4200	37.1	3.63	6.50	6.50	6.50	0.40	1.60	± 13.1 %
4400	36.9	3.84	6.35	6.35	6.35	0.40	1.60	± 13.1 %
4600	36.7	4.04	6.30	6.30	6.30	0.40	1.60	± 13.1 %
4800	36.4	4.25	6.25	6.25	6.25	0.40	1.80	± 13.1 %
4950	36.3	4.40	6.10	6.10	6.10	0.40	1.80	± 13.1 %
5200	36.0	4.66	5.49	5.49	5.49	0.40	1.80	± 13.1 %
5250	35.9	4.71	5.39	5.39	5.39	0.40	1.80	± 13.1 %
5300	35.9	4.76	5.29	5.29	5.29	0.40	1.80	± 13.1 %
5500	35.6	4.96	5.14	5.14	5.14	0.40	1.80	± 13.1 %
5600	35.5	5.07	4.99	4.99	4.99	0.40	1.80	± 13.1 %
5750	35.4	5.22	5.10	5.10	5.10	0.40	1.80	± 13.1 %
5800	35.3	5.27	5.00	5.00	5.00	0.40	1.80	± 13.1 %

^C Frequency validity above 300 MHz of ± 100 MHz only applies for DASY v4.4 and higher (see Page 2), else it is restricted to ± 50 MHz. The uncertainty is the RSS of the ConvF uncertainty at calibration frequency and the uncertainty for the indicated frequency band. Frequency validity below 300 MHz is ± 10, 25, 40, 50 and 70 MHz for ConvF assessments at 30, 64, 128, 150 and 220 MHz respectively. Validity of ConvF assessed at 6 MHz is 4-9 MHz, and ConvF assessed at 13 MHz is 9-19 MHz. Above 5 GHz frequency validity can be extended to ± 110 MHz.

^F At frequencies below 3 GHz, the validity of tissue parameters (ϵ and σ) can be relaxed to ± 10% if liquid compensation formula is applied to measured SAR values. At frequencies above 3 GHz, the validity of tissue parameters (ϵ and σ) is restricted to ± 5%. The uncertainty is the RSS of the ConvF uncertainty for indicated target tissue parameters.

^G Alpha/Depth are determined during calibration. SPEAG warrants that the remaining deviation due to the boundary effect after compensation is always less than ± 1% for frequencies below 3 GHz and below ± 2% for frequencies between 3-6 GHz at any distance larger than half the probe tip diameter from the boundary.



EX3DV4– SN:3617

January 30, 2020

DASY/EASY - Parameters of Probe: EX3DV4 - SN:3617**Calibration Parameter Determined in Body Tissue Simulating Media**

f (MHz) ^C	Relative Permittivity ^F	Conductivity (S/m) ^F	ConvF X	ConvF Y	ConvF Z	Alpha ^G	Depth ^G (mm)	Unc (k=2)
750	55.5	0.96	9.80	9.80	9.80	0.50	0.80	± 12.0 %
835	55.2	0.97	9.53	9.53	9.53	0.43	0.80	± 12.0 %
900	55.0	1.05	9.49	9.49	9.49	0.42	0.80	± 12.0 %
1450	54.0	1.30	8.56	8.56	8.56	0.25	0.80	± 12.0 %
1640	53.7	1.42	8.44	8.44	8.44	0.32	0.80	± 12.0 %
1750	53.4	1.49	8.09	8.09	8.09	0.48	0.80	± 12.0 %
1810	53.3	1.52	8.05	8.05	8.05	0.44	0.80	± 12.0 %
1900	53.3	1.52	7.94	7.94	7.94	0.39	0.80	± 12.0 %
2000	53.3	1.52	7.92	7.92	7.92	0.37	0.86	± 12.0 %
2100	53.2	1.62	7.89	7.89	7.89	0.35	0.89	± 12.0 %
2300	52.9	1.81	7.78	7.78	7.78	0.39	0.85	± 12.0 %
2450	52.7	1.95	7.76	7.76	7.76	0.41	0.80	± 12.0 %
2600	52.5	2.16	7.45	7.45	7.45	0.32	0.80	± 12.0 %
3300	51.6	3.08	6.44	6.44	6.44	0.40	1.70	± 13.1 %
3500	51.3	3.31	6.30	6.30	6.30	0.40	1.70	± 13.1 %
3700	51.0	3.55	6.27	6.27	6.27	0.40	1.70	± 13.1 %
3900	51.2	3.78	6.24	6.24	6.24	0.40	1.70	± 13.1 %
4100	50.5	4.01	6.21	6.21	6.21	0.40	1.70	± 13.1 %
4200	50.4	4.13	6.20	6.20	6.20	0.40	1.70	± 13.1 %
4400	50.1	4.37	5.97	5.97	5.97	0.40	1.70	± 13.1 %
4600	49.8	4.60	5.83	5.83	5.83	0.40	1.70	± 13.1 %
4800	49.6	4.83	5.72	5.72	5.72	0.50	1.80	± 13.1 %
4950	49.4	5.01	5.41	5.41	5.41	0.50	1.90	± 13.1 %
5200	49.0	5.30	4.80	4.80	4.80	0.50	1.90	± 13.1 %
5250	48.9	5.36	4.70	4.70	4.70	0.50	1.90	± 13.1 %
5300	48.9	5.42	4.61	4.61	4.61	0.50	1.90	± 13.1 %
5500	48.6	5.65	4.32	4.32	4.32	0.50	1.90	± 13.1 %
5600	48.5	5.77	4.23	4.23	4.23	0.50	1.90	± 13.1 %
5750	48.3	5.94	4.36	4.36	4.36	0.50	1.90	± 13.1 %
5800	48.2	6.00	4.22	4.22	4.22	0.50	1.90	± 13.1 %

^C Frequency validity above 300 MHz of ± 100 MHz only applies for DASY v4.4 and higher (see Page 2), else it is restricted to ± 50 MHz. The uncertainty is the RSS of the ConvF uncertainty at calibration frequency and the uncertainty for the indicated frequency band. Frequency validity below 300 MHz is ± 10, 25, 40, 50 and 70 MHz for ConvF assessments at 30, 64, 128, 150 and 220 MHz respectively. Validity of ConvF assessed at 6 MHz is 4-9 MHz, and ConvF assessed at 13 MHz is 9-19 MHz. Above 5 GHz frequency validity can be extended to ± 110 MHz.

^F At frequencies below 3 GHz, the validity of tissue parameters (ϵ and σ) can be relaxed to ± 10% if liquid compensation formula is applied to measured SAR values. At frequencies above 3 GHz, the validity of tissue parameters (ϵ and σ) is restricted to ± 5%. The uncertainty is the RSS of the ConvF uncertainty for indicated target tissue parameters.

^G Alpha/Depth are determined during calibration. SPEAG warrants that the remaining deviation due to the boundary effect after compensation is always less than ± 1% for frequencies below 3 GHz and below ± 2% for frequencies between 3-6 GHz at any distance larger than half the probe tip diameter from the boundary.

Frequency Response of E-Field (TEM-Cell:ifi110 EXX, Waveguide: R22)

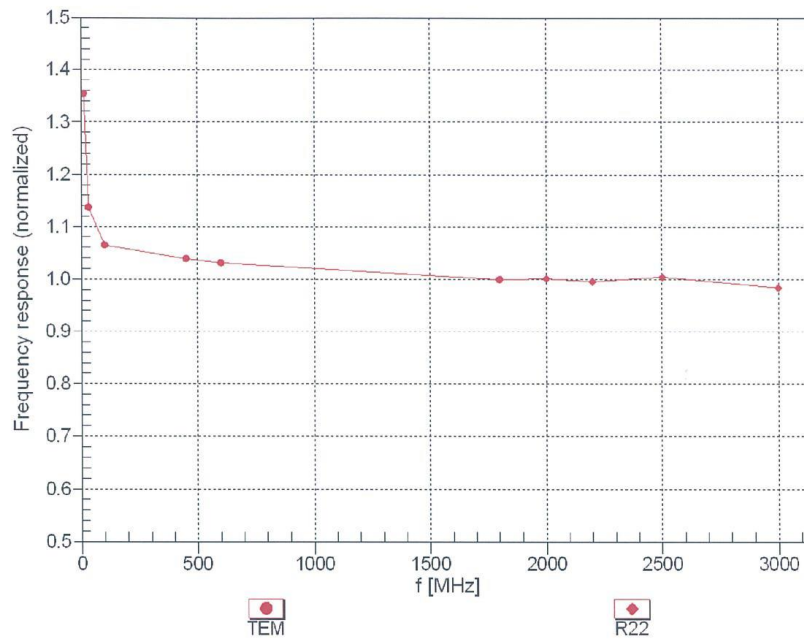

Uncertainty of Frequency Response of E-field: $\pm 6.3\%$ (k=2)