



TEST REPORT

No.I19N00481-SAR

For

TCL Communication Ltd.

Tablet PC

Model Name: 9027G

With

Hardware Version: 03

Software Version: E7B

FCC ID: 2ACCJBT15

Issued Date: 2019-03-30

Designation Number: CN1210

Note:

The test results in this test report relate only to the devices specified in this report. This report shall not be reproduced except in full without the written approval of SAICT.

Test Laboratory:

Shenzhen Academy of Information and Communications Technology
Building G, Shenzhen International Innovation Center, No.1006 Shennan Road, Futian District, Shenzhen,
Guangdong, P. R. China 518026.

Tel: +86(0)755-33322000, Fax: +86(0)755-33322001

Email: yewu@caict.ac.cn, website: www.cszit.com

REPORT HISTORY

Report Number	Revision	Issue Date	Description
I19N00481-SAR	Rev.0	2019-03-30	Initial creation of test report

TABLE OF CONTENT

1 TEST LABORATORY	5
1.1 TESTING LOCATION	5
1.2 TESTING ENVIRONMENT	5
1.3 PROJECT DATA	5
1.4 SIGNATURE	5
2 STATEMENT OF COMPLIANCE	6
3 CLIENT INFORMATION.....	8
3.1 APPLICANT INFORMATION.....	8
3.2 MANUFACTURER INFORMATION	8
4 EQUIPMENT UNDER TEST (EUT) AND ANCILLARY EQUIPMENT (AE)	9
4.1 ABOUT EUT	9
4.2 INTERNAL IDENTIFICATION OF EUT USED DURING THE TEST	9
4.3 INTERNAL IDENTIFICATION OF AE USED DURING THE TEST	9
5 TEST METHODOLOGY	10
5.1 APPLICABLE LIMIT REGULATIONS.....	10
5.2 APPLICABLE MEASUREMENT STANDARDS	10
6 SPECIFIC ABSORPTION RATE (SAR).....	11
6.1 INTRODUCTION.....	11
6.2 SAR DEFINITION.....	11
7 TISSUE SIMULATING LIQUIDS	12
7.1 TARGETS FOR TISSUE SIMULATING LIQUID	12
7.2 DIELECTRIC PERFORMANCE	12
8 SYSTEM VERIFICATION.....	17
8.1 SYSTEM SETUP.....	17
8.2 SYSTEM VERIFICATION	18
9 MEASUREMENT PROCEDURES	19
9.1 TESTS TO BE PERFORMED.....	19
9.2 GENERAL MEASUREMENT PROCEDURE	21
9.3 WCDMA MEASUREMENT PROCEDURES FOR SAR	22
9.4 BLUETOOTH & WI-FI MEASUREMENT PROCEDURES FOR SAR	22
9.5 SAR MEASUREMENT FOR LTE.....	23
9.6 POWER DRIFT.....	23
10 CONDUCTED OUTPUT POWER.....	24
10.1 GSM MEASUREMENT RESULT	24
10.2 WCDMA MEASUREMENT RESULT	26
10.3 LTE MEASUREMENT RESULT	28
10.4 WI-FI MEASUREMENT RESULT.....	57

11 SIMULTANEOUS TX SAR CONSIDERATIONS	61
11.1 INTRODUCTION.....	61
11.2 TRANSMIT ANTENNA SEPARATION DISTANCES	61
11.3 STANDALONE SAR TEST EXCLUSION CONSIDERATIONS	62
12 EVALUATION OF SIMULTANEOUS.....	63
13 SAR TEST RESULT	65
13.1 SAR RESULTS.....	65
13.2 WLAN EVALUATION FOR 2.4G	74
13.3 WLAN EVALUATION FOR 5G.....	75
14 SAR MEASUREMENT VARIABILITY.....	77
15 MEASUREMENT UNCERTAINTY	79
15.1 MEASUREMENT UNCERTAINTY FOR NORMAL SAR TESTS (300MHZ~3GHZ)	79
15.2 MEASUREMENT UNCERTAINTY FOR FAST SAR TESTS (300MHZ~3GHZ)	80
15.3 MEASUREMENT UNCERTAINTY FOR NORMAL SAR TESTS (3GHZ~6GHZ)	81
15.4 MEASUREMENT UNCERTAINTY FOR FAST SAR TESTS (3GHZ~6GHZ)	82
16 MAIN TEST INSTRUMENTS	83
ANNEX A GRAPH RESULTS	84
ANNEX B SYSTEMVERIFICATION RESULTS	97
ANNEX C SAR MEASUREMENT SETUP.....	105
C.1 MEASUREMENT SET-UP	105
C.2 DASY5 E-FIELD PROBE SYSTEM	106
C.3 E-FIELD PROBE CALIBRATION.....	106
C.4 OTHER TEST EQUIPMENT.....	107
ANNEX D POSITION OF THE WIRELESS DEVICE IN RELATION TO THE PHANTOM.....	111
D.1 BODY-WORN DEVICE	111
D.2 DESKTOP DEVICE.....	111
D.3 DUT SETUP PHOTOS.....	112
ANNEX E EQUIVALENT MEDIA RECIPES.....	113
ANNEX F SYSTEM VALIDATION.....	114
ANNEX G DAE CALIBRATION CERTIFICATE.....	115
ANNEX H PROBE CALIBRATION CERTIFICATE.....	118
ANNEX I DIPOLE CALIBRATION CERTIFICATE.....	129
ANNEX J EXTENDED CALIBRATION SAR DIPOLE	193
ANNEX K SENSOR TRIGGERING DATA SUMMARY	195

1 Test Laboratory

1.1 Testing Location

Company Name:	Shenzhen Academy of Information and Communications Technology
Address:	Building G, Shenzhen International Innovation Center, No.1006 Shennan Road, Futian District, Shenzhen, Guangdong, P. R. China
Postal Code:	518026
Telephone:	+86-0755-33322000
Fax:	+86-0755-33322001

1.2 Testing Environment

Temperature:	18°C~25 °C
Relative humidity:	30%~ 70%
Ground system resistance:	<4Ω
Ambient noise & Reflection:	< 0.012 W/kg

1.3 Project Data

Testing Start Date:	March 14, 2019
Testing End Date:	March 26, 2019

1.4 Signature

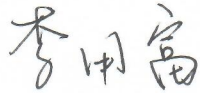

Li Yongfu

(Prepared this test report)



Zhang Yunzhan

(Reviewed this test report)

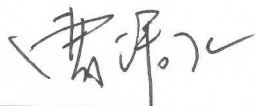

Cao Junfei

Deputy Director of the laboratory
(Approved this test report)

2 Statement of Compliance

The maximum results of Specific Absorption Rate (SAR) found during testing for TCL Communication Ltd. Tablet PC 9027G are as follows:

Table 2.1: Highest Reported SAR for Body (1g)

Exposure Configuration	Technology Band	Highest Reported SAR 1g(W/Kg)	Equipment Class
Hotspot(Body)	GSM850	0.91	PCB
	GSM1900	1.19	
	WCDMA850	1.33	
	WCDMA1900	1.32	
	WCDMA1700	1.16	
	LTE Band 2	1.26	
	LTE Band 5	0.67	
	LTE Band 7	1.26	
	LTE Band 12	0.90	
	LTE Band 66	1.03	
	LTE Band 71	0.77	
	BT 2.4G	0.21	DSS
	WLAN 2.4G	0.39	DTS
WLAN 5G	0.40	U-NII-3	

The SAR values found for the EUT are below the maximum recommended levels of 1.6 W/Kg as averaged over any 1g tissue according to the ANSI C95.1-1992.

For body worn operation, this device has been tested and meets FCC RF exposure guidelines when used with any accessory that contains no metal and which provides a minimum separation distance from 0/9/12/14/15mm between this device and the body of the user. Use of other accessories may not ensure compliance with FCC RF exposure guidelines.

The EUT battery must be fully charged and checked periodically during the test to ascertain uniform power output.

The measurement together with the test system set-up is described in annex C of this test report. A detailed description of the equipment under test can be found in chapter 4 of this test report.

The highest reported SAR value is obtained at the case of **(Table 2.1)**, and the values are: **1.33 W/kg (1g)**.

Table 2.2: The sum of reported SAR values for main antenna and Wi-Fi

/	Band	Position	Main antenna	WiFi	Sum	SPLSR
Maximum reported SAR value for Body	W850	Rear	1.33	0.27	1.60	Yes

According to the KDB 447498 D01, when the sum of SAR is larger than the limit, SAR test exclusion is determined by the SAR to peak location separation ratio. The ratio is determined by $(SAR1 + SAR2)^{1.5}/R_i$, rounded to two decimal digits, and must be ≤ 0.04 for all antenna pairs in the configuration to qualify for 1-g SAR test exclusion.

Table 2.3: The sum of reported SAR values for main antenna and BT

/	Position	Main antenna	BT	Sum
Highest reported SAR value for Body	Rear	1.33	0.19	1.52

BT* - Estimated SAR for Bluetooth (see the table 12.3)

According to the above tables, the highest sum of reported SAR values is **1.60W/kg (1g)**. The detail for simultaneous transmission consideration is described in chapter 12.

3 Client Information

3.1 Applicant Information

Company Name:	TCL Communication Ltd.
Address /Post:	7/F, Block F4, TCL Communication Technology Building, TCL International E City, Zhong Shan Yuan Road, Nanshan District, Shenzhen, Guangdong, P.R. China 518052
Contact:	Gong Zhizhou
Email:	zhizhou.gong@tcl.com
Telephone:	0086-755-36611722
Fax:	/

3.2 Manufacturer Information

Company Name:	TCL Communication Ltd.
Address /Post:	7/F, Block F4, TCL Communication Technology Building, TCL International E City, Zhong Shan Yuan Road, Nanshan District, Shenzhen, Guangdong, P.R. China 518052
Contact:	Gong Zhizhou
Email:	zhizhou.gong@tcl.com
Telephone:	0086-755-36611722
Fax:	/

4 Equipment under Test (EUT) and Ancillary Equipment (AE)

4.1 About EUT

Description:	Tablet PC
Model Name:	9027G
Condition of EUT as received	No obvious damage in appearance
Operating mode(s):	GSM850/1900, WCDMA850/1700/1900, LTE Band 2/4/5/7/12/17/66/71, BT, Wi-Fi 2.4G/5G
Tested Tx Frequency:	825 – 848.8MHz (GSM 850)
	1850.2 – 1910MHz (GSM 1900)
	826.4 – 846.6MHz (WCDMA850 Band V)
	1712.4 – 1752.6MHz (WCDMA1700 Band IV)
	1852.4 – 1907.6MHz (WCDMA1900 Band II)
	1850.7 – 1909.3MHz (LTE FDD Band 2)
	1710.7 – 1754.3MHz (LTE FDD Band 4)
	824.7 – 848.3MHz (LTE FDD Band 5)
	2502.5 – 2567.5MHz (LTE FDD Band 7)
	699.7 – 715.3MHz (LTE FDD Band 12)
	706.7 – 713.5MHz (LTE FDD Band 17)
	1710.7 – 1779.3MHz (LTE FDD Band 66)
	665.5 – 695.5MHz (LTE FDD Band 71)
2412 – 2462MHz (Wi-Fi 2.4G)	
5150 – 5350MHz, 5725 – 5825MHz (Wi-Fi 5G)	
Test device Production information:	Production unit
Device type:	Portable device
Antenna type:	Integrated antenna
Product dimension	Long 209.5mm ;Wide 125mm ;Diagonal 243.96mm

4.2 Internal Identification of EUT used during the test

EUT ID*	IMEI	HW Version	SW Version
EUT1	015450000000240	03	E7B
EUT2	015450000000265	03	E7B
EUT3	015450000000257	03	E7B

*EUT ID: is used to identify the test sample in the lab internally.

Note: It is performed to test SAR with the EUT 1 & EUT 2, and conducted power with the EUT 3.

4.3 Internal Identification of AE used during the test

AE ID*	Description	Type	Manufacturer
AE1	Battery	TLp040J1	BYD

*AE ID: is used to identify the test sample in the lab internally.

5 Test Methodology

5.1 Applicable Limit Regulations

ANSI C95.1–1992: IEEE Standard for Safety Levels with Respect to Human Exposure to Radio Frequency Electromagnetic Fields, 3 kHz to 300 GHz.

It specifies the maximum exposure limit of **1.6 W/kg** as averaged over any 1 gram of tissue for portable devices being used within 20 cm of the user in the uncontrolled environment.

5.2 Applicable Measurement Standards

IEEE 1528–2013: Recommended Practice for Determining the Peak Spatial-Average Specific Absorption Rate (SAR) in the Human Head from Wireless Communications Devices: Experimental Techniques.

KDB 648474 D04 Handset SAR v01r03: SAR Evaluation Considerations for Wireless Handsets.

KDB 447498 D01 General RF Exposure Guidance v06: Mobile and Portable Devices RF Exposure Procedures and Equipment Authorization Policies.

KDB 616217 D04 SAR for laptop and tablets v01r02: SAR Evaluation Considerations for Laptop, Notebook, Notebook and Tablet Computers.

KDB 941225 D01 SAR test for 3G devices v03r01: SAR Measurement Procedures for 3G Devices

KDB 941225 D05 SAR for LTE Devices v02r05: SAR Evaluation Considerations for LTE Devices

KDB 248227 D01 802.11 Wi-Fi SAR v02r02: SAR Guidance for IEEE 802.11 (Wi-Fi) Transmitters.

KDB 865664 D01 SAR measurement 100 MHz to 6 GHz v01r04: SAR Measurement Requirements for 100 MHz to 6 GHz.

KDB 865664 D02 RF Exposure Reporting v01r02: RF Exposure Compliance Reporting and Documentation Considerations

6 Specific Absorption Rate (SAR)

6.1 Introduction

SAR is related to the rate at which energy is absorbed per unit mass in an object exposed to a radio field. The SAR distribution in a biological body is complicated and is usually carried out by experimental techniques or numerical modeling. The standard recommends limits for two tiers of groups, occupational/controlled and general population/uncontrolled, based on a person's awareness and ability to exercise control over his or her exposure. In general, occupational/controlled exposure limits are higher than the limits for general population/uncontrolled.

6.2 SAR Definition

The SAR definition is the time derivative (rate) of the incremental energy (dW) absorbed by (dissipated in) an incremental mass (dm) contained in a volume element (dv) of a given density (ρ). The equation description is as below:

$$SAR = \frac{d}{dt} \left(\frac{dW}{dm} \right) = \frac{d}{dt} \left(\frac{dW}{\rho dv} \right)$$

SAR is expressed in units of Watts per kilogram (W/kg)

SAR measurement can be either related to the temperature elevation in tissue by

$$SAR = c \left(\frac{\delta T}{\delta t} \right)$$

Where: C is the specific heat capacity, δT is the temperature rise and δt is the exposure duration, or related to the electrical field in the tissue by

$$SAR = \frac{\sigma |E|^2}{\rho}$$

Where: σ is the conductivity of the tissue, ρ is the mass density of tissue and E is the RMS electrical field strength.

However for evaluating SAR of low power transmitter, electrical field measurement is typically applied.

7 Tissue Simulating Liquids

7.1 Targets for tissue simulating liquid

Table 7.1: Targets for tissue simulating liquid

Frequency (MHz)	Liquid Type	Conductivity (σ)	$\pm 5\%$ Range	Permittivity (ϵ)	$\pm 5\%$ Range
750	Body	0.96	0.91~1.01	55.50	52.7~58.3
835	Body	0.97	0.92~1.02	55.20	52.4~58.0
1750	Body	1.49	1.42~1.56	53.40	50.7~56.1
1900	Body	1.52	1.44~1.60	53.30	50.6~56.0
2450	Body	1.95	1.85~2.05	52.70	50.1~55.3
2550	Body	2.09	1.99~2.19	52.60	50.0~55.2
5300	Body	5.42	5.15~5.69	48.90	46.5~51.3
5800	Body	6.00	5.70~6.30	48.20	45.8~50.6

7.2 Dielectric Performance

Table 7.2: Dielectric Performance of Tissue Simulating Liquid

Measurement Date (yyyy-mm-dd)	Type	Frequency	Conductivity σ (S/m)	Drift (%)	Permittivity ϵ	Drift (%)
2019-3-17	Body	750	1.001	4.27	54.892	-1.10
2019-3-19	Body	835	0.989	1.96	52.694	-4.54
2019-3-14	Body	1750	1.458	-2.15	53.391	-0.02
2019-3-24	Body	1900	1.574	3.55	52.954	-0.65
2019-3-23	Body	2450	1.928	-1.13	50.533	-4.11
2019-3-20	Body	2550	2.052	-1.82	52.208	-0.75
2019-3-26	Body	5300	5.474	1.00	47.628	-2.60
2019-3-26	Body	5800	6.202	3.37	47.395	-1.67

Note: The liquid temperature is 22.0°C.

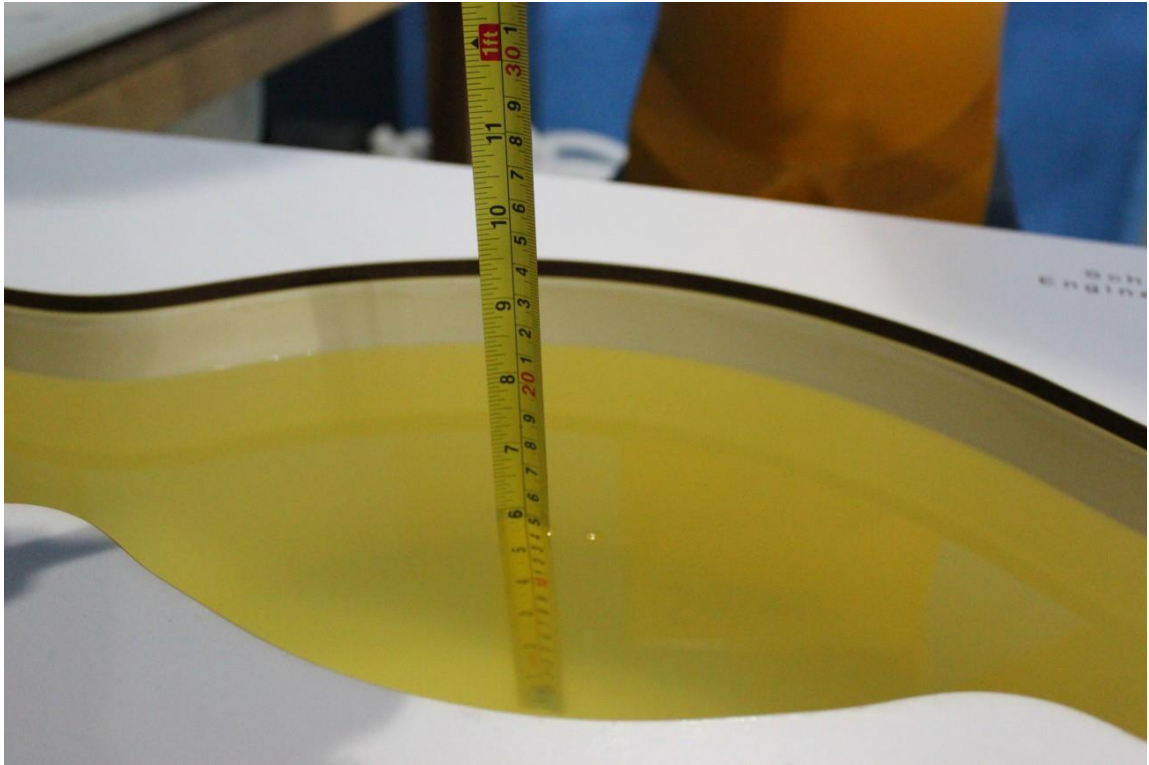

Picture 7-1: Liquid depth in the Flat Phantom (750 MHz)

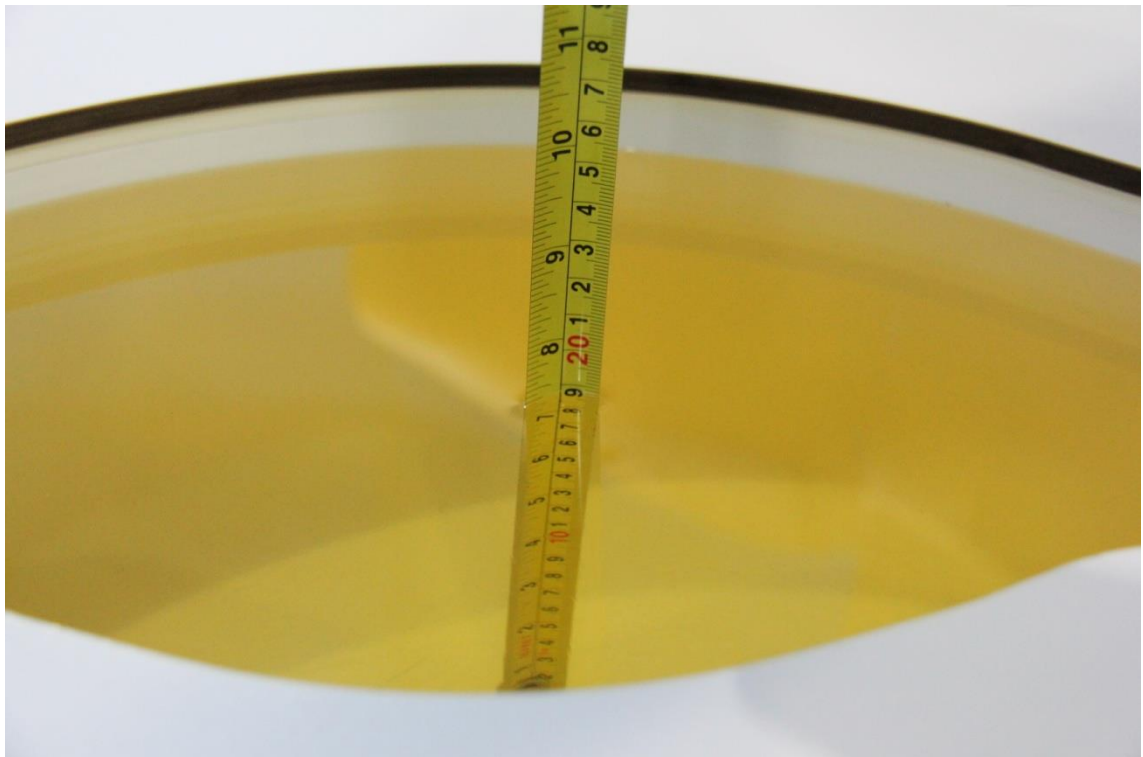

Picture 7-2: Liquid depth in the Flat Phantom (835 MHz)

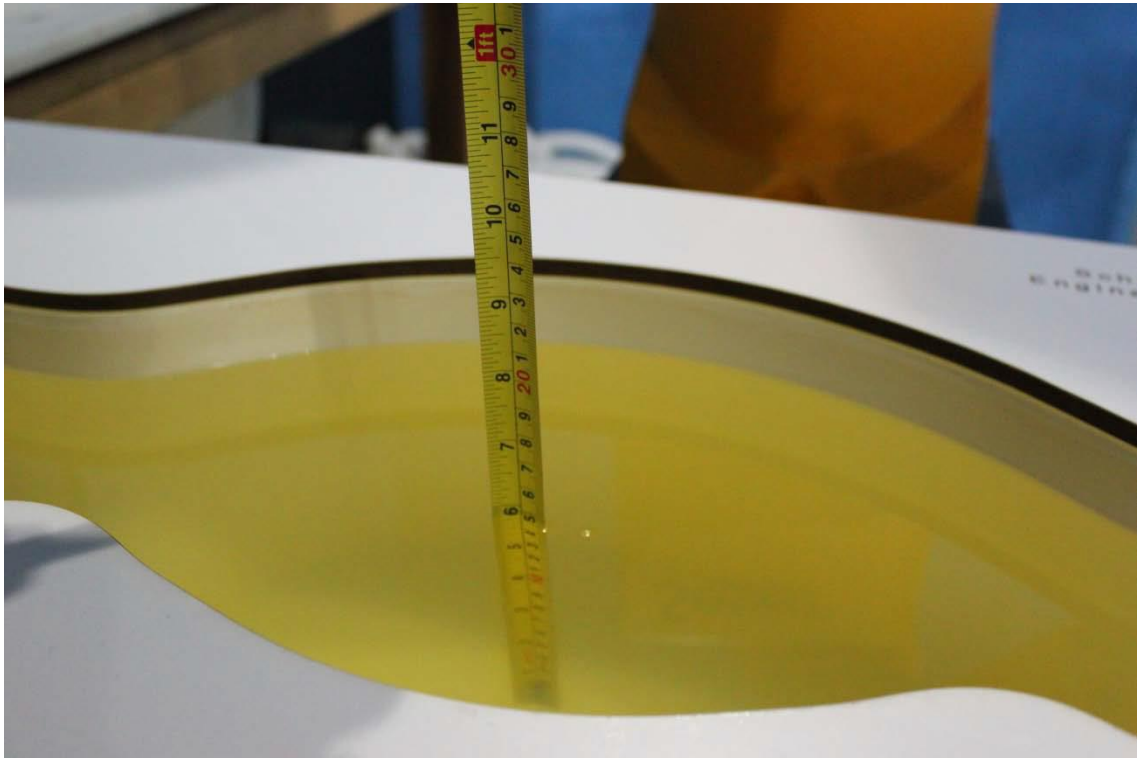

Picture 7-3: Liquid depth in the Flat Phantom (1750 MHz)

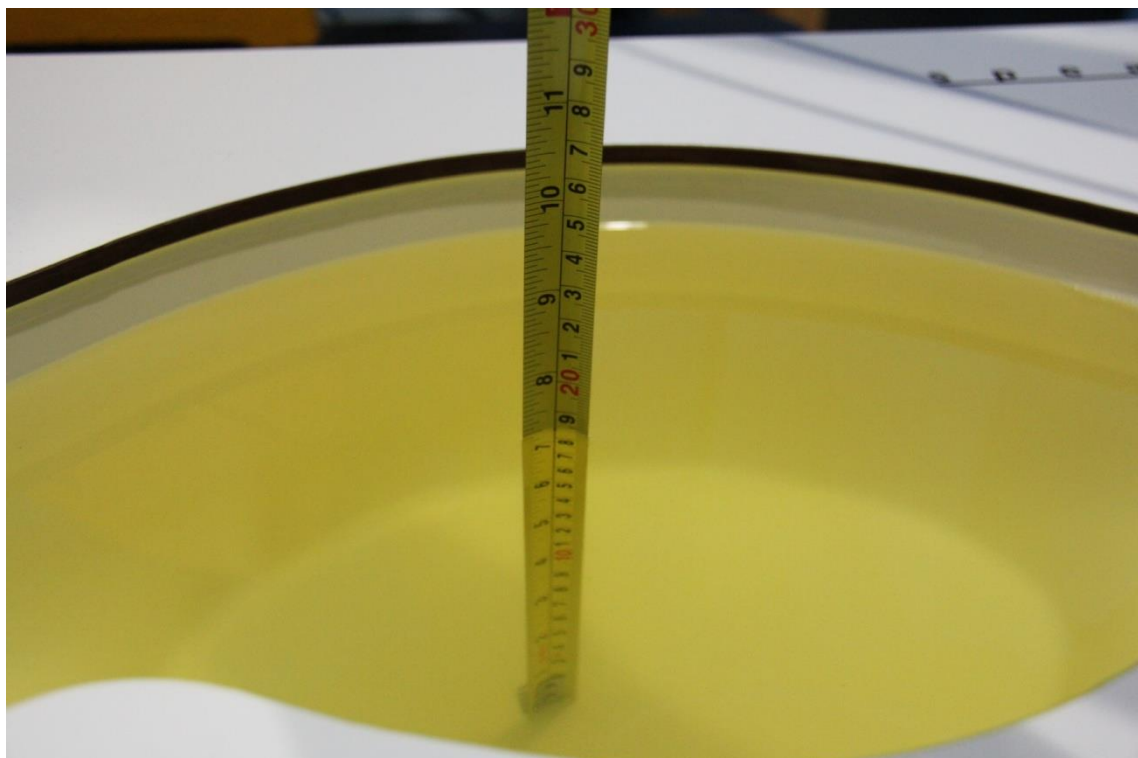

Picture 7-4: Liquid depth in the Flat Phantom (1900MHz)

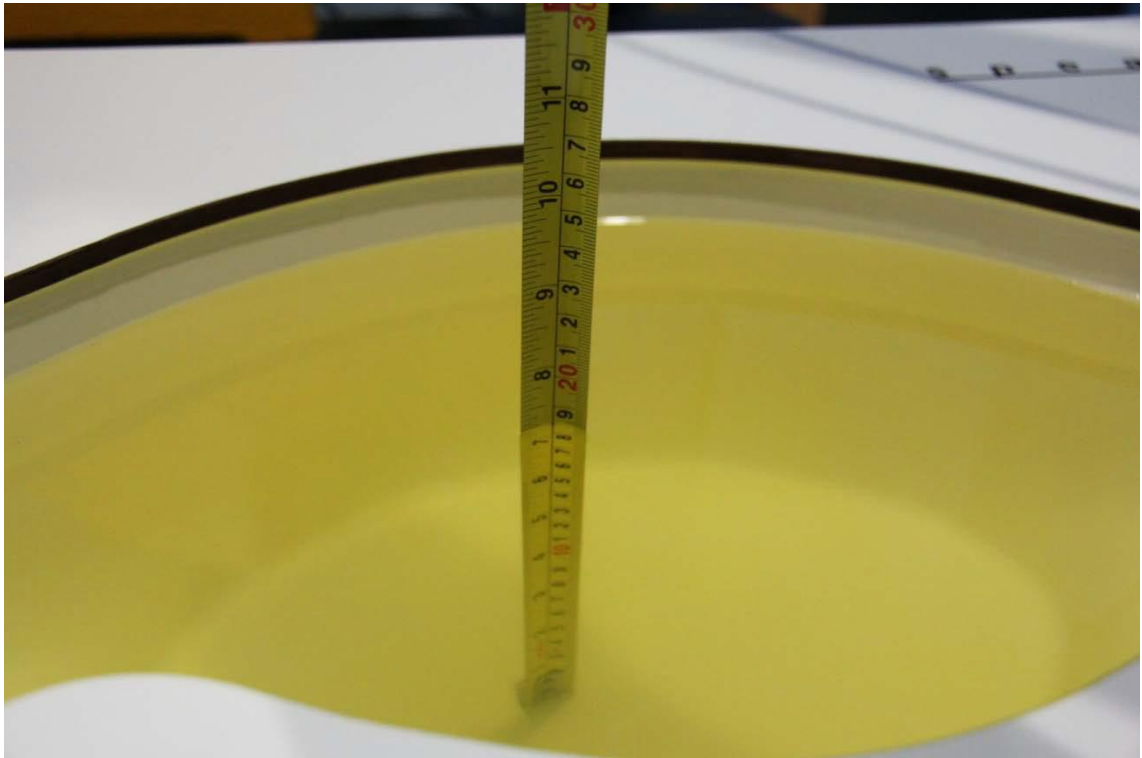

Picture 7-5: Liquid depth in the Flat Phantom(2450MHz)

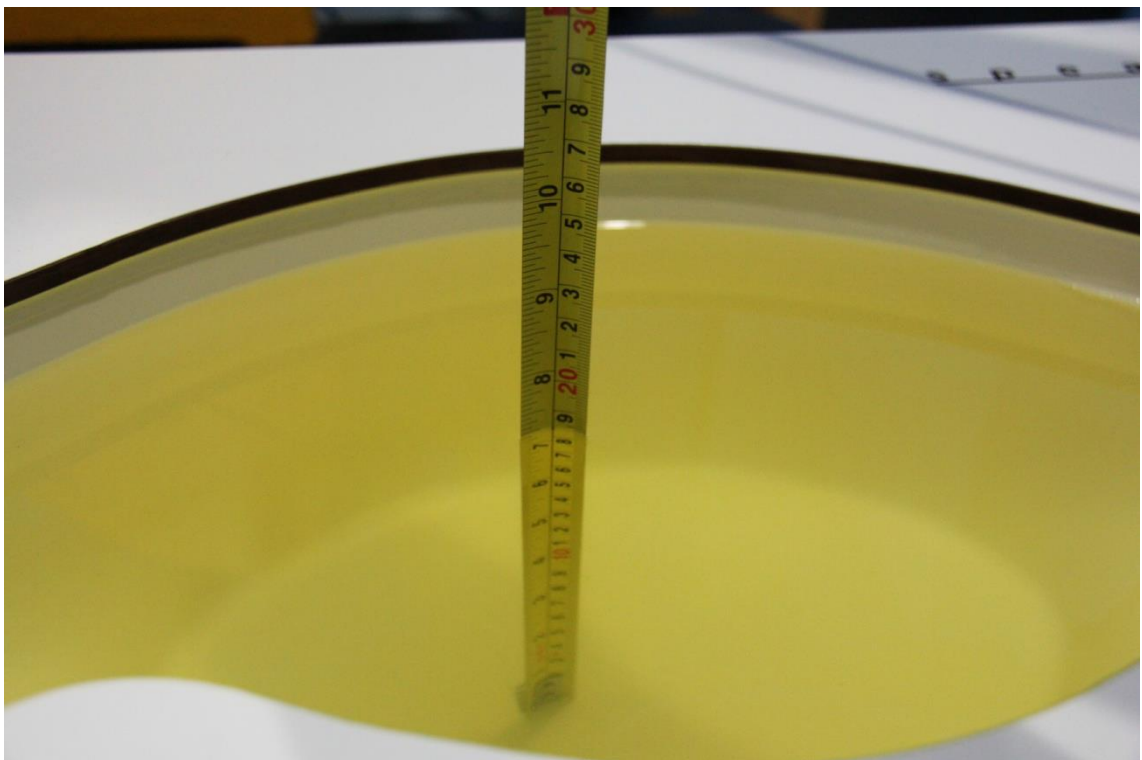

Picture 7-6: Liquid depth in the Flat Phantom(2550MHz)

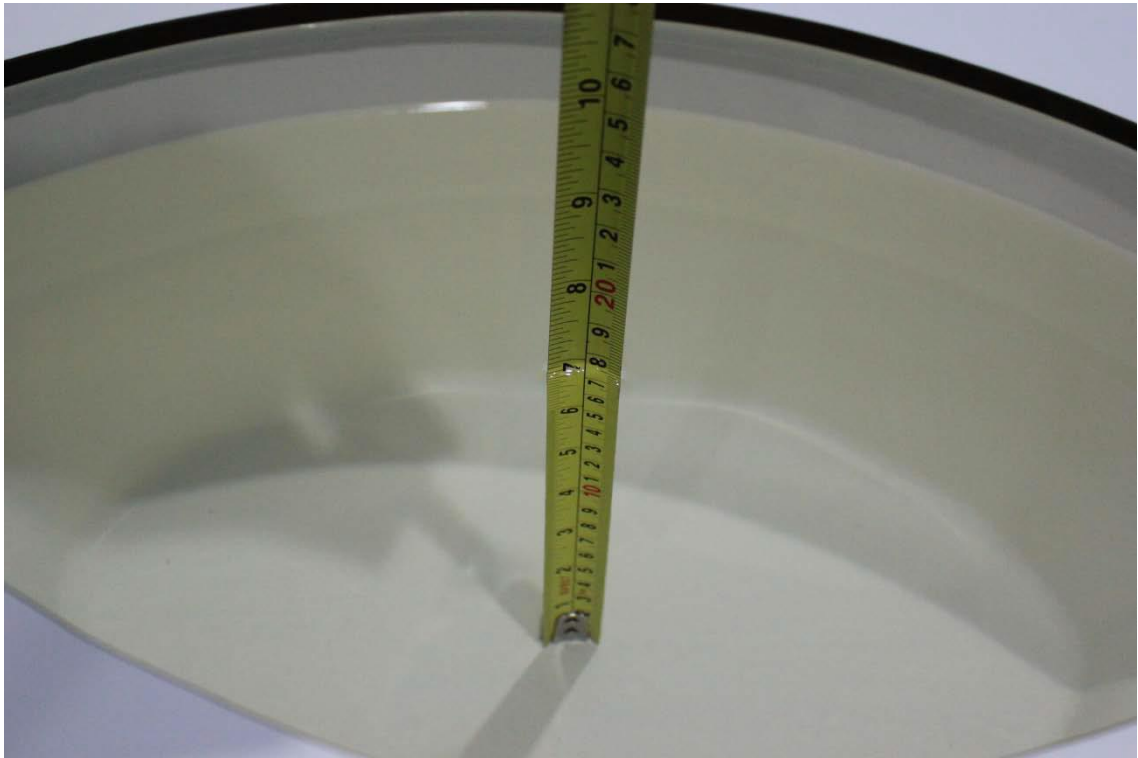

Picture 7-7: Liquid depth in the Flat Phantom(5GHz)

8 System verification

8.1 System Setup

In the simplified setup for system evaluation, the DUT is replaced by a calibrated dipole and the power source is replaced by a continuous wave that comes from a signal generator. The calibrated dipole must be placed beneath the flat phantom section of the SAM twin phantom with the correct distance holder. The distance holder should touch the phantom surface with a light pressure at the reference marking and be oriented parallel to the long side of the phantom. The equipment setup is shown below:

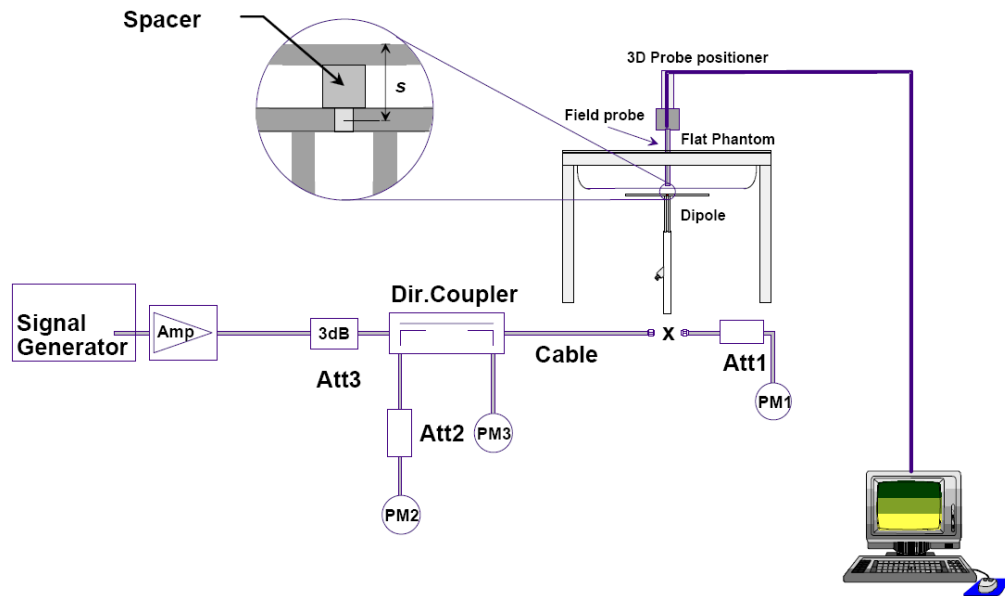

Picture 8.1 System Setup for System Evaluation



Picture 8.2 Photo of Dipole Setup

8.2 System Verification

SAR system verification is required to confirm measurement accuracy, according to the tissue dielectric media, probe calibration points and other system operating parameters required for measuring the SAR of a test device. The system verification must be performed for each frequency band and within the valid range of each probe calibration point required for testing the device.

Table 8.1: System Verification of Body

Measurement Date (yyyy-mm-dd)	Frequency	Target value (W/kg)		Measured value (W/kg)		Deviation (%)	
		10 g Average	1 g Average	10 g Average	1 g Average	10 g Average	1 g Average
2019-3-17	750 MHz	5.64	8.58	5.76	8.88	2.13	3.50
2019-3-19	835 MHz	6.56	9.90	6.68	10.24	1.83	3.43
2019-3-14	1750 MHz	19.5	36.2	19.12	34.92	-1.95	-3.54
2019-3-24	1900 MHz	21.4	40.6	21.96	42.40	2.62	4.43
2019-3-23	2450 MHz	23.5	50.5	22.92	48.40	-2.47	-4.16
2019-3-20	2550 MHz	24.7	54.0	24.20	52.00	-2.02	-3.70
2019-3-26	5300 MHz	21.5	76.5	21.80	78.30	1.40	2.35
2019-3-26	5800 MHz	21.1	76.2	21.50	78.70	1.90	3.28

9 Measurement Procedures

9.1 Tests to be performed

In order to determine the highest value of the peak spatial-average SAR of a handset, all device positions, configurations and operational modes shall be tested for each frequency band according to steps 1 to 3 below. A flowchart of the test process is shown in picture 9.1.

Step 1: The tests described in 9.2 shall be performed at the channel that is closest to the center of the transmit frequency band (f_c) for:

- a) all device positions (cheek and tilt, for both left and right sides of the SAM phantom, as described in annex D),
- b) all configurations for each device position in a), e.g., antenna extended and retracted, and
- c) all operational modes, e.g., analogue and digital, for each device position in a) and configuration in b) in each frequency band.

If more than three frequencies need to be tested according to 11.1 (i.e., $N_c > 3$), then all frequencies, configurations and modes shall be tested for all of the above test conditions.

Step 2: For the condition providing highest peak spatial-average SAR determined in Step 1, perform all tests described in 9.2 at all other test frequencies, i.e., lowest and highest frequencies. In addition, for all other conditions (device position, configuration and operational mode) where the peak spatial-average SAR value determined in Step 1 is within 3 dB of the applicable SAR limit, it is recommended that all other test frequencies shall be tested as well.

Step 3: Examine all data to determine the highest value of the peak spatial-average SAR found in Steps 1 to 2.

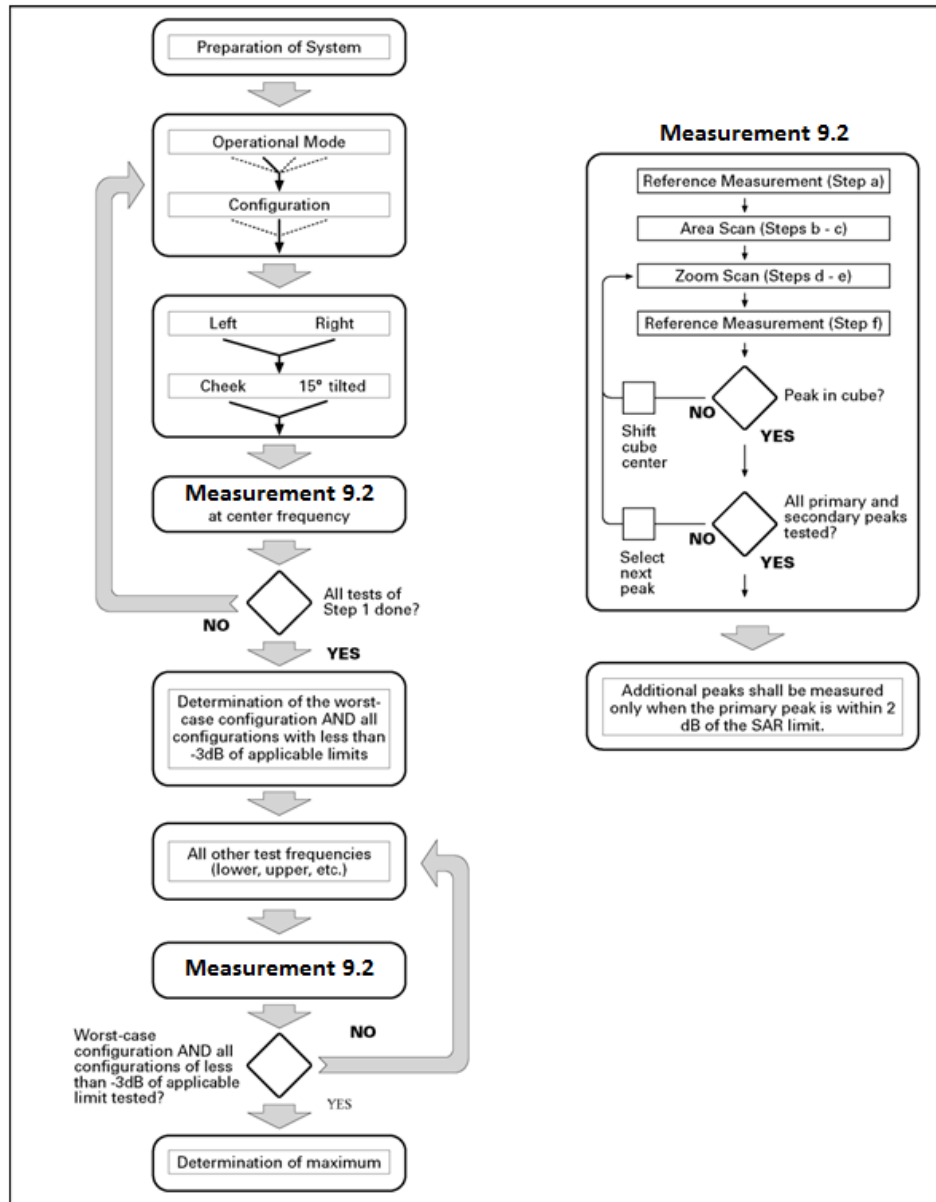

Picture 9.1 Block diagram of the tests to be performed

9.2 General Measurement Procedure

The area and zoom scan resolutions specified in the table below must be applied to the SAR measurements and fully documented in SAR reports to qualify for TCB approval. Probe boundary effect error compensation is required for measurements with the probe tip closer than half a probe tip diameter to the phantom surface. Both the probe tip diameter and sensor offset distance must satisfy measurement protocols; to ensure probe boundary effect errors are minimized and the higher fields closest to the phantom surface can be correctly measured and extrapolated to the phantom surface for computing 1-g SAR. Tolerances of the post-processing algorithms must be verified by the test laboratory for the scan resolutions used in the SAR measurements, according to the reference distribution functions specified in IEEE Std 1528-2013. The results should be documented as part of the system validation records and may be requested to support test results when all the measurement parameters in the following table are not satisfied.

		≤ 3 GHz	> 3 GHz	
Maximum distance from closest measurement point (geometric center of probe sensors) to phantom surface		5 ± 1 mm	$\frac{1}{2} \cdot \delta \cdot \ln(2) \pm 0.5$ mm	
Maximum probe angle from probe axis to phantom surface normal at the measurement location		$30^\circ \pm 1^\circ$	$20^\circ \pm 1^\circ$	
Maximum area scan spatial resolution: $\Delta x_{Area}, \Delta y_{Area}$		≤ 2 GHz: ≤ 15 mm 2 – 3 GHz: ≤ 12 mm	3 – 4 GHz: ≤ 12 mm 4 – 6 GHz: ≤ 10 mm	
		When the x or y dimension of the test device, in the measurement plane orientation, is smaller than the above, the measurement resolution must be \leq the corresponding x or y dimension of the test device with at least one measurement point on the test device.		
Maximum zoom scan spatial resolution: $\Delta x_{Zoom}, \Delta y_{Zoom}$		≤ 2 GHz: ≤ 8 mm 2 – 3 GHz: ≤ 5 mm*	3 – 4 GHz: ≤ 5 mm* 4 – 6 GHz: ≤ 4 mm*	
Maximum zoom scan spatial resolution, normal to phantom surface	uniform grid: $\Delta z_{Zoom}(n)$	≤ 5 mm	3 – 4 GHz: ≤ 4 mm 4 – 5 GHz: ≤ 3 mm 5 – 6 GHz: ≤ 2 mm	
	graded grid	$\Delta z_{Zoom}(1)$: between 1 st two points closest to phantom surface	≤ 4 mm	3 – 4 GHz: ≤ 3 mm 4 – 5 GHz: ≤ 2.5 mm 5 – 6 GHz: ≤ 2 mm
		$\Delta z_{Zoom}(n>1)$: between subsequent points	$\leq 1.5 \cdot \Delta z_{Zoom}(n-1)$	
Minimum zoom scan volume	x, y, z	≥ 30 mm	3 – 4 GHz: ≥ 28 mm 4 – 5 GHz: ≥ 25 mm 5 – 6 GHz: ≥ 22 mm	
Note: δ is the penetration depth of a plane-wave at normal incidence to the tissue medium; see draft standard IEEE P1528-2011 for details.				
* When zoom scan is required and the reported SAR from the area scan based 1-g SAR estimation procedures of KDB 447498 is ≤ 1.4 W/kg, ≤ 8 mm, ≤ 7 mm and ≤ 5 mm zoom scan resolution may be applied, respectively, for 2 GHz to 3 GHz, 3 GHz to 4 GHz and 4 GHz to 6 GHz.				

9.3 WCDMA Measurement Procedures for SAR

The following procedures are applicable to WCDMA handsets operating under 3GPP Release99, Release 5 and Release 6. The default test configuration is to measure SAR with an established radio link between the DUT and a communication test set using a 12.2kbps RMC (reference measurement channel) configured in Test Loop Mode 1. SAR is selectively confirmed for other physical channel configurations (DPCCH & DPDCH_n), HSDPA and HSPA (HSUPA/HSDPA) modes according to output power, exposure conditions and device operating capabilities. Both uplink and downlink should be configured with the same RMC or AMR, when required. SAR for Release 5 HSDPA and Release 6 HSPA are measured using the applicable FRC (fixed reference channel) and E-DCH reference channel configurations. Maximum output power is verified according to applicable versions of 3GPP TS 34.121 and SAR must be measured according to these maximum output conditions. When Maximum Power Reduction (MPR) is not implemented according to Cubic Metric (CM) requirements for Release 6 HSPA, the following procedures do not apply.

For Release 5 HSDPA Data Devices:

Sub-test	β_c	β_d	β_d (SF)	β_c / β_d	β_{hs}	CM/dB
1	2/15	15/15	64	2/15	4/15	0.0
2	12/15	15/15	64	12/15	24/25	1.0
3	15/15	8/15	64	15/8	30/15	1.5
4	15/15	4/15	64	15/4	30/15	1.5

For Release 6 HSPA Data Devices

Sub-test	β_c	β_d	β_d (SF)	β_c / β_d	β_{hs}	β_{ec}	β_{ed}	β_{ed} (SF)	β_{ed} (codes)	CM (dB)	MPR (dB)	AG Index	E-TFCI
1	11/15	15/15	64	11/15	22/15	209/225	1039/225	4	1	1.0	0.0	20	75
2	6/15	15/15	64	6/15	12/15	12/15	12/15	4	1	3.0	2.0	12	67
3	15/15	9/15	64	15/9	30/15	30/15	$\beta_{ed1}:47/15$ $\beta_{ed2}:47/15$	4	2	2.0	1.0	15	92
4	2/15	15/15	64	2/15	4/15	4/15	56/75	4	1	3.0	2.0	17	71
5	15/15	15/15	64	15/15	24/15	30/15	134/15	4	1	1.0	0.0	21	81

9.4 Bluetooth & WI-FI Measurement Procedures for SAR

Normal network operating configurations are not suitable for measuring the SAR of 802.11 transmitters in general. Unpredictable fluctuations in network traffic and antenna diversity conditions can introduce undesirable variations in SAR results. The SAR for these devices should be measured using chipset based test mode software to ensure that the results are consistent and reliable.

Chipset based test mode software is hardware dependent and generally varies among manufacturers. The device operating parameters established in a test mode for SAR measurements must be identical to those programmed in production units, including output power levels, amplifier gain settings and other RF performance tuning parameters. The test frequencies should correspond to actual channel frequencies defined for domestic use. SAR for devices with switched diversity should be measured with only one antenna transmitting at a time during each SAR measurement, according to a fixed modulation and data rate. The same data pattern should be used for all measurements.

9.5 SAR Measurement for LTE

SAR tests for LTE are performed with a base station simulator, Anristu MT8820C. Closed loop power control was used so the UE transmits with maximum output power during SAR testing. All powers were measured with the Anristu MT8820C. It is performed for conducted power and SAR based on the KDB941225 D05.

SAR is evaluated separately according to the following procedures for the different test positions in each exposure condition – head, body, body-worn accessories and other use conditions. The procedures in the following subsections are applied separately to test each LTE frequency band.

1) QPSK with 1 RB allocation

Start with the largest channel bandwidth and measure SAR for QPSK with 1 RB allocation, using the RB offset and required test channel combination with the highest maximum output power among RB offsets at the upper edge, middle and lower edge of each required test channel. When the reported SAR is ≤ 0.8 W/kg, testing of the remaining RB offset configurations and required test channels is not required for 1 RB allocation; otherwise, SAR is required for the remaining required test channels and only for the RB offset configuration with the highest output power for that channel. When the reported SAR of a required test channel is > 1.45 W/kg, SAR is required for all three RB offset configurations for that required test channel.

2) QPSK with 50% RB allocation

The procedures required for 1 RB allocation in 1) are applied to measure the SAR for QPSK with 50% RB allocation.

3) QPSK with 100% RB allocation

For QPSK with 100% RB allocation, SAR is not required when the highest maximum output power for 100 % RB allocation is less than the highest maximum output power in 50% and 1 RB allocations and the highest reported SAR for 1 RB and 50% RB allocation in 1) and 2) are ≤ 0.8 W/kg. Otherwise, SAR is measured for the highest output power channel; and if the reported SAR is > 1.45 W/kg, the remaining required test channels must also be tested.

9.6 Power Drift

To control the output power stability during the SAR test, DASY5 system calculates the power drift by measuring the E-field at the same location at the beginning and at the end of the measurement for each test position. These drift values can be found in Section 14 labeled as: (Power Drift [dB]). This ensures that the power drift during one measurement is within 5%.

10 Conducted Output Power

10.1 GSM Measurement result

During the process of testing, the EUT was controlled via Agilent Digital Radio Communication tester (E5515C) to ensure the maximum power transmission and proper modulation. This result contains conducted output power for the EUT. In all cases, the measured peak output power should be greater and within 5% than EMI measurement.

able 10.1: The conducted power measurement results for GPRS and EGPRS

Normal Power								
GPRS 850	Tune up	Measured Power (dBm)			calculation	Average Power (dBm)		
		251	190	128		251	190	128
1Tx-slots	34.0	32.60	32.63	32.52	-9.03dB	23.57	23.60	23.49
2Tx-slots	32.0	31.01	31.04	30.91	-6.02dB	24.99	25.02	24.89
3Tx-slots	30.0	29.01	29.00	28.84	-4.26dB	24.75	24.74	24.58
4Tx-slots	28.5	27.53	27.51	27.29	-3.01dB	24.52	24.50	24.28
EGPRS 850 (8PSK)	Tune up	Measured Power (dBm)			calculation	Measured Power (dBm)		
		251	190	128		251	190	128
1Tx-slots	28.0	26.68	26.92	26.83	-9.03dB	17.65	17.89	17.80
2Tx-slots	27.0	25.98	25.86	25.96	-6.02dB	19.96	19.84	19.94
3Tx-slots	25.0	23.74	23.61	23.86	-4.26dB	19.48	20.35	19.60
4Tx-slots	24.0	22.58	22.54	22.63	-3.01dB	19.57	19.53	19.62
GPRS 1900	Tune up	Measured Power (dBm)			calculation	Average Power (dBm)		
		810	661	512		810	661	512
1Tx-slots	31.0	29.79	29.73	29.78	-9.03dB	20.76	20.70	20.75
2Tx-slots	29.5	28.33	28.24	28.31	-6.02dB	22.31	22.22	22.29
3Tx-slots	27.5	26.40	26.29	26.33	-4.26dB	22.14	22.03	22.07
4Tx-slots	26.0	24.98	24.88	24.94	-3.01dB	21.97	21.87	21.93
EGPRS 1900 (8PSK)	Tune up	Measured Power (dBm)			calculation	Measured Power (dBm)		
		810	661	512		810	661	512
1Tx-slots	27.5	26.40	26.36	26.31	-9.03dB	17.37	17.33	17.28
2Tx-slots	26.5	25.26	25.45	25.42	-6.02dB	19.24	19.43	19.40
3Tx-slots	24.5	23.17	23.27	23.24	-4.26dB	18.91	19.01	18.98
4Tx-slots	23.5	22.07	22.26	22.19	-3.01dB	19.06	19.25	19.18

sensor-on								
GPRS 850	Tune up	Measured Power (dBm)			calculation	Average Power (dBm)		
		251	190	128		251	190	128
1Tx-slots	24.0	23.13	23.06	22.84	-9.03dB	14.10	14.03	13.81
2Tx-slots	24.0	23.11	23.05	22.81	-6.02dB	17.09	17.03	16.79
3Tx-slots	24.0	23.07	23.01	22.75	-4.26dB	18.81	18.75	18.49
4Tx-slots	24.0	23.03	22.96	22.68	-3.01dB	20.02	19.95	19.67
EGPRS 850 (8PSK)	Tune up	Measured Power (dBm)			calculation	Measured Power (dBm)		
		251	190	128		251	190	128
1Tx-slots	18.0	16.86	16.87	16.92	-9.03dB	7.83	7.84	7.89
2Tx-slots	18.0	16.84	16.86	16.91	-6.02dB	10.82	10.84	10.89
3Tx-slots	18.0	16.68	16.67	16.72	-4.26dB	12.42	12.41	12.46
4Tx-slots	18.0	16.49	16.47	16.53	-3.01dB	13.48	13.46	13.52
GPRS 1900	Tune up	Measured Power (dBm)			calculation	Average Power (dBm)		
		810	661	512		810	661	512
1Tx-slots	17.5	16.35	16.26	16.27	-9.03dB	7.32	7.23	7.24
2Tx-slots	17.5	16.40	16.31	16.33	-6.02dB	10.38	10.29	10.31
3Tx-slots	17.5	16.45	16.36	16.38	-4.26dB	12.19	12.10	12.12
4Tx-slots	17.5	16.50	16.41	16.43	-3.01dB	13.49	13.40	13.42
EGPRS 1900 (8PSK)	Tune up	Measured Power (dBm)			calculation	Measured Power (dBm)		
		810	661	512		810	661	512
1Tx-slots	13.5	12.51	12.57	12.53	-9.03dB	3.48	3.54	3.50
2Tx-slots	13.5	12.28	12.36	12.29	-6.02dB	6.26	6.34	6.27
3Tx-slots	13.5	12.09	12.22	12.25	-4.26dB	7.83	7.96	7.99
4Tx-slots	13.5	12.02	12.18	12.13	-3.01dB	9.01	9.17	9.12

NOTES:

1) Division Factors

To average the power, the division factor is as follows:

1TX-slot = 1 transmit time slot out of 8 time slots=> conducted power divided by (8/1) => -9.03dB

2TX-slots = 2 transmit time slots out of 8 time slots=> conducted power divided by (8/2) => -6.02dB

3TX-slots = 3 transmit time slots out of 8 time slots=> conducted power divided by (8/3) => -4.26dB

4TX-slots = 4 transmit time slots out of 8 time slots=> conducted power divided by (8/4) => -3.01dB

10.2 WCDMA Measurement result

Table 10.3 he conducted Power for WCDMA850/1700/1900

Normal Power					
Item	band	FDD Band 5 result			
	ARFCN	Tune up	4233 (846.6MHz)	4182 (836.4MHz)	4132 (826.4MHz)
WCDMA	RMC	24.0	23.38	23.40	23.36
HSUPA	1	23.0	22.34	22.33	22.32
	2	23.0	22.33	22.29	22.31
	3	23.0	21.80	21.79	21.81
	4	23.0	22.32	22.30	22.27
	5	23.0	21.32	21.31	21.29
HSPA+(16QAM)	/	23.0	21.83	21.84	21.80
DC-HSDPA	1	23.0	22.24	22.27	22.23
	2	23.0	22.13	22.16	22.26
	3	23.0	21.72	21.74	21.85
	4	23.0	21.71	21.73	21.81
Item	band	FDD Band 2 result			
	ARFCN	Tune up	9538 (1907.6MHz)	9400 (1880MHz)	9262 (1852.4MHz)
WCDMA	RMC	24.0	23.41	23.45	23.49
HSUPA	1	23.5	22.41	22.39	22.47
	2	23.5	22.35	22.38	22.44
	3	23.0	21.74	21.76	21.78
	4	23.5	22.34	22.36	22.39
	5	23.0	21.22	21.38	21.33
HSPA+(16QAM)	/	23.0	21.79	21.83	21.97
DC-HSDPA	1	23.0	22.29	22.31	22.41
	2	23.0	22.16	22.17	22.36
	3	23.0	21.80	21.83	21.95
	4	23.0	21.78	21.82	21.91

Normal Power					
Item	band	FDD Band 4 result			
	ARFCN	Tune up	1513 (1752.6MHz)	1413 (1732.6MHz)	1312 (1712.4MHz)
WCDMA	RMC	24.0	23.44	23.42	23.32
HSUPA	1	23.5	22.36	22.40	22.45
	2	23.5	22.32	22.37	22.38
	3	23.0	21.82	21.76	21.72
	4	23.5	22.36	22.32	22.35
	5	23.0	21.23	21.24	21.25
HSPA+(16QAM)	/	23.0	21.91	21.86	21.85
DC-HSDPA	1	23.0	22.28	22.26	22.29
	2	23.0	22.18	22.20	22.14
	3	23.0	21.79	21.81	21.78
	4	23.0	21.76	21.77	21.75

sensor-on					
Item	band	FDD Band 2 result			
	ARFCN	Tune up	9538 (1907.6MHz)	9400 (1880MHz)	9262 (1852.4MHz)
WCDMA	RMC	13.0	12.69	12.78	12.87
HSUPA	1	13.0	12.68	12.71	12.84
	2	13.0	12.67	12.76	12.83
	3	13.0	12.26	12.21	12.34
	4	13.0	12.66	12.78	12.86
	5	13.0	11.71	12.82	11.97
DC-HSDPA	1	13.0	12.77	12.83	12.96
	2	13.0	12.73	12.80	12.91
	3	13.0	12.18	12.23	12.33
	4	13.0	12.17	12.21	12.34
Item	band	FDD Band 4 result			
	ARFCN	Tune up	1513 (1752.6MHz)	1413 (1732.6MHz)	1312 (1712.4MHz)
WCDMA	RMC	15.0	13.31	13.26	13.28
HSUPA	1	15.0	13.26	13.21	13.23
	2	15.0	13.23	13.25	13.22
	3	14.0	12.84	12.81	12.79
	4	15.0	13.25	13.23	13.29
	5	14.0	12.27	12.29	12.31
DC-HSDPA	1	15.0	13.32	13.30	13.29
	2	15.0	13.23	13.24	13.25
	3	14.0	12.71	12.66	12.72
	4	14.0	12.69	12.67	12.66

10.3 LTE Measurement result

Table 10.4: The conducted Power measurement results for LTE

Normal Power

LTE-FDD Band 2				Actual output Power (dBm)			Tune up
Band-width	RB allocation	RB offset	Modulation	High	Middle	Low	
1.4 MHz				1909.3MHz	1880MHz	1850.7MHz	
	1RB	High	QPSK	23.24	23.25	23.04	24
			16QAM	22.16	22.34	22.58	23
		Middle	QPSK	23.37	23.41	23.43	24
			16QAM	22.28	22.50	22.78	23
		Low	QPSK	23.04	23.12	23.19	24
			16QAM	22.15	22.37	22.60	23
	3RB	High	QPSK	23.10	23.23	23.21	24
			16QAM	22.31	22.36	22.46	23
		Middle	QPSK	23.13	23.27	23.33	24
			16QAM	22.35	22.42	22.45	23
		Low	QPSK	23.12	23.23	23.29	24
			16QAM	22.33	22.37	22.47	23
	6RB	/	QPSK	22.18	22.28	22.26	23
16QAM			21.36	21.43	21.24	22	
3 MHz				1908.5MHz	1880MHz	1851.5MHz	/
	1RB	High	QPSK	23.27	23.32	23.39	24
			16QAM	22.60	22.29	22.24	23
		Middle	QPSK	23.23	23.42	23.41	24
			16QAM	22.77	22.49	22.33	23
		Low	QPSK	23.15	23.22	23.35	24
			16QAM	22.57	22.40	22.20	23
	8RB	High	QPSK	22.31	22.40	22.39	23
			16QAM	21.28	21.35	21.48	22
		Middle	QPSK	22.28	22.27	22.33	23
			16QAM	21.35	21.39	21.55	22
		Low	QPSK	22.17	22.27	22.26	23
			16QAM	21.28	21.33	21.51	22
	15RB	/	QPSK	22.20	22.32	22.33	23
16QAM			21.25	21.30	21.45	22	

Normal Power

LTE-FDD Band 2				Actual output Power (dBm)			Tune up
Band-width	RB allocation	RB offset	Modulation	High	Middle	Low	
5 MHz				1907.5MHz	1880MHz	1852.5MHz	
	1RB	High	QPSK	23.06	23.14	23.23	24
			16QAM	22.24	22.41	22.79	23
		Middle	QPSK	23.31	23.39	23.49	24
			16QAM	22.51	22.62	23.02	23
		Low	QPSK	23.07	23.14	23.24	24
			16QAM	22.24	22.36	22.70	23
	12RB	High	QPSK	22.27	22.31	22.36	23
			16QAM	21.28	21.36	21.51	22
		Middle	QPSK	22.26	22.34	22.39	23
			16QAM	21.34	21.44	21.59	22
		Low	QPSK	22.23	22.32	22.31	23
			16QAM	21.29	21.40	21.55	22
	25RB	/	QPSK	22.26	22.35	22.34	23
			16QAM	21.19	21.36	21.48	22
	10 MHz				1905MHz	1880MHz	1855MHz
1RB		High	QPSK	23.19	23.31	23.38	24
			16QAM	22.18	22.19	22.64	23
		Middle	QPSK	23.29	23.49	23.51	24
			16QAM	22.34	22.38	22.82	23
		Low	QPSK	23.26	23.29	23.45	24
			16QAM	22.19	22.14	22.62	23
25RB		High	QPSK	22.27	22.34	22.57	23
			16QAM	21.32	21.39	21.52	22
		Middle	QPSK	22.28	22.35	22.41	23
			16QAM	21.37	21.41	21.47	22
		Low	QPSK	22.34	22.38	22.33	23
			16QAM	21.40	21.42	21.49	22
50RB		/	QPSK	22.28	22.39	22.46	23
			16QAM	21.30	21.42	21.46	22

Normal Power

LTE-FDD Band 2				Actual output Power (dBm)			Tune up
Band-width	RB allocation	RB offset	Modulation	High	Middle	Low	
15 MHz				1902.5MHz	1880MHz	1857.5MHz	
	1RB	High	QPSK	23.07	23.10	23.20	24
			16QAM	22.51	22.11	22.53	23
		Middle	QPSK	23.19	23.25	23.38	24
			16QAM	22.59	22.26	22.73	23
		Low	QPSK	23.11	23.20	23.33	24
			16QAM	22.56	22.12	22.57	23
	36RB	High	QPSK	22.28	22.35	22.42	23
			16QAM	21.21	21.39	21.47	22
		Middle	QPSK	22.29	22.37	22.43	23
			16QAM	21.26	21.38	21.48	22
		Low	QPSK	22.31	22.41	22.35	23
			16QAM	21.22	21.38	21.44	22
	75RB	/	QPSK	22.27	22.44	22.49	23
			16QAM	21.20	21.38	21.45	22
	20 MHz				1900MHz	1880MHz	1860MHz
1RB		High	QPSK	23.10	23.15	23.29	24
			16QAM	22.35	22.39	22.51	23
		Middle	QPSK	23.23	23.33	23.40	24
			16QAM	22.77	22.86	22.96	23
		Low	QPSK	23.17	23.19	23.30	24
			16QAM	22.47	22.41	22.53	23
50RB		High	QPSK	22.07	22.34	22.37	23
			16QAM	21.09	21.30	21.40	22
		Middle	QPSK	22.19	22.39	22.39	23
			16QAM	21.22	21.34	21.41	22
		Low	QPSK	22.13	22.42	22.31	23
			16QAM	21.14	21.39	21.35	22
100RB		/	QPSK	22.14	22.44	22.33	23
			16QAM	21.10	21.37	21.40	22

Normal Power

LTE-FDD Band 5				Actual output Power (dBm)			Tune up	
Band-width	RB allocation	RB offset	Modulation	High	Middle	Low		
1.4 MHz				848.3MHz	836.5MHz	824.7MHz		
	1RB	High	QPSK	23.19	23.25	23.31	24	
			16QAM	22.12	22.26	22.50	23	
		Middle	QPSK	23.43	23.46	23.49	24	
			16QAM	22.28	22.46	22.61	23	
		Low	QPSK	23.18	23.28	23.31	24	
			16QAM	22.08	22.29	22.50	23	
	3RB	High	QPSK	23.27	23.30	23.28	24	
			16QAM	22.32	22.29	22.37	23	
		Middle	QPSK	23.25	23.33	23.36	24	
			16QAM	22.38	22.31	22.44	23	
		Low	QPSK	23.22	23.28	23.31	24	
			16QAM	22.32	22.30	22.38	23	
	6RB	/	QPSK	22.33	22.31	22.34	23	
			16QAM	21.36	21.41	21.10	22	
	3 MHz				847.5MHz	836.5MHz	825.5MHz	/
		1RB	High	QPSK	23.27	23.35	23.39	24
				16QAM	22.11	22.09	22.60	23
Middle			QPSK	23.37	23.40	23.53	24	
			16QAM	22.27	22.25	22.72	23	
Low			QPSK	23.30	23.27	23.39	24	
			16QAM	22.16	22.17	22.50	23	
8RB		High	QPSK	22.30	22.29	22.34	23	
			16QAM	21.22	21.31	21.34	22	
		Middle	QPSK	22.37	22.37	22.43	23	
			16QAM	21.28	21.38	21.37	22	
		Low	QPSK	22.30	22.29	22.32	23	
			16QAM	21.21	21.32	21.26	22	
15RB		/	QPSK	22.26	22.29	22.24	23	
			16QAM	21.12	21.24	21.20	22	

Normal Power

LTE-FDD Band 5				Actual output Power (dBm)			Tune up
Band-width	RB allocation	RB offset	Modulation	High	Middle	Low	
5 MHz				846.5MHz	836.5MHz	826.5MHz	
	1RB	High	QPSK	23.19	23.29	23.24	24
			16QAM	22.15	22.34	22.66	23
		Middle	QPSK	23.43	23.53	23.50	24
			16QAM	22.40	22.54	22.86	23
		Low	QPSK	23.25	23.32	23.29	24
			16QAM	22.20	22.31	22.58	23
	12RB	High	QPSK	22.20	22.23	22.26	23
			16QAM	21.21	21.26	21.36	22
		Middle	QPSK	22.25	22.29	22.28	23
			16QAM	21.29	21.35	21.42	22
		Low	QPSK	22.21	22.24	22.22	23
			16QAM	21.21	21.27	21.32	22
	25RB	/	QPSK	22.19	22.24	22.23	23
			16QAM	21.12	21.21	21.26	22
	10 MHz				844MHz	836.5MHz	829MHz
1RB		High	QPSK	23.28	23.27	23.30	24
			16QAM	22.46	22.21	22.17	23
		Middle	QPSK	23.35	23.34	23.45	24
			16QAM	22.59	22.29	22.23	23
		Low	QPSK	23.29	23.22	23.30	24
			16QAM	22.54	22.20	22.05	23
25RB		High	QPSK	22.24	22.31	22.32	23
			16QAM	21.23	21.34	21.29	22
		Middle	QPSK	22.26	22.30	22.31	23
			16QAM	21.22	21.35	21.27	22
		Low	QPSK	22.25	22.30	22.24	23
			16QAM	21.20	21.32	21.23	22
50RB		/	QPSK	22.24	22.28	22.31	23
			16QAM	21.18	21.26	21.22	22

Normal Power

LTE-FDD Band 7				Actual output Power (dBm)			Tune up
Band-width	RB allocation	RB offset	Modulation	High	Middle	Low	
5 MHz				2567.4MHz	2535MHz	2502.5MHz	
	1RB	High	QPSK	23.27	23.32	23.26	24
			16QAM	22.27	22.29	22.70	23
		Middle	QPSK	23.49	23.53	23.56	24
			16QAM	22.44	22.56	22.91	23
		Low	QPSK	23.25	23.34	23.31	24
			16QAM	22.22	22.31	22.72	23
	12RB	High	QPSK	22.25	22.27	22.31	23
			16QAM	21.36	21.37	21.47	22
		Middle	QPSK	22.31	22.30	22.31	23
			16QAM	21.43	21.48	21.50	22
		Low	QPSK	22.25	22.29	22.23	23
			16QAM	21.36	21.45	21.46	22
	25RB	/	QPSK	22.30	22.32	22.32	23
			16QAM	21.29	21.36	21.43	22
	10 MHz				2565MHz	2535MHz	2505MHz
1RB		High	QPSK	23.26	23.26	23.38	24
			16QAM	22.18	22.11	22.58	23
		Middle	QPSK	23.40	23.50	23.58	24
			16QAM	22.31	22.26	22.70	23
		Low	QPSK	23.19	23.28	23.44	24
			16QAM	22.21	22.12	22.59	23
25RB		High	QPSK	22.34	22.33	22.38	23
			16QAM	21.45	21.39	21.44	22
		Middle	QPSK	22.34	22.39	22.38	23
			16QAM	21.46	21.44	21.43	22
		Low	QPSK	22.29	22.34	22.35	23
			16QAM	21.42	21.38	21.35	22
50RB		/	QPSK	22.34	22.32	22.39	23
			16QAM	21.41	21.35	21.39	22

Normal Power

LTE-FDD Band 7				Actual output Power (dBm)			Tune up
Band-width	RB allocation	RB offset	Modulation	High	Middle	Low	
15 MHz				2562.5MHz	2535MHz	2507.5MHz	
	1RB	High	QPSK	23.25	23.19	23.31	24
			16QAM	22.44	22.01	22.51	23
		Middle	QPSK	23.38	23.38	23.48	24
			16QAM	22.65	22.18	22.65	23
		Low	QPSK	23.24	23.25	23.36	24
			16QAM	22.55	22.08	22.56	23
	36RB	High	QPSK	22.42	22.39	22.48	23
			16QAM	21.39	21.37	21.52	22
		Middle	QPSK	22.37	22.40	22.44	23
			16QAM	21.35	21.39	21.49	22
		Low	QPSK	22.33	22.35	22.40	23
			16QAM	21.30	21.34	21.42	22
	75RB	/	QPSK	22.39	22.39	22.47	23
			16QAM	21.34	21.39	21.45	22
	20 MHz				2560MHz	2535MHz	2510MHz
1RB		High	QPSK	23.02	22.97	23.04	24
			16QAM	22.31	22.28	22.44	23
		Middle	QPSK	23.44	23.51	23.60	24
			16QAM	22.79	22.77	22.95	23
		Low	QPSK	22.97	23.05	23.12	24
			16QAM	22.43	22.34	22.52	23
50RB		High	QPSK	22.26	22.29	22.30	23
			16QAM	21.34	21.34	21.33	22
		Middle	QPSK	22.26	22.33	22.31	23
			16QAM	21.40	21.38	21.36	22
		Low	QPSK	22.27	22.27	22.19	23
			16QAM	21.36	21.32	21.31	22
100RB		/	QPSK	22.27	22.27	22.25	23
			16QAM	21.32	21.29	21.31	22

Normal Power

LTE-FDD Band 12				Actual output Power (dBm)			Tune up
Band-width	RB allocation	RB offset	Modulation	High	Middle	Low	
1.4 MHz				715.3MHz	707.5MHz	699.7MHz	
	1RB	High	QPSK	23.41	23.49	23.53	24
			16QAM	22.41	22.49	22.75	23
		Middle	QPSK	23.59	23.70	23.70	24
			16QAM	22.57	22.69	22.94	23
		Low	QPSK	23.40	23.53	23.57	24
			16QAM	22.40	22.52	22.74	23
	3RB	High	QPSK	23.48	23.52	23.52	24
			16QAM	22.58	22.46	22.60	23
		Middle	QPSK	23.51	23.56	23.62	24
			16QAM	22.66	22.53	22.63	23
		Low	QPSK	23.47	23.51	23.58	24
			16QAM	22.62	22.48	22.58	23
	6RB	/	QPSK	22.60	22.60	22.57	23
16QAM			21.75	21.72	21.49	22	
3 MHz				714.5MHz	707.5MHz	700.5MHz	/
	1RB	High	QPSK	23.40	23.49	23.53	24
			16QAM	22.35	22.29	22.78	23
		Middle	QPSK	23.55	23.60	23.67	24
			16QAM	22.56	22.45	22.93	23
		Low	QPSK	23.45	23.48	23.58	24
			16QAM	22.46	22.36	22.75	23
	8RB	High	QPSK	22.45	22.45	22.50	23
			16QAM	21.51	21.58	21.59	22
		Middle	QPSK	22.46	22.53	22.55	23
			16QAM	21.56	21.64	21.62	22
		Low	QPSK	22.45	22.46	22.52	23
			16QAM	21.54	21.58	21.58	22
	15RB	/	QPSK	22.39	22.42	22.46	23
16QAM			21.45	21.49	21.49	22	

Normal Power

LTE-FDD Band 12				Actual output Power (dBm)			Tune up
Band-width	RB allocation	RB offset	Modulation	High	Middle	Low	
5 MHz				713.5MHz	707.5MHz	701.5MHz	
	1RB	High	QPSK	23.43	23.46	23.45	24
			16QAM	22.39	22.46	22.87	23
		Middle	QPSK	23.64	23.71	23.67	24
			16QAM	22.66	22.75	23.07	23
		Low	QPSK	23.37	23.50	23.41	24
			16QAM	22.38	22.48	22.77	23
	12RB	High	QPSK	22.38	22.43	22.49	23
			16QAM	21.48	21.56	21.67	22
		Middle	QPSK	22.46	22.45	22.48	23
			16QAM	21.59	21.63	21.68	22
		Low	QPSK	22.47	22.38	22.39	23
			16QAM	21.56	21.49	21.61	22
	25RB	/	QPSK	22.44	22.43	22.46	23
			16QAM	21.43	21.51	21.55	22
	10 MHz				711MHz	707.5MHz	704MHz
1RB		High	QPSK	23.40	23.47	23.39	24
			16QAM	22.27	22.72	22.38	23
		Middle	QPSK	23.62	23.62	23.61	24
			16QAM	22.44	22.87	22.56	23
		Low	QPSK	23.41	23.50	23.43	24
			16QAM	22.28	22.76	22.31	23
25RB		High	QPSK	22.39	22.49	22.59	23
			16QAM	21.47	21.55	21.72	22
		Middle	QPSK	22.45	22.48	22.53	23
			16QAM	21.56	21.56	21.67	22
		Low	QPSK	22.40	22.47	22.51	23
			16QAM	21.43	21.51	21.63	22
50RB		/	QPSK	22.41	22.44	22.53	23
			16QAM	21.42	21.49	21.60	22

Note: SAR for LTE Band 17 is covered by LTE Band 12 due to similar frequency range, same maximum tune-up limit and same channel bandwidth.

Normal Power

LTE-FDD Band 66				Actual output Power (dBm)			Tune up
Band-width	RB allocation	RB offset	Modulation	High	Middle	Low	
1.4 MHz				1779.3MHz	1745MHz	1710.7MHz	
	1RB	High	QPSK	23.13	23.01	23.01	24
			16QAM	22.17	22.35	22.07	23
		Middle	QPSK	23.36	23.21	23.14	24
			16QAM	22.34	22.49	22.21	23
		Low	QPSK	23.15	23.06	23.02	24
			16QAM	22.14	22.32	22.07	23
	3RB	High	QPSK	23.14	23.07	23.13	24
			16QAM	22.13	22.21	22.29	23
		Middle	QPSK	23.18	23.13	23.16	24
			16QAM	22.19	22.23	22.32	23
		Low	QPSK	23.12	23.08	23.09	24
			16QAM	22.14	22.21	22.27	23
	6RB	/	QPSK	22.14	22.03	22.12	23
16QAM			21.34	21.00	21.40	22	
3 MHz				1778.5MHz	1745MHz	1711.5MHz	/
	1RB	High	QPSK	23.20	23.11	23.09	24
			16QAM	22.01	22.39	22.08	23
		Middle	QPSK	23.33	23.25	23.22	24
			16QAM	22.17	22.52	22.29	23
		Low	QPSK	23.14	23.10	23.11	24
			16QAM	22.05	22.34	22.14	23
	8RB	High	QPSK	22.19	22.02	22.10	23
			16QAM	21.29	21.13	21.16	22
		Middle	QPSK	22.23	22.09	22.17	23
			16QAM	21.34	21.20	21.26	22
		Low	QPSK	22.17	22.05	22.11	23
			16QAM	21.31	21.13	21.19	22
	15RB	/	QPSK	22.18	21.99	22.09	23
16QAM			21.22	21.11	21.12	22	

Normal Power

LTE-FDD Band 66				Actual output Power (dBm)			Tune up
Band-width	RB allocation	RB offset	Modulation	High	Middle	Low	
5 MHz				1777.5MHz	1745MHz	1712.5MHz	
	1RB	High	QPSK	23.16	22.96	23.09	24
			16QAM	22.18	22.44	22.10	23
		Middle	QPSK	23.43	23.24	23.35	24
			16QAM	22.45	22.71	22.36	23
		Low	QPSK	23.14	22.93	23.08	24
			16QAM	22.13	22.44	22.09	23
	12RB	High	QPSK	22.09	21.99	22.11	23
			16QAM	21.25	21.21	21.23	22
		Middle	QPSK	22.16	22.06	22.18	23
			16QAM	21.33	21.29	21.28	22
		Low	QPSK	22.08	22.01	22.09	23
			16QAM	21.27	21.23	21.23	22
	25RB	/	QPSK	22.11	22.04	22.11	23
			16QAM	21.19	21.15	21.12	22
	10 MHz				1775MHz	1745MHz	1715MHz
1RB		High	QPSK	23.14	23.06	23.04	24
			16QAM	22.00	22.35	22.06	23
		Middle	QPSK	23.25	23.17	23.21	24
			16QAM	22.14	22.43	22.22	23
		Low	QPSK	23.13	23.01	23.05	24
			16QAM	21.98	22.28	22.10	23
25RB		High	QPSK	22.18	22.02	22.22	23
			16QAM	21.25	21.14	21.37	22
		Middle	QPSK	22.18	22.07	22.16	23
			16QAM	21.23	21.18	21.34	22
		Low	QPSK	22.18	22.05	22.11	23
			16QAM	21.25	21.16	21.27	22
50RB		/	QPSK	22.19	22.04	22.18	23
			16QAM	21.25	21.13	21.29	22

Normal Power

LTE-FDD Band 66				Actual output Power (dBm)			Tune up
Band-width	RB allocation	RB offset	Modulation	High	Middle	Low	
15 MHz				1772.5MHz	1745MHz	1717.5MHz	
	1RB	High	QPSK	22.99	22.95	22.97	24
			16QAM	21.88	22.30	22.31	23
		Middle	QPSK	23.09	23.07	23.13	24
			16QAM	21.98	22.38	22.55	23
		Low	QPSK	23.00	22.96	23.04	24
			16QAM	21.91	22.26	22.40	23
	36RB	High	QPSK	22.17	22.05	22.17	23
			16QAM	21.19	21.16	21.24	22
		Middle	QPSK	22.18	22.03	22.13	23
			16QAM	21.23	21.15	21.20	22
		Low	QPSK	22.17	22.10	22.13	23
			16QAM	21.22	21.18	21.16	22
	75RB	/	QPSK	22.23	22.13	22.20	23
16QAM			21.22	21.15	21.24	22	
20 MHz				1770MHz	1745MHz	1720MHz	/
	1RB	High	QPSK	22.76	22.72	22.74	24
			16QAM	22.13	22.22	22.18	23
		Middle	QPSK	23.23	23.17	23.23	24
			16QAM	22.58	22.66	22.65	23
		Low	QPSK	22.70	22.71	22.80	24
			16QAM	22.13	22.19	22.20	23
	50RB	High	QPSK	22.09	22.01	22.22	23
			16QAM	21.15	21.07	21.31	22
		Middle	QPSK	22.15	21.99	22.13	23
			16QAM	21.19	21.10	21.18	22
		Low	QPSK	22.09	22.08	22.02	23
			16QAM	21.20	21.16	21.13	22
	100RB	/	QPSK	22.12	21.99	22.16	23
16QAM			21.15	21.07	21.21	22	

Note: SAR for LTE Band 4 is covered by LTE Band 66 due to similar frequency range, same maximum tune-up limit and same channel bandwidth.

Normal Power

LTE-FDD Band 71				Actual output Power (dBm)			Tune up	
Band-width	RB allocation	RB offset	Modulation	High	Middle	Low		
5 MHz				695.5MHz	680.5MHz	665.5MHz		
	1RB	High	QPSK	23.13	23.13	23.19	24	
			16QAM	22.21	22.20	22.60	23	
		Middle	QPSK	23.36	23.40	23.48	24	
			16QAM	22.48	22.51	22.77	23	
		Low	QPSK	23.13	23.29	23.24	24	
			16QAM	22.17	22.22	22.62	23	
	12RB	High	QPSK	22.31	22.20	22.23	23	
			16QAM	21.33	21.23	21.31	22	
		Middle	QPSK	22.30	22.22	22.25	23	
			16QAM	21.27	21.27	21.36	22	
		Low	QPSK	22.16	22.15	22.18	23	
			16QAM	21.18	21.14	21.26	22	
	25RB	/	QPSK	22.24	22.20	22.17	23	
			16QAM	21.10	21.11	21.20	22	
	10 MHz				693MHz	680.5MHz	668MHz	/
		1RB	High	QPSK	23.16	23.14	23.30	24
				16QAM	22.19	22.10	22.53	23
Middle			QPSK	23.27	23.29	23.43	24	
			16QAM	22.30	22.18	22.64	23	
Low			QPSK	23.09	23.23	23.35	24	
			16QAM	22.20	22.04	22.51	23	
25RB		High	QPSK	22.41	22.21	22.32	23	
			16QAM	21.42	21.20	21.27	22	
		Middle	QPSK	22.28	22.24	22.30	23	
			16QAM	21.33	21.21	21.24	22	
		Low	QPSK	22.27	22.21	22.21	23	
			16QAM	21.30	21.18	21.18	22	
50RB		/	QPSK	22.34	22.21	22.26	23	
			16QAM	21.31	21.16	21.24	22	

Normal Power

LTE-FDD Band 71				Actual output Power (dBm)			Tune up	
Band-width	RB allocation	RB offset	Modulation	High	Middle	Low		
15 MHz				690.5MHz	680.5MHz	670.5MHz		
	1RB	High	QPSK	23.19	23.13	23.25	24	
			16QAM	22.48	22.01	22.47	23	
		Middle	QPSK	23.23	23.17	23.33	24	
			16QAM	22.59	22.10	22.58	23	
		Low	QPSK	23.07	23.15	23.29	24	
			16QAM	22.42	21.97	22.44	23	
	36RB	High	QPSK	22.42	22.28	22.39	23	
			16QAM	21.31	21.19	21.38	22	
		Middle	QPSK	22.35	22.30	22.31	23	
			16QAM	21.22	21.22	21.27	22	
		Low	QPSK	22.25	22.22	22.30	23	
			16QAM	21.14	21.10	21.24	22	
	75RB	/	QPSK	22.35	22.26	22.33	23	
			16QAM	21.26	21.16	21.25	22	
	20 MHz				688MHz	683MHz	673MHz	/
		1RB	High	QPSK	22.95	22.94	22.91	24
				16QAM	22.48	22.38	22.30	23
Middle			QPSK	23.34	23.28	23.38	24	
			16QAM	22.83	22.68	22.66	23	
Low			QPSK	22.93	22.97	23.01	24	
			16QAM	22.36	22.30	22.25	23	
50RB		High	QPSK	22.32	22.29	22.31	23	
			16QAM	21.28	21.21	21.22	22	
		Middle	QPSK	22.23	22.22	22.22	23	
			16QAM	21.23	21.17	21.10	22	
		Low	QPSK	22.16	22.04	22.11	23	
			16QAM	21.12	21.00	21.02	22	
100RB		/	QPSK	22.24	22.16	22.24	23	
			16QAM	21.23	21.08	21.17	22	

Sensor-on

LTE-FDD Band 2				Actual output Power (dBm)			Tune up
Band-width	RB allocation	RB offset	Modulation	High	Middle	Low	
1.4 MHz				1909.3MHz	1880MHz	1850.7MHz	
	1RB	High	QPSK	12.17	12.21	12.24	13.5
			16QAM	12.47	12.23	12.37	13.5
		Middle	QPSK	12.22	12.41	12.43	13.5
			16QAM	12.67	12.38	12.54	13.5
		Low	QPSK	12.09	12.13	12.28	13.5
			16QAM	12.47	12.21	12.35	13.5
	3RB	High	QPSK	12.21	12.26	12.29	13.5
			16QAM	12.44	12.44	12.37	13.5
		Middle	QPSK	12.19	12.29	12.38	13.5
			16QAM	12.43	12.47	12.43	13.5
		Low	QPSK	12.18	12.22	12.28	13.5
			16QAM	12.42	12.40	12.35	13.5
	6RB	/	QPSK	12.19	12.20	12.29	13.5
16QAM			12.10	12.41	12.40	13.5	
3 MHz				1908.5MHz	1880MHz	1851.5MHz	/
	1RB	High	QPSK	12.15	12.23	12.26	13.5
			16QAM	12.18	12.13	12.66	13.5
		Middle	QPSK	12.19	12.45	12.49	13.5
			16QAM	12.35	12.31	12.83	13.5
		Low	QPSK	12.16	12.29	12.36	13.5
			16QAM	12.24	12.21	12.64	13.5
	8RB	High	QPSK	12.21	12.19	12.33	13.5
			16QAM	12.22	12.30	12.35	13.5
		Middle	QPSK	12.19	12.26	12.37	13.5
			16QAM	12.24	12.35	12.43	13.5
		Low	QPSK	12.13	12.24	12.35	13.5
			16QAM	12.20	12.31	12.39	13.5
	15RB	/	QPSK	12.14	12.23	12.31	13.5
16QAM			12.10	12.29	12.37	13.5	

Sensor-on

LTE-FDD Band 2				Actual output Power (dBm)			Tune up
Band-width	RB allocation	RB offset	Modulation	High	Middle	Low	
5 MHz				1907.5MHz	1880MHz	1852.5MHz	
	1RB	High	QPSK	12.04	12.16	12.14	13.5
			16QAM	12.22	12.30	12.68	13.5
		Middle	QPSK	12.30	12.42	12.45	13.5
			16QAM	12.45	12.56	12.92	13.5
		Low	QPSK	12.04	12.12	12.19	13.5
			16QAM	12.21	12.30	12.69	13.5
	12RB	High	QPSK	12.15	12.18	12.24	13.5
			16QAM	12.26	12.29	12.39	13.5
		Middle	QPSK	12.18	12.23	12.31	13.5
			16QAM	12.22	12.35	12.51	13.5
		Low	QPSK	12.21	12.25	12.28	13.5
			16QAM	12.27	12.33	12.52	13.5
	25RB	/	QPSK	12.16	12.22	12.32	13.5
16QAM			12.14	12.26	12.39	13.5	
10 MHz				1905MHz	1880MHz	1855MHz	/
	1RB	High	QPSK	12.13	12.23	12.18	13.5
			16QAM	12.15	12.14	12.59	13.5
		Middle	QPSK	12.41	12.38	12.40	13.5
			16QAM	12.32	12.30	12.79	13.5
		Low	QPSK	12.79	12.26	12.39	13.5
			16QAM	12.10	12.10	12.62	13.5
	25RB	High	QPSK	12.20	12.32	12.39	13.5
			16QAM	12.27	12.27	12.39	13.5
		Middle	QPSK	12.24	12.33	12.35	13.5
			16QAM	12.28	12.31	12.36	13.5
		Low	QPSK	12.29	12.35	12.39	13.5
			16QAM	12.36	12.34	12.39	13.5
	50RB	/	QPSK	12.28	12.33	12.38	13.5
16QAM			12.25	12.32	12.38	13.5	

Sensor-on

LTE-FDD Band 2				Actual output Power (dBm)			Tune up
Band-width	RB allocation	RB offset	Modulation	High	Middle	Low	
15 MHz				1902.5MHz	1880MHz	1857.5MHz	
	1RB	High	QPSK	12.02	11.98	12.13	13.5
			16QAM	12.45	11.99	12.42	13.5
		Middle	QPSK	12.11	12.16	12.26	13.5
			16QAM	12.56	12.17	12.59	13.5
		Low	QPSK	12.01	12.10	12.22	13.5
			16QAM	12.47	12.04	12.58	13.5
	36RB	High	QPSK	12.02	12.19	12.25	13.5
			16QAM	12.11	12.23	12.35	13.5
		Middle	QPSK	12.09	12.20	12.24	13.5
			16QAM	12.10	12.23	12.36	13.5
		Low	QPSK	12.13	12.24	12.26	13.5
			16QAM	12.12	12.26	12.38	13.5
	75RB	/	QPSK	12.09	12.19	12.26	13.5
16QAM			12.10	12.21	12.36	13.5	
20 MHz				1900MHz	1880MHz	1860MHz	/
	1RB	High	QPSK	11.86	11.92	11.90	13.5
			16QAM	12.24	12.40	12.43	13.5
		Middle	QPSK	12.24	12.38	12.32	13.5
			16QAM	12.60	12.87	12.93	13.5
		Low	QPSK	11.82	11.94	11.99	13.5
			16QAM	12.24	12.41	12.55	13.5
	50RB	High	QPSK	11.99	12.21	12.26	13.5
			16QAM	11.93	12.24	12.33	13.5
		Middle	QPSK	12.14	12.23	12.25	13.5
			16QAM	12.08	12.28	12.28	13.5
		Low	QPSK	12.05	12.37	12.28	13.5
			16QAM	12.04	12.40	12.28	13.5
	100RB	/	QPSK	18.96	12.32	12.31	13.5
16QAM			12.04	12.35	12.29	13.5	

Sensor-on

LTE-FDD Band 5				Actual output Power (dBm)			Tune up
Band-width	RB allocation	RB offset	Modulation	High	Middle	Low	
1.4 MHz				848.3MHz	836.5MHz	824.7MHz	
	1RB	High	QPSK	17.17	17.20	17.25	19.0
			16QAM	17.20	17.31	17.63	19.0
		Middle	QPSK	17.31	17.40	17.37	19.0
			16QAM	17.39	17.55	17.76	19.0
		Low	QPSK	17.11	17.20	17.21	19.0
			16QAM	17.23	17.34	17.62	19.0
	3RB	High	QPSK	17.23	17.22	17.20	19.0
			16QAM	17.43	17.34	17.51	19.0
		Middle	QPSK	17.23	17.26	17.30	19.0
			16QAM	17.49	17.39	17.55	19.0
		Low	QPSK	17.18	17.21	17.26	19.0
			16QAM	17.46	17.35	17.51	19.0
	6RB	/	QPSK	17.37	17.30	17.36	19.0
16QAM			17.42	17.41	17.16	19.0	
3 MHz				847.5MHz	836.5MHz	825.5MHz	/
	1RB	High	QPSK	17.20	17.26	17.32	19.0
			16QAM	17.19	17.15	17.69	19.0
		Middle	QPSK	17.31	17.34	17.46	19.0
			16QAM	17.39	17.31	17.84	19.0
		Low	QPSK	17.23	17.18	17.30	19.0
			16QAM	17.26	17.23	17.65	19.0
	8RB	High	QPSK	17.27	17.25	17.31	19.0
			16QAM	17.28	17.35	17.38	19.0
		Middle	QPSK	17.33	17.31	17.37	19.0
			16QAM	17.32	17.41	17.41	19.0
		Low	QPSK	17.27	17.29	17.30	19.0
			16QAM	17.29	17.40	17.36	19.0
	15RB	/	QPSK	17.21	17.24	17.22	19.0
16QAM			17.23	17.29	17.32	19.0	

Sensor-on

LTE-FDD Band 5				Actual output Power (dBm)			Tune up
Band-width	RB allocation	RB offset	Modulation	High	Middle	Low	
5 MHz				846.5MHz	836.5MHz	826.5MHz	
	1RB	High	QPSK	17.17	17.21	17.17	19.0
			16QAM	17.29	17.35	17.71	19.0
		Middle	QPSK	17.41	17.48	17.42	19.0
			16QAM	17.50	17.50	17.88	19.0
		Low	QPSK	17.15	17.24	17.15	19.0
			16QAM	17.31	17.37	17.67	19.0
	12RB	High	QPSK	17.16	17.17	17.16	19.0
			16QAM	17.30	17.30	17.42	19.0
		Middle	QPSK	17.22	17.23	17.26	19.0
			16QAM	17.32	17.36	17.46	19.0
		Low	QPSK	17.18	17.19	17.15	19.0
			16QAM	17.25	17.31	17.37	19.0
	25RB	/	QPSK	17.13	17.22	17.17	19.0
16QAM			17.13	17.23	17.29	19.0	
10 MHz				844MHz	836.5MHz	829MHz	/
	1RB	High	QPSK	17.25	17.30	17.25	19.0
			16QAM	17.16	17.61	17.31	19.0
		Middle	QPSK	17.35	17.38	17.32	19.0
			16QAM	17.29	17.77	17.40	19.0
		Low	QPSK	17.21	17.25	17.19	19.0
			16QAM	17.16	17.62	17.25	19.0
	25RB	High	QPSK	17.21	17.27	17.25	19.0
			16QAM	17.26	17.37	17.42	19.0
		Middle	QPSK	17.25	17.29	17.27	19.0
			16QAM	17.31	17.33	17.42	19.0
		Low	QPSK	17.22	17.28	17.24	19.0
			16QAM	17.31	17.38	17.39	19.0
	50RB	/	QPSK	17.23	17.26	17.25	19.0
16QAM			17.29	17.33	17.32	19.0	

Sensor-on

LTE-FDD Band 7				Actual output Power (dBm)			Tune up
Band-width	RB allocation	RB offset	Modulation	High	Middle	Low	
5 MHz				2567.4MHz	2535MHz	2502.5MHz	
	1RB	High	QPSK	12.20	12.11	12.16	13.5
			16QAM	12.20	12.22	12.64	13.5
		Middle	QPSK	12.37	12.41	12.39	13.5
			16QAM	12.42	12.46	12.85	13.5
		Low	QPSK	12.17	12.12	12.19	13.5
			16QAM	12.23	12.19	12.66	13.5
	12RB	High	QPSK	12.19	12.08	12.20	13.5
			16QAM	12.23	12.18	12.33	13.5
		Middle	QPSK	12.24	12.13	12.27	13.5
			16QAM	12.24	12.24	12.41	13.5
		Low	QPSK	12.23	12.14	12.23	13.5
			16QAM	12.24	12.18	12.34	13.5
	25RB	/	QPSK	12.23	12.13	12.24	13.5
			16QAM	12.14	12.15	12.27	13.5
	10 MHz				2565MHz	2535MHz	2505MHz
1RB		High	QPSK	12.15	12.07	12.30	13.5
			16QAM	12.17	12.03	12.57	13.5
		Middle	QPSK	12.31	12.21	12.41	13.5
			16QAM	12.25	12.17	12.68	13.5
		Low	QPSK	12.11	12.07	12.22	13.5
			16QAM	12.14	12.07	12.61	13.5
25RB		High	QPSK	12.31	12.16	12.30	13.5
			16QAM	12.33	12.18	12.30	13.5
		Middle	QPSK	12.25	12.23	12.29	13.5
			16QAM	12.32	12.26	12.29	13.5
		Low	QPSK	12.21	12.11	12.20	13.5
			16QAM	12.22	12.13	12.18	13.5
50RB		/	QPSK	12.32	12.16	12.28	13.5
			16QAM	12.22	12.12	12.28	13.5

Sensor-on

LTE-FDD Band 7				Actual output Power (dBm)			Tune up
Band-width	RB allocation	RB offset	Modulation	High	Middle	Low	
15 MHz				2562.5MHz	2535MHz	2507.5MHz	
	1RB	High	QPSK	12.23	12.02	12.16	13.5
			16QAM	12.50	11.95	12.46	13.5
		Middle	QPSK	12.20	12.15	12.31	13.5
			16QAM	12.58	12.15	12.62	13.5
		Low	QPSK	12.12	12.10	12.27	13.5
			16QAM	12.48	12.00	12.58	13.5
	36RB	High	QPSK	12.30	12.19	12.32	13.5
			16QAM	12.25	12.16	12.35	13.5
		Middle	QPSK	12.22	12.21	12.33	13.5
			16QAM	12.20	12.21	12.37	13.5
		Low	QPSK	12.23	12.18	12.25	13.5
			16QAM	12.17	12.18	12.30	13.5
	75RB	/	QPSK	12.27	12.20	12.35	13.5
16QAM			12.23	12.20	12.29	13.5	
20 MHz				2560MHz	2535MHz	2510MHz	/
	1RB	High	QPSK	11.94	11.81	11.89	13.5
			16QAM	12.41	12.31	12.29	13.5
		Middle	QPSK	12.23	12.33	12.44	13.5
			16QAM	12.79	12.83	12.71	13.5
		Low	QPSK	11.91	11.89	12.03	13.5
			16QAM	12.38	12.37	12.38	13.5
	50RB	High	QPSK	12.25	12.17	12.25	13.5
			16QAM	12.27	12.19	12.21	13.5
		Middle	QPSK	12.22	12.21	12.28	13.5
			16QAM	12.26	12.24	12.20	13.5
		Low	QPSK	12.22	12.17	12.21	13.5
			16QAM	12.23	12.18	12.17	13.5
	100RB	/	QPSK	12.27	12.18	12.24	13.5
16QAM			12.25	12.17	12.18	13.5	

Sensor-on

LTE-FDD Band 12				Actual output Power (dBm)			Tune up	
Band-width	RB allocation	RB offset	Modulation	High	Middle	Low		
1.4 MHz				715.3MHz	707.5MHz	699.7MHz		
	1RB	High	QPSK	18.41	18.46	18.55	19.5	
			16QAM	18.52	18.60	18.90	19.5	
		Middle	QPSK	18.76	18.74	18.75	19.5	
			16QAM	18.70	18.85	19.05	19.5	
		Low	QPSK	18.39	18.52	18.57	19.5	
			16QAM	18.50	18.61	18.88	19.5	
	3RB	High	QPSK	18.60	18.53	18.60	19.5	
			16QAM	18.76	18.60	18.80	19.5	
		Middle	QPSK	18.62	18.61	18.68	19.5	
			16QAM	18.77	18.67	18.84	19.5	
		Low	QPSK	18.54	18.54	18.58	19.5	
			16QAM	18.74	18.62	18.79	19.5	
	6RB	/	QPSK	18.58	18.59	18.60	19.5	
			16QAM	18.72	18.70	18.44	19.5	
	3 MHz				714.5MHz	707.5MHz	700.5MHz	/
		1RB	High	QPSK	18.45	18.50	18.58	19.5
				16QAM	18.47	18.36	18.87	19.5
Middle			QPSK	18.59	18.62	18.70	19.5	
			16QAM	18.64	18.55	19.05	19.5	
Low			QPSK	18.45	18.43	18.57	19.5	
			16QAM	18.52	18.40	18.86	19.5	
8RB		High	QPSK	18.51	18.51	18.52	19.5	
			16QAM	18.51	18.60	18.58	19.5	
		Middle	QPSK	18.56	18.55	18.56	19.5	
			16QAM	18.56	18.65	18.65	19.5	
		Low	QPSK	18.51	18.51	18.52	19.5	
			16QAM	18.52	18.61	18.59	19.5	
15RB		/	QPSK	18.49	18.49	18.50	19.5	
			16QAM	18.44	18.51	18.49	19.5	

Sensor-on

LTE-FDD Band 12				Actual output Power (dBm)			Tune up
Band-width	RB allocation	RB offset	Modulation	High	Middle	Low	
5 MHz				713.5MHz	707.5MHz	701.5MHz	
	1RB	High	QPSK	18.48	18.45	18.51	19.5
			16QAM	18.55	18.56	18.98	19.5
		Middle	QPSK	18.73	18.74	18.67	19.5
			16QAM	18.74	18.84	19.11	19.5
		Low	QPSK	18.45	18.53	18.46	19.5
			16QAM	18.54	18.58	18.95	19.5
	12RB	High	QPSK	18.42	18.47	18.54	19.5
			16QAM	18.48	18.56	18.65	19.5
		Middle	QPSK	18.56	18.52	18.54	19.5
			16QAM	18.60	18.62	18.71	19.5
		Low	QPSK	18.54	18.47	18.47	19.5
			16QAM	18.61	18.53	18.61	19.5
	25RB	/	QPSK	18.50	18.49	18.51	19.5
16QAM			18.43	18.49	18.56	19.5	
10 MHz				711MHz	707.5MHz	704MHz	/
	1RB	High	QPSK	18.48	18.45	18.53	19.5
			16QAM	18.50	18.40	18.84	19.5
		Middle	QPSK	18.61	18.63	18.70	19.5
			16QAM	18.61	18.57	19.03	19.5
		Low	QPSK	18.43	18.47	18.54	19.5
			16QAM	18.51	18.44	18.82	19.5
	25RB	High	QPSK	18.45	18.56	18.67	19.5
			16QAM	18.55	18.55	18.67	19.5
		Middle	QPSK	18.56	18.57	18.63	19.5
			16QAM	18.60	18.58	18.64	19.5
		Low	QPSK	18.47	18.52	18.64	19.5
			16QAM	18.54	18.52	18.64	19.5
	50RB	/	QPSK	18.46	18.54	18.63	19.5
16QAM			18.50	18.51	18.61	19.5	

Note: SAR for LTE Band 17 is covered by LTE Band 12 due to similar frequency range, same maximum tune-up limit and same channel bandwidth.

Sensor-on

LTE-FDD Band 66				Actual output Power (dBm)			Tune up
Band-width	RB allocation	RB offset	Modulation	High	Middle	Low	
1.4 MHz				1779.3MHz	1745MHz	1710.7MHz	
	1RB	High	QPSK	12.85	12.83	12.84	14.0
			16QAM	13.04	13.23	13.03	14.0
		Middle	QPSK	13.07	12.95	13.04	14.0
			16QAM	13.25	13.41	13.19	14.0
		Low	QPSK	12.88	12.81	12.82	14.0
			16QAM	13.04	13.21	13.00	14.0
	3RB	High	QPSK	12.98	12.90	13.01	14.0
			16QAM	13.08	13.13	13.28	14.0
		Middle	QPSK	13.01	12.97	13.02	14.0
			16QAM	13.12	13.19	13.35	14.0
		Low	QPSK	12.95	12.86	12.97	14.0
			16QAM	13.10	13.11	13.27	14.0
	6RB	/	QPSK	12.93	12.84	12.94	14.0
16QAM			13.12	12.77	13.15	14.0	
3 MHz				1778.5MHz	1745MHz	1711.5MHz	/
	1RB	High	QPSK	12.94	12.88	12.87	14.0
			16QAM	12.87	13.26	13.00	14.0
		Middle	QPSK	13.04	12.99	13.04	14.0
			16QAM	13.03	13.43	13.19	14.0
		Low	QPSK	12.90	12.85	12.90	14.0
			16QAM	12.88	13.26	13.08	14.0
	8RB	High	QPSK	12.95	12.82	12.95	14.0
			16QAM	13.06	12.97	13.01	14.0
		Middle	QPSK	12.99	12.83	12.96	14.0
			16QAM	13.10	13.03	13.10	14.0
		Low	QPSK	12.95	12.83	12.92	14.0
			16QAM	13.07	12.97	12.96	14.0
	15RB	/	QPSK	12.96	12.87	12.95	14.0
16QAM			13.01	12.90	12.96	14.0	

Sensor-on

LTE-FDD Band 66				Actual output Power (dBm)			Tune up
Band-width	RB allocation	RB offset	Modulation	High	Middle	Low	
5 MHz				1777.5MHz	1745MHz	1712.5MHz	
	1RB	High	QPSK	12.89	12.75	12.89	14.0
			16QAM	13.02	13.29	13.03	14.0
		Middle	QPSK	13.16	13.02	13.15	14.0
			16QAM	13.34	13.54	13.31	14.0
		Low	QPSK	12.92	12.76	12.91	14.0
			16QAM	13.01	13.27	13.05	14.0
	12RB	High	QPSK	12.91	12.84	12.98	14.0
			16QAM	13.07	13.03	13.06	14.0
		Middle	QPSK	12.98	12.89	12.99	14.0
			16QAM	13.13	13.10	13.12	14.0
		Low	QPSK	12.92	12.92	12.92	14.0
			16QAM	13.04	13.04	13.06	14.0
	25RB	/	QPSK	12.94	12.89	12.97	14.0
16QAM			13.04	12.95	12.93	14.0	
10 MHz				1775MHz	1745MHz	1715MHz	/
	1RB	High	QPSK	12.91	12.89	12.88	14.0
			16QAM	12.92	13.24	12.95	14.0
		Middle	QPSK	12.98	13.02	13.02	14.0
			16QAM	12.97	13.33	13.11	14.0
		Low	QPSK	12.89	12.87	12.88	14.0
			16QAM	12.86	13.17	13.00	14.0
	25RB	High	QPSK	12.97	12.87	13.03	14.0
			16QAM	13.03	12.93	13.13	14.0
		Middle	QPSK	13.01	12.91	13.01	14.0
			16QAM	13.02	12.96	13.14	14.0
		Low	QPSK	12.94	12.94	13.00	14.0
			16QAM	13.01	12.97	13.09	14.0
	50RB	/	QPSK	13.02	12.88	13.02	14.0
16QAM			13.06	12.93	13.05	14.0	

Sensor-on

LTE-FDD Band 66				Actual output Power (dBm)			Tune up
Band-width	RB allocation	RB offset	Modulation	High	Middle	Low	
15 MHz				1772.5MHz	1745MHz	1717.5MHz	
	1RB	High	QPSK	12.79	12.82	12.78	14.0
			16QAM	12.80	13.14	13.32	14.0
		Middle	QPSK	12.90	12.94	12.94	14.0
			16QAM	12.90	13.28	13.54	14.0
		Low	QPSK	12.79	12.77	12.84	14.0
			16QAM	12.82	13.15	13.44	14.0
	36RB	High	QPSK	12.90	12.80	12.96	14.0
			16QAM	12.97	12.90	13.02	14.0
		Middle	QPSK	12.97	12.83	12.96	14.0
			16QAM	12.98	12.92	12.99	14.0
		Low	QPSK	12.91	12.84	12.93	14.0
			16QAM	13.01	12.96	12.97	14.0
	75RB	/	QPSK	12.98	12.86	12.98	14.0
16QAM			12.97	12.90	13.00	14.0	
20 MHz				1770MHz	1745MHz	1720MHz	/
	1RB	High	QPSK	12.66	12.55	12.56	14.0
			16QAM	13.17	13.18	13.05	14.0
		Middle	QPSK	13.07	12.99	13.00	14.0
			16QAM	13.63	13.54	13.59	14.0
		Low	QPSK	12.57	12.53	12.59	14.0
			16QAM	13.14	13.10	13.11	14.0
	50RB	High	QPSK	13.02	12.87	13.10	14.0
			16QAM	13.08	12.91	13.08	14.0
		Middle	QPSK	12.99	12.91	13.00	14.0
			16QAM	13.04	12.94	13.03	14.0
		Low	QPSK	13.04	12.95	12.99	14.0
			16QAM	13.07	13.01	13.00	14.0
	100RB	/	QPSK	13.04	12.91	13.07	14.0
16QAM			13.07	12.93	13.07	14.0	

Note: SAR for LTE Band 4 is covered by LTE Band 66 due to similar frequency range, same maximum tune-up limit and same channel bandwidth.

Sensor-on

LTE-FDD Band 71				Actual output Power (dBm)			Tune up
Band-width	RB allocation	RB offset	Modulation	High	Middle	Low	
5 MHz				695.5MHz	680.5MHz	665.5MHz	
	1RB	High	QPSK	17.88	17.81	17.80	19.0
			16QAM	17.94	17.90	18.31	19.0
		Middle	QPSK	18.11	18.08	18.07	19.0
			16QAM	18.08	18.22	18.56	19.0
		Low	QPSK	17.81	17.80	17.85	19.0
			16QAM	17.92	17.91	18.34	19.0
	12RB	High	QPSK	17.94	17.82	17.88	19.0
			16QAM	17.99	17.97	18.09	19.0
		Middle	QPSK	17.92	17.86	17.91	19.0
			16QAM	18.05	17.97	18.09	19.0
		Low	QPSK	17.79	17.77	17.77	19.0
			16QAM	17.90	17.89	17.98	19.0
	25RB	/	QPSK	17.90	17.87	17.87	19.0
			16QAM	17.88	17.88	17.95	19.0
	10 MHz				693MHz	680.5MHz	668MHz
1RB		High	QPSK	17.87	17.84	17.92	19.0
			16QAM	17.93	17.79	18.21	19.0
		Middle	QPSK	17.99	17.97	18.04	19.0
			16QAM	18.06	17.94	18.38	19.0
		Low	QPSK	17.77	17.81	17.92	19.0
			16QAM	17.88	17.75	18.24	19.0
25RB		High	QPSK	18.05	17.89	17.96	19.0
			16QAM	18.15	17.92	17.98	19.0
		Middle	QPSK	17.97	17.92	17.93	19.0
			16QAM	18.06	17.92	17.97	19.0
		Low	QPSK	17.91	17.88	17.87	19.0
			16QAM	18.03	17.91	17.93	19.0
50RB		/	QPSK	17.99	17.94	17.93	19.0
			16QAM	18.04	17.90	17.95	19.0

Sensor-on

LTE-FDD Band 71				Actual output Power (dBm)			Tune up
Band-width	RB allocation	RB offset	Modulation	High	Middle	Low	
15 MHz				690.5MHz	680.5MHz	670.5MHz	
	1RB	High	QPSK	17.83	17.76	17.85	19.0
			16QAM	18.33	17.74	18.17	19.0
		Middle	QPSK	17.89	17.83	17.95	19.0
			16QAM	18.33	17.83	18.27	19.0
		Low	QPSK	17.73	17.73	17.89	19.0
			16QAM	18.24	17.66	18.22	19.0
	36RB	High	QPSK	18.01	17.86	17.99	19.0
			16QAM	17.98	17.90	18.09	19.0
		Middle	QPSK	17.94	17.90	17.96	19.0
			16QAM	17.95	17.92	17.98	19.0
		Low	QPSK	17.87	17.82	17.91	19.0
			16QAM	17.88	17.83	17.97	19.0
	75RB	/	QPSK	17.94	17.85	17.92	19.0
16QAM			17.91	17.87	17.96	19.0	
20 MHz				688MHz	683MHz	673MHz	/
	1RB	High	QPSK	17.67	17.58	17.57	19.0
			16QAM	18.18	18.17	18.04	19.0
		Middle	QPSK	18.08	17.86	17.99	19.0
			16QAM	18.56	18.51	18.38	19.0
		Low	QPSK	17.56	17.51	17.59	19.0
			16QAM	18.05	18.03	18.00	19.0
	50RB	High	QPSK	18.01	18.02	18.03	19.0
			16QAM	18.08	17.99	17.98	19.0
		Middle	QPSK	17.92	17.90	17.89	19.0
			16QAM	17.94	17.87	17.87	19.0
		Low	QPSK	17.87	17.74	17.84	19.0
			16QAM	17.90	17.80	17.82	19.0
	100RB	/	QPSK	17.98	17.86	17.97	19.0
16QAM			18.00	17.89	17.91	19.0	

10.4 Wi-Fi Measurement result

Table 10.5: The conducted Power measurement results for BT

BT Mode	Averaged Power (dBm)			Tune up
	Ch.0 (2402 MHz)	Ch39 (2441 MHz)	Ch78 (2480 MHz)	
GFSK	5.29	5.95	5.87	6.5
EDR2M-4_DQPSK	4.35	4.90	4.82	5.0
EDR3M-8DPSK	4.42	4.95	4.88	5.0

Table 10.6: The conducted Power measurement results for 2.4G WIFI

802.11b (dBm)

Channel / data rate	1Mbps	2Mbps	5.5Mbps	11Mbps
Tune up	21	21	21	21
11	19.82	/	/	20.04
6	20.66	20.79	20.47	20.83
1	19.50	/	/	19.86

802.11g (dBm)

Channel /data rate	6Mbps	9Mbps	12Mbps	18Mbps	24Mbps	36Mbps	48Mbps	54Mbps
Tune up	20	20	20	20	18	18	18	17
11	19.17	/	/	/	/	/	/	/
6	19.43	19.00	18.45	18.36	17.01	16.80	16.09	15.16
1	18.54	/	/	/	/	/	/	/

802.11n-HT20 (dBm)

Channel\data rate	MCS0	MCS1	MCS2	MCS3	MCS4	MCS5	MCS6	MCS7
Tune up	20	20	20	18	18	17	17	17
11	19.04	/	/	/	/	/	/	/
6	19.28	18.14	18.33	17.47	17.46	15.51	15.47	15.44
1	18.49	/	/	/	/	/	/	/

802.11n-HT40 (dBm)

Channel\data rate	MCS0	MCS1	MCS2	MCS3	MCS4	MCS5	MCS6	MCS7
Tune up	17	17	17	17	17	15	15	15
9	15.76	/	/	/	/	/	/	/
6	16.36	16.33	16.32	16.35	16.26	13.65	13.68	13.64
3	15.82	/	/	/	/	/	/	/

Table 10.7: The Reduce conducted Power measurement results for 2.4G WIFI

802.11b (dBm)

Channel / data rate	1Mbps	2Mbps	5.5Mbps	11Mbps
Tune up	11	11	11	11
11	/	/	10.68	/
6	10.63	10.68	10.92	10.91
1	/	/	10.41	/

802.11g (dBm)

Channel /data rate	6Mbps	9Mbps	12Mbps	18Mbps	24Mbps	36Mbps	48Mbps	54Mbps
Tune up	10.5	10.5	10.5	10.5	10.5	10.5	7	7
11	9.70	/	/	/	/	/	/	/
6	9.93	9.89	8.71	8.86	8.94	8.96	6.72	5.72
1	9.48	/	/	/	/	/	/	/

802.11n-HT20 (dBm)

Channel\data rate	MCS0	MCS1	MCS2	MCS3	MCS4	MCS5	MCS6	MCS7
Tune up	10.5	9.5	9.5	9.5	9.5	6.5	6.5	6.5
11	9.99	8.48	8.87	7.68	7.67	5.38	5.41	5.36
6	9.98	/	/	/	/	/	/	/
1	9.46	/	/	/	/	/	/	/

802.11n-HT40 (dBm)

Channel\data rate	MCS0	MCS1	MCS2	MCS3	MCS4	MCS5	MCS6	MCS7
Tune up	8	8	8	8	8	8	5	5
9	6.50	/	/	/	/	/	/	/
6	6.70	6.72	6.75	6.72	6.73	6.03	3.98	3.74
3	6.32	/	/	/	/	/	/	/

Table 10.8: The conducted Power measurement results for 5G WIFI

802.11a (dBm)								
Channel / data rate	6Mbps	9Mbps	12Mbps	18Mbps	24Mbps	36Mbps	48Mbps	54Mbps
U-NII-1 / Tune up	19	19	18	18	18	18	15	15
36(5180 MHz)	17.49	/	/	/	/	/	/	/
40(5200 MHz)	17.94	/	/	/	/	/	/	/
44(5220 MHz)	18.36	18.14	16.74	16.81	16.62	16.01	14.27	13.75
48(5240 MHz)	18.33	/	/	/	/	/	/	/
U-NII-2A / Tune up	19	19	17	17	17	17	15	15
52(5260 MHz)	18.98	18.61	16.80	16.81	16.71	15.97	14.38	13.18
56(5280 MHz)	18.17	/	/	/	/	/	/	/
60(5300 MHz)	17.64	/	/	/	/	/	/	/
64(5320 MHz)	17.68	/	/	/	/	/	/	/
U-NII-3 / Tune up	19.5	19.5	18	18	18	18	15	15
149(5745 MHz)	19.10	18.94	17.05	17.09	16.89	16.45	14.65	13.88
153(5765 MHz)	18.83	/	/	/	/	/	/	/
157(5785 MHz)	19.01	/	/	/	/	/	/	/
161(5805 MHz)	18.51	/	/	/	/	/	/	/
165(5825 MHz)	17.97	/	/	/	/	/	/	/

Table 10.9: The Reduce conducted Power measurement results for 5G WIFI

802.11a (dBm)								
Channel / data rate	6Mbps	9Mbps	12Mbps	18Mbps	24Mbps	36Mbps	48Mbps	54Mbps
U-NII-1 / Tune up	7	7	7	7	7	7	5	5
36(5180 MHz)	5.30	/	/	/	/	/	/	/
40(5200 MHz)	5.72	/	/	/	/	/	/	/
44(5220 MHz)	6.26	/	/	/	/	/	/	/
48(5240 MHz)	6.67	6.65	5.32	5.40	5.67	5.40	3.55	3.54
U-NII-2A / Tune up	7	7	6	6	6	6	4	4
52(5260 MHz)	6.49	6.48	4.70	5.04	5.29	5.19	2.80	2.78
56(5280 MHz)	5.88	/	/	/	/	/	/	/
60(5300 MHz)	5.14	/	/	/	/	/	/	/
64(5320 MHz)	5.08	/	/	/	/	/	/	/
U-NII-3 / Tune up	7	7	7	7	7	7	4	4
149(5745 MHz)	6.30	/	/	/	/	/	/	/
153(5765 MHz)	6.47	6.22	5.60	5.67	5.45	5.14	3.19	3.14
157(5785 MHz)	6.09	/	/	/	/	/	/	/
161(5805 MHz)	6.20	/	/	/	/	/	/	/
165(5825 MHz)	6.00	/	/	/	/	/	/	/

11 Simultaneous TX SAR Considerations

11.1 Introduction

The following procedures adopted from “FCC SAR Considerations for Cell Phones with Multiple Transmitters” are applicable to handsets with built-in unlicensed transmitters such as 802.11 a/b/g devices which may simultaneously transmit with the licensed transmitter.

For this device, the Wi-Fi can transmit simultaneous with other transmitters.

11.2 Transmit Antenna Separation Distances

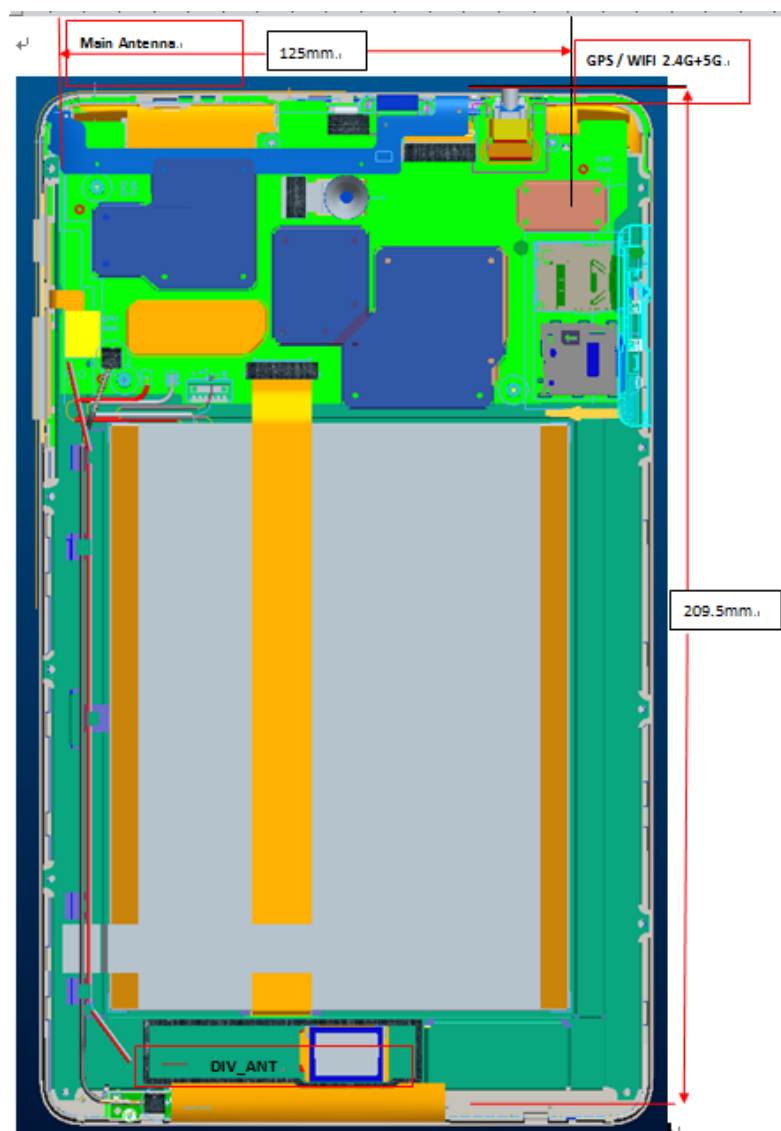

Picture 12.1 Antenna Locations (Back View)

11.3 Standalone SAR Test Exclusion Considerations

Standalone 1-g head or body SAR evaluation by measurement or numerical simulation is not required when the corresponding SAR Exclusion Threshold condition, listed below, is satisfied. The 1-g SAR test exclusion threshold for 100 MHz to 6 GHz at test separation distances ≤ 50 mm are determined by:

$[(\text{max. power of channel, including tune-up tolerance, mW}) / (\text{min. test separation distance, mm})] \cdot [\sqrt{f(\text{GHz})}] \leq 3.0$ for 1-g SAR, where

- $f(\text{GHz})$ is the RF channel transmit frequency in GHz
- Power and distance are rounded to the nearest mW and mm before calculation
- The result is rounded to one decimal place for comparison

Table 11.1: Standalone SAR test exclusion considerations

Band/Mode	f(GHz)	Position	SAR test exclusion threshold (mW)	RF output power		SAR test exclusion
				dBm	mW	
Bluetooth	2.44	Body	19.20	6.5	4.47	Yes
2.4GHz WLAN	2.45		19.17	21	125.9	No
5GHz WLAN	5.2		13.16	19	79.4	No
	5.3		13.03	19	79.4	No
	5.8		12.46	19.5	89.1	No

12 Evaluation of Simultaneous

Table 12.1: The sum of reported SAR values for main antenna and Wi-Fi

/	Band	Position	Main antenna	WiFi	Sum	SPLSR
Maximum reported SAR value for Body	W850	Rear	1.33	0.27	1.60	Yes

According to the KDB 447498 D01, when the sum of SAR is larger than the limit, SAR test exclusion is determined by the SAR to peak location separation ratio. The ratio is determined by $(SAR1 + SAR2)^{1.5}/R_i$, rounded to two decimal digits, and must be ≤ 0.04 for all antenna pairs in the configuration to qualify for 1-g SAR test exclusion.

Band	Position	SAR (W/kg)	Gap (cm)	SAR peak location (m)			3D distance (mm)	Pair SAR sum (W/kg)	SPLSR	Simultaneous SAR
				X	Y	Z				
W850	Rear	1.44	0	-0.0705	0.236	-0.169	83.8	1.92	0.03	Not required
WLAN 2.4G		0.482	0	-0.04	0.314	-0.169				

