



SAR TEST REPORT

No. I17Z61900-SEM02

For

TCL Communication Ltd.

Mobile Phone

Model Name: 5026D

With

Hardware Version: V03

Software Version: FD1

FCC ID: 2ACCJBT10

Issued Date: 2017-11-24



Note:

The test results in this test report relate only to the devices specified in this report. This report shall not be reproduced except in full without the written approval of CTTL.

The report must not be used by the client to claim product certification, approval, or endorsement by NVLAP, NIST, or any agency of the U.S. Government.

Test Laboratory:

CTTL, Telecommunication Technology Labs, CAICT

No. 52, Huayuan North Road, Haidian District, Beijing, P. R. China 100191.

Tel:+86(0)10-62304633-2512, Fax:+86(0)10-62304633-2504

Email: ctl_terminals@caict.ac.cn, website: www.caict.ac.cn



REPORT HISTORY

Report Number	Revision	Issue Date	Description
I17Z61900-SEM02	Rev.0	2017-11-24	Initial creation of test report



TABLE OF CONTENT

1	TEST LABORATORY	6
1.1	TESTING LOCATION	6
1.2	TESTING ENVIRONMENT.....	6
1.3	PROJECT DATA.....	6
1.4	SIGNATURE.....	6
2	STATEMENT OF COMPLIANCE	7
3	CLIENT INFORMATION	9
3.1	APPLICANT INFORMATION	9
3.2	MANUFACTURER INFORMATION	9
4	EQUIPMENT UNDER TEST (EUT) AND ANCILLARY EQUIPMENT (AE)	10
4.1	ABOUT EUT	10
4.2	INTERNAL IDENTIFICATION OF EUT USED DURING THE TEST	10
4.3	INTERNAL IDENTIFICATION OF AE USED DURING THE TEST.....	10
5	TEST METHODOLOGY	11
5.1	APPLICABLE LIMIT REGULATIONS	11
5.2	APPLICABLE MEASUREMENT STANDARDS.....	11
6	SPECIFIC ABSORPTION RATE (SAR)	12
6.1	INTRODUCTION	12
6.2	SAR DEFINITION	12
7	TISSUE SIMULATING LIQUIDS	13
7.1	TARGETS FOR TISSUE SIMULATING LIQUID	13
7.2	DIELECTRIC PERFORMANCE	13
8	SYSTEM VERIFICATION	17
8.1	SYSTEM SETUP	17
8.2	SYSTEM VERIFICATION.....	18
9	MEASUREMENT PROCEDURES	19
9.1	TESTS TO BE PERFORMED.....	19
9.2	GENERAL MEASUREMENT PROCEDURE	21
9.3	WCDMA MEASUREMENT PROCEDURES FOR SAR.....	22
9.4	BLUETOOTH & WI-FI MEASUREMENT PROCEDURES FOR SAR.....	23
9.5	POWER DRIFT	23
10	AREA SCAN BASED 1-G SAR	24
10.1	REQUIREMENT OF KDB	24
10.2	FAST SAR ALGORITHMS.....	24
11	CONDUCTED OUTPUT POWER	25



11.1	GSM MEASUREMENT RESULT	25
11.2	WCDMA MEASUREMENT RESULT.....	26
11.3	WI-FI AND BT MEASUREMENT RESULT	27
12	SIMULTANEOUS TX SAR CONSIDERATIONS.....	30
12.1	INTRODUCTION.....	30
12.2	TRANSMIT ANTENNA SEPARATION DISTANCES	30
12.3	SAR MEASUREMENT POSITIONS	31
12.4	STANDALONE SAR TEST EXCLUSION CONSIDERATIONS.....	31
13	EVALUATION OF SIMULTANEOUS.....	32
14	SAR TEST RESULT	33
14.1	EVALUATION OF MULTI-BATTERIES	33
14.2	SAR RESULTS	34
14.3	FULL SAR	38
14.4	WLAN EVALUATION	39
15	SAR MEASUREMENT VARIABILITY.....	41
16	MEASUREMENT UNCERTAINTY	42
16.1	MEASUREMENT UNCERTAINTY FOR NORMAL SAR TESTS (300MHZ~3GHZ)	42
16.2	MEASUREMENT UNCERTAINTY FOR NORMAL SAR TESTS (3~6GHZ).....	43
16.3	MEASUREMENT UNCERTAINTY FOR FAST SAR TESTS (300MHZ~3GHZ).....	44
16.4	MEASUREMENT UNCERTAINTY FOR FAST SAR TESTS (3~6GHZ).....	45
17	MAIN TEST INSTRUMENTS.....	47
ANNEX A	GRAPH RESULTS.....	48
ANNEX B	SYSTEM VERIFICATION RESULTS	58
ANNEX C	SAR MEASUREMENT SETUP	65
C.1	MEASUREMENT SET-UP	65
C.2	DASY4 OR DASY5 E-FIELD PROBE SYSTEM	66
C.3	E-FIELD PROBE CALIBRATION	66
C.4	OTHER TEST EQUIPMENT.....	67
C.4.1	DATA ACQUISITION ELECTRONICS(DAE)	67
C.4.2	ROBOT.....	68
C.4.3	MEASUREMENT SERVER	68
C.4.4	DEVICE HOLDER FOR PHANTOM.....	69
C.4.5	PHANTOM.....	69
ANNEX D	POSITION OF THE WIRELESS DEVICE IN RELATION TO THE PHANTOM	71
D.1	GENERAL CONSIDERATIONS.....	71
D.2	BODY-WORN DEVICE	72
D.3	DESKTOP DEVICE.....	72
D.4	DUT SETUP PHOTOS.....	73



ANNEX E	EQUIVALENT MEDIA RECIPES	74
ANNEX F	SYSTEM VALIDATION	75
ANNEX G	PROBE CALIBRATION CERTIFICATE	76
ANNEX H	DIPOLE CALIBRATION CERTIFICATE	87
ANNEX I	SPOT CHECK FOR 5026D	111
	I.1 CONDUCTED POWER OF SELECTED CASE	111
	I.2 MEASUREMENT RESULTS	112
	I.3 REPORTED SAR COMPARISON	113
ANNEX J	ACCREDITATION CERTIFICATE	124

1 Test Laboratory

1.1 Testing Location

Company Name:	CTTL(Shouxiang)
Address:	No. 51 Shouxiang Science Building, Xueyuan Road, Haidian District, Beijing, P. R. China100191

1.2 Testing Environment

Temperature:	18°C~25 °C,
Relative humidity:	30%~ 70%
Ground system resistance:	< 0.5 Ω
Ambient noise & Reflection:	< 0.012 W/kg

1.3 Project Data

Project Leader:	Qi Dianyuan
Test Engineer:	Lin Xiaojun
Testing Start Date:	November 8, 2017
Testing End Date:	November 11, 2017

1.4 Signature



Lin Xiaojun

(Prepared this test report)

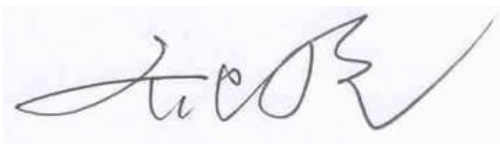

Qi Dianyuan

(Reviewed this test report)



Lu Bingsong

Deputy Director of the laboratory
(Approved this test report)

2 Statement of Compliance

This EUT is a variant product and the report of original sample is No.I17Z61901-SEM01. According to the client request, we share the test results of original sample and remove the values of WCDMA1700-BIV. The results of spot check are presented in the annex I.

The maximum results of SAR found during testing for TCL Communication Ltd. Mobile Phone 5026D is as follows:

Table 2.1: Highest Reported SAR (1g)

Exposure Configuration	Technology Band	Highest Reported SAR 1g (W/Kg)	Equipment Class
Head (Separation Distance 0mm)	GSM850	0.21	PCE
	PCS1900	0.11	
	WCDMA1900-BII	0.20	
	WCDMA850-BV	0.24	
	WLAN2450	1.27	DTS
Hotspot (Separation Distance 10mm)	GSM850	0.45	PCE
	PCS1900	1.08	
	WCDMA1900-BII	1.16	
	WCDMA850-BV	0.40	
	WLAN2450	0.13	DTS

The SAR values found for the Mobile Phone are below the maximum recommended levels of 1.6 W/Kg as averaged over any 1g tissue according to the ANSI C95.1-1992.

For body worn operation, this device has been tested and meets FCC RF exposure guidelines when used with any accessory that contains no metal and which provides a minimum separation distance of 10 mm between this device and the body of the user. Use of other accessories may not ensure compliance with FCC RF exposure guidelines.

The EUT battery must be fully charged and checked periodically during the test to ascertain uniform power output.

The measurement together with the test system set-up is described in annex C of this test report. A detailed description of the equipment under test can be found in chapter 4 of this test report.

The highest reported SAR value is obtained at the case of **(Table 2.1)**, and the values are: **1.27 W/kg (1g)**.

Table 2.2: The sum of reported SAR values for main antenna and WiFi

	Position	Main antenna	WiFi	Sum
Highest reported SAR value for Head	Left hand, Touch cheek	0.21	1.27	1.48
Highest reported SAR value for Body	Bottom	1.16	/	1.16

Table 2.3: The sum of reported SAR values for main antenna and BT

	Position	Main antenna	BT	Sum
Maximum reported SAR value for Head	Left hand, Touch cheek	0.21	0.09	0.30
Maximum reported SAR value for Body	Bottom	1.16	0.05	1.21

[1] - Estimated SAR for Bluetooth (see the table 13.3)

According to the above tables, the highest sum of reported SAR values is 1.48 **W/kg (1g)**. The detail for simultaneous transmission consideration is described in chapter 13.



3 Client Information

3.1 Applicant Information

Company Name:	TCL Communication Ltd.
Address /Post:	5F, C building, No. 232, Liang Jing Road ZhangJiang High-Tech Park, Pudong Area Shanghai, P.R. China. 201203
City:	Shanghai
Postal Code:	201203
Country:	China
Contact Person:	Gong Zhizhou
E-mail:	zhizhou.gong@tcl.com
Telephone:	0086-21-31363544
Fax:	0086-21-61460602

3.2 Manufacturer Information

Company Name:	TCL Communication Ltd.
Address /Post:	5F, C building, No. 232, Liang Jing Road ZhangJiang High-Tech Park, Pudong Area Shanghai, P.R. China. 201203
City:	Shanghai
Postal Code:	201203
Country:	China
Contact Person:	Gong Zhizhou
E-mail:	zhizhou.gong@tcl.com
Telephone:	0086-21-31363544
Fax:	0086-21-61460602

4 Equipment Under Test (EUT) and Ancillary Equipment (AE)

4.1 About EUT

Description:	Mobile Phone
Model name:	5026D
Operating mode(s):	GSM 850/900/1800/1900 WCDMA850/900/1900/2100, BT, WLAN
Tested Tx Frequency:	825 – 848.8 MHz (GSM 850)
	1850.2 – 1910 MHz (GSM 1900)
	826.4–846.6 MHz (WCDMA 850 Band V)
	1852.4–1907.6 MHz (WCDMA1900 Band II)
2412 – 2462 MHz (Wi-Fi 2.4G)	
GPRS/EGPRS Multislot Class:	12
Test device Production information:	Production unit
Device type:	Portable device
Antenna type:	Integrated antenna
Accessories/Body-worn configurations:	Headset
Hotspot mode:	Support
Product dimension	Long161 mm ;Wide 76mm ; Overall Diagonal 178mm

4.2 Internal Identification of EUT used during the test

EUT ID*	IMEI	HW	SW Version
EUT1	015088000200087	V03	FA2
EUT2	015088000200012	V03	FA2
EUT3	015088000200186	V03	FA2
EUT4	015088000200111	V03	FA2
EUT5	353441090200394	V03	FD1
	353441090200402		
EUT6	353441090200410	V03	FD1
	353441090200428		
EUT7	353441090200253	V03	FD1
	353441090200261		

*EUT ID: is used to identify the test sample in the lab internally.

Note: It is performed to test SAR with the EUT1&2 and conducted power with the EUT3&4.

It is performed to test Spot check with the EUT5 and conducted power with the EUT6&7.

4.3 Internal Identification of AE used during the test

AE ID	Description	Model	SN	Manufactory
AE1	Battery	TLp029C7	/	VEKEN
AE2	Battery	TLp029C1	/	BYD
AE3	Headset	CCB0046A10C1	/	JUWEI
AE4	Headset	CCB0046A10C4	/	MEIHAO

*AE ID: is used to identify the test sample in the lab internally.



5 TEST METHODOLOGY

5.1 Applicable Limit Regulations

ANSI C95.1–1992: IEEE Standard for Safety Levels with Respect to Human Exposure to Radio Frequency Electromagnetic Fields, 3 kHz to 300 GHz.

It specifies the maximum exposure limit of **1.6 W/kg** as averaged over any 1 gram of tissue for portable devices being used within 20 cm of the user in the uncontrolled environment.

5.2 Applicable Measurement Standards

IEEE 1528–2013: Recommended Practice for Determining the Peak Spatial-Average Specific Absorption Rate (SAR) in the Human Head from Wireless Communications Devices: Measurement Techniques.

KDB447498 D01 General RF Exposure Guidance v06: Mobile and Portable Devices RF Exposure Procedures and Equipment Authorization Policies.

KDB648474 D04 Handset SAR v01r03: SAR Evaluation Considerations for Wireless Handsets.

KDB941225 D01 SAR test for 3G devices v03r01: SAR Measurement Procedures for 3G Devices

KDB941225 D05 SAR for LTE Devices v02r05: SAR Evaluation Considerations for LTE Devices

KDB248227 D01 802.11 Wi-Fi SAR v02r02: SAR GUIDANCE FOR IEEE 802.11 (Wi-Fi) TRANSMITTERS

KDB865664 D01 SAR measurement 100 MHz to 6 GHz v01r04: SAR Measurement Requirements for 100 MHz to 6 GHz.

KDB865664 D02 RF Exposure Reporting v01r02: RF Exposure Compliance Reporting and Documentation Considerations

6 Specific Absorption Rate (SAR)

6.1 Introduction

SAR is related to the rate at which energy is absorbed per unit mass in an object exposed to a radio field. The SAR distribution in a biological body is complicated and is usually carried out by experimental techniques or numerical modeling. The standard recommends limits for two tiers of groups, occupational/controlled and general population/uncontrolled, based on a person's awareness and ability to exercise control over his or her exposure. In general, occupational/controlled exposure limits are higher than the limits for general population/uncontrolled.

6.2 SAR Definition

The SAR definition is the time derivative (rate) of the incremental energy (dW) absorbed by (dissipated in) an incremental mass (dm) contained in a volume element (dv) of a given density (ρ). The equation description is as below:

$$SAR = \frac{d}{dt} \left(\frac{dW}{dm} \right) = \frac{d}{dt} \left(\frac{dW}{\rho dv} \right)$$

SAR is expressed in units of Watts per kilogram (W/kg)

SAR measurement can be either related to the temperature elevation in tissue by

$$SAR = c \left(\frac{\delta T}{\delta t} \right)$$

Where: C is the specific heat capacity, δT is the temperature rise and δt is the exposure duration, or related to the electrical field in the tissue by

$$SAR = \frac{\sigma |E|^2}{\rho}$$

Where: σ is the conductivity of the tissue, ρ is the mass density of tissue and E is the RMS electrical field strength.

However for evaluating SAR of low power transmitter, electrical field measurement is typically applied.

7 Tissue Simulating Liquids

7.1 Targets for tissue simulating liquid

Table 7.1: Targets for tissue simulating liquid

Frequency(MHz)	Liquid Type	Conductivity(σ)	$\pm 5\%$ Range	Permittivity(ϵ)	$\pm 5\%$ Range
835	Head	0.90	0.86~0.95	41.5	39.4~43.6
835	Body	0.97	0.92~1.02	55.2	52.4~58.0
1900	Head	1.40	1.33~1.47	40.0	38.0~42.0
1900	Body	1.52	1.44~1.60	53.3	50.6~56.0
2450	Head	1.80	1.71~1.89	39.2	37.2~41.2
2450	Body	1.95	1.85~2.05	52.7	50.1~55.3

7.2 Dielectric Performance

Table 7.2: Dielectric Performance of Tissue Simulating Liquid

Measurement Date yyyy/mm/dd	Frequency	Type	Permittivity ϵ	Drift (%)	Conductivity σ (S/m)	Drift (%)
2017/11/8	835 MHz	Head	42.26	1.83	0.905	0.56
		Body	54.35	-1.54	0.967	-0.31
2017/11/10	1900 MHz	Head	39.78	-0.55	1.385	-1.07
		Body	54.1	1.50	1.525	0.33
2017/11/11	2450 MHz	Head	39.25	0.13	1.767	-1.83
		Body	52.83	0.25	1.967	0.87

Note: The liquid temperature is 22.0 °C

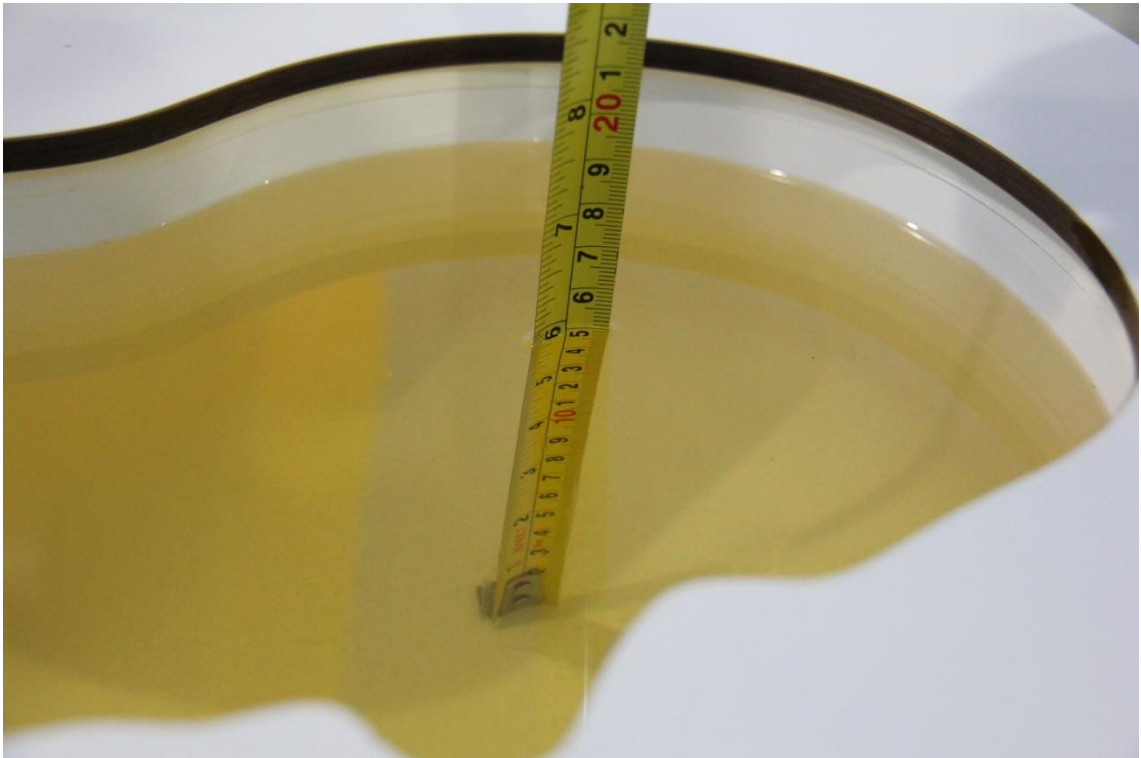

Picture 7-1 Liquid depth in the Head Phantom (835MHz)

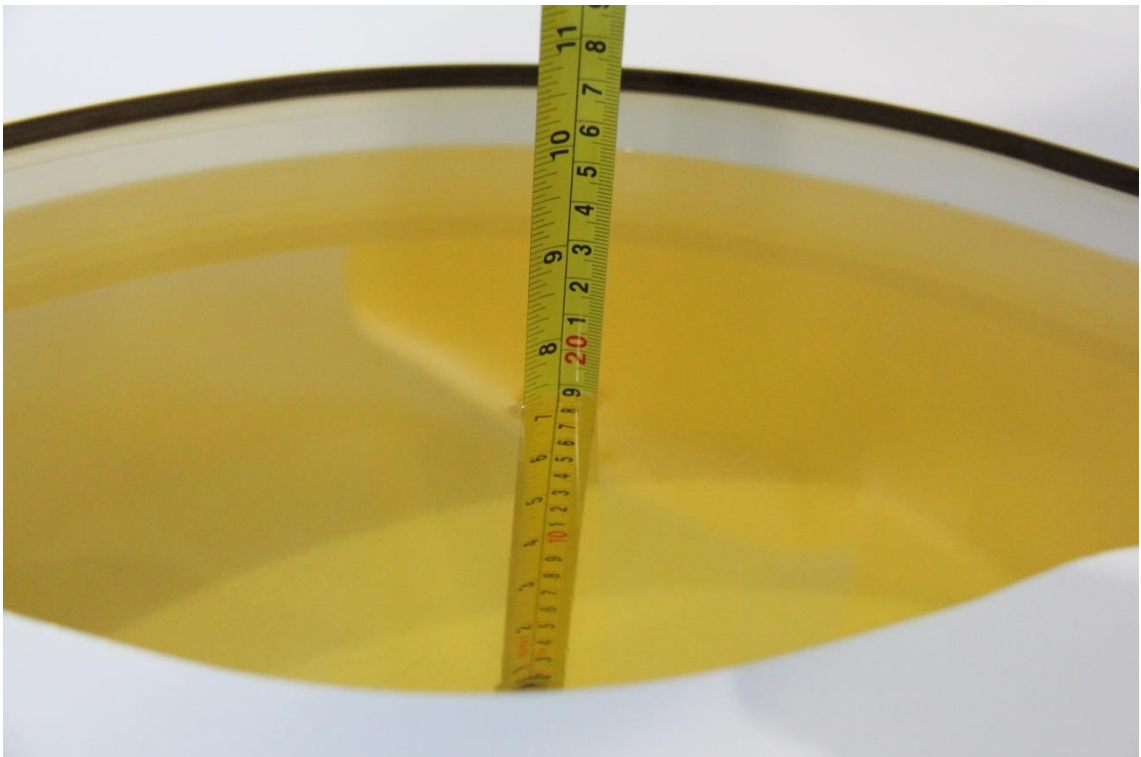

Picture 7-2 Liquid depth in the Flat Phantom (835MHz)

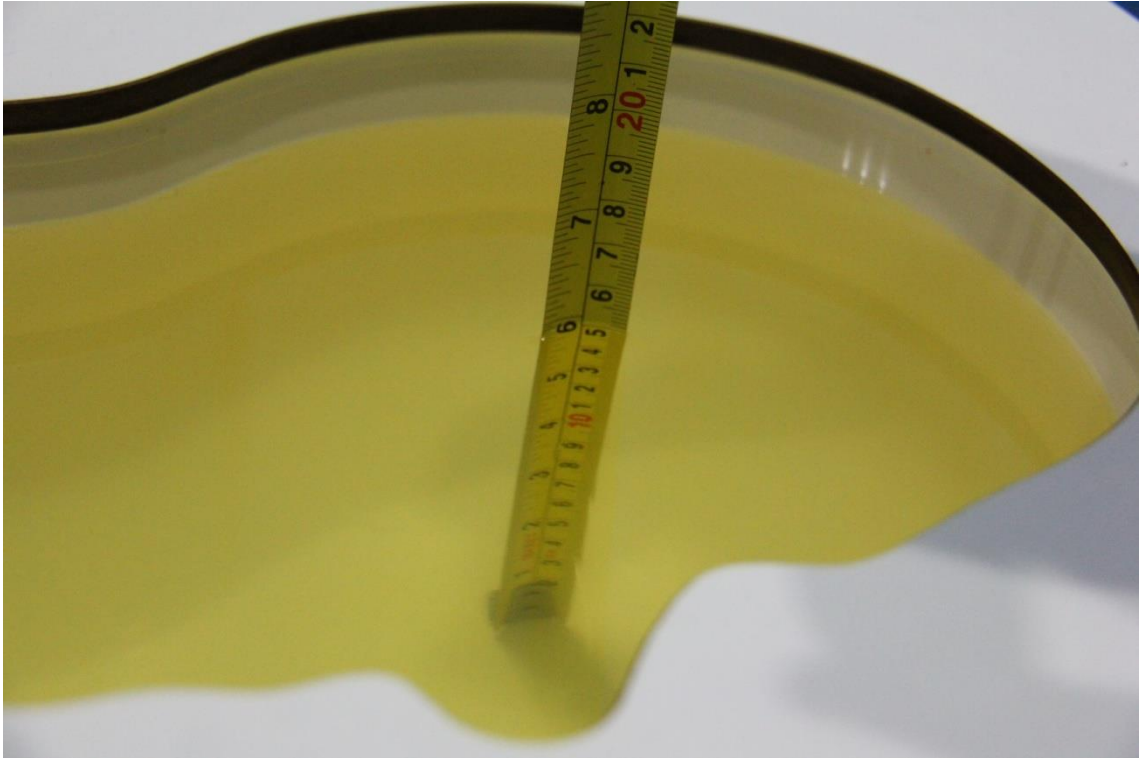

Picture 7-3 Liquid depth in the Head Phantom (1900 MHz)



Picture 7-4 Liquid depth in the Flat Phantom (1900MHz)

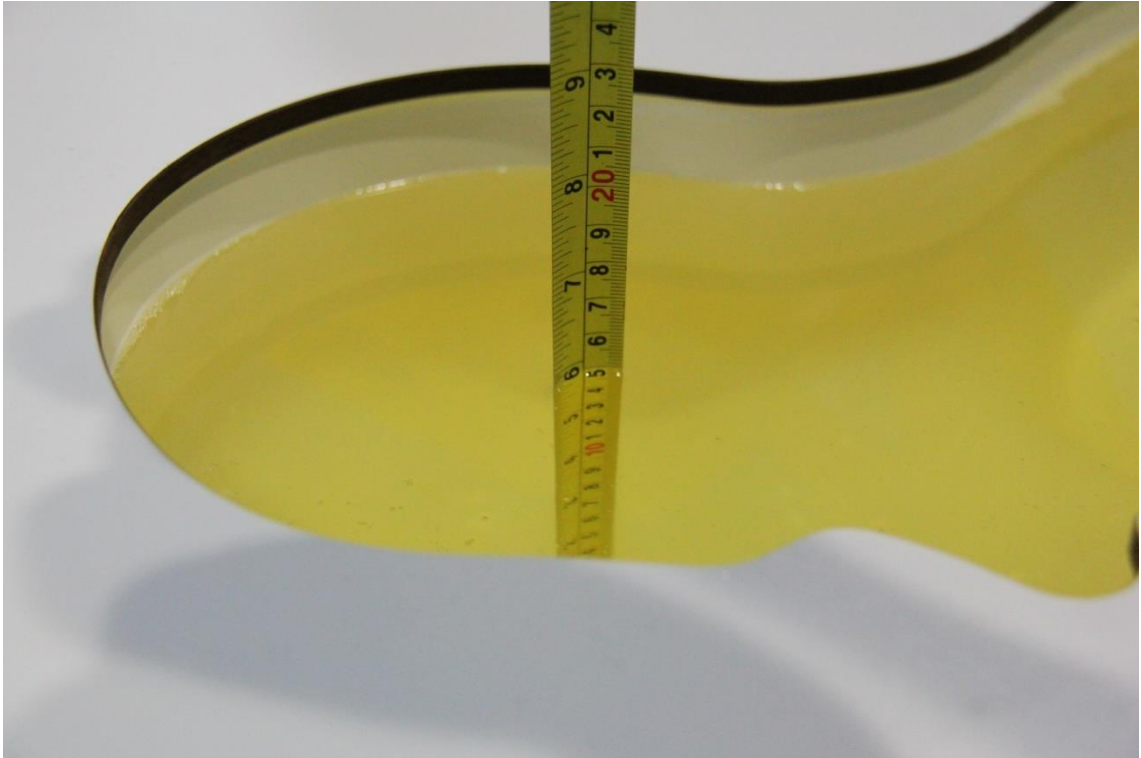

Picture 7-5 Liquid depth in the Head Phantom (2450MHz)

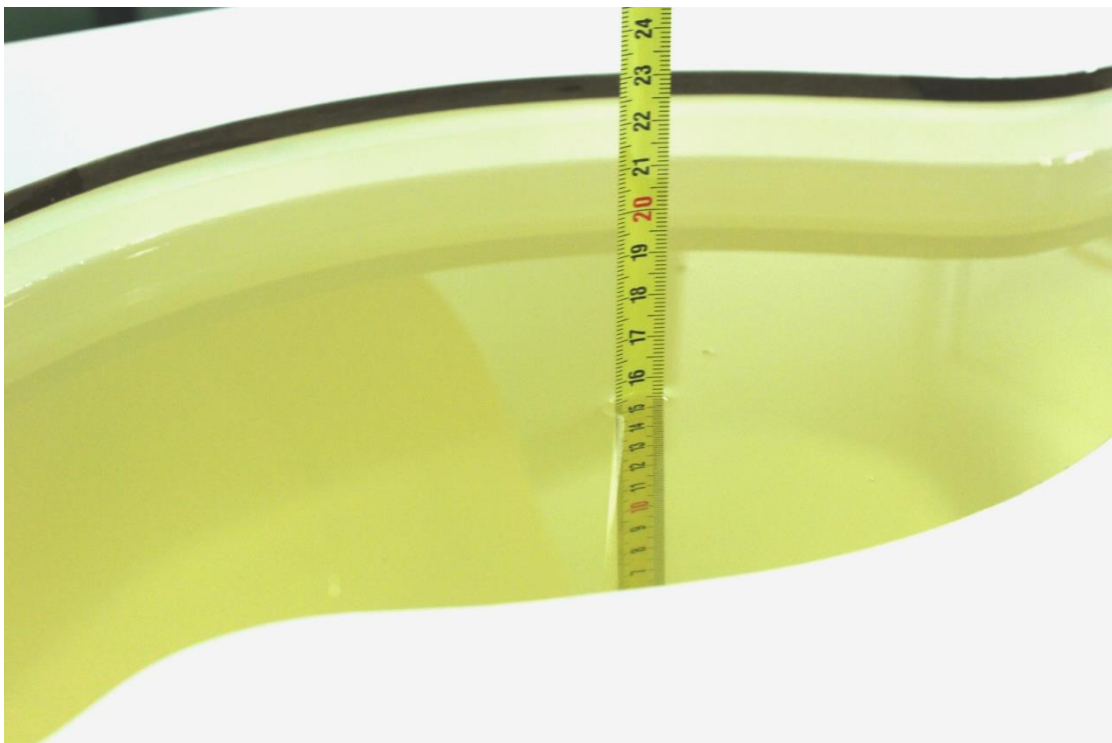

Picture 7-6 Liquid depth in the Flat Phantom (2450MHz)

8 System verification

8.1 System Setup

In the simplified setup for system evaluation, the DUT is replaced by a calibrated dipole and the power source is replaced by a continuous wave that comes from a signal generator. The calibrated dipole must be placed beneath the flat phantom section of the SAM twin phantom with the correct distance holder. The distance holder should touch the phantom surface with a light pressure at the reference marking and be oriented parallel to the long side of the phantom. The equipment setup is shown below:

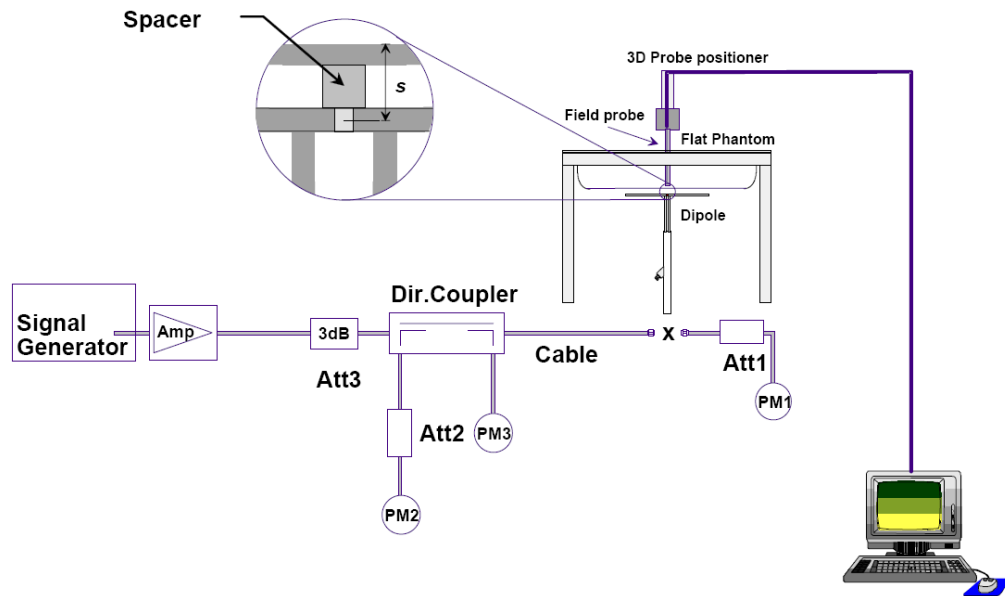

Picture 8.1 System Setup for System Evaluation

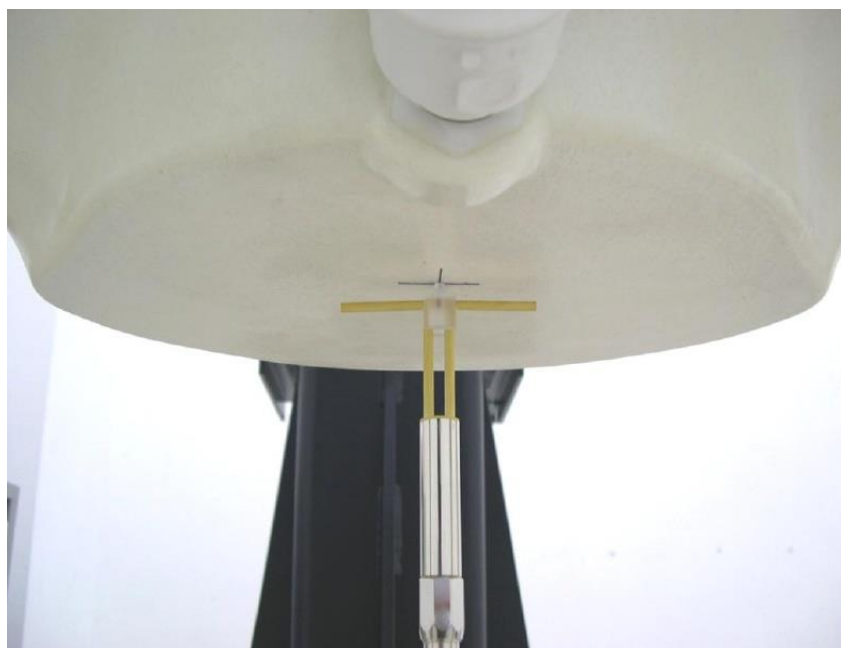

Picture 8.2 Photo of Dipole Setup

8.2 System Verification

SAR system verification is required to confirm measurement accuracy, according to the tissue dielectric media, probe calibration points and other system operating parameters required for measuring the SAR of a test device. The system verification must be performed for each frequency band and within the valid range of each probe calibration point required for testing the device.

The system verification results are required that the area scan estimated 1-g SAR is within 3% of the zoom scan 1-g SAR. The details are presented in annex B.

Table 8.1: System Verification of Head

Measurement Date (yyyy-mm-dd)	Frequency	Target value (W/kg)		Measured value (W/kg)		Deviation	
		10 g Average	1 g Average	10 g Average	1 g Average	10 g Average	1 g Average
2017/11/8	835 MHz	6.06	9.37	6.08	9.4	0.33%	0.32%
2017/11/10	1900 MHz	21.0	40.0	21.24	39.32	1.14%	-1.70%
2017/11/11	2450 MHz	24.7	52.2	24.6	51.2	-0.40%	-1.92%

Table 8.2: System Verification of Body

Measurement Date (yyyy-mm-dd)	Frequency	Target value (W/kg)		Measured value (W/kg)		Deviation	
		10 g Average	1 g Average	10 g Average	1 g Average	10 g Average	1 g Average
2017/11/8	835 MHz	6.12	9.41	6.08	9.56	-0.65%	1.59%
2017/11/10	1900 MHz	21.5	40.5	21.4	39.8	-0.47%	-1.73%
2017/11/11	2450 MHz	23.8	50.4	23.6	50.28	-0.84%	-0.24%

9 Measurement Procedures

9.1 Tests to be performed

In order to determine the highest value of the peak spatial-average SAR of a handset, all device positions, configurations and operational modes shall be tested for each frequency band according to steps 1 to 3 below. A flowchart of the test process is shown in picture 9.1.

Step 1: The tests described in 9.2 shall be performed at the channel that is closest to the center of the transmit frequency band (f_c) for:

- a) all device positions (cheek and tilt, for both left and right sides of the SAM phantom, as described in annex D),
- b) all configurations for each device position in a), e.g., antenna extended and retracted, and
- c) all operational modes, e.g., analogue and digital, for each device position in a) and configuration in b) in each frequency band.

If more than three frequencies need to be tested according to 11.1 (i.e., $N_c > 3$), then all frequencies, configurations and modes shall be tested for all of the above test conditions.

Step 2: For the condition providing highest peak spatial-average SAR determined in Step 1, perform all tests described in 9.2 at all other test frequencies, i.e., lowest and highest frequencies. In addition, for all other conditions (device position, configuration and operational mode) where the peak spatial-average SAR value determined in Step 1 is within 3 dB of the applicable SAR limit, it is recommended that all other test frequencies shall be tested as well.

Step 3: Examine all data to determine the highest value of the peak spatial-average SAR found in Steps 1 to 2.

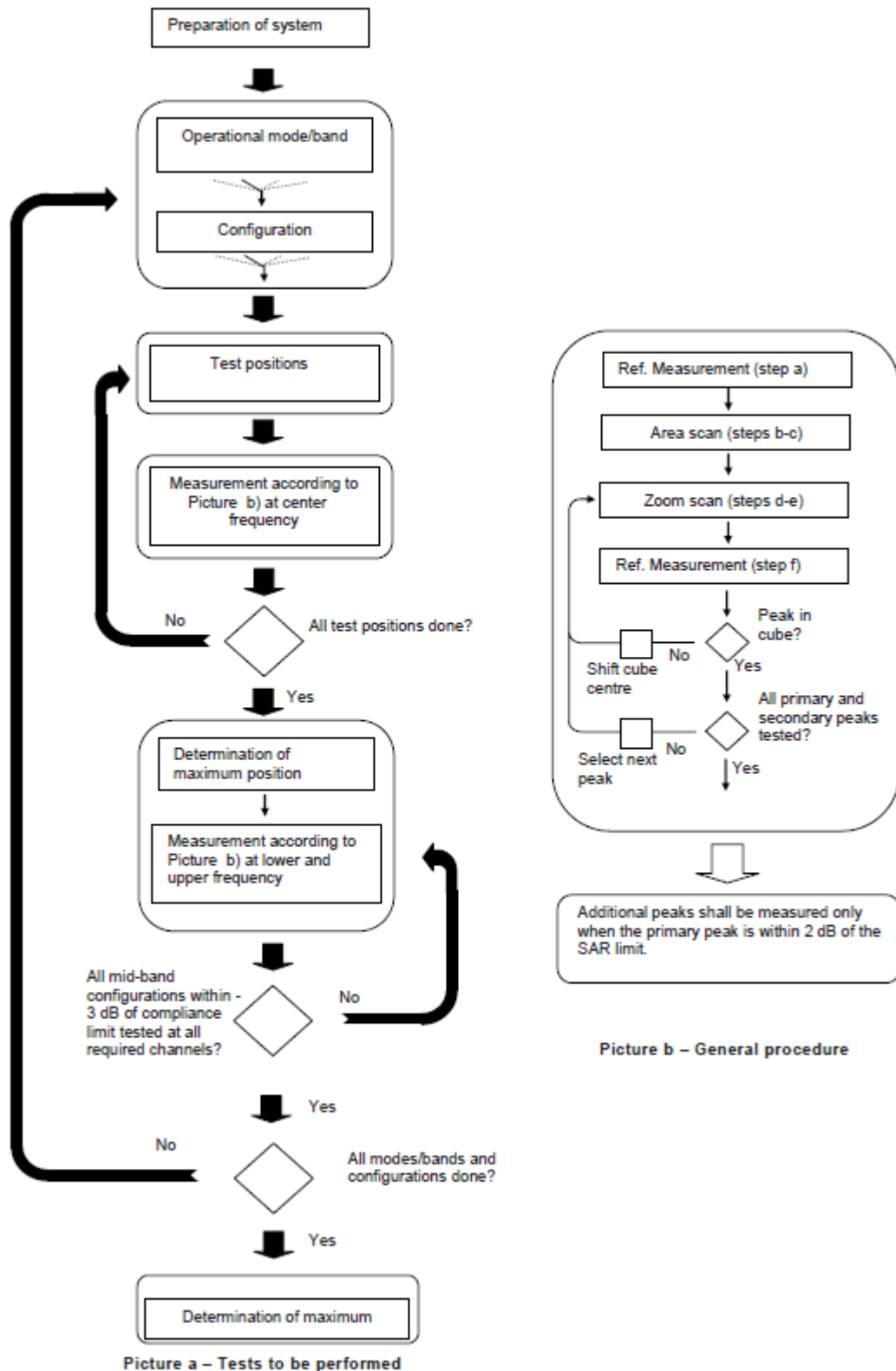

Picture 9.1 Block diagram of the tests to be performed

9.2 General Measurement Procedure

The area and zoom scan resolutions specified in the table below must be applied to the SAR measurements and fully documented in SAR reports to qualify for TCB approval. Probe boundary effect error compensation is required for measurements with the probe tip closer than half a probe tip diameter to the phantom surface. Both the probe tip diameter and sensor offset distance must satisfy measurement protocols; to ensure probe boundary effect errors are minimized and the higher fields closest to the phantom surface can be correctly measured and extrapolated to the phantom surface for computing 1-g SAR. Tolerances of the post-processing algorithms must be verified by the test laboratory for the scan resolutions used in the SAR measurements, according to the reference distribution functions specified in IEEE Std 1528-2003. The results should be documented as part of the system validation records and may be requested to support test results when all the measurement parameters in the following table are not satisfied.

		≤ 3 GHz	> 3 GHz	
Maximum distance from closest measurement point (geometric center of probe sensors) to phantom surface		5 ± 1 mm	$\frac{1}{2} \cdot \delta \cdot \ln(2) \pm 0.5$ mm	
Maximum probe angle from probe axis to phantom surface normal at the measurement location		$30^\circ \pm 1^\circ$	$20^\circ \pm 1^\circ$	
Maximum area scan spatial resolution: Δx_{Area} , Δy_{Area}		≤ 2 GHz: ≤ 15 mm 2 – 3 GHz: ≤ 12 mm	3 – 4 GHz: ≤ 12 mm 4 – 6 GHz: ≤ 10 mm	
		When the x or y dimension of the test device, in the measurement plane orientation, is smaller than the above, the measurement resolution must be \leq the corresponding x or y dimension of the test device with at least one measurement point on the test device.		
Maximum zoom scan spatial resolution: Δx_{Zoom} , Δy_{Zoom}		≤ 2 GHz: ≤ 8 mm 2 – 3 GHz: ≤ 5 mm*	3 – 4 GHz: ≤ 5 mm* 4 – 6 GHz: ≤ 4 mm*	
Maximum zoom scan spatial resolution, normal to phantom surface	uniform grid: $\Delta z_{Zoom}(n)$	≤ 5 mm	3 – 4 GHz: ≤ 4 mm 4 – 5 GHz: ≤ 3 mm 5 – 6 GHz: ≤ 2 mm	
	graded grid	$\Delta z_{Zoom}(1)$: between 1 st two points closest to phantom surface	≤ 4 mm	3 – 4 GHz: ≤ 3 mm 4 – 5 GHz: ≤ 2.5 mm 5 – 6 GHz: ≤ 2 mm
		$\Delta z_{Zoom}(n>1)$: between subsequent points	$\leq 1.5 \cdot \Delta z_{Zoom}(n-1)$	
Minimum zoom scan volume	x, y, z	≥ 30 mm	3 – 4 GHz: ≥ 28 mm 4 – 5 GHz: ≥ 25 mm 5 – 6 GHz: ≥ 22 mm	
<p>Note: δ is the penetration depth of a plane-wave at normal incidence to the tissue medium; see draft standard IEEE P1528-2011 for details.</p> <p>* When zoom scan is required and the <i>reported</i> SAR from the area scan based 1-g SAR estimation procedures of KDB 447498 is ≤ 1.4 W/kg, ≤ 8 mm, ≤ 7 mm and ≤ 5 mm zoom scan resolution may be applied, respectively, for 2 GHz to 3 GHz, 3 GHz to 4 GHz and 4 GHz to 6 GHz.</p>				

9.3 WCDMA Measurement Procedures for SAR

The following procedures are applicable to WCDMA handsets operating under 3GPP Release99, Release 5 and Release 6. The default test configuration is to measure SAR with an established radio link between the DUT and a communication test set using a 12.2kbps RMC (reference measurement channel) configured in Test Loop Mode 1. SAR is selectively confirmed for other physical channel configurations (DPCCH & DPDCH_n), HSDPA and HSPA (HSUPA/HSDPA) modes according to output power, exposure conditions and device operating capabilities. Both uplink and downlink should be configured with the same RMC or AMR, when required. SAR for Release 5 HSDPA and Release 6 HSPA are measured using the applicable FRC (fixed reference channel) and E-DCH reference channel configurations. Maximum output power is verified according to applicable versions of 3GPP TS 34.121 and SAR must be measured according to these maximum output conditions. When Maximum Power Reduction (MPR) is not implemented according to Cubic Metric (CM) requirements for Release 6 HSPA, the following procedures do not apply.

For Release 5 HSDPA Data Devices:

Sub-test	β_c	β_d	β_d (SF)	β_c / β_d	β_{hs}	CM/dB
1	2/15	15/15	64	2/15	4/15	0.0
2	12/15	15/15	64	12/15	24/25	1.0
3	15/15	8/15	64	15/8	30/15	1.5
4	15/15	4/15	64	15/4	30/15	1.5

For Release 6 HSPA Data Devices

Sub-test	β_c	β_d	β_d (SF)	β_c / β_d	β_{hs}	β_{ec}	β_{ed}	β_{ed} (SF)	β_{ed} (codes)	CM (dB)	MPR (dB)	AG Index	E-TFCI
1	11/15	15/15	64	11/15	22/15	209/225	1039/225	4	1	1.5	1.5	20	75
2	6/15	15/15	64	6/15	12/15	12/15	12/15	4	1	1.5	1.5	12	67
3	15/15	9/15	64	15/9	30/15	30/15	$\beta_{ed1}:47/15$ $\beta_{ed2}:47/15$	4	2	1.5	1.5	15	92
4	2/15	15/15	64	2/15	4/15	4/15	56/75	4	1	1.5	1.5	17	71
5	15/15	15/15	64	15/15	24/15	30/15	134/15	4	1	1.5	1.5	21	81

Rel.8 DC-HSDPA (Cat 24)

SAR test exclusion for Rel.8 DC-HSDPA must satisfy the SAR test exclusion requirements of Rel.5 HSDPA. SAR test exclusion for DC-HSDPA devices is determined by power measurements according to the H-Set 12, Fixed Reference Channel (FRC) configuration in Table C.8.1.12 of 3GPP TS 34.121-1. A primary and a secondary serving HS-DSCH Cell are required to perform the power measurement and for the results to qualify for SAR test exclusion.

9.4 Bluetooth & Wi-Fi Measurement Procedures for SAR

Normal network operating configurations are not suitable for measuring the SAR of 802.11 transmitters in general. Unpredictable fluctuations in network traffic and antenna diversity conditions can introduce undesirable variations in SAR results. The SAR for these devices should be measured using chipset based test mode software to ensure that the results are consistent and reliable.

Chipset based test mode software is hardware dependent and generally varies among manufacturers. The device operating parameters established in a test mode for SAR measurements must be identical to those programmed in production units, including output power levels, amplifier gain settings and other RF performance tuning parameters. The test frequencies should correspond to actual channel frequencies defined for domestic use. SAR for devices with switched diversity should be measured with only one antenna transmitting at a time during each SAR measurement, according to a fixed modulation and data rate. The same data pattern should be used for all measurements.

9.5 Power Drift

To control the output power stability during the SAR test, DASY4 system calculates the power drift by measuring the E-field at the same location at the beginning and at the end of the measurement for each test position. These drift values can be found in section 14 labeled as: (Power Drift [dB]). This ensures that the power drift during one measurement is within 5%.

10 Area Scan Based 1-g SAR

10.1 Requirement of KDB

According to the KDB447498 D01 v05, when the implementation is based the specific polynomial fit algorithm as presented at the 29th Bioelectromagnetics Society meeting (2007) and the estimated 1-g SAR is ≤ 1.2 W/kg, a zoom scan measurement is not required provided it is also not needed for any other purpose; for example, if the peak SAR location required for simultaneous transmission SAR test exclusion can be determined accurately by the SAR system or manually to discriminate between distinctive peaks and scattered noisy SAR distributions from area scans.

There must not be any warning or alert messages due to various measurement concerns identified by the SAR system; for example, noise in measurements, peaks too close to scan boundary, peaks are too sharp, spatial resolution and uncertainty issues etc. The SAR system verification must also demonstrate that the area scan estimated 1-g SAR is within 3% of the zoom scan 1-g SAR (See Annex B). When all the SAR results for each exposure condition in a frequency band and wireless mode are based on estimated 1-g SAR, the 1-g SAR for the highest SAR configuration must be determined by a zoom scan.

10.2 Fast SAR Algorithms

The approach is based on the area scan measurement applying a frequency dependent attenuation parameter. This attenuation parameter was empirically determined by analyzing a large number of phones. The MOTOROLA FAST SAR was developed and validated by the MOTOROLA Research Group in Ft. Lauderdale.

In the initial study, an approximation algorithm based on Linear fit was developed. The accuracy of the algorithm has been demonstrated across a broad frequency range (136-2450 MHz) and for both 1- and 10-g averaged SAR using a sample of 264 SAR measurements from 55 wireless handsets. For the sample size studied, the root-mean-squared errors of the algorithm are 1.2% and 5.8% for 1- and 10-g averaged SAR, respectively. The paper describing the algorithm in detail is expected to be published in August 2004 within the Special Issue of Transactions on MTT.

In the second step, the same research group optimized the fitting algorithm to an Polynomial fit whereby the frequency validity was extended to cover the range 30-6000MHz. Details of this study can be found in the BEMS 2007 Proceedings.

Both algorithms are implemented in DASY software.

11 Conducted Output Power

11.1 GSM Measurement result

During the process of testing, the EUT was controlled via Agilent Digital Radio Communication tester (E5515C) to ensure the maximum power transmission and proper modulation. This result contains conducted output power for the EUT. In all cases, the measured peak output power should be greater and within 5% than EMI measurement.

Table 11-1 GSM850 #1

GSM850 #1								
Config	Tune-up	Measured Power (dBm)			Calculation	Average Power (dBm)		
		CH251 848.8 MHz	CH190 836.6 MHz	CH128 824.2 MHz		CH251 848.8 MHz	CH190 836.6 MHz	CH128 824.2 MHz
GSM Speech	34.50	32.85	32.89	32.87				
GPRS 1 Txslot	34.00	32.90	32.92	32.90	-9.03	23.87	23.89	23.87
GPRS 2 Txslots	32.50	31.36	31.40	31.38	-6.02	25.34	25.38	25.36
GPRS 3 Txslots	31.00	29.36	29.40	29.38	-4.26	25.10	25.14	25.12
GPRS 4 Txslots	29.00	27.88	27.93	27.91	-3.01	24.87	24.92	24.90
EGPRS GMSK 1 Txslot	34.00	32.37	32.92	33.41	-9.03	23.34	23.89	24.38
EGPRS GMSK 2 Txslots	32.50	30.94	31.39	31.89	-6.02	24.92	25.37	25.87
EGPRS GMSK 3 Txslots	31.00	29.83	29.40	29.89	-4.26	25.57	25.14	25.63
EGPRS GMSK 4 Txslots	29.00	27.36	27.93	28.42	-3.01	24.35	24.92	25.41
EGPRS 8PSK 1 Txslot	28.00	27.04	26.79	26.84	-9.03	18.01	17.76	17.81
EGPRS 8PSK 2 Txslots	27.50	25.72	26.27	25.64	-6.02	19.70	20.25	19.62
EGPRS 8PSK 3 Txslots	25.00	24.29	23.33	23.42	-4.26	20.03	19.07	19.16
EGPRS 8PSK 4 Txslots	23.00	22.14	21.92	21.93	-3.01	19.13	18.91	18.92

Table 11-2 PCS1900 #1

PCS1900 #1								
Config	Tune-up	Measured Power (dBm)			Calculation	Average Power (dBm)		
		CH810 1909.8 MHz	CH661 1880 MHz	CH512 1850.2 MHz		CH810 1909.8 MHz	CH661 1880 MHz	CH512 1850.2 MHz
GSM Speech	31.00	30.07	30.10	30.08				
GPRS 1 Txslot	31.00	30.16	30.17	30.14	-9.03	21.13	21.14	21.11
GPRS 2 Txslots	29.50	28.60	28.63	28.58	-6.02	22.58	22.61	22.56
GPRS 3 Txslots	27.50	26.57	26.60	26.53	-4.26	22.31	22.34	22.27
GPRS 4 Txslots	26.00	25.13	25.15	25.08	-3.01	22.12	22.14	22.07
EGPRS GMSK 1 Txslot	31.00	30.15	30.23	30.12	-9.03	21.12	21.20	21.09
EGPRS GMSK 2 Txslots	29.50	28.59	28.69	28.57	-6.02	22.57	22.67	22.55
EGPRS GMSK 3 Txslots	27.50	26.57	26.66	26.52	-4.26	22.31	22.40	22.26
EGPRS GMSK 4 Txslots	26.00	25.13	25.21	25.07	-3.01	22.12	22.20	22.06
EGPRS 8PSK 1 Txslot	27.00	26.13	25.97	25.83	-9.03	17.10	16.94	16.80
EGPRS 8PSK 2 Txslots	26.00	24.83	25.11	24.85	-6.02	18.81	19.09	18.83
EGPRS 8PSK 3 Txslots	23.50	22.52	22.77	22.62	-4.26	18.26	18.51	18.36
EGPRS 8PSK 4 Txslots	22.50	21.40	21.50	21.35	-3.01	18.39	18.49	18.34

NOTES:

Division Factors

To average the power, the division factor is as follows:

1TX-slot = 1 transmit time slot out of 8 time slots=> conducted power divided by (8/1) => -9.03dB

2TX-slots = 2 transmit time slots out of 8 time slots=> conducted power divided by (8/2) => -6.02dB

3TX-slots = 3 transmit time slots out of 8 time slots=> conducted power divided by (8/3) => -4.26dB

4TX-slots = 4 transmit time slots out of 8 time slots=> conducted power divided by (8/4) => -3.01dB

According to the conducted power as above, the body measurements are performed with 2Txslots for 850MHz GPRS and 1900MHz.

11.2 WCDMA Measurement result

Table 11-3 WCDMA1900-BII #1

WCDMA1900-BII #1					
			Measured Power (dBm)		
Item		Tune-up	CH9538 1907.6 MHz	CH9400 1880 MHz	CH9262 1852.4 MHz
WCDMA	RMC	24.00	22.81	23.00	23.01
HSUPA	subtest1	22.00	20.44	20.12	20.15
	subtest2	21.50	19.94	20.10	20.01
	subtest3	22.00	20.93	21.08	21.03
	subtest4	21.00	19.29	19.56	19.60
	subtest5	22.50	21.91	22.11	22.11

Table 11-4 WCDMA850-BV #1

WCDMA850-BV #1					
			Measured Power (dBm)		
Item		Tune-up	CH4233 846.6 MHz	CH4182 835.4 MHz	CH4132 826.4 MHz
WCDMA	RMC	24.50	22.83	22.86	22.80
HSUPA	subtest1	21.50	20.44	19.98	19.90
	subtest2	21.50	19.95	19.97	19.90
	subtest3	22.50	20.92	20.96	20.88
	subtest4	21.00	19.42	19.45	19.36
	subtest5	22.50	21.89	21.94	21.85

11.3 Wi-Fi and BT Measurement result

Table 11-5 Bluetooth Power

Bluetooth Power				
Mode	Channel	Frequency	Tune-up	Measured
GFSK	78	2480 MHz	3.5	2.78
	39	2441 MHz	3.5	2.92
	0	2402 MHz	3.5	2.63
EDR2M-4_DQPSK	78	2480 MHz	3	2.32
	39	2441 MHz	3	2.51
	0	2402 MHz	3	2.26
EDR3M-8DPSK	78	2480 MHz	2.5	1.97
	39	2441 MHz	2.5	2.16
	0	2402 MHz	2.5	2.31



Table 11-6 WLAN2450 #1

WLAN2450 #1						
Band	Mode	Channel	Frequency	Data Rate	Tune-up	Measured
WLAN 2.4G 20M	802.11b	11	2462 MHz	1Mbps	15.50	14.48
		6	2437 MHz		15.50	14.75
		1	2412 MHz		15.50	14.58
		11	2462 MHz	2Mbps	/	/
		6	2437 MHz		15.50	14.70
		1	2412 MHz		/	/
		11	2462 MHz	5.5Mbps	/	/
		6	2437 MHz		15.50	14.30
		1	2412 MHz		/	/
	11	2462 MHz	11Mbps	/	/	
	6	2437 MHz		15.50	14.20	
	1	2412 MHz		/	/	
	802.11g	6Mbps	11	2462 MHz	14.50	13.67
			6	2437 MHz	14.50	14.10
			1	2412 MHz	14.50	13.37
		9Mbps	11	2462 MHz	/	/
			6	2437 MHz	14.50	14.05
			1	2412 MHz	/	/
		12Mbps	11	2462 MHz	/	/
			6	2437 MHz	14.50	14.00
			1	2412 MHz	/	/
		18Mbps	11	2462 MHz	/	/
			6	2437 MHz	14.50	13.36
			1	2412 MHz	/	/
		24Mbps	11	2462 MHz	/	/
			6	2437 MHz	14.50	13.80
			1	2412 MHz	/	/
		36Mbps	11	2462 MHz	/	/
			6	2437 MHz	14.50	13.64
			1	2412 MHz	/	/
		48Mbps	11	2462 MHz	/	/
			6	2437 MHz	14.50	13.71
			1	2412 MHz	/	/
	54Mbps	11	2462 MHz	/	/	
		6	2437 MHz	14.50	13.18	
		1	2412 MHz	/	/	
	802.11n 20M	MCS0	11	2462 MHz	14.50	13.63
			6	2437 MHz	14.50	14.06
			1	2412 MHz	14.00	13.15
		MCS1	11	2462 MHz	/	/
			6	2437 MHz	14.50	13.96
			1	2412 MHz	/	/
		MCS2	11	2462 MHz	/	/
			6	2437 MHz	14.50	13.88
			1	2412 MHz	/	/
MCS3		11	2462 MHz	/	/	
		6	2437 MHz	14.50	13.21	
		1	2412 MHz	/	/	
MCS4		11	2462 MHz	/	/	
		6	2437 MHz	14.50	13.65	
		1	2412 MHz	/	/	
MCS5		11	2462 MHz	/	/	
		6	2437 MHz	14.50	13.25	
		1	2412 MHz	/	/	
MCS6		11	2462 MHz	/	/	
		6	2437 MHz	14.50	13.21	
		1	2412 MHz	/	/	
MCS7	11	2462 MHz	/	/		
	6	2437 MHz	14.50	13.13		
	1	2412 MHz	/	/		



WLAN 2.4G 40M	802.11n 40M	9	2462 MHz	MCS0	11.50	10.78
		6	2437 MHz		11.50	11.49
		3	2412 MHz		11.50	11.38
		9	2462 MHz	MCS1	/	/
		6	2437 MHz		11.50	11.29
		3	2412 MHz		/	/
		9	2462 MHz	MCS2	/	/
		6	2437 MHz		11.50	11.13
		3	2412 MHz		/	/
		9	2462 MHz	MCS3	/	/
		6	2437 MHz		11.50	10.97
		3	2412 MHz		/	/
		9	2462 MHz	MCS4	/	/
		6	2437 MHz		11.50	10.74
		3	2412 MHz		/	/
		9	2462 MHz	MCS5	/	/
		6	2437 MHz		11.50	9.71
		3	2412 MHz		/	/
		9	2462 MHz	MCS6	/	/
		6	2437 MHz		11.50	9.81
		3	2412 MHz		/	/
9	2462 MHz	MCS7	/	/		
6	2437 MHz		11.50	9.74		
3	2412 MHz		/	/		

12 Simultaneous TX SAR Considerations

12.1 Introduction

The following procedures adopted from “FCC SAR Considerations for Cell Phones with Multiple Transmitters” are applicable to handsets with built-in unlicensed transmitters such as 802.11 a/b/g and Bluetooth devices which may simultaneously transmit with the licensed transmitter. For this device, the BT and Wi-Fi can transmit simultaneous with other transmitters.

12.2 Transmit Antenna Separation Distances

WIFI/GPS

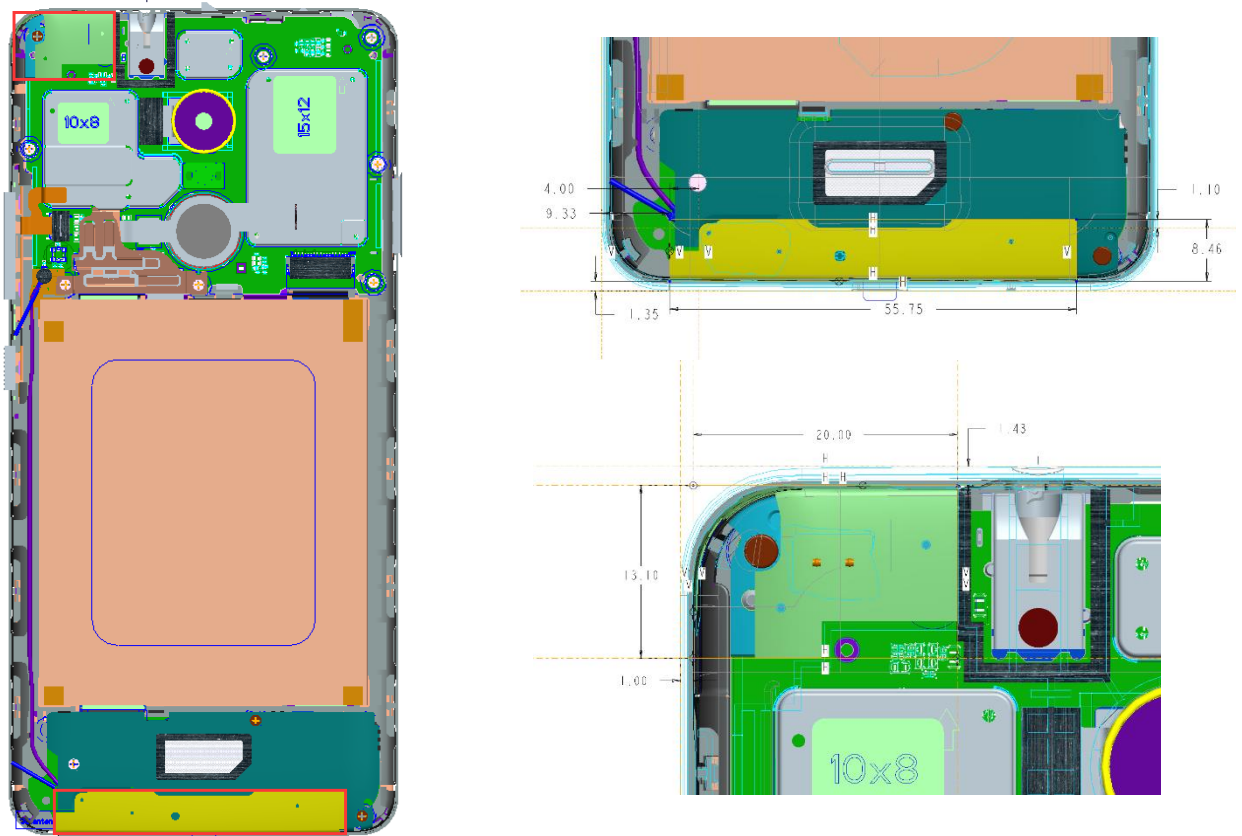

Picture 12.1 Antenna Locations

12.3 SAR Measurement Positions

According to the KDB941225 D06 Hot Spot SAR v01, the edges with less than 2.5 cm distance to the antennas need to be tested for SAR.

SAR measurement positions						
Mode	Front	Rear	Left edge	Right edge	Top edge	Bottom edge
Main antenna	Yes	Yes	Yes	Yes	No	Yes
WLAN	Yes	Yes	No	Yes	Yes	No

12.4 Standalone SAR Test Exclusion Considerations

Standalone 1-g head or body SAR evaluation by measurement or numerical simulation is not required when the corresponding SAR Exclusion Threshold condition, listed below, is satisfied. The 1-g SAR test exclusion threshold for 100 MHz to 6 GHz at test separation distances ≤ 50 mm are determined by:

$[(\text{max. power of channel, including tune-up tolerance, mW}) / (\text{min. test separation distance, mm})] \cdot [\sqrt{f(\text{GHz})}] \leq 3.0$ for 1-g SAR, where

- $f(\text{GHz})$ is the RF channel transmit frequency in GHz
- Power and distance are rounded to the nearest mW and mm before calculation
- The result is rounded to one decimal place for comparison

Table 12.1: Standalone SAR test exclusion considerations

Band/Mode	F(GHz)	Position	SAR test exclusion threshold (mW)	RF output power		SAR test exclusion
				dBm	mW	
Bluetooth	2.441	Head	9.6	3.5	2.24	Yes
		Body	9.6	3.5	2.24	Yes
2.4GHz WLAN 802.11 b	2.45	Head	9.58	15.5	35.48	No
		Body	9.58	15.5	35.48	No

13 Evaluation of Simultaneous

Table 13.1: The sum of reported SAR values for main antenna and WiFi

	Position	Main antenna	WiFi	Sum
Highest reported SAR value for Head	Left hand, Touch cheek	0.21	1.27	1.48
Highest reported SAR value for Body	Bottom	1.16	/	1.16

Table 13.2: The sum of reported SAR values for main antenna and BT

	Position	Main antenna	BT	Sum
Maximum reported SAR value for Head	Left hand, Touch cheek	0.21	0.09	0.30
Maximum reported SAR value for Body	Bottom	1.16	0.05	1.21

[1] - Estimated SAR for Bluetooth (see the table 13.3)

Table 13.3: Estimated SAR for Bluetooth

Mode/Band	F (GHz)	Position	Distance (mm)	Upper limit of power *		Estimated _{1g} (W/kg)
				dBm	mW	
Bluetooth	2.441	Head	5	3.5	2.24	0.09
Bluetooth	2.441	Body	10	3.5	2.24	0.05

* - Maximum possible output power declared by manufacturer

When standalone SAR test exclusion applies to an antenna that transmits simultaneously with other antennas, the standalone SAR must be estimated according to following to determine simultaneous transmission SAR test exclusion:

(max. power of channel, including tune-up tolerance, mW)/(min. test separation distance, mm) · [$\sqrt{f(\text{GHz})/x}$] W/kg for test separation distances ≤ 50 mm;

where $x = 7.5$ for 1-g SAR.

When the minimum test separation distance is < 5 mm, a distance of 5 mm is applied to determine SAR test exclusion

Conclusion:

According to the above tables, the sum of reported SAR values is < 1.6 W/kg. So the simultaneous transmission SAR with volume scans is not required.

14 SAR Test Result

It is determined by user manual for the distance between the EUT and the phantom bottom.

The distance is 10mm and just applied to the condition of body worn accessory.

It is performed for all SAR measurements with area scan based 1-g SAR estimation (Fast SAR). A zoom scan measurement is added when the estimated 1-g SAR is the highest measured SAR in each exposure configuration, wireless mode and frequency band combination or more than 1.2W/kg.

The calculated SAR is obtained by the following formula:

$$\text{Reported SAR} = \text{Measured SAR} \times 10^{(P_{\text{Target}} - P_{\text{Measured}})/10}$$

Where P_{Target} is the power of manufacturing upper limit;

P_{Measured} is the measured power in chapter 11.

Mode	Duty Cycle
Speech for GSM850/1900	1:8.3
GPRS&EGPRS for GSM850/1900	1:4
WCDMA	1:1

14.1 Evaluation of multi-batteries

Note: B1: TLp029C7 **B2:** TLp029C1

We'll perform the head measurement in all bands with the primary battery depending on the evaluation of multi-batteries retest on highest value point with other battery. Then, repeat the measurement in the Body test.

frequency		Mode/Band	Side	Position	BatteryType	1g SAR (W/kg)	PowerDrift
MHz	Channel						
836.6	190	GSM850	Left	Cheek	TLp029C7	0.105	0.06
836.6	190	GSM850	Left	Cheek	TLp029C1	0.106	0.02

Note: According to the values in the above table, the battery, B2, is the primary

battery. We'll perform the head measurement with this battery and retest on highest value point

with others.

frequency		Mode/Band	Position	BatteryType	1g SAR (W/kg)	PowerDrift
MHz	Channel					
836.6	190	GSM850	Front	TLp029C7	0.077	-0.07
836.6	190	GSM850	Front	TLp029C1	0.088	0.01

Note: According to the values in the above table, the battery, B2, is the primary

battery. We'll perform the Body measurement with this battery and retest on highest value point

with others.

14.2 SAR results

Note: H1: CCB0046A10C1 H2: CCB0046A10C4

Table 14-1 GSM850 #1 Head

GSM850 #1 Head									
Ambient Temperature:			22.5			Liquid Temperature:			22.3
Mode	Device orientation	SAR measurement	Measured SAR [W/kg]			Reported SAR [W/kg]			
			CH251 848.8 MHz	CH190 836.6 MHz	CH128 824.2 MHz	CH251 848.8 MHz	CH190 836.6 MHz	CH128 824.2 MHz	
GSM	Tune-up		34.50	34.50	34.50	Scaling factor*			
	Slot Average Power [dBm]		32.85	32.89	32.87	1.46	1.45	1.45	
	Left Cheek	1g SAR	0.127	0.106	0.089	0.19	0.15	0.13	
		10g SAR	0.097	0.083	0.068	0.14	0.12	0.10	
		Deviation	0.09	0.02	-0.04	0.09	0.02	-0.04	
	Left Tilt	1g SAR		0.062			0.09		
		10g SAR		0.047			0.07		
		Deviation		0.08			0.08		
	Right Cheek	1g SAR		0.073			0.11		
		10g SAR		0.058			0.08		
		Deviation		-0.01			-0.01		
	Right Tilt	1g SAR		0.067			0.10		
		10g SAR		0.053			0.08		
		Deviation		0.05			0.05		
	GSM B1	Left Cheek	1g SAR	0.124			0.18		
10g SAR			0.094			0.14			
Deviation			0.06			0.06			

Table 14-2 GSM850 #1 Body

GSM850 #1 Body									
Ambient Temperature:			22.5			Liquid Temperature:			22.3
Mode	Device orientation	SAR measurement	Measured SAR [W/kg]			Reported SAR [W/kg]			
			CH251 848.8 MHz	CH190 836.6 MHz	CH128 824.2 MHz	CH251 848.8 MHz	CH190 836.6 MHz	CH128 824.2 MHz	
GPRS 2 Txslots	Tune-up		32.50	32.50	32.50	Scaling factor*			
	Slot Average Power [dBm]		31.36	31.40	31.38	1.30	1.29	1.30	
	Front	1g SAR		0.088			0.11		
		10g SAR		0.053			0.07		
		Deviation		0.01			0.01		
	Rear	1g SAR	0.236	0.186	0.145	0.31	0.24	0.19	
		10g SAR	0.128	0.092	0.08	0.17	0.12	0.10	
		Deviation	0.01	0.02	0.18	0.01	0.02	0.18	
	Left edge	1g SAR		0.067			0.09		
		10g SAR		0.04			0.05		
		Deviation		0.09			0.09		
	Right edge	1g SAR		0.039			0.05		
		10g SAR		0.023			0.03		
		Deviation		0.09			0.09		
	Bottom edge	1g SAR		0.074			0.10		
		10g SAR		0.036			0.05		
		Deviation		0.07			0.07		
	EGPRS GMSK 2 Txslots	Tune-up		32.50	32.50	32.50	Scaling factor*		
		Slot Average Power [dBm]		30.94	31.39	31.89	1.43	1.29	1.15
		Rear	1g SAR	0.219			0.31		
			10g SAR	0.106			0.15		
Deviation	0.05				0.05				
GPRS 2 Txslots B1	Rear	1g SAR	0.224			0.29			
		10g SAR	0.113			0.15			
		Deviation	0.07			0.07			

Table 14-3 PCS1900 #1 Head

PCS1900 #1 Head									
Ambient Temperature:				22.5			Liquid Temperature:		22.3
Mode	Device orientation	SAR measurement	Measured SAR [W/kg]			Reported SAR [W/kg]			
			CH810 1909.8	CH661 1880 MHz	CH512 1850.2	CH810 1909.8	CH661 1880 MHz	CH512 1850.2	
GSM	Tune-up		31.00	31.00	31.00	Scaling factor*			
	Slot Average Power [dBm]		30.07	30.10	30.08	1.24	1.23	1.24	
	Left Cheek	1g SAR		0.064			0.08		
		10g SAR		0.039			0.05		
		Deviation		0.12			0.12		
	Left Tilt	1g SAR		0.028			0.03		
		10g SAR		0.015			0.02		
		Deviation		0.04			0.04		
	Right Cheek	1g SAR	0.075	0.077	0.093	0.09	0.09	0.11	
		10g SAR	0.046	0.046	0.057	0.06	0.06	0.07	
		Deviation	0.09	0.05	0.03	0.09	0.05	0.03	
	Right Tilt	1g SAR		0.032			0.04		
		10g SAR		0.019			0.02		
		Deviation		-0.05			-0.05		
	GSM B1	Right Cheek	1g SAR			0.09			0.11
10g SAR					0.053			0.07	
Deviation					-0.06			-0.06	

Table 14-4 PCS1900 #1 Body

PCS1900 #1 Body									
Ambient Temperature:				22.5			Liquid Temperature:		22.3
Mode	Device orientation	SAR measurement	Measured SAR [W/kg]			Reported SAR [W/kg]			
			CH810 1909.8	CH661 1880 MHz	CH512 1850.2	CH810 1909.8	CH661 1880 MHz	CH512 1850.2	
GPRS 2 Txslots	Tune-up		29.50	29.50	29.50	Scaling factor*			
	Slot Average Power [dBm]		28.60	28.63	28.58	1.23	1.22	1.24	
	Front	1g SAR		0.402			0.49		
		10g SAR		0.218			0.27		
		Deviation		-0.05			-0.05		
	Rear	1g SAR		0.567			0.69		
		10g SAR		0.299			0.37		
		Deviation		0.01			0.01		
	Left edge	1g SAR		0.046			0.06		
		10g SAR		0.03			0.04		
		Deviation		-0.09			-0.09		
	Right edge	1g SAR		0.066			0.08		
		10g SAR		0.042			0.05		
		Deviation		-0.01			-0.01		
	Bottom edge	1g SAR	0.587	0.706	0.756	0.72	0.86	0.93	
10g SAR		0.302	0.374	0.4	0.37	0.46	0.49		
Deviation		-0.01	-0.01	-0.05	-0.01	-0.01	-0.05		
EGPRS GMSK 2 Txslots	Tune-up		29.50	29.50	29.50	Scaling factor*			
	Slot Average Power [dBm]		28.59	28.69	28.57	1.23	1.21	1.24	
	Bottom edge	1g SAR			0.749			0.93	
		10g SAR			0.391			0.48	
		Deviation			0.05			0.05	

Table 14-5 WCDMA1900-BII #1Head

WCDMA1900-BII #1Head								
Ambient Temperature: 22.5						Liquid Temperature: 22.3		
Mode	Device orientation	SAR measurement	Measured SAR [W/kg]			Reported SAR [W/kg]		
			CH9538 1907.6 MHz	CH9400 1880 MHz	CH9262 1852.4 MHz	CH9538 1907.6 MHz	CH9400 1880 MHz	CH9262 1852.4 MHz
RMC	Tune-up		24.00	24.00	24.00	Scaling factor*		
	Slot Average Power [dBm]		22.81	23.00	23.01	1.32	1.26	1.26
	Left Cheek	1g SAR		0.083			0.10	
		10g SAR		0.051			0.06	
		Deviation		0.04			0.04	
	Left Tilt	1g SAR		0.063			0.08	
		10g SAR		0.034			0.04	
		Deviation		0.01			0.01	
	Right Cheek	1g SAR	0.107	0.134	0.162	0.14	0.17	0.20
		10g SAR	0.064	0.08	0.098	0.08	0.10	0.12
		Deviation	0.12	-0.02	0.08	0.12	-0.02	0.08
	Right Tilt	1g SAR		0.084			0.11	
		10g SAR		0.047			0.06	
		Deviation		-0.08			-0.08	
	RMC B1	Right Cheek	1g SAR			0.158		
10g SAR					0.095			0.12
Deviation					-0.04			-0.04

Table 14-6 WCDMA1900-BII #1Body

WCDMA1900-BII #1Body									
Ambient Temperature: 22.5						Liquid Temperature: 22.3			
Mode	Device orientation	SAR measurement	Measured SAR [W/kg]			Reported SAR [W/kg]			
			CH9538 1907.6 MHz	CH9400 1880 MHz	CH9262 1852.4 MHz	CH9538 1907.6 MHz	CH9400 1880 MHz	CH9262 1852.4 MHz	
RMC	Tune-up		24.00	24.00	24.00	Scaling factor*			
	Slot Average Power [dBm]		22.81	23.00	23.01	1.32	1.26	1.26	
	Front	1g SAR		0.475			0.60		
		10g SAR		0.259			0.33		
		Deviation		0.04			0.04		
	Rear	1g SAR	0.496	0.649	0.709	0.65	0.82	0.89	
		10g SAR	0.269	0.358	0.393	0.35	0.45	0.49	
		Deviation	0.02	-0.09	-0.05	0.02	-0.09	-0.05	
	Left edge	1g SAR		0.041			0.05		
		10g SAR		0.026			0.03		
		Deviation		0.08			0.08		
	Right edge	1g SAR		0.074			0.09		
		10g SAR		0.046			0.06		
		Deviation		0.01			0.01		
	Bottom edge	1g SAR	0.692	0.857	0.926	0.91	1.08	1.16	
		10g SAR	0.359	0.45	0.488	0.47	0.57	0.61	
		Deviation	0.02	0.03	-0.04	0.02	0.03	-0.04	
	RMC B1	Bottom edge	1g SAR			0.92			1.16
			10g SAR			0.481			0.60
			Deviation			-0.06			-0.06

Table 14-7 WCDMA850-BV #1Head

WCDMA850-BV #1Head								
Ambient Temperature: 22.5			Liquid Temperature: 22.3					
Mode	Device orientation	SAR measurement	Measured SAR [W/kg]			Reported SAR [W/kg]		
			CH4233 846.6 MHz	CH4182 835.4 MHz	CH4132 826.4 MHz	CH4233 846.6 MHz	CH4182 835.4 MHz	CH4132 826.4 MHz
RMC	Tune-up		24.50	24.50	24.50	Scaling factor*		
	Slot Average Power [dBm]		22.83	22.86	22.80	1.47	1.46	1.48
	Left Cheek	1g SAR	0.139	0.142	0.078	0.20	0.21	0.12
		10g SAR	0.106	0.108	0.059	0.16	0.16	0.09
		Deviation	0.19	0.01	-0.05	0.19	0.01	-0.05
	Left Tilt	1g SAR		0.089			0.13	
		10g SAR		0.071			0.10	
		Deviation		0.01			0.01	
	Right Cheek	1g SAR		0.137			0.20	
		10g SAR		0.102			0.15	
		Deviation		-0.09			-0.09	
	Right Tilt	1g SAR		0.107			0.16	
		10g SAR		0.085			0.12	
		Deviation		0.04			0.04	
	RMC B1	Left Cheek	1g SAR		0.139			0.20
10g SAR				0.104			0.15	
Deviation				0.03			0.03	

Table 14-8 WCDMA850-BV #1Body

WCDMA850-BV #1Body									
Ambient Temperature: 22.5			Liquid Temperature: 22.3						
Mode	Device orientation	SAR measurement	Measured SAR [W/kg]			Reported SAR [W/kg]			
			CH4233 846.6 MHz	CH4182 835.4 MHz	CH4132 826.4 MHz	CH4233 846.6 MHz	CH4182 835.4 MHz	CH4132 826.4 MHz	
RMC	Tune-up		24.50	24.50	24.50	Scaling factor*			
	Slot Average Power [dBm]		22.83	22.86	22.80	1.47	1.46	1.48	
	Front	1g SAR		0.105			0.15		
		10g SAR		0.069			0.10		
		Deviation		0.03			0.03		
	Rear	1g SAR	0.192	0.187	0.104	0.28	0.27	0.15	
		10g SAR	0.106	0.104	0.058	0.16	0.15	0.09	
		Deviation	0.04	0.05	0.04	0.04	0.05	0.04	
	Left edge	1g SAR		0.074			0.11		
		10g SAR		0.05			0.07		
		Deviation		0.01			0.01		
	Right edge	1g SAR		0.046			0.07		
		10g SAR		0.03			0.04		
		Deviation		0.12			0.12		
	Bottom edge	1g SAR		0.058			0.08		
		10g SAR		0.035			0.05		
		Deviation		0.02			0.02		
	RMC B1	Rear	1g SAR	0.19			0.28		
			10g SAR	0.103			0.15		
			Deviation	-0.06			-0.06		



14.3 Full SAR

Test Band	Channel	Frequency	Tune-Up	Measured Power	Test Position	Measured 10g SAR	Measured 1g SAR	Reported 10g SAR	Reported 1g SAR	Power Drift	Figure
GSM850	251	848.8 MHz	34.5	32.85	Left Cheek	0.097	0.127	0.14	0.19	0.09	Fig A.1
GSM850	251	848.8 MHz	32.5	31.36	Rear	0.128	0.236	0.17	0.31	0.01	Fig A.2
PCS1900	512	1850.2 MHz	31	30.08	Right Cheek	0.057	0.093	0.07	0.11	0.03	Fig A.3
PCS1900	512	1850.2 MHz	29.5	28.58	Bottom edge	0.4	0.756	0.49	0.93	-0.05	Fig A.4
WCDMA1900-BII	9262	1852.4 MHz	24	23.01	Right Cheek	0.098	0.162	0.12	0.20	0.08	Fig A.5
WCDMA1900-BII	9262	1852.4 MHz	24	23.01	Bottom edge	0.488	0.926	0.61	1.16	-0.04	Fig A.6
WCDMA1700-BIV	1412	1732.4 MHz	24	22.95	Right Cheek	0.096	0.143	0.12	0.18	-0.04	Fig A.7
WCDMA1700-BIV	1513	1752.6 MHz	24	23.04	Bottom edge	0.432	0.827	0.54	1.03	-0.19	Fig A.8
WCDMA850-BV	4182	835.4 MHz	24.5	22.86	Left Cheek	0.108	0.142	0.16	0.21	0.01	Fig A.9
WCDMA850-BV	4233	846.6 MHz	24.5	22.83	Rear	0.106	0.192	0.16	0.28	0.04	Fig A.10

14.4 WLAN Evaluation

According to the KDB248227 D01, SAR is measured for 802.11b DSSS using the initial test position procedure.

Note1: When the reported SAR of the initial test position is > 0.4 W/kg, SAR is repeated for the 802.11 transmission mode configuration tested in the initial test position using subsequent highest estimated 1-g SAR conditions determined by area scans, on the highest maximum output power channel, until the reported SAR is ≤ 0.8 W/kg.

Note2: For all positions/configurations tested using the initial test position and subsequent test positions, when the reported SAR is > 0.8 W/kg, SAR is measured for these test positions/configurations on the subsequent next highest measured output power channel until the reported SAR is ≤ 1.2 W/kg or all required channels are tested.

Note3: According to the KDB248227 D01, The reported SAR must be scaled to 100% transmission duty factor to determine compliance at the maximum tune-up tolerance limit.

Table 14-9 WLAN2450 #1

WLAN2450 #1								
Ambient Temperature: 22.5				Liquid Temperature: 22.3				
Rate	Device orientation	SAR measurement	Measured SAR [W/kg]			Reported SAR [W/kg]		
			11 2462 MHz	6 2437 MHz	1 2412 MHz	11	6	1
802.11b 1Mbps	Tune up		15.5	15.5	15.5	Scaling factor*		
	Slot Average Power [dBm]		14.48	14.75	14.58	1.26	1.19	1.24
	Left Cheek	1g Fast SAR		0.865			1.03	
		10g SAR		0.415			0.49	
		Deviation		0.03			0.03	
	Left Tilt	1g Fast SAR		0.576			0.68	
		10g SAR		0.285			0.34	
		Deviation		0.05			0.05	
	Right Cheek	1g Fast SAR		0.394			0.47	
		10g SAR		0.191			0.23	
		Deviation		0.04			0.04	
	Right Tilt	1g Fast SAR		0.437			0.52	
		10g SAR		0.196			0.23	
		Deviation		0.06			0.06	
B1	Left Cheek	1g Fast SAR		0.859			1.02	
		10g SAR		0.409			0.49	
		Deviation		-0.02			-0.02	

Table 14-10 WLAN2450 #1 Head Full SAR

WLAN2450 #1 Head Full SAR								
Ambient Temperature: 22.5				Liquid Temperature: 22.3				
Rate	Device orientation	SAR measurement	Measured SAR [W/kg]			Reported SAR [W/kg]		
			11 2462 MHz	6 2437 MHz	1 2412 MHz	11	6	1
802.11b 1Mbps	Tune up		15.5	15.5	15.5	Scaling factor*		
	Slot Average Power [dBm]		14.48	14.75	14.58	1.26	1.19	1.24
	Left Cheek	1g Full SAR	0.982	0.955	1.02	1.24	1.14	1.26
		10g SAR	0.439	0.431	0.454	0.56	0.51	0.56
		Deviation	0.09	0.03	-0.17	0.09	0.03	-0.17
	Left Tilt	1g Full SAR		0.633			0.75	
		10g SAR		0.283			0.34	
		Deviation		0.05			0.05	

According to the KDB248227 D01, The reported SAR must be scaled to 100% transmission duty factor to determine compliance at the maximum tune-up tolerance limit. The scaled reported SAR is presented as below

Frequency		Test Position		Actual duty factor	maximum duty factor	Reported SAR(1g)(W/kg)	Scaled reported SAR(1g)(W/kg)	Figure
MHz	Ch.							
2412	1	Left	Cheek	99.52%	100%	1.26	1.27	Fig.11

Table 14-11 WLAN2450 #1 Body Fast SAR

WLAN2450 #1 Body Fast SAR								
Ambient Temperature: 22.5			Liquid Temperature: 22.3					
Rate	Device orientation	SAR measurement	Measured SAR [W/kg]			Reported SAR [W/kg]		
			11 2462 MHz	6 2437 MHz	1 2412 MHz	11	6	1
802.11b 1Mbps	Tune up		15.5	15.5	15.5	Scaling factor*		
	Slot Average Power [dBm]		14.48	14.75	14.58	1.26	1.19	1.24
	Front	1g Fast SAR		0.105			0.12	
		10g SAR		0.055			0.07	
		Deviation		0.18			0.18	
	Rear	1g Fast SAR		0.09			0.11	
		10g SAR		0.047			0.06	
		Deviation		-0.06			-0.06	
	Top edge	1g Fast SAR		0.08			0.10	
		10g SAR		0.043			0.05	
		Deviation		0.02			0.02	
	Right edge	1g Fast SAR		0.084			0.10	
10g SAR			0.045			0.05		
Deviation			-0.08			-0.08		
B1	Front	1g Fast SAR		0.102			0.12	
		10g SAR		0.053			0.06	
		Deviation		-0.01			-0.01	

Table 14-12 WLAN2450 #1 Body Full SAR

WLAN2450 #1 Body Full SAR								
Ambient Temperature: 22.5			Liquid Temperature: 22.3					
Rate	Device orientation	SAR measurement	Measured SAR [W/kg]			Reported SAR [W/kg]		
			11 2462 MHz	6 2437 MHz	1 2412 MHz	11	6	1
802.11b 1Mbps	Tune up		15.5	15.5	15.5	Scaling factor*		
	Slot Average Power [dBm]		14.48	14.75	14.58	1.26	1.19	1.24
	Front	1g Full SAR		0.108			0.13	
		10g SAR		0.057			0.07	
Deviation			0.18			0.18		

According to the KDB248227 D01, The reported SAR must be scaled to 100% transmission duty factor to determine compliance at the maximum tune-up tolerance limit. The scaled reported SAR is presented as below

Frequency		Test Position	Actual duty factor	maximum duty factor	Reported SAR(1g)(W/kg)	Scaled reported SAR(1g)(W/kg)	Figure
MHz	Ch.						
2437	6	Front	99.53%	100%	0.13	0.13	Fig.12

SAR is not required for OFDM because the 802.11b adjusted SAR \leq 1.2 W/kg.

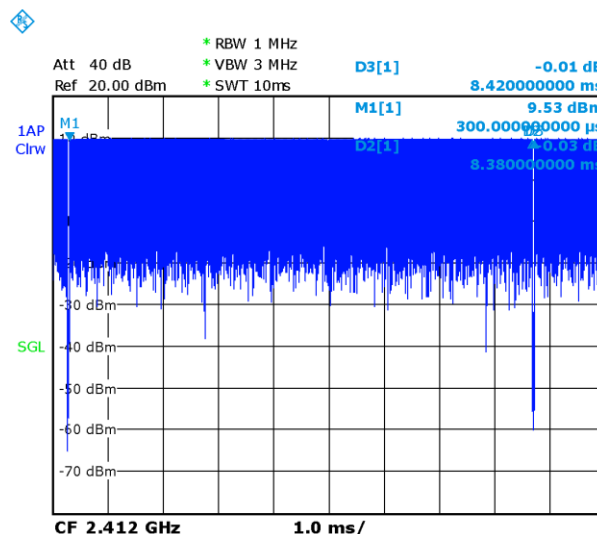

Picture 14.1 Duty factor plot CH1

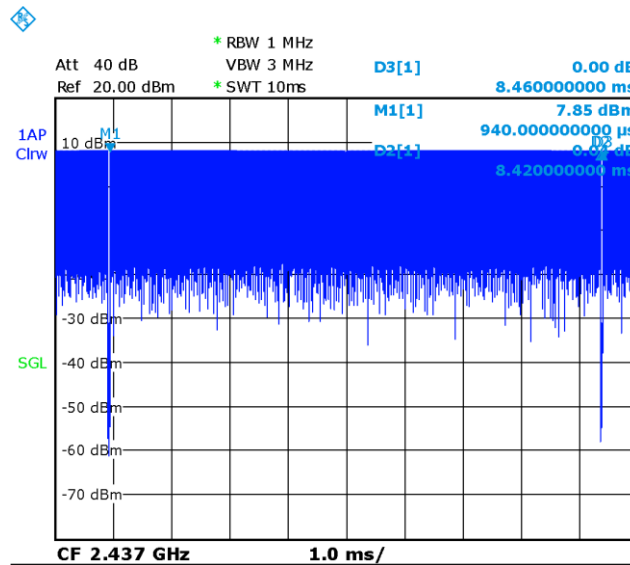

Picture 14.2 Duty factor plot CH6

15 SAR Measurement Variability

SAR measurement variability must be assessed for each frequency band, which is determined by the SAR probe calibration point and tissue-equivalent medium used for the device measurements. When both head and body tissue-equivalent media are required for SAR measurements in a frequency band, the variability measurement procedures should be applied to the tissue medium with the highest measured SAR, using the highest measured SAR configuration for that tissue-equivalent medium.

The following procedures are applied to determine if repeated measurements are required.

- 1) Repeated measurement is not required when the original highest measured SAR is < 0.80 W/kg; steps 2) through 4) do not apply.
- 2) When the original highest measured SAR is ≥ 0.80 W/kg, repeat that measurement once.
- 3) Perform a second repeated measurement only if the ratio of largest to smallest SAR for the original and first repeated measurements is > 1.20 or when the original or repeated measurement is ≥ 1.45 W/kg (~ 10% from the 1-g SAR limit).
- 4) Perform a third repeated measurement only if the original, first or second repeated measurement is ≥ 1.5 W/kg and the ratio of largest to smallest SAR for the original, first and second repeated measurements is > 1.20 .

Mode	CH	Freq	Test Position	Original SAR (W/kg)	First Repeated SAR(W/kg)	The Ratio
WCDMA1900-BII	9262	1852.4 MHz	Bottom edge	0.926	0.924	1.00
WLAN2450	1	2412 MHz	Left Cheek	1.02	1.01	1.01

16 Measurement Uncertainty

16.1 Measurement Uncertainty for Normal SAR Tests (300MHz~3GHz)

No.	Error Description	Type	Uncertainty value	Probably Distribution	Div.	(Ci) 1g	(Ci) 10g	Std. Unc. (1g)	Std. Unc. (10g)	Degree of freedom
Measurement system										
1	Probe calibration	B	6.0	N	1	1	1	6.0	6.0	∞
2	Isotropy	B	4.7	R	$\sqrt{3}$	0.7	0.7	1.9	1.9	∞
3	Boundary effect	B	1.0	R	$\sqrt{3}$	1	1	0.6	0.6	∞
4	Linearity	B	4.7	R	$\sqrt{3}$	1	1	2.7	2.7	∞
5	Detection limit	B	1.0	N	1	1	1	0.6	0.6	∞
6	Readout electronics	B	0.3	R	$\sqrt{3}$	1	1	0.3	0.3	∞
7	Response time	B	0.8	R	$\sqrt{3}$	1	1	0.5	0.5	∞
8	Integration time	B	2.6	R	$\sqrt{3}$	1	1	1.5	1.5	∞
9	RF ambient conditions-noise	B	0	R	$\sqrt{3}$	1	1	0	0	∞
10	RFambient conditions-reflection	B	0	R	$\sqrt{3}$	1	1	0	0	∞
11	Probe positioned mech. restrictions	B	0.4	R	$\sqrt{3}$	1	1	0.2	0.2	∞
12	Probe positioning with respect to phantom shell	B	2.9	R	$\sqrt{3}$	1	1	1.7	1.7	∞
13	Post-processing	B	1.0	R	$\sqrt{3}$	1	1	0.6	0.6	∞
Test sample related										
14	Test sample positioning	A	3.3	N	1	1	1	3.3	3.3	71
15	Device holder uncertainty	A	3.4	N	1	1	1	3.4	3.4	5
16	Drift of output power	B	5.0	R	$\sqrt{3}$	1	1	2.9	2.9	∞
Phantom and set-up										
17	Phantom uncertainty	B	4.0	R	$\sqrt{3}$	1	1	2.3	2.3	∞
18	Liquid conductivity (target)	B	5.0	R	$\sqrt{3}$	0.64	0.43	1.8	1.2	∞
19	Liquid conductivity (meas.)	A	2.06	N	1	0.64	0.43	1.32	0.89	43
20	Liquid permittivity (target)	B	5.0	R	$\sqrt{3}$	0.6	0.49	1.7	1.4	∞
21	Liquid permittivity (meas.)	A	1.6	N	1	0.6	0.49	1.0	0.8	521

Combined standard uncertainty	$u_c = \sqrt{\sum_{i=1}^{21} c_i^2 u_i^2}$						9.55	9.43	257
Expanded uncertainty (confidence interval of 95 %)	$u_e = 2u_c$						19.1	18.9	

16.2 Measurement Uncertainty for Normal SAR Tests (3~6GHz)

No.	Error Description	Type	Uncertainty value	Probably Distribution	Div.	(Ci) 1g	(Ci) 10g	Std. Unc. (1g)	Std. Unc. (10g)	Degree of freedom
Measurement system										
1	Probe calibration	B	6.55	N	1	1	1	6.55	6.55	∞
2	Isotropy	B	4.7	R	$\sqrt{3}$	0.7	0.7	1.9	1.9	∞
3	Boundary effect	B	2.0	R	$\sqrt{3}$	1	1	1.2	1.2	∞
4	Linearity	B	4.7	R	$\sqrt{3}$	1	1	2.7	2.7	∞
5	Detection limit	B	1.0	R	$\sqrt{3}$	1	1	0.6	0.6	∞
6	Readout electronics	B	0.3	R	$\sqrt{3}$	1	1	0.3	0.3	∞
7	Response time	B	0.8	R	$\sqrt{3}$	1	1	0.5	0.5	∞
8	Integration time	B	2.6	R	$\sqrt{3}$	1	1	1.5	1.5	∞
9	RF ambient conditions-noise	B	0	R	$\sqrt{3}$	1	1	0	0	∞
10	RF ambient conditions-reflection	B	0	R	$\sqrt{3}$	1	1	0	0	∞
11	Probe positioned mech. restrictions	B	0.8	R	$\sqrt{3}$	1	1	0.5	0.5	∞
12	Probe positioning with respect to phantom shell	B	6.7	R	$\sqrt{3}$	1	1	3.9	3.9	∞
13	Post-processing	B	4.0	R	$\sqrt{3}$	1	1	2.3	2.3	∞
Test sample related										
14	Test sample positioning	A	3.3	N	1	1	1	3.3	3.3	71
15	Device holder uncertainty	A	3.4	N	1	1	1	3.4	3.4	5
16	Drift of output power	B	5.0	R	$\sqrt{3}$	1	1	2.9	2.9	∞
Phantom and set-up										
17	Phantom uncertainty	B	4.0	R	$\sqrt{3}$	1	1	2.3	2.3	∞
18	Liquid conductivity (target)	B	5.0	R	$\sqrt{3}$	0.64	0.43	1.8	1.2	∞
19	Liquid conductivity (meas.)	A	2.06	N	1	0.64	0.43	1.32	0.89	43
20	Liquid permittivity	B	5.0	R	$\sqrt{3}$	0.6	0.49	1.7	1.4	∞

	(target)									
21	Liquid permittivity (meas.)	A	1.6	N	1	0.6	0.49	1.0	0.8	521
Combined standard uncertainty		$u_c' = \sqrt{\sum_{i=1}^{21} c_i^2 u_i^2}$						10.7	10.6	257
Expanded uncertainty (confidence interval of 95 %)		$u_e = 2u_c$						21.4	21.1	

16.3 Measurement Uncertainty for Fast SAR Tests (300MHz~3GHz)

No.	Error Description	Type	Uncertainty value	Probably Distribution	Div.	(Ci) 1g	(Ci) 10g	Std. Unc. (1g)	Std. Unc. (10g)	Degree of freedom
Measurement system										
1	Probe calibration	B	6.0	N	1	1	1	6.0	6.0	∞
2	Isotropy	B	4.7	R	$\sqrt{3}$	0.7	0.7	1.9	1.9	∞
3	Boundary effect	B	1.0	R	$\sqrt{3}$	1	1	0.6	0.6	∞
4	Linearity	B	4.7	R	$\sqrt{3}$	1	1	2.7	2.7	∞
5	Detection limit	B	1.0	R	$\sqrt{3}$	1	1	0.6	0.6	∞
6	Readout electronics	B	0.3	R	$\sqrt{3}$	1	1	0.3	0.3	∞
7	Response time	B	0.8	R	$\sqrt{3}$	1	1	0.5	0.5	∞
8	Integration time	B	2.6	R	$\sqrt{3}$	1	1	1.5	1.5	∞
9	RF ambient conditions-noise	B	0	R	$\sqrt{3}$	1	1	0	0	∞
10	RF ambient conditions-reflection	B	0	R	$\sqrt{3}$	1	1	0	0	∞
11	Probe positioned mech. Restrictions	B	0.4	R	$\sqrt{3}$	1	1	0.2	0.2	∞
12	Probe positioning with respect to phantom shell	B	2.9	R	$\sqrt{3}$	1	1	1.7	1.7	∞
13	Post-processing	B	1.0	R	$\sqrt{3}$	1	1	0.6	0.6	∞
14	Fast SAR z-Approximation	B	7.0	R	$\sqrt{3}$	1	1	4.0	4.0	∞
Test sample related										
15	Test sample positioning	A	3.3	N	1	1	1	3.3	3.3	71
16	Device holder uncertainty	A	3.4	N	1	1	1	3.4	3.4	5
17	Drift of output power	B	5.0	R	$\sqrt{3}$	1	1	2.9	2.9	∞
Phantom and set-up										
18	Phantom uncertainty	B	4.0	R	$\sqrt{3}$	1	1	2.3	2.3	∞

19	Liquid conductivity (target)	B	5.0	R	$\sqrt{3}$	0.64	0.43	1.8	1.2	∞
20	Liquid conductivity (meas.)	A	2.06	N	1	0.64	0.43	1.32	0.89	43
21	Liquid permittivity (target)	B	5.0	R	$\sqrt{3}$	0.6	0.49	1.7	1.4	∞
22	Liquid permittivity (meas.)	A	1.6	N	1	0.6	0.49	1.0	0.8	521
Combined standard uncertainty		$u_c = \sqrt{\sum_{i=1}^{22} c_i^2 u_i^2}$						10.4	10.3	257
Expanded uncertainty (confidence interval of 95 %)		$u_e = 2u_c$						20.8	20.6	

16.4 Measurement Uncertainty for Fast SAR Tests (3~6GHz)

No.	Error Description	Type	Uncertainty value	Probably Distribution	Div.	(Ci) 1g	(Ci) 10g	Std. Unc. (1g)	Std. Unc. (10g)	Degree of freedom
Measurement system										
1	Probe calibration	B	6.55	N	1	1	1	6.55	6.55	∞
2	Isotropy	B	4.7	R	$\sqrt{3}$	0.7	0.7	1.9	1.9	∞
3	Boundary effect	B	2.0	R	$\sqrt{3}$	1	1	1.2	1.2	∞
4	Linearity	B	4.7	R	$\sqrt{3}$	1	1	2.7	2.7	∞
5	Detection limit	B	1.0	R	$\sqrt{3}$	1	1	0.6	0.6	∞
6	Readout electronics	B	0.3	R	$\sqrt{3}$	1	1	0.3	0.3	∞
7	Response time	B	0.8	R	$\sqrt{3}$	1	1	0.5	0.5	∞
8	Integration time	B	2.6	R	$\sqrt{3}$	1	1	1.5	1.5	∞
9	RF ambient conditions-noise	B	0	R	$\sqrt{3}$	1	1	0	0	∞
10	RF ambient conditions-reflection	B	0	R	$\sqrt{3}$	1	1	0	0	∞
11	Probe positioned mech. Restrictions	B	0.8	R	$\sqrt{3}$	1	1	0.5	0.5	∞
12	Probe positioning with respect to phantom shell	B	6.7	R	$\sqrt{3}$	1	1	3.9	3.9	∞
13	Post-processing	B	1.0	R	$\sqrt{3}$	1	1	0.6	0.6	∞
14	Fast SAR z-Approximation	B	14.0	R	$\sqrt{3}$	1	1	8.1	8.1	∞
Test sample related										
15	Test sample positioning	A	3.3	N	1	1	1	3.3	3.3	71

16	Device holder uncertainty	A	3.4	N	1	1	1	3.4	3.4	5
17	Drift of output power	B	5.0	R	$\sqrt{3}$	1	1	2.9	2.9	∞
Phantom and set-up										
18	Phantom uncertainty	B	4.0	R	$\sqrt{3}$	1	1	2.3	2.3	∞
19	Liquid conductivity (target)	B	5.0	R	$\sqrt{3}$	0.64	0.43	1.8	1.2	∞
20	Liquid conductivity (meas.)	A	2.06	N	1	0.64	0.43	1.32	0.89	43
21	Liquid permittivity (target)	B	5.0	R	$\sqrt{3}$	0.6	0.49	1.7	1.4	∞
22	Liquid permittivity (meas.)	A	1.6	N	1	0.6	0.49	1.0	0.8	521
Combined standard uncertainty		$u_c = \sqrt{\sum_{i=1}^{22} c_i^2 u_i^2}$						13.5	13.4	257
Expanded uncertainty (confidence interval of 95 %)		$u_e = 2u_c$						27.0	26.8	



17 MAIN TEST INSTRUMENTS

Table 17.1: List of Main Instruments

No.	Name	Type	Serial Number	Calibration Date	Valid Period
01	Network analyzer	E5071C	MY46110673	January 13, 2017	One year
02	Power meter	NRVD	102196	March 2, 2017	One year
03	Power sensor	NRV-Z5	100596		
04	Signal Generator	E4438C	MY49071430	January 13,2017	One Year
05	Amplifier	60S1G4	0331848	No Calibration Requested	
06	BTS	E5515C	MY50263375	January 16, 2017	One year
07	BTS	CMW500	149646	October 31,2017	One year
08	E-field Probe	SPEAG EX3DV4	3846	January 13,2017	One year
09	DAE	SPEAG DAE4	1331	January19, 2017	One year
10	Dipole Validation Kit	SPEAG D835V2	4d069	July 19,2017	One year
11	Dipole Validation Kit	SPEAG D1900V2	5d101	July 26,2017	One year
12	Dipole Validation Kit	SPEAG D2450V2	853	July 21,2017	One year

END OF REPORT BODY

ANNEX A Graph Results

GSM850_CH251 Left Cheek

Date: 11/8/2017

Electronics: DAE4 Sn1331

Medium: Head 835 MHz

Medium parameters used: $f = 848.8$ MHz; $\sigma = 0.918$ mho/m; $\epsilon_r = 42.24$; $\rho = 1000$ kg/m³

Ambient Temperature: 22.5°C, Liquid Temperature: 22.3°C

Communication System: GSM850 848.8 MHz Duty Cycle: 1:8.3

Probe: EX3DV4 – SN3846 ConvF(9.33,9.33,9.33)

Area Scan (71x121x1): Interpolated grid: dx=1.000 mm, dy=1.000 mm

Maximum value of SAR (interpolated) = 0.142 W/kg

Zoom Scan (7x7x7)/Cube 0: Measurement grid: dx=5mm, dy=5mm, dz=5mm

Reference Value = 4.262 V/m; Power Drift = 0.09 dB

Peak SAR (extrapolated) = 0.164 W/kg

SAR(1 g) = 0.127 W/kg; SAR(10 g) = 0.097 W/kg

Maximum value of SAR (measured) = 0.139 W/kg

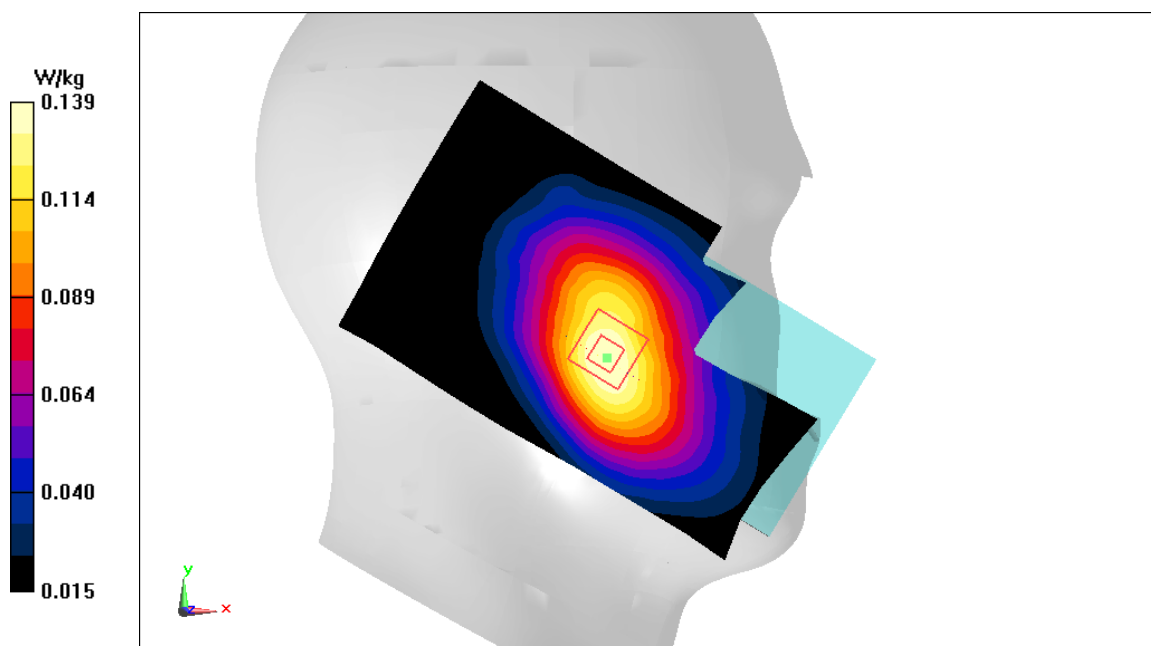

Fig A.1

GSM850_CH251 Rear

Date: 11/8/2017

Electronics: DAE4 Sn1331

Medium: Head 835 MHz

Medium parameters used: $f = 848.8$ MHz; $\sigma = 0.98$ mho/m; $\epsilon_r = 54.33$; $\rho = 1000$ kg/m³

Ambient Temperature: 22.5°C, Liquid Temperature: 22.3°C

Communication System: GSM850 848.8 MHz Duty Cycle: 1:4

Probe: EX3DV4 – SN3846 ConvF(9.52,9.52,9.52)

Area Scan (71x121x1): Interpolated grid: dx=1.000 mm, dy=1.000 mm

Maximum value of SAR (interpolated) = 0.357 W/kg

Zoom Scan (7x7x7)/Cube 0: Measurement grid: dx=5mm, dy=5mm, dz=5mm

Reference Value = 13.87 V/m; Power Drift = 0.01 dB

Peak SAR (extrapolated) = 0.436 W/kg

SAR(1 g) = 0.236 W/kg; SAR(10 g) = 0.128 W/kg

Maximum value of SAR (measured) = 0.316 W/kg

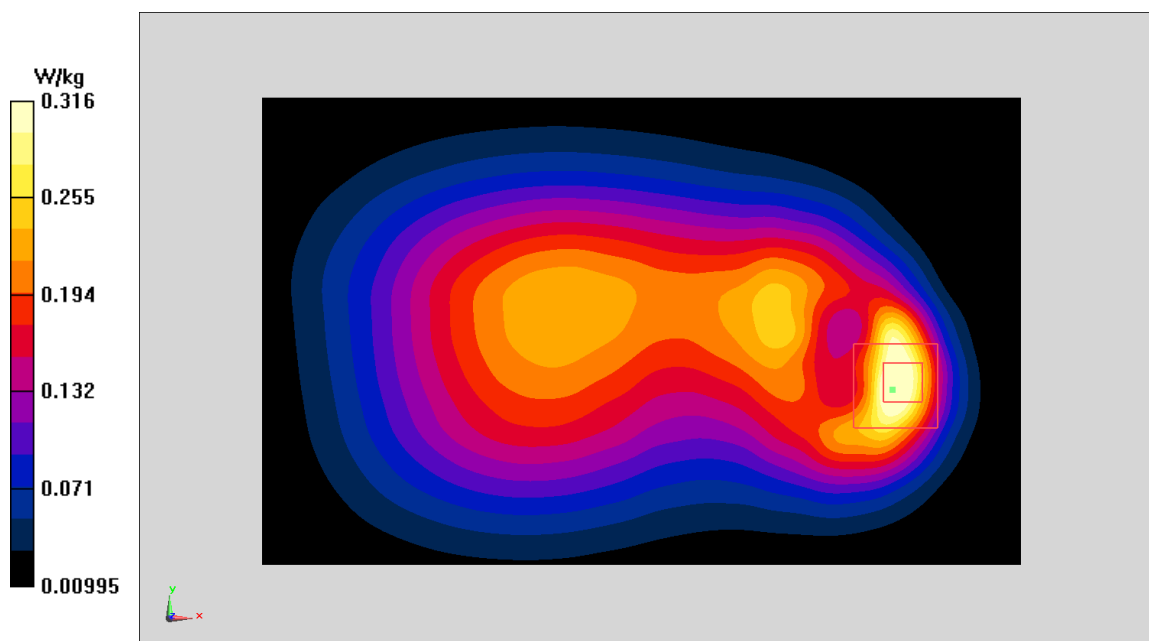

Fig A.2

PCS1900_CH512 Right Cheek

Date: 11/10/2017

Electronics: DAE4 Sn1331

Medium: Head 1900 MHz

Medium parameters used: $f = 1850.2$ MHz; $\sigma = 1.338$ mho/m; $\epsilon_r = 39.84$; $\rho = 1000$ kg/m³

Ambient Temperature: 22.5°C, Liquid Temperature: 22.3°C

Communication System: PCS1900 1850.2 MHz Duty Cycle: 1:8.3

Probe: EX3DV4 – SN3846 ConvF(7.89,7.89,7.89)

Area Scan (71x121x1): Interpolated grid: dx=1.000 mm, dy=1.000 mm

Maximum value of SAR (interpolated) = 0.113 W/kg

Zoom Scan (7x7x7)/Cube 0: Measurement grid: dx=5mm, dy=5mm, dz=5mm

Reference Value = 3.501 V/m; Power Drift = 0.03 dB

Peak SAR (extrapolated) = 0.144 W/kg

SAR(1 g) = 0.093 W/kg; SAR(10 g) = 0.057 W/kg

Maximum value of SAR (measured) = 0.106 W/kg

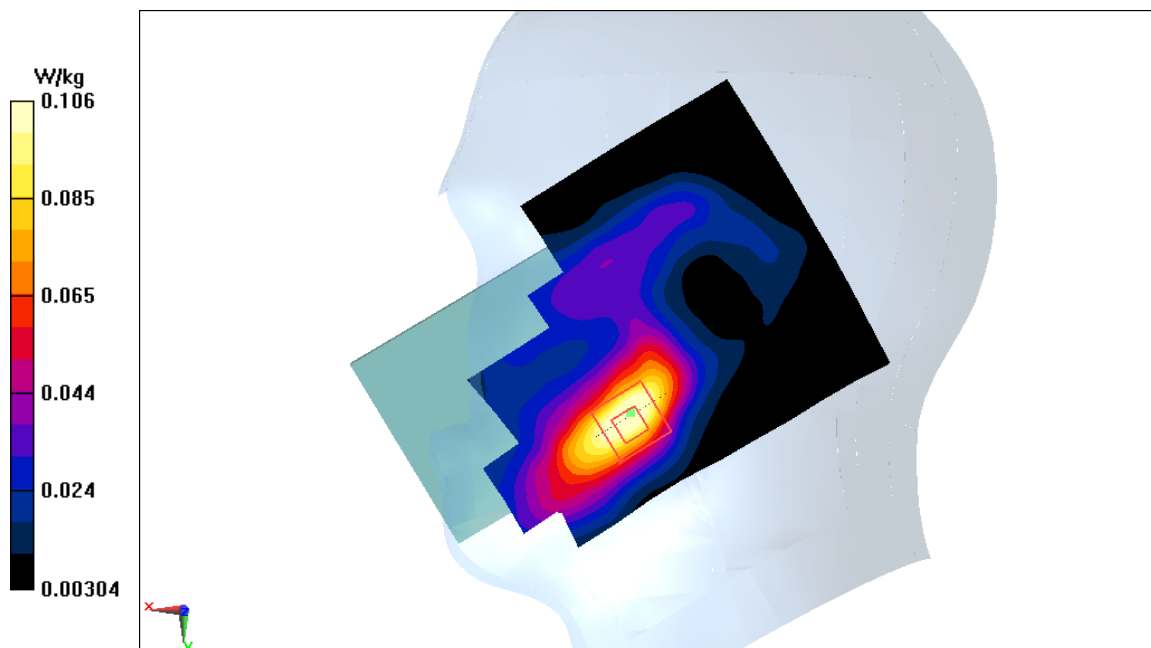

Fig A.3

PCS1900_CH512 Bottom edge

Date: 11/10/2017

Electronics: DAE4 Sn1331

Medium: Head 1900 MHz

Medium parameters used: $f = 1850.2$ MHz; $\sigma = 1.477$ mho/m; $\epsilon_r = 54.16$; $\rho = 1000$ kg/m³

Ambient Temperature: 22.5°C, Liquid Temperature: 22.3°C

Communication System: PCS1900 1850.2 MHz Duty Cycle: 1:4

Probe: EX3DV4 – SN3846 ConvF(7.57,7.57,7.57)

Area Scan (71x121x1): Interpolated grid: dx=1.000 mm, dy=1.000 mm

Maximum value of SAR (interpolated) = 0.947 W/kg

Zoom Scan (7x7x7)/Cube 0: Measurement grid: dx=5mm, dy=5mm, dz=5mm

Reference Value = 24.47 V/m; Power Drift = -0.05 dB

Peak SAR (extrapolated) = 1.27 W/kg

SAR(1 g) = 0.756 W/kg; SAR(10 g) = 0.4 W/kg

Maximum value of SAR (measured) = 0.942 W/kg

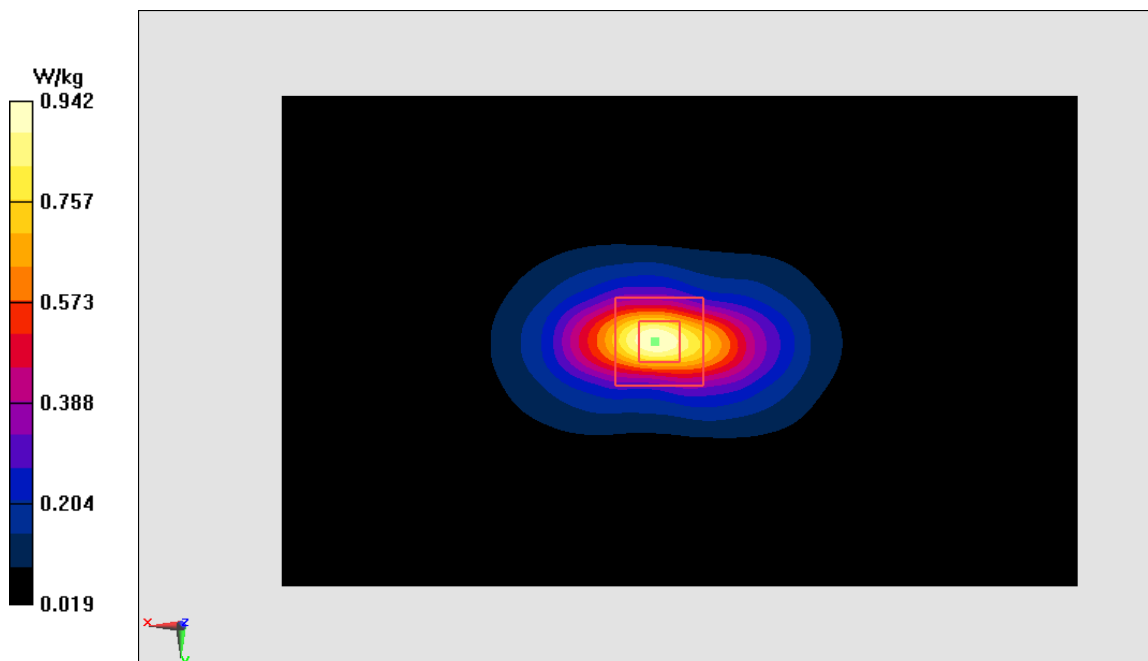

Fig A.4

WCDMA1900-BII_CH9262 Right Cheek

Date: 11/10/2017

Electronics: DAE4 Sn1331

Medium: Head 1900 MHz

Medium parameters used: $f = 1852.4$ MHz; $\sigma = 1.339$ mho/m; $\epsilon_r = 39.84$; $\rho = 1000$ kg/m³

Ambient Temperature: 22.5°C, Liquid Temperature: 22.3°C

Communication System: WCDMA1900-BII 1852.4 MHz Duty Cycle: 1:1

Probe: EX3DV4 – SN3846 ConvF(7.89,7.89,7.89)

Area Scan (71x121x1): Interpolated grid: dx=1.000 mm, dy=1.000 mm

Maximum value of SAR (interpolated) = 0.186 W/kg

Zoom Scan (7x7x7)/Cube 0: Measurement grid: dx=5mm, dy=5mm, dz=5mm

Reference Value = 4.622 V/m; Power Drift = 0.08 dB

Peak SAR (extrapolated) = 0.249 W/kg

SAR(1 g) = 0.162 W/kg; SAR(10 g) = 0.098 W/kg

Maximum value of SAR (measured) = 0.195 W/kg

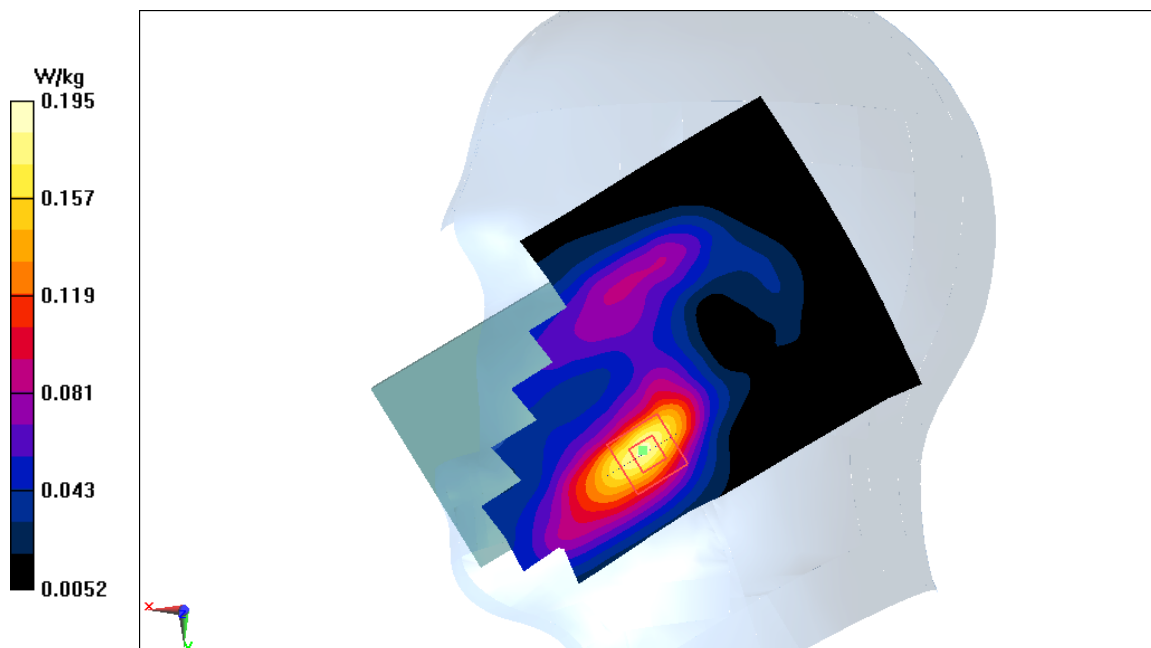

Fig A.5

WCDMA1900-BII_CH9262 Bottom edge

Date: 11/10/2017

Electronics: DAE4 Sn1331

Medium: Head 1900 MHz

Medium parameters used: $f = 1852.4$ MHz; $\sigma = 1.479$ mho/m; $\epsilon_r = 54.16$; $\rho = 1000$ kg/m³

Ambient Temperature: 22.5°C, Liquid Temperature: 22.3°C

Communication System: WCDMA1900-BII 1852.4 MHz Duty Cycle: 1:1

Probe: EX3DV4 – SN3846 ConvF(7.57,7.57,7.57)

Area Scan (71x121x1): Interpolated grid: dx=1.000 mm, dy=1.000 mm

Maximum value of SAR (interpolated) = 1.14 W/kg

Zoom Scan (7x7x7)/Cube 0: Measurement grid: dx=5mm, dy=5mm, dz=5mm

Reference Value = 23.16 V/m; Power Drift = -0.04 dB

Peak SAR (extrapolated) = 1.56 W/kg

SAR(1 g) = 0.926 W/kg; SAR(10 g) = 0.488 W/kg

Maximum value of SAR (measured) = 1.13 W/kg

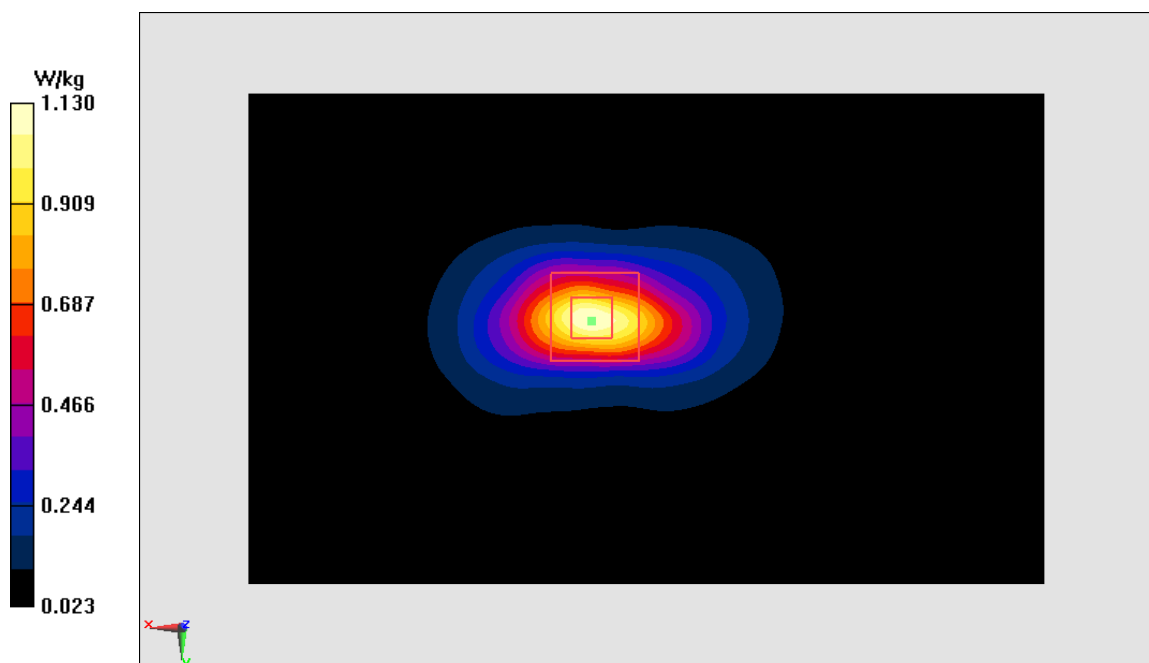

Fig A.6

WCDMA850-BV_CH4182 Left Cheek

Date: 11/8/2017

Electronics: DAE4 Sn1331

Medium: Head 835 MHz

Medium parameters used: $f = 835.4$ MHz; $\sigma = 0.905$ mho/m; $\epsilon_r = 42.26$; $\rho = 1000$ kg/m³

Ambient Temperature: 22.5°C, Liquid Temperature: 22.3°C

Communication System: WCDMA850-BV 835.4 MHz Duty Cycle: 1:1

Probe: EX3DV4 – SN3846 ConvF(9.33,9.33,9.33)

Area Scan (71x121x1): Interpolated grid: dx=1.000 mm, dy=1.000 mm

Maximum value of SAR (interpolated) = 0.158 W/kg

Zoom Scan (7x7x7)/Cube 0: Measurement grid: dx=5mm, dy=5mm, dz=5mm

Reference Value = 3.917 V/m; Power Drift = 0.01 dB

Peak SAR (extrapolated) = 0.184 W/kg

SAR(1 g) = 0.142 W/kg; SAR(10 g) = 0.108 W/kg

Maximum value of SAR (measured) = 0.157 W/kg

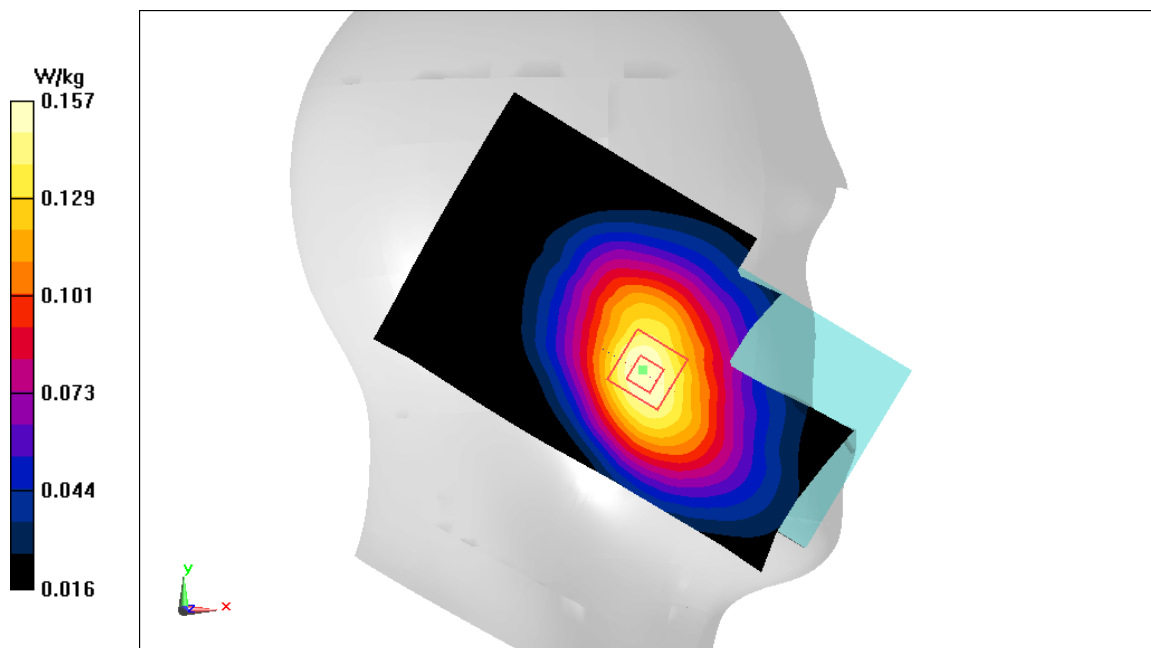

Fig A.7

WCDMA850-BV_CH4233 Rear

Date: 11/8/2017

Electronics: DAE4 Sn1331

Medium: Head 835 MHz

Medium parameters used: $f = 846.6$ MHz; $\sigma = 0.978$ mho/m; $\epsilon_r = 54.34$; $\rho = 1000$ kg/m³

Ambient Temperature: 22.5°C, Liquid Temperature: 22.3°C

Communication System: WCDMA850-BV 846.6 MHz Duty Cycle: 1:1

Probe: EX3DV4 – SN3846 ConvF(9.52,9.52,9.52)

Area Scan (71x121x1): Interpolated grid: dx=1.000 mm, dy=1.000 mm

Maximum value of SAR (interpolated) = 0.288 W/kg

Zoom Scan (7x7x7)/Cube 0: Measurement grid: dx=5mm, dy=5mm, dz=5mm

Reference Value = 13.35 V/m; Power Drift = 0.04 dB

Peak SAR (extrapolated) = 0.349 W/kg

SAR(1 g) = 0.192 W/kg; SAR(10 g) = 0.106 W/kg

Maximum value of SAR (measured) = 0.247 W/kg

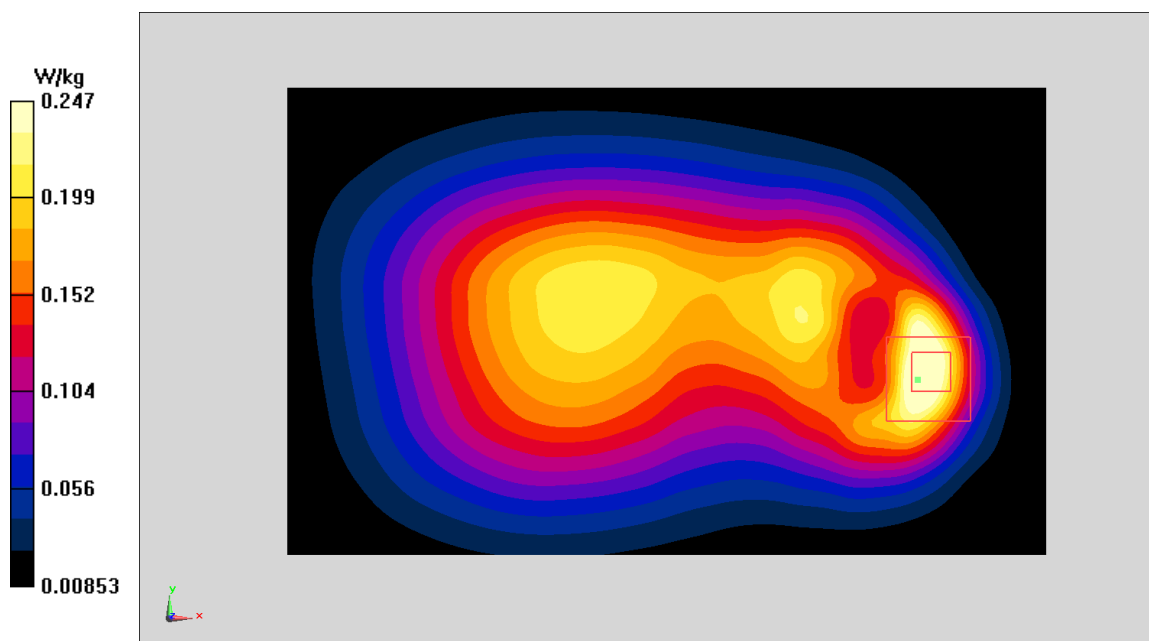

Fig A.8

WLAN2450_CH1 Left Cheek

Date: 11/11/2017

Electronics: DAE4 Sn1331

Medium: Head 2450 MHz

Medium parameters used: $f = 2412$ MHz; $\sigma = 1.731$ mho/m; $\epsilon_r = 39.3$; $\rho = 1000$ kg/m³

Ambient Temperature: 22.5°C, Liquid Temperature: 22.3°C

Communication System: WLAN2450 2412 MHz Duty Cycle: 1:1

Probe: EX3DV4 – SN3846 ConvF(7.22,7.22,7.22)

Area Scan (71x121x1): Interpolated grid: dx=1.000 mm, dy=1.000 mm

Maximum value of SAR (interpolated) = 1.53 W/kg

Zoom Scan (7x7x7)/Cube 0: Measurement grid: dx=5mm, dy=5mm, dz=5mm

Reference Value = 11.11 V/m; Power Drift = -0.17 dB

Peak SAR (extrapolated) = 2.28 W/kg

SAR(1 g) = 1.02 W/kg; SAR(10 g) = 0.454 W/kg

Maximum value of SAR (measured) = 1.32 W/kg

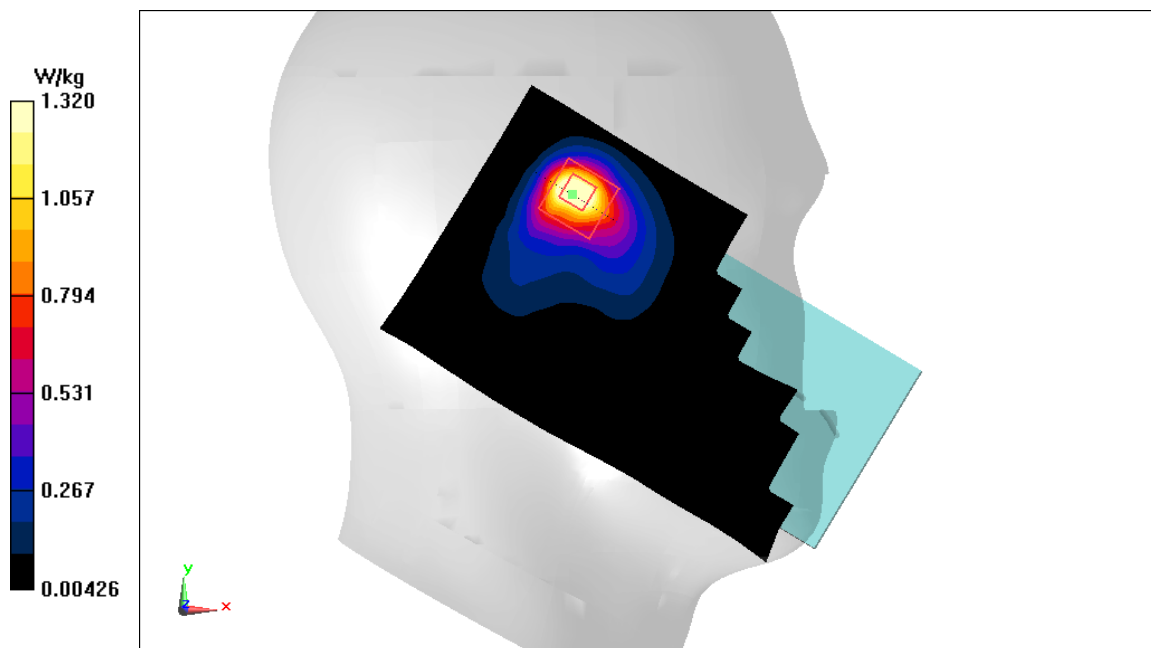

Fig A.9

WLAN2450_CH6 Front

Date: 11/11/2017

Electronics: DAE4 Sn1331

Medium: Head 2450 MHz

Medium parameters used: $f = 2437$ MHz; $\sigma = 1.955$ mho/m; $\epsilon_r = 52.85$; $\rho = 1000$ kg/m³

Ambient Temperature: 22.5°C, Liquid Temperature: 22.3°C

Communication System: WLAN2450 2437 MHz Duty Cycle: 1:1

Probe: EX3DV4 – SN3846 ConvF(7.31,7.31,7.31)

Area Scan (71x121x1): Interpolated grid: dx=1.000 mm, dy=1.000 mm

Maximum value of SAR (interpolated) = 0.135 W/kg

Zoom Scan (7x7x7)/Cube 0: Measurement grid: dx=5mm, dy=5mm, dz=5mm

Reference Value = 3.518 V/m; Power Drift = 0.18 dB

Peak SAR (extrapolated) = 0.204 W/kg

SAR(1 g) = 0.108 W/kg; SAR(10 g) = 0.057 W/kg

Maximum value of SAR (measured) = 0.136 W/kg

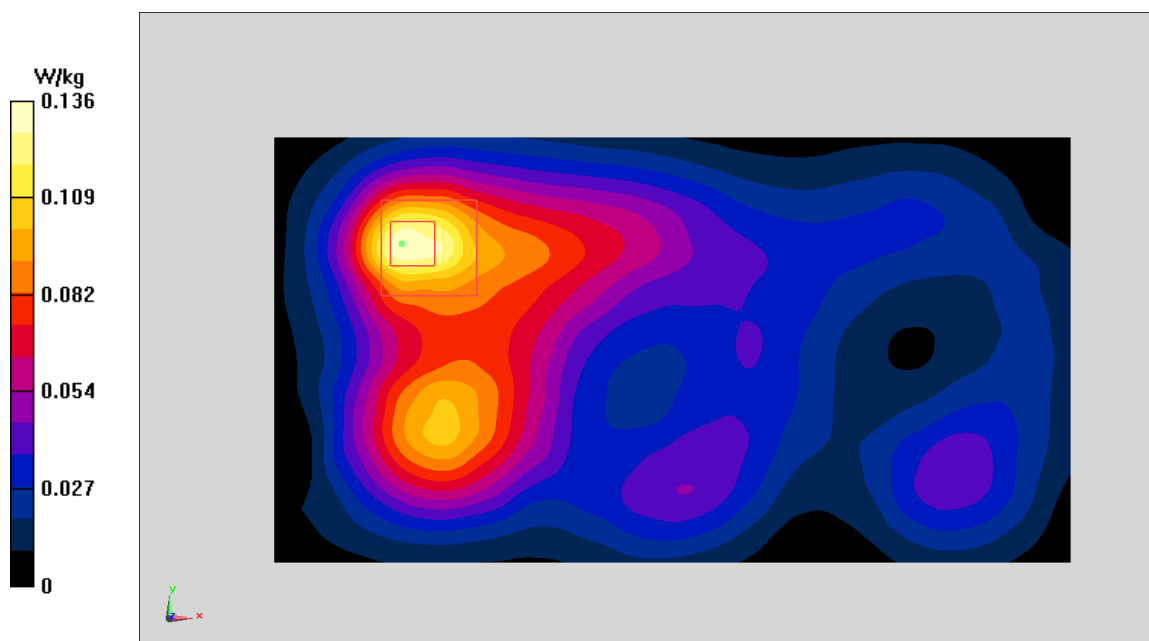

Fig A.10

ANNEX B System Verification Results

835 MHz

Date: 11/8/2017

Electronics: DAE4 Sn1331

Medium: Head 835 MHz

Medium parameters used: $f = 835 \text{ MHz}$; $\sigma = 0.905 \text{ mho/m}$; $\epsilon_r = 42.26$; $\rho = 1000 \text{ kg/m}^3$

Ambient Temperature: 22.5°C Liquid Temperature: 22.3°C

Communication System: CW Frequency: 835 MHz Duty Cycle: 1:1

Probe: EX3DV4 – SN3846 ConvF(9.33,9.33,9.33)

System Validation /Area Scan (81x191x1): Interpolated grid: $dx=1.000 \text{ mm}$, $dy=1.000 \text{ mm}$

Reference Value = 65.49 V/m ; Power Drift = -0.03

Fast SAR: SAR(1 g) = 2.39 W/kg ; SAR(10 g) = 1.49 W/kg

Maximum value of SAR (interpolated) = 3.76 W/kg

System Validation /Zoom Scan (7x7x7)/Cube 0: Measurement grid: $dx=5\text{mm}$, $dy=5\text{mm}$, $dz=5\text{mm}$

Reference Value = 65.49 V/m ; Power Drift = -0.03 dB

Peak SAR (extrapolated) = 4.08 W/kg

SAR(1 g) = 2.35 W/kg ; SAR(10 g) = 1.52 W/kg

Maximum value of SAR (measured) = 3.64 W/kg

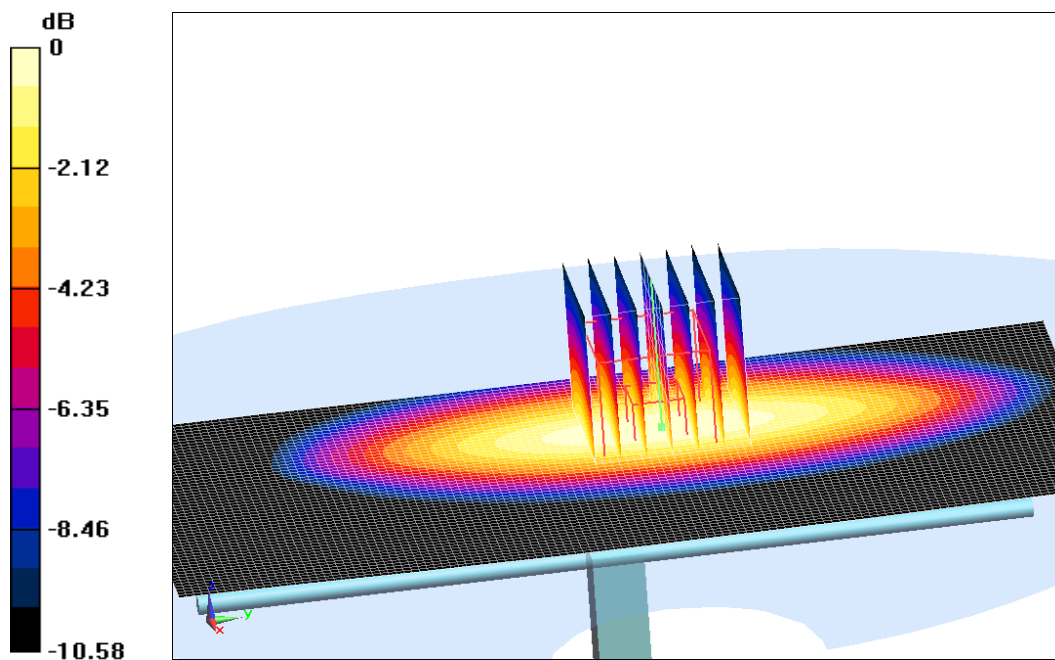

$0 \text{ dB} = 3.64 \text{ W/kg} = 5.61 \text{ dB W/kg}$

Fig.B.1 validation 835 MHz 250mW

835 MHz

Date: 11/8/2017

Electronics: DAE4 Sn1331

Medium: Body 835 MHz

Medium parameters used: $f = 835 \text{ MHz}$; $\sigma = 0.967 \text{ mho/m}$; $\epsilon_r = 54.35$; $\rho = 1000 \text{ kg/m}^3$

Ambient Temperature: 22.5°C Liquid Temperature: 22.3°C

Communication System: CW Frequency: 835 MHz Duty Cycle: 1:1

Probe: EX3DV4 – SN3846 ConvF(9.52,9.52,9.52)

System Validation /Area Scan (81x191x1): Interpolated grid: $dx=1.000 \text{ mm}$, $dy=1.000 \text{ mm}$

Reference Value = 59.64 V/m ; Power Drift = -0.07

Fast SAR: SAR(1 g) = 2.42 W/kg ; SAR(10 g) = 1.52 W/kg

Maximum value of SAR (interpolated) = 3.57 W/kg

System Validation /Zoom Scan (7x7x7)/Cube 0: Measurement grid: $dx=5\text{mm}$, $dy=5\text{mm}$, $dz=5\text{mm}$

Reference Value = 59.64 V/m ; Power Drift = -0.07 dB

Peak SAR (extrapolated) = 3.63 W/kg

SAR(1 g) = 2.39 W/kg ; SAR(10 g) = 1.52 W/kg

Maximum value of SAR (measured) = 3.26 W/kg

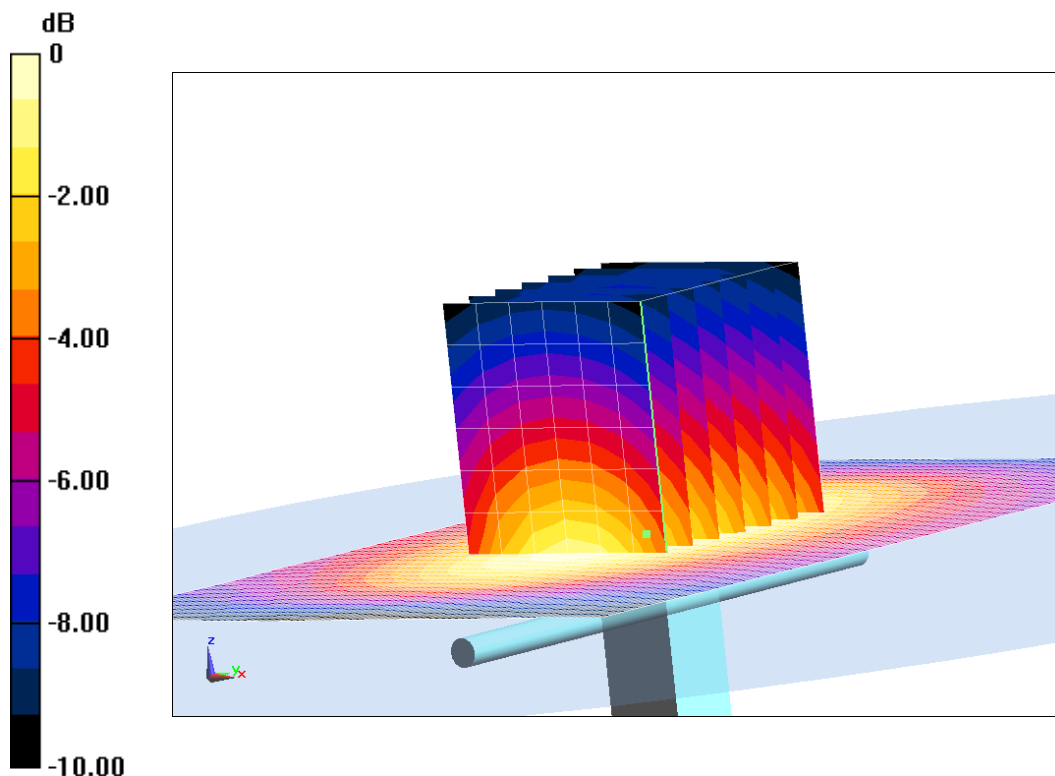

$0 \text{ dB} = 3.26 \text{ W/kg} = 5.13 \text{ dB W/kg}$

Fig.B.2 validation 835 MHz 250mW

1900 MHz

Date: 11/10/2017

Electronics: DAE4 Sn1331

Medium: Head 1900 MHz

Medium parameters used: $f = 1900 \text{ MHz}$; $\sigma = 1.385 \text{ mho/m}$; $\epsilon_r = 39.78$; $\rho = 1000 \text{ kg/m}^3$

Ambient Temperature: 22.5°C Liquid Temperature: 22.3°C

Communication System: CW Frequency: 1900 MHz Duty Cycle: 1:1

Probe: EX3DV4 – SN3846 ConvF(7.89,7.89,7.89)

System Validation /Area Scan (81x191x1): Interpolated grid: $dx=1.000 \text{ mm}$, $dy=1.000 \text{ mm}$

Reference Value = 106.21 V/m ; Power Drift = 0.04

Fast SAR: SAR(1 g) = 9.86 W/kg ; SAR(10 g) = 5.19 W/kg

Maximum value of SAR (interpolated) = 14.58 W/kg

System Validation /Zoom Scan (7x7x7)/Cube 0: Measurement grid: $dx=5\text{mm}$, $dy=5\text{mm}$, $dz=5\text{mm}$

Reference Value = 106.21 V/m ; Power Drift = 0.04 dB

Peak SAR (extrapolated) = 18.48 W/kg

SAR(1 g) = 9.83 W/kg ; SAR(10 g) = 5.31 W/kg

Maximum value of SAR (measured) = 14.88 W/kg

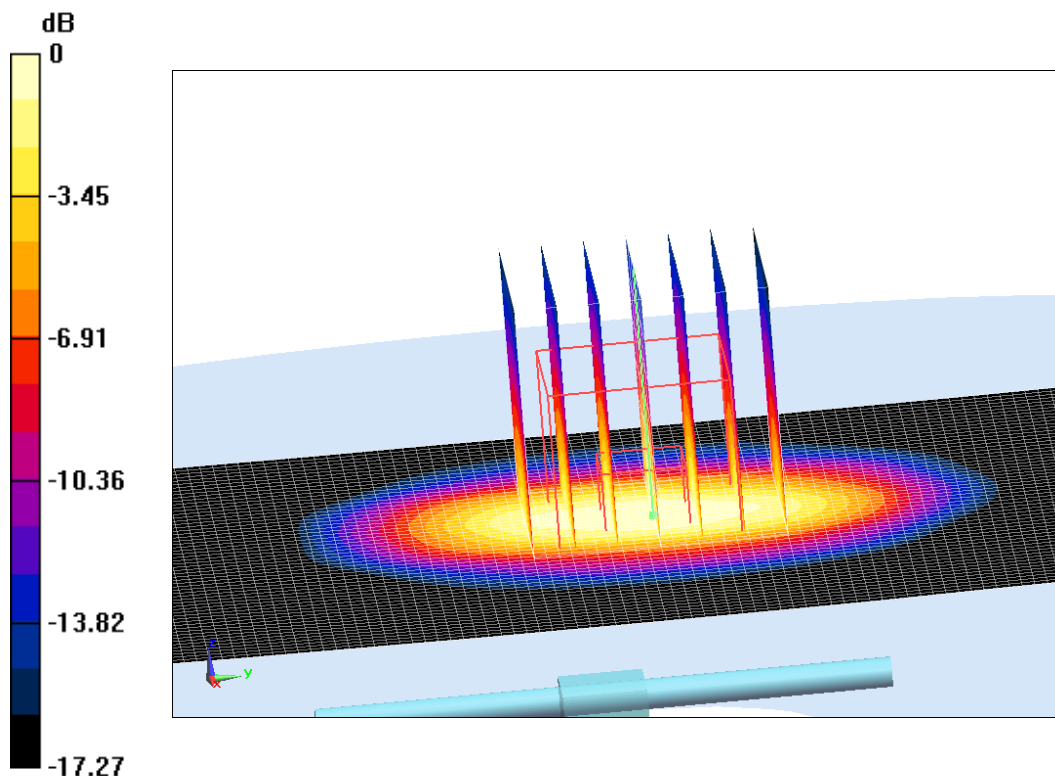

$0 \text{ dB} = 14.88 \text{ W/kg} = 11.73 \text{ dB W/kg}$

Fig.B.3 validation 1900 MHz 250mW

1900 MHz

Date: 11/10/2017

Electronics: DAE4 Sn1331

Medium: Body 1900 MHz

Medium parameters used: $f = 1900$ MHz; $\sigma = 1.525$ mho/m; $\epsilon_r = 54.1$; $\rho = 1000$ kg/m³

Ambient Temperature: 22.5°C Liquid Temperature: 22.3°C

Communication System: CW Frequency: 1900 MHz Duty Cycle: 1:1

Probe: EX3DV4 – SN3846 ConvF(7.57,7.57,7.57)

System Validation /Area Scan (81x191x1): Interpolated grid: dx=1.000 mm, dy=1.000 mm

Reference Value = 100.54 V/m; Power Drift = 0.05

Fast SAR: SAR(1 g) = 10.15 W/kg; SAR(10 g) = 5.47 W/kg

Maximum value of SAR (interpolated) = 17.31 W/kg

System Validation /Zoom Scan (7x7x7)/Cube 0: Measurement grid: dx=5mm, dy=5mm, dz=5mm

Reference Value = 100.54 V/m; Power Drift = 0.05 dB

Peak SAR (extrapolated) = 17.8 W/kg

SAR(1 g) = 9.95 W/kg; SAR(10 g) = 5.35 W/kg

Maximum value of SAR (measured) = 14.18 W/kg

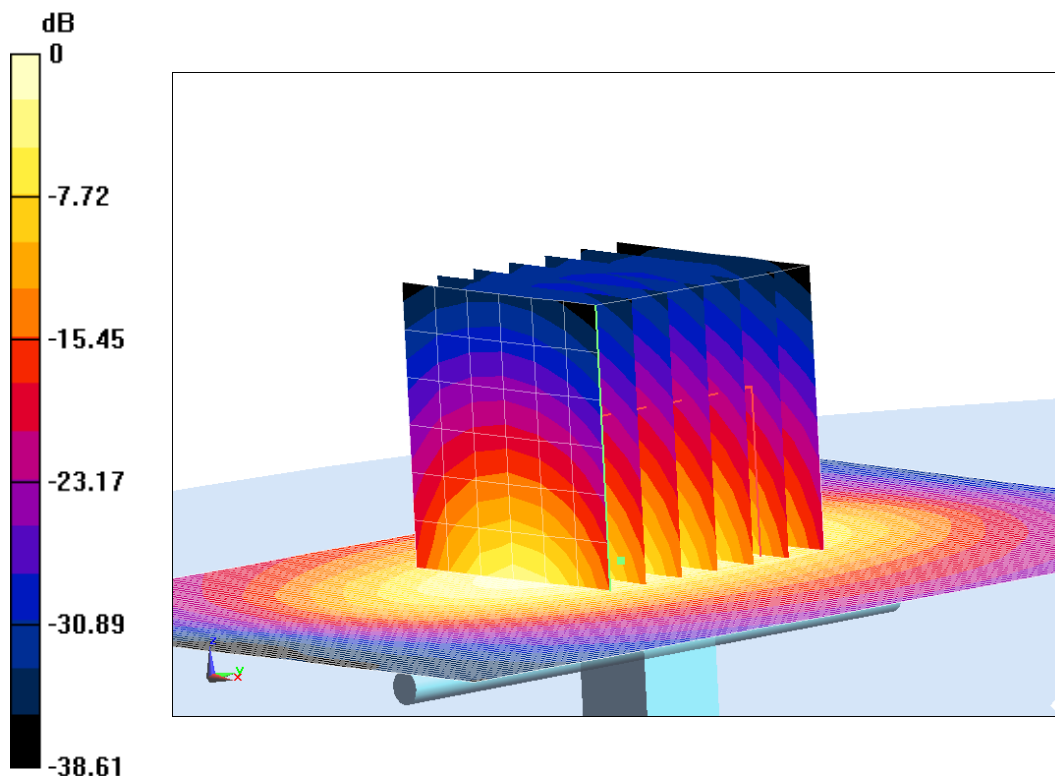

0 dB = 14.18 W/kg = 11.52 dB W/kg

Fig.B.4 validation 1900 MHz 250mW

2450 MHz

Date: 11/11/2017

Electronics: DAE4 Sn1331

Medium: Head 2450 MHz

Medium parameters used: $f = 2450$ MHz; $\sigma = 1.767$ mho/m; $\epsilon_r = 39.25$; $\rho = 1000$ kg/m³

Ambient Temperature: 22.5°C Liquid Temperature: 22.3°C

Communication System: CW Frequency: 2450 MHz Duty Cycle: 1:1

Probe: EX3DV4 – SN3846 ConvF(7.22,7.22,7.22)

System Validation /Area Scan (81x191x1): Interpolated grid: dx=1.000 mm, dy=1.000 mm

Reference Value = 111.42 V/m; Power Drift = 0.05

Fast SAR: SAR(1 g) = 13.08 W/kg; SAR(10 g) = 6.21 W/kg

Maximum value of SAR (interpolated) = 21.49 W/kg

System Validation /Zoom Scan (7x7x7)/Cube 0: Measurement grid: dx=5mm, dy=5mm, dz=5mm

Reference Value = 111.42 V/m; Power Drift = 0.05 dB

Peak SAR (extrapolated) = 26.89 W/kg

SAR(1 g) = 12.8 W/kg; SAR(10 g) = 6.15 W/kg

Maximum value of SAR (measured) = 21.92 W/kg

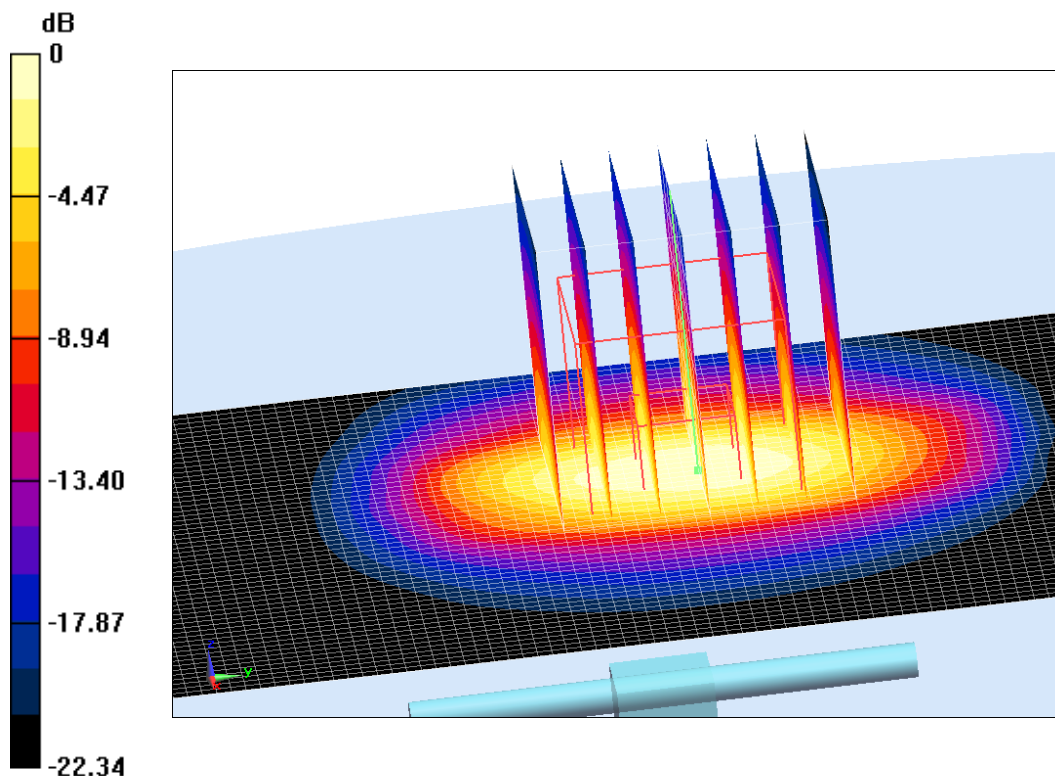

0 dB = 21.92 W/kg = 13.41 dB W/kg

Fig.B.5 validation 2450 MHz 250mW

2450 MHz

Date: 11/11/2017

Electronics: DAE4 Sn1331

Medium: Body 2450 MHz

Medium parameters used: $f = 2450$ MHz; $\sigma = 1.967$ mho/m; $\epsilon_r = 52.83$; $\rho = 1000$ kg/m³

Ambient Temperature: 22.5°C Liquid Temperature: 22.3°C

Communication System: CW Frequency: 2450 MHz Duty Cycle: 1:1

Probe: EX3DV4 – SN3846 ConvF(7.31,7.31,7.31)

System Validation /Area Scan (81x191x1): Interpolated grid: dx=1.000 mm, dy=1.000 mm

Reference Value = 103.97 V/m; Power Drift = 0.05

Fast SAR: SAR(1 g) = 12.39 W/kg; SAR(10 g) = 6 W/kg

Maximum value of SAR (interpolated) = 25.39 W/kg

System Validation /Zoom Scan (7x7x7)/Cube 0: Measurement grid: dx=5mm, dy=5mm, dz=5mm

Reference Value = 103.97 V/m; Power Drift = 0.05 dB

Peak SAR (extrapolated) = 25.91 W/kg

SAR(1 g) = 12.57 W/kg; SAR(10 g) = 5.9 W/kg

Maximum value of SAR (measured) = 20.24 W/kg

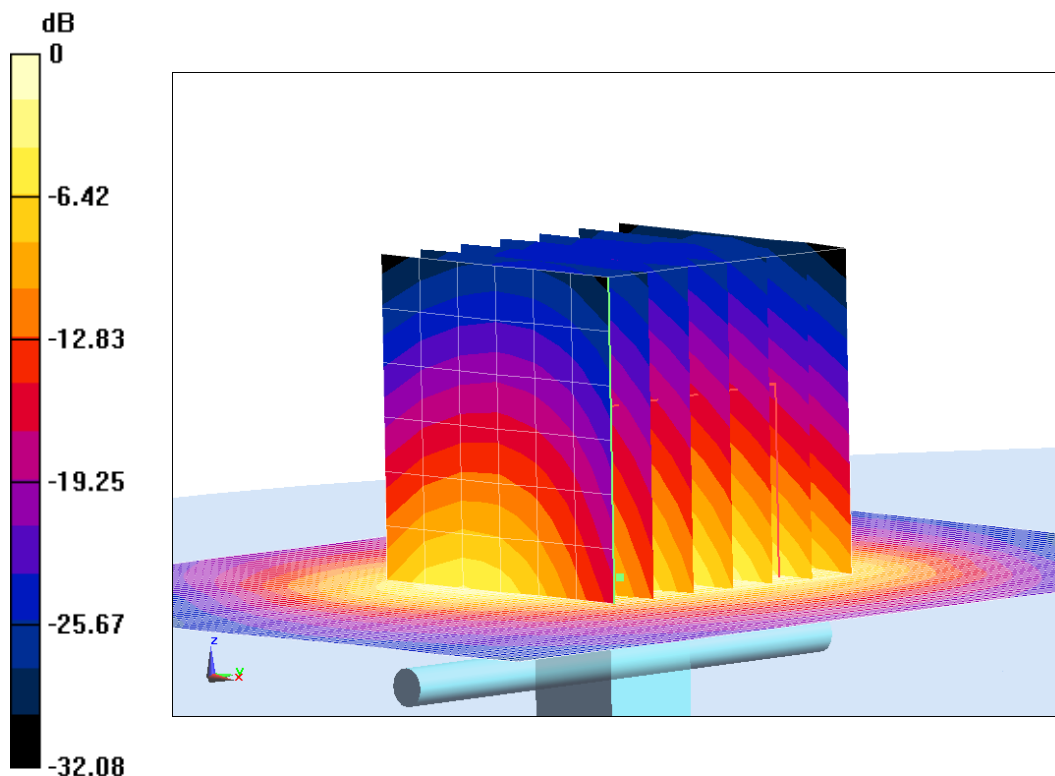

0 dB = 20.24 W/kg = 13.06 dB W/kg

Fig.B.6 validation 2450 MHz 250mW

The SAR system verification must be required that the area scan estimated 1-g SAR is within 3% of the zoom scan 1-g SAR.

Table B.1 Comparison between area scan and zoom scan for system verification

Date	Band	Position	Area scan (1g)	Zoom scan (1g)	Drift (%)
2017-11-8	835	Head	2.39	2.35	1.70
	835	Body	2.42	2.39	1.26
2017-11-10	1900	Head	9.86	9.83	0.31
	1900	Body	10.15	9.95	2.01
2017-11-11	2450	Head	13.08	12.8	2.19
	2450	Body	12.39	12.57	-1.43

ANNEX C SAR Measurement Setup

C.1 Measurement Set-up

The Dasy4 or DASY5 system for performing compliance tests is illustrated above graphically. This system consists of the following items:

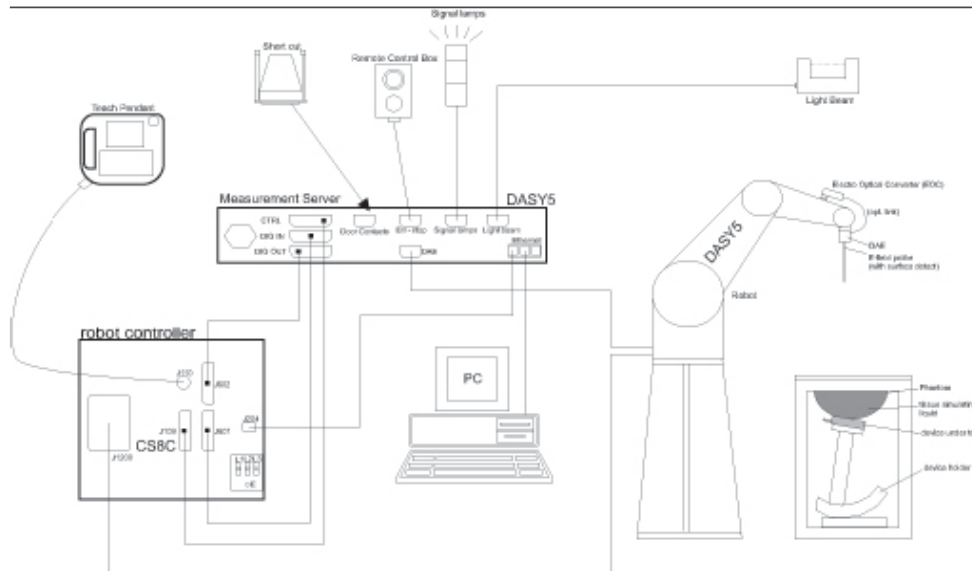

Picture C.1 SAR Lab Test Measurement Set-up

- A standard high precision 6-axis robot (Stäubli TX=RX family) with controller, teach pendant and software. An arm extension for accommodating the data acquisition electronics (DAE).
- An isotropic field probe optimized and calibrated for the targeted measurement.
- A data acquisition electronics (DAE) which performs the signal amplification, signal multiplexing, AD-conversion, offset measurements, mechanical surface detection, collision detection, etc. The unit is battery powered with standard or rechargeable batteries. The signal is optically transmitted to the EOC.
- The Electro-optical converter (EOC) performs the conversion from optical to electrical signals for the digital communication to the DAE. To use optical surface detection, a special version of the EOC is required. The EOC signal is transmitted to the measurement server.
- The function of the measurement server is to perform the time critical tasks such as signal filtering, control of the robot operation and fast movement interrupts.
- The Light Beam used is for probe alignment. This improves the (absolute) accuracy of the probe positioning.
- A computer running WinXP and the DASY4 or DASY5 software.
- Remote control and teach pendant as well as additional circuitry for robot safety such as
- warning lamps, etc.
- The phantom, the device holder and other accessories according to the targeted measurement.

C.2 Dasy4 or DASY5 E-field Probe System

The SAR measurements were conducted with the dosimetric probe designed in the classical triangular configuration and optimized for dosimetric evaluation. The probe is constructed using the thick film technique; with printed resistive lines on ceramic substrates. The probe is equipped with an optical multifiber line ending at the front of the probe tip. It is connected to the EOC box on the robot arm and provides an automatic detection of the phantom surface. Half of the fibers are connected to a pulsed infrared transmitter, the other half to a synchronized receiver. As the probe approaches the surface, the reflection from the surface produces a coupling from the transmitting to the receiving fibers. This reflection increases first during the approach, reaches maximum and then decreases. If the probe is flatly touching the surface, the coupling is zero. The distance of the coupling maximum to the surface is independent of the surface reflectivity and largely independent of the surface to probe angle. The DASY4 or DASY5 software reads the reflection during a software approach and looks for the maximum using 2nd ord curve fitting. The approach is stopped at reaching the maximum.

Probe Specifications:

Model:	ES3DV3, EX3DV4
Frequency	10MHz — 6.0GHz(EX3DV4)
Range:	10MHz — 4GHz(ES3DV3)
Calibration:	In head and body simulating tissue at Frequencies from 835 up to 5800MHz
Linearity:	± 0.2 dB(30 MHz to 6 GHz) for EX3DV4 ± 0.2 dB(30 MHz to 4 GHz) for ES3DV3
Dynamic Range:	10 mW/kg — 100W/kg
Probe Length:	330 mm
Probe Tip	
Length:	20 mm
Body Diameter:	12 mm
Tip Diameter:	2.5 mm (3.9 mm for ES3DV3)
Tip-Center:	1 mm (2.0mm for ES3DV3)
Application:	SAR Dosimetry Testing Compliance tests of mobile phones Dosimetry in strong gradient fields



Picture C.2 Near-field Probe



Picture C.3 E-field Probe

C.3 E-field Probe Calibration

Each E-Probe/Probe Amplifier combination has unique calibration parameters. A TEM cell calibration procedure is conducted to determine the proper amplifier settings to enter in the probe parameters. The amplifier settings are determined for a given frequency by subjecting the probe to a known E-field density (1 mW/cm²) using an RF Signal generator, TEM cell, and RF Power Meter.

The free space E-field from amplified probe outputs is determined in a test chamber. This calibration can be performed in a TEM cell if the frequency is below 1 GHz and in a waveguide or other methodologies above 1 GHz for free space. For the free space calibration, the probe is placed

in the volumetric center of the cavity and at the proper orientation with the field. The probe is then rotated 360 degrees until the three channels show the maximum reading. The power density readings equates to 1 mW/ cm².

E-field temperature correlation calibration is performed in a flat phantom filled with the appropriate simulated brain tissue. The E-field in the medium correlates with the temperature rise in the dielectric medium. For temperature correlation calibration a RF transparent thermistor-based temperature probe is used in conjunction with the E-field probe.

$$SAR = C \frac{\Delta T}{\Delta t}$$

Where:

Δt = Exposure time (30 seconds),

C = Heat capacity of tissue (brain or muscle),

ΔT = Temperature increase due to RF exposure.

$$SAR = \frac{|E|^2 \cdot \sigma}{\rho}$$

Where:

σ = Simulated tissue conductivity,

ρ = Tissue density (kg/m³).

C.4 Other Test Equipment

C.4.1 Data Acquisition Electronics(DAE)

The data acquisition electronics consist of a highly sensitive electrometer-grade preamplifier with auto-zeroing, a channel and gain-switching multiplexer, a fast 16 bit AD-converter and a command decoder with a control logic unit. Transmission to the measurement server is accomplished through an optical downlink for data and status information, as well as an optical uplink for commands and the clock.

The mechanical probe mounting device includes two different sensor systems for frontal and sideways probe contacts. They are used for mechanical surface detection and probe collision detection.

The input impedance of the DAE is 200 MOhm; the inputs are symmetrical and floating. Common mode rejection is above 80 dB.



PictureC.4: DAE

C.4.2 Robot

The SPEAG DASY system uses the high precision robots (DASY4: RX90XL; DASY5: RX160L) type from Stäubli SA (France). For the 6-axis controller system, the robot controller version from Stäubli is used. The Stäubli robot series have many features that are important for our application:

- High precision (repeatability 0.02mm)
- High reliability (industrial design)
- Low maintenance costs (virtually maintenance free due to direct drive gears; no belt drives)
- Jerk-free straight movements (brushless synchron motors; no stepper motors)
- Low ELF interference (motor control fields shielded via the closed metallic construction shields)



Picture C.5 DASY 4



Picture C.6 DASY 5

C.4.3 Measurement Server

The Measurement server is based on a PC/104 CPU board with CPU (dasy4: 166 MHz, Intel Pentium; DASY5: 400 MHz, Intel Celeron), chipdisk (DASY4: 32 MB; DASY5: 128MB), RAM (DASY4: 64 MB, DASY5: 128MB). The necessary circuits for communication with the DAE electronic box, as well as the 16 bit AD converter system for optical detection and digital I/O interface are contained on the DASY I/O board, which is directly connected to the PC/104 bus of the CPU board.

The measurement server performs all real-time data evaluation of field measurements and surface detection, controls robot movements and handles safety operation. The PC operating system cannot interfere with these time critical processes. All connections are supervised by a watchdog, and disconnection of any of the cables to the measurement server will automatically disarm the robot and disable all program-controlled robot movements. Furthermore, the measurement server is equipped with an expansion port which is reserved for future applications. Please note that this expansion port does not have a standardized pinout, and therefore only devices provided by SPEAG can be connected. Devices from any other supplier could seriously damage the measurement server.



Picture C.7 Server for DASY 4



Picture C.8 Server for DASY 5

C.4.4 Device Holder for Phantom

The SAR in the phantom is approximately inversely proportional to the square of the distance between the source and the liquid surface. For a source at 5mm distance, a positioning uncertainty of $\pm 0.5\text{mm}$ would produce a SAR uncertainty of $\pm 20\%$. Accurate device positioning is therefore crucial for accurate and repeatable measurements. The positions in which the devices must be measured are defined by the standards.

The DASY device holder is designed to cope with the different positions given in the standard. It has two scales for device rotation (with respect to the body axis) and device inclination (with respect to the line between the ear reference points). The rotation centers for both scales is the ear reference point (ERP). Thus the device needs no repositioning when changing the angles.

The DASY device holder is constructed of low-loss

POM material having the following dielectric

parameters: relative permittivity $\epsilon = 3$ and loss

tangent $\delta = 0.02$. The amount of dielectric material has been reduced in the closest vicinity of the device, since measurements have suggested that the influence of the clamp on the test results could thus be lowered.

<Laptop Extension Kit>

The extension is lightweight and made of POM, acrylic glass and foam. It fits easily on the upper part of the Mounting Device in place of the phone positioner. The extension is fully compatible with the Twin-SAM and ELI phantoms.



Picture C.9-1: Device Holder

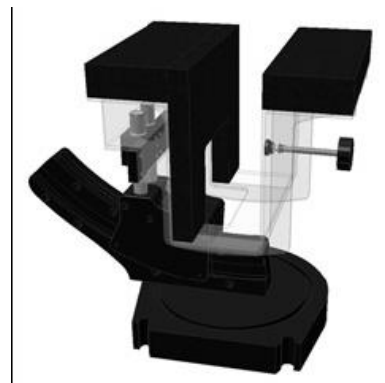

Picture C.9-2: Laptop Extension Kit

C.4.5 Phantom

The SAM Twin Phantom V4.0 is constructed of a fiberglass shell integrated in a table. The shape of the shell is based on data from an anatomical study designed to

Represent the 90th percentile of the population. The phantom enables the dissymmetric evaluation of SAR for both left and right handed handset usage, as well as body-worn usage using the flat phantom region. Reference markings on the Phantom allow the complete setup of all predefined phantom positions and measurement grids by manually teaching three points in the robot. The shell phantom has a 2mm shell thickness (except the ear region where shell thickness increases to 6 mm).

Shell Thickness: 2 ± 0.2 mm

Filling Volume: Approx. 25 liters

Dimensions: 810 x 1000 x 500 mm (H x L x W)

Available: Special



Picture C.10: SAM Twin Phantom

ANNEX D Position of the wireless device in relation to the phantom

D.1 General considerations

This standard specifies two handset test positions against the head phantom – the “cheek” position and the “tilt” position.

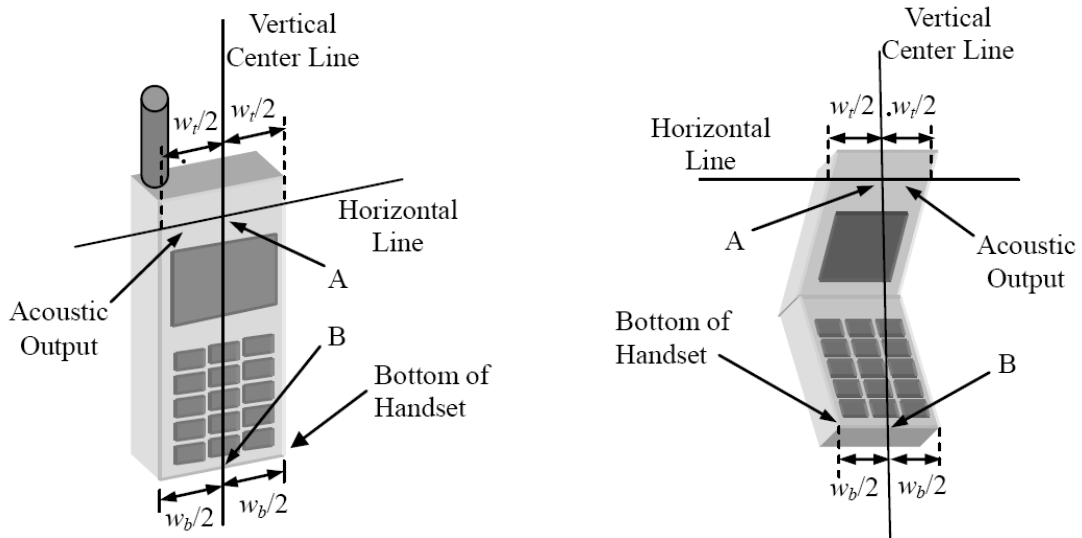

- w_t Width of the handset at the level of the acoustic
- w_b Width of the bottom of the handset
- A Midpoint of the width w_t of the handset at the level of the acoustic output
- B Midpoint of the width w_b of the bottom of the handset

Picture D.1-a Typical “fixed” case handset Picture D.1-b Typical “clam-shell” case handset

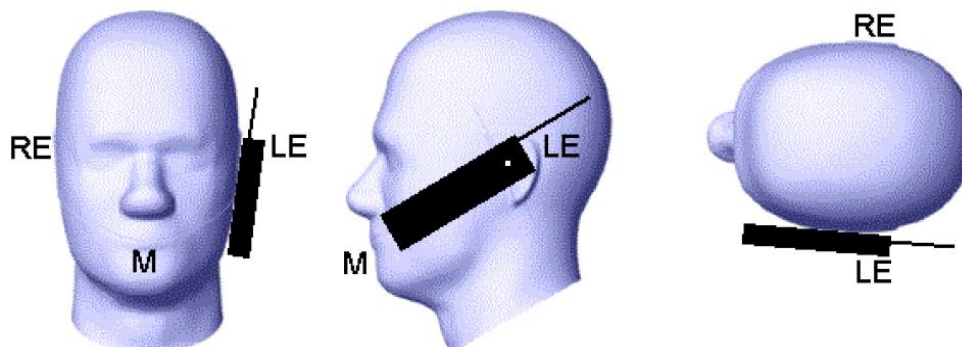

Picture D.2 Cheek position of the wireless device on the left side of SAM

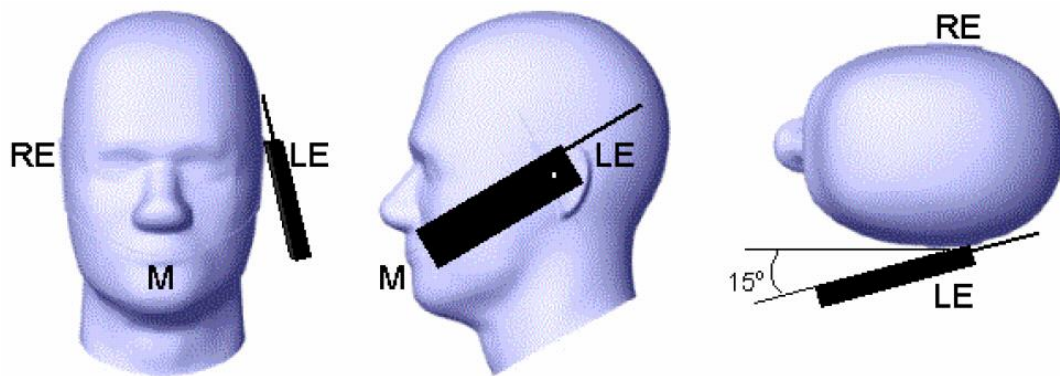

Picture D.3 Tilt position of the wireless device on the left side of SAM

D.2 Body-worn device

A typical example of a body-worn device is a mobile phone, wireless enabled PDA or other battery operated wireless device with the ability to transmit while mounted on a person's body using a carry accessory approved by the wireless device manufacturer.

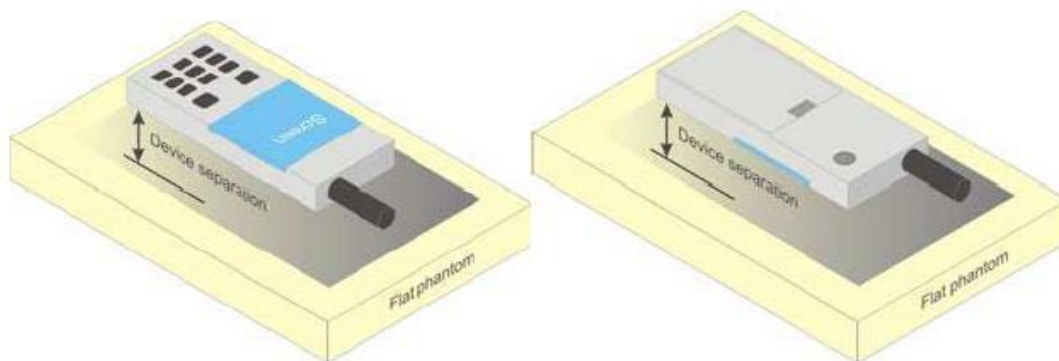

Picture D.4 Test positions for body-worn devices

D.3 Desktop device

A typical example of a desktop device is a wireless enabled desktop computer placed on a table or desk when used.

The DUT shall be positioned at the distance and in the orientation to the phantom that corresponds to the intended use as specified by the manufacturer in the user instructions. For devices that employ an external antenna with variable positions, tests shall be performed for all antenna positions specified. Picture 8.5 show positions for desktop device SAR tests. If the intended use is not specified, the device shall be tested directly against the flat phantom.

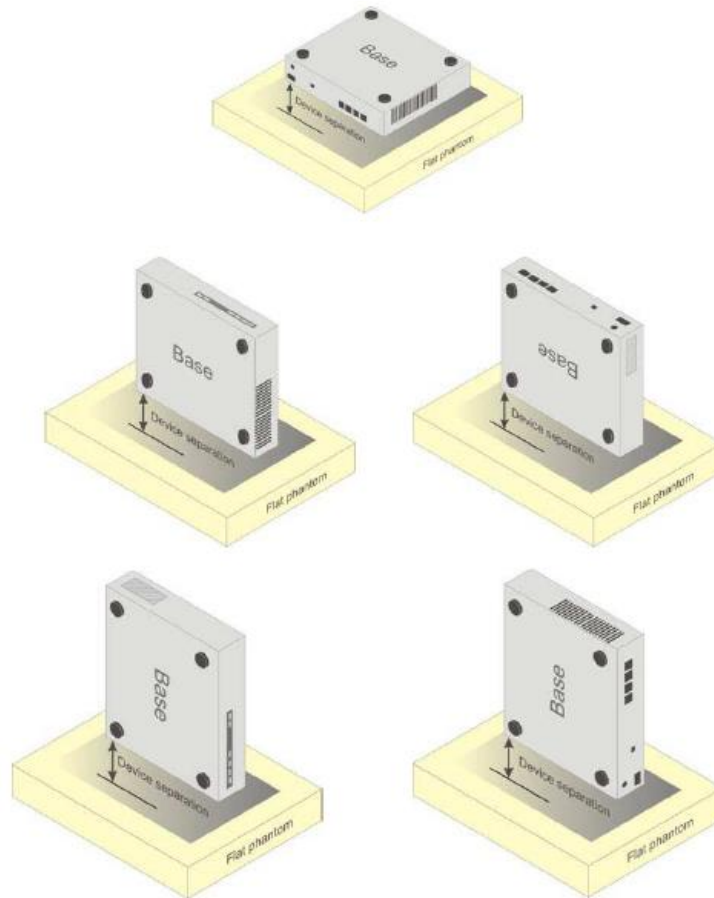

Picture D.5 Test positions for desktop devices

D.4 DUT Setup Photos



Picture D.6

ANNEX E Equivalent Media Recipes

The liquid used for the frequency range of 800-3000 MHz consisted of water, sugar, salt, preventol, glycol monobutyl and Cellulose. The liquid has been previously proven to be suited for worst-case. The Table E.1 shows the detail solution. It's satisfying the latest tissue dielectric parameters requirements proposed by the IEEE 1528 and IEC 62209.

Table E.1: Composition of the Tissue Equivalent Matter

Frequency (MHz)	835 Head	835 Body	1900 Head	1900 Body	2450 Head	2450 Body	5800 Head	5800 Body
Ingredients (% by weight)								
Water	41.45	52.5	55.242	69.91	58.79	72.60	65.53	65.53
Sugar	56.0	45.0	\	\	\	\	\	\
Salt	1.45	1.4	0.306	0.13	0.06	0.18	\	\
Preventol	0.1	0.1	\	\	\	\	\	\
Cellulose	1.0	1.0	\	\	\	\	\	\
Glycol Monobutyl	\	\	44.452	29.96	41.15	27.22	\	\
Diethylenglycol monohexylether	\	\	\	\	\	\	17.24	17.24
Triton X-100	\	\	\	\	\	\	17.24	17.24
Dielectric Parameters Target Value	$\epsilon=41.5$ $\sigma=0.90$	$\epsilon=55.2$ $\sigma=0.97$	$\epsilon=40.0$ $\sigma=1.40$	$\epsilon=53.3$ $\sigma=1.52$	$\epsilon=39.2$ $\sigma=1.80$	$\epsilon=52.7$ $\sigma=1.95$	$\epsilon=35.3$ $\sigma=5.27$	$\epsilon=48.2$ $\sigma=6.00$

Note: There are a little adjustment respectively for 750, 1750, 2600, 5200, 5300 and 5600 based on the recipe of closest frequency in table E.1.

ANNEX F System Validation

The SAR system must be validated against its performance specifications before it is deployed. When SAR probes, system components or software are changed, upgraded or recalibrated, these must be validated with the SAR system(s) that operates with such components.

Table F.1: System Validation for 3846

Probe SN.	Liquid name	Validation date	Frequency point	Status (OK or Not)
3846	Head 750MHz	Jan.19,2017	750 MHz	OK
3846	Head 850MHz	Jan.19,2017	850 MHz	OK
3846	Head 900MHz	Jan.18,2017	900 MHz	OK
3846	Head 1750MHz	Jan.17,2017	1750 MHz	OK
3846	Head 1810MHz	Jan.17,2017	1810 MHz	OK
3846	Head 1900MHz	Jan.16,2017	1900 MHz	OK
3846	Head 1950MHz	Jan.16,2017	1950 MHz	OK
3846	Head 2000MHz	Jan.16,2017	2000 MHz	OK
3846	Head 2100MHz	Jan.16,2017	2100 MHz	OK
3846	Head 2300MHz	Jan.15,2017	2300 MHz	OK
3846	Head 2450MHz	Jan.15,2017	2450 MHz	OK
3846	Head 2550MHz	Jan.15,2017	2550 MHz	OK
3846	Head 2600MHz	Jan.15,2017	2600 MHz	OK
3846	Head 3500MHz	Jan.14,2017	3500 MHz	OK
3846	Head 3700MHz	Jan.14,2017	3700 MHz	OK
3846	Head 5200MHz	Jan.13,2017	5200 MHz	OK
3846	Head 5500MHz	Jan.13,2017	5500 MHz	OK
3846	Head 5800MHz	Jan.13,2017	5800 MHz	OK
3846	Body 750MHz	Jan.19,2017	750 MHz	OK
3846	Body 850MHz	Jan.19,2017	850 MHz	OK
3846	Body 900MHz	Jan.18,2017	900 MHz	OK
3846	Body 1750MHz	Jan.17,2017	1750 MHz	OK
3846	Body 1810MHz	Jan.17,2017	1810 MHz	OK
3846	Body 1900MHz	Jan.16,2017	1900 MHz	OK
3846	Body 1950MHz	Jan.16,2017	1950 MHz	OK
3846	Body 2000MHz	Jan.16,2017	2000 MHz	OK
3846	Body 2100MHz	Jan.16,2017	2100 MHz	OK
3846	Body 2300MHz	Jan.15,2017	2300 MHz	OK
3846	Body 2450MHz	Jan.15,2017	2450 MHz	OK
3846	Body 2550MHz	Jan.15,2017	2550 MHz	OK
3846	Body 2600MHz	Jan.15,2017	2600 MHz	OK
3846	Body 3500MHz	Jan.14,2017	3500 MHz	OK
3846	Body 3700MHz	Jan.14,2017	3700 MHz	OK
3846	Body 5200MHz	Jan.13,2017	5200 MHz	OK
3846	Body 5500MHz	Jan.13,2017	5500 MHz	OK
3846	Body 5800MHz	Jan.13,2017	5800 MHz	OK