

HEARING AID COMPATIBILITY

Applicant Name:

TCL Communication Ltd.
7/F, Block F4, TCL Communication Technology Building
TCL International E City
Zhong Shan Yuan Road
Nanshan District, Shenzhen, Guangdong
P.R. China 518052

Date of Testing:

08/05/2018 - 08/07/2018

Test Site/Location:

PCTEST Lab, Columbia, MD, USA

Test Report Serial No.:

1M1808060150-02-R1.2ACCJ

FCC ID:

2ACCJBT09

APPLICANT:

TCL COMMUNICATION LTD.

Scope of Test:

Audio Band Magnetic Testing (T-Coil)

Application Type:

Class II Permissive Change

FCC Rule Part(s):

CFR §20.19(b)

HAC Standard:

ANSI C63.19-2011

285076 D01 HAC Guidance v05

285076 D02 T-Coil testing for CMRS IP v03

DUT Type:

Portable Handset

Model:

6062W

Additional Model(s):

REVV L 2 PLUS 6062Z

Test Device Serial No.:

Pre-Production Sample [S/N: 08306]

Class II Permissive Change(s):

Adding Google Duo

C63.19-2011 HAC Category:

T3 (SIGNAL TO NOISE CATEGORY)

Note: This revised Test Report (S/N: 1M1808060150-02-R1.2ACCJ) supersedes and replaces the previously issued test report on the same subject device for the same type of testing as indicated. Please discard or destroy the previously issued test report(s) and dispose of it accordingly.

This wireless portable device has been shown to be hearing-aid compatible for the modes represented in this report, under the above rated category, specified in ANSI/IEEE Std. C63.19-2011 and has been tested in accordance with the specified measurement procedures. Test results reported herein relate only to the item(s) tested. Hearing-Aid Compatibility is based on the assumption that all production units will be designed electrically identical to the device tested in this report. North American Bands only.

I attest to the accuracy of data. All measurements reported herein were performed by me or were made under my supervision and are correct to the best of my knowledge and belief. I assume full responsibility for the completeness of these measurements and vouch for the qualifications of all persons taking them.



Randy Ortanez
President







FCC ID: 2ACCJBT09		HAC (T-COIL) TEST REPORT		Approved by: Quality Manager
Filename: 1M1808060150-02-R1.2ACCJ	Test Dates: 08/05/2018 - 08/07/2018	DUT Type: Portable Handset	Page 1 of 47	

TABLE OF CONTENTS

1.	INTRODUCTION	3
2.	DUT DESCRIPTION.....	4
3.	ANSI C63.19-2011 PERFORMANCE CATEGORIES	5
4.	METHOD OF MEASUREMENT	7
5.	OTT VOIP TEST SYSTEM AND DUT CONFIGURATION	17
6.	T-COIL TEST SUMMARY	22
7.	MEASUREMENT UNCERTAINTY	28
8.	EQUIPMENT LIST.....	29
9.	TEST DATA.....	30
10.	CALIBRATION CERTIFICATES.....	35
11.	CONCLUSION.....	42
12.	REFERENCES	43
13.	TEST SETUP PHOTOGRAPHS	45

FCC ID: 2ACCJBT09		HAC (T-COIL) TEST REPORT		Approved by: Quality Manager
Filename: 1M1808060150-02- R1.2ACCJ	Test Dates: 08/05/2018 - 08/07/2018	DUT Type: Portable Handset	Page 2 of 47	

1. INTRODUCTION

On July 10, 2003, the Federal Communications Commission (FCC) adopted new rules requiring wireless manufacturers and service providers to provide digital wireless phones that are compatible with hearing aids. The FCC has modified the exemption for wireless phones under the Hearing Aid Compatibility Act of 1998 (HAC Act) in WT Docket 01-309 RM-8658¹ to extend the benefits of wireless telecommunications to individuals with hearing disabilities. These benefits encompass business, social and emergency communications, which increase the value of the wireless network for everyone. An estimated more than 10% of the population in the United States show signs of hearing impairment and of that fraction, almost 80% use hearing aids. Approximately 500 million people worldwide and 30 million people in the United States suffer from hearing loss.

Compatibility Tests Involved:

The standard calls for wireless communications devices to be measured for:

- RF Electric-field emissions
- T-coil mode, magnetic-signal strength in the audio band
- T-coil mode, magnetic-signal frequency response through the audio band
- T-coil mode, magnetic-signal and noise articulation index

The hearing aid must be measured for:

- RF immunity in microphone mode
- RF immunity in T-coil mode

In the following tests and results, this report includes the evaluation for a wireless communications device.

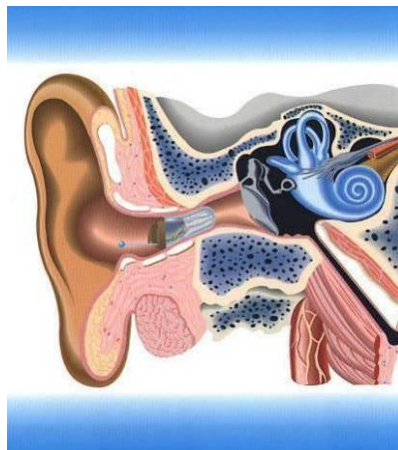



Figure 1-1 Hearing Aid *in-vitu*

¹ FCC Rule & Order, WT Docket 01-309 RM-8658

FCC ID: 2ACCJBT09		HAC (T-COIL) TEST REPORT		Approved by: Quality Manager
Filename: 1M1808060150-02- R1.2ACCJ	Test Dates: 08/05/2018 - 08/07/2018	DUT Type: Portable Handset		Page 3 of 47

2. DUT DESCRIPTION



FCC ID: 2ACCJBT09
 Applicant: TCL Communication Ltd.
 7/F, Block F4, TCL Communication Technology Building
 TCL International E City
 Zhong Shan Yuan Road
 Nanshan District, Shenzhen, Guangdong
 P.R. China 518052

Model: 6062W
 Additional Model(s): REVVL 2 PLUS 6062Z
 Serial Number: 08306
 HW Version: 06
 SW Version: v1A80
 Antenna: Internal Antenna
 DUT Type: Portable Handset

Table 2-1
 2ACCJBT09 HAC Air Interfaces

Air-Interface	Band (MHz)	Type Transport	HAC Tested	Simultaneous But Not Tested	Name of Voice Service
GSM	850	VO	No ³	Yes: WIFI or BT	CMRS Voice ¹
	1900		VD	Yes	Yes: WIFI or BT
	GPRS/EDGE				
UMTS	850	VD			
	1700				
	1900	VD	Yes	Yes: WIFI or BT	Google Duo ²
	HSPA				
LTE (FDD)	680 (B71)	VD	Yes ^{3,4}	Yes: WIFI or BT	VoLTE ¹ , Google Duo ²
	700 (B12)				
	780 (B13)				
	850 (B5)		Yes ³		
	1700 (B4)				
	1700 (B66)				
	1900 (B2)				
2500 (B7)					
WIFI	2450	VD	Yes ³	Yes: GSM, UMTS, or LTE	VoWIFI ² , Google Duo ²
	5200 (U-NII 1)				
	5300 (U-NII 2A)				
	5500 (U-NII 2C)				
	5800 (U-NII 3)				
BT	2450	DT	No	Yes: GSM, UMTS, or LTE	N/A
Type Transport VO = Voice Only DT = Digital Data - Not intended for CMRS Service VD = CMRS and IP Voice over Data Transport			Notes: ¹ Reference level in accordance with 7.4.2.1 of ANSI C63.19-2011 and July 2012 C63 VoLTE Interpretation. ² Reference level is -20dBm0 in accordance with FCC KDB 285076 D02 ³ This report only pertains to OTT VoIP testing for EDGE, HSPA, LTE, and WLAN modes. Please refer to the original certification report (SN: I17Z62005-SEM03) full test data on this device. ⁴ LTE B71, while outside the scope of ANSI C63.19 and FCC HAC regulations, was tested according to the existing HAC procedures.		

FCC ID: 2ACCJBT09		HAC (T-COIL) TEST REPORT		Approved by: Quality Manager
Filename: 1M1808060150-02-R1.2ACCJ	Test Dates: 08/05/2018 - 08/07/2018	DUT Type: Portable Handset	Page 4 of 47	

3. ANSI C63.19-2011 PERFORMANCE CATEGORIES

I. MAGNETIC COUPLING

Axial and Radial Field Intensity

All orientations of the magnetic field, in the axial and radial position along the measurement plane shall be ≥ -18 dB(A/m) at 1 kHz in a 1/3 octave band filter per §8.3.1.

Frequency Response

The frequency response of the axial component of the magnetic field shall follow the response curve specified in EIA RS-504-1983, over the frequency range 300 Hz – 3000 Hz per §8.3.2.

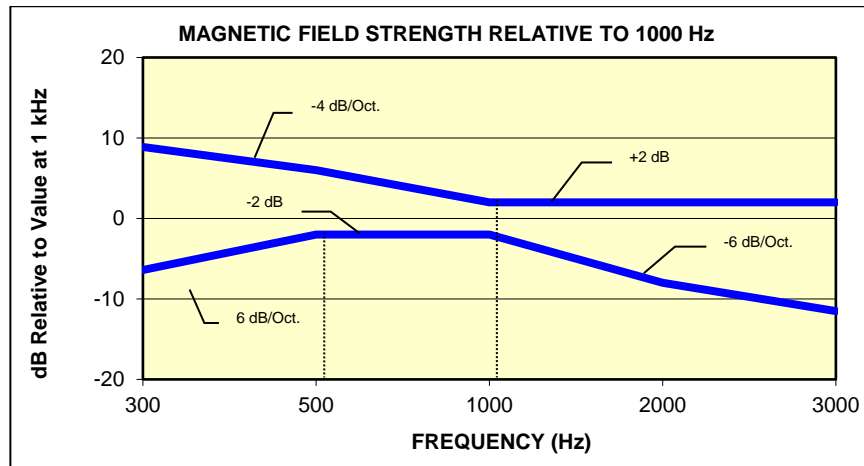

Figure 3-1
Magnetic field frequency response for Wireless Devices with an axial field ≤ -15 dB(A/m) at 1 kHz

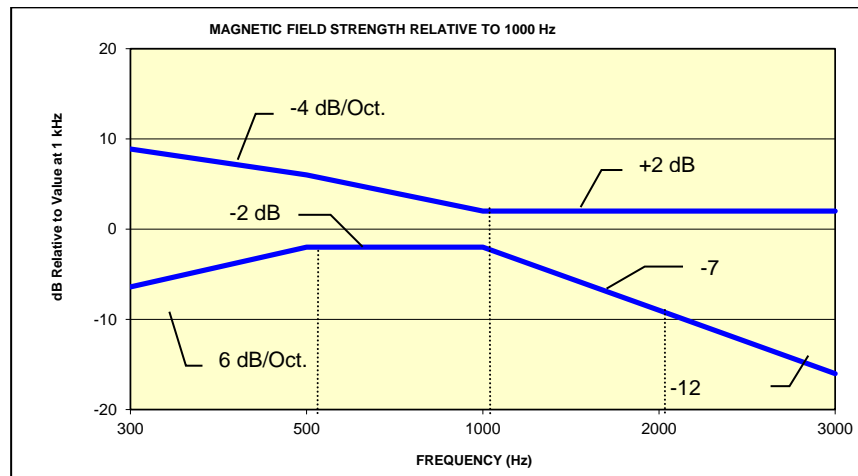

Figure 3-2
Magnetic Field frequency response for wireless devices with an axial field that exceeds -15 dB(A/m) at 1 kHz

FCC ID: 2ACCJBT09		HAC (T-COIL) TEST REPORT		Approved by: Quality Manager
Filename: 1M1808060150-02- R1.2ACCJ	Test Dates: 08/05/2018 - 08/07/2018	DUT Type: Portable Handset		Page 5 of 47

Signal Quality



The table below provides the signal quality requirement for the intended audio magnetic signal from a wireless device. Only the RF immunity of the hearing aid is measured in T-coil mode. It is assumed that a hearing aid can have no immunity to an interference signal in the audio band, which is the intended reception band for this mode. The only criterion that can be measured is the RF immunity in T-coil mode. This is measured using the same procedure as the audio coupling mode at the same levels.

The signal quality of the axial and radial components of the magnetic field was used to determine the T-coil mode category.

Category	Telephone RF Parameters
	Wireless Device Signal Quality [(Signal + Noise)-to-noise ratio in dB]
T1	0 to 10 dB
T2	10 to 20 dB
T3	20 to 30 dB
T4	> 30 dB

Table 3-1
Magnetic Coupling Parameters

Note: The FCC limit for SNNR is 20dB and the test data margins will indicate a margin from the FCC limit for compliance.

FCC ID: 2ACCJBT09		HAC (T-COIL) TEST REPORT		Approved by: Quality Manager
Filename: 1M1808060150-02- R1.2ACCJ	Test Dates: 08/05/2018 - 08/07/2018	DUT Type: Portable Handset		Page 6 of 47

4. METHOD OF MEASUREMENT

I. Test Setup

The equipment was connected as shown in an acoustic/RF hemi-anechoic chamber:

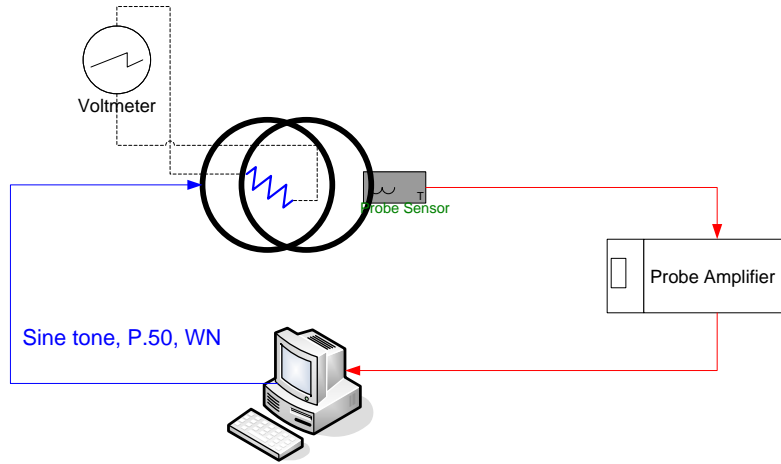

Figure 4-1
Validation Setup with Helmholtz Coil

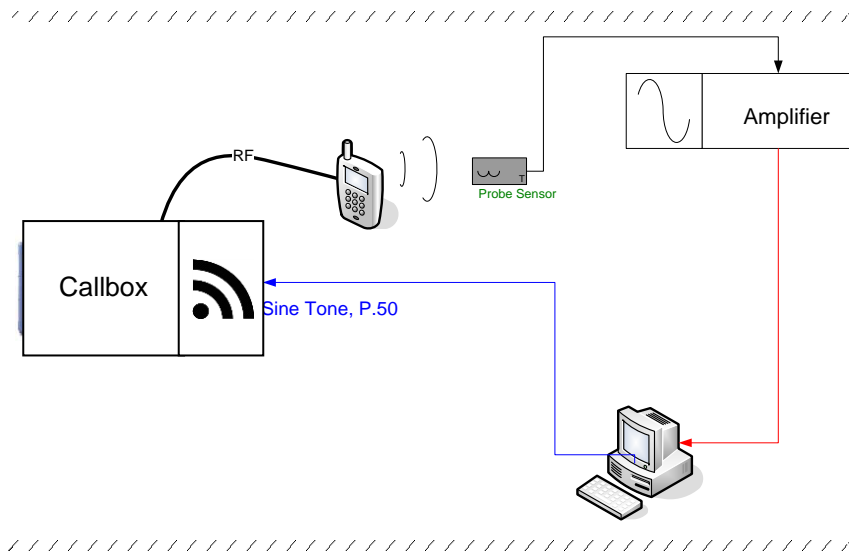



Figure 4-2
T-Coil Test Setup

FCC ID: 2ACCJBT09	 PCTEST ENGINEERING LABORATORY, INC.	HAC (T-COIL) TEST REPORT	 alcatel	Approved by: Quality Manager
Filename: 1M1808060150-02- R1.2ACCJ	Test Dates: 08/05/2018 - 08/07/2018	DUT Type: Portable Handset		Page 7 of 47

© 2018 PCTEST Engineering Laboratory, Inc.

REV 3.2.M
04/17/2018

© 2018 PCTEST Engineering Laboratory, Inc. All rights reserved. Unless otherwise specified, no part of this report may be reproduced or utilized in any part, form or by any means, electronic or mechanical, including photocopying and microfilm, without permission in writing from PCTEST Engineering Laboratory, Inc. If you have any questions about this international copyright or have an enquiry about obtaining additional rights to this report or assembly of contents thereof, please contact INFO@PCTEST.COM.

II. Scanning Mechanism

Manufacturer:	TEM
Accuracy:	± 0.83 cm/meter
Minimum Step Size:	0.1 mm
Maximum speed	6.1 cm/sec
Line Voltage:	115 VAC
Line Frequency:	60 Hz
Material Composite:	Delrin (Acetal)
Data Control:	Parallel Port
Dynamic Range (X-Y-Z):	45 x 31.75 x 47 cm
Dimensions:	36" x 25" x 38"
Operating Area:	36" x 49" x 55"
Reflections:	< -20 dB (in anechoic chamber)

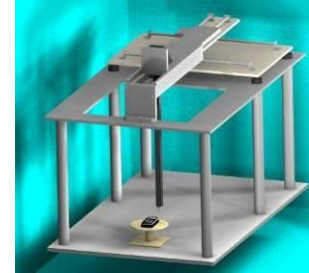

Figure 4-3
RF Near-Field Scanner

III. ITU-T P.50 Artificial Voice

Manufacturer:	ITU-T
Active Frequency Range:	100 Hz – 8 kHz
Stimulus Type:	Male and Female, no spaces
Single Sample Duration:	20.96 seconds
Activity Level:	100%



Figure 4-4
Spectral Characteristic of full P.50

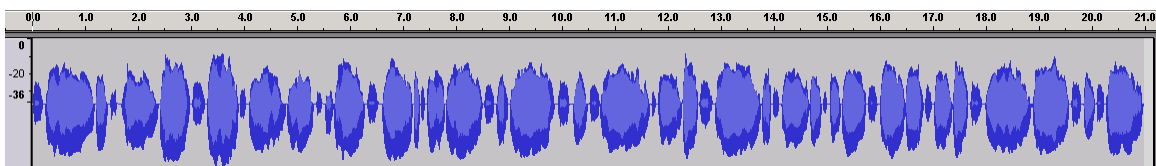

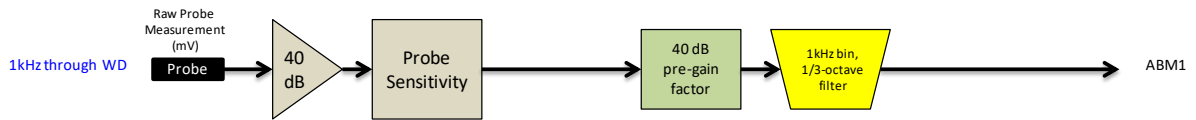

Figure 4-5
Temporal Characteristic of full P.50

FCC ID: 2ACCJBT09		HAC (T-COIL) TEST REPORT		Approved by: Quality Manager
Filename: 1M1808060150-02- R1.2ACCJ	Test Dates: 08/05/2018 - 08/07/2018	DUT Type: Portable Handset		Page 8 of 47

ABM1 Measurement Block Diagram:



ABM2 Measurement Block Diagram:

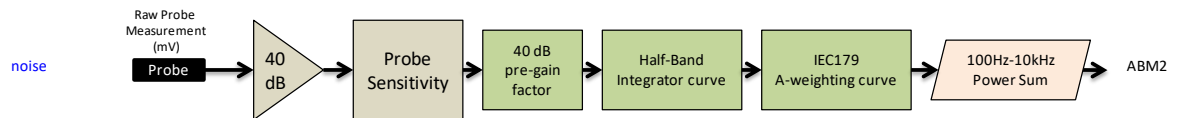

Figure 4-6 Magnetic Measurement Processing Steps

IV. Test Procedure

1. Ambient Noise Check per C63.19 §7.3.1
 - a. Ambient interference was monitored using a Real-Time Analyzer between 100-10,000 Hz with 1/3 octave filtering.
 - b. “A-weighting” and Half-Band Integration was applied to the measurements.
 - c. Since this measurement was measured in the same method as ABM2 measurements, this level was verified to be more than 10 dB below the lowest measurement signal (which is the highest ABM2 measurement for a T4 WD). Therefore the maximum noise level for a T4 WD with an ABM1 = -18 dBA/m is:

$$-18 - 30 - 10 = -58 \text{ dBA/m}$$
2. Measurement System Validation(See Figure 4-1)
 - a. The measurement system including the probe, pre-amplifier and acquisition system were validated as an entire system to ensure the reliability of test measurements.
 - b. ABM1 Validation
 The magnetic field at the center of the Helmholtz coil is given by the equation (per C63.19 Annex D.10.1):

$$H_c = \frac{NI}{r\sqrt{1.25^3}} = \frac{N\left(\frac{V}{R}\right)}{r\sqrt{1.25^3}}$$

Where H_c = magnetic field strength in amperes per meter
 N = number of turns per coil

For the Helmholtz Coil, $N=20$; 0.08m ; $R=10.2\Omega$ and using 18mV :

$$H_c = \frac{20 \cdot \left(\frac{0.018}{10.2}\right)}{0.08 \cdot \sqrt{1.25^3}} = 0.316 \text{ A/m} \approx -10 \text{ dB(A/m)}$$

Therefore a pure tone of 1kHz was applied into the coils such that 18mV was observed across the resistor. The voltmeter used for measurement was verified to be capable of measurements in the audio band range. This theoretically generates an expected field of -10 dB(A/m) in the center of the Helmholtz coil which was used to validate the probe

FCC ID: 2ACCJB09		HAC (T-COIL) TEST REPORT		Approved by: Quality Manager
Filename: 1M1808060150-02-R1.2ACCJ	Test Dates: 08/05/2018 - 08/07/2018	DUT Type: Portable Handset		Page 9 of 47

measurement at -10dB(A/m). This was verified to be within ± 0.5 dB of the -10dB(A/m) value (see Page 26).

c. Frequency Response Validation

The frequency response through the Helmholtz Coil was verified to be within 0.5 dB relative to 1kHz, between 300 – 3000 Hz using the P.50 signal as shown below:

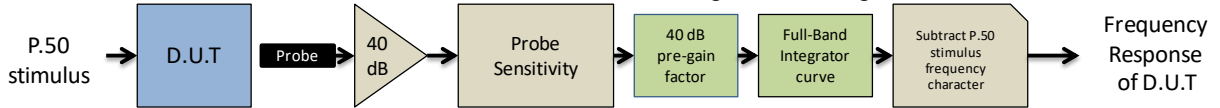

Figure 4-7 Frequency Response Validation

d. ABM2 Measurement Validation

WD noise measurements are filtered with A-weighting and Half-Band Integration over a frequency range of 100Hz – 10kHz to process ABM2 measurements. Below is the verification of the system processing A-weighting and Half-Band integration between system input to output within 0.5 dB of the theoretical result:

**Table 4-1
ABM2 Frequency Response Validation**

f (Hz)	HBI, A - Measured (dB re 1kHz)	HBI, A - Theoretical (dB re 1kHz)	dB Var.
100	-16.180	-16.170	-0.010
125	-13.257	-13.250	-0.007
160	-10.347	-10.340	-0.007
200	-8.017	-8.010	-0.007
250	-5.925	-5.920	-0.005
315	-4.045	-4.040	-0.005
400	-2.405	-2.400	-0.005
500	-1.212	-1.210	-0.002
630	-0.349	-0.350	0.001
800	0.071	0.070	0.001
1000	0.000	0.000	0.000
1250	-0.503	-0.500	-0.003
1600	-1.513	-1.510	-0.003
2000	-2.778	-2.780	0.002
2500	-4.316	-4.320	0.004
3150	-6.166	-6.170	0.004
4000	-8.322	-8.330	0.008
5000	-10.573	-10.590	0.017
6300	-13.178	-13.200	0.022
8000	-16.241	-16.270	0.029
10000	-19.495	-19.520	0.025

FCC ID: 2ACCJBT09		HAC (T-COIL) TEST REPORT		Approved by: Quality Manager
Filename: 1M1808060150-02-R1.2ACCJ	Test Dates: 08/05/2018 - 08/07/2018	DUT Type: Portable Handset		Page 10 of 47

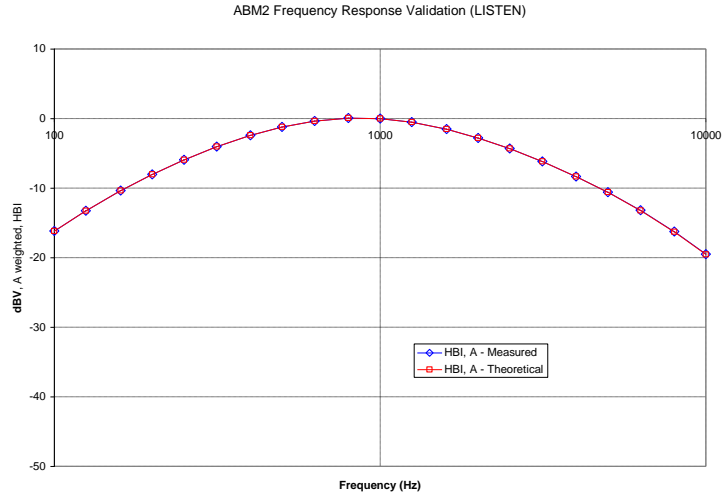

Figure 4-8
ABM2 Frequency Response Validation

The ABM2 result is a power sum from 100Hz to 10kHz with half-band integration and A-weighting. To verify the power sum measurement, a power sum over the full band was measured and verified to track with the source level (See Figure 4-9). Therefore the setup in this step was used to verify the power sum post-processing for ABM2 measurements. See below block diagram:

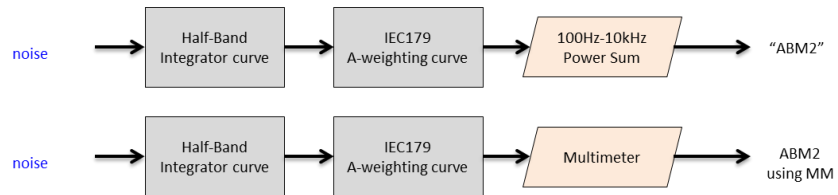

Figure 4-9
ABM2 Validation Block Diagram

The power summed output results for a known input were compared to the multi-meter results to verify any deviation in the post-processing implemented with the power-sum.

Table 4-2
ABM2 Power Sum Validation

WN Input (dBV)	Power Sum (dBV)	Multimeter-Full (dBV)	Dev (dB)
-60	-60.36	-60.2	0.16
-50	-50.19	-50.13	0.06
-40	-40.14	-40.03	0.11
-30	-30.13	-30.01	0.12
-20	-20.12	-20	0.12
-10	-10.14	-10	0.14

FCC ID: 2ACCJBT09	PCTEST ENGINEERING LABORATORY, INC.	HAC (T-COIL) TEST REPORT	alcatel	Approved by: Quality Manager
Filename: 1M1808060150-02- R1.2ACCJ	Test Dates: 08/05/2018 - 08/07/2018	DUT Type: Portable Handset		Page 11 of 47

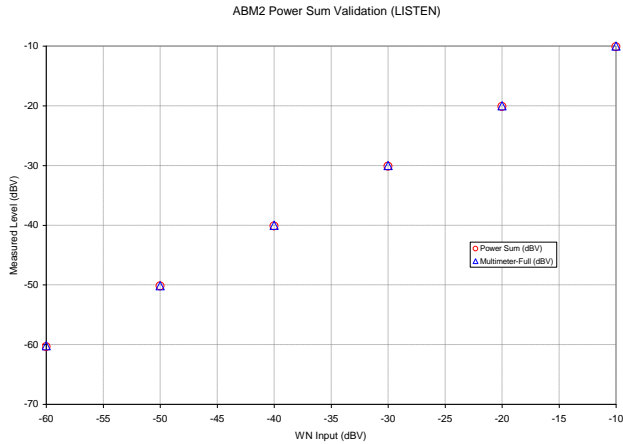

Figure 4-10
ABM2 Power Sum Validation

3. Measurement Test Setup

a. Fine scan above the WD (TEM)

- i. A multitone signal was applied to the handset such that the phone acoustic output was stable within 1dB over the probe settling time and with the acoustic output level at the C63.19 specified levels (below). The measurement step size was in 2 mm increments at a distance of 10 mm between the surface of the wireless device as shown below (note that in Figure 4-12, the grid is not to scale but merely a graphical representation of the coordinate system in use):

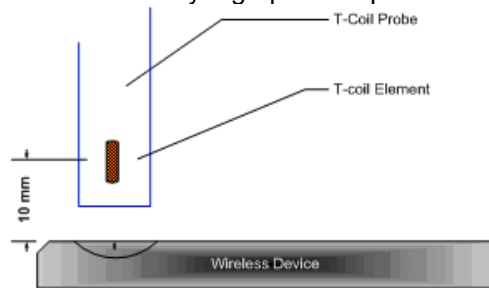

Figure 4-11
Measurement Distance

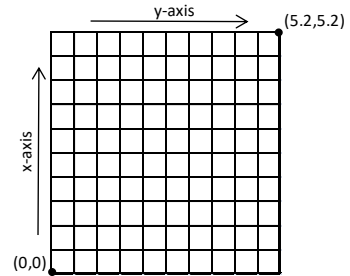



Figure 4-12
Measurement Grid

- ii. After scanning, the planar field maximum point was determined. The position of the probe was moved to this location to setup the test using the SoundCheck system.
 - iii. These steps were repeated for all T-coil orientations (axial and radial) per Figure 4-14 after a T-coil orientation was fully measured with the SoundCheck system.
- b. Speech Signal Setup to Base Station Simulator
- i. C63.19 Table 7-1 states audio reference input levels for various technologies:

Standard	Technology	Input Level (dBm0)
TIA/EIA/IS-2000	CDMA	-18
J-STD-007	GSM (217)	-16
T1/T1P1/3GPP	UMTS (WCDMA)	-16
IDEN™	TDMA (22 and 11 Hz)	-18

FCC ID: 2ACCJBT09	PCTEST ENGINEERING LABORATORY, INC.	HAC (T-COIL) TEST REPORT	alcatel	Approved by: Quality Manager
Filename: 1M1808060150-02-R1.2ACCJ	Test Dates: 08/05/2018 - 08/07/2018	DUT Type: Portable Handset	Page 12 of 47	

- ii. See Section 5 for more information regarding audio level settings for Over-The-Top (OTT) Voice Over IP (VoIP) Testing.
 - c. Real-Time Analyzer (RTA)
 - i. The Real-Time Analyzer was configured to analyze measurements using 1/3 Octave band weighted filtering.
 - d. WD Radio Configuration Selection
 - i. The device was chosen to be tested in the worst-case ABM2 condition (see Section 5 for more information regarding worst-case configurations).
4. Signal Quality Data Analysis
- a. Narrow-band Magnetic Intensity
 - i. The standard specifies a 1kHz 1/3 octave band minimum field intensity for a sine tone. The ABM1 measurements were evaluated at 1kHz with 1/3 octave band filtering over an averaged period of 10 seconds.
 - b. Frequency Response
 - i. The appropriate frequency response curve was measured to curves in Figure 3-1 or Figure 3-2 between 300 – 3000 Hz using digital linear averaging (limit lines chosen according to measurement found in step 4a). A linear average over 3x the length of the artificial voice signal (3x sampling) was performed. A 10 second delay was configured in the measurement process of the stimulus to ensure handset vocoder latency effects and echo cancellation devices (if any) were appropriately stabilized during measurements.
 - ii. The appropriate post-processing was applied according to the system processing chain illustrated in Figure 4-7. All R10 frequencies were plotted with respect to 0dB at 1kHz value and aligned with respect to the EIA-504 mask.
 - iii. The margin is represented by the closest measured data point on the curve to the EIA-504 limit lines, in dB.
 - c. Signal Quality Index
 - i. Ensuring the WD was at maximum RF power, maximum volume, backlight off, display on, maximum contrast setting, keypad lights on (when possible) with no audio signal through the vocoder, the WD was measured over at least 100 Hz – 10,000 Hz, maximized over 5 seconds with a 50ms sample time for the ABM2 measurement (5 second time period is used in noise measurements under standards such as IEEE 269, etc.).
 - ii. After applying half-band integration and A-weighting to the result, a power sum was applied over each 1/3 octave bandwidth frequency for an ABM2 value.
 - iii. This result was subtracted from the ABM1 result in step a, to obtain the Signal Quality.

FCC ID: 2ACCJBT09		HAC (T-COIL) TEST REPORT		Approved by: Quality Manager
Filename: 1M1808060150-02-R1.2ACCJ	Test Dates: 08/05/2018 - 08/07/2018	DUT Type: Portable Handset	Page 13 of 47	

V. Test Setup

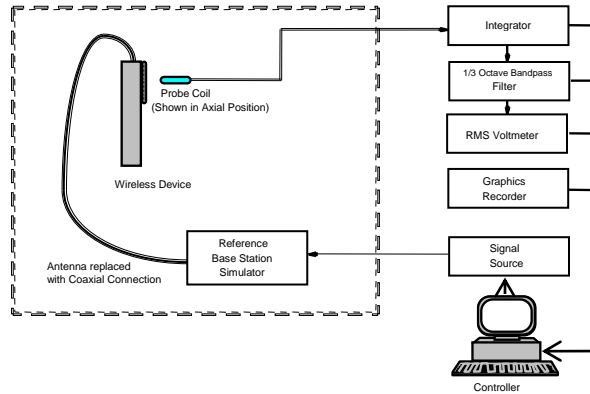



Figure 4-13
Audio Magnetic Field Test Setup

VI. Deviation from C63.19 Test Procedure

Non-conducted RF connection due to inaccessible RF ports.

VII. Air Interface Technologies Tested

All air interfaces which support voice capabilities over pre-installed OTT VoIP applications were tested for T-coil. See Table 2-1 for more details regarding which modes were tested.

FCC ID: 2ACCJBT09		HAC (T-COIL) TEST REPORT		Approved by: Quality Manager
Filename: 1M1808060150-02-R1.2ACCJ	Test Dates: 08/05/2018 - 08/07/2018	DUT Type: Portable Handset		Page 14 of 47

VIII. Wireless Device Channels and Frequencies

1. 2G/3G Modes

The frequencies listed in the table below are those that lie in the center of the bands used for cellular telephony. Only middle channels were evaluated for 2G/3G modes.

**Table 4-3
Center Channels and Frequencies**



Test frequencies & associated channels	
Channel	Frequency (MHz)
Cellular 850	
190 (EDGE)	836.60
4183 (HSPA)	836.60
AWS 1750	
1412 (HSPA)	1730.40
PCS 1900	
661 (EDGE)	1880
9400 (HSPA)	1880

2. 4G (LTE) Modes

The middle channel and supported bandwidths from the worst-case band according to Table 5-6 was evaluated with OTT VoIP for each probe orientation. See Table 6-4 for LTE bandwidths and channels.

3. WIFI

The middle channel for each 802.11 standard was tested for each probe orientation. The 2.4GHz 802.11 standard from each probe orientation resulting in the worst-case SNNR was additionally tested using low and high channels. The 5GHz 802.11 standard from each probe orientation resulting in the worst-case SNNR was additionally tested on higher U-NII bands as well as applicable low and high channels. See Tables 6-5 to 6-8 for WIFI standards and channels.

FCC ID: 2ACCJBT09		HAC (T-COIL) TEST REPORT		Approved by: Quality Manager
Filename: 1M1808060150-02- R1.2ACCJ	Test Dates: 08/05/2018 - 08/07/2018	DUT Type: Portable Handset		Page 15 of 47

IX. Test Flow

The flow diagram below was followed (From C63.19):

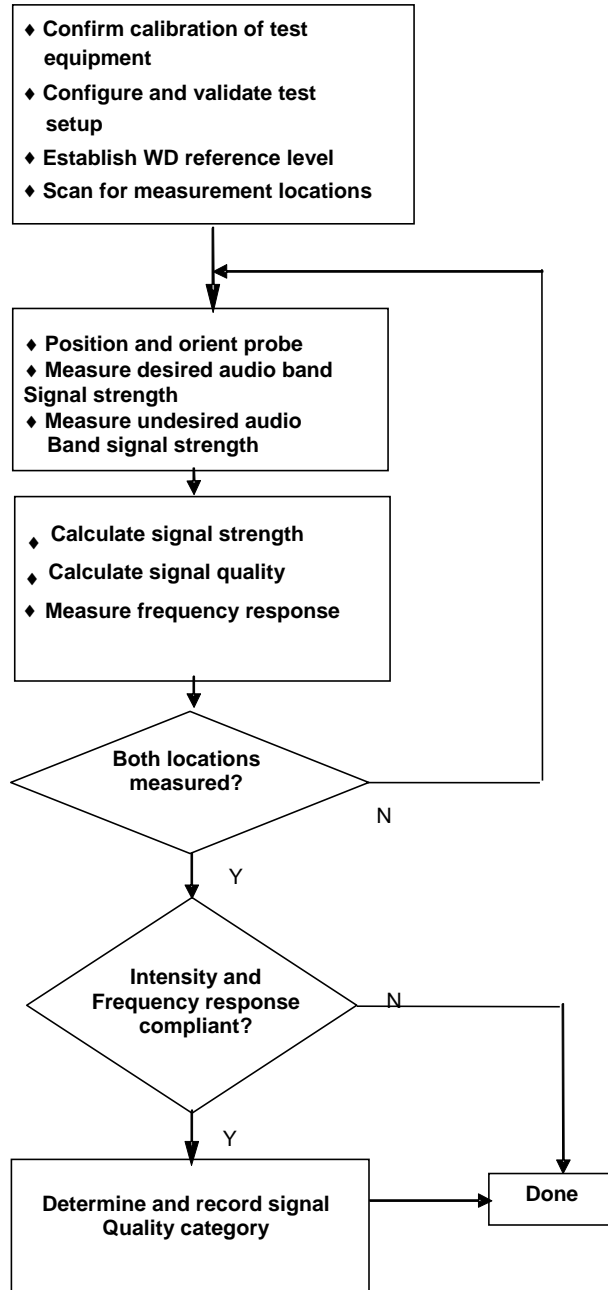



Figure 4-14
C63.19 T-Coil Signal Test Process

FCC ID: 2ACCJBT09		HAC (T-COIL) TEST REPORT		Approved by: Quality Manager
Filename: 1M1808060150-02- R1.2ACCJ	Test Dates: 08/05/2018 - 08/07/2018	DUT Type: Portable Handset		Page 16 of 47

© 2018 PCTEST Engineering Laboratory, Inc.

REV 3.2.M
04/17/2018

© 2018 PCTEST Engineering Laboratory, Inc. All rights reserved. Unless otherwise specified, no part of this report may be reproduced or utilized in any part, form or by any means, electronic or mechanical, including photocopying and microfilm, without permission in writing from PCTEST Engineering Laboratory, Inc. If you have any questions about this international copyright or have an enquiry about obtaining additional rights to this report or assembly of contents thereof, please contact INFO@PCTEST.COM.

5. OTT VOIP TEST SYSTEM AND DUT CONFIGURATION

I. Test System Setup for OTT VoIP T-Coil Testing

1. OTT VoIP Application

Google Duo is a pre-installed application on the DUT which allows for VoIP calls in a held-to-ear scenario. Duo uses the OPUS audio codec and supports a bitrate range of 6kb/s to 64kb/s. All air interfaces capable of a data connection were evaluated with Google Duo.

2. Equipment Setup

A CMW500 callbox was used to perform OTT VoIP T-coil measurements. The Data Application Unit (DAU) of the CMW500 was connected to the internet and allowed for an IP data connection on the DUT. An auxiliary VoIP unit was used to initiate an OTT VoIP call to the DUT. The auxiliary VoIP unit allowed for the configuration and monitoring of the OTT VoIP codec bitrate during a call. Both high and low bitrate settings were evaluated in to determine the worst-case configuration.

3. Audio Level Settings

According to KDB 285076 D02, the average speech level of -20dBm0 shall be used for protocols not specifically listed in Table 7.1 of ANSI C63.19-2011 or the ANSI C63.19-2011 VoLTE interpretation². The auxiliary VoIP unit allowed for monitoring the signal input level to ensure that the settings for speech input and full scale levels resulted in the -20dBm0 speech input level to the DUT for the OTT VoIP call.

II. DUT Configuration for OTT VoIP T-Coil Testing



1. Codec Configuration

An investigation was performed for each applicable data mode to determine the audio codec configuration to be used for testing. The 64kbps codec setting was used for the audio codec on the auxiliary VoIP unit for OTT VoIP T-Coil testing. See below tables for comparisons between codec data rates on all applicable data modes:

**Table 5-1
Codec Investigation – OTT VoIP (EDGE)**

Codec Setting:	64kbps	6kbps	Orientation	Channel
ABM1 (dBA/m)	7.84	7.52	Axial	661
ABM2 (dBA/m)	-40.37	-42.03		
Frequency Response	Pass	Pass		
S+N/N (dB)	48.21	49.55		

² FCC Office of Engineering and Technology KDB, "285076 D02 T-Coil Testing for CMRS IP v03," September 13, 2017

FCC ID: 2ACCJBT09		HAC (T-COIL) TEST REPORT		Approved by: Quality Manager
Filename: 1M1808060150-02-R1.2ACCJ	Test Dates: 08/05/2018 - 08/07/2018	DUT Type: Portable Handset	Page 17 of 47	

**Table 5-2
Codec Investigation – OTT VoIP (HSPA)**

Codec Setting:	64kbps	6kbps	Orientation	Channel
ABM1 (dBA/m)	7.63	7.38	Axial	9400
ABM2 (dBA/m)	-44.73	-45.08		
Frequency Response	Pass	Pass		
S+N/N (dB)	52.36	52.46		

**Table 5-3
Codec Investigation – OTT VoIP (LTE)**

Codec Setting:	64kbps	6kbps	Orientation	Band / BW	Channel
ABM1 (dBA/m)	8.36	7.33	Axial	Band 13 10MHz	23230
ABM2 (dBA/m)	-27.07	-28.48			
Frequency Response	Pass	Pass			
S+N/N (dB)	35.43	35.81			

**Table 5-4
Codec Investigation – OTT VoIP (WIFI)**

Codec Setting:	64kbps	6kbps	Orientation	Band	Standard	Channel
ABM1 (dBA/m)	7.70	7.44	Axial	2.4GHz	IEEE 802.11b	6
ABM2 (dBA/m)	-37.99	-40.14				
Frequency Response	Pass	Pass				
S+N/N (dB)	45.69	47.58				

- Mute on; Backlight off; Max Volume; Max Contrast
- Radio Configurations can be found in Section 6.II.B

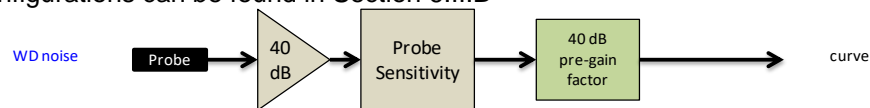

**Figure 5-1
Audio Band Magnetic Curve Measurement Block Diagram**

FCC ID: 2ACCJBT09		HAC (T-COIL) TEST REPORT		Approved by: Quality Manager
Filename: 1M1808060150-02- R1.2ACCJ	Test Dates: 08/05/2018 - 08/07/2018	DUT Type: Portable Handset		Page 18 of 47

2. Radio Configuration for OTT VoIP (LTE)

An investigation was performed to determine the modulation and RB configuration to be used for testing. 16QAM, 1RB, 0RB offset was used for the testing as the worst-case configuration for the handset. See below table for SNNR comparison between different radio configurations:



Table 5-5
OTT VoIP (LTE) SNNR by Radio Configuration

Frequency [MHz]	Channel	Bandwidth [MHz]	Modulation	RB Size	RB Offset	ABM1 [dB(A/m)]	ABM2 [dB(A/m)]	SNNR [dB]
782.0	23230	10	QPSK	1	0	7.72	-33.54	41.26
782.0	23230	10	QPSK	1	25	7.69	-33.13	40.82
782.0	23230	10	QPSK	1	49	7.57	-37.17	44.74
782.0	23230	10	QPSK	25	0	7.61	-40.24	47.85
782.0	23230	10	QPSK	25	12	7.57	-41.49	49.06
782.0	23230	10	QPSK	25	25	7.59	-42.29	49.88
782.0	23230	10	QPSK	50	0	7.62	-41.56	49.18
782.0	23230	10	16QAM	1	0	7.64	-26.03	33.67
782.0	23230	10	16QAM	1	25	7.55	-26.63	34.18
782.0	23230	10	16QAM	1	49	7.56	-31.34	38.90
782.0	23230	10	16QAM	25	0	7.60	-39.13	46.73
782.0	23230	10	16QAM	25	12	7.63	-39.47	47.10
782.0	23230	10	16QAM	25	25	7.58	-39.06	46.64
782.0	23230	10	16QAM	50	0	7.62	-40.31	47.93

An investigation was performed to determine the worst-case LTE band to be used for OTT VoIP testing. LTE Band 13 was used for the testing as the worst-case configuration for the handset. See below table for SNNR comparison between different LTE bands:

Table 5-6
OTT VoIP (LTE) SNNR by LTE Band

Band	Frequency [MHz]	Channel	Bandwidth [MHz]	Modulation	RB Size	RB Offset	ABM1 [dB(A/m)]	ABM2 [dB(A/m)]	SNNR [dB]
71	680.5	133297	20	16QAM	1	0	8.65	-29.21	37.86
12	707.5	23095	10	16QAM	1	0	8.31	-30.27	38.58
13	782.0	23230	10	16QAM	1	0	8.39	-27.15	35.54
5	836.5	20525	10	16QAM	1	0	8.26	-31.20	39.46
66	1745.0	132322	20	16QAM	1	0	8.56	-31.49	40.05
4	1732.5	20175	20	16QAM	1	0	8.71	-30.87	39.58
2	1880.0	18900	20	16QAM	1	0	8.64	-29.96	38.60
7	2535.0	21100	20	16QAM	1	0	8.30	-29.65	37.95

FCC ID: 2ACCJBT09		HAC (T-COIL) TEST REPORT		Approved by: Quality Manager
Filename: 1M1808060150-02-R1.2ACCJ	Test Dates: 08/05/2018 - 08/07/2018	DUT Type: Portable Handset		Page 19 of 47

3. Radio Configuration for OTT VoIP (WIFI)

An investigation was performed on all applicable data rates and modulations to determine the radio configuration to be used for testing. See tables below for SNNR comparison between radio configurations in each 802.11 standard:

Table 5-7
802.11b SNNR by Radio Configuration

Mode	Channel	Modulation	Data Rate [Mbps]	ABM1 [dB(A/m)]	ABM2 [dB(A/m)]	SNNR [dB]
802.11b	6	DSSS	1	7.68	-39.91	47.59
802.11b	6	DSSS	2	7.78	-39.88	47.66
802.11b	6	CCK	5.5	7.65	-40.06	47.71
802.11b	6	CCK	11	7.73	-38.86	46.59

Table 5-8
802.11g/a SNNR by Radio Configuration

Mode	Channel	Modulation	Data Rate [Mbps]	ABM1 [dB(A/m)]	ABM2 [dB(A/m)]	SNNR [dB]
802.11g	6	BPSK	6	7.66	-42.80	50.46
802.11g	6	BPSK	9	7.73	-42.29	50.02
802.11g	6	QPSK	12	7.72	-43.19	50.91
802.11g	6	QPSK	18	7.83	-43.68	51.51
802.11g	6	16-QAM	24	7.68	-44.10	51.78
802.11g	6	16-QAM	36	7.76	-44.58	52.34
802.11g	6	64-QAM	48	7.67	-45.07	52.74
802.11g	6	64-QAM	54	7.35	-44.57	51.92

Table 5-9
802.11n/ac 20MHz BW SNNR by Radio Configuration

Mode	Bandwidth [MHz]	Channel	Modulation	Data Rate [Mbps]	ABM1 [dB(A/m)]	ABM2 [dB(A/m)]	SNNR [dB]
802.11n	20	40	BPSK	6.5	7.64	-42.59	50.23
802.11n	20	40	QPSK	13	7.62	-43.00	50.62
802.11n	20	40	QPSK	19.5	7.63	-43.68	51.31
802.11n	20	40	16-QAM	26	7.69	-43.51	51.20
802.11n	20	40	16-QAM	39	7.59	-43.64	51.23
802.11n	20	40	64-QAM	52	7.62	-43.74	51.36
802.11n	20	40	64-QAM	58.5	7.60	-43.92	51.52
802.11n	20	40	64-QAM	65	7.68	-43.71	51.39
802.11ac	20	40	256-QAM	78	7.70	-42.80	50.50





FCC ID: 2ACCJBT09		HAC (T-COIL) TEST REPORT		Approved by: Quality Manager
Filename: 1M1808060150-02-R1.2ACCJ	Test Dates: 08/05/2018 - 08/07/2018	DUT Type: Portable Handset		Page 20 of 47

Table 5-10
802.11n/ac 40MHz BW SNNR by Radio Configuration



Mode	Bandwidth [MHz]	Channel	Modulation	Data Rate [Mbps]	ABM1 [dB(A/m)]	ABM2 [dB(A/m)]	SNNR [dB]
802.11n	40	38	BPSK	13.5	7.57	-42.88	50.45
802.11n	40	38	QPSK	27	7.30	-44.38	51.68
802.11n	40	38	QPSK	40.5	7.54	-43.82	51.36
802.11n	40	38	16-QAM	54	7.50	-43.98	51.48
802.11n	40	38	16-QAM	81	7.51	-44.05	51.56
802.11n	40	38	64-QAM	108	7.88	-42.59	50.47
802.11n	40	38	64-QAM	121.5	7.89	-43.20	51.09
802.11n	40	38	64-QAM	135	7.75	-43.42	51.17
802.11ac	40	38	256-QAM	162	7.91	-42.84	50.75
802.11ac	40	38	256-QAM	180	7.83	-43.31	51.14

FCC ID: 2ACCJBT09		HAC (T-COIL) TEST REPORT		Approved by: Quality Manager
Filename: 1M1808060150-02- R1.2ACCJ	Test Dates: 08/05/2018 - 08/07/2018	DUT Type: Portable Handset	Page 21 of 47	

6. T-COIL TEST SUMMARY

**Table 6-1
Consolidated Tabled Results**

		Freq. Response Margin		Magnetic Intensity Verdict		FCC SNNR Verdict		Margin from FCC Limit (dB)	C63.19-2011 Rating
		8.3.2		8.3.1		8.3.4			
		Axial	Radial	Axial	Radial	Axial	Radial		
EDGE (OTT VoIP)	Cellular	PASS	NA	PASS	PASS	PASS	PASS	-12.44	T4
	PCS	PASS	NA	PASS	PASS	PASS	PASS		
HSPA (OTT VoIP)	Cellular	PASS	NA	PASS	PASS	PASS	PASS	-25.75	T4
	AWS	PASS	NA	PASS	PASS	PASS	PASS		
	PCS	PASS	NA	PASS	PASS	PASS	PASS		
LTE FDD (OTT VoIP)	B13	PASS	NA	PASS	PASS	PASS	PASS	-4.28	T3
WLAN (OTT VoIP)	802.11b	PASS	NA	PASS	PASS	PASS	PASS	-18.40	T4
	802.11g	PASS	NA	PASS	PASS	PASS	PASS		
	802.11n	PASS	NA	PASS	PASS	PASS	PASS		
U-NII (OTT VoIP)	802.11a	PASS	NA	PASS	PASS	PASS	PASS	-21.48	T4
	802.11n	PASS	NA	PASS	PASS	PASS	PASS		
	802.11ac	PASS	NA	PASS	PASS	PASS	PASS		

FCC ID: 2ACCJBT09		HAC (T-COIL) TEST REPORT		Approved by: Quality Manager
Filename: 1M1808060150-02-R1.2ACCJ	Test Dates: 08/05/2018 - 08/07/2018	DUT Type: Portable Handset	Page 22 of 47	

I. Raw Handset Data

Table 6-2
Raw Data Results for EDGE (OTT VoIP)

Mode	Orientation	Channel	ABM1 [dB(A/m)]	ABM2 [dB(A/m)]	Ambient Noise [dB(A/m)]	Frequency Response Margin (dB)	S+N/N (dB)	FCC Limit (dB)	Margin from FCC Limit (dB)	C63.19-2011 Rating	Test Coordinates
EDGE850	Axial	190	8.17	-41.04	-62.83	1.53	49.21	20.00	-29.21	T4	2.8, 2.2
	Radial	190	2.19	-30.25	-62.89	N/A	32.44	20.00	-12.44	T4	2.6, 1.8
EDGE1900	Axial	661	7.47	-41.81	-62.83	1.63	49.28	20.00	-29.28	T4	2.8, 2.2
	Radial	661	2.18	-30.44	-62.89	N/A	32.62	20.00	-12.62	T4	2.6, 1.8

Table 6-3
Raw Data Results for HSPA (OTT VoIP)



Mode	Orientation	Channel	ABM1 [dB(A/m)]	ABM2 [dB(A/m)]	Ambient Noise [dB(A/m)]	Frequency Response Margin (dB)	S+N/N (dB)	FCC Limit (dB)	Margin from FCC Limit (dB)	C63.19-2011 Rating	Test Coordinates
HSPA V	Axial	4183	7.89	-41.85	-62.83	1.53	49.74	20.00	-29.74	T4	2.8, 2.2
	Radial	4183	2.14	-43.61	-62.89	N/A	45.75	20.00	-25.75	T4	2.6, 1.8
HSPA IV	Axial	1412	7.74	-44.27	-62.83	1.63	52.01	20.00	-32.01	T4	2.8, 2.2
	Radial	1412	2.17	-44.05	-62.89	N/A	46.22	20.00	-26.22	T4	2.6, 1.8
HSPA II	Axial	9400	8.30	-42.36	-62.83	1.43	50.66	20.00	-30.66	T4	2.8, 2.2
	Radial	9400	2.19	-43.95	-62.89	N/A	46.14	20.00	-26.14	T4	2.6, 1.8

Table 6-4
Raw Data Results for LTE B13 (OTT VoIP)

Mode	Orientation	Bandwidth	Channel	ABM1 [dB(A/m)]	ABM2 [dB(A/m)]	Ambient Noise [dB(A/m)]	Frequency Response Margin (dB)	S+N/N (dB)	FCC Limit (dB)	Margin from FCC Limit (dB)	C63.19-2011 Rating	Test Coordinates
LTE Band 13	Axial	10MHz	23230	8.33	-27.04	-62.83	1.58	35.37	20.00	-15.37	T4	2.8, 2.2
		5MHz	23255	8.04	-27.11		1.39	35.15	20.00	-15.15	T4	
		5MHz	23230	8.29	-25.50		1.59	33.79	20.00	-13.79	T4	
		5MHz	23205	8.46	-27.82		1.49	36.28	20.00	-16.28	T4	
	Radial	10MHz	23230	2.09	-23.51	-62.89	N/A	25.60	20.00	-5.60	T3	2.6, 1.8
		5MHz	23255	2.14	-23.82			25.96	20.00	-5.96	T3	
		5MHz	23230	2.17	-22.11			24.28	20.00	-4.28	T3	
		5MHz	23205	2.12	-24.33			26.45	20.00	-6.45	T3	

Table 6-5
Raw Data Results for 2.4GHz WIFI (OTT VoIP)

Mode	Orientation	Channel	ABM1 [dB(A/m)]	ABM2 [dB(A/m)]	Ambient Noise [dB(A/m)]	Frequency Response Margin (dB)	S+N/N (dB)	FCC Limit (dB)	Margin from FCC Limit (dB)	C63.19-2011 Rating	Test Coordinates
WLAN 802.11b	Axial	1	7.82	-39.27	-62.83	1.57	47.09	20.00	-27.09	T4	2.8, 2.2
		6	7.88	-38.56		1.59	46.44	20.00	-26.44	T4	
		11	7.86	-39.69		1.57	47.55	20.00	-27.55	T4	
	Radial	1	2.12	-37.10	-62.89	N/A	39.22	20.00	-19.22	T4	2.6, 1.8
		6	2.11	-36.29			38.40	20.00	-18.40	T4	
		11	2.16	-37.26			39.42	20.00	-19.42	T4	
WLAN 802.11g	Axial	6	7.86	-40.78	-62.83	1.38	48.64	20.00	-28.64	T4	2.8, 2.2
	Radial	6	2.14	-41.09	-62.89	N/A	43.23	20.00	-23.23	T4	2.6, 1.8
WLAN 802.11n	Axial	6	7.89	-40.91	-62.83	1.54	48.80	20.00	-28.80	T4	2.8, 2.2
	Radial	6	2.15	-39.04	-62.89	N/A	41.19	20.00	-21.19	T4	2.6, 1.8

FCC ID: 2ACCJBT09		HAC (T-COIL) TEST REPORT		Approved by: Quality Manager
Filename: 1M1808060150-02-R1.2ACCJ	Test Dates: 08/05/2018 - 08/07/2018	DUT Type: Portable Handset	Page 23 of 47	

**Table 6-6
Raw Data Results for 5GHz WIFI 802.11a (OTT VoIP)**

Mode	Orientation	Bandwidth	U-NII	Channel	ABM1 [dB(A/m)]	ABM2 [dB(A/m)]	Ambient Noise [dB(A/m)]	Frequency Response Margin (dB)	S+N/N (dB)	FCC Limit (dB)	Margin from FCC Limit (dB)	C63.19-2011 Rating	Test Coordinates
802.11a	Axial	20MHz	1	40	7.47	-42.15	-62.83	1.32	49.62	20.00	-29.62	T4	2.8, 2.2
		20MHz	2A	56	7.77	-43.32		1.58	51.09	20.00	-31.09	T4	
		20MHz	2C	116	8.00	-40.04		1.32	48.04	20.00	-28.04	T4	
		20MHz	3	149	7.90	-40.82		1.41	48.72	20.00	-28.72	T4	
		20MHz	3	157	7.68	-40.07		1.40	47.75	20.00	-27.75	T4	
		20MHz	3	165	7.71	-42.04		1.57	49.75	20.00	-29.75	T4	
	Radial	20MHz	1	40	1.99	-40.35	-62.89	N/A	42.34	20.00	-22.34	T4	2.6, 1.8
		20MHz	2A	56	2.07	-40.23			42.30	20.00	-22.30	T4	
		20MHz	2C	116	2.01	-40.66			42.67	20.00	-22.67	T4	
		20MHz	3	149	2.14	-39.34			41.48	20.00	-21.48	T4	
		20MHz	3	157	2.10	-39.69			41.79	20.00	-21.79	T4	
		20MHz	3	165	2.12	-39.71			41.83	20.00	-21.83	T4	

**Table 6-7
Raw Data Results for 5GHz WIFI 802.11n (OTT VoIP)**

Mode	Orientation	Bandwidth	U-NII	Channel	ABM1 [dB(A/m)]	ABM2 [dB(A/m)]	Ambient Noise [dB(A/m)]	Frequency Response Margin (dB)	S+N/N (dB)	FCC Limit (dB)	Margin from FCC Limit (dB)	C63.19-2011 Rating	Test Coordinates
802.11n	Axial	40MHz	1	38	7.79	-41.99	-62.83	1.43	49.78	20.00	-29.78	T4	2.8, 2.2
		20MHz	1	40	7.79	-42.61		1.56	50.40	20.00	-30.40	T4	
	Radial	40MHz	1	38	2.10	-41.11	-62.89	N/A	43.21	20.00	-23.21	T4	2.6, 1.8
		20MHz	1	40	2.05	-40.34			42.39	20.00	-22.39	T4	



**Table 6-8
Raw Data Results for 5GHz WIFI 802.11ac (OTT VoIP)**

Mode	Orientation	Bandwidth	U-NII	Channel	ABM1 [dB(A/m)]	ABM2 [dB(A/m)]	Ambient Noise [dB(A/m)]	Frequency Response Margin (dB)	S+N/N (dB)	FCC Limit (dB)	Margin from FCC Limit (dB)	C63.19-2011 Rating	Test Coordinates
802.11ac	Axial	40MHz	1	38	7.79	-42.95	-62.83	1.40	50.74	20.00	-30.74	T4	2.8, 2.2
		20MHz	1	40	7.74	-42.02		1.59	49.76	20.00	-29.76	T4	
	Radial	40MHz	1	38	2.09	-40.55	-62.89	N/A	42.64	20.00	-22.64	T4	2.6, 1.8
		20MHz	1	40	2.09	-40.54			42.63	20.00	-22.63	T4	

II. Test Notes



A. General

1. Phone Condition: Mute on; Backlight off; Max Volume; Max Contrast
2. 'Radial' orientation refers to radial transverse.
3. Hearing Aid Mode (**Phone→Settings→Accessibility→Hearing aids**) as well as Noise reduction Mode (**Phone→Settings→Accessibility→Noise Reduction**) were set to ON for Frequency Response compliance.
4. Speech Signal: ITU-T P.50 Artificial Voice
5. Bluetooth and WIFI were disabled for 2G/3G/4G modes while testing.
6. Licensed data modes and Bluetooth were disabled for WIFI modes while testing.
7. The Margin from FCC limit column indicates a margin from the FCC limit for compliance (T3).

FCC ID: 2ACCJBT09	 PCTEST ENGINEERING LABORATORY, INC.	HAC (T-COIL) TEST REPORT		Approved by: Quality Manager
Filename: 1M1808060150-02-R1.2ACCJ	Test Dates: 08/05/2018 - 08/07/2018	DUT Type: Portable Handset	Page 24 of 47	

B. OTT VoIP

1. Vocoder Configuration: 64kbps
2. EDGE Configuration
 - a. MCS Index: 7
 - b. Number of TX slots: 2
3. HSPA Configuration:
 - a. Release: 6
 - b. 3GPP 34.121 Subtest 1
4. LTE FDD Configuration:
 - a. Power Configuration: TPC = "Max Power"
 - b. Radio Configuration: 16QAM, 1RB, 0RB offset
 - c. LTE Band 13 was the worst-case band from Table 5-6 and was used to test both Axial and Radial probe orientations.
 - d. The worst-case band and bandwidth combination for each probe orientation is additionally tested on the low and high channels for those combinations. LTE Band 13 at 5MHz is the worst-case for both the Axial and Radial probe orientations.
5. WIFI Configuration:
 - a. Radio Configuration
 - i. 802.11b: CCK, 11Mbps
 - ii. 802.11g/a: BPSK, 9Mbps
 - iii. 802.11n/ac 20MHz: BPSK, 6.5Mbps
 - iv. 802.11n/ac 40MHz: BPSK, 13.5Mbps
 - b. The worst-case standard for 2.4GHz WIFI in each probe orientation is additionally tested on the low and high channels. 802.11b is the worst-case for both the Axial and Radial probe orientations.
 - c. The worst-case standard for 5GHz WIFI in each probe orientation is additionally tested on higher U-NII bands as well as applicable low and high channels. 802.11a (U-NII 3) is the worst-case for both the Axial and Radial probe orientations.

FCC ID: 2ACCJBT09		HAC (T-COIL) TEST REPORT		Approved by: Quality Manager
Filename: 1M1808060150-02- R1.2ACCJ	Test Dates: 08/05/2018 - 08/07/2018	DUT Type: Portable Handset		Page 25 of 47

III. 1 kHz Vocoder Application Check

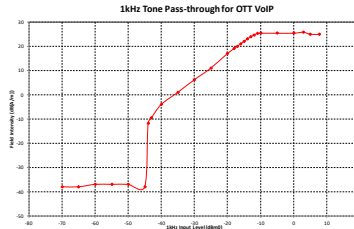



This model was verified to be within the linear region for ABM1 measurements at -20 dBm0 for OTT VoIP. This measurement was taken in the axial configuration above the maximum location.

IV. T-Coil Validation Test Results

Table 6-9
Helmholtz Coil Validation Table of Results

Item	Target	Result	Verdict
Axial			
Magnetic Intensity, -10 dBA/m	-10 ± 0.5 dB	-10.163	PASS
Environmental Noise	< -58 dBA/m	-62.83	PASS
Frequency Response, from limits	> 0 dB	0.80	PASS
Radial			
Magnetic Intensity, -10 dBA/m	-10 ± 0.5 dB	-10.264	PASS
Environmental Noise	< -58 dBA/m	-62.89	PASS
Frequency Response, from limits	> 0 dB	0.80	PASS

FCC ID: 2ACCJBT09		HAC (T-COIL) TEST REPORT		Approved by: Quality Manager
Filename: 1M1808060150-02- R1.2ACCJ	Test Dates: 08/05/2018 - 08/07/2018	DUT Type: Portable Handset		Page 26 of 47

V. ABM1 Magnetic Field Distribution Scan Overlays

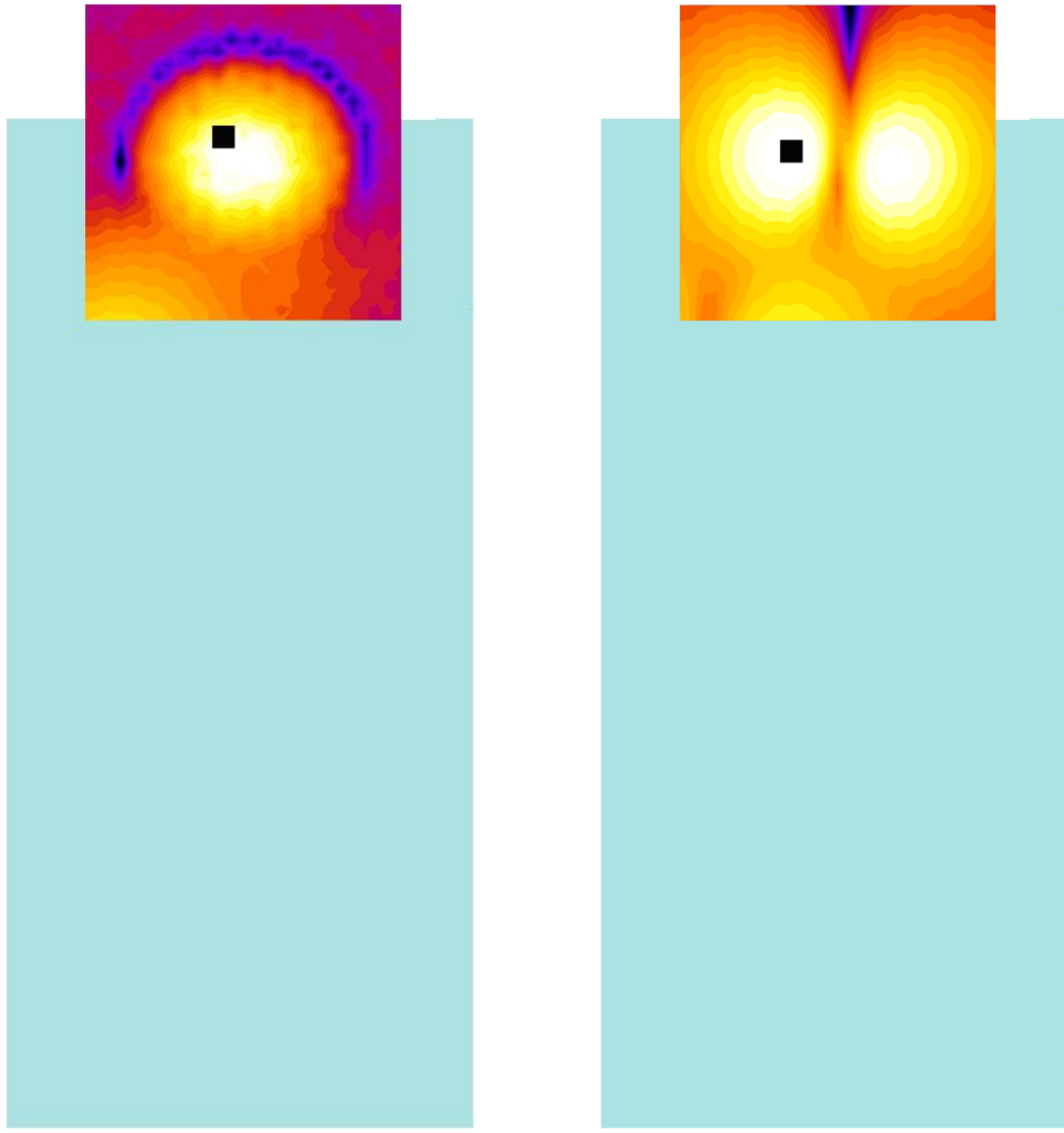



Axial

Radial (Transverse)

Figure 6-1
T-Coil Scan Overlay Magnetic Field Distributions

Notes:

1. Final measurement locations are indicated by a cursor on the contour plots.
2. See Test Setup Photographs for actual WD overlay.

FCC ID: 2ACCJBT09		HAC (T-COIL) TEST REPORT	 Approved by: Quality Manager
Filename: 1M1808060150-02-R1.2ACCJ	Test Dates: 08/05/2018 - 08/07/2018	DUT Type: Portable Handset	Page 27 of 47

© 2018 PCTEST Engineering Laboratory, Inc.

REV 3.2.M
04/17/2018

© 2018 PCTEST Engineering Laboratory, Inc. All rights reserved. Unless otherwise specified, no part of this report may be reproduced or utilized in any part, form or by any means, electronic or mechanical, including photocopying and microfilm, without permission in writing from PCTEST Engineering Laboratory, Inc. If you have any questions about this international copyright or have an enquiry about obtaining additional rights to this report or assembly of contents thereof, please contact INFO@PCTEST.COM.

7. MEASUREMENT UNCERTAINTY



**Table 7-1
Uncertainty Estimation Table**

Contribution	Data +/- %	Data +/- dB	Data Type	Probability distribution	Divisor	Standard uncertainty	Standard Uncertainty (dB)
ABM Noise	7.0%	0.29	Std. Dev.	Normal k=1	1.00	7.0%	
RF Reflections	4.7%	0.20	Specification	Rectangular	1.73	2.7%	
Reference Signal Level	12.2%	0.50	Specification	Rectangular	1.73	7.0%	
Positioning Accuracy	10.0%	0.41	Uncertainty	Rectangular	1.73	5.8%	
Probe Coil Sensitivity	12.2%	0.50	Specification	Rectangular	1.73	7.0%	
Probe Linearity	2.4%	0.10	Std. Dev.	Normal k=1	1.00	2.4%	
Cable Loss	2.8%	0.12	Specification	Rectangular	1.73	1.6%	
Frequency Analyzer	5.0%	0.21	Specification	Rectangular	1.73	2.9%	
System Repeatability	5.0%	0.21	Std. Dev.	Normal k=1	1.00	5.0%	
WD Repeatability	9.0%	0.37	Std. Dev.	Normal k=1	1.00	9.0%	
Positioner Accuracy	1.0%	0.04	Specification	Rectangular	1.73	0.6%	
Combined standard uncertainty, u_c (k=1)						17.7%	0.71
Expanded uncertainty (k=2), 95% confidence level						35.3%	1.31

Notes:

1. Test equipments are calibrated according to techniques outlined in NIS81, NIS3003 and NIST Tech Note 1297.
2. All equipments have traceability according to NIST. Measurement Uncertainties are defined in further detail in NIS 81 and NIST Tech Note 1297 and UKAS M3003.



Measurement uncertainty reflects the quality and accuracy of a measured result as compared to the true value. Such statements are generally required when stating results of measurements so that it is clear to the intended audience that the results may differ when reproduced by different facilities. Measurement results vary due to the measurement uncertainty of the instrumentation, measurement technique, and test engineer. Most uncertainties are calculated using the tolerances of the instrumentation used in the measurement, the measurement setup variability, and the technique used in performing the test. While not generally included, the variability of the equipment under test also figures into the overall measurement uncertainty. Another component of the overall uncertainty is based on the variability of repeated measurements (so-called Type A uncertainty). This may mean that the Hearing Aid compatibility tests may have to be repeated by taking down the test setup and resetting it up so that there are a statistically significant number of repeat measurements to identify the measurement uncertainty. By combining the repeat measurement results with that of the instrumentation chain using the technique contained in NIS 81 and NIS 3003, the overall measurement uncertainty was estimated.

FCC ID: 2ACCJBT09		HAC (T-COIL) TEST REPORT		Approved by: Quality Manager
Filename: 1M1808060150-02- R1.2ACCJ	Test Dates: 08/05/2018 - 08/07/2018	DUT Type: Portable Handset		Page 28 of 47

8. EQUIPMENT LIST

**Table 8-1
Equipment List**

Manufacturer	Model	Description	Cal Date	Cal Interval	Cal Due	Serial Number
Dell	Latitude E6540	SoundCheck Acoustic Analyzer Laptop	4/11/2017	Biennial	4/11/2019	7BFNM32
Listen	SoundConnect	Microphone Power Supply	12/2/2016	Biennial	12/2/2018	PS2612
RME	Fireface UC	Soundcheck Acoustic Analyzer External Audio Interface	4/11/2017	Biennial	4/11/2019	23528889
Rohde & Schwarz	CMW500	Wideband Radio Communication Tester	1/19/2018	Annual	1/19/2019	162125
Seekonk	NC-100	Torque Wrench (8" lb)	9/1/2016	Biennial	9/1/2018	21053
TEM	C63.19	Helmholtz Coil	12/7/2016	Biennial	12/7/2018	925
TEM	Radial T-Coil Probe	Radial T-Coil Probe	12/7/2016	Biennial	12/7/2018	TEM-1130
TEM	Axial T-Coil Probe	Axial T-Coil Probe	12/7/2016	Biennial	12/7/2018	TEM-1124
TEM		HAC System Controller with Software	N/A		N/A	N/A
TEM		HAC Positioner	N/A		N/A	N/A



FCC ID: 2ACCJBT09		HAC (T-COIL) TEST REPORT		Approved by: Quality Manager
Filename: 1M1808060150-02- R1.2ACCJ	Test Dates: 08/05/2018 - 08/07/2018	DUT Type: Portable Handset	Page 29 of 47	

© 2018 PCTEST Engineering Laboratory, Inc.

REV 3.2.M
04/17/2018

© 2018 PCTEST Engineering Laboratory, Inc. All rights reserved. Unless otherwise specified, no part of this report may be reproduced or utilized in any part, form or by any means, electronic or mechanical, including photocopying and microfilm, without permission in writing from PCTEST Engineering Laboratory, Inc. If you have any questions about this international copyright or have an enquiry about obtaining additional rights to this report or assembly of contents thereof, please contact INFO@PCTEST.COM.

9. TEST DATA

FCC ID: 2ACCJBT09		HAC (T-COIL) TEST REPORT		Approved by: Quality Manager
Filename: 1M1808060150-02- R1.2ACCJ	Test Dates: 08/05/2018 - 08/07/2018	DUT Type: Portable Handset	Page 30 of 47	

© 2018 PCTEST Engineering Laboratory, Inc.

REV 3.2.M
04/17/2018

© 2018 PCTEST Engineering Laboratory, Inc. All rights reserved. Unless otherwise specified, no part of this report may be reproduced or utilized in any part, form or by any means, electronic or mechanical, including photocopying and microfilm, without permission in writing from PCTEST Engineering Laboratory, Inc. If you have any questions about this international copyright or have an enquiry about obtaining additional rights to this report or assembly of contents thereof, please contact INFO@PCTEST.COM.



PCTEST Hearing-Aid Compatibility Facility

DUT: HH Coil – SN: 925

Type: HH Coil
Serial: 925

Measurement Standard: ANSI C63.19-2011

Equipment:

- Probe: Axial T-Coil Probe – SN: TEM-1124; Calibrated: 12/07/2016
- Helmholtz Coil – SN: 925; Calibrated: 12/07/2016

Noise Spectrum

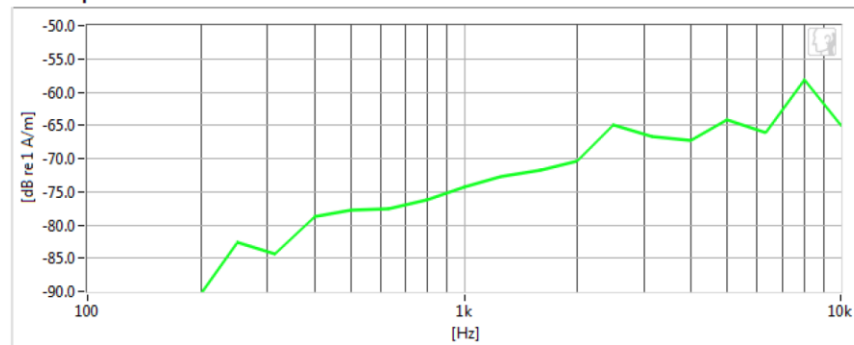

Frequency Response

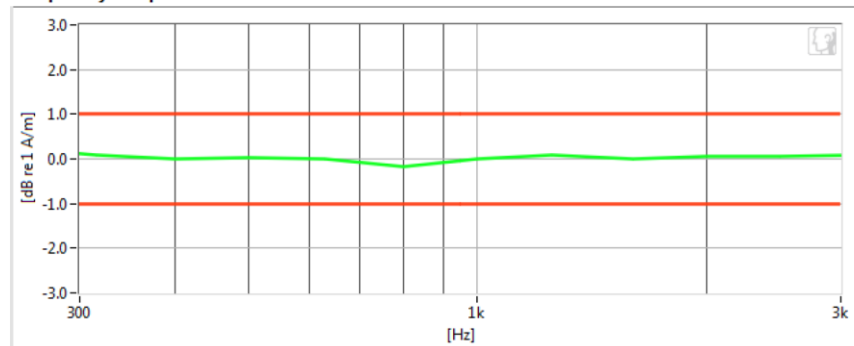

Results

Verification 1kHz Intensity	-10.163 dB	✓	Max/Min	-9.5/-10.5
Verification ABM2	-62.83 dB	✓	Maximum	-58.0
Frequency Response Margin	800m dB	✓	Tolerance curves	Aligned Data

PCTEST 2018

FCC ID: 2ACCJBT09		HAC (T-COIL) TEST REPORT		Approved by: Quality Manager
Filename: 1M1808060150-02-R1.2ACCJ	Test Dates: 08/05/2018 - 08/07/2018	DUT Type: Portable Handset		Page 31 of 47

© 2018 PCTEST Engineering Laboratory, Inc.

REV 3.2.M
04/17/2018

© 2018 PCTEST Engineering Laboratory, Inc. All rights reserved. Unless otherwise specified, no part of this report may be reproduced or utilized in any part, form or by any means, electronic or mechanical, including photocopying and microfilm, without permission in writing from PCTEST Engineering Laboratory, Inc. If you have any questions about this international copyright or have an enquiry about obtaining additional rights to this report or assembly of contents thereof, please contact INFO@PCTEST.COM.



PCTEST Hearing-Aid Compatibility Facility

DUT: HH Coil – SN: 925

Type: HH Coil
Serial: 925

Measurement Standard: ANSI C63.19-2011

Equipment:

- Probe: Radial T-Coil Probe – SN: TEM-1130; Calibrated: 12/07/2016
- Helmholtz Coil – SN: 925; Calibrated: 12/07/2016

Noise Spectrum

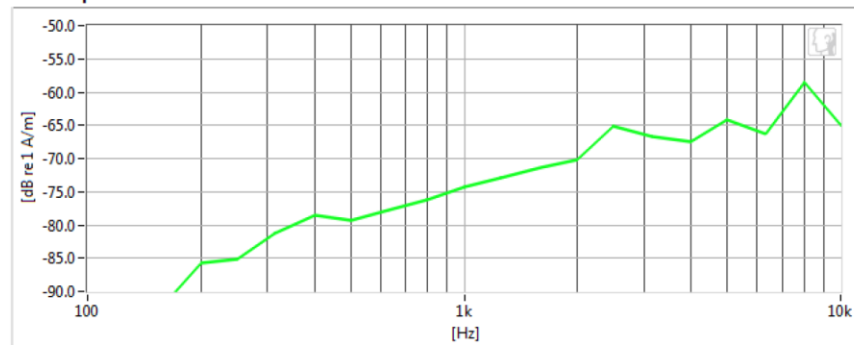

Frequency Response

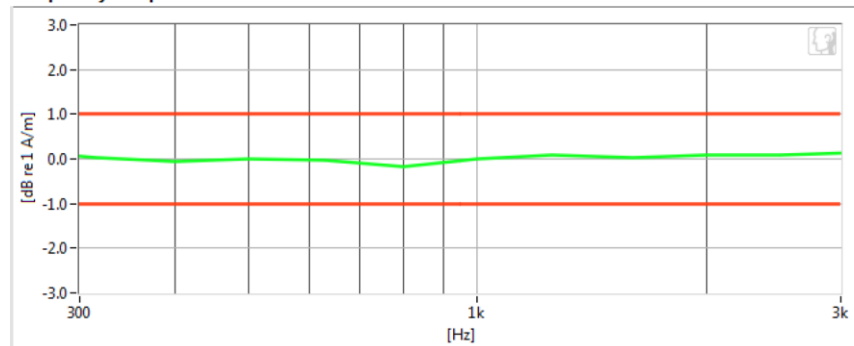

Results

Verification 1kHz Intensity	-10.264 dB	✓	Max/Min	-9.5/-10.5
Verification ABM2	-62.89 dB	✓	Maximum	-58.0
Frequency Response Margin	800m dB	✓	Tolerance curves	Aligned Data

PCTEST 2018

FCC ID: 2ACCJBT09		HAC (T-COIL) TEST REPORT		Approved by: Quality Manager
Filename: 1M1808060150-02-R1.2ACCJ	Test Dates: 08/05/2018 - 08/07/2018	DUT Type: Portable Handset		Page 32 of 47

© 2018 PCTEST Engineering Laboratory, Inc.

REV 3.2.M
04/17/2018

© 2018 PCTEST Engineering Laboratory, Inc. All rights reserved. Unless otherwise specified, no part of this report may be reproduced or utilized in any part, form or by any means, electronic or mechanical, including photocopying and microfilm, without permission in writing from PCTEST Engineering Laboratory, Inc. If you have any questions about this international copyright or have an enquiry about obtaining additional rights to this report or assembly of contents thereof, please contact INFO@PCTEST.COM.



PCTEST Hearing-Aid Compatibility Facility

DUT: 2ACCJBT09

Type: Portable Handset
Serial: 08306

Measurement Standard: ANSI C63.19-2011

Equipment:

- Probe: Axial T-Coil Probe – SN: TEM-1124; Calibrated: 12/07/2016

Test Configuration:

- VoIP Application: Google Duo
- Mode: LTE FDD Band 13
- Bandwidth: 5MHz
- Channel: 23230
- Speech Signal: ITU-T P.50 Artificial Voice

Noise Spectrum

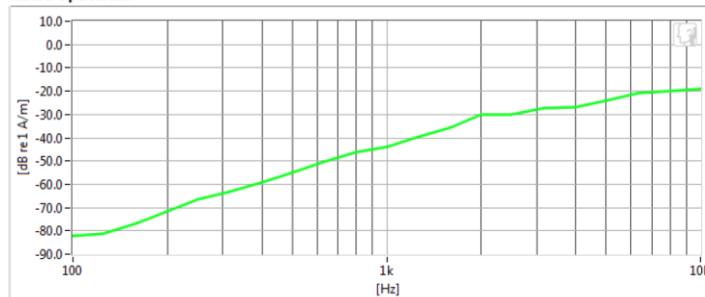

Frequency Response

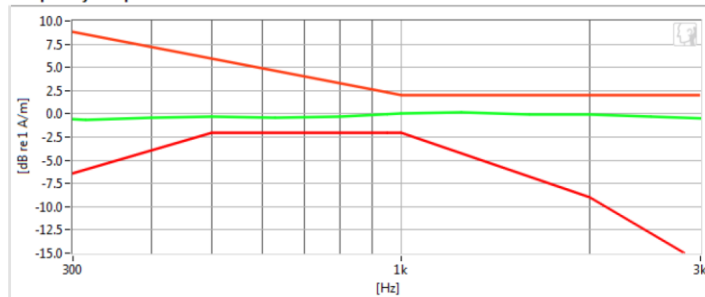

Results

ABM1	8.29 dB	✓	Minimum	-18.0
ABM2	-25.51 dB	✓	Maximum	0.0
SNNR	33.79 dB	✓	Minimum	20.0
Aligned Response - P.50	1.59 dB	✓	Tolerance curves	Aligned Data

PCTEST 2018

FCC ID: 2ACCJBT09		HAC (T-COIL) TEST REPORT		Approved by: Quality Manager
Filename: 1M1808060150-02-R1.2ACCJ	Test Dates: 08/05/2018 - 08/07/2018	DUT Type: Portable Handset		Page 33 of 47

© 2018 PCTEST Engineering Laboratory, Inc.

REV 3.2.M

04/17/2018

© 2018 PCTEST Engineering Laboratory, Inc. All rights reserved. Unless otherwise specified, no part of this report may be reproduced or utilized in any part, form or by any means, electronic or mechanical, including photocopying and microfilm, without permission in writing from PCTEST Engineering Laboratory, Inc. If you have any questions about this international copyright or have an enquiry about obtaining additional rights to this report or assembly of contents thereof, please contact INFO@PCTEST.COM.



PCTEST Hearing-Aid Compatibility Facility

DUT: 2ACCJBT09

Type: Portable Handset
Serial: 08306

Measurement Standard: ANSI C63.19-2011

Equipment:

- Probe: Radial T-Coil Probe – SN: TEM-1130; Calibrated: 12/07/2016

Test Configuration:

- VoIP Application: Google Duo
- Mode: LTE FDD Band 13
- Bandwidth: 5MHz
- Channel: 23230

Noise Spectrum

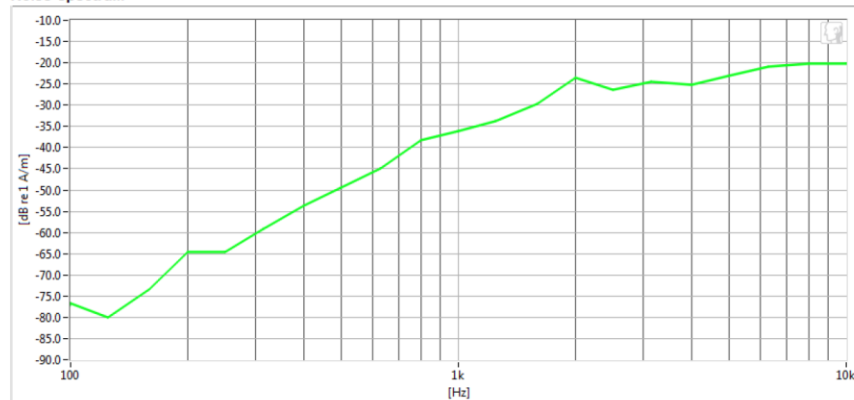

Results

ABM1	2.17 dB	✓	Minimum	-18.0
ABM2	-22.11 dB	✓	Maximum	0.0
SNNR	24.28 dB	✓	Minimum	20.0

PCTEST 2018



FCC ID: 2ACCJBT09		HAC (T-COIL) TEST REPORT		Approved by: Quality Manager
Filename: 1M1808060150-02-R1.2ACCJ	Test Dates: 08/05/2018 - 08/07/2018	DUT Type: Portable Handset		Page 34 of 47

© 2018 PCTEST Engineering Laboratory, Inc.

REV 3.2.M
04/17/2018

© 2018 PCTEST Engineering Laboratory, Inc. All rights reserved. Unless otherwise specified, no part of this report may be reproduced or utilized in any part, form or by any means, electronic or mechanical, including photocopying and microfilm, without permission in writing from PCTEST Engineering Laboratory, Inc. If you have any questions about this international copyright or have an enquiry about obtaining additional rights to this report or assembly of contents thereof, please contact INFO@PCTEST.COM.

10. CALIBRATION CERTIFICATES

FCC ID: 2ACCJBT09		HAC (T-COIL) TEST REPORT		Approved by: Quality Manager
Filename: 1M1808060150-02- R1.2ACCJ	Test Dates: 08/05/2018 - 08/07/2018	DUT Type: Portable Handset	Page 35 of 47	

© 2018 PCTEST Engineering Laboratory, Inc.

REV 3.2.M
04/17/2018

© 2018 PCTEST Engineering Laboratory, Inc. All rights reserved. Unless otherwise specified, no part of this report may be reproduced or utilized in any part, form or by any means, electronic or mechanical, including photocopying and microfilm, without permission in writing from PCTEST Engineering Laboratory, Inc. If you have any questions about this international copyright or have an enquiry about obtaining additional rights to this report or assembly of contents thereof, please contact INFO@PCTEST.COM.

West Caldwell Calibration Laboratories Inc.

Certificate of Calibration

for

AXIAL T COIL PROBE

Manufactured by: TEM CONSULTING
 Model No: AXIAL T COIL PROBE
 Serial No: TEM-1124
 Calibration Recall No: 27068

Submitted By:

Customer: ANDREW HARWELL
 Company: PCTEST ENGINEERING LAB
 Address: 6660-B DOBBIN ROAD
 COLUMBIA MD 21045

The subject instrument was calibrated to the indicated specification using standards traceable to the National Institute of Standards and Technology or to accepted values of natural physical constants. This document certifies that the instrument met the following specification upon its return to the submitter.

West Caldwell Calibration Laboratories Procedure No. AXIAL T C TEM C

Upon receipt for Calibration, the instrument was found to be:

Within (X)

ASA
12/29/2016

tolerance of the indicated specification. See attached Report of Calibration.

West Caldwell Calibration Laboratories' calibration control system meets the following requirements, ISO 10012-1 MIL STD 45662A, ANSI/NCSL Z540-1, IEC Guide 25, ISO 9001:2008 and ISO 17025

Note: With this Certificate, Report of Calibration is included.

Approved by:

Calibration Date: 07-Dec-16

FC

Certificate No: 27068 -3

Felix Christopher (QA Mgr.)

QA Doc. #1051 Rev. 2.0 10/1/01



Certificate Page 1 of 1

ISO/IEC 17025:2005

 uncompromised calibration
 1575 State Route 96, Victor, NY 14564, U.S.A.



Calibration Lab. Cert. # 1533.01

FCC ID: 2ACCJB09		HAC (T-COIL) TEST REPORT		Approved by: Quality Manager
Filename: 1M1808060150-02- R1.2ACCJ	Test Dates: 08/05/2018 - 08/07/2018	DUT Type: Portable Handset		Page 36 of 47

© 2018 PCTEST Engineering Laboratory, Inc.

REV 3.2.M
04/17/2018

© 2018 PCTEST Engineering Laboratory, Inc. All rights reserved. Unless otherwise specified, no part of this report may be reproduced or utilized in any part, form or by any means, electronic or mechanical, including photocopying and microfilm, without permission in writing from PCTEST Engineering Laboratory, Inc. If you have any questions about this international copyright or have an enquiry about obtaining additional rights to this report or assembly of contents thereof, please contact INFO@PCTEST.COM.



1575 State Route 96, Victor NY 14564

ISO/IEC 17025: 2005



Calibration Lab. Cert. # 1533.01

REPORT OF CALIBRATION

TEM Consulting LP Axial T Coil Probe

for
Model No.: Axial T Coil Probe

Serial No.: TEM 1124

Company : PCTEST Engineering Lab.

I. D. No: 80578

Calibration results:			
Probe Sensitivity measured with Helmholtz Coil			
Helmholtz Coil;			
the number of turns on each coil;	10	No.	
the radius of each coil, in meters;	0.204	m	
the current in the coils, in amperes.;	0.09	A	
Helmholtz Coil Constant;	7.09	A/m/V	
Helmholtz Coil magnetic field;	5.98	A/m	
Probe Sensitivity at	1000	Hz.	
was	-60.23	dBV/A/m	
	0.974	mV/A/m	
Probe resistance	904	Ohms	
Before & after data same: ...X.....			
Laboratory Environment:			
Ambient Temperature:	20.2	°C	
Ambient Humidity:	31.4	% RH	
Ambient Pressure:	99.1	kPa	
Calibration Date:	7-Dec-16		
Report Number:	27068	-3	
Control Number:	27068		

The above listed instrument meets or exceeds the tested manufacturer's specifications.

This Calibration is traceable through NIST test numbers: 683/284413-14
The expanded uncertainty of calibration: 0.30dB at 95% confidence level with a coverage factor of k=2.

Graph represents Probes Frequency Response.

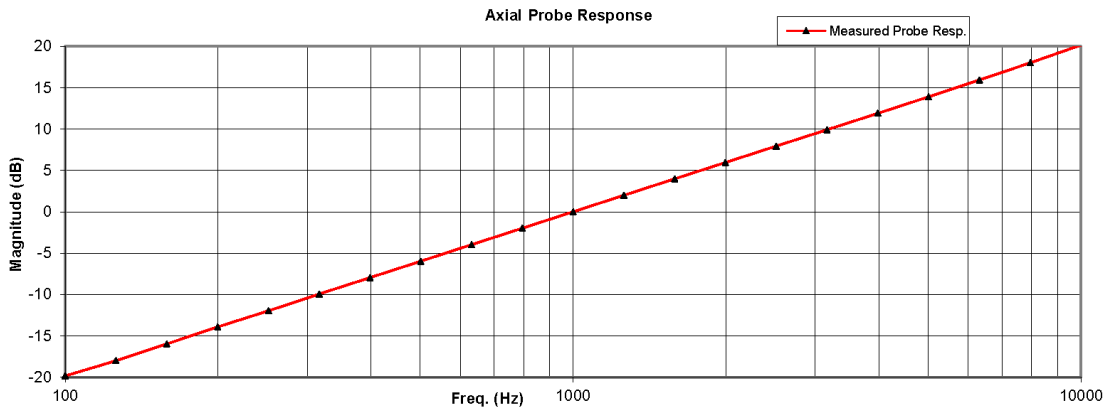

The above listed instrument was checked using calibration procedure documented in West Caldwell Calibration Laboratories Inc. procedure : **Rev. 7.0 Jan. 24, 2014 Doc. # 1038 HCATEMC**
Calibration was performed by West Caldwell Calibration Laboratories Inc. under Operating Procedures intended to implement the requirements of ISO10012-1, IEC Guide 25, ANSI/NCSL Z540-1, (MIL-STD-45662A) and ISO 9001:2008, ISO 17025

Cal. Date: 7-Dec-2016
Calibrated on WCCL system type 9700

Measurements performed by: FC
Felix Christopher

This document shall not be reproduced, except in full, without the written approval from West Caldwell Cal. Labs. Inc.

Rev. 7.0 Jan. 24, 2014 Doc. # 1038 HCATEMC

FCC ID: 2ACCJB09		HAC (T-COIL) TEST REPORT		Approved by: Quality Manager
Filename: 1M1808060150-02-R1.2ACCJ	Test Dates: 08/05/2018 - 08/07/2018	DUT Type: Portable Handset		Page 37 of 47

West Caldwell Calibration Laboratories Inc.

1575 State Route 96, Victor NY 14564
 Tel. (585) 586-3900 FAX (585) 586-4327

Calibration Data Record

TEM Consulting LP Axial T Coil Probe

for Model No.: Axial T Coil Probe

Serial No.: TEM 1124

Company : PCTEST Engineering Lab.

Test	Function	Tolerance	Measured values		
			Before	Out	Remarks
1.0	Probe Sensitivity at	1000 Hz. \pm BV/A/m	-60.23		
2.0	Probe Level Linearity	Ref. (0 \pm B)	\pm B		
			6	6.03	
			0	0.00	
			-6	-6.03	
			-12	-12.05	
3.0	Probe Frequency Response	Ref. (0 \pm B)	Hz		
			100	-19.8	
			126	-18.0	
			158	-16.0	
			200	-13.9	
			251	-12.0	
			316	-9.9	
			398	-8.0	
			501	-6.0	
			631	-4.0	
			794	-2.0	
			1000	0.0	
			1259	2.0	
			1585	4.0	
			1995	6.0	
			2512	7.9	
			3162	9.9	
3981	11.9				
5012	13.9				
6310	15.9				
7943	18.0				
10000	20.2				



Instruments used for calibration:			Date of Cal.	Traceability No.	Due Date
HP	34401A	S/N 36064102	1-Oct-2016	,287708	1-Oct-2017
HP	34401A	S/N 36102471	1-Oct-2016	,287708	1-Oct-2017
HP	33120A	S/N 36043716	1-Oct-2016	,287708	1-Oct-2017
B&K	2133	S/N 1583254	1-Oct-2016	683/284413-14	1-Oct-2017

Cal. Date: 7-Dec-2016
 Calibrated on WCCL system type 9700

Tested by: Felix Christopher

This document shall not be reproduced, except in full, without the written approval from West Caldwell Cal. Labs., Inc.

Rev. 7.0 Jan. 24, 2014 Doc. # 1038 HCATEMC

FCC ID: 2ACCJBT09		HAC (T-COIL) TEST REPORT		Approved by: Quality Manager
Filename: 1M1808060150-02-R1.2ACCJ	Test Dates: 08/05/2018 - 08/07/2018	DUT Type: Portable Handset	Page 38 of 47	

West Caldwell Calibration Laboratories Inc.

Certificate of Calibration

for

RADIAL T COIL PROBE

Manufactured by: TEM CONSULTING
Model No: RADIAL T COIL PROBE
Serial No: TEM-1130
Calibration Recall No: 27068

Submitted By:

Customer: ANDREW HARWELL
Company: PCTEST ENGINEERING LAB
Address: 6660-B DOBBIN ROAD
COLUMBIA MD 21045

The subject instrument was calibrated to the indicated specification using standards traceable to the National Institute of Standards and Technology or to accepted values of natural physical constants. This document certifies that the instrument met the following specification upon its return to the submitter.

West Caldwell Calibration Laboratories Procedure No. RADIAL T TEM C

Upon receipt for Calibration, the instrument was found to be:

Within (X)

QA&A
12/29/2016

tolerance of the indicated specification. See attached Report of Calibration.

West Caldwell Calibration Laboratories' calibration control system meets the following requirements, ISO 10012-1 MIL STD 45662A, ANSI/NC SL Z540-1, IEC Guide 25, ISO 9001:2008 and ISO 17025

Note: With this Certificate, Report of Calibration is included.

Approved by:

Calibration Date: 07-Dec-16

FC

Certificate No: 27068 - 2

Felix Christopher (QA Mgr.)

QA Doc. #1061 Rev. 2.0 10/1/01

Certificate Page 1 of 1

ISO/IEC 17025:2005

West Caldwell Calibration Laboratories, Inc.
uncompromised calibration
1575 State Route 96, Victor, NY 14564, U.S.A.



Calibration Lab. Cert. # 1533.01

FCC ID: 2ACCJB09		HAC (T-COIL) TEST REPORT		Approved by: Quality Manager
Filename: 1M1808060150-02- R1.2ACCJ	Test Dates: 08/05/2018 - 08/07/2018	DUT Type: Portable Handset		Page 39 of 47

© 2018 PCTEST Engineering Laboratory, Inc.

REV 3.2.M

04/17/2018

© 2018 PCTEST Engineering Laboratory, Inc. All rights reserved. Unless otherwise specified, no part of this report may be reproduced or utilized in any part, form or by any means, electronic or mechanical, including photocopying and microfilm, without permission in writing from PCTEST Engineering Laboratory, Inc. If you have any questions about this international copyright or have an enquiry about obtaining additional rights to this report or assembly of contents thereof, please contact INFO@PCTEST.COM.



1575 State Route 96, Victor NY 14564

ISO/IEC 17025: 2005



Calibration Lab. Cert. # 1533.01

REPORT OF CALIBRATION

TEM Consulting LP Radial T Coil Probe

for
Model No.: Radial T Coil Probe

Serial No.: TEM-1130

Company : PCTEST Engineering Lab.

I. D. No: 80579

Calibration results:

Probe Sensitivity measured with Helmholtz Coil			Before & after data same: ...X.....	
Helmholtz Coil;				
the number of turns on each coil;	10	No.		
the radius of each coil, in meters;	0.204	m		
the current in the coils, in amperes.;	0.09	A	Laboratory Environment:	
			Ambient Temperature:	20.2 °C
Helmholtz Coil Constant;	7.09	A/m/V	Ambient Humidity:	31.4 % RH
Helmholtz Coil magnetic field;	5.98	A/m	Ambient Pressure:	99.1 kPa
			Calibration Date:	7-Dec-16
Probe Sensitivity at	1000	Hz.	Report Number:	27068 -2
was	-60.27	dBV/A/m	Control Number:	27068
	0.969	mV/A/m		
Probe resistance	902	Ohms		

The above listed instrument meets or exceeds the tested manufacturer's specifications.

This Calibration is traceable through NIST test numbers: 683/284413-14

The expanded uncertainty of calibration: 0.30dB at 95% confidence level with a coverage factor of k=2.

Graph represents Probes Frequency Response.

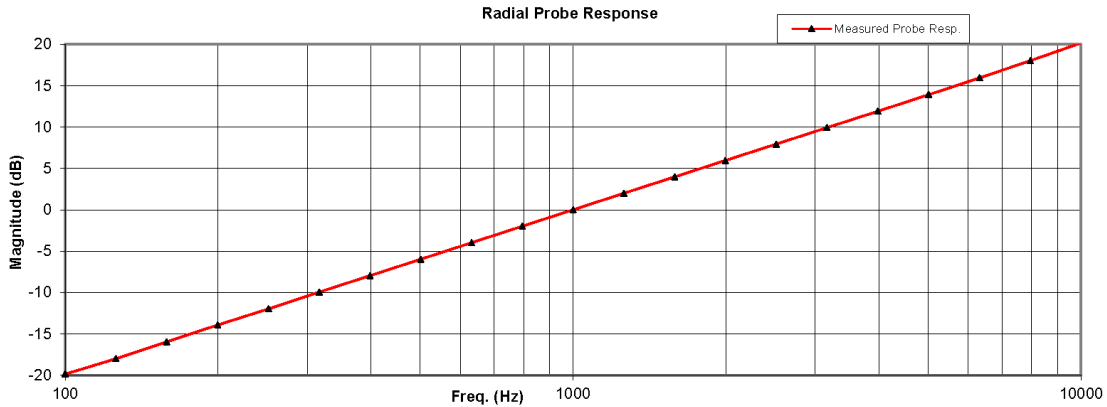

The above listed instrument was checked using calibration procedure documented in West Caldwell Calibration Laboratories Inc. procedure : **Rev. 7.0 Jan. 24, 2014 Doc. # 1038 HCRTEMC**

Calibration was performed by West Caldwell Calibration Laboratories Inc. under Operating Procedures intended to implement the requirements of ISO10012-1, IEC Guide 25, ANSI/NCSL Z540-1, (MIL-STD-45662A) and ISO 9001:2008, ISO 17025

Cal. Date: 7-Dec-2016
Calibrated on WCCL system type 9700

Measurements performed by: FC
Felix Christopher

This document shall not be reproduced, except in full, without the written approval from West Caldwell Cal. Labs. Inc.

Rev. 7.0 Jan. 24, 2014 Doc. # 1038 HCRTEMC

FCC ID: 2ACCJB09		HAC (T-COIL) TEST REPORT		Approved by: Quality Manager
Filename: 1M1808060150-02-R1.2ACCJ	Test Dates: 08/05/2018 - 08/07/2018	DUT Type: Portable Handset	Page 40 of 47	

West Caldwell Calibration Laboratories Inc.

1575 State Route 96, Victor NY 14564
 Tel. (585) 586-3900 FAX (585) 586-4327

Calibration Data Record

TEM Consulting LP Radial T Coil Probe

Model No.: Radial T Coil Probe

Serial No.: TEM-1130

Company : PCTEST Engineering Lab.

Test	Function	Tolerance	Measured values		
			Before	Out	Remarks
1.0	Probe Sensitivity at	1000 Hz. \pm BV/A/m	-60.27		
2.0	Probe Level Linearity	Ref. (0 \pm B)	\pm B		
			6	6.03	
			0	0.00	
			-6	-6.03	
		-12	-12.06		
3.0	Probe Frequency Response	Ref. (0 \pm B)	Hz		
			100	-19.9	
			126	-18.0	
			158	-16.0	
			200	-13.9	
			251	-12.0	
			316	-10.0	
			398	-8.0	
			501	-6.0	
			631	-4.0	
			794	-2.0	
			1000	0.0	
			1259	2.0	
			1585	4.0	
			1995	6.0	
			2512	7.9	
			3162	9.9	
3981	11.9				
5012	13.9				
6310	15.9				
7943	18.0				
10000	20.2				



Instruments used for calibration:			Date of Cal.	Traceability No.	Due Date
HP	34401A	S/N 36064102	1-Oct-2016	,287708	1-Oct-2017
HP	34401A	S/N 36102471	1-Oct-2016	,287708	1-Oct-2017
HP	33120A	S/N 36043716	1-Oct-2016	,287708	1-Oct-2017
B&K	2133	S/N 1583254	1-Oct-2016	683/284413-14	1-Oct-2017

Cal. Date: 7-Dec-2016
 Calibrated on WCCL system type 9700

Tested by: Felix Christopher

This document shall not be reproduced, except in full, without the written approval from West Caldwell Cal. Labs., Inc.



Rev. 7.0 Jan. 24, 2014 Doc. # 1038 HCRTEMC

FCC ID: 2ACCJBT09		HAC (T-COIL) TEST REPORT		Approved by: Quality Manager
Filename: 1M1808060150-02- R1.2ACCJ	Test Dates: 08/05/2018 - 08/07/2018	DUT Type: Portable Handset	Page 41 of 47	

11. CONCLUSION

The measurements indicate that the wireless communications device complies with the HAC limits specified in accordance with the ANSI C63.19 Standard and FCC WT Docket No. 01-309 RM-8658 for the modes represented in this report. Precise laboratory measures were taken to assure repeatability of the tests. The tested device complies with the requirements in respect to all parameters specific to the test. The test results and statements relate only to the item(s) tested.

The measurement system and techniques presented in this evaluation are proposed in the ANSI standard as a means of best approximating wireless device compatibility with a hearing-aid. The literature is under continual re-construction.

FCC ID: 2ACCJBT09		HAC (T-COIL) TEST REPORT		Approved by: Quality Manager
Filename: 1M1808060150-02- R1.2ACCJ	Test Dates: 08/05/2018 - 08/07/2018	DUT Type: Portable Handset		Page 42 of 47



© 2018 PCTEST Engineering Laboratory, Inc.

REV 3.2.M
04/17/2018

© 2018 PCTEST Engineering Laboratory, Inc. All rights reserved. Unless otherwise specified, no part of this report may be reproduced or utilized in any part, form or by any means, electronic or mechanical, including photocopying and microfilm, without permission in writing from PCTEST Engineering Laboratory, Inc. If you have any questions about this international copyright or have an enquiry about obtaining additional rights to this report or assembly of contents thereof, please contact INFO@PCTEST.COM.

12. REFERENCES

1. ANSI C63.19-2011, American National Standard for Methods of Measurement of Compatibility between Wireless communication devices and Hearing Aids., New York, NY, IEEE, May 2011
2. FCC Office of Engineering and Technology KDB, "285076 D01 HAC Guidance v05," September 13, 2017
3. FCC Office of Engineering and Technology KDB, "285076 D02 T-Coil Testing for CMRS IP v03," September 13, 2017
4. FCC Public Notice DA 06-1215, *Wireless Telecommunications Bureau and Office of Engineering and Technology Clarify Use of Revised Wireless Phone Hearing Aid Compatibility Standard*, June 6, 2006
5. FCC 3G Review Guidance, Laboratory Division OET FCC, May/June 2006
6. Berger, H. S., "Compatibility Between Hearing Aids and Wireless Devices," Electronic Industries Forum, Boston, MA, May, 1997
7. Berger, H. S., "Hearing Aid and Cellular Phone Compatibility: Working Toward Solutions," Wireless Telephones and Hearing Aids: New Challenges for Audiology, Gallaudet University, Washington, D.C., May, 1997 (To be reprinted in the American Journal of Audiology).
8. Berger, H. S., "Hearing Aid Compatibility with Wireless Communications Devices," IEEE International Symposium on Electromagnetic Compatibility, Austin, TX, August, 1997.
9. Bronaugh, E. L., "Simplifying EMI Immunity (Susceptibility) Tests in TEM Cells," in the 1990 IEEE International Symposium on Electromagnetic Compatibility Symposium Record, Washington, D.C., August 1990, pp. 488-491
10. Byrne, D. and Dillon, H., The National Acoustics Laboratory (NAL) New Procedure for Selecting the Gain and Frequency Response of a Hearing Aid, Ear and Hearing 7:257-265, 1986.
11. Crawford, M. L., "Measurement of Electromagnetic Radiation from Electronic Equipment using TEM Transmission Cells," U.S. Department of Commerce, National Bureau of Standards, NBSIR 73-306, Feb. 1973.
12. Crawford, M. L., and Workman, J. L., "Using a TEM Cell for EMC Measurements of Electronic Equipment," U.S. Department of Commerce, National Bureau of Standards. Technical Note 1013, July 1981.
13. EHIMA GSM Project, Development phase, Project Report (1st part) Revision A. Technical-Audiological Laboratory and Telecom Denmark, October 1993.
14. EHIMA GSM Project, Development phase, Part II Project Report. Technical-Audiological Laboratory and Telecom Denmark, June 1994.
15. EHIMA GSM Project Final Report, Hearing Aids and GSM Mobile Telephones: Interference Problems, Methods of Measurement and Levels of Immunity. Technical-Audiological Laboratory and Telecom Denmark, 1995.
16. HAMPIS Report, Comparison of Mobile phone electromagnetic near field with an upscaled electromagnetic far field, using hearing aid as reference, 21 October 1999.
17. Hearing Aids/GSM, Report from OTWIDAM, Technical-Audiological Laboratory and Telecom Denmark, April 1993.
18. IEEE 100, The Authoritative Dictionary of IEEE Standards Terms, Seventh Edition.
19. Joyner, K. H, et. al., Interference to Hearing Aids by the New Digital Mobile Telephone System, Global System for Mobile (GSM) Communication Standard, National Acoustic Laboratory, Australian Hearing Series, Sydney 1993.
20. Joyner, K. H., et. al., Interference to Hearing Aids by the Digital Mobile Telephone System, Global System for Mobile Communications (GSM), NAL Report #131, National Acoustic Laboratory, Australian Hearing Series, Sydney, 1995.
21. Kecker, W. T., Crawford, M. L., and Wilson, W. A., "Construction of a Transverse Electromagnetic Cell", U.S. Department of Commerce, National Bureau of Standards, Technical Note 1011, Nov. 1978.

FCC ID: 2ACCJBT09		HAC (T-COIL) TEST REPORT		Approved by: Quality Manager
Filename: 1M1808060150-02-R1.2ACCJ	Test Dates: 08/05/2018 - 08/07/2018	DUT Type: Portable Handset	Page 43 of 47	



© 2018 PCTEST Engineering Laboratory, Inc.

REV 3.2.M

04/17/2018

© 2018 PCTEST Engineering Laboratory, Inc. All rights reserved. Unless otherwise specified, no part of this report may be reproduced or utilized in any part, form or by any means, electronic or mechanical, including photocopying and microfilm, without permission in writing from PCTEST Engineering Laboratory, Inc. If you have any questions about this international copyright or have an enquiry about obtaining additional rights to this report or assembly of contents thereof, please contact INFO@PCTEST.COM.

22. Konigstein, D., and Hansen, D., "A New Family of TEM Cells with enlarged bandwidth and Optimized working Volume," in the Proceedings of the 7th International Symposium on EMC, Zurich, Switzerland, March 1987; 50:9, pp. 127-132.
23. Kuk, F., and Hjordgaard, N. K., "Factors affecting interference from digital cellular telephones," Hearing Journal, 1997; 50:9, pp 32-34.
24. Ma, M. A., and Kanda, M., "Electromagnetic Compatibility and Interference Metrology," U.S. Department of Commerce, National Bureau of Standards, Technical Note 1099, July 1986, pp. 17-43.
25. Ma, M. A., Sreenivashiah, I. , and Chang, D. C., "A Method of Determining the Emission and Susceptibility Levels of Electrically Small Objects Using a TEM Cell," U.S. Department of Commerce, National Bureau of Standards, Technical Note 1040, July 1981.
26. McCandless, G. A., and Lyregaard, P. E., Prescription of Gain/Output (POGO) for Hearing Aids, Hearing Instruments 1:16-21, 1983
27. Skopec, M., "Hearing Aid Electromagnetic Interference from Digital Wireless Telephones, "IEEE Transactions on Rehabilitation Engineering, vol. 6, no. 2, pp. 235-239, June 1998.
28. Technical Report, GSM 05.90, GSM EMC Considerations, European Telecommunications Standards Institute, January 1993.
29. Victorian, T. A., "Digital Cellular Telephone Interference and Hearing Aid Compatibility—an Update," Hearing Journal 1998; 51:10, pp. 53-60
30. Wong, G. S. K., and Embleton, T. F. W., eds., AIP Handbook of Condenser Microphones: Theory, Calibration and Measurements, AIP Press.

FCC ID: 2ACCJBT09		HAC (T-COIL) TEST REPORT		Approved by: Quality Manager
Filename: 1M1808060150-02- R1.2ACCJ	Test Dates: 08/05/2018 - 08/07/2018	DUT Type: Portable Handset		Page 44 of 47

© 2018 PCTEST Engineering Laboratory, Inc.

REV 3.2.M
04/17/2018

© 2018 PCTEST Engineering Laboratory, Inc. All rights reserved. Unless otherwise specified, no part of this report may be reproduced or utilized in any part, form or by any means, electronic or mechanical, including photocopying and microfilm, without permission in writing from PCTEST Engineering Laboratory, Inc. If you have any questions about this international copyright or have an enquiry about obtaining additional rights to this report or assembly of contents thereof, please contact INFO@PCTEST.COM.