



HAC RF TESTREPORT

No. I17Z62005-SEM07

For

TCL Communication Ltd.

A70A XL TMO

Model Name: 6062W

With

Hardware Version: 06

Software Version: v1A65

FCC ID: 2ACCJBT09

Results Summary: M Category = M4

Issued Date: 2018-8-8



Note:

The test results in this test report relate only to the devices specified in this report. This report shall not be reproduced except in full without the written approval of CTTL.

The report must not be used by the client to claim product certification, approval, or endorsement by NVLAP, NIST, or any agency of the U.S. Government.

Test Laboratory:

CTTL, Telecommunication Technology Labs, CAICT

No. 51, Xueyuan Road, Haidian District, Beijing, P. R. China 100191.

Tel:+86(0)10-62304633-2512, Fax:+86(0)10-62304633-2504



REPORT HISTORY

Report Number	Revision	Issue Date	Description
I17Z62005-SEM07	Rev.0	2018-8-8	Initial creation of test report



TABLE OF CONTENT

1 TEST LABORATORY	5
1.1 TESTING LOCATION	5
1.2 TESTING ENVIRONMENT.....	5
1.3 PROJECT DATA	5
1.4 SIGNATURE.....	5
2 CLIENT INFORMATION	6
2.1 APPLICANT INFORMATION	6
2.2 MANUFACTURER INFORMATION	6
3 EQUIPMENT UNDER TEST (EUT) AND ANCILLARY EQUIPMENT (AE)	7
3.1 ABOUT EUT	7
3.2 INTERNAL IDENTIFICATION OF EUT USED DURING THE TEST	7
3.3 INTERNAL IDENTIFICATION OF AE USED DURING THE TEST	7
3.4 AIR INTERFACES / BANDS INDICATING OPERATING MODES	7
4 CONDUCTED OUTPUT POWER MEASUREMENT	7
4.1 SUMMARY	8
4.2 CONDUCTED POWER	8
5 REFERENCE DOCUMENTS.....	9
5.1 REFERENCE DOCUMENTS FOR TESTING	9
6 OPERATIONAL CONDITIONS DURING TEST	10
6.1 HAC MEASUREMENT SET-UP.....	10
6.2 PROBE SPECIFICATION	11
6.3 TEST ARCH PHANTOM & PHONE POSITIONER	12
6.4 ROBOTIC SYSTEM SPECIFICATIONS	12
7 EUT ARRANGEMENT	13
7.1 WD RF EMISSION MEASUREMENTS REFERENCE AND PLANE	13
8 SYSTEM VALIDATION	14
8.1 VALIDATION PROCEDURE	14
8.2 VALIDATION RESULT	14
9 EVALUATION OF MIF	15
9.1 INTRODUCTION.....	15
9.2 MIF MEASUREMENT WITH THE AIA	16
9.3 TEST EQUIPMENT FOR THE MIF MEASUREMENT	16
9.4 TEST SIGNAL VALIDATION	16
9.5 DUTMIF RESULTS	17
10 EVALUATION FOR LOW-POWER EXEMPTION	19
10.1 PRODUCT TESTING THRESHOLD	19
10.2 CONDUCTED POWER	19



10.3 CONCLUSION	19
11 RF TEST PROCEDURES.....	20
12 MEASUREMENT RESULTS (E-FIELD).....	21
13 ANSIC 63.19-2011 LIMITS	21
14 MEASUREMENT UNCERTAINTY	22
15 MAIN TEST INSTRUMENTS.....	23
16 CONCLUSION	23
ANNEX A TEST LAYOUT	24
ANNEX B TEST PLOTS	25
ANNEX C SYSTEM VALIDATION RESULT.....	31
ANNEX D PROBE CALIBRATION CERTIFICATE	31
ANNEX E DIPOLE CALIBRATION CERTIFICATE.....	43

1 Test Laboratory

1.1 Testing Location

CompanyName:	CTTL(Shouxiang)
Address:	No. 51 Shouxiang Science Building, Xueyuan Road, Haidian District, Beijing, P. R. China100191

1.2 Testing Environment

Temperature:	18°C~25°C,
Relative humidity:	30%~ 70%
Ground system resistance:	< 0.5 Ω
Ambient noise is checked and found very low and in compliance with requirement of standards. Reflection of surrounding objects is minimized and in compliance with requirement of standards.	

1.3 Project Data

Project Leader:	Qi Dianyuan
Test Engineer:	Lin Hao
Testing Start Date:	April 9, 2018
Testing End Date:	April 9, 2018

1.4 Signature



Lin Xiaojun
(Prepared this test report)

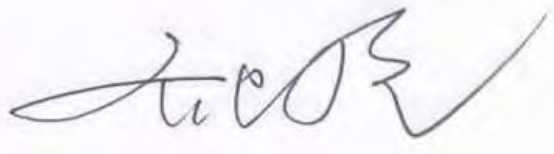

Qi Dianyuan
(Reviewed this test report)

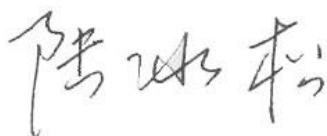

Lu Bingsong
Deputy Director of the laboratory
(Approved this test report)



2 Client Information

2.1 Applicant Information

Company Name	TCL Communication Ltd.
Company Address	7/F, Block F4, TCL Communication Technology Building, TCL International E City, Zhong Shan Yuan Road, Nanshan District, Shenzhen, Guangdong, P.R. China 518052
Post Code	518052
Contact Person	Zhizhou Gong
Tel	0086-755-36611722
Mobile	0086-18217635320
Fax	0086-755-36612000 ext: 81722
E-Mail	zhizhou.gong@tcl.com
Company URL	www.alcatel-mobile.com

2.2 Manufacturer Information

Company Name	TCL Communication Ltd.
Company Address	7/F, Block F4, TCL Communication Technology Building, TCL International E City, Zhong Shan Yuan Road, Nanshan District, Shenzhen, Guangdong, P.R. China 518052
Post Code	518052
Contact Person	Zhizhou Gong
Tel	0086-755-36611722
Mobile	0086-18217635320
Fax	0086-755-36612000 ext: 81722
E-Mail	zhizhou.gong@tcl.com
Company URL	www.alcatel-mobile.com

3 Equipment Under Test (EUT) and Ancillary Equipment (AE)

3.1 About EUT

Description:	A70A XL TMO
Model name:	6062W
Operating mode(s):	GSM 850/900/1800/1900 WCDMA850/1700/1900/2100 LTE B1/2/3/4/5/7/12/13/20/66/71, BT, WLAN

3.2 Internal Identification of EUT used during the test

EUT ID*	IMEI	HW Version	SW Version
EUT1	015126000202859	06	v1A65
EUT2	015126000202842	06	v1A65
EUT3	015126000205399	06	v1A65

*EUT ID: is used to identify the test sample in the lab internally.

3.3 Internal Identification of AE used during the test

AE ID*	Description	Model	SN	Manufacturer
AE1	Battery	TLp038C1	CAC3860010C1	BYD

*AE ID: is used to identify the test sample in the lab internally.

3.4 Air Interfaces / Bands Indicating Operating Modes

Air-interface	Band(MHz)	Type	C63.19/tested	Simultaneous Transmissions	OTT
GSM	850	VO	Yes	BT, WLAN	Google duo*
	1900				
GPRS/EDGE	850	DT	Yes		
	1900				
WCDMA (UMTS)	850	VO	Yes	BT, WLAN	Google duo*
	1700				
	1900	DT	Yes		
LTE	Band 2/4/5/7/12/13/66/71	V/D	Yes	BT, WLAN	Google duo*
BT	2450	DT	NA	GSM, WCDMA, LTE	NA
WLAN	2450	V/D	Yes	GSM, WCDMA, LTE	Google duo*
	5200 (UNII-1)				
	5300 (UNII-2A)				
	5800 (UNII-3)				

VO: Voice CMRS/PSTN Service Only V/D: Voice CMRS/PSTN and Data Service DT: Digital Transport

* See OTT HAC report for the measurement of Google duo.

4 CONDUCTED OUTPUT POWER MEASUREMENT

4.1 Summary

During the process of testing, the EUT was controlled via Agilent Digital Radio Communication tester (E5515C) to ensure the maximum power transmission and proper modulation. This result contains conducted output power for the EUT. In all cases, the measured output power should be greater and within 5% than EMI measurement.

4.2 Conducted Power

GSM 850MHz	Conducted Power (dBm)		
	Channel 251(848.8MHz)	Channel 190(836.6MHz)	Channel 128(824.2MHz)
Voice	32.65	32.77	32.74
GPRS	29.33	29.49	29.45
EDGE	26.65	26.64	26.68
GSM 1900MHz	Conducted Power(dBm)		
	Channel 810(1909.8MHz)	Channel 661(1880MHz)	Channel 512(1850.2MHz)
Voice	29.72	29.90	30.44
GPRS	28.95	29.12	29.64
EDGE	25.23	25.01	25.29
WCDMA 850MHz	Conducted Power (dBm)		
	Channel 4233(846.6MHz)	Channel 4182(836.4MHz)	Channel 4132(826.4MHz)
RMC	23.91	23.89	23.85
HSPA	21.54	21.43	21.36
WCDMA 1700MHz	Conducted Power (dBm)		
	Channel 1513 (1752.6MHz)	Channel 1412 (1732.4MHz)	Channel 1312 (1712.4MHz)
RMC	24.04	24.05	24.08
HSPA	21.70	21.74	21.81
WCDMA 1900MHz	Conducted Power (dBm)		
	Channel 9538(1907.6MHz)	Channel 9400(1880MHz)	Channel 9262(1852.4MHz)
RMC	23.98	23.88	23.95
HSPA	21.93	21.70	21.75
LTE Band2	Conducted Power (dBm)		
	Channel 19100(1900MHz)	Channel18900(1880MHz)	Channel 18700(1860MHz)
QPSK	23.19	23.20	23.24
16QAM	22.75	22.64	22.75
LTE Band5	Conducted Power (dBm)		
	Channel 20600(844MHz)	Channel 20525(836.5MHz)	Channel20450(829MHz)
QPSK	23.03	22.89	22.91
16QAM	22.24	21.92	21.80

LTE Band7	Conducted Power (dBm)		
	Channel 21350(2560MHz)	Channel21100(2535MHz)	Channel 20850(2510MHz)
QPSK	23.90	23.94	23.86
16QAM	23.32	23.33	23.08
LTE Band12	Conducted Power (dBm)		
	Channel 23130(711MHz)	Channel 23095(707.5MHz)	Channel23060(704MHz)
QPSK	23.35	23.16	23.30
16QAM	22.62	22.20	22.15
LTE Band13	Conducted Power (dBm)		
	Channel 23230(782MHz)		
QPSK	23.23		
16QAM	22.48		
LTE Band66	Conducted Power (dBm)		
	Channel 132572(1770MHz)	Channel 132322(1745MHz)	Channel 132072(1720MHz)
QPSK	23.19	23.28	23.41
16QAM	22.41	22.48	22.41
LTE Band71	Conducted Power (dBm)		
	Channel 133372(688MHz)	Channel 133297(680.5MHz)	Channel 133222(673MHz)
QPSK	23.44	23.32	23.38
16QAM	22.61	22.56	22.59
2.4GHz 802.11b 5.5M	Conducted Power (dBm)		
	Channel 11 (2462MHz)	Channel 6 (2437MHz)	Channel 1 (2412MHz)
	14.39	13.28	12.92
5GHz 802.11n-20M MCS5	Conducted Power (dBm)		
	Channel 44 (5220MHz)		
	18.38		

5 Reference Documents

5.1 Reference Documents for testing

The following document listed in this section is referred for testing.

Reference	Title	Version
ANSI C63.19-2011	American National Standard for Methods of Measurement of Compatibility between Wireless Communication Devices and Hearing Aids	2011 Edition
FCC 47 CFR §20.19	Hearing Aid Compatible Mobile Headsets	2015 Edition
KDB 285076 D01	Equipment Authorization Guidance for Hearing Aid Compatibility	v04

6 OPERATIONAL CONDITIONS DURING TEST

6.1 HAC MEASUREMENT SET-UP

These measurements are performed using the DASY5 NEO automated dosimetric assessment system. It is made by Schmid & Partner Engineering AG (SPEAG) in Zurich, Switzerland. It consists of high precision robotics system (Stäubli), robot controller, Intel Core2 computer, near-field probe, probe alignment sensor. The robot is a six-axis industrial robot performing precise movements. A cell controller system contains the power supply, robot controller, teach pendant (Joystick), and remote control, is used to drive the robot motors. The PC consists of the HP Intel Core2 1.86 GHz computer with Windows XP system and HAC Measurement Software DASY5 NEO, A/D interface card, monitor, mouse, and keyboard. The Stäubli Robot is connected to the cell controller to allow software manipulation of the robot. A data acquisition electronic (DAE) circuit performs the signal amplification, signal multiplexing, AD-conversion, offset measurements, mechanical surface detection, collision detection, etc. is connected to the Electro-optical coupler (EOC). The EOC performs the conversion from the optical into digital electric signal of the DAE and transfers data to the PC plug-in card.

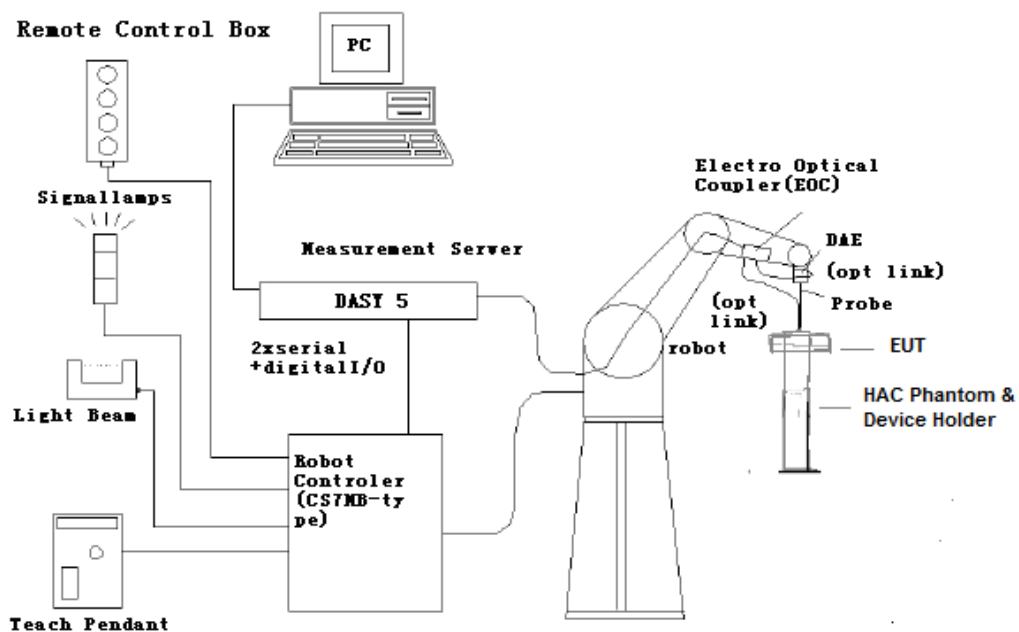

Fig. 1 HAC Test Measurement Set-up

The DAE4 consists of a highly sensitive electrometer-grade preamplifier with auto-zeroing, a channel and gain-switching multiplexer, a fast 16 bit AD-converter and a command decoder and control logic unit. Transmission to the PC-card is accomplished through an optical downlink for data and status information and an optical uplink for commands and clock lines. The mechanical probe mounting device includes two different sensor systems for frontal and sidewise probe contacts. They are also used for mechanical surface detection and probe collision detection. The robot uses its own controller with a built in VME-bus computer.

6.2 Probe Specification

E-Field Probe Description

Construction	One dipole parallel, two dipoles normal to probe axis Built-in shielding against static charges PEEK enclosure material
Calibration	In air from 100 MHz to 3.0 GHz (absolute accuracy $\pm 6.0\%$, k=2)
Frequency	40 MHz to > 6 GHz (can be extended to < 20 MHz) Linearity: ± 0.2 dB (100 MHz to 3 GHz)
Directivity	± 0.2 dB in air (rotation around probe axis) ± 0.4 dB in air (rotation normal to probe axis)
Dynamic Range	2 V/m to > 1000 V/m; Linearity: ± 0.2 dB
Dimensions	Overall length: 330 mm (Tip: 16 mm) Tip diameter: 8 mm (Body: 12 mm) Distance from probe tip to dipole centers: 2.5 mm
Application	General near-field measurements up to 6 GHz Field component measurements Fast automatic scanning in phantoms



[ER3DV6]

6.3 Test Arch Phantom & Phone Positioner

The Test Arch phantom should be positioned horizontally on a stable surface. Reference markings on the Phantom allow the complete setup of all predefined phantom positions and measurement grids by manually teaching three points in the robot. It enables easy and well defined positioning of the phone and validation dipoles as well as simple teaching of the robot (Dimensions: 370 x 370 x 370 mm).

The Phone Positioner supports accurate and reliable positioning of any phone with effect on near field $< \pm 0.5$ dB.

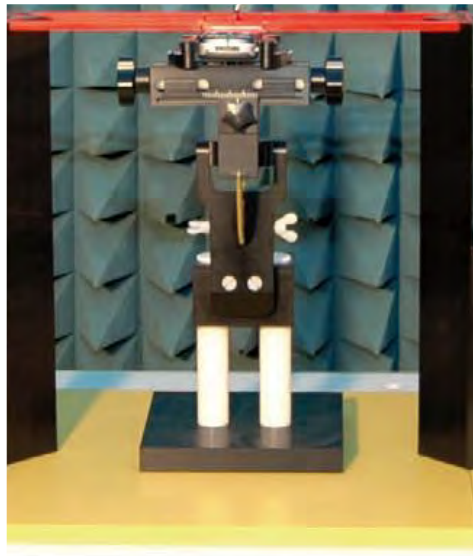

Fig. 2 HAC Phantom & Device Holder

6.4 Robotic System Specifications

Specifications

Positioner: Stäubli Unimation Corp. Robot Model: RX160L

Repeatability: ± 0.02 mm

No. of Axis: 6

Data Acquisition Electronic (DAE) System

Cell Controller

Processor: Intel Core2

Clock Speed: 1.86GHz

Operating System: Windows XP

Data Converter

Features: Signal Amplifier, multiplexer, A/D converter, and control logic

Software: DASY5 software

Connecting Lines: Optical downlink for data and status info.

Optical uplink for commands and clock

7 EUT ARRANGEMENT

7.1 WD RF Emission Measurements Reference and Plane

Figure 4 illustrates the references and reference plane that shall be used in the WD emissions measurement.

- The grid is 5 cm by 5 cm area that is divided into 9 evenly sized blocks or sub-grids.
- The grid is centered on the audio frequency output transducer of the WD (speaker or T-coil).
- The grid is located by reference to a reference plane. This reference plane is the planar area that contains the highest point in the area of the WD that normally rests against the user's ear
- The measurement plane is located parallel to the reference plane and 15 mm from it, out from the phone. The grid is located in the measurement plane.

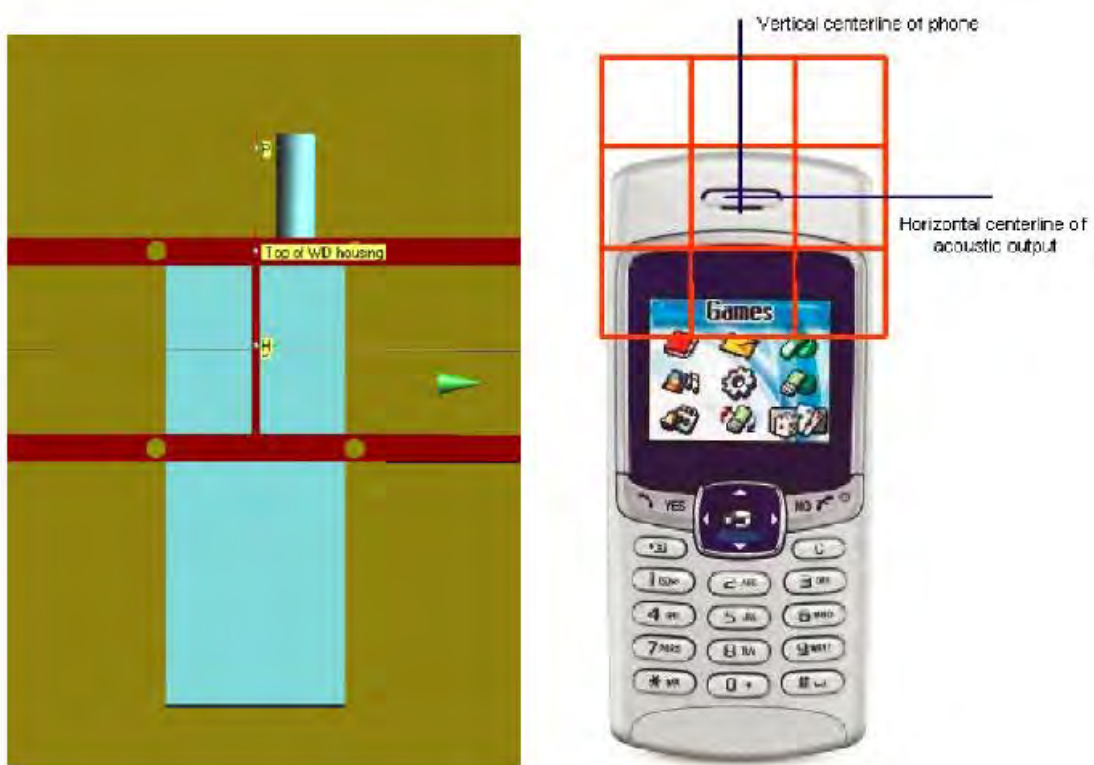

Fig. 3 WD reference and plane for RF emission measurements

8 SYSTEM VALIDATION

8.1 Validation Procedure

Place a dipole antenna meeting the requirements given in ANSI C63.19 in the position normally occupied by the WD. The dipole antenna serves as a known source for an electrical output. Position the E-field probes so that:

- The probes and their cables are parallel to the coaxial feed of the dipole antenna
- The probe cables and the coaxial feed of the dipole antenna approach the measurement area from opposite directions
- The center point of the probe element(s) are 15 mm from the closest surface of the dipole elements.

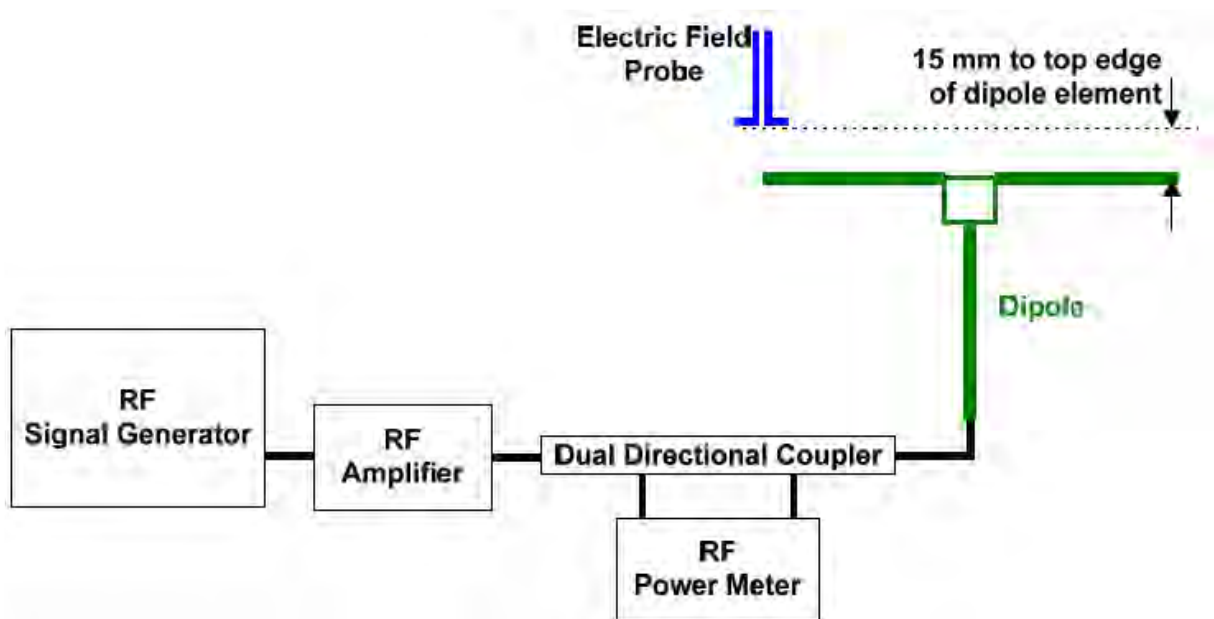

Fig. 4 Dipole Validation Setup

8.2 Validation Result

E-Field Scan						
Mode	Frequency (MHz)	Input Power (mW)	Measured ¹ Value(dBV/m)	Target ² Value(dBV/m)	Deviation ³ (%)	Limit ⁴ (%)
CW	835	100	40.53	40.67	-1.60	±25
CW	1880	100	39.45	39.24	2.45	±25

Notes:

1. Please refer to the attachment for detailed measurement data and plot.
2. Target value is provided by SPEAD in the calibration certificate of specific dipoles.
3. Deviation (%) = 100 * (Measured value minus Target value) divided by Target value.
4. ANSI C63.19 requires values within ± 25% are acceptable, of which 12% is deviation and 13% is measurement uncertainty. Values independently validated for the dipole actually used in the measurements should be used, when available.

9 Evaluation of MIF

9.1 Introduction

The MIF (Modulation Interference Factor) is used to classify E-field emission to determine Hearing Aid Compatibility (HAC). It scales the power-averaged signal to the RF audio interference level and is characteristic to a modulation scheme. The HAC standard preferred "indirect" measurement method is based on average field measurement with separate scaling by the MIF. With an Audio Interference Analyzer (AIA) designed by SPEAG specifically for the MIF measurement, these values have been verified by practical measurements on an RF signal modulated with each of the waveforms. The resulting deviations from the simulated values are within the requirements of the HAC standard.

The AIA (Audio Interference Analyzer) is a USB powered electronic sensor to evaluate signals in the frequency range 698MHz - 6 GHz. It contains RMS detector and audio frequency circuits for sampling of the RF envelope.

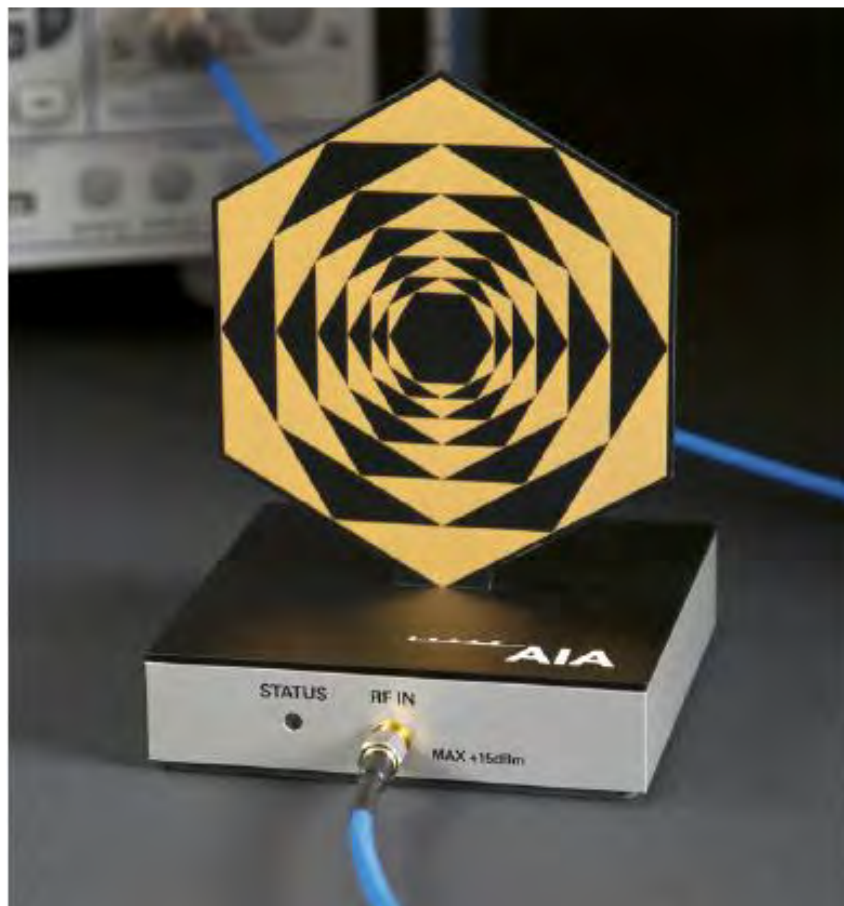

Fig. 5 AIA Front View

9.2 MIF measurement with the AIA

The MIF is measured with the AIA as follows:

1. Connect the AIA via USB to the DASY5 PC and verify the configuration settings.
2. Couple the RF signal to be evaluated to an AIA via cable or antenna.
3. Generate a MIF measurement job for the unknown signal and select the measurement port and timing settings.
4. Document the results via the post processor in a report.

9.3 Test equipment for the MIF measurement

No.	Name	Type	Serial Number	Manufacturer
01	Signal Generator	E4438C	MY49071430	Agilent
02	AIA	SE UMS 170 CB	1029	SPEAG
03	BTS	E5515C	MY50263375	Agilent

9.4 Test signal validation

The signal generator (E4438C) is used to generate a 1GHz signal with different modulation in the below table based on the ANSI C63.19-2011. The measured MIF with AIA are compared with the target values given in ANSI C63.19-2011 table D.3, D.4 and D5.

Pulse modulation	Target MIF	Measured MIF	Deviation
0.5ms pulse, 1000Hz repetition rate	-0.9 dB	-0.9 dB	0 dB
1ms pulse, 100Hz repetition rate	+3.9 dB	+3.7 dB	0.2 dB
0.1ms pulse, 100Hz repetition rate	+10.1 dB	+10.0 dB	0.1 dB
10ms pulse, 10Hz repetition rate	+1.6 dB	+1.7 dB	0.1 dB
Sine-wave modulation	Target MIF	Measured MIF	Deviation
1 kHz, 80% AM	-1.2 dB	-1.3 dB	0.1 dB
1 kHz, 10% AM	-9.1 dB	-9.0 dB	0.1 dB
1 kHz, 1% AM	-19.1 dB	-18.9 dB	0.2 dB
100 Hz, 10% AM	-16.1 dB	-16.0 dB	0.1 dB
10 kHz, 10% AM	-21.5 dB	-21.6 dB	0.1 dB
Transmission protocol	Target MIF	Measured MIF	Deviation
GSM; full-rate version 2; speech codec/handset low	+3.5 dB	+3.47 dB	0.03 dB
WCDMA; speech; speech codec low; AMR 12.2 kb/s	-20.0 dB	-19.8 dB	0.2 dB
CDMA; speech; SO3; RC3; full frame rate; 8kEVRC	-19.0 dB	-19.1 dB	0.1 dB
CDMA; speech; SO3; RC1; 1/8 th frame rate; 8kEVRC	+3.3 dB	+3.44 dB	0.14 dB

9.5 DUT MIF results

Typical MIF levels in ANSI C63.19-2011	
Transmission protocol	Modulation interference factor
GSM; full-rate version 2; speech codec/handset low	+3.5 dB
WCDMA; speech; speech codec low; AMR 12.2 kb/s	-20.0 dB
LTE-FDD (SC-FDMA, 1RB, 20MHz, QPSK)	-15.63 dB
LTE-FDD (SC-FDMA, 1RB, 20MHz, 16QAM)	-9.76 dB

Measured MIF for GSM							
Band		GSM 850			GSM 1900		
Channel		251	190	128	810	661	512
Mode	Voice	3.44	3.45	3.50	3.43	3.43	3.44
	GPRS	-2.69	-2.51	-2.37	0.98	1.00	0.93
	EDGE	-2.13	-2.13	-2.18	1.01	1.05	1.06

Measured MIF for WCDMA										
Band		WCDMA 850			WCDMA 1700			WCDMA 1900		
Channel		4233	4182	4132	1513	1412	1312	9538	9400	9262
Mode	RMC	-23.71	-23.20	-23.22	-22.71	-22.84	-22.91	-22.93	-22.42	-22.91
	HSPA	-20.06	-20.25	-20.48	-19.17	-19.26	-19.22	-20.24	-20.11	-19.93

Measured MIF for LTE			
Band	Channel	Mode	MIF
LTE Band 2	19100	QPSK	-15.32
	18900	QPSK	-14.70
	18700	QPSK	-15.14
	19100	16QAM	-10.44
	18900	16QAM	-10.62
	18700	16QAM	-9.71
LTE Band 5	20600	QPSK	-15.24
	20525	QPSK	-15.09
	20450	QPSK	-14.58
	20600	16QAM	-10.19
	20525	16QAM	-11.25
	20450	16QAM	-10.99
LTE Band 7	21350	QPSK	-14.89
	21100	QPSK	-14.89
	20850	QPSK	-14.31
	21350	16QAM	-10.11
	21100	16QAM	-10.82
	20850	16QAM	-11.19



LTE Band 12	23130	QPSK	-14.13
	23095	QPSK	-14.18
	23060	QPSK	-14.20
	23130	16QAM	-10.99
	23095	16QAM	-11.15
	23060	16QAM	-10.59
LTE Band 13	23230	QPSK	-14.83
	23230	16QAM	-11.17
LTE Band 66	132572	QPSK	-14.63
	132322	QPSK	-14.77
	132072	QPSK	-14.63
	132572	16QAM	-10.65
	132322	16QAM	-10.64
	132072	16QAM	-10.71

Measured MIF for WLAN				
Band	Mode	Rate	Channel	MIF
2.4GHz	802.11b	5.5Mbps	11	-10.16
			6	-10.45
			1	-9.41
5GHz	802.11n-20M	MCS5	44	-10.11

10 Evaluation for low-power exemption

10.1 Product testing threshold

There are two methods for exempting an RF air interface technology from testing. The first method requires evaluation of the MIF for the worst-case operating mode. An RF air interface technology of a device is exempt from testing when its average antenna input power plus its MIF is ≤ 17 dBm for any of its operating modes. The second method does not require determination of the MIF. The RF emissions testing exemption shall be applied to an RF air interface technology in a device whose peak antenna input power, averaged over intervals $\leq 50 \mu s$, is ≤ 23 dBm. An RF air interface technology that is exempted from testing by either method shall be rated as M4.

The first method is used to be exempt from testing for the RF air interface technology in this report.

10.2 Conducted power

Band	Average power (dBm)	MIF (dB)	Sum (dBm)	C63.19 Tested
GSM 850 - Voice	32.77	3.50	36.27	Yes
GSM 850 - GPRS	29.49	-2.37	27.12	Yes*
GSM 850 - EDGE	26.68	-2.13	24.55	Yes*
GSM 1900 - Voice	30.44	3.44	33.88	Yes
GSM 1900 - GPRS	29.64	1.00	28.64	Yes*
GSM 1900 - EDGE	25.29	1.06	24.23	Yes*
WCDMA 850 - RMC	23.91	-23.20	0.71	No
WCDMA 850 - HSPA	21.54	-20.06	1.48	No
WCDMA 1700 - RMC	24.08	-22.71	1.37	No
WCDMA 1700 - HSPA	21.81	-19.17	2.64	No
WCDMA 1900 - RMC	23.98	-22.42	1.56	No
WCDMA 1900 - HSPA	21.93	-19.93	2.00	No
LTE B2	23.24	-14.70	8.54	No
LTE B5	23.03	-14.58	8.45	No
LTE B7	23.94	-14.31	9.63	No
LTE B12	23.35	-14.13	9.22	No
LTE B13	23.23	-14.83	8.40	No
LTE B66	23.41	-14.63	8.78	No
WiFi-2.4G	14.39	-9.41	4.98	No
WiFi-5G	18.38	-10.11	8.27	No

*Note: For GSM bands, GPRS/EDGE modes were not evaluated as Voice modes were found to be the worst-case modes for the GSM air interface.

10.3 Conclusion

According to the above table, the sums of average power and MIF for UMTS, LTE and WiFi are less than 17dBm. So it is only measured for GSM bands. The UMTS, LTE and WiFi are exempt from testing and rated as M4.

11 RF TEST PROCEDURES

The evaluation was performed with the following procedure:

- 1) Confirm proper operation of the field probe, probe measurement system and other instrumentation and the positioning system.
- 2) Position the WD in its intended test position. The gauge block can simplify this positioning.
- 3) Configure the WD normal operation for maximum rated RF output power, at the desired channel and other operating parameters (e.g., test mode), as intended for the test.
- 4) The center sub-grid shall be centered on the center of the T-Coil mode axial measurement point or the acoustic output, as appropriate. Locate the field probe at the initial test position in the 50 mm by 50 mm grid, which is contained in the measurement plane. If the field alignment method is used, align the probe for maximum field reception.
- 5) Record the reading.
- 6) Scan the entire 50 mm by 50 mm region in equally spaced increments and record the reading at each measurement point. The distance between measurement points shall be sufficient to assure the identification of the maximum reading.
- 7) Identify the five contiguous sub-grids around the center sub-grid whose maximum reading is the lowest of all available choices. This eliminates the three sub-grids with the maximum readings. Thus, the six areas to be used to determine the WD's highest emissions are identified.
- 8) Identify the maximum field reading within the non-excluded sub-grids identified in Step 7)
- 9) Evaluate the MIF and add to the maximum steady-state rms field-strength reading to obtain the RF audio interference level..
- 10) Compare this RF audio interference level with the categories and record the resulting WD category rating.

12 Measurement Results (E-Field)

Frequency		Measured Value(dBV/m)	Power Drift (dB)	Category
MHz	Channel			
GSM 850				
848.8	251	30.8	0.01	M4 (see Fig B.1)
836.6	190	31.86	0.04	M4 (see Fig B.2)
824.2	128	32.54	-0.07	M4 (see Fig B.3)
GSM 1900				
1909.8	810	28.18	0.03	M4 (see Fig B.4)
1880	661	27.82	0.06	M4 (see Fig B.5)
1850.2	512	28.66	0.17	M4 (see Fig B.6)

13 ANSIC 63.19-2011 LIMITS

WD RF audio interference level categories in logarithmic units

Emission categories	< 960 MHz	
	E-field emissions	
Category M1	50 to 55	dB (V/m)
Category M2	45 to 50	dB (V/m)
Category M3	40 to 45	dB (V/m)
Category M4	< 40	dB (V/m)
Emission categories	>960 MHz	
	E-field emissions	
Category M1	40 to 45	dB (V/m)
Category M2	35 to 40	dB (V/m)
Category M3	30 to 35	dB (V/m)
Category M4	< 30	dB (V/m)

14 MEASUREMENT UNCERTAINTY

No.	Error source	Type	Uncertainty Value(%)	Prob. Dist.	k	c _i E	Standard Uncertainty (%) u_i ; (%)E	Degree of freedom V_{eff} or ν_i
Measurement System								
1	Probe Calibration	B	5.	N	1	1	5.1	∞
2	Axial Isotropy	B	4.7	R	$\sqrt{3}$	1	2.7	∞
3	Sensor Displacement	B	16.5	R	$\sqrt{3}$	1	9.5	∞
4	Boundary Effects	B	2.4	R	$\sqrt{3}$	1	1.4	∞
5	Linearity	B	4.7	R	$\sqrt{3}$	1	2.7	∞
6	Scaling to Peak Envelope Power	B	2.0	R	$\sqrt{3}$	1	1.2	∞
7	System Detection Limit	B	1.0	R	$\sqrt{3}$	1	0.6	∞
8	Readout Electronics	B	0.3	N	1	1	0.3	∞
9	Response Time	B	0.8	R	$\sqrt{3}$	1	0.5	∞
10	Integration Time	B	2.6	R	$\sqrt{3}$	1	1.5	∞
11	RF Ambient Conditions	B	3.0	R	$\sqrt{3}$	1	1.7	∞
12	RF Reflections	B	12.0	R	$\sqrt{3}$	1	6.9	∞
13	Probe Positioner	B	1.2	R	$\sqrt{3}$	1	0.7	∞
14	Probe Positioning	A	4.7	R	$\sqrt{3}$	1	2.7	∞
15	Extra. And Interpolation	B	1.0	R	$\sqrt{3}$	1	0.6	∞
Test Sample Related								
16	Device Positioning Vertical	B	4.7	R	$\sqrt{3}$	1	2.7	∞
17	Device Positioning Lateral	B	1.0	R	$\sqrt{3}$	1	0.6	∞
18	Device Holder and Phantom	B	2.4	R	$\sqrt{3}$	1	1.4	∞
19	Power Drift	B	5.0	R	$\sqrt{3}$	1	2.9	∞

20	AIA measurement	B	12	R	$\sqrt{3}$	1	6.9	∞
Phantom and Setup related								
21	Phantom Thickness	B	2.4	R	$\sqrt{3}$	1	1.4	∞
Combined standard uncertainty(%)							16.2	
Expanded uncertainty (confidence interval of 95 %)		$u_e = 2u_c$		N	k=2		32.4	

15 MAIN TEST INSTRUMENTS

Table 1: List of Main Instruments

No.	Name	Type	Serial Number	Calibration Date	Valid Period
01	Signal Generator	E4438C	MY49071430	January 2, 2018	One Year
02	Power meter	NRVD	102083	November 01, 2017	One year
03	Power sensor	NRV-Z5	100542		
04	Amplifier	60S1G4	0331848	No Calibration Requested	
05	AIA	SE UMS 170 CB	1029	No Calibration Requested	
06	E-Field Probe	ER3DV6	2272	December 19, 2017	One year
07	DAE	SPEAG DAE4	777	September 8, 2017	One year
08	HAC Dipole	CD835V3	1023	August 23, 2017	One year
09	HAC Dipole	CD1880V3	1018	August 23, 2017	One year
10	BTS	E5515C	MY50263375	January 23, 2018	One year
11	BTS	CMW 500	164049	September 12, 2017	One year

16 CONCLUSION

The HAC measurement indicates that the EUT complies with the HAC limits of the ANSIC63.19-2011. The total M-rating is **M4**.

END OF REPORT BODY

ANNEX A TEST LAYOUT



Picture A1:HAC RF System Layout

ANNEX B TEST PLOTS

HAC RF E-Field GSM 850 High

Date: 2018-4-9

Electronics: DAE4 Sn777

Medium: Air

Medium parameters used: $\sigma = 0$ mho/m, $\epsilon_r = 1$; $\rho = 1000$ kg/m³

Ambient Temperature: 22.0°C

Communication System: GSM 850; Frequency: 848.8 MHz; Duty Cycle: 1:8.3

Probe: ER3DV6 - SN2272; ConvF(1, 1, 1)

E Scan - ER3DV6 - 2011: 15 mm from Probe Center to the Device/Hearing Aid Compatibility Test (101x101x1): Interpolated grid: dx=0.5000 mm, dy=0.5000 mm

Device Reference Point: 0, 0, -6.3 mm

Reference Value = 28.88 V/m; Power Drift = 0.01 dB

Applied MIF = 3.44 dB

RF audio interference level = 30.80 dBV/m

Emission category: M4

MIF scaled E-field

Grid 1 M4 30.79 dBV/m	Grid 2 M4 30.87 dBV/m	Grid 3 M4 30.56 dBV/m
Grid 4 M4 30.53 dBV/m	Grid 5 M4 30.8 dBV/m	Grid 6 M4 30.58 dBV/m
Grid 7 M4 30.27 dBV/m	Grid 8 M4 30.64 dBV/m	Grid 9 M4 30.35 dBV/m

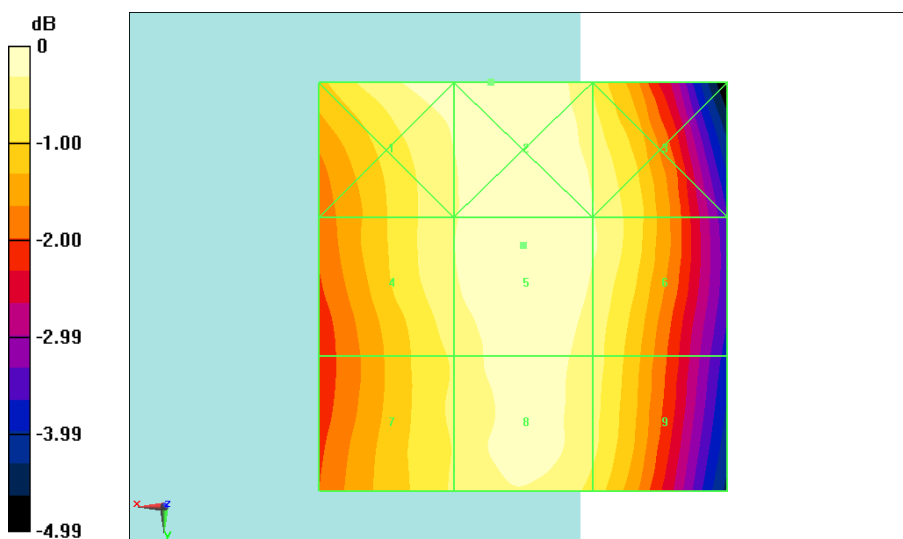

0 dB = 34.94 V/m = 30.87 dBV/m

Fig B.1 HAC RF E-Field GSM 850 High

HAC RF E-Field GSM 850 Middle

Date: 2018-4-9

Electronics: DAE4 Sn777

Medium: Air

Medium parameters used: $\sigma = 0$ mho/m, $\epsilon_r = 1$; $\rho = 1000$ kg/m³

Ambient Temperature: 22.0°C

Communication System: GSM 850; Frequency: 836.6 MHz; Duty Cycle: 1:8.3

Probe: ER3DV6 - SN2272;ConvF(1, 1, 1)

E Scan - ER3DV6 - 2011: 15 mm from Probe Center to the Device 2/Hearing Aid

Compatibility Test (101x101x1): Interpolated grid: dx=0.5000 mm, dy=0.5000 mm

Device Reference Point: 0, 0, -6.3 mm

Reference Value = 32.42 V/m; Power Drift = 0.04 dB

Applied MIF = 3.45 dB

RF audio interference level = 31.86 dBV/m

Emission category: M4

MIF scaled E-field

Grid 1 M4 31.78 dBV/m	Grid 2 M4 31.85 dBV/m	Grid 3 M4 31.53 dBV/m
Grid 4 M4 31.62 dBV/m	Grid 5 M4 31.86 dBV/m	Grid 6 M4 31.57 dBV/m
Grid 7 M4 31.49 dBV/m	Grid 8 M4 31.76 dBV/m	Grid 9 M4 31.39 dBV/m

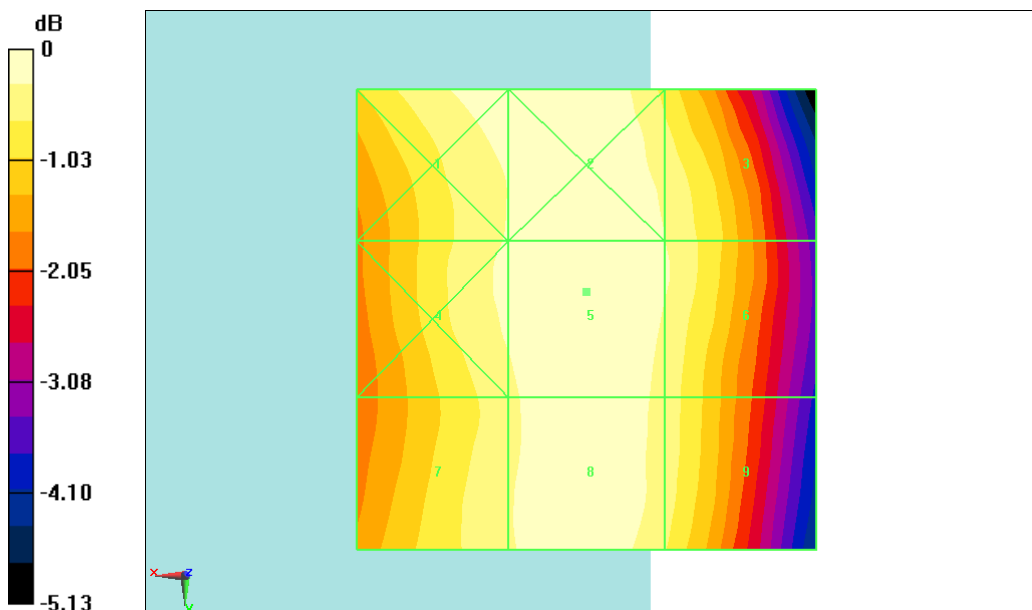

0 dB = 39.18 V/m = 31.86 dBV/m

Fig B.2 HAC RF E-Field GSM 850 Middle

HAC RF E-Field GSM 850 Low

Date: 2018-4-9

Electronics: DAE4 Sn777

Medium: Air

Medium parameters used: $\sigma = 0$ mho/m, $\epsilon_r = 1$; $\rho = 1000$ kg/m³

Ambient Temperature: 22.0°C

Communication System: GSM 850; Frequency: 824.2 MHz; Duty Cycle: 1:8.3

Probe: ER3DV6 - SN2272;ConvF(1, 1, 1)

E Scan - ER3DV6 - 2011: 15 mm from Probe Center to the Device 3/Hearing Aid

Compatibility Test (101x101x1): Interpolated grid: dx=0.5000 mm, dy=0.5000 mm

Device Reference Point: 0, 0, -6.3 mm

Reference Value = 35.18 V/m; Power Drift = -0.07 dB

Applied MIF = 3.50 dB

RF audio interference level = 32.54 dBV/m

Emission category: M4

MIF scaled E-field

Grid 1 M4 32.38 dBV/m	Grid 2 M4 32.47 dBV/m	Grid 3 M4 32.15 dBV/m
Grid 4 M4 32.36 dBV/m	Grid 5 M4 32.54 dBV/m	Grid 6 M4 32.16 dBV/m
Grid 7 M4 32.39 dBV/m	Grid 8 M4 32.59 dBV/m	Grid 9 M4 32.13 dBV/m

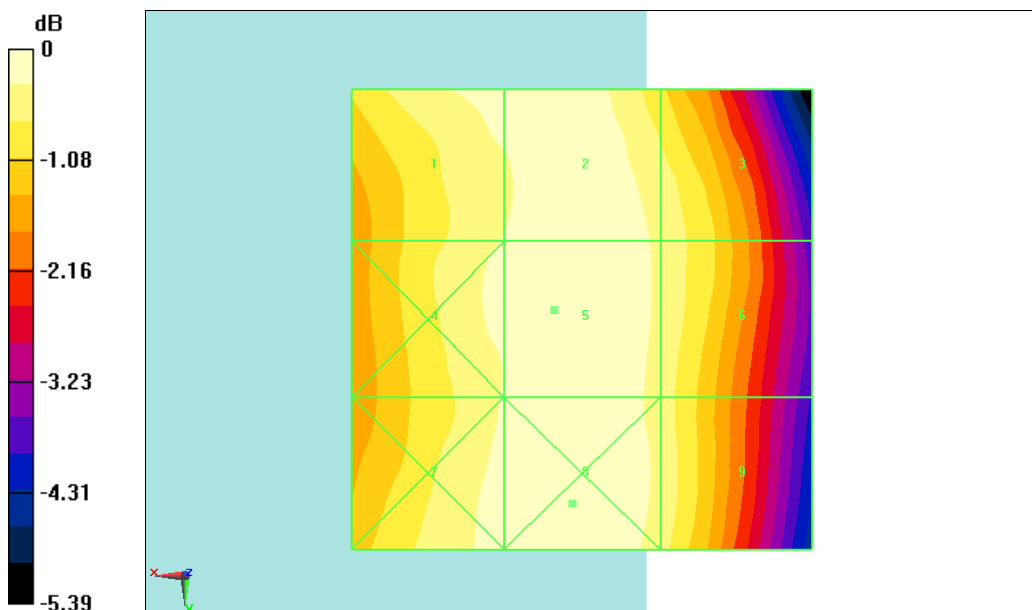

0 dB = 42.59 V/m = 32.59 dBV/m

Fig B.3 HAC RF E-Field GSM 850 Low

HAC RF E-Field GSM 1900 High

Date: 2018-4-9

Electronics: DAE4 Sn777

Medium: Air

Medium parameters used: $\sigma = 0$ mho/m, $\epsilon_r = 1$; $\rho = 1000$ kg/m³

Ambient Temperature: 22.0°C

Communication System: DCS 1900; Frequency: 1909.8 MHz; Duty Cycle: 1:8.3

Probe: ER3DV6 - SN2272;ConvF(1, 1, 1)

E Scan - ER3DV6 - 2011: 15 mm from Probe Center to the Device/Hearing Aid

Compatibility Test (101x101x1): Interpolated grid: dx=0.5000 mm, dy=0.5000 mm

Device Reference Point: 0, 0, -6.3 mm

Reference Value = 18.14 V/m; Power Drift = 0.03 dB

Applied MIF = 3.43 dB

RF audio interference level = 28.18 dBV/m

Emission category: M4

MIF scaled E-field

Grid 1 M4 23.45 dBV/m	Grid 2 M4 27.73 dBV/m	Grid 3 M4 28.2 dBV/m
Grid 4 M4 25.07 dBV/m	Grid 5 M4 28.15 dBV/m	Grid 6 M4 28.17 dBV/m
Grid 7 M4 26.44 dBV/m	Grid 8 M4 28.18 dBV/m	Grid 9 M4 28.19 dBV/m

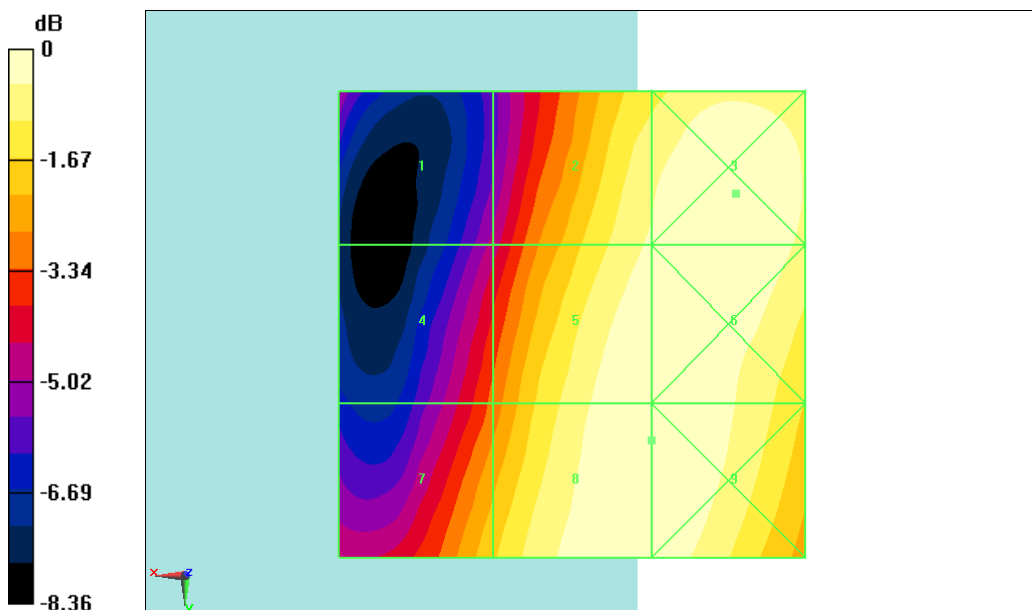

0 dB = 25.70 V/m = 28.20 dBV/m

Fig B.4 HAC RF E-Field GSM 1900 High

HAC RF E-Field GSM 1900 Middle

Date: 2018-4-9

Electronics: DAE4 Sn777

Medium: Air

Medium parameters used: $\sigma = 0$ mho/m, $\epsilon_r = 1$; $\rho = 1000$ kg/m³

Ambient Temperature: 22.0°C

Communication System: DCS 1900; Frequency: 1880 MHz; Duty Cycle: 1:8.3

Probe: ER3DV6 - SN2272;ConvF(1, 1, 1)

E Scan - ER3DV6 - 2011: 15 mm from Probe Center to the Device 2/Hearing Aid

Compatibility Test (101x101x1): Interpolated grid: dx=0.5000 mm, dy=0.5000 mm

Device Reference Point: 0, 0, -6.3 mm

Reference Value = 16.79 V/m; Power Drift = 0.06 dB

Applied MIF = 3.43 dB

RF audio interference level = 27.82 dBV/m

Emission category: M4

MIF scaled E-field

Grid 1 M4 22.96 dBV/m	Grid 2 M4 27.29 dBV/m	Grid 3 M4 28.12 dBV/m
Grid 4 M4 24.63 dBV/m	Grid 5 M4 27.67 dBV/m	Grid 6 M4 27.86 dBV/m
Grid 7 M4 26.19 dBV/m	Grid 8 M4 27.82 dBV/m	Grid 9 M4 27.82 dBV/m

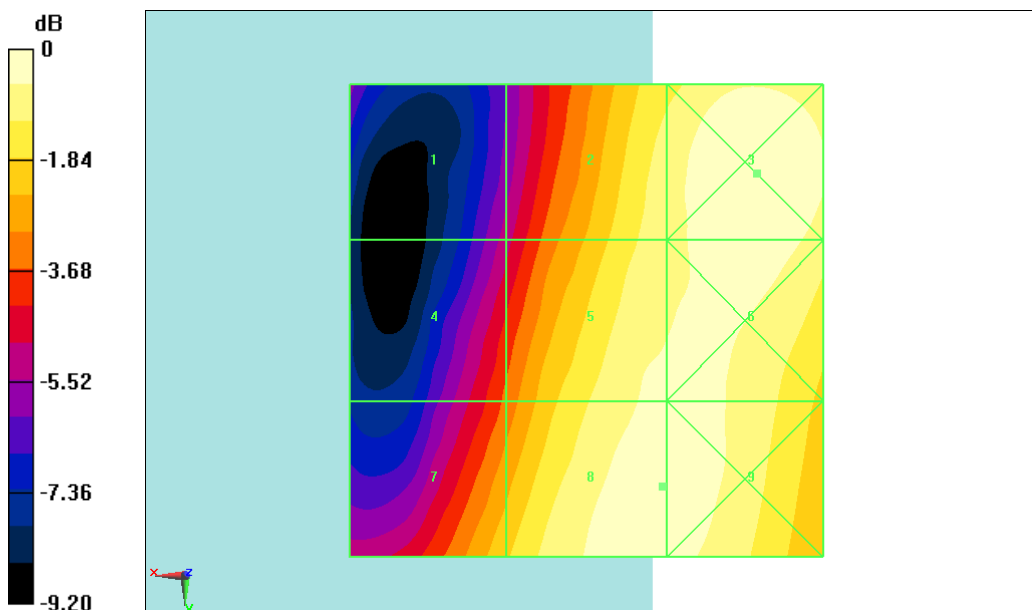

0 dB = 25.46 V/m = 28.12 dBV/m

Fig B.5 HAC RF E-Field GSM 1900 Middle

HAC RF E-Field GSM 1900 Low

Date: 2018-4-9

Electronics: DAE4 Sn777

Medium: Air

Medium parameters used: $\sigma = 0$ mho/m, $\epsilon_r = 1$; $\rho = 1000$ kg/m³

Ambient Temperature: 22.0°C

Communication System: DCS 1900; Frequency: 1850.2 MHz; Duty Cycle: 1:8.3

Probe: ER3DV6 - SN2272;ConvF(1, 1, 1)

E Scan - ER3DV6 - 2011: 15 mm from Probe Center to the Device 3/Hearing Aid

Compatibility Test (101x101x1): Interpolated grid: dx=0.5000 mm, dy=0.5000 mm

Device Reference Point: 0, 0, -6.3 mm

Reference Value = 17.08 V/m; Power Drift = 0.17 dB

Applied MIF = 3.44 dB

RF audio interference level = 28.66 dBV/m

Emission category: M4

MIF scaled E-field

Grid 1 M4 23.68 dBV/m	Grid 2 M4 27.72 dBV/m	Grid 3 M4 28.66 dBV/m
Grid 4 M4 25.81 dBV/m	Grid 5 M4 28.51 dBV/m	Grid 6 M4 28.52 dBV/m
Grid 7 M4 27.78 dBV/m	Grid 8 M4 29.18 dBV/m	Grid 9 M4 29.12 dBV/m

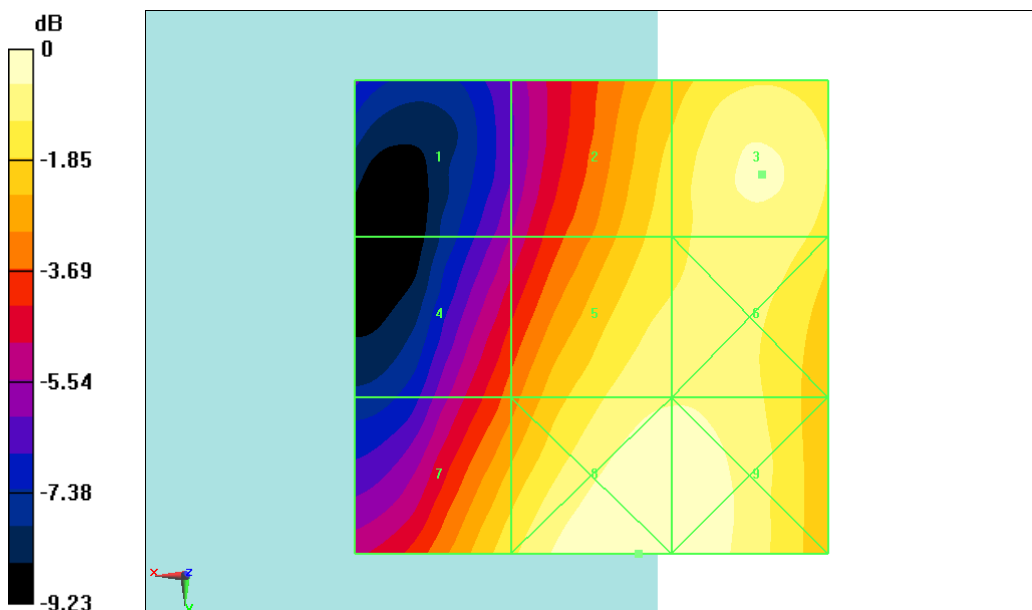

0 dB = 28.76 V/m = 29.18 dBV/m

Fig B.6 HAC RF E-Field GSM 1900 Low

ANNEX C SYSTEM VALIDATION RESULT

E SCAN of Dipole 835 MHz

Date: 2018-4-9

Electronics: DAE4 Sn777

Medium: Air

Medium parameters used: $\sigma = 0$ mho/m, $\epsilon_r = 1$; $\rho = 1000$ kg/m³

Communication System: CW; Frequency: 835 MHz; Duty Cycle: 1:1

Probe: ER3DV6 - SN2272;ConvF(1, 1, 1)

E Scan - measurement distance from the probe sensor center to CD835 Dipole = 15mm/Hearing Aid Compatibility Test (41x361x1): Interpolated grid: dx=0.5000 mm, dy=0.5000 mm

Device Reference Point: 0, 0, -6.3 mm

Reference Value = 106.9 V/m; Power Drift = -0.01 dB

Applied MIF = 0.00 dB

RF audio interference level = 40.53 dBV/m

Emission category: M3

MIF scaled E-field

Grid 1M3 40.39 dBV/m	Grid 2M3 40.51 dBV/m	Grid 3M3 40.33 dBV/m
Grid 4 M4 35.93 dBV/m	Grid 5 M4 36.04 dBV/m	Grid 6 M4 35.88 dBV/m
Grid 7 M3 40.34 dBV/m	Grid 8 M3 40.53 dBV/m	Grid 9 M3 40.46 dBV/m

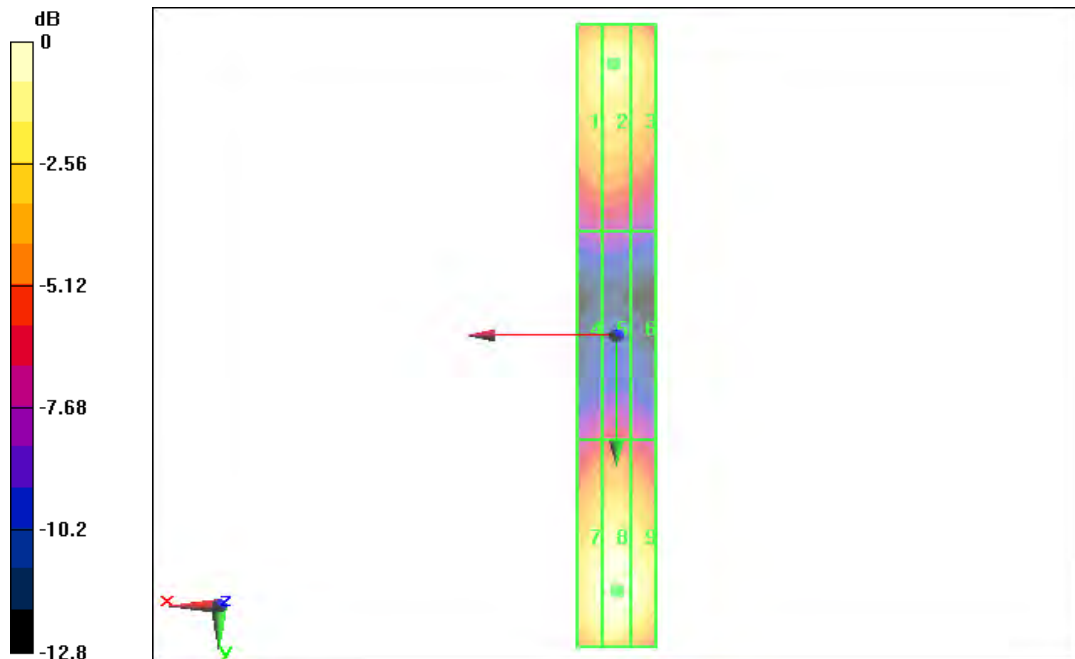

0 dB = 40.53 dBV/m

E SCAN of Dipole 1880 MHz

Date: 2018-4-9

Electronics: DAE4 Sn777

Medium: Air

Medium parameters used: $\sigma = 0$ mho/m, $\epsilon_r = 1$; $\rho = 1000$ kg/m³

Communication System: CW; Frequency: 1880 MHz; Duty Cycle: 1:1

Probe: ER3DV6 - SN2272;ConvF(1, 1, 1)

E Scan - measurement distance from the probe sensor center to CD1880 Dipole = 15mm/Hearing Aid Compatibility Test (41x181x1): Interpolated grid: dx=0.5000 mm, dy=0.5000 mm

Device Reference Point: 0, 0, -6.3 mm

Reference Value = 154.9 V/m; Power Drift = 0.02 dB

Applied MIF = 0.00 dB

RF audio interference level = 39.45 dBV/m

Emission category: M2

MIF scaled E-field

Grid 1M2 39.21 dBV/m	Grid 2M2 39.45 dBV/m	Grid 3M2 39.36 dBV/m
Grid 4M2 37.22 dBV/m	Grid 5M2 37.36 dBV/m	Grid 6M2 37.26 dBV/m
Grid 7M2 38.78 dBV/m	Grid 8M2 39.05dBV/m	Grid 9M2 38.98 dBV/m

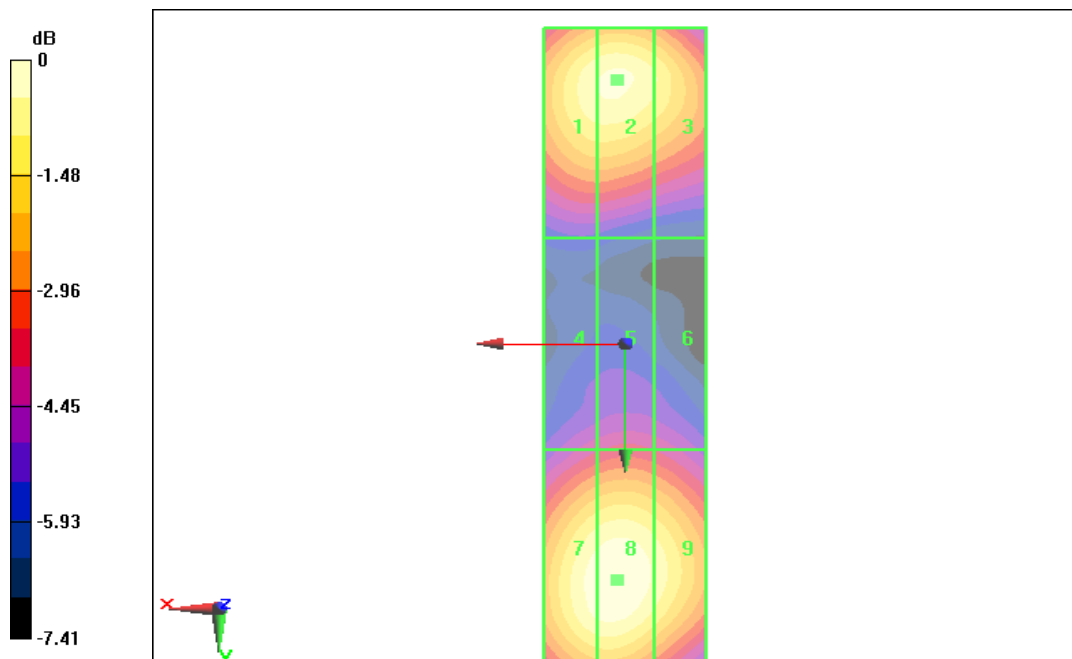

0 dB = 39.45 dBV/m

ANNEX D PROBE CALIBRATION CERTIFICATE

E_Probe ER3DV6

Calibration Laboratory of
Schmid & Partner
Engineering AG
Zeughausstrasse 43, 8004 Zurich, Switzerland



S Schweizerischer Kalibrierdienst
S Service suisse d'étalonnage
C Servizio svizzero di taratura
S Swiss Calibration Service

Accredited by the Swiss Accreditation Service (SAS)
The Swiss Accreditation Service is one of the signatories to the EA
Multilateral Agreement for the recognition of calibration certificates

Accreditation No.: **SCS 0108**

Client **CTTL (Auden)**

Certificate No: **ER3-2272_Dec17**

CALIBRATION CERTIFICATE

Object: **ER3DV6 - SN:2272**

Calibration procedure(s): **QA CAL-02.v8, QA CAL-25.v6**
Calibration procedure for E-field probes optimized for close near field evaluations in air



Calibration date: **December 19, 2017**

This calibration certificate documents the traceability to national standards, which realize the physical units of measurements (SI). The measurements and the uncertainties with confidence probability are given on the following pages and are part of the certificate.

All calibrations have been conducted in the closed laboratory facility: environment temperature (22 ± 3)°C and humidity < 70%.

Calibration Equipment used (M&TE critical for calibration)

Primary Standards	ID	Cal Date (Certificate No.)	Scheduled Calibration
Power meter NRP	SN: 104778	04-Apr-17 (No. 217-02521/02522)	Apr-18
Power sensor NRP-Z91	SN: 103244	04-Apr-17 (No. 217-02521)	Apr-18
Power sensor NRP-Z91	SN: 103245	04-Apr-17 (No. 217-02525)	Apr-18
Reference 20 dB Attenuator	SN: S5277 (20x)	07-Apr-17 (No. 217-02528)	Apr-18
Reference Probe ER3DV6	SN: 2328	10-Oct-17 (No. ER3-2328_Oct17)	Oct-18
DAE4	SN: 789	2-Aug-17 (No. DAE4-789_Aug17)	Aug-18
Secondary Standards	ID	Check Date (in house)	Scheduled Check
Power meter E4419B	SN: GB41293874	06-Apr-16 (in house check Jun-16)	In house check: Jun-18
Power sensor E4412A	SN: MY41498087	06-Apr-16 (in house check Jun-16)	In house check: Jun-18
Power sensor E4412A	SN: 000110210	06-Apr-16 (in house check Jun-16)	In house check: Jun-18
RF generator HP 8648C	SN: US3642U01700	04-Aug-99 (in house check Jun-16)	In house check: Jun-18
Network Analyzer HP 8753E	SN: US37390585	18-Oct-01 (in house check Oct-17)	In house check: Oct-18

Calibrated by:	Name Jeton Kastrati	Function Laboratory Technician	Signature 
Approved by:	Name Katja Pokovic	Function Technical Manager	Signature 

Issued: December 20, 2017

This calibration certificate shall not be reproduced except in full without written approval of the laboratory.

**Calibration Laboratory of
Schmid & Partner
Engineering AG**
Zeughausstrasse 43, 8004 Zurich, Switzerland



S Schweizerischer Kalibrierdienst
C Service suisse d'étalonnage
S Servizio svizzero di taratura
S Swiss Calibration Service

Accredited by the Swiss Accreditation Service (SAS)
The Swiss Accreditation Service is one of the signatories to the EA
Multilateral Agreement for the recognition of calibration certificates

Accreditation No.: **SCS 0108**

Glossary:

NORM _{x,y,z}	sensitivity in free space
DCP	diode compression point
CF	crest factor (1/duty_cycle) of the RF signal
A, B, C, D	modulation dependent linearization parameters
Polarization φ	φ rotation around probe axis
Polarization ϑ	ϑ rotation around an axis that is in the plane normal to probe axis (at measurement center), i.e., $\vartheta = 0$ is normal to probe axis
Connector Angle	information used in DASYS system to align probe sensor X to the robot coordinate system

Calibration is Performed According to the Following Standards:

- IEEE Std 1309-2005, "IEEE Standard for calibration of electromagnetic field sensors and probes, excluding antennas, from 9 kHz to 40 GHz", December 2005
- CTIA Test Plan for Hearing Aid Compatibility, Rev 3.0, November 2013

Methods Applied and Interpretation of Parameters:

- NORM_{x,y,z}**: Assessed for E-field polarization $\vartheta = 0$ for XY sensors and $\vartheta = 90$ for Z sensor ($f \leq 900$ MHz in TEM-cell; $f > 1800$ MHz: R22 waveguide).
- NORM(f)_{x,y,z}** = NORM_{x,y,z} * frequency_response (see Frequency Response Chart).
- DCP_{x,y,z}**: DCP are numerical linearization parameters assessed based on the data of power sweep with CW signal (no uncertainty required). DCP does not depend on frequency nor media.
- PAR**: PAR is the Peak to Average Ratio that is not calibrated but determined based on the signal characteristics
- A_{x,y,z}; B_{x,y,z}; C_{x,y,z}; D_{x,y,z}; VR_{x,y,z}**: A, B, C, D are numerical linearization parameters assessed based on the data of power sweep for specific modulation signal. The parameters do not depend on frequency nor media. VR is the maximum calibration range expressed in RMS voltage across the diode.
- Spherical isotropy (3D deviation from isotropy)**: in a locally homogeneous field realized using an open waveguide setup.
- Sensor Offset**: The sensor offset corresponds to the offset of virtual measurement center from the probe tip (on probe axis). No tolerance required.
- Connector Angle**: The angle is assessed using the information gained by determining the NORM_x (no uncertainty required).



ER3DV6 – SN:2272

December 19, 2017

Probe ER3DV6

SN:2272

Manufactured: November 29, 2001
Calibrated: December 19, 2017

Calibrated for DASY/EASY Systems
(Note: non-compatible with DASY2 system!)

ER3DV6 – SN:2272

December 19, 2017

DASY/EASY - Parameters of Probe: ER3DV6 - SN:2272

Basic Calibration Parameters

	Sensor X	Sensor Y	Sensor Z	Unc (k=2)
Norm ($\mu\text{V}/(\text{V}/\text{m})^2$)	1.60	1.67	1.72	$\pm 10.1\%$
DCP (mV) ^B	101.0	97.8	100.7	

Modulation Calibration Parameters

UID	Communication System Name		A dB	B dB $\sqrt{\mu\text{V}}$	C	D dB	VR mV	Unc ^E (k=2)
0	CW	X	0.0	0.0	1.0	0.00	200.2	$\pm 3.5\%$
		Y	0.0	0.0	1.0		165.8	
		Z	0.0	0.0	1.0		197.0	

Note: For details on UID parameters see Appendix.

Sensor Model Parameters

	C1 fF	C2 fF	α V^{-1}	T1 $\text{ms}\cdot\text{V}^{-2}$	T2 $\text{ms}\cdot\text{V}^{-1}$	T3 ms	T4 V^{-2}	T5 V^{-1}	T6
X	94.34	448.4	35.94	25.97	1.333	5.10	0.00	0.662	1.014
Y	100.1	483.8	36.93	26.47	1.401	5.10	0.00	0.669	1.019
Z	83.01	396.9	36.42	29.84	3.892	5.10	0.00	0.874	1.016

The reported uncertainty of measurement is stated as the standard uncertainty of measurement multiplied by the coverage factor $k=2$, which for a normal distribution corresponds to a coverage probability of approximately 95%.

^B Numerical linearization parameter; uncertainty not required.

^E Uncertainty is determined using the max. deviation from linear response applying rectangular distribution and is expressed for the square of the field value.

ER3DV6 – SN:2272

December 19, 2017

Frequency Response of E-Field (TEM-Cell: ifi110 EXX, Waveguide: R22)

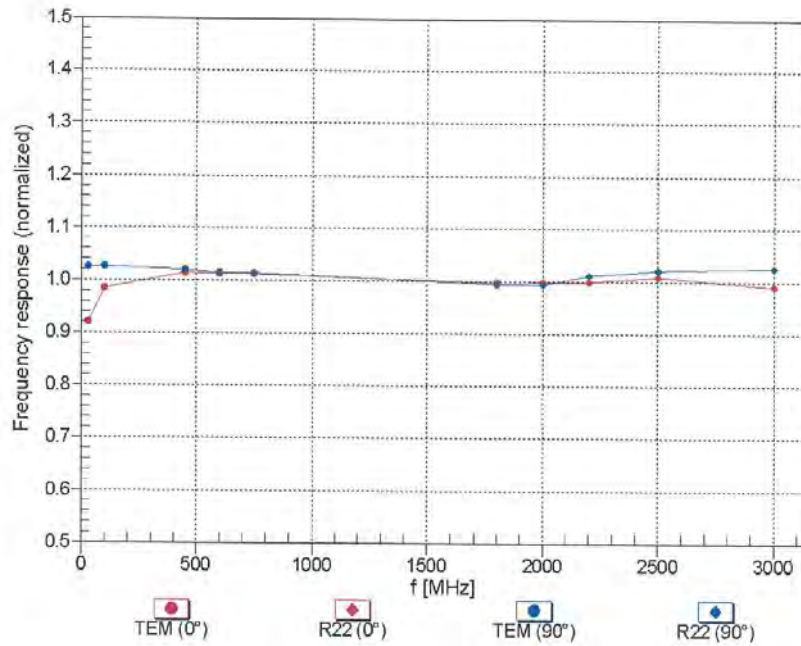

Uncertainty of Frequency Response of E-field: $\pm 6.3\%$ (k=2)

ER3DV6 – SN:2272

December 19, 2017

Receiving Pattern (ϕ), $\vartheta = 0^\circ$

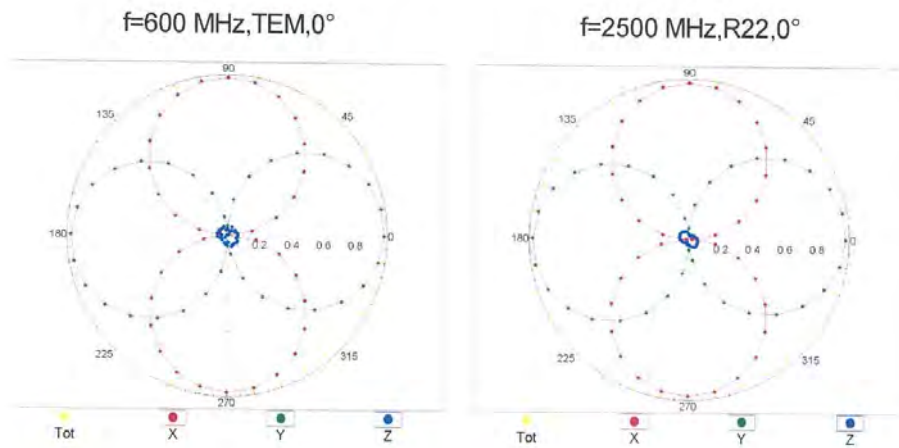

Receiving Pattern (ϕ), $\vartheta = 90^\circ$

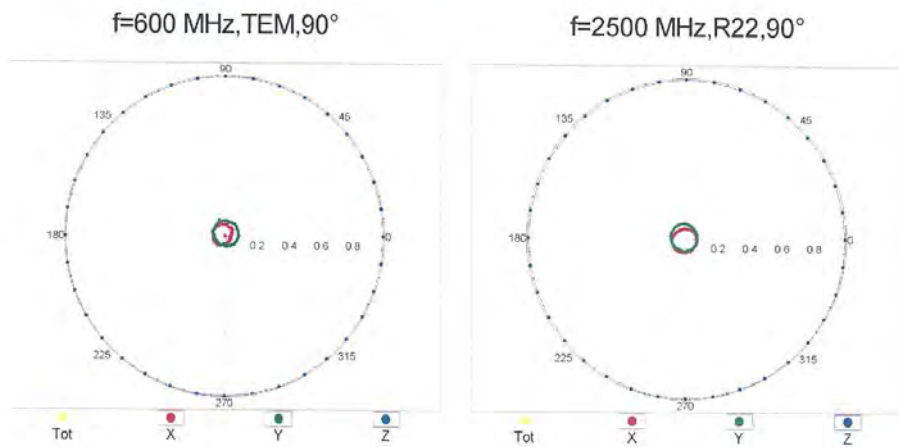

ER3DV6 – SN:2272

December 19, 2017

Receiving Pattern (ϕ), $\vartheta = 0^\circ$

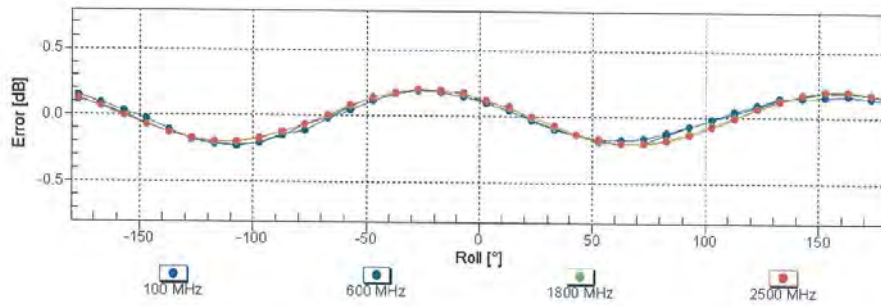

Uncertainty of Axial Isotropy Assessment: $\pm 0.5\%$ ($k=2$)

Receiving Pattern (ϕ), $\vartheta = 90^\circ$

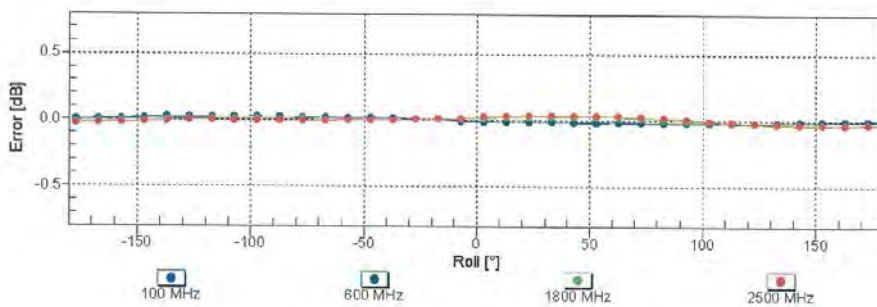

Uncertainty of Axial Isotropy Assessment: $\pm 0.5\%$ ($k=2$)

ER3DV6 – SN:2272

December 19, 2017

Dynamic Range f(E-field) (TEM cell , f = 900 MHz)

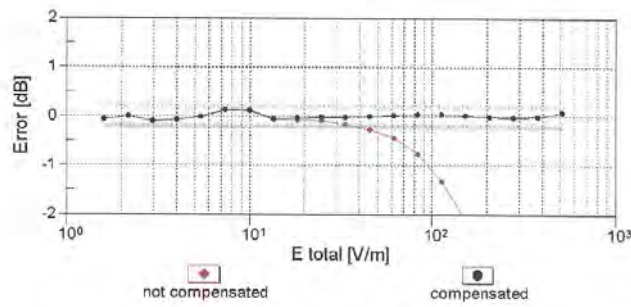
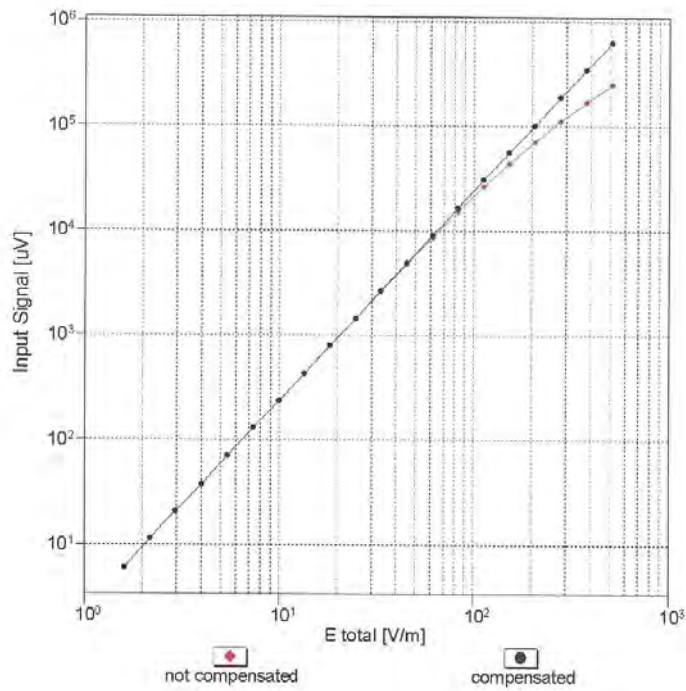

Uncertainty of Linearity Assessment: $\pm 0.6\%$ (k=2)

ER3DV6 – SN:2272

December 19, 2017

Deviation from Isotropy in Air Error (ϕ , θ), $f = 900$ MHz

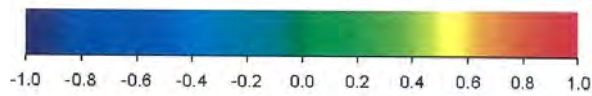
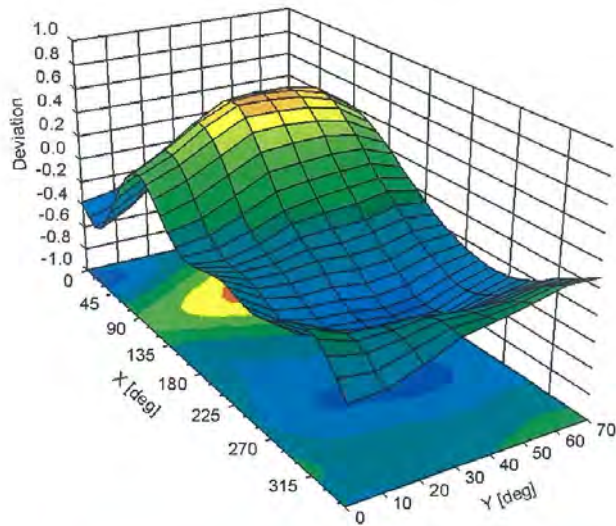

Uncertainty of Spherical Isotropy Assessment: $\pm 2.6\%$ ($k=2$)



ER3DV6 – SN:2272

December 19, 2017

DASY/EASY - Parameters of Probe: ER3DV6 - SN:2272

Other Probe Parameters

Sensor Arrangement	Rectangular
Connector Angle (°)	112.9
Mechanical Surface Detection Mode	enabled
Optical Surface Detection Mode	disabled
Probe Overall Length	337 mm
Probe Body Diameter	10 mm
Tip Length	10 mm
Tip Diameter	8 mm
Probe Tip to Sensor X Calibration Point	2.5 mm
Probe Tip to Sensor Y Calibration Point	2.5 mm
Probe Tip to Sensor Z Calibration Point	2.5 mm

ANNEX E DIPOLE CALIBRATION CERTIFICATE

Dipole 835 MHz

**Calibration Laboratory of
Schmid & Partner
Engineering AG**
Zeughausstrasse 43, 8004 Zurich, Switzerland





S Schweizerischer Kalibrierdienst
S Service suisse d'étalonnage
S Servizio svizzero di taratura
S Swiss Calibration Service

Accredited by the Swiss Accreditation Service (SAS)
The Swiss Accreditation Service is one of the signatories to the EA
Multilateral Agreement for the recognition of calibration certificates

Accreditation No.: **SCS 0108**

Client **CTTL (Auden)**

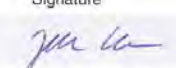
Certificate No: **CD835V3-1023_Aug17**

CALIBRATION CERTIFICATE			
Object	CD835V3 - SN: 1023		
Calibration procedure(s)	QA CAL-20.v6 Calibration procedure for dipoles in air		
Calibration date:	August 23, 2017		
This calibration certificate documents the traceability to national standards, which realize the physical units of measurements (SI). The measurements and the uncertainties with confidence probability are given on the following pages and are part of the certificate.			
All calibrations have been conducted in the closed laboratory facility: environment temperature (22 ± 3)°C and humidity < 70%.			
Calibration Equipment used (M&TE critical for calibration)			
Primary Standards	ID #	Cal Date (Certificate No.)	Scheduled Calibration
Power meter NRP	SN: 104778	04-Apr-17 (No. 217-02521/02522)	Apr-18
Power sensor NRP-Z91	SN: 103244	04-Apr-17 (No. 217-02521)	Apr-18
Power sensor NRP-Z91	SN: 103245	04-Apr-17 (No. 217-02522)	Apr-18
Reference 20 dB Attenuator	SN: 5058 (20k)	07-Apr-17 (No. 217-02528)	Apr-18
Type-N mismatch combination	SN: 5047.2 / 06327	07-Apr-17 (No. 217-02529)	Apr-18
Probe ER3DV6	SN: 2336	30-Dec-16 (No. ER3-2336_Dec16)	Dec-17
Probe H3DV6	SN: 6065	30-Dec-16 (No. H3-6065_Dec16)	Dec-17
DAE4	SN: 781	13-Jul-17 (No. DAE4-781_Jul17)	Jul-18
Secondary Standards	ID #	Check Date (in house)	Scheduled Check
Power meter Agilent 4419B	SN: GB42420191	09-Oct-09 (in house check Sep-14)	In house check: Oct-17
Power sensor HP E4412A	SN: US38485102	05-Jan-10 (in house check Sep-14)	In house check: Oct-17
Power sensor HP 8482A	SN: US37295597	09-Oct-09 (in house check Sep-14)	In house check: Oct-17
RF generator R&S SMT-06	SN: 832283/011	27-Aug-12 (in house check Oct-15)	In house check: Oct-17
Network Analyzer HP 8753E	SN: US37390585	18-Oct-01 (in house check Oct-16)	In house check: Oct-17
Calibrated by:	Name Johannes Kurikka	Function Laboratory Technician	Signature 
Approved by:	Name Katja Pokovic	Technical Manager	Signature 
			Issued: August 23, 2017
This calibration certificate shall not be reproduced except in full without written approval of the laboratory.			

**Calibration Laboratory of
Schmid & Partner
Engineering AG**
Zeughausstrasse 43, 8004 Zurich, Switzerland



S Schweizerischer Kalibrierdienst
S Service suisse d'étalonnage
C Servizio svizzero di taratura
S Swiss Calibration Service

Accredited by the Swiss Accreditation Service (SAS)
The Swiss Accreditation Service is one of the signatories to the EA
Multilateral Agreement for the recognition of calibration certificates

Accreditation No.: **SCS 0108**

References

- [1] ANSI-C63.19-2007
American National Standard for Methods of Measurement of Compatibility between Wireless Communications Devices and Hearing Aids.
- [2] ANSI-C63.19-2011
American National Standard, Methods of Measurement of Compatibility between Wireless Communications Devices and Hearing Aids.

Methods Applied and Interpretation of Parameters:

- **Coordinate System:** y-axis is in the direction of the dipole arms. z-axis is from the basis of the antenna (mounted on the table) towards its feed point between the two dipole arms. x-axis is normal to the other axes. In coincidence with the standards [1], the measurement planes (probe sensor center) are selected to be at a distance of 10 mm (15 mm for [2]) above the top metal edge of the dipole arms.
- **Measurement Conditions:** Further details are available from the hardcopies at the end of the certificate. All figures stated in the certificate are valid at the frequency indicated. The forward power to the dipole connector is set with a calibrated power meter connected and monitored with an auxiliary power meter connected to a directional coupler. While the dipole under test is connected, the forward power is adjusted to the same level.
- **Antenna Positioning:** The dipole is mounted on a HAC Test Arch phantom using the matching dipole positioner with the arms horizontal and the feeding cable coming from the floor. The measurements are performed in a shielded room with absorbers around the setup to reduce the reflections. It is verified before the mounting of the dipole under the Test Arch phantom, that its arms are perfectly in a line. It is installed on the HAC dipole positioner with its arms parallel below the dielectric reference wire and able to move elastically in vertical direction without changing its relative position to the top center of the Test Arch phantom. The vertical distance to the probe is adjusted after dipole mounting with a DASY5 Surface Check job. Before the measurement, the distance between phantom surface and probe tip is verified. The proper measurement distance is selected by choosing the matching section of the HAC Test Arch phantom with the proper device reference point (upper surface of the dipole) and the matching grid reference point (tip of the probe) considering the probe sensor offset. The vertical distance to the probe is essential for the accuracy.
- **Feed Point Impedance and Return Loss:** These parameters are measured using a HP 8753E Vector Network Analyzer. The impedance is specified at the SMA connector of the dipole. The influence of reflections was eliminated by applying the averaging function while moving the dipole in the air, at least 70cm away from any obstacles.
- **E-field distribution:** E field is measured in the x-y-plane with an isotropic ER3D-field probe with 100 mW forward power to the antenna feed point. In accordance with [1] and [2], the scan area is 20mm wide, its length exceeds the dipole arm length (180 or 90mm). The sensor center is 10 mm (15 mm for [2]) (in z) above the metal top of the dipole arms. Two 3D maxima are available near the end of the dipole arms. Assuming the dipole arms are perfectly in one line, the average of these two maxima (in subgrid 2 and subgrid 8) is determined to compensate for any non-parallelity to the measurement plane as well as the sensor displacement. The E-field value stated as calibration value represents the maximum of the interpolated 3D-E-field, in the plane above the dipole surface.
- **H-field distribution:** H-field is measured with an isotropic H-field probe with 100mW forward power to the antenna feed point, in the x-y-plane. The scan area and sensor distance is equivalent to the E-field scan. The maximum of the field is available at the center (subgrid 5) above the feed point. The H-field value stated as calibration value represents the maximum of the interpolated H-field, 10mm above the dipole surface at the feed point.

The reported uncertainty of measurement is stated as the standard uncertainty of measurement multiplied by the coverage factor $k=2$, which for a normal distribution corresponds to a coverage probability of approximately 95%.

Measurement Conditions

DASY system configuration, as far as not given on page 1.

DASY Version	DASY5	V52.10.0
Phantom	HAC Test Arch	
Distance Dipole Top - Probe Center	10, 15 mm	
Scan resolution	dx, dy = 5 mm	
Frequency	835 MHz \pm 1 MHz	
Input power drift	< 0.05 dB	

Maximum Field values at 835 MHz

H-field 10 mm above dipole surface	condition	interpolated maximum
Maximum measured	100 mW input power	0.457 A/m \pm 8.2 % (k=2)

E-field 10 mm above dipole surface	condition	Interpolated maximum
Maximum measured above high end	100 mW input power	168.6 V/m = 44.54 dBV/m
Maximum measured above low end	100 mW input power	165.9 V/m = 44.40 dBV/m
Averaged maximum above arm	100 mW input power	167.3 V/m \pm 12.8 % (k=2)

E-field 15 mm above dipole surface	condition	Interpolated maximum
Maximum measured above high end	100 mW input power	108.0 V/m = 40.67 dBV/m
Maximum measured above low end	100 mW input power	107.9 V/m = 40.66 dBV/m
Averaged maximum above arm	100 mW input power	108.0 V/m \pm 12.8 % (k=2)

Appendix (Additional assessments outside the scope of SCS 0108)**Antenna Parameters**

Frequency	Return Loss	Impedance
800 MHz	16.8 dB	41.0 Ω - 9.7 j Ω
835 MHz	23.2 dB	53.2 Ω + 6.4 j Ω
900 MHz	15.7 dB	52.8 Ω - 16.9 j Ω
950 MHz	23.1 dB	48.9 Ω + 6.9 j Ω
960 MHz	16.9 dB	58.6 Ω + 13.1 j Ω

3.2 Antenna Design and Handling

The calibration dipole has a symmetric geometry with a built-in two stub matching network, which leads to the enhanced bandwidth.

The dipole is built of standard semirigid coaxial cable. The internal matching line is open ended. The antenna is therefore open for DC signals.

Do not apply force to dipole arms, as they are liable to bend. The soldered connections near the feedpoint may be damaged. After excessive mechanical stress or overheating, check the impedance characteristics to ensure that the internal matching network is not affected.

After long term use with 40W radiated power, only a slight warming of the dipole near the feedpoint can be measured.

Impedance Measurement Plot

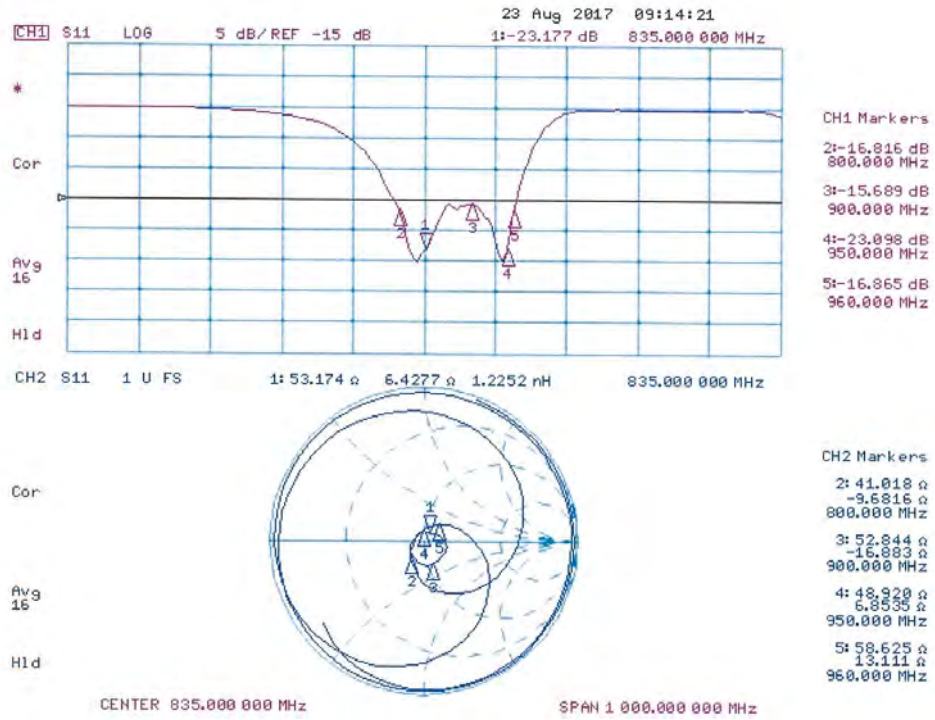

DASY5 H-field Result

Test Laboratory: SPEAG Lab2

Date: 22.08.2017

DUT: HAC-Dipole 835 MHz; Type: CD835V3; Serial: CD835V3 - SN: 1023

Communication System: UID 0 - CW ; Frequency: 835 MHz
 Medium parameters used: $\sigma = 0$ S/m, $\epsilon_r = 1$; $\rho = 1$ kg/m³
 Phantom section: RF Section
 Measurement Standard: DASY5 (IEEE/IEC/ANSI C63.19-2011)

DASY52 Configuration:

- Probe: H3DV6 - SN6065; ; Calibrated: 30.12.2016
- Sensor-Surface: (Fix Surface)
- Electronics: DAE4 Sn781; Calibrated: 13.07.2017
- Phantom: HAC Test Arch with AMCC; Type: SD HAC P01 BA; Serial: 1070
- DASY52 52.10.0(1446); SEMCAD X 14.6.10(7417)

Dipole H-Field measurement @ 835MHz/H-Scan - 835MHz d=10mm/Hearing Aid Compatibility Test (41x361x1): Interpolated grid: dx=0.5000 mm, dy=0.5000 mm
 Device Reference Point: 0, 0, -6.3 mm
 Reference Value = 0.4830 A/m; Power Drift = 0.04 dB
 PMR not calibrated. PMF = 1.000 is applied.
 H-field emissions = 0.4568 A/m
Near-field category: M4 (AWF 0 dB)

PMF scaled H-field

Grid 1 M4 0.368 A/m	Grid 2 M4 0.405 A/m	Grid 3 M4 0.392 A/m
Grid 4 M4 0.416 A/m	Grid 5 M4 0.457 A/m	Grid 6 M4 0.446 A/m
Grid 7 M4 0.373 A/m	Grid 8 M4 0.409 A/m	Grid 9 M4 0.398 A/m

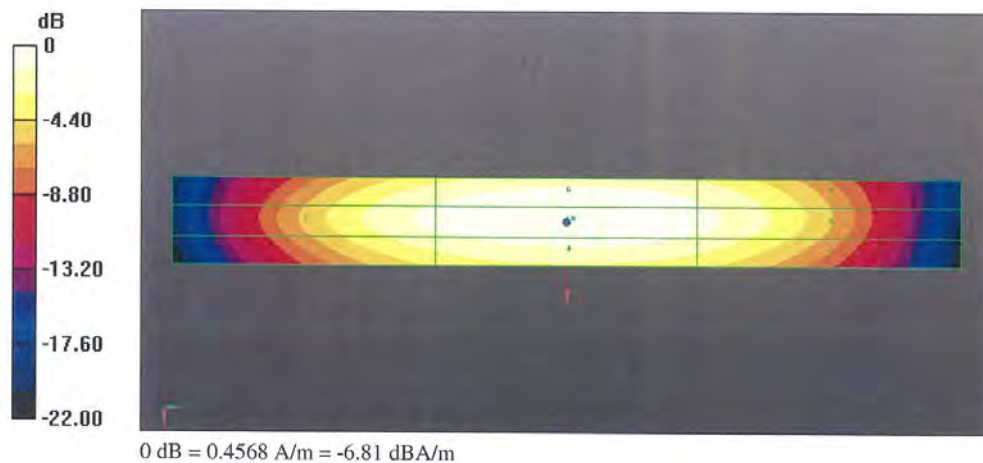

DASY5 E-field Result

Date: 22.08.2017

Test Laboratory: SPEAG Lab2

DUT: HAC-Dipole 835 MHz; Type: CD835V3; Serial: CD835V3 - SN: 1023

Communication System: UID 0 - CW ; Frequency: 835 MHz
 Medium parameters used: $\sigma = 0$ S/m, $\epsilon_r = 1$; $\rho = 1000$ kg/m³
 Phantom section: RF Section
 Measurement Standard: DASY5 (IEEE/IEC/ANSI C63.19-2011)

DASY52 Configuration:

- Probe: ER3DV6 - SN2336; ConvF(1, 1, 1); Calibrated: 30.12.2016;
- Sensor-Surface: (Fix Surface)
- Electronics: DAE4 Sn781; Calibrated: 13.07.2017
- Phantom: HAC Test Arch with AMCC; Type: SD HAC P01 BA; Serial: 1070
- DASY52 52.10.0(1446); SEMCAD X 14.6.10(7417)

Dipole E-Field measurement @ 835MHz/E-Scan - 835MHz d=10mm/Hearing Aid Compatibility Test

(41x361x1): Interpolated grid: dx=0.5000 mm, dy=0.5000 mm

Device Reference Point: 0, 0, -6.3 mm

Reference Value = 108.5 V/m; Power Drift = -0.03 dB

Applied MIF = 0.00 dB

RF audio interference level = 44.54 dBV/m

Emission category: M3

MIF scaled E-field

Grid 1 M3 44.17 dBV/m	Grid 2 M3 44.4 dBV/m	Grid 3 M3 44.08 dBV/m
Grid 4 M4 38.83 dBV/m	Grid 5 M4 39.1 dBV/m	Grid 6 M4 38.86 dBV/m
Grid 7 M3 44.02 dBV/m	Grid 8 M3 44.54 dBV/m	Grid 9 M3 44.45 dBV/m

Dipole E-Field measurement @ 835MHz/E-Scan - 835MHz d=15mm/Hearing Aid Compatibility Test
 (41x361x1): Interpolated grid: dx=0.5000 mm, dy=0.5000 mm
 Device Reference Point: 0, 0, -6.3 mm
 Reference Value = 108.0 V/m; Power Drift = 0.01 dB
 Applied MIF = 0.00 dB
 RF audio interference level = 40.67 dBV/m
Emission category: M3

MIF scaled E-field

Grid 1 M3 40.52 dBV/m	Grid 2 M3 40.66 dBV/m	Grid 3 M3 40.47 dBV/m
Grid 4 M4 36.06 dBV/m	Grid 5 M4 36.18 dBV/m	Grid 6 M4 36.03 dBV/m
Grid 7 M3 40.48 dBV/m	Grid 8 M3 40.67 dBV/m	Grid 9 M3 40.6 dBV/m

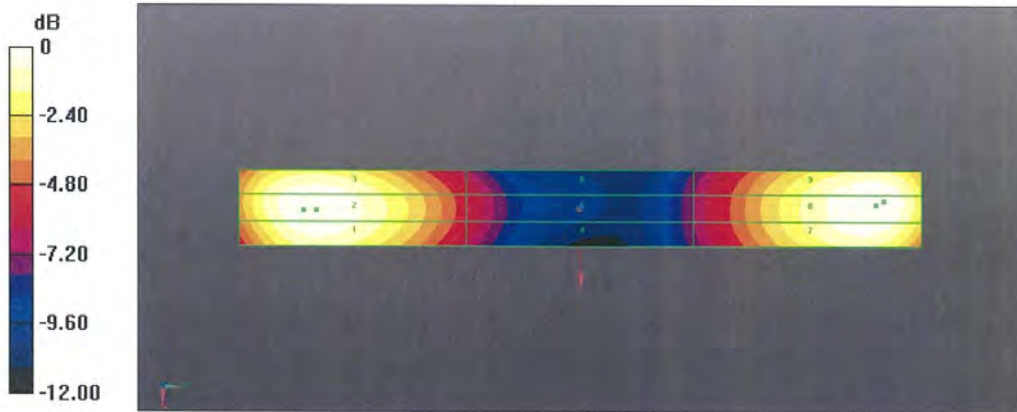

Dipole 1880 MHz

**Calibration Laboratory of
Schmid & Partner
Engineering AG**
Zeughausstrasse 43, 8004 Zurich, Switzerland



S Schweizerischer Kalibrierdienst
S Service suisse d'étalonnage
S Servizio svizzero di taratura
S Swiss Calibration Service

Accredited by the Swiss Accreditation Service (SAS)
The Swiss Accreditation Service is one of the signatories to the EA
Multilateral Agreement for the recognition of calibration certificates

Accreditation No.: **SCS 0108**

Client **CTTL (Auden)**

Certificate No: **CD1880V3-1018_Aug17**

CALIBRATION CERTIFICATE

Object **CD1880V3 - SN: 1018**

Calibration procedure(s) **QA CAL-20.v6
Calibration procedure for dipoles in air**



Calibration date: **August 23, 2017**

This calibration certificate documents the traceability to national standards, which realize the physical units of measurements (SI).
The measurements and the uncertainties with confidence probability are given on the following pages and are part of the certificate.

All calibrations have been conducted in the closed laboratory facility: environment temperature (22 ± 3)°C and humidity < 70%.

Calibration Equipment used (M&TE critical for calibration)

Primary Standards	ID #	Cal Date (Certificate No.)	Scheduled Calibration
Power meter NRP	SN: 104778	04-Apr-17 (No. 217-02521/02522)	Apr-18
Power sensor NRP-Z91	SN: 103244	04-Apr-17 (No. 217-02521)	Apr-18
Power sensor NRP-Z91	SN: 103245	04-Apr-17 (No. 217-02522)	Apr-18
Reference 20 dB Attenuator	SN: 5058 (20k)	07-Apr-17 (No. 217-02528)	Apr-18
Type-N mismatch combination	SN: 5047.2 / 06327	07-Apr-17 (No. 217-02529)	Apr-18
Probe ER3DV6	SN: 2336	30-Dec-16 (No. ER3-2336_Dec16)	Dec-17
Probe H3DV6	SN: 6065	30-Dec-16 (No. H3-6065_Dec16)	Dec-17
DAE4	SN: 781	13-Jul-17 (No. DAE4-781_Jul17)	Jul-18
Secondary Standards	ID #	Check Date (in house)	Scheduled Check
Power meter Agilent 4419B	SN: GB42420191	09-Oct-09 (in house check Sep-14)	In house check: Oct-17
Power sensor HP E4412A	SN: US38485102	05-Jan-10 (in house check Sep-14)	In house check: Oct-17
Power sensor HP 8482A	SN: US37295597	09-Oct-09 (in house check Sep-14)	In house check: Oct-17
RF generator R&S SMT-06	SN: 832283/011	27-Aug-12 (in house check Oct-15)	In house check: Oct-17
Network Analyzer HP 8753E	SN: US37390585	18-Oct-01 (in house check Oct-16)	In house check: Oct-17

	Name	Function	Signature
Calibrated by:	Johannes Kurikka	Laboratory Technician	
Approved by:	Katja Pokovic	Technical Manager	

Issued: August 23, 2017

This calibration certificate shall not be reproduced except in full without written approval of the laboratory.

**Calibration Laboratory of
Schmid & Partner
Engineering AG**
Zeughausstrasse 43, 8004 Zurich, Switzerland



S Schweizerischer Kalibrierdienst
S Service suisse d'étalonnage
S Servizio svizzero di taratura
S Swiss Calibration Service

Accredited by the Swiss Accreditation Service (SAS)
The Swiss Accreditation Service is one of the signatories to the EA
Multilateral Agreement for the recognition of calibration certificates

Accreditation No.: **SCS 0108**

References

- [1] ANSI-C63.19-2007
American National Standard for Methods of Measurement of Compatibility between Wireless Communications Devices and Hearing Aids.
- [2] ANSI-C63.19-2011
American National Standard, Methods of Measurement of Compatibility between Wireless Communications Devices and Hearing Aids.

Methods Applied and Interpretation of Parameters:

- **Coordinate System:** y-axis is in the direction of the dipole arms. z-axis is from the basis of the antenna (mounted on the table) towards its feed point between the two dipole arms. x-axis is normal to the other axes. In coincidence with the standards [1], the measurement planes (probe sensor center) are selected to be at a distance of 10 mm (15 mm for [2]) above the top metal edge of the dipole arms.
- **Measurement Conditions:** Further details are available from the hardcopies at the end of the certificate. All figures stated in the certificate are valid at the frequency indicated. The forward power to the dipole connector is set with a calibrated power meter connected and monitored with an auxiliary power meter connected to a directional coupler. While the dipole under test is connected, the forward power is adjusted to the same level.
- **Antenna Positioning:** The dipole is mounted on a HAC Test Arch phantom using the matching dipole positioner with the arms horizontal and the feeding cable coming from the floor. The measurements are performed in a shielded room with absorbers around the setup to reduce the reflections. It is verified before the mounting of the dipole under the Test Arch phantom, that its arms are perfectly in a line. It is installed on the HAC dipole positioner with its arms parallel below the dielectric reference wire and able to move elastically in vertical direction without changing its relative position to the top center of the Test Arch phantom. The vertical distance to the probe is adjusted after dipole mounting with a DASY5 Surface Check job. Before the measurement, the distance between phantom surface and probe tip is verified. The proper measurement distance is selected by choosing the matching section of the HAC Test Arch phantom with the proper device reference point (upper surface of the dipole) and the matching grid reference point (tip of the probe) considering the probe sensor offset. The vertical distance to the probe is essential for the accuracy.
- **Feed Point Impedance and Return Loss:** These parameters are measured using a HP 8753E Vector Network Analyzer. The impedance is specified at the SMA connector of the dipole. The influence of reflections was eliminated by applying the averaging function while moving the dipole in the air, at least 70cm away from any obstacles.
- **E-field distribution:** E field is measured in the x-y-plane with an isotropic ER3D-field probe with 100 mW forward power to the antenna feed point. In accordance with [1] and [2], the scan area is 20mm wide, its length exceeds the dipole arm length (180 or 90mm). The sensor center is 10 mm (15 mm for [2]) (in z) above the metal top of the dipole arms. Two 3D maxima are available near the end of the dipole arms. Assuming the dipole arms are perfectly in one line, the average of these two maxima (in subgrid 2 and subgrid 8) is determined to compensate for any non-parallelity to the measurement plane as well as the sensor displacement. The E-field value stated as calibration value represents the maximum of the interpolated 3D-E-field, in the plane above the dipole surface.
- **H-field distribution:** H-field is measured with an isotropic H-field probe with 100mW forward power to the antenna feed point, in the x-y-plane. The scan area and sensor distance is equivalent to the E-field scan. The maximum of the field is available at the center (subgrid 5) above the feed point. The H-field value stated as calibration value represents the maximum of the interpolated H-field, 10mm above the dipole surface at the feed point.

The reported uncertainty of measurement is stated as the standard uncertainty of measurement multiplied by the coverage factor $k=2$, which for a normal distribution corresponds to a coverage probability of approximately 95%.

Measurement Conditions

DASY system configuration, as far as not given on page 1.

DASY Version	DASY5	V52.10.0
Phantom	HAC Test Arch	
Distance Dipole Top - Probe Center	10, 15 mm	
Scan resolution	dx, dy = 5 mm	
Frequency	1880 MHz \pm 1 MHz	
Input power drift	< 0.05 dB	

Maximum Field values at 1880 MHz

H-field 10 mm above dipole surface	condition	interpolated maximum
Maximum measured	100 mW input power	0.466 A/m \pm 8.2 % (k=2)

E-field 10 mm above dipole surface	condition	Interpolated maximum
Maximum measured above high end	100 mW input power	139.3 V/m = 42.88 dBV/m
Maximum measured above low end	100 mW input power	137.4 V/m = 42.76 dBV/m
Averaged maximum above arm	100 mW input power	138.3 V/m \pm 12.8 % (k=2)

E-field 15 mm above dipole surface	condition	Interpolated maximum
Maximum measured above high end	100 mW input power	91.7 V/m = 39.24 dBV/m
Maximum measured above low end	100 mW input power	87.4 V/m = 38.83 dBV/m
Averaged maximum above arm	100 mW input power	89.5 V/m \pm 12.8 % (k=2)

Appendix (Additional assessments outside the scope of SCS 0108)

Antenna Parameters

Frequency	Return Loss	Impedance
1730 MHz	28.3 dB	54.0 Ω + 0.2 j Ω
1880 MHz	22.6 dB	54.2 Ω + 6.5 j Ω
1900 MHz	22.4 dB	56.3 Ω + 5.1 j Ω
1950 MHz	33.2 dB	52.2 Ω - 0.1 j Ω
2000 MHz	19.3 dB	47.9 Ω + 10.5 j Ω

3.2 Antenna Design and Handling

The calibration dipole has a symmetric geometry with a built-in two stub matching network, which leads to the enhanced bandwidth.

The dipole is built of standard semirigid coaxial cable. The internal matching line is open ended. The antenna is therefore open for DC signals.

Do not apply force to dipole arms, as they are liable to bend. The soldered connections near the feedpoint may be damaged. After excessive mechanical stress or overheating, check the impedance characteristics to ensure that the internal matching network is not affected.

After long term use with 40W radiated power, only a slight warming of the dipole near the feedpoint can be measured.

Impedance Measurement Plot

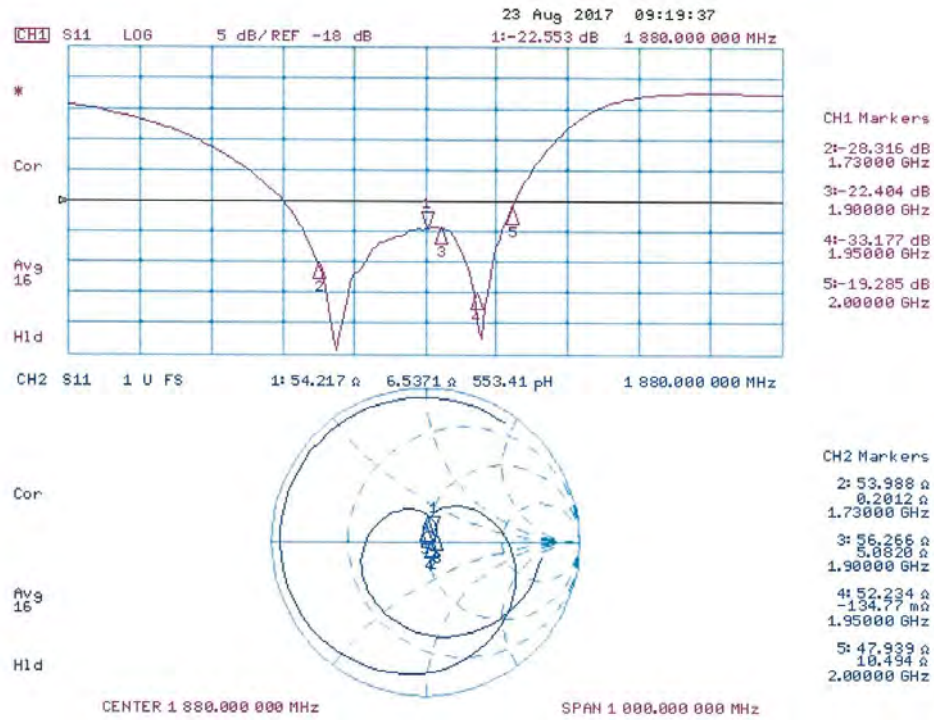

DASY5 H-field Result

Date: 22.08.2017

Test Laboratory: SPEAG Lab2

DUT: HAC Dipole 1880 MHz; Type: CD1880V3; Serial: CD1880V3 - SN: 1018

Communication System: UID 0 - CW ; Frequency: 1880 MHz
 Medium parameters used: $\sigma = 0$ S/m, $\epsilon_r = 1$; $\rho = 1$ kg/m³
 Phantom section: RF Section
 Measurement Standard: DASY5 (IEEE/IEC/ANSI C63.19-2011)

DASY52 Configuration:

- Probe: H3DV6 - SN6065; ; Calibrated: 30.12.2016
- Sensor-Surface: (Fix Surface)
- Electronics: DAE4 Sn781; Calibrated: 13.07.2017
- Phantom: HAC Test Arch with AMCC; Type: SD HAC P01 BA; Serial: 1070
- DASY52 52.10.0(1446); SEMCAD X 14.6.10(7417)

Dipole H-Field measurement @ 1880MHz/H-Scan - 1880MHz d=10mm/Hearing Aid Compatibility Test (41x181x1): Interpolated grid: dx=0.5000 mm, dy=0.5000 mm
 Device Reference Point: 0, 0, -6.3 mm
 Reference Value = 0.4890 A/m; Power Drift = 0.02 dB
 PMR not calibrated. PMF = 1.000 is applied.
 H-field emissions = 0.4659 A/m
Near-field category: M2 (AWF 0 dB)

PMF scaled H-field

Grid 1 M2 0.394 A/m	Grid 2 M2 0.435 A/m	Grid 3 M2 0.424 A/m
Grid 4 M2 0.428 A/m	Grid 5 M2 0.466 A/m	Grid 6 M2 0.456 A/m
Grid 7 M2 0.392 A/m	Grid 8 M2 0.424 A/m	Grid 9 M2 0.413 A/m

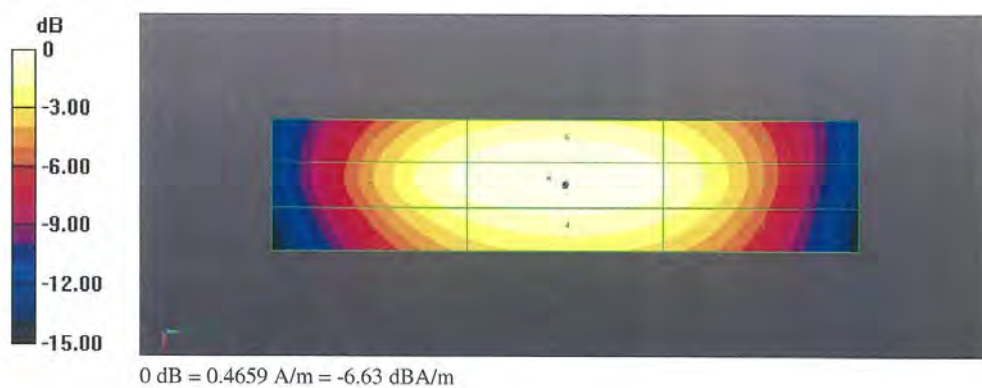

DASY5 E-field Result

Date: 22.08.2017

Test Laboratory: SPEAG Lab2

DUT: HAC Dipole 1880 MHz; Type: CD1880V3; Serial: CD1880V3 - SN: 1018

Communication System: UID 0 - CW ; Frequency: 1880 MHz
 Medium parameters used: $\sigma = 0$ S/m, $\epsilon_r = 1$; $\rho = 1000$ kg/m³
 Phantom section: RF Section
 Measurement Standard: DASY5 (IEEE/IEC/ANSI C63.19-2011)

DASY52 Configuration:

- Probe: ER3DV6 - SN2336; ConvF(1, 1, 1); Calibrated: 30.12.2016;
- Sensor-Surface: (Fix Surface)
- Electronics: DAE4 Sn781; Calibrated: 13.07.2017
- Phantom: HAC Test Arch with AMCC; Type: SD HAC P01 BA; Serial: 1070
- DASY52 52.10.0(1446); SEMCAD X 14.6.10(7417)

Dipole E-Field measurement @ 1880MHz/E-Scan - 1880MHz d=10mm/Hearing Aid Compatibility Test

(41x181x1); Interpolated grid: dx=0.5000 mm, dy=0.5000 mm

Device Reference Point: 0, 0, -6.3 mm

Reference Value = 155.3 V/m; Power Drift = -0.01 dB

Applied MIF = 0.00 dB

RF audio interference level = 42.88 dBV/m

Emission category: M1

MIF scaled E-field

Grid 1 M1 42.43 dBV/m	Grid 2 M1 42.88 dBV/m	Grid 3 M1 42.74 dBV/m
Grid 4 M2 39.11 dBV/m	Grid 5 M2 39.45 dBV/m	Grid 6 M2 39.19 dBV/m
Grid 7 M1 42.22 dBV/m	Grid 8 M1 42.76 dBV/m	Grid 9 M1 42.65 dBV/m

Dipole E-Field measurement @ 1880MHz/E-Scan - 1880MHz d=15mm/Hearing Aid Compatibility Test (41x181x1): Interpolated grid: dx=0.5000 mm, dy=0.5000 mm
 Device Reference Point: 0, 0, -6.3 mm
 Reference Value = 155.1 V/m; Power Drift = 0.01 dB
 Applied MIF = 0.00 dB
 RF audio interference level = 39.24 dBV/m
Emission category: M2

MIF scaled E-field

Grid 1 M2	Grid 2 M2	Grid 3 M2
38.99 dBV/m	39.24 dBV/m	39.15 dBV/m
Grid 4 M2	Grid 5 M2	Grid 6 M2
37.01 dBV/m	37.16 dBV/m	37.06 dBV/m
Grid 7 M2	Grid 8 M2	Grid 9 M2
38.56 dBV/m	38.83 dBV/m	38.77 dBV/m

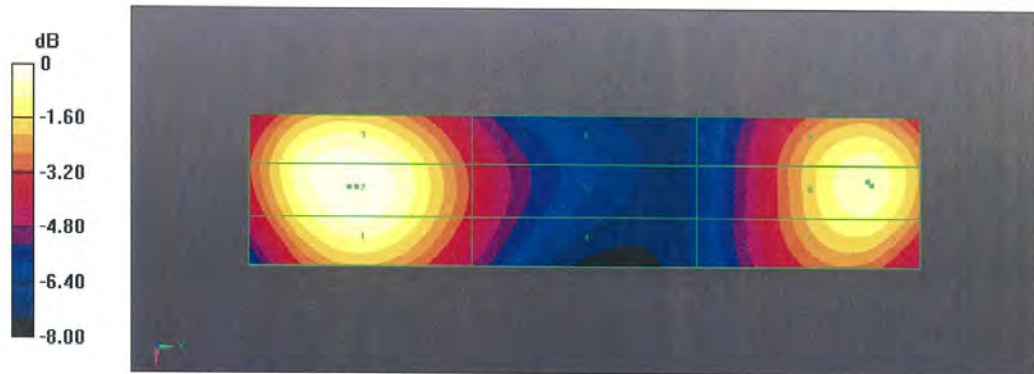

ANNEX F DAE CALIBRATION CERTIFICATE

**Calibration Laboratory of
Schmid & Partner
Engineering AG**
Zeughausstrasse 43, 8004 Zurich, Switzerland



S Schweizerischer Kalibrierdienst
C Service suisse d'étalonnage
S Servizio svizzero di taratura
S Swiss Calibration Service

Accredited by the Swiss Accreditation Service (SAS)
The Swiss Accreditation Service is one of the signatories to the EA
Multilateral Agreement for the recognition of calibration certificates

Accreditation No.: **SCS 0108**

Client **CTTL (Auden)**

Certificate No: **DAE4-777_Sep17**

CALIBRATION CERTIFICATE

Object **DAE4 - SD 000 D04 BM - SN: 777**

Calibration procedure(s) **QA CAL-06.v29
Calibration procedure for the data acquisition electronics (DAE)**

Calibration date: **September 08, 2017**

This calibration certificate documents the traceability to national standards, which realize the physical units of measurements (SI).
The measurements and the uncertainties with confidence probability are given on the following pages and are part of the certificate.

All calibrations have been conducted in the closed laboratory facility: environment temperature (22 ± 3)°C and humidity < 70%.

Calibration Equipment used (M&TE critical for calibration)

Primary Standards	ID #	Cal Date (Certificate No.)	Scheduled Calibration
Keithley Multimeter Type 2001	SN: 0810278	31-Aug-17 (No:21092)	Aug-18
Secondary Standards	ID #	Check Date (in house)	Scheduled Check
Auto DAE Calibration Unit	SE UWS 053 AA 1001	05-Jan-17 (in house check)	In house check: Jan-18
Calibrator Box V2.1	SE UMS 006 AA 1002	05-Jan-17 (in house check)	In house check: Jan-18

Calibrated by: **Name** Dominique Steffen **Function** Laboratory Technician

Signature



Approved by: **Name** Sven Kühn **Function** Deputy Manager

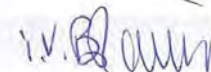

Issued: September 8, 2017

This calibration certificate shall not be reproduced except in full without written approval of the laboratory.

**Calibration Laboratory of
Schmid & Partner
Engineering AG**
Zeughausstrasse 43, 8004 Zurich, Switzerland



S Schweizerischer Kalibrierdienst
C Service suisse d'étalonnage
S Servizio svizzero di taratura
S Swiss Calibration Service

Accredited by the Swiss Accreditation Service (SAS)
The Swiss Accreditation Service is one of the signatories to the EA
Multilateral Agreement for the recognition of calibration certificates

Accreditation No.: **SCS 0108**

Glossary

DAE data acquisition electronics
Connector angle information used in DASY system to align probe sensor X to the robot coordinate system.

Methods Applied and Interpretation of Parameters

- *DC Voltage Measurement:* Calibration Factor assessed for use in DASY system by comparison with a calibrated instrument traceable to national standards. The figure given corresponds to the full scale range of the voltmeter in the respective range.
- *Connector angle:* The angle of the connector is assessed measuring the angle mechanically by a tool inserted. Uncertainty is not required.
- The following parameters as documented in the Appendix contain technical information as a result from the performance test and require no uncertainty.
 - *DC Voltage Measurement Linearity:* Verification of the Linearity at +10% and -10% of the nominal calibration voltage. Influence of offset voltage is included in this measurement.
 - *Common mode sensitivity:* Influence of a positive or negative common mode voltage on the differential measurement.
 - *Channel separation:* Influence of a voltage on the neighbor channels not subject to an input voltage.
 - *AD Converter Values with inputs shorted:* Values on the internal AD converter corresponding to zero input voltage
 - *Input Offset Measurement:* Output voltage and statistical results over a large number of zero voltage measurements.
 - *Input Offset Current:* Typical value for information; Maximum channel input offset current, not considering the input resistance.
 - *Input resistance:* Typical value for information: DAE input resistance at the connector, during internal auto-zeroing and during measurement.
 - *Low Battery Alarm Voltage:* Typical value for information. Below this voltage, a battery alarm signal is generated.
 - *Power consumption:* Typical value for information. Supply currents in various operating modes.

DC Voltage Measurement

A/D - Converter Resolution nominal

High Range: 1LSB = 6.1 μ V, full range = -100...+300 mV

Low Range: 1LSB = 61nV, full range = -1.....+3mV

DASY measurement parameters: Auto Zero Time: 3 sec; Measuring time: 3 sec

Calibration Factors	X	Y	Z
High Range	405.400 \pm 0.02% (k=2)	405.869 \pm 0.02% (k=2)	405.579 \pm 0.02% (k=2)
Low Range	3.96640 \pm 1.50% (k=2)	3.96264 \pm 1.50% (k=2)	4.00499 \pm 1.50% (k=2)

Connector Angle

Connector Angle to be used in DASY system	97.0° \pm 1°
---	----------------

Appendix (Additional assessments outside the scope of SCS0108)

1. DC Voltage Linearity

High Range	Reading (μV)	Difference (μV)	Error (%)
Channel X + Input	200022.73	-12.42	-0.01
Channel X + Input	20003.49	-1.25	-0.01
Channel X - Input	-19998.82	6.77	-0.03
Channel Y + Input	200025.10	-10.04	-0.01
Channel Y + Input	20007.22	2.54	0.01
Channel Y - Input	-20002.34	3.30	-0.02
Channel Z + Input	200028.10	-6.82	-0.00
Channel Z + Input	20002.36	-2.19	-0.01
Channel Z - Input	-20003.64	2.12	-0.01

Low Range	Reading (μV)	Difference (μV)	Error (%)
Channel X + Input	2000.54	-0.37	-0.02
Channel X + Input	201.37	0.50	0.25
Channel X - Input	-199.19	-0.20	0.10
Channel Y + Input	1999.95	-0.89	-0.04
Channel Y + Input	200.04	-0.75	-0.37
Channel Y - Input	-199.96	-0.85	0.43
Channel Z + Input	2001.05	0.20	0.01
Channel Z + Input	199.88	-0.86	-0.43
Channel Z - Input	-200.02	-0.88	0.44

2. Common mode sensitivity

DASY measurement parameters: Auto Zero Time: 3 sec; Measuring time: 3 sec

	Common mode Input Voltage (mV)	High Range Average Reading (μV)	Low Range Average Reading (μV)
Channel X	200	5.45	3.79
	- 200	3.93	0.83
Channel Y	200	7.70	7.39
	- 200	-9.52	-8.90
Channel Z	200	7.51	6.49
	- 200	-9.21	-8.71

3. Channel separation

DASY measurement parameters: Auto Zero Time: 3 sec; Measuring time: 3 sec

	Input Voltage (mV)	Channel X (μV)	Channel Y (μV)	Channel Z (μV)
Channel X	200	-	-1.61	-2.84
Channel Y	200	8.30	-	0.46
Channel Z	200	6.69	5.02	-

4. AD-Converter Values with inputs shorted

DASY measurement parameters: Auto Zero Time: 3 sec; Measuring time: 3 sec

	High Range (LSB)	Low Range (LSB)
Channel X	15919	14652
Channel Y	18343	14477
Channel Z	16033	14911

5. Input Offset Measurement

DASY measurement parameters: Auto Zero Time: 3 sec; Measuring time: 3 sec
Input 10M Ω

	Average (μ V)	min. Offset (μ V)	max. Offset (μ V)	Std. Deviation (μ V)
Channel X	-0.50	-2.04	0.95	0.51
Channel Y	1.56	0.40	2.80	0.48
Channel Z	0.26	-0.78	1.16	0.42

6. Input Offset Current

Nominal Input circuitry offset current on all channels: <251A

7. Input Resistance (Typical values for information)

	Zeroing (kOhm)	Measuring (MOhm)
Channel X	200	200
Channel Y	200	200
Channel Z	200	200

8. Low Battery Alarm Voltage (Typical values for information)

Typical values	Alarm Level (VDC)
Supply (+ Vcc)	+7.9
Supply (- Vcc)	-7.6

9. Power Consumption (Typical values for information)

Typical values	Switched off (mA)	Stand by (mA)	Transmitting (mA)
Supply (+ Vcc)	+0.01	+6	+14
Supply (- Vcc)	-0.01	-8	-9