



TEST REPORT

No. 24B01N000091-003-HAC T-coil

For

TCL Communication Ltd.

GSM/UMTS/LTE Mobile phone

Model Name: T433E

With

Hardware Version: 05

Software Version: BM35

FCC ID: 2ACCJB218

HAC-2019 Compliance: PASS

Issued Date: 2024-03-08

Designation Number: CN1210

Note:

The test results in this test report relate only to the devices specified in this report. This report shall not be reproduced except in full without the written approval of SAICT.

Test Laboratory:

SAICT, Shenzhen Academy of Information and Communications Technology

Building G, Shenzhen International Innovation Center, No.1006 Shennan Road, Futian District, Shenzhen, Guangdong, P. R. China 518000.

Tel: +86(0)755-33322000, Fax: +86(0)755-33322001

Email: yewu@saict.ac.cn www.saict.ac.cn



REPORT HISTORY

Report Number	Revision	Description	Issue Date
24B01N000091-003-HAC T-coil	Rev.0	1st edition	2024-03-08



CONTENTS

1. Summary of Test Report	5
1.1. Test Items	5
1.2. Test Standards	5
1.3. Test Result	5
1.4. Testing Location	5
1.5. Project Data	5
1.6. Signature	5
2. Client Information	6
2.1. Applicant Information	6
2.2. Manufacturer Information	6
3. Equipment Under Test (EUT) and Ancillary Equipment (AE)	7
3.1. About EUT	7
3.2. Internal Identification of EUT used during the test	7
3.3. Internal Identification of AE used during the test	7
3.4. Air Interfaces / Bands Indicating Operating Modes	7
4. Reference Documents	8
5. Operational Conditions during Test	9
5.1. HAC Measurement Set-up	9
5.2. AM1D probe	10
5.3. AMCC	10
5.4. AMMI	11
5.5. Test Arch Phantom & Phone Positioner	11
5.6. Robotic System Specifications	12
5.7. T-Coil measurement points and reference plane	12
6. T-Coil Test Procedures	14
7. T-Coil Performance Requirements	16
7.1. T-Coil coupling qualifying field strengths	16
When measured as specified in ANSI C63.19, there are two groups of qualifying measurement points:	16
7.2. Frequency response	16
7.3. Desired ABM signal, undesired ABM field qualification requirements	17
8. T-Coil testing for CMRS Voice	18
8.1. GSM Tests Results	18
8.2. WCDMA Tests Results	18
9. T-Coil testing for VoLTE	19



9.1. Test System Setup for VoLTE over IMS T-coil Testing.....19

9.2. Codec Configuration20

9.3. Radio Configuration21

9.4. VoLTE Tests Results22

10. T-Coil testing for VoWIFI..... 23

10.1. Test System Setup for VoWIFI over IMS T-coil Testing.....23

10.2. Codec Configuration24

10.3. Radio Configuration25

10.4. VoWIFI Tests Results26

11. T-Coil testing for OTT VoIP Calling 27

11.1. Test System Setup for OTT VoIP T-coil Testing27

11.2. Test Data Summary29

12. Measurement Uncertainty 31

13. Main Test Instruments 32

ANNEX A: Test Plots 33

ANNEX B: Frequency Response Curves 59

ANNEX C: Probe Calibration Certificate 72

ANNEX D: DAE Calibration Certificate..... 75

1. Summary of Test Report

1.1. Test Items

Description:	GSM/UMTS/LTE Mobile phone
Model Name:	T433E
Applicant's Name:	TCL Communication Ltd.
Manufacturer's Name:	TCL Communication Ltd.

1.2. Test Standards

ANSI C63.19:2019

1.3. Test Result

Pass

1.4. Testing Location

Address: Building G, Shenzhen International Innovation Center, No.1006 Shennan Road, Futian District, Shenzhen, Guangdong, P. R. China

1.5. Project Data

Testing Start Date: 2024-01-30

Testing End Date: 2024-02-05

1.6. Signature

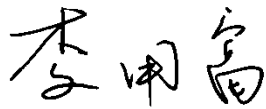

Li Yongfu
(Prepared this test report)

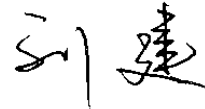

Liu Jian
(Reviewed this test report)

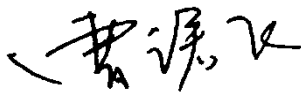

Cao Junfei
(Approved this test report)



2. Client Information

2.1. Applicant Information

Company Name:	TCL Communication Ltd.
Address:	5/F, Building 22E, 22 Science Park East Avenue, Hong Kong Science Park, Shatin, NT, Hong Kong, China
City:	Hong Kong
Country:	China
Telephone:	+86 755 3661 1621

2.2. Manufacturer Information

Company Name:	TCL Communication Ltd.
Address:	5/F, Building 22E, 22 Science Park East Avenue, Hong Kong Science Park, Shatin, NT, Hong Kong, China
City:	Hong Kong
Country:	China
Telephone:	+86 755 3661 1621



3. Equipment Under Test (EUT) and Ancillary Equipment (AE)

3.1. About EUT

Description:	GSM/UMTS/LTE Mobile phone
Mode Name:	T433E
Condition of EUT as received:	No obvious damage in appearance
Frequency Bands:	GSM 850/900/1800/1900, WCDMA Band 1/2/4/5/8, LTE Band 1/2/3/4/5/7/8/12/13/17/26/28/38/40 ⁽¹⁾ /41/66, Bluetooth, WLAN 2.4GHz/5GHz
General Note: 1.LTE band 40 be disabled by software.	

3.2. Internal Identification of EUT used during the test

EUT ID*	IMEI	HW Version	SW Version	Receipt Date
UT09aa	355518370201875	05	BM35	2021-01-29
UT10aa	355518370201883	05	BM35	2021-01-29

*EUT ID: is used to identify the test sample in the lab internally.

Note: It is performed to test HAC with the UT09aa & UT10aa.

3.3. Internal Identification of AE used during the test

AE ID*	Description	Model	Manufacturer
AE1	Battery	TLi028C9	Fenhua New EnergyCo.,Ltd
AE2	Battery	TLi028CB	Shenzhen Aerospace Electronic Co., Ltd.
AE3	Headset	HE0501-000316-000	Shenzhen Xinchengyuteng Co.,Ltd

*AE ID: is used to identify the test sample in the lab internally.

3.4. Air Interfaces / Bands Indicating Operating Modes

Air-interface	Band (MHz)	Type	C63.19 / tested	Simultaneous Transmissions	Name of Voice Service
GSM	GSM 850/1900	VO	Yes	BT, WLAN	CMRS Voice
	EDGE	DT	No	BT, WLAN	NA
WCDMA	B2/B4/B5	VO	Yes	BT, WLAN	CMRS Voice
	HSPA	VD	Yes	BT, WLAN	MEET
LTE (FDD)	2/4/5/7/12/13/17/26/66	VD	Yes	BT, WLAN	VoLTE, MEET
LTE (TDD)	38/41	VD	Yes	BT, WLAN	VoLTE, MEET
WLAN	2.4GHz	VD	Yes	WWAN	VoWiFi, MEET
WLAN	5GHz	VD	Yes	WWAN	VoWiFi, MEET
Bluetooth	2.4GHz	DT	No	WWAN	NA

VO: Voice CMRS/PSTN Service Only

VD: Voice CMRS/PSTN and Data Service

DT: Digital Transport



4. Reference Documents

The following document listed in this section is referred for testing.

Reference	Title	Version
ANSI C63.19	American National Standard for Methods of Measurement of Compatibility Between Wireless Communication Devices and Hearing Aids	2019 Edition
KDB 285076 D01v06r04	Equipment Authorization Guidance for Hearing Aid Compatibility	2023 Edition
KDB 285076 D02v04	Guidance for performing T-Coil tests for air interfaces supporting voice over IP (e.g., LTE and WiFi) to support CMRS based telephone services	2022 Edition
KDB 285076 D03v01r06	Hearing Aid Compatibility Frequently Asked Questions	2022 Edition

5. Operational Conditions during Test

5.1. HAC Measurement Set-up

These measurements are performed using the DASY8 automated dosimetric assessment system. It is made by Schmid & Partner Engineering AG (SPEAG) in Zurich, Switzerland. It consists of high precision robotics system (Stäubli), robot controller, Intel Core2 computer, near-field probe, probe alignment sensor. The robot is a six-axis industrial robot performing precise movements. A cell controller system contains the power supply, robot controller, teach pendant (Joystick), and remote control, is used to drive the robot motors. The PC consists of the HP Intel Core2 1.86 GHz computer with Windows 10 system and HAC Measurement Software DASY8, A/D interface card, monitor, mouse, and keyboard. The Stäubli Robot is connected to the cell controller to allow software manipulation of the robot. A data acquisition electronic (DAE) circuit performs the signal amplification; signal multiplexing, AD-conversion, offset measurements, mechanical surface detection, collision detection, etc. is connected to the Electro-optical coupler (EOC). The EOC performs the conversion from the optical into digital electric signal of the DAE and transfers data to the PC plug-in card.

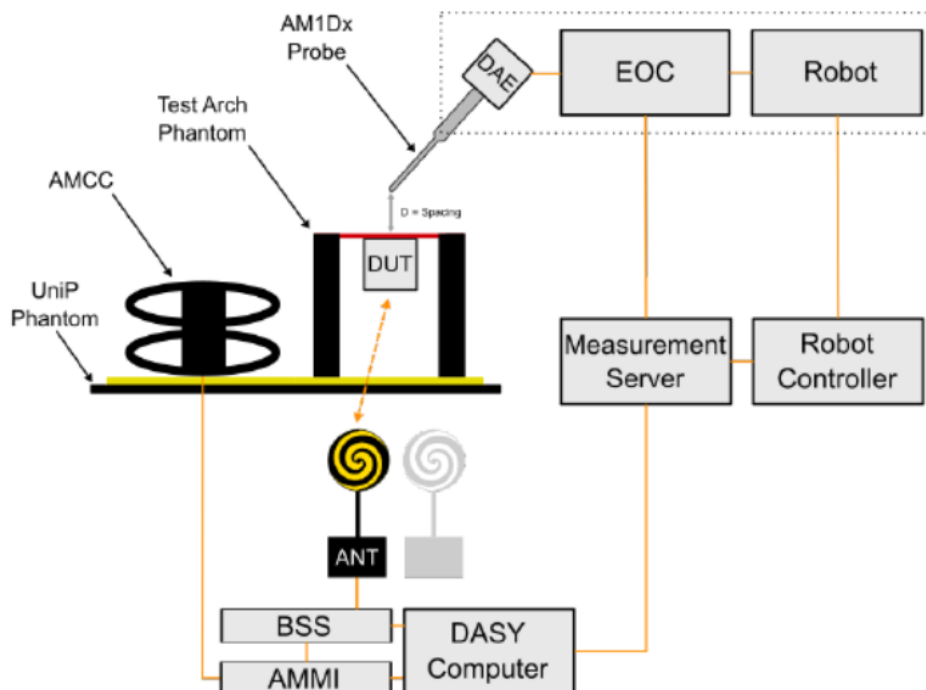

Figure 5.1 HAC Test Measurement Set-up

The DAE4 consists of a highly sensitive electrometer-grade preamplifier with auto-zeroing, a channel and gain-switching multiplexer, a fast 16 bit AD-converter and a command decoder and control logic unit. Transmission to the PC-card is accomplished through an optical downlink for data and status information and an optical uplink for commands and clock lines. The mechanical probe mounting device includes two different sensor systems for frontal and sidewise probe contacts. They are also used for mechanical surface detection and probe collision detection. The robot uses its own controller with a built in VME-bus computer.

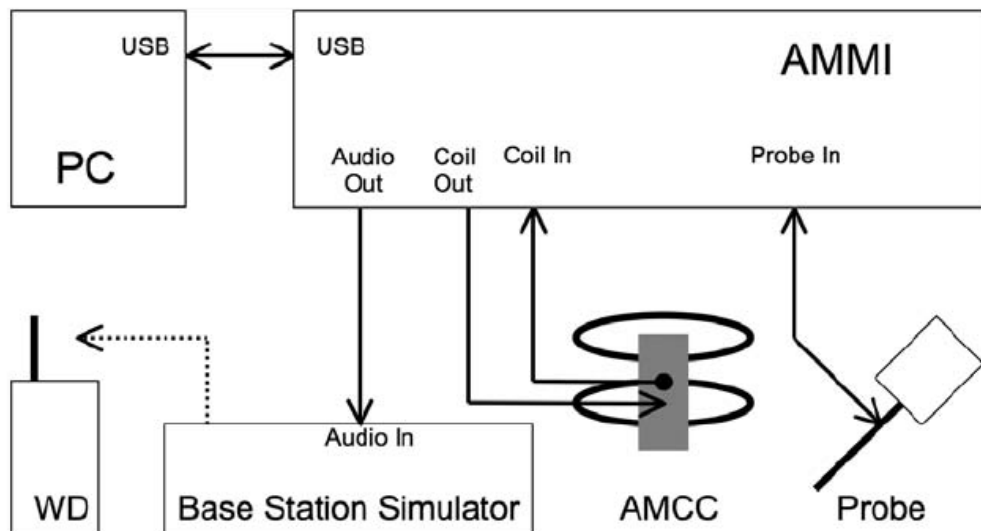

Figure 5.2 T-Coil setup with HAC Test Arch and AMCC

5.2. AM1D probe

The AM1D probe is an active probe with a single sensor. It is fully RF-shielded and has a rounded tip 6mm in diameter incorporating a pickup coil with its center offset 3mm from the tip and the sides. The symmetric signal preamplifier in the probe is fed via the shielded symmetric output cable from the AMMI with a 48V "phantom" voltage supply. The 7-pin connector on the back in the axis of the probe does not carry any signals. It is mounted to the DAE for the correct orientation of the sensor. If the probe axis is tilted 54.7 degree from the vertical, the sensor is approximately vertical when the signal connector is at the underside of the probe (cable hanging downwards).

Specification:

Frequency range	0.1~20kHz (RF sensitivity < -100dB, fully RF shielded)
Sensitivity	< -50dB A/m @ 1kHz
Pre-amplifier	40dB, symmetric
Dimensions	Tip diameter/length: 6/290mm, sensor according to ANSI-C63.19

5.3. AMCC

The Audio Magnetic Calibration coil is a Helmholtz Coil designed for calibration of the AM1D probe. The two horizontal coils generate a homogeneous magnetic field in the z direction. The DC input resistance is adjusted by a series resistor to approximately 50Ohm, and a shunt resistor of 10Ohm permits monitoring the current with a scale of 1:10

Port description:

Signal	Connector	Resistance
Coil In	BNC	Typically 50Ohm
Coil Monitor	BNO	10Ohm±1% (100mV corresponding to 1 A/m)

Specification:

Dimensions	370 x 370 x 196 mm, according to ANSI-C63.19
-------------------	--

5.4. AMMI

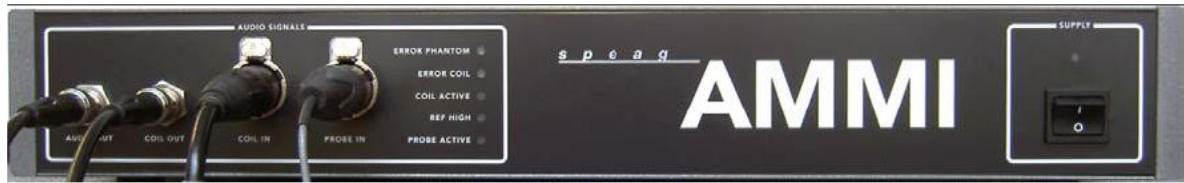

Figure 5.3 AMMI front panel

The Audio Magnetic Measuring Instrument (AMMI) is a desktop 19-inch unit containing a sampling unit, a waveform generator for test and calibration signals, and a USB interface.

Specification:

Sampling rate	48 kHz / 24 bit
Dynamic range	85 dB
Test signal generation	User selectable and predefined (vis PC)
Calibration	Auto-calibration / full system calibration using AMCC with monitor output
Dimensions	482 x 65 x 270 mm

5.5. Test Arch Phantom & Phone Positioner

The Test Arch phantom should be positioned horizontally on a stable surface. Reference markings on the Phantom allow the complete setup of all predefined phantom positions and measurement grids by manually teaching three points in the robot. It enables easy and well defined positioning of the phone and validation dipoles as well as simple teaching of the robot (Dimensions: 370 x 370 x 370 mm).

The Phone Positioner supports accurate and reliable positioning of any phone with effect on near field $\leq \pm 0.5$ dB.

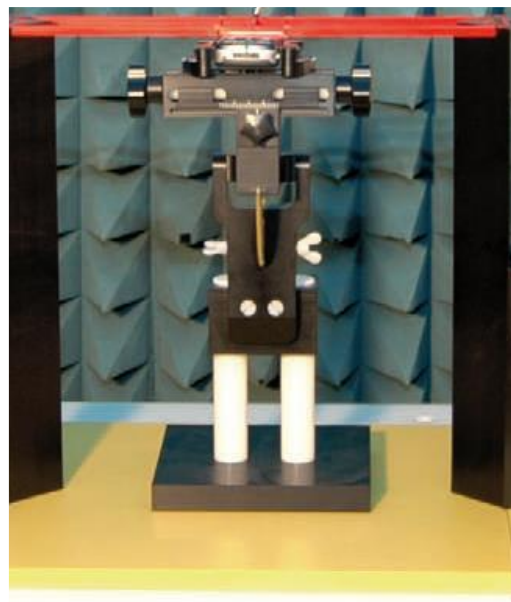

Figure 5.4 HAC Phantom & Device Holder



5.6. Robotic System Specifications

Specifications

Positioner: Stäubli Unimation Corp. Robot Model: RX160L

Repeatability: ± 0.02 mm

No. of Axis: 6

Data Acquisition Electronic (DAE) System

Cell Controller

Processor: Intel Core2

Clock Speed: 1.86 GHz

Operating System: Windows XP

Data Converter

Features: Signal Amplifier, multiplexer, A/D converter, and control logic

Software: DASY5 software

Connecting Lines: Optical downlink for data and status info.

Optical uplink for commands and clock

5.7. T-Coil measurement points and reference plane

The T-Coil measurement plane, reference plane and other measurement parameters shall be:

- a) The reference plane is the planar area that contains the highest point in the area of the phone that normally rests against the user's ear. It is parallel to the centerline of the receiver area of the phone and is defined by the points of the receiver-end of the WD handset, which, in normal handset use, rest against the ear.
- b) The measurement plane is parallel to, and 10 mm in front of, the reference plane.
- c) The reference axis is normal to the reference plane and passes through the center of the acoustic output (or the center of the hole array); or may be centered on or near a secondary inductive source. The actual location of the reference axis and resultant measurement area shall be noted in the test report.
- d) The measurement area shall be 50 mm by 50 mm. The measurement area for both desired ABM signal and undesired ABM field may be located where the transverse magnetic measurements are optimum with regard to the requirements. However, the measurement area should be in the vicinity of the acoustic output of the WD and shall be located in the same half of the phone as the WD receiver. In a WD handset with a centered receiver and a circularly symmetrical magnetic field, the measurement axis and the reference axis would coincide.
- e) Measurements of desired ABM signal strength and undesired ABM field are made at 2.0 mm +0.5 mm or 4 mm intervals in an X-Y measurement area pattern over the entire measurement area (676 measurement points total); either all measured, or measured plus interpolated.
- f) Desired ABM signal frequency response is measured at a single location at or near the maximum desired ABM signal strength location.
- g) The actual locations of the measurement points shall be noted in the test report.

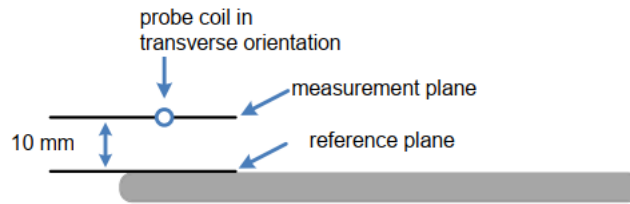
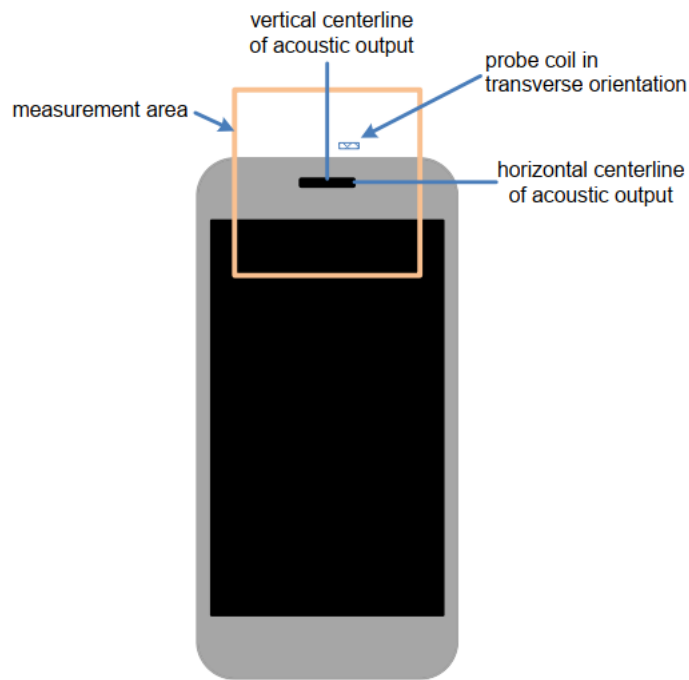

Figure 5.5 Measurement and reference planes probe orientation for WD audio frequency magnetic field measurements

6. T-Coil Test Procedures

The following steps summarize the basic test flow for determining desired ABM signal and undesired ABM field:

- a) A validation of the test setup and instrumentation shall be performed. This may be done using a TMFS or Helmholtz Coil. Measure the emissions and confirm that they are within tolerance of the expected values.
- b) Confirm that equipment that requires calibration has been calibrated, and that the noise level meets the requirements given in C63.19-2019 section 6.3.2.
- c) Position the WD in the test setup and connect the WD RF connector to a base station simulator.
- d) The drive level to the WD is set such that the reference input level specified in Table 6-1 is input to the base station simulator (or manufacturer's test mode equivalent) in the 1 kHz, 1/3 octave band. This drive level shall be used for the T-Coil signal test (desired ABM signal) at $f = 1$ kHz. Either a sine wave at 1025 Hz, or a voice-like signal, band-limited to the 1 kHz 1/3 octave, shall be used for the reference audio signal. If interference is found at 1025 Hz an alternative nearby reference audio signal frequency may be used.³⁵ The same drive level will be used for the desired ABM signal frequency response measurements at each 1/3 octave band center frequency. The WD volume control may be set at any level up to maximum, provided that a signal at any frequency at maximum modulation would not result in clipping or signal overload.
- e) At each measurement location over the measurement area and in the transverse orientation, measure and record the desired 1 kHz T-Coil magnetic signal (desired ABM signal) as described in Step c).
- f) At or near a location representing a maximum in the just-measured desired ABM signal, measure and record the desired T-Coil magnetic signals (desired ABM signal at f_i) in each individual ISO 266:1975 R10 standard 1/3 octave band. The desired audio band input frequency (f_i) shall be centered in each 1/3 octave band maintaining the same drive level as determined in Step c), and the reading taken for that band.³⁶ Equivalent methods of determining the frequency response may also be employed, such as fast Fourier transform (FFT) analysis using noise excitation or input-output comparison using simulated speech. The full-band integrated or half-band integrated probe output, may be used, as long as the appropriate calibration curve is applied to the measured result, so as to yield an accurate measurement of the field magnitude. (The resulting measurement shall be an accurate measurement in dB(A/m).) Compare the frequency response found to the requirements of section 7.
- g) At the same locations measured in Step d), measure and record the undesired broadband audio magnetic signal (undesired ABM field) with no audio signal applied (or digital zero applied, if appropriate) using the specified spectral weighting, the half-band integrator followed by the temporal weighting.
- h) Calculate and record the location and number of the measurement points that satisfy both the minimum desired ABM signal level and the maximum undesired ABM field level specified. Compare this to the requirements section 7 and record the result.
- i) Calculate and record the location and number of the measurement points that satisfy the maximum undesired ABM field level and distribution requirements specified in section 7.

**Table 6-1: T-Coil signal quality categories**

Standard	Protocol	Input (dBm0)
TIA-2000	CDMA	-18
TIA/EIA-136	TDMA (50 Hz)	-18
J-STD-007	GSM (217 Hz)	-16
T1/T1P1/3GPP (See Note 1)	UMTS (WCDMA)	-16
iDEN®	TDMA (22 Hz and 11 Hz)	-18
VoIP a (See Note 2)	Voice over Internet Protocol	-16

NOTE 1—For UMTS (Universal Mobile Telecommunications System), refer to 3GPP TS26.131 and TS26.132 (<http://www.3gpp.org>).

NOTE 2—VoIP is used in this table as a general term specifying a group of voice services that use -16 dBm0 as their normal acoustic level. The group includes a variety of voice services, including Voice-over-LTE (VoLTE), Voice-over-IP-multimedia-subsystem (VoIMS), Voice-over-WiFi (VoWiFi) and similar services. For 3G, LTE, and WLAN terminals used for Commercial Mobile Radio Service (CMRS) based telephony, refer to 3GPP TS26.131 and TS26.132.

7. T-Coil Performance Requirements

In order to comply with the requirements for T-Coil use, a WD's tested operating modes shall simultaneously meet the requirements for minimum desired ABM signal level and maximum undesired ABM field contained in this part at the minimum specified number of scanned locations.

7.1. T-Coil coupling qualifying field strengths

When measured as specified in ANSI C63.19, there are two groups of qualifying measurement points:

Primary group: A qualifying measurement point shall have its T-Coil signal, desired ABM signal, ≥ -18 dB(A/m) at 1 kHz, in a 1/3 octave band filter. These measurements shall be made with the WD operating at a reference input level as specified in Table 6.1. Simultaneously, the qualifying measurement point shall have its weighted magnetic noise, undesired ABM field ≤ -38 dB(A/m).

Secondary group: A qualifying measurement point shall have its weighted magnetic noise, undesired ABM field ≤ -38 dB(A/m). This group inherently includes all the members of the primary group.

7.2. Frequency response

The frequency response of the axial component of the magnetic field, measured in 1/3 octave bands, shall follow the response curve specified in this sub-clause, over the frequency range 300 Hz to 3000 Hz. Figure 7.1 and Figure 7.2 provide the boundaries for the specified frequency. These response curves are for true field strength measurements of the T-Coil signal. Thus the 6 dB/octave probe response has been corrected from the raw readings.

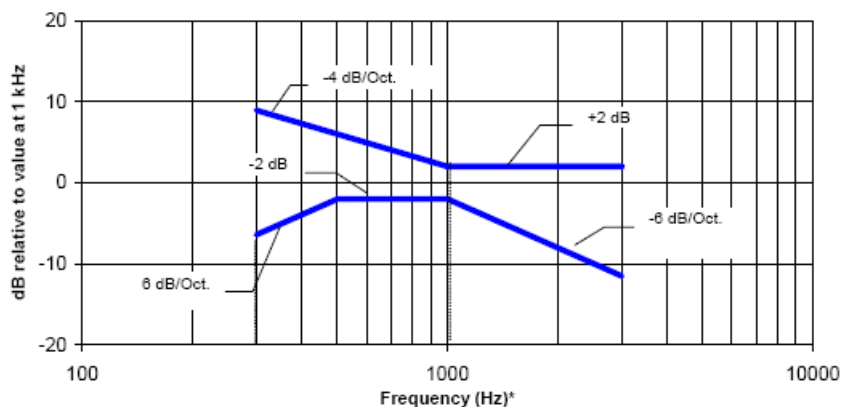

NOTE—Frequency response is between 300 Hz and 3000 Hz.

Figure 7.1—Magnetic field frequency response for WDs with a field ≤ -15 dB (A/m) at 1 kHz

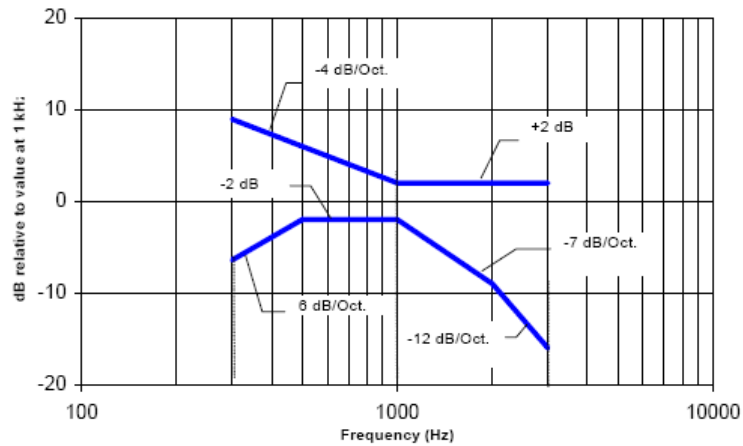

NOTE—Frequency response is between 300 Hz and 3000 Hz.

Figure 7.2—Magnetic field frequency response for WDs with a field that exceeds – 15dB(A/m) at 1 kHz

7.3. Desired ABM signal, undesired ABM field qualification requirements

For a WD that is expected to operate primarily in radio access technologies that include 2G GSM for legacy support, the WD shall be qualified for telecoil compatibility one of two ways:

- a) The WD shall be rated for telecoil use for all other voice operating modes, exclusive of 2G GSM, according to the section 7.3.1.
- b) If the WD is to be rated for telecoil use in its 2G GSM operating modes, these modes shall be qualified according to the section 7.3.2.

7.3.1. Non-2G GSM operating modes

The goal of this requirement is to ensure an adequate area where desired ABM signal is sufficiently strong to be heard clearly and a larger area where undesired ABM field is sufficiently low as to avoid undue annoyance. Qualifying measurement points shall fulfill the requirements of 7.1; both the primary and secondary group requirements shall be met:

The primary group shall include at least 75 measurement points.

The secondary group shall include at least 300 contiguous measurement points.

Additionally, to avoid an oddly shaped area of low noise, the secondary group shall include at least one longitudinal column of at least 10 contiguous qualifying points and at least one transverse row containing at least 15 contiguous qualifying points.

7.3.2. 2G GSM operating modes

If the 2G GSM operating mode(s) are selected for qualification, the qualifying measurement points shall fulfill the requirements of 6.6.2; both the primary and secondary group requirements shall be met:

The primary group shall include at least 25 measurement points.

The secondary group shall include at least 125 contiguous measurement points.

8. T-Coil testing for CMRS Voice

Note:

1. Bluetooth and WiFi function is turn off and microphone is muted.
2. The volume is adjusted to maximum level during T-Coil testing.
3. Choose worst case from radio configuration investigation. After investigation was performed to determine the audio codec configuration to be used for testing, the following tests results which the worst case codec would be remarked to be used for the testing for the handset.

8.1. GSM Tests Results

<Codec Investigation>

Codec	FR V1	FR V2	HR V1	Orientation	Band / Channel
Primary Group Contiguous Point Count	89	95	92	Transverse	GSM 850 / 190
Secondary Group Point Count	200	212	205		
Freq. Response	Pass	Pass	Pass		

<Summary Tests Results>

Plot No.	Band	Channel	Primary Group Contiguous Point Count	Secondary Group Point Count	Secondary Group Max Longitudinal	Secondary Group Max Transverse	Freq. Response
1	GSM 850	190	89	200	26	18	Pass
2	GSM 1900	661	131	315	26	26	Pass

8.2. WCDMA Tests Results

<Codec Investigation>

Codec	AMR 12.2Kbps	AMR 7.95Kbps	AMR 4.75Kbps	Orientation	Band / Channel
Primary Group Contiguous Point Count	473	464	459	Transverse	Band 2 / 9400
Secondary Group Point Count	676	676	676		
Freq. Response	Pass	Pass	Pass		

<Summary Tests Results>

Plot No.	Band	Channel	Primary Group Contiguous Point Count	Secondary Group Point Count	Secondary Group Max Longitudinal	Secondary Group Max Transverse	Freq. Response
3	WCDMA Band 2	9400	459	676	26	26	Pass
4	WCDMA Band 4	1413	458	676	26	26	Pass
5	WCDMA Band 5	4182	456	676	26	26	Pass

9. T-Coil testing for VoLTE

9.1. Test System Setup for VoLTE over IMS T-coil Testing

The general test setup used for VoLTE over IP Multimedia Subsystem (IMS) is shown below. The callbox used when performing VoLTE over IMS T-coil measurements is a CMW500. The Data Application Unit (DAU) of the CMW500 was used to simulate the IP Multimedia Subsystem (IMS) server. According to C63 and KDB 285076 D02v03, VoLTE input level is -20dBm0.

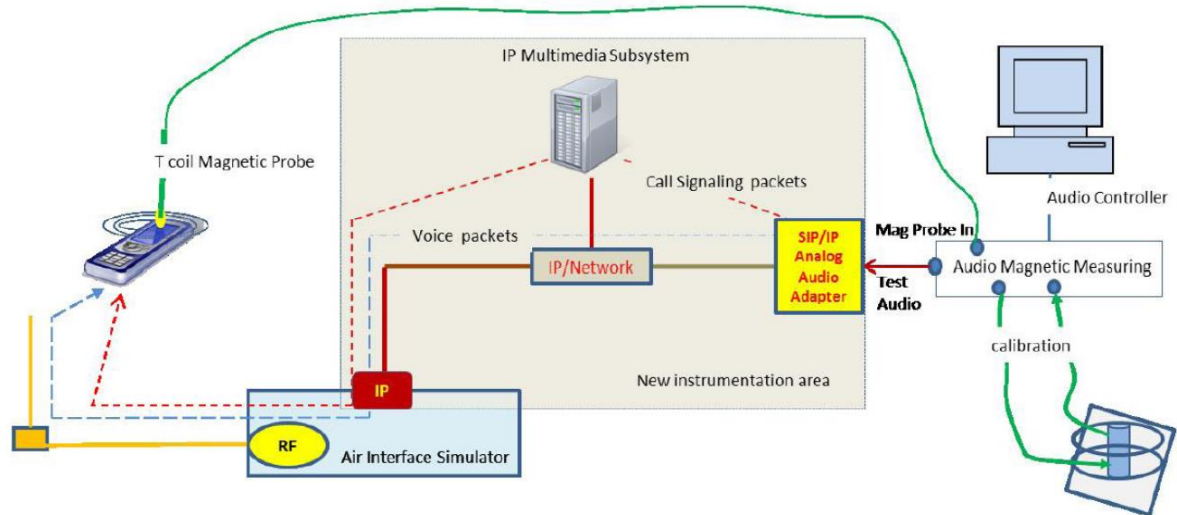

Figure 9.1 Test Setup for VoLTE over IMS T-coil Measurements

No correction gain factors were measured for VoLTE due to the Rohde & Schwarz CMW500, hosting a calibrated audio board. The gains used to measure VoLTE are set to 100. The following software/firmware was used to simulate the VoLTE server for testing:

Firmware	License Keys	Software Name
for LTE	KS500	LTE FDD R8 SIG BASIC
	KS550	LTE TDD R8 SIG BASIC
	KA100	IP APPL ENABLING IPv4
	KA150	IP APPL ENABLING IPv6
for Audio	KAA20	IP APPL IMS BASIC
	KM050	DATA APPL MEAS
	KS104	EVS SPEECH CODEC



9.2. Codec Configuration

An investigation was performed to determine the audio codec configuration to be used for testing. WB AMR 6.6Kbps setting was used for the audio codec on the CMW500 for VoLTE over IMS T-coil testing. See below table for comparisons between different codecs and codec data rates:

<AMR Codec Investigation>

Codec	NB AMR 4.75Kbps	NB AMR 12.2Kbps	WB AMR 6.6Kbps	WB AMR 23.85Kbps	Orientation	Band / BW / Channel
Primary Group Contiguous Point Count	456	461	451	458	Transverse	LTE Band 2 / 20M / 18900
Secondary Group Point Count	676	676	676	676		
Freq. Response	Pass	Pass	Pass	Pass		

<EVS Codec Investigation>

Codec	EVS Primary NB 5.9kbps	EVS Primary NB 24.4kbps	EVS Primary WB 5.9kbps	EVS Primary WB 128kbps	EVS Primary SWB 9.6kbps	EVS Primary SWB 128kbps	Orientation	Band / BW / Channel
Primary Group Contiguous Point Count	457	462	459	466	471	460	Transverse	LTE Band 2 / 20M / 18900
Secondary Group Point Count	676	676	676	676	676	676		
Freq. Response	Pass	Pass	Pass	Pass	Pass	Pass		

9.3. Radio Configuration

An investigation was performed to determine the modulation, the bandwidth configuration and RB configuration to be used for testing. For LTE-FDD bands, 20MHz/15MHz/10MHz BW, QPSK, 1RB, 0RB offset was used for the testing as the worst-case configuration for the handset. For LTE-TDD bands, 20MHz BW, QPSK, 1RB, 0RB offset was used for the testing as the worst-case configuration for the handset. See below table for comparisons between different radios configurations:

<Radio Configuration Investigation>-FDD

Band	Bandwidth (MHz)	Modulation	RB size	RB offset	channel	Primary Group Contiguous Point Count	Secondary Group Point Count
LTE Band 2	20	QPSK	1	0	18900	451	676
LTE Band 2	20	QPSK	50	0	18900	464	676
LTE Band 2	20	QPSK	100	0	18900	469	676
LTE Band 2	20	16QAM	1	0	18900	461	676
LTE Band 2	15	QPSK	1	0	18900	457	676
LTE Band 2	10	QPSK	1	0	18900	460	676
LTE Band 2	5	QPSK	1	0	18900	468	676
LTE Band 2	3	QPSK	1	0	18900	464	676
LTE Band 2	1.4	QPSK	1	0	18900	467	676

<Radio Configuration Investigation>-TDD

Band	Bandwidth (MHz)	Modulation	RB size	RB offset	channel	UL-DL Configuration	Primary Group Contiguous Point Count	Secondary Group Point Count
LTE Band 41	20	QPSK	1	0	40620	0	270	474
LTE Band 41	20	QPSK	50	0	40620	0	278	475
LTE Band 41	20	QPSK	100	0	40620	0	284	481
LTE Band 41	20	16QAM	1	0	40620	0	277	474
LTE Band 41	20	64QAM	1	0	40620	0	280	479
LTE Band 41	15	QPSK	1	0	40620	0	273	474
LTE Band 41	10	QPSK	1	0	40620	0	288	474
LTE Band 41	5	QPSK	1	0	40620	0	291	476
LTE Band 41	20	QPSK	1	0	40620	1	273	472
LTE Band 41	20	QPSK	1	0	40620	2	282	474
LTE Band 41	20	QPSK	1	0	40620	3	275	476
LTE Band 41	20	QPSK	1	0	40620	4	277	474
LTE Band 41	20	QPSK	1	0	40620	5	283	477
LTE Band 41	20	QPSK	1	0	40620	6	286	478



9.4. VoLTE Tests Results

<Summary Tests Results>

Plot No.	Band	Channel	Primary Group Contiguous Point Count	Secondary Group Point Count	Secondary Group Max Longitudinal	Secondary Group Max Transverse	Freq. Response
6	LTE Band 2	18900	451	676	26	26	Pass
7	LTE Band 4	20175	450	676	26	26	Pass
8	LTE Band 5	20525	451	676	26	26	Pass
9	LTE Band 7	21100	451	676	26	26	Pass
10	LTE Band 12	23095	446	676	26	26	Pass
11	LTE Band 13	23230	446	676	26	26	Pass
12	LTE Band 17	23790	440	664	26	26	Pass
13	LTE Band 26	26865	448	676	26	26	Pass
14	LTE Band 66	132322	450	676	26	26	Pass
15	LTE Band 38	38000	267	472	26	26	Pass
16	LTE Band 41	40620	270	474	26	26	Pass

10. T-Coil testing for VoWiFi

10.1. Test System Setup for VoWiFi over IMS T-coil Testing

The general test setup used for VoWiFi over IMS, or CMRS WiFi Calling, is shown below. The callbox used when performing VoWiFi over IMS T-coil measurements is a CMW500. The Data Application Unit (DAU) of the CMW500 was used to simulate the IP Multimedia Subsystem (IMS) server.

According to C63 and KDB 285076 D02v03, VoWiFi input level is -20dBm0.

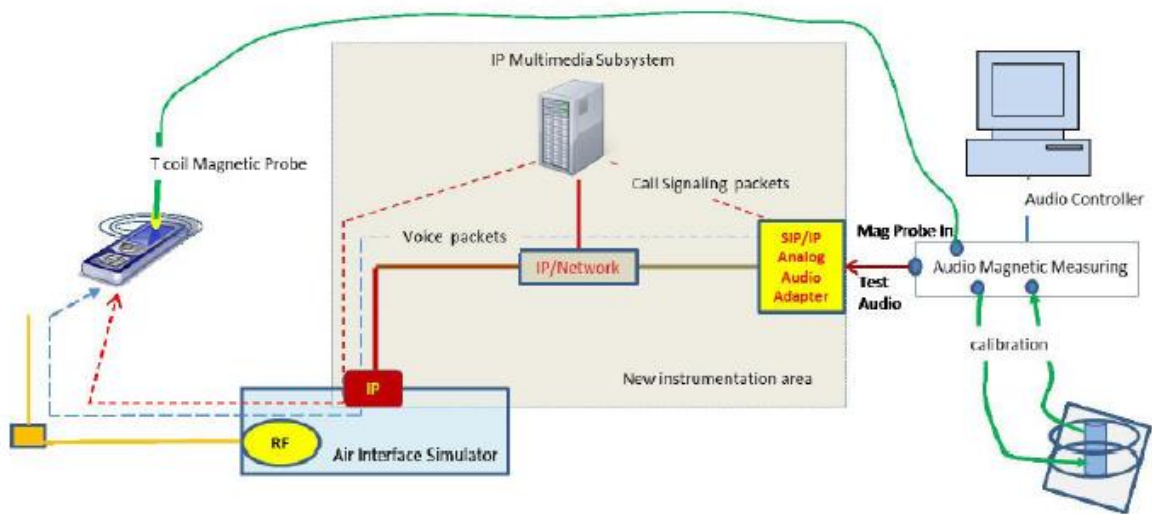

Figure 10.1 Test Setup for VoWiFi over IMS T-coil Measurements

No correction gain factors were measured for VoWiFi due to the Rohde & Schwarz CMW500, hosting a calibrated audio board. The gains used to measure VoWiFi are set to 100.

Firmware	License Keys	Software Name
for WLAN	KS650	WLAN A/B/G SIG BASIC
	KS651	WLAN N SIG BASIC
	KA100	IP APPL ENABLING IPv4
	KA150	IP APPL ENABLING IPv6
for Audio	KAA20	IP APPL IMS BASIC
	KM050	DATAAPPL MEAS
	KS104	EVS SPEECH CODEC



10.2. Codec Configuration

An investigation was performed to determine the audio codec configuration to be used for testing. WB AMR 6.6Kbps setting was used for the audio codec on the CMW500 for VoWiFi over IMS T-coil testing. See below table for comparisons between different codecs and codec data rates:

<AMR Codec Investigation>

Codec	NB AMR 4.75Kbps	NB AMR 12.2Kbps	WB AMR 6.6Kbps	WB AMR 23.85Kbps	Orientation	Band / BW / Channel
Primary Group Contiguous Point Count	447	448	445	451	Transverse	WLAN 2.4G / 20 / 6
Secondary Group Point Count	661	659	661	663		
Freq. Response	Pass	Pass	Pass	Pass		

<EVS Codec Investigation>

Codec	EVS Primary NB 5.9kbps	EVS Primary NB 24.4kbps	EVS Primary WB 5.9kbps	EVS Primary WB 128kbps	EVS Primary SWB 9.6kbps	EVS Primary SWB 128kbps	Orientation	Band / BW / Channel
Primary Group Contiguous Point Count	451	458	455	462	464	457	Transverse	WLAN 2.4G / 20 / 6
Secondary Group Point Count	662	664	660	663	664	662		
Freq. Response	Pass	Pass	Pass	Pass	Pass	Pass		



10.3. Radio Configuration

An investigation was performed on all applicable data rates and modulations to determine the radio configuration to be used for testing. See below table for comparisons between different radios configurations in each 802.11 standard:

<Radio Configuration Investigation>

Mode	Bandwidth	Data rate	Channel	Primary Group Contiguous Point Count	Secondary Group Point Count
WLAN 2.4GHz					
802.11b	20	1M	6	445	661
802.11b	20	11M	6	462	664
802.11g	20	6M	6	451	663
802.11g	20	54M	6	469	660
802.11n	20	MCS0	6	455	667
802.11n	20	MCS7	6	473	662
802.11n	40	MCS0	6	451	669
802.11n	40	MCS7	6	468	661
WLAN 5GHz					
802.11a	20	6M	40	461	676
802.11a	20	54M	40	475	676
802.11n	20	MCS0	40	470	676
802.11n	20	MCS7	40	477	676
802.11n	40	MCS0	38	466	676
802.11n	40	MCS7	38	471	676
802.11ac	20	MCS0	40	477	676
802.11ac	20	MCS8	40	484	676
802.11ac	40	MCS0	38	469	676
802.11ac	40	MCS9	38	475	676
802.11ac	80	MCS0	42	471	676
802.11ac	80	MCS9	42	476	676



10.4. VoWiFi Tests Results

<Summary Tests Results>

Plot No.	Band	Channel	Primary Group Contiguous Point Count	Secondary Group Point Count	Secondary Group Max Longitudinal	Secondary Group Max Transverse	Freq. Response
17	WLAN 2.4GHz	6	445	661	26	26	Pass
18	WLAN 5.2GHz	40	461	676	26	26	Pass
19	WLAN 5.3GHz	56	458	676	26	26	Pass
20	WLAN 5.5GHz	124	460	676	26	26	Pass
21	WLAN 5.8GHz	157	459	676	26	26	Pass

11. T-Coil testing for OTT VoIP Calling

11.1. Test System Setup for OTT VoIP T-coil Testing

OTT VoIP Application

Google Duo is a pre-installed application on the DUT which allows for VoIP calls in a head-to-ear scenario. Duo uses the OPUS audio codec and supports a bitrate range of 6kbps to 75kbps. All air interfaces capable of a data connection were evaluated with Google Duo. When HAC testing we are using the Google Duo version is 26.0.179825522.alpha.DEV and the bitrate configuration can find at settings → Voice call parameters settings → Audio codec bitrate(6-75kbps).

Test Procedure and Equipment Setup

The test procedure for OTT testing is identical to the section above, except for how the signal is sent to the DUT, as outlined in the diagram below.

The AMMI is connected to the support device's Mic via Audio Data Line. The support device is connected to the Internet via Wi-Fi and the DUT is connected to the mobile base station via the technology under test. Using the DUT's OTT application, a VoIP call is established with the support device. The test signal is sent from the DASY PC to the AMMI, from the AMMI to the support device, and finally to the DUT. To exercise the license antenna, the DUT was simultaneously connected to an external AP and to a mobile base station.

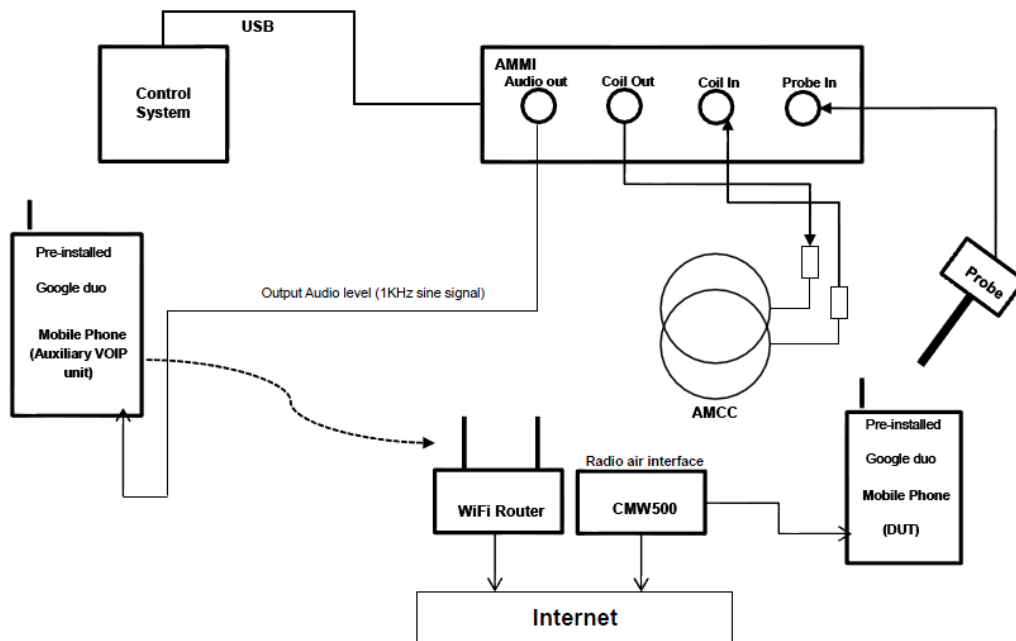



Audio Level Settings

According to KDB 285076 D02, the average speech level of -20dBm0 shall be used for protocols not specifically listed in Table 7.1 of ANSI C63.19-2001.

Determine Input Audio level is based on the Added additional dBFS level readout by Google Duo customizes application and three steps need to do.

1. Input a gain value to readout the -23dBFS level as reference. (0dBFS = 3.14 dBm0)
2. Adjust gain level to readout the dBFS level until it changes to -24dBFS.
3. Based on the step 1 and 2, and then calculate the gain value(dB) by interpolation to get the -20dBm0 corresponding gain value.

Codec Bit-rate Investigation

An investigation between the various bit-rate configurations (Low/Mid/High bit rates for Narrowband, Wideband, and EVS) are documented (ABM1, ABM2, SNNR, frequency response) to determine the worst case bit-rate for each voice service type. The tables below compare the varying bit-rate configurations

Air Interface Investigation

Using the worst-case bit-rate and Radio Configuration found in §9.2, a limited set of bands/channel/bandwidths were then tested to confirm that there is no effect to the T-rating when changing the band/channel/bandwidth, it is necessary to report only a set band/channel/bandwidth for each orientation for a voice service/air interface.

**11.2. Test Data Summary****<Codec Investigation>-HSPA**

codec	Bitrate 75Kbps	Bitrate 40Kbps	Bitrate 6Kbps	Orientation	Band / Channel
Primary Group Contiguous Point Count	545	541	534	Transverse	Band 5 / 4182
Secondary Group Point Count	676	676	676		
Freq. Response	Pass	Pass	Pass		

For WCDMA, it is observed that 6Kbps is the worst case.

<Codec Investigation>-LTE

codec	Bitrate 75Kbps	Bitrate 40Kbps	Bitrate 6Kbps	Orientation	Band / Channel
Primary Group Contiguous Point Count	331	335	326	Transverse	Band 38 / 38000
Secondary Group Point Count	466	468	462		
Freq. Response	Pass	Pass	Pass		

For LTE, it is observed that 6Kbps is the worst case.

<Codec Investigation>-WLAN

codec	Bitrate 75Kbps	Bitrate 40Kbps	Bitrate 6Kbps	Orientation	Band / Channel
Primary Group Contiguous Point Count	544	537	532	Transverse	WLAN 2.4GHz / 6
Secondary Group Point Count	676	676	676		
Freq. Response	Pass	Pass	Pass		

For WLAN, it is observed that 6Kbps is the worst case.



<Summary Tests Results>

Due to OTT service are all is established over the internet protocol for the voice service, and on both services use the identical RF air interface, therefore according to the summary test results, the worst case air interface is used for OTT T-Coil testing.

Plot No.	Band	Channel	Primary Group Contiguous Point Count	Secondary Group Point Count	Secondary Group Max Longitudinal	Secondary Group Max Transverse	Freq. Response
22	WCDMA Band 5	4182	534	676	26	26	Pass
23	LTE Band 17	23790	530	676	26	26	Pass
24	LTE Band 38	38000	326	462	26	26	Pass
25	WLAN 2.4GHz	6	532	676	26	26	Pass
26	WLAN 5.3GHz	56	532	673	26	26	Pass

12. Measurement Uncertainty

No.	Error source	Type	Uncertainty Value a_i (%)	Prob. Dist.	Div.	ABM1 c_i	ABM2 c_i	Std. Unc. ABM1 u_i (%)	Std. Unc. ABM2 u_i (%)	Source
1	System Repeatability	A	0.016	N	1	1	1	0.016	0.016	Measurement
Probe Sensitivity										
2	Reference Level	B	3.0	R	$\sqrt{3}$	1	1	3.0	3.0	Manufacturer
3	AMCC Geometry	B	0.4	R	$\sqrt{3}$	1	1	0.2	0.2	Manufacturer
4	AMCC Current	B	0.6	R	$\sqrt{3}$	1	1	0.4	0.4	Manufacturer
5	Probe Positioning during Calibration	B	0.2	R	$\sqrt{3}$	1	1	0.1	0.1	Manufacturer
6	Noise Contribution	B	0.7	R	$\sqrt{3}$	0.0143	1	0.0	0.4	Measurement
7	Frequency Slope	B	5.9	R	$\sqrt{3}$	0.1	1	0.3	3.5	Manufacturer
Probe System										
8	Repeatability / Drift	B	1.0	R	$\sqrt{3}$	1	1	0.6	0.6	Manufacturer
9	Linearity / Dynamic Range	B	0.6	N	1	1	1	0.4	0.4	Manufacturer
10	Acoustic Noise	B	1.0	R	$\sqrt{3}$	0.1	1	0.1	0.6	Standard
11	Probe Angle	B	2.3	R	$\sqrt{3}$	1	1	1.4	1.4	Manufacturer
12	Spectral Processing	B	0.9	R	$\sqrt{3}$	1	1	0.5	0.5	Manufacturer
13	Integration Time	B	0.6	N	1	1	5	0.6	3.0	Manufacturer
14	Field Distribution	B	0.2	R	$\sqrt{3}$	1	1	0.1	0.1	Standard
Test Signal										
15	Ref. Signal Spectral Response	B	0.6	R	$\sqrt{3}$	0	1	0.0	0.4	Manufacturer
Positioning										
16	Probe Positioning	B	1.9	R	$\sqrt{3}$	1	1	1.1	1.1	Manufacturer
17	Phantom Thickness	B	0.9	R	$\sqrt{3}$	1	1	0.5	0.5	Manufacturer
18	DUT Positioning	B	1.9	R	$\sqrt{3}$	1	1	1.1	1.1	Measurement
External Contributions										
19	RF Interference	B	0.0	R	$\sqrt{3}$	1	0.3	0.0	0.0	Manufacturer
20	Test Signal Variation	B	2.0	R	$\sqrt{3}$	1	1	1.2	1.2	Manufacturer
Combined standard uncertainty (%)		$u_c = \sqrt{\sum_{i=1}^{20} c_i^2 u_i^2}$						4.1	6.1	
Expanded uncertainty (Confidence interval of 95 %)		$u_e = 2u_c$		N	$k = 2$		8.2	12.2		



13. Main Test Instruments

Table 13-1: List of Main Instruments

No.	Name	Type	Serial Number	Calibration Date	Valid Period
01	Audio Magnetic Calibration Coil	AMCC	1105	/	/
02	Audio Measuring Instrument	AMMI	1121	/	/
03	HAC Test Arch	N/A	1150	/	/
04	Audio Magnetic 1D Field Probe	AM1DV3	3086	2021-02-22	Three years
05	DAE	DAE4	1527	2023-08-07	One year
06	BTS	CMW500	152499	2023-07-14	One year
07	Software	DASY8	/	/	/

ANNEX A: Test Plots

T-Coil GSM850 Transverse

Measurement performed on 2024-02-04

T-Coil Coupling Mode Test Report

Results

Primary Group Contiguous Point Count	Secondary Group Point Count	Secondary Group Max Longitudinal	Secondary Group Max Transverse
89	200	26	18

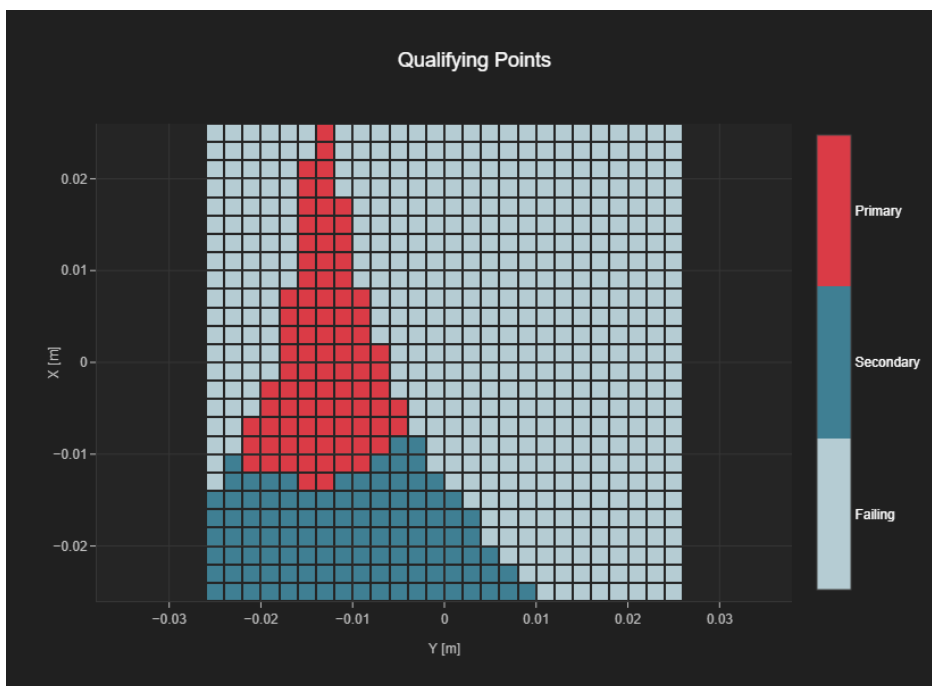

Fig A.1 T-Coil GSM850

T-Coil GSM1900 Transverse

Measurement performed on 2024-02-04

T-Coil Coupling Mode Test Report

Results

Primary Group Contiguous Point Count	Secondary Group Point Count	Secondary Group Max Longitudinal	Secondary Group Max Transverse
131	315	26	26

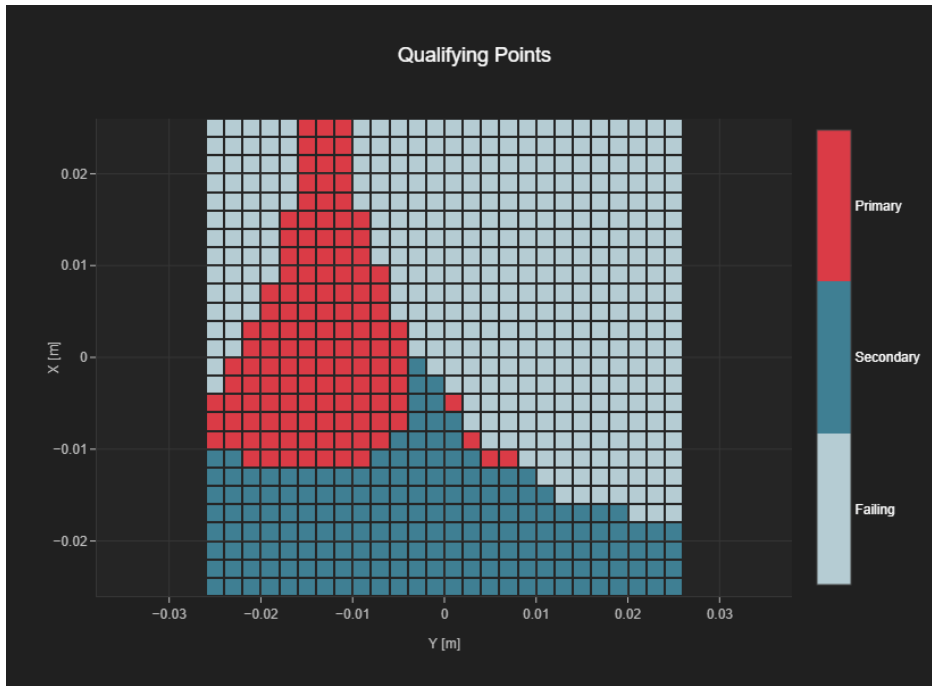

Fig A.2 T-Coil GSM1900

T-Coil WCDMA Band 2 Transverse

Measurement performed on 2024-01-30

T-Coil Coupling Mode Test Report

Results

Primary Group Contiguous Point Count	Secondary Group Point Count	Secondary Group Max Longitudinal	Secondary Group Max Transverse
459	676	26	26

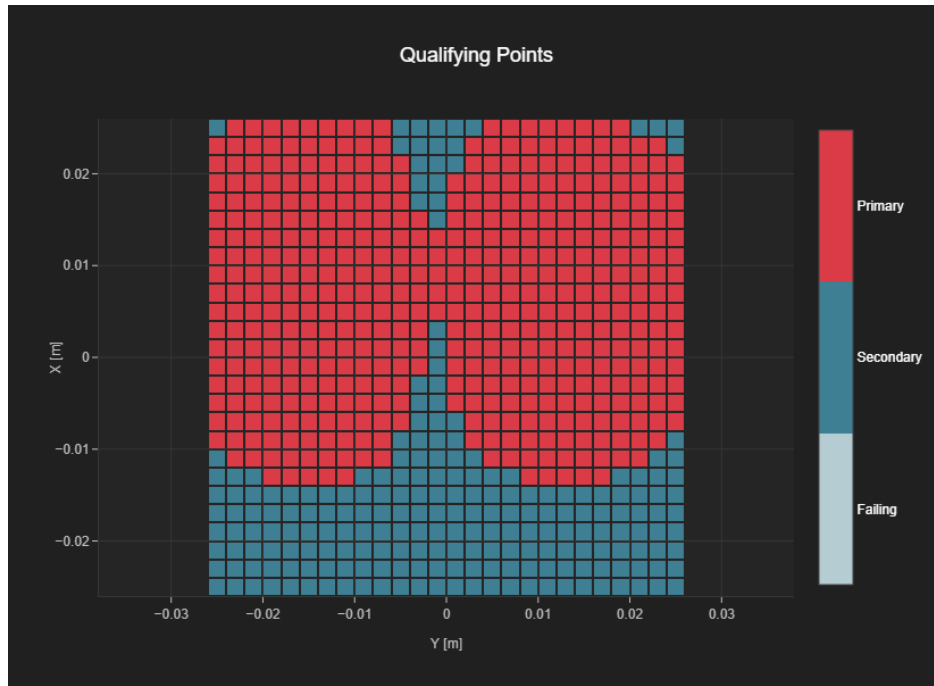

Fig A.3 T-Coil WCDMA Band 2

T-Coil WCDMA Band 4 Transverse

Measurement performed on 2024-01-30

T-Coil Coupling Mode Test Report

Results

Primary Group Contiguous Point Count	Secondary Group Point Count	Secondary Group Max Longitudinal	Secondary Group Max Transverse
458	676	26	26

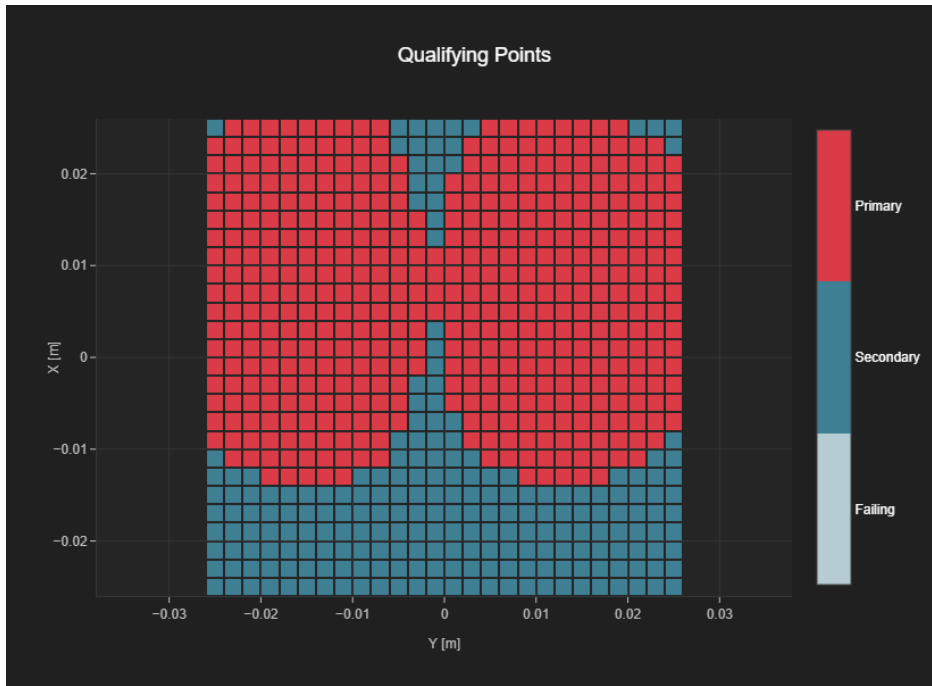

Fig A.4 T-Coil WCDMA Band 4

T-Coil WCDMA Band 5 Transverse

Measurement performed on 2024-01-30

T-Coil Coupling Mode Test Report

Results

Primary Group Contiguous Point Count	Secondary Group Point Count	Secondary Group Max Longitudinal	Secondary Group Max Transverse
456	676	26	26

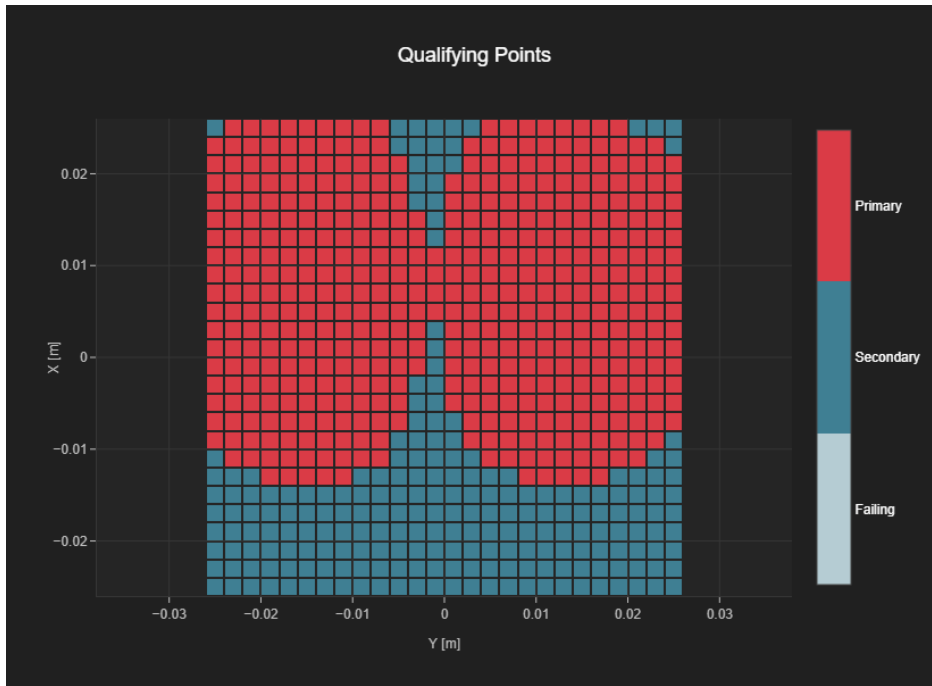

Fig A.5 T-Coil WCDMA Band 5

T-Coil LTE Band 2 Transverse

Measurement performed on 2024-02-01

T-Coil Coupling Mode Test Report

Results

Primary Group Contiguous Point Count	Secondary Group Point Count	Secondary Group Max Longitudinal	Secondary Group Max Transverse
451	676	26	26

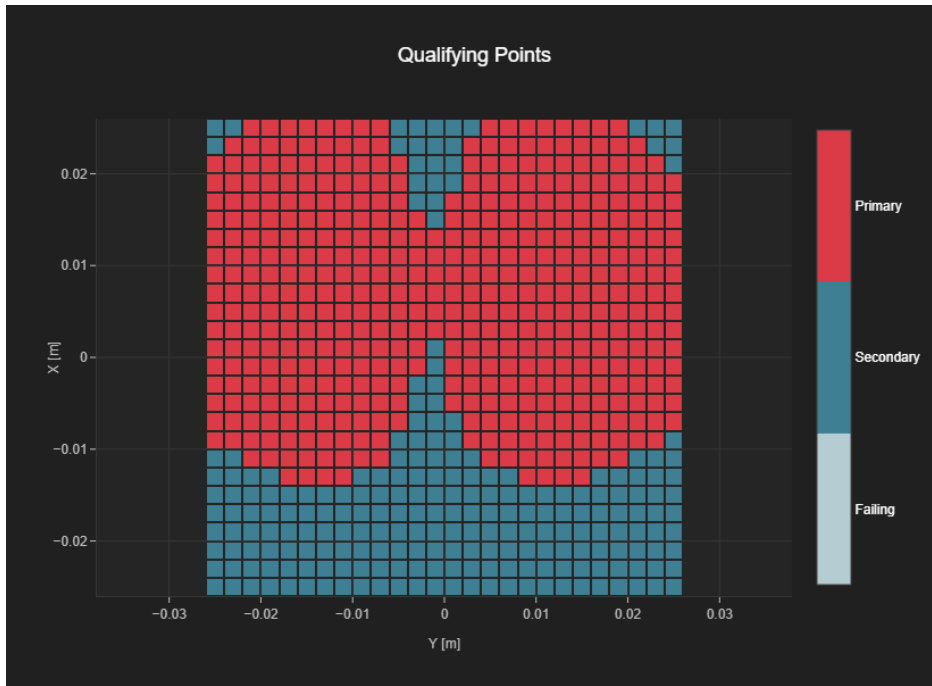

Fig A.6 T-Coil LTE Band 2

T-Coil LTE Band 4 Transverse

Measurement performed on 2024-02-01

T-Coil Coupling Mode Test Report

Results

Primary Group Contiguous Point Count	Secondary Group Point Count	Secondary Group Max Longitudinal	Secondary Group Max Transverse
450	676	26	26



Fig A.7 T-Coil LTE Band 4

T-Coil LTE-Band 5 Transverse

Measurement performed on 2024-02-01

T-Coil Coupling Mode Test Report

Results

Primary Group Contiguous Point Count	Secondary Group Point Count	Secondary Group Max Longitudinal	Secondary Group Max Transverse
451	676	26	26

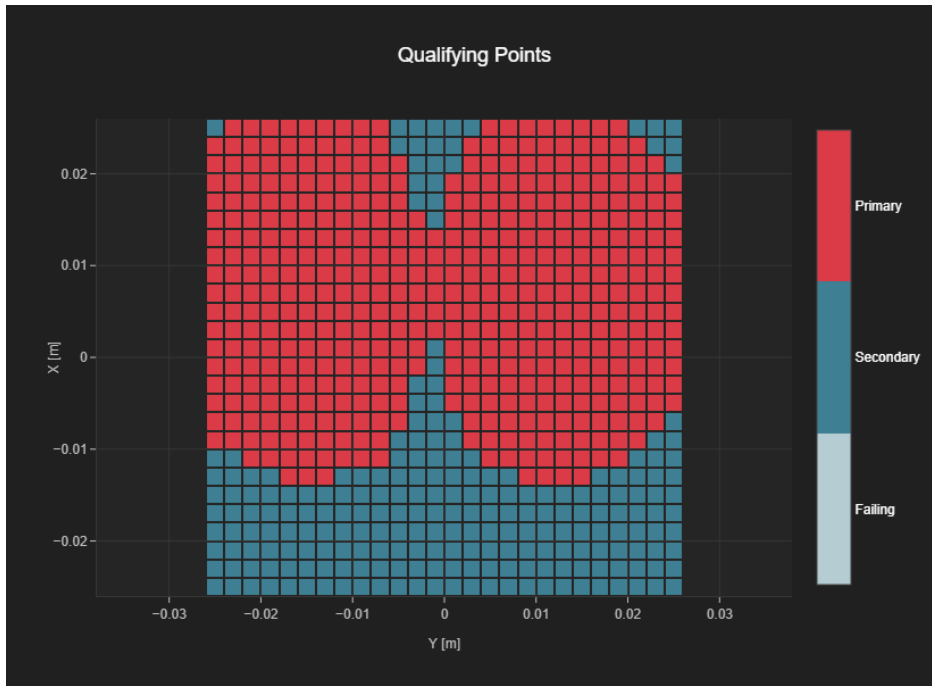

Fig A.8 T-Coil LTE-Band 5

T-Coil LTE-Band 7 Transverse

Measurement performed on 2024-02-01

T-Coil Coupling Mode Test Report

Results

Primary Group Contiguous Point Count	Secondary Group Point Count	Secondary Group Max Longitudinal	Secondary Group Max Transverse
451	676	26	26



Fig A.9 T-Coil LTE-Band 7

T-Coil LTE-Band 12 Transverse

Measurement performed on 2024-02-01

T-Coil Coupling Mode Test Report

Results

Primary Group Contiguous Point Count	Secondary Group Point Count	Secondary Group Max Longitudinal	Secondary Group Max Transverse
446	676	26	26



Fig A.10 T-Coil LTE-Band 12

T-Coil LTE-Band 13 Transverse

Measurement performed on 2024-02-01

T-Coil Coupling Mode Test Report

Results

Primary Group Contiguous Point Count	Secondary Group Point Count	Secondary Group Max Longitudinal	Secondary Group Max Transverse
446	676	26	26

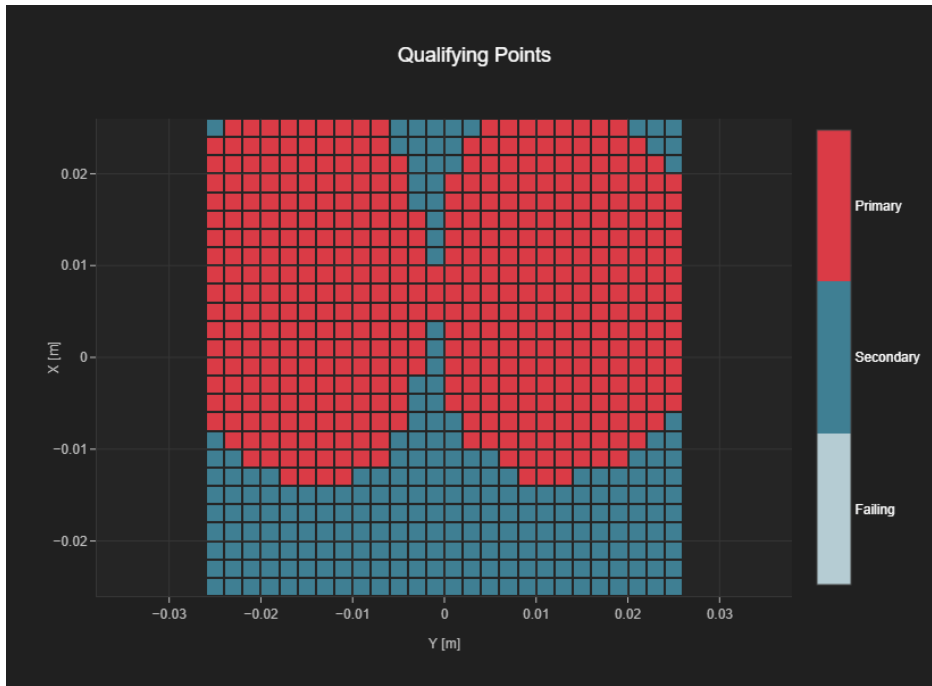

Fig A.11 T-Coil LTE-Band 13

T-Coil LTE-Band 17 Transverse

Measurement performed on 2024-02-01

T-Coil Coupling Mode Test Report

Results

Primary Group Contiguous Point Count	Secondary Group Point Count	Secondary Group Max Longitudinal	Secondary Group Max Transverse
440	664	26	26



Fig A.12 T-Coil LTE-Band 17

T-Coil LTE-Band 26 Transverse

Measurement performed on 2024-02-01

T-Coil Coupling Mode Test Report

Results

Primary Group Contiguous Point Count	Secondary Group Point Count	Secondary Group Max Longitudinal	Secondary Group Max Transverse
448	676	26	26

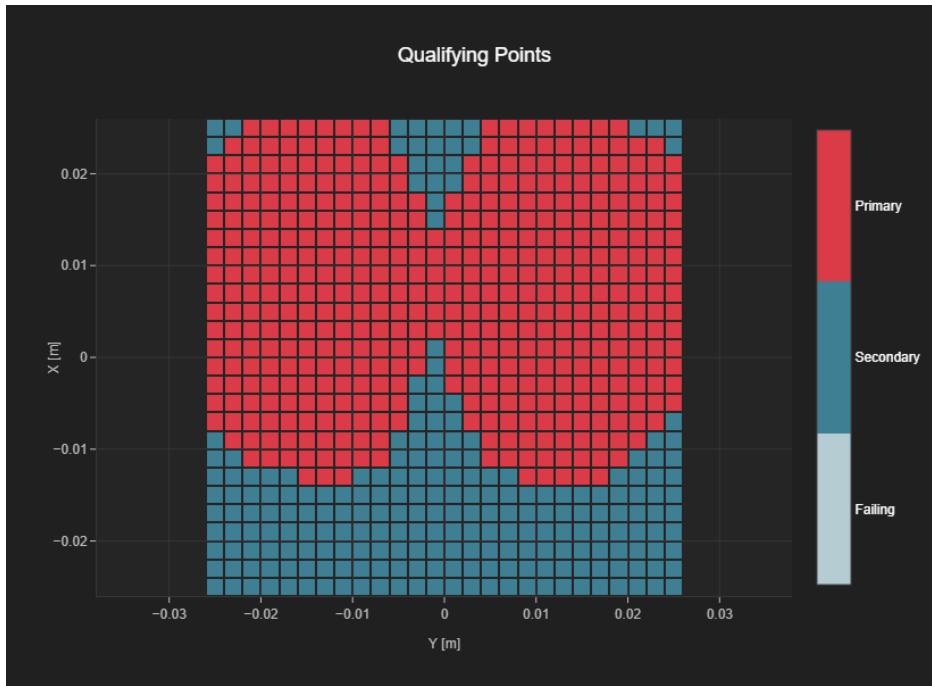

Fig A.13 T-Coil LTE-Band 26

T-Coil LTE-Band 66 Transverse

Measurement performed on 2024-02-01

T-Coil Coupling Mode Test Report

Results

Primary Group Contiguous Point Count	Secondary Group Point Count	Secondary Group Max Longitudinal	Secondary Group Max Transverse
450	676	26	26

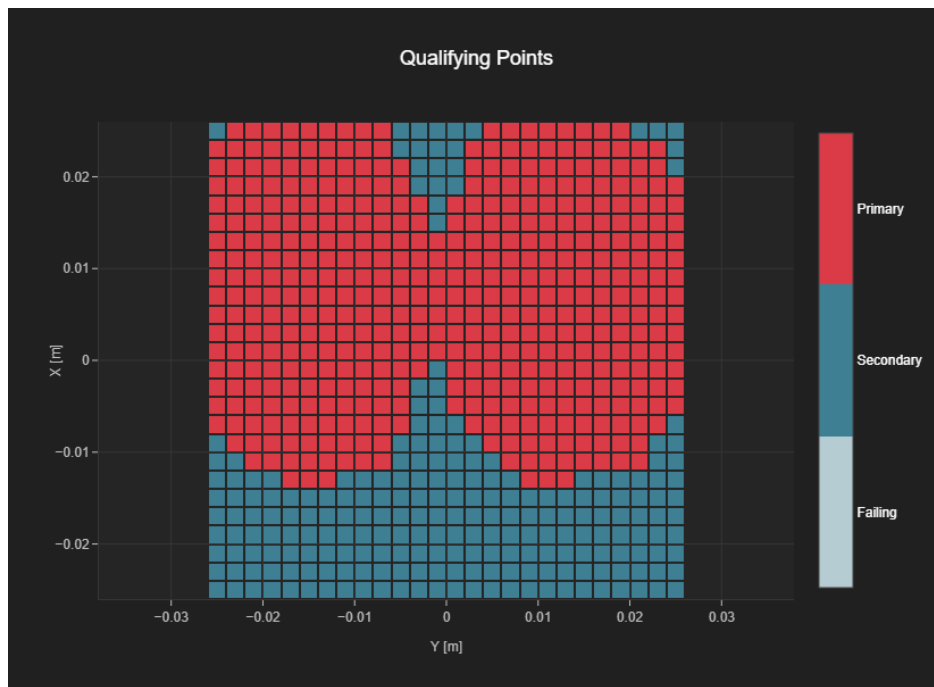

Fig A.14 T-Coil LTE-Band 66

T-Coil LTE-Band 38 Transverse

Measurement performed on 2024-02-01

T-Coil Coupling Mode Test Report

Results

Primary Group Contiguous Point Count	Secondary Group Point Count	Secondary Group Max Longitudinal	Secondary Group Max Transverse
267	472	26	26

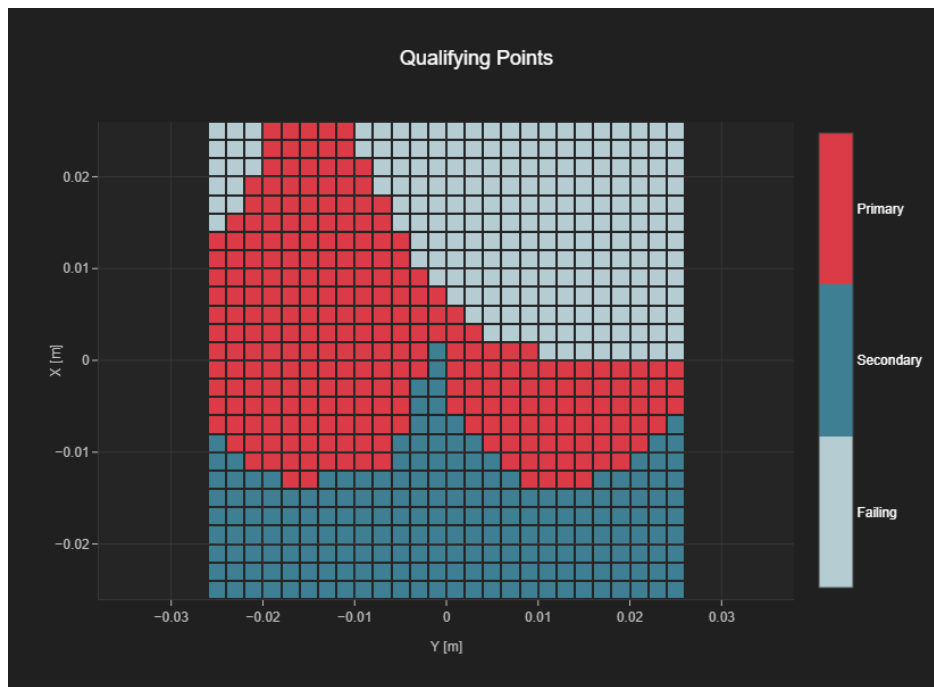

Fig A.15 T-Coil LTE-Band 38

T-Coil LTE-Band 41 Transverse

Measurement performed on 2024-02-01

T-Coil Coupling Mode Test Report

Results

Primary Group Contiguous Point Count	Secondary Group Point Count	Secondary Group Max Longitudinal	Secondary Group Max Transverse
270	474	26	26

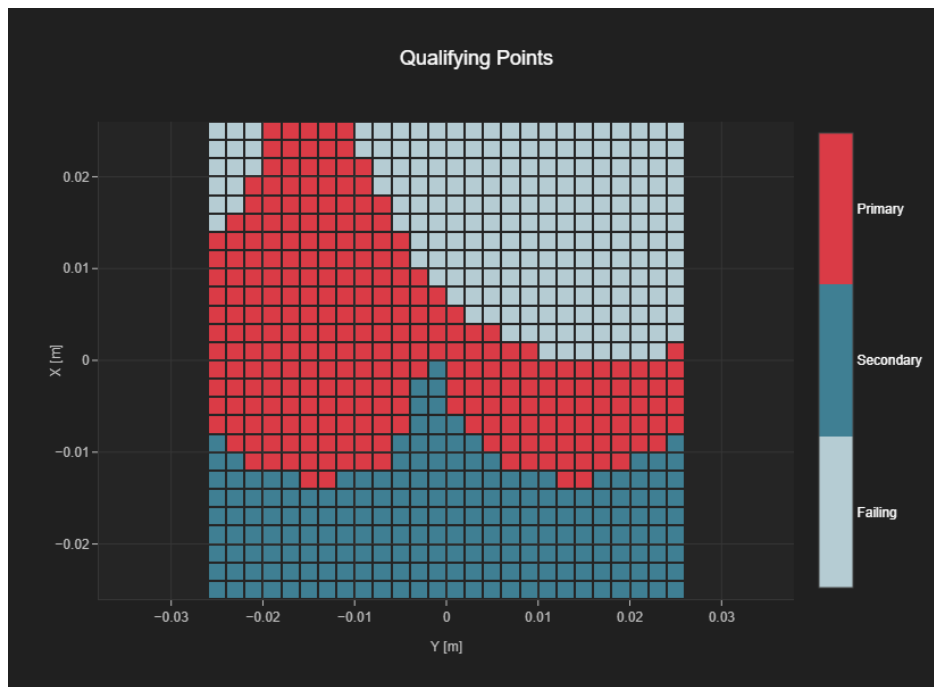

Fig A.16 T-Coil LTE-Band 41

T-Coil WLAN 2.4GHz Transverse

Measurement performed on 2024-02-05

T-Coil Coupling Mode Test Report

Results

Primary Group Contiguous Point Count	Secondary Group Point Count	Secondary Group Max Longitudinal	Secondary Group Max Transverse
445	661	26	26

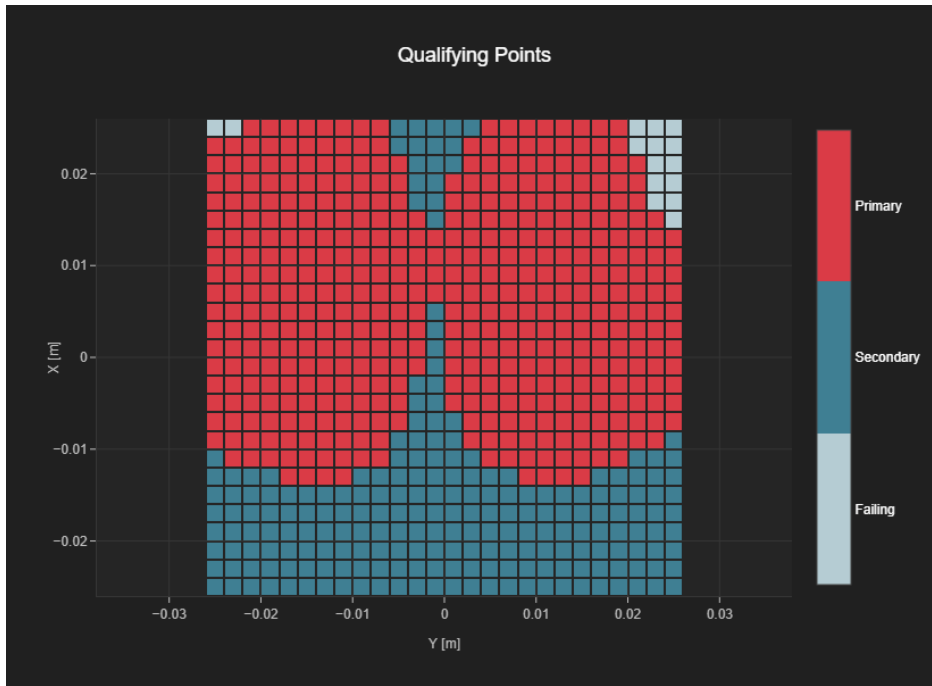

Fig A.17 T-Coil WLAN 2.4GHz

T-Coil WLAN 5.2GHz Transverse

Measurement performed on 2024-02-05

T-Coil Coupling Mode Test Report

Results

Primary Group Contiguous Point Count	Secondary Group Point Count	Secondary Group Max Longitudinal	Secondary Group Max Transverse
461	676	26	26

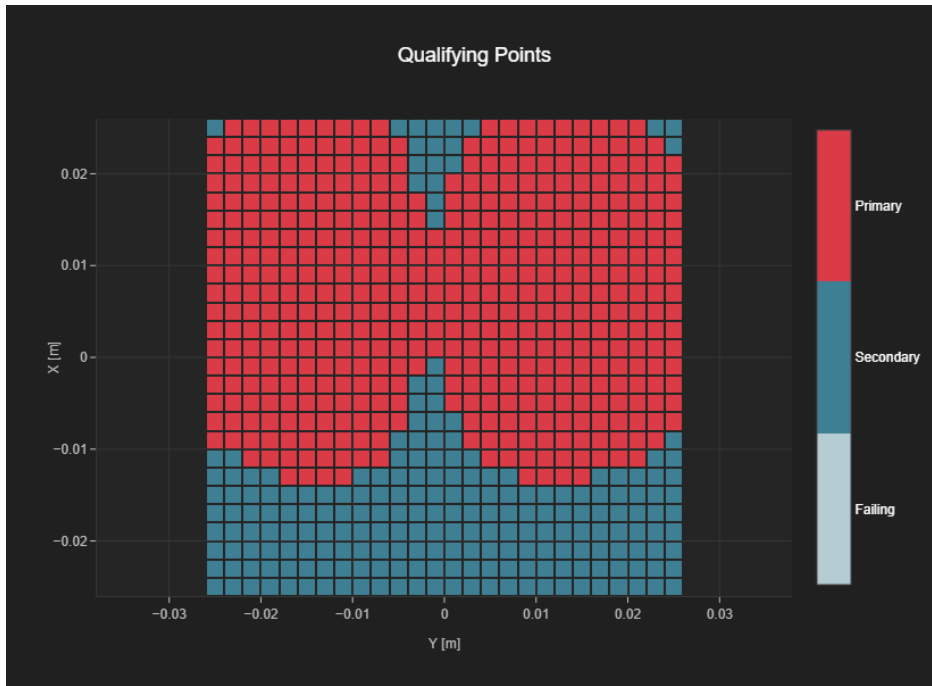

Fig A.18 T-Coil WLAN 5.2GHz

T-Coil WLAN 5.3GHz Transverse

Measurement performed on 2024-02-05

T-Coil Coupling Mode Test Report

Results

Primary Group Contiguous Point Count	Secondary Group Point Count	Secondary Group Max Longitudinal	Secondary Group Max Transverse
458	676	26	26

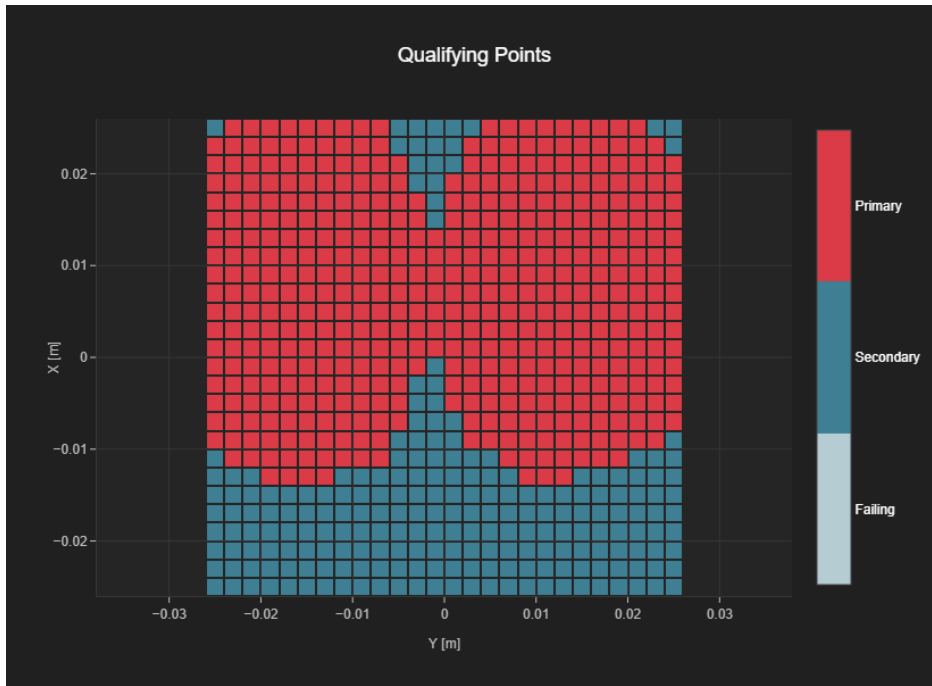

Fig A.19 T-Coil WLAN 5.3GHz

T-Coil WLAN 5.5GHz Transverse

Measurement performed on 2024-02-05

T-Coil Coupling Mode Test Report

Results

Primary Group Contiguous Point Count	Secondary Group Point Count	Secondary Group Max Longitudinal	Secondary Group Max Transverse
460	676	26	26

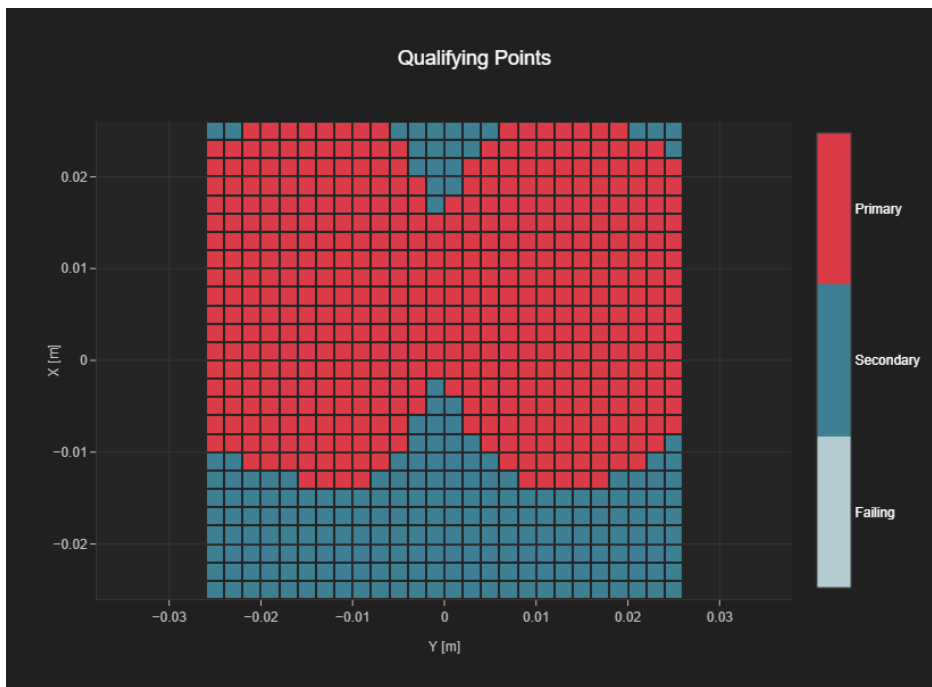

Fig A.20 T-Coil WLAN 5.5GHz

T-Coil WLAN 5.8GHz Transverse

Measurement performed on 2024-02-05

T-Coil Coupling Mode Test Report

Results

Primary Group Contiguous Point Count	Secondary Group Point Count	Secondary Group Max Longitudinal	Secondary Group Max Transverse
459	676	26	26

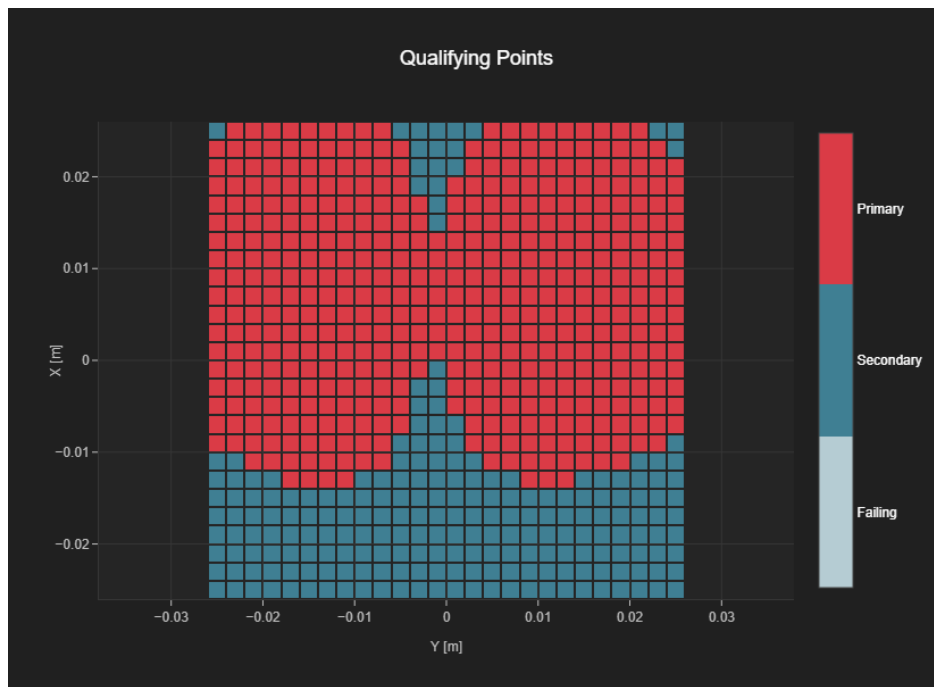

Fig A.21 T-Coil WLAN 5.8GHz

T-Coil (MEET) WCDMA Band 5 Transverse

Measurement performed on 2024-02-05

T-Coil Coupling Mode Test Report

Results

Primary Group Contiguous Point Count	Secondary Group Point Count	Secondary Group Max Longitudinal	Secondary Group Max Transverse
534	676	26	26

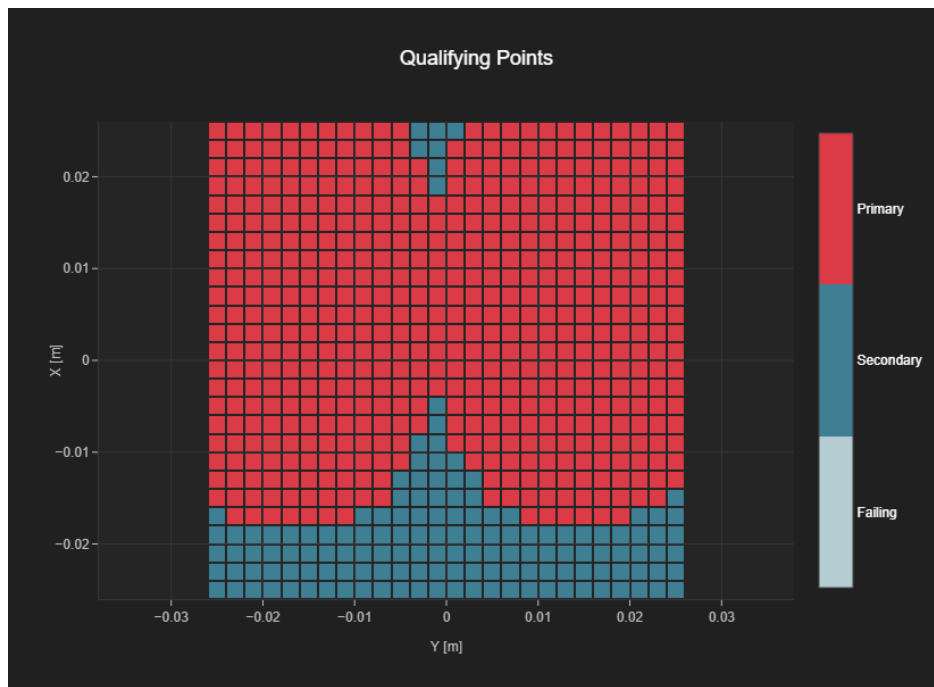

Fig A.22 T-Coil WCDMA Band 5

T-Coil (MEET) LTE Band 17 Transverse

Measurement performed on 2024-02-05

T-Coil Coupling Mode Test Report

Results

Primary Group Contiguous Point Count	Secondary Group Point Count	Secondary Group Max Longitudinal	Secondary Group Max Transverse
530	676	26	26

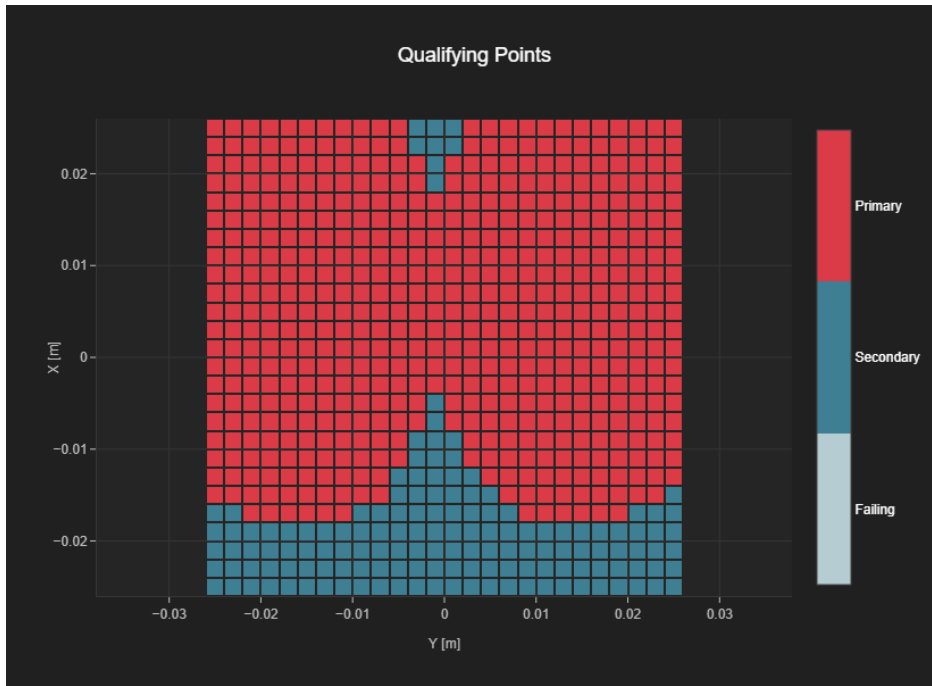

Fig A.23 T-Coil LTE Band 17

T-Coil (MEET) LTE Band 38 Transverse

Measurement performed on 2024-02-05

T-Coil Coupling Mode Test Report

Results

Primary Group Contiguous Point Count	Secondary Group Point Count	Secondary Group Max Longitudinal	Secondary Group Max Transverse
326	462	26	26

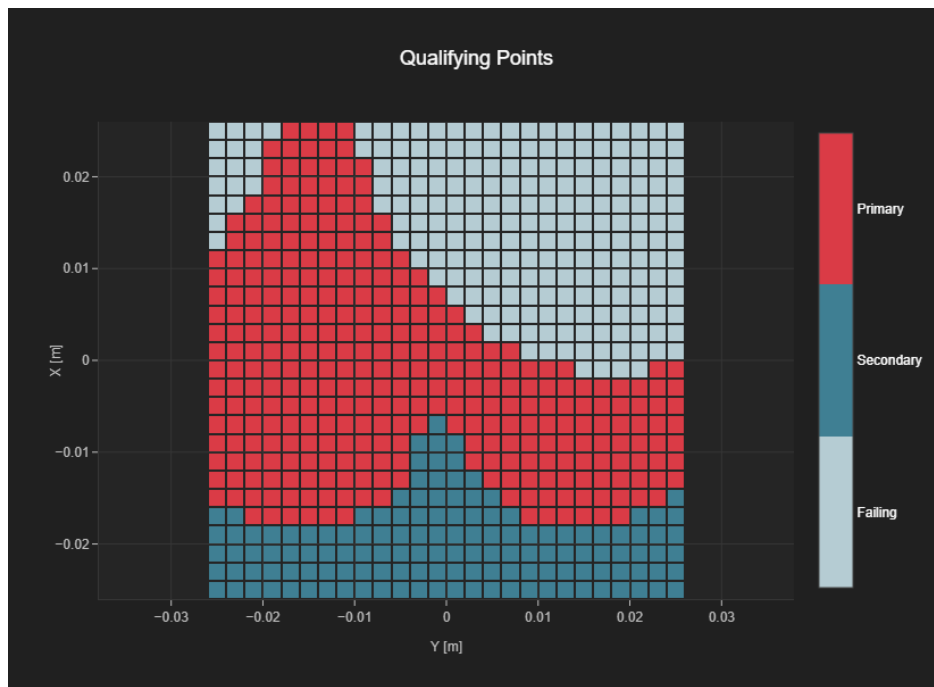

Fig A.24 T-Coil LTE Band 38



T-Coil (MEET) WLAN 2.4GHz Transverse

Measurement performed on 2024-02-05

T-Coil Coupling Mode Test Report

Results

Primary Group Contiguous Point Count	Secondary Group Point Count	Secondary Group Max Longitudinal	Secondary Group Max Transverse
532	676	26	26

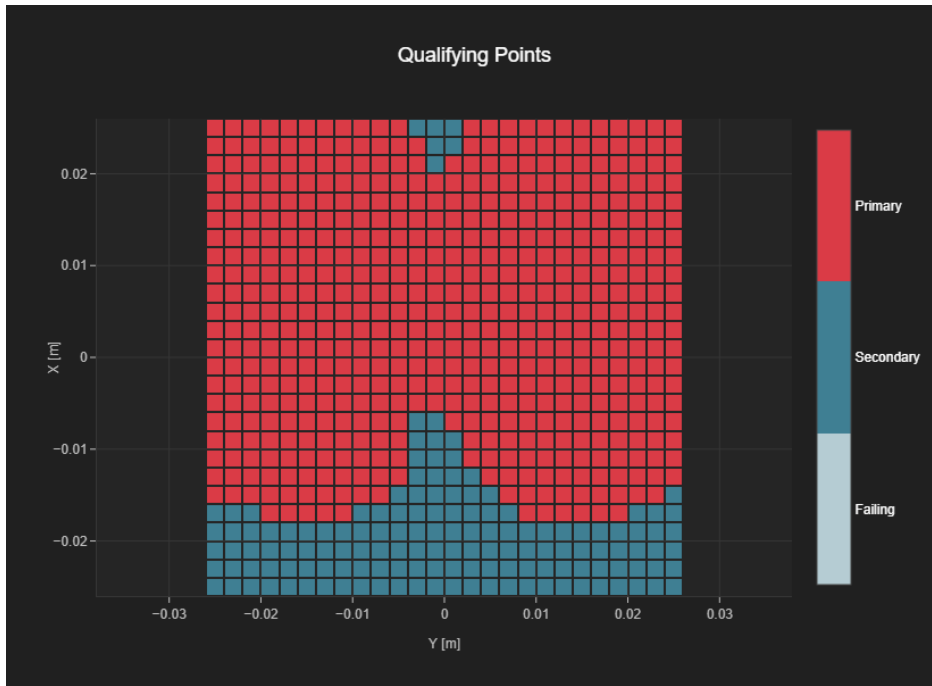

Fig A.25 T-Coil WLAN 2.4GHz



T-Coil (MEET) WLAN 5.3GHz Transverse

Measurement performed on 2024-02-05

T-Coil Coupling Mode Test Report

Results

Primary Group Contiguous Point Count	Secondary Group Point Count	Secondary Group Max Longitudinal	Secondary Group Max Transverse
532	673	26	18

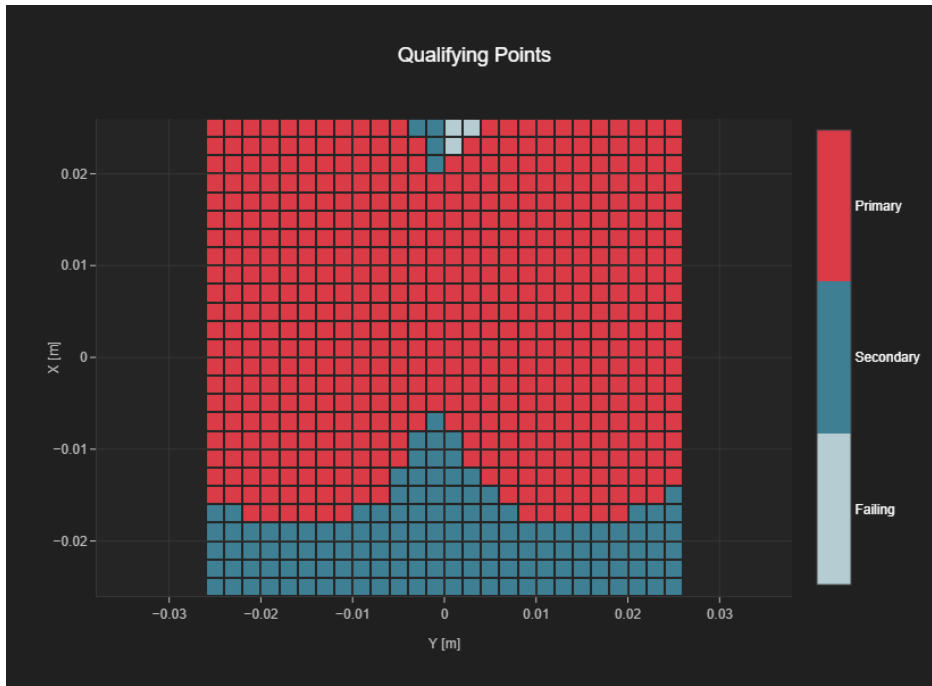

Fig A.26 T-Coil WLAN 5.3GHz

ANNEX B: Frequency Response Curves

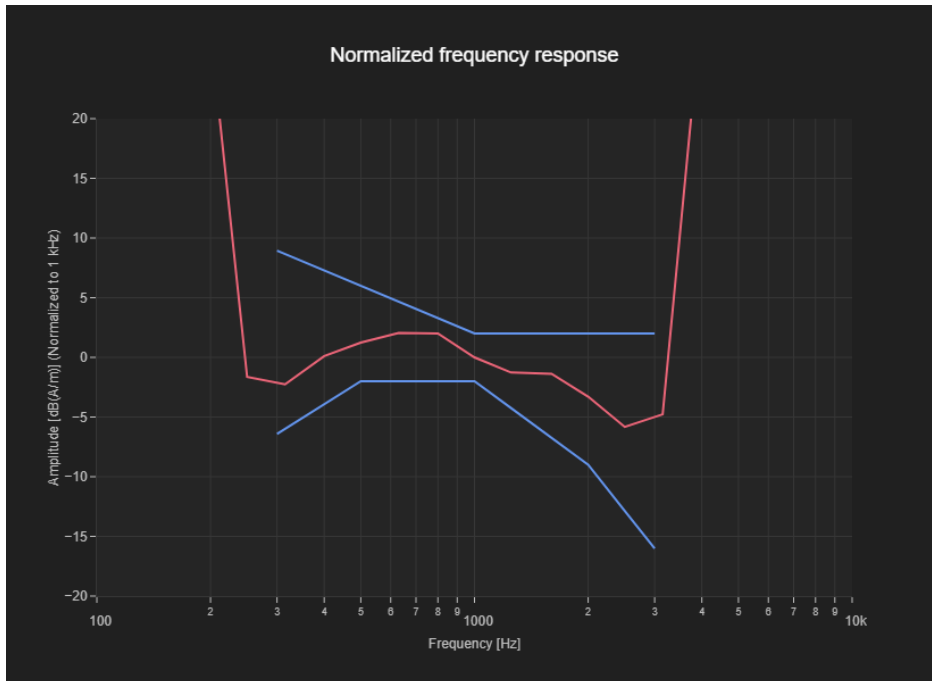

Figure B.1 Frequency Response of GSM850

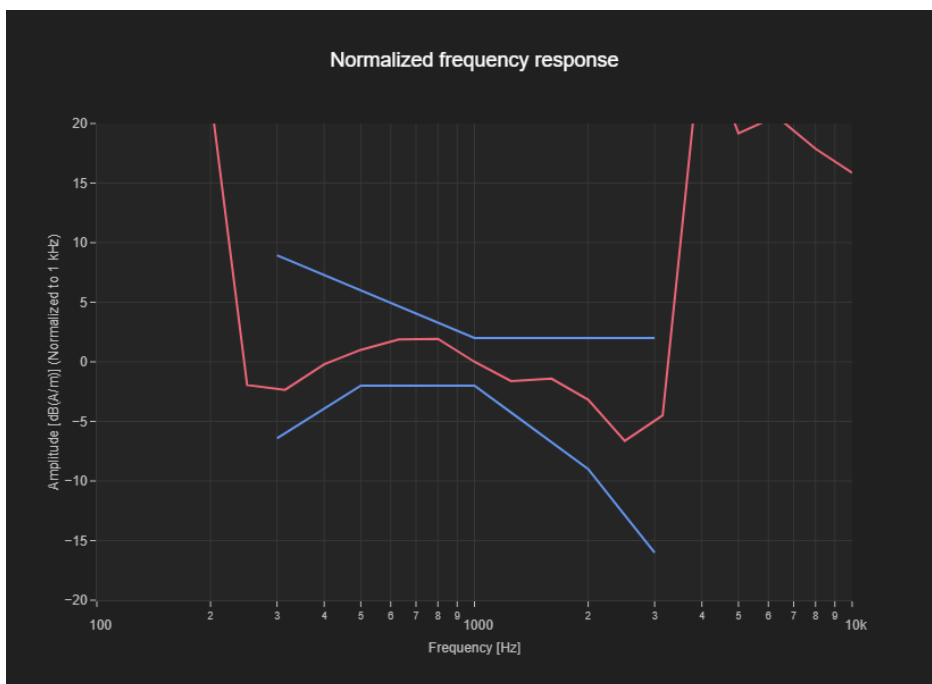

Figure B.2 Frequency Response of GSM1900

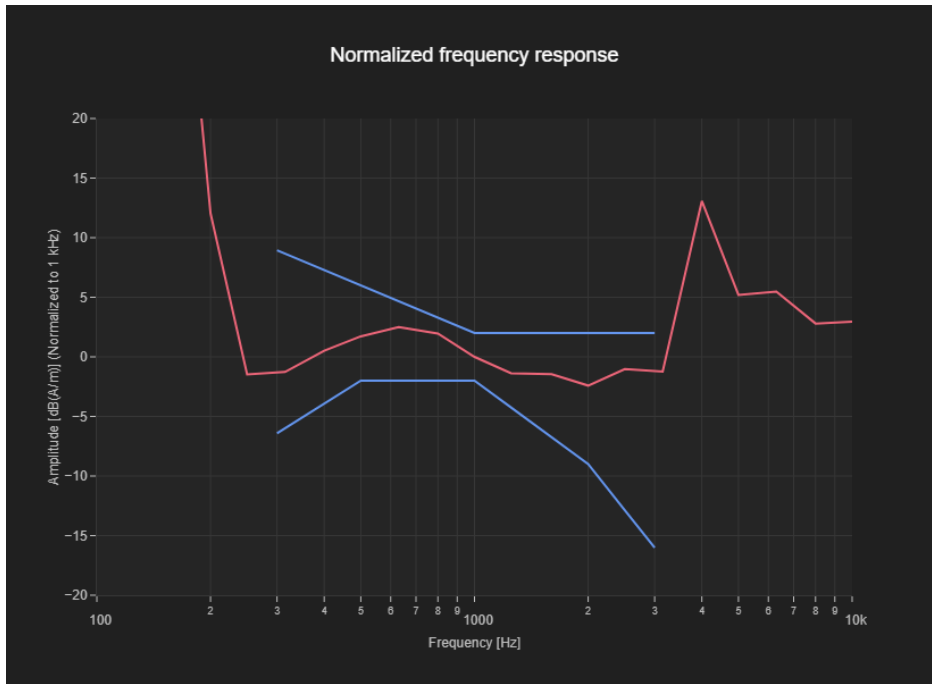

Figure B.3 Frequency Response of WCDMA Band 2

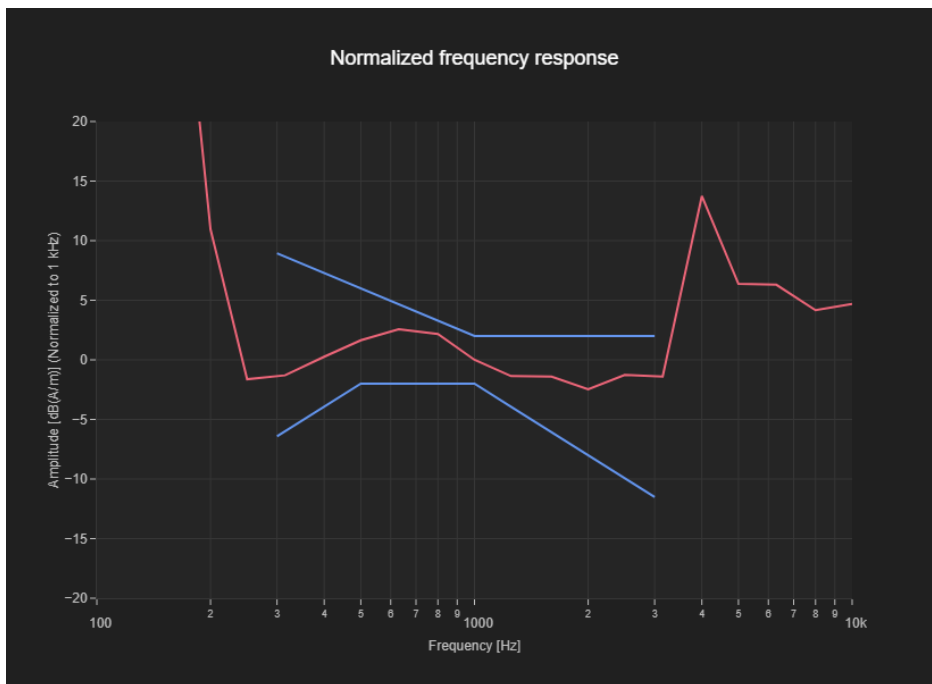

Figure B.4 Frequency Response of WCDMA Band 4

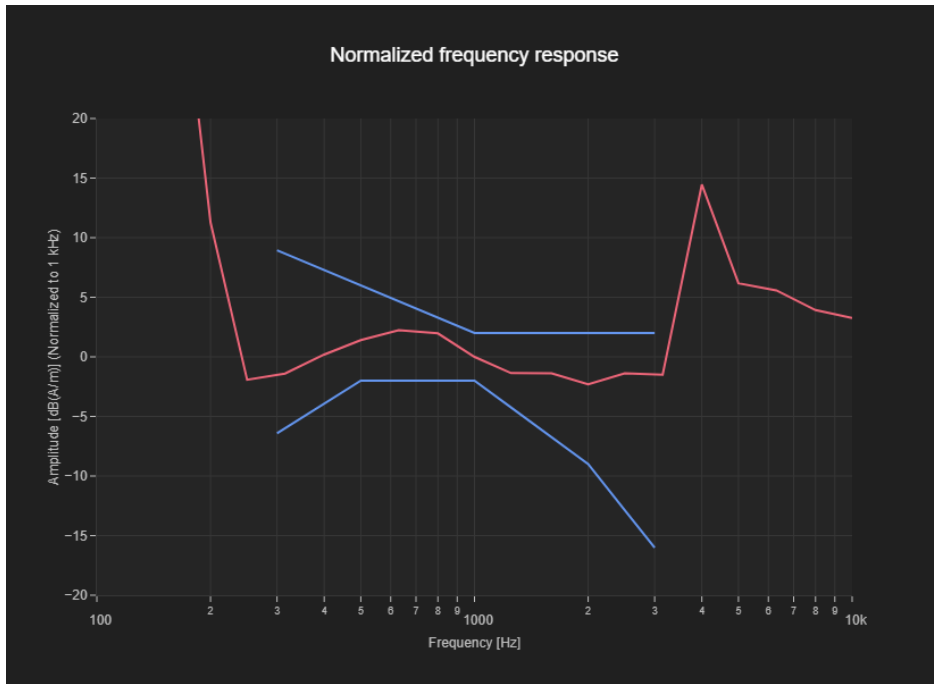

Figure B.5 Frequency Response of WCDMA Band 5

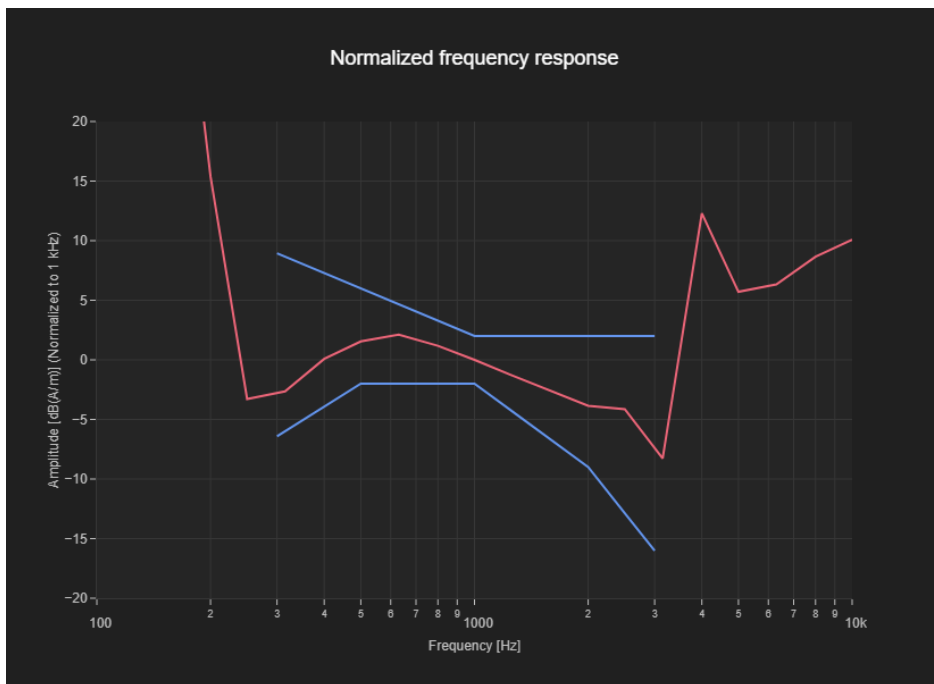

Figure B.6 Frequency Response of LTE Band 2

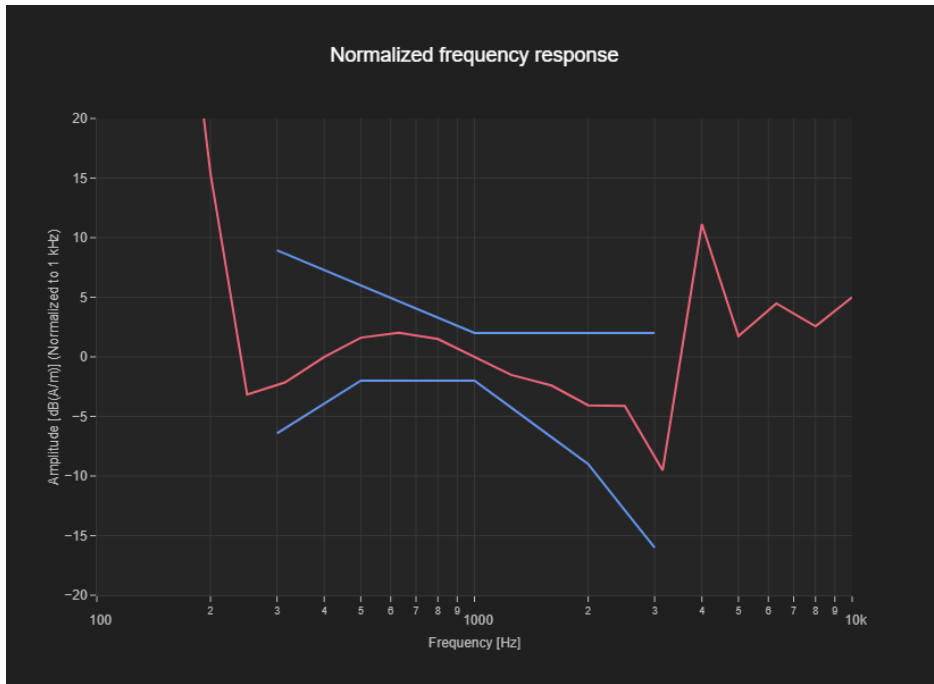

Figure B.7 Frequency Response of LTE Band 4

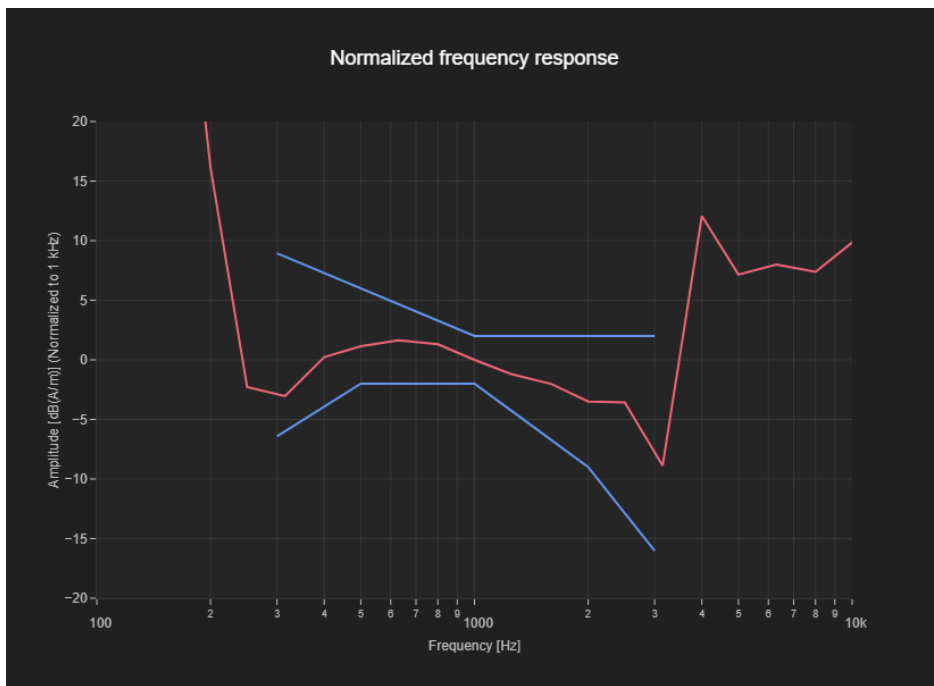

Figure B.8 Frequency Response of LTE Band 5

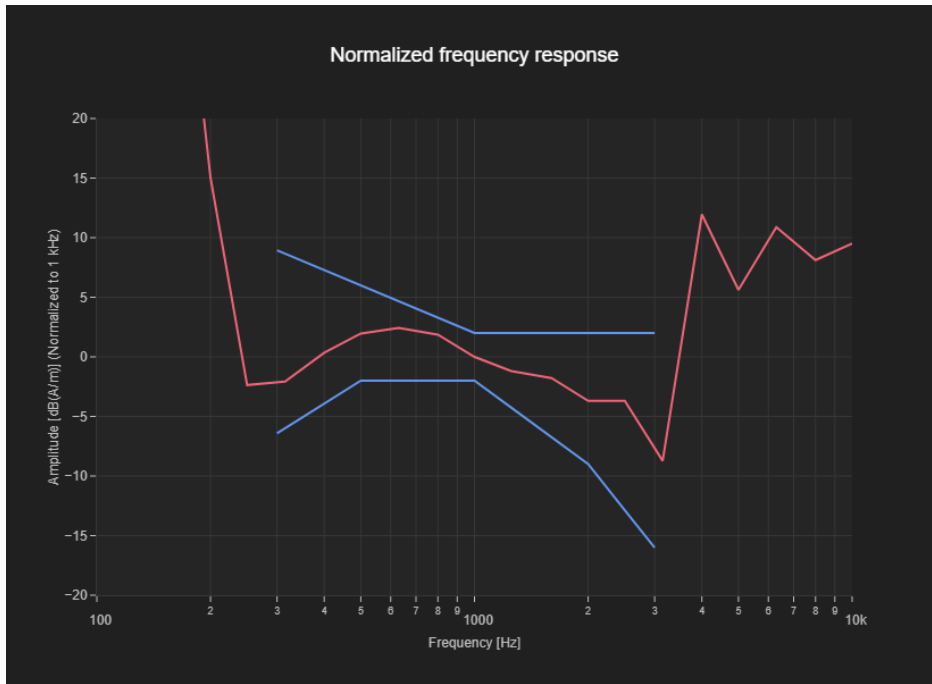

Figure B.9 Frequency Response of LTE Band 7

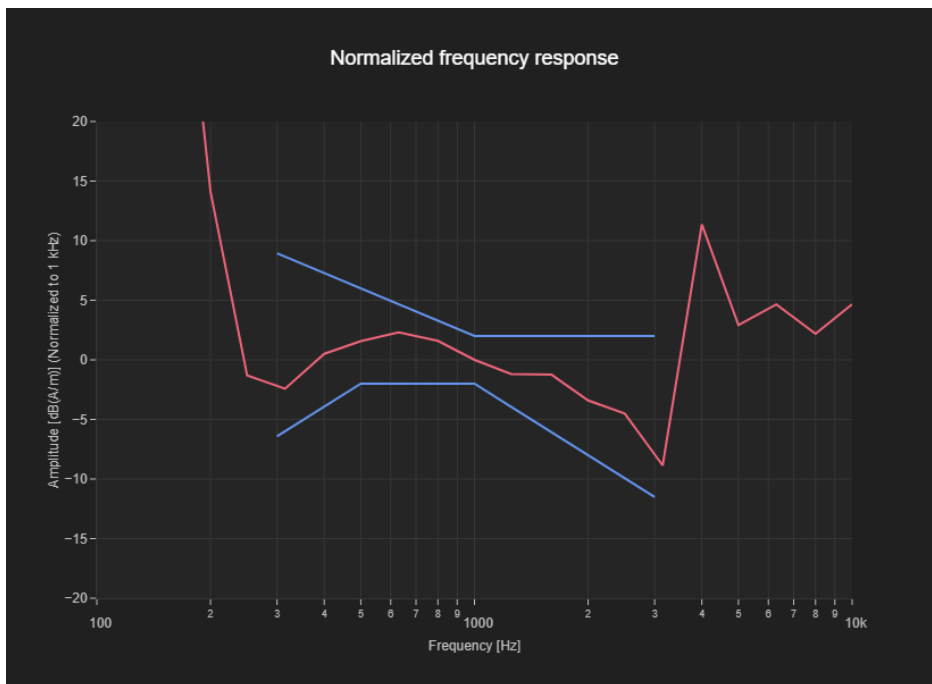

Figure B.10 Frequency Response of LTE Band 12

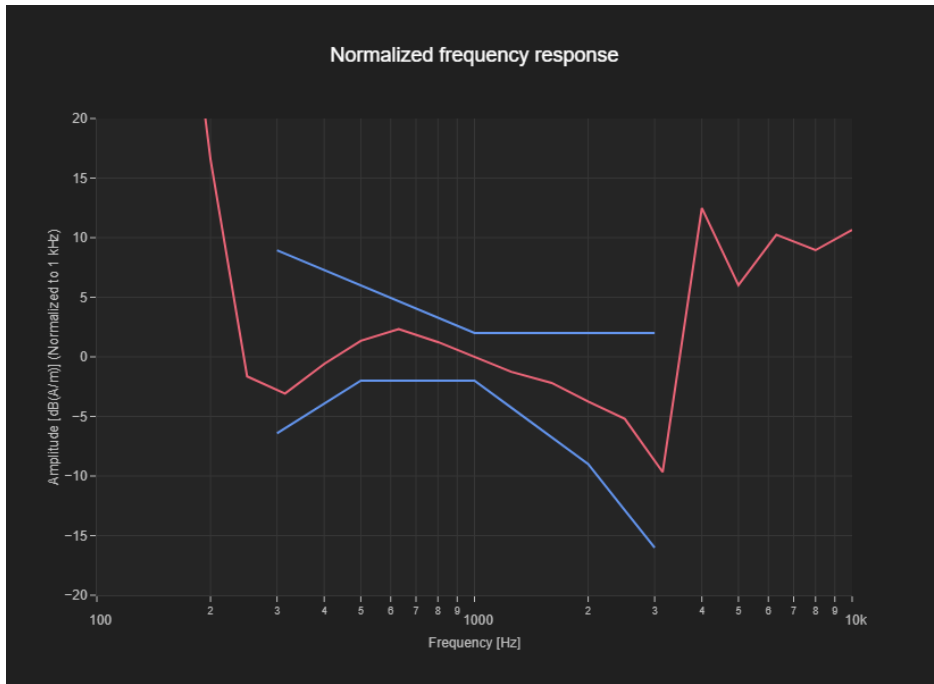

Figure B.11 Frequency Response of LTE Band 13

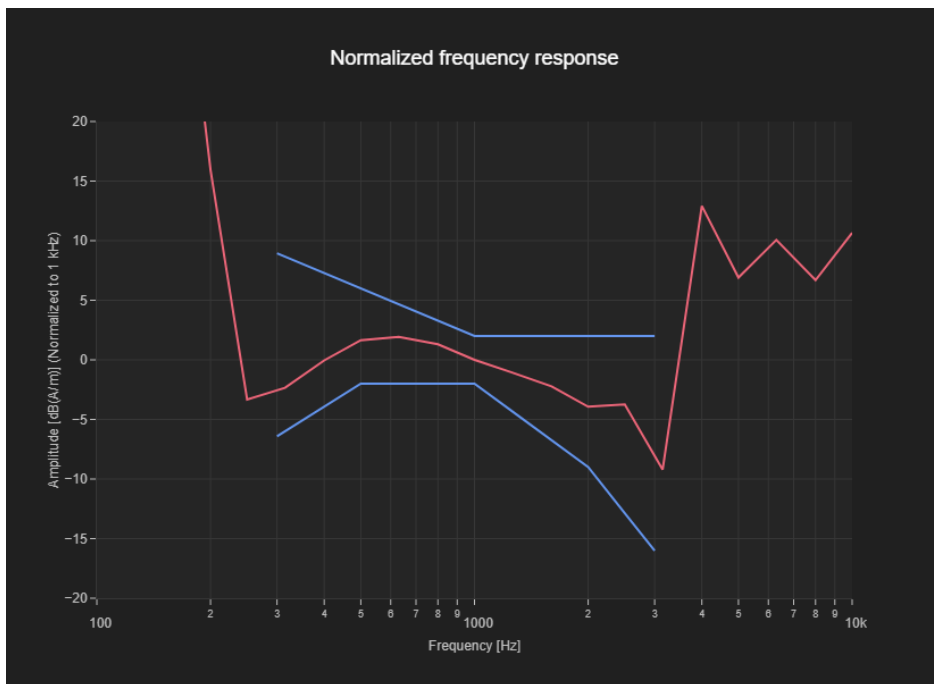

Figure B.12 Frequency Response of LTE Band 17

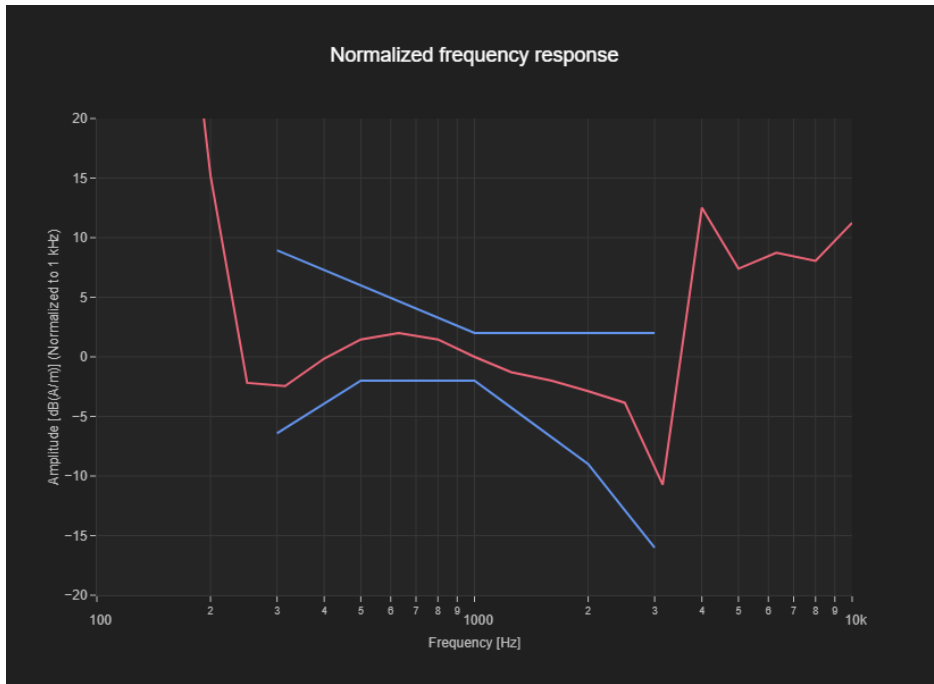

Figure B.13 Frequency Response of LTE Band 26

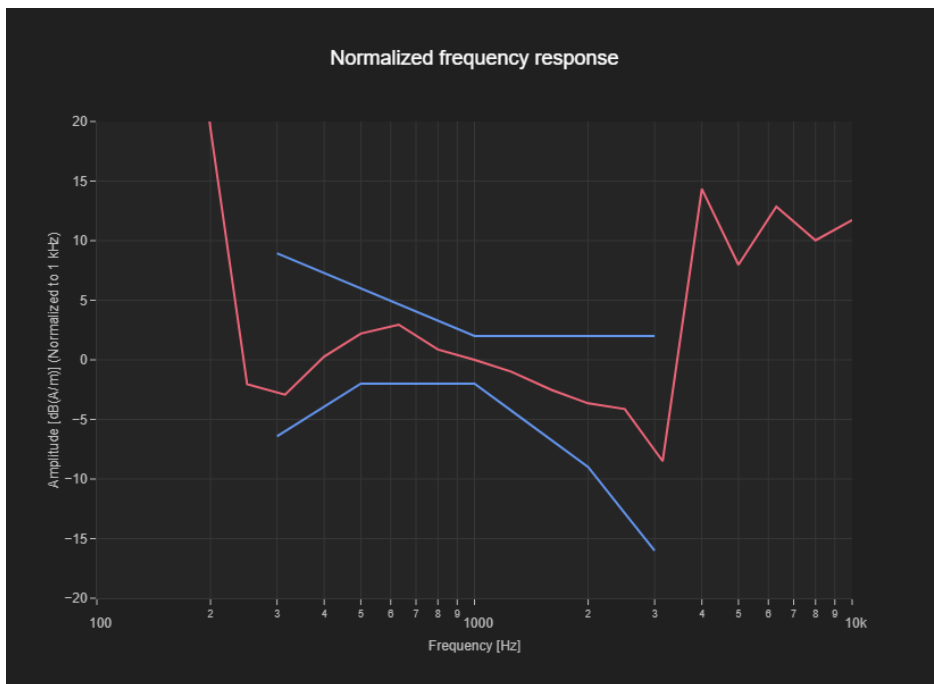

Figure B.14 Frequency Response of LTE Band 66

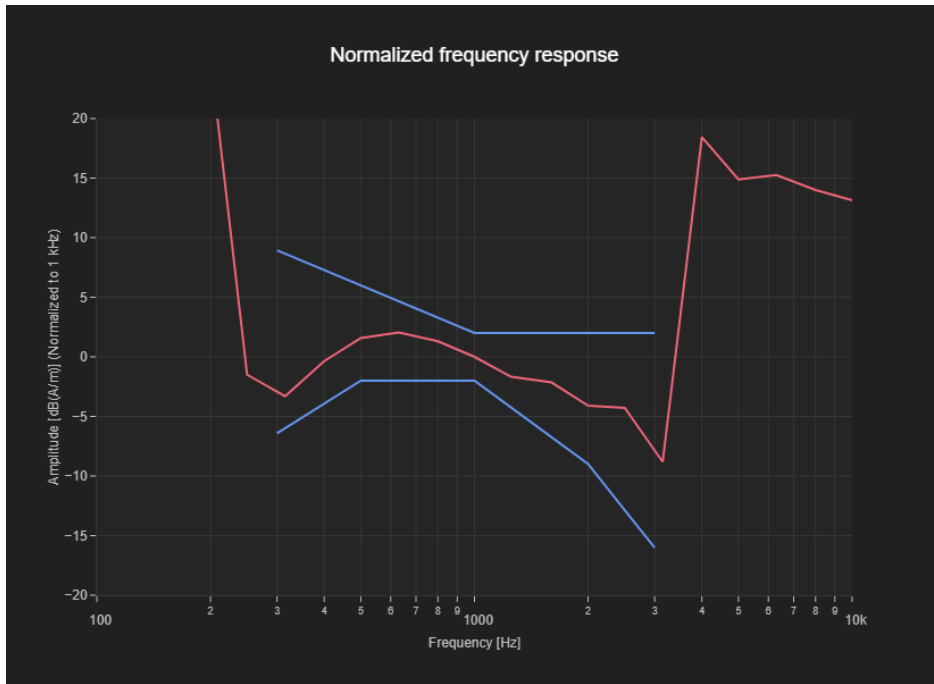

Figure B.15 Frequency Response of LTE Band 38

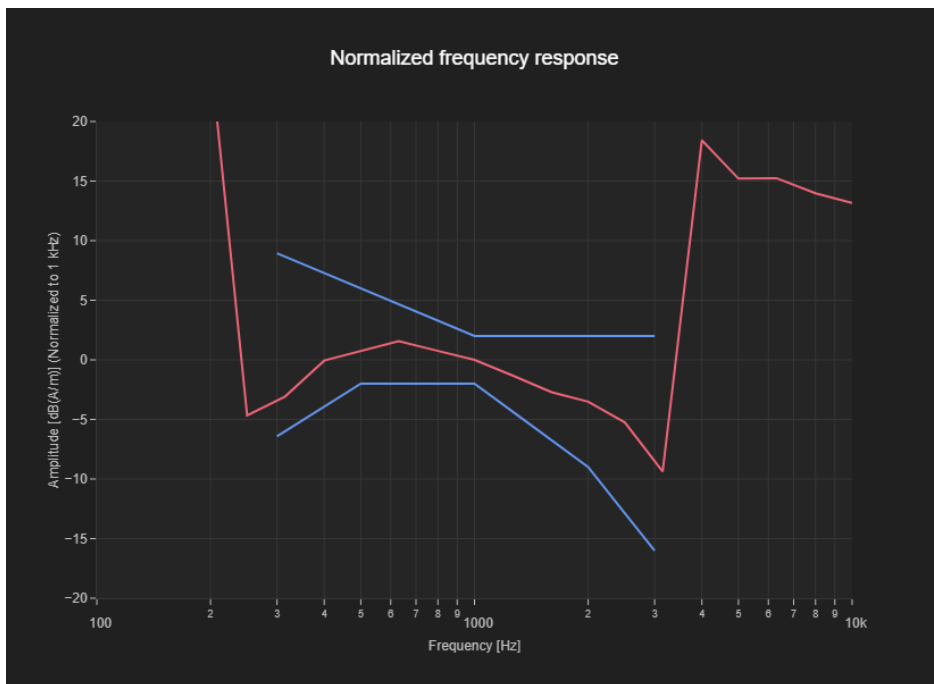

Figure B.16 Frequency Response of LTE Band 41

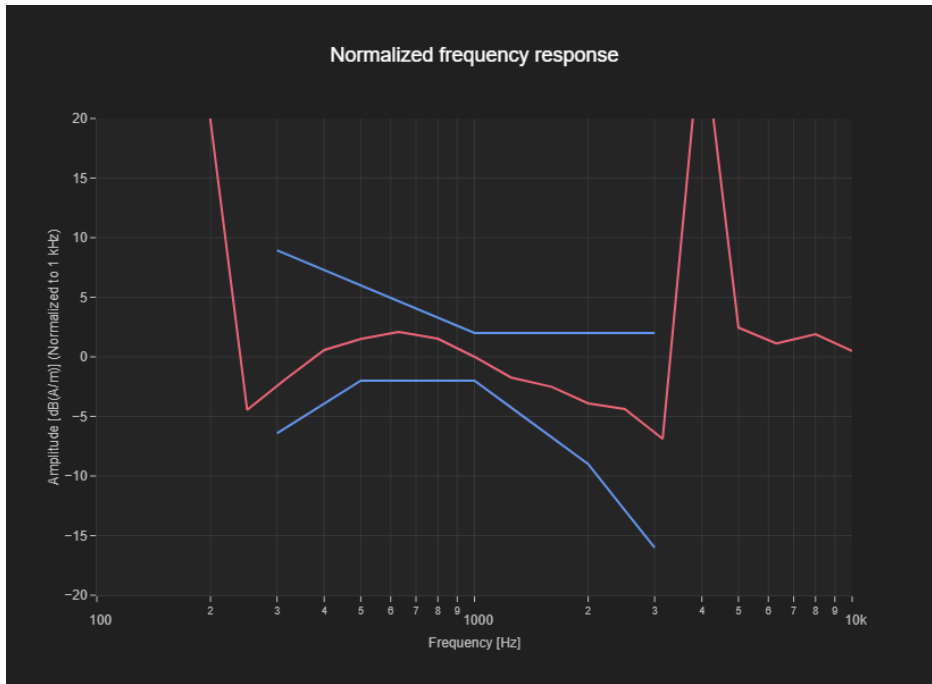

Figure B.17 Frequency Response of WLAN 2.4GHz

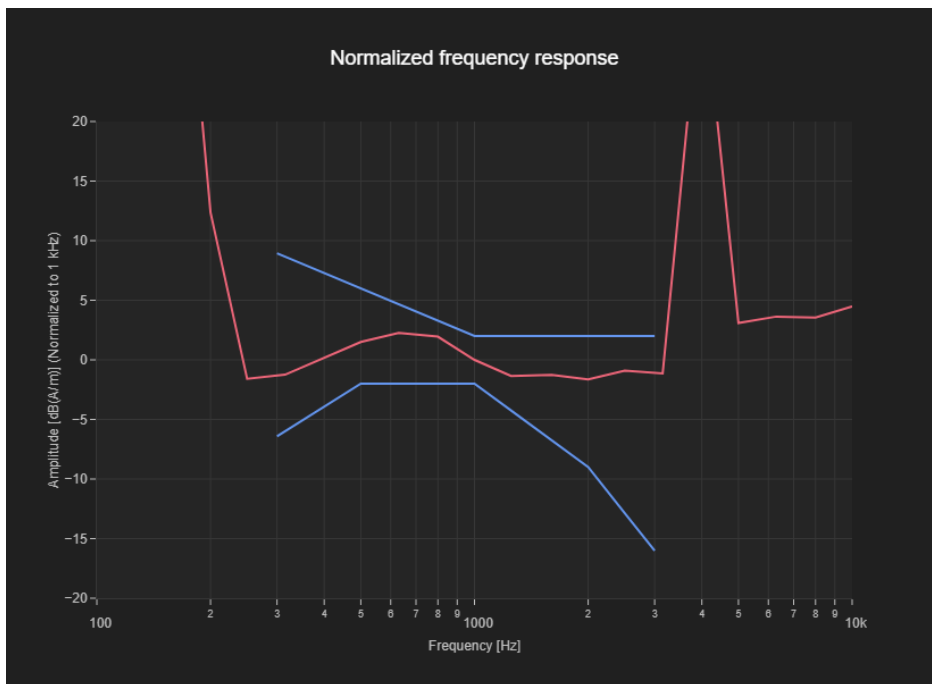

Figure B.18 Frequency Response of WLAN 5.2GHz

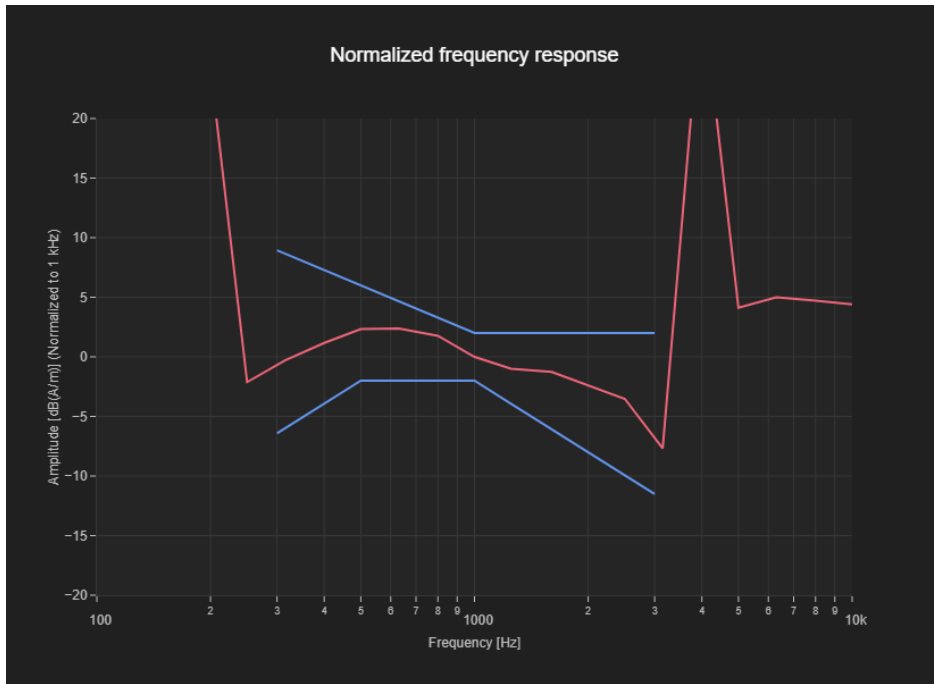

Figure B.19 Frequency Response of WLAN 5.3GHz

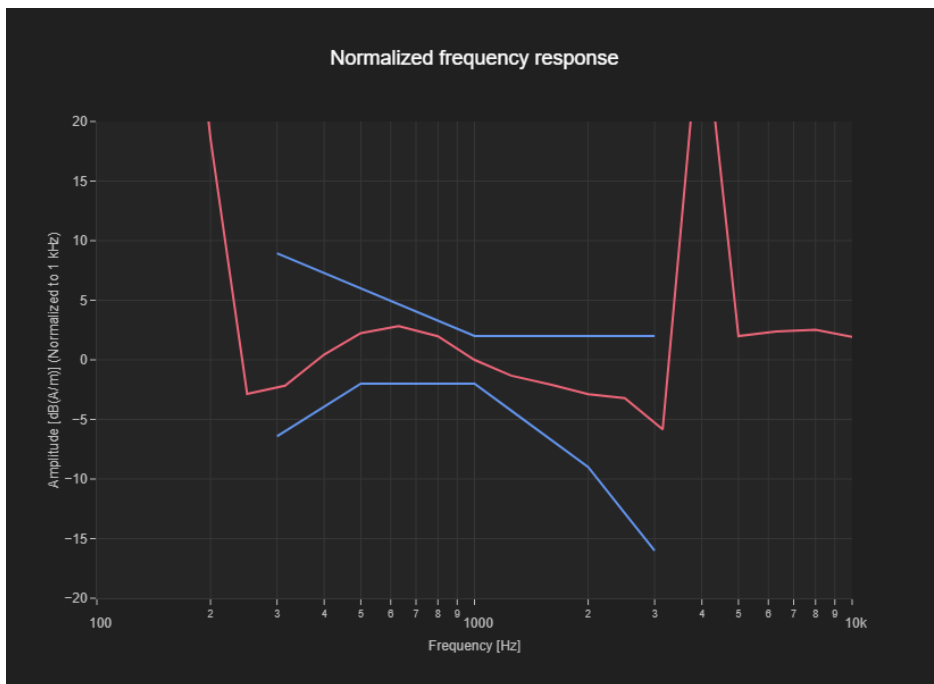

Figure B.20 Frequency Response of WLAN 5.5GHz

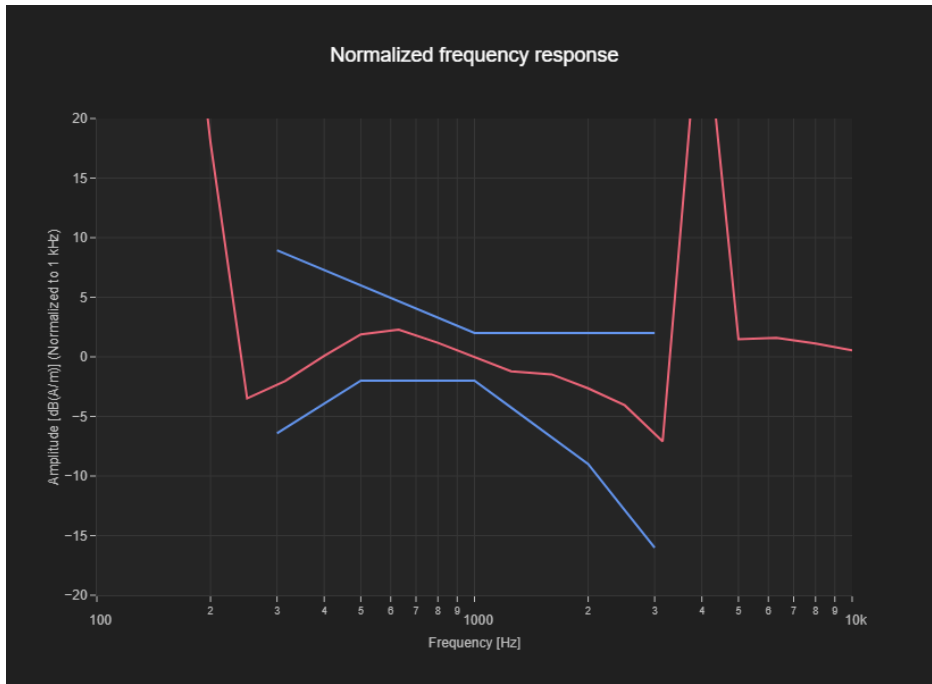

Figure B.21 Frequency Response of WLAN 5.8GHz

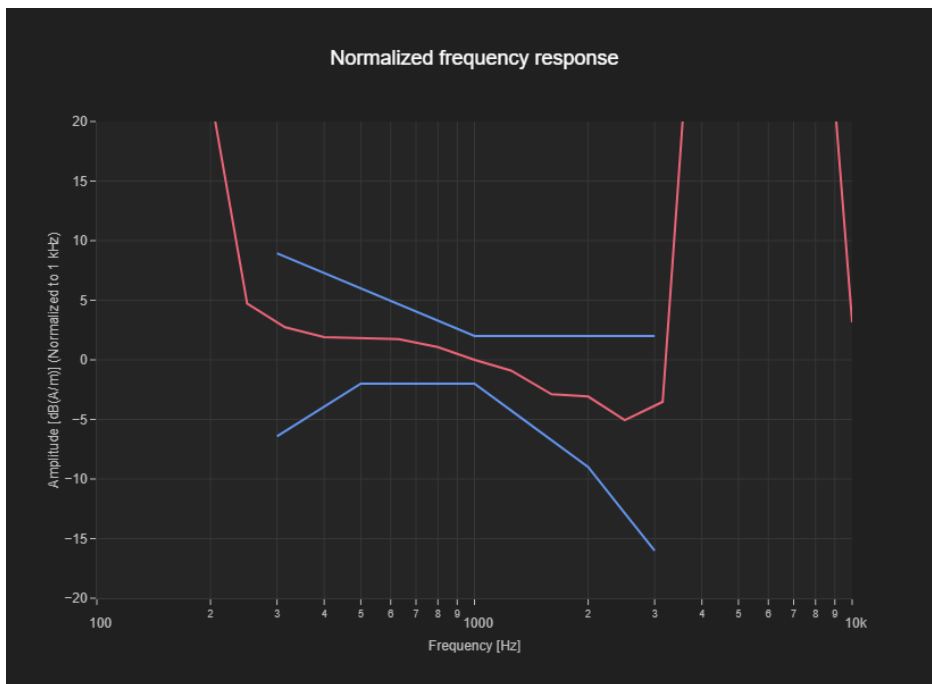

Figure B.22 Frequency Response of WCDMA Band 5 (MEET)

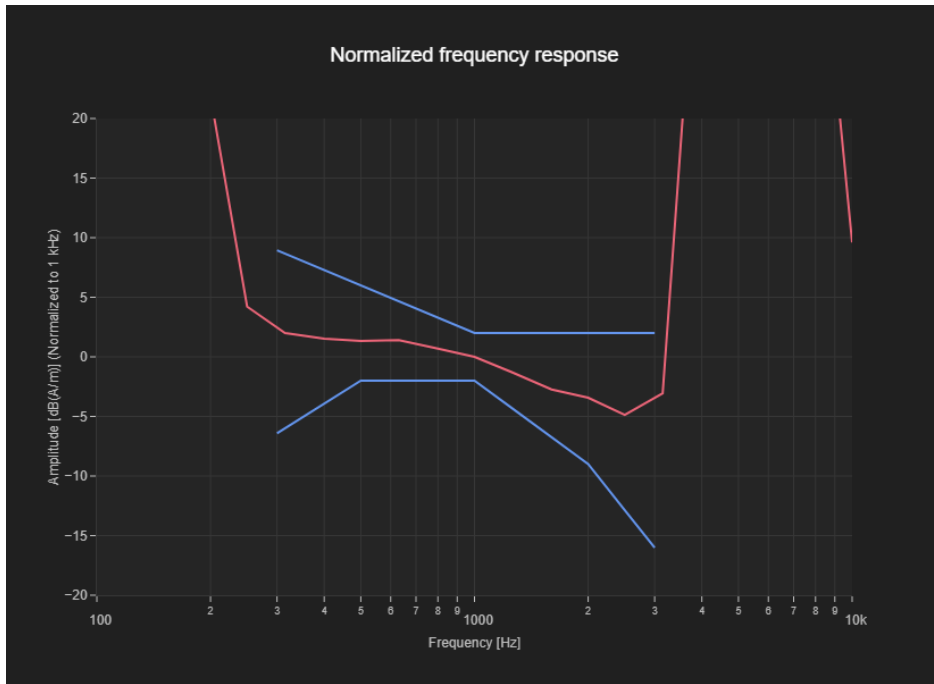

Figure B.23 Frequency Response of LTE Band 17 (MEET)

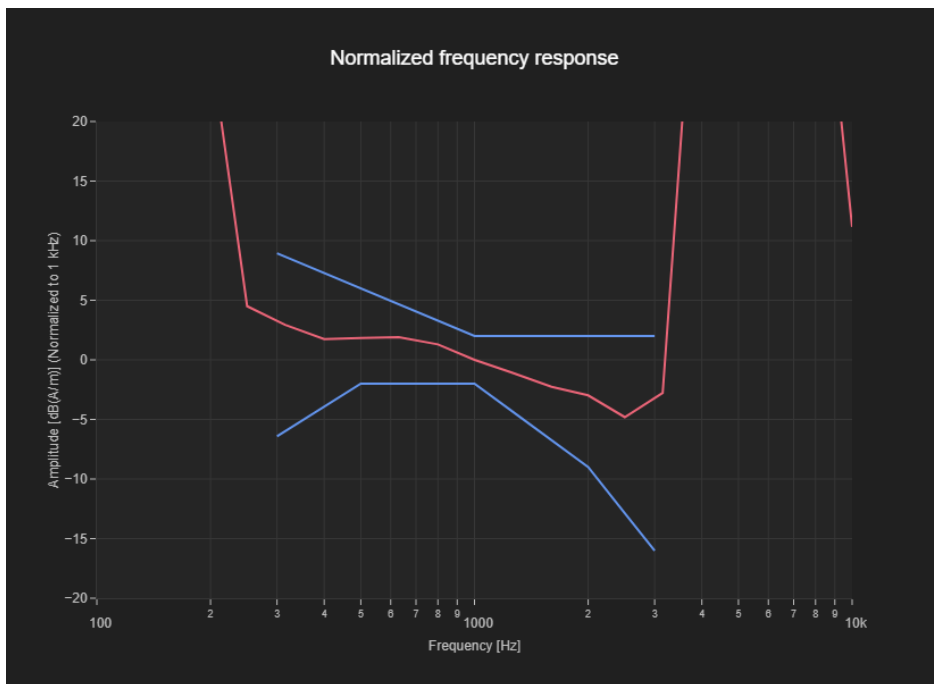

Figure B.24 Frequency Response of LTE Band 38 (MEET)

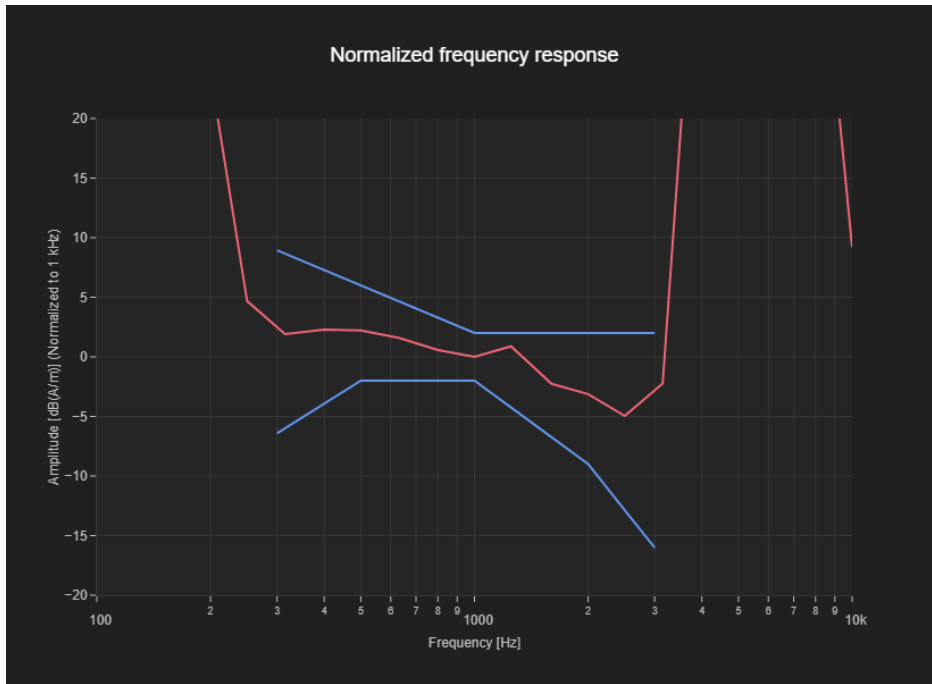

Figure B.25 Frequency Response of WLAN 2.4GHz (MEET)

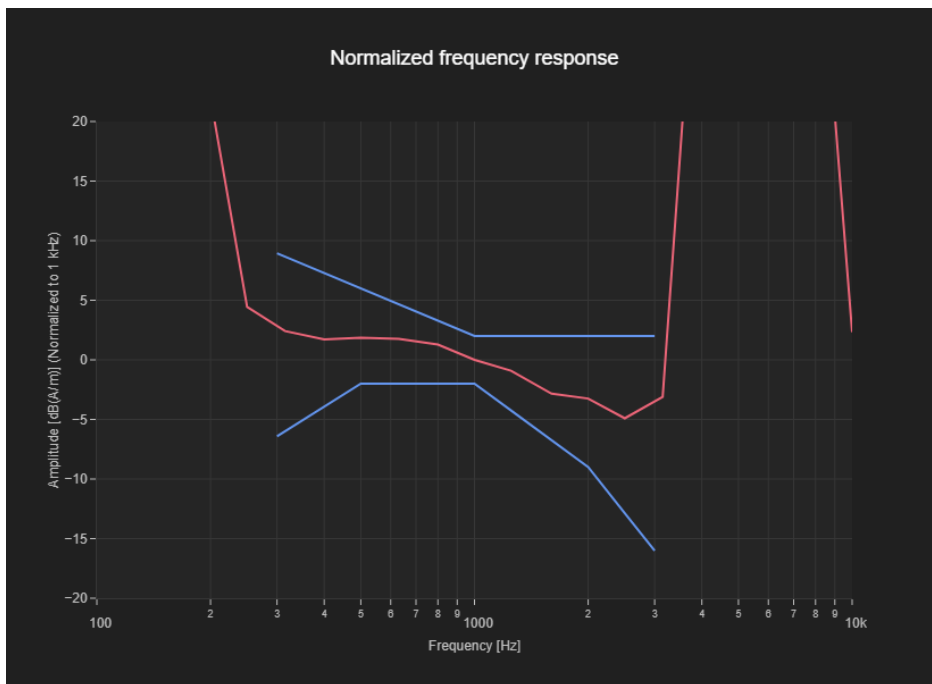

Figure B.26 Frequency Response of WLAN 5.3GHz (MEET)

ANNEX C: Probe Calibration Certificate

**Calibration Laboratory of
Schmid & Partner
Engineering AG**
Zeughausstrasse 43, 8004 Zurich, Switzerland





S Schweizerischer Kalibrierdienst
C Service suisse d'étalonnage
S Servizio svizzero di taratura
S Swiss Calibration Service

Accredited by the Swiss Accreditation Service (SAS)
The Swiss Accreditation Service is one of the signatories to the EA
Multilateral Agreement for the recognition of calibration certificates

Accreditation No.: **SCS 0108**

Client **TMC-SZ (Auden)**

Certificate No: **AM1DV3-3086_Feb21**

CALIBRATION CERTIFICATE			
Object	AM1DV3 - SN: 3086		
Calibration procedure(s)	QA CAL-24.v4 Calibration procedure for AM1D magnetic field probes and TMFS in the audio range		
Calibration date:	February 22, 2021		
<p>This calibration certificate documents the traceability to national standards, which realize the physical units of measurements (SI). The measurements and the uncertainties with confidence probability are given on the following pages and are part of the certificate.</p> <p>All calibrations have been conducted in the closed laboratory facility: environment temperature (22 ± 3)°C and humidity < 70%.</p> <p>Calibration Equipment used (M&TE critical for calibration)</p>			
Primary Standards	ID #	Cal Date (Certificate No.)	Scheduled Calibration
Keithley Multimeter Type 2001	SN: 0810278	07-Sep-20 (No. 28647)	Sep-21
Reference Probe AM1DV2	SN: 1008	15-Dec-20 (No. AM1DV2-1008_Dec20)	Dec-21
DAE4	SN: 781	23-Dec-20 (No. DAE4-781_Dec20)	Dec-21
Secondary Standards	ID #	Check Date (in house)	Scheduled Check
AMCC	SN: 1050	01-Oct-13 (in house check Oct-20)	Oct-23
AMMI Audio Measuring Instrument	SN: 1062	26-Sep-12 (in house check Oct-20)	Oct-23
Calibrated by:	Name Jeton Kastrati	Function Laboratory Technician	Signature 
Approved by:	Name Katja Pokovic	Function Technical Manager	Signature 
			Issued: February 22, 2021
This calibration certificate shall not be reproduced except in full without written approval of the laboratory.			

References

- [1] ANSI-C63.19-2007
American National Standard for Methods of Measurement of Compatibility between Wireless Communications Devices and Hearing Aids.
- [2] ANSI-C63.19-2011
American National Standard, Methods of Measurement of Compatibility between Wireless Communications Devices and Hearing Aids.
- [3] DASY5 manual, Chapter: Hearing Aid Compatibility (HAC) T-Coil Extension

Description of the AM1D probe

The AM1D Audio Magnetic Field Probe is a fully shielded magnetic field probe for the frequency range from 100 Hz to 20 kHz. The pickup coil is compliant with the dimensional requirements of [1+2]. The probe includes a symmetric low noise amplifier for the signal available at the shielded 3 pin connector at the side. Power is supplied via the same connector (phantom power supply) and monitored via the LED near the connector. The 7 pin connector at the end of the probe does not carry any signals, but determines the angle of the sensor when mounted on the DAE. The probe supports mechanical detection of the surface.

The single sensor in the probe is arranged in a tilt angle allowing measurement of 3 orthogonal field components when rotating the probe by 120° around its axis. It is aligned with the perpendicular component of the field, if the probe axis is tilted nominally 35.3° above the measurement plane, using the connector rotation and sensor angle stated below.

The probe is fully RF shielded when operated with the matching signal cable (shielded) and allows measurement of audio magnetic fields in the close vicinity of RF emitting wireless devices according to [1+2] without additional shielding.

Handling of the item

The probe is manufactured from stainless steel. In order to maintain the performance and calibration of the probe, it must not be opened. The probe is designed for operation in air and shall not be exposed to humidity or liquids. For proper operation of the surface detection and emergency stop functions in a DASY system, the probe must be operated with the special probe cup provided (larger diameter).

Methods Applied and Interpretation of Parameters

- *Coordinate System:* The AM1D probe is mounted in the DASY system for operation with a HAC Test Arch phantom with AMCC Helmholtz calibration coil according to [3], with the tip pointing to "southwest" orientation.
- *Functional Test:* The functional test preceding calibration includes test of Noise level RF immunity (1kHz AM modulated signal). The shield of the probe cable must be well connected. Frequency response verification from 100 Hz to 10 kHz.
- *Connector Rotation:* The connector at the end of the probe does not carry any signals and is used for fixation to the DAE only. The probe is operated in the center of the AMCC Helmholtz coil using a 1 kHz magnetic field signal. Its angle is determined from the two minima at nominally +120° and -120° rotation, so the sensor in the tip of the probe is aligned to the vertical plane in z-direction, corresponding to the field maximum in the AMCC Helmholtz calibration coil.
- *Sensor Angle:* The sensor tilting in the vertical plane from the ideal vertical direction is determined from the two minima at nominally +120° and -120°. DASY system uses this angle to align the sensor for radial measurements to the x and y axis in the horizontal plane.
- *Sensitivity:* With the probe sensor aligned to the z-field in the AMCC, the output of the probe is compared to the magnetic field in the AMCC at 1 kHz. The field in the AMCC Helmholtz coil is given by the geometry and the current through the coil, which is monitored on the precision shunt resistor of the coil.



AM1D probe identification and configuration data

Item	AM1DV3 Audio Magnetic 1D Field Probe
Type No	SP AM1 001 BA
Serial No	3086

Overall length	296 mm
Tip diameter	6.0 mm (at the tip)
Sensor offset	3.0 mm (centre of sensor from tip)
Internal Amplifier	20 dB

Manufacturer / Origin	Schmid & Partner Engineering AG, Zurich, Switzerland
-----------------------	--

Calibration data

Connector rotation angle	(in DASY system)	204.9 °	+/- 3.6 ° (k=2)
Sensor angle	(in DASY system)	1.35 °	+/- 0.5 ° (k=2)
Sensitivity at 1 kHz	(in DASY system)	0.00743 V/(A/m)	+/- 2.2 % (k=2)

The reported uncertainty of measurement is stated as the standard uncertainty of measurement multiplied by the coverage factor k=2, which for a normal distribution corresponds to a coverage probability of approximately 95%.



ANNEX D: DAE Calibration Certificate



In Collaboration with
s p e a g
CALIBRATION LABORATORY

Add: No.52 HuaYuanBei Road, Haidian District, Beijing, 100191, China
Tel: +86-10-62304633-2117
E-mail: emf@caict.ac.cn <http://www.caict.ac.cn>



中国认可
国际互认
校准
CALIBRATION
CNAS L0570

Client : **SAICT** Certificate No: **J23Z60348**

CALIBRATION CERTIFICATE

Object: **DAE4 - SN: 1527**

Calibration Procedure(s): **FF-Z11-002-01
Calibration Procedure for the Data Acquisition Electronics (DAEx)**

Calibration date: **August 07, 2023**

This calibration Certificate documents the traceability to national standards, which realize the physical units of measurements(SI). The measurements and the uncertainties with confidence probability are given on the following pages and are part of the certificate.

All calibrations have been conducted in the closed laboratory facility: environment temperature(22±3)°C and humidity<70%.

Calibration Equipment used (M&TE critical for calibration)

Primary Standards	ID #	Cal Date(Calibrated by, Certificate No.)	Scheduled Calibration
Process Calibrator 753	1971018	12-Jun-23 (CTTL, No.J23X05436)	Jun-24

	Name	Function
Calibrated by:	Yu Zongying	SAR Test Engineer
Reviewed by:	Lin Hao	SAR Test Engineer
Approved by:	Qi Dianyuan	SAR Project Leader

Signature



Issued: August 13, 2023

This calibration certificate shall not be reproduced except in full without written approval of the laboratory.



Add: No.52 HuaYuanBei Road, Haidian District, Beijing, 100191, China
Tel: +86-10-62304633-2117
E-mail: emf@caict.ac.cn <http://www.caict.ac.cn>

Glossary:

DAE data acquisition electronics
Connector angle information used in DASY system to align probe sensor X to the robot coordinate system.

Methods Applied and Interpretation of Parameters:

- *DC Voltage Measurement:* Calibration Factor assessed for use in DASY system by comparison with a calibrated instrument traceable to national standards. The figure given corresponds to the full scale range of the voltmeter in the respective range.
- *Connector angle:* The angle of the connector is assessed measuring the angle mechanically by a tool inserted. Uncertainty is not required.
- The report provide only calibration results for DAE, it does not contain other performance test results.



 In Collaboration with
s p e a g
 CALIBRATION LABORATORY



Add: No.52 HuaYuanBei Road, Haidian District, Beijing, 100191, China
 Tel: +86-10-62304633-2117
 E-mail: emf@caict.ac.cn <http://www.caict.ac.cn>

DC Voltage Measurement

A/D - Converter Resolution nominal

High Range: 1LSB = 6.1μV, full range = -100...+300 mV
 Low Range: 1LSB = 61nV, full range = -1.....+3mV

DASY measurement parameters: Auto Zero Time: 3 sec; Measuring time: 3 sec

Calibration Factors	X	Y	Z
High Range	403.899 ± 0.15% (k=2)	403.622 ± 0.15% (k=2)	403.838 ± 0.15% (k=2)
Low Range	3.95893 ± 0.7% (k=2)	3.98923 ± 0.7% (k=2)	3.96778 ± 0.7% (k=2)

Connector Angle

Connector Angle to be used in DASY system	62° ± 1 °
---	-----------

*****END OF REPORT*****