



# FCC PART 15 TEST REPORT No.23T04Z80619-10

for

**TCL Communication Ltd.**

**GSM/UMTS/LTE mobile phone**

**T509A**

**FCC ID: 2ACCJB216**

with

**Hardware Version: 05**

**Software Version: BL3F**

**Issued Date: 2024-01-02**

**Note:**

The test results in this test report relate only to the devices specified in this report. This report shall not be reproduced except in full without the written approval of CTTL.

**Test Laboratory:**

**CTTL-Telecommunication Technology Labs, CAICT**

No. 52, Huayuan North Road, Haidian District, Beijing, P. R. China 100191.

Tel:+86(0)10-62304633-2512, Fax:+86(0)10-62304633-2504

Email: [cttl\\_terminals@caict.ac.cn](mailto:cttl_terminals@caict.ac.cn), website: [www.caict.ac.cn](http://www.caict.ac.cn)



## **REPORT HISTORY**

<b>Report Number</b>	<b>Revision</b>	<b>Description</b>	<b>Issue Date</b>
23T04Z80619-10	Rev.0	1st edition	2024-01-02

Note: the latest revision of the test report supersedes all previous version.

## **CONTENTS**

<b>CONTENTS</b> .....	<b>3</b>
<b>1. TEST LABORATORY</b> .....	<b>4</b>
1.1. INTRODUCTION & ACCREDITATION .....	4
1.2. TESTING LOCATION .....	4
1.3. TESTING ENVIRONMENT .....	4
1.4. PROJECT DATE .....	4
1.5. SIGNATURE .....	4
<b>2. CLIENT INFORMATION</b> .....	<b>5</b>
2.1. APPLICANT INFORMATION .....	5
2.2. MANUFACTURER INFORMATION .....	5
<b>3. EQUIPMENT UNDER TEST (EUT) AND ANCILLARY EQUIPMENT (AE)</b> .....	<b>6</b>
3.1. ABOUT EUT .....	6
3.2. INTERNAL IDENTIFICATION OF EUT USED DURING THE TEST .....	6
3.3. GENERAL DESCRIPTION .....	6
<b>4. REFERENCE DOCUMENTS</b> .....	<b>7</b>
4.1. DOCUMENTS SUPPLIED BY APPLICANT .....	7
4.2. REFERENCE DOCUMENTS FOR TESTING .....	7
<b>5. LABORATORY ENVIRONMENT</b> .....	<b>7</b>
<b>6. TEST RESULTS</b> .....	<b>7</b>
6.1. SUMMARY OF TEST RESULTS .....	7
6.2. STATEMENTS .....	7
6.3. TEST CONDITIONS .....	8
<b>7. TEST FACILITIES UTILIZED</b> .....	<b>8</b>
<b>ANNEX A: DETAILED TEST RESULTS</b> .....	<b>9</b>
A.1. MEASUREMENT METHOD .....	9
A.2. CHANNEL MOVE TIME AND CHANNEL CLOSING TRANSMISSION TIME .....	11
A.3. NON-OCCUPANCY PERIOD .....	14
A3.1 ASSOCIATED TEST .....	14
<b>ANNEX B: EUT PARAMETERS</b> .....	<b>15</b>
<b>ANNEX C: ACCREDITATION CERTIFICATE</b> .....	<b>16</b>

## 1. Test Laboratory

### 1.1. Introduction & Accreditation

Telecommunication Technology Labs, CAICT is an ISO/IEC 17025:2017 accredited test laboratory under American Association for Laboratory Accreditation (A2LA) with lab code 7049.01, and is also an FCC accredited test laboratory (CN1349), and ISED accredited test laboratory (CAB identifier:CN0066). The detail accreditation scope can be found on A2LA website.

### 1.2. Testing Location

Conducted testing Location: CTTL(Huayuan North Road)

Address: No. 52, Huayuan North Road, Haidian District, Beijing,  
P. R. China100191

### 1.3. Testing Environment

Normal Temperature: 15-35°C

Relative Humidity: 20-75%

### 1.4. Project date

Testing Start Date: 2023-11-28

Testing End Date: 2024-01-02

### 1.5. Signature



---

Yao Xingyu

(Prepared this test report)

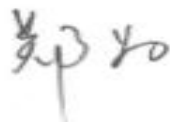

---

Zheng Wei

(Reviewed this test report)



---

Pang Shuai

(Approved this test report)



## **2. Client Information**

### **2.1. Applicant Information**

Company Name: TCL Communication Ltd.  
Address: 5/F, Building 22E, 22 Science Park East Avenue, Hong Kong Science  
Park, Shatin, NT, Hong Kong  
City: Hong Kong  
Postal Code: /  
Country: China  
Telephone: 0086-755-3661 1621  
Fax: 0086-755-36612000-81722

### **2.2. Manufacturer Information**

Company Name: TCL Communication Ltd.  
Address: 5/F, Building 22E, 22 Science Park East Avenue, Hong Kong Science  
Park, Shatin, NT, Hong Kong  
City: Hong Kong  
Postal Code: /  
Country: China  
Telephone: 0086-755-3661 1621  
Fax: 0086-755-36612000-81722

### **3. Equipment Under Test (EUT) and Ancillary Equipment (AE)**

#### **3.1. About EUT**

Description	GSM/UMTS/LTE mobile phone
Model name	T509A
FCC ID	2ACCJB216
WLAN Frequency Band	ISM Band: -5250MHz~5350MHz -5470MHz~5725MHz
Type of modulation	OFDM
Antenna	Integral Antenna
Extreme vol. Limits	3.8V
Device Type (DFS)	Client without radar detection(only support client mode)
TPC mechanism	Not support
Antenna gain	1.5dBi
Nominal Voltage	3.87V
Extreme High Voltage	4.45V
Extreme Low Voltage	3.6V

#### **3.2. Internal Identification of EUT used during the test**

<b>EUT ID*</b>	<b>S/N</b>	<b>HW Version</b>	<b>SW Version</b>	<b>Date of receipt</b>
UT06a	359735330000819/ 359735330000934	05	BL3F	2023-11-28

\*EUT ID: is used to identify the test sample in the lab internally.

#### **3.3. General Description**

The Equipment Under Test (EUT) is a model of GSM/UMTS/LTE mobile phone with integrated antenna. It consists of normal options: lithium battery, charger. Manual and specifications of the EUT were provided to fulfil the test.

## 4. Reference Documents

### 4.1. Documents supplied by applicant

EUT feature information is supplied by the applicant or manufacturer, which is the basis of testing.

### 4.2. Reference Documents for testing

The following documents listed in this section are referred for testing.

FCC Part15	FCC CFR 47, Part 15, Subpart E: 15.407 General technical requirements.	2021
KDB 905462 D03	UNII Clients Without Radar Detection New Rules v01r02 COMPLIANCE MEASUREMENT PROCEDURES FOR UNLICENSED-NATIONAL INFORMATION	2016
KDB 905462 D02	INFRASTRUCTURE DEVICES OPERATING IN THE 5250-5350 MHz AND 5470-5725 MHz BANDS INCORPORATING DYNAMIC FREQUENCY SELECTION	2016

## 5. Laboratory Environment

Measurement is performed in shielding room.

## 6. Test Results

### 6.1. Summary of Test Results

SUMMARY OF MEASUREMENT RESULTS	Sub-clause of Part15E	Verdict
Channel move time and channel closing transmission time	15.407 (h)(2)(iii)	P
Non-Occupancy Period	15.407 (h)(2) (iv)	P

Please refer to **ANNEX A** for detail.

Terms used in Verdict column

P	Pass, The EUT complies with the essential requirements in the standard.
NM	Not measured, The test was not measured by CTTL
NA	Not Applicable, The test was not applicable
F	Fail, The EUT does not comply with the essential requirements in the standard

### 6.2. Statements

CTTL has evaluated the test cases as listed in section 6.1 of this report for the EUT specified in section 3 according to the standards or reference documents listed in section 4.

This report only deal with the UNII DFS functions among the features described in section 3, and The EUT met all requirements of the reference documents.

The end user is not available to get and modify the parameters of the detected Radar Waveforms in this product.

### 6.3. Test Conditions

For this report, all the test cases are tested under normal temperature and normal voltage, and also under norm humidity, the specific condition is shown as follows:

Temperature	26°C
Voltage	3.87V
Humidity	44%

## 7. Test Facilities Utilized

### Conducted test system

No.	Equipment	Model	Serial Number	Manufacturer	Calibration Period	Calibration Due Date
1	Vector Signal Analyzer	FSQ40	200089	Rohde & Schwarz	1 year	2024-07-04
2	Vector Signal Generator	SMU200A	103752	Rohde & Schwarz	1 year	2024-07-04
3	Shielding Room	S81	/	ETS-Lindgren	/	/



## **ANNEX A: Detailed Test Results**

### **A.1. Measurement Method**

#### **A.1.1. Conducted Measurements**

The below figure shows the DFS setup, where the EUT is a WLAN device operating in slave mode, without Radar Interference Detection function. This setup also contains a device operating in master mode. The radar test signals are injected into the master device. The EUT (slave device) is associated with the master device. WLAN traffic is generated by streaming the mpeg file from the master to the slave in full monitor video mode using the media player.

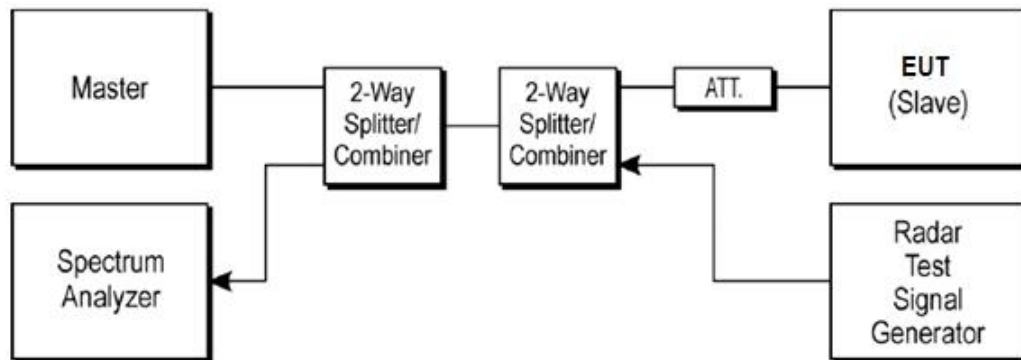

Note:

- 1) All Measurements are performed with the EUT's narrowest channel bandwidth.
- 2) The master device information is as follows  
 Vendor: RUCKUS  
 Model: R600  
 FCC ID: S9GR600
- 3) The software of radar signal generator (R&S SMU200A) is completely designed based on KDB 905462 requirement.

#### **A.1.2. Parameters of DFS test signal**

1). Interference threshold values, master or client incorporation in service monitoring. For device power less than 23dBm (E.I.R.P.), the threshold level is -62 dBm at the antenna port after correction for antenna gain and procedural adjustments.

Because of conducted measurement performed, the calibration power from radar signal generator to antenna port of DFS test equipment is -62 dBm.

<b>Maximum Transmit Power</b>	<b>Value</b>
> 200 mW	-64 dBm
< 200 mW	-62 dBm

The radar Detection Threshold, lowest antenna gain is the parameter of interference radar DFS detection threshold.

One 10 Second plot bee reported for the short Pulse Radar type 1-4 , the type 0 was be used, which was selected by auto test software.

Radar Waveform Calibration Result:

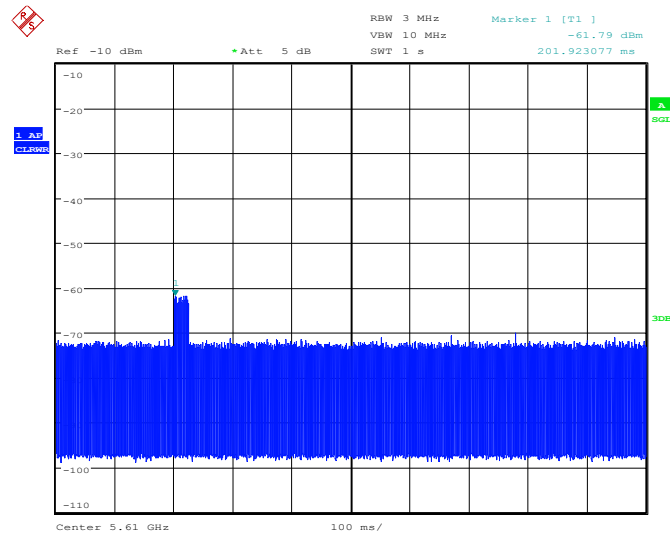

Date: 15.JAN.2022 06:39:49

**Fig.A.1 80M Calibration Result**

2). DFS requirement values

The required values are as the following table.

Parameter	Value
Non-occupancy	> 1800 s
Channel Availability Check Time	60 s
Channel Move Time	10 s
Channel Closing Transmission Time	200 ms + 60 ms
U-NII Detection Bandwidth	Minimum 80% of the 99% transmission power bandwidth

As the EUT is IP based system, the MPEG video file from NTIA website is used to steam to EUT via the Master device.

**A.1.3. Measurement Uncertainty**

Item	Measurement Uncertainty
Time	0.70 ms
Power	0.75 dBm

## A.2. Channel move time and channel closing transmission time

### Measurement Limit:

Test Items	Limit
channel closing transmission time	< 200 ms + 60 ms
Channel move time	< 10 s

### Measurement Results:

Frequency Band: 5250MHz ~ 5350MHz(80M-5290MHz)

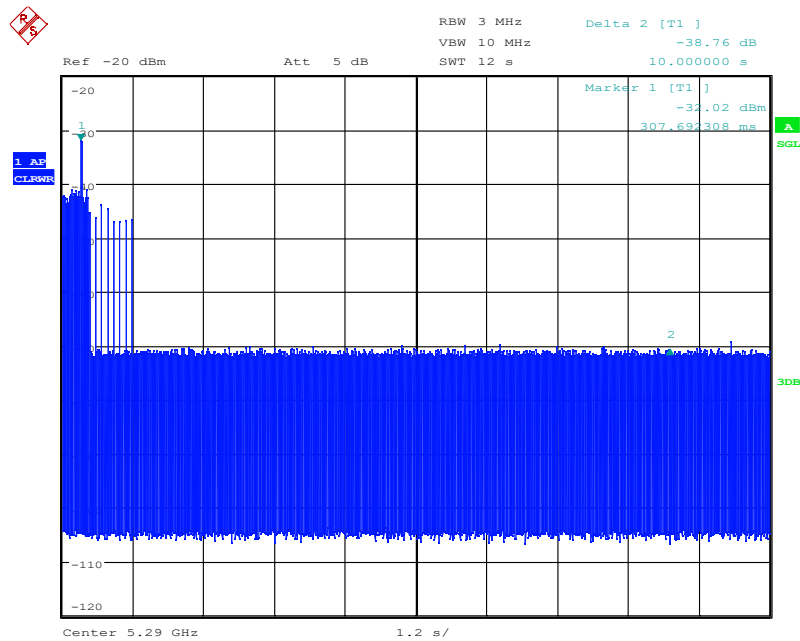

Date: 7.DEC.2023 15:10:23

**Fig.A.2 Channel move time**

The channel move time is as the figure. It shows the time of the radar and the client pulses. The figure shows that the client stops transmission within 10 seconds, and no transmissions occur after 10 seconds later of the radar burst signal.

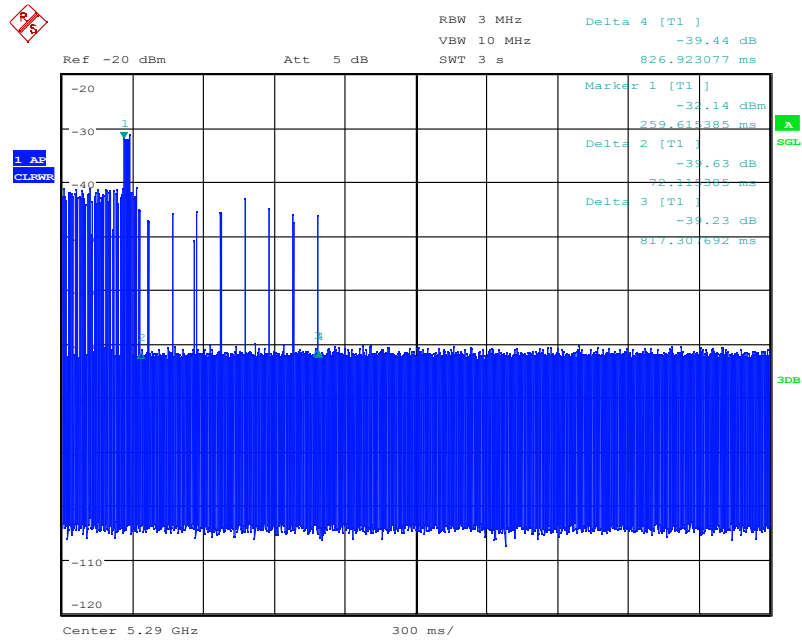

Date: 7.DEC.2023 15:04:04

**Fig.A.3 channel closing transmission time**

The closing transmission time is as the figure, and the result is  
 $187.44\text{ms} = \text{Delta}2 + (\text{Delta}4 - \text{Delta}3) * 12$ .

**Conclusion: PASS**

**Frequency Band 5470MHz ~ 5725MHz(80M-5530MHz)**

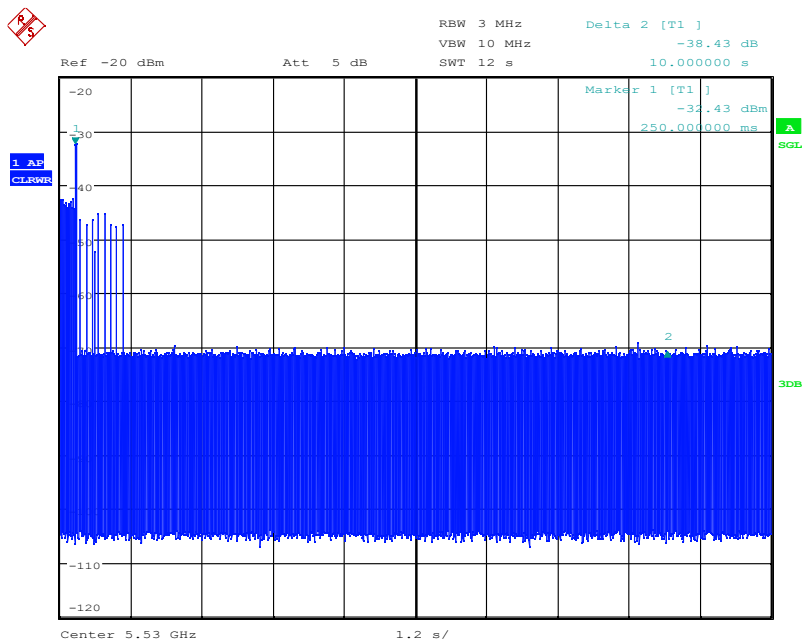

Date: 7.DEC.2023 16:24:49

**Fig.A.4 Channel move time**

The channel move time is as the figure. It shows the time of the radar and the client pulses. The figure shows that the client stops transmission within 10 seconds, and no transmissions occur after 10 seconds later of the radar burst signal.

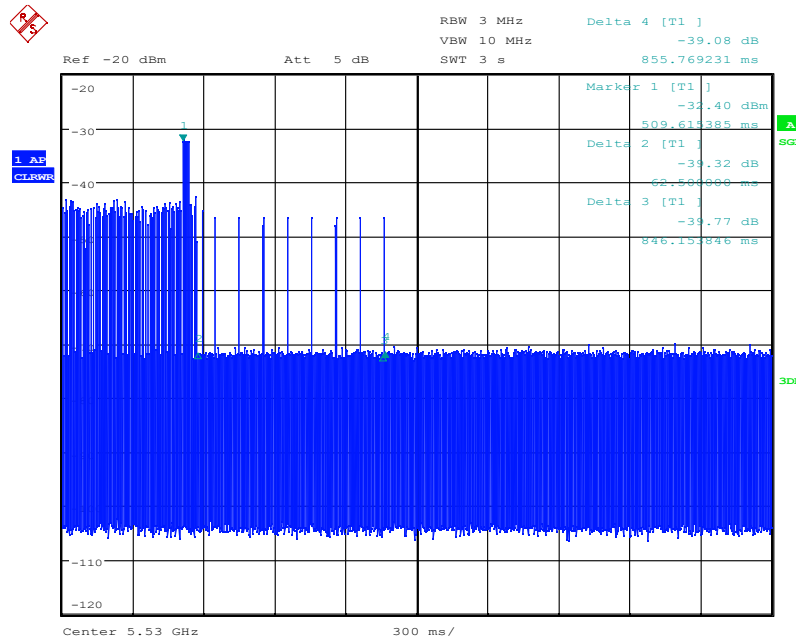

Date: 7.DEC.2023 16:16:51

**Fig.A.5 channel closing transmission time**

The closing transmission time is as the figure, and the result is  $168.32\text{ms} = \text{Delta}2 + (\text{Delta}4 - \text{Delta}3) * 11$ .

**Conclusion: PASS**

### A.3.Non-Occupancy Period

#### Measurement Limit:

Test Items	Limit
Non-Occupancy Period	> 1800 s

#### A3.1 Associated test

Associate the master and client, transmit specified stream between the master and client; monitor the analyzer on the operating frequency to make sure no beacons have been transmitted for 1800 seconds.

**Frequency Band: 5150MHz ~ 5350MHz(80M-5290MHz)**

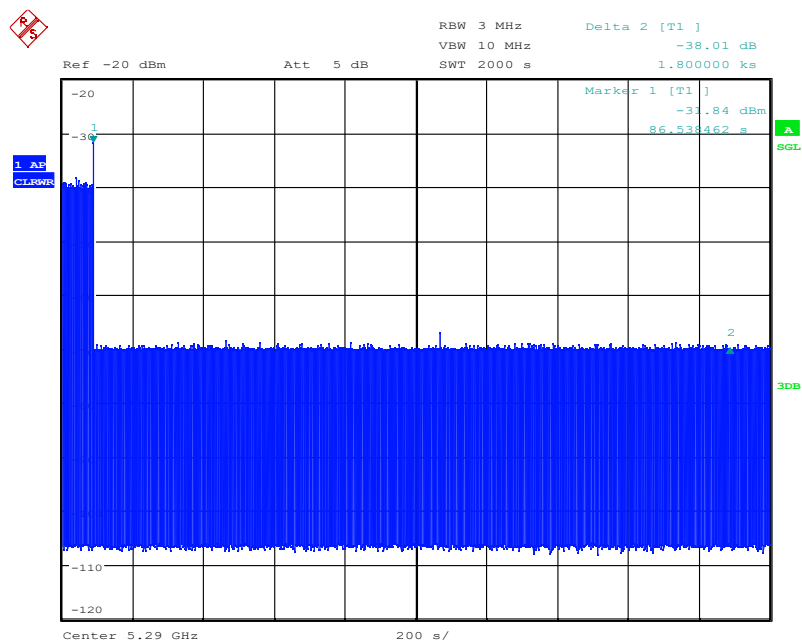

Date: 7.DEC.2023 15:51:04

**Fig.A.6 Non-Occupancy Period**

The figure above shows that the client does not transmit any emission within 1800 seconds after getting the order of “stop transmits” from the DFS master (access point).

**Conclusion: PASS**

**Frequency Band: 5470MHz ~ 5725MHz**

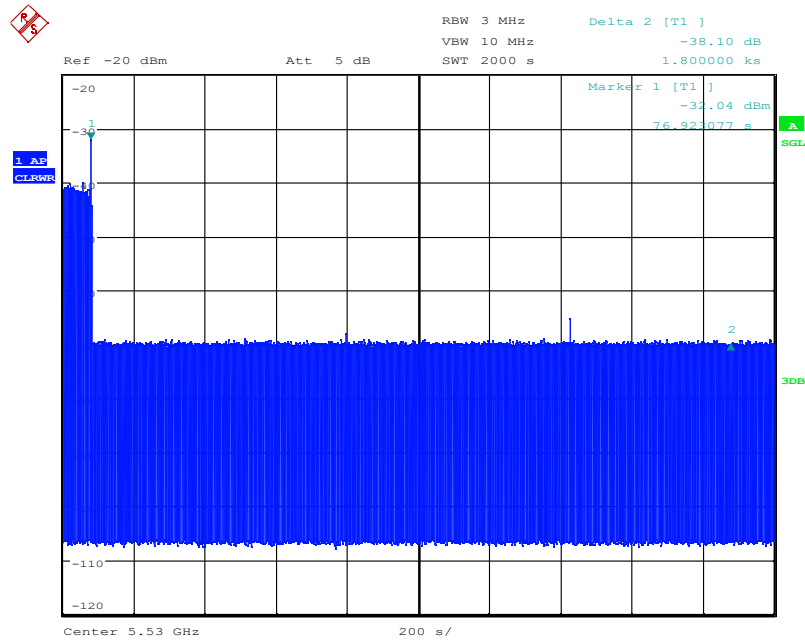

Date: 7.DEC.2023 17:02:07

**Fig.A.7 Non-Occupancy Period**

The figure above shows that the client does not transmit any emission within 1800 seconds after getting the order of “stop transmits” from the DFS master (access point).

**Conclusion: PASS**

**ANNEX B: EUT parameters**

Disclaimer: The antenna gain provided by the client may affect the validity of the measurement results in this report, and the client shall bear the impact and consequences arising therefrom.

## ANNEX C: Accreditation Certificate



### Accredited Laboratory

A2LA has accredited

### TELECOMMUNICATION TECHNOLOGY LABS, CAICT

Beijing, People's Republic of China

for technical competence in the field of

### Electrical Testing

This laboratory is accredited in accordance with the recognized International Standard ISO/IEC 17025:2017 *General requirements for the competence of testing and calibration laboratories*. This accreditation demonstrates technical competence for a defined scope and the operation of a laboratory quality management system (refer to joint ISO-ILAC-IAF Communiqué dated April 2017).



Presented this 26<sup>th</sup> day of June 2023.



Mr. Trace McInturf, Vice President, Accreditation Services  
For the Accreditation Council  
Certificate Number 7049.01  
Valid to July 31, 2024

*For the tests to which this accreditation applies, please refer to the laboratory's Electrical Scope of Accreditation.*

\*\*\* END OF REPORT BODY \*\*\*