



NFC TEST REPORT

No.I23Z60023-IOT05

for

TCL Communication Ltd.

GSM/UMTS/LTE mobile phone

Model Name: T610P

FCC ID: 2ACCJB198

with

Hardware Version: PIO

Software Version: 7GSA

Issued Date: 2023-02-02

Note:

The test results in this test report relate only to the devices specified in this report. This report shall not be reproduced except in full without the written approval of CTTL.

The report must not be used by the client to claim product certification, approval, or endorsement by NVLAP, NIST, or any agency of the U.S.Government.

Test Laboratory:

CTTL-Telecommunication Technology Labs, CAICT

No. 52, Huayuan North Road, Haidian District, Beijing, P. R. China 100191.

Tel:+86(0)10-62304633-2512, Fax:+86(0)10-62304633-2504

Email: ctl_terminals@caict.ac.cn, website: www.caict.ac.cn



REPORT HISTORY

Report Number	Revision	Description	Issue Date
I23Z60023-IOT05	Rev.0	1 st edition	2023-02-02

Note: the latest revision of the test report supersedes all previous version.

CONTENTS

1. TEST LABORATORY	4
1.1. INTRODUCTION & ACCREDITATION.....	4
1.2. TESTING LOCATION	4
1.3. TESTING ENVIRONMENT	5
1.4. PROJECT DATA	5
1.5. SIGNATURE.....	5
2. CLIENT INFORMATION.....	6
2.1. APPLICANT INFORMATION.....	6
2.2. MANUFACTURER INFORMATION.....	6
3. EQUIPMENT UNDER TEST (EUT) AND ANCILLARY EQUIPMENT (AE)	7
3.1. ABOUT EUT	7
3.2. INTERNAL IDENTIFICATION OF EUT	7
3.3. INTERNAL IDENTIFICATION OF AE	7
3.4. EUT SET-UPS.....	8
4. REFERENCE DOCUMENTS	9
4.1. DOCUMENTS SUPPLIED BY APPLICANT	9
4.2. REFERENCE DOCUMENTS FOR TESTING.....	9
5. TEST RESULTS	10
5.1. SUMMARY OF TEST RESULTS	10
5.2. STATEMENTS.....	10
6. TEST FACILITIES UTILIZED	11
7. MEASUREMENT UNCERTAINTY	12
ANNEX A: EUT PARAMETERS.....	13
ANNEX B: DETAILED TEST RESULTS.....	14
ANNEX C: PERSONS INVOLVED IN THIS TESTING	25
ANNEX D: ACCREDITATION CERTIFICATE	27



1. Test Laboratory

1.1. Introduction & Accreditation

Telecommunication Technology Labs, CAICT is an ISO/IEC 17025:2017 accredited test laboratory under NATIONAL VOLUNTARY LABORATORY ACCREDITATION PROGRAM (NVLAP) with lab code 600118-0, and is also an FCC accredited test laboratory (CN5017), and ISED accredited test laboratory (ISED#: 24849). The detail accreditation scope can be found on NVLAP website.

1.2. Testing Location

Location 1: CTTL(huayuan North Road)

Address: No. 52, Huayuan North Road, Haidian District, Beijing,
P. R. China 100191

1.3. Testing Environment

Normal Temperature: 15-35°C
Extreme Temperature: -20/+50°C
Normal Relative Humidity: 20-75%
Normal Air Pressure 86Kpa-106Kpa

1.4. Project data

Testing Start Date: 2023-01-11
Testing End Date: 2023-01-30

1.5. Signature

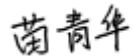

Miao Qinghua
(Prepared this test report)



Zhou Bin
(Reviewed this test report)



Pang Shuai
(Approved this test report)



2. Client Information

2.1. Applicant Information

Company Name: TCL Communication Ltd.
Address: 5/F, Building 22E, 22 Science Park East Avenue, Hong Kong Science Park, Shatin, NT, Hong Kong
Contact: Annie Jiang
Telephone: +86 755 3661 1621
Email: nianxiang.jiang@tcl.com

2.2. Manufacturer Information

Company Name: TCL Communication Ltd.
Address: 5/F, Building 22E, 22 Science Park East Avenue, Hong Kong Science Park, Shatin, NT, Hong Kong
Contact: Annie Jiang
Telephone: +86 755 3661 1621
Email: nianxiang.jiang@tcl.com

3. Equipment Under Test (EUT) and Ancillary Equipment (AE)

3.1. About EUT

Description	GSM/UMTS/LTE mobile phone
Model Name	T610P
FCC ID	2ACCJB198
GSM Frequency bands	850/900/1800/1900
UMTS Frequency bands	FDD I/II/IV/V/VIII
E-UTRA Frequency bands	FDD 1/2/3/4/5/7/8/12/13/17/28 A+B/66 TDD 38/40
Operating temperature	-10/+55°C
Extreme low voltage	3.6 V
Normal voltage	3.87 V
Extreme high voltage	4.45 V

3.2. Internal Identification of EUT

EUT ID*	SN or IMEI	HW Version	SW Version
UT08a	352422290200237/	PIO	7GSA
	352422290200245		
UT09a	352422290200054/	PIO	7GSA
	352422290200062		

*EUT ID: is used to identify the test sample in the lab internally.

3.3. Internal Identification of AE

AE ID*	Description	SN	Remarks
AE1	Battery	/	
AE2	Charger	/	
AE3	USB Cable	/	
AE1			
	Model	TLp049C8	
	Manufacturer	Dongguan Ganfeng Electronics Co., LTD	
	Capacity	4900mAh	
	Nominal Voltage	3.87V	
AE2			
	Model	YJC018R-US	
	Manufacturer	Dongguan YingJu Power Co., Ltd.	
AE3			
	Model	JWUB1520-M01R	
	Manufacturer	Huizhou Juwei Electronics Co., Ltd.	

*AE ID: is used to identify the ancillary equipment in the lab internally.



3.4. EUT Set-ups

EUT set-up No.	Combination of EUT and AE	Remarks
Set.NFC01	UT09a + AE1 + AE2+ AE3 + NFC Card	Charge
Set.NFC02	UT09a + AE1 + NFC card	NFC
Set.NFC03	UT08a	---

The Transmit State of NFC: the NFC function is on. The EUT will transmit the NFC data and command continuously during the test.

The Transmit state without modulation: The EUT will transmit the CW signal at the operating frequency.

4. Reference Documents

4.1. Documents supplied by applicant

EUT parameters, referring to Annex A for detailed information, are supplied by the client or manufacturer, which are the bases of testing.

4.2. Reference Documents for testing

The following documents listed in this section are referred for testing.

Reference	Title	Version
CFR 47 Part 2	Part 2 — Frequency Allocations and Radio Treaty Matters; General Rules and Regulations.	2019
CFR 47 Part 15	Part 15 — Radio Frequency Devices. Subpart C — Intentional Radiators. § 15.35 Measurement detector functions and bandwidths. § 15.207 Conducted limits. § 15.209 Radiated emission limits, general requirements. § 15.215 Additional provisions to the general radiated emission limitations. § 15.225 Operation within the band 13.110–14.010 MHz.	2019
ANSI C63.10	American National Standard of Procedures for Compliance Testing of Unlicensed Wireless Devices	2013

5. Test Results

5.1. Summary of Test Results

No	Test Cases	Clause in Regulation	Section in This Report	Verdict
1	Electric Field Strength of Fundamental Emissions	CFR 47 § 15.225(a)	B.1	P(Set. NFC02)
2	Electric Field Strength of Outside the Allocated Bands	CFR 47 § 15.225(b) CFR 47 § 15.225(c)		P(Set. NFC02)
3	Electric Field Radiated Emissions	CFR 47 § 15.209	B.2	P(Set. NFC01)
		CFR 47 § 15.225(d)	B.3	P(Set. NFC01)
4	Frequency Tolerance	CFR 47 § 15.225(e)	B.4	P(Set. NFC03)
5	20dB Bandwidth	CFR 47 § 15.215(c)	B.5	P(Set. NFC03)
6	Conducted Emissions	CFR 47 § 15.207	B.6	P(Set. NFC01)
The measurement is carried out according to ANSI C63.10. See ANNEX B for details.				

Test Conditions:

For this report, all the test cases listed above were tested under normal Temperature, Voltage, humidity and Air Pressure except the Frequency Tolerance test case. The specific conditions of Frequency Tolerance test case are listed in section B.4.3

See **Table 3** for terms for result verdict:

Table 1 Terms for result verdict

P	Pass, The EUT complies with the essential requirements in the standard.
NP	Not Perform, The test was not performed by CTTL
NA	Not Applicable, The test was not applicable
F	Fail, The EUT does not comply with the essential requirements in the standard

5.2. Statements

The test cases listed in Section 5.1 of this report for the EUT specified in Section 3 were performed by CTTL according to the reference documents in Section 4.

The EUT meets all applicable requirements of the regulations and standards in Section 4.2.

6. Test Facilities Utilized

NO.	NAME	TYPE	SERIES NUMBER	PRODUCER	CAL. DUE DATE	CAL. INTERVAL
1.	Spectrum Analyzer	FSL 6	100869	Rohde & schwarz	2023-10-21	1 Year
2.	Climatic chamber	SH242	93008658	ESPEC	2023-02-21	2 Year
3.	Spectrum Analyzer	FSQ26	200136	Rohde & schwarz	2023-01-13	1 Year
4.	Test Receiver	ESU26	100235	R&S	2023-03-08	1 Year
5.	H-field Antenna	HFH2-Z2	829324/007	R&S	2023-12-23	1 Year
6.	EMI Antenna	VULB 9163	01223	SCHWARZBECK	2023-07-25	1 Year
7.	Test Receiver	ESCI	100344	R&S	2023-03-21	1 Year
8.	LISN	ENV216	101200	R&S	2023-05-30	1 Year

Note: The Spectrum Analyzer which SERIES NUMBER is 200136 was before CAL. DUE DATE when used.

7. Measurement Uncertainty

Item	Uncertainty
Frequency Tolerance	$U = 73 \text{ Hz}, k=2$
20dB Bandwidth	$U = 72 \text{ Hz}, k=2$
Radiated Emissions(9kHz-30MHz)	$U = 4.92 \text{ dB}, k=2$
Radiated Emissions (30MHz-1GHz)	$U = 5.15 \text{ dB}, k=2$
Radiated Emissions (>1GHz)	$U = 5.54 \text{ dB}, k=2$
Conducted emission	$U = 3.08 \text{ dB}, k=2$



ANNEX A: EUT parameters

/

ANNEX B: Detailed Test Results

B.1. Electric Field Strength of Fundamental and Outside the Allocated bands

B.1.1. Reference

See CFR 47 Part 15 § 15.209

See CFR 47 Part 15 § 15.225

See Clause 4, Clause 5 of ANSI C63.10-2013 generally.

B.1.2. Measurement Methods

The transmitter carrier output levels (E-Field) from the EUT are measured in a semi-anechoic chamber. The EUT is placed on a non-conductive stand of 80cm high, and at a measurement distance of 3m from the receiving antenna. The center of the receiving loop antenna is 1.0 meter above the ground. The E-field is measured with a shielded loop antenna connected to a measurement receiver. Detected E-field was maximized by rotating the EUT through 360° and adjusting the receiving antenna polarizations. The maximization processes were repeated with the EUT positioned respectively in its three orthogonal axes. The measurements were performed with the peak detector and if required, the quasi-peak detector.

The measurement bandwidth is:

Table B-1: Measurement bandwidth

Frequency of Emission (MHz)	RBW/VBW
12.56-14.56	10/30 kHz

The E-field measured at 3m is calculated as:

$$\text{E-field (dB}\mu\text{V/m)} = \text{Rx (dB}\mu\text{V)} + \text{Cable Loss (dB)} + \text{AF@3m (dB/m)}$$

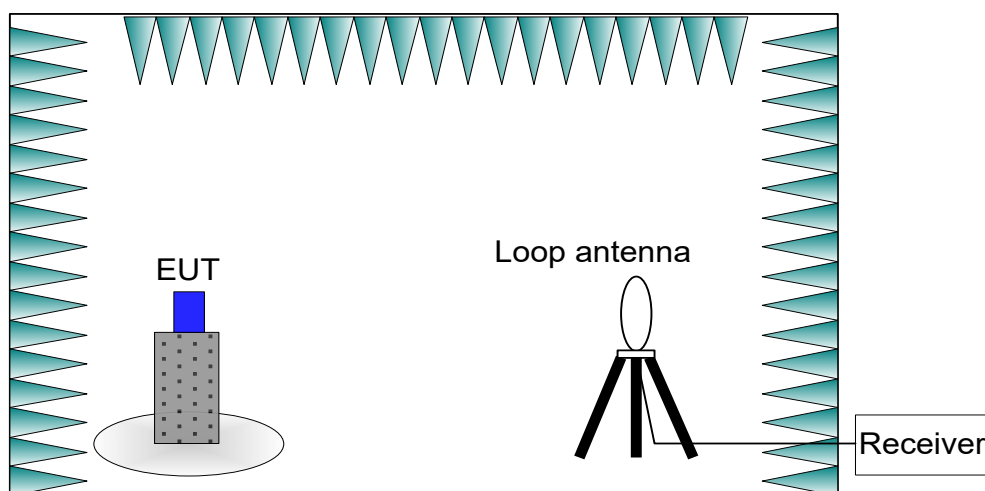

Figure B-1: Measurement Setup

B.1.3. EUT Operating Mode and Test Conditions

The measurement of EUT is carried out under the transmit state of NFC(See 3.4).

The EUT is powered by a travel adapter.

During the measurements, the ambient temperature of the electromagnetic anechoic chamber is in the range of 15 ~ 25 °C.

B.1.4. Limits

Table B-2: Limits

Frequency Range (MHz)	E-field Strength Limit @ 30 m (μV/m)	E-field Strength Limit @ 3 m (dBμV/m)
13.560 ± 0.007	+15,848	124
13.410 to 13.553 13.567 to 13.710	+334	90
13.110 to 13.410 13.710 to 14.010	+106	81

Note: Where the limits have been defined at one distance, and a signal level measured at another, the limits have been extrapolated using the following formula:

$$\text{Extrapolation(dB)} = 40\log_{10}(\text{Measurement Distance}/\text{Specification Distance})$$

B.1.5. Measurement Results

Measurement results of normal conditions see Figure B-2 for different set-ups of EUT. The results displayed take into account applicable antenna factors and cable losses.

Conclusions: Set.NFC02, **PASS.**

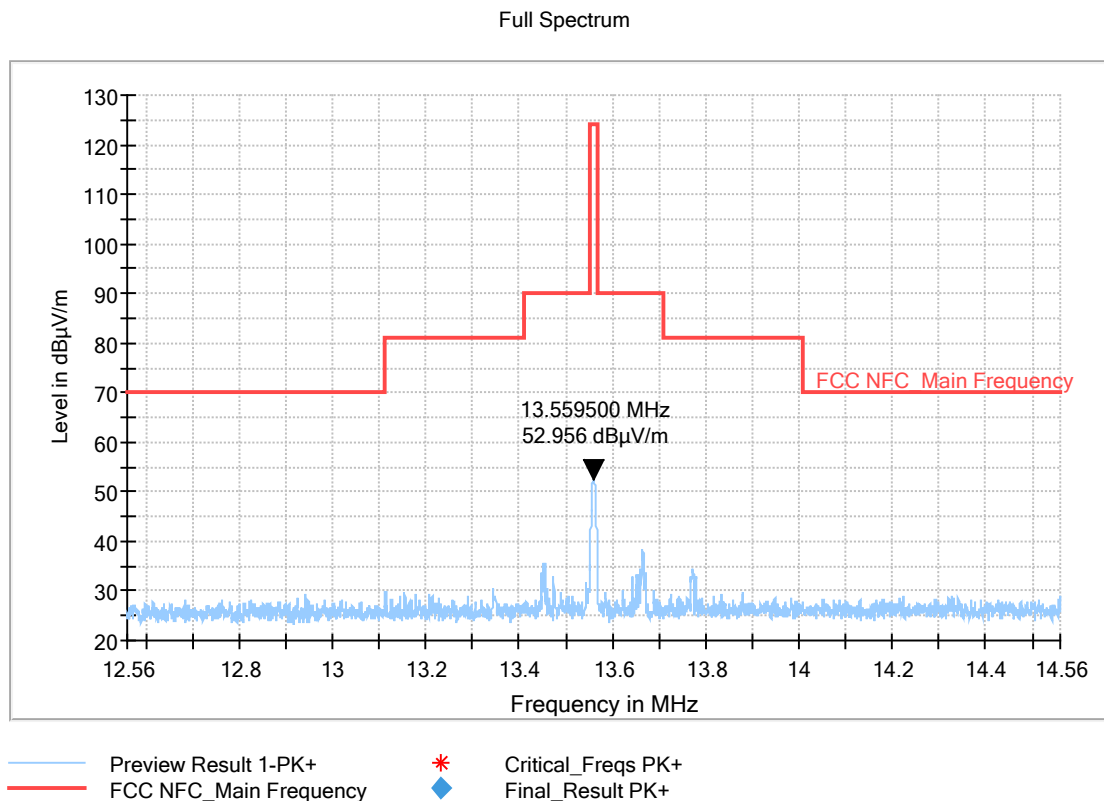

Figure B-2: Measurement results for Electric Field Strength of Fundamental and Outside the Allocated bands

B.2. Electric Field Radiated Emissions (< 30MHz)

B.2.1. Reference

See CFR 47 Part 15 § 15.209

See Clause 6.4 of ANSI C63.10-2013 specifically.

See Clause 4 and Clause 5 of ANSI C63.10-2013 generally.

B.2.2. Measurement Methods

The transmitter carrier output levels (E-Field) from the EUT are measured in a semi-anechoic chamber. The EUT is placed on a non-conductive stand of 80cm high, and at a measurement distance of 3m from the receiving antenna. The center of the receiving loop antenna is 1.0 meter above the ground. The E-field is measured with a shielded loop antenna connected to a measurement receiver. Detected E-field was maximized by rotating the EUT through 360° and adjusting the receiving antenna polarizations. The maximization processes were repeated with the EUT positioned respectively in its three orthogonal axes. The measurements were performed with the peak detector and if required, the quasi-peak detector.

The measurement bandwidth is:

Frequency of Emission (MHz)	RBW/VBW
0.009-0.15	100/300 Hz
0.15-30	10/30 kHz

The E-field measured at 3m is calculated as:

$$\text{E-field (dB}\mu\text{V/m)} = \text{Rx (dB}\mu\text{V)} + \text{Cable Loss (dB)} + \text{AF@3m (dB/m)}$$

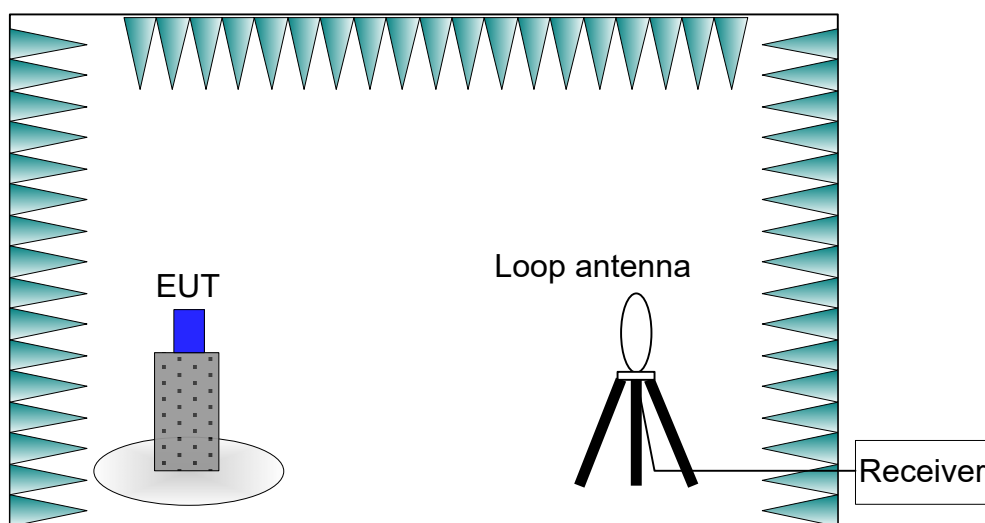

Figure B-3: Measurement Setup

B.2.3. EUT Operating Mode and Test Conditions

The measurement of EUT is carried out under the transmit state of NFC(See 3.4).

The EUT is powered by a travel adapter.

During the measurements, the ambient temperature of the electromagnetic anechoic chamber is in the range of 15 ~ 25 °C.

B.2.4. Limits

Frequency Range (MHz)	E-field Strength Limit @ 30m (mV/m)	E-field Strength Limit @ 3m (dBµV/m)
0.009-0.490	2400/F(kHz)	129-94
0.490-1.705	24000/F(kHz)	74-63
1.705-30	30	70

Note: Where the limits have been defined at one distance, and a signal level measured at another, the limits have been extrapolated using the following formula:
 Extrapolation(dB) = 40log₁₀(Measurement Distance/Specification Distance)

B.2.5. Measurement Results

Measurement results of normal conditions see Figure B-4 for different set-ups of EUT. The results displayed take into account applicable antenna factors and cable losses.

Conclusions: Set.NFC01, **PASS**.

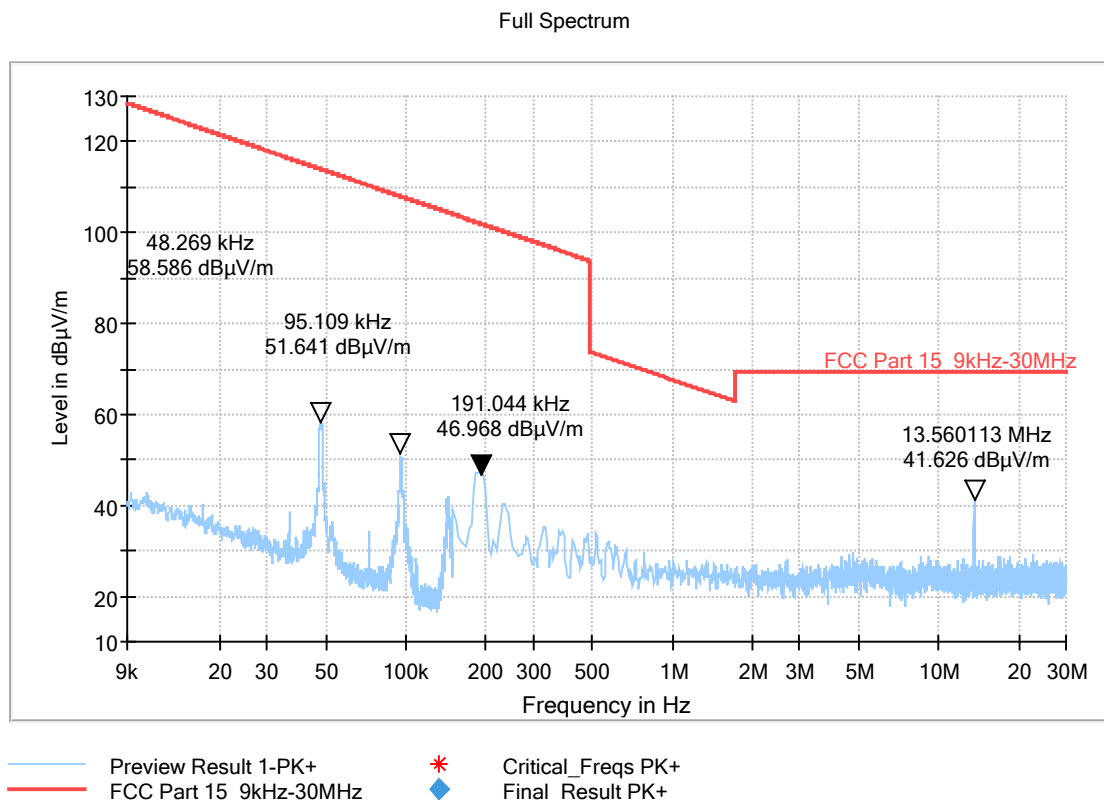

Figure B-4: Measurement results for Electric Field Radiated Emissions (< 30MHz)

B.3. Electric Field Radiated Emissions ($\geq 30\text{MHz}$)

B.3.1. Reference

See CFR 47 Part 15 § 15.209

See Clause 6.5 of ANSI C63.10-2013 specifically.

See Clause 4 and Clause 5 of ANSI C63.10-2013 generally.

B.3.2. Measurement Methods

The electric field radiated emissions from the EUT are measured in a semi-anechoic chamber. The EUT is placed on a non-conductive stand of 80cm high, and at a measurement distance of 10m from the receiving antenna. The receiving antennas connected to a measurement receiver. In order to search for maximum field strength emitted from the EUT, the receiving antenna can be moved between the height of 1.0 m to 4.0 m. Detected E-field was maximized at each frequency by rotating the EUT through 360° and adjusting the receiving antenna positions for both vertical and horizontal antenna polarizations. The maximization processes were repeated with the EUT positioned respectively in its three orthogonal axes. The measurements were performed with the peak detector and if required, the quasi-peak detector.

The measurement bandwidth is:

Frequency of Emission (MHz)	RBW/VBW
30-1000	120kHz

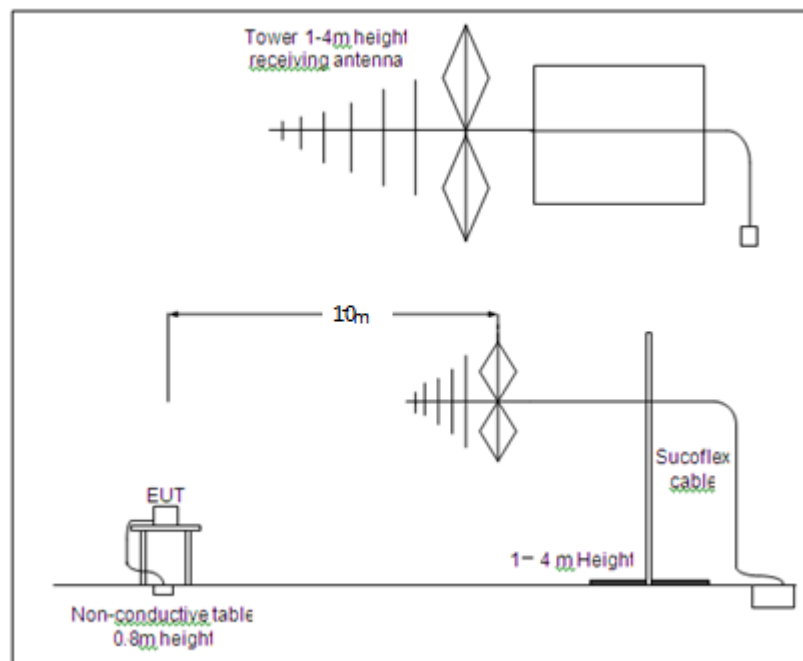

Figure B-5: Measurement Setup

B.3.3. EUT Operating Mode and Test Conditions

The measurement of EUT is carried out under the transmit state of NFC(See 3.4).

The EUT had been connected to a travel adapter.

During the measurements, the ambient temperature of the electromagnetic anechoic chamber is

in the range of 15 ~ 25 °C.

B.3.4. Limits

Frequency Range (MHz)	E-field Strength Limit @ 3m (mV/m)	E-field Strength Limit @ 3m (dB μ V/m)	E-field Strength Limit @ 10m (dB μ V/m)
30-88	100	40	30
88-216	150	43.5	33.5
216-960	200	46	36
960-1000	500	54	44

B.3.5. Measurement Results

Measurement results of normal conditions see Figure B-6 for different set-ups of EUT. The results displayed take into account applicable antenna factors and cable losses.

Conclusions: Set.NFC01, **PASS**.

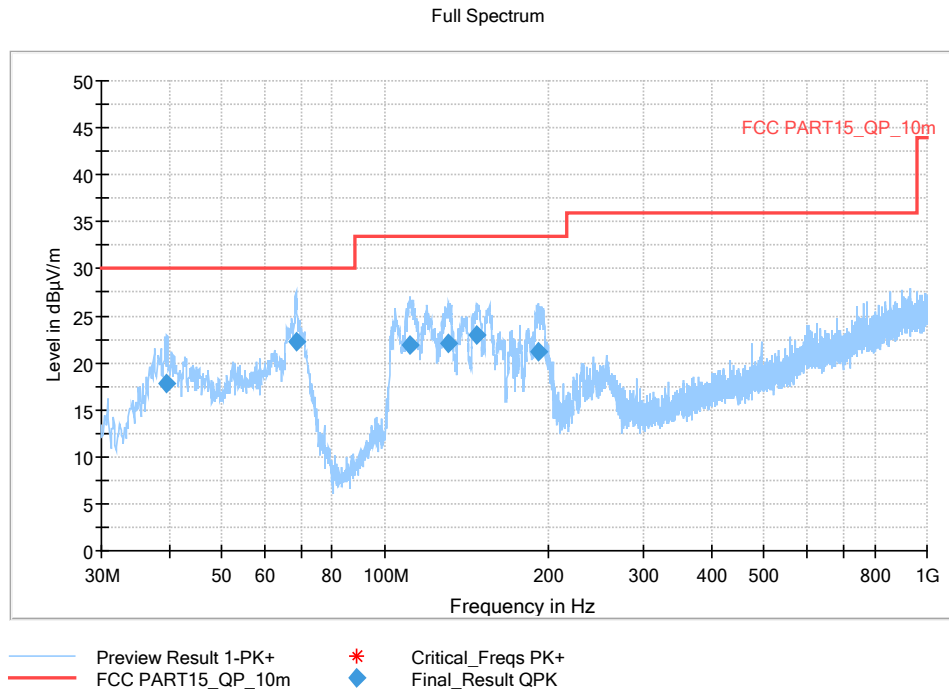

Figure B-6: Measurement results for Electric Field Radiated Emissions (≥ 30 MHz)

Final_Result

Frequency (MHz)	QuasiPeak (dB μ V/m)	Limit (dB μ V/m)	Margin (dB)	Bandwidth (kHz)	Height (cm)	Pol	Azimuth (deg)	Corr. (dB/m)
39.603000	17.74	30.00	12.26	120.000	183.0	V	-4.0	-12.6
68.509000	22.27	30.00	7.73	120.000	223.0	V	9.0	-14.4
111.480000	21.87	33.52	11.65	120.000	100.0	V	-6.0	-12.9
131.268000	22.05	33.52	11.47	120.000	100.0	V	124.0	-15.3
147.467000	22.96	33.52	10.56	120.000	108.0	V	137.0	-15.8
191.408000	21.18	33.52	12.34	120.000	100.0	V	265.0	-12.5

B.4. Frequency Tolerance

B.4.1. Reference

See CFR 47 Part 15 § 15.225(e)

See Clause 6.8 of ANSI C63.10-2013 specifically.

See Clause 4 and Clause 5 of ANSI C63.10-2013 generally.

B.4.2. Measurement Methods

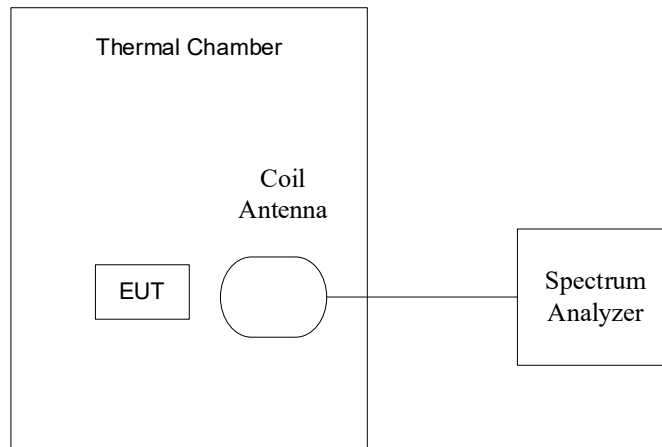

Figure B-7: Measurement Setup

The transmitter output signal was picked up by coil antenna connected to the spectrum analyzer. The center frequency was measured with 30Hz RBW and 1kHz span.

During the test, the EUT was placed in a thermal chamber until thermal balance and lasting appropriate time.

B.4.3. EUT Operating Mode and Test Conditions

The measurement of EUT was carried out under the transmit state of without modulation(See 3.4). EUT had not been connected to a travel adapter. The frequency stability was measured with the different voltage and temperature combinations:

- a) The nominal voltage 3.87V(See 3.1)was used and the temperature was varied from -20°C to +50°C in 10°C increments using an environmental chamber.
- b) The 20°C was used and the voltages were 3.6V, 3.87V and 4.45V (The extreme low voltage ,the normal voltage and the normal voltage defined in section 3.1).

The details were as following:

Table B-3: Combinations of Voltage andTemperature

Test items	Voltage	Temperature
Frequency stability with respect to ambient temperature	3.87 V	-20°C
		-10°C
		0°C
		10°C
		20°C
		30°C

		40°C
		50°C
Frequency stability when varying supply voltage	3.6 V	20°C
	3.87V	
	4.45V	

B.4.4. Test Layouts

See B.4.2.

B.4.5. Limits

The frequency tolerance of the carrier signal shall be maintained within +/- 0.01% of the operating frequency.

B.4.6. Measurement Results

Measurement results see Table B-4 for different test conditions.

Conclusions: Set.NFC03, **PASS**.

Table B-4: Measurement results for Frequency Tolerance

Temperature	Voltage	Frequency (MHz)			
		Startup	2 Min Later	5 Min Later	10 Min Later
-20°C	3.87V	13.560018000	13.560018000	13.560016000	13.560014000
-10°C	3.87V	13.560036000	13.560032000	13.560032000	13.560028000
0°C	3.87V	13.560054000	13.560048000	13.560048000	13.560042000
10°C	3.87V	13.560018000	13.560036000	13.560036000	13.560036000
20°C	3.87V	13.559982000	13.559982000	13.559984000	13.559986000
30°C	3.87V	13.559982000	13.559972000	13.559968000	13.559964000
40°C	3.87V	13.559946000	13.559946000	13.559952000	13.559952000
50°C	3.87V	13.559928000	13.559928000	13.559936000	13.559936000
20°C	3.6V	13.559982000	13.559986000	13.559986000	13.560018000
20°C	4.45V	13.559990000	13.559988000	13.559986000	13.559982000

Temperature	Voltage	Frequency Error (%)			
		Startup	2 Min Later	5 Min Later	10 Min Later
-20°C	3.87V	0.000	0.000	0.000	0.000
-10°C	3.87V	0.000	0.000	0.000	0.000
0°C	3.87V	0.000	0.000	0.000	0.000
10°C	3.87V	0.000	0.000	0.000	0.000
20°C	3.87V	0.000	0.000	0.000	0.000
30°C	3.87V	0.000	0.000	0.000	0.000
40°C	3.87V	0.000	0.000	0.000	0.000
50°C	3.87V	-0.001	-0.001	0.000	0.000
20°C	3.6V	0.000	0.000	0.000	0.000
20°C	4.45V	0.000	0.000	0.000	0.000

B.4.7. Measurement Uncertainty

Measurement uncertainty: $U = 73 \text{ Hz}$, $k=2$

B.5. 20dB Bandwidth

B.5.1. Reference

See CFR 47 Part 15 § 15.215(c)

See Clause 6.9 of ANSI C63.10-2013 specifically.

See Clause 4 and Clause 5 of ANSI C63.10-2013 generally.

B.5.2. Measurement Methods

The transmitter output signal was picked up by coil antenna connected to the spectrum analyzer. The bandwidth of the center frequency was measured with 100Hz RBW, 300Hz VBW and 15kHz span.

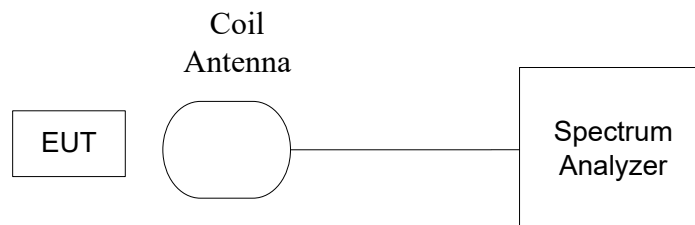

Figure B-8: Measurement Setup

B.5.3. EUT Operating Mode and Test Conditions

The measurement of EUT was carried out under the transmit state of NFC (See 3.4).

EUT had not been connected to a travel adapter.

During the measurements, the ambient temperature was in the range of 15 ~ 25 °C.

B.5.4. Test Layouts

See B.5.2.

B.5.5. Limits

The 20dB bandwidth shall be less than 80% of the permitted frequency band. For 13.56 MHz NFC, the permitted frequency band is 14kHz, so the limit is 11.2 kHz.

B.5.6. Measurement Results

Measurement results see Figure B-9.

Conclusions: Set.NFC03, **PASS**.

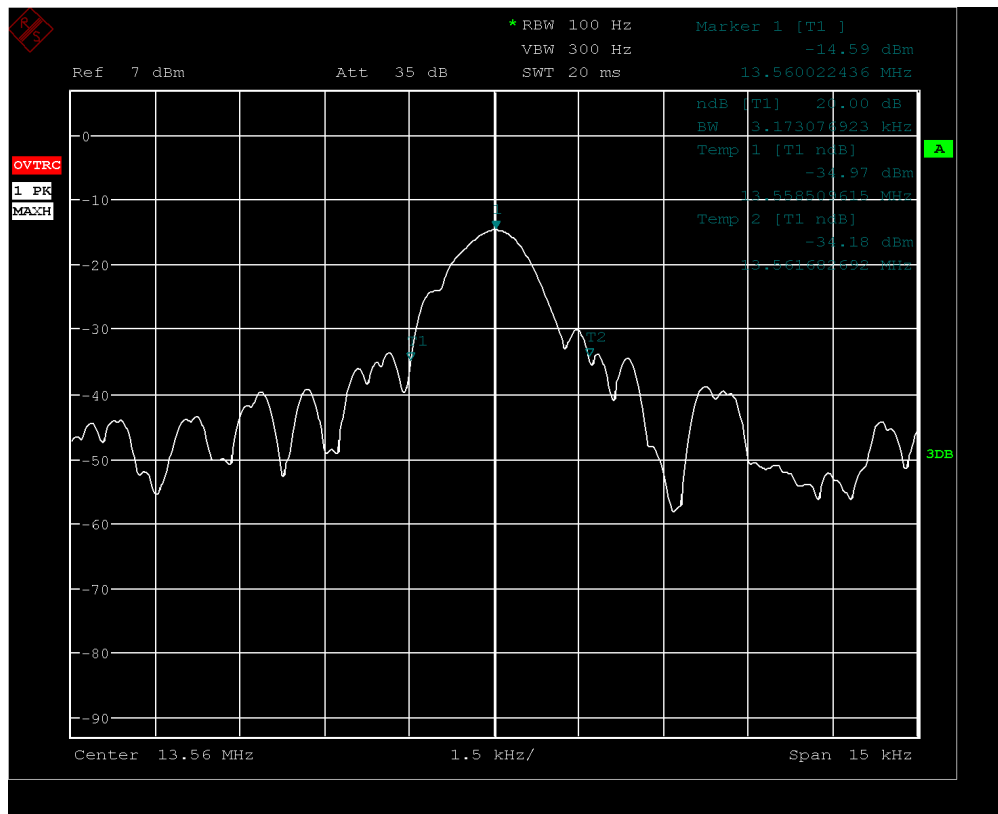

Figure B-9: Measurement results for 20dB Bandwidth

B.5.7. Measurement Uncertainty

Measurement uncertainty: $U = 72$ Hz, $k=2$

B.6. Conducted emission

B.6.1. Reference

See CFR 47 Part 15 § 15.207

See Clause 6.2 of ANSI C63.10-2013 specifically.

See Clause 4 and Clause 5 of ANSI C63.10-2013 generally.

B.6.2. Measurement Methods

The conducted emissions from the AC port of the EUT are measured in a shielding room. The EUT is connected to a Line Impedance Stabilization Network (LISN). An overview sweep with peak detection was performed. The measurements were performed with a quasi-peak detector and if required, an average detector.

The conducted emission measurements were made with the following detector of the test receiver: Quasi-Peak / Average Detector.

The measurement bandwidth is:

Table B-5: Measurement Bandwidth

Frequency of Emission (MHz)	RBW/VBW
0.15-30	9kHz

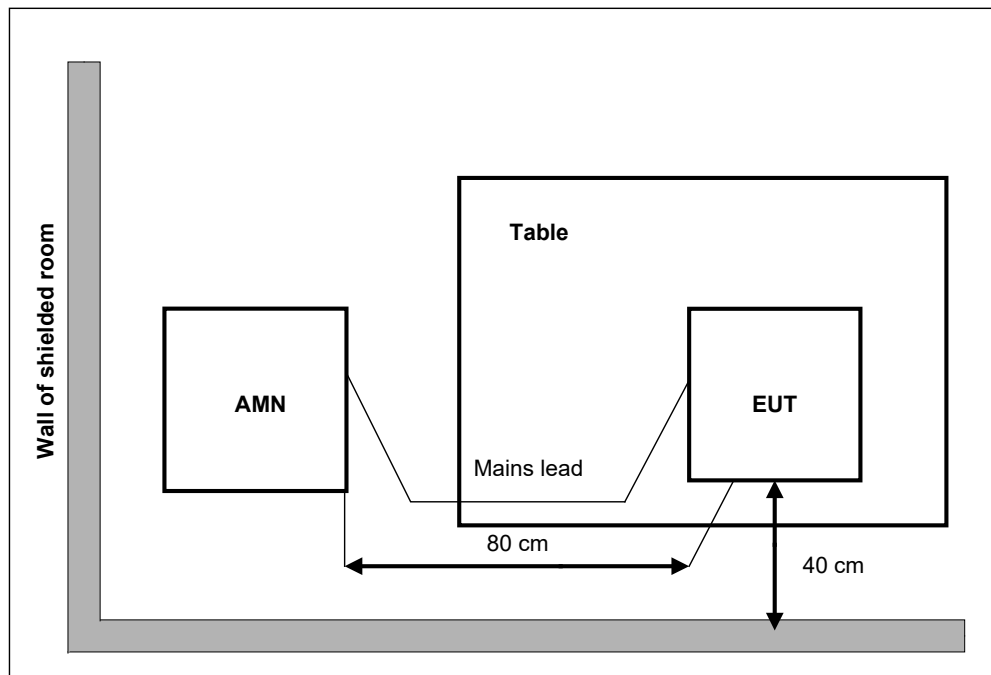

Figure B-10: Measurement Setup

B.6.3. EUT Operating Mode and Test Conditions

The measurement of EUT is carried out under the transmit state of NFC(See 3.4).

The EUT is powered by a travel adapter.

During the measurements, the ambient temperature is in the range of 15 ~ 25 °C.

B.6.4. Limits

Frequency range (MHz)	Quasi-peak Limit (dB μ V)	Average Limit (dB μ V)
0.15 to 0.5	66 to 56	56 to 46
0.5 to 5	56	46
5 to 30	60	50

B.6.5. Measurement Results

Measurement results see Figure B-11.

Conclusions: Set.NFC01, PASS.

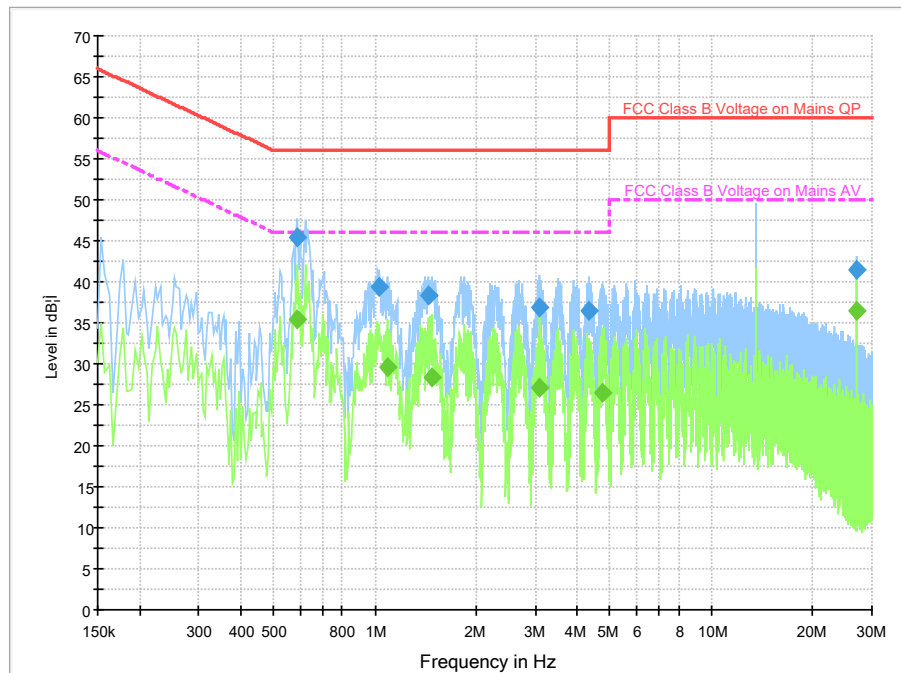
Figure B-11: Measurement results for Conducted Emission
Final Result 1

Frequency (MHz)	QuasiPeak (dB μ V)	Meas. Time (ms)	Bandwidth (kHz)	Filter	Line	Corr. (dB)	Margin (dB)	Limit (dB μ V)
0.590000	45.4	2000.0	9.000	On	L1	19.7	10.6	56.0
1.034000	39.3	2000.0	9.000	On	L1	19.7	16.7	56.0
1.438000	38.3	2000.0	9.000	On	L1	19.7	17.7	56.0
3.098000	36.9	2000.0	9.000	On	L1	19.6	19.1	56.0
4.314000	36.6	2000.0	9.000	On	L1	19.6	19.4	56.0
27.118000	41.5	2000.0	9.000	On	L1	19.9	18.5	60.0

Final Result 2

Frequency (MHz)	CAverage (dB μ V)	Meas. Time (ms)	Bandwidth (kHz)	Filter	Line	Corr. (dB)	Margin (dB)	Limit (dB μ V)
0.590000	35.4	2000.0	9.000	On	L1	19.7	10.6	46.0
1.086000	29.5	2000.0	9.000	On	L1	19.7	16.5	46.0
1.470000	28.4	2000.0	9.000	On	L1	19.7	17.6	46.0
3.098000	27.2	2000.0	9.000	On	L1	19.6	18.8	46.0
4.754000	26.4	2000.0	9.000	On	L1	19.6	19.6	46.0
27.118000	36.4	2000.0	9.000	On	L1	19.9	13.6	50.0

ANNEX C: Persons involved in this testing

Test Item	Tester
20dB Bandwidth	Miao Qinghua
Frequency Tolerance	Miao Qinghua
Electric Field Strength of Fundamental and Outside the Allocated bands	Ding Zai
Electric Field Radiated Emissions (< 30MHz)	Ding Zai
Electric Field Radiated Emissions (≥ 30 MHz)	Ding Zai
Conducted Emissions	Zhang Tianli

ANNEX D: Accreditation Certificate

<p>United States Department of Commerce National Institute of Standards and Technology</p> <p>NVLAP </p> <hr/> <p>Certificate of Accreditation to ISO/IEC 17025:2017</p> <hr/> <p>NVLAP LAB CODE: 600118-0</p> <p>Telecommunication Technology Labs, CAICT Beijing China</p> <p><i>is accredited by the National Voluntary Laboratory Accreditation Program for specific services, listed on the Scope of Accreditation, for:</i></p> <p>Electromagnetic Compatibility & Telecommunications</p> <p><i>This laboratory is accredited in accordance with the recognized International Standard ISO/IEC 17025:2017. This accreditation demonstrates technical competence for a defined scope and the operation of a laboratory quality management system (refer to joint ISO-ILAC-IAF Communique dated January 2009).</i></p> <hr/> <p>2022-10-01 through 2023-09-30 <i>Effective Dates</i></p> <p style="text-align: center;"></p> <p style="text-align: right;"> <i>For the National Voluntary Laboratory Accreditation Program</i></p>	
---	--

END OF REPORT