



TEST REPORT

No.I21N02839-SAR

For

TCL Communication Ltd.

Tablet PC

Model Name: 9296G

With

Hardware Version: PIO

Software Version: 5C57

FCC ID: 2ACCJB189

Issued Date: 2022-08-11

Designation Number: CN1210

Note:

The test results in this test report relate only to the devices specified in this report. This report shall not be reproduced except in full without the written approval of SAICT.

Test Laboratory:

SAICT, Shenzhen Academy of Information and Communications Technology

Building G, Shenzhen International Innovation Center, No.1006 Shennan Road, Futian District, Shenzhen, Guangdong, P. R. China 518000.

Tel:+86(0)755-33322000, Fax:+86(0)755-33322001

Email: yewu@caict.ac.cn. www.saict.ac.cn



REPORT HISTORY

Report Number	Revision	Description	Issue Date
I21N02839-SAR	Rev.0	1st edition	2022-08-11



TCONTENTS

1. SUMMARY OF TEST REPORT	5
1.1. TEST ITEMS	5
1.2. TEST STANDARDS	5
1.3. TEST RESULT.....	5
1.4. TESTING LOCATION	5
1.5. PROJECT DATA	5
1.6. SIGNATURE	5
2. STATEMENT OF COMPLIANCE	6
3. CLIENT INFORMATION	7
3.1. APPLICANT INFORMATION.....	7
3.2. MANUFACTURER INFORMATION	7
4. EQUIPMENT UNDER TEST (EUT) AND ANCILLARY EQUIPMENT (AE)	8
4.1. ABOUT EUT	8
4.2. INTERNAL IDENTIFICATION OF EUT USED DURING THE TEST	8
4.3. INTERNAL IDENTIFICATION OF AE USED DURING THE TEST	8
5. TEST METHODOLOGY	9
5.1. APPLICABLE LIMIT REGULATIONS.....	9
5.2. APPLICABLE MEASUREMENT STANDARDS	9
6. SPECIFIC ABSORPTION RATE (SAR).....	10
6.1. INTRODUCTION.....	10
6.2. SAR DEFINITION.....	10
7. TISSUE SIMULATING LIQUIDS	11
7.1. TARGETS FOR TISSUE SIMULATING LIQUID	11
7.2. DIELECTRIC PERFORMANCE	11
8. SYSTEM VERIFICATION	13
8.1. SYSTEM SETUP.....	13
8.2. SYSTEM VERIFICATION	14
9. MEASUREMENT PROCEDURES	15
9.1. TESTS TO BE PERFORMED.....	15
9.2. GENERAL MEASUREMENT PROCEDURE	17
9.3. BLUETOOTH & WLAN MEASUREMENT PROCEDURES FOR SAR.....	18
9.4. POWER DRIFT.....	18
10. CONDUCTED OUTPUT POWER	19
11. SIMULTANEOUS TX SAR CONSIDERATIONS.....	21
11.1. INTRODUCTION.....	21



11.2. TRANSMIT ANTENNA SEPARATION DISTANCES 21

11.3. SAR MEASUREMENT POSITIONS..... 22

11.4. STANDALONE SAR TEST EXCLUSION CONSIDERATIONS 22

12. EVALUATION OF SIMULTANEOUS.....23

13. SUMMARY OF TEST RESULTS.....24

13.1. TESTING ENVIRONMENT 24

13.2. SAR RESULTS..... 25

13.3. WLAN EVALUATION FOR 2.4G 25

13.4. WLAN EVALUATION FOR 5G 26

14. SAR MEASUREMENT VARIABILITY27

15. MEASUREMENT UNCERTAINTY28

15.1. MEASUREMENT UNCERTAINTY FOR NORMAL SAR TESTS (300MHZ~3GHZ) 28

15.2. MEASUREMENT UNCERTAINTY FOR NORMAL SAR TESTS (3GHZ~6GHZ) 29

16. MAIN TEST INSTRUMENTS.....30

ANNEX A: GRAPH RESULTS31

ANNEX B: SYSTEMVERIFICATION RESULTS.....34

ANNEX C: SAR MEASUREMENT SETUP.....38

C.1. MEASUREMENT SET-UP 38

C.2. DASY5 E-FIELD PROBE SYSTEM 39

C.3. E-FIELD PROBE CALIBRATION..... 40

C.4. OTHER TEST EQUIPMENT..... 41

ANNEX D: POSITION OF THE WIRELESS DEVICE IN RELATION TO THE PHANTOM.....44

D.1. BODY-WORN DEVICE 44

D.2. DESKTOP DEVICE..... 44

D.3. DUT SETUP PHOTOS..... 45

ANNEX E: EQUIVALENT MEDIA RECIPES46

ANNEX F: SYSTEM VALIDATION.....47

ANNEX G: DAE CALIBRATION CERTIFICATE48

ANNEX H: PROBE CALIBRATION CERTIFICATE51

ANNEX I: DIPOLE CALIBRATION CERTIFICATE60

ANNEX J: EXTENDED CALIBRATION SAR DIPOLE.....80



1. Summary of Test Report

1.1. Test Items

Description: Tablet PC
Model Name: 9296G
Applicant's Name: TCL Communication Ltd.
Manufacturer's Name: TCL Communication Ltd.

1.2. Test Standards

ANSI C95.1:1992, IEEE 1528:2013

1.3. Test Result

Pass. Please refer to "13. Summary of Test Results"

1.4. Testing Location

Address: Building G, Shenzhen International Innovation Center, No.1006 Shennan Road, Futian District, Shenzhen, Guangdong, P. R. China

1.5. Project Data

Testing Start Date: 2022-08-09

Testing End Date: 2022-08-10

1.6. Signature

Li Yongfu
(Prepared this test report)

Zhang Yunzhan
(Reviewed this test report)

Cao Junfei
(Approved this test report)

2. Statement of Compliance

The maximum results of Specific Absorption Rate (SAR) found during testing for TCL Communication Ltd. Tablet PC 9296G are as follows:

Table 2.1: Highest Reported SAR for Body (1g)

Exposure Configuration	Technology Band	Highest Reported SAR 1g(W/Kg)	Equipment Class
Body	Bluetooth	0.15	DSS
	WLAN 2.4GHz	0.99	DTS
	WLAN 5GHz	1.39	NII

The SAR values found for the Mobile Phone are below the maximum recommended levels of 1.6 W/Kg as averaged over any 1g tissue according to the ANSI C95.1-1992.

The measurement together with the test system set-up is described in annex C of this test report. A detailed description of the equipment under test can be found in chapter 4 of this test report.

The highest reported SAR value is obtained at the case of (Table 2.1), the value is: **1.39 W/kg (1g)**.

Table2.2: The sum of reported SAR values for WLAN antenna and Bluetooth antenna

/	Position	WLAN (W/kg)	Bluetooth (W/kg)	Sum (W/kg)
Highest reported SAR value for Body	Rear Side	1.39	0.15	1.54

Note: the test positions of above tables are for the worse case that has been evaluated.

According to the above tables, the highest sum of reported SAR values is **1.54 W/kg (1g)**.

The detail for simultaneous transmission consideration is described in chapter 12.



3. Client Information

3.1. Applicant Information

Company Name:	TCL Communication Ltd.
Address:	5/F, Building 22E, 22 Science Park East Avenue, Hong Kong Science Park, Shatin, NT
City:	Hong Kong
Country:	China
Telephone:	+86 755 3664 5759

3.2. Manufacturer Information

Company Name:	TCL Communication Ltd.
Address:	5/F, Building 22E, 22 Science Park East Avenue, Hong Kong Science Park, Shatin, NT
City:	Hong Kong
Country:	China
Telephone:	+86 755 3664 5759

4. Equipment under Test (EUT) and Ancillary Equipment (AE)

4.1. About EUT

Description:	Tablet PC
Model Name:	9296G
Condition of EUT as received:	No obvious damage in appearance
Frequency Bands:	Bluetooth, WLAN 2.4GHz, WLAN 5GHz
Tested Tx Frequency:	2402 – 2480MHz (Bluetooth)
	2412 – 2462MHz (WLAN 2.4GHz)
	5150 – 5850MHz (WLAN 5GHz)
Test device Production information:	Production unit
Device type:	Portable device
Antenna type:	Integrated antenna
Product Dimensions:	Long 247.8mm; Wide 157.56mm; Overall Diagonal 284mm

4.2. Internal Identification of EUT used during the test

EUT ID*	SN	HW Version	SW Version	Receipt Date
UT09aa	B4695F800A65079	PIO	5C57	2022-08-04
UT10aa	B4695F761E99229	PIO	5C57	2022-08-04

*EUT ID: is used to identify the test sample in the lab internally.

Note: It is performed to test SAR with the UT09aa, and conducted power with the UT10aa.

4.3. Internal Identification of AE used during the test

AE ID*	Description	Model	Manufacturer
AE1	Battery	TLp078A1	BYD

*AE ID: is used to identify the test sample in the lab internally.



5. Test Methodology

5.1. Applicable Limit Regulations

ANSI C95.1–1992 IEEE Standard for Safety Levels with Respect to Human Exposure to Radio Frequency Electromagnetic Fields, 3 kHz to 300 GHz

It specifies the maximum exposure limit of **1.60 W/kg** as averaged over any 1 gram of tissue for portable devices being used within 20 cm of the user in the uncontrolled environment.

5.2. Applicable Measurement Standards

IEEE 1528–2013 Recommended Practice for Determining the Peak Spatial-Average Specific Absorption Rate (SAR) in the Human Head from Wireless Communications Devices: Experimental Techniques

KDB 447498 D01 General RF Exposure Guidance v06 Mobile and Portable Devices RF Exposure Procedures and Equipment Authorization Policies

KDB 616217 D04 SAR for laptop and tablets v01r02 SAR Evaluation Considerations for Laptop, Notebook, Notebook and Tablet Computers

KDB 248227 D01 802.11 Wi-Fi SAR v02r02 SAR Guidance for IEEE 802.11 (Wi-Fi) Transmitters

KDB 865664 D01 SAR measurement 100 MHz to 6 GHz v01r04 SAR Measurement Requirements for 100 MHz to 6 GHz

KDB 865664 D02 RF Exposure Reporting v01r02 RF Exposure Compliance Reporting and Documentation Considerations

TCB workshop April 2019; RF Exposure Procedures (Tissue Simulating Liquids)

6. Specific Absorption Rate (SAR)

6.1. Introduction

SAR is related to the rate at which energy is absorbed per unit mass in an object exposed to a radio field. The SAR distribution in a biological body is complicated and is usually carried out by experimental techniques or numerical modeling. The standard recommends limits for two tiers of groups, occupational/controlled and general population/uncontrolled, based on a person's awareness and ability to exercise control over his or her exposure. In general, occupational/controlled exposure limits are higher than the limits for general population/uncontrolled.

6.2. SAR Definition

The SAR definition is the time derivative (rate) of the incremental energy (dW) absorbed by (dissipated in) an incremental mass (dm) contained in a volume element (dv) of a given density (ρ). The equation description is as below:

$$SAR = \frac{d}{dt} \left(\frac{dW}{dm} \right) = \frac{d}{dt} \left(\frac{dW}{\rho dv} \right)$$

SAR is expressed in units of Watts per kilogram (W/kg)

SAR measurement can be either related to the temperature elevation in tissue by

$$SAR = c \left(\frac{\delta T}{\delta t} \right)$$

Where: C is the specific heat capacity, δT is the temperature rise and δt is the exposure duration, or related to the electrical field in the tissue by

$$SAR = \frac{\sigma |E|^2}{\rho}$$

Where: σ is the conductivity of the tissue, ρ is the mass density of tissue and E is the RMS electrical field strength.

However for evaluating SAR of low power transmitter, electrical field measurement is typically applied.

7. Tissue Simulating Liquids

7.1. Targets for tissue simulating liquid

Table 7.1: Targets for tissue simulating liquid

Frequency (MHz)	Liquid Type	Conductivity (σ)	$\pm 5\%$ Range	Permittivity (ϵ)	$\pm 5\%$ Range
2450	Head	1.80	1.71~1.89	39.2	37.2~41.2
5250	Head	4.71	4.47~4.95	35.9	34.1~37.7
5600	Head	5.07	4.82~5.32	35.5	33.8~37.3
5750	Head	5.22	4.96~5.48	35.4	33.6~37.1

7.2. Dielectric Performance

Table 7.2: Dielectric Performance of Tissue Simulating Liquid

Measurement Date (yyyy-mm-dd)	Type	Frequency (MHz)	Conductivity σ (S/m)	Drift (%)	Permittivity ϵ	Drift (%)
2022-08-09	2450	Head	1.835	1.94	38.36	-2.14
2022-08-10	5250	Head	4.806	2.04	35.28	-1.73
2022-08-10	5600	Head	5.017	-1.05	35.89	1.10
2022-08-10	5750	Head	5.126	-1.80	36.35	2.68

Note: The liquid temperature is 22.0°C.

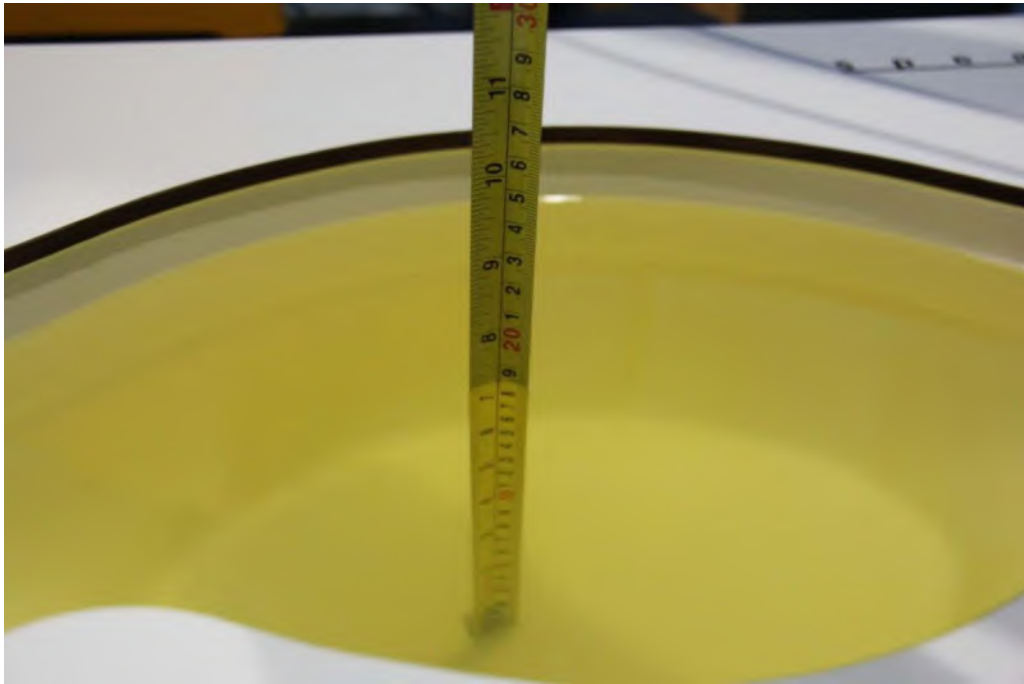

Picture 7-1: Liquid depth in the Flat Phantom(2450MHz)



Picture 7-2: Liquid depth in the Flat Phantom(5GHz)

8. System verification

8.1. System Setup

In the simplified setup for system evaluation, the DUT is replaced by a calibrated dipole and the power source is replaced by a continuous wave that comes from a signal generator. The calibrated dipole must be placed beneath the flat phantom section of the SAM twin phantom with the correct distance holder. The distance holder should touch the phantom surface with a light pressure at the reference marking and be oriented parallel to the long side of the phantom. The equipment setup is shown below:

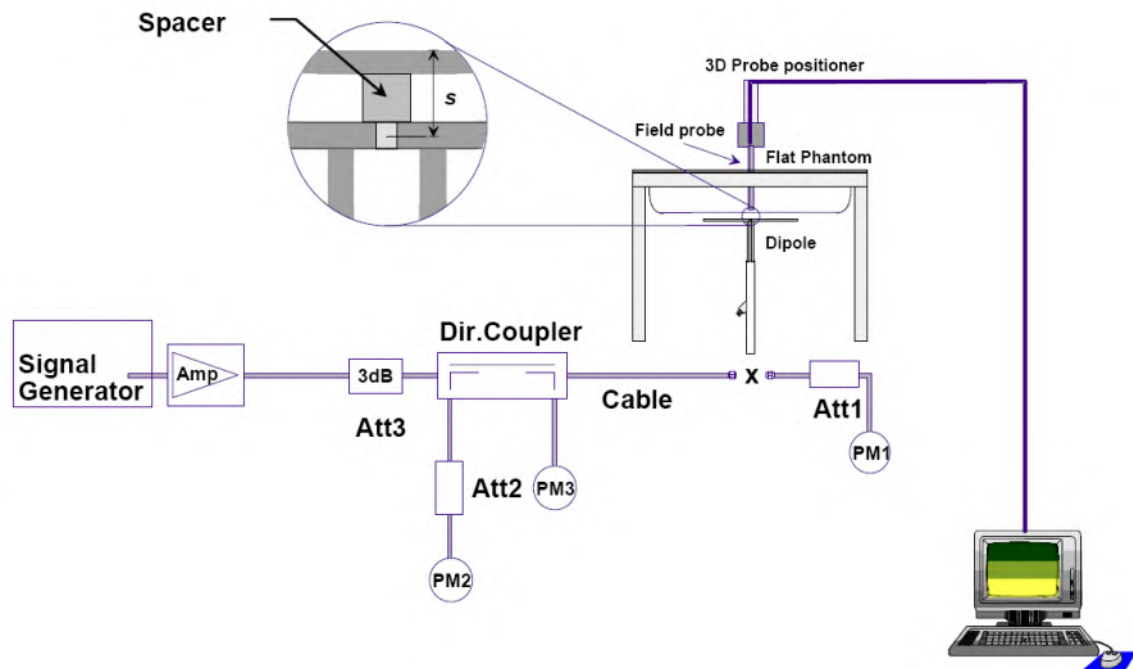

Picture 8.1 System Setup for System Evaluation

For the dipole below 3GHz, the output power on dipole port must be calibrated to 24 dBm (250mW) before dipole is connected.

For the dipole above 3GHz, the output power on dipole port must be calibrated to 20 dBm (100mW) before dipole is connected.



Picture 8.2 Photo of Dipole Setup

8.2. System Verification

SAR system verification is required to confirm measurement accuracy, according to the tissue dielectric media, probe calibration points and other system operating parameters required for measuring the SAR of a test device. The system verification must be performed for each frequency band and within the valid range of each probe calibration point required for testing the device.

Table 8.1: System Verification of Head

Measurement Date	Frequency (MHz)	Target value (W/kg)		Measured value (W/kg)				Deviation (%)	
		10 g	1 g	/		Normalize to 1W		10 g	1 g
				10 g	1 g	10 g	1 g		
2022-08-09	2450	24.20	53.20	6.20	13.8	24.80	55.20	2.48	3.76
2022-08-10	5250	22.30	78.00	2.27	8.03	22.70	80.30	1.79	2.95
2022-08-10	5600	22.70	79.50	2.23	7.75	22.30	77.50	-1.76	-2.52
2022-08-10	5750	22.20	78.40	2.16	7.54	21.60	75.40	-2.70	-3.83

9. Measurement Procedures

9.1. Tests to be performed

In order to determine the highest value of the peak spatial-average SAR of a handset, all device positions, configurations and operational modes shall be tested for each frequency band according to steps 1 to 3 below. A flowchart of the test process is shown in picture 9.1.

Step 1: The tests described in 9.2 shall be performed at the channel that is closest to the center of the transmit frequency band (f_c) for:

- a) all device positions (cheek and tilt, for both left and right sides of the SAM phantom, as described in annex D),
- b) all configurations for each device position in a), e.g., antenna extended and retracted, and
- c) all operational modes, e.g., analogue and digital, for each device position in a) and configuration in b) in each frequency band.

If more than three frequencies need to be tested according to 11.1 (i.e., $N_c > 3$), then all frequencies, configurations and modes shall be tested for all of the above test conditions.

Step 2: For the condition providing highest peak spatial-average SAR determined in Step 1, perform all tests described in 9.2 at all other test frequencies, i.e., lowest and highest frequencies. In addition, for all other conditions (device position, configuration and operational mode) where the peak spatial-average SAR value determined in Step 1 is within 3 dB of the applicable SAR limit, it is recommended that all other test frequencies shall be tested as well.

Step 3: Examine all data to determine the highest value of the peak spatial-average SAR found in Steps 1 to 2.

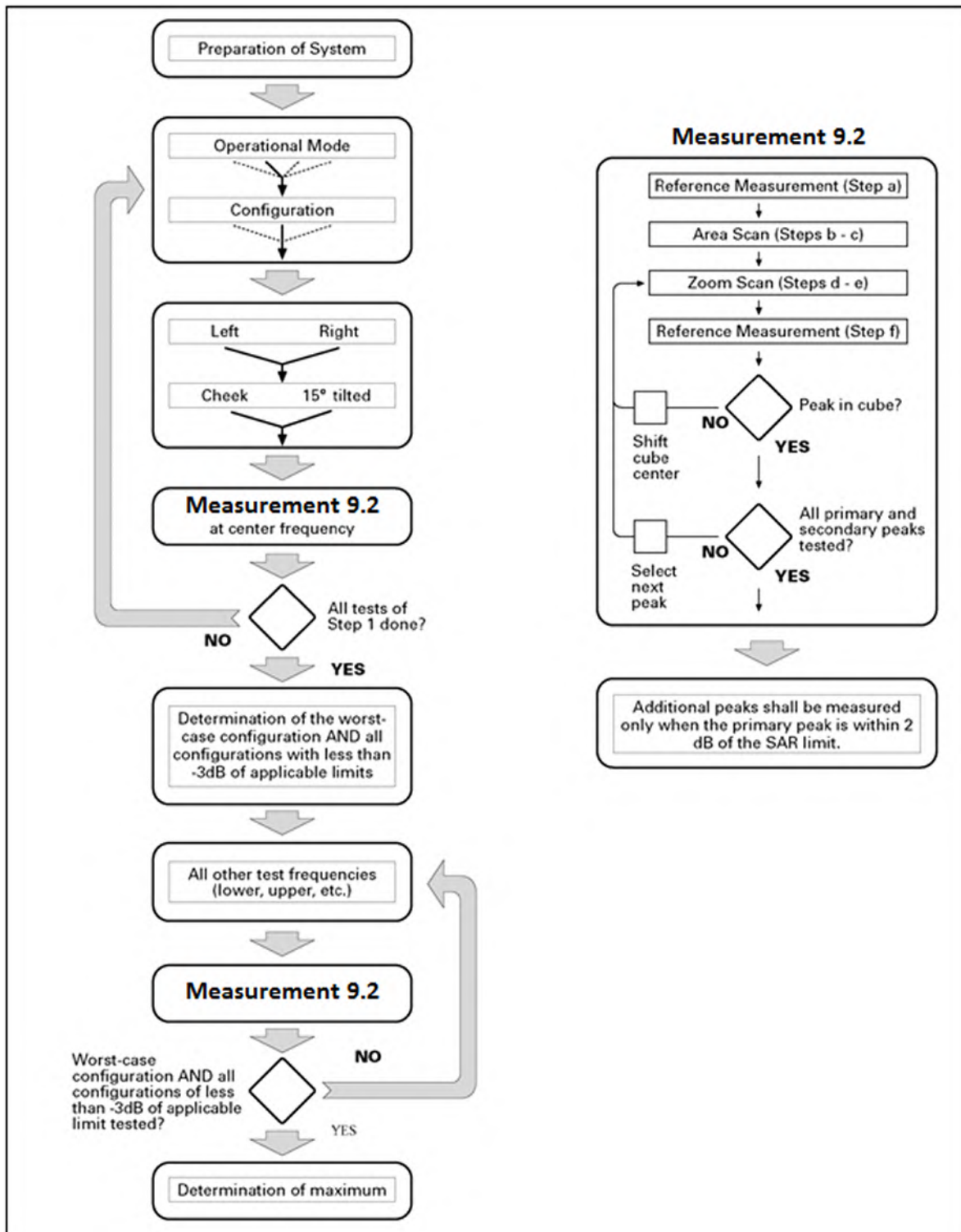

Picture 9.1 Block diagram of the tests to be performed

9.2. General Measurement Procedure

The area and zoom scan resolutions specified in the table below must be applied to the SAR measurements and fully documented in SAR reports to qualify for TCB approval. Probe boundary effect error compensation is required for measurements with the probe tip closer than half a probe tip diameter to the phantom surface. Both the probe tip diameter and sensor offset distance must satisfy measurement protocols; to ensure probe boundary effect errors are minimized and the higher fields closest to the phantom surface can be correctly measured and extrapolated to the phantom surface for computing 1-g SAR. Tolerances of the post-processing algorithms must be verified by the test laboratory for the scan resolutions used in the SAR measurements, according to the reference distribution functions specified in IEEE Std 1528-2013. The results should be documented as part of the system validation records and may be requested to support test results when all the measurement parameters in the following table are not satisfied.

		≤ 3 GHz	> 3 GHz
Maximum distance from closest measurement point (geometric center of probe sensors) to phantom surface		5 ± 1 mm	$\frac{1}{2} \cdot \delta \cdot \ln(2) \pm 0.5$ mm
Maximum probe angle from probe axis to phantom surface normal at the measurement location		$30^\circ \pm 1^\circ$	$20^\circ \pm 1^\circ$
Maximum area scan spatial resolution: Δx_{Area} , Δy_{Area}		≤ 2 GHz: ≤ 15 mm 2 – 3 GHz: ≤ 12 mm	3 – 4 GHz: ≤ 12 mm 4 – 6 GHz: ≤ 10 mm
		When the x or y dimension of the test device, in the measurement plane orientation, is smaller than the above, the measurement resolution must be \leq the corresponding x or y dimension of the test device with at least one measurement point on the test device.	
Maximum zoom scan spatial resolution: Δx_{Zoom} , Δy_{Zoom}		≤ 2 GHz: ≤ 8 mm 2 – 3 GHz: ≤ 5 mm*	3 – 4 GHz: ≤ 5 mm* 4 – 6 GHz: ≤ 4 mm*
Maximum zoom scan spatial resolution, normal to phantom surface	uniform grid: $\Delta z_{Zoom}(n)$	≤ 5 mm	3 – 4 GHz: ≤ 4 mm 4 – 5 GHz: ≤ 3 mm 5 – 6 GHz: ≤ 2 mm
	graded grid	$\Delta z_{Zoom}(1)$: between 1 st two points closest to phantom surface	≤ 4 mm
		$\Delta z_{Zoom}(n>1)$: between subsequent points	$\leq 1.5 \cdot \Delta z_{Zoom}(n-1)$
Minimum zoom scan volume	x, y, z	≥ 30 mm	3 – 4 GHz: ≥ 28 mm 4 – 5 GHz: ≥ 25 mm 5 – 6 GHz: ≥ 22 mm
Note: δ is the penetration depth of a plane-wave at normal incidence to the tissue medium; see draft standard IEEE P1528-2011 for details. * When zoom scan is required and the <i>reported</i> SAR from the area scan based 1-g SAR estimation procedures of KDB 447498 is ≤ 1.4 W/kg, ≤ 8 mm, ≤ 7 mm and ≤ 5 mm zoom scan resolution may be applied, respectively, for 2 GHz to 3 GHz, 3 GHz to 4 GHz and 4 GHz to 6 GHz.			

9.3. Bluetooth & WLAN Measurement Procedures for SAR

Normal network operating configurations are not suitable for measuring the SAR of 802.11 transmitters in general. Unpredictable fluctuations in network traffic and antenna diversity conditions can introduce undesirable variations in SAR results. The SAR for these devices should be measured using chipset based test mode software to ensure that the results are consistent and reliable.

Chipset based test mode software is hardware dependent and generally varies among manufacturers. The device operating parameters established in a test mode for SAR measurements must be identical to those programmed in production units, including output power levels, amplifier gain settings and other RF performance tuning parameters. The test frequencies should correspond to actual channel frequencies defined for domestic use. SAR for devices with switched diversity should be measured with only one antenna transmitting at a time during each SAR measurement, according to a fixed modulation and data rate. The same data pattern should be used for all measurements.

9.4. Power Drift

To control the output power stability during the SAR test, DASY5 system calculates the power drift by measuring the E-field at the same location at the beginning and at the end of the measurement for each test position. These drift values can be found in Section 14 labeled as: (Power Drift [dB]). This ensures that the power drift during one measurement is within 5%.

10. Conducted Output Power

Table 10.1: The conducted Power measurement results for Bluetooth

Averaged Power (dBm)				
Mode	Tune up	Ch.0 (2402MHz)	Ch.39 (2441MHz)	Ch.78 (2480MHz)
GFSK	12.5	9.75	11.89	11.90
EDR2M-4_DQPSK	12.0	9.33	11.47	11.41
EDR3M-8DPSK	12.0	9.23	11.33	11.21
/	/	Ch.0 (2402MHz)	Ch.19 (2440MHz)	Ch.39 (2480MHz)
BLE(1M)	-0.5	-1.92	-1.01	-1.75

Table 10.2: The conducted Power measurement results for WLAN 2.4GHz

Averaged Power (dBm) Duty Cycle: 100%				
Mode	Tune up	Ch.1 (2412MHz)	Ch.6 (2437MHz)	Ch.11 (2462MHz)
802.11b	16.5	16.00	16.09	15.87
802.11g	15.5	14.46	14.69	14.63
802.11n(20MHz)	15.5	14.35	14.56	14.51
/	/	Ch.3 (2422MHz)	Ch.6 (2437MHz)	Ch.9 (2452MHz)
802.11n(40MHz)	14.5	13.71	13.82	13.48

Table 10.3: The conducted Power measurement results for WLAN 5GHz

Averaged Power (dBm) Duty Cycle: 100%								
Mode	802.11a	802.11n -20MHz	802.11ac -20MHz	Mode	802.11n -40MHz	802.11ac -40MHz	Mode	802.11ac -80MHz
Channel	6Mbps	MCS0	MCS0	Channel	MCS0	MCS0	Channel	MCS0
<U-NII-1>								
Tune up	11.0	10.5	10.5	/	10.0	10.0	/	10.0
36(5180MHz)	10.54	9.40	9.42	38(5190MHz)	9.11	9.05	42(5210MHz)	9.42
40(5200MHz)	10.56	9.38	9.50	46(5230MHz)	9.15	9.09	/	/
44(5220MHz)	10.71	9.60	9.44	/	/	/	/	/
48(5240MHz)	10.75	9.62	9.61	/	/	/	/	/
<U-NII-2A>								
Tune up	11.5	10.5	10.5	/	10.0	10.0	/	10.0
52(5260MHz)	10.71	9.58	9.58	54(5270MHz)	9.16	9.06	58(5290MHz)	9.49
56(5280MHz)	10.79	9.61	9.62	62(5310MHz)	9.23	9.11	/	/
60(5300MHz)	10.71	9.62	9.63	/	/	/	/	/
64(5320MHz)	10.56	9.45	9.44	/	/	/	/	/
<U-NII-2C>								
Tune up	11.5	10.5	10.5	/	10.0	10.0	/	10.0
100(5500MHz)	10.73	9.62	9.61	102(5510MHz)	9.19	9.06	106(5530MHz)	9.30
116(5580MHz)	10.53	9.40	9.39	110(5550MHz)	9.11	9.00	122(5610MHz)	9.29
124(5620MHz)	10.54	9.44	9.44	126(5630MHz)	9.00	8.90	138(5690MHz)	9.34
132(5660MHz)	10.48	9.35	9.33	134(5670MHz)	9.10	8.99	/	/
140(5700MHz)	10.59	9.41	9.51	142(5710MHz)	9.02	8.89	/	/
144(5720MHz)	10.38	9.28	9.24					
<U-NII-3>								
Tune up	11.5	10.5	10.5	/	10.0	10.0	/	10.0
149(5745MHz)	10.40	9.30	9.27	151(5755MHz)	9.01	8.89	155(5775MHz)	9.24
157(5785MHz)	10.51	9.39	9.38	159(5795MHz)	9.06	8.94	/	/
165(5825MHz)	10.49	9.41	9.39	/	/	/	/	/

11. Simultaneous TX SAR Considerations

11.1. Introduction

The following procedures adopted from “FCC SAR Considerations for Cell Phones with Multiple Transmitters” are applicable to handsets with built-in unlicensed transmitters such as 802.11 a/b/g and Bluetooth devices which may simultaneously transmit with the licensed transmitter.

For this device, the Bluetooth and WLAN can transmit simultaneous.

11.2. Transmit Antenna Separation Distances

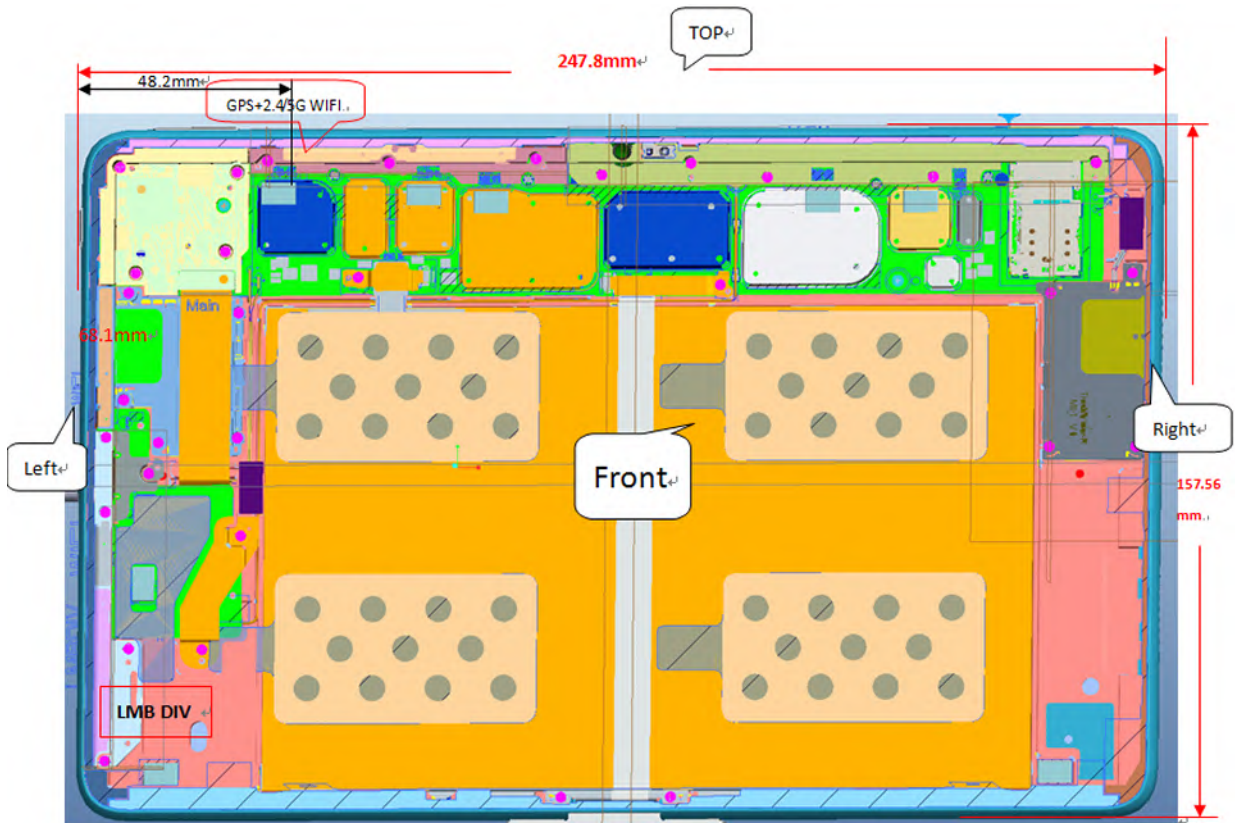

Picture 11.1 Antenna Locations (Front View)

11.3. SAR Measurement Positions

SAR measurement positions					
Antenna	Rear	Left edge	Right edge	Top edge	Bottom edge
WLAN	Yes	Yes	No	Yes	No

Note:

1. Per KDB 447498 D01v06, the 1-g SAR test exclusion thresholds for 100 MHz to 6 GHz at test separation distances ≤ 50 mm are determined by:

$[(\text{max. power of channel, including tune-up tolerance, mW}) / (\text{min. test separation distance, mm})] \cdot [\sqrt{f(\text{GHz})}] \leq 3.0$ for 1-g SAR, where

$f(\text{GHz})$ is the RF channel transmit frequency in GHz

Power and distance are rounded to the nearest mW and mm before calculation

2. Per KDB 447498 D01v06, For 100 MHz to 6 GHz and test separation distances > 50 mm, the 1-g and 10-g SAR test exclusion thresholds are determined by the following

1) $\{[\text{Power allowed at numeric threshold for 50 mm in step a)}] + [(\text{test separation distance} - 50 \text{ mm}) \cdot (f(\text{MHz})/150)]\}$ mW, for 100 MHz to 1500 MHz

2) $\{[\text{Power allowed at numeric threshold for 50 mm in step a)}] + [(\text{test separation distance} - 50 \text{ mm}) \cdot 10]\}$ mW, for > 1500 MHz and ≤ 6 GHz

11.4. Standalone SAR Test Exclusion Considerations

Standalone 1-g head or body SAR evaluation by measurement or numerical simulation is not required when the corresponding SAR Exclusion Threshold condition, listed below, is satisfied.

The 1-g SAR test exclusion threshold for 100 MHz to 6 GHz at test separation distances ≤ 50 mm are determined by:

$[(\text{max. power of channel, including tune-up tolerance, mW}) / (\text{min. test separation distance, mm})] \cdot [\sqrt{f(\text{GHz})}] \leq 3.0$ for 1-g SAR, where

- $f(\text{GHz})$ is the RF channel transmit frequency in GHz
- Power and distance are rounded to the nearest mW and mm before calculation
- The result is rounded to one decimal place for comparison

Table 11.1: Standalone SAR test exclusion considerations

Band/Mode	f(GHz)	Position	SAR test exclusion threshold (mW)	RF output power		SAR test exclusion
				dBm	mW	
Bluetooth	2.4	Body	9.60	12.5	17.78	No
WLAN 2.4GHz	2.4	Body	9.58	16.5	44.67	No
WLAN 5.2GHz	5.2	Body	6.58	11.0	12.59	No
WLAN 5.3GHz	5.3	Body	6.52	11.5	14.13	No
WLAN 5.5GHz	5.6	Body	6.34	11.5	14.13	No
WLAN 5.8GHz	5.8	Body	6.23	11.5	14.13	No

12. Evaluation of Simultaneous

Table 12.1: The sum of reported SAR values for WLAN antenna and Bluetooth antenna

/	Position	WLAN (W/kg)	Bluetooth (W/kg)	Sum (W/kg)
Highest reported SAR value for Body	Rear Side	1.39	0.15	1.54

Note: the test positions of above tables are for the worse case that has been evaluated.

Conclusion:

According to the above tables, the sum of reported SAR values is less than limit. So the simultaneous transmission SAR with volume scans is not required.

13. Summary of Test Results

According to the client's decision rule in the test registration form, which is "based on the measurement results as the basis of the conformity statement", the test conclusion of this report meets the limit requirements.

The calculated SAR is obtained by the following formula:

$$\text{Reported SAR} = \text{Measured SAR} \times 10^{(P_{\text{Target}} - P_{\text{Measured}})/10}$$

Where P_{Target} is the power of manufacturing upper limit;

P_{Measured} is the measured power in chapter 10.

Duty Cycle

Mode	Duty Cycle
Bluetooth	1:1
WLAN	1:1

13.1. Testing Environment

Temperature:	18°C~25°C
Relative humidity:	30%~70%
Ground system resistance:	<4Ω
Ambient noise & Reflection:	< 0.012 W/kg

13.2. SAR results

Table 13.1: SAR Values (Bluetooth - Body)

Frequency		Test Mode	Test Position	Figure No./ Note	Conducted Power (dBm)	Max. tune-up Power (dBm)	Measured SAR(1g) (W/kg)	Reported SAR(1g) (W/kg)	Power Drift(dB)
Ch.	MHz								
Test Data (0mm)									
78	2480.0	GFSK	Rear	/	11.90	12.5	0.118	0.14	0.14
78	2480.0	GFSK	Left	/	11.90	12.5	0.022	0.03	0.05
78	2480.0	GFSK	Top	1	11.90	12.5	0.128	0.15	0.02

13.3. WLAN Evaluation for 2.4G

Table 13.2: SAR Values (WLAN 2.4GHz - Body)

Frequency		Test Mode	Test Position	Figure No./ Note	Conducted Power (dBm)	Max. tune-up Power (dBm)	Measured SAR(1g) (W/kg)	Reported SAR(1g) (W/kg)	Power Drift(dB)
Ch.	MHz								
Test Data (0mm)									
6	2437.0	802.11b	Rear	/	16.09	16.5	0.866	0.95	0.09
6	2437.0	802.11b	Left	/	16.09	16.5	0.153	0.17	0.16
6	2437.0	802.11b	Top	/	16.09	16.5	0.817	0.90	0.09
1	2412.0	802.11b	Rear	2	16.00	16.5	0.883	0.99	-0.02
1	2412.0	802.11b	Top	/	16.00	16.5	0.746	0.84	0.10

Note: For all positions/configurations tested using the initial test position and subsequent test positions, when the reported SAR is > 0.8 W/kg, SAR is measured for these test positions/configurations on the subsequent next highest measured output power channel until the reported SAR is ≤ 1.2 W/kg or all required channels are tested.

According to the KDB248227 D01, The reported SAR must be scaled to 100% transmission duty factor to determine compliance at the maximum tune-up tolerance limit.

Table 13.3: SAR Values (WLAN - Body) – 802.11b (Scaled Reported SAR)

Frequency		Test Position	Actual duty factor	maximum duty factor	Reported SAR (1g)(W/kg)	Scaled reported SAR (1g)(W/kg)
Ch.	MHz					
1	2412.0	Rear	100%	100%	0.99	0.99

SAR is not required for OFDM because the 802.11b adjusted SAR ≤ 1.2 W/kg.

13.4. WLAN Evaluation for 5G

Table 13.4: SAR Values (WLAN 5GHz - Body)

Frequency		Test Mode	Test Position	Figure No./ Note	Conducted Power (dBm)	Max. tune-up Power (dBm)	Measured SAR(1g) (W/kg)	Reported SAR(1g) (W/kg)	Power Drift(dB)
Ch.	MHz								
<U-NII-1> - Test Data (0mm)									
48	5240.0	802.11a	Rear	/	10.75	11.0	0.458	0.49	0.07
48	5240.0	802.11a	Left	/	10.75	11.0	0.049	0.05	0.01
48	5240.0	802.11a	Top	/	10.75	11.0	1.190	1.26	0.04
44	5220.0	802.11a	Top	/	10.71	11.0	1.170	1.25	-0.15
40	5200.0	802.11a	Top	/	10.56	11.0	1.200	1.33	0.03
36	5180.0	802.11a	Top	3	10.54	11.0	1.250	1.39	0.01
<U-NII-2A> - Test Data (0mm)									
56	5280.0	802.11a	Rear	/	10.79	11.5	0.542	0.64	0.09
56	5280.0	802.11a	Left	/	10.79	11.5	0.045	0.05	0.13
56	5280.0	802.11a	Top	/	10.79	11.5	1.100	1.30	0.03
60	5300.0	802.11a	Top	/	10.71	11.5	1.110	1.33	0.06
52	5260.0	802.11a	Top	/	10.71	11.5	1.130	1.36	0.04
64	5320.0	802.11a	Top	/	10.56	11.5	1.040	1.29	0.13
< U-NII-2C> - Test Data (0mm)									
100	5500.0	802.11a	Rear	/	10.73	11.5	0.465	0.56	0.09
100	5500.0	802.11a	Left	/	10.73	11.5	0.024	0.03	0.03
100	5500.0	802.11a	Top	/	10.73	11.5	0.839	1.00	0.04
140	5700.0	802.11a	Top	/	10.59	11.5	0.653	0.81	0.15
< U-NII-3> - Test Data (0mm)									
157	5785.0	802.11a	Rear	/	10.51	11.5	0.391	0.49	0.09
157	5785.0	802.11a	Left	/	10.51	11.5	0.006	0.01	0.07
157	5785.0	802.11a	Top	/	10.51	11.5	0.597	0.75	0.14

Note: For all positions/configurations tested using the initial test position and subsequent test positions, when the reported SAR is > 0.8 W/kg, SAR is measured for these test positions/configurations on the subsequent next highest measured output power channel until the reported SAR is ≤ 1.2 W/kg or all required channels are tested.

According to the KDB248227 D01, The reported SAR must be scaled to 100% transmission duty factor to determine compliance at the maximum tune-up tolerance limit.

Table 13.5: SAR Values (WLAN - Body) – 802.11a (Scaled Reported SAR)

Frequency		Test Position	Actual duty factor	maximum duty factor	Reported SAR (1g)(W/kg)	Scaled reported SAR (1g)(W/kg)
Ch.	MHz					
36	5180.0	Top	100%	100%	1.39	1.39

14. SAR Measurement Variability

SAR measurement variability must be assessed for each frequency band, which is determined by the SAR probe calibration point and tissue-equivalent medium used for the device measurements. When both head and body tissue-equivalent media are required for SAR measurements in a frequency band, the variability measurement procedures should be applied to the tissue medium with the highest measured SAR, using the highest measured SAR configuration for that tissue-equivalent medium.

The following procedures are applied to determine if repeated measurements are required.

- 1) Repeated measurement is not required when the original highest measured SAR is < 0.80 W/kg; steps 2) through 4) do not apply.
- 2) When the original highest measured SAR is ≥ 0.80 W/kg, repeat that measurement once.
- 3) Perform a second repeated measurement only if the ratio of largest to smallest SAR for the original and first repeated measurements is > 1.20 or when the original or repeated measurement is ≥ 1.45 W/kg (~ 10% from the 1-g SAR limit).
- 4) Perform a third repeated measurement only if the original, first or second repeated measurement is ≥ 1.5 W/kg and the ratio of largest to smallest SAR for the original, first and second repeated measurements is > 1.20 .

Table 14.1: SAR Measurement Variability for Body – WLAN 2.4GHz

Frequency		Test Position	Original	1 st Repeated	Ratio	2 nd Repeated
Ch.	MHz		SAR (W/kg)	SAR (W/kg)		SAR (W/kg)
1	2412.0	Rear	0.883	0.870	1.01	/

Table 14.2: SAR Measurement Variability for Body – WLAN 5GHz

Frequency		Test Position	Original	1 st Repeated	Ratio	2 nd Repeated
Ch.	MHz		SAR (W/kg)	SAR (W/kg)		SAR (W/kg)
36	5180.0	Top	1.250	1.220	1.02	/

15. Measurement Uncertainty

15.1. Measurement Uncertainty for Normal SAR Tests (300MHz~3GHz)

No.	Error Description	Type	Uncertainty value	Probably Distribution	Div.	(Ci) 1g	(Ci) 10g	Std. Unc. (1g)	Std. Unc. (10g)	Degree of freedom
Measurement system										
1	Probe calibration	B	12	N	2	1	1	6.0	6.0	∞
2	Axial isotropy	B	4.7	R	$\sqrt{3}$	$\sqrt{0.5}$	$\sqrt{0.5}$	4.3	4.3	∞
3	Hemispherical isotropy	B	9.6	R	$\sqrt{3}$	1	1	4.8	4.8	∞
4	Boundary effect	B	1.1	R	$\sqrt{3}$	1	1	0.6	0.6	∞
5	Linearity	B	4.7	R	$\sqrt{3}$	1	1	2.7	2.7	∞
6	Detection limit	B	1.0	R	$\sqrt{3}$	1	1	0.6	0.6	∞
7	Modulation response	B	4.0	R	$\sqrt{3}$	1	1	2.3	2.3	∞
8	Readout electronics	B	1.0	N	1	1	1	1.0	1.0	∞
9	Response time	B	0.8	R	$\sqrt{3}$	1	1	0.5	0.5	∞
10	Integration time	B	1.7	R	$\sqrt{3}$	1	1	1.0	1.0	∞
11	RF ambient conditions-noise	B	3.0	R	$\sqrt{3}$	1	1	1.7	1.7	∞
12	RF ambient conditions-reflection	B	3.0	R	$\sqrt{3}$	1	1	1.7	1.7	∞
13	Probe positioned mech. restrictions	B	0.35	R	$\sqrt{3}$	1	1	0.2	0.2	∞
14	Probe positioning with respect to phantom shell	B	2.9	R	$\sqrt{3}$	1	1	1.7	1.7	∞
15	Post-processing	B	1.0	R	$\sqrt{3}$	1	1	0.6	0.6	∞
Test sample related										
16	Test sample positioning	A	3.3	N	1	1	1	3.3	3.3	5
17	Device holder uncertainty	A	3.4	N	1	1	1	3.4	3.4	5
18	Drift of output power	B	5.0	R	$\sqrt{3}$	1	1	2.9	2.9	∞
Phantom and set-up										
19	Phantom uncertainty	B	1.0	R	$\sqrt{3}$	1	1	0.6	0.6	∞
20	Liquid conductivity (target)	B	5.0	R	$\sqrt{3}$	0.64	0.43	1.8	1.2	∞
21	Liquid conductivity (meas.)	A	1.3	N	1	0.64	0.43	0.83	0.56	9
22	Liquid permittivity (target)	B	5.0	R	$\sqrt{3}$	0.6	0.49	1.7	1.4	∞
23	Liquid permittivity (meas.)	A	1.6	N	1	0.6	0.49	0.96	0.78	9
Combined standard uncertainty		$u_c = \sqrt{\sum_{i=1}^{23} c_i^2 u_i^2}$						11.3	11.2	95.5
Expanded uncertainty (Confidence interval of 95 %)		$u_e = 2u_c$						22.6	22.4	

15.2. Measurement Uncertainty for Normal SAR Tests (3GHz~6GHz)

No.	Error Description	Type	Uncertainty value	Probably Distribution	Div.	(Ci) 1g	(Ci) 10g	Std. Unc. (1g)	Std. Unc. (10g)	Degree of freedom
Measurement system										
1	Probe calibration	B	13.1	N	2	1	1	6.65	6.65	∞
2	Axial isotropy	B	4.7	R	$\sqrt{3}$	$\sqrt{0.5}$	$\sqrt{0.5}$	4.3	4.3	∞
3	Hemispherical isotropy	B	9.6	R	$\sqrt{3}$	1	1	4.8	4.8	∞
4	Boundary effect	B	1.1	R	$\sqrt{3}$	1	1	0.6	0.6	∞
5	Linearity	B	4.7	R	$\sqrt{3}$	1	1	2.7	2.7	∞
6	Detection limit	B	1.0	R	$\sqrt{3}$	1	1	0.6	0.6	∞
7	modulation response	B	4.0	R	$\sqrt{3}$	1	1	2.3	2.3	∞
8	Readout electronics	B	1.0	N	1	1	1	1.0	1.0	∞
9	Response time	B	0.0	R	$\sqrt{3}$	1	1	0.0	0.0	∞
10	Integration time	B	1.7	R	$\sqrt{3}$	1	1	1.0	1.0	∞
11	RF ambient conditions-noise	B	3.0	R	$\sqrt{3}$	1	1	1.7	1.7	∞
12	RF ambient conditions-reflection	B	3.0	R	$\sqrt{3}$	1	1	1.7	1.7	∞
13	Probe positioned mech. Restrictions	B	0.35	R	$\sqrt{3}$	1	1	0.2	0.2	∞
14	Probe positioning with respect to phantom shell	B	2.9	R	$\sqrt{3}$	1	1	1.7	1.7	∞
15	Post-processing	B	1.0	R	$\sqrt{3}$	1	1	0.6	0.6	∞
Test sample related										
16	Test sample positioning	A	3.3	N	1	1	1	3.3	3.3	5
17	Device holder uncertainty	A	3.4	N	1	1	1	3.4	3.4	5
18	Drift of output power	B	5.0	R	$\sqrt{3}$	1	1	2.9	2.9	∞
Phantom and set-up										
19	Phantom uncertainty	B	1.0	R	$\sqrt{3}$	1	1	0.6	0.6	∞
20	Liquid conductivity (target)	B	5.0	R	$\sqrt{3}$	0.64	0.43	1.8	1.2	∞
21	Liquid conductivity (meas.)	A	1.3	N	1	0.64	0.43	0.83	0.56	43
22	Liquid permittivity (target)	B	5.0	R	$\sqrt{3}$	0.6	0.49	1.7	1.4	∞
23	Liquid permittivity (meas.)	A	1.6	N	1	0.6	0.49	0.96	0.78	521
Combined standard uncertainty		$u_c = \sqrt{\sum_{i=1}^{22} c_i^2 u_i^2}$						11.6	11.5	257
Expanded uncertainty (Confidence interval of 95 %)		$u_e = 2u_c$						23.2	23.0	

16. Main Test Instruments

Table 16.1: List of Main Instruments

No.	Name	Type	Serial Number	Calibration Date	Valid Period
01	Network analyzer	E5071C	MY46103759	2021-11-15	One year
02	Dielectric probe	85070E	MY44300317	/	/
03	Power meter	E4418B	MY50000366	2021-12-12	One year
04	Power sensor	E9304A	MY50000188	2021-12-12	One year
05	Power meter	NRP	101260	2021-12-30	One year
06	Power sensor	NRP-Z91	102211	2021-12-30	One year
07	Signal Generator	E8257D	MY47461211	2022-01-14	One year
08	Amplifier	VTL5400	0404	/	/
09	E-field Probe	EX3DV4	7621	2022-05-06	One year
10	DAE	DAE4	1527	2022-01-12	One year
11	Dipole Validation Kit	D2450V2	873	2021-10-21	Three years
12	Dipole Validation Kit	D5GHzV2	1238	2019-08-29	Three years
13	Software	DASY5	/	/	/

ANNEX A: Graph Results

Bluetooth Body

Date: 2022-8-9

Electronics: DAE4 Sn1527

Medium: Head 2450MHz

Medium parameters used: $f = 2480$ MHz; $\sigma = 1.87$ S/m; $\epsilon_r = 38.258$; $\rho = 1000$ kg/m³

Communication System: UID 0, BT (0) Frequency: 2480 MHz Duty Cycle: 1:1

Probe: EX3DV4 - SN7621 ConvF (8.17, 8.17, 8.17)

Top Side Ch.78/Area Scan (121x61x1): Interpolated grid: dx=1.000 mm, dy=1.000 mm

Maximum value of SAR (interpolated) = 0.221 W/kg

Top Side Ch.78/Zoom Scan (7x7x7)/Cube 0: Measurement grid: dx=5mm, dy=5mm, dz=5mm

Reference Value = 5.542 V/m; Power Drift = 0.02 dB

Peak SAR (extrapolated) = 0.355 W/kg

SAR(1 g) = 0.128 W/kg; SAR(10 g) = 0.048 W/kg

Maximum value of SAR (measured) = 0.233 W/kg

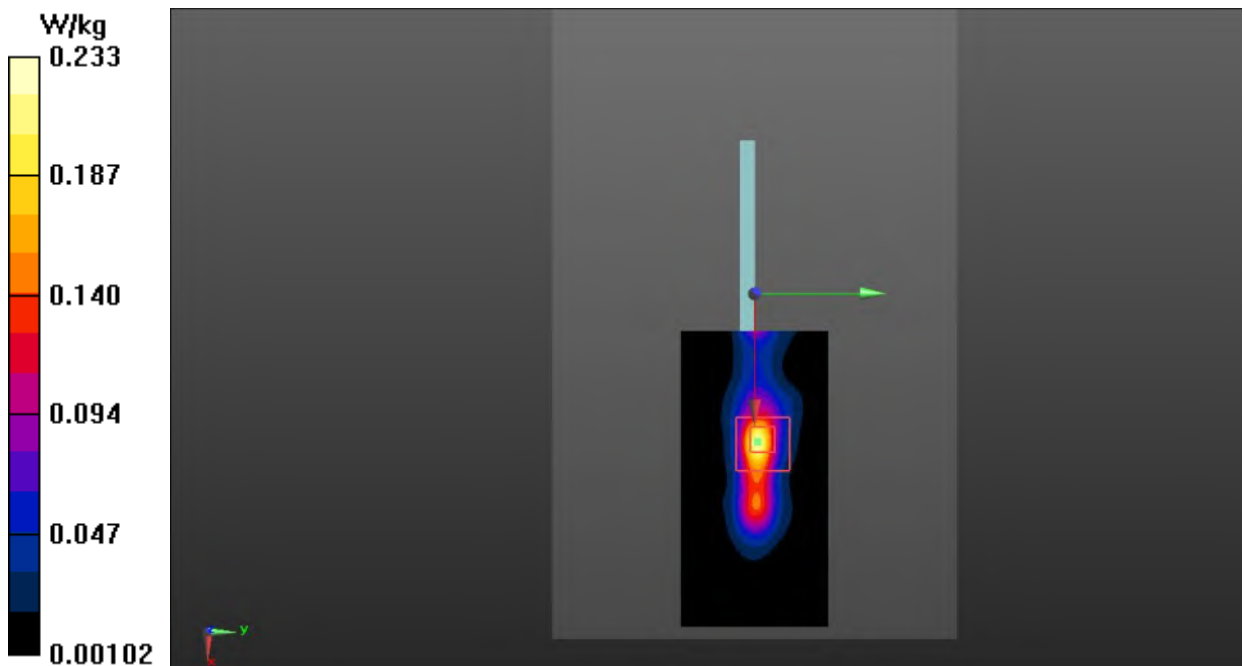

Fig.1 Bluetooth Body

WLAN 2.4GHz Body

Date: 2022-8-9

Electronics: DAE4 Sn1527

Medium: Head 2450MHz

Medium parameters used: $f = 2412$ MHz; $\sigma = 1.791$ S/m; $\epsilon_r = 38.487$; $\rho = 1000$ kg/m³

Communication System: UID 0, WLAN (0) Frequency: 2412 MHz Duty Cycle: 1:1

Probe: EX3DV4 - SN7621 ConvF (8.17, 8.17, 8.17)

Rear Side Ch.1/Area Scan (111x91x1): Interpolated grid: $dx=1.000$ mm, $dy=1.000$ mm

Maximum value of SAR (interpolated) = 1.45 W/kg

Rear Side Ch.1/Zoom Scan (7x7x7)/Cube 0: Measurement grid: $dx=5$ mm, $dy=5$ mm, $dz=5$ mm

Reference Value = 2.811 V/m; Power Drift = -0.02 dB

Peak SAR (extrapolated) = 2.26 W/kg

SAR(1 g) = 0.883 W/kg; SAR(10 g) = 0.386 W/kg

Maximum value of SAR (measured) = 1.51 W/kg

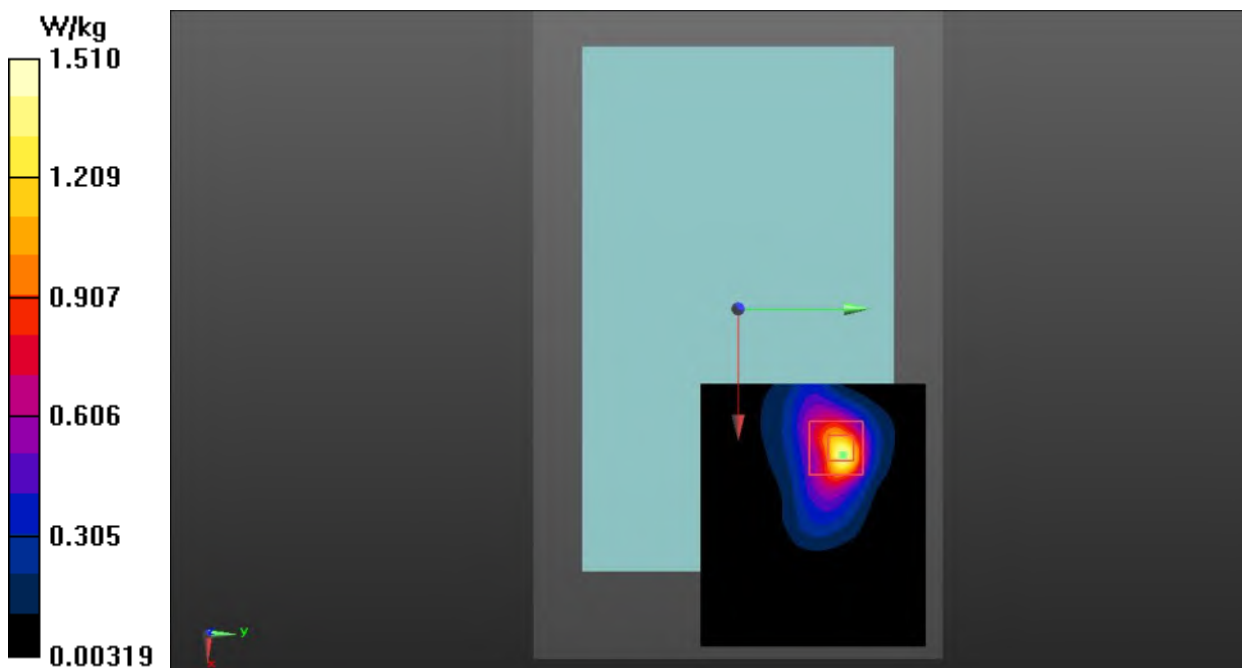

Fig.2 WLAN 2.4GHz Body

WLAN 5GHz Body

Date: 2022-8-10

Electronics: DAE4 Sn1527

Medium: Head 5250MHz

Medium parameters used: $f = 5180$ MHz; $\sigma = 4.723$ S/m; $\epsilon_r = 35.513$; $\rho = 1000$ kg/m³

Communication System: UID 0, WLAN 5G (0) Frequency: 5180 MHz Duty Cycle: 1:1

Probe: EX3DV4 - SN7621 ConvF (5.98, 5.98, 5.98)

Top Side Ch.36/Area Scan (91x61x1): Interpolated grid: dx=1.000 mm, dy=1.000 mm
Maximum value of SAR (interpolated) = 1.70 W/kg

Top Side Ch.36/Zoom Scan (8x8x21)/Cube 0: Measurement grid: dx=4mm, dy=4mm, dz=1.4mm
Reference Value = 1.887 V/m; Power Drift = 0.01 dB

Peak SAR (extrapolated) = 6.61 W/kg

SAR(1 g) = 1.25 W/kg; SAR(10 g) = 0.266 W/kg

Maximum value of SAR (measured) = 2.74 W/kg

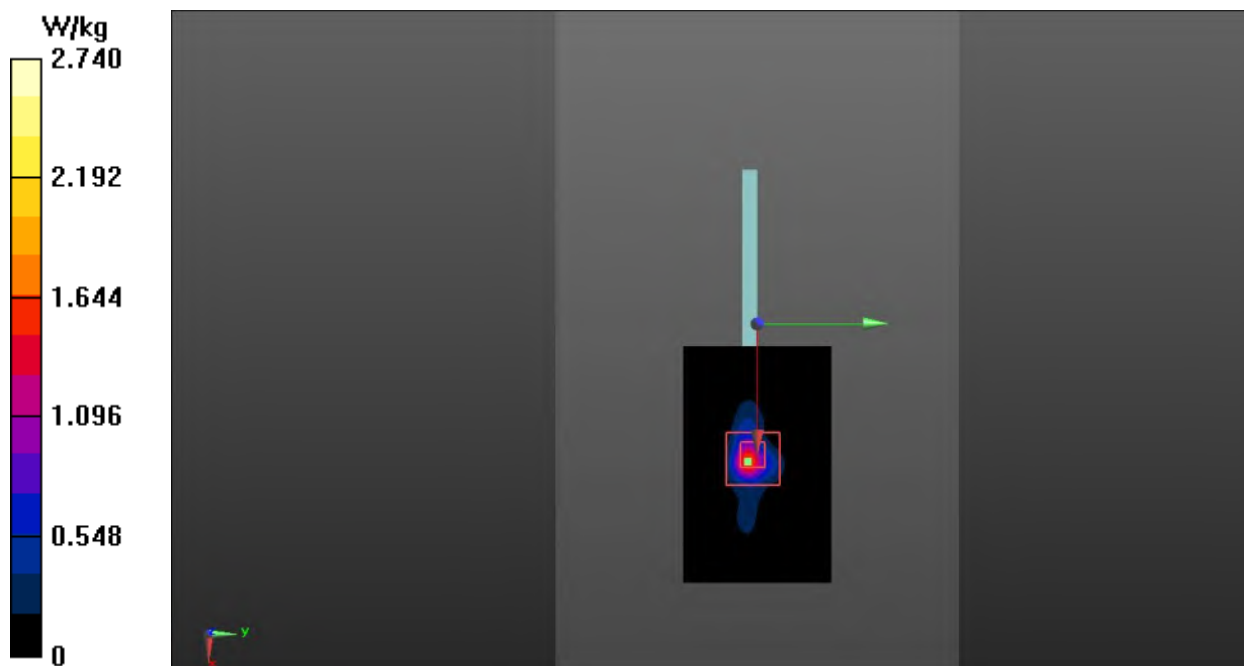
**Fig.3 WLAN 5GHz Body**

ANNEX B: SystemVerification Results

2450MHz

Date: 2022-8-9

Electronics: DAE4 Sn1527

Medium: Head 2450MHz

Medium parameters used: $f = 2450$ MHz; $\sigma = 1.835$ S/m; $\epsilon_r = 38.359$; $\rho = 1000$ kg/m³

Communication System: CW_TMC Frequency: 2450 MHz Duty Cycle: 1:1

Probe: EX3DV4 - SN7621 ConvF (8.17, 8.17, 8.17)

System Validation/Area Scan (81x121x1): Interpolated grid: $dx=1.000$ mm, $dy=1.000$ mm

Reference Value = 92.148 V/m; Power Drift = 0.08 dB

SAR(1 g) = 13.5 W/kg; SAR(10 g) = 6.09 W/kg

Maximum value of SAR (interpolated) = 15.7 W/kg

System Validation/Zoom Scan (7x7x7)/Cube0: Measurement grid: $dx=5$ mm, $dy=5$ mm, $dz=5$ mm

Reference Value = 92.148 V/m; Power Drift = 0.08 dB

Peak SAR (extrapolated) = 35.3 W/kg

SAR(1 g) = 13.8 W/kg; SAR(10 g) = 6.20 W/kg

Maximum value of SAR (measured) = 15.9 W/kg

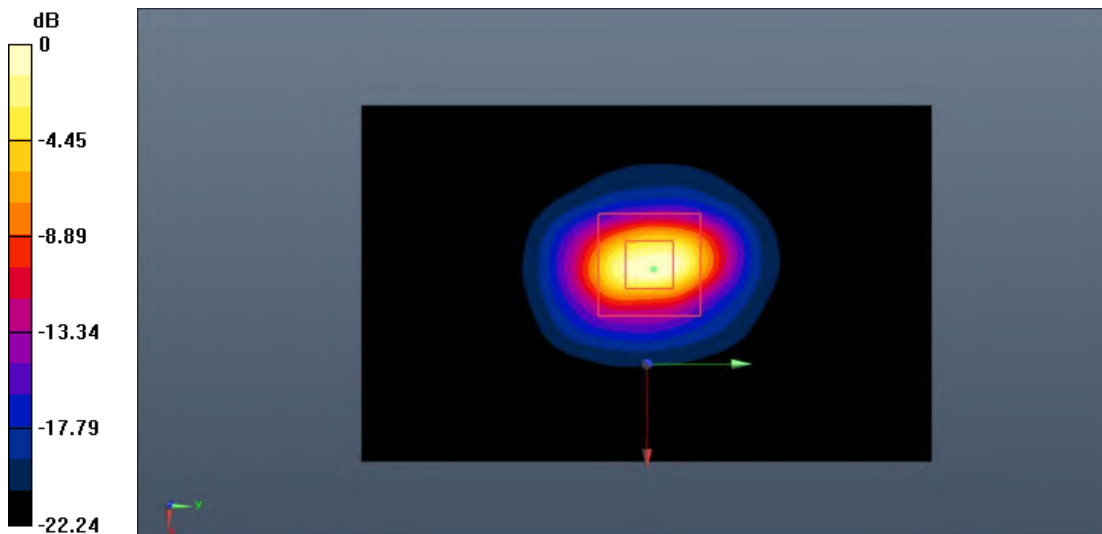

0 dB = 15.9 W/kg = 12.01 dB W/kg

Fig.B.1. Validation 2450MHz 250mW

5250MHz

Date: 2022-8-10

Electronics: DAE4 Sn1527

Medium: Head 5250MHz

Medium parameters used: $f = 5250$ MHz; $\sigma = 4.806$ S/m; $\epsilon_r = 35.282$; $\rho = 1000$ kg/m³

Communication System: CW_TMC Frequency: 5250 MHz Duty Cycle: 1:1

Probe: EX3DV4 - SN7621 ConvF (5.98, 5.98, 5.98)

System Validation/Area Scan (61x91x1): Interpolated grid: dx=1.000 mm, dy=1.000 mm

Reference Value = 65.987 V/m; Power Drift = 0.06 dB

SAR(1 g) = 7.95 W/kg; SAR(10 g) = 2.23 W/kg

Maximum value of SAR (interpolated) = 10.0 W/kg

System Validation/Zoom Scan (8x8x21)/Cube0: Measurement grid: dx=4mm, dy=4mm, dz=1.4mm

Reference Value = 65.987 V/m; Power Drift = 0.06 dB

Peak SAR (extrapolated) = 26.2 W/kg

SAR(1 g) = 8.03 W/kg; SAR(10 g) = 2.27 W/kg

Maximum value of SAR (measured) = 10.2 W/kg

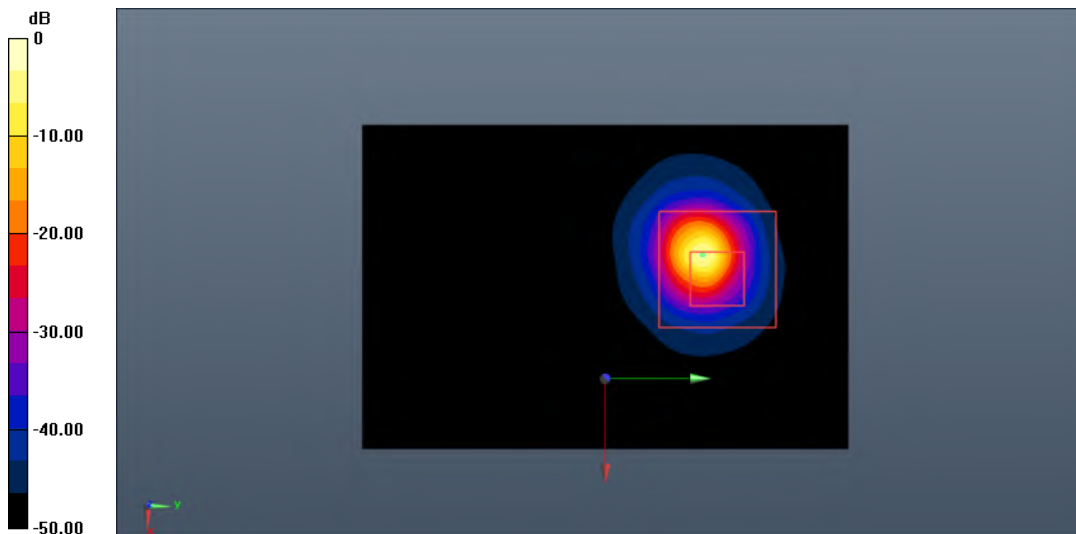

0 dB = 10.2 W/kg = 10.09 dB W/kg

Fig.B.2. Validation 5250MHz 100mW

5600MHz

Date: 2022-8-10

Electronics: DAE4 Sn1527

Medium: Head 5600MHz

Medium parameters used: $f = 5600$ MHz; $\sigma = 5.017$ S/m; $\epsilon_r = 35.885$; $\rho = 1000$ kg/m³

Communication System: CW_TMC Frequency: 5600 MHz Duty Cycle: 1:1

Probe: EX3DV4 - SN7621 ConvF (5.47, 5.47, 5.47)

System Validation/Area Scan (61x91x1): Interpolated grid: dx=1.000 mm, dy=1.000 mm

Reference Value = 63.844 V/m; Power Drift = -0.11 dB

SAR(1 g) = 7.90 W/kg; SAR(10 g) = 2.26 W/kg

Maximum value of SAR (interpolated) = 9.86 W/kg

System Validation/Zoom Scan (8x8x21)/Cube0: Measurement grid: dx=4mm, dy=4mm, dz=1.4mm

Reference Value = 63.844 V/m; Power Drift = -0.11 dB

Peak SAR (extrapolated) = 23.5 W/kg

SAR(1 g) = 7.75 W/kg; SAR(10 g) = 2.23 W/kg

Maximum value of SAR (measured) = 9.81 W/kg

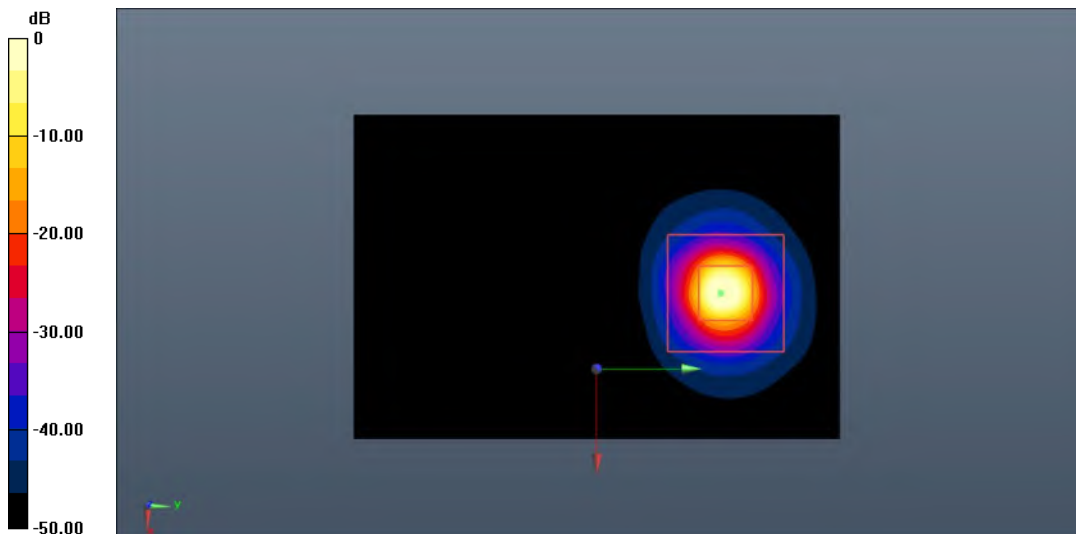

0 dB = 9.81 W/kg = 9.92 dB W/kg

Fig.B.3. Validation 5600MHz 100mW

5750MHz

Date: 2022-8-10

Electronics: DAE4 Sn1527

Medium: Head 5750MHz

Medium parameters used: $f = 5750$ MHz; $\sigma = 5.126$ S/m; $\epsilon_r = 36.352$; $\rho = 1000$ kg/m³

Communication System: CW_TMC Frequency: 5750 MHz Duty Cycle: 1:1

Probe: EX3DV4 - SN7621 ConvF (5.40, 5.40, 5.40)

System Validation/Area Scan (61x91x1): Interpolated grid: dx=1.000 mm, dy=1.000 mm

Reference Value = 63.056 V/m; Power Drift = -0.03 dB

SAR(1 g) = 7.70 W/kg; SAR(10 g) = 2.18 W/kg

Maximum value of SAR (interpolated) = 9.77 W/kg

System Validation/Zoom Scan (8x8x21)/Cube0: Measurement grid: dx=4mm, dy=4mm, dz=1.4mm

Reference Value = 63.056 V/m; Power Drift = -0.03 dB

Peak SAR (extrapolated) = 22.9 W/kg

SAR(1 g) = 7.54 W/kg; SAR(10 g) = 2.16 W/kg

Maximum value of SAR (measured) = 9.73 W/kg

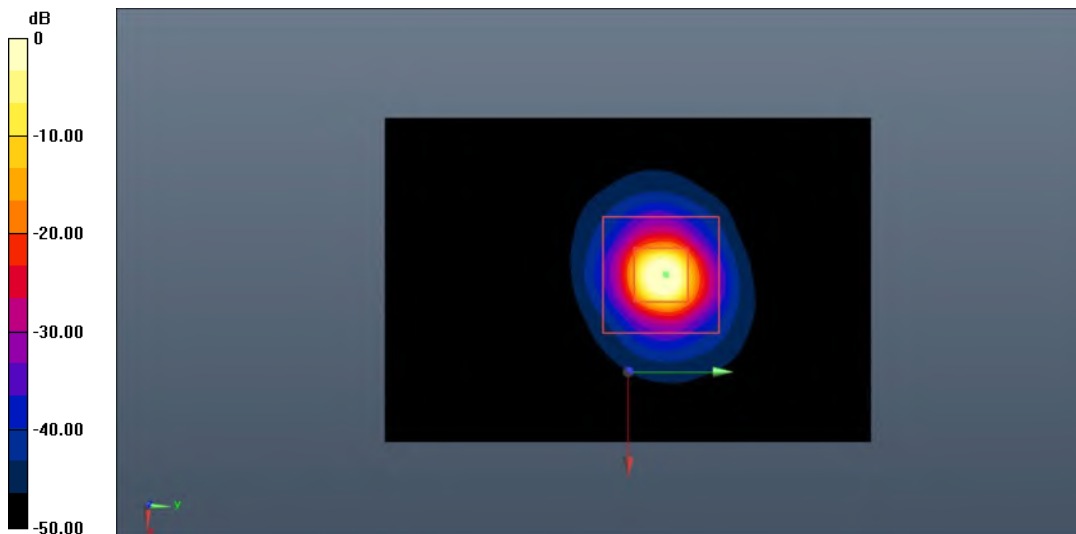

0 dB = 9.73 W/kg = 9.88 dB W/kg

Fig.B.4. Validation 5750MHz 100mW

ANNEX C: SAR Measurement Setup

C.1. Measurement Set-up

DASY5 system for performing compliance tests is illustrated above graphically. This system consists of the following items:

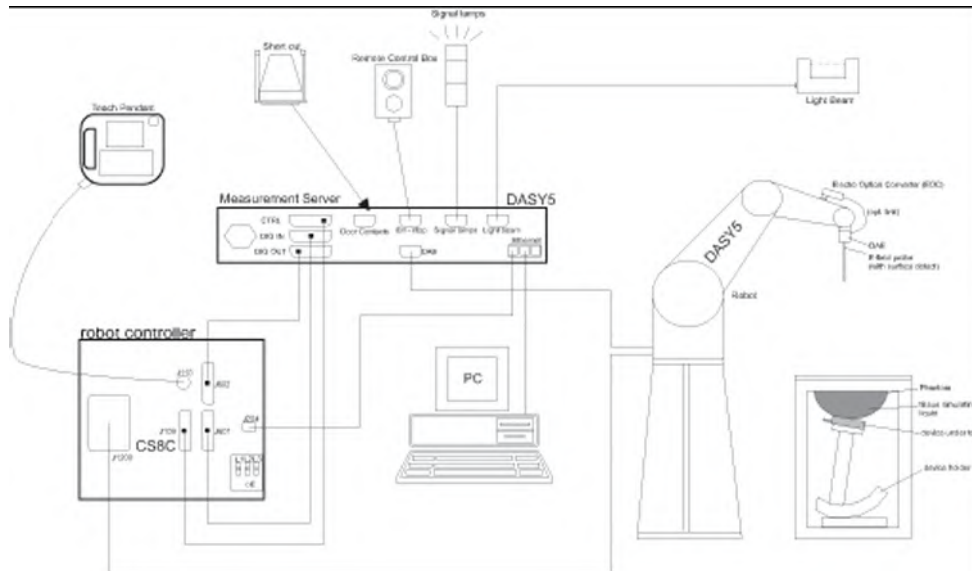

Picture C.1 SAR Lab Test Measurement Set-up

- A standard high precision 6-axis robot (Stäubli TX=RX family) with controller, teach pendant and software. An arm extension for accommodating the data acquisition electronics (DAE).
- An isotropic field probe optimized and calibrated for the targeted measurement.
- A data acquisition electronics (DAE) which performs the signal amplification, signal multiplexing, AD-conversion, offset measurements, mechanical surface detection, collision detection, etc. The unit is battery powered with standard or rechargeable batteries. The signal is optically transmitted to the EOC.
- The Electro-optical converter (EOC) performs the conversion from optical to electrical signals for the digital communication to the DAE. To use optical surface detection, a special version of the EOC is required. The EOC signal is transmitted to the measurement server.
- The function of the measurement server is to perform the time critical tasks such as signal filtering, control of the robot operation and fast movement interrupts.
- The Light Beam used is for probe alignment. This improves the (absolute) accuracy of the probe positioning.
- A computer running WinXP and the DASY5 software.
- Remote control and teach pendant as well as additional circuitry for robot safety such as
- warning lamps, etc.
- The phantom, the device holder and other accessories according to the targeted measurement.

C.2. DASY5 E-field Probe System

The SAR measurements were conducted with the dosimetric probe designed in the classical triangular configuration and optimized for dosimetric evaluation. The probe is constructed using the thick film technique; with printed resistive lines on ceramic substrates. The probe is equipped with an optical multifiber line ending at the front of the probe tip. It is connected to the EOC box on the robot arm and provides an automatic detection of the phantom surface. Half of the fibers are connected to a pulsed infrared transmitter, the other half to a synchronized receiver. As the probe approaches the surface, the reflection from the surface produces a coupling from the transmitting to the receiving fibers. This reflection increases first during the approach, reaches maximum and then decreases. If the probe is flatly touching the surface, the coupling is zero. The distance of the coupling maximum to the surface is independent of the surface reflectivity and largely independent of the surface to probe angle. The DASY5 software reads the reflection during a software approach and looks for the maximum using 2nd order curve fitting. The approach is stopped at reaching the maximum.

Probe Specifications:

Model:	ES3DV3, EX3DV4
Frequency	10MHz — 6.0GHz(EX3DV4)
Range:	10MHz — 4GHz(ES3DV3)
Calibration:	In head and body simulating tissue at Frequencies from 835 up to 5800MHz
Linearity:	± 0.2 dB(30 MHz to 6 GHz) for EX3DV4 ± 0.2 dB(30 MHz to 4 GHz) for ES3DV3
Dynamic Range:	10 mW/kg — 100W/kg
Probe Length:	330 mm
Probe Tip	
Length:	20 mm
Body Diameter:	12 mm
Tip Diameter:	2.5 mm (3.9 mm for ES3DV3)
Tip-Center:	1 mm (2.0mm for ES3DV3)
Application:	SAR Dosimetry Testing Compliance tests of mobile phones Dosimetry in strong gradient fields



Picture C.2 Near-field Probe



Picture C.3 E-field Probe

C.3. E-field Probe Calibration

Each E-Probe/Probe Amplifier combination has unique calibration parameters. A TEM cell calibration procedure is conducted to determine the proper amplifier settings to enter in the probe parameters. The amplifier settings are determined for a given frequency by subjecting the probe to a known E-field density (1 mW/cm²) using an RF Signal generator, TEM cell, and RF Power Meter.

The free space E-field from amplified probe outputs is determined in a test chamber. This calibration can be performed in a TEM cell if the frequency is below 1 GHz and in a waveguide or other methodologies above 1 GHz for free space. For the free space calibration, the probe is placed in the volumetric center of the cavity and at the proper orientation with the field. The probe is then rotated 360 degrees until the three channels show the maximum reading. The power density readings equates to 1 mW/ cm².

E-field temperature correlation calibration is performed in a flat phantom filled with the appropriate simulated brain tissue. The E-field in the medium correlates with the temperature rise in the dielectric medium. For temperature correlation calibration a RF transparent thermistor-based temperature probe is used in conjunction with the E-field probe.

$$SAR = C \frac{\Delta T}{\Delta t}$$

Where:

Δt = Exposure time (30 seconds),

C = Heat capacity of tissue (brain or muscle),

ΔT = Temperature increase due to RF exposure.

$$SAR = \frac{|E|^2 \cdot \sigma}{\rho}$$

Where:

σ = Simulated tissue conductivity,

ρ = Tissue density (kg/m³).

C.4. Other Test Equipment

C.4.1. Data Acquisition Electronics (DAE)

The data acquisition electronics consist of a highly sensitive electrometer-grade preamplifier with auto-zeroing, a channel and gain-switching multiplexer, a fast 16 bit AD-converter and a command decoder with a control logic unit. Transmission to the measurement server is accomplished through an optical downlink for data and status information, as well as an optical uplink for commands and the clock.

The mechanical probe mounting device includes two different sensor systems for frontal and sideways probe contacts. They are used for mechanical surface detection and probe collision detection.

The input impedance of the DAE is 200 MOhm; the inputs are symmetrical and floating. Common mode rejection is above 80 dB.

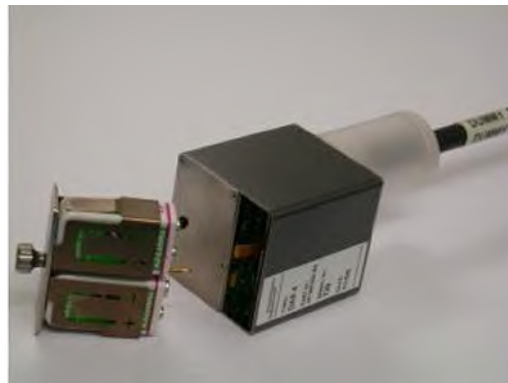

PictureC.4: DAE

C.4.2. Robot

The SPEAG DASY system uses the high precision robots (DASY5: RX160L) type from Stäubli SA (France). For the 6-axis controller system, the robot controller version from Stäubli is used. The Stäubli robot series have many features that are important for our application:

- High precision (repeatability 0.02mm)
- High reliability (industrial design)
- Low maintenance costs (virtually maintenance free due to direct drive gears; no belt drives)
- Jerk-free straight movements (brushless synchron motors; no stepper motors)
- Low ELF interference (motor control fields shielded via the closed metallic construction shields)



Picture C.5 DASY 5

C.4.3. Measurement Server

The Measurement server is based on a PC/104 CPU board with CPU (DASY5: 400 MHz, Intel Celeron), chipdisk (DASY5:128MB), RAM (DASY5:128MB). The necessary circuits for communication with the DAE electronic box, as well as the 16 bit AD converter system for optical detection and digital I/O interface are contained on the DASY I/O board, which is directly connected to the PC/104 bus of the CPU board.

The measurement server performs all real-time data evaluation of field measurements and surface detection, controls robot movements and handles safety operation. The PC operating system cannot interfere with these time critical processes. All connections are supervised by a watchdog, and disconnection of any of the cables to the measurement server will automatically disarm the robot and disable all program-controlled robot movements. Furthermore, the measurement server is equipped with an expansion port which is reserved for future applications. Please note that this expansion port does not have a standardized pinout, and therefore only devices provided by SPEAG can be connected. Devices from any other supplier could seriously damage the measurement server.



Picture C.6 Server for DASY 5

C.4.4. Device Holder for Phantom

The SAR in the phantom is approximately inversely proportional to the square of the distance between the source and the liquid surface. For a source at 5mm distance, a positioning uncertainty of $\pm 0.5\text{mm}$ would produce a SAR uncertainty of $\pm 20\%$. Accurate device positioning is therefore crucial for accurate and repeatable measurements. The positions in which the devices must be measured are defined by the standards.

The DASY device holder is designed to cope with the different positions given in the standard. It has two scales for device rotation (with respect to the body axis) and device inclination (with respect to the line between the ear reference points). The rotation centers for both scales is the ear reference point (ERP). Thus the device needs no repositioning when changing the angles.

The DASY device holder is constructed of low-loss POM material having the following dielectric

parameters: relative permittivity $\epsilon = 3$ and loss tangent $\delta = 0.02$. The amount of dielectric material has been reduced in the closest vicinity of the device, since measurements have suggested that the influence of the clamp on the test results could thus be lowered.

<Laptop Extension Kit>

The extension is lightweight and made of POM, acrylic glass and foam. It fits easily on the upper part of the Mounting Device in place of the phone positioner. The extension is fully compatible with the Twin-SAM and ELI phantoms.



Picture C.7-1: Device Holder

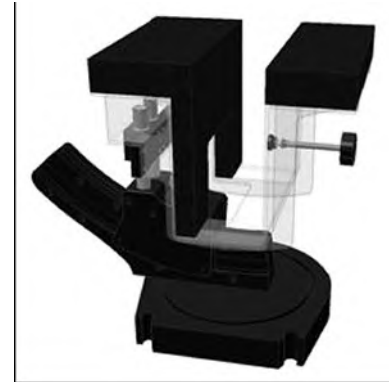

Picture C.7-2: Laptop Extension Kit

C.4.5. Phantom

The SAM Twin Phantom V4.0 is constructed of a fiberglass shell integrated in a table. The shape of the shell is based on data from an anatomical study designed to represent the 90th percentile of the population. The phantom enables the dissymmetric evaluation of SAR for both left and right handed handset usage, as well as body-worn usage using the flat phantom region. Reference markings on the Phantom allow the complete setup of all predefined phantom positions and measurement grids by manually teaching three points in the robot. The shell phantom has a 2mm shell thickness (except the ear region where shell thickness increases to 6 mm).

Shell Thickness: 2 ± 0.2 mm
Filling Volume: Approx. 25 liters
Dimensions: 810 x 1000 x 500 mm (H x L x W)
Available: Special



Picture C.8: SAM Twin Phantom

ANNEX D: Position of the wireless device in relation to the phantom

D.1. Body-worn device

A typical example of a body-worn device is a mobile phone, wireless enabled PDA or other battery operated wireless device with the ability to transmit while mounted on a person's body using a carry accessory approved by the wireless device manufacturer.

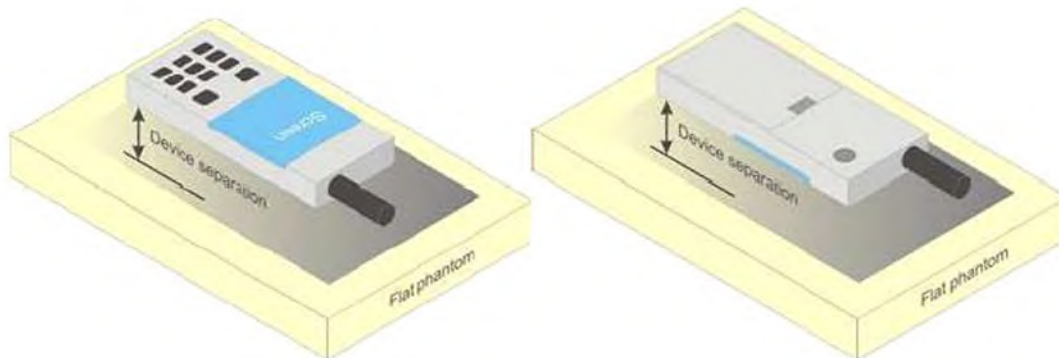

Picture D.4 Test positions for body-worn devices

D.2. Desktop device

A typical example of a desktop device is a wireless enabled desktop computer placed on a table or desk when used.

The DUT shall be positioned at the distance and in the orientation to the phantom that corresponds to the intended use as specified by the manufacturer in the user instructions. For devices that employ an external antenna with variable positions, tests shall be performed for all antenna positions specified. Picture 8.5 show positions for desktop device SAR tests. If the intended use is not specified, the device shall be tested directly against the flat phantom.

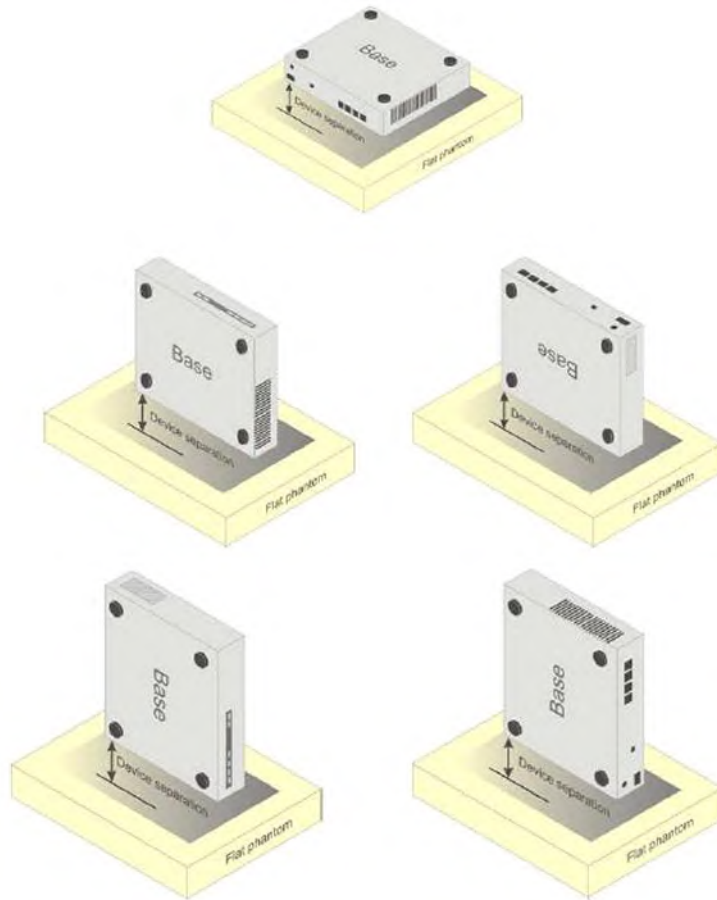

Picture D.5 Test positions for desktop devices

D.3. DUT Setup Photos



Picture D.6

ANNEX E: Equivalent Media Recipes

The liquid used for the frequency range of 700-6000 MHz consisted of water, sugar, salt, preventol, glycol monobutyl and Cellulose. The liquid has been previously proven to be suited for worst-case. The Table E.1 shows the detail solution. It's satisfying the latest tissue dielectric parameters requirements proposed by the IEEE 1528 and IEC 62209.

Table E.1: Composition of the Tissue Equivalent Matter

Frequency (MHz)	835	1750	1900	2450	2600	5200	5800
Water	41.45	55.242	55.242	58.79	58.79	65.53	66.10
Sugar	56.0	/	/	/	/	/	/
Salt	1.45	0.306	0.306	0.06	0.06		
Preventol	0.1	/	/	/	/	17.24	16.95
Cellulose	1.0	/	/	/	/	17.24	16.95
Glycol Monobutyl	/	44.452	44.452	41.15	41.15	/	/
Diethylenglycol monohexylether	/	/	/	/	/	/	/
Triton X-100	/	/	/	/	/	/	/
Dielectric Parameters Target Value	$\epsilon=41.5$ $\sigma=0.90$	$\epsilon=40.08$ $\sigma=1.37$	$\epsilon=40.0$ $\sigma=1.40$	$\epsilon=39.20$ $\sigma=1.80$	$\epsilon=39.01$ $\sigma=1.96$	$\epsilon=35.99$ $\sigma=4.66$	$\epsilon=35.30$ $\sigma=5.27$

Note: There is a little adjustment respectively for 750, 5300 and 5600, based on the recipe of closest frequency in table E.1

ANNEX F: System Validation

The SAR system must be validated against its performance specifications before it is deployed. When SAR probes, system components or software are changed, upgraded or recalibrated, these must be validated with the SAR system(s) that operates with such components.

Table F.1: System Validation

Probe SN.	Liquid name	Validation date	Frequency point	Status (OK or Not)
7621	Head 750MHz	2022-05-09	750MHz	OK
7621	Head 835MHz	2022-05-09	835MHz	OK
7621	Head 1750MHz	2022-05-09	1750MHz	OK
7621	Head 1900MHz	2022-05-09	1900MHz	OK
7621	Head 2300MHz	2022-05-09	2300MHz	OK
7621	Head 2450MHz	2022-05-08	2450MHz	OK
7621	Head 2550MHz	2022-05-08	2550MHz	OK
7621	Head 5250MHz	2022-05-08	5250MHz	OK
7621	Head 5600MHz	2022-05-08	5600MHz	OK
7621	Head 5750MHz	2022-05-08	5750MHz	OK



ANNEX G: DAE Calibration Certificate



Add: No.52 HuaYuanBei Road, Haidian District, Beijing, 100191, China
Tel: +86-10-62304633-2512 Fax: +86-10-62304633-2504
E-mail: cttl@chinattl.com <http://www.chinattl.cn>



中国认可
国际互认
校准
CALIBRATION
CNAS L0570



Client : SAICT

Certificate No: Z22-60003

CALIBRATION CERTIFICATE

Object: DAE4 - SN: 1527

Calibration Procedure(s): FF-Z11-002-01
Calibration Procedure for the Data Acquisition Electronics (DAEx)

Calibration date: January 12, 2022

This calibration Certificate documents the traceability to national standards, which realize the physical units of measurements(SI). The measurements and the uncertainties with confidence probability are given on the following pages and are part of the certificate.

All calibrations have been conducted in the closed laboratory facility: environment temperature(22±3)°C and humidity<70%.

Calibration Equipment used (M&TE critical for calibration)

Primary Standards	ID #	Cal Date(Calibrated by, Certificate No.)	Scheduled Calibration
Process Calibrator 753	1971018	15-Jun-21 (CTTL, No.J21X04465)	Jun-22

	Name	Function	Signature
Calibrated by:	Yu Zongying	SAR Test Engineer	
Reviewed by:	Lin Hao	SAR Test Engineer	
Approved by:	Qi Dianyuan	SAR Project Leader	

Issued: January 14, 2022

This calibration certificate shall not be reproduced except in full without written approval of the laboratory.



Add: No.52 HuaYuanBei Road, Haidian District, Beijing, 100191, China
Tel: +86-10-62304633-2512 Fax: +86-10-62304633-2504
E-mail: ettl@chinattl.com [Http://www.chinattl.cn](http://www.chinattl.cn)

Glossary:

DAE data acquisition electronics
Connector angle information used in DASY system to align probe sensor X to the robot coordinate system.

Methods Applied and Interpretation of Parameters:

- *DC Voltage Measurement:* Calibration Factor assessed for use in DASY system by comparison with a calibrated instrument traceable to national standards. The figure given corresponds to the full scale range of the voltmeter in the respective range.
- *Connector angle:* The angle of the connector is assessed measuring the angle mechanically by a tool inserted. Uncertainty is not required.
- The report provide only calibration results for DAE, it does not contain other performance test results.



Add: No.52 HuaYuanBei Road, Haidian District, Beijing, 100191, China
Tel: +86-10-62304633-2512 Fax: +86-10-62304633-2504
E-mail: cttl@chinattl.com Http://www.chinattl.cn

DC Voltage Measurement

A/D - Converter Resolution nominal

High Range: 1LSB = 6.1μV, full range = -100...+300 mV

Low Range: 1LSB = 61nV, full range = -1.....+3mV

DASY measurement parameters: Auto Zero Time: 3 sec; Measuring time: 3 sec

Calibration Factors	X	Y	Z
High Range	403.864 ± 0.15% (k=2)	403.585 ± 0.15% (k=2)	403.806 ± 0.15% (k=2)
Low Range	3.95854 ± 0.7% (k=2)	3.98858 ± 0.7% (k=2)	3.96746 ± 0.7% (k=2)

Connector Angle

Connector Angle to be used in DASY system	224° ± 1 °
---	------------



ANNEX H: Probe Calibration Certificate



Add: No.52 HuaYuanBei Road, Haidian District, Beijing, 100191, China
Tel: +86-10-62304633-2117
E-mail: cttl@chinattl.com http://www.caict.ac.cn



Client SAICT

Certificate No: Z22-60124

CALIBRATION CERTIFICATE			
Object	EX3DV4 - SN : 7621		
Calibration Procedure(s)	FF-Z11-004-02 Calibration Procedures for Dosimetric E-field Probes		
Calibration date:	May 06, 2022		
<p>This calibration Certificate documents the traceability to national standards, which realize the physical units of measurements(SI). The measurements and the uncertainties with confidence probability are given on the following pages and are part of the certificate.</p> <p>All calibrations have been conducted in the closed laboratory facility: environment temperature(22±3)°C and humidity<70%.</p> <p>Calibration Equipment used (M&TE critical for calibration)</p>			
Primary Standards	ID #	Cal Date(Calibrated by, Certificate No.)	Scheduled Calibration
Power Meter NRP2	101919	15-Jun-21(CTTL, No.J21X04466)	Jun-22
Power sensor NRP-Z91	101547	15-Jun-21(CTTL, No.J21X04466)	Jun-22
Power sensor NRP-Z91	101548	15-Jun-21(CTTL, No.J21X04466)	Jun-22
Reference 10dBAttenuator	18N50W-10dB	20-Jan-21(CTTL, No.J21X00486)	Jan-23
Reference 20dBAttenuator	18N50W-20dB	20-Jan-21(CTTL, No.J21X00485)	Jan-23
Reference Probe EX3DV4	SN 7464	26-Jan-22(SPEAG, No.EX3-7464_Jan22)	Jan-23
DAE4	SN 1555	20-Aug-21(SPEAG, No.DAE4-1555_Aug21/2)	Aug-22
Secondary Standards	ID #	Cal Date(Calibrated by, Certificate No.)	Scheduled Calibration
SignalGenerator MG3700A	6201052605	16-Jun-21(CTTL, No.J21X04467)	Jun-22
Network Analyzer E5071C	MY46110673	14-Jan-22(CTTL, No.J22X00406)	Jan-23
Calibrated by:	Name Yu Zongying	Function SAR Test Engineer	Signature
Reviewed by:	Name Lin Hao	Function SAR Test Engineer	Signature
Approved by:	Name Qi Dianyuan	Function SAR Project Leader	Signature
Issued: May 23, 2022			
This calibration certificate shall not be reproduced except in full without written approval of the laboratory.			

Certificate No: Z22-60124

Page 1 of 9

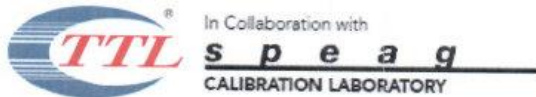

Add: No.52 HuaYuanBei Road, Haidian District, Beijing, 100191, China
Tel: +86-10-62304633-2117
E-mail: cttl@chinattl.com <http://www.caict.ac.cn>

Glossary:

TSL	tissue simulating liquid
NORM _{x,y,z}	sensitivity in free space
ConvF	sensitivity in TSL / NORM _{x,y,z}
DCP	diode compression point
CF	crest factor (1/duty_cycle) of the RF signal
A,B,C,D	modulation dependent linearization parameters
Polarization Φ	Φ rotation around probe axis
Polarization θ	θ rotation around an axis that is in the plane normal to probe axis (at measurement center), i $\theta=0$ is normal to probe axis

Connector Angle information used in DASY system to align probe sensor X to the robot coordinate system

Calibration is Performed According to the Following Standards:

- IEEE Std 1528-2013, "IEEE Recommended Practice for Determining the Peak Spatial-Averaged Specific Absorption Rate (SAR) in the Human Head from Wireless Communications Devices: Measurement Techniques", June 2013
- IEC 62209-1, "Measurement procedure for the assessment of Specific Absorption Rate (SAR) from hand-held and body-mounted devices used next to the ear (frequency range of 300 MHz to 6 GHz)", July 2016
- IEC 62209-2, "Procedure to determine the Specific Absorption Rate (SAR) for wireless communication devices used in close proximity to the human body (frequency range of 30 MHz to 6 GHz)", March 2010
- KDB 865664, "SAR Measurement Requirements for 100 MHz to 6 GHz"

Methods Applied and Interpretation of Parameters:

- NORM_{x,y,z}**: Assessed for E-field polarization $\theta=0$ ($f \leq 900\text{MHz}$ in TEM-cell; $f > 1800\text{MHz}$: waveguide). NORM_{x,y,z} are only intermediate values, i.e., the uncertainties of NORM_{x,y,z} does not effect the E^2 -field uncertainty inside TSL (see below ConvF).
- NORM(f)_{x,y,z}** = NORM_{x,y,z} * frequency_response (see Frequency Response Chart). This linearization is implemented in DASY4 software versions later than 4.2. The uncertainty of the frequency response is included in the stated uncertainty of ConvF.
- DCP_{x,y,z}**: DCP are numerical linearization parameters assessed based on the data of power sweep (no uncertainty required). DCP does not depend on frequency nor media.
- PAR**: PAR is the Peak to Average Ratio that is not calibrated but determined based on the signal characteristics.
- A_{x,y,z}; B_{x,y,z}; C_{x,y,z}; VR_{x,y,z}; A,B,C** are numerical linearization parameters assessed based on the data of power sweep for specific modulation signal. The parameters do not depend on frequency nor media. VR is the maximum calibration range expressed in RMS voltage across the diode.
- ConvF and Boundary Effect Parameters**: Assessed in flat phantom using E-field (or Temperature Transfer Standard for $f \leq 800\text{MHz}$) and inside waveguide using analytical field distributions based on power measurements for $f > 800\text{MHz}$. The same setups are used for assessment of the parameters applied for boundary compensation (alpha, depth) of which typical uncertainty valued are given. These parameters are used in DASY4 software to improve probe accuracy close to the boundary. The sensitivity in TSL corresponds to NORM_{x,y,z} * ConvF whereby the uncertainty corresponds to that given for ConvF. A frequency dependent ConvF is used in DASY version 4.4 and higher which allows extending the validity from $\pm 50\text{MHz}$ to $\pm 100\text{MHz}$.
- Spherical isotropy (3D deviation from isotropy)**: in a field of low gradients realized using a flat phantom exposed by a patch antenna.
- Sensor Offset**: The sensor offset corresponds to the offset of virtual measurement center from the probe tip (on probe axis). No tolerance required.
- Connector Angle**: The angle is assessed using the information gained by determining the NORM_x (no uncertainty required).

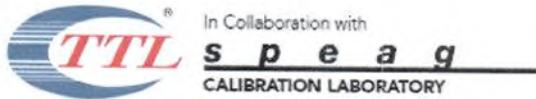

Add: No.52 HuaYuanBei Road, Haidian District, Beijing, 100191, China
Tel: +86-10-62304633-2117
E-mail: cttl@chinattl.com http://www.caict.ac.cn

DASY/EASY – Parameters of Probe: EX3DV4 – SN:7621

Basic Calibration Parameters

	Sensor X	Sensor Y	Sensor Z	Unc (k=2)
Norm($\mu\text{V}/(\text{V}/\text{m})^2$) ^A	0.71	0.71	0.56	$\pm 10.0\%$
DCP(mV) ^B	111.7	111.8	115.7	

Modulation Calibration Parameters

UID	Communication System Name		A dB	B dB $\cdot\mu\text{V}$	C	D dB	VR mV	Unc ^E (k=2)
0	CW	X	0.0	0.0	1.0	0.00	210.8	$\pm 3.5\%$
		Y	0.0	0.0	1.0		218.6	
		Z	0.0	0.0	1.0		190.8	

The reported uncertainty of measurement is stated as the standard uncertainty of Measurement multiplied by the coverage factor $k=2$, which for a normal distribution Corresponds to a coverage probability of approximately 95%.

^A The uncertainties of Norm X, Y, Z do not affect the E²-field uncertainty inside TSL (see Page 4).

^B Numerical linearization parameter: uncertainty not required.

^E Uncertainty is determined using the max. deviation from linear response applying rectangular distribution and is expressed for the square of the field value.

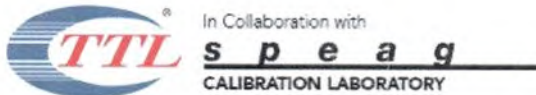

Add: No.52 HuaYuanBei Road, Haidian District, Beijing, 100191, China
Tel: +86-10-62304633-2117
E-mail: ttl@chinattl.com http://www.caict.ac.cn

DASY/EASY – Parameters of Probe: EX3DV4 – SN:7621

Calibration Parameter Determined in Head Tissue Simulating Media

f [MHz] ^C	Relative Permittivity ^F	Conductivity (S/m) ^F	ConvF X	ConvF Y	ConvF Z	Alpha ^G	Depth ^G (mm)	Unct. (k=2)
750	41.9	0.89	11.12	11.12	11.12	0.18	1.14	±12.1%
900	41.5	0.97	10.68	10.68	10.68	0.14	1.14	±12.1%
1450	40.5	1.20	9.65	9.65	9.65	0.21	0.91	±12.1%
1750	40.1	1.37	9.22	9.22	9.22	0.31	0.90	±12.1%
1900	40.0	1.40	8.90	8.90	8.90	0.35	0.84	±12.1%
2100	39.8	1.49	8.95	8.95	8.95	0.23	1.13	±12.1%
2300	39.5	1.67	8.60	8.60	8.60	0.44	0.78	±12.1%
2450	39.2	1.80	8.17	8.17	8.17	0.49	0.78	±12.1%
2600	39.0	1.96	7.93	7.93	7.93	0.51	0.75	±12.1%
3300	38.2	2.71	7.74	7.74	7.74	0.45	0.92	±13.3%
3500	37.9	2.91	7.56	7.56	7.56	0.44	1.00	±13.3%
3700	37.7	3.12	7.18	7.18	7.18	0.38	1.05	±13.3%
3900	37.5	3.32	7.26	7.26	7.26	0.35	1.35	±13.3%
4100	37.2	3.53	7.21	7.21	7.21	0.25	1.30	±13.3%
4400	36.9	3.84	7.01	7.01	7.01	0.25	1.55	±13.3%
4600	36.7	4.04	6.90	6.90	6.90	0.30	1.72	±13.3%
4800	36.4	4.25	6.79	6.79	6.79	0.30	1.85	±13.3%
4950	36.3	4.40	6.44	6.44	6.44	0.30	1.80	±13.3%
5250	35.9	4.71	5.98	5.98	5.98	0.35	1.63	±13.3%
5600	35.5	5.07	5.47	5.47	5.47	0.40	1.55	±13.3%
5750	35.4	5.22	5.40	5.40	5.40	0.40	1.55	±13.3%

^C Frequency validity above 300 MHz of ±100MHz only applies for DASY v4.4 and higher (Page 2), else it is restricted to ±50MHz. The uncertainty is the RSS of ConvF uncertainty at calibration frequency and the uncertainty for the indicated frequency band. Frequency validity below 300 MHz is ± 10, 25, 40, 50 and 70 MHz for ConvF assessments at 30, 64, 128, 150 and 220 MHz respectively. Above 5 GHz frequency validity can be extended to ± 110 MHz.

^F At frequency below 3 GHz, the validity of tissue parameters (ϵ and σ) can be relaxed to ±10% if liquid compensation formula is applied to measured SAR values. At frequencies above 3 GHz, the validity of tissue parameters (ϵ and σ) is restricted to ±5%. The uncertainty is the RSS of the ConvF uncertainty for indicated target tissue parameters.

^G Alpha/Depth are determined during calibration. SPEAG warrants that the remaining deviation due to the boundary effect after compensation is always less than ± 1% for frequencies below 3 GHz and below ± 2% for the frequencies between 3-6 GHz at any distance larger than half the probe tip diameter from the boundary.

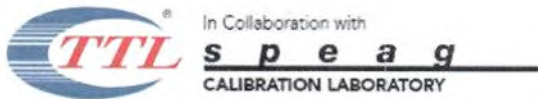

Add: No.52 HuaYuanBei Road, Haidian District, Beijing, 100191, China
Tel: +86-10-62304633-2117
E-mail: cttl@chinattl.com <http://www.caict.ac.cn>

Frequency Response of E-Field (TEM-Cell: ifi110 EXX, Waveguide: R22)

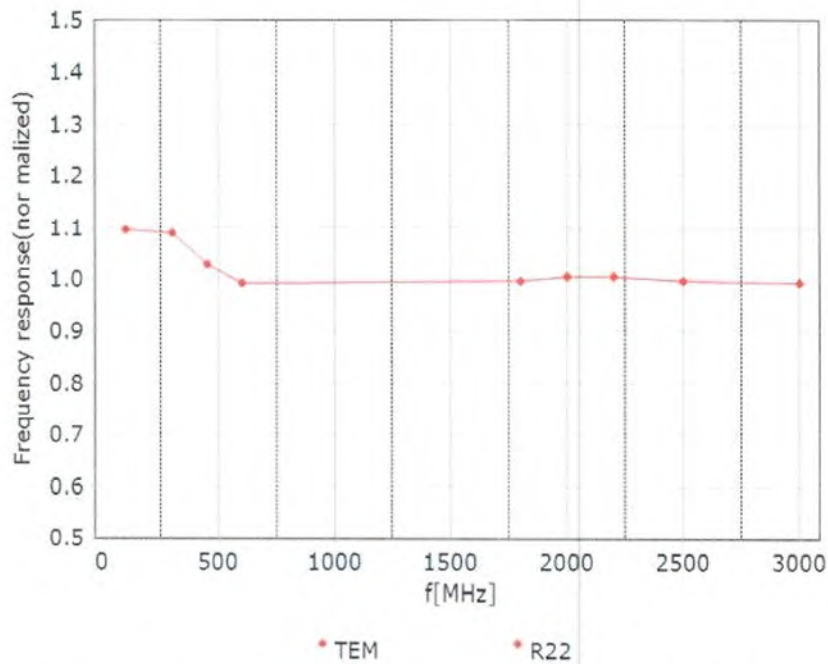

Uncertainty of Frequency Response of E-field: $\pm 7.4\%$ ($k=2$)

Receiving Pattern (Φ), $\theta=0^\circ$

f=600 MHz, TEM

f=1800 MHz, R22

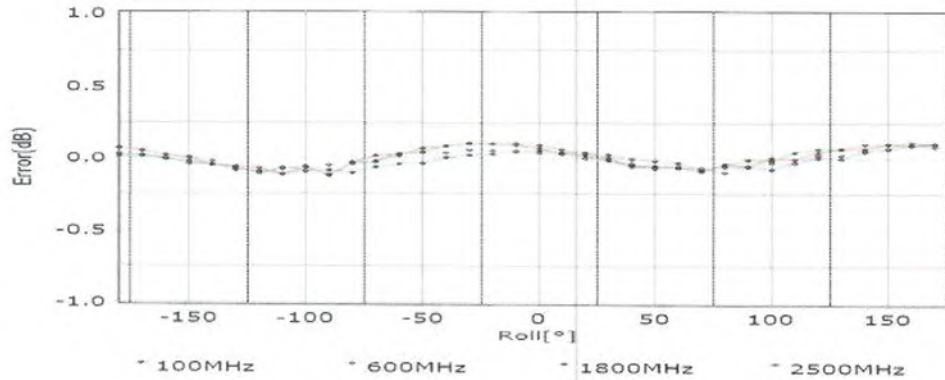
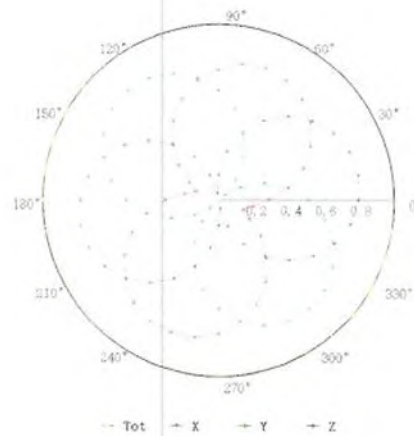
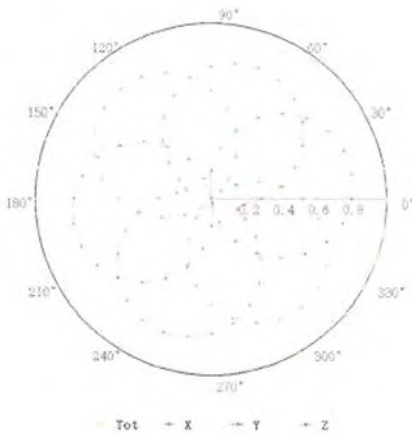

Uncertainty of Axial Isotropy Assessment: $\pm 1.2\%$ ($k=2$)

Dynamic Range f(SAR_{head}) (TEM cell, f = 900 MHz)

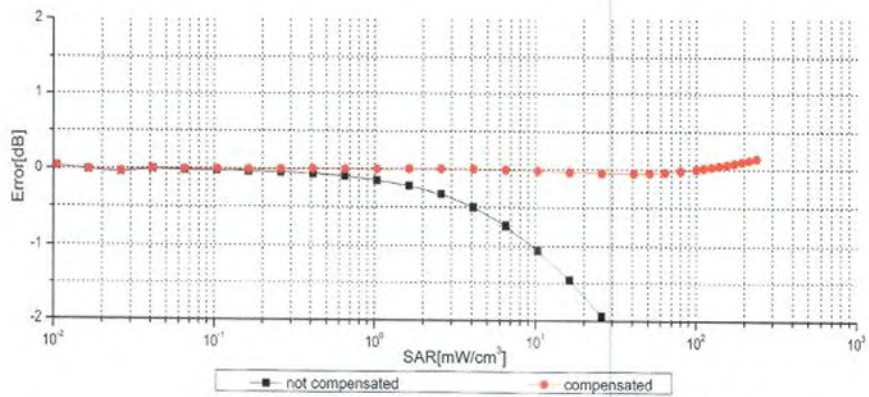
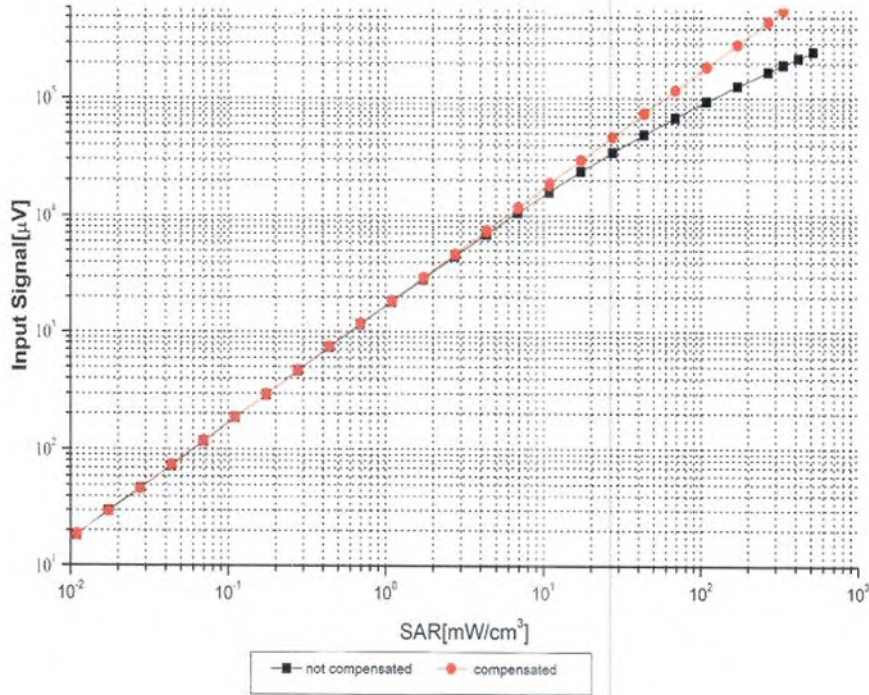

Uncertainty of Linearity Assessment: ±0.9% (k=2)

Conversion Factor Assessment

f=750 MHz,WGLS R9(H_convF)

f=1750 MHz,WGLS R22(H_convF)

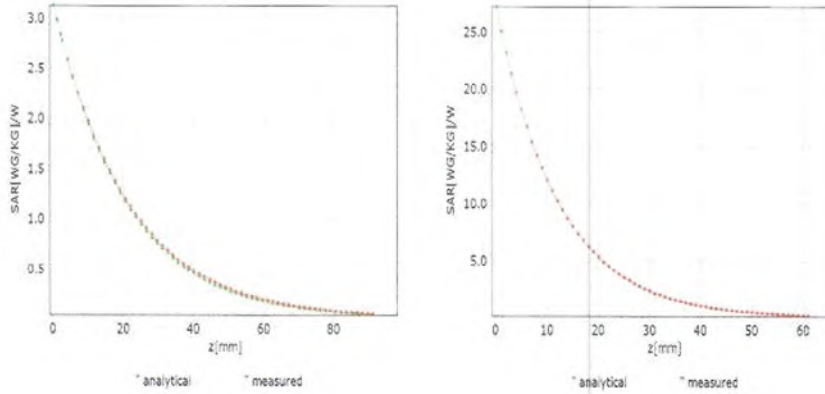

Deviation from Isotropy in Liquid

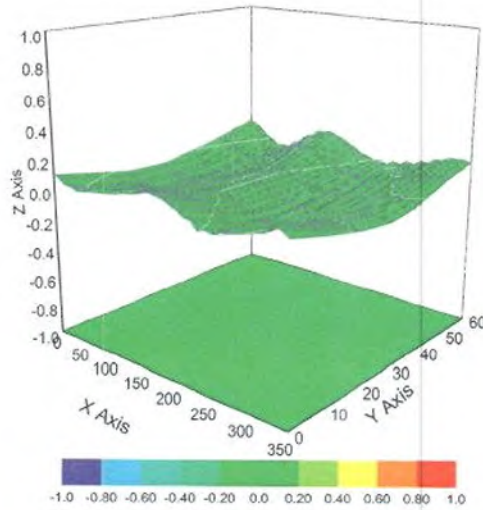

Uncertainty of Spherical Isotropy Assessment: $\pm 3.2\%$ ($k=2$)

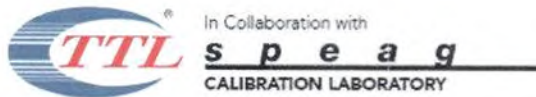

Add: No.52 HuaYuanBei Road, Haidian District, Beijing, 100191, China
Tel: +86-10-62304633-2117
E-mail: cttl@chinattl.com <http://www.caict.ac.cn>

DASY/EASY – Parameters of Probe: EX3DV4 – SN:7621

Other Probe Parameters

Sensor Arrangement	Triangular
Connector Angle (°)	95.4
Mechanical Surface Detection Mode	enabled
Optical Surface Detection Mode	disable
Probe Overall Length	337mm
Probe Body Diameter	10mm
Tip Length	9mm
Tip Diameter	2.5mm
Probe Tip to Sensor X Calibration Point	1mm
Probe Tip to Sensor Y Calibration Point	1mm
Probe Tip to Sensor Z Calibration Point	1mm
Recommended Measurement Distance from Surface	1.4mm



ANNEX I: Dipole Calibration Certificate

2450MHz Dipole



In Collaboration with
s p e a g
CALIBRATION LABORATORY



中国认可
国际互认
校准
CALIBRATION
CNAS L0570

Add: No.52 HuaYuanBei Road, Haidian District, Beijing, 100191, Chi
Tel: +86-10-62304633-2079 Fax: +86-10-62304633-2504
E-mail: entl@chinattl.com http://www.chinattl.cn

Client **SAICT**

Certificate No: **Z21-60358**

CALIBRATION CERTIFICATE			
Object	D2450V2 - SN: 873		
Calibration Procedure(s)	FF-Z11-003-01 Calibration Procedures for dipole validation kits		
Calibration date:	October 21, 2021		
This calibration Certificate documents the traceability to national standards, which realize the physical units of measurements (SI). The measurements and the uncertainties with confidence probability are given on the following pages and are part of the certificate.			
All calibrations have been conducted in the closed laboratory facility: environment temperature (22±3)°C and humidity<70%.			
Calibration Equipment used (M&TE critical for calibration)			
Primary Standards	ID #	Cal Date (Calibrated by, Certificate No.)	Scheduled Calibration
Power Meter NRP2	106277	24-Sep-21 (CTTL, No.J21X08326)	Sep-22
Power sensor NRP8S	104291	24-Sep-21 (CTTL, No.J21X08326)	Sep-22
Reference Probe EX3DV4	SN 7517	03-Feb-21(CTTL-SPEAG.No.Z21-60001)	Feb-22
DAE4	SN 1556	15-Jan-21(SPEAG,No.DAE4-1556_Jan21)	Jan-22
Secondary Standards	ID #	Cal Date (Calibrated by, Certificate No.)	Scheduled Calibration
Signal Generator E4438C	MY49071430	01-Feb-21 (CTTL, No.J21X00593)	Jan-22
NetworkAnalyzer E5071C	MY46110673	14-Jan-21 (CTTL, No.J21X00232)	Jan-22
Calibrated by:	Name Zhao Jing	Function SAR Test Engineer	Signature
Reviewed by:	Name Lin Hao	Function SAR Test Engineer	Signature
Approved by:	Name Qi Dianyuan	Function SAR Project Leader	Signature
Issued: October 27, 2021			
This calibration certificate shall not be reproduced except in full without written approval of the laboratory.			



In Collaboration with
s p e a g
CALIBRATION LABORATORY

Add: No.52 HuaYuanBei Road, Haidian District, Beijing, 100191, China
Tel: +86-10-62304633-2079 Fax: +86-10-62304633-2504
E-mail: cttl@chinattl.com http://www.chinattl.cn

Glossary:

TSL	tissue simulating liquid
ConvF	sensitivity in TSL / NORM _{x,y,z}
N/A	not applicable or not measured

Calibration is Performed According to the Following Standards:

- IEEE Std 1528-2013, "IEEE Recommended Practice for Determining the Peak Spatial-Averaged Specific Absorption Rate (SAR) in the Human Head from Wireless Communications Devices: Measurement Techniques", June 2013
- IEC 62209-1, "Measurement procedure for assessment of specific absorption rate of human exposure to radio frequency fields from hand-held and body-mounted wireless communication devices- Part 1: Device used next to the ear (Frequency range of 300MHz to 6GHz)", July 2016
- IEC 62209-2, "Procedure to measure the Specific Absorption Rate (SAR) For wireless communication devices used in close proximity to the human body (frequency range of 30MHz to 6GHz)", March 2010
- KDB865664, SAR Measurement Requirements for 100 MHz to 6 GHz

Additional Documentation:

- DASY4/5 System Handbook

Methods Applied and Interpretation of Parameters:

- Measurement Conditions:* Further details are available from the Validation Report at the end of the certificate. All figures stated in the certificate are valid at the frequency indicated.
- Antenna Parameters with TSL:* The dipole is mounted with the spacer to position its feed point exactly below the center marking of the flat phantom section, with the arms oriented parallel to the body axis.
- Feed Point Impedance and Return Loss:* These parameters are measured with the dipole positioned under the liquid filled phantom. The impedance stated is transformed from the measurement at the SMA connector to the feed point. The Return Loss ensures low reflected power. No uncertainty required.
- Electrical Delay:* One-way delay between the SMA connector and the antenna feed point. No uncertainty required.
- SAR measured:* SAR measured at the stated antenna input power.
- SAR normalized:* SAR as measured, normalized to an input power of 1 W at the antenna connector.
- SAR for nominal TSL parameters:* The measured TSL parameters are used to calculate the nominal SAR result.

The reported uncertainty of measurement is stated as the standard uncertainty of Measurement multiplied by the coverage factor $k=2$, which for a normal distribution Corresponds to a coverage probability of approximately 95%.



In Collaboration with
s p e a g
CALIBRATION LABORATORY

Add: No.52 HuaYuanBei Road, Haidian District, Beijing, 100191, China
Tel: +86-10-62304633-2079 Fax: +86-10-62304633-2504
E-mail: cttl@chinattl.com http://www.chinattl.cn

Measurement Conditions

DASY system configuration, as far as not given on page 1.

DASY Version	DASY52	V52.10.4
Extrapolation	Advanced Extrapolation	
Phantom	Triple Flat Phantom 5.1C	
Distance Dipole Center - TSL	10 mm	with Spacer
Zoom Scan Resolution	dx, dy, dz = 5 mm	
Frequency	2450 MHz \pm 1 MHz	

Head TSL parameters

The following parameters and calculations were applied.

	Temperature	Permittivity	Conductivity
Nominal Head TSL parameters	22.0 °C	39.2	1.80 mho/m
Measured Head TSL parameters	(22.0 \pm 0.2) °C	39.5 \pm 6 %	1.81 mho/m \pm 6 %
Head TSL temperature change during test	<1.0 °C	---	---

SAR result with Head TSL

SAR averaged over 1 cm^3 (1 g) of Head TSL	Condition	
SAR measured	250 mW input power	13.3 W/kg
SAR for nominal Head TSL parameters	normalized to 1W	53.2 W/kg \pm 18.8 % (k=2)
SAR averaged over 10 cm^3 (10 g) of Head TSL	Condition	
SAR measured	250 mW input power	6.05 W/kg
SAR for nominal Head TSL parameters	normalized to 1W	24.2 W/kg \pm 18.7 % (k=2)



In Collaboration with
s p e a g
CALIBRATION LABORATORY

Add: No.52 HuaYuanBei Road, Haidian District, Beijing, 100191, China
Tel: +86-10-62304633-2079 Fax: +86-10-62304633-2504
E-mail: cttl@chinattl.com http://www.chinattl.cn

Appendix (Additional assessments outside the scope of CNAS L0570)

Antenna Parameters with Head TSL

Impedance, transformed to feed point	53.6Ω+ 1.26jΩ
Return Loss	- 28.8dB

General Antenna Parameters and Design

Electrical Delay (one direction)	1.066 ns
----------------------------------	----------

After long term use with 100W radiated power, only a slight warming of the dipole near the feedpoint can be measured.

The dipole is made of standard semirigid coaxial cable. The center conductor of the feeding line is directly connected to the second arm of the dipole. The antenna is therefore short-circuited for DC-signals. On some of the dipoles, small end caps are added to the dipole arms in order to improve matching when loaded according to the position as explained in the "Measurement Conditions" paragraph. The SAR data are not affected by this change. The overall dipole length is still according to the Standard. No excessive force must be applied to the dipole arms, because they might bend or the soldered connections near the feedpoint may be damaged.

Additional EUT Data

Manufactured by	SPEAG
-----------------	-------



Add: No.52 HuaYuanBei Road, Haidian District, Beijing, 100191, China
 Tel: +86-10-62304633-2079 Fax: +86-10-62304633-2504
 E-mail: ctll@chinattl.com http://www.chinattl.cn

DASY5 Validation Report for Head TSL

Date: 10.21.2021

Test Laboratory: CTTL, Beijing, China

DUT: Dipole 2450 MHz; Type: D2450V2; Serial: D2450V2 - SN: 873

Communication System: UID 0, CW; Frequency: 2450 MHz; Duty Cycle: 1:1

Medium parameters used: $f = 2450$ MHz; $\sigma = 1.809$ S/m; $\epsilon_r = 39.51$; $\rho = 1000$ kg/m³

Phantom section: Right Section

DASY5 Configuration:

- Probe: EX3DV4 - SN7517: ConvF(7.34, 7.34, 7.34) @ 2450 MHz; Calibrated: 2021-02-03
- Sensor-Surface: 1.4mm (Mechanical Surface Detection)
- Electronics: DAE4 Sn1556; Calibrated: 2021-01-15
- Phantom: MFP_V5.1C (20deg probe tilt); Type: QD 000 P51 Cx; Serial: 1062
- Measurement SW: DASY52, Version 52.10 (4); SEMCAD X Version 14.6.14 (7501)

Dipole Calibration/Zoom Scan (7x7x7) (7x7x7)/Cube 0; Measurement grid: dx=5mm,

dy=5mm, dz=5mm

Reference Value = 108.0 V/m; Power Drift = -0.03 dB

Peak SAR (extrapolated) = 28.0 W/kg

SAR(1 g) = 13.3 W/kg; SAR(10 g) = 6.05 W/kg

Smallest distance from peaks to all points 3 dB below = 9.2 mm

Ratio of SAR at M2 to SAR at M1 = 46.9%

Maximum value of SAR (measured) = 22.6 W/kg

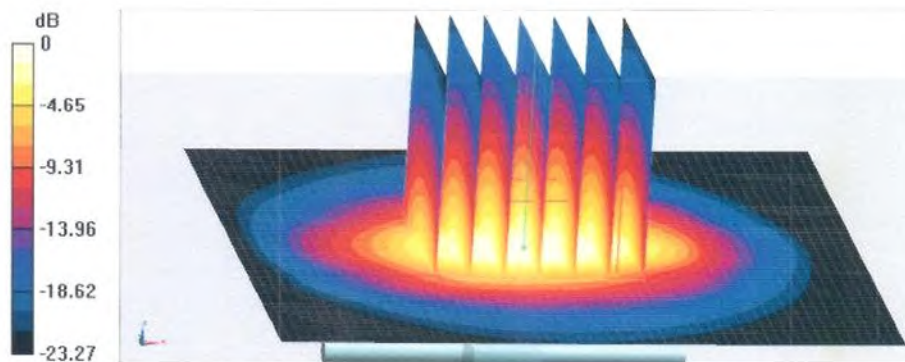

0 dB = 22.6 W/kg = 13.54 dBW/kg



In Collaboration with
s p e a g
CALIBRATION LABORATORY

Add: No.52 HuaYuanBei Road, Haidian District, Beijing, 100191, China
Tel: +86-10-62304633-2079 Fax: +86-10-62304633-2504
E-mail: cttl@chinattl.com http://www.chinattl.cn

Impedance Measurement Plot for Head TSL

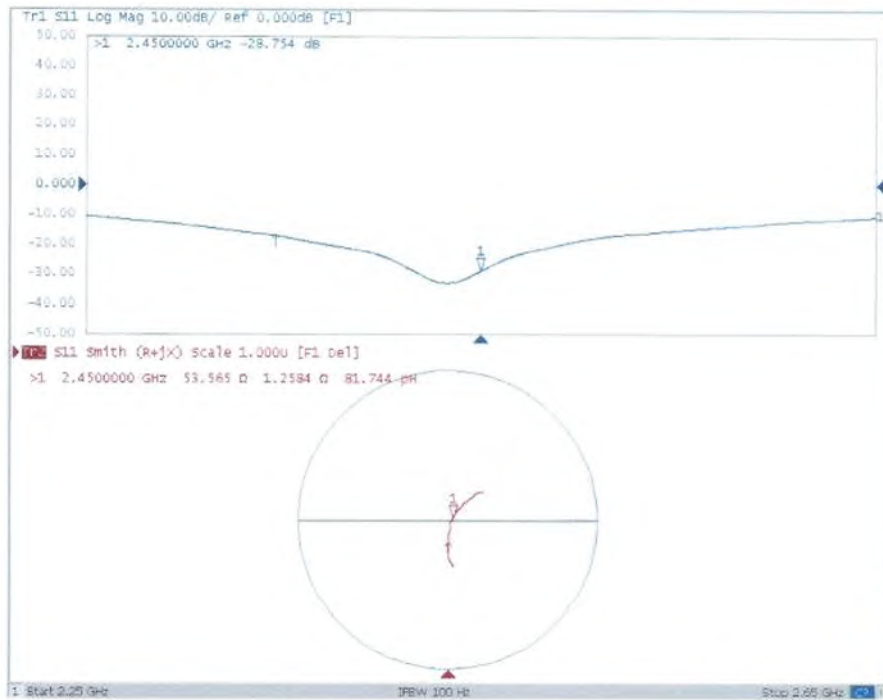



5GHz Dipole

In Collaboration with



s p e a g
CALIBRATION LABORATORY



中国认可
国际互认
校准
CALIBRATION
CNAS L0570

Add: No.51 Xueyuan Road, Haidian District, Beijing, 100191, China
Tel: +86-10-62304633-2512 Fax: +86-10-62304633-2504
E-mail: cttl@chinattl.com http://www.chinattl.cn

Client **CTTL(South Branch)** Certificate No: **Z19-60293**

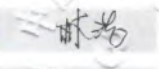
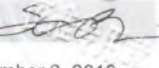
CALIBRATION CERTIFICATE			
Object	D5GHzV2 - SN: 1238		
Calibration Procedure(s)	FF-Z11-003-01 Calibration Procedures for dipole validation kits		
Calibration date:	August 29, 2019		
<p>This calibration Certificate documents the traceability to national standards, which realize the physical units of measurements(SI). The measurements and the uncertainties with confidence probability are given on the following pages and are part of the certificate.</p> <p>All calibrations have been conducted in the closed laboratory facility: environment temperature(22±3)°C and humidity<70%.</p> <p>Calibration Equipment used (M&TE critical for calibration)</p>			
Primary Standards	ID #	Cal Date(Calibrated by, Certificate No.)	Scheduled Calibration
Power Meter NRP2	106276	11-Apr-19 (CTTL, No.J19X02605)	Apr-20
Power sensor NRP6A	101369	11-Apr-19 (CTTL, No.J19X02605)	Apr-20
ReferenceProbe EX3DV4	SN 3617	31-Jan-19(SPEAG,No.EX3-3617_Jan19)	Jan-20
DAE4	SN 1555	22-Aug-19(CTTL-SPEAG,No.Z19-60295)	Aug-20
Secondary Standards	ID #	Cal Date(Calibrated by, Certificate No.)	Scheduled Calibration
Signal Generator E4438C	MY49071430	23-Jan-19 (CTTL, No.J19X00336)	Jan-20
NetworkAnalyzerE5071C	MY46110673	24-Jan-19 (CTTL, No.J19X00547)	Jan-20
Calibrated by:	Name	Function	Signature
	Zhao Jing	SAR Test Engineer	
Reviewed by:	Lin Hao	SAR Test Engineer	
Approved by:	Qi Dianyuan	SAR Project Leader	
			Issued: September 2, 2019
This calibration certificate shall not be reproduced except in full without written approval of the laboratory.			



Add: No.51 Xueyuan Road, Haidian District, Beijing, 100191, China
Tel: +86-10-62304633-2512 Fax: +86-10-62304633-2504
E-mail: cttl@chinattl.com http://www.chinattl.cn

Glossary:

TSL	tissue simulating liquid
ConvF	sensitivity in TSL / NORM _{x,y,z}
N/A	not applicable or not measured

Calibration is Performed According to the Following Standards:

- IEEE Std 1528-2013, "IEEE Recommended Practice for Determining the Peak Spatial-Averaged Specific Absorption Rate (SAR) in the Human Head from Wireless Communications Devices: Measurement Techniques", June 2013
- IEC 62209-1, "Measurement procedure for assessment of specific absorption rate of human exposure to radio frequency fields from hand-held and body-mounted wireless communication devices- Part 1: Device used next to the ear (Frequency range of 300MHz to 6GHz)", July 2016
- IEC 62209-2, "Procedure to measure the Specific Absorption Rate (SAR) For wireless communication devices used in close proximity to the human body (frequency range of 30MHz to 6GHz)", March 2010
- KDB865664, SAR Measurement Requirements for 100 MHz to 6 GHz

Additional Documentation:

- DASY4/5 System Handbook

Methods Applied and Interpretation of Parameters:

- Measurement Conditions:* Further details are available from the Validation Report at the end of the certificate. All figures stated in the certificate are valid at the frequency indicated.
- Antenna Parameters with TSL:* The dipole is mounted with the spacer to position its feed point exactly below the center marking of the flat phantom section, with the arms oriented parallel to the body axis.
- Feed Point Impedance and Return Loss:* These parameters are measured with the dipole positioned under the liquid filled phantom. The impedance stated is transformed from the measurement at the SMA connector to the feed point. The Return Loss ensures low reflected power. No uncertainty required.
- Electrical Delay:* One-way delay between the SMA connector and the antenna feed point. No uncertainty required.
- SAR measured:* SAR measured at the stated antenna input power.
- SAR normalized:* SAR as measured, normalized to an input power of 1 W at the antenna connector.
- SAR for nominal TSL parameters:* The measured TSL parameters are used to calculate the nominal SAR result.

The reported uncertainty of measurement is stated as the standard uncertainty of Measurement multiplied by the coverage factor $k=2$, which for a normal distribution corresponds to a coverage probability of approximately 95%.



Add: No.51 Xueyuan Road, Haidian District, Beijing, 100191, China
 Tel: +86-10-62304633-2512 Fax: +86-10-62304633-2504
 E-mail: cttl@chinattl.com http://www.chinattl.cn

Measurement Conditions

DASY system configuration, as far as not given on page 1.

DASY Version	DASY52	V52.10.2
Extrapolation	Advanced Extrapolation	
Phantom	Triple Flat Phantom 5.1C	
Distance Dipole Center - TSL	10 mm	with Spacer
Zoom Scan Resolution	dx, dy = 4 mm, dz = 1.4 mm	Graded Ratio = 1.4 (Z direction)
Frequency	5250 MHz ± 1 MHz 5600 MHz ± 1 MHz 5750 MHz ± 1 MHz	

Head TSL parameters at 5250 MHz

The following parameters and calculations were applied.

	Temperature	Permittivity	Conductivity
Nominal Head TSL parameters	22.0 °C	35.9	4.71 mho/m
Measured Head TSL parameters	(22.0 ± 0.2) °C	35.7 ± 6 %	4.69 mho/m ± 6 %
Head TSL temperature change during test	<1.0 °C	----	----

SAR result with Head TSL at 5250 MHz

SAR averaged over 1 cm ³ (1 g) of Head TSL	Condition	
SAR measured	100 mW input power	7.81 W/kg
SAR for nominal Head TSL parameters	normalized to 1W	78.0 W/kg ± 24.4 % (k=2)
SAR averaged over 10 cm ³ (10 g) of Head TSL	Condition	
SAR measured	100 mW input power	2.23 W/kg
SAR for nominal Head TSL parameters	normalized to 1W	22.3 W/kg ± 24.2 % (k=2)



Add: No.51 Xueyuan Road, Haidian District, Beijing, 100191, China
 Tel: +86-10-62304633-2512 Fax: +86-10-62304633-2504
 E-mail: cttl@chinattl.com http://www.chinattl.cn

Head TSL parameters at 5600 MHz

The following parameters and calculations were applied.

	Temperature	Permittivity	Conductivity
Nominal Head TSL parameters	22.0 °C	35.5	5.07 mho/m
Measured Head TSL parameters	(22.0 ± 0.2) °C	35.4 ± 6 %	4.99 mho/m ± 6 %
Head TSL temperature change during test	<1.0 °C	----	----

SAR result with Head TSL at 5600 MHz

SAR averaged over 1 cm ³ (1 g) of Head TSL	Condition	
SAR measured	100 mW input power	7.96 W/kg
SAR for nominal Head TSL parameters	normalized to 1W	79.5 W/kg ± 24.4 % (k=2)
SAR averaged over 10 cm ³ (10 g) of Head TSL	Condition	
SAR measured	100 mW input power	2.27 W/kg
SAR for nominal Head TSL parameters	normalized to 1W	22.7 W/kg ± 24.2 % (k=2)

Head TSL parameters at 5750 MHz

The following parameters and calculations were applied.

	Temperature	Permittivity	Conductivity
Nominal Head TSL parameters	22.0 °C	35.4	5.22 mho/m
Measured Head TSL parameters	(22.0 ± 0.2) °C	35.1 ± 6 %	5.10 mho/m ± 6 %
Head TSL temperature change during test	<1.0 °C	----	----

SAR result with Head TSL at 5750 MHz

SAR averaged over 1 cm ³ (1 g) of Head TSL	Condition	
SAR measured	100 mW input power	7.86 W/kg
SAR for nominal Head TSL parameters	normalized to 1W	78.4 W/kg ± 24.4 % (k=2)
SAR averaged over 10 cm ³ (10 g) of Head TSL	Condition	
SAR measured	100 mW input power	2.23 W/kg
SAR for nominal Head TSL parameters	normalized to 1W	22.2 W/kg ± 24.2 % (k=2)



Add: No.51 Xueyuan Road, Haidian District, Beijing, 100191, China
 Tel: +86-10-62304633-2512 Fax: +86-10-62304633-2504
 E-mail: cttl@chinattl.com http://www.chinattl.cn

Body TSL parameters at 5250 MHz

The following parameters and calculations were applied.

	Temperature	Permittivity	Conductivity
Nominal Body TSL parameters	22.0 °C	48.9	5.36 mho/m
Measured Body TSL parameters	(22.0 ± 0.2) °C	48.1 ± 6 %	5.40 mho/m ± 6 %
Body TSL temperature change during test	<1.0 °C	----	----

SAR result with Body TSL at 5250 MHz

SAR averaged over 1 cm ³ (1 g) of Body TSL	Condition	
SAR measured	100 mW input power	7.17 W/kg
SAR for nominal Body TSL parameters	normalized to 1W	71.5 W/kg ± 24.4 % (k=2)
SAR averaged over 10 cm ³ (10 g) of Body TSL	Condition	
SAR measured	100 mW input power	2.04 W/kg
SAR for nominal Body TSL parameters	normalized to 1W	20.3 W/kg ± 24.2 % (k=2)

Body TSL parameters at 5600 MHz

The following parameters and calculations were applied.

	Temperature	Permittivity	Conductivity
Nominal Body TSL parameters	22.0 °C	48.5	5.77 mho/m
Measured Body TSL parameters	(22.0 ± 0.2) °C	47.6 ± 6 %	5.70 mho/m ± 6 %
Body TSL temperature change during test	<1.0 °C	----	----

SAR result with Body TSL at 5600 MHz

SAR averaged over 1 cm ³ (1 g) of Body TSL	Condition	
SAR measured	100 mW input power	7.62 W/kg
SAR for nominal Body TSL parameters	normalized to 1W	75.9 W/kg ± 24.4 % (k=2)
SAR averaged over 10 cm ³ (10 g) of Body TSL	Condition	
SAR measured	100 mW input power	2.18 W/kg
SAR for nominal Body TSL parameters	normalized to 1W	21.7 W/kg ± 24.2 % (k=2)



Add: No.51 Xueyuan Road, Haidian District, Beijing, 100191, China
 Tel: +86-10-62304633-2512 Fax: +86-10-62304633-2504
 E-mail: cttl@chinattl.com http://www.chinattl.cn

Body TSL parameters at 5750 MHz

The following parameters and calculations were applied.

	Temperature	Permittivity	Conductivity
Nominal Body TSL parameters	22.0 °C	48.3	5.94 mho/m
Measured Body TSL parameters	(22.0 ± 0.2) °C	47.5 ± 6 %	5.78 mho/m ± 6 %
Body TSL temperature change during test	<1.0 °C	----	----

SAR result with Body TSL at 5750 MHz

SAR averaged over 1 cm^3 (1 g) of Body TSL	Condition	
SAR measured	100 mW input power	7.39 W/kg
SAR for nominal Body TSL parameters	normalized to 1W	73.6 W/kg ± 24.4 % (k=2)
SAR averaged over 10 cm^3 (10 g) of Body TSL	Condition	
SAR measured	100 mW input power	2.10 W/kg
SAR for nominal Body TSL parameters	normalized to 1W	20.9 W/kg ± 24.2 % (k=2)



Add: No.51 Xueyuan Road, Haidian District, Beijing, 100191, China
Tel: +86-10-62304633-2512 Fax: +86-10-62304633-2504
E-mail: cttl@chinattl.com http://www.chinattl.cn

Appendix (Additional assessments outside the scope of CNAS L0570)

Antenna Parameters with Head TSL at 5250 MHz

Impedance, transformed to feed point	48.8Ω - 4.65jΩ
Return Loss	- 26.2dB

Antenna Parameters with Head TSL at 5600 MHz

Impedance, transformed to feed point	49.2Ω + 0.58jΩ
Return Loss	- 40.0dB

Antenna Parameters with Head TSL at 5750 MHz

Impedance, transformed to feed point	50.3Ω + 1.08jΩ
Return Loss	- 39.0dB

Antenna Parameters with Body TSL at 5250 MHz

Impedance, transformed to feed point	48.8Ω - 2.02jΩ
Return Loss	- 32.5dB

Antenna Parameters with Body TSL at 5600 MHz

Impedance, transformed to feed point	51.3Ω + 3.94jΩ
Return Loss	- 27.8dB

Antenna Parameters with Body TSL at 5750 MHz

Impedance, transformed to feed point	52.2Ω + 4.77jΩ
Return Loss	- 25.8dB



Add: No.51 Xueyuan Road, Haidian District, Beijing, 100191, China
Tel: +86-10-62304633-2512 Fax: +86-10-62304633-2504
E-mail: cttl@chinattl.com http://www.chinattl.cn

General Antenna Parameters and Design

Electrical Delay (one direction)	1.059 ns
----------------------------------	----------

After long term use with 100W radiated power, only a slight warming of the dipole near the feedpoint can be measured.

The dipole is made of standard semirigid coaxial cable. The center conductor of the feeding line is directly connected to the second arm of the dipole. The antenna is therefore short-circuited for DC-signals. On some of the dipoles, small end caps are added to the dipole arms in order to improve matching when loaded according to the position as explained in the "Measurement Conditions" paragraph. The SAR data are not affected by this change. The overall dipole length is still according to the Standard.

No excessive force must be applied to the dipole arms, because they might bend or the soldered connections near the feedpoint may be damaged.

Additional EUT Data

Manufactured by	SPEAG
-----------------	-------



Add: No.51 Xueyuan Road, Haidian District, Beijing, 100191, China
Tel: +86-10-62304633-2512 Fax: +86-10-62304633-2504
E-mail: ettl@chinattl.com http://www.chinattl.cn

DASY5 Validation Report for Head TSL

Date: 08.28.2019

Test Laboratory: CTTL, Beijing, China

DUT: Dipole 5GHz; Type: D5GHzV2; Serial: D5GHzV2 - SN: 1238

Communication System: CW; Frequency: 5250 MHz, Frequency: 5600 MHz,
Frequency: 5750 MHz,

Medium parameters used: $f = 5250$ MHz; $\sigma = 4.692$ S/m; $\epsilon_r = 35.71$; $\rho = 1000$ kg/m³,
Medium parameters used: $f = 5600$ MHz; $\sigma = 4.992$ S/m; $\epsilon_r = 35.42$; $\rho = 1000$ kg/m³,
Medium parameters used: $f = 5750$ MHz; $\sigma = 5.096$ S/m; $\epsilon_r = 35.13$; $\rho = 1000$ kg/m³,

Phantom section: Center Section

DASY5 Configuration:

- Probe: EX3DV4 - SN3617; ConvF(5.39, 5.39, 5.39) @ 5250 MHz; ConvF(5.06, 5.06, 5.06) @ 5600 MHz; ConvF(5.07, 5.07, 5.07) @ 5750 MHz; Calibrated: 1/31/2019
- Sensor-Surface: 1.4mm (Mechanical Surface Detection)
- Electronics: DAE4 Sn1555; Calibrated: 8/22/2019
- Phantom: MFP_V5.1C ; Type: QD 000 P51CA; Serial: 1062
- Measurement SW: DASY52, Version 52.10 (2); SEMCAD X Version 14.6.12 (7470)

Dipole Calibration /Pin=100mW, d=10mm, f=5250 MHz/Zoom Scan,**dist=1.4mm (8x8x7)/Cube 0:** Measurement grid: dx=4mm, dy=4mm, dz=1.4mm

Reference Value = 69.41 V/m; Power Drift = -0.05 dB

Peak SAR (extrapolated) = 32.8 W/kg

SAR(1 g) = 7.81 W/kg; SAR(10 g) = 2.23 W/kg

Maximum value of SAR (measured) = 18.7 W/kg

Dipole Calibration /Pin=100mW, d=10mm, f=5600 MHz/Zoom Scan,**dist=1.4mm (8x8x7)/Cube 0:** Measurement grid: dx=4mm, dy=4mm, dz=1.4mm

Reference Value = 70.02 V/m; Power Drift = 0.04 dB

Peak SAR (extrapolated) = 35.7 W/kg

SAR(1 g) = 7.96 W/kg; SAR(10 g) = 2.27 W/kg

Maximum value of SAR (measured) = 19.2 W/kg

Dipole Calibration /Pin=100mW, d=10mm, f=5750 MHz/Zoom Scan,**dist=1.4mm (8x8x7)/Cube 0:** Measurement grid: dx=4mm, dy=4mm, dz=1.4mm

Reference Value = 68.55 V/m; Power Drift = 0.02 dB

Peak SAR (extrapolated) = 36.5 W/kg

SAR(1 g) = 7.86 W/kg; SAR(10 g) = 2.23 W/kg

Maximum value of SAR (measured) = 18.9 W/kg



Add: No.51 Xueyuan Road, Haidian District, Beijing, 100191, China
Tel: +86-10-62304633-2512 Fax: +86-10-62304633-2504
E-mail: cttl@chinattl.com http://www.chinattl.cn

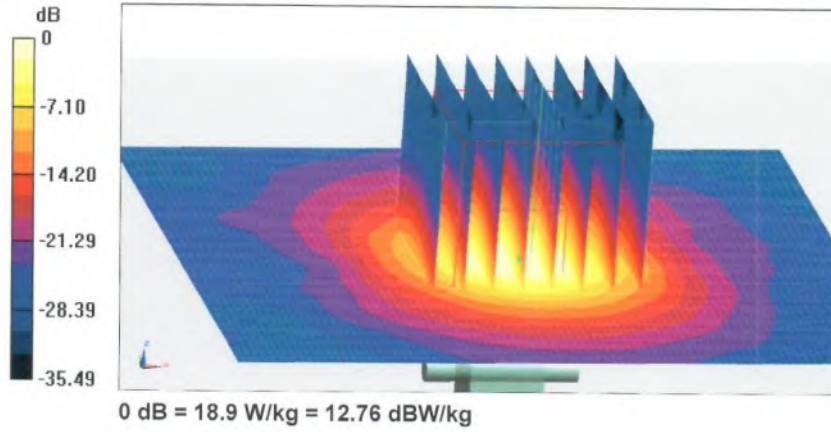



Add: No.51 Xueyuan Road, Haidian District, Beijing, 100191, China
Tel: +86-10-62304633-2512 Fax: +86-10-62304633-2504
E-mail: ettl@chinattl.com http://www.chinattl.cn

Impedance Measurement Plot for Head TSL

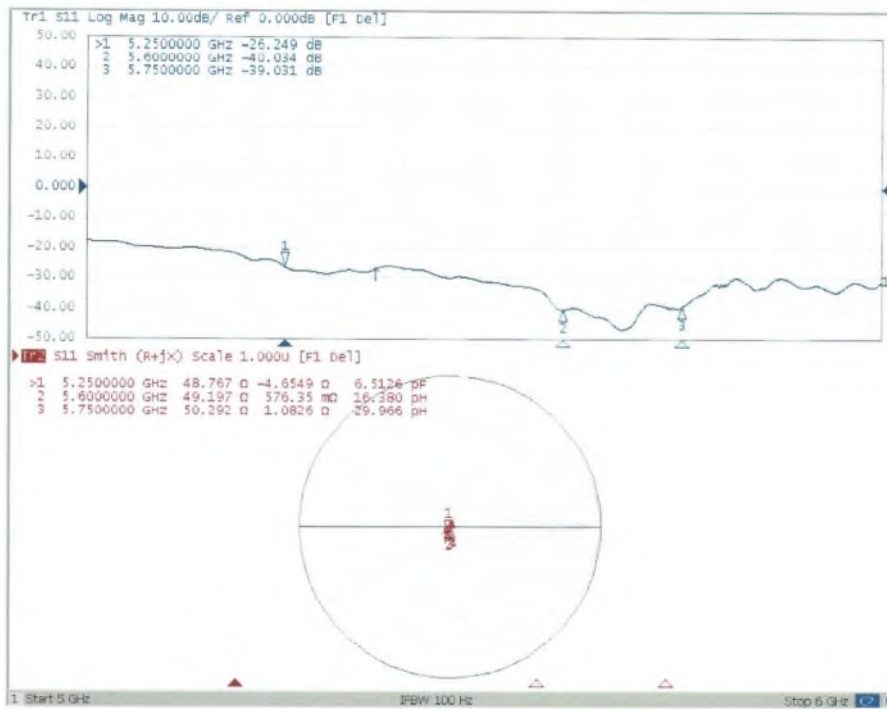



Add: No.51 Xueyuan Road, Haidian District, Beijing, 100191, China
Tel: +86-10-62304633-2512 Fax: +86-10-62304633-2504
E-mail: cttl@chinattl.com http://www.chinattl.cn

DASY5 Validation Report for Body TSL

Date: 08.29.2019

Test Laboratory: CTTL, Beijing, China

DUT: Dipole 5GHz; Type: D5GHzV2; Serial: D5GHzV2 - SN: 1238

Communication System: CW; Frequency: 5250 MHz, Frequency: 5600 MHz,
Frequency: 5750 MHz,

Medium parameters used: $f = 5250$ MHz; $\sigma = 5.402$ S/m; $\epsilon_r = 48.05$; $\rho = 1000$ kg/m³,
Medium parameters used: $f = 5600$ MHz; $\sigma = 5.703$ S/m; $\epsilon_r = 47.61$; $\rho = 1000$ kg/m³,
Medium parameters used: $f = 5750$ MHz; $\sigma = 5.782$ S/m; $\epsilon_r = 47.49$; $\rho = 1000$ kg/m³,

Phantom section: Right Section

DASY5 Configuration:

- Probe: EX3DV4 - SN3617; ConvF(4.76, 4.76, 4.76) @ 5250 MHz; ConvF(4.23, 4.23, 4.23) @ 5600 MHz; ConvF(4.36, 4.36, 4.36) @ 5750 MHz; Calibrated: 1/31/2019
- Sensor-Surface: 1.4mm (Mechanical Surface Detection)
- Electronics: DAE4 Sn1555; Calibrated: 8/22/2019
- Phantom: MFP_V5.1C ; Type: QD 000 P51CA; Serial: 1062
- Measurement SW: DASY52, Version 52.10 (2); SEMCAD X Version 14.6.12 (7470)

Dipole Calibration /Pin=100mW, d=10mm, f=5250 MHz/Zoom Scan,**dist=1.4mm (8x8x7)/Cube 0:** Measurement grid: dx=4mm, dy=4mm, dz=1.4mm

Reference Value = 54.85 V/m; Power Drift = 0.04 dB

Peak SAR (extrapolated) = 27.5 W/kg

SAR(1 g) = 7.17 W/kg; SAR(10 g) = 2.04 W/kg

Maximum value of SAR (measured) = 16.4 W/kg

Dipole Calibration /Pin=100mW, d=10mm, f=5600 MHz/Zoom Scan,**dist=1.4mm (8x8x7)/Cube 0:** Measurement grid: dx=4mm, dy=4mm, dz=1.4mm

Reference Value = 56.17 V/m; Power Drift = 0.07 dB

Peak SAR (extrapolated) = 32.3 W/kg

SAR(1 g) = 7.62 W/kg; SAR(10 g) = 2.18 W/kg

Maximum value of SAR (measured) = 18.4 W/kg

Dipole Calibration /Pin=100mW, d=10mm, f=5750 MHz/Zoom Scan,**dist=1.4mm (8x8x7)/Cube 0:** Measurement grid: dx=4mm, dy=4mm, dz=1.4mm

Reference Value = 55.47 V/m; Power Drift = 0.04 dB

Peak SAR (extrapolated) = 33.2 W/kg

SAR(1 g) = 7.39 W/kg; SAR(10 g) = 2.1 W/kg

Maximum value of SAR (measured) = 18.1 W/kg



Add: No.51 Xueyuan Road, Haidian District, Beijing, 100191, China
Tel: +86-10-62304633-2512 Fax: +86-10-62304633-2504
E-mail: cttl@chinattl.com http://www.chinattl.cn

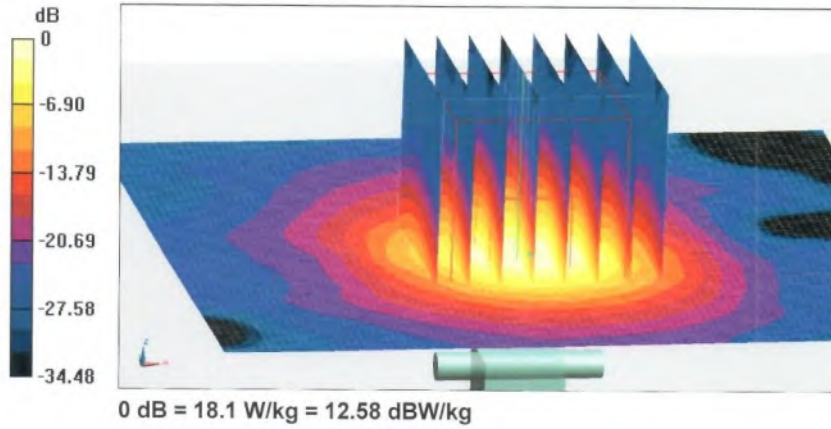



Add: No.51 Xueyuan Road, Haidian District, Beijing, 100191, China
Tel: +86-10-62304633-2512 Fax: +86-10-62304633-2504
E-mail: cttl@chinattl.com http://www.chinattl.cn

Impedance Measurement Plot for Body TSL

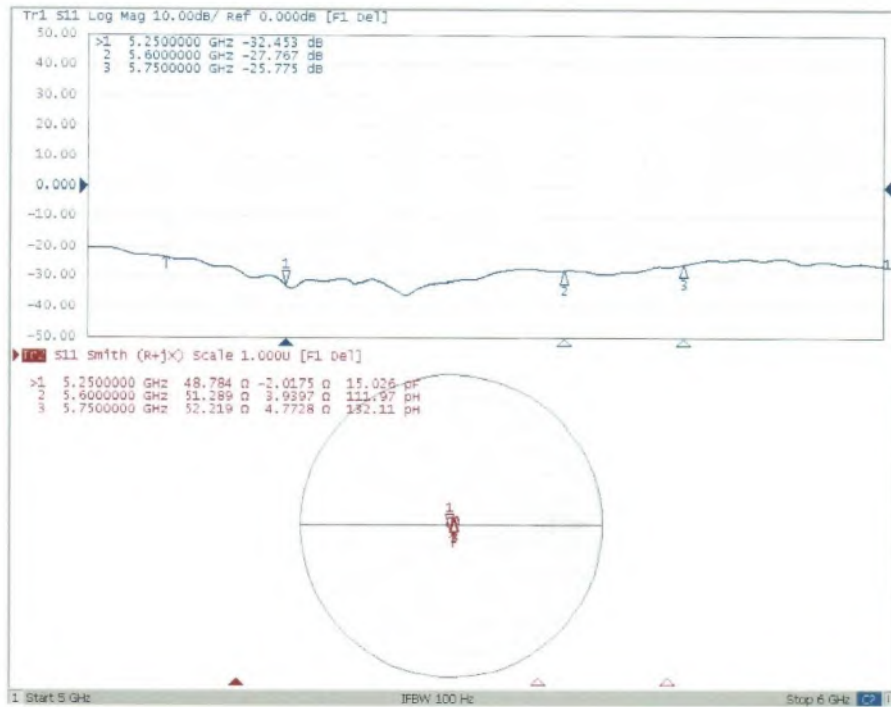

ANNEX J: Extended Calibration SAR Dipole

Referring to KDB865664 D01, if dipoles are verified in return loss (<-20dBm, within 20% of prior calibration), and in impedance (within 5 ohm of prior calibration), the annual calibration is not necessary and the calibration interval can be extended.

Justification of Extended Calibration SAR Dipole D5GHzV2– serial no.1238

Head						
Date of Measurement	Return-Loss (dB)	Delta (%)	Real Impedance (ohm)	Delta (ohm)	Imaginary Impedance (johm)	Delta (johm)
5250MHz						
2019-08-29	-26.2	/	48.8	/	-4.65	/
2020-08-28	-25.1	4.2	49.7	0.9	-4.26	0.39
2021-08-26	-24.7	5.7	50.2	1.4	-4.01	0.64
5600MHz						
2019-08-29	-40.0	/	49.2	/	0.58	/
2020-08-28	-38.1	4.8	50.3	1.1	0.85	0.27
2021-08-26	-37.7	5.7	50.8	1.6	0.92	0.34
5750MHz						
2019-08-29	-39.0	/	50.3	/	1.08	/
2020-08-28	-37.7	3.3	51.1	0.8	1.44	0.36
2021-08-26	-37.2	4.6	51.6	1.3	1.53	0.45

The Return-Loss is <-20dB, and within 20% of prior calibration; the impedance is within 5 ohm of prior calibration. Therefore the value result should support extended cabration.

*****END OF REPORT*****