



# TEST REPORT

No.I22N02153-SAR

For

**TCL Communication Ltd.**

**Mobile WiFi**

**Model Name: MW63AF**

With

**Hardware Version: FG11\_AF\_MB\_V1.1**

**Software Version: MW63AF\_V01.18b01**

**FCC ID: 2ACCJB188**

**Issued Date: 2022-11-28**

**Designation Number: CN1210**

**Note:**

The test results in this test report relate only to the devices specified in this report. This report shall not be reproduced except in full without the written approval of SAICT.

**Test Laboratory:**

**SAICT, Shenzhen Academy of Information and Communications Technology**

Building G, Shenzhen International Innovation Center, No.1006 Shennan Road, Futian District, Shenzhen, Guangdong, P. R. China 518000.

Tel:+86(0)755-33322000, Fax:+86(0)755-33322001

Email: yewu@caict.ac.cn. www.saict.ac.cn



## **REPORT HISTORY**

<b>Report Number</b>	<b>Revision</b>	<b>Description</b>	<b>Issue Date</b>
I22N02153-SAR	Rev.0	1st edition	2022-11-28

## CONTENTS

<b>1. SUMMARY OF TEST REPORT .....</b>	<b>5</b>
1.1. TEST ITEMS .....	5
1.2. TEST STANDARDS .....	5
1.3. TEST RESULT .....	5
1.4. TESTING LOCATION .....	5
1.5. PROJECT DATA .....	5
1.6. SIGNATURE .....	5
<b>2. STATEMENT OF COMPLIANCE .....</b>	<b>6</b>
<b>3. CLIENT INFORMATION .....</b>	<b>7</b>
3.1. APPLICANT INFORMATION .....	7
3.2. MANUFACTURER INFORMATION .....	7
<b>4. EQUIPMENT UNDER TEST (EUT) AND ANCILLARY EQUIPMENT (AE) .....</b>	<b>8</b>
4.1. ABOUT EUT .....	8
4.2. INTERNAL IDENTIFICATION OF EUT USED DURING THE TEST .....	8
4.3. INTERNAL IDENTIFICATION OF AE USED DURING THE TEST .....	8
<b>5. TEST METHODOLOGY .....</b>	<b>9</b>
5.1. APPLICABLE LIMIT REGULATIONS .....	9
5.2. APPLICABLE MEASUREMENT STANDARDS .....	9
<b>6. SPECIFIC ABSORPTION RATE (SAR) .....</b>	<b>10</b>
6.1. INTRODUCTION .....	10
6.2. SAR DEFINITION .....	10
<b>7. TISSUE SIMULATING LIQUIDS .....</b>	<b>11</b>
7.1. TARGETS FOR TISSUE SIMULATING LIQUID .....	11
7.2. DIELECTRIC PERFORMANCE .....	11
<b>8. SYSTEM VERIFICATION .....</b>	<b>15</b>
8.1. SYSTEM SETUP .....	15
8.2. SYSTEM VERIFICATION .....	16
<b>9. MEASUREMENT PROCEDURES .....</b>	<b>17</b>
9.1. TESTS TO BE PERFORMED .....	17
9.2. GENERAL MEASUREMENT PROCEDURE .....	19
9.3. WCDMA MEASUREMENT PROCEDURES FOR SAR .....	20
9.4. SAR MEASUREMENT FOR LTE .....	21
9.5. WLAN MEASUREMENT PROCEDURES FOR SAR .....	22
9.6. POWER DRIFT .....	22
<b>10. CONDUCTED OUTPUT POWER .....</b>	<b>23</b>

10.1. WCDMA MEASUREMENT RESULT .....	23
10.2. LTE MEASUREMENT RESULT .....	25
10.3. WLAN MEASUREMENT RESULT .....	46
<b>11. SIMULTANEOUS TX SAR CONSIDERATIONS .....</b>	<b>51</b>
11.1. INTRODUCTION.....	51
11.2. TRANSMIT ANTENNA SEPARATION DISTANCES.....	51
11.3. SAR MEASUREMENT POSITIONS.....	52
11.4. STANDALONE SAR TEST EXCLUSION CONSIDERATIONS.....	52
<b>12. EVALUATION OF SIMULTANEOUS.....</b>	<b>53</b>
<b>13. SUMMARY OF TEST RESULTS.....</b>	<b>54</b>
13.1. TESTING ENVIRONMENT.....	54
13.2. SAR RESULTS .....	55
13.3. WLAN EVALUATION FOR 2.4G.....	59
13.4. WLAN EVALUATION FOR 5G .....	60
<b>14. SAR MEASUREMENT VARIABILITY .....</b>	<b>62</b>
<b>15. MEASUREMENT UNCERTAINTY .....</b>	<b>63</b>
15.1. MEASUREMENT UNCERTAINTY FOR NORMAL SAR TESTS (300MHZ~3GHZ) .....	63
15.2. MEASUREMENT UNCERTAINTY FOR NORMAL SAR TESTS (3GHZ~6GHZ).....	64
<b>16. MAIN TEST INSTRUMENTS.....</b>	<b>65</b>
<b>ANNEX A: GRAPH RESULTS .....</b>	<b>66</b>
<b>ANNEX B: SYSTEMVERIFICATION RESULTS.....</b>	<b>75</b>
<b>ANNEX C: SAR MEASUREMENT SETUP.....</b>	<b>82</b>
<b>ANNEX D: POSITION OF THE WIRELESS DEVICE IN RELATION TO THE PHANTOM.....</b>	<b>88</b>
<b>ANNEX E: EQUIVALENT MEDIA RECIPES .....</b>	<b>90</b>
<b>ANNEX F: SYSTEM VALIDATION.....</b>	<b>91</b>
<b>ANNEX G: DAE CALIBRATION CERTIFICATE .....</b>	<b>92</b>
<b>ANNEX H: PROBE CALIBRATION CERTIFICATE .....</b>	<b>97</b>
<b>ANNEX I: DIPOLE CALIBRATION CERTIFICATE .....</b>	<b>106</b>
<b>ANNEX J: EXTENDED CALIBRATION SAR DIPOLE.....</b>	<b>146</b>

## 1. Summary of Test Report

### 1.1. Test Items

Description: Mobile WiFi  
Model Name: MW63AF  
Applicant's Name: TCL Communication Ltd.  
Manufacturer's Name: TCL Communication Ltd.

### 1.2. Test Standards

ANSI C95.1:1992, IEEE 1528:2013

### 1.3. Test Result

Pass. Please refer to "13. Summary of Test Results"

### 1.4. Testing Location

Address: Building G, Shenzhen International Innovation Center, No.1006 Shennan Road,  
Futian District, Shenzhen, Guangdong, P. R. China

### 1.5. Project Data

Testing Start Date: 2022-11-01

Testing End Date: 2022-11-21

### 1.6. Signature

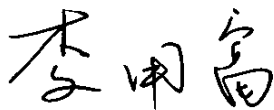

---

Li Yongfu  
(Prepared this test report)

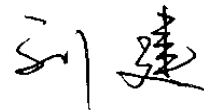

---

Liu Jian  
(Reviewed this test report)

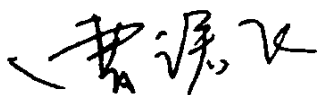

---

Cao Junfei  
(Approved this test report)

## 2. Statement of Compliance

The maximum results of Specific Absorption Rate (SAR) found during testing for TCL Communication Ltd. Mobile WiFi MW63AF are as follows:

**Table 2.1: Highest Reported SAR for Body (1g)**

Exposure Configuration	Technology Band	Highest Reported SAR 1g(W/Kg)	Equipment Class
Hotspot (Separation Distance 10mm)	WCDMA Band 2	0.74	PCB
	WCDMA Band 4	0.94	
	WCDMA Band 5	1.00	
	LTE Band 2	0.69	
	LTE Band 5	0.97	
	LTE Band 7	<b>1.25</b>	
	LTE Band 66/4	1.07	
	WLAN 2.4GHz	0.24	DTS
WLAN 5GHz	0.26	NII	

The SAR values found for the Mobile Phone are below the maximum recommended levels of 1.6 W/Kg as averaged over any 1g tissue according to the ANSI C95.1-1992.

The measurement together with the test system set-up is described in annex C of this test report. A detailed description of the equipment under test can be found in chapter 4 of this test report.

The highest reported SAR value is obtained at the case of **(Table 2.1)**, hotspot value is **1.25 W/kg (1g)**.

**Table2.2: The sum of reported SAR values for WWAN antenna and WLAN antenna**

/	Position	WWAN (W/kg)	WLAN (W/kg)	Sum (W/kg)
Highest reported SAR value for Hotspot	Rear Side	1.25 (LTE Band 7)	0.24 (WLAN 2.4GHz)	<b>1.49</b>

Note: the test positions of above tables are for the worse case that has been evaluated.

According to the above tables, the highest sum of reported SAR values is **1.49 W/kg (1g)**.

The detail for simultaneous transmission consideration is described in chapter 12.



### 3. Client Information

#### 3.1. Applicant Information

Company Name:	TCL Communication Ltd.
Address:	5/F, Building 22E, 22 Science Park East Avenue, Hong Kong Science Park, Shatin, NT, Hong Kong
City:	Hong Kong
Country:	China
Telephone:	+86 755 3661 1621

#### 3.2. Manufacturer Information

Company Name:	TCL Communication Ltd.
Address:	5/F, Building 22E, 22 Science Park East Avenue, Hong Kong Science Park, Shatin, NT, Hong Kong
City:	Hong Kong
Country:	China
Telephone:	+86 755 3661 1621

## 4. Equipment under Test (EUT) and Ancillary Equipment (AE)

### 4.1. About EUT

Description:	Mobile WiFi
Model Name:	MW63AF
Condition of EUT as received:	No obvious damage in appearance
Frequency Bands:	WCDMA Band 2/4/5 LTE Band 2/4/5/7/66 WLAN 2.4GHz, WLAN 5GHz
Tested Tx Frequency:	1850 - 1910MHz (WCDMA Band 2)
	1710 - 1755MHz (WCDMA Band 4)
	824 - 849MHz (WCDMA Band 5)
	1850 - 1910MHz (LTE Band 2)
	1710 - 1755MHz (LTE Band 4)
	824 - 849MHz (LTE Band 5)
	2500 - 2570MHz (LTE Band 7)
	1710 - 1780MHz (LTE Band 66)
	2412 - 2462MHz (WLAN 2.4GHz)
5150 - 5850MHz (WLAN 5GHz)	
Test device Production information:	Production unit
Device type:	Portable device
Antenna type:	Integrated antenna
Hotspot mode:	Support
Product Dimensions:	Long 92.0mm; Wide 62.5mm; Overall Diagonal 105mm
<b>Remark:</b> This device WLAN 5GHz U-NII-2A and U-NII-2C don't support hotspot operation.	

### 4.2. Internal Identification of EUT used during the test

EUT ID*	IMEI	HW Version	SW Version	Receipt Date
UT01aa	355341750000613	FG11_AF_MB_V1.1	MW63AF_V01.18b01	2022-10-31
UT10aa	355341750000944	FG11_AF_MB_V1.1	MW63AF_V01.18b01	2022-10-31

\*EUT ID: is used to identify the test sample in the lab internally.

**Note:** It is performed to test SAR with the UT10aa, and conducted power with the UT01aa.

### 4.3. Internal Identification of AE used during the test

AE ID*	Description	Model	Manufacturer
AE1	Battery	TLi021F7	Veken
AE2	Battery	TLi021FA	TMB

\*AE ID: is used to identify the test sample in the lab internally.

**Note:** The device has two types of batteries. We'll perform the main SAR measurement with AE1 battery and Spot check test with AE2 battery.



## 5. Test Methodology

### 5.1. Applicable Limit Regulations

**ANSI C95.1:1992** IEEE Standard for Safety Levels with Respect to Human Exposure to Radio Frequency Electromagnetic Fields, 3 kHz to 300 GHz.

It specifies the maximum exposure limit of **1.6 W/kg** as averaged over any 1 gram of tissue for portable devices being used within 20 cm of the user in the uncontrolled environment.

### 5.2. Applicable Measurement Standards

**IEEE 1528:2013** Recommended Practice for Determining the Peak Spatial-Average Specific Absorption Rate (SAR) in the Human Head from Wireless Communications Devices: Experimental Techniques.

**KDB 447498 D01 General RF Exposure Guidance v06** RF Exposure Procedures and Equipment Authorization Policies for Mobile and Portable Devices

**KDB 941225 D06 Hot Spot SAR v02r01** SAR Evaluation Procedures for Portable Devices with Wireless Router Capabilities

**KDB 941225 D05 SAR for LTE Devices v02r05** SAR Evaluation Considerations for LTE Devices

**KDB 248227 D01 802.11 Wi-Fi SAR v02r02** SAR Guidance for IEEE 802.11 (Wi-Fi) Transmitters.

**KDB 865664 D01 SAR measurement 100 MHz to 6 GHz v01r04** SAR Measurement Requirements for 100 MHz to 6 GHz

**KDB 865664 D02 RF Exposure Reporting v01r02** RF Exposure Compliance Reporting and Documentation Considerations

**TCB workshop April 2019; RF Exposure Procedures (Tissue Simulating Liquids)**

## 6. Specific Absorption Rate (SAR)

### 6.1. Introduction

SAR is related to the rate at which energy is absorbed per unit mass in an object exposed to a radio field. The SAR distribution in a biological body is complicated and is usually carried out by experimental techniques or numerical modeling. The standard recommends limits for two tiers of groups, occupational/controlled and general population/uncontrolled, based on a person's awareness and ability to exercise control over his or her exposure. In general, occupational/controlled exposure limits are higher than the limits for general population/uncontrolled.

### 6.2. SAR Definition

The SAR definition is the time derivative (rate) of the incremental energy ( $dW$ ) absorbed by (dissipated in) an incremental mass ( $dm$ ) contained in a volume element ( $dv$ ) of a given density ( $\rho$ ). The equation description is as below:

$$SAR = \frac{d}{dt} \left( \frac{dW}{dm} \right) = \frac{d}{dt} \left( \frac{dW}{\rho dv} \right)$$

SAR is expressed in units of Watts per kilogram (W/kg)

SAR measurement can be either related to the temperature elevation in tissue by

$$SAR = c \left( \frac{\delta T}{\delta t} \right)$$

Where:  $C$  is the specific heat capacity,  $\delta T$  is the temperature rise and  $\delta t$  is the exposure duration, or related to the electrical field in the tissue by

$$SAR = \frac{\sigma |E|^2}{\rho}$$

Where:  $\sigma$  is the conductivity of the tissue,  $\rho$  is the mass density of tissue and  $E$  is the RMS electrical field strength.

However for evaluating SAR of low power transmitter, electrical field measurement is typically applied.

## 7. Tissue Simulating Liquids

### 7.1. Targets for tissue simulating liquid

**Table 7.1: Targets for tissue simulating liquid**

Frequency (MHz)	Liquid Type	Conductivity ( $\sigma$ )	$\pm 5\%$ Range	Permittivity ( $\epsilon$ )	$\pm 5\%$ Range
835	Head	0.90	0.86~0.95	41.5	39.4~43.6
1750	Head	1.37	1.30~1.44	40.1	38.1~42.1
1900	Head	1.40	1.33~1.47	40.0	38.0~42.0
2450	Head	1.80	1.71~1.89	39.2	37.2~41.2
2550	Head	1.91	1.81~2.01	39.1	37.1~41.0
5250	Head	4.71	4.47~4.95	35.9	34.1~37.7
5750	Head	5.22	4.96~5.48	35.4	33.6~37.1

### 7.2. Dielectric Performance

**Table 7.2: Dielectric Performance of Tissue Simulating Liquid**

Measurement Date (yyyy-mm-dd)	Type	Frequency (MHz)	Conductivity $\sigma$ (S/m)	Drift (%)	Permittivity $\epsilon$	Drift (%)
2022-11-05	835	Head	0.916	1.78	40.68	-1.98
2022-11-14	1750	Head	1.382	0.88	39.54	-1.40
2022-11-16	1900	Head	1.419	1.36	39.23	-1.93
2022-11-01	2450	Head	1.836	2.00	38.08	-2.86
2022-11-21	2550	Head	1.954	2.30	38.16	-2.40
2022-11-03	5250	Head	4.805	2.02	35.13	-2.14
2022-11-03	5750	Head	5.142	-1.49	36.24	2.37

Note: The liquid temperature is 22.0°C.

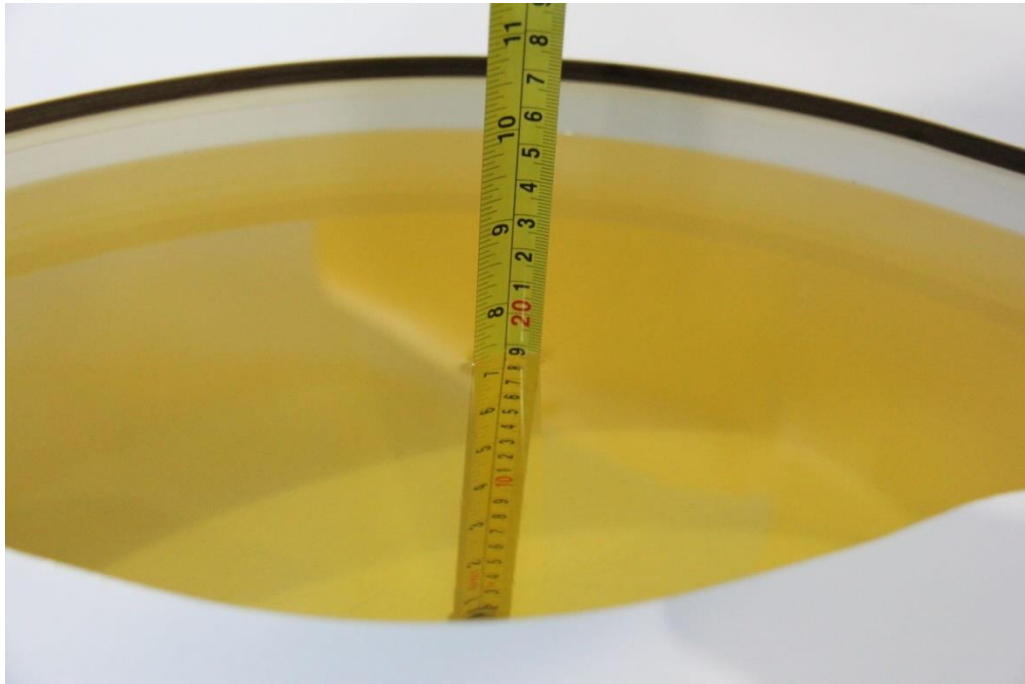

**Picture 7-1: Liquid depth in the Flat Phantom (835MHz)**

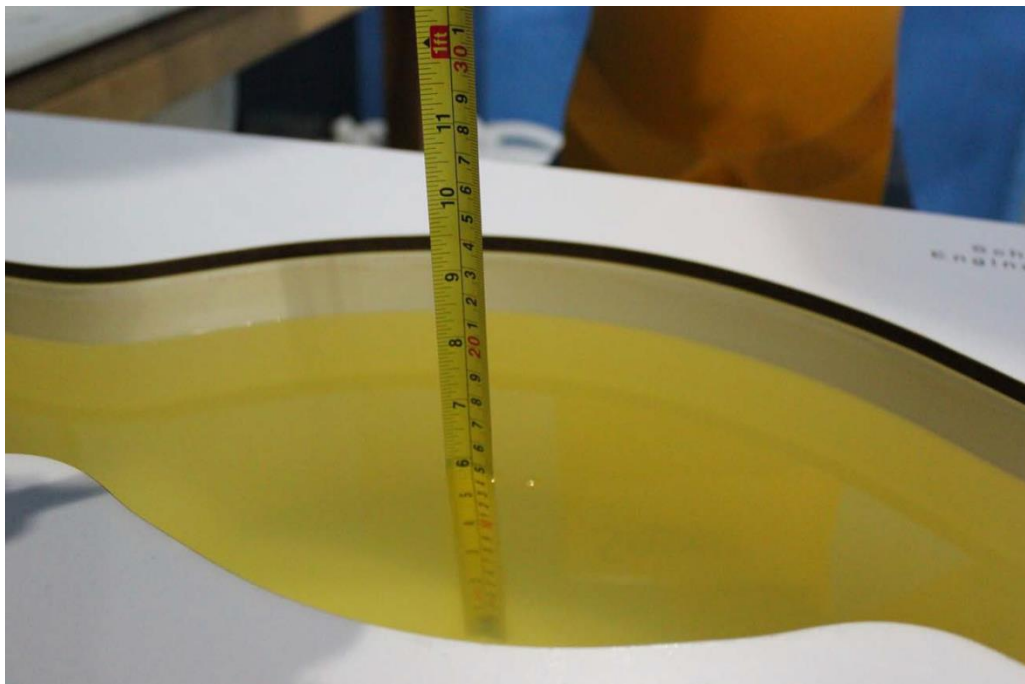

**Picture 7-2: Liquid depth in the Flat Phantom (1750MHz)**

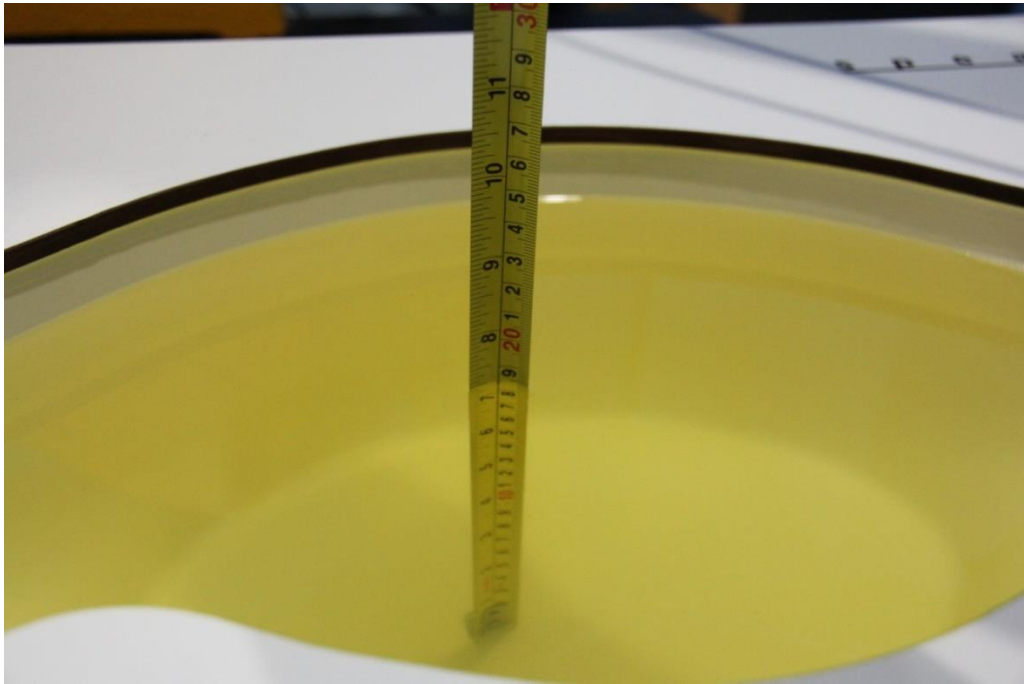

**Picture 7-3: Liquid depth in the Flat Phantom (1900MHz)**

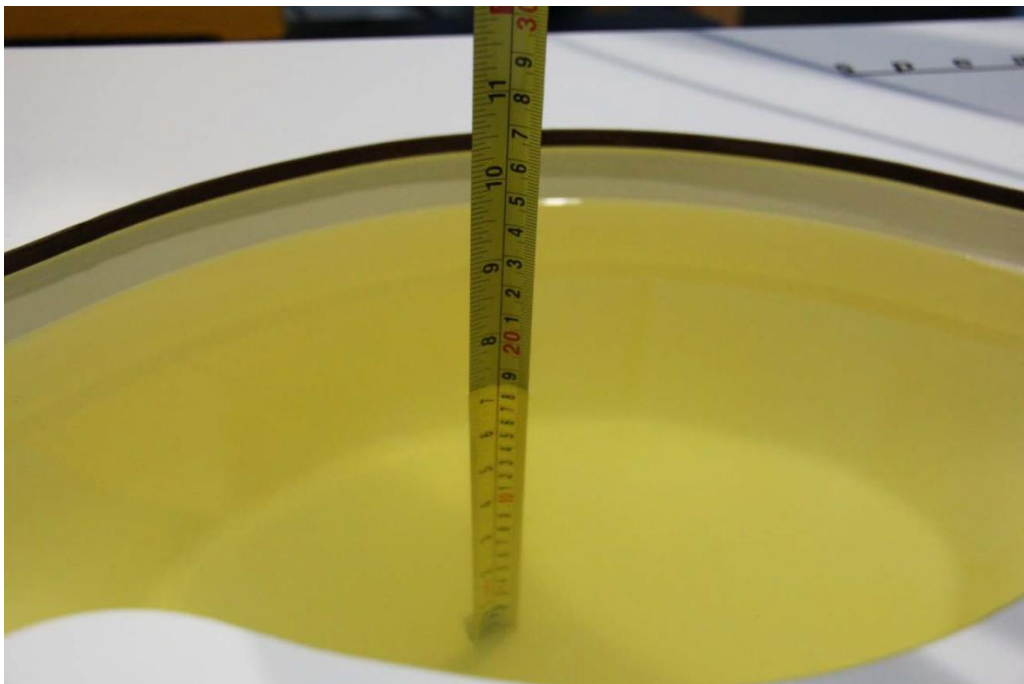

**Picture 7-4: Liquid depth in the Flat Phantom (2450MHz)**

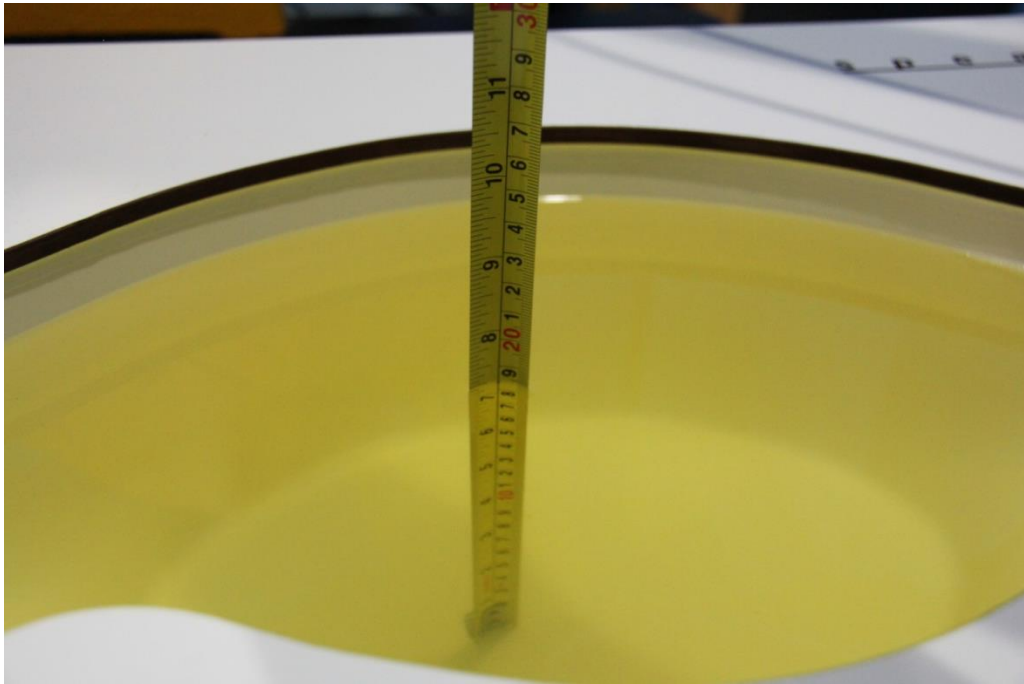

Picture 7-5: Liquid depth in the Flat Phantom (2550MHz)



Picture 7-6: Liquid depth in the Flat Phantom (5GHz)

## 8. System verification

### 8.1. System Setup

In the simplified setup for system evaluation, the DUT is replaced by a calibrated dipole and the power source is replaced by a continuous wave that comes from a signal generator. The calibrated dipole must be placed beneath the flat phantom section of the SAM twin phantom with the correct distance holder. The distance holder should touch the phantom surface with a light pressure at the reference marking and be oriented parallel to the long side of the phantom. The equipment setup is shown below:

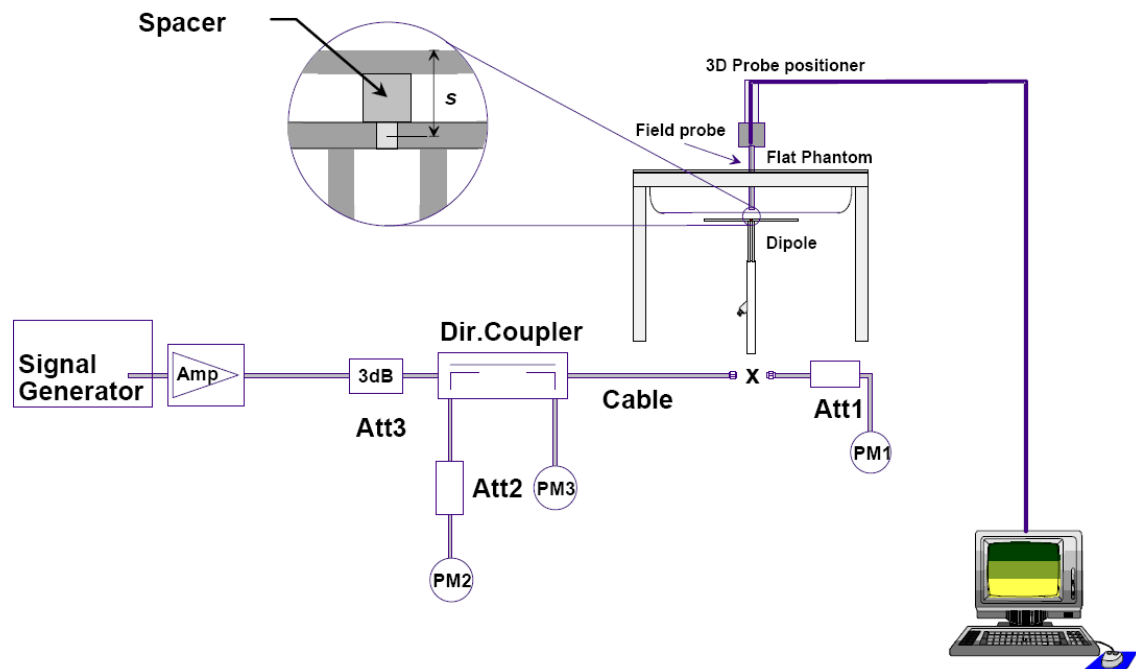

**Picture 8.1 System Setup for System Evaluation**

For the dipole below 3GHz, the output power on dipole port must be calibrated to 24 dBm (250mW) before dipole is connected.

For the dipole above 3GHz, the output power on dipole port must be calibrated to 20 dBm (100mW) before dipole is connected.

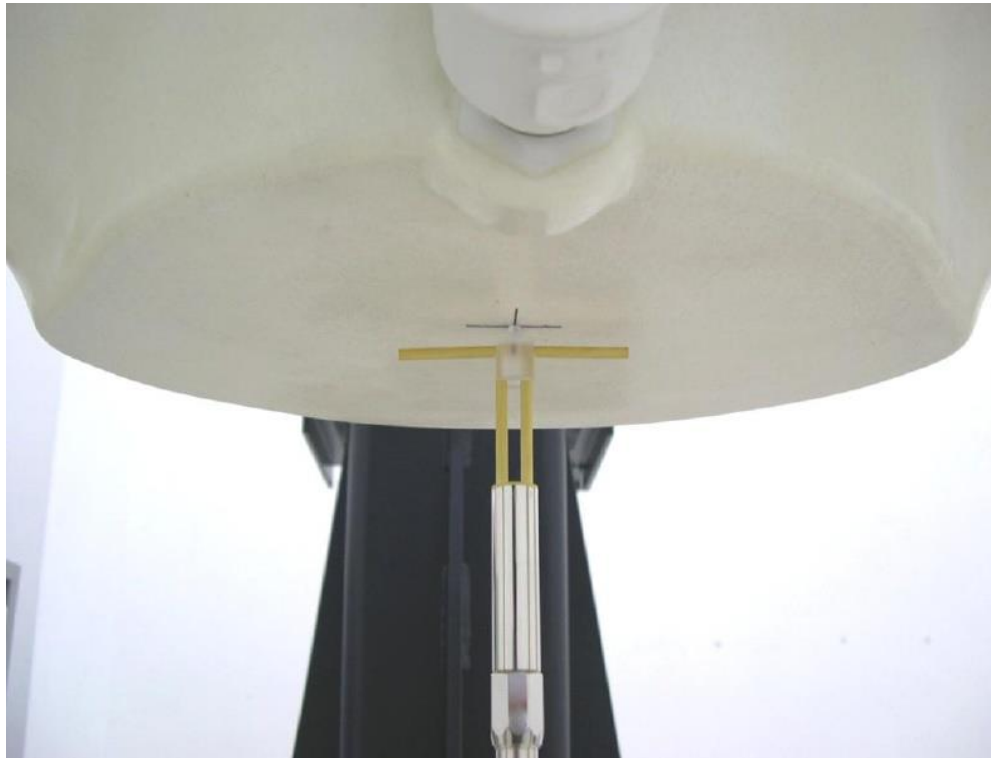

Picture 8.2 Photo of Dipole Setup

## 8.2. System Verification

SAR system verification is required to confirm measurement accuracy, according to the tissue dielectric media, probe calibration points and other system operating parameters required for measuring the SAR of a test device. The system verification must be performed for each frequency band and within the valid range of each probe calibration point required for testing the device.

Table 8.1: System Verification of Head

Measurement Date	Frequency (MHz)	Target value (W/kg)		Measured value (W/kg)				Deviation (%)	
		10 g	1 g	/		Normalize to 1W		10 g	1 g
				10 g	1 g	10 g	1 g		
2022-11-05	835	6.29	9.64	1.60	2.48	6.40	9.92	1.75	2.90
2022-11-14	1750	19.60	36.30	4.99	9.37	19.96	37.48	1.84	3.25
2022-11-16	1900	20.50	40.20	5.26	10.4	21.04	41.60	2.63	3.48
2022-11-01	2450	24.20	53.20	6.18	13.8	24.72	55.20	2.15	3.76
2022-11-21	2550	25.20	55.90	6.40	14.3	25.60	57.20	1.59	2.33
2022-11-03	5250	22.80	79.70	2.32	8.25	23.20	82.50	1.75	3.51
2022-11-03	5750	22.10	78.50	2.16	7.58	21.60	75.80	-2.26	-3.44



## 9. Measurement Procedures

### 9.1. Tests to be performed

In order to determine the highest value of the peak spatial-average SAR of a handset, all device positions, configurations and operational modes shall be tested for each frequency band according to steps 1 to 3 below. A flowchart of the test process is shown in picture 9.1.

**Step 1:** The tests described in 9.2 shall be performed at the channel that is closest to the center of the transmit frequency band ( $f_c$ ) for:

- a) all device positions (cheek and tilt, for both left and right sides of the SAM phantom, as described in annex D),
- b) all configurations for each device position in a), e.g., antenna extended and retracted, and
- c) all operational modes, e.g., analogue and digital, for each device position in a) and configuration in b) in each frequency band.

If more than three frequencies need to be tested according to 11.1 (i.e.,  $N_c > 3$ ), then all frequencies, configurations and modes shall be tested for all of the above test conditions.

**Step 2:** For the condition providing highest peak spatial-average SAR determined in Step 1, perform all tests described in 9.2 at all other test frequencies, i.e., lowest and highest frequencies. In addition, for all other conditions (device position, configuration and operational mode) where the peak spatial-average SAR value determined in Step 1 is within 3 dB of the applicable SAR limit, it is recommended that all other test frequencies shall be tested as well.

**Step 3:** Examine all data to determine the highest value of the peak spatial-average SAR found in Steps 1 to 2.

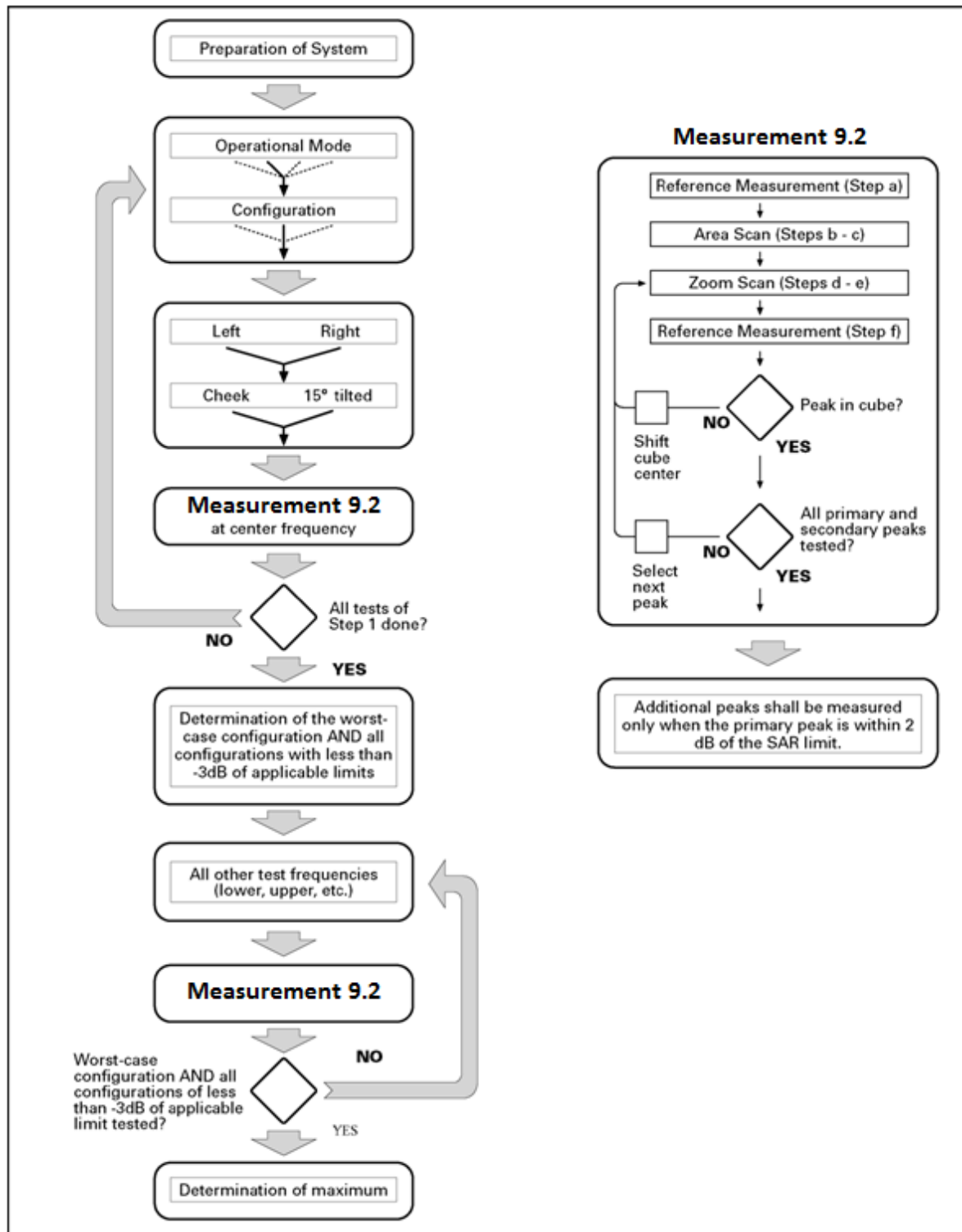

Picture 9.1 Block diagram of the tests to be performed

## 9.2. General Measurement Procedure

The area and zoom scan resolutions specified in the table below must be applied to the SAR measurements and fully documented in SAR reports to qualify for TCB approval. Probe boundary effect error compensation is required for measurements with the probe tip closer than half a probe tip diameter to the phantom surface. Both the probe tip diameter and sensor offset distance must satisfy measurement protocols; to ensure probe boundary effect errors are minimized and the higher fields closest to the phantom surface can be correctly measured and extrapolated to the phantom surface for computing 1-g SAR. Tolerances of the post-processing algorithms must be verified by the test laboratory for the scan resolutions used in the SAR measurements, according to the reference distribution functions specified in IEEE Std 1528-2013. The results should be documented as part of the system validation records and may be requested to support test results when all the measurement parameters in the following table are not satisfied.

		$\leq 3$ GHz	$> 3$ GHz	
Maximum distance from closest measurement point (geometric center of probe sensors) to phantom surface		$5 \pm 1$ mm	$\frac{1}{2} \cdot \delta \cdot \ln(2) \pm 0.5$ mm	
Maximum probe angle from probe axis to phantom surface normal at the measurement location		$30^\circ \pm 1^\circ$	$20^\circ \pm 1^\circ$	
Maximum area scan spatial resolution: $\Delta x_{Area}$ , $\Delta y_{Area}$		$\leq 2$ GHz: $\leq 15$ mm 2 – 3 GHz: $\leq 12$ mm	3 – 4 GHz: $\leq 12$ mm 4 – 6 GHz: $\leq 10$ mm	
		When the x or y dimension of the test device, in the measurement plane orientation, is smaller than the above, the measurement resolution must be $\leq$ the corresponding x or y dimension of the test device with at least one measurement point on the test device.		
Maximum zoom scan spatial resolution: $\Delta x_{Zoom}$ , $\Delta y_{Zoom}$		$\leq 2$ GHz: $\leq 8$ mm 2 – 3 GHz: $\leq 5$ mm*	3 – 4 GHz: $\leq 5$ mm* 4 – 6 GHz: $\leq 4$ mm*	
Maximum zoom scan spatial resolution, normal to phantom surface	uniform grid: $\Delta z_{Zoom}(n)$	$\leq 5$ mm	3 – 4 GHz: $\leq 4$ mm 4 – 5 GHz: $\leq 3$ mm 5 – 6 GHz: $\leq 2$ mm	
	graded grid	$\Delta z_{Zoom}(1)$ : between 1 <sup>st</sup> two points closest to phantom surface	$\leq 4$ mm	3 – 4 GHz: $\leq 3$ mm 4 – 5 GHz: $\leq 2.5$ mm 5 – 6 GHz: $\leq 2$ mm
		$\Delta z_{Zoom}(n>1)$ : between subsequent points	$\leq 1.5 \cdot \Delta z_{Zoom}(n-1)$	
Minimum zoom scan volume	x, y, z	$\geq 30$ mm	3 – 4 GHz: $\geq 28$ mm 4 – 5 GHz: $\geq 25$ mm 5 – 6 GHz: $\geq 22$ mm	
Note: $\delta$ is the penetration depth of a plane-wave at normal incidence to the tissue medium; see draft standard IEEE P1528-2011 for details. * When zoom scan is required and the <u>reported</u> SAR from the area scan based 1-g SAR estimation procedures of KDB 447498 is $\leq 1.4$ W/kg, $\leq 8$ mm, $\leq 7$ mm and $\leq 5$ mm zoom scan resolution may be applied, respectively, for 2 GHz to 3 GHz, 3 GHz to 4 GHz and 4 GHz to 6 GHz.				

### 9.3. WCDMA Measurement Procedures for SAR

The following procedures are applicable to WCDMA handsets operating under 3GPP Release99, Release 5 and Release 6. The default test configuration is to measure SAR with an established radio link between the DUT and a communication test set using a 12.2kbps RMC (reference measurement channel) configured in Test Loop Mode 1. SAR is selectively confirmed for other physical channel configurations (DPCCH & DPDCH<sub>n</sub>), HSDPA and HSPA (HSUPA/HSDPA) modes according to output power, exposure conditions and device operating capabilities. Both uplink and downlink should be configured with the same RMC or AMR, when required. SAR for Release 5 HSDPA and Release 6 HSPA are measured using the applicable FRC (fixed reference channel) and E-DCH reference channel configurations. Maximum output power is verified according to applicable versions of 3GPP TS 34.121 and SAR must be measured according to these maximum output conditions. When Maximum Power Reduction (MPR) is not implemented according to Cubic Metric (CM) requirements for Release 6 HSPA, the following procedures do not apply.

#### For Release 5 HSDPA Data Devices:

Sub-test	$\beta_c$	$\beta_d$	$\beta_d$ (SF)	$\beta_c / \beta_d$	$\beta_{hs}$	CM/dB
1	2/15	15/15	64	2/15	4/15	0.0
2	12/15	15/15	64	12/15	24/25	1.0
3	15/15	8/15	64	15/8	30/15	1.5
4	15/15	4/15	64	15/4	30/15	1.5

#### For Release 6 HSPA Data Devices

Sub-test	$\beta_c$	$\beta_d$	$\beta_d$ (SF)	$\beta_c / \beta_d$	$\beta_{hs}$	$\beta_{ec}$	$\beta_{ed}$	$\beta_{ed}$ (SF)	$\beta_{ed}$ (codes)	CM (dB)	MPR (dB)	AG Index	E-TFCI
1	11/15	15/15	64	11/15	22/15	209/225	1039/225	4	1	1.0	0.0	20	75
2	6/15	15/15	64	6/15	12/15	12/15	12/15	4	1	3.0	2.0	12	67
3	15/15	9/15	64	15/9	30/15	30/15	$\beta_{ed1}:47/15$ $\beta_{ed2}:47/15$	4	2	2.0	1.0	15	92
4	2/15	15/15	64	2/15	4/15	4/15	56/75	4	1	3.0	2.0	17	71
5	15/15	15/15	64	15/15	24/15	30/15	134/15	4	1	1.0	0.0	21	81

#### 9.4. SAR Measurement for LTE

SAR tests for LTE are performed with a base station simulator, Anristu MT8820C. Closed loop power control was used so the UE transmits with maximum output power during SAR testing. All powers were measured with the Anristu MT8820C. It is performed for conducted power and SAR based on the KDB941225 D05.

SAR is evaluated separately according to the following procedures for the different test positions in each exposure condition – head, body, body-worn accessories and other use conditions. The procedures in the following subsections are applied separately to test each LTE frequency band.

1) QPSK with 1 RB allocation

Start with the largest channel bandwidth and measure SAR for QPSK with 1 RB allocation, using the RB offset and required test channel combination with the highest maximum output power among RB offsets at the upper edge, middle and lower edge of each required test channel. When the reported SAR is  $\leq 0.8$  W/kg, testing of the remaining RB offset configurations and required test channels is not required for 1 RB allocation; otherwise, SAR is required for the remaining required test channels and only for the RB offset configuration with the highest output power for that channel. When the reported SAR of a required test channel is  $> 1.45$  W/kg, SAR is required for all three RB offset configurations for that required test channel.

2) QPSK with 50% RB allocation

The procedures required for 1 RB allocation in 1) are applied to measure the SAR for QPSK with 50% RB allocation.

3) QPSK with 100% RB allocation

For QPSK with 100% RB allocation, SAR is not required when the highest maximum output power for 100 % RB allocation is less than the highest maximum output power in 50% and 1 RB allocations and the highest reported SAR for 1 RB and 50% RB allocation in 1) and 2) are  $\leq 0.8$  W/kg. Otherwise, SAR is measured for the highest output power channel; and if the reported SAR is  $> 1.45$  W/kg, the remaining required test channels must also be tested.

## 9.5. WLAN Measurement Procedures for SAR

Normal network operating configurations are not suitable for measuring the SAR of 802.11 transmitters in general. Unpredictable fluctuations in network traffic and antenna diversity conditions can introduce undesirable variations in SAR results. The SAR for these devices should be measured using chipset based test mode software to ensure that the results are consistent and reliable.

Chipset based test mode software is hardware dependent and generally varies among manufacturers. The device operating parameters established in a test mode for SAR measurements must be identical to those programmed in production units, including output power levels, amplifier gain settings and other RF performance tuning parameters. The test frequencies should correspond to actual channel frequencies defined for domestic use. SAR for devices with switched diversity should be measured with only one antenna transmitting at a time during each SAR measurement, according to a fixed modulation and data rate. The same data pattern should be used for all measurements.

## 9.6. Power Drift

To control the output power stability during the SAR test, DASY5 system calculates the power drift by measuring the E-field at the same location at the beginning and at the end of the measurement for each test position. These drift values can be found in Section 14 labeled as: (Power Drift [dB]). This ensures that the power drift during one measurement is within 5%.

## 10. Conducted Output Power

### 10.1. WCDMA Measurement result

Table 10.1: The conducted power measurement results WCDMA

Item	band	WCDMA Band 2			
	ARFCN	Tune up	Ch.9538 (1907.6MHz)	Ch.9400 (1880MHz)	Ch.9262 (1852.4MHz)
WCDMA	\	<b>23.0</b>	<b>22.10</b>	<b>22.10</b>	<b>22.10</b>
HSUPA	1	<b>20.5</b>	19.80	19.40	19.40
	2	<b>20.5</b>	19.90	19.50	19.50
	3	<b>21.0</b>	20.00	19.40	19.30
	4	<b>19.5</b>	18.60	18.30	18.80
	5	<b>21.5</b>	20.60	20.50	20.70
HSDPA	1	<b>22.0</b>	20.80	20.70	20.90
	2	<b>22.0</b>	20.90	20.80	21.00
	3	<b>21.5</b>	20.10	19.80	20.20
	4	<b>21.5</b>	20.20	19.70	20.40
DC-HSDPA	1	<b>22.0</b>	20.90	20.80	21.00
	2	<b>22.0</b>	21.00	20.90	21.10
	3	<b>21.5</b>	20.20	19.90	20.30
	4	<b>21.5</b>	20.30	19.80	20.50
Item	band	WCDMA Band 4			
	ARFCN	Tune up	Ch.1513 (1752.6MHz)	Ch.1413 (1732.6MHz)	Ch.1312 (1712.4MHz)
WCDMA	\	<b>22.5</b>	<b>21.80</b>	<b>21.70</b>	<b>21.90</b>
HSUPA	1	<b>21.0</b>	20.20	19.80	20.10
	2	<b>21.0</b>	20.30	19.90	20.20
	3	<b>21.0</b>	20.30	19.90	20.20
	4	<b>20.0</b>	18.50	19.10	18.90
	5	<b>22.0</b>	21.20	20.60	21.30
HSDPA	1	<b>22.0</b>	20.80	20.80	21.20
	2	<b>22.0</b>	20.90	20.90	21.30
	3	<b>22.0</b>	21.00	20.70	21.00
	4	<b>22.0</b>	21.20	20.80	21.10
DC-HSDPA	1	<b>22.0</b>	20.90	20.90	21.30
	2	<b>22.0</b>	21.00	21.00	21.40
	3	<b>22.0</b>	21.10	20.80	21.10
	4	<b>22.0</b>	21.30	20.90	21.20

Item	band	WCDMA Band 5			
	ARFCN	Tune up	Ch.4233 (846.6MHz)	Ch.4183 (836.6MHz)	Ch.4132 (826.4MHz)
WCDMA	\	<b>23.0</b>	<b>22.00</b>	<b>21.80</b>	<b>21.80</b>
HSUPA	1	<b>20.5</b>	19.20	20.10	19.10
	2	<b>21.0</b>	19.30	20.20	19.20
	3	<b>20.5</b>	18.60	19.40	19.20
	4	<b>19.0</b>	18.30	17.90	18.30
	5	<b>21.0</b>	20.10	20.30	20.10
HSDPA	1	<b>22.0</b>	20.40	20.30	20.20
	2	<b>22.0</b>	20.50	20.40	20.30
	3	<b>21.5</b>	19.90	19.60	19.90
	4	<b>21.5</b>	20.00	19.70	20.20
DC-HSDPA	1	<b>22.0</b>	20.50	20.40	20.30
	2	<b>22.0</b>	20.60	20.50	20.40
	3	<b>21.5</b>	20.00	19.70	20.00
	4	<b>21.5</b>	20.10	19.80	20.30



### 10.2. LTE Measurement result

According to April 2015 TCB workshop, SAR Test exclusion can be applied for testing overlapping LTE Bands as follows:

- a) The maximum out power, including tolerance, for the smaller band must be  $\leq$  the larger band to qualify for SAR test exclusion.
- b) The channel bandwidth and other operating parameters for the smaller band must be fully supported by the larger band.

LTE Band 4 (1710 - 1755MHz) is covered by LTE Band 66 (1710 - 1780MHz)

**Table 10.2: The conducted Power for LTE**

LTE Band 2			Actual output Power (dBm)			Tune up			
Band -width	RB No. / RB offset	Frequency (MHz)	Modulation			Modulation			
			QPSK	16QAM	64QAM	QPSK	16QAM	64QAM	
1.4 MHz	1RB_5	1909.3	21.82	20.97	20.96	23.0	22.0	22.0	
		1880.0	21.91	21.17	21.15				
		1850.7	21.97	21.28	21.25				
	1RB_3	1909.3	21.89	21.05	21.05				
		1880.0	21.95	21.20	21.11				
		1850.7	22.04	21.40	21.36				
	1RB_0	1909.3	21.82	21.06	21.02				
		1880.0	21.89	21.11	21.02				
		1850.7	21.86	21.25	21.15				
	3RB_3	1909.3	21.88	20.74	20.74	22.0	21.0	21.0	
		1880.0	21.95	20.95	20.89				
		1850.7	22.02	21.08	21.00				
		3RB_1	1909.3	21.92	20.86				20.82
			1880.0	21.95	20.96				20.93
			1850.7	22.08	21.13				21.13
	3RB_0	1909.3	21.87	20.74	20.67				
		1880.0	21.91	20.92	20.88				
		1850.7	21.92	20.99	20.93				
	6RB_0	1909.3	20.88	19.89	19.80				
		1880.0	20.94	20.06	20.03				
		1850.7	20.93	20.04	19.98				



LTE Band 2			Actual output Power (dBm)			Tune up		
Band -width	RB No. / RB offset	Frequency (MHz)	Modulation			Modulation		
			QPSK	16QAM	64QAM	QPSK	16QAM	64QAM
3 MHz	1RB_14	1908.5	21.88	21.03	21.01	23.0	22.0	22.0
		1880.0	21.97	21.21	21.15			
		1851.5	22.02	21.37	21.27			
	1RB_7	1908.5	21.97	21.11	21.09			
		1880.0	22.07	21.39	21.35			
		1851.5	22.15	21.53	21.52			
	1RB_0	1908.5	21.87	21.02	20.95	22.0	21.0	21.0
		1880.0	21.97	21.22	21.14			
		1851.5	21.97	21.40	21.32			
	8RB_7	1908.5	20.88	19.88	19.85			
		1880.0	20.99	20.09	20.08			
		1851.5	20.93	20.15	20.11			
	8RB_4	1908.5	20.97	20.01	20.00	22.0	21.0	21.0
		1880.0	21.04	20.14	20.08			
		1851.5	21.00	20.19	20.14			
	8RB_0	1908.5	20.89	19.87	19.82			
		1880.0	20.99	20.10	20.05			
		1851.5	20.96	20.10	20.06			
15RB_0	1908.5	20.94	19.94	19.88				
	1880.0	20.94	20.02	19.99				
	1851.5	21.06	20.08	20.05				



LTE Band 2			Actual output Power (dBm)			Tune up		
Band -width	RB No. / RB offset	Frequency (MHz)	Modulation			Modulation		
			QPSK	16QAM	64QAM	QPSK	16QAM	64QAM
5 MHz	1RB_24	1907.5	21.88	21.02	20.93	<b>23.0</b>	<b>22.0</b>	<b>22.0</b>
		1880.0	21.97	21.37	21.28			
		1852.5	22.04	21.42	21.36			
	1RB_12	1907.5	21.91	21.05	20.96			
		1880.0	21.94	21.31	21.23			
		1852.5	21.92	21.31	21.23			
	1RB_0	1907.5	21.85	21.03	20.97			
		1880.0	21.93	21.22	21.18			
		1852.5	21.98	21.30	21.20			
	12RB_13	1907.5	20.96	19.81	19.79	<b>22.0</b>	<b>21.0</b>	<b>21.0</b>
		1880.0	21.02	19.94	19.93			
		1852.5	20.97	20.01	19.99			
	12RB_6	1907.5	20.94	19.81	19.78			
		1880.0	21.05	20.06	20.05			
		1852.5	20.99	20.17	20.07			
	12RB_0	1907.5	20.89	19.81	19.79			
		1880.0	21.01	20.06	19.98			
		1852.5	20.94	20.16	20.06			
	25RB_0	1907.5	20.93	19.81	19.77			
		1880.0	21.00	20.03	20.00			
		1852.5	20.99	20.09	20.02			



LTE Band 2			Actual output Power (dBm)			Tune up		
Band -width	RB No. / RB offset	Frequency (MHz)	Modulation			Modulation		
			QPSK	16QAM	64QAM	QPSK	16QAM	64QAM
10 MHz	1RB_49	1905.0	21.89	20.97	20.96	<b>23.0</b>	<b>22.0</b>	<b>22.0</b>
		1880.0	21.89	21.22	21.15			
		1855.0	21.98	21.27	21.26			
	1RB_24	1905.0	21.85	21.05	20.98			
		1880.0	21.88	21.20	21.15			
		1855.0	21.97	21.29	21.26			
	1RB_0	1905.0	21.90	21.06	20.99			
		1880.0	21.89	21.19	21.10			
		1855.0	21.96	21.32	21.28			
	25RB_25	1905.0	20.97	19.78	19.72	<b>22.0</b>	<b>21.0</b>	<b>21.0</b>
		1880.0	21.00	20.01	19.99			
		1855.0	21.00	20.02	20.01			
	25RB_12	1905.0	20.93	19.78	19.74			
		1880.0	20.93	19.93	19.86			
		1855.0	21.05	20.04	19.94			
	25RB_0	1905.0	20.93	19.83	19.75			
		1880.0	20.93	19.89	19.87			
		1855.0	20.99	19.99	19.90			
50RB_0	1905.0	20.93	19.84	19.75				
	1880.0	20.90	19.94	19.87				
	1855.0	21.01	20.01	19.95				



LTE Band 2			Actual output Power (dBm)			Tune up		
Band -width	RB No. / RB offset	Frequency (MHz)	Modulation			Modulation		
			QPSK	16QAM	64QAM	QPSK	16QAM	64QAM
15 MHz	1RB_74	1902.5	21.85	21.01	20.95	<b>23.0</b>	<b>22.0</b>	<b>22.0</b>
		1880.0	21.91	21.10	21.02			
		1857.5	21.95	21.17	21.10			
	1RB_37	1902.5	21.89	21.06	21.04			
		1880.0	21.89	21.09	21.06			
		1857.5	22.00	21.26	21.21			
	1RB_0	1902.5	21.88	20.99	20.95	<b>22.0</b>	<b>21.0</b>	<b>21.0</b>
		1880.0	21.91	21.01	21.00			
		1857.5	22.06	21.31	21.25			
	36RB_38	1902.5	20.82	19.78	19.71			
		1880.0	20.90	19.96	19.88			
		1857.5	21.00	20.01	19.96			
	36RB_19	1902.5	20.96	19.84	19.76			
		1880.0	20.93	20.02	19.98			
		1857.5	21.03	20.05	19.97			
	36RB_0	1902.5	20.82	19.81	19.79			
		1880.0	20.94	19.93	19.91			
		1857.5	21.03	20.05	19.96			
75RB_0	1902.5	20.81	19.80	19.73				
	1880.0	20.97	19.99	19.96				
	1857.5	20.99	20.04	20.04				



LTE Band 2			Actual output Power (dBm)			Tune up			
Band -width	RB No. / RB offset	Frequency (MHz)	Modulation			Modulation			
			QPSK	16QAM	64QAM	QPSK	16QAM	64QAM	
20 MHz	1RB_99	1900.0	21.91	21.01	20.96	<b>23.0</b>	<b>22.0</b>	<b>22.0</b>	
		1880.0	22.03	21.16	21.11				
		1860.0	21.98	21.22	21.18				
	1RB_50	1900.0	21.96	21.05	20.95				
		1880.0	22.05	21.16	21.06				
		1860.0	<b>22.17</b>	21.37	21.35				
	1RB_0	1900.0	21.95	21.19	21.16				
		1880.0	22.00	21.15	21.09				
		1860.0	22.13	21.31	21.24				
	50RB_50	50RB_50	1900.0	20.96	19.69	19.62	<b>22.0</b>	<b>21.0</b>	<b>21.0</b>
			1880.0	21.06	19.97	19.90			
			1860.0	21.05	19.82	19.81			
		50RB_25	1900.0	20.99	19.81	19.74			
			1880.0	21.05	19.96	19.90			
			1860.0	21.17	19.96	19.94			
	50RB_0	50RB_0	1900.0	21.04	19.92	19.86			
			1880.0	21.07	19.96	19.95			
			1860.0	<b>21.18</b>	20.05	19.98			
100RB_0	100RB_0	1900.0	20.99	19.92	19.88				
		1880.0	21.06	19.94	19.92				
		1860.0	21.05	19.83	19.75				



LTE Band 5			Actual output Power (dBm)			Tune up			
Band -width	RB No. / RB offset	Frequency (MHz)	Modulation			Modulation			
			QPSK	16QAM	64QAM	QPSK	16QAM	64QAM	
1.4 MHz	1RB_5	848.3	21.98	20.96	20.93	<b>23.0</b>	<b>22.0</b>	<b>22.0</b>	
		836.5	21.96	21.21	21.17				
		824.7	21.88	21.19	21.11				
	1RB_3	848.3	22.03	21.08	21.07				
		836.5	21.99	21.31	21.24				
		824.7	21.99	21.36	21.26				
	1RB_0	848.3	21.93	20.99	20.92				
		836.5	21.91	21.25	21.17				
		824.7	21.90	21.26	21.18				
	3RB_3	3RB_3	848.3	21.99	20.84	20.78	<b>22.0</b>	<b>21.0</b>	<b>21.0</b>
			836.5	22.02	20.98	20.92			
			824.7	21.99	20.96	20.96			
		3RB_1	848.3	22.02	20.87	20.82			
			836.5	22.04	21.00	20.98			
			824.7	21.96	21.03	21.03			
	3RB_0	3RB_0	848.3	21.99	20.76	20.70			
			836.5	21.99	20.99	20.98			
			824.7	21.96	20.95	20.90			
	6RB_0	6RB_0	848.3	20.96	19.89	19.84			
			836.5	20.95	20.01	19.98			
			824.7	21.00	20.09	20.04			



LTE Band 5			Actual output Power (dBm)			Tune up			
Band -width	RB No. / RB offset	Frequency (MHz)	Modulation			Modulation			
			QPSK	16QAM	64QAM	QPSK	16QAM	64QAM	
3 MHz	1RB_14	847.5	21.98	21.04	20.99	<b>23.0</b>	<b>22.0</b>	<b>22.0</b>	
		836.5	21.99	21.26	21.25				
		825.5	21.94	21.19	21.14				
	1RB_7	847.5	22.09	21.20	21.16				
		836.5	22.07	21.37	21.29				
		825.5	22.08	21.31	21.22				
	1RB_0	847.5	21.99	21.08	21.04				
		836.5	22.00	21.27	21.27				
		825.5	21.96	21.21	21.20				
	8RB_7	847.5	21.01	19.92	19.82	<b>22.0</b>	<b>21.0</b>	<b>21.0</b>	
		836.5	20.98	20.10	20.03				
		825.5	20.98	20.13	20.12				
		8RB_4	847.5	21.05	19.94				19.94
			836.5	21.03	20.13				20.07
			825.5	21.06	20.12				20.06
	8RB_0	847.5	20.98	19.91	19.87				
		836.5	21.00	20.07	19.99				
		825.5	21.08	20.15	20.11				
	15RB_0	847.5	20.98	19.96	19.86				
		836.5	20.99	20.04	20.03				
		825.5	21.04	20.06	20.03				





LTE Band 5			Actual output Power (dBm)			Tune up			
Band -width	RB No. / RB offset	Frequency (MHz)	Modulation			Modulation			
			QPSK	16QAM	64QAM	QPSK	16QAM	64QAM	
5 MHz	1RB_24	846.5	21.94	21.15	21.12	<b>23.0</b>	<b>22.0</b>	<b>22.0</b>	
		836.5	21.98	21.16	21.09				
		826.5	21.95	21.11	21.01				
	1RB_12	846.5	21.99	21.22	21.12				
		836.5	21.97	21.15	21.07				
		826.5	21.99	21.16	21.08				
	1RB_0	846.5	21.96	21.23	21.18				
		836.5	21.99	21.18	21.09				
		826.5	21.95	21.13	21.11				
	12RB_13	846.5	20.96	19.99	19.97	<b>22.0</b>	<b>21.0</b>	<b>21.0</b>	
		836.5	21.01	20.06	20.03				
		826.5	21.03	20.09	20.05				
		12RB_6	846.5	20.98	20.03				19.96
			836.5	21.04	20.09				20.08
			826.5	21.06	20.10				20.10
	12RB_0	846.5	21.01	19.98	19.94				
		836.5	21.01	20.06	20.05				
		826.5	21.02	20.09	20.05				
	25RB_0	846.5	20.95	19.98	19.98				
		836.5	21.03	20.07	20.03				
		826.5	21.04	20.07	19.97				



LTE Band 5			Actual output Power (dBm)			Tune up		
Band -width	RB No. / RB offset	Frequency (MHz)	Modulation			Modulation		
			QPSK	16QAM	64QAM	QPSK	16QAM	64QAM
10 MHz	1RB_49	844.0	21.82	21.29	21.26	<b>23.0</b>	<b>22.0</b>	<b>22.0</b>
		836.5	22.03	21.32	21.27			
		829.0	22.00	21.39	21.29			
	1RB_24	844.0	21.87	21.32	21.24			
		836.5	22.04	21.27	21.22			
		829.0	21.95	21.22	21.18			
	1RB_0	844.0	21.88	21.26	21.23			
		836.5	<b>22.09</b>	21.33	21.28			
		829.0	22.01	21.30	21.26			
	25RB_25	844.0	20.94	19.94	19.93	<b>22.0</b>	<b>21.0</b>	<b>21.0</b>
		836.5	21.08	20.04	20.03			
		829.0	21.12	20.09	20.06			
	25RB_12	844.0	20.96	20.04	20.03			
		836.5	<b>21.16</b>	20.09	20.03			
		829.0	21.15	20.15	20.11			
	25RB_0	844.0	20.95	20.05	20.02			
		836.5	21.03	20.08	20.04			
		829.0	21.06	20.05	19.96			
50RB_0	844.0	20.93	20.01	19.97				
	836.5	21.06	20.09	20.01				
	829.0	21.16	20.14	20.13				



LTE Band 7			Actual output Power (dBm)			Tune up		
Band -width	RB No. / RB offset	Frequency (MHz)	Modulation			Modulation		
			QPSK	16QAM	64QAM	QPSK	16QAM	64QAM
5 MHz	1RB_24	2567.5	22.09	21.24	21.29	<b>22.3</b>	<b>21.3</b>	<b>21.3</b>
		2535.0	21.83	21.20	21.14			
		2502.5	21.78	21.21	21.05			
	1RB_12	2567.5	22.09	21.24	21.24			
		2535.0	21.80	21.18	21.14			
		2502.5	21.78	21.22	20.99			
	1RB_0	2567.5	22.01	21.22	21.20			
		2535.0	21.77	21.11	21.05			
		2502.5	21.74	21.17	20.92			
	12RB_13	2567.5	21.12	20.16	20.12	<b>21.3</b>	<b>20.3</b>	<b>20.3</b>
		2535.0	20.87	19.89	19.92			
		2502.5	20.81	19.82	19.86			
	12RB_6	2567.5	21.14	20.12	20.10			
		2535.0	20.88	19.88	19.92			
		2502.5	20.82	19.84	19.85			
	12RB_0	2567.5	21.03	20.05	20.04			
		2535.0	20.81	19.82	19.86			
		2502.5	20.74	19.79	19.74			
	25RB_0	2567.5	21.05	20.08	20.09			
		2535.0	20.87	19.83	19.88			
		2502.5	20.81	19.84	19.85			



LTE Band 7			Actual output Power (dBm)			Tune up		
Band -width	RB No. / RB offset	Frequency (MHz)	Modulation			Modulation		
			QPSK	16QAM	64QAM	QPSK	16QAM	64QAM
10 MHz	1RB_49	2565.0	22.16	21.27	21.22	22.3	21.3	21.3
		2535.0	21.87	21.22	21.09			
		2505.0	21.92	21.16	21.05			
	1RB_24	2565.0	22.05	21.21	21.21			
		2535.0	21.80	21.14	20.99			
		2505.0	21.79	21.07	20.90			
	1RB_0	2565.0	22.04	21.27	21.28			
		2535.0	21.80	21.07	21.00			
		2505.0	21.73	21.05	20.85			
	25RB_25	2565.0	21.14	20.18	20.17	21.3	20.3	20.3
		2535.0	20.90	19.93	19.86			
		2505.0	20.87	19.89	19.87			
	25RB_12	2565.0	21.11	20.16	20.13			
		2535.0	20.86	19.95	19.89			
		2505.0	20.89	19.82	19.90			
	25RB_0	2565.0	21.08	20.12	20.09			
		2535.0	20.90	19.86	19.85			
		2505.0	20.77	19.78	19.82			
	50RB_0	2565.0	21.09	20.13	20.08			
		2535.0	20.87	19.90	19.86			
		2505.0	20.85	19.86	19.87			



LTE Band 7			Actual output Power (dBm)			Tune up		
Band -width	RB No. / RB offset	Frequency (MHz)	Modulation			Modulation		
			QPSK	16QAM	64QAM	QPSK	16QAM	64QAM
15 MHz	1RB_74	2562.5	22.22	21.20	21.18	22.3	21.3	21.3
		2535.0	21.97	21.27	21.11			
		2507.5	22.06	21.22	21.25			
	1RB_37	2562.5	22.15	21.16	21.14			
		2535.0	21.86	21.16	21.05			
		2507.5	21.90	21.09	21.09			
	1RB_0	2562.5	22.03	21.28	21.26			
		2535.0	21.80	21.16	21.06			
		2507.5	21.77	21.12	21.02			
	36RB_38	2562.5	21.23	20.22	20.23	21.3	20.3	20.3
		2535.0	20.98	19.95	19.98			
		2507.5	20.96	19.98	19.97			
	36RB_19	2562.5	21.13	20.20	20.16			
		2535.0	20.93	19.96	19.88			
		2507.5	20.88	19.91	19.93			
	36RB_0	2562.5	21.11	20.14	20.12			
		2535.0	20.86	19.92	19.85			
		2507.5	20.85	19.88	19.87			
	75RB_0	2562.5	21.16	20.15	20.12			
		2535.0	20.93	19.95	19.96			
		2507.5	20.91	19.92	19.89			



LTE Band 7			Actual output Power (dBm)			Tune up		
Band -width	RB No. / RB offset	Frequency (MHz)	Modulation			Modulation		
			QPSK	16QAM	64QAM	QPSK	16QAM	64QAM
20 MHz	1RB_99	2560.0	<b>22.08</b>	21.21	21.17	<b>22.3</b>	<b>21.3</b>	<b>21.3</b>
		2535.0	22.05	21.14	21.18			
		2510.0	21.97	21.16	21.11			
	1RB_50	2560.0	21.86	21.23	21.24			
		2535.0	21.85	21.14	21.08			
		2510.0	21.90	21.14	21.11			
	1RB_0	2560.0	21.84	21.28	21.08			
		2535.0	21.79	21.12	20.99			
		2510.0	21.79	21.01	21.01			
	50RB_50	2560.0	<b>21.04</b>	20.10	20.09	<b>21.3</b>	<b>20.3</b>	<b>20.3</b>
		2535.0	20.95	19.98	19.97			
		2510.0	20.94	19.95	19.89			
	50RB_25	2560.0	20.99	20.06	20.05			
		2535.0	20.93	19.95	19.93			
		2510.0	20.92	19.95	19.97			
	50RB_0	2560.0	20.98	20.01	20.02			
		2535.0	20.88	19.89	19.89			
		2510.0	20.90	19.89	19.86			
	100RB_0	2560.0	21.02	20.03	20.07			
		2535.0	20.93	19.97	19.91			
		2510.0	20.88	19.83	19.82			



LTE Band 66			Actual output Power (dBm)			Tune up			
Band -width	RB No. / RB offset	Frequency (MHz)	Modulation			Modulation			
			QPSK	16QAM	64QAM	QPSK	16QAM	64QAM	
1.4 MHz	1RB_5	1779.3	21.82	21.05	20.99	23.0	22.0	22.0	
		1745.0	21.84	21.15	21.08				
		1710.7	21.96	21.22	21.18				
	1RB_3	1779.3	21.95	21.26	21.24				
		1745.0	21.95	21.30	21.22				
		1710.7	22.06	21.25	21.24				
	1RB_0	1779.3	21.86	21.16	21.14				
		1745.0	21.84	21.17	21.14				
		1710.7	21.96	21.22	21.19				
	3RB_3	3RB_3	1779.3	21.71	20.75	20.67	22.0	21.0	21.0
			1745.0	21.72	20.80	20.73			
			1710.7	21.84	20.89	20.83			
		3RB_1	1779.3	21.73	20.77	20.67			
			1745.0	21.74	20.83	20.74			
			1710.7	21.85	20.96	20.87			
	3RB_0	1779.3	21.71	20.76	20.73				
		1745.0	21.72	20.79	20.75				
		1710.7	21.86	20.89	20.80				
	6RB_0	6RB_0	1779.3	21.78	20.75	20.74			
			1745.0	21.75	20.76	20.68			
			1710.7	21.89	20.86	20.81			



LTE Band 66			Actual output Power (dBm)			Tune up			
Band -width	RB No. / RB offset	Frequency (MHz)	Modulation			Modulation			
			QPSK	16QAM	64QAM	QPSK	16QAM	64QAM	
3 MHz	1RB_14	1778.5	21.82	21.05	21.03	23.0	22.0	22.0	
		1745.0	21.84	21.15	21.14				
		1711.5	21.96	21.22	21.18				
	1RB_7	1778.5	21.95	21.26	21.23				
		1745.0	21.95	21.30	21.26				
		1711.5	22.06	21.25	21.20				
	1RB_0	1778.5	21.86	21.16	21.10				
		1745.0	21.84	21.17	21.11				
		1711.5	21.96	21.22	21.14				
	8RB_7	8RB_7	1778.5	20.91	19.95	19.94	22.0	21.0	21.0
			1745.0	20.92	20.00	19.99			
			1711.5	21.04	20.09	20.08			
		8RB_4	1778.5	20.93	19.97	19.92			
			1745.0	20.94	20.03	19.93			
			1711.5	21.05	20.16	20.10			
	8RB_0	1778.5	20.91	19.96	19.92				
		1745.0	20.92	19.99	19.94				
		1711.5	21.06	20.09	20.03				
15RB_0	1778.5	20.98	19.95	19.89					
	1745.0	20.95	19.96	19.95					
	1711.5	21.09	20.06	19.98					





LTE Band 66			Actual output Power (dBm)			Tune up		
Band -width	RB No. / RB offset	Frequency (MHz)	Modulation			Modulation		
			QPSK	16QAM	64QAM	QPSK	16QAM	64QAM
5 MHz	1RB_24	1777.5	21.83	21.02	21.01	23.0	22.0	22.0
		1745.0	21.85	21.11	21.10			
		1712.5	21.88	21.17	21.08			
	1RB_12	1777.5	21.90	21.12	21.07			
		1745.0	21.90	21.18	21.10			
		1712.5	21.91	21.23	21.19			
	1RB_0	1777.5	21.87	21.09	21.01			
		1745.0	21.86	21.16	21.09			
		1712.5	21.88	21.20	21.14			
	12RB_13	1777.5	20.97	19.95	19.90	22.0	21.0	21.0
		1745.0	20.96	19.94	19.92			
		1712.5	20.98	20.07	20.01			
	12RB_6	1777.5	20.99	19.99	19.97			
		1745.0	21.00	20.01	19.98			
		1712.5	20.98	20.08	20.07			
	12RB_0	1777.5	20.97	19.95	19.89			
		1745.0	20.93	20.02	19.98			
		1712.5	20.95	20.07	20.00			
25RB_0	1777.5	20.96	19.94	19.88				
	1745.0	20.99	19.99	19.98				
	1712.5	20.98	20.02	19.92				



LTE Band 66			Actual output Power (dBm)			Tune up		
Band -width	RB No. / RB offset	Frequency (MHz)	Modulation			Modulation		
			QPSK	16QAM	64QAM	QPSK	16QAM	64QAM
10 MHz	1RB_49	1775.0	21.86	21.22	21.15	<b>23.0</b>	<b>22.0</b>	<b>22.0</b>
		1745.0	21.86	21.16	21.09			
		1715.0	21.86	21.28	21.25			
	1RB_24	1775.0	21.89	21.16	21.07			
		1745.0	21.93	21.14	21.11			
		1715.0	21.90	21.32	21.29			
	1RB_0	1775.0	21.91	21.22	21.19			
		1745.0	21.91	21.16	21.14			
		1715.0	21.94	21.30	21.25			
	25RB_25	1775.0	20.98	19.95	19.93	<b>22.0</b>	<b>21.0</b>	<b>21.0</b>
		1745.0	20.97	19.92	19.84			
		1715.0	20.96	20.00	19.95			
	25RB_12	1775.0	21.00	19.98	19.92			
		1745.0	21.01	19.95	19.90			
		1715.0	20.98	20.09	20.00			
	25RB_0	1775.0	21.01	19.99	19.95			
		1745.0	21.00	19.99	19.91			
		1715.0	21.01	20.00	19.94			
	50RB_0	1775.0	21.00	19.94	19.90			
		1745.0	20.99	19.98	19.90			
		1715.0	20.98	20.07	20.03			



LTE Band 66			Actual output Power (dBm)			Tune up			
Band -width	RB No. / RB offset	Frequency (MHz)	Modulation			Modulation			
			QPSK	16QAM	64QAM	QPSK	16QAM	64QAM	
15 MHz	1RB_74	1772.5	21.84	21.23	21.15	23.0	22.0	22.0	
		1745.0	21.86	21.16	21.11				
		1717.5	21.84	21.22	21.19				
	1RB_37	1772.5	21.89	21.26	21.23				
		1745.0	21.89	21.23	21.21				
		1717.5	21.90	21.25	21.23				
	1RB_0	1772.5	21.90	21.24	21.23				
		1745.0	21.90	21.16	21.12				
		1717.5	21.98	21.21	21.19				
	36RB_38	1772.5	20.97	19.95	19.88	22.0	21.0	21.0	
		1745.0	20.99	19.99	19.96				
		1717.5	21.02	20.07	20.02				
		36RB_19	1772.5	21.00	20.00				19.93
			1745.0	20.98	19.98				19.95
			1717.5	21.00	20.08				20.07
	36RB_0	1772.5	21.00	20.01	19.97				
		1745.0	21.00	19.96	19.89				
		1717.5	21.10	20.02	19.98				
75RB_0	1772.5	20.98	19.97	19.92					
	1745.0	21.01	19.97	19.88					
	1717.5	21.06	20.02	20.00					



LTE Band 66			Actual output Power (dBm)			Tune up			
Band -width	RB No. / RB offset	Frequency (MHz)	Modulation			Modulation			
			QPSK	16QAM	64QAM	QPSK	16QAM	64QAM	
20 MHz	1RB_99	1770.0	21.91	21.22	21.14	<b>23.0</b>	<b>22.0</b>	<b>22.0</b>	
		1745.0	21.92	21.22	21.17				
		1720.0	21.98	21.17	21.10				
	1RB_50	1770.0	21.96	21.23	21.16				
		1745.0	21.94	21.13	21.08				
		1720.0	21.97	21.27	21.19				
	1RB_0	1770.0	<b>22.01</b>	21.30	21.21				
		1745.0	21.97	21.14	21.14				
		1720.0	21.99	21.27	21.23				
	50RB_50	50RB_50	1770.0	21.05	19.93	19.86	<b>22.0</b>	<b>21.0</b>	<b>21.0</b>
			1745.0	21.02	19.95	19.91			
			1720.0	21.11	20.03	20.00			
		50RB_25	1770.0	21.05	20.00	19.98			
			1745.0	21.06	19.99	19.96			
			1720.0	21.16	20.07	19.99			
	50RB_0	1770.0	<b>21.18</b>	19.96	19.95				
		1745.0	21.09	19.96	19.95				
		1720.0	21.16	20.08	20.03				
100RB_0	100RB_0	1770.0	21.04	19.94	19.93				
		1745.0	21.05	19.93	19.90				
		1720.0	21.11	19.98	19.94				



**LTE Down-Link Carrier Aggregation**

The measurement results of down-link LTE 2CA Conducted Power are as below:

	CA List	PCC							SCC				Power		
		LTE	BW	UL	UL	Mod.	UL#	UL	LTE	BW	DL	DL	With CA	Without CA	
		Band	(MHz)	Freq. (MHz)	Channel		RB	Offset	Band	(MHz)	Freq. (MHz)	Channel	Tx. Power (dBm)	Tx. Power (dBm)	
Inter-Band	CA_2A-4A	Band 2	20M	1860	18700	QPSK	1	50	Band 4	20M	2132.5	2175	22.15	22.17	
	CA_2A-5A	Band 2	20M	1860	18700	QPSK	1	50	Band 5	10M	881.5	2525	22.12	22.17	
	CA_2A-7A	Band 2	20M	1860	18700	QPSK	1	50	Band 7	20M	2655	3100	22.09	22.17	
	CA_4A-5A	Band 4	20M	1720	20050	QPSK	1	0	Band 5	10M	881.5	2525	22.03	22.08	
	CA_4A-7A	Band 4	20M	1720	20050	QPSK	1	0	Band 7	20M	2655	3100	22.05	22.08	
	CA_5A-7A	Band 5	10M	836.5	20525	QPSK	1	0	Band 7	20M	2655	3100	22.07	22.09	
Intra-Band	Contiguous	CA_5A-66A	Band 5	10M	836.5	20525	QPSK	1	0	Band 66	20M	2155	66886	22.04	22.09
		CA_2C	Band 2	20M	1860	18700	QPSK	1	0	Band 2	20M	1959.8	898	22.10	22.13
	Non-Contiguous	CA_7C	Band 7	20M	2560	21350	QPSK	1	99	Band 7	20M	2660.2	3152	22.01	22.08
		CA_7A-7A	Band 7	20M	2560	21350	QPSK	1	99	Band 7	5M	2622.5	2775	22.03	22.08
		CA_66A-66A	Band 66	20M	1770	132572	QPSK	1	0	Band 66	5M	2112.5	66461	21.98	22.01

### 10.3. WLAN Measurement result

**Table 10.3: The conducted Power measurement results for WLAN 2.4GHz**

<b>Ant.2</b>				
Averaged Power (dBm) Duty Cycle: <b>100%</b>				
Mode	<b>Tune up</b>	Ch.1(2412MHz)	Ch.6(2437MHz)	Ch.11 (2462MHz)
802.11b	<b>16.5</b>	15.26	15.69	<b>16.31</b>
802.11g	<b>15.5</b>	14.10	14.41	15.06
802.11n(20MHz)	<b>14.5</b>	12.92	13.34	13.88
/	/	Ch.3(2422MHz)	Ch.6(2437MHz)	Ch.9 (2452MHz)
802.11n(40MHz)	<b>14.0</b>	12.11	12.67	13.21
<b>Ant.1</b>				
Averaged Power (dBm) Duty Cycle: <b>100%</b>				
Mode	<b>Tune up</b>	Ch.1(2412MHz)	Ch.6(2437MHz)	Ch.11 (2462MHz)
802.11b	<b>17.0</b>	15.07	15.51	<b>15.97</b>
802.11g	<b>15.5</b>	13.73	14.34	14.57
802.11n(20MHz)	<b>14.5</b>	12.65	13.24	13.51
/	/	Ch.3(2422MHz)	Ch.6(2437MHz)	Ch.9 (2452MHz)
802.11n(40MHz)	<b>14.0</b>	12.35	12.72	12.94
<b>MIMO (Ant.2 &amp; Ant.1)</b>				
Averaged Power (dBm) Duty Cycle: <b>100%</b>				
Mode	<b>Tune up</b>	Ch.1(2412MHz)	Ch.6(2437MHz)	Ch.11 (2462MHz)
802.11n(20MHz)	<b>17.0</b>	15.75	16.21	<b>16.65</b>
/	/	Ch.3(2422MHz)	Ch.6(2437MHz)	Ch.9 (2452MHz)
802.11n(40MHz)	<b>16.5</b>	15.15	15.66	16.00

**Table 10.4: The conducted Power measurement results for WLAN 5GHz**

Averaged Power (dBm) Duty Cycle: <b>100%</b>								
Mode	802.11a	802.11n -20MHz	802.11ac -20MHz	Mode	802.11n -40MHz	802.11ac -40MHz	Mode	802.11ac -80MHz
Channel	6Mbps	MCS0	MCS0	Channel	MCS0	MCS0	Channel	MCS0
<b>Ant.2 - &lt;U-NII-1&gt;</b>								
<b>Tune up</b>	<b>13.0</b>	<b>12.0</b>	<b>11.0</b>	/	<b>11.0</b>	<b>11.0</b>	/	<b>11.0</b>
36(5180MHz)	11.94	10.72	9.81	38(5190MHz)	9.61	9.78	42(5210MHz)	9.86
40(5200MHz)	11.92	10.76	9.79	46(5230MHz)	9.73	9.85	/	/
44(5220MHz)	12.04	10.81	9.95	/	/	/	/	/
48(5240MHz)	<b>12.07</b>	10.82	9.89	/	/	/	/	/
<b>Ant.1 - &lt;U-NII-1&gt;</b>								
<b>Tune up</b>	<b>13.0</b>	<b>11.0</b>	<b>10.0</b>	/	<b>10.0</b>	<b>10.0</b>	/	<b>10.0</b>
36(5180MHz)	<b>11.48</b>	10.29	9.23	38(5190MHz)	9.14	9.27	42(5210MHz)	9.12
40(5200MHz)	11.35	10.26	9.19	46(5230MHz)	9.12	9.16	/	/
44(5220MHz)	11.29	10.17	9.11	/	/	/	/	/
48(5240MHz)	11.17	10.03	9.06	/	/	/	/	/
<b>MIMO (Ant.2 &amp; Ant.1) - &lt;U-NII-1&gt;</b>								
<b>Tune up</b>	/	<b>14.0</b>	<b>13.0</b>	/	<b>13.0</b>	<b>13.0</b>	/	<b>13.0</b>
36(5180MHz)	/	<b>13.47</b>	12.62	38(5190MHz)	12.42	12.49	42(5210MHz)	12.50
40(5200MHz)	/	13.45	12.53	46(5230MHz)	12.46	12.50	/	/
44(5220MHz)	/	13.39	12.55	/	/	/	/	/
48(5240MHz)	/	13.37	12.49	/	/	/	/	/



Averaged Power (dBm) Duty Cycle: <b>100%</b>								
Mode	802.11a	802.11n -20MHz	802.11ac -20MHz	Mode	802.11n -40MHz	802.11ac -40MHz	Mode	802.11ac -80MHz
Channel	6Mbps	MCS0	MCS0	Channel	MCS0	MCS0	Channel	MCS0
<b>Ant.2 - &lt;U-NII-2A&gt;</b>								
<b>Tune up</b>	<b>13.0</b>	<b>12.0</b>	<b>11.0</b>	/	<b>11.0</b>	<b>11.0</b>	/	<b>11.0</b>
52(5260MHz)	11.92	10.76	9.83	54(5270MHz)	9.67	9.77	58(5290MHz)	9.65
56(5280MHz)	11.88	10.72	9.77	62(5310MHz)	9.74	9.83	/	/
60(5300MHz)	11.96	10.81	9.87	/	/	/	/	/
64(5320MHz)	11.94	10.74	9.79	/	/	/	/	/
<b>Ant.1 - &lt;U-NII-2A&gt;</b>								
<b>Tune up</b>	<b>13.0</b>	<b>11.0</b>	<b>10.0</b>	/	<b>10.0</b>	<b>10.0</b>	/	<b>10.0</b>
52(5260MHz)	11.14	9.93	8.99	54(5270MHz)	9.00	9.06	58(5290MHz)	8.88
56(5280MHz)	11.05	9.90	8.94	62(5310MHz)	9.05	9.11	/	/
60(5300MHz)	11.25	10.08	9.08	/	/	/	/	/
64(5320MHz)	11.17	10.07	9.02	/	/	/	/	/
<b>MIMO (Ant.2 &amp; Ant.1) - &lt;U-NII-2A&gt;</b>								
<b>Tune up</b>	/	<b>14.0</b>	<b>13.0</b>	/	<b>13.0</b>	<b>13.0</b>	/	<b>13.0</b>
52(5260MHz)	/	13.36	12.42	54(5270MHz)	12.33	12.35	58(5290MHz)	12.31
56(5280MHz)	/	13.29	12.35	62(5310MHz)	12.40	12.42	/	/
60(5300MHz)	/	13.40	12.46	/	/	/	/	/
64(5320MHz)	/	13.39	12.41	/	/	/	/	/



Averaged Power (dBm) Duty Cycle: <b>100%</b>								
Mode	802.11a	802.11n -20MHz	802.11ac -20MHz	Mode	802.11n -40MHz	802.11ac -40MHz	Mode	802.11ac -80MHz
Channel	6Mbps	MCS0	MCS0	Channel	MCS0	MCS0	Channel	MCS0
<b>Ant.2 - &lt;U-NII-2C&gt;</b>								
<b>Tune up</b>	<b>14.0</b>	<b>13.0</b>	<b>12.0</b>	/	<b>12.0</b>	<b>12.0</b>	/	<b>12.0</b>
100(5500MHz)	12.56	11.42	10.48	102(5510MHz)	10.31	10.43	106(5530MHz)	10.53
116(5580MHz)	12.64	11.44	10.51	110(5550MHz)	10.48	10.55	122(5610MHz)	10.35
124(5620MHz)	12.47	11.26	10.27	126(5630MHz)	10.15	10.25	138(5690MHz)	10.19
132(5660MHz)	12.42	11.24	10.28	134(5670MHz)	10.18	10.26	/	/
140(5700MHz)	12.49	11.34	10.32	142(5710MHz)	10.21	10.29	/	/
144(5720MHz)	12.42	11.23	10.26	/	/	/	/	/
<b>Ant.1 - &lt;U-NII-2C&gt;</b>								
<b>Tune up</b>	<b>13.0</b>	<b>12.0</b>	<b>11.0</b>	/	<b>11.0</b>	<b>11.0</b>	/	<b>11.0</b>
100(5500MHz)	11.53	10.45	9.35	102(5510MHz)	9.33	9.37	106(5530MHz)	9.42
116(5580MHz)	11.44	10.31	9.27	110(5550MHz)	9.30	9.35	122(5610MHz)	9.13
124(5620MHz)	11.22	10.12	9.12	126(5630MHz)	9.06	9.11	138(5690MHz)	9.02
132(5660MHz)	11.12	10.06	9.00	134(5670MHz)	9.01	9.05	/	/
140(5700MHz)	11.33	10.26	9.18	142(5710MHz)	9.24	9.27	/	/
144(5720MHz)	11.27	10.21	9.16					
<b>MIMO (Ant.2 &amp; Ant.1) - &lt;U-NII-2C&gt;</b>								
<b>Tune up</b>	<b>/</b>	<b>15.0</b>	<b>14.0</b>	/	<b>14.0</b>	<b>14.0</b>	/	<b>14.0</b>
100(5500MHz)	/	13.89	12.93	102(5510MHz)	12.84	12.95	106(5530MHz)	12.96
116(5580MHz)	/	13.91	12.96	110(5550MHz)	12.90	12.97	122(5610MHz)	12.77
124(5620MHz)	/	13.71	12.69	126(5630MHz)	12.61	12.64	138(5690MHz)	12.61
132(5660MHz)	/	13.68	12.73	134(5670MHz)	12.65	12.64	/	/
140(5700MHz)	/	13.79	12.83	142(5710MHz)	12.71	12.76	/	/
144(5720MHz)	/	13.76	12.75					



Averaged Power (dBm) Duty Cycle: <b>100%</b>								
Mode	802.11a	802.11n -20MHz	802.11ac -20MHz	Mode	802.11n -40MHz	802.11ac -40MHz	Mode	802.11ac -80MHz
Channel	6Mbps	MCS0	MCS0	Channel	MCS0	MCS0	Channel	MCS0
<b>Ant.2 - &lt;U-NII-3&gt;</b>								
<b>Tune up</b>	<b>14.0</b>	<b>13.0</b>	<b>12.0</b>	/	<b>12.0</b>	<b>12.0</b>	/	<b>12.0</b>
149(5745MHz)	12.55	11.35	10.43	151(5755MHz)	10.28	10.35	155(5775MHz)	10.64
157(5785MHz)	12.82	11.72	10.67	159(5795MHz)	10.60	10.71	/	/
165(5825MHz)	<b>12.95</b>	11.85	10.86	/	/	/	/	/
<b>Ant.1 - &lt;U-NII-3&gt;</b>								
<b>Tune up</b>	<b>13.0</b>	<b>12.0</b>	<b>11.0</b>	/	<b>11.0</b>	<b>11.0</b>	/	<b>11.0</b>
149(5745MHz)	11.35	10.28	9.39	151(5755MHz)	9.30	9.39	155(5775MHz)	9.72
157(5785MHz)	11.61	10.67	9.77	159(5795MHz)	9.64	9.71	/	/
165(5825MHz)	<b>11.78</b>	10.79	9.86	/	/	/	/	/
<b>MIMO (Ant.2 &amp; Ant.1) - &lt;U-NII-3&gt;</b>								
<b>Tune up</b>	/	<b>15.0</b>	<b>14.0</b>	/	<b>14.0</b>	<b>14.0</b>	/	<b>14.0</b>
149(5745MHz)	/	13.85	12.84	151(5755MHz)	12.82	12.83	155(5775MHz)	13.16
157(5785MHz)	/	14.18	13.19	159(5795MHz)	13.15	13.17	/	/
165(5825MHz)	/	<b>14.31</b>	13.32	/	/	/	/	/

## 11. Simultaneous TX SAR Considerations

### 11.1. Introduction

The following procedures adopted from “FCC SAR Considerations for Cell Phones with Multiple Transmitters” are applicable to handsets with built-in unlicensed transmitters such as 802.11 a/b/g and Bluetooth devices which may simultaneously transmit with the licensed transmitter.

For this device, the WLAN can transmit simultaneous with other transmitters.

### 11.2. Transmit Antenna Separation Distances

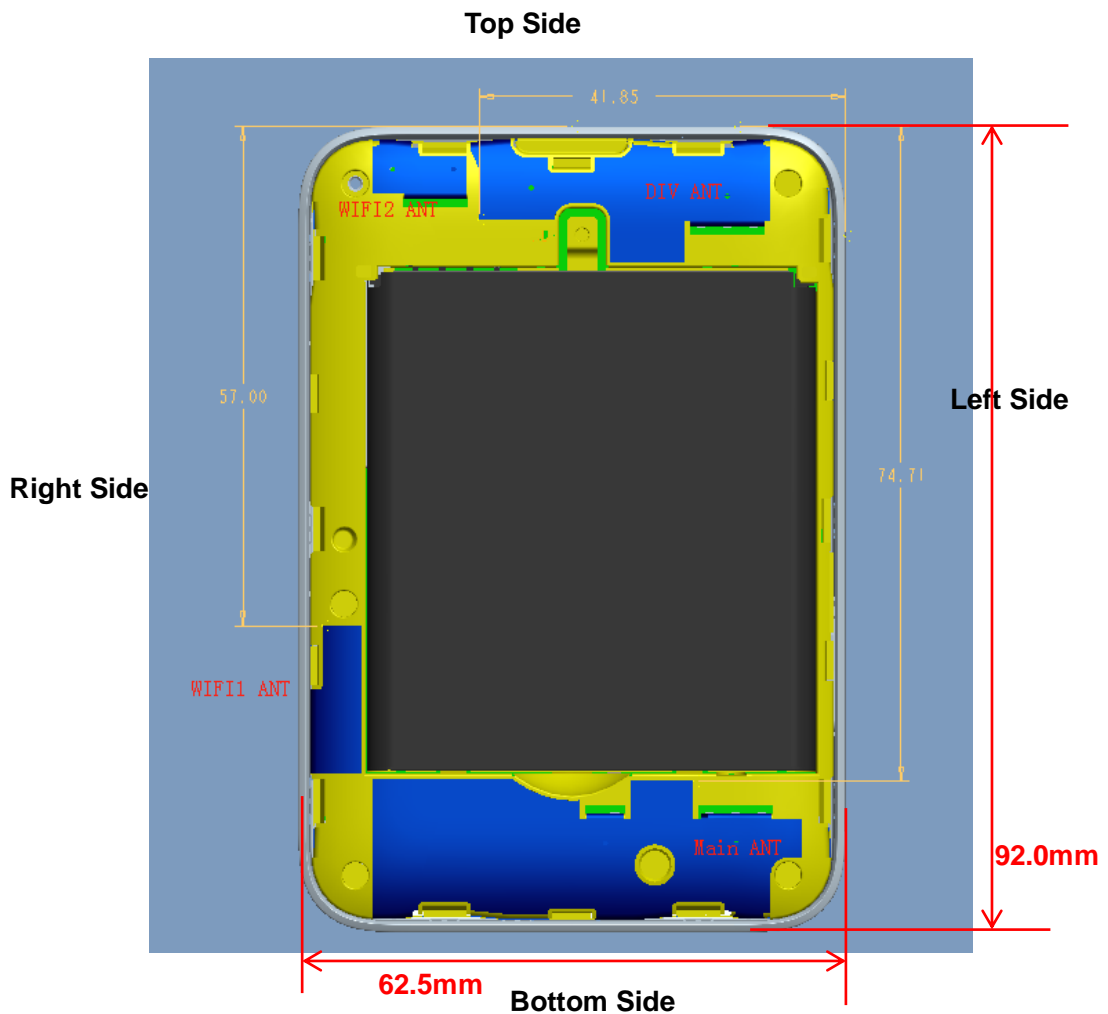

Picture 11.1 Antenna Locations (Back View)

### 11.3. SAR Measurement Positions

According to the KDB941225 D06 Hot Spot SAR, the edges with less than 25mm distance to the antennas need to be tested for SAR.

SAR measurement positions						
Antenna	Front	Rear	Left edge	Right edge	Top edge	Bottom edge
Main antenna	Yes	Yes	Yes	Yes	No	Yes
WLAN Ant.2	Yes	Yes	Yes	Yes	Yes	No
WLAN Ant.1	Yes	Yes	Yes	Yes	No	Yes

### 11.4. Standalone SAR Test Exclusion Considerations

Standalone 1-g head or body SAR evaluation by measurement or numerical simulation is not required when the corresponding SAR Exclusion Threshold condition, listed below, is satisfied. The 1-g SAR test exclusion threshold for 100 MHz to 6 GHz at test separation distances  $\leq 50$  mm are determined by:

$$\left[ \frac{\text{max. power of channel, including tune-up tolerance, mW}}{\text{min. test separation distance, mm}} \right] \cdot \sqrt{f(\text{GHz})} \leq 3.0 \text{ for 1-g SAR, where}$$

- $f(\text{GHz})$  is the RF channel transmit frequency in GHz
- Power and distance are rounded to the nearest mW and mm before calculation
- The result is rounded to one decimal place for comparison

**Table 12.1: Standalone SAR test exclusion considerations**

Band/Mode	f(GHz)	Position	SAR test exclusion threshold(mW)	RF output power		SAR test exclusion
				dBm	mW	
WLAN 2.4GHz	2.45	Body	19.17	17.0	50.12	No
WLAN 5GHz	5.2	Body	13.16	14.0	25.12	No
	5.8	Body	12.46	15.0	31.62	No

## 12. Evaluation of Simultaneous

**Table 12.2: The sum of reported SAR values for WWAN antenna and WLAN antenna**

/	Position	WWAN (W/kg)	WLAN (W/kg)	Sum (W/kg)
Highest reported SAR value for Hotspot	Rear Side	1.25 (LTE Band 7)	0.24 (WLAN 2.4GHz)	<b>1.49</b>

Note: the test positions of above tables are for the worse case that has been evaluated.

### **Conclusion:**

According to the above tables, the sum of reported SAR values is less than limit. So the simultaneous transmission SAR with volume scans is not required.

### 13. Summary of Test Results

According to the client's decision rule in the test registration form, which is "based on the measurement results as the basis of the conformity statement", the test conclusion of this report meets the limit requirements.

The calculated SAR is obtained by the following formula:

$$\text{Reported SAR} = \text{Measured SAR} \times 10^{(P_{\text{Target}} - P_{\text{Measured}})/10}$$

Where  $P_{\text{Target}}$  is the power of manufacturing upper limit;

$P_{\text{Measured}}$  is the measured power in chapter 10.

#### Duty Cycle

Mode	Duty Cycle
WCDMA	1:1
FDD_LTE	1:1
WLAN	1:1

#### 13.1. Testing Environment

Temperature:	18°C~25°C
Relative humidity:	30%~70%
Ambient noise & Reflection:	< 0.012 W/kg

### 13.2. SAR results

**General Note:**

B2: Battery (TMB)

**Table 13.1: SAR Values (WCDMA Band 2 - Body)**

Frequency		Test Mode	Test Position	Figure No./ Note	Conducted Power (dBm)	Max. tune-up Power (dBm)	Measured SAR(1g) (W/kg)	Reported SAR(1g) (W/kg)	Power Drift(dB)
Ch.	MHz								
<b>Hotspot Test Data (10mm)</b>									
9400	1880.0	RMC	Front	/	22.10	23.0	0.537	<b>0.66</b>	0.11
9400	1880.0	RMC	Rear	<b>1</b>	22.10	23.0	<b>0.602</b>	<b>0.74</b>	0.04
9400	1880.0	RMC	Left	/	22.10	23.0	0.465	<b>0.57</b>	-0.18
9400	1880.0	RMC	Right	/	22.10	23.0	0.228	<b>0.28</b>	-0.04
9400	1880.0	RMC	Bottom	/	22.10	23.0	0.361	<b>0.44</b>	0.06
9538	1907.6	RMC	Rear	/	22.10	23.0	0.542	<b>0.67</b>	0.03
9262	1852.4	RMC	Rear	/	22.10	23.0	0.600	<b>0.74</b>	0.02

**Table 13.2: SAR Values (WCDMA Band 4 - Body)**

Frequency		Test Mode	Test Position	Figure No./ Note	Conducted Power (dBm)	Max. tune-up Power (dBm)	Measured SAR(1g) (W/kg)	Reported SAR(1g) (W/kg)	Power Drift(dB)
Ch.	MHz								
<b>Hotspot Test Data (10mm)</b>									
1413	1732.6	RMC	Front	/	21.70	22.5	0.747	<b>0.90</b>	0.17
1413	1732.6	RMC	Rear	/	21.70	22.5	0.785	<b>0.94</b>	0.10
1413	1732.6	RMC	Left	/	21.70	22.5	0.469	<b>0.56</b>	-0.08
1413	1732.6	RMC	Right	/	21.70	22.5	0.082	<b>0.10</b>	0.07
1413	1732.6	RMC	Bottom	/	21.70	22.5	0.559	<b>0.67</b>	0.03
1513	1752.6	RMC	Rear	/	21.80	22.5	0.758	<b>0.89</b>	0.14
1312	1712.4	RMC	Rear	<b>2</b>	21.90	22.5	<b>0.794</b>	<b>0.91</b>	0.09

**Table 13.3: SAR Values (WCDMA Band 5 - Body)**

Frequency		Test Mode	Test Position	Figure No./ Note	Conducted Power (dBm)	Max. tune-up Power (dBm)	Measured SAR(1g) (W/kg)	Reported SAR(1g) (W/kg)	Power Drift(dB)
Ch.	MHz								
<b>Hotspot Test Data (10mm)</b>									
4183	836.6	RMC	Front	/	21.80	23.0	0.742	<b>0.98</b>	0.01
4183	836.6	RMC	Rear	/	21.80	23.0	0.724	<b>0.95</b>	0.13
4183	836.6	RMC	Left	/	21.80	23.0	0.278	<b>0.37</b>	-0.16
4183	836.6	RMC	Right	/	21.80	23.0	0.569	<b>0.75</b>	0.01
4183	836.6	RMC	Bottom	/	21.80	23.0	0.075	<b>0.10</b>	-0.11
4233	846.6	RMC	Front	/	22.00	23.0	0.699	<b>0.88</b>	0.01
4132	826.4	RMC	Front	<b>3</b>	21.80	23.0	<b>0.757</b>	<b>1.00</b>	0.15

**Table 13.4: SAR Values (LTE Band 2 - Body)**

Frequency		Test Mode	Test Position	Figure No./ Note	Conducted Power (dBm)	Max. tune-up Power (dBm)	Measured SAR(1g) (W/kg)	Reported SAR(1g) (W/kg)	Power Drift(dB)
Ch.	MHz								
<b>Hotspot Test Data (10mm)</b>									
18700	1860.0	1RB50	Front	/	22.17	23.0	0.514	<b>0.62</b>	-0.11
18700	1860.0	50RB0	Front	/	21.18	22.0	0.406	<b>0.49</b>	-0.04
18700	1860.0	1RB50	Rear	<b>4</b>	22.17	23.0	<b>0.570</b>	<b>0.69</b>	0.01
18700	1860.0	50RB0	Rear	/	21.18	22.0	0.447	<b>0.54</b>	0.02
18700	1860.0	1RB50	Left	/	22.17	23.0	0.443	<b>0.54</b>	0.04
18700	1860.0	50RB0	Left	/	21.18	22.0	0.361	<b>0.44</b>	0.02
18700	1860.0	1RB50	Right	/	22.17	23.0	0.255	<b>0.31</b>	-0.06
18700	1860.0	50RB0	Right	/	21.18	22.0	0.196	<b>0.24</b>	0.04
18700	1860.0	1RB50	Bottom	/	22.17	23.0	0.325	<b>0.39</b>	-0.06
18700	1860.0	50RB0	Bottom	/	21.18	22.0	0.259	<b>0.31</b>	0.12

**Table 13.5: SAR Values (LTE Band 5 - Body)**

Frequency		Test Mode	Test Position	Figure No./ Note	Conducted Power (dBm)	Max. tune-up Power (dBm)	Measured SAR(1g) (W/kg)	Reported SAR(1g) (W/kg)	Power Drift(dB)
Ch.	MHz								
<b>Hotspot Test Data (10mm)</b>									
20525	836.5	1RB0	Front	<b>5</b>	22.09	23.0	<b>0.789</b>	<b>0.97</b>	-0.04
20525	836.5	25RB12	Front	/	21.16	22.0	0.593	<b>0.72</b>	0.03
20525	836.5	1RB0	Rear	/	22.09	23.0	0.729	<b>0.90</b>	-0.02
20525	836.5	25RB12	Rear	/	21.16	22.0	0.549	<b>0.67</b>	0.11
20525	836.5	1RB0	Left	/	22.09	23.0	0.485	<b>0.60</b>	-0.05
20525	836.5	25RB12	Left	/	21.16	22.0	0.377	<b>0.46</b>	0.07
20525	836.5	1RB0	Right	/	22.09	23.0	0.262	<b>0.32</b>	0.11
20525	836.5	25RB12	Right	/	21.16	22.0	0.211	<b>0.26</b>	0.05
20525	836.5	1RB0	Bottom	/	22.09	23.0	0.061	<b>0.08</b>	-0.02
20525	836.5	25RB12	Bottom	/	21.16	22.0	0.043	<b>0.05</b>	0.01
20600	844.0	1RB0	Front	/	21.88	23.0	0.739	<b>0.96</b>	0.08
20450	829.0	1RB0	Front	/	22.01	23.0	0.749	<b>0.94</b>	0.17
20450	829.0	50RB	Front	/	21.16	22.0	0.591	<b>0.72</b>	0.06
20600	844.0	1RB0	Rear	/	21.88	23.0	0.686	<b>0.89</b>	-0.05
20450	829.0	1RB0	Rear	/	22.01	23.0	0.700	<b>0.88</b>	0.08
20450	829.0	50RB	Rear	/	21.16	22.0	0.547	<b>0.66</b>	-0.03



**Table 13.6: SAR Values (LTE Band 7 - Body)**

Frequency		Test Mode	Test Position	Figure No./ Note	Conducted Power (dBm)	Max. tune-up Power (dBm)	Measured SAR(1g) (W/kg)	Reported SAR(1g) (W/kg)	Power Drift(dB)
Ch.	MHz								
<b>Hotspot Test Data (10mm)</b>									
21350	2560.0	1RB99	Front	/	22.08	22.3	0.441	<b>0.46</b>	0.14
21350	2560.0	50RB50	Front	/	21.04	21.3	0.353	<b>0.37</b>	-0.05
21350	2560.0	1RB99	Rear	/	22.08	22.3	1.100	<b>1.16</b>	0.03
21350	2560.0	50RB50	Rear	/	21.04	21.3	0.902	<b>0.96</b>	0.13
21350	2560.0	1RB99	Left	/	22.08	22.3	0.509	<b>0.54</b>	0.17
21350	2560.0	50RB50	Left	/	21.04	21.3	0.402	<b>0.43</b>	-0.17
21350	2560.0	1RB99	Right	/	22.08	22.3	0.058	<b>0.06</b>	0.18
21350	2560.0	50RB50	Right	/	21.04	21.3	0.045	<b>0.05</b>	-0.14
21350	2560.0	1RB99	Bottom	/	22.08	22.3	0.489	<b>0.51</b>	0.10
21350	2560.0	50RB50	Bottom	/	21.04	21.3	0.430	<b>0.46</b>	-0.01
21100	2560.0	1RB99	Rear	<b>6</b>	22.05	22.3	<b>1.180</b>	<b>1.25</b>	-0.10
20850	2560.0	1RB99	Rear	/	21.97	22.3	1.100	<b>1.19</b>	0.03
21100	2560.0	50RB50	Rear	/	20.95	21.3	0.893	<b>0.97</b>	0.04
20850	2560.0	50RB50	Rear	/	20.94	21.3	0.765	<b>0.83</b>	-0.19
21350	2560.0	100RB	Rear	/	21.02	21.3	0.853	<b>0.91</b>	-0.12
21100	2560.0	1RB99	Rear	B2	22.05	22.3	1.160	<b>1.23</b>	0.05

**Table 13.7: SAR Values (LTE Band 66 - Body)**

Frequency		Test Mode	Test Position	Figure No./ Note	Conducted Power (dBm)	Max. tune-up Power (dBm)	Measured SAR(1g) (W/kg)	Reported SAR(1g) (W/kg)	Power Drift(dB)
Ch.	MHz								
<b>Hotspot Test Data (10mm)</b>									
132572	1770.0	1RB0	Front	/	22.01	23.0	0.630	<b>0.79</b>	-0.11
132572	1770.0	50RB0	Front	/	21.18	22.0	0.567	<b>0.68</b>	0.04
132572	1770.0	1RB0	Rear	/	22.01	23.0	0.821	<b>1.03</b>	-0.07
132572	1770.0	50RB0	Rear	/	21.18	22.0	0.653	<b>0.79</b>	0.08
132572	1770.0	1RB0	Left	/	22.01	23.0	0.629	<b>0.79</b>	0.02
132572	1770.0	50RB0	Left	/	21.18	22.0	0.534	<b>0.64</b>	-0.02
132572	1770.0	1RB0	Right	/	22.01	23.0	0.051	<b>0.06</b>	-0.17
132572	1770.0	50RB0	Right	/	21.18	22.0	0.049	<b>0.06</b>	-0.10
132572	1770.0	1RB0	Bottom	/	22.01	23.0	0.462	<b>0.58</b>	0.01
132572	1770.0	50RB0	Bottom	/	21.18	22.0	0.373	<b>0.45</b>	0.00
132322	1745.0	1RB0	Rear	/	21.97	23.0	0.848	<b>1.07</b>	0.03
132072	1720.0	1RB0	Rear	<b>7</b>	21.99	23.0	<b>0.850</b>	<b>1.07</b>	0.13
132072	1720.0	100RB	Rear	/	21.11	22.0	0.679	<b>0.83</b>	0.03

**Note:** SAR for LTE Band 4 is covered by LTE Band 66 due to similar frequency range, same maximum tune-up limit and same channel bandwidth.

### 13.3. WLAN Evaluation for 2.4G

According to the KDB248227 D01, SAR is measured for 2.4GHz 802.11b DSSS using the initial test position procedure.

**Table 13.8: SAR Values (WLAN 2.4GHz - Body)**

Frequency		Test Mode	Test Position	Figure No./ Note	Conducted Power (dBm)	Max. tune-up Power (dBm)	Measured SAR(1g) (W/kg)	Reported SAR(1g) (W/kg)	Power Drift(dB)
Ch.	MHz								
<b>Ant.2 - Hotspot Test Data (10mm)</b>									
11	2462.0	802.11b	Front	/	16.31	16.5	0.213	<b>0.22</b>	0.02
11	2462.0	802.11b	Rear	<b>8</b>	16.31	16.5	<b>0.232</b>	<b>0.24</b>	0.01
11	2462.0	802.11b	Left	/	16.31	16.5	0.045	<b>0.05</b>	0.12
11	2462.0	802.11b	Right	/	16.31	16.5	0.196	<b>0.20</b>	0.15
11	2462.0	802.11b	Top	/	16.31	16.5	0.066	<b>0.07</b>	0.06
<b>Ant.1 - Hotspot Test Data (10mm)</b>									
11	2462.0	802.11b	Front	/	15.97	17.0	0.087	<b>0.11</b>	0.04
11	2462.0	802.11b	Rear	/	15.97	17.0	0.085	<b>0.11</b>	0.13
11	2462.0	802.11b	Left	/	15.97	17.0	0.041	<b>0.05</b>	0.10
11	2462.0	802.11b	Right	/	15.97	17.0	0.066	<b>0.08</b>	0.02
11	2462.0	802.11b	Bottom	/	15.97	17.0	0.042	<b>0.05</b>	0.07
<b>MIMO - Hotspot Test Data (10mm)</b>									
11	2462.0	802.11n-20	Front	/	16.65	17.0	0.128	<b>0.14</b>	-0.01
11	2462.0	802.11n-20	Rear	/	16.65	17.0	0.128	<b>0.14</b>	0.04
11	2462.0	802.11n-20	Left	/	16.65	17.0	0.043	<b>0.05</b>	0.08
11	2462.0	802.11n-20	Right	/	16.65	17.0	0.119	<b>0.13</b>	0.03
11	2462.0	802.11n-20	Top	/	16.65	17.0	0.038	<b>0.04</b>	0.04
11	2462.0	802.11n-20	Bottom	/	16.65	17.0	0.017	<b>0.02</b>	0.02

Note: For all positions/configurations tested using the initial test position and subsequent test positions, when the reported SAR is > 0.8 W/kg, SAR is measured for these test positions/configurations on the subsequent next highest measured output power channel until the reported SAR is ≤ 1.2 W/kg or all required channels are tested.

According to the KDB248227 D01, The reported SAR must be scaled to 100% transmission duty factor to determine compliance at the maximum tune-up tolerance limit.

**Table 13.9: SAR Values (WLAN - Body) – 802.11b (Scaled Reported SAR)**

Frequency		Test Position	Actual duty factor	maximum duty factor	Reported SAR (1g)(W/kg)	Scaled reported SAR (1g)(W/kg)
Ch.	MHz					
11	2462.0	Right	100%	100%	0.24	<b>0.24</b>

SAR is not required for OFDM because the 802.11b adjusted SAR ≤ 1.2 W/kg.

13.4. WLAN Evaluation for 5G

Table 13.10: SAR Values (WLAN 5GHz - Body)

Frequency		Test Mode	Test Position	Figure No./ Note	Conducted Power (dBm)	Max. tune-up Power (dBm)	Measured SAR(1g) (W/kg)	Reported SAR(1g) (W/kg)	Power Drift(dB)
Ch.	MHz								
<b>Ant.2 - &lt;U-NII-1&gt; - Hotspot Test Data (10mm)</b>									
48	5240.0	802.11a	Front	/	12.07	13.0	0.073	<b>0.09</b>	0.01
48	5240.0	802.11a	Rear	/	12.07	13.0	0.161	<b>0.20</b>	0.17
48	5240.0	802.11a	Left	/	12.07	13.0	0.036	<b>0.04</b>	0.06
48	5240.0	802.11a	Right	/	12.07	13.0	0.078	<b>0.10</b>	0.03
48	5240.0	802.11a	Top	/	12.07	13.0	0.142	<b>0.18</b>	0.19
<b>Ant.1 - &lt;U-NII-1&gt; - Hotspot Test Data (10mm)</b>									
36	5180.0	802.11a	Front	/	11.48	13.0	0.059	<b>0.08</b>	0.09
36	5180.0	802.11a	Rear	/	11.48	13.0	0.030	<b>0.04</b>	0.01
36	5180.0	802.11a	Left	/	11.48	13.0	<0.01	<b>&lt;0.01</b>	/
36	5180.0	802.11a	Right	<b>9</b>	11.48	13.0	<b>0.186</b>	<b>0.26</b>	0.04
36	5180.0	802.11a	Bottom	/	11.48	13.0	0.024	<b>0.03</b>	0.16
<b>MIMO - &lt;U-NII-1&gt; - Hotspot Test Data (10mm)</b>									
36	5180.0	802.11n-20	Front	/	13.47	14.0	<0.01	<b>&lt;0.01</b>	/
36	5180.0	802.11n-20	Rear	/	13.47	14.0	0.110	<b>0.12</b>	0.06
36	5180.0	802.11n-20	Left	/	13.47	14.0	0.016	<b>0.02</b>	0.02
36	5180.0	802.11n-20	Right	/	13.47	14.0	0.123	<b>0.14</b>	0.04
36	5180.0	802.11n-20	Top	/	13.47	14.0	0.092	<b>0.10</b>	0.12
36	5180.0	802.11n-20	Bottom	/	13.47	14.0	0.027	<b>0.03</b>	0.03
<b>Ant.2 - &lt;U-NII-3&gt; - Hotspot Test Data (10mm)</b>									
165	5825.0	802.11a	Front	/	12.95	14.0	0.028	<b>0.04</b>	0.03
165	5825.0	802.11a	Rear	/	12.95	14.0	0.096	<b>0.12</b>	0.05
165	5825.0	802.11a	Left	/	12.95	14.0	0.052	<b>0.07</b>	0.09
165	5825.0	802.11a	Right	/	12.95	14.0	0.081	<b>0.10</b>	0.07
165	5825.0	802.11a	Top	/	12.95	14.0	0.131	<b>0.17</b>	0.08
<b>Ant.1 - &lt;U-NII-3&gt; - Hotspot Test Data (10mm)</b>									
165	5825.0	802.11a	Front	/	11.78	13.0	0.061	<b>0.08</b>	0.08
165	5825.0	802.11a	Rear	/	11.78	13.0	0.052	<b>0.07</b>	0.03
165	5825.0	802.11a	Left	/	11.78	13.0	<0.01	<b>&lt;0.01</b>	/
165	5825.0	802.11a	Right	/	11.78	13.0	0.080	<b>0.11</b>	0.11
165	5825.0	802.11a	Bottom	/	11.78	13.0	0.015	<b>0.02</b>	0.09
<b>MIMO - &lt;U-NII-3&gt; - Hotspot Test Data (10mm)</b>									
165	5825.0	802.11n-20	Front	/	14.31	15.0	0.042	<b>0.05</b>	0.08
165	5825.0	802.11n-20	Rear	/	14.31	15.0	0.044	<b>0.05</b>	0.03
165	5825.0	802.11n-20	Left	/	14.31	15.0	0.026	<b>0.03</b>	0.09
165	5825.0	802.11n-20	Right	/	14.31	15.0	0.057	<b>0.07</b>	0.04
165	5825.0	802.11n-20	Top	/	14.31	15.0	0.065	<b>0.08</b>	0.02



165	5825.0	802.11n-20	Bottom	/	14.31	15.0	<0.01	<b>&lt;0.01</b>	/
-----	--------	------------	--------	---	-------	------	-------	-----------------	---

Note: For all positions/configurations tested using the initial test position and subsequent test positions, when the reported SAR is > 0.8 W/kg, SAR is measured for these test positions/configurations on the subsequent next highest measured output power channel until the reported SAR is ≤ 1.2 W/kg or all required channels are tested.

According to the KDB248227 D01, The reported SAR must be scaled to 100% transmission duty factor to determine compliance at the maximum tune-up tolerance limit.

**Table 13.11: SAR Values (WLAN - Body) – 802.11a (Scaled Reported SAR)**

Frequency		Test Position	Actual duty factor	maximum duty factor	Reported SAR (1g)(W/kg)	Scaled reported SAR (1g)(W/kg)
Ch.	MHz					
36	5180.0	Right	100%	100%	0.26	<b>0.26</b>

## 14. SAR Measurement Variability

SAR measurement variability must be assessed for each frequency band, which is determined by the SAR probe calibration point and tissue-equivalent medium used for the device measurements. When both head and body tissue-equivalent media are required for SAR measurements in a frequency band, the variability measurement procedures should be applied to the tissue medium with the highest measured SAR, using the highest measured SAR configuration for that tissue-equivalent medium.

The following procedures are applied to determine if repeated measurements are required.

- 1) Repeated measurement is not required when the original highest measured SAR is  $< 0.80$  W/kg; steps 2) through 4) do not apply.
- 2) When the original highest measured SAR is  $\geq 0.80$  W/kg, repeat that measurement once.
- 3) Perform a second repeated measurement only if the ratio of largest to smallest SAR for the original and first repeated measurements is  $> 1.20$  or when the original or repeated measurement is  $\geq 1.45$  W/kg (~ 10% from the 1-g SAR limit).
- 4) Perform a third repeated measurement only if the original, first or second repeated measurement is  $\geq 1.5$  W/kg and the ratio of largest to smallest SAR for the original, first and second repeated measurements is  $> 1.20$ .

**Table 14.1: SAR Measurement Variability for Body - LTE Band 7**

Frequency		Test Position	Original	1 <sup>st</sup> Repeated	Ratio	2 <sup>nd</sup> Repeated
Ch.	MHz		SAR (W/kg)	SAR (W/kg)		SAR (W/kg)
21100	2535.0	Rear	1.18	1.15	1.03	/

**Table 14.2: SAR Measurement Variability for Body - LTE Band 66**

Frequency		Test Position	Original	1 <sup>st</sup> Repeated	Ratio	2 <sup>nd</sup> Repeated
Ch.	MHz		SAR (W/kg)	SAR (W/kg)		SAR (W/kg)
132072	1720.0	Rear	0.850	0.842	1.01	/

## 15. Measurement Uncertainty

### 15.1. Measurement Uncertainty for Normal SAR Tests (300MHz~3GHz)

No.	Error Description	Type	Uncertainty value	Probably Distribution	Div.	(Ci) 1g	(Ci) 10g	Std. Unc. (1g)	Std. Unc. (10g)	Degree of freedom
<b>Measurement system</b>										
1	Probe calibration	B	12	N	2	1	1	6.0	6.0	∞
2	Axial isotropy	B	4.7	R	$\sqrt{3}$	$\sqrt{0.5}$	$\sqrt{0.5}$	4.3	4.3	∞
3	Hemispherical isotropy	B	9.6	R	$\sqrt{3}$	1	1	4.8	4.8	∞
4	Boundary effect	B	1.1	R	$\sqrt{3}$	1	1	0.6	0.6	∞
5	Linearity	B	4.7	R	$\sqrt{3}$	1	1	2.7	2.7	∞
6	Detection limit	B	1.0	R	$\sqrt{3}$	1	1	0.6	0.6	∞
7	Modulation response	B	4.0	R	$\sqrt{3}$	1	1	2.3	2.3	∞
8	Readout electronics	B	1.0	N	1	1	1	1.0	1.0	∞
9	Response time	B	0.8	R	$\sqrt{3}$	1	1	0.5	0.5	∞
10	Integration time	B	1.7	R	$\sqrt{3}$	1	1	1.0	1.0	∞
11	RF ambient conditions-noise	B	3.0	R	$\sqrt{3}$	1	1	1.7	1.7	∞
12	RF ambient conditions-reflection	B	3.0	R	$\sqrt{3}$	1	1	1.7	1.7	∞
13	Probe positioned mech. restrictions	B	0.35	R	$\sqrt{3}$	1	1	0.2	0.2	∞
14	Probe positioning with respect to phantom shell	B	2.9	R	$\sqrt{3}$	1	1	1.7	1.7	∞
15	Post-processing	B	1.0	R	$\sqrt{3}$	1	1	0.6	0.6	∞
<b>Test sample related</b>										
16	Test sample positioning	A	3.3	N	1	1	1	3.3	3.3	5
17	Device holder uncertainty	A	3.4	N	1	1	1	3.4	3.4	5
18	Drift of output power	B	5.0	R	$\sqrt{3}$	1	1	2.9	2.9	∞
<b>Phantom and set-up</b>										
19	Phantom uncertainty	B	1.0	R	$\sqrt{3}$	1	1	0.6	0.6	∞
20	Liquid conductivity (target)	B	5.0	R	$\sqrt{3}$	0.64	0.43	1.8	1.2	∞
21	Liquid conductivity (meas.)	A	1.3	N	1	0.64	0.43	0.83	0.56	9
22	Liquid permittivity (target)	B	5.0	R	$\sqrt{3}$	0.6	0.49	1.7	1.4	∞
23	Liquid permittivity (meas.)	A	1.6	N	1	0.6	0.49	0.96	0.78	9
Combined standard uncertainty		$u_c = \sqrt{\sum_{i=1}^{23} c_i^2 u_i^2}$						11.3	11.2	95.5
Expanded uncertainty (Confidence interval of 95 %)		$u_e = 2u_c$						22.6	22.4	

**15.2. Measurement Uncertainty for Normal SAR Tests (3GHz~6GHz)**

No.	Error Description	Type	Uncertainty value	Probably Distribution	Div.	(Ci) 1g	(Ci) 10g	Std. Unc. (1g)	Std. Unc. (10g)	Degree of freedom
<b>Measurement system</b>										
1	Probe calibration	B	13.1	N	2	1	1	6.65	6.65	∞
2	Axial isotropy	B	4.7	R	$\sqrt{3}$	$\sqrt{0.5}$	$\sqrt{0.5}$	4.3	4.3	∞
3	Hemispherical isotropy	B	9.6	R	$\sqrt{3}$	1	1	4.8	4.8	∞
4	Boundary effect	B	1.1	R	$\sqrt{3}$	1	1	0.6	0.6	∞
5	Linearity	B	4.7	R	$\sqrt{3}$	1	1	2.7	2.7	∞
6	Detection limit	B	1.0	R	$\sqrt{3}$	1	1	0.6	0.6	∞
7	modulation response	B	4.0	R	$\sqrt{3}$	1	1	2.3	2.3	∞
8	Readout electronics	B	1.0	N	1	1	1	1.0	1.0	∞
9	Response time	B	0.0	R	$\sqrt{3}$	1	1	0.0	0.0	∞
10	Integration time	B	1.7	R	$\sqrt{3}$	1	1	1.0	1.0	∞
11	RF ambient conditions-noise	B	3.0	R	$\sqrt{3}$	1	1	1.7	1.7	∞
12	RF ambient conditions-reflection	B	3.0	R	$\sqrt{3}$	1	1	1.7	1.7	∞
13	Probe positioned mech. Restrictions	B	0.35	R	$\sqrt{3}$	1	1	0.2	0.2	∞
14	Probe positioning with respect to phantom shell	B	2.9	R	$\sqrt{3}$	1	1	1.7	1.7	∞
15	Post-processing	B	1.0	R	$\sqrt{3}$	1	1	0.6	0.6	∞
<b>Test sample related</b>										
16	Test sample positioning	A	3.3	N	1	1	1	3.3	3.3	5
17	Device holder uncertainty	A	3.4	N	1	1	1	3.4	3.4	5
18	Drift of output power	B	5.0	R	$\sqrt{3}$	1	1	2.9	2.9	∞
<b>Phantom and set-up</b>										
19	Phantom uncertainty	B	1.0	R	$\sqrt{3}$	1	1	0.6	0.6	∞
20	Liquid conductivity (target)	B	5.0	R	$\sqrt{3}$	0.64	0.43	1.8	1.2	∞
21	Liquid conductivity (meas.)	A	1.3	N	1	0.64	0.43	0.83	0.56	43
22	Liquid permittivity (target)	B	5.0	R	$\sqrt{3}$	0.6	0.49	1.7	1.4	∞
23	Liquid permittivity (meas.)	A	1.6	N	1	0.6	0.49	0.96	0.78	521
Combined standard uncertainty		$u_c = \sqrt{\sum_{i=1}^{22} c_i^2 u_i^2}$						11.6	11.5	257
Expanded uncertainty (Confidence interval of 95 %)		$u_e = 2u_c$						23.2	23.0	



## 16. Main Test Instruments

**Table 16.1: List of Main Instruments**

No.	Name	Type	Serial Number	Calibration Date	Valid Period
01	Network analyzer	E5071C	MY46103759	2021-11-15&2022-11-14	One year
02	Dielectric probe	85070E	MY44300317	/	/
03	Power meter	E4418B	MY50000366	2021-12-12	One year
04	Power sensor	E9304A	MY50000188	2021-12-12	One year
05	Power meter	NRP	101260	2021-12-30	One year
06	Power sensor	NRP-Z91	102211	2021-12-30	One year
07	Signal Generator	E8257D	MY47461211	2022-01-14	One year
08	Amplifier	VTL5400	0404	/	/
09	DAE	DAE4	1527	2022-06-21	One year
10	E-field Probe	EX3DV4	7621	2022-05-06	One year
11	Dipole Validation Kit	D835V2	4d057	2021-10-18	Three years
12	Dipole Validation Kit	D1750V2	1152	2022-08-22	Three years
13	Dipole Validation Kit	D1900V2	5d088	2021-10-18	Three years
14	Dipole Validation Kit	D2450V2	873	2021-10-21	Three years
15	Dipole Validation Kit	D2550V2	1010	2021-05-21	Three years
16	Dipole Validation Kit	D5GHzV2	1238	2022-08-17	Three years
17	BTS	MT8820C	6201341853	2022-01-14	One year
18	BTS	CMW500	152499	2022-07-15	One year
19	Software	DASY5	/	/	/

## ANNEX A: Graph Results

### WCDMA Band 2 Body

Date: 2022-11-16

Electronics: DAE4 Sn1527

Medium: Head 1900MHz

Medium parameters used:  $f = 1880$  MHz;  $\sigma = 1.401$  S/m;  $\epsilon_r = 39.311$ ;  $\rho = 1000$  kg/m<sup>3</sup>

Communication System: UID 0, WCDMA (0) Frequency: 1880 MHz Duty Cycle: 1:1

Probe: EX3DV4 - SN7621 ConvF (8.90, 8.90, 8.90)

**Rear Side Middle/Area Scan (71x71x1):** Interpolated grid:  $dx=1.500$  mm,  $dy=1.500$  mm

Maximum value of SAR (interpolated) = 0.830 W/kg

**Rear Side Middle/Zoom Scan (5x5x7)/Cube 0:** Measurement grid:  $dx=8$ mm,  $dy=8$ mm,  $dz=5$ mm

Reference Value = 22.10 V/m; Power Drift = 0.04 dB

Peak SAR (extrapolated) = 0.932 W/kg

**SAR(1 g) = 0.602 W/kg; SAR(10 g) = 0.387 W/kg**

Maximum value of SAR (measured) = 0.768 W/kg

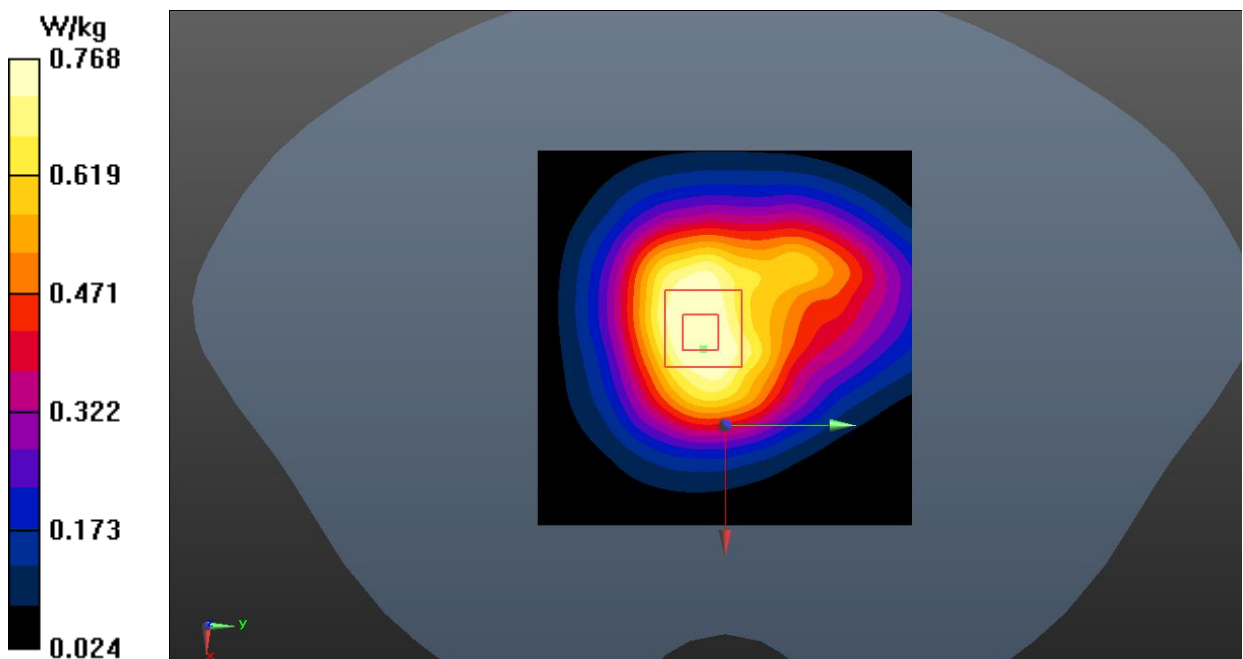

Fig.1 WCDMA Band 2 Body

**WCDMA Band 4 Body**

Date: 2022-11-14

Electronics: DAE4 Sn1527

Medium: Head 1750MHz

Medium parameters used (interpolated):  $f = 1712.4$  MHz;  $\sigma = 1.347$  S/m;  $\epsilon_r = 39.699$ ;  $\rho = 1000$  kg/m<sup>3</sup>

Communication System: UID 0, WCDMA (0) Frequency: 1712.4 MHz Duty Cycle: 1:1

Probe: EX3DV4 - SN7621 ConvF (9.22, 9.22, 9.22)

**Rear Side Low/Area Scan (71x71x1):** Interpolated grid: dx=1.500 mm, dy=1.500 mm

Maximum value of SAR (interpolated) = 1.03 W/kg

**Rear Side Low/Zoom Scan (5x5x7)/Cube 0:** Measurement grid: dx=8mm, dy=8mm, dz=5mm

Reference Value = 13.45 V/m; Power Drift = 0.09 dB

Peak SAR (extrapolated) = 1.27 W/kg

**SAR(1 g) = 0.794 W/kg; SAR(10 g) = 0.481 W/kg**

Maximum value of SAR (measured) = 1.04 W/kg

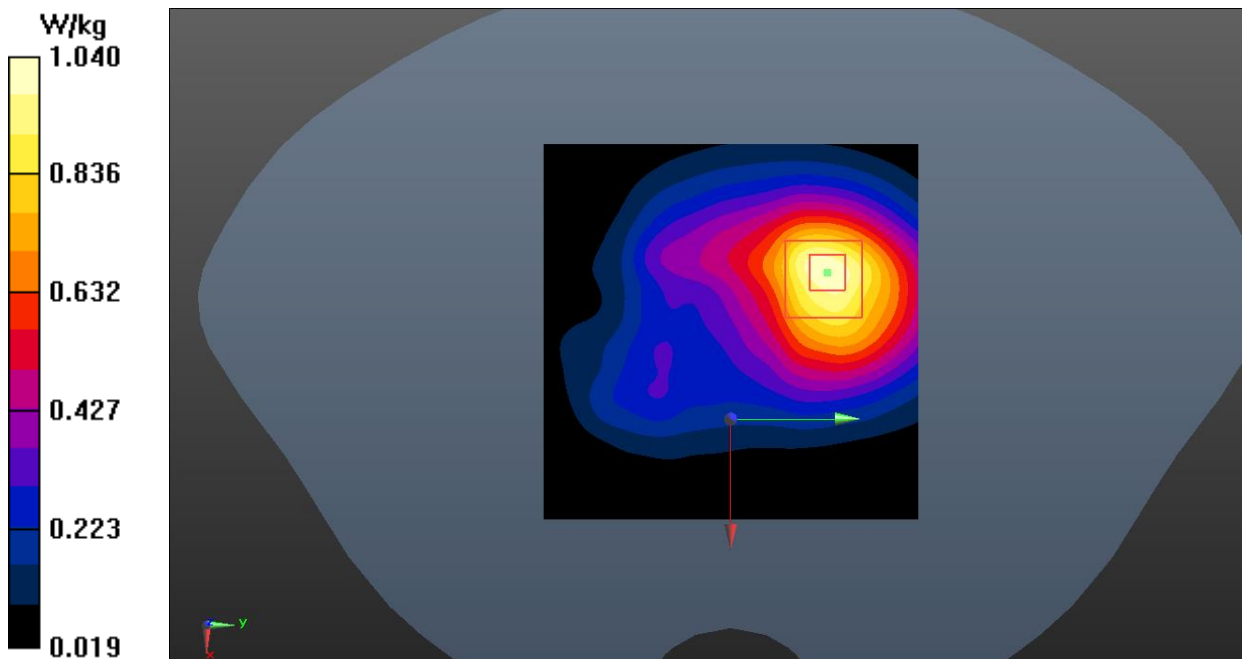

Fig.2 WCDMA Band 4 Body

**WCDMA Band 5 Body**

Date: 2022-11-5

Electronics: DAE4 Sn1527

Medium: Head 835MHz

Medium parameters used (interpolated):  $f = 826.4$  MHz;  $\sigma = 0.908$  S/m;  $\epsilon_r = 40.787$ ;  $\rho = 1000$  kg/m<sup>3</sup>

Communication System: UID 0, WCDMA (0) Frequency: 826.4 MHz Duty Cycle: 1:1

Probe: EX3DV4 - SN7621 ConvF (11.12, 11.12, 11.12)

**Front Side Low/Area Scan (71x71x1):** Interpolated grid: dx=1.500 mm, dy=1.500 mm

Maximum value of SAR (interpolated) = 0.920 W/kg

**Front Side Low/Zoom Scan (5x5x7)/Cube 0:** Measurement grid: dx=8mm, dy=8mm, dz=5mm

Reference Value = 24.52 V/m; Power Drift = 0.15 dB

Peak SAR (extrapolated) = 1.08 W/kg

**SAR(1 g) = 0.757 W/kg; SAR(10 g) = 0.520 W/kg**

Maximum value of SAR (measured) = 0.920 W/kg

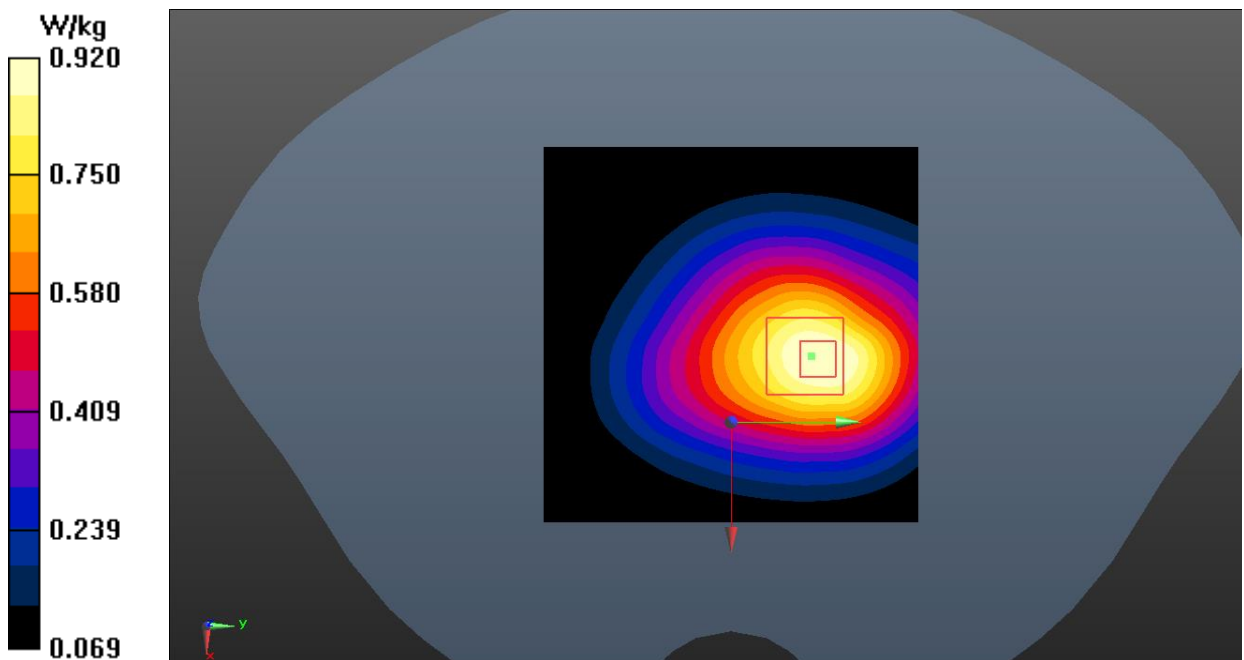

Fig.3 WCDMA Band 5 Body

**LTE Band 2 Body**

Date: 2022-11-16

Electronics: DAE4 Sn1527

Medium: Head 1900MHz

Medium parameters used:  $f = 1860$  MHz;  $\sigma = 1.384$  S/m;  $\epsilon_r = 39.389$ ;  $\rho = 1000$  kg/m<sup>3</sup>

Communication System: UID 0, LTE\_FDD (0) Frequency: 1860 MHz Duty Cycle: 1:1

Probe: EX3DV4 - SN7621 ConvF (8.90, 8.90, 8.90)

**Rear Side Low 1RB50/Area Scan (71x71x1):** Interpolated grid: dx=1.500 mm, dy=1.500 mm

Maximum value of SAR (interpolated) = 0.768 W/kg

**Rear Side Low 1RB50/Zoom Scan (5x5x7)/Cube 0:** Measurement grid: dx=8mm, dy=8mm, dz=5mm

Reference Value = 21.02 V/m; Power Drift = 0.01 dB

Peak SAR (extrapolated) = 0.861 W/kg

**SAR(1 g) = 0.570 W/kg; SAR(10 g) = 0.372 W/kg**

Maximum value of SAR (measured) = 0.720 W/kg

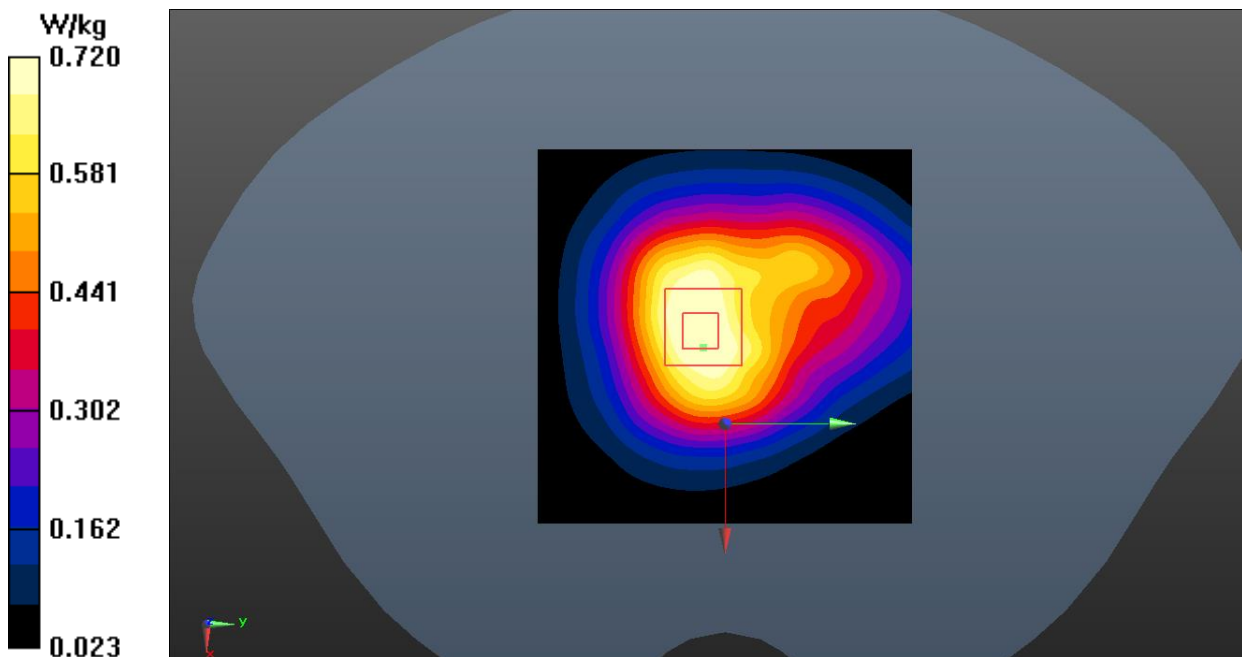

Fig.4 LTE Band 2 Body

**LTE Band 5 Body**

Date: 2022-11-5

Electronics: DAE4 Sn1527

Medium: Head 835MHz

Medium parameters used (interpolated):  $f = 836.5$  MHz;  $\sigma = 0.917$  S/m;  $\epsilon_r = 40.666$ ;  $\rho = 1000$  kg/m<sup>3</sup>

Communication System: UID 0, LTE\_FDD (0) Frequency: 836.5 MHz Duty Cycle: 1:1

Probe: EX3DV4 - SN7621 ConvF (11.12, 11.12, 11.12)

**Front Side Middle 1RB0/Area Scan (61x71x1):** Interpolated grid: dx=1.500 mm, dy=1.500 mm

Maximum value of SAR (interpolated) = 1.01 W/kg

**Front Side Middle 1RB0/Zoom Scan (5x5x7)/Cube 0:** Measurement grid: dx=8mm, dy=8mm, dz=5mm

Reference Value = 29.25 V/m; Power Drift = -0.04 dB

Peak SAR (extrapolated) = 1.12 W/kg

**SAR(1 g) = 0.789 W/kg; SAR(10 g) = 0.541 W/kg**

Maximum value of SAR (measured) = 0.970 W/kg

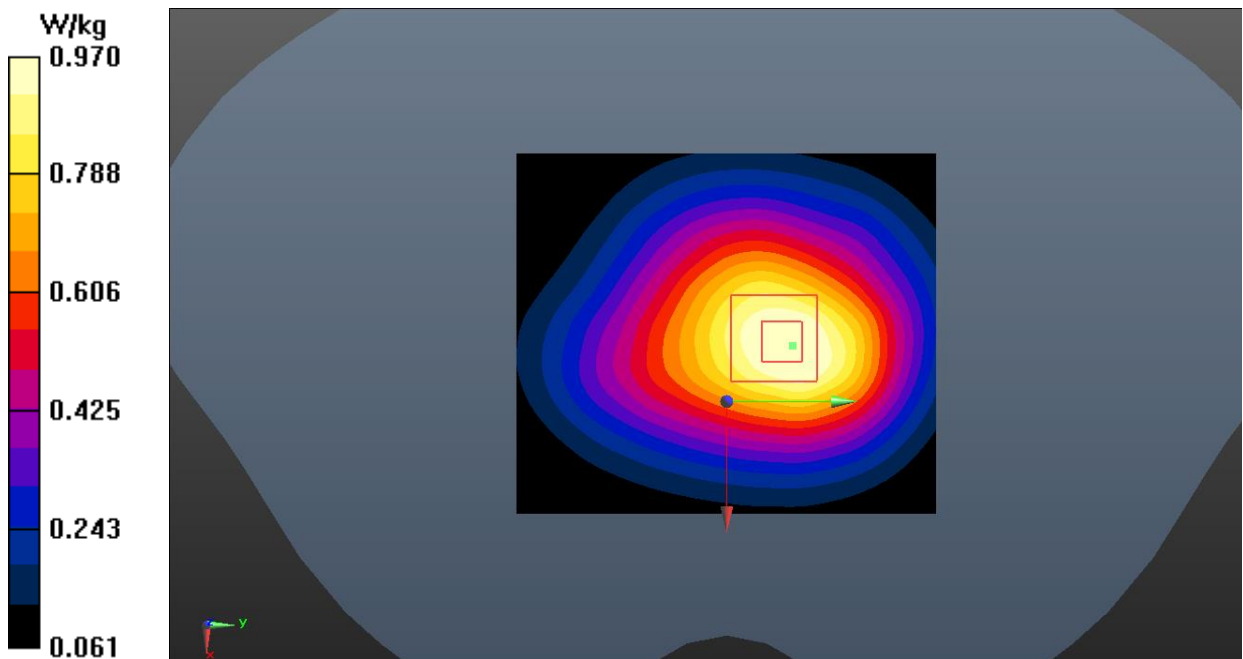

Fig.5 LTE Band 5 Body

**LTE Band 7 Body**

Date: 2022-11-21

Electronics: DAE4 Sn1527

Medium: Head 2550MHz

Medium parameters used (interpolated):  $f = 2535$  MHz;  $\sigma = 1.936$  S/m;  $\epsilon_r = 38.208$ ;  $\rho = 1000$  kg/m<sup>3</sup>

Communication System: UID 0, LTE\_FDD (0) Frequency: 2535 MHz Duty Cycle: 1:1

Probe: EX3DV4 - SN7621 ConvF (8.17, 8.17, 8.17)

**Rear Side Middle 1RB99/Area Scan (91x121x1):** Interpolated grid: dx=1.000 mm, dy=1.000 mm  
Maximum value of SAR (interpolated) = 1.65 W/kg**Rear Side Middle 1RB99/Zoom Scan (7x7x7)/Cube 0:** Measurement grid: dx=5mm, dy=5mm, dz=5mm

Reference Value = 5.796 V/m; Power Drift = -0.10 dB

Peak SAR (extrapolated) = 2.39 W/kg

**SAR(1 g) = 1.18 W/kg; SAR(10 g) = 0.547 W/kg**

Maximum value of SAR (measured) = 1.79 W/kg

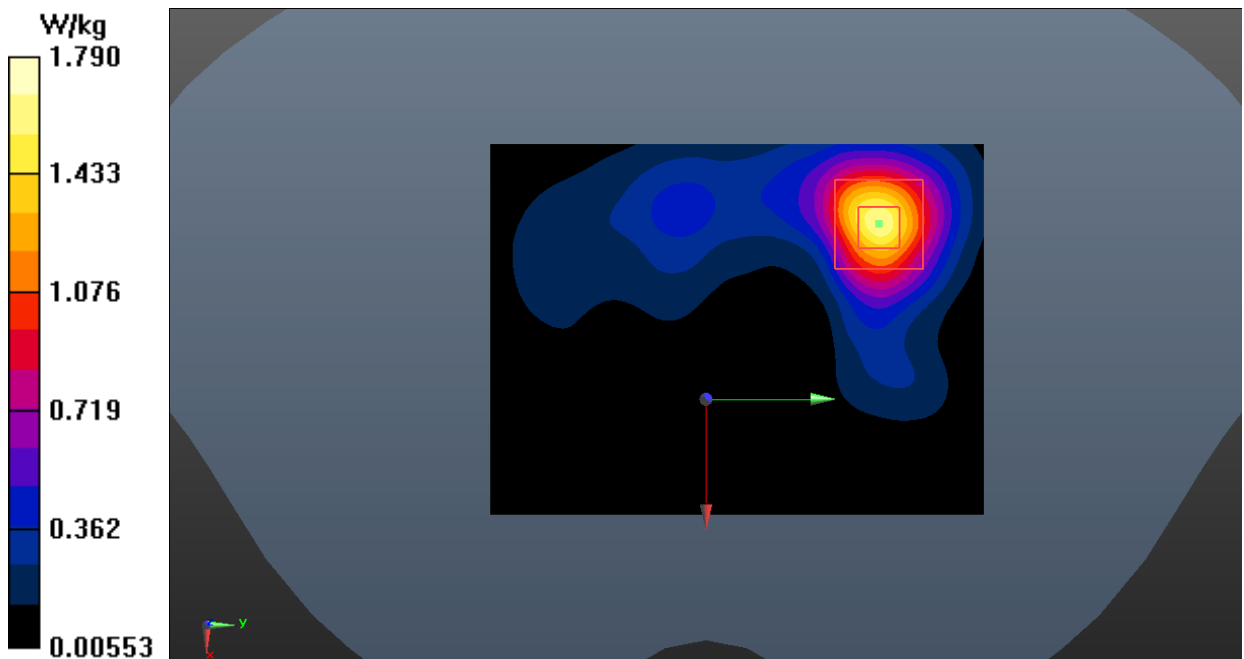

Fig.6 LTE Band 7 Body

**LTE Band 66 Body**

Date: 2022-11-14

Electronics: DAE4 Sn1527

Medium: Head 1750MHz

Medium parameters used:  $f = 1720$  MHz;  $\sigma = 1.356$  S/m;  $\epsilon_r = 39.661$ ;  $\rho = 1000$  kg/m<sup>3</sup>

Communication System: UID 0, LTE\_FDD (0) Frequency: 1720 MHz Duty Cycle: 1:1

Probe: EX3DV4 - SN7621 ConvF (9.22, 9.22, 9.22)

**Rear Side Low 1RB0/Area Scan (61x71x1):** Interpolated grid: dx=1.500 mm, dy=1.500 mm

Maximum value of SAR (interpolated) = 1.14 W/kg

**Rear Side Low 1RB0/Zoom Scan (5x5x7)/Cube 0:** Measurement grid: dx=8mm, dy=8mm, dz=5mm

Reference Value = 14.77 V/m; Power Drift = 0.13 dB

Peak SAR (extrapolated) = 1.37 W/kg

**SAR(1 g) = 0.850 W/kg; SAR(10 g) = 0.513 W/kg**

Maximum value of SAR (measured) = 1.12 W/kg

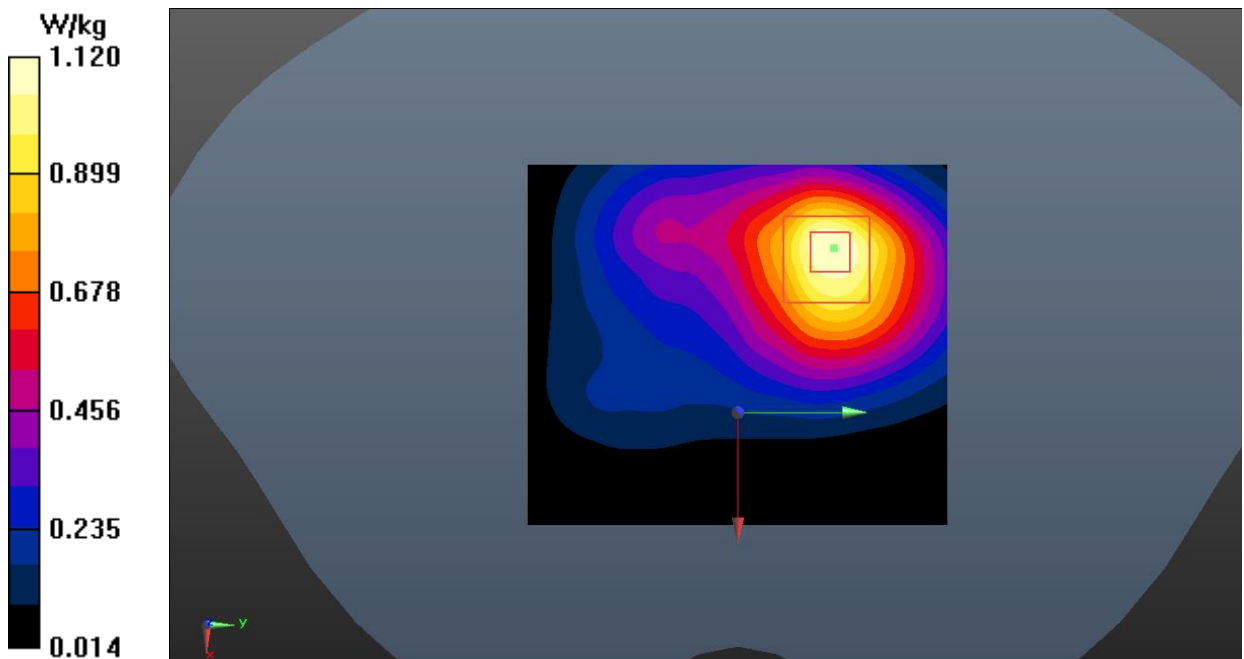

Fig.7 LTE Band 66 Body



**WLAN 2.4GHz Body**

Date: 2022-11-1

Electronics: DAE4 Sn1527

Medium: Head 2450MHz

Medium parameters used:  $f = 2462$  MHz;  $\sigma = 1.85$  S/m;  $\epsilon_r = 38.035$ ;  $\rho = 1000$  kg/m<sup>3</sup>

Communication System: UID 0, WLAN (0) Frequency: 2462 MHz Duty Cycle: 1:1

Probe: EX3DV4 - SN7621 ConvF (8.17, 8.17, 8.17)

**Rear Side Ch.11/Area Scan (71x91x1):** Interpolated grid: dx=1.000 mm, dy=1.000 mm

Maximum value of SAR (interpolated) = 0.348 W/kg

**Rear Side Ch.11/Zoom Scan (7x7x7)/Cube 0:** Measurement grid: dx=5mm, dy=5mm, dz=5mm

Reference Value = 7.406 V/m; Power Drift = 0.01 dB

Peak SAR (extrapolated) = 0.461 W/kg

**SAR(1 g) = 0.232 W/kg; SAR(10 g) = 0.121 W/kg**

Maximum value of SAR (measured) = 0.336 W/kg

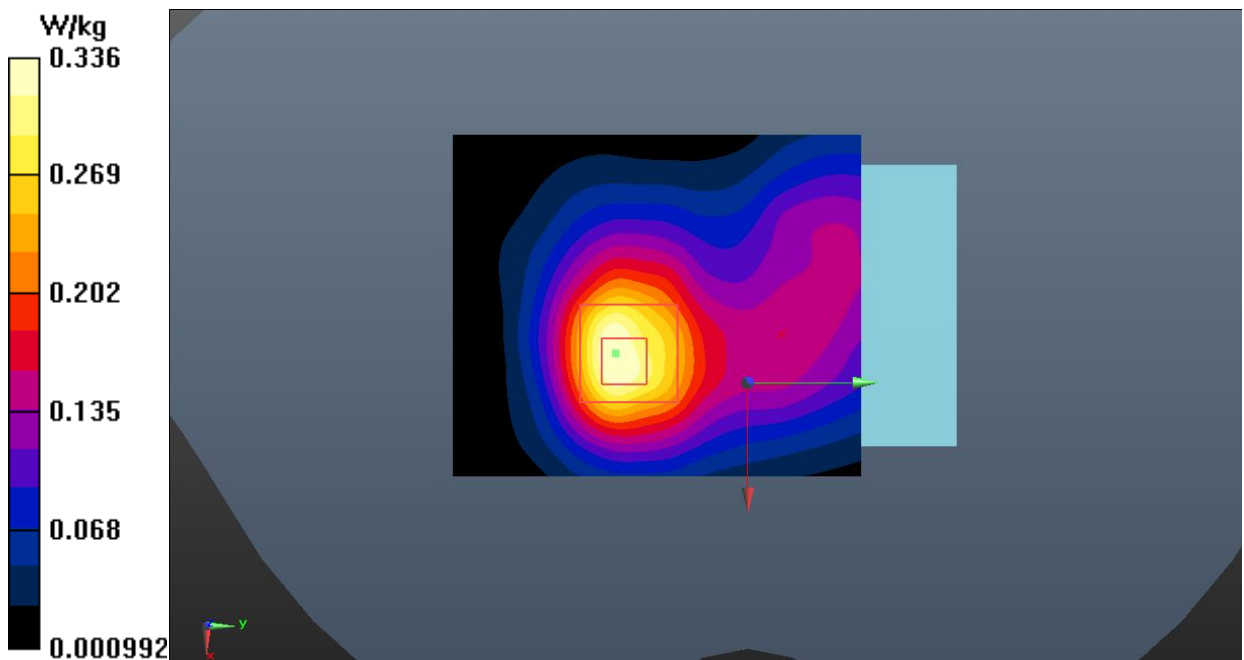
**Fig.8 WLAN 2.4GHz Body**

**WLAN 5GHz Body**

Date: 2022-11-3

Electronics: DAE4 Sn1527

Medium: Head 5250MHz

Medium parameters used:  $f = 5180$  MHz;  $\sigma = 4.711$  S/m;  $\epsilon_r = 35.322$ ;  $\rho = 1000$  kg/m<sup>3</sup>

Communication System: UID 0, WLAN 5G (0) Frequency: 5180 MHz Duty Cycle: 1:1

Probe: EX3DV4 - SN7621 ConvF (5.98, 5.98, 5.98)

**Right Side Ch.36/Area Scan (61x91x1):** Interpolated grid:  $dx=1.000$  mm,  $dy=1.000$  mm  
Maximum value of SAR (interpolated) = 0.378 W/kg**Right Side Ch.36/Zoom Scan (8x8x21)/Cube 0:** Measurement grid:  $dx=4$ mm,  $dy=4$ mm,  
 $dz=1.4$ mm

Reference Value = 2.198 V/m; Power Drift = 0.04 dB

Peak SAR (extrapolated) = 0.722 W/kg

**SAR(1 g) = 0.186 W/kg; SAR(10 g) = 0.060 W/kg**

Maximum value of SAR (measured) = 0.365 W/kg

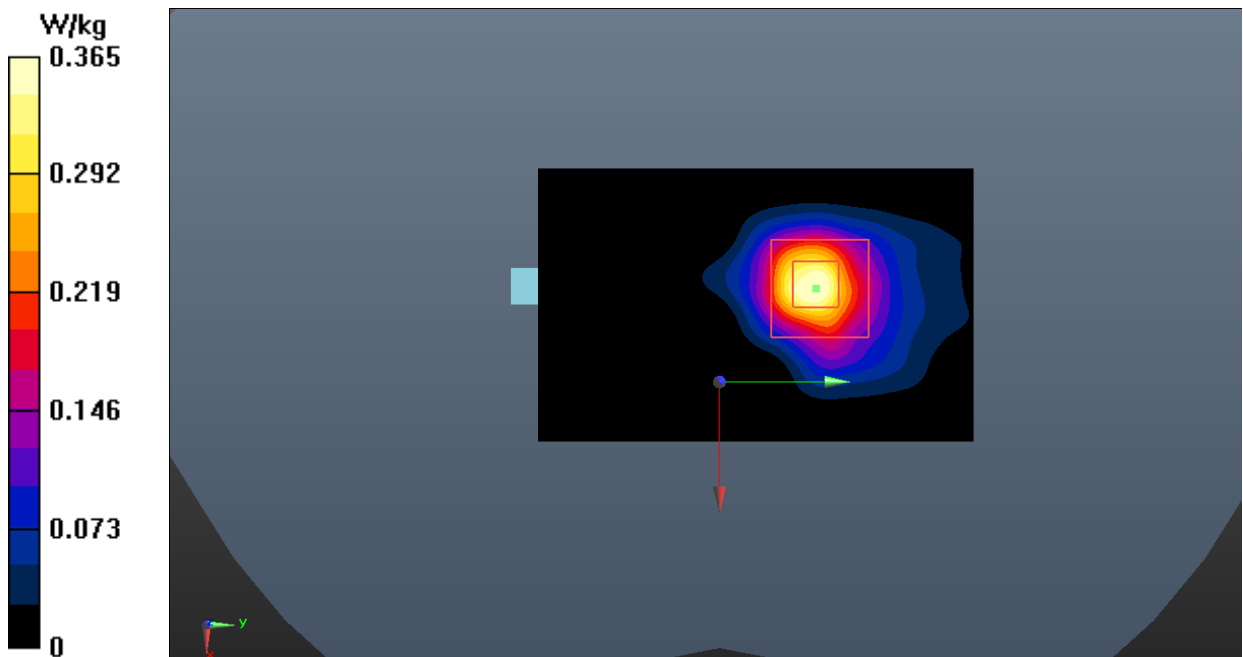
**Fig.9 WLAN 5GHz Body**

## ANNEX B: System Verification Results

### 835MHz

Date: 2022-11-5

Electronics: DAE4 Sn1527

Medium: Head 835MHz

Medium parameters used:  $f = 835$  MHz;  $\sigma = 0.916$  S/m;  $\epsilon_r = 40.684$ ;  $\rho = 1000$  kg/m<sup>3</sup>

Communication System: CW\_TMC Frequency: 835 MHz Duty Cycle: 1:1

Probe: EX3DV4 - SN7621 ConvF (11.12, 11.12, 11.12)

**System Validation/Area Scan (91x161x1):** Interpolated grid:  $dx=1.000$  mm,  $dy=1.000$  mm

Reference Value = 63.245 V/m; Power Drift = 0.11 dB

**SAR(1 g) = 2.44 W/kg; SAR(10 g) = 1.57 W/kg**

Maximum value of SAR (interpolated) = 3.61 W/kg

**System Validation/Zoom Scan (7x7x7)/Cube 0:** Measurement grid:  $dx=5$ mm,  $dy=5$ mm,  $dz=5$ mm

Reference Value = 63.245 V/m; Power Drift = 0.11 dB

Peak SAR (extrapolated) = 4.29 W/kg

**SAR(1 g) = 2.48 W/kg; SAR(10 g) = 1.60 W/kg**

Maximum value of SAR (measured) = 3.64 W/kg

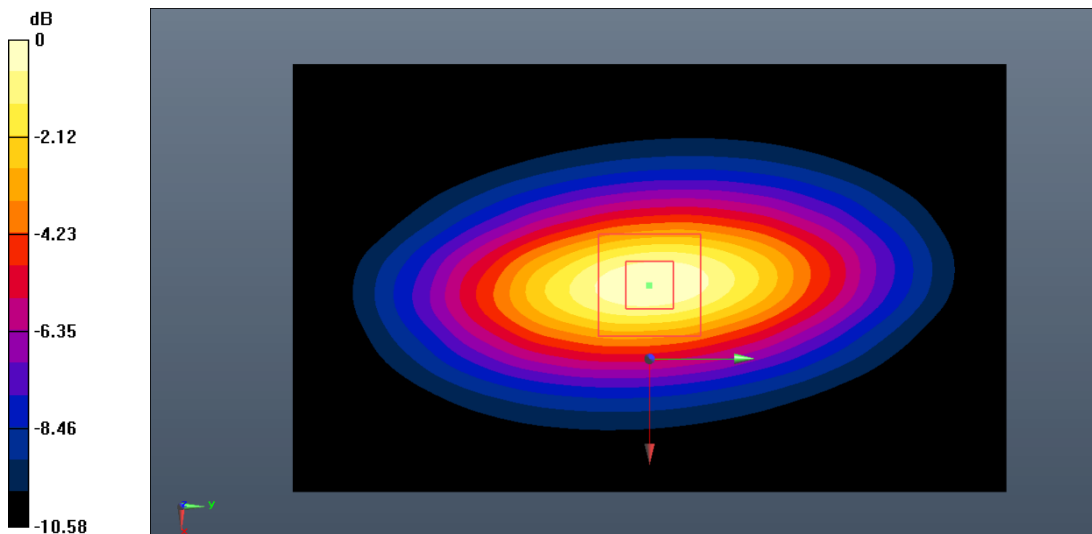

0 dB = 3.64 W/kg = 5.61 dB W/kg

**Fig.B.1. Validation 835MHz 250mW**

**1750MHz**

Date: 2022-11-14

Electronics: DAE4 Sn1527

Medium: Head 1750MHz

Medium parameters used:  $f = 1750$  MHz;  $\sigma = 1.382$  S/m;  $\epsilon_r = 39.544$ ;  $\rho = 1000$  kg/m<sup>3</sup>

Communication System: CW\_TMC Frequency: 1750 MHz Duty Cycle: 1:1

Probe: EX3DV4 - SN7621 ConvF (9.22, 9.22, 9.22)

**System Validation/Area Scan (81x121x1):** Interpolated grid: dx=1.000 mm, dy=1.000 mm

Reference Value = 80.115 V/m; Power Drift = 0.06 dB

**SAR(1 g) = 9.18 W/kg; SAR(10 g) = 4.94 W/kg**

Maximum value of SAR (interpolated) = 11.2 W/kg

**System Validation/Zoom Scan (7x7x7)/Cube0:** Measurement grid: dx=5mm, dy=5mm, dz=5mm

Reference Value = 80.115 V/m; Power Drift = 0.06 dB

Peak SAR (extrapolated) = 22.3 W/kg

**SAR(1 g) = 9.37 W/kg; SAR(10 g) = 4.99 W/kg**

Maximum value of SAR (measured) = 11.4 W/kg

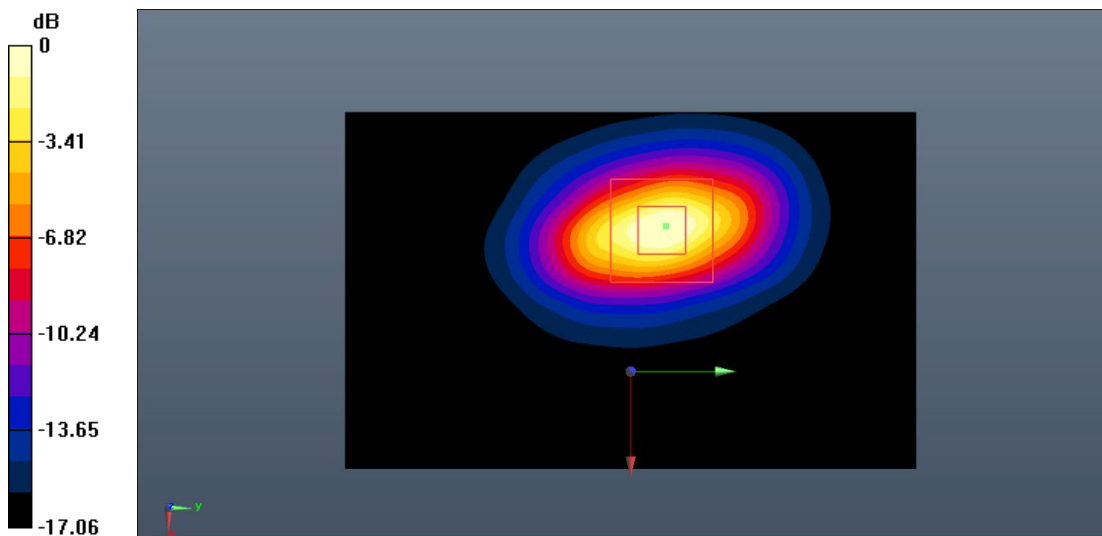

0 dB = 11.4 W/kg = 10.33 dB W/kg

**Fig.B.2. Validation 1750MHz 250mW**

**1900MHz**

Date: 2022-11-16

Electronics: DAE4 Sn1527

Medium: Head 1900MHz

Medium parameters used:  $f = 1900 \text{ MHz}$ ;  $\sigma = 1.419 \text{ S/m}$ ;  $\epsilon_r = 39.233$ ;  $\rho = 1000 \text{ kg/m}^3$

Communication System: CW\_TMC Frequency: 1900 MHz Duty Cycle: 1:1

Probe: EX3DV4 - SN7621 ConvF (8.90, 8.90, 8.90)

**System Validation/Area Scan (91x91x1):** Interpolated grid:  $dx=1.000 \text{ mm}$ ,  $dy=1.000 \text{ mm}$

Reference Value = 83.456 V/m; Power Drift = 0.06 dB

**SAR(1 g) = 10.1 W/kg; SAR(10 g) = 5.17 W/kg**

Maximum value of SAR (interpolated) = 12.2 W/kg

**System Validation/Zoom Scan (7x7x7)/Cube0:** Measurement grid:  $dx=5\text{mm}$ ,  $dy=5\text{mm}$ ,  $dz=5\text{mm}$

Reference Value = 83.456 V/m; Power Drift = 0.06 dB

Peak SAR (extrapolated) = 25.2 W/kg

**SAR(1 g) = 10.4 W/kg; SAR(10 g) = 5.26 W/kg**

Maximum value of SAR (measured) = 12.4 W/kg

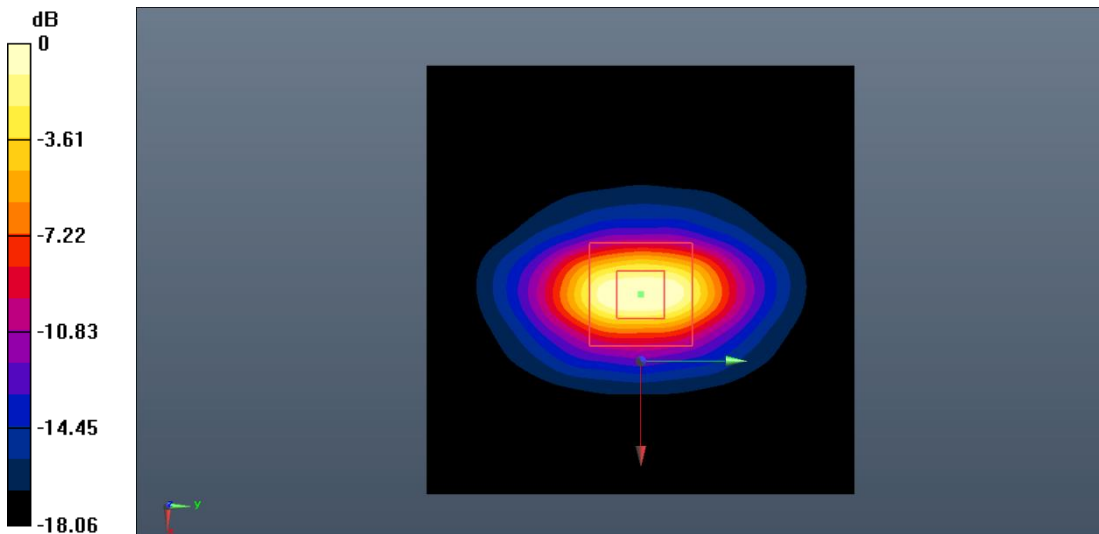

0 dB = 12.4 W/kg = 10.93 dB W/kg

**Fig.B.3. Validation 1900MHz 250mW**

**2450MHz**

Date: 2022-11-1

Electronics: DAE4 Sn1527

Medium: Head 2450MHz

Medium parameters used:  $f = 2450$  MHz;  $\sigma = 1.836$  S/m;  $\epsilon_r = 38.075$ ;  $\rho = 1000$  kg/m<sup>3</sup>

Communication System: CW\_TMC Frequency: 2450 MHz Duty Cycle: 1:1

Probe: EX3DV4 - SN7621 ConvF (8.17, 8.17, 8.17)

**System Validation/Area Scan (81x121x1):** Interpolated grid: dx=1.000 mm, dy=1.000 mm

Reference Value = 91.785 V/m; Power Drift = 0.12 dB

**SAR(1 g) = 13.5 W/kg; SAR(10 g) = 6.07 W/kg**

Maximum value of SAR (interpolated) = 15.4 W/kg

**System Validation/Zoom Scan (7x7x7)/Cube0:** Measurement grid: dx=5mm, dy=5mm, dz=5mm

Reference Value = 91.785 V/m; Power Drift = 0.12 dB

Peak SAR (extrapolated) = 36.6 W/kg

**SAR(1 g) = 13.8 W/kg; SAR(10 g) = 6.18 W/kg**

Maximum value of SAR (measured) = 15.8 W/kg

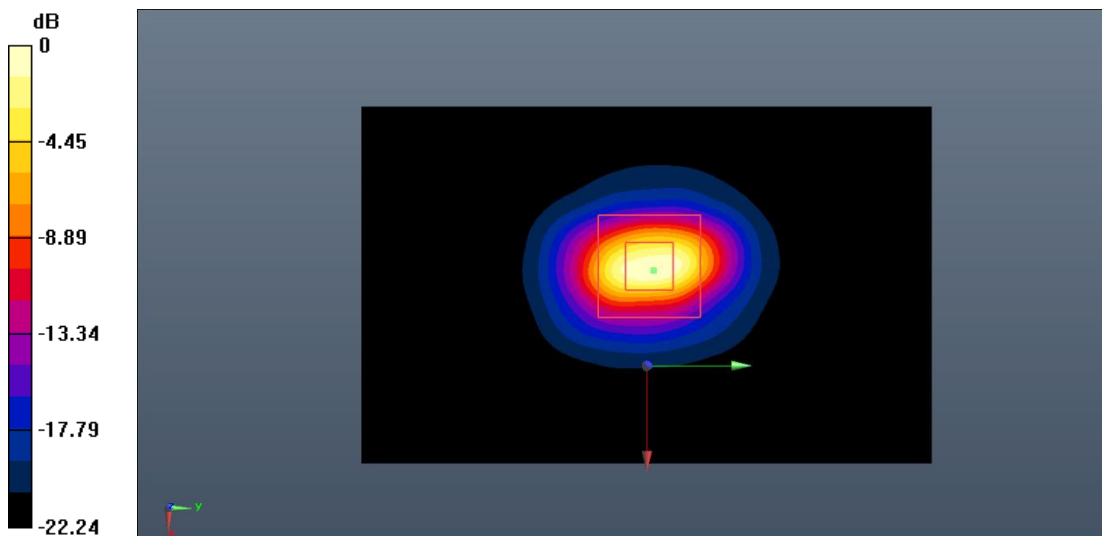

0 dB = 15.8 W/kg = 11.99 dB W/kg

**Fig.B.4. Validation 2450MHz 250mW**

**2550MHz**

Date: 2022-11-21

Electronics: DAE4 Sn1527

Medium: Head 2550MHz

Medium parameters used:  $f = 2550$  MHz;  $\sigma = 1.954$  S/m;  $\epsilon_r = 38.158$ ;  $\rho = 1000$  kg/m<sup>3</sup>

Communication System: CW\_TMC Frequency: 2550 MHz Duty Cycle: 1:1

Probe: EX3DV4 - SN7621 ConvF (8.17, 8.17, 8.17)

**System Validation/Area Scan (91x91x1):** Interpolated grid: dx=1.000 mm, dy=1.000 mm

Reference Value = 93.842 V/m; Power Drift = 0.07 dB

**SAR(1 g) = 14.1 W/kg; SAR(10 g) = 6.31 W/kg**

Maximum value of SAR (interpolated) = 16.0 W/kg

**System Validation/Zoom Scan (7x7x7)/Cube0:** Measurement grid: dx=5mm, dy=5mm, dz=5mm

Reference Value = 93.842 V/m; Power Drift = 0.07 dB

Peak SAR (extrapolated) = 36.9 W/kg

**SAR(1 g) = 14.3 W/kg; SAR(10 g) = 6.40 W/kg**

Maximum value of SAR (measured) = 16.3 W/kg

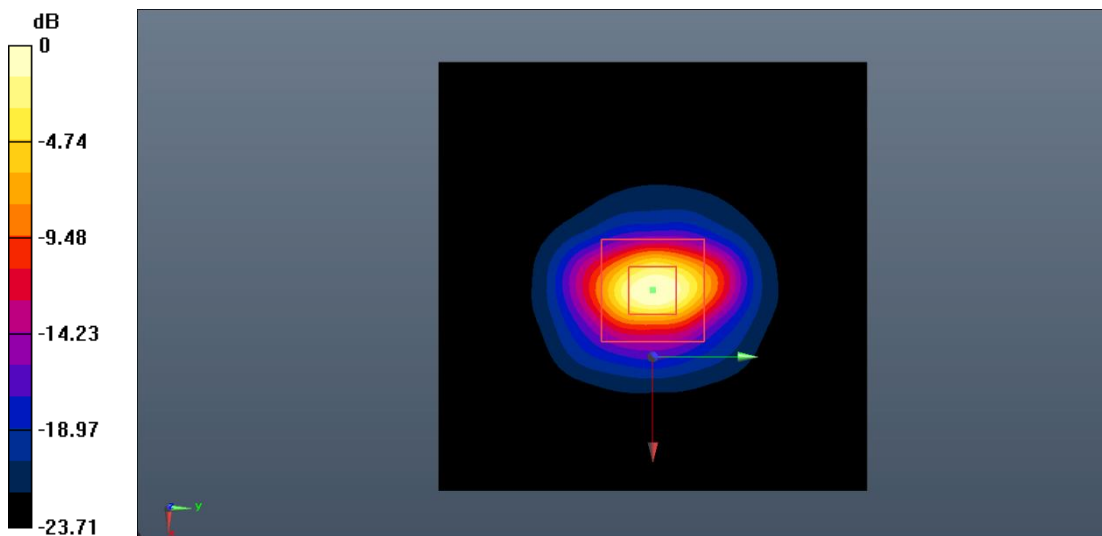

0 dB = 16.3 W/kg = 12.12 dB W/kg

**Fig.B.5. Validation 2550MHz 250mW**

**5250MHz**

Date: 2022-11-3

Electronics: DAE4 Sn1527

Medium: Head 5250MHz

Medium parameters used:  $f = 5250 \text{ MHz}$ ;  $\sigma = 4.805 \text{ S/m}$ ;  $\epsilon_r = 35.133$ ;  $\rho = 1000 \text{ kg/m}^3$

Communication System: CW\_TMC Frequency: 5250 MHz Duty Cycle: 1:1

Probe: EX3DV4 - SN7621 ConvF (5.98, 5.98, 5.98)

**System Validation/Area Scan (61x91x1):** Interpolated grid:  $dx=1.000 \text{ mm}$ ,  $dy=1.000 \text{ mm}$

Reference Value = 68.754 V/m; Power Drift = 0.10 dB

**SAR(1 g) = 8.05 W/kg; SAR(10 g) = 2.29 W/kg**

Maximum value of SAR (interpolated) = 10.1 W/kg

**System Validation/Zoom Scan (8x8x21)/Cube0:** Measurement grid:  $dx=4\text{mm}$ ,  $dy=4\text{mm}$ ,  $dz=1.4\text{mm}$

Reference Value = 68.754 V/m; Power Drift = 0.10 dB

Peak SAR (extrapolated) = 26.2 W/kg

**SAR(1 g) = 8.25 W/kg; SAR(10 g) = 2.32 W/kg**

Maximum value of SAR (measured) = 10.3 W/kg

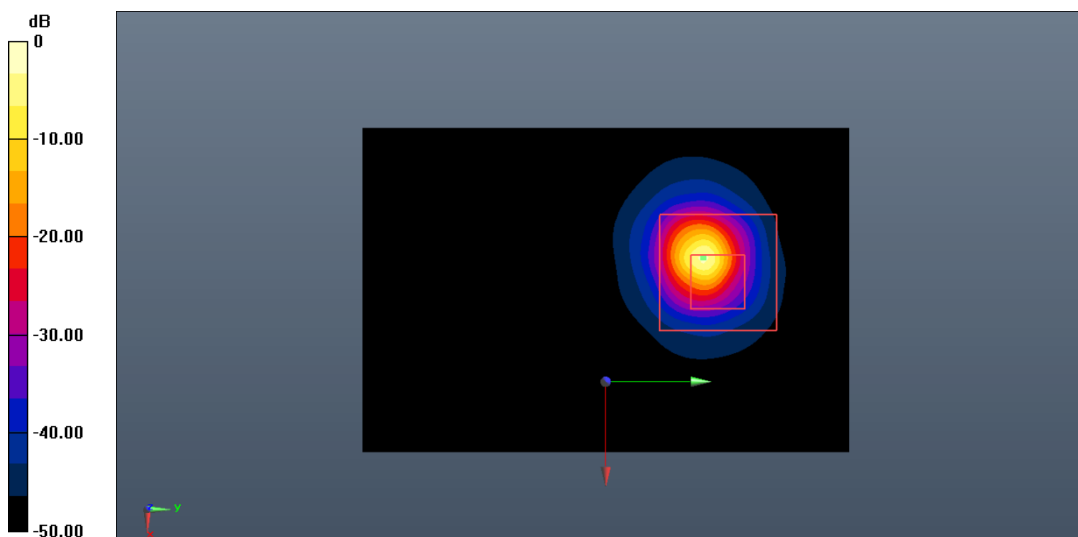

0 dB = 10.3 W/kg = 10.13 dB W/kg

**Fig.B.6. Validation 5250MHz 100mW**



**5750MHz**

Date: 2022-11-3

Electronics: DAE4 Sn1527

Medium: Head 5750MHz

Medium parameters used:  $f = 5750$  MHz;  $\sigma = 5.142$  S/m;  $\epsilon_r = 36.236$ ;  $\rho = 1000$  kg/m<sup>3</sup>

Communication System: CW\_TMC Frequency: 5750 MHz Duty Cycle: 1:1

Probe: EX3DV4 - SN7621 ConvF (5.40, 5.40, 5.40)

**System Validation/Area Scan (61x91x1):** Interpolated grid: dx=1.000 mm, dy=1.000 mm

Reference Value = 63.399 V/m; Power Drift = -0.01 dB

**SAR(1 g) = 7.74 W/kg; SAR(10 g) = 2.18 W/kg**

Maximum value of SAR (interpolated) = 9.92 W/kg

**System Validation/Zoom Scan (8x8x21)/Cube0:** Measurement grid: dx=4mm, dy=4mm, dz=1.4mm

Reference Value = 63.399 V/m; Power Drift = -0.01 dB

Peak SAR (extrapolated) = 23.9 W/kg

**SAR(1 g) = 7.58 W/kg; SAR(10 g) = 2.16 W/kg**

Maximum value of SAR (measured) = 9.87 W/kg

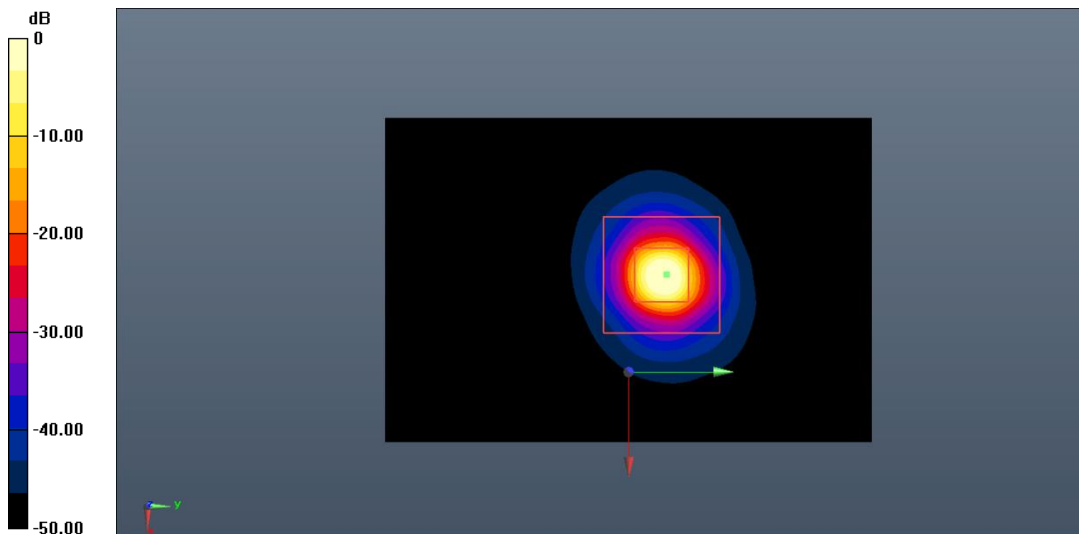

0 dB = 9.87 W/kg = 9.94 dB W/kg

**Fig.B.7. Validation 5750MHz 100mW**

## ANNEX C: SAR Measurement Setup

### C.1. Measurement Set-up

DASY5 system for performing compliance tests is illustrated above graphically. This system consists of the following items:

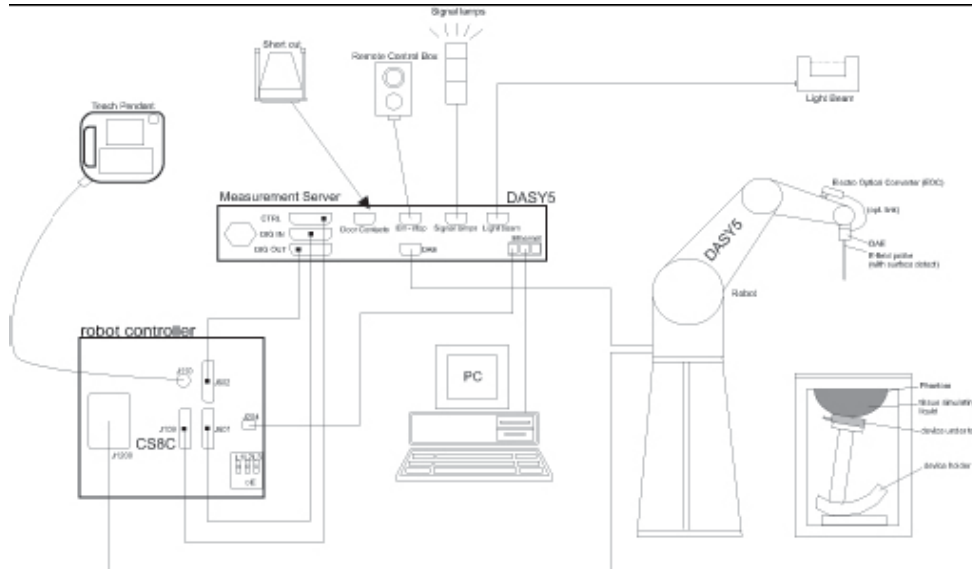

Picture C.1 SAR Lab Test Measurement Set-up

- A standard high precision 6-axis robot (Stäubli TX=RX family) with controller, teach pendant and software. An arm extension for accommodating the data acquisition electronics (DAE).
- An isotropic field probe optimized and calibrated for the targeted measurement.
- A data acquisition electronics (DAE) which performs the signal amplification, signal multiplexing, AD-conversion, offset measurements, mechanical surface detection, collision detection, etc. The unit is battery powered with standard or rechargeable batteries. The signal is optically transmitted to the EOC.
- The Electro-optical converter (EOC) performs the conversion from optical to electrical signals for the digital communication to the DAE. To use optical surface detection, a special version of the EOC is required. The EOC signal is transmitted to the measurement server.
- The function of the measurement server is to perform the time critical tasks such as signal filtering, control of the robot operation and fast movement interrupts.
- The Light Beam used is for probe alignment. This improves the (absolute) accuracy of the probe positioning.
- A computer running WinXP and the DASY5 software.
- Remote control and teach pendant as well as additional circuitry for robot safety such as
- warning lamps, etc.
- The phantom, the device holder and other accessories according to the targeted measurement.

## C.2. DASY5 E-field Probe System

The SAR measurements were conducted with the dosimetric probe designed in the classical triangular configuration and optimized for dosimetric evaluation. The probe is constructed using the thick film technique; with printed resistive lines on ceramic substrates. The probe is equipped with an optical multifiber line ending at the front of the probe tip. It is connected to the EOC box on the robot arm and provides an automatic detection of the phantom surface. Half of the fibers are connected to a pulsed infrared transmitter, the other half to a synchronized receiver. As the probe approaches the surface, the reflection from the surface produces a coupling from the transmitting to the receiving fibers. This reflection increases first during the approach, reaches maximum and then decreases. If the probe is flatly touching the surface, the coupling is zero. The distance of the coupling maximum to the surface is independent of the surface reflectivity and largely independent of the surface to probe angle. The DASY5 software reads the reflection during a software approach and looks for the maximum using 2<sup>nd</sup> order curve fitting. The approach is stopped at reaching the maximum.

### Probe Specifications:

<b>Model:</b>	ES3DV3, EX3DV4
<b>Frequency</b>	10MHz — 6.0GHz(EX3DV4)
<b>Range:</b>	10MHz — 4GHz(ES3DV3)
<b>Calibration:</b>	In head and body simulating tissue at Frequencies from 835 up to 5800MHz
<b>Linearity:</b>	± 0.2 dB(30 MHz to 6 GHz) for EX3DV4 ± 0.2 dB(30 MHz to 4 GHz) for ES3DV3
<b>Dynamic Range:</b>	10 mW/kg — 100W/kg
<b>Probe Length:</b>	330 mm
<b>Probe Tip</b>	
<b>Length:</b>	20 mm
<b>Body Diameter:</b>	12 mm
<b>Tip Diameter:</b>	2.5 mm (3.9 mm for ES3DV3)
<b>Tip-Center:</b>	1 mm (2.0mm for ES3DV3)
<b>Application:</b>	SAR Dosimetry Testing Compliance tests of mobile phones Dosimetry in strong gradient fields



Picture C.2 Near-field Probe



Picture C.3 E-field Probe

### C.3. E-field Probe Calibration

Each E-Probe/Probe Amplifier combination has unique calibration parameters. A TEM cell calibration procedure is conducted to determine the proper amplifier settings to enter in the probe parameters. The amplifier settings are determined for a given frequency by subjecting the probe to a known E-field density (1 mW/cm<sup>2</sup>) using an RF Signal generator, TEM cell, and RF Power Meter.

The free space E-field from amplified probe outputs is determined in a test chamber. This calibration can be performed in a TEM cell if the frequency is below 1 GHz and in a waveguide or other methodologies above 1 GHz for free space. For the free space calibration, the probe is placed in the volumetric center of the cavity and at the proper orientation with the field. The probe is then rotated 360 degrees until the three channels show the maximum reading. The power density readings equates to 1 mW/ cm<sup>2</sup>.

E-field temperature correlation calibration is performed in a flat phantom filled with the appropriate simulated brain tissue. The E-field in the medium correlates with the temperature rise in the dielectric medium. For temperature correlation calibration a RF transparent thermistor-based temperature probe is used in conjunction with the E-field probe.

$$SAR = C \frac{\Delta T}{\Delta t}$$

Where:

$\Delta t$  = Exposure time (30 seconds),

C = Heat capacity of tissue (brain or muscle),

$\Delta T$  = Temperature increase due to RF exposure.

$$SAR = \frac{|E|^2 \cdot \sigma}{\rho}$$

Where:

$\sigma$  = Simulated tissue conductivity,

$\rho$  = Tissue density (kg/m<sup>3</sup>).

## C.4. Other Test Equipment

### C.4.1. Data Acquisition Electronics (DAE)

The data acquisition electronics consist of a highly sensitive electrometer-grade preamplifier with auto-zeroing, a channel and gain-switching multiplexer, a fast 16 bit AD-converter and a command decoder with a control logic unit. Transmission to the measurement server is accomplished through an optical downlink for data and status information, as well as an optical uplink for commands and the clock.

The mechanical probe mounting device includes two different sensor systems for frontal and sideways probe contacts. They are used for mechanical surface detection and probe collision detection.

The input impedance of the DAE is 200 MOhm; the inputs are symmetrical and floating. Common mode rejection is above 80 dB.



PictureC.4: DAE

### C.4.2. Robot

The SPEAG DASY system uses the high precision robots (DASY5: RX160L) type from Stäubli SA (France). For the 6-axis controller system, the robot controller version from Stäubli is used. The Stäubli robot series have many features that are important for our application:

- High precision (repeatability 0.02mm)
- High reliability (industrial design)
- Low maintenance costs (virtually maintenance free due to direct drive gears; no belt drives)
- Jerk-free straight movements (brushless synchron motors; no stepper motors)
- Low ELF interference (motor control fields shielded via the closed metallic construction shields)



Picture C.5 DASY 5

### C.4.3. Measurement Server

The Measurement server is based on a PC/104 CPU board with CPU (DASY5: 400 MHz, Intel Celeron), chipdisk (DASY5:128MB), RAM (DASY5:128MB). The necessary circuits for communication with the DAE electronic box, as well as the 16 bit AD converter system for optical detection and digital I/O interface are contained on the DASY I/O board, which is directly connected to the PC/104 bus of the CPU board.

The measurement server performs all real-time data evaluation of field measurements and surface detection, controls robot movements and handles safety operation. The PC operating system cannot interfere with these time critical processes. All connections are supervised by a watchdog, and disconnection of any of the cables to the measurement server will automatically disarm the robot and disable all program-controlled robot movements. Furthermore, the measurement server is equipped with an expansion port which is reserved for future applications. Please note that this expansion port does not have a standardized pinout, and therefore only devices provided by SPEAG can be connected. Devices from any other supplier could seriously damage the measurement server.



Picture C.6 Server for DASY 5

### C.4.4. Device Holder for Phantom

The SAR in the phantom is approximately inversely proportional to the square of the distance between the source and the liquid surface. For a source at 5mm distance, a positioning uncertainty of  $\pm 0.5\text{mm}$  would produce a SAR uncertainty of  $\pm 20\%$ . Accurate device positioning is therefore crucial for accurate and repeatable measurements. The positions in which the devices must be measured are defined by the standards.

The DASY device holder is designed to cope with the different positions given in the standard. It has two scales for device rotation (with respect to the body axis) and device inclination (with respect to the line between the ear reference points). The rotation centers for both scales is the ear reference point (ERP). Thus the device needs no repositioning when changing the angles.

The DASY device holder is constructed of low-loss POM material having the following dielectric

parameters: relative permittivity  $\epsilon = 3$  and loss tangent  $\delta = 0.02$ . The amount of dielectric material has been reduced in the closest vicinity of the device, since measurements have suggested that the influence of the clamp on the test results could thus be lowered.

<Laptop Extension Kit>

The extension is lightweight and made of POM, acrylic glass and foam. It fits easily on the upper part of the Mounting Device in place of the phone positioner. The extension is fully compatible with the Twin-SAM and ELI phantoms.



**Picture C.7-1: Device Holder**

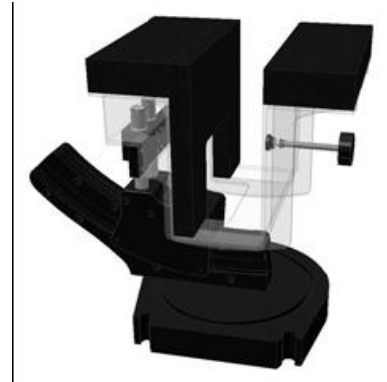

**Picture C.7-2: Laptop Extension Kit**

#### **C.4.5. Phantom**

The SAM Twin Phantom V4.0 is constructed of a fiberglass shell integrated in a table. The shape of the shell is based on data from an anatomical study designed to represent the 90<sup>th</sup> percentile of the population. The phantom enables the dissymmetric evaluation of SAR for both left and right handed handset usage, as well as body-worn usage using the flat phantom region. Reference markings on the Phantom allow the complete setup of all predefined phantom positions and measurement grids by manually teaching three points in the robot. The shell phantom has a 2mm shell thickness (except the ear region where shell thickness increases to 6 mm).

Shell Thickness:  $2 \pm 0.2$  mm  
Filling Volume: Approx. 25 liters  
Dimensions: 810 x 1000 x 500 mm (H x L x W)  
Available: Special



**Picture C.8: SAM Twin Phantom**

## ANNEX D: Position of the wireless device in relation to the phantom

### D.1. Body-worn device

A typical example of a body-worn device is a mobile phone, wireless enabled PDA or other battery operated wireless device with the ability to transmit while mounted on a person's body using a carry accessory approved by the wireless device manufacturer.

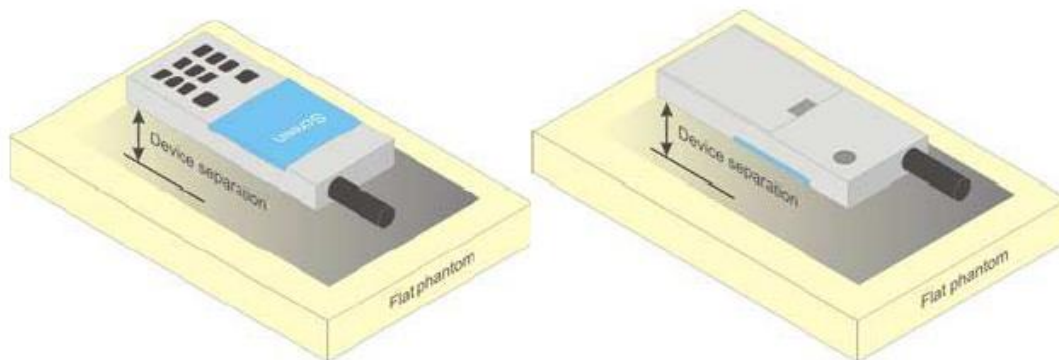

Picture D.4 Test positions for body-worn devices

### D.2. Desktop device

A typical example of a desktop device is a wireless enabled desktop computer placed on a table or desk when used.

The DUT shall be positioned at the distance and in the orientation to the phantom that corresponds to the intended use as specified by the manufacturer in the user instructions. For devices that employ an external antenna with variable positions, tests shall be performed for all antenna positions specified. Picture 8.5 show positions for desktop device SAR tests. If the intended use is not specified, the device shall be tested directly against the flat phantom.



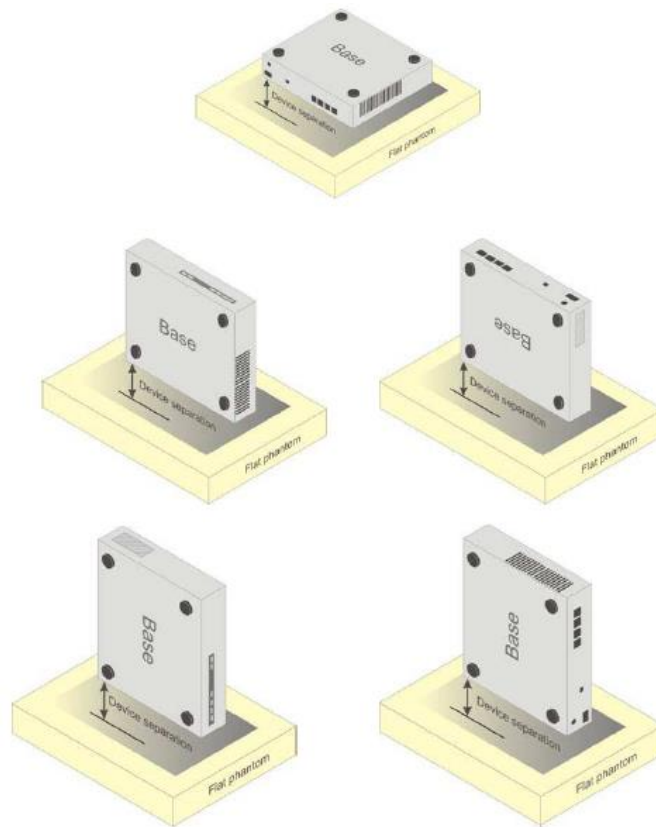

Picture D.5 Test positions for desktop devices

### D.3. DUT Setup Photos



Picture D.6

## ANNEX E: Equivalent Media Recipes

The liquid used for the frequency range of 700-6000 MHz consisted of water, sugar, salt, preventol, glycol monobutyl and Cellulose. The liquid has been previously proven to be suited for worst-case. The Table E.1 shows the detail solution. It's satisfying the latest tissue dielectric parameters requirements proposed by the IEEE 1528 and IEC 62209.

**Table E.1: Composition of the Tissue Equivalent Matter**

Frequency (MHz)	835	1750	1900	2450	2600	5200	5800
Water	41.45	55.242	55.242	58.79	58.79	65.53	66.10
Sugar	56.0	/	/	/	/	/	/
Salt	1.45	0.306	0.306	0.06	0.06		
Preventol	0.1	/	/	/	/	17.24	16.95
Cellulose	1.0	/	/	/	/	17.24	16.95
Glycol Monobutyl	/	44.452	44.452	41.15	41.15	/	/
Diethylenglycol monohexylether	/	/	/	/	/	/	/
Triton X-100	/	/	/	/	/	/	/
Dielectric Parameters Target Value	$\epsilon=41.5$ $\sigma=0.90$	$\epsilon=40.08$ $\sigma=1.37$	$\epsilon=40.0$ $\sigma=1.40$	$\epsilon=39.20$ $\sigma=1.80$	$\epsilon=39.01$ $\sigma=1.96$	$\epsilon=35.99$ $\sigma=4.66$	$\epsilon=35.30$ $\sigma=5.27$

**Note: There is a little adjustment respectively for 750, 5300 and 5600, based on the recipe of closest frequency in table E.1**

## ANNEX F: System Validation

The SAR system must be validated against its performance specifications before it is deployed. When SAR probes, system components or software are changed, upgraded or recalibrated, these must be validated with the SAR system(s) that operates with such components.

**Table F.1: System Validation**

Probe SN.	Liquid name (MHz)	Validation date	Frequency point	CW Validation	Modulation Signal Validation		
					Modulation Type	Duty Factor	PAR
7621	Head 750	2022-05-09	750MHz	Pass	N/A	N/A	N/A
7621	Head 835	2022-05-09	835MHz	Pass	GMSK	Pass	N/A
7621	Head 1750	2022-05-09	1750MHz	Pass	N/A	N/A	N/A
7621	Head 1900	2022-05-09	1900MHz	Pass	GMSK	Pass	N/A
7621	Head 2450	2022-05-08	2450MHz	Pass	OFDM/TDD	Pass	Pass
7621	Head 2550	2022-05-08	2550MHz	Pass	TDD	Pass	N/A
7621	Head 3500	2022-05-10	3500MHz	Pass	TDD	Pass	N/A
7621	Head 3700	2022-05-10	3700MHz	Pass	TDD	Pass	N/A
7621	Head 3900	2022-05-10	3900MHz	Pass	TDD	Pass	N/A
7621	Head 5250	2022-05-08	5250MHz	Pass	OFDM	N/A	Pass
7621	Head 5600	2022-05-08	5600MHz	Pass	OFDM	N/A	Pass
7621	Head 5750	2022-05-08	5750MHz	Pass	OFDM	N/A	Pass

## ANNEX G: DAE Calibration Certificate

Calibration Laboratory of  
Schmid & Partner  
Engineering AG  
Zeughausstrasse 43, 8004 Zurich, Switzerland





S Schweizerischer Kalibrierdienst  
C Service suisse d'étalonnage  
S Servizio svizzero di taratura  
S Swiss Calibration Service

Accredited by the Swiss Accreditation Service (SAS)  
The Swiss Accreditation Service is one of the signatories to the EA  
Multilateral Agreement for the recognition of calibration certificates

Accreditation No.: SCS 0108

Client **Saict-SZ (Auden)**

Certificate No: DAE4-1527\_Jun22

CALIBRATION CERTIFICATE			
Object	DAE4 - SD 000 D04 BM - SN: 1527		
Calibration procedure(s)	QA CAL-06.V30 Calibration procedure for the data acquisition electronics (DAE)		
Calibration date:	June 21, 2022		
This calibration certificate documents the traceability to national standards, which realize the physical units of measurements (SI). The measurements and the uncertainties with confidence probability are given on the following pages and are part of the certificate.			
All calibrations have been conducted in the closed laboratory facility: environment temperature (22 ± 3)°C and humidity < 70%.			
Calibration Equipment used (M&TE critical for calibration)			
Primary Standards	ID #	Cal Date (Certificate No.)	Scheduled Calibration
Keithley Multimeter Type 2001	SN: 0810278	31-Aug-21 (No:31368)	Aug-22
Secondary Standards	ID #	Check Date (in house)	Scheduled Check
Auto DAE Calibration Unit	SE UWS 053 AA 1001	24-Jan-22 (in house check)	In house check: Jan-23
Calibrator Box V2.1	SE UMS 006 AA 1002	24-Jan-22 (in house check)	In house check: Jan-23
Calibrated by:	Name Adrian Gehring	Function Laboratory Technician	Signature 
Approved by:	Sven Kühn	Technical Manager	
			Issued: June 21, 2022
This calibration certificate shall not be reproduced except in full without written approval of the laboratory.			

**Calibration Laboratory of**  
Schmid & Partner  
Engineering AG  
Zeughausstrasse 43, 8004 Zurich, Switzerland



**S** Schweizerischer Kalibrierdienst  
**C** Service suisse d'étalonnage  
**S** Servizio svizzero di taratura  
**S** Swiss Calibration Service

Accredited by the Swiss Accreditation Service (SAS)

The Swiss Accreditation Service is one of the signatories to the EA  
Multilateral Agreement for the recognition of calibration certificates

Accreditation No.: **SCS 0108**

### Glossary

DAE data acquisition electronics  
Connector angle information used in DASY system to align probe sensor X to the robot coordinate system.

### Methods Applied and Interpretation of Parameters

- *DC Voltage Measurement:* Calibration Factor assessed for use in DASY system by comparison with a calibrated instrument traceable to national standards. The figure given corresponds to the full scale range of the voltmeter in the respective range.
- *Connector angle:* The angle of the connector is assessed measuring the angle mechanically by a tool inserted. Uncertainty is not required.
- The following parameters as documented in the Appendix contain technical information as a result from the performance test and require no uncertainty.
  - *DC Voltage Measurement Linearity:* Verification of the Linearity at +10% and -10% of the nominal calibration voltage. Influence of offset voltage is included in this measurement.
  - *Common mode sensitivity:* Influence of a positive or negative common mode voltage on the differential measurement.
  - *Channel separation:* Influence of a voltage on the neighbor channels not subject to an input voltage.
  - *AD Converter Values with inputs shorted:* Values on the internal AD converter corresponding to zero input voltage
  - *Input Offset Measurement:* Output voltage and statistical results over a large number of zero voltage measurements.
  - *Input Offset Current:* Typical value for information; Maximum channel input offset current, not considering the input resistance.
  - *Input resistance:* Typical value for information: DAE input resistance at the connector, during internal auto-zeroing and during measurement.
  - *Low Battery Alarm Voltage:* Typical value for information. Below this voltage, a battery alarm signal is generated.
  - *Power consumption:* Typical value for information. Supply currents in various operating modes.



**DC Voltage Measurement**

A/D - Converter Resolution nominal

High Range: 1LSB = 6.1μV, full range = -100...+300 mV

Low Range: 1LSB = 61nV, full range = -1.....+3mV

DASY measurement parameters: Auto Zero Time: 3 sec; Measuring time: 3 sec

Calibration Factors	X	Y	Z
High Range	403.865 ± 0.02% (k=2)	403.595 ± 0.02% (k=2)	403.805 ± 0.02% (k=2)
Low Range	3.95898 ± 1.50% (k=2)	3.98939 ± 1.50% (k=2)	3.96763 ± 1.50% (k=2)

**Connector Angle**

Connector Angle to be used in DASY system	61.0 ° ± 1 °
---	--------------

**Appendix (Additional assessments outside the scope of SCS0108)**
**1. DC Voltage Linearity**

High Range	Reading ( $\mu\text{V}$ )	Difference ( $\mu\text{V}$ )	Error (%)
Channel X + Input	200037.59	1.98	0.00
Channel X + Input	20007.61	1.34	0.01
Channel X - Input	-20004.09	1.79	-0.01
Channel Y + Input	200037.45	1.53	0.00
Channel Y + Input	20002.68	-3.42	-0.02
Channel Y - Input	-20007.17	-1.14	0.01
Channel Z + Input	200037.73	2.17	0.00
Channel Z + Input	20005.72	-0.34	-0.00
Channel Z - Input	-20006.63	-0.49	0.00

Low Range	Reading ( $\mu\text{V}$ )	Difference ( $\mu\text{V}$ )	Error (%)
Channel X + Input	2001.36	-0.15	-0.01
Channel X + Input	201.70	0.16	0.08
Channel X - Input	-198.10	0.49	-0.24
Channel Y + Input	2001.44	0.07	0.00
Channel Y + Input	201.07	-0.21	-0.11
Channel Y - Input	-199.66	-0.98	0.50
Channel Z + Input	2001.52	0.21	0.01
Channel Z + Input	200.61	-0.41	-0.20
Channel Z - Input	-199.00	-0.15	0.07

**2. Common mode sensitivity**

DASY measurement parameters: Auto Zero Time: 3 sec; Measuring time: 3 sec

	Common mode Input Voltage (mV)	High Range Average Reading ( $\mu\text{V}$ )	Low Range Average Reading ( $\mu\text{V}$ )
Channel X	200	-3.95	-5.31
	-200	5.96	4.97
Channel Y	200	-16.18	-16.25
	-200	14.41	14.34
Channel Z	200	3.01	2.86
	-200	-3.93	-4.13

**3. Channel separation**

DASY measurement parameters: Auto Zero Time: 3 sec; Measuring time: 3 sec

	Input Voltage (mV)	Channel X ( $\mu\text{V}$ )	Channel Y ( $\mu\text{V}$ )	Channel Z ( $\mu\text{V}$ )
Channel X	200	-	-0.68	-2.76
Channel Y	200	5.43	-	-0.31
Channel Z	200	10.73	3.29	-

**4. AD-Converter Values with inputs shorted**

DASY measurement parameters: Auto Zero Time: 3 sec; Measuring time: 3 sec

	High Range (LSB)	Low Range (LSB)
Channel X	16059	17078
Channel Y	15965	16219
Channel Z	15888	13556

**5. Input Offset Measurement**

DASY measurement parameters: Auto Zero Time: 3 sec; Measuring time: 3 sec  
Input 10MΩ

	Average (μV)	min. Offset (μV)	max. Offset (μV)	Std. Deviation (μV)
Channel X	1.40	0.90	2.25	0.35
Channel Y	-0.62	-1.30	0.47	0.33
Channel Z	-0.18	-0.90	0.60	0.31

**6. Input Offset Current**

Nominal input circuitry offset current on all channels: <25fA

**7. Input Resistance** (Typical values for information)

	Zeroing (kOhm)	Measuring (MOhm)
Channel X	200	200
Channel Y	200	200
Channel Z	200	200

**8. Low Battery Alarm Voltage** (Typical values for information)

Typical values	Alarm Level (VDC)
Supply (+ Vcc)	+7.9
Supply (- Vcc)	-7.6

**9. Power Consumption** (Typical values for information)

Typical values	Switched off (mA)	Stand by (mA)	Transmitting (mA)
Supply (+ Vcc)	+0.01	+6	+14
Supply (- Vcc)	-0.01	-8	-9



**ANNEX H: Probe Calibration Certificate**

 In Collaboration with <b>S p e a g</b> CALIBRATION LABORATORY		  中国认可 国际互认 校准 CALIBRATION CNAS L0570	
Add: No.52 HuaYuanBei Road, Haidian District, Beijing, 100191, China Tel: +86-10-62304633-2117 E-mail: cttl@chinattl.com      http://www.caict.ac.cn			
Client	SAICT	Certificate No: Z22-60124	
<b>CALIBRATION CERTIFICATE</b>			
Object	EX3DV4 - SN : 7621		
Calibration Procedure(s)	FF-Z11-004-02 Calibration Procedures for Dosimetric E-field Probes		
Calibration date:	May 06, 2022		
This calibration Certificate documents the traceability to national standards, which realize the physical units of measurements(SI). The measurements and the uncertainties with confidence probability are given on the following pages and are part of the certificate.			
All calibrations have been conducted in the closed laboratory facility: environment temperature(22±3)°C and humidity<70%.			
Calibration Equipment used (M&TE critical for calibration)			
Primary Standards	ID #	Cal Date(Calibrated by, Certificate No.)	Scheduled Calibration
Power Meter NRP2	101919	15-Jun-21(CTTL, No.J21X04466)	Jun-22
Power sensor NRP-Z91	101547	15-Jun-21(CTTL, No.J21X04466)	Jun-22
Power sensor NRP-Z91	101548	15-Jun-21(CTTL, No.J21X04466)	Jun-22
Reference 10dBAttenuator	18N50W-10dB	20-Jan-21(CTTL, No.J21X00486)	Jan-23
Reference 20dBAttenuator	18N50W-20dB	20-Jan-21(CTTL, No.J21X00485)	Jan-23
Reference Probe EX3DV4	SN 7464	26-Jan-22(SPEAG, No.EX3-7464_Jan22)	Jan-23
DAE4	SN 1555	20-Aug-21(SPEAG, No.DAE4-1555_Aug21/2)	Aug-22
Secondary Standards	ID #	Cal Date(Calibrated by, Certificate No.)	Scheduled Calibration
SignalGenerator MG3700A	6201052605	16-Jun-21(CTTL, No.J21X04467)	Jun-22
Network Analyzer E5071C	MY46110673	14-Jan-22(CTTL, No.J22X00406)	Jan-23
Calibrated by:	Name	Function	Signature
	Yu Zongying	SAR Test Engineer	
Reviewed by:	Lin Hao	SAR Test Engineer	
Approved by:	Qi Dianyuan	SAR Project Leader	
			Issued: May 23, 2022
This calibration certificate shall not be reproduced except in full without written approval of the laboratory.			

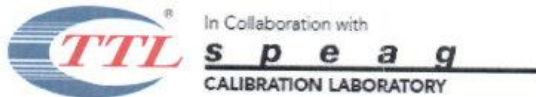

Add: No.52 HuaYuanBei Road, Haidian District, Beijing, 100191, China  
Tel: +86-10-62304633-2117  
E-mail: cttl@chinattl.com <http://www.caict.ac.cn>

#### Glossary:

TSL	tissue simulating liquid
NORM <sub>x,y,z</sub>	sensitivity in free space
ConvF	sensitivity in TSL / NORM <sub>x,y,z</sub>
DCP	diode compression point
CF	crest factor (1/duty_cycle) of the RF signal
A,B,C,D	modulation dependent linearization parameters
Polarization $\Phi$	$\Phi$ rotation around probe axis
Polarization $\theta$	$\theta$ rotation around an axis that is in the plane normal to probe axis (at measurement center), $i$ $\theta=0$ is normal to probe axis

Connector Angle information used in DASY system to align probe sensor X to the robot coordinate system

#### Calibration is Performed According to the Following Standards:

- IEEE Std 1528-2013, "IEEE Recommended Practice for Determining the Peak Spatial-Averaged Specific Absorption Rate (SAR) in the Human Head from Wireless Communications Devices: Measurement Techniques", June 2013
- IEC 62209-1, "Measurement procedure for the assessment of Specific Absorption Rate (SAR) from hand-held and body-mounted devices used next to the ear (frequency range of 300 MHz to 6 GHz)", July 2016
- IEC 62209-2, "Procedure to determine the Specific Absorption Rate (SAR) for wireless communication devices used in close proximity to the human body (frequency range of 30 MHz to 6 GHz)", March 2010
- KDB 865664, "SAR Measurement Requirements for 100 MHz to 6 GHz"

#### Methods Applied and Interpretation of Parameters:

- NORM<sub>x,y,z</sub>:** Assessed for E-field polarization  $\theta=0$  ( $f \leq 900\text{MHz}$  in TEM-cell;  $f > 1800\text{MHz}$ : waveguide). NORM<sub>x,y,z</sub> are only intermediate values, i.e., the uncertainties of NORM<sub>x,y,z</sub> does not effect the  $E^2$ -field uncertainty inside TSL (see below ConvF).
- NORM( $f$ )<sub>x,y,z</sub> = NORM<sub>x,y,z</sub> \* frequency\_response** (see Frequency Response Chart). This linearization is implemented in DASY4 software versions later than 4.2. The uncertainty of the frequency response is included in the stated uncertainty of ConvF.
- DCP<sub>x,y,z</sub>:** DCP are numerical linearization parameters assessed based on the data of power sweep (no uncertainty required). DCP does not depend on frequency nor media.
- PAR:** PAR is the Peak to Average Ratio that is not calibrated but determined based on the signal characteristics.
- A<sub>x,y,z</sub>; B<sub>x,y,z</sub>; C<sub>x,y,z</sub>; VR<sub>x,y,z</sub>; A,B,C** are numerical linearization parameters assessed based on the data of power sweep for specific modulation signal. The parameters do not depend on frequency nor media. VR is the maximum calibration range expressed in RMS voltage across the diode.
- ConvF and Boundary Effect Parameters:** Assessed in flat phantom using E-field (or Temperature Transfer Standard for  $f \leq 800\text{MHz}$ ) and inside waveguide using analytical field distributions based on power measurements for  $f > 800\text{MHz}$ . The same setups are used for assessment of the parameters applied for boundary compensation (alpha, depth) of which typical uncertainty valued are given. These parameters are used in DASY4 software to improve probe accuracy close to the boundary. The sensitivity in TSL corresponds to NORM<sub>x,y,z</sub> \* ConvF whereby the uncertainty corresponds to that given for ConvF. A frequency dependent ConvF is used in DASY version 4.4 and higher which allows extending the validity from  $\pm 50\text{MHz}$  to  $\pm 100\text{MHz}$ .
- Spherical isotropy (3D deviation from isotropy):** in a field of low gradients realized using a flat phantom exposed by a patch antenna.
- Sensor Offset:** The sensor offset corresponds to the offset of virtual measurement center from the probe tip (on probe axis). No tolerance required.
- Connector Angle:** The angle is assessed using the information gained by determining the NORM<sub>x</sub> (no uncertainty required).



Add: No.52 HuaYuanBei Road, Haidian District, Beijing, 100191, China  
 Tel: +86-10-62304633-2117  
 E-mail: cttl@chinattl.com      http://www.caict.ac.cn

## DASY/EASY – Parameters of Probe: EX3DV4 – SN:7621

### Basic Calibration Parameters

	Sensor X	Sensor Y	Sensor Z	Unc (k=2)
Norm( $\mu\text{V}/(\text{V}/\text{m})^2$ ) <sup>A</sup>	0.71	0.71	0.56	$\pm 10.0\%$
DCP(mV) <sup>B</sup>	111.7	111.8	115.7	

### Modulation Calibration Parameters

UID	Communication System Name		A dB	B dB- $\mu\text{V}$	C	D dB	VR mV	Unc <sup>E</sup> (k=2)
0	CW	X	0.0	0.0	1.0	0.00	210.8	$\pm 3.5\%$
		Y	0.0	0.0	1.0		218.6	
		Z	0.0	0.0	1.0		190.8	

The reported uncertainty of measurement is stated as the standard uncertainty of Measurement multiplied by the coverage factor  $k=2$ , which for a normal distribution Corresponds to a coverage probability of approximately 95%.

<sup>A</sup> The uncertainties of Norm X, Y, Z do not affect the E<sup>2</sup>-field uncertainty inside TSL (see Page 4).

<sup>B</sup> Numerical linearization parameter: uncertainty not required.

<sup>E</sup> Uncertainty is determined using the max. deviation from linear response applying rectangular distribution and is expressed for the square of the field value.

## DASY/EASY – Parameters of Probe: EX3DV4 – SN:7621

### Calibration Parameter Determined in Head Tissue Simulating Media

f [MHz] <sup>C</sup>	Relative Permittivity <sup>F</sup>	Conductivity (S/m) <sup>F</sup>	ConvF X	ConvF Y	ConvF Z	Alpha <sup>G</sup>	Depth <sup>G</sup> (mm)	Unct. (k=2)
750	41.9	0.89	11.12	11.12	11.12	0.18	1.14	±12.1%
900	41.5	0.97	10.68	10.68	10.68	0.14	1.14	±12.1%
1450	40.5	1.20	9.65	9.65	9.65	0.21	0.91	±12.1%
1750	40.1	1.37	9.22	9.22	9.22	0.31	0.90	±12.1%
1900	40.0	1.40	8.90	8.90	8.90	0.35	0.84	±12.1%
2100	39.8	1.49	8.95	8.95	8.95	0.23	1.13	±12.1%
2300	39.5	1.67	8.60	8.60	8.60	0.44	0.78	±12.1%
2450	39.2	1.80	8.17	8.17	8.17	0.49	0.78	±12.1%
2600	39.0	1.96	7.93	7.93	7.93	0.51	0.75	±12.1%
3300	38.2	2.71	7.74	7.74	7.74	0.45	0.92	±13.3%
3500	37.9	2.91	7.56	7.56	7.56	0.44	1.00	±13.3%
3700	37.7	3.12	7.18	7.18	7.18	0.38	1.05	±13.3%
3900	37.5	3.32	7.26	7.26	7.26	0.35	1.35	±13.3%
4100	37.2	3.53	7.21	7.21	7.21	0.25	1.30	±13.3%
4400	36.9	3.84	7.01	7.01	7.01	0.25	1.55	±13.3%
4600	36.7	4.04	6.90	6.90	6.90	0.30	1.72	±13.3%
4800	36.4	4.25	6.79	6.79	6.79	0.30	1.85	±13.3%
4950	36.3	4.40	6.44	6.44	6.44	0.30	1.80	±13.3%
5250	35.9	4.71	5.98	5.98	5.98	0.35	1.63	±13.3%
5600	35.5	5.07	5.47	5.47	5.47	0.40	1.55	±13.3%
5750	35.4	5.22	5.40	5.40	5.40	0.40	1.55	±13.3%

<sup>C</sup> Frequency validity above 300 MHz of ±100MHz only applies for DASY v4.4 and higher (Page 2), else it is restricted to ±50MHz. The uncertainty is the RSS of ConvF uncertainty at calibration frequency and the uncertainty for the indicated frequency band. Frequency validity below 300 MHz is ± 10, 25, 40, 50 and 70 MHz for ConvF assessments at 30, 64, 128, 150 and 220 MHz respectively. Above 5 GHz frequency validity can be extended to ± 110 MHz.

<sup>F</sup> At frequency below 3 GHz, the validity of tissue parameters ( $\epsilon$  and  $\sigma$ ) can be relaxed to ±10% if liquid compensation formula is applied to measured SAR values. At frequencies above 3 GHz, the validity of tissue parameters ( $\epsilon$  and  $\sigma$ ) is restricted to ±5%. The uncertainty is the RSS of the ConvF uncertainty for indicated target tissue parameters.

<sup>G</sup> Alpha/Depth are determined during calibration. SPEAG warrants that the remaining deviation due to the boundary effect after compensation is always less than ± 1% for frequencies below 3 GHz and below ± 2% for the frequencies between 3-6 GHz at any distance larger than half the probe tip diameter from the boundary.

### Frequency Response of E-Field (TEM-Cell: ifi110 EXX, Waveguide: R22)

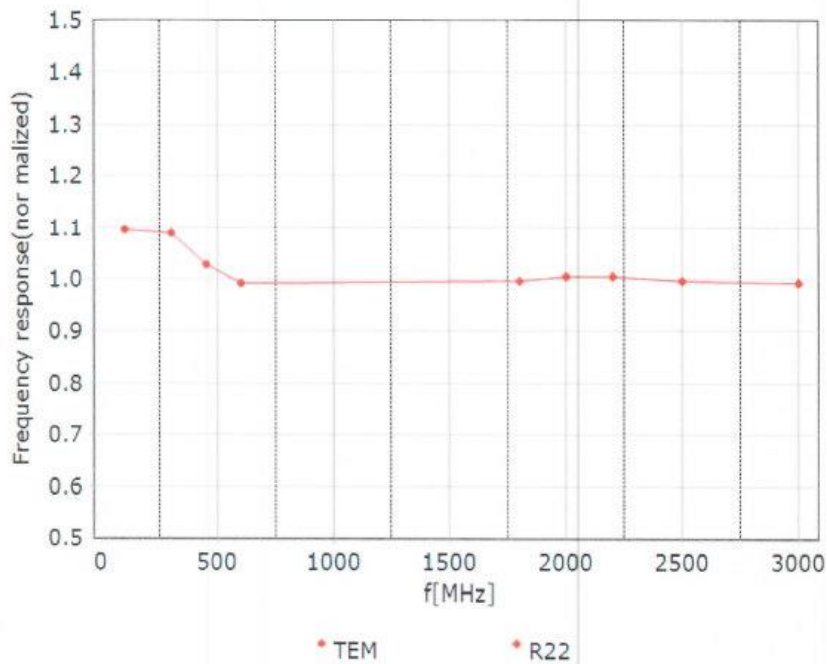

Uncertainty of Frequency Response of E-field:  $\pm 7.4\%$  ( $k=2$ )

### Receiving Pattern ( $\Phi$ ), $\theta=0^\circ$

**f=600 MHz, TEM**

**f=1800 MHz, R22**

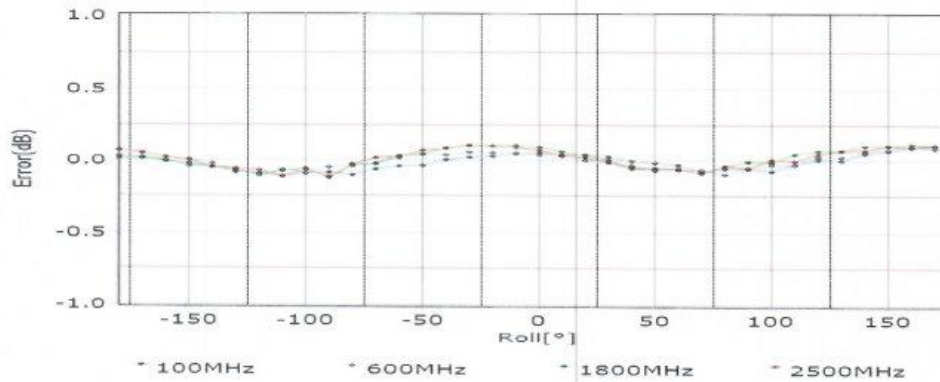
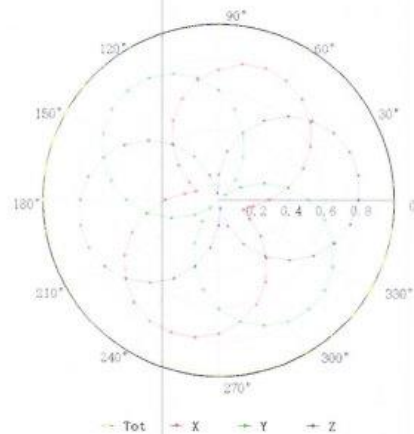
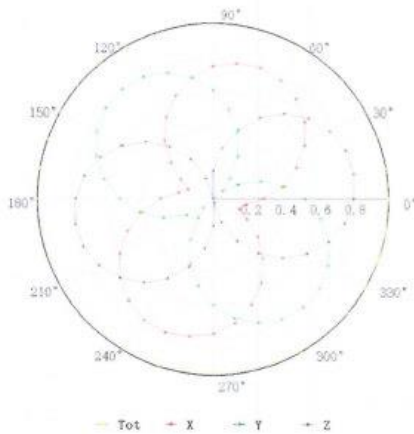

Uncertainty of Axial Isotropy Assessment:  $\pm 1.2\%$  ( $k=2$ )

### Dynamic Range f(SAR<sub>head</sub>) (TEM cell, f = 900 MHz)

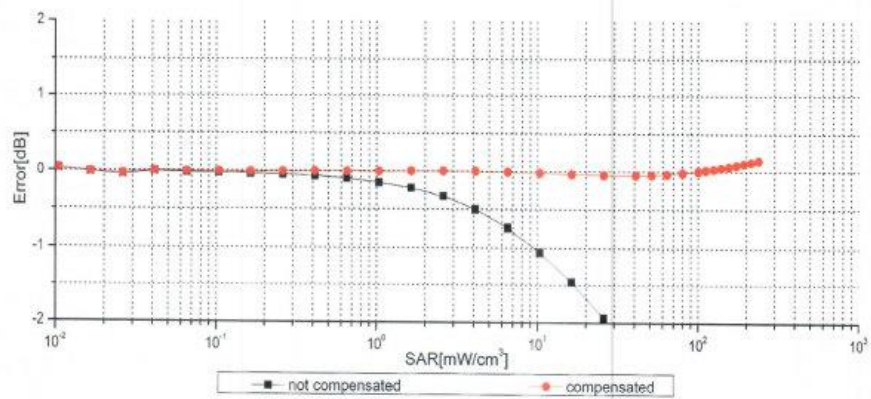
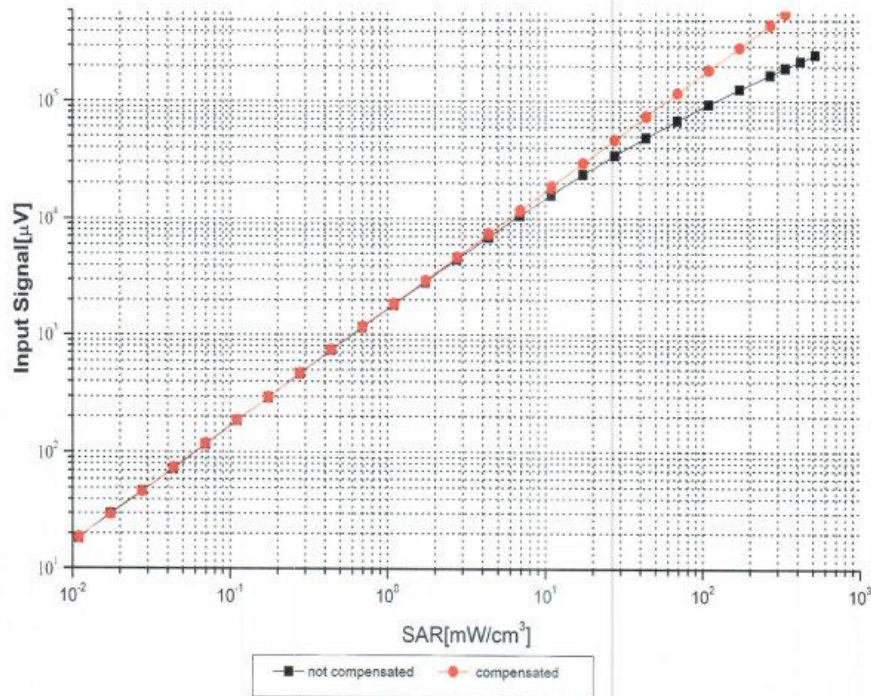

Uncertainty of Linearity Assessment: ±0.9% (k=2)

### Conversion Factor Assessment

f=750 MHz,WGLS R9(H\_convF)

f=1750 MHz,WGLS R22(H\_convF)

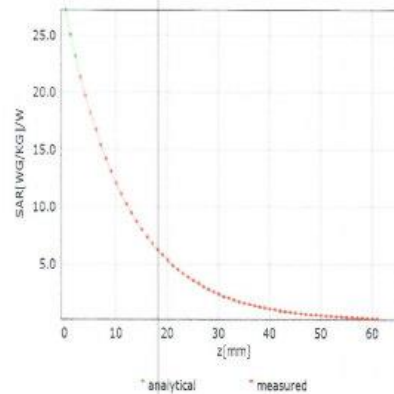
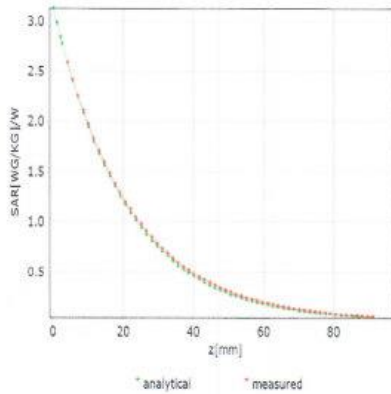

### Deviation from Isotropy in Liquid

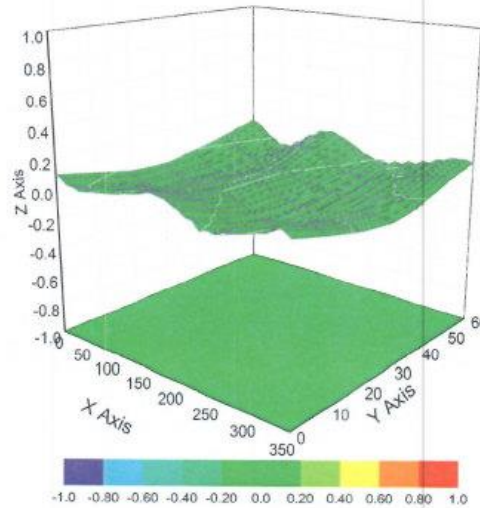

Uncertainty of Spherical Isotropy Assessment:  $\pm 3.2\%$  ( $k=2$ )



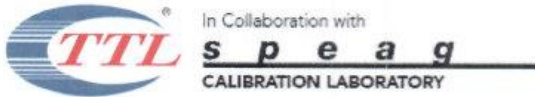

Add: No.52 HuaYuanBei Road, Haidian District, Beijing, 100191, China  
Tel: +86-10-62304633-2117  
E-mail: cttl@chinattf.com <http://www.caict.ac.cn>



## DASY/EASY – Parameters of Probe: EX3DV4 – SN:7621

### Other Probe Parameters

Sensor Arrangement	Triangular
Connector Angle (°)	95.4
Mechanical Surface Detection Mode	enabled
Optical Surface Detection Mode	disable
Probe Overall Length	337mm
Probe Body Diameter	10mm
Tip Length	9mm
Tip Diameter	2.5mm
Probe Tip to Sensor X Calibration Point	1mm
Probe Tip to Sensor Y Calibration Point	1mm
Probe Tip to Sensor Z Calibration Point	1mm
Recommended Measurement Distance from Surface	1.4mm



# ANNEX I: Dipole Calibration Certificate

## 835MHz Dipole



In Collaboration with  
**s p e a g**  
CALIBRATION LABORATORY



中国认可  
国际互认  
校准  
CALIBRATION  
CNAS L0570

Add: No.52 HuaYuanBei Road, Haidian District, Beijing, 100191, Chi  
Tel: +86-10-62304633-2079 Fax: +86-10-62304633-2504  
E-mail: cttl@chinattl.com http://www.chinattl.cn

Client SAICT

Certificate No: Z21-60355

### CALIBRATION CERTIFICATE

Object: D835V2 - SN: 4d057

Calibration Procedure(s): FF-Z11-003-01  
Calibration Procedures for dipole validation kits

Calibration date: October 18, 2021

This calibration Certificate documents the traceability to national standards, which realize the physical units of measurements (SI). The measurements and the uncertainties with confidence probability are given on the following pages and are part of the certificate.

All calibrations have been conducted in the closed laboratory facility: environment temperature (22±3)°C and humidity<70%.

Calibration Equipment used (M&TE critical for calibration)

Primary Standards	ID #	Cal Date (Calibrated by, Certificate No.)	Scheduled Calibration
Power Meter NRP2	106277	24-Sep-21 (CTTL, No.J21X08326)	Sep-22
Power sensor NRP8S	104291	24-Sep-21 (CTTL, No.J21X08326)	Sep-22
Reference Probe EX3DV4	SN 7517	03-Feb-21(CTTL-SPEAG, No.Z21-60001)	Feb-22
DAE4	SN 1556	15-Jan-21(SPEAG, No.DAE4-1556_Jan21)	Jan-22
Secondary Standards	ID #	Cal Date (Calibrated by, Certificate No.)	Scheduled Calibration
Signal Generator E4438C	MY49071430	01-Feb-21 (CTTL, No.J21X00593)	Jan-22
NetworkAnalyzer E5071C	MY46110673	14-Jan-21 (CTTL, No.J21X00232)	Jan-22

	Name	Function	Signature
Calibrated by:	Zhao Jing	SAR Test Engineer	
Reviewed by:	Lin Hao	SAR Test Engineer	
Approved by:	Qi Dianyuan	SAR Project Leader	

Issued: October 24, 2021

This calibration certificate shall not be reproduced except in full without written approval of the laboratory.



Add: No.52 HuaYuanBei Road, Haidian District, Beijing, 100191, China  
Tel: +86-10-62304633-2079 Fax: +86-10-62304633-2504  
E-mail: cttl@chinattl.com http://www.chinattl.cn

**Glossary:**

TSL	tissue simulating liquid
ConvF	sensitivity in TSL / NORM <sub>x,y,z</sub>
N/A	not applicable or not measured

**Calibration is Performed According to the Following Standards:**

- IEEE Std 1528-2013, "IEEE Recommended Practice for Determining the Peak Spatial-Averaged Specific Absorption Rate (SAR) in the Human Head from Wireless Communications Devices: Measurement Techniques", June 2013
- IEC 62209-1, "Measurement procedure for assessment of specific absorption rate of human exposure to radio frequency fields from hand-held and body-mounted wireless communication devices- Part 1: Device used next to the ear (Frequency range of 300MHz to 6GHz)", July 2016
- IEC 62209-2, "Procedure to measure the Specific Absorption Rate (SAR) For wireless communication devices used in close proximity to the human body (frequency range of 30MHz to 6GHz)", March 2010
- KDB865664, SAR Measurement Requirements for 100 MHz to 6 GHz

**Additional Documentation:**

- DASY4/5 System Handbook

**Methods Applied and Interpretation of Parameters:**

- Measurement Conditions:* Further details are available from the Validation Report at the end of the certificate. All figures stated in the certificate are valid at the frequency indicated.
- Antenna Parameters with TSL:* The dipole is mounted with the spacer to position its feed point exactly below the center marking of the flat phantom section, with the arms oriented parallel to the body axis.
- Feed Point Impedance and Return Loss:* These parameters are measured with the dipole positioned under the liquid filled phantom. The impedance stated is transformed from the measurement at the SMA connector to the feed point. The Return Loss ensures low reflected power. No uncertainty required.
- Electrical Delay:* One-way delay between the SMA connector and the antenna feed point. No uncertainty required.
- SAR measured:* SAR measured at the stated antenna input power.
- SAR normalized:* SAR as measured, normalized to an input power of 1 W at the antenna connector.
- SAR for nominal TSL parameters:* The measured TSL parameters are used to calculate the nominal SAR result.

The reported uncertainty of measurement is stated as the standard uncertainty of Measurement multiplied by the coverage factor  $k=2$ , which for a normal distribution Corresponds to a coverage probability of approximately 95%.



Add: No.52 HuaYuanBei Road, Haidian District, Beijing, 100191, China  
 Tel: +86-10-62304633-2079 Fax: +86-10-62304633-2504  
 E-mail: cttl@chinattl.com http://www.chinattl.cn

**Measurement Conditions**

DASY system configuration, as far as not given on page 1.

DASY Version	DASY52	V52.10.4
Extrapolation	Advanced Extrapolation	
Phantom	Triple Flat Phantom 5.1C	
Distance Dipole Center - TSL	15 mm	with Spacer
Zoom Scan Resolution	dx, dy, dz = 5 mm	
Frequency	835 MHz ± 1 MHz	

**Head TSL parameters**

The following parameters and calculations were applied.

	Temperature	Permittivity	Conductivity
Nominal Head TSL parameters	22.0 °C	41.5	0.90 mho/m
Measured Head TSL parameters	(22.0 ± 0.2) °C	40.9 ± 6 %	0.89 mho/m ± 6 %
Head TSL temperature change during test	<1.0 °C	---	---

**SAR result with Head TSL**

SAR averaged over 1 cm <sup>3</sup> (1 g) of Head TSL	Condition	
SAR measured	250 mW input power	2.39 W/kg
SAR for nominal Head TSL parameters	normalized to 1W	<b>9.64 W/kg ± 18.8 % (k=2)</b>
SAR averaged over 10 cm <sup>3</sup> (10 g) of Head TSL	Condition	
SAR measured	250 mW input power	1.56 W/kg
SAR for nominal Head TSL parameters	normalized to 1W	<b>6.29 W/kg ± 18.7 % (k=2)</b>



Add: No.52 HuaYuanBei Road, Haidian District, Beijing, 100191, China  
Tel: +86-10-62304633-2079 Fax: +86-10-62304633-2504  
E-mail: cttl@chinattl.com http://www.chinattl.cn

**Appendix (Additional assessments outside the scope of CNAS L0570)**

**Antenna Parameters with Head TSL**

Impedance, transformed to feed point	49.8Ω- 4.19jΩ
Return Loss	- 27.5dB

**General Antenna Parameters and Design**

Electrical Delay (one direction)	1.301 ns
----------------------------------	----------

After long term use with 100W radiated power, only a slight warming of the dipole near the feedpoint can be measured.

The dipole is made of standard semirigid coaxial cable. The center conductor of the feeding line is directly connected to the second arm of the dipole. The antenna is therefore short-circuited for DC-signals. On some of the dipoles, small end caps are added to the dipole arms in order to improve matching when loaded according to the position as explained in the "Measurement Conditions" paragraph. The SAR data are not affected by this change. The overall dipole length is still according to the Standard. No excessive force must be applied to the dipole arms, because they might bend or the soldered connections near the feedpoint may be damaged.

**Additional EUT Data**

Manufactured by	SPEAG
-----------------	-------



Add: No.52 HuaYuanBei Road, Haidian District, Beijing, 100191, China  
 Tel: +86-10-62304633-2079 Fax: +86-10-62304633-2504  
 E-mail: cttl@chinattl.com http://www.chinattl.cn

**DASY5 Validation Report for Head TSL**

Date: 10.18.2021

Test Laboratory: CTTL, Beijing, China

**DUT: Dipole 835 MHz; Type: D835V2; Serial: D835V2 - SN: 4d057**

Communication System: UID 0, CW; Frequency: 835 MHz; Duty Cycle: 1:1

Medium parameters used:  $f = 835$  MHz;  $\sigma = 0.886$  S/m;  $\epsilon_r = 40.9$ ;  $\rho = 1000$  kg/m<sup>3</sup>

Phantom section: Right Section

DASY5 Configuration:

- Probe: EX3DV4 - SN7517; ConvF(9.81, 9.81, 9.81) @ 835 MHz; Calibrated: 2021-02-03
- Sensor-Surface: 1.4mm (Mechanical Surface Detection)
- Electronics: DAE4 Sn1556; Calibrated: 2021-01-15
- Phantom: MFP\_V5.1C (20deg probe tilt); Type: QD 000 P51 Cx; Serial: 1062
- Measurement SW: DASY52, Version 52.10 (4); SEMCAD X Version 14.6.14 (7501)

**Dipole Calibration/Zoom Scan (7x7x7) (7x7x7)/Cube 0:** Measurement grid: dx=5mm, dy=5mm, dz=5mm

Reference Value = 58.86 V/m; Power Drift = 0.00 dB

Peak SAR (extrapolated) = 3.68 W/kg

**SAR(1 g) = 2.39 W/kg; SAR(10 g) = 1.56 W/kg**

Smallest distance from peaks to all points 3 dB below = 18 mm

Ratio of SAR at M2 to SAR at M1 = 64.9%

Maximum value of SAR (measured) = 3.23 W/kg

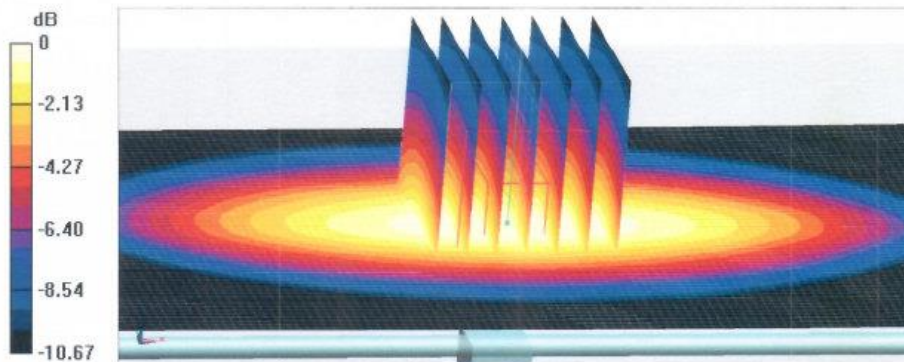

0 dB = 3.23 W/kg = 5.09 dBW/kg



Add: No.52 HuaYuanBei Road, Haidian District, Beijing, 100191, China  
Tel: +86-10-62304633-2079 Fax: +86-10-62304633-2504  
E-mail: cttl@chinattl.com http://www.chinattl.cn

Impedance Measurement Plot for Head TSL

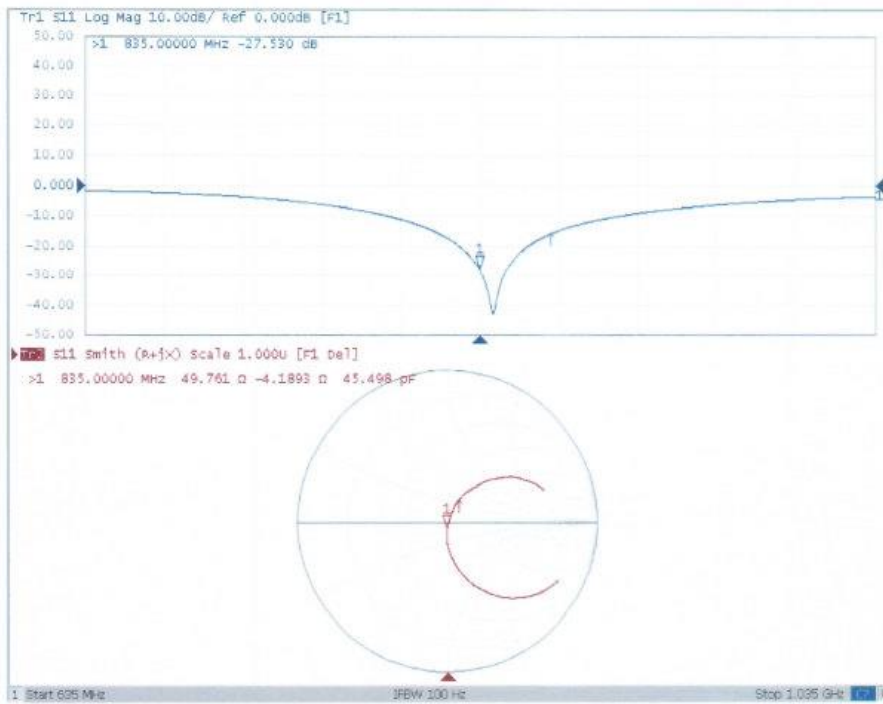



1750MHz Dipole



Add: No.52 HuaYuanBei Road, Haidian District, Beijing, 100191  
Tel: +86-10-62304633-2117  
E-mail: emf@caict.ac.cn http://www.caict.ac.cn



中国认可  
国际互认  
校准  
CALIBRATION  
CNAS L0570



Client SAICT

Certificate No: Z22-60335

CALIBRATION CERTIFICATE

Object D1750V2 - SN: 1152  
Calibration Procedure(s) FF-Z11-003-01  
Calibration Procedures for dipole validation kits  
Calibration date: August 22, 2022

This calibration Certificate documents the traceability to national standards, which realize the physical units of measurements (SI). The measurements and the uncertainties with confidence probability are given on the following pages and are part of the certificate.

All calibrations have been conducted in the closed laboratory facility: environment temperature (22±3)°C and humidity<70%.

Calibration Equipment used (M&TE critical for calibration)

Primary Standards	ID #	Cal Date (Calibrated by, Certificate No.)	Scheduled Calibration
Power Meter NRP2	106277	24-Sep-21 (CTTL, No.J21X08326)	Sep-22
Power sensor NRP8S	104291	24-Sep-21 (CTTL, No.J21X08326)	Sep-22
Reference Probe EX3DV4	SN 7464	26-Jan-22(SPEAG,No.EX3-7464_Jan22)	Jan-23
DAE4	SN 1556	12-Jan-22(CTTL-SPEAG,No.Z22-60007)	Jan-23
Secondary Standards	ID #	Cal Date (Calibrated by, Certificate No.)	Scheduled Calibration
Signal Generator E4438C	MY49071430	13-Jan-22 (CTTL, No.J22X00409)	Jan-23
Network Analyzer E5071C	MY46110673	14-Jan-22 (CTTL, No.J22X00406)	Jan-23

	Name	Function	Signature
Calibrated by:	Zhao Jing	SAR Test Engineer	
Reviewed by:	Lin Hao	SAR Test Engineer	
Approved by:	Qi Dianyuan	SAR Project Leader	

Issued: August 26, 2022

This calibration certificate shall not be reproduced except in full without written approval of the laboratory.





Add: No.52 HuaYuanBei Road, Haidian District, Beijing, 100191, China  
Tel: +86-10-62304633-2117  
E-mail: emf@caict.ac.cn <http://www.caict.ac.cn>

**Glossary:**

TSL	tissue simulating liquid
ConvF	sensitivity in TSL / NORM <sub>x,y,z</sub>
N/A	not applicable or not measured

**Calibration is Performed According to the Following Standards:**

- IEC/IEEE 62209-1528, "Measurement Procedure for The Assessment of Specific Absorption Rate of Human Exposure to Radio Frequency Fields from Hand-held and Body-mounted Wireless Communication Devices- Part 1528: Human Models, Instrumentation and Procedures (Frequency range of 4 MHz to 10 GHz)", October 2020
- KDB 865664, "SAR Measurement Requirements for 100 MHz to 6 GHz"

**Additional Documentation:**

- DASY4/5 System Handbook

**Methods Applied and Interpretation of Parameters:**

- Measurement Conditions:** Further details are available from the Validation Report at the end of the certificate. All figures stated in the certificate are valid at the frequency indicated.
- Antenna Parameters with TSL:** The dipole is mounted with the spacer to position its feed point exactly below the center marking of the flat phantom section, with the arms oriented parallel to the body axis.
- Feed Point Impedance and Return Loss:** These parameters are measured with the dipole positioned under the liquid filled phantom. The impedance stated is transformed from the measurement at the SMA connector to the feed point. The Return Loss ensures low reflected power. No uncertainty required.
- Electrical Delay:** One-way delay between the SMA connector and the antenna feed point. No uncertainty required.
- SAR measured:** SAR measured at the stated antenna input power.
- SAR normalized:** SAR as measured, normalized to an input power of 1 W at the antenna connector.
- SAR for nominal TSL parameters:** The measured TSL parameters are used to calculate the nominal SAR result.

The reported uncertainty of measurement is stated as the standard uncertainty of Measurement multiplied by the coverage factor  $k=2$ , which for a normal distribution corresponds to a coverage probability of approximately 95%.



Add: No.52 HuaYuanBei Road, Haidian District, Beijing, 100191, China  
 Tel: +86-10-62304633-2117  
 E-mail: emf@caict.ac.cn http://www.caict.ac.cn

### Measurement Conditions

DASY system configuration, as far as not given on page 1.

DASY Version	DASY52	52.10.4
Extrapolation	Advanced Extrapolation	
Phantom	Triple Flat Phantom 5.1C	
Distance Dipole Center - TSL	10 mm	with Spacer
Zoom Scan Resolution	dx, dy, dz = 5 mm	
Frequency	1750 MHz $\pm$ 1 MHz	

### Head TSL parameters

The following parameters and calculations were applied.

	Temperature	Permittivity	Conductivity
Nominal Head TSL parameters	22.0 °C	40.1	1.37 mho/m
Measured Head TSL parameters	(22.0 $\pm$ 0.2) °C	41.3 $\pm$ 6 %	1.41 mho/m $\pm$ 6 %
Head TSL temperature change during test	<1.0 °C	---	---

### SAR result with Head TSL

SAR averaged over 1 $cm^3$ (1 g) of Head TSL	Condition	
SAR measured	250 mW input power	9.18 W/kg
SAR for nominal Head TSL parameters	normalized to 1W	<b>36.3 W/kg <math>\pm</math> 18.8 % (k=2)</b>
SAR averaged over 10 $cm^3$ (10 g) of Head TSL	Condition	
SAR measured	250 mW input power	4.94 W/kg
SAR for nominal Head TSL parameters	normalized to 1W	<b>19.6 W/kg <math>\pm</math> 18.7 % (k=2)</b>



Add: No.52 HuaYuanBei Road, Haidian District, Beijing, 100191, China  
Tel: +86-10-62304633-2117  
E-mail: emf@caict.ac.cn      http://www.caict.ac.cn



#### Appendix (Additional assessments outside the scope of CNAS L0570)

##### Antenna Parameters with Head TSL

Impedance, transformed to feed point	47.9Ω- 0.71jΩ
Return Loss	- 32.8dB

##### General Antenna Parameters and Design

Electrical Delay (one direction)	1.120 ns
----------------------------------	----------

After long term use with 100W radiated power, only a slight warming of the dipole near the feed-point can be measured.

The dipole is made of standard semirigid coaxial cable. The center conductor of the feeding line is directly connected to the second arm of the dipole. The antenna is therefore short-circuited for DC-signals. On some of the dipoles, small end caps are added to the dipole arms in order to improve matching when loaded according to the position as explained in the "Measurement Conditions" paragraph. The SAR data are not affected by this change. The overall dipole length is still according to the Standard. No excessive force must be applied to the dipole arms, because they might bend or the soldered connections near the feed-point may be damaged.

##### Additional EUT Data

Manufactured by	SPEAG
-----------------	-------