



TEST REPORT

No. I22N00378-DFS

TCL Communication Ltd.

Tablet PC

Model Name: 9132X

with

Hardware Version: PIO

Software Version: CS61

FCC ID: 2ACCJB176

Issued Date: 2022-03-18

Designation Number: CN1210

Note:

The test results in this test report relate only to the devices specified in this report. This report shall not be reproduced except in full without the written approval of SAICT.

Test Laboratory:

Shenzhen Academy of Information and Communications Technology

Building G, Shenzhen International Innovation Center, No.1006 Shennan Road, Futian District, Shenzhen, Guangdong, P. R. China 518000.

Tel: +86(0)755-33322000, Fax: +86(0)755-33322001

Email: yewu@caict.ac.cn, website: www.cszit.com



CONTENTS

1.	SUMMARY OF TEST REPORT.....	3
1.1.	TEST ITEMS.....	3
1.2.	TEST STANDARDS	3
1.3.	TEST RESULT	3
1.4.	TESTING LOCATION	3
1.5.	PROJECT DATA	3
1.6.	SIGNATURE	3
2.	CLIENT INFORMATION.....	4
2.1.	APPLICANT INFORMATION.....	4
2.2.	MANUFACTURER INFORMATION	4
3.	EQUIPMENT UNDER TEST (EUT) AND ANCILLARY EQUIPMENT(AE)	5
3.1.	ABOUT EUT	5
3.2.	INTERNAL IDENTIFICATION OF EUT	5
3.3.	INTERNAL IDENTIFICATION OF AE.....	5
3.4.	GENERAL DESCRIPTION.....	5
4.	REFERENCE DOCUMENTS	6
4.1.	DOCUMENTS SUPPLIED BY APPLICANT	6
4.2.	REFERENCE DOCUMENTS FOR TESTING.....	6
5.	TEST RESULTS.....	7
5.1.	TESTING ENVIRONMENT.....	7
5.2.	TEST RESULTS	7
5.3.	STATEMENTS.....	7
6.	TEST EQUIPMENTS UTILIZED	8
7.	LABORATORY ENVIRONMENT.....	9
	ANNEX A: MEASUREMENT RESULTS.....	10
A.1.	PARAMETERS OF DFS TEST SIGNAL	10
A.2.	CHANNEL MOVE TIME AND CHANNEL CLOSING TRANSMISSION TIME	12
A.3.	NON-OCCUPANCY PERIOD	13
	ANNEX B: DFS TEST SET-UP	14
B.1.	MEASUREMENT METHOD	14
B.2.	LAYOUT OF DFS TEST.....	14



1. Summary of Test Report

1.1. Test Items

Description	Tablet PC
Model Name	9132X
Applicant's name	TCL Communication Ltd.
Manufacturer's Name	TCL Communication Ltd.

1.2. Test Standards

FCC Part15-2019; FCC 06-96-2006; KDB 905462-D02

1.3. Test Result

Pass

Please refer to 5.2 Test Results.

1.4. Testing Location

Address: Building G, Shenzhen International Innovation Center, No.1006 Shennan Road, Futian District, Shenzhen, Guangdong, P. R. China

1.5. Project data

Testing Start Date:	2022-02-10
Testing End Date:	2022-03-10

1.6. Signature

Lin Kanfeng
(Prepared this test report)

An Ran
(Reviewed this test report)

Zhang Bojun
(Approved this test report)



2. Client Information

2.1. Applicant Information

Company Name: TCL Communication Ltd.
Address: 5/F, Building 22E, 22 Science Park East Avenue, Hong Kong Science Park, Shatin, NT, Hong Kong
Contact Person: Peter yang
E-Mail: peter.yang@tcl.com
Telephone: +86 755 3664 5759
Fax: 0086-755-36612000-81722

2.2. Manufacturer Information

Company Name: TCL Communication Ltd.
Address: 5/F, Building 22E, 22 Science Park East Avenue, Hong Kong Science Park, Shatin, NT, Hong Kong
Contact Person: Peter yang
E-Mail: peter.yang@tcl.com
Telephone: +86 755 3664 5759
Fax: 0086-755-36612000-81722



3. Equipment Under Test (EUT) and Ancillary Equipment(AE)

3.1. About EUT

Description	Tablet PC
Model name	9132X
RLAN Frequency Range	ISM Band: 5250MHz~5350MHz
RLAN Protocol	IEEE 802.11a, 802.11n-HT20/40, 802.11ac-VHT20/40/80
Type of modulation	OFDM
Antenna	Integrated
Antenna Gain	1.6 dBi
Power Supply	3.85V DC by Battery
FCC ID	2ACCJB176
Device Type (DFS)	Client without radar detection (only support client mode)
With TPC	No
Condition of EUT as received	No abnormality in appearance

3.2. Internal Identification of EUT

EUT ID*	IMEI	HW Version	SW Version	Receive Date
UT02aa	/	PIO	CS61	2022-02-23

*EUT ID: is used to identify the test sample in the lab internally.

3.3. Internal Identification of AE

AE ID*	Description	SN
AE1	Battery	CAC4000018C7
AE2	Adapter	CBA0058AATC5
AE3	Adapter	CBA0058ABTC5
AE4	Adapter	CBA0058AGTC5
AE5	USB Cable	CDA0000162C2
AE6	USB Cable	CDA0000162C1

*AE ID: is used to identify the test sample in the lab internally.

3.4. General Description

The Equipment under Test (EUT) is a model of Tablet PC with integrated antenna and battery.

It consists of normal options: Lithium Battery and Charger.

Manual and specifications of the EUT were provided to fulfil the test.

Samples undergoing test were selected by the client.



4. Reference Documents

4.1. Documents supplied by applicant

EUT feature information is supplied by the applicant or manufacturer, which is the basis of testing.

4.2. Reference Documents for testing

The following documents listed in this section are referred for testing.

Reference	Title	Version
FCC Part15	Title 47 of the Code of Federal Regulations; Chapter I Part 15 - Radio frequency devices Subpart E - UNII Devices	2019
FCC 06-96	Revision of Parts 2 and 15 of the Commission's Rules to Permit Unlicensed National Information Infrastructure (U-NII) devices in the 5 GHz band	2006
KDB 905462	Compliance Measurement Procedures for Unlicensed-national Information Infrastructure Devices Operating in the 5250-5350 MHz and 5470-5725 MHz Bands Incorporating Dynamic Frequency Selection	D02

Note: This report is only for DFS



5. Test Results

5.1. Testing Environment

Normal Temperature: 15~35°C

Relative Humidity: 20~75%

5.2. Test Results

No	Test cases	Sub-clause of Part15E	Verdict
1	Channel move time and channel closing transmission time	15.407 (h)(2)(iii)	P
2	Non-Occupancy Period	15.407 (h)(2) (iv)	P

Please refer to **ANNEX A** for detail.

5.3. Statements

SAICT has evaluated the test cases requested by the applicant/manufacture as listed in section 5.2 of this report, for the EUT specified in section 3, according to the standards or reference documents listed in section 4.2.

This report only deal with the UNII DFS functions among the features described in section 3, and The EUT met all requirements of the reference documents.

The end user is not available to get and modify the parameters of the detected Radar Waveforms in this product.

Disclaimer:

A. After confirmation with the customer, the sample information provided by the customer may affect the validity of the measurement results in this report, and the impact and consequences arising therefrom shall be borne by the customer.

B. The samples in this report are provided by the customer, and the test results are only applicable to the samples received.

6. Test Equipments Utilized

Conducted test system

No.	Equipment	Model	Serial Number	Manufacturer	Calibration Due date	Calibration Period
1	Vector Signal Analyzer	FSV40	100903	Rohde & Schwarz	2022-12-29	1 year
2	Vector Signal General	SMU200A	104096	Rohde & Schwarz	2022-12-29	1 year
3	Shielding Room	S81	/	ETS-Lindgren	2022-11-14	3 year
No.	Equipment	Model	FCC ID	Manufacturer	Calibration Due date	Calibration Period
4	Master AP	BCM94709R	QDS-BR CM1091	BROADCOM	/	/

7. Laboratory Environment

Measurement is performed in shielding room.

Shielded room

Temperature	Min. = 15 °C, Max. = 35 °C
Relative humidity	Min. = 20 %, Max. = 75 %
Shielding effectiveness	0.014MHz-1MHz> 60 dB; 1MHz-1000MHz>90 dB
Electrical insulation	> 2M Ω
Ground system resistance	< 4 Ω

ANNEX A: MEASUREMENT RESULTS

A.1. Parameters of DFS test signal

1). Interference threshold values, master or client incorporation in service monitoring. For device Power less than 23 dBm (E.I.R.P.), the threshold level is -62 dBm at the antenna port after Correction for antenna gain and procedural adjustments.

Because of conducted measurement performed, the calibration power from radar signal generator to antenna port of DFS test equipment is -62 dBm.

Maximum Transmit Power	Value
> 200 mW	-64 dBm
< 200 mW	-62 dBm

2). DFS requirement values

The required values are as the following table.

Parameter	Value
Non-occupancy	> 1800 s
Channel Availability Check Time	60 s
Channel Move Time	10 s
Channel Closing Transmission Time	200 ms + 60 ms
U-NII Detection Bandwidth	Minimum 80% of the 99% transmission power bandwidth

As the EUT is IP based system, the MPEG video file from NTIA website is used to stream to EUT via the Master device.

3). Radar waveform

Radar Type	Pulse Width (µsec)	PRI (µsec)	Number of Pulses
0	1	1428	18

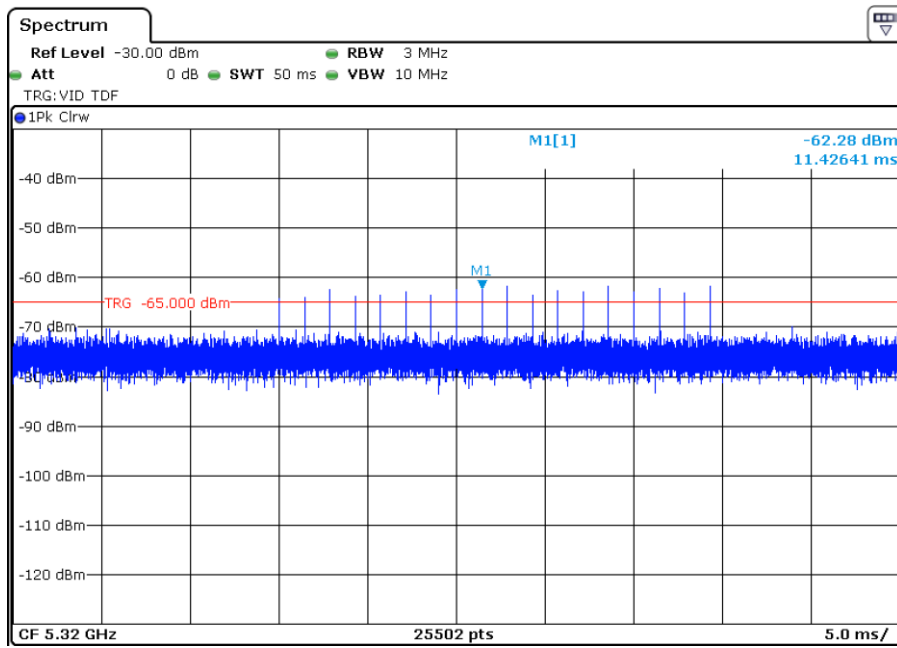

Radar Signal (Type 0)

4). Channel Loading

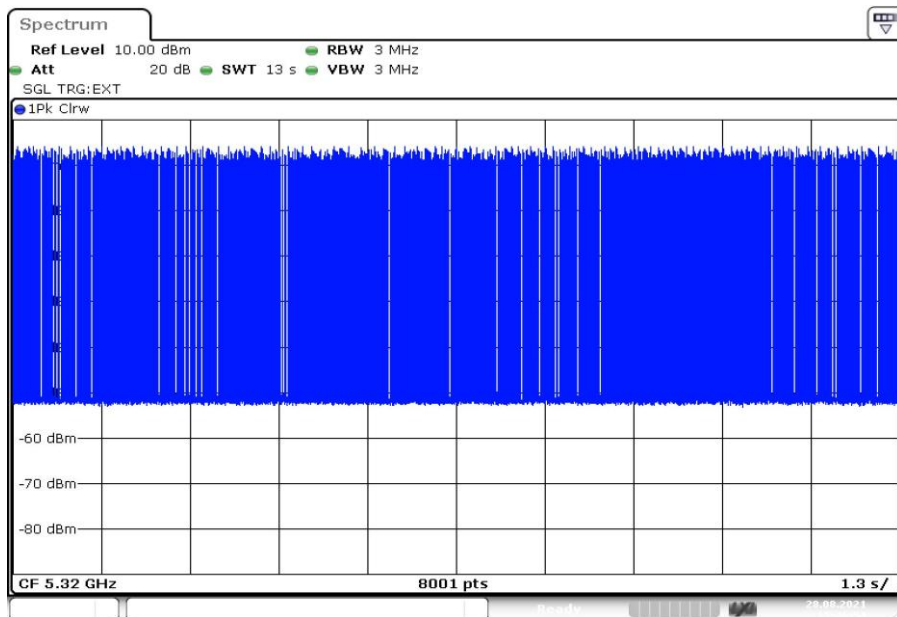

Channel load timing plot

The level of traffic loading on the channel by EUT is > 17%.

5). IP Based Systems

The channel loading data file will be transferred from the Master Device to the Client Device for all test configurations.

A.2. Channel move time and channel closing transmission time

Measurement Limit:

Test Items	Limit
channel closing transmission time	< 200 ms + 60 ms
Channel move time	< 10 s

Measurement Results:

Mode	Channel	Test Results	Conclusion
802.11a	5320MHz (CH64)	Fig.1	P
802.11ac-VHT80	5290MHz (CH58)	Fig.2	P

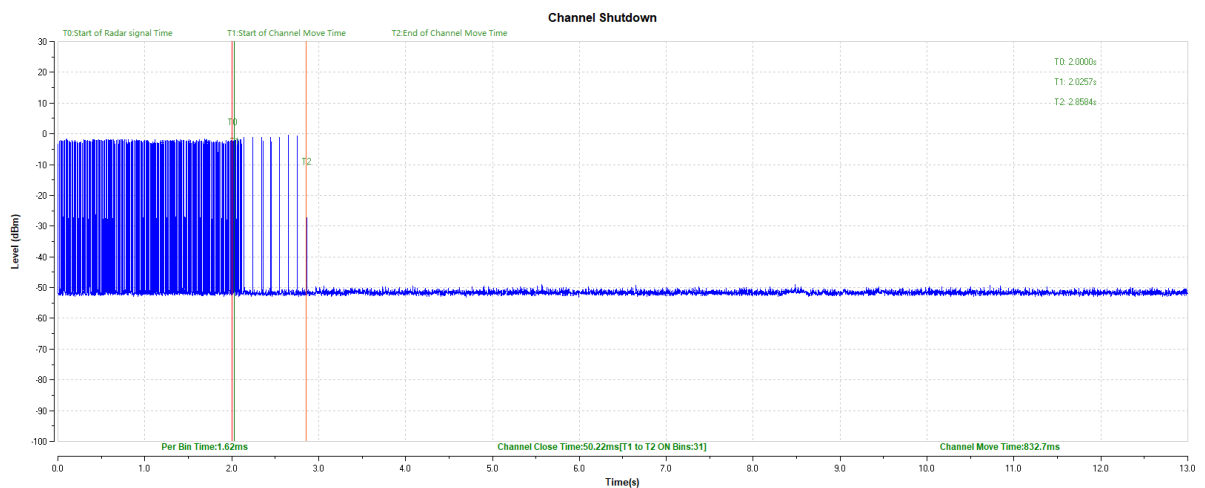

Fig.1 Channel Move Time & Channel Closing Transmission Time (HT20 Frequency Band: 5250MHz ~ 5350MHz)

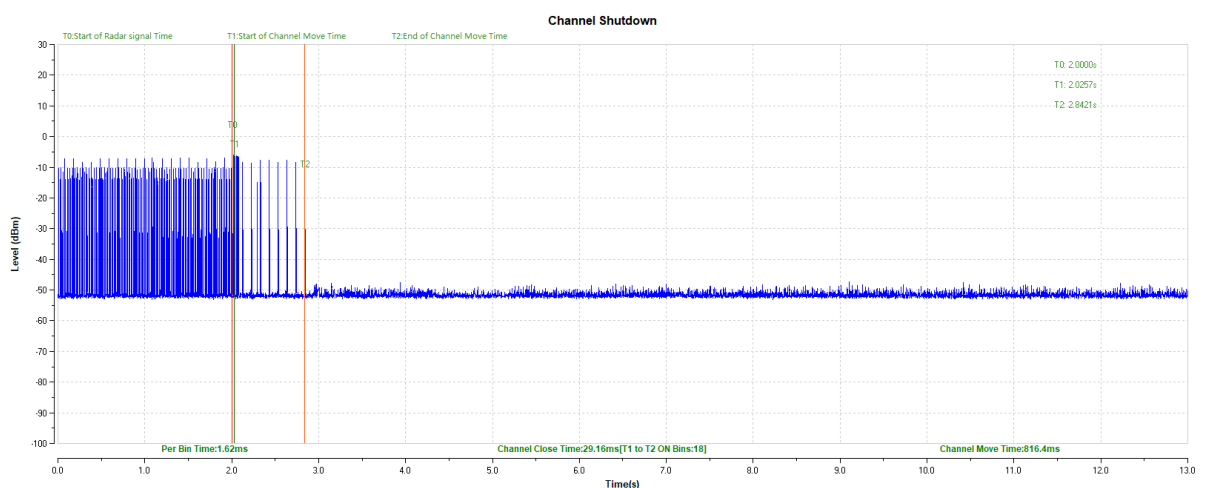

Fig.2 Channel Move Time & Channel Closing Transmission Time (HT80 Frequency Band: 5250MHz ~ 5350MHz)

A.3. Non-Occupancy Period

Measurement Limit:

Test Items	Limit
Non-Occupancy Period	> 1800 s

Measurement Results:

Mode	Channel	Test Results	Conclusion
802.11a	5320MHz (CH64)	Fig.3	P
802.11ac-VHT80	5290MHz (CH58)	Fig.4	P

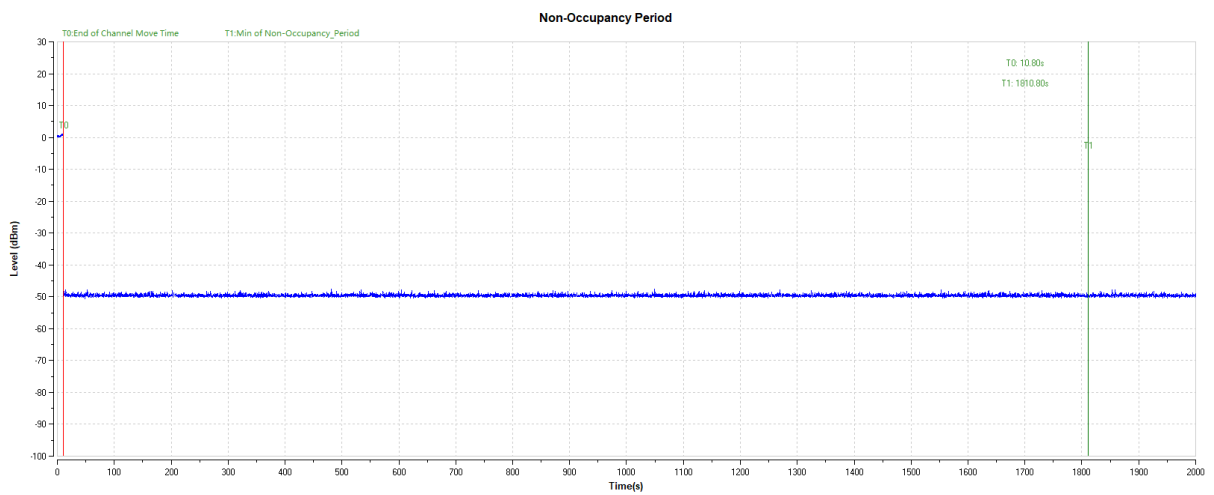

Fig.3 Non-Occupancy Period (HT20 Frequency Band: 5250MHz ~ 5350MHz)

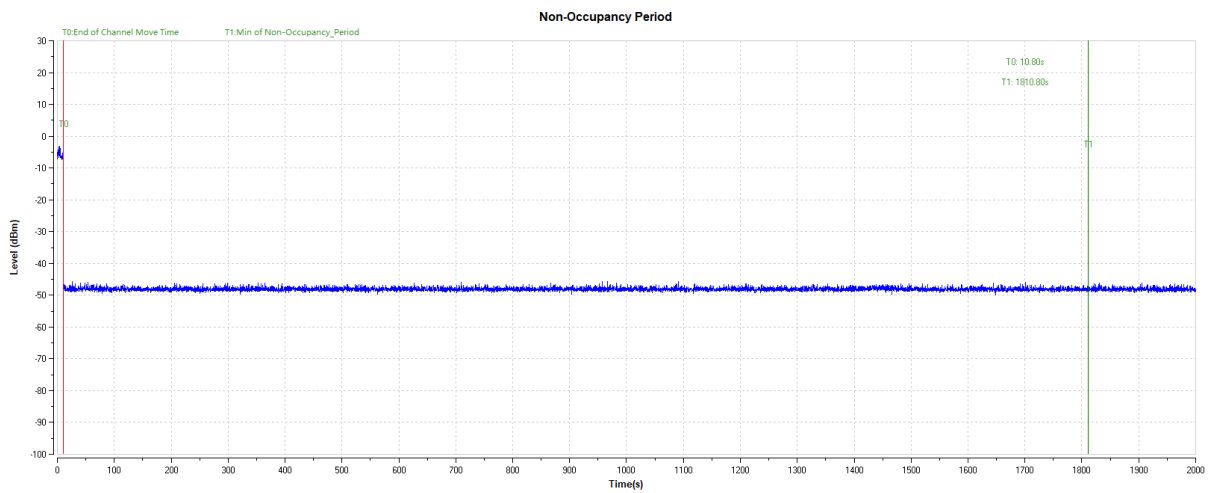
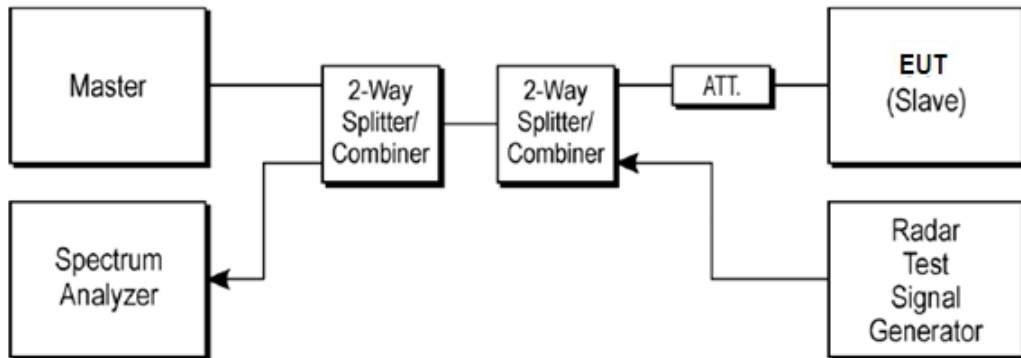

Fig.4 Non-Occupancy Period (HT80 Frequency Band: 5250MHz ~ 5350MHz)

ANNEX B: DFS TEST SET-UP

B.1. Measurement Method

The below figure shows the DFS setup, where the EUT is a WLAN device operating in slave mode, without Radar Interference Detection function. This setup also contains a device operating in master mode. The radar test signals are injected into the master device. The EUT (slave device) is associated with the master device. WLAN traffic is generated by streaming the mpeg file from the master to the slave in full monitor video mode using the media player.



B.2. Layout of DFS Test



*** END OF REPORT BODY ***