



Add: No.51 Xueyuan Road, Haidian District, Beijing, 100191, China
Tel: +86-10-62304633-2512 Fax: +86-10-62304633-2504
E-mail: cttl@chinattl.com http://www.chinattl.cn

Glossary:

TSL	tissue simulating liquid
ConvF	sensitivity in TSL / NORM _{x,y,z}
N/A	not applicable or not measured

Calibration is Performed According to the Following Standards:

- a) IEEE Std 1528-2013, "IEEE Recommended Practice for Determining the Peak Spatial-Averaged Specific Absorption Rate (SAR) in the Human Head from Wireless Communications Devices: Measurement Techniques", June 2013
- b) IEC 62209-1, "Measurement procedure for assessment of specific absorption rate of human exposure to radio frequency fields from hand-held and body-mounted wireless communication devices- Part 1: Device used next to the ear (Frequency range of 300MHz to 6GHz)", July 2016
- c) IEC 62209-2, "Procedure to measure the Specific Absorption Rate (SAR) For wireless communication devices used in close proximity to the human body (frequency range of 30MHz to 6GHz)", March 2010
- d) KDB865664, SAR Measurement Requirements for 100 MHz to 6 GHz

Additional Documentation:

- e) DASY4/5 System Handbook

Methods Applied and Interpretation of Parameters:

- *Measurement Conditions:* Further details are available from the Validation Report at the end of the certificate. All figures stated in the certificate are valid at the frequency indicated.
- *Antenna Parameters with TSL:* The dipole is mounted with the spacer to position its feed point exactly below the center marking of the flat phantom section, with the arms oriented parallel to the body axis.
- *Feed Point Impedance and Return Loss:* These parameters are measured with the dipole positioned under the liquid filled phantom. The impedance stated is transformed from the measurement at the SMA connector to the feed point. The Return Loss ensures low reflected power. No uncertainty required.
- *Electrical Delay:* One-way delay between the SMA connector and the antenna feed point. No uncertainty required.
- *SAR measured:* SAR measured at the stated antenna input power.
- *SAR normalized:* SAR as measured, normalized to an input power of 1 W at the antenna connector.
- *SAR for nominal TSL parameters:* The measured TSL parameters are used to calculate the nominal SAR result.

The reported uncertainty of measurement is stated as the standard uncertainty of Measurement multiplied by the coverage factor $k=2$, which for a normal distribution Corresponds to a coverage probability of approximately 95%.



Add: No.51 Xueyuan Road, Haidian District, Beijing, 100191, China
 Tel: +86-10-62304633-2512 Fax: +86-10-62304633-2504
 E-mail: cttl@chinattl.com http://www.chinattl.cn

Measurement Conditions

DASY system configuration, as far as not given on page 1.

DASY Version	DASY52	V52.10.2
Extrapolation	Advanced Extrapolation	
Phantom	Triple Flat Phantom 5.1C	
Distance Dipole Center - TSL	10 mm	with Spacer
Zoom Scan Resolution	dx, dy = 4 mm, dz = 1.4 mm	Graded Ratio = 1.4 (Z direction)
Frequency	5250 MHz ± 1 MHz 5600 MHz ± 1 MHz 5750 MHz ± 1 MHz	

Head TSL parameters at 5250 MHz

The following parameters and calculations were applied.

	Temperature	Permittivity	Conductivity
Nominal Head TSL parameters	22.0 °C	35.9	4.71 mho/m
Measured Head TSL parameters	(22.0 ± 0.2) °C	35.7 ± 6 %	4.69 mho/m ± 6 %
Head TSL temperature change during test	<1.0 °C	----	----

SAR result with Head TSL at 5250 MHz

SAR averaged over 1 cm ³ (1 g) of Head TSL	Condition	
SAR measured	100 mW input power	7.81 W/kg
SAR for nominal Head TSL parameters	normalized to 1W	78.0 W/kg ± 24.4 % (k=2)
SAR averaged over 10 cm ³ (10 g) of Head TSL	Condition	
SAR measured	100 mW input power	2.23 W/kg
SAR for nominal Head TSL parameters	normalized to 1W	22.3 W/kg ± 24.2 % (k=2)



Add: No.51 Xueyuan Road, Haidian District, Beijing, 100191, China
 Tel: +86-10-62304633-2512 Fax: +86-10-62304633-2504
 E-mail: cttl@chinattl.com http://www.chinattl.cn

Head TSL parameters at 5600 MHz

The following parameters and calculations were applied.

	Temperature	Permittivity	Conductivity
Nominal Head TSL parameters	22.0 °C	35.5	5.07 mho/m
Measured Head TSL parameters	(22.0 ± 0.2) °C	35.4 ± 6 %	4.99 mho/m ± 6 %
Head TSL temperature change during test	<1.0 °C	----	----

SAR result with Head TSL at 5600 MHz

SAR averaged over 1 cm ³ (1 g) of Head TSL	Condition	
SAR measured	100 mW input power	7.96 W/kg
SAR for nominal Head TSL parameters	normalized to 1W	79.5 W/kg ± 24.4 % (k=2)
SAR averaged over 10 cm ³ (10 g) of Head TSL	Condition	
SAR measured	100 mW input power	2.27 W/kg
SAR for nominal Head TSL parameters	normalized to 1W	22.7 W/kg ± 24.2 % (k=2)

Head TSL parameters at 5750 MHz

The following parameters and calculations were applied.

	Temperature	Permittivity	Conductivity
Nominal Head TSL parameters	22.0 °C	35.4	5.22 mho/m
Measured Head TSL parameters	(22.0 ± 0.2) °C	35.1 ± 6 %	5.10 mho/m ± 6 %
Head TSL temperature change during test	<1.0 °C	----	----

SAR result with Head TSL at 5750 MHz

SAR averaged over 1 cm ³ (1 g) of Head TSL	Condition	
SAR measured	100 mW input power	7.86 W/kg
SAR for nominal Head TSL parameters	normalized to 1W	78.4 W/kg ± 24.4 % (k=2)
SAR averaged over 10 cm ³ (10 g) of Head TSL	Condition	
SAR measured	100 mW input power	2.23 W/kg
SAR for nominal Head TSL parameters	normalized to 1W	22.2 W/kg ± 24.2 % (k=2)



Add: No.51 Xueyuan Road, Haidian District, Beijing, 100191, China
 Tel: +86-10-62304633-2512 Fax: +86-10-62304633-2504
 E-mail: cttl@chinattl.com http://www.chinattl.cn

Body TSL parameters at 5250 MHz

The following parameters and calculations were applied.

	Temperature	Permittivity	Conductivity
Nominal Body TSL parameters	22.0 °C	48.9	5.36 mho/m
Measured Body TSL parameters	(22.0 ± 0.2) °C	48.1 ± 6 %	5.40 mho/m ± 6 %
Body TSL temperature change during test	<1.0 °C	----	----

SAR result with Body TSL at 5250 MHz

SAR averaged over 1 cm ³ (1 g) of Body TSL	Condition	
SAR measured	100 mW input power	7.17 W/kg
SAR for nominal Body TSL parameters	normalized to 1W	71.5 W/kg ± 24.4 % (k=2)
SAR averaged over 10 cm ³ (10 g) of Body TSL	Condition	
SAR measured	100 mW input power	2.04 W/kg
SAR for nominal Body TSL parameters	normalized to 1W	20.3 W/kg ± 24.2 % (k=2)

Body TSL parameters at 5600 MHz

The following parameters and calculations were applied.

	Temperature	Permittivity	Conductivity
Nominal Body TSL parameters	22.0 °C	48.5	5.77 mho/m
Measured Body TSL parameters	(22.0 ± 0.2) °C	47.6 ± 6 %	5.70 mho/m ± 6 %
Body TSL temperature change during test	<1.0 °C	----	----

SAR result with Body TSL at 5600 MHz

SAR averaged over 1 cm ³ (1 g) of Body TSL	Condition	
SAR measured	100 mW input power	7.62 W/kg
SAR for nominal Body TSL parameters	normalized to 1W	75.9 W/kg ± 24.4 % (k=2)
SAR averaged over 10 cm ³ (10 g) of Body TSL	Condition	
SAR measured	100 mW input power	2.18 W/kg
SAR for nominal Body TSL parameters	normalized to 1W	21.7 W/kg ± 24.2 % (k=2)



Add: No.51 Xueyuan Road, Haidian District, Beijing, 100191, China
 Tel: +86-10-62304633-2512 Fax: +86-10-62304633-2504
 E-mail: cttl@chinattl.com http://www.chinattl.cn

Body TSL parameters at 5750 MHz

The following parameters and calculations were applied.

	Temperature	Permittivity	Conductivity
Nominal Body TSL parameters	22.0 °C	48.3	5.94 mho/m
Measured Body TSL parameters	(22.0 ± 0.2) °C	47.5 ± 6 %	5.78 mho/m ± 6 %
Body TSL temperature change during test	<1.0 °C	----	----

SAR result with Body TSL at 5750 MHz

SAR averaged over 1 cm³ (1 g) of Body TSL	Condition	
SAR measured	100 mW input power	7.39 W/kg
SAR for nominal Body TSL parameters	normalized to 1W	73.6 W/kg ± 24.4 % (k=2)
SAR averaged over 10 cm³ (10 g) of Body TSL	Condition	
SAR measured	100 mW input power	2.10 W/kg
SAR for nominal Body TSL parameters	normalized to 1W	20.9 W/kg ± 24.2 % (k=2)

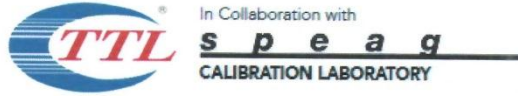

Add: No.51 Xueyuan Road, Haidian District, Beijing, 100191, China
Tel: +86-10-62304633-2512 Fax: +86-10-62304633-2504
E-mail: cttl@chinattl.com http://www.chinattl.cn

Appendix (Additional assessments outside the scope of CNAS L0570)

Antenna Parameters with Head TSL at 5250 MHz

Impedance, transformed to feed point	48.8Ω - 4.65jΩ
Return Loss	- 26.2dB

Antenna Parameters with Head TSL at 5600 MHz

Impedance, transformed to feed point	49.2Ω + 0.58jΩ
Return Loss	- 40.0dB

Antenna Parameters with Head TSL at 5750 MHz

Impedance, transformed to feed point	50.3Ω + 1.08jΩ
Return Loss	- 39.0dB

Antenna Parameters with Body TSL at 5250 MHz

Impedance, transformed to feed point	48.8Ω - 2.02jΩ
Return Loss	- 32.5dB

Antenna Parameters with Body TSL at 5600 MHz

Impedance, transformed to feed point	51.3Ω + 3.94jΩ
Return Loss	- 27.8dB

Antenna Parameters with Body TSL at 5750 MHz

Impedance, transformed to feed point	52.2Ω + 4.77jΩ
Return Loss	- 25.8dB



Add: No.51 Xueyuan Road, Haidian District, Beijing, 100191, China
Tel: +86-10-62304633-2512 Fax: +86-10-62304633-2504
E-mail: cttl@chinattl.com http://www.chinattl.cn

General Antenna Parameters and Design

Electrical Delay (one direction)	1.059 ns
----------------------------------	----------

After long term use with 100W radiated power, only a slight warming of the dipole near the feedpoint can be measured.

The dipole is made of standard semirigid coaxial cable. The center conductor of the feeding line is directly connected to the second arm of the dipole. The antenna is therefore short-circuited for DC-signals. On some of the dipoles, small end caps are added to the dipole arms in order to improve matching when loaded according to the position as explained in the "Measurement Conditions" paragraph. The SAR data are not affected by this change. The overall dipole length is still according to the Standard.

No excessive force must be applied to the dipole arms, because they might bend or the soldered connections near the feedpoint may be damaged.

Additional EUT Data

Manufactured by	SPEAG
-----------------	-------



Add: No.51 Xueyuan Road, Haidian District, Beijing, 100191, China
Tel: +86-10-62304633-2512 Fax: +86-10-62304633-2504
E-mail: cttl@chinattl.com http://www.chinattl.cn

DASY5 Validation Report for Head TSL

Date: 08.28.2019

Test Laboratory: CTTL, Beijing, China

DUT: Dipole 5GHz; Type: D5GHzV2; Serial: D5GHzV2 - SN: 1238

Communication System: CW; Frequency: 5250 MHz, Frequency: 5600 MHz,
Frequency: 5750 MHz,

Medium parameters used: $f = 5250$ MHz; $\sigma = 4.692$ S/m; $\epsilon_r = 35.71$; $\rho = 1000$ kg/m³,
Medium parameters used: $f = 5600$ MHz; $\sigma = 4.992$ S/m; $\epsilon_r = 35.42$; $\rho = 1000$ kg/m³,
Medium parameters used: $f = 5750$ MHz; $\sigma = 5.096$ S/m; $\epsilon_r = 35.13$; $\rho = 1000$ kg/m³,

Phantom section: Center Section

DASY5 Configuration:

- Probe: EX3DV4 - SN3617; ConvF(5.39, 5.39, 5.39) @ 5250 MHz; ConvF(5.06, 5.06, 5.06) @ 5600 MHz; ConvF(5.07, 5.07, 5.07) @ 5750 MHz; Calibrated: 1/31/2019
- Sensor-Surface: 1.4mm (Mechanical Surface Detection)
- Electronics: DAE4 Sn1555; Calibrated: 8/22/2019
- Phantom: MFP_V5.1C ; Type: QD 000 P51CA; Serial: 1062
- Measurement SW: DASY52, Version 52.10 (2); SEMCAD X Version 14.6.12 (7470)

Dipole Calibration /Pin=100mW, d=10mm, f=5250 MHz/Zoom Scan,**dist=1.4mm (8x8x7)/Cube 0:** Measurement grid: dx=4mm, dy=4mm, dz=1.4mm

Reference Value = 69.41 V/m; Power Drift = -0.05 dB

Peak SAR (extrapolated) = 32.8 W/kg

SAR(1 g) = 7.81 W/kg; SAR(10 g) = 2.23 W/kg

Maximum value of SAR (measured) = 18.7 W/kg

Dipole Calibration /Pin=100mW, d=10mm, f=5600 MHz/Zoom Scan,**dist=1.4mm (8x8x7)/Cube 0:** Measurement grid: dx=4mm, dy=4mm, dz=1.4mm

Reference Value = 70.02 V/m; Power Drift = 0.04 dB

Peak SAR (extrapolated) = 35.7 W/kg

SAR(1 g) = 7.96 W/kg; SAR(10 g) = 2.27 W/kg

Maximum value of SAR (measured) = 19.2 W/kg

Dipole Calibration /Pin=100mW, d=10mm, f=5750 MHz/Zoom Scan,**dist=1.4mm (8x8x7)/Cube 0:** Measurement grid: dx=4mm, dy=4mm, dz=1.4mm

Reference Value = 68.55 V/m; Power Drift = 0.02 dB

Peak SAR (extrapolated) = 36.5 W/kg

SAR(1 g) = 7.86 W/kg; SAR(10 g) = 2.23 W/kg

Maximum value of SAR (measured) = 18.9 W/kg

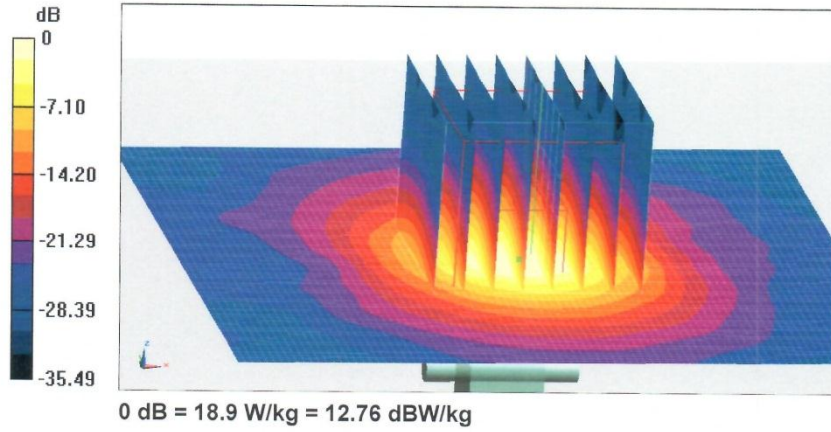

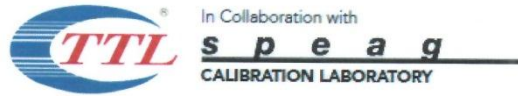

Add: No.51 Xueyuan Road, Haidian District, Beijing, 100191, China
Tel: +86-10-62304633-2512 Fax: +86-10-62304633-2504
E-mail: ettl@chinattl.com http://www.chinattl.cn

Impedance Measurement Plot for Head TSL

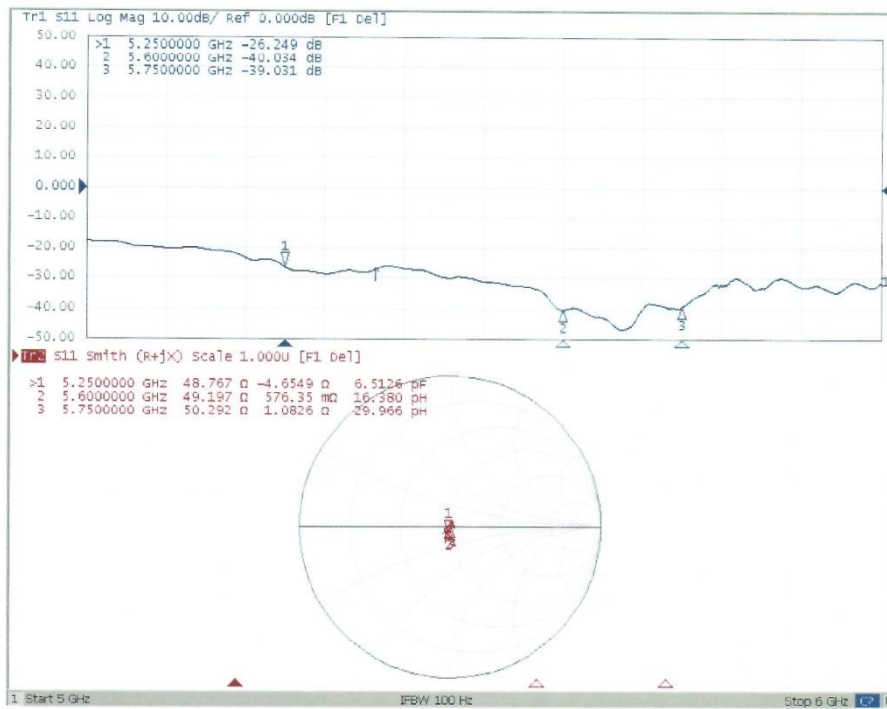



Add: No.51 Xueyuan Road, Haidian District, Beijing, 100191, China
Tel: +86-10-62304633-2512 Fax: +86-10-62304633-2504
E-mail: cttl@chinattl.com http://www.chinattl.cn

DASY5 Validation Report for Body TSL

Date: 08.29.2019

Test Laboratory: CTTL, Beijing, China

DUT: Dipole 5GHz; Type: D5GHzV2; Serial: D5GHzV2 - SN: 1238

Communication System: CW; Frequency: 5250 MHz, Frequency: 5600 MHz,
Frequency: 5750 MHz,

Medium parameters used: $f = 5250$ MHz; $\sigma = 5.402$ S/m; $\epsilon_r = 48.05$; $\rho = 1000$ kg/m³,
Medium parameters used: $f = 5600$ MHz; $\sigma = 5.703$ S/m; $\epsilon_r = 47.61$; $\rho = 1000$ kg/m³,
Medium parameters used: $f = 5750$ MHz; $\sigma = 5.782$ S/m; $\epsilon_r = 47.49$; $\rho = 1000$ kg/m³,

Phantom section: Right Section

DASY5 Configuration:

- Probe: EX3DV4 - SN3617; ConvF(4.76, 4.76, 4.76) @ 5250 MHz; ConvF(4.23, 4.23, 4.23) @ 5600 MHz; ConvF(4.36, 4.36, 4.36) @ 5750 MHz; Calibrated: 1/31/2019
- Sensor-Surface: 1.4mm (Mechanical Surface Detection)
- Electronics: DAE4 Sn1555; Calibrated: 8/22/2019
- Phantom: MFP_V5.1C ; Type: QD 000 P51CA; Serial: 1062
- Measurement SW: DASY52, Version 52.10 (2); SEMCAD X Version 14.6.12 (7470)

Dipole Calibration /Pin=100mW, d=10mm, f=5250 MHz/Zoom Scan,**dist=1.4mm (8x8x7)/Cube 0:** Measurement grid: dx=4mm, dy=4mm, dz=1.4mm

Reference Value = 54.85 V/m; Power Drift = 0.04 dB

Peak SAR (extrapolated) = 27.5 W/kg

SAR(1 g) = 7.17 W/kg; SAR(10 g) = 2.04 W/kg

Maximum value of SAR (measured) = 16.4 W/kg

Dipole Calibration /Pin=100mW, d=10mm, f=5600 MHz/Zoom Scan,**dist=1.4mm (8x8x7)/Cube 0:** Measurement grid: dx=4mm, dy=4mm, dz=1.4mm

Reference Value = 56.17 V/m; Power Drift = 0.07 dB

Peak SAR (extrapolated) = 32.3 W/kg

SAR(1 g) = 7.62 W/kg; SAR(10 g) = 2.18 W/kg

Maximum value of SAR (measured) = 18.4 W/kg

Dipole Calibration /Pin=100mW, d=10mm, f=5750 MHz/Zoom Scan,**dist=1.4mm (8x8x7)/Cube 0:** Measurement grid: dx=4mm, dy=4mm, dz=1.4mm

Reference Value = 55.47 V/m; Power Drift = 0.04 dB

Peak SAR (extrapolated) = 33.2 W/kg

SAR(1 g) = 7.39 W/kg; SAR(10 g) = 2.1 W/kg

Maximum value of SAR (measured) = 18.1 W/kg



Add: No.51 Xueyuan Road, Haidian District, Beijing, 100191, China
Tel: +86-10-62304633-2512 Fax: +86-10-62304633-2504
E-mail: cttl@chinattl.com http://www.chinattl.cn

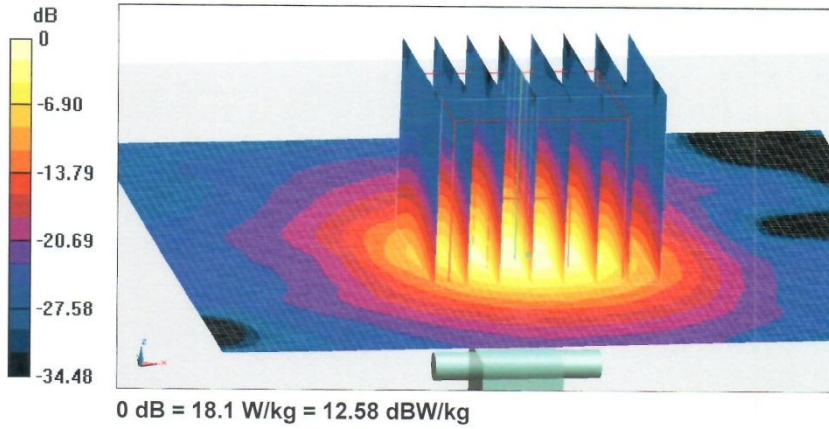



Add: No.51 Xueyuan Road, Haidian District, Beijing, 100191, China
Tel: +86-10-62304633-2512 Fax: +86-10-62304633-2504
E-mail: cttl@chinattl.com http://www.chinattl.cn

Impedance Measurement Plot for Body TSL

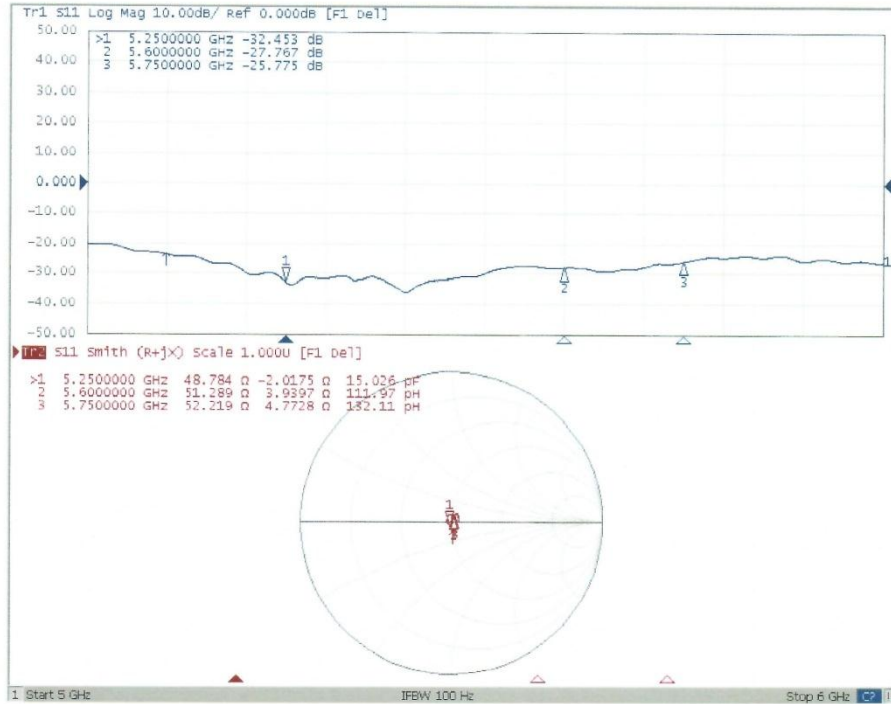

ANNEX J: Extended Calibration SAR Dipole

Referring to KDB865664 D01, if dipoles are verified in return loss (<-20dBm, within 20% of prior calibration), and in impedance (within 5 ohm of prior calibration), the annual calibration is not necessary and the calibration interval can be extended.

Justification of Extended Calibration SAR Dipole D5GHzV2– serial no.1238

Head						
Date of Measurement	Return-Loss (dB)	Delta (%)	Real Impedance (ohm)	Delta (ohm)	Imaginary Impedance (johm)	Delta (johm)
5250MHz						
2019-08-29	-26.2	/	48.8	/	-4.65	/
2020-08-28	-25.1	4.2	49.7	0.9	-4.26	0.39
2021-08-26	-24.7	5.7	50.2	1.4	-4.01	0.64
5600MHz						
2019-08-29	-40.0	/	49.2	/	0.58	/
2020-08-28	-38.1	4.8	50.3	1.1	0.85	0.27
2021-08-26	-37.7	5.7	50.8	1.6	0.92	0.34
5750MHz						
2019-08-29	-39.0	/	50.3	/	1.08	/
2020-08-28	-37.7	3.3	51.1	0.8	1.44	0.36
2021-08-26	-37.2	4.6	51.6	1.3	1.53	0.45

The Return-Loss is <-20dB, and within 20% of prior calibration; the impedance is within 5 ohm of prior calibration. Therefore the value result should support extended cabration.

ANNEX K: Sensor Triggering Data Summary

Per FCC KDB Publication 616217 D04, this device was tested by the manufacturer to determine the proximity sensor triggering distances for all applicable sides and edges of the device. The measured output power at distances within ± 5 mm of the triggering points (or until touching the phantom) is included for back side and each applicable edge per Step i) in Section 6.2 of the KDB. The technical descriptions in the filing contain the complete set of triggering data required by Section 6 of FCC KDB Publication 616217 D04.

To ensure all production units are compliant, it is necessary to test SAR at a distance 1 mm less than the smallest distance between the device and SAR phantom with the device at the maximum output power (without power reduction). These SAR tests are included in addition to the SAR tests for the device touching the SAR phantom (at the reduced output power level).

The operational description contains information explaining how this device remains compliant in the event of a sensor malfunction.

The DUT has the proximity sensors to reduce the output power. The position of the sensor is as shown in the graphic.

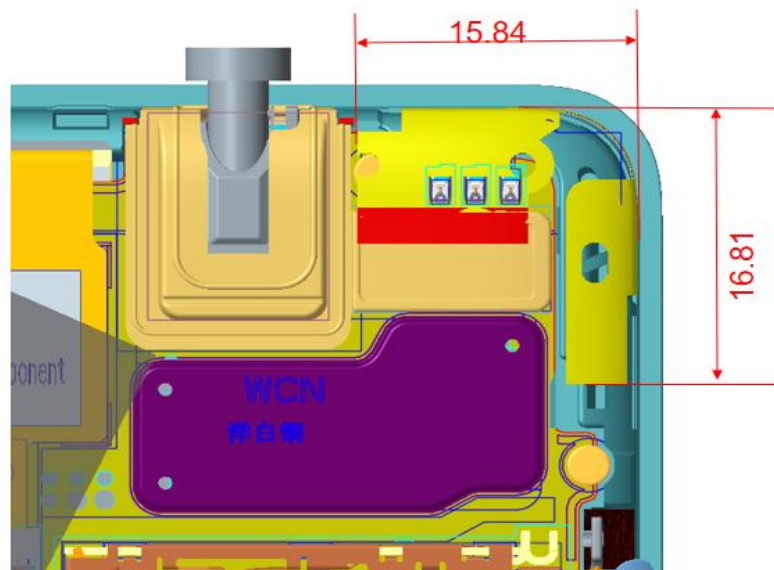

P-sensor coexisted with WIFI antenna

WLAN Antenna

Rear Side:

Moving device toward the phantom:

Sensor triggered (YES or NO)											
Distance(mm)	15	14	13	12	11	10	9	8	7	6	5
WLAN Antenna	NO	NO	NO	NO	NO	YES	YES	YES	YES	YES	YES

Moving device away from the phantom:

Sensor triggered (YES or NO)											
Distance(mm)	5	6	7	8	9	10	11	12	13	14	15
WLAN Antenna	YES	YES	YES	YES	YES	YES	NO	NO	NO	NO	NO

Based on the most conservative measured triggering distance of 10 mm, additional SAR measurements were required at 9 mm from the rear side for the above modes.

Left Side:

Moving device toward the phantom:

Sensor triggered (YES or NO)											
Distance(mm)	15	14	13	12	11	10	9	8	7	6	5
WLAN Antenna	NO	NO	NO	NO	NO	YES	YES	YES	YES	YES	YES

Moving device away from the phantom:

Sensor triggered (YES or NO)											
Distance(mm)	5	6	7	8	9	10	11	12	13	14	15
WLAN Antenna	YES	YES	YES	YES	YES	YES	NO	NO	NO	NO	NO

Based on the most conservative measured triggering distance of 10 mm, additional SAR measurements were required at 9 mm from the left side for the above modes.

Top Side:

Moving device toward the phantom:

Sensor triggered (YES or NO)											
Distance(mm)	12	11	10	9	8	7	6	5	4	3	2
WLAN Antenna	NO	NO	NO	NO	NO	YES	YES	YES	YES	YES	YES

Moving device away from the phantom:

Sensor triggered (YES or NO)											
Distance(mm)	2	3	4	5	6	7	8	9	10	10	12
WLAN Antenna	YES	YES	YES	YES	YES	YES	NO	NO	NO	NO	NO

Based on the most conservative measured triggering distance of 7 mm, additional SAR measurements were required at 6 mm from the top side for the above modes.

The influence of table tilt angles to proximity sensor triggering is determined by positioning each edge that contains a transmitting antenna, perpendicular to the flat phantom, at the smallest sensor triggering test distance by rotating the device around the edge next to the phantom in $\leq 10^\circ$ increments until the tablet is $\pm 45^\circ$ or more from the vertical position at 0° .

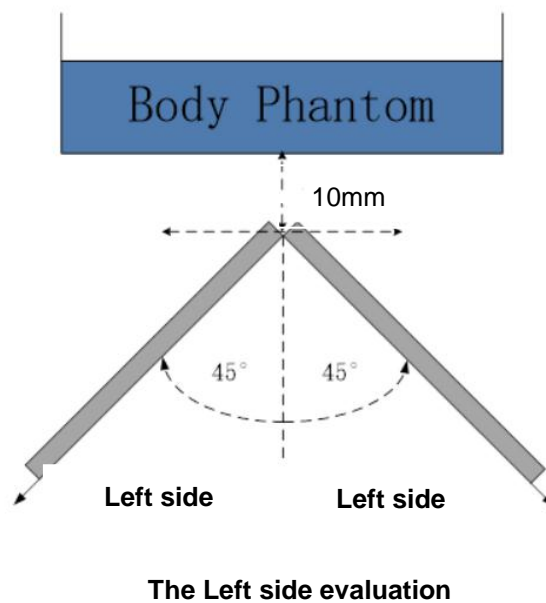
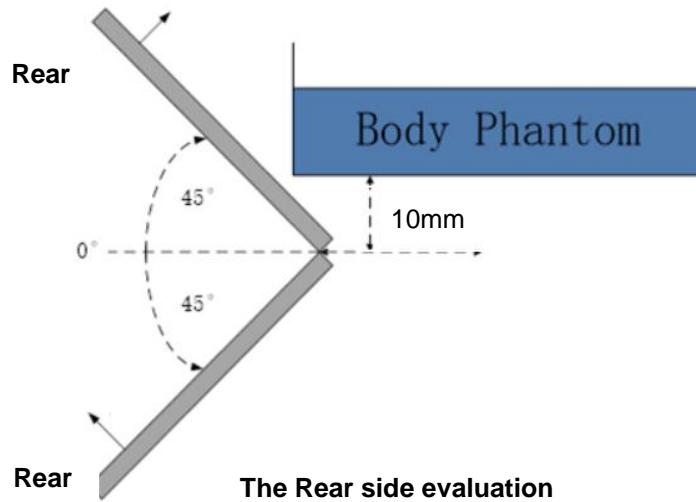

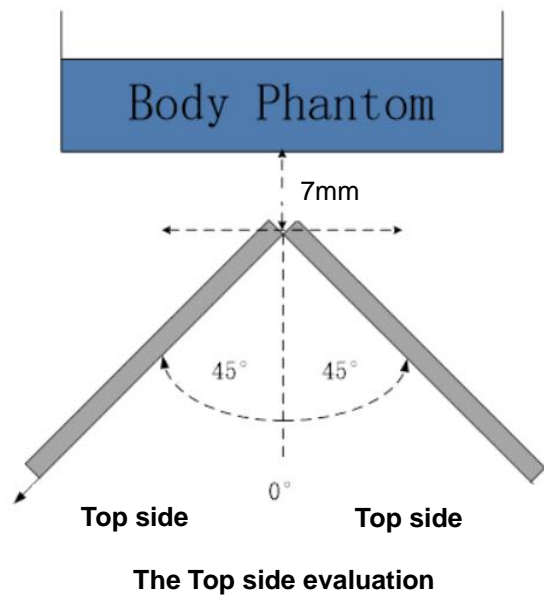

Based on the above evaluation, we come to the conclusion that the sensor triggering is not released and normal maximum output power is not restored within the $\pm 45^\circ$ range at the smallest sensor triggering test distance declared by manufacturer.

*****END OF REPORT*****