

TEST REPORT FOR SAR TESTING

Report No.: SRTC2023-9004(F)-23112701(H)

Product Name: tracker

Product Model: MK40

Applicant: TCL Communication Ltd.

Manufacturer: TCL Communication Ltd.

Specification: Part 2.1093

IEEE Std 1528

KDB Procedures

FCC ID: 2ACCJB172

The State Radio_monitoring_center Testing Center (SRTC)

15th Building, No.30 Shixing Street, Shijingshan District, Beijing, P.R. China

Tel: 86-10-57996183 Fax: 86-10-57996388

Contents

1. GENERAL INFORMATION	2
1.1 NOTES OF THE TEST REPORT	2
1.2 INFORMATION ABOUT THE TESTING LABORATORY	2
1.3 APPLICANT’S DETAILS	2
1.4 MANUFACTURER’S DETAILS	2
1.5 TEST ENVIRONMENT	3
2. DESCRIPTION OF THE DEVICE UNDER TEST	4
2.1 FINAL EQUIPMENT BUILD STATUS	4
2.2 SUPPORT EQUIPMENT	7
3. REFERENCE SPECIFICATION	9
4. TEST CONDITIONS	10
4.1 PICTURE TO DEMONSTRATE THE REQUIRED LIQUID DEPTH	10
4.2 TEST SIGNAL, FREQUENCIES AND OUTPUT POWER	10
4.3 SAR MEASUREMENT SET-UP	10
4.4 PHANTOMS	11
4.5 TISSUE SIMULANTS	11
4.6 DESCRIPTION OF THE TEST PROCEDURE	12
5 RESULT SUMMAR	15
6 TEST RESULT	17
6.1 MANUFACTURING TOLERANCE	17
6.2 WCDMA MEASUREMENT RESULT	31
6.3 LTE MEASUREMENT RESULT	42
6.4 WI-FI MEASUREMENT RESULT	137
6.5 STANDALONE SAR TEST EXCLUSION CONSIDERATIONS	138
6.6 RF EXPOSURE CONDITIONS	140
6.7 SYSTEM CHECKING	142
6.8 SAR TEST RESULT	144
6.9 SAR MEASUREMENT VARIABILITY	205
6.10 SIMULTANEOUS TRANSMISSION SAR ANALYSIS	206
7 MEASUREMENT UNCERTAINTY	207
8 TEST EQUIPMENTS	210
ANNEX A – TEST PLOTS	221
TUNE UP – RELEVANT PAGES FROM CALIBRATION REPORTS	221

1. GENERAL INFORMATION

1.1 Notes of the test report

The test report may only be reproduced or published in full. Reproduction or publication of extracts from the report requires the prior written permission of The State Radio_monitoring_center Testing Center (SRTC).

The test results relate only to individual items of the samples which have been tested.

The certification and accreditation identifiers used in this report shall not be applicable to the tested or calibrated samples thereof. The manufacturer shall not mark the tested samples or items (or a separate part of the item) with the identifiers of certification and accreditation to mislead relevant parties about the tested samples or items.

1.2 Information about the testing laboratory

Company:	The State Radio_monitoring_center Testing Center (SRTC)
Address:	15th Building, No.30 Shixing Street, Shijingshan District, Beijing P.R. China
City:	Beijing
Country or Region:	P.R. China
Contacted person:	Liu Jia
Tel:	+86 10 57996183
Fax:	+86 10 57996388
Email:	liujiaf@srtc.org.cn

1.3 Applicant's details

Company:	TCL Communication Ltd.
Address:	5/F, Building 22E, 22 Science Park East Avenue Hong Kong Science Park, Shatin, NT
City:	Hong Kong
Country or Region:	China
Contacted person:	Peter Yang
Tel:	8675536645759
Fax:	NA
Email:	peter.yang@tcl.com

1.4 Manufacturer's details

Company:	TCL Communication Ltd.
Address:	5/F, Building 22E, 22 Science Park East Avenue

	Hong Kong Science Park, Shatin, NT
City:	Hong Kong
Country or Region:	China
Contacted person:	Peter Yang
Tel:	8675536645759
Fax:	NA
Email:	peter.yang@tcl.com

1.5 Test Environment

Date of Receipt of test sample at SRTC:	2023-11-27
Testing Start Date:	2023-11-28
Testing End Date:	2023-12-4

Environmental Data:	Temperature (°C)	Humidity (%)
Ambient	25	30
Maximum Extreme	55	---
Minimum Extreme	-10	---

Normal Supply Voltage (V dc.):	3.85
Maximum Extreme Supply Voltage (V dc.):	4.30
Minimum Extreme Supply Voltage (V dc.):	3.60

2. DESCRIPTION OF THE DEVICE UNDER TEST

2.1 Final Equipment Build Status

Wireless Technology and Frequency Bands	<input type="checkbox"/> GSM Band: GSM850/GSM1900 <input checked="" type="checkbox"/> WCDMA Band: FDD II/IV/V <input checked="" type="checkbox"/> LTE Band: 2/4/5/12/13/25/26/41/66/71 <input checked="" type="checkbox"/> Wi-Fi Band: 2.4GHz <input type="checkbox"/> BT/BLE
Mode	<p>GSM</p> <input type="checkbox"/> GPRS (GMSK) <input type="checkbox"/> EGPRS (GMSK/8PSK) <p>WCDMA</p> <input checked="" type="checkbox"/> UMTS Rel. 99 <input checked="" type="checkbox"/> HSDPA (Rel. 5) <input checked="" type="checkbox"/> HSUPA (Rel. 6) <input checked="" type="checkbox"/> HSPA+ (Rel.7) <input checked="" type="checkbox"/> DC-HSDPA (Rel.8) <p>LTE</p> <input checked="" type="checkbox"/> QPSK <input checked="" type="checkbox"/> 16QAM <input type="checkbox"/> 64QAM <p>Bluetooth</p> <input type="checkbox"/> BR(GFSK) <input type="checkbox"/> EDR($\pi/4$ DQPSK , 8-DPSK) <input type="checkbox"/> BLE(GFSK) <p>Wi-Fi 2.4GHz</p> <input checked="" type="checkbox"/> 802.11b <input checked="" type="checkbox"/> 802.11g <input checked="" type="checkbox"/> 802.11n HT20 <input checked="" type="checkbox"/> 802.11n HT40
Duty Cycle*	<p>WCDMA: 100%</p> <p>LTE(FDD): 100% LTE(TDD): maximum63.3%</p> <p>802.11b:98.1%</p> <p>802.11g:97.2%</p> <p>802.11n20:97.0%</p> <p>802.11n40:95.6%</p>
Multi-Slot Class for GPRS/EDGE	<input type="checkbox"/> Class 8 - One Up <input type="checkbox"/> Class 10 - Two Up <input type="checkbox"/> Class 12 - Four Up <input type="checkbox"/> Class 33- Four Up
Mobile Phone Capability	<input type="checkbox"/> Class A - Mobile phones can be connected to both GPRS and GSM services simultaneously. <input type="checkbox"/> Class B - Mobile phones can be attached to both GPRS and GSM services, using one service at a time. <input type="checkbox"/> Class C - Mobile phones are attached to either GPRS or GSM voice service. You need to switch manually between services
DTM	Not Supported
Note	<p>For licensed cellular network duty cycle is inherent.</p> <p>For unlicensed network WLAN Duty cycle is depends on the data traffic,and the traffic allocation in operating mode could be the most conservative condition which with 100% duty cycle. SAR measurement also use non signalling</p>

mode, so the duty factor shall be taken into consideration.

Declaration of changes from Initial MK40 to Variant MK40

General: MK40 is a variant product of MK40:

- **SOFTWARE MODIFICATIONS:**

- OS update (e.g. from Android 12 to 13) / change (e.g. from Android to other OS) : **NO**
- Protocol Stack changes: **NO**
- MMS/STK/USAT/USIM changes: **NO**
- DM/SUPL/VT/FUMO/SWP/HCI: **NO**
- Other changes detail: **NO**

- **HARDWARE MODIFICATIONS:**

- Baseband changes: NO
 - Band changes: NO
- PCB layout/material changes: NO
- Main components changes:

LTE	Base Band	Antenna	Transceiver	AS M	Power Amplifier	Tx SAW Filter	Rx SAW Filter (SAW Duplexer)
LTE B2	NO	NO	NO	/	Yes	NO	NO
LTE B4	NO	NO	NO	/	Yes	NO	NO
LTE B5	NO	NO	NO	/	Yes	NO	NO
LTE B12	NO	NO	NO	/	Yes	NO	NO
LTE B13	NO	NO	NO	/	Yes	NO	NO
LTE B25	NO	NO	NO	/	Yes	NO	NO

LTE B26	NO	NO	NO	/	Yes	NO	NO
LTE B41	NO	NO	NO	/	Yes	NO	NO
LTE B66	NO	NO	NO	/	Yes	NO	NO
LTE B71	NO	NO	NO	/	Yes	NO	NO
UTMS B2	NO	NO	NO	/	Yes	NO	NO
UTMS B4	NO	NO	NO	/	Yes	NO	NO
UTMS B5	NO	NO	NO	/	Yes	NO	NO

Other Radio	Antenna	AP	MODEM	Transceiver	Balun	Band pass filter	Triplexer
Wi-Fi	NO	NO	/	NO	/	NO	NO

- FM changes: NO
- GPS changes: TBD (e.g. Saw is different): NO
- Memory/TP/LCD/ Camera/SIM changes: NO
- Other changes detailed:

1. P sensor from SX9310ICSTRT change to SX9311ICSTRT1
2. RF switch from HS8775C-15 change to OM8775C-25
3. RF switch from AW13412DNR change to AW13412HDNR
4. Antenna switch from AW13418QNR change to AW13418RQNR

All the change do not influence the RF performance

● **MECHANICAL MODIFICATIONS:**

- Use new metal front/back cover or keypad: NO
- Mechanical shell changes: No

Whole size of EUT: No

Distance of Ear reference point to bottom of handset: No

Other trinkets to change the surface of handset: NO

- Other changes detailed: No (e.g. new mechanical design)

● **Accessory changes:**

- Use new charger/battery/headset/USB cable: NO

According to the difference description:

We selected the locations with the largest SAR values from WCDMA, LTE and WIFI for the second test (WCDMA IV, LTE71, WIFI2.4G) , and gave the test results.

2.2 Support Equipment

The following support equipment was used to exercise the DUT during testing:

State of sample	Normal
H/W Version	P1
S/W Version	3.18.505.P0.200514.cp314AT
IMEI	Sample1:864156050000038 Sample2:864156050002976
Notes	1.As the information described above, we use test sample offered by the customer. The relevant tests have been performed in order to verify in which combination case the EUT would have the worst features. 2. EUT disabled A-PR during SAR testing.

The following support equipment was used to exercise the DUT during testing:

Equipment	Battery
Manufacturer	Lishen
Model Number	CPLD-432
Serial Number	---

Equipment	Charger
Manufacturer	Shenzhen RUIDE
Model Number	RD0501000-USBA-18MG

Serial Number	---
---------------	-----

3. REFERENCE SPECIFICATION

Specification	Version	Title
Part 2.1093	2019	Radiofrequency radiation exposure evaluation: portable devices.
IEEE Std 1528	2013	IEEE Recommended Practice for Determining the Peak Spatial-Average Specific Absorption Rate (SAR) in the Human Head from Wireless Communications Devices: Measurement Techniques
KDB 447498 D01	v06	General RF Exposure Guidance
KDB 447498 D02	v02r01	SAR MEASUREMENT PROCEDURES FOR USB DONGLE TRANSMITTERS
KDB 616217 D04	v01r02	SAR for laptop and tablets
KDB 648474 D04	v01r03	Handset SAR
KDB 941225 D01	v03r01	3G SAR Procedures
KDB 248227 D01	v02r02	SAR GUIDANCE FOR IEEE 802.11 (Wi-Fi) TRANSMITTERS
KDB 865664 D01	v01r04	SAR Measurement from 100 MHz to 6 GHz
KDB 865664 D02	v01r02	RF Exposure Reporting
KDB 941225 D05	v02r05	SAR for LTE Devices

4. TEST CONDITIONS

4.1 Picture to demonstrate the required liquid depth

The liquid depth is large than 15cm in the used SAM phantoms in flat section, and the depth of the tissue simulant was 15.0 ± 0.5 cm measured from the ear reference point during system checking and device measurements.



Liquid depth for SAR Measurement

4.2 Test Signal, Frequencies and Output Power

The device was put into operation by using a call tester. Communication between the device and the call tester was established by air link.

The device output power was set to maximum power level for all tests; a fully charged battery was used for every test sequence.

In all operating bands the measurements were performed on middle channel, and few of them were also performed on lowest and highest channels.

4.3 SAR Measurement Set-up

The system is based on a high precision robot (working range greater than 0.9m), which positions the probes with a positional repeatability of better than ± 0.02 mm. Special E-field probes have been developed for measurements

close to material discontinuity, the sensors of which are directly loaded with a Schottky diode and connected via highly resistive lines (length =300mm) to the data acquisition unit. A cell controller system contains the power supply, robot controller, teaches pendant (Joystick), and remote control, is used to drive the robot motors.

The PC consists of the Micron Pentium IV computer with Win7 system and SAR Measurement Software DASY5 Professional, A/D interface card, monitor, mouse, and keyboard. The Stäubli Robot is connected to the cell controller to allow software manipulation of the robot.

A data acquisition electronic (DAE) circuit performs the signal amplification; signal multiplexing, AD-conversion, offset measurements, mechanical surface detection, collision detection, etc. is connected to the Electro-optical coupler (EOC). The EOC performs the conversion from the optical into digital electric signal of the DAE and transfers data to the PC plug-in card. The DAE consists of a highly sensitive electrometer-grade preamplifier with auto-zeroing, a channel and gain-switching multiplexer, a fast 16bit AD-converter and a command decoder and control logic unit. Transmission to the PC-card is accomplished through an optical downlink for data and status information and an optical uplink for commands and clock lines.

The mechanical probe mounting device includes two different sensor systems for frontal and sidewise probe contacts. They are also used for mechanical surface detection and probe collision detection

The robot uses its own controller with a built in VME-bus computer.

4.4 Phantoms

The phantom used for all tests i.e. for both system checks and device testing, was the twin headed "SAM Phantom", manufactured by SPEAG. The phantom conforms to the requirements of IEEE 1528.

System checking was performed using the flat section, whilst Head SAR tests used the left and right head profile sections. Body SAR testing also used the flat section between the head profiles. **There is no need for shifting because radiating structures are small compared to both the DUT and the phantom and/or the first area scan shows that the SAR distribution is entirely captured within the scanning area.**

The SPEAG device holder was used to position the device in all tests whilst a tripod was used to position the validation dipoles against the flat section of phantom.

4.5 Tissue Simulants

Recommended values for the dielectric parameters of the tissue simulants are

given in IEEE 1528. All tests were carried out using simulants whose dielectric parameters were within $\pm 10\%$ below 3GHz and $\pm 5\%$ above 3GHz of the recommended values when use DASY system according to KDB865664D01. All tests were carried out within 24 hours of measuring the dielectric parameters.

Tissue Stimulant Recipes	
Name	Broadband tissue-equivalent liquid
Type	HBBL600-6000V6 Simulating Liquid
Note: The stimulant could be the same for head and body.	

4.6 DESCRIPTION OF THE TEST PROCEDURE

4.6.1 Device Holder

The device was placed in the device holder (illustrated below) that is supplied by SPEAG as an integral part of the Dasy system.



Device holder supplied by SPEAG

4.6.2 Test Exposure Conditions

4.6.2.1 Head Configuration

Measurements were made in “cheek” and “tilt” positions on both the left hand and right-hand sides of the phantom.

The positions used in the measurements were according to IEEE 1528 "IEEE Recommended Practice for Determining the Peak Spatial-Average Specific Absorption Rate (SAR) in the Human Head from Wireless Communications Devices: Measurement Techniques".

4.6.2.2 Body Worn Configuration

The device was placed in the SPEAG holder below the flat section of the phantom. The distance between the device and the phantom was kept at the separation distance using a separate flat spacer that was removed before the start of the measurements. And the distance is normally determined according to the actual scene which might be the worst use condition for general exposure. The device's front and rear were oriented facing the phantom since these orientations give higher results for most regular portable devices.

4.6.2.3 Hotspot Configuration

Hotspot mode SAR is measured for all edges and surfaces of the device with a transmitting antenna located within 25 mm from that surface or edge; for the data modes, wireless technologies and frequency bands supporting hotspot mode.

4.6.3 Scan Procedure

First, area scans were used for determination of the field distribution and the approximate location of the local peak SAR values. The SAR distribution is scanned along the inside surface, at least for an area larger than the projection of the handset and antenna. The angle between the probe axis and the surface normal line is recommended but not required to be less than 30°. The SAR distribution is first measured on a 2-D coarse grid. The scan region should cover all areas that are exposed and encompassed by the projection of the handset. There are 15 mm × 15 mm (equal or less than 2GHz), 12 mm × 12 mm (from 2GHz~4GHz) and 10mm x 10mm (from 4GHz~6GHz) measurement grid used when two staggered one-dimensional cubic splines are used to estimate the maximum SAR location.

When the reported 1g-SAR estimated by area scan is less than 1.40 w/kg.

Zoom scan was performed by using the configuration mentioned below or more conservative scan area and step to determine the averaged SAR value. Drift was determined by measuring the same point at the start of the area scan and again at the end of the zoom scan.

Below 3GHz: 32mmX32mmX30mm scan area with 8 mm X8 mm X5 mm steps

2GHz-3GHz: 32mmX32mmX30mm scan area with 8 mm X8 mm X5 mm steps

3GHz-4GHz: 28mmX28mmX28mm scan area with 7 mm X7 mm X4 mm steps

4GHz-5GHz: 25mmX25mmX24mm scan area with 5 mm X5 mm X3 mm steps

5GHz-6GHz: 25mmX25mmX22mm scan area with 5 mm X5 mm X2 mm steps

4.6.4 SAR Averaging Methods

The maximum SAR value was averaged over a cube of tissue using interpolation and extrapolation.

The interpolation, extrapolation and maximum search routines within DASYS are all based on the modified Quadratic Shepard's method (Robert J. Renka, "Multivariate Interpolation of Large Sets of Scattered Data", University of North Texas ACM Transactions on Mathematical Software, vol. 14, no. 2, June 1988, pp. 139-148).

The interpolation scheme combines a least-square fitted function method with a weighted average method. A triradiate 3-D / bivariate 2-D quadratic function is computed for each measurement point and fitted to neighboring points by a least-square method. For the zoom scan, inverse distance weighting is incorporated to fit distant points more accurately. The interpolating function is finally calculated as a weighted average of the quadratics.

In the zoom scan, the interpolation function is used to extrapolate the Peak SAR from the deepest measurement points to the inner surface of the phantom.

5 RESULT SUMMAR

The maximum reported SAR values for Body configuration are given as follows. The device conforms to the requirements of the standard(s) when the maximum reported SAR value is less than or equal to the limit.

Standalone Transmission

Exposure Position	Frequency Band	1g-SAR Result(W/kg)	Highest 1g-SAR Result(W/kg)	Limit(W/kg)/1g	Result
Body	WCDMA Band II(0mm)	0.93	1.19	1.60	Pass
	WCDMA Band IV(0mm)	1.19			
	WCDMA Band V(0mm)	0.81			
	LTE Band 2(0mm)	0.92			
	LTE Band 4(14mm)	1.13			
	LTE Band 5(0mm)	0.83			
	LTE Band 12(0mm)	0.96			
	LTE Band 13(0mm)	0.93			
	LTE Band 25(0mm)	0.82			
	LTE Band 26(0mm)	0.87			
	LTE Band 41(0mm)	0.87			
	LTE Band 66(14mm)	0.92			
	LTE Band 71(10mm)	0.95			
	WLAN 2.4GHz(10mm)	0.55			

Improved model measurement results

Exposure Position	Frequency Band	1g-SAR Result(W/kg)	Highest 1g-SAR Result(W/kg)	Limit(W/kg)/1g	Result
Body	WCDMA Band II(0mm)	0.93	1.13	1.60	Pass
	WCDMA Band IV(0mm)	0.85			
	WCDMA Band V(0mm)	0.81			
	LTE Band 2(0mm)	0.92			
	LTE Band 4(14mm)	1.13			
	LTE Band 5(0mm)	0.83			
	LTE Band 12(0mm)	0.96			
	LTE Band 13(0mm)	0.93			
	LTE Band 25(0mm)	0.82			



	LTE Band 26(0mm)	0.87			
	LTE Band 41(0mm)	0.87			
	LTE Band 66(14mm)	0.92			
	LTE Band 71(10mm)	0.95			
	WLAN 2.4GHz(10mm)	0.55			

Simultaneous Transmission (worst case)

Exposure Position	Frequency Band	Highest 1g-SAR Result(W/kg)	Limit (W/kg)/1g	Result
Body(0mm) Bottom	LTE & Wi-Fi	1.42	1.60	Pass

Improved model measurement results

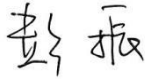
Exposure Position	Frequency Band	Highest 1g-SAR Result(W/kg)	Limit (W/kg)/1g	Result
Body(0mm) Bottom	LTE & Wi-Fi	0.643	1.60	Pass

This Test Report Is Approved by: Mr. Peng Zhen 	Review by: Mr. Li Bin 
Tested and issued by: Mr. Hui Wen 	Approved date: 20231204

6 TEST RESULT

6.1 Manufacturing Tolerance

WCDMA

WCDMA band II

Mode		Carrier frequency (MHz)	Channel No.	Full power Tune-up limit (dBm)	Reduced Power Tune-up limit (dBm)
Release 99	RMC,12.2kbps	1852.4	9262	22.0	14.0
		1880.0	9400		
		1907.6	9538		
	RMC,64kbps	1852.4	9262		
		1880.0	9400		
		1907.6	9538		
	RMC,144kbps	1852.4	9262		
		1880.0	9400		
		1907.6	9538		
	RMC,384kbps	1852.4	9262		
		1880.0	9400		
		1907.6	9538		
HSDPA	Subtest 1	1852.4	9262	21.5	13.5
		1880.0	9400		
		1907.6	9538		
	Subtest 2	1852.4	9262		
		1880.0	9400		
		1907.6	9538		
	Subtest 3	1852.4	9262		
		1880.0	9400		
		1907.6	9538		
	Subtest 4	1852.4	9262		
		1880.0	9400		
		1907.6	9538		
HSUPA	Subtest 1	1852.4	9262	21.5	13.5
		1880.0	9400		
		1907.6	9538		
	Subtest 2	1852.4	9262		
		1880.0	9400		
		1907.6	9538		
	Subtest 3	1852.4	9262		
		1880.0	9400		
		1907.6	9538		
	Subtest 4	1852.4	9262		
		1880.0	9400		
		1907.6	9538		
	Subtest 5	1852.4	9262		
		1880.0	9400		
		1907.6	9538		
HSPA+	QPSK	1852.4	9262	21.5	13.5
		1880.0	9400		
		1907.6	9538		
	16QAM	1852.4	9262		
		1880.0	9400		

		1907.6	9538		
DA-HSDPA	Subtest 1	1852.4	9262	21.5	13.5
		1880.0	9400		
		1907.6	9538		
	Subtest 2	1852.4	9262		
		1880.0	9400		
		1907.6	9538		
	Subtest 3	1852.4	9262		
		1880.0	9400		
		1907.6	9538		
	Subtest 4	1852.4	9262		
		1880.0	9400		
		1907.6	9538		

WCDMA band IV

Mode		Carrier frequency (MHz)	Channel No.	Full power Tune-up limit (dBm)	Reduced Power Tune-up limit (dBm)
Release 99	RMC,12.2kbps	1712.4	1312	23.0	14.0
		1732.4	1412		
		1752.6	1513		
	RMC,64kbps	1712.4	1312		
		1732.4	1412		
		1752.6	1513		
	RMC,144kbps	1712.4	1312		
		1732.4	1412		
		1752.6	1513		
	RMC,384kbps	1712.4	1312		
		1732.4	1412		
		1752.6	1513		
HSDPA	Subtest 1	1712.4	1312	22.0	13.0
		1732.4	1412		
		1752.6	1513		
	Subtest 2	1712.4	1312		
		1732.4	1412		
		1752.6	1513		
	Subtest 3	1712.4	1312		
		1732.4	1412		
		1752.6	1513		
	Subtest 4	1712.4	1312		
		1732.4	1412		
		1752.6	1513		
HSUPA	Subtest 1	1712.4	1312	22.0	13.0
		1732.4	1412		
		1752.6	1513		
	Subtest 2	1712.4	1312		
		1732.4	1412		
		1752.6	1513		
	Subtest 3	1712.4	1312		
		1732.4	1412		
		1752.6	1513		
	Subtest 4	1712.4	1312		
		1732.4	1412		

	Subtest 5	1752.6	1513		
		1712.4	1312		
		1732.4	1412		
		1752.6	1513		
HSPA+	QPSK	1712.4	1312	22.0	13.0
		1732.4	1412		
		1752.6	1513		
	16QAM	1712.4	1312		
		1732.4	1412		
DA-HSDPA	Subtest 1	1712.4	1312	22.0	13.0
		1732.4	1412		
		1752.6	1513		
	Subtest 2	1712.4	1312		
		1732.4	1412		
		1752.6	1513		
	Subtest 3	1712.4	1312		
		1732.4	1412		
		1752.6	1513		
	Subtest 4	1712.4	1312		
		1732.4	1412		
		1752.6	1513		

WCDMA band V

Mode		Carrier frequency (MHz)	Channel No.	Full power Tune-up limit (dBm)	Reduced Power Tune-up limit (dBm)
Release 99	RMC,12.2kbps	826.4	4132	23.0	19.0
		836.6	4183		
		846.6	4233		
	RMC,64kbps	826.4	4132		
		836.6	4183		
		846.6	4233		
	RMC,144kbps	826.4	4132		
		836.6	4183		
		846.6	4233		
	RMC,384kbps	826.4	4132		
		836.6	4183		
		846.6	4233		
HSDPA	Subtest 1	826.4	4132	22.0	18.0
		836.6	4183		
		846.6	4233		
	Subtest 2	826.4	4132		
		836.6	4183		
		846.6	4233		
	Subtest 3	826.4	4132		
		836.6	4183		
		846.6	4233		
	Subtest 4	826.4	4132		
		836.6	4183		
		846.6	4233		
HSUPA	Subtest 1	826.4	4132	22.0	18.0
		836.6	4183		

	Subtest 2	846.6	4233		
		826.4	4132		
		836.6	4183		
		846.6	4233		
	Subtest 3	826.4	4132		
		836.6	4183		
		846.6	4233		
	Subtest 4	826.4	4132		
		836.6	4183		
		846.6	4233		
	Subtest 5	826.4	4132		
		836.6	4183		
846.6		4233			
HSPA+	QPSK	826.4	4132	22.0	18.0
		836.6	4183		
		846.6	4233		
	16QAM	826.4	4132		
		836.6	4183		
		846.6	4233		
DA-HSDPA	Subtest 1	826.4	4132	22.0	18.0
		836.6	4183		
		846.6	4233		
	Subtest 2	826.4	4132		
		836.6	4183		
		846.6	4233		
	Subtest 3	826.4	4132		
		836.6	4183		
		846.6	4233		
	Subtest 4	826.4	4132		
		836.6	4183		
		846.6	4233		

LTE

Note: RB allocation mentioned below is for all Bandwidths, and the Frequency Range are divided to 3 ranges (Low, Mid, High)

Band 2

BW	Modulation	RB allocation with different offset	Frequency range	Full power Tune-up limit (dBm)	Reduced Power Tune-up limit (dBm)
All Bandwidth	QPSK	1	Low	21.5	14.5
			Mid		
			High		
		50%	Low	20.5	13.5
			Mid		
			High		
	100%	Low	20.5	13.5	
		Mid			
		High			
	16QAM	1	Low	20.5	13.5
			Mid		
			High		
		50%	Low	19.5	12.5
			Mid		
			High		
100%		Low	19.5	12.5	
		Mid			
		High			

Band 4

BW	Modulation	RB allocation with different offset	Frequency range	Full power Tune-up limit (dBm)	Reduced Power Tune-up limit (dBm)
All Bandwidth	QPSK	1	Low	23.5	14.5
			Mid		
			High		
		50%	Low	22.5	13.5
			Mid		
			High		
	100%	Low	22.5	13.5	
		Mid			
		High			
	16QAM	1	Low	22.5	13.5
			Mid		
			High		
		50%	Low	21.5	12.5
			Mid		
			High		
100%		Low	21.5	12.5	
		Mid			
		High			

Band 5

BW	Modulation	RB allocation with different offset	Frequency range	Full power Tune-up limit (dBm)	Reduced Power Tune-up limit (dBm)
All Bandwidth	QPSK	1	Low	23.5	18.5
			Mid		
			High		
		50%	Low	22.5	17.5
			Mid		
			High		
		100%	Low	22.5	17.5
			Mid		
			High		
	16QAM	1	Low	22.5	17.5
			Mid		
			High		
		50%	Low	21.5	16.5
			Mid		
			High		
100%		Low	21.5	16.5	
		Mid			
		High			

Band 12

BW	Modulation	RB allocation with different offset	Frequency range	Full power Tune-up limit (dBm)	Reduced Power Tune-up limit (dBm)
All Bandwidth	QPSK	1	Low	22.0	20.0
			Mid		
			High		
		50%	Low	21.0	19.0
			Mid		
			High		
		100%	Low	21.0	19.0
			Mid		
			High		
	16QAM	1	Low	21.0	19.0
			Mid		
			High		
		50%	Low	20.0	18.0
			Mid		
			High		
100%		Low	20.0	18.0	
		Mid			
		High			

Band 13

BW	Modulation	RB allocation with different offset	Frequency range	Full power Tune-up limit (dBm)	Reduced Power Tune-up limit (dBm)
All Bandwidth	QPSK	1	Low	24.0	20.0
			Mid		
			High		
		50%	Low	23.0	19.0
			Mid		
			High		
		100%	Low	23.0	19.0
			Mid		
			High		
	16QAM	1	Low	23.0	19.0
			Mid		
			High		
		50%	Low	22.0	18.0
			Mid		
			High		
100%		Low	22.0	18.0	
		Mid			
		High			

Band 25

BW	Modulation	RB allocation with different offset	Frequency range	Full power Tune-up limit (dBm)	Reduced Power Tune-up limit (dBm)
All Bandwidth	QPSK	1	Low	21.5	14.5
			Mid		
			High		
		50%	Low	20.5	13.5
			Mid		
			High		
		100%	Low	20.5	13.5
			Mid		
			High		
	16QAM	1	Low	20.5	13.0
			Mid		
			High		
		50%	Low	19.5	12.5
			Mid		
			High		
100%		Low	19.5	12.5	
		Mid			
		High			

Band 26

BW	Modulation	RB allocation with different offset	Frequency range	Full power Tune-up limit (dBm)	Reduced Power Tune-up limit (dBm)
All Bandwidth	QPSK	1	Low	24.0	19.0
			Mid		
			High		
		50%	Low	23.0	18.0
			Mid		
			High		
		100%	Low	23.0	18.0
			Mid		
			High		
	16QAM	1	Low	23.0	18.0
			Mid		
			High		
		50%	Low	22.0	17.0
			Mid		
			High		
100%		Low	22.0	17.0	
		Mid			
		High			

Band 41

BW	Modulation	RB allocation with different offset	Frequency range	Full power Tune-up limit (dBm)	Reduced Power Tune-up limit (dBm)
All Bandwidth	QPSK	1	Low	24.5	19.5
			Mid		
			High		
		50%	Low	23.5	18.5
			Mid		
			High		
	100%	Low	23.5	18.5	
		Mid			
		High			
	16QAM	1	Low	23.5	18.5
			Mid		
			High		
		50%	Low	22.5	17.5
			Mid		
			High		
100%		Low	22.5	17.5	
		Mid			
		High			

Band 66

BW	Modulation	RB allocation with different offset	Frequency range	Full power Tune-up limit (dBm)	Reduced Power Tune-up limit (dBm)
All Bandwidth	QPSK	1	Low	24.5	15.5
			Mid		
			High		
		50%	Low	23.5	14.5
			Mid		
			High		
	100%	Low	23.5	14.5	
		Mid			
		High			
	16QAM	1	Low	23.5	14.0
			Mid		
			High		
		50%	Low	22.5	13.5
			Mid		
			High		
100%		Low	22.5	13.5	
		Mid			
		High			

Band 71

BW	Modulation	RB allocation with different offset	Frequency range	Full power Tune-up limit (dBm)	Reduced Power Tune-up limit (dBm)
All Bandwidth	QPSK	1	Low	24.5	20.5
			Mid		
			High		
		50%	Low	23.5	19.5
			Mid		
			High		
	100%	Low	23.5	19.5	
		Mid			
		High			
	16QAM	1	Low	23.5	19.5
			Mid		
			High		
50%		Low	22.5	18.5	
		Mid			
		High			
100%		Low	22.5	18.5	
		Mid			
		High			

WLAN 2.4GHz

Modulation type	Full power Tune-up limit (dBm)		
	2412MHz	2437MHz	2462MHz
11b	16.0		
11g	14.0		
11n HT20	13.0		
Modulation type	2422MHz	2437MHz	2452MHz
11n HT40	12.0		

6.2 WCDMA Measurement result

Release 99

The following procedures are according to FCC KDB Publication 941225 D01. The following tests were completed according to the test requirements outlined in section 5.2 of the 3GPP TS34.121-1 specification. The DUT supports power Class 3, which has a nominal maximum output power of 24 dBm (+1.7/-3.7).

Mode	Subtest	Rel99
WCDMA General Settings	Loopback Mode	Test Mode 1
	RMC mode AMR mode	12.2kbps RMC 12.2kbps RMC in 3.4 kbps SRB
	Power Control Algorithm	Algorithm2
	β_c/β_d	8/15

Release 5

The following 4 Sub-tests were completed according to Release 5 procedures in section 5.2 of 3GPP TS34.121.

Sub-test	β_c	β_d	β_d (SF)	β_c/β_d	$\beta_{hs}^{(1)}$	CM(dB) ⁽²⁾
1	2/15	15/15	64	2/15	4/15	0.0
2	12/15 ⁽³⁾	15/15 ⁽³⁾	64	12/15 ⁽³⁾	24/15	1.0
3	15/15	8/15	64	15/18	30/15	1.5
4	15/15	4/15	64	15/4	30/15	1.5

Note1: Δ_{ACK} , Δ_{NACK} and $\Delta_{CQI} = 8 \Leftrightarrow A_{hs} = \beta_{hs}/\beta_c = 30/15 \Leftrightarrow \beta_{hs} = 30/15 * \beta_c$.
Note2: CM=1 for $\beta_c/\beta_d = 12/15$, $\beta_{hs}/\beta_c = 24/15$.
Note3: For subtest 2 the β_c/β_d ratio of 12/15 for the TFC during the measurement period(TF1,TF0) is achieved by setting the signaled gain factors for the reference TFC(TF1,TF1) to $\beta_c = 11/15$ and $\beta_d = 15/15$.

Release 6

The following 5 Sub-tests were completed according to Release 6 procedures in section 5.2 of 3GPP TS34.121.

Sub-test	β_c	β_d	β_d (S F)	β_c/β_d	$\beta_{hs}^{(1)}$	β_{ec}	β_{ed}	β_e β_d (S F)	β_{ed} (codes)	C M (² dB)	M P R (dB)	AG (⁴ Index)	E-T FCI
1	11/1 5 ⁽³⁾	15/1 5 ⁽³⁾	64	11/1 5 ⁽³⁾	22/ 15	209/ 225	1039/ 225	4	1	1. 0	2. 0	20	75
2	6/15	15/1 5	64	6/15	12/ 15	12/1 5	94/75	4	1	3. 0	2. 0	12	67
3	15/1 5	9/15	64	15/9	30/ 15	30/1 5	$\beta_{ed1}:4$ 7/15 $\beta_{ed2}:4$ 7/15	4	2	2. 0	2. 0	15	92
4	2/15	15/1 5	64	2/15	4/1 5	2/15	56/75	4	1	3. 0	2. 0	17	71
5	15/1 5 ⁽⁴⁾	15/1 5 ⁽⁴⁾	64	15/1 5 ⁽⁴⁾	30/ 15	24/1 5	134/1 5	4	1	1. 0	2. 0	21	81

Note1: Δ_{ACK} , Δ_{NACK} and $\Delta_{CQI} = 8 \Leftrightarrow A_{hs} = \beta_{hs}/\beta_c = 30/15 \Leftrightarrow \beta_{hs} = 30/15 * \beta_c$.

Note2: CM=1 for $\beta_c/\beta_d = 12/15, \beta_{hs}/\beta_c = 24/15$. For all other combinations of DPDCH, DPCCH, HS-DPCCH, E-DPDCH and E-DPCCH the MPR is based on the relative CM difference.

Note3: For subtest 1 the β_c/β_d ratio of 11/15 for the TFC during the measurement period(TF1,TF0) is achieved by setting the signaled gain factors for the reference TFC(TF1,TF1) to $\beta_c=10/15$ and $\beta_d=15/15$.

Note4: For subtest 5 the β_c/β_d ratio of 15/15 for the TFC during the measurement period(TF1,TF0) is achieved by setting the signaled gain factors for the reference TFC(TF1,TF1) to $\beta_c=14/15$ and $\beta_d=15/15$.

NOTE5: Testing UE using E-DPDCH Physical layer category 1 Sub-test 3 is not required according to TS 25.306 Table 5.1g.

NOTE6: β_{ed} can not be set directly; it is set by Absolute Grant Value.

WCDMA band II

Test results conducted power measurement (Full Power)

Mode		Carrier frequency (MHz)	Channel No.	RF Power Output (dBm)
Release 99	RMC,12.2kbps	1852.4	9262	21.86
		1880.0	9400	21.88
		1907.6	9538	21.75
	RMC,64kbps	1852.4	9262	21.64
		1880.0	9400	21.71
		1907.6	9538	21.66
	RMC,144kbps	1852.4	9262	21.70
		1880.0	9400	21.62
		1907.6	9538	21.57
	RMC,384kbps	1852.4	9262	21.47
		1880.0	9400	21.52
		1907.6	9538	21.51
HSDPA	Subtest 1	1852.4	9262	21.00
		1880.0	9400	21.04
		1907.6	9538	20.97
	Subtest 2	1852.4	9262	20.93
		1880.0	9400	20.96
		1907.6	9538	20.93
	Subtest 3	1852.4	9262	20.89
		1880.0	9400	20.91
		1907.6	9538	20.87
	Subtest 4	1852.4	9262	20.83
		1880.0	9400	20.85
		1907.6	9538	20.79
HSUPA	Subtest 1	1852.4	9262	21.05
		1880.0	9400	21.06
		1907.6	9538	21.01
	Subtest 2	1852.4	9262	21.08
		1880.0	9400	21.11
		1907.6	9538	21.04
	Subtest 3	1852.4	9262	21.03
		1880.0	9400	21.01
		1907.6	9538	20.99
	Subtest 4	1852.4	9262	21.07
		1880.0	9400	21.11
		1907.6	9538	21.03
	Subtest 5	1852.4	9262	20.99
		1880.0	9400	21.01
		1907.6	9538	20.96
HSPA+	QPSK	1852.4	9262	21.11
		1880.0	9400	21.14
		1907.6	9538	21.09

	16QAM	1852.4	9262	20.78
		1880.0	9400	20.81
		1907.6	9538	20.75
DC-HSDPA	Subtest 1	1852.4	9262	20.91
		1880.0	9400	20.94
		1907.6	9538	20.88
	Subtest 2	1852.4	9262	20.86
		1880.0	9400	20.87
		1907.6	9538	20.85
	Subtest 3	1852.4	9262	20.79
		1880.0	9400	20.83
		1907.6	9538	20.78
	Subtest 4	1852.4	9262	20.76
		1880.0	9400	20.77
		1907.6	9538	20.72

Test results conducted power measurement (Reduced Power)

Mode		Carrier frequency (MHz)	Channel No.	RF Power Output (dBm)
Release 99	RMC,12.2kbps	1852.4	9262	13.86
		1880.0	9400	13.88
		1907.6	9538	13.75
	RMC,64kbps	1852.4	9262	13.64
		1880.0	9400	13.71
		1907.6	9538	13.66
	RMC,144kbps	1852.4	9262	13.70
		1880.0	9400	13.62
		1907.6	9538	13.57
	RMC,384kbps	1852.4	9262	13.47
		1880.0	9400	13.52
		1907.6	9538	13.51
HSDPA	Subtest 1	1852.4	9262	13.00
		1880.0	9400	13.04
		1907.6	9538	12.97
	Subtest 2	1852.4	9262	12.93
		1880.0	9400	12.96
		1907.6	9538	12.93
	Subtest 3	1852.4	9262	12.89
		1880.0	9400	12.91
		1907.6	9538	12.87
	Subtest 4	1852.4	9262	12.83
		1880.0	9400	12.85
		1907.6	9538	12.79
HSUPA	Subtest 1	1852.4	9262	13.05

		1880.0	9400	13.06	
		1907.6	9538	13.01	
		1852.4	9262	13.08	
	Subtest 2		1880.0	9400	13.11
			1907.6	9538	13.04
			1852.4	9262	13.03
	Subtest 3		1880.0	9400	13.01
			1907.6	9538	12.99
			1852.4	9262	13.07
	Subtest 4		1880.0	9400	13.11
			1907.6	9538	13.03
			1852.4	9262	12.99
	Subtest 5		1880.0	9400	13.01
			1907.6	9538	12.96
			1852.4	9262	13.11
HSPA+	QPSK	1880.0	9400	13.14	
		1907.6	9538	13.09	
		1852.4	9262	12.78	
	16QAM	1880.0	9400	12.81	
		1907.6	9538	12.75	
		1852.4	9262	12.91	
DC-HSDPA	Subtest 1	1880.0	9400	12.94	
		1907.6	9538	12.88	
		1852.4	9262	12.86	
	Subtest 2	1880.0	9400	12.87	
		1907.6	9538	12.85	
		1852.4	9262	12.79	
	Subtest 3	1880.0	9400	12.83	
		1907.6	9538	12.78	
		1852.4	9262	12.76	
	Subtest 4	1880.0	9400	12.77	
		1907.6	9538	12.72	
		1852.4	9262		

WCDMA band IV

Test results conducted power measurement (Full Power)

Mode		Carrier frequency (MHz)	Channel No.	RF Power Output (dBm)
Release 99	RMC,12.2kbps	1712.4	1312	22.61
		1732.4	1412	22.64
		1752.6	1513	22.65
	RMC,64kbps	1712.4	1312	22.53
		1732.4	1412	22.55
		1752.6	1513	22.59
	RMC,144kbps	1712.4	1312	22.47
		1732.4	1412	22.51
		1752.6	1513	22.54
	RMC,384kbps	1712.4	1312	22.38
		1880.0	9400	22.43
		1907.6	9538	22.47
HSDPA	Subtest 1	1712.4	1312	21.97
		1732.4	1412	21.86
		1752.6	1513	21.90
	Subtest 2	1712.4	1312	21.79
		1732.4	1412	21.81
		1752.6	1513	21.82
	Subtest 3	1712.4	1312	21.75
		1732.4	1412	21.77
		1752.6	1513	21.81
	Subtest 4	1712.4	1312	21.71
		1732.4	1412	21.74
		1752.6	1513	21.78
HSUPA	Subtest 1	1712.4	1312	22.01
		1732.4	1412	22.03
		1752.6	1513	22.04
	Subtest 2	1712.4	1312	21.98
		1732.4	1412	21.98
		1752.6	1513	22.01
	Subtest 3	1712.4	1312	21.96
		1732.4	1412	21.99
		1752.6	1513	22.02
	Subtest 4	1712.4	1312	21.93
		1732.4	1412	21.95
		1752.6	1513	21.98
	Subtest 5	1712.4	1312	21.96
		1732.4	1412	21.97
		1752.6	1513	21.99
HSPA+	QPSK	1712.4	1312	21.85
		1732.4	1412	21.87
		1752.6	1513	21.84

	16QAM	1712.4	1312	21.73
		1732.4	1412	21.77
		1752.6	1513	21.72
DC-HSDPA	Subtest 1	1712.4	1312	21.89
		1732.4	1412	21.79
		1752.6	1513	21.80
	Subtest 2	1712.4	1312	21.70
		1732.4	1412	21.73
		1752.6	1513	21.73
	Subtest 3	1712.4	1312	21.64
		1732.4	1412	21.69
		1752.6	1513	21.72
	Subtest 4	1712.4	1312	21.60
		1732.4	1412	21.64
		1752.6	1513	21.69

Test results conducted power measurement (Reduced Power)

Mode		Carrier frequency (MHz)	Channel No.	RF Power Output (dBm)
Release 99	RMC,12.2kbps	1712.4	1312	13.61
		1732.4	1412	13.64
		1752.6	1513	13.65
	RMC,64kbps	1712.4	1312	13.53
		1732.4	1412	13.55
		1752.6	1513	13.59
	RMC,144kbps	1712.4	1312	13.47
		1732.4	1412	13.51
		1752.6	1513	13.54
	RMC,384kbps	1712.4	1312	13.38
		1732.4	1412	13.43
		1752.6	1513	13.47
HSDPA	Subtest 1	1712.4	1312	12.97
		1732.4	1412	12.86
		1752.6	1513	12.90
	Subtest 2	1712.4	1312	12.79
		1732.4	1412	12.81
		1752.6	1513	12.82
	Subtest 3	1712.4	1312	12.75
		1732.4	1412	12.77
		1752.6	1513	12.81
	Subtest 4	1712.4	1312	12.71
		1732.4	1412	12.74
		1752.6	1513	12.78
HSUPA	Subtest 1	1712.4	1312	13.01

		1732.4	1412	13.03	
		1752.6	1513	13.04	
		1712.4	1312	12.98	
	Subtest 2		1732.4	1412	12.98
			1752.6	1513	13.01
			1712.4	1312	12.96
	Subtest 3		1732.4	1412	12.99
			1752.6	1513	13.02
			1712.4	1312	12.93
	Subtest 4		1732.4	1412	12.95
			1752.6	1513	12.98
			1712.4	1312	12.96
	Subtest 5		1732.4	1412	12.97
			1752.6	1513	12.99
			1712.4	1312	12.85
HSPA+	QPSK	1732.4	1412	12.87	
		1752.6	1513	12.84	
		1712.4	1312	12.73	
	16QAM		1732.4	1412	12.77
			1752.6	1513	12.72
			1712.4	1312	12.89
DC-HSDPA	Subtest 1		1732.4	1412	12.79
			1752.6	1513	12.80
			1712.4	1312	12.70
	Subtest 2		1732.4	1412	12.73
			1752.6	1513	12.73
			1712.4	1312	12.64
	Subtest 3		1732.4	1412	12.69
			1752.6	1513	12.72
			1712.4	1312	12.60
	Subtest 4		1732.4	1412	12.64
			1752.6	1513	12.69
			1712.4	1312	12.69

WCDMA band V

Test results conducted power measurement (Full Power)

Mode		Carrier frequency (MHz)	Channel No.	RF Power Output (dBm)
Release 99	RMC,12.2kbps	826.4	4132	22.57
		836.6	4183	22.58
		846.6	4233	22.68
	RMC,64kbps	826.4	4132	22.53
		836.6	4183	22.45
		846.6	4233	22.48
	RMC,144kbps	826.4	4132	22.43
		836.6	4183	22.46
		846.6	4233	22.54
	RMC,384kbps	826.4	4132	22.38
		836.6	4183	22.41
		846.6	4233	22.47
HSDPA	Subtest 1	826.4	4132	21.82
		836.6	4183	21.85
		846.6	4233	21.89
	Subtest 2	826.4	4132	21.79
		836.6	4183	21.80
		846.6	4233	21.86
	Subtest 3	826.4	4132	21.73
		836.6	4183	21.77
		846.6	4233	21.82
	Subtest 4	826.4	4132	21.70
		836.6	4183	21.73
		846.6	4233	21.78
HSUPA	Subtest 1	826.4	4132	21.86
		836.6	4183	21.89
		846.6	4233	21.94
	Subtest 2	826.4	4132	21.80
		836.6	4183	21.84
		846.6	4233	21.88
	Subtest 3	826.4	4132	21.77
		836.6	4183	21.82
		846.6	4233	21.85
	Subtest 4	826.4	4132	21.78
		836.6	4183	21.80
		846.6	4233	21.87
	Subtest 5	826.4	4132	21.76
		836.6	4183	21.79
		846.6	4233	21.84
HSPA+	QPSK	826.4	4132	21.75

	16QAM	836.6	4183	21.77
		846.6	4233	21.81
		826.4	4132	21.68
		836.6	4183	21.71
		846.6	4233	21.75
DC-HSDPA	Subtest 1	826.4	4132	21.71
		836.6	4183	21.74
		846.6	4233	21.79
	Subtest 2	826.4	4132	21.71
		836.6	4183	21.73
		846.6	4233	21.75
	Subtest 3	826.4	4132	21.66
		836.6	4183	21.69
		846.6	4233	21.71
	Subtest 4	826.4	4132	21.63
		836.6	4183	21.66
		846.6	4233	21.69

Test results conducted power measurement (Reduced Power)

Mode		Carrier frequency (MHz)	Channel No.	RF Power Output (dBm)
Release 99	RMC,12.2kbps	826.4	4132	18.57
		836.6	4183	18.58
		846.6	4233	18.68
	RMC,64kbps	826.4	4132	18.53
		836.6	4183	18.45
		846.6	4233	18.48
	RMC,144kbps	826.4	4132	18.43
		836.6	4183	18.46
		846.6	4233	18.54
	RMC,384kbps	826.4	4132	18.38
		836.6	4183	18.41
		846.6	4233	18.47
HSDPA	Subtest 1	826.4	4132	17.82
		836.6	4183	17.85
		846.6	4233	17.89
	Subtest 2	826.4	4132	17.79
		836.6	4183	17.80
		846.6	4233	17.86
	Subtest 3	826.4	4132	17.73
		836.6	4183	17.77
		846.6	4233	17.82
	Subtest 4	826.4	4132	17.70
		836.6	4183	17.73
		846.6	4233	17.78

HSUPA	Subtest 1	826.4	4132	17.86
		836.6	4183	17.89
		846.6	4233	17.94
	Subtest 2	826.4	4132	17.80
		836.6	4183	17.84
		846.6	4233	17.88
	Subtest 3	826.4	4132	17.77
		836.6	4183	17.82
		846.6	4233	17.85
	Subtest 4	826.4	4132	17.78
		836.6	4183	17.80
		846.6	4233	17.87
Subtest 5	826.4	4132	17.76	
	836.6	4183	17.79	
	846.6	4233	17.84	
HSPA+	QPSK	826.4	4132	17.75
		836.6	4183	17.77
		846.6	4233	17.81
	16QAM	826.4	4132	17.68
		836.6	4183	17.71
		846.6	4233	17.75
DC-HSDPA	Subtest 1	826.4	4132	17.71
		836.6	4183	17.74
		846.6	4233	17.79
	Subtest 2	826.4	4132	17.71
		836.6	4183	17.73
		846.6	4233	17.75
	Subtest 3	826.4	4132	17.66
		836.6	4183	17.69
		846.6	4233	17.71
	Subtest 4	826.4	4132	17.63
		836.6	4183	17.66
		846.6	4233	17.69

Note: UMTS SAR was tested under Rel.99 RMC 12.2kbps mode per KDB Publication 941225 D01.for other higher release configuration, SAR was not required since any average output power was not more than 0.25 dB higher than the RMC level and the adjusted SAR was less than 1.2 W/kg.

6.3 LTE Measurement result

General description:

TDD-LTE frame structure

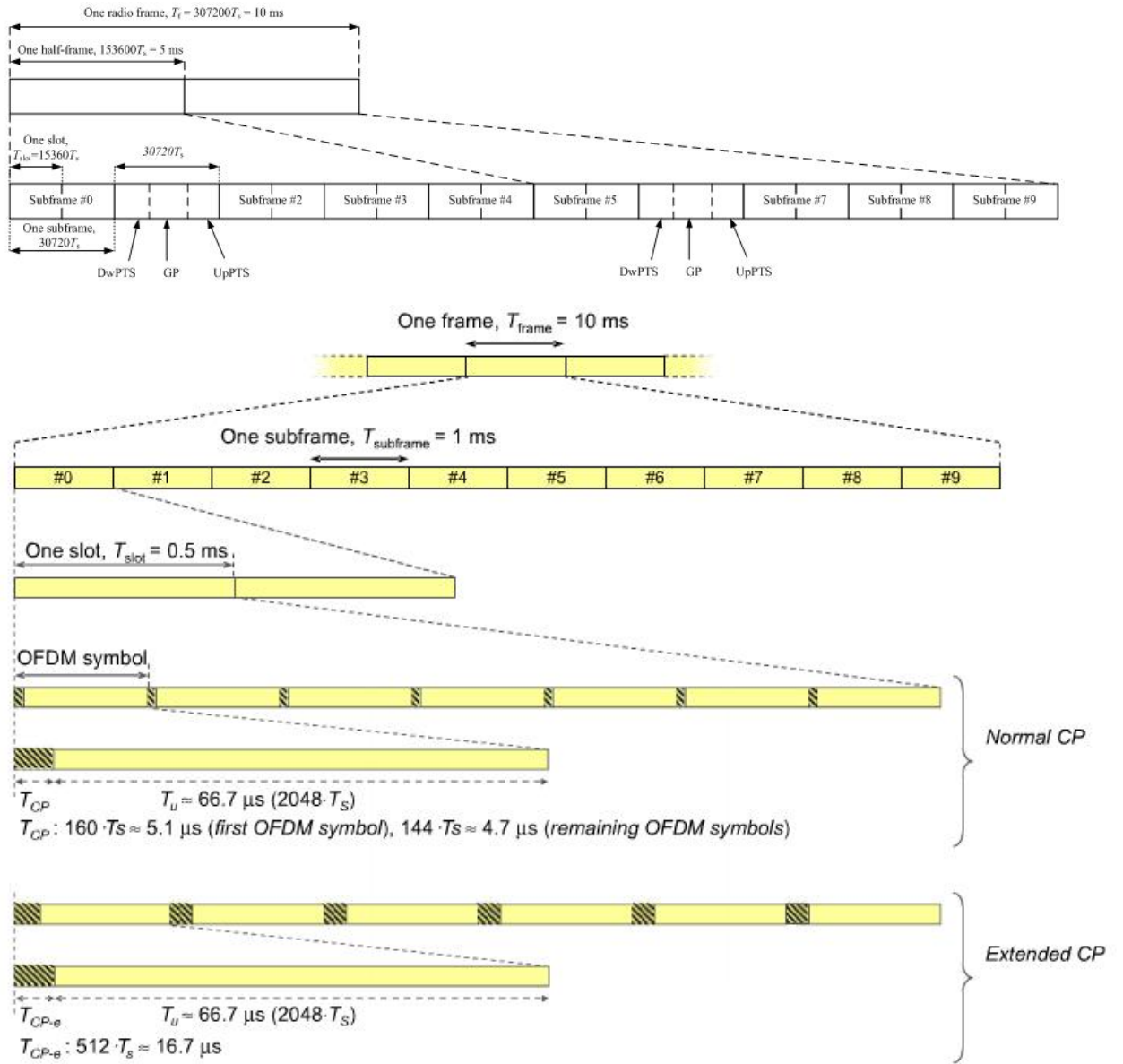

Uplink-downlink configuration

Uplink-downlink configuration	Downlink-to-Uplink Switch-point periodicity	Subframe number									
		0	1	2	3	4	5	6	7	8	9
0	5 ms	D	S	U	U	U	D	S	U	U	U
1	5 ms	D	S	U	U	D	D	S	U	U	D
2	5 ms	D	S	U	D	D	D	S	U	D	D
3	10 ms	D	S	U	U	U	D	D	D	D	D
4	10 ms	D	S	U	U	D	D	D	D	D	D
5	10 ms	D	S	U	D	D	D	D	D	D	D
6	5 ms	D	S	U	U	U	D	S	U	U	D

Special sub-frame configuration

Special subframe configuration	Normal cyclic prefix in downlink			Extended cyclic prefix in downlink		
	DwPTS	UpPTS		DwPTS	UpPTS	
		Normal cyclic prefix in uplink	Extended cyclic prefix in uplink		Normal cyclic prefix in uplink	Extended cyclic prefix in uplink
0	$6592 \cdot T_s$	$2192 \cdot T_s$	$2560 \cdot T_s$	$7680 \cdot T_s$	$2192 \cdot T_s$	$2560 \cdot T_s$
1	$19760 \cdot T_s$			$20480 \cdot T_s$		
2	$21952 \cdot T_s$			$23040 \cdot T_s$		
3	$24144 \cdot T_s$			$25600 \cdot T_s$		
4	$26336 \cdot T_s$	$4384 \cdot T_s$	$5120 \cdot T_s$	$7680 \cdot T_s$	$4384 \cdot T_s$	$5120 \cdot T_s$
5	$6592 \cdot T_s$			$20480 \cdot T_s$		
6	$19760 \cdot T_s$			$23040 \cdot T_s$		
7	$21952 \cdot T_s$			-		
8	$24144 \cdot T_s$	-	-	-	-	-

Special sub-frame with cyclic prefix uplink

Special sub-frame configuration		Duty factor with normal cyclic prefix in uplink	Duty factor with extended cyclic prefix in uplink
Normal cyclic prefix in downlink	0~4	7.13%	8.33%
	5~9	14.3%	16.7%
Extended cyclic prefix in downlink	0~3	7.13%	8.33%
	4~7	14.3%	16.7%

So we perform SAR test with maximum duty factor equal to 63.3% by using uplink-downlink configuration 0.

Note: One sub-frame is $30720T_s=1\text{ms}$, when UpPTS(uplink) in special sub-frame with extended cyclic prefix, duty factor = $5120/30720=0.167$. There are 5 sub-frames in half frame(3up link), so the final duty factor is $(30720 \cdot 3 + 5120) / (30720 \cdot 5) = 63.3\%$ which we used to evaluate the SAR compliance (worst case)

FDD-LTE frame structure

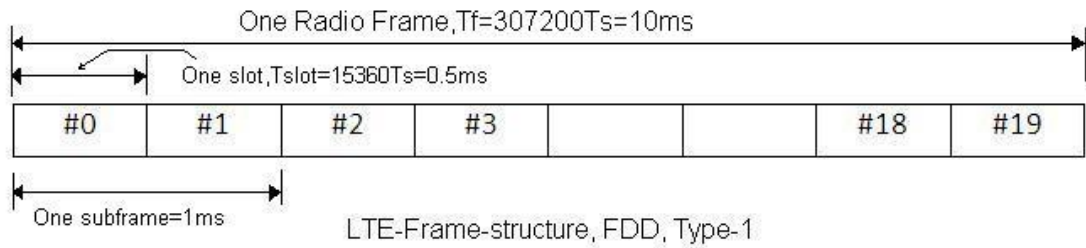

Type 1 is used as LTE FDD frame structure. As shown in the figure above, an LTE TDD frame is made of total 20 slots, each of 0.5ms. Two consecutive time slots will form one subframe. 10 such subframes form one radio frame. One subframe duration is about 1 ms.and the duty cycle is inherent as100%

LTE Band 2

Test results conducted power measurement (Full Power)

Modulation	Carrier frequency (MHz)	UL Channel	BW	RB Size	RB Offset	Conducted power (dBm)
QPSK	1850.7	18607	1.4	1	0	20.88
				1	5	20.86
				3	2	20.04
				6	0	20.02
	1880	18900		1	0	21.06
				1	5	20.92
				3	2	20.07
				6	0	19.93
	1909.3	19193		1	0	21.05
				1	5	20.98
				3	2	20.23
				6	0	20.16
16QAM	1850.7	18607	1.4	1	0	19.93
				1	5	19.83
				3	2	19.02
				6	0	18.98
	1880	18900		1	0	20.09
				1	5	20.13
				3	2	19.20
				6	0	19.13
	1909.3	19193		1	0	20.12
				1	5	20.10
				3	2	19.23
				6	0	19.19

Modulation	Carrier frequency (MHz)	UL Channel	BW	RB Size	RB Offset	Conducted power (dBm)
QPSK	1851.5	18615	3	1	0	20.92
				1	14	20.90
				8	4	20.05
				15	0	20.01
	1880	18900		1	0	21.02
				1	14	20.90
				8	4	20.05
				15	0	19.98
	1908.5	19185		1	0	21.04
				1	14	20.99
				8	4	20.16
				15	0	20.19
16QAM	1851.5	18615	3	1	0	19.89
				1	14	19.91
				8	4	19.08
				15	0	19.08
	1880	18900		1	0	20.15
				1	14	20.07
				8	4	19.11
				15	0	19.09
	1908.5	19185		1	0	20.09
				1	14	20.03
				8	4	19.28
				15	0	19.22

Modulation	Carrier frequency (MHz)	UL Channel	BW	RB Size	RB Offset	Conducted power (dBm)
QPSK	1852.5	18625	5	1	0	20.90
				1	24	20.90
				12	6	20.10
				25	0	20.11
	1880	18900		1	0	21.08
				1	24	21.01
				12	6	20.15
				25	0	20.03
	1907.5	19175		1	0	21.07
				1	24	21.02
				12	6	20.29
				25	0	20.27
16QAM	1852.5	18625	5	1	0	19.96
				1	24	19.87
				12	6	19.15
				25	0	19.10
	1880	18900		1	0	20.22
				1	24	20.16
				12	6	19.19
				25	0	19.15
	1907.5	19175		1	0	20.22
				1	24	20.18
				12	6	19.29
				25	0	19.25

Modulation	Carrier frequency (MHz)	UL Channel	BW	RB Size	RB Offset	Conducted power (dBm)
QPSK	1855	18650	10	1	0	21.05
				1	49	21.07
				24	12	20.25
				50	0	20.15
	1880	18900		1	0	21.14
				1	49	21.05
				24	12	20.16
				50	0	20.10
	1905	19150		1	0	21.18
				1	49	21.14
				24	12	20.32
				50	0	20.25
16QAM	1855	18650	10	1	0	20.09
				1	49	20.05
				24	12	19.17
				50	0	19.16
	1880	18900		1	0	20.26
				1	49	20.19
				24	12	19.32
				50	0	19.24
	1905	19150		1	0	20.20
				1	49	20.21
				24	12	19.37
				50	0	19.34

Modulation	Carrier frequency (MHz)	UL Channel	BW	RB Size	RB Offset	Conducted power (dBm)
QPSK	1857.5	18675	15	1	0	21.02
				1	74	21.05
				40	18	20.18
				75	0	20.11
	1880	18900		1	0	21.21
				1	74	21.06
				40	18	20.18
				75	0	20.17
	1902.5	19125		1	0	21.22
				1	74	21.13
				40	18	20.33
				75	0	20.31
16QAM	1857.5	18675	15	1	0	20.14
				1	74	20.01
				40	18	19.14
				75	0	19.15
	1880	18900		1	0	20.27
				1	74	20.21
				40	18	19.37
				75	0	19.25
	1902.5	19125		1	0	20.27
				1	74	20.20
				40	18	19.42
				75	0	19.36

Modulation	Carrier frequency (MHz)	UL Channel	BW	RB Size	RB Offset	Conducted power (dBm)
QPSK	1860	18700	20	1	0	21.17
				1	99	21.15
				50	25	20.33
				100	0	20.25
	1880	18900		1	0	21.28
				1	99	21.16
				50	25	20.29
				100	0	20.22
	1900	19100		1	0	21.33
				1	99	21.28
				50	25	20.47
				100	0	20.41
16QAM	1860	18700	20	1	0	20.19
				1	99	20.14
				50	25	19.29
				100	0	19.28
	1880	18900		1	0	20.38
				1	99	20.35
				50	25	19.42
				100	0	19.38
	1900	19100		1	0	20.36
				1	99	20.34
				50	25	19.48
				100	0	19.46

Test results conducted power measurement (Reduced Power)

Modulation	Carrier frequency (MHz)	UL Channel	BW	RB Size	RB Offset	Conducted power (dBm)
QPSK	1850.7	18607	1.4	1	0	13.88
				1	5	13.86
				3	2	13.04
				6	0	13.02
	1880	18900		1	0	14.06
				1	5	13.92
				3	2	13.07
				6	0	12.93
	1909.3	19193		1	0	14.05
				1	5	13.98
				3	2	13.23
				6	0	13.16
16QAM	1850.7	18607	1.4	1	0	12.93
				1	5	12.83
				3	2	12.02
				6	0	11.98
	1880	18900		1	0	13.09
				1	5	13.13
				3	2	12.20
				6	0	12.13
	1909.3	19193		1	0	13.12
				1	5	13.10
				3	2	12.23
				6	0	12.19

Modulation	Carrier frequency (MHz)	UL Channel	BW	RB Size	RB Offset	Conducted power (dBm)
QPSK	1851.5	18615	3	1	0	13.92
				1	14	13.90
				8	4	13.05
				15	0	13.01
	1880	18900		1	0	14.02
				1	14	13.90
				8	4	13.05
				15	0	12.98
	1908.5	19185		1	0	14.04
				1	14	13.99
				8	4	13.16
				15	0	13.19
16QAM	1851.5	18615	3	1	0	12.89
				1	14	12.91
				8	4	12.08
				15	0	12.08
	1880	18900		1	0	13.15
				1	14	13.07
				8	4	12.11
				15	0	12.09
	1908.5	19185		1	0	13.09
				1	14	13.03
				8	4	12.28
				15	0	12.22

Modulation	Carrier frequency (MHz)	UL Channel	BW	RB Size	RB Offset	Conducted power (dBm)
QPSK	1852.5	18625	5	1	0	13.90
				1	24	13.90
				12	6	13.10
				25	0	13.11
	1880	18900		1	0	14.08
				1	24	14.01
				12	6	13.15
				25	0	13.03
	1907.5	19175		1	0	14.07
				1	24	14.02
				12	6	13.29
				25	0	13.27
16QAM	1852.5	18625	5	1	0	12.96
				1	24	12.87
				12	6	12.15
				25	0	12.10
	1880	18900		1	0	13.22
				1	24	13.16
				12	6	12.19
				25	0	12.15
	1907.5	19175		1	0	13.22
				1	24	13.18
				12	6	12.29
				25	0	12.25

Modulation	Carrier frequency (MHz)	UL Channel	BW	RB Size	RB Offset	Conducted power (dBm)
QPSK	1855	18650	10	1	0	14.05
				1	49	14.07
				24	12	13.25
				50	0	13.15
	1880	18900		1	0	14.14
				1	49	14.05
				24	12	13.16
				50	0	13.10
	1905	19150		1	0	14.18
				1	49	14.14
				24	12	13.32
				50	0	13.25
16QAM	1855	18650	10	1	0	13.09
				1	49	13.05
				24	12	12.17
				50	0	12.16
	1880	18900		1	0	13.26
				1	49	13.19
				24	12	12.32
				50	0	12.24
	1905	19150		1	0	13.20
				1	49	13.21
				24	12	12.37
				50	0	12.34

Modulation	Carrier frequency (MHz)	UL Channel	BW	RB Size	RB Offset	Conducted power (dBm)
QPSK	1857.5	18675	15	1	0	14.02
				1	74	14.05
				40	18	13.18
				75	0	13.11
	1880	18900		1	0	14.21
				1	74	14.06
				40	18	13.18
				75	0	13.17
	1902.5	19125		1	0	14.22
				1	74	14.13
				40	18	13.33
				75	0	13.31
16QAM	1857.5	18675	15	1	0	13.14
				1	74	13.01
				40	18	12.14
				75	0	12.15
	1880	18900		1	0	13.27
				1	74	13.21
				40	18	12.37
				75	0	12.25
	1902.5	19125		1	0	13.27
				1	74	13.20
				40	18	12.42
				75	0	12.36

Modulation	Carrier frequency (MHz)	UL Channel	BW	RB Size	RB Offset	Conducted power (dBm)
QPSK	1860	18700	20	1	0	14.17
				1	99	14.15
				50	25	13.33
				100	0	13.25
	1880	18900		1	0	14.28
				1	99	14.16
				50	25	13.29
				100	0	13.22
	1900	19100		1	0	14.33
				1	99	14.28
				50	25	13.47
				100	0	13.41
16QAM	1860	18700	20	1	0	13.19
				1	99	13.14
				50	25	12.29
				100	0	12.28
	1880	18900		1	0	13.38
				1	99	13.35
				50	25	12.42
				100	0	12.38
	1900	19100		1	0	13.36
				1	99	13.34
				50	25	12.48
				100	0	12.46

LTE Band 4

Test results conducted power measurement (Full Power)

Modulation	Carrier frequency (MHz)	UL Channel	BW	RB Size	RB Offset	Conducted power (dBm)
QPSK	1710.7	19957	1.4	1	0	22.67
				1	5	22.55
				3	2	21.61
				6	0	21.59
	1732.5	20175		1	0	22.66
				1	5	22.65
				3	2	21.70
				6	0	21.63
	1754.3	20393		1	0	22.86
				1	5	22.78
				3	2	21.88
				6	0	21.75
16QAM	1710.7	19957	1.4	1	0	21.75
				1	5	21.53
				3	2	20.65
				6	0	20.59
	1732.5	20175		1	0	21.72
				1	5	21.63
				3	2	20.70
				6	0	20.65
	1754.3	20393		1	0	21.94
				1	5	21.79
				3	2	20.95
				6	0	20.80

Modulation	Carrier frequency (MHz)	UL Channel	BW	RB Size	RB Offset	Conducted power (dBm)
QPSK	1711.5	19965	3	1	0	22.69
				1	14	22.63
				8	4	21.63
				15	0	21.61
	1732.5	20175		1	0	22.77
				1	14	22.70
				8	4	21.66
				15	0	21.63
	1753.5	20385		1	0	22.80
				1	14	22.88
				8	4	21.90
				15	0	21.85
16QAM	1711.5	19965	3	1	0	21.68
				1	14	21.52
				8	4	20.60
				15	0	20.61
	1732.5	20175		1	0	21.75
				1	14	21.70
				8	4	20.74
				15	0	20.69
	1753.5	20385		1	0	21.95
				1	14	21.78
				8	4	20.98
				15	0	20.89

Modulation	Carrier frequency (MHz)	UL Channel	BW	RB Size	RB Offset	Conducted power (dBm)
QPSK	1712.5	19975	5	1	0	22.81
				1	24	22.59
				12	6	21.66
				25	0	21.59
	1732.5	20175		1	0	22.73
				1	24	22.77
				12	6	21.65
				25	0	21.63
	1752.5	20375		1	0	22.94
				1	24	22.88
				12	6	21.97
				25	0	21.81
16QAM	1712.5	19975	5	1	0	21.75
				1	24	21.67
				12	6	20.67
				25	0	20.57
	1732.5	20175		1	0	21.81
				1	24	21.75
				12	6	20.67
				25	0	20.63
	1752.5	20375		1	0	22.00
				1	24	21.91
				12	6	21.00
				25	0	20.92

Modulation	Carrier frequency (MHz)	UL Channel	BW	RB Size	RB Offset	Conducted power (dBm)
QPSK	1715	20000	10	1	0	22.87
				1	49	22.70
				24	12	21.79
				50	0	21.66
	1732.5	20175		1	0	22.81
				1	49	22.74
				24	12	21.75
				50	0	21.69
	1750	20350		1	0	22.96
				1	49	22.99
				24	12	22.04
				50	0	21.90
16QAM	1715	20000	10	1	0	21.88
				1	49	21.67
				24	12	20.79
				50	0	20.72
	1732.5	20175		1	0	21.83
				1	49	21.75
				24	12	20.79
				50	0	20.80
	1750	20350		1	0	22.05
				1	49	21.90
				24	12	21.08
				50	0	20.93

Modulation	Carrier frequency (MHz)	UL Channel	BW	RB Size	RB Offset	Conducted power (dBm)
QPSK	1717.5	20025	15	1	0	22.90
				1	74	22.76
				40	18	21.73
				75	0	21.74
	1732.5	20175		1	0	22.83
				1	74	22.79
				40	18	21.83
				75	0	21.74
	1747.5	20325		1	0	23.06
				1	74	22.93
				40	18	22.07
				75	0	22.00
16QAM	1717.5	20025	15	1	0	21.93
				1	74	21.76
				40	18	20.81
				75	0	20.77
	1732.5	20175		1	0	21.88
				1	74	21.87
				40	18	20.85
				75	0	20.80
	1747.5	20325		1	0	22.08
				1	74	22.01
				40	18	21.14
				75	0	21.00

Modulation	Carrier frequency (MHz)	UL Channel	BW	RB Size	RB Offset	Conducted power (dBm)
QPSK	1720	20050	20	1	0	22.95
				1	99	22.83
				50	25	21.87
				100	0	21.83
	1732.5	20175		1	0	22.97
				1	99	22.91
				50	25	21.92
				100	0	21.87
	1745	20300		1	0	23.11
				1	99	23.08
				50	25	22.18
				100	0	22.06
16QAM	1720	20050	20	1	0	21.99
				1	99	21.82
				50	25	20.91
				100	0	20.83
	1732.5	20175		1	0	21.98
				1	99	21.92
				50	25	20.94
				100	0	20.90
	1745	20300		1	0	22.16
				1	99	22.06
				50	25	21.20
				100	0	21.11

Test results conducted power measurement (Reduced Power)

Modulation	Carrier frequency (MHz)	UL Channel	BW	RB Size	RB Offset	Conducted power (dBm)
QPSK	1710.7	19957	1.4	1	0	14.67
				1	5	14.55
				3	2	13.61
				6	0	13.59
	1732.5	20175		1	0	14.66
				1	5	14.65
				3	2	13.70
				6	0	13.63
	1754.3	20393		1	0	14.86
				1	5	14.78
				3	2	13.88
				6	0	13.75
16QAM	1710.7	19957	1.4	1	0	13.75
				1	5	13.53
				3	2	12.65
				6	0	12.59
	1732.5	20175		1	0	13.72
				1	5	13.63
				3	2	12.70
				6	0	12.65
	1754.3	20393		1	0	13.94
				1	5	13.79
				3	2	12.95
				6	0	12.80

Modulation	Carrier frequency (MHz)	UL Channel	BW	RB Size	RB Offset	Conducted power (dBm)
QPSK	1711.5	19965	3	1	0	14.69
				1	14	14.63
				8	4	13.63
				15	0	13.61
	1732.5	20175		1	0	14.77
				1	14	14.70
				8	4	13.66
				15	0	13.63
	1753.5	20385		1	0	14.80
				1	14	14.88
				8	4	13.90
				15	0	13.85
16QAM	1711.5	19965	3	1	0	13.68
				1	14	13.52
				8	4	12.60
				15	0	12.61
	1732.5	20175		1	0	13.75
				1	14	13.70
				8	4	12.74
				15	0	12.69
	1753.5	20385		1	0	13.95
				1	14	13.78
				8	4	12.98
				15	0	12.89

Modulation	Carrier frequency (MHz)	UL Channel	BW	RB Size	RB Offset	Conducted power (dBm)
QPSK	1712.5	19975	5	1	0	14.81
				1	24	14.59
				12	6	13.66
				25	0	13.59
	1732.5	20175		1	0	14.73
				1	24	14.77
				12	6	13.65
				25	0	13.63
	1752.5	20375		1	0	14.94
				1	24	14.88
				12	6	13.97
				25	0	13.81
16QAM	1712.5	19975	5	1	0	13.75
				1	24	13.67
				12	6	12.67
				25	0	12.57
	1732.5	20175		1	0	13.81
				1	24	13.75
				12	6	12.67
				25	0	12.63
	1752.5	20375		1	0	14.00
				1	24	13.91
				12	6	13.00
				25	0	12.92

Modulation	Carrier frequency (MHz)	UL Channel	BW	RB Size	RB Offset	Conducted power (dBm)
QPSK	1715	20000	10	1	0	14.87
				1	49	14.70
				24	12	13.79
				50	0	13.66
	1732.5	20175		1	0	14.81
				1	49	14.74
				24	12	13.75
				50	0	13.69
	1750	20350		1	0	14.96
				1	49	14.99
				24	12	14.04
				50	0	13.90
16QAM	1715	20000	10	1	0	13.88
				1	49	13.67
				24	12	12.79
				50	0	12.72
	1732.5	20175		1	0	13.83
				1	49	13.75
				24	12	12.79
				50	0	12.80
	1750	20350		1	0	14.05
				1	49	13.90
				24	12	13.08
				50	0	12.93

Modulation	Carrier frequency (MHz)	UL Channel	BW	RB Size	RB Offset	Conducted power (dBm)
QPSK	1717.5	20025	15	1	0	14.90
				1	74	14.76
				40	18	13.73
				75	0	13.74
	1732.5	20175		1	0	14.83
				1	74	14.79
				40	18	13.83
				75	0	13.74
	1747.5	20325		1	0	15.06
				1	74	14.93
				40	18	14.07
				75	0	14.00
16QAM	1717.5	20025	15	1	0	13.93
				1	74	13.76
				40	18	12.81
				75	0	12.77
	1732.5	20175		1	0	13.88
				1	74	13.87
				40	18	12.85
				75	0	12.80
	1747.5	20325		1	0	14.08
				1	74	14.01
				40	18	13.14
				75	0	13.00

Modulation	Carrier frequency (MHz)	UL Channel	BW	RB Size	RB Offset	Conducted power (dBm)
QPSK	1720	20050	20	1	0	14.95
				1	99	14.83
				50	25	13.87
				100	0	13.83
	1732.5	20175		1	0	14.97
				1	99	14.91
				50	25	13.92
				100	0	13.87
	1745	20300		1	0	15.11
				1	99	15.08
				50	25	14.18
				100	0	14.06
16QAM	1720	20050	20	1	0	13.99
				1	99	13.82
				50	25	12.91
				100	0	12.83
	1732.5	20175		1	0	13.98
				1	99	13.92
				50	25	12.94
				100	0	12.90
	1745	20300		1	0	14.16
				1	99	14.06
				50	25	13.20
				100	0	13.11

LTE Band 5

Test results conducted power measurement (Full Power)

Modulation	Carrier frequency (MHz)	UL Channel	BW	RB Size	RB Offset	Conducted power (dBm)
QPSK	824.7	20407	1.4	1	0	22.93
				1	5	22.93
				3	2	22.02
				6	0	21.96
	836.5	20525		1	0	22.88
				1	5	22.82
				3	2	20.91
				6	0	20.89
	848.3	20643		1	0	22.79
				1	5	22.75
				3	2	21.93
				6	0	21.88
16QAM	824.7	20407	1.4	1	0	21.99
				1	5	21.93
				3	2	21.06
				6	0	21.03
	836.5	20525		1	0	21.86
				1	5	21.92
				3	2	19.95
				6	0	19.97
	848.3	20643		1	0	21.85
				1	5	21.71
				3	2	20.81
				6	0	20.74

Modulation	Carrier frequency (MHz)	UL Channel	BW	RB Size	RB Offset	Conducted power (dBm)
QPSK	825.5	20415	3	1	0	23.07
				1	14	22.99
				8	4	22.10
				15	0	22.02
	836.5	20525		1	0	22.95
				1	14	22.92
				8	4	21.06
				15	0	21.05
	847.5	20635		1	0	22.83
				1	14	22.81
				8	4	21.92
				15	0	21.86
16QAM	825.5	20415	3	1	0	22.02
				1	14	22.01
				8	4	21.09
				15	0	21.04
	836.5	20525		1	0	22.00
				1	14	21.94
				8	4	20.03
				15	0	20.01
	847.5	20635		1	0	21.91
				1	14	21.81
				8	4	20.97
				15	0	20.88

Modulation	Carrier frequency (MHz)	UL Channel	BW	RB Size	RB Offset	Conducted power (dBm)
QPSK	826.5	20425	5	1	0	23.07
				1	24	23.08
				12	6	22.12
				25	0	22.04
	836.5	20525		1	0	22.97
				1	24	22.98
				12	6	21.08
				25	0	21.02
	846.5	20625		1	0	22.85
				1	24	22.84
				12	6	22.00
				25	0	21.96
16QAM	826.5	20425	5	1	0	22.07
				1	24	22.04
				12	6	21.08
				25	0	21.05
	836.5	20525		1	0	21.95
				1	24	21.93
				12	6	20.07
				25	0	20.07
	846.5	20625		1	0	21.87
				1	24	21.91
				12	6	20.96
				25	0	20.91

Modulation	Carrier frequency (MHz)	UL Channel	BW	RB Size	RB Offset	Conducted power (dBm)
QPSK	829	20450	10	1	0	23.17
				1	49	23.13
				24	12	22.19
				50	0	22.18
	836.5	20525		1	0	23.07
				1	49	23.06
				24	12	21.17
				50	0	21.14
	844	20600		1	0	22.99
				1	49	22.95
				24	12	22.07
				50	0	22.02
16QAM	829	20450	10	1	0	22.20
				1	49	22.17
				24	12	21.23
				50	0	21.18
	836.5	20525		1	0	22.09
				1	49	22.06
				24	12	20.20
				50	0	20.16
	844	20600		1	0	22.00
				1	49	21.96
				24	12	21.08
				50	0	21.01

Test results conducted power measurement (Reduced Power)

Modulation	Carrier frequency (MHz)	UL Channel	BW	RB Size	RB Offset	Conducted power (dBm)
QPSK	824.7	20407	1.4	1	0	17.93
				1	5	17.93
				3	2	17.02
				6	0	16.96
	836.5	20525		1	0	17.88
				1	5	17.82
				3	2	15.91
				6	0	15.89
	848.3	20643		1	0	17.79
				1	5	17.75
				3	2	16.93
				6	0	16.88
16QAM	824.7	20407	1.4	1	0	16.99
				1	5	16.93
				3	2	16.06
				6	0	16.03
	836.5	20525		1	0	16.86
				1	5	16.92
				3	2	14.95
				6	0	14.97
	848.3	20643		1	0	16.85
				1	5	16.71
				3	2	15.81
				6	0	15.74

Modulation	Carrier frequency (MHz)	UL Channel	BW	RB Size	RB Offset	Conducted power (dBm)
QPSK	825.5	20415	3	1	0	18.07
				1	14	17.99
				8	4	17.10
				15	0	17.02
	836.5	20525		1	0	17.95
				1	14	17.92
				8	4	16.06
				15	0	16.05
	847.5	20635		1	0	17.83
				1	14	17.81
				8	4	16.92
				15	0	16.86
16QAM	825.5	20415	3	1	0	17.02
				1	14	17.01
				8	4	16.09
				15	0	16.04
	836.5	20525		1	0	17.00
				1	14	16.94
				8	4	15.03
				15	0	15.01
	847.5	20635		1	0	16.91
				1	14	16.81
				8	4	15.97
				15	0	15.88

Modulation	Carrier frequency (MHz)	UL Channel	BW	RB Size	RB Offset	Conducted power (dBm)
QPSK	826.5	20425	5	1	0	18.07
				1	24	18.08
				12	6	17.12
				25	0	17.04
	836.5	20525		1	0	17.97
				1	24	17.98
				12	6	16.08
				25	0	16.02
	846.5	20625		1	0	17.85
				1	24	17.84
				12	6	17.00
				25	0	16.96
16QAM	826.5	20425	5	1	0	17.07
				1	24	17.04
				12	6	16.08
				25	0	16.05
	836.5	20525		1	0	16.95
				1	24	16.93
				12	6	15.07
				25	0	15.07
	846.5	20625		1	0	16.87
				1	24	16.91
				12	6	15.96
				25	0	15.91

Modulation	Carrier frequency (MHz)	UL Channel	BW	RB Size	RB Offset	Conducted power (dBm)
QPSK	829	20450	10	1	0	18.17
				1	49	18.13
				24	12	17.19
				50	0	17.18
	836.5	20525		1	0	18.07
				1	49	18.06
				24	12	16.17
				50	0	16.14
	844	20600		1	0	17.99
				1	49	17.95
				24	12	17.07
				50	0	17.02
16QAM	829	20450	10	1	0	17.20
				1	49	17.17
				24	12	16.23
				50	0	16.18
	836.5	20525		1	0	17.09
				1	49	17.06
				24	12	15.20
				50	0	15.16
	844	20600		1	0	17.00
				1	49	16.96
				24	12	16.08
				50	0	16.01

LTE Band 12

Test results conducted power measurement (Full Power)

Modulation	Carrier frequency (MHz)	UL Channel	BW	RB Size	RB Offset	Conducted power (dBm)
QPSK	699.7	23017	1.4	1	0	21.44
				1	5	21.55
				3	2	20.76
				6	0	20.67
	707.5	23095		1	0	21.77
				1	5	21.64
				3	2	20.92
				6	0	20.89
	715.3	23173		1	0	21.50
				1	5	21.49
				3	2	20.71
				6	0	20.65
16QAM	699.7	23017	1.4	1	0	20.26
				1	5	20.21
				3	2	19.67
				6	0	19.63
	707.5	23095		1	0	20.22
				1	5	20.38
				3	2	19.77
				6	0	19.60
	715.3	23173		1	0	20.38
				1	5	20.14
				3	2	19.69
				6	0	19.62

Modulation	Carrier frequency (MHz)	UL Channel	BW	RB Size	RB Offset	Conducted power (dBm)
QPSK	700.5	23025	3	1	0	21.62
				1	14	21.59
				8	4	20.70
				15	0	20.78
	707.5	23095		1	0	21.71
				1	14	21.71
				8	4	20.70
				15	0	20.75
	714.5	23165		1	0	21.62
				1	14	21.65
				8	4	20.90
				15	0	20.67
16QAM	700.5	23025	3	1	0	20.17
				1	14	20.31
				8	4	19.87
				15	0	19.67
	707.5	23095		1	0	20.31
				1	14	20.21
				8	4	19.79
				15	0	19.62
	714.5	23165		1	0	20.31
				1	14	20.18
				8	4	19.84
				15	0	19.53

Modulation	Carrier frequency (MHz)	UL Channel	BW	RB Size	RB Offset	Conducted power (dBm)
QPSK	701.5	23035	5	1	0	21.58
				1	24	21.54
				12	6	20.89
				25	0	20.74
	707.5	23095		1	0	21.72
				1	24	21.62
				12	6	20.75
				25	0	20.71
	713.5	23155		1	0	21.76
				1	24	21.45
				12	6	20.93
				25	0	20.84
16QAM	701.5	23035	5	1	0	20.11
				1	24	20.17
				12	6	19.94
				25	0	19.67
	707.5	23095		1	0	20.39
				1	24	20.24
				12	6	19.85
				25	0	19.65
	713.5	23155		1	0	20.22
				1	24	20.31
				12	6	19.81
				25	0	19.52

Modulation	Carrier frequency (MHz)	UL Channel	BW	RB Size	RB Offset	Conducted power (dBm)
QPSK	704	23060	10	1	0	21.66
				1	49	21.62
				24	12	20.68
				50	0	20.63
	707.5	23095		1	0	21.78
				1	49	21.73
				24	12	20.59
				50	0	20.52
	711	23130		1	0	21.85
				1	49	21.82
				24	12	20.79
				50	0	20.73
16QAM	704	23060	10	1	0	20.66
				1	49	20.65
				24	12	19.72
				50	0	19.66
	707.5	23095		1	0	20.81
				1	49	20.77
				24	12	19.59
				50	0	19.52
	711	23130		1	0	20.88
				1	49	20.83
				24	12	19.80
				50	0	19.72

Test results conducted power measurement (Reduced Power)

Modulation	Carrier frequency (MHz)	UL Channel	BW	RB Size	RB Offset	Conducted power (dBm)
QPSK	699.7	23017	1.4	1	0	19.44
				1	5	19.55
				3	2	18.76
				6	0	18.67
	707.5	23095		1	0	19.77
				1	5	19.64
				3	2	18.92
				6	0	18.89
	715.3	23173		1	0	19.50
				1	5	19.49
				3	2	18.71
				6	0	18.65
16QAM	699.7	23017	1.4	1	0	18.26
				1	5	18.21
				3	2	17.67
				6	0	17.63
	707.5	23095		1	0	18.22
				1	5	18.38
				3	2	17.77
				6	0	17.60
	715.3	23173		1	0	18.38
				1	5	18.14
				3	2	17.69
				6	0	17.62

Modulation	Carrier frequency (MHz)	UL Channel	BW	RB Size	RB Offset	Conducted power (dBm)
QPSK	700.5	23025	3	1	0	19.62
				1	14	19.59
				8	4	18.70
				15	0	18.78
	707.5	23095		1	0	19.71
				1	14	19.71
				8	4	18.70
				15	0	18.75
	714.5	23165		1	0	19.62
				1	14	19.65
				8	4	18.90
				15	0	18.67
16QAM	700.5	23025	3	1	0	18.17
				1	14	18.31
				8	4	17.87
				15	0	17.67
	707.5	23095		1	0	18.31
				1	14	18.21
				8	4	17.79
				15	0	17.62
	714.5	23165		1	0	18.31
				1	14	18.18
				8	4	17.84
				15	0	17.53

Modulation	Carrier frequency (MHz)	UL Channel	BW	RB Size	RB Offset	Conducted power (dBm)
QPSK	701.5	23035	5	1	0	19.58
				1	24	19.54
				12	6	18.89
				25	0	18.74
	707.5	23095		1	0	19.72
				1	24	19.62
				12	6	18.75
				25	0	18.71
	713.5	23155		1	0	19.76
				1	24	19.45
				12	6	18.93
				25	0	18.84
16QAM	701.5	23035	5	1	0	18.11
				1	24	18.17
				12	6	17.94
				25	0	17.67
	707.5	23095		1	0	18.39
				1	24	18.24
				12	6	17.85
				25	0	17.65
	713.5	23155		1	0	18.22
				1	24	18.31
				12	6	17.81
				25	0	17.52

Modulation	Carrier frequency (MHz)	UL Channel	BW	RB Size	RB Offset	Conducted power (dBm)
QPSK	704	23060	10	1	0	19.66
				1	49	19.62
				24	12	18.68
				50	0	18.63
	707.5	23095		1	0	19.78
				1	49	19.73
				24	12	18.59
				50	0	18.52
	711	23130		1	0	19.85
				1	49	19.82
				24	12	18.79
				50	0	18.73
16QAM	704	23060	10	1	0	18.66
				1	49	18.65
				24	12	17.72
				50	0	17.66
	707.5	23095		1	0	18.81
				1	49	18.77
				24	12	17.59
				50	0	17.52
	711	23130		1	0	18.88
				1	49	18.83
				24	12	17.80
				50	0	17.72

LTE Band 13

Test results conducted power measurement (Full Power)

Modulation	Carrier frequency (MHz)	UL Channel	BW	RB Size	RB Offset	Conducted power (dBm)
QPSK	779.5	23205	5	1	0	23.73
				1	24	23.68
				12	6	22.65
				25	0	22.62
	782	23230		1	0	23.71
				1	24	23.66
				12	6	22.61
				25	0	22.57
	784.5	23255		1	0	23.77
				1	24	23.73
				12	6	22.71
				25	0	22.66
16QAM	779.5	23205	5	1	0	22.68
				1	24	22.63
				12	6	21.57
				25	0	21.58
	782	23230		1	0	22.63
				1	24	22.60
				12	6	21.51
				25	0	21.51
	784.5	23255		1	0	22.75
				1	24	22.66
				12	6	21.63
				25	0	21.62

Modulation	Carrier frequency (MHz)	UL Channel	BW	RB Size	RB Offset	Conducted power (dBm)
QPSK	782	23230	10	1	0	23.87
				1	49	23.81
				24	12	22.76
				50	0	22.73
16QAM	782	23230	10	1	0	22.89
				1	49	22.83
				24	12	21.80
				50	0	21.78

Test results conducted power measurement (Reduced Power)

Modulation	Carrier frequency (MHz)	UL Channel	BW	RB Size	RB Offset	Conducted power (dBm)
QPSK	779.5	23205	5	1	0	19.73
				1	24	19.68
				12	6	18.65
				25	0	18.62
	782	23230		1	0	19.71
				1	24	19.66
				12	6	18.61
				25	0	18.57
	784.5	23255		1	0	19.77
				1	24	19.73
				12	6	18.71
				25	0	18.66
16QAM	779.5	23205	5	1	0	18.68
				1	24	18.63
				12	6	17.57
				25	0	17.58
	782	23230		1	0	18.63
				1	24	18.60
				12	6	17.51
				25	0	17.51
	784.5	23255		1	0	18.75
				1	24	18.66
				12	6	17.63
				25	0	17.62

Modulation	Carrier frequency (MHz)	UL Channel	BW	RB Size	RB Offset	Conducted power (dBm)
QPSK	782	23230	10	1	0	19.87
				1	49	19.81
				24	12	18.76
				50	0	18.73
16QAM	782	23230	10	1	0	18.89
				1	49	18.83
				24	12	17.80
				50	0	17.78

LTE Band 25

Test results conducted power measurement (Full Power)

Modulation	Carrier frequency (MHz)	UL Channel	BW	RB Size	RB Offset	Conducted power (dBm)
QPSK	1850.7	26047	1.4	1	0	21.12
				1	5	21.12
				3	2	20.10
				6	0	19.96
	1882.5	26365		1	0	21.16
				1	5	21.09
				3	2	20.13
				6	0	20.00
	1914.3	26683		1	0	21.15
				1	5	21.07
				3	2	20.15
				6	0	20.09
16QAM	1850.7	26047	1.4	1	0	20.11
				1	5	20.02
				3	2	19.12
				6	0	19.02
	1882.5	26365		1	0	20.07
				1	5	20.04
				3	2	19.13
				6	0	19.10
	1914.3	26683		1	0	20.12
				1	5	20.07
				3	2	19.15
				6	0	19.08

Modulation	Carrier frequency (MHz)	UL Channel	BW	RB Size	RB Offset	Conducted power (dBm)
QPSK	1851.5	26055	3	1	0	21.24
				1	14	21.19
				8	4	20.20
				15	0	20.13
	1882.5	26365		1	0	21.28
				1	14	21.23
				8	4	20.21
				15	0	20.14
	1913.5	26675		1	0	21.25
				1	14	21.18
				8	4	20.25
				15	0	20.25
16QAM	1851.5	26055	3	1	0	20.16
				1	14	20.15
				8	4	19.20
				15	0	19.16
	1882.5	26365		1	0	20.29
				1	14	20.17
				8	4	19.30
				15	0	19.19
	1913.5	26675		1	0	20.27
				1	14	20.23
				8	4	19.26
				15	0	19.19

Modulation	Carrier frequency (MHz)	UL Channel	BW	RB Size	RB Offset	Conducted power (dBm)
QPSK	1852.5	26065	5	1	0	21.15
				1	24	21.10
				12	6	20.04
				25	0	20.06
	1882.5	26365		1	0	21.22
				1	24	21.12
				12	6	20.10
				25	0	20.03
	1912.5	26665		1	0	21.14
				1	24	21.15
				12	6	20.14
				25	0	20.14
16QAM	1852.5	26065	5	1	0	20.10
				1	24	20.00
				12	6	19.08
				25	0	19.03
	1882.5	26365		1	0	20.09
				1	24	20.01
				12	6	19.17
				25	0	19.04
	1912.5	26665		1	0	20.20
				1	24	20.16
				12	6	19.17
				25	0	19.05

Modulation	Carrier frequency (MHz)	UL Channel	BW	RB Size	RB Offset	Conducted power (dBm)
QPSK	1855	26090	10	1	0	21.22
				1	49	21.07
				24	12	20.07
				50	0	20.05
	1882.5	26365		1	0	21.29
				1	49	21.15
				24	12	20.16
				50	0	20.07
	1910	26640		1	0	21.17
				1	49	21.19
				24	12	20.23
				50	0	20.14
16QAM	1855	26090	10	1	0	20.06
				1	49	20.10
				24	12	19.15
				50	0	19.11
	1882.5	26365		1	0	20.21
				1	49	20.14
				24	12	19.24
				50	0	19.14
	1910	26640		1	0	20.17
				1	49	20.10
				24	12	19.20
				50	0	19.09

Modulation	Carrier frequency (MHz)	UL Channel	BW	RB Size	RB Offset	Conducted power (dBm)
QPSK	1857.5	26115	15	1	0	21.29
				1	74	21.24
				40	18	20.23
				75	0	20.15
	1882.5	26365		1	0	21.32
				1	74	21.28
				40	18	20.26
				75	0	20.22
	1907.5	26615		1	0	21.30
				1	74	21.26
				40	18	20.27
				75	0	20.29
16QAM	1857.5	26115	15	1	0	20.25
				1	74	20.21
				40	18	19.29
				75	0	19.25
	1882.5	26365		1	0	20.27
				1	74	20.24
				40	18	19.34
				75	0	19.24
	1907.5	26615		1	0	20.29
				1	74	20.24
				40	18	19.25
				75	0	19.17

Modulation	Carrier frequency (MHz)	UL Channel	BW	RB Size	RB Offset	Conducted power (dBm)
QPSK	1860	26140	20	1	0	21.37
				1	99	21.34
				50	25	20.32
				100	0	20.26
	1882.5	26365		1	0	21.43
				1	99	21.36
				50	25	20.37
				100	0	20.31
	1905	26590		1	0	21.40
				1	99	21.35
				50	25	20.38
				100	0	20.36
16QAM	1860	26140	20	1	0	20.33
				1	99	20.27
				50	25	19.34
				100	0	19.31
	1882.5	26365		1	0	20.37
				1	99	20.32
				50	25	19.41
				100	0	19.35
	1905	26590		1	0	20.41
				1	99	20.37
				50	25	19.38
				100	0	19.30

Test results conducted power measurement (Reduced Power)

Modulation	Carrier frequency (MHz)	UL Channel	BW	RB Size	RB Offset	Conducted power (dBm)
QPSK	1850.7	26047	1.4	1	0	14.12
				1	5	14.12
				3	2	13.10
				6	0	12.96
	1882.5	26365		1	0	14.16
				1	5	14.09
				3	2	13.13
				6	0	13.00
	1914.3	26683		1	0	14.15
				1	5	14.07
				3	2	13.15
				6	0	13.09
16QAM	1850.7	26047	1.4	1	0	13.11
				1	5	13.02
				3	2	12.12
				6	0	12.02
	1882.5	26365		1	0	13.07
				1	5	13.04
				3	2	12.13
				6	0	12.10
	1914.3	26683		1	0	13.12
				1	5	13.07
				3	2	12.15
				6	0	12.08

Modulation	Carrier frequency (MHz)	UL Channel	BW	RB Size	RB Offset	Conducted power (dBm)
QPSK	1851.5	26055	3	1	0	14.24
				1	14	14.19
				8	4	13.20
				15	0	13.13
	1882.5	26365		1	0	14.28
				1	14	14.23
				8	4	13.21
				15	0	13.14
	1913.5	26675		1	0	14.25
				1	14	14.18
				8	4	13.25
				15	0	13.25
16QAM	1851.5	26055	3	1	0	13.16
				1	14	13.15
				8	4	12.20
				15	0	12.16
	1882.5	26365		1	0	13.29
				1	14	13.17
				8	4	12.30
				15	0	12.19
	1913.5	26675		1	0	13.27
				1	14	13.23
				8	4	12.26
				15	0	12.19

Modulation	Carrier frequency (MHz)	UL Channel	BW	RB Size	RB Offset	Conducted power (dBm)
QPSK	1852.5	26065	5	1	0	14.15
				1	24	14.10
				12	6	13.04
				25	0	13.06
	1882.5	26365		1	0	14.22
				1	24	14.12
				12	6	13.10
				25	0	13.03
	1912.5	26665		1	0	14.14
				1	24	14.15
				12	6	13.14
				25	0	13.14
16QAM	1852.5	26065	5	1	0	13.10
				1	24	13.00
				12	6	12.08
				25	0	12.03
	1882.5	26365		1	0	13.09
				1	24	13.01
				12	6	12.17
				25	0	12.04
	1912.5	26665		1	0	13.20
				1	24	13.16
				12	6	12.17
				25	0	12.05

Modulation	Carrier frequency (MHz)	UL Channel	BW	RB Size	RB Offset	Conducted power (dBm)
QPSK	1855	26090	10	1	0	14.29
				1	49	14.07
				24	12	13.07
				50	0	13.05
	1882.5	26365		1	0	14.29
				1	49	14.15
				24	12	13.16
				50	0	13.07
	1910	26640		1	0	14.17
				1	49	14.19
				24	12	13.23
				50	0	13.14
16QAM	1855	26090	10	1	0	13.06
				1	49	13.10
				24	12	12.15
				50	0	12.11
	1882.5	26365		1	0	13.21
				1	49	13.14
				24	12	12.24
				50	0	12.14
	1910	26640		1	0	13.17
				1	49	13.10
				24	12	12.20
				50	0	12.09

Modulation	Carrier frequency (MHz)	UL Channel	BW	RB Size	RB Offset	Conducted power (dBm)
QPSK	1857.5	26115	15	1	0	14.37
				1	74	14.34
				40	18	13.32
				75	0	13.26
	1882.5	26365		1	0	14.43
				1	74	14.36
				40	18	13.37
				75	0	13.31
	1907.5	26615		1	0	14.40
				1	74	14.35
				40	18	13.38
				75	0	13.36
16QAM	1857.5	26115	15	1	0	13.33
				1	74	13.27
				40	18	12.34
				75	0	12.31
	1882.5	26365		1	0	13.37
				1	74	13.32
				40	18	12.41
				75	0	12.35
	1907.5	26615		1	0	13.41
				1	74	13.37
				40	18	12.38
				75	0	12.30

Modulation	Carrier frequency (MHz)	UL Channel	BW	RB Size	RB Offset	Conducted power (dBm)
QPSK	1860	26140	20	1	0	21.37
				1	99	21.34
				50	25	20.32
				100	0	20.26
	1882.5	26365		1	0	21.43
				1	99	21.36
				50	25	20.37
				100	0	20.31
	1905	26590		1	0	21.40
				1	99	21.35
				50	25	20.38
				100	0	20.36
16QAM	1860	26140	20	1	0	20.33
				1	99	20.27
				50	25	19.34
				100	0	19.31
	1882.5	26365		1	0	20.37
				1	99	20.32
				50	25	19.41
				100	0	19.35
	1905	26590		1	0	20.41
				1	99	20.37
				50	25	19.38
				100	0	19.30

LTE Band 26

Test results conducted power measurement (Full Power)

Modulation	Carrier frequency (MHz)	UL Channel	BW	RB Size	RB Offset	Conducted power (dBm)
QPSK	824.7	26797	1.4	1	0	23.34
				1	5	23.25
				3	2	22.34
				6	0	22.11
	836.5	26915		1	0	23.28
				1	5	23.33
				3	2	22.15
				6	0	22.20
	848.3	27033		1	0	23.26
				1	5	23.46
				3	2	22.28
				6	0	22.16
16QAM	824.7	26797	1.4	1	0	22.19
				1	5	22.10
				3	2	21.24
				6	0	21.20
	836.5	26915		1	0	22.34
				1	5	22.38
				3	2	21.30
				6	0	21.12
	848.3	27033		1	0	22.14
				1	5	22.36
				3	2	21.21
				6	0	21.28

Modulation	Carrier frequency (MHz)	UL Channel	BW	RB Size	RB Offset	Conducted power (dBm)
QPSK	825.5	26805	3	1	0	23.40
				1	14	23.36
				8	4	22.30
				15	0	22.18
	836.5	26915		1	0	23.38
				1	14	23.39
				8	4	22.15
				15	0	22.27
	847.5	27025		1	0	23.25
				1	14	23.39
				8	4	22.32
				15	0	22.29
16QAM	825.5	26805	3	1	0	22.29
				1	14	22.09
				8	4	21.24
				15	0	21.31
	836.5	26915		1	0	22.42
				1	14	22.51
				8	4	21.25
				15	0	21.15
	847.5	27025		1	0	22.10
				1	14	22.34
				8	4	21.29
				15	0	21.29

Modulation	Carrier frequency (MHz)	UL Channel	BW	RB Size	RB Offset	Conducted power (dBm)
QPSK	826.5	26815	5	1	0	23.48
				1	24	23.44
				12	6	22.41
				25	0	22.33
	836.5	26915		1	0	23.45
				1	24	23.48
				12	6	22.24
				25	0	22.30
	846.5	27015		1	0	23.36
				1	24	23.52
				12	6	22.40
				25	0	22.26
16QAM	826.5	26815	5	1	0	22.34
				1	24	22.22
				12	6	21.37
				25	0	21.34
	836.5	26915		1	0	22.47
				1	24	22.52
				12	6	21.32
				25	0	21.24
	846.5	27015		1	0	22.26
				1	24	22.52
				12	6	21.34
				25	0	21.33

Modulation	Carrier frequency (MHz)	UL Channel	BW	RB Size	RB Offset	Conducted power (dBm)
QPSK	829	26840	10	1	0	23.50
				1	49	23.46
				24	12	22.45
				50	0	22.31
	836.5	26915		1	0	23.40
				1	49	23.45
				24	12	22.34
				50	0	22.36
	844	26990		1	0	23.43
				1	49	23.58
				24	12	22.50
				50	0	22.37
16QAM	829	26840	10	1	0	22.35
				1	49	22.24
				24	12	21.34
				50	0	21.37
	836.5	26915		1	0	22.47
				1	49	22.53
				24	12	21.36
				50	0	21.21
	844	26990		1	0	22.30
				1	49	22.48
				24	12	21.39
				50	0	21.46

Modulation	Carrier frequency (MHz)	UL Channel	BW	RB Size	RB Offset	Conducted power (dBm)
QPSK	831.5	26865	15	1	0	23.63
				1	74	23.54
				40	18	22.56
				75	0	22.41
	836.5	26915		1	0	23.55
				1	74	23.59
				40	18	22.41
				75	0	22.44
	841.5	26965		1	0	23.52
				1	74	23.66
				40	18	22.58
				75	0	22.44
16QAM	831.5	26865	15	1	0	22.48
				1	74	22.34
				40	18	21.49
				75	0	21.45
	836.5	26915		1	0	22.60
				1	74	22.65
				40	18	21.50
				75	0	21.32
	841.5	26965		1	0	22.37
				1	74	22.61
				40	18	21.45
				75	0	21.51

Test results conducted power measurement (Reduced Power)

Modulation	Carrier frequency (MHz)	UL Channel	BW	RB Size	RB Offset	Conducted power (dBm)
QPSK	824.7	26797	1.4	1	0	18.34
				1	5	18.25
				3	2	17.34
				6	0	17.11
	836.5	26915		1	0	18.28
				1	5	18.33
				3	2	17.15
				6	0	17.20
	848.3	27033		1	0	18.26
				1	5	18.46
				3	2	17.28
				6	0	17.16
16QAM	824.7	26797	1.4	1	0	17.19
				1	5	17.10
				3	2	16.24
				6	0	16.20
	836.5	26915		1	0	17.34
				1	5	17.38
				3	2	16.30
				6	0	16.12
	848.3	27033		1	0	17.14
				1	5	17.36
				3	2	16.21
				6	0	16.28

Modulation	Carrier frequency (MHz)	UL Channel	BW	RB Size	RB Offset	Conducted power (dBm)
QPSK	825.5	26805	3	1	0	18.40
				1	14	18.36
				8	4	17.30
				15	0	17.18
	836.5	26915		1	0	18.38
				1	14	18.39
				8	4	17.15
				15	0	17.27
	847.5	27025		1	0	18.25
				1	14	18.39
				8	4	17.32
				15	0	17.29
16QAM	825.5	26805	3	1	0	17.29
				1	14	17.09
				8	4	16.24
				15	0	16.31
	836.5	26915		1	0	17.42
				1	14	17.51
				8	4	16.25
				15	0	16.15
	847.5	27025		1	0	17.10
				1	14	17.34
				8	4	16.29
				15	0	16.29

Modulation	Carrier frequency (MHz)	UL Channel	BW	RB Size	RB Offset	Conducted power (dBm)
QPSK	826.5	26815	5	1	0	18.48
				1	24	18.44
				12	6	17.41
				25	0	17.33
	836.5	26915		1	0	18.45
				1	24	18.48
				12	6	17.24
				25	0	17.30
	846.5	27015		1	0	18.36
				1	24	18.52
				12	6	17.40
				25	0	17.26
16QAM	826.5	26815	5	1	0	17.34
				1	24	17.22
				12	6	16.37
				25	0	16.34
	836.5	26915		1	0	17.47
				1	24	17.52
				12	6	16.32
				25	0	16.24
	846.5	27015		1	0	17.26
				1	24	17.52
				12	6	16.34
				25	0	16.33

Modulation	Carrier frequency (MHz)	UL Channel	BW	RB Size	RB Offset	Conducted power (dBm)
QPSK	829	26840	10	1	0	18.50
				1	49	18.46
				24	12	17.45
				50	0	17.31
	836.5	26915		1	0	18.40
				1	49	18.45
				24	12	17.34
				50	0	17.36
	844	26990		1	0	18.43
				1	49	18.58
				24	12	17.50
				50	0	17.37
16QAM	829	26840	10	1	0	17.35
				1	49	17.24
				24	12	16.34
				50	0	16.37
	836.5	26915		1	0	17.47
				1	49	17.53
				24	12	16.36
				50	0	16.21
	844	26990		1	0	17.30
				1	49	17.48
				24	12	16.39
				50	0	16.46

Modulation	Carrier frequency (MHz)	UL Channel	BW	RB Size	RB Offset	Conducted power (dBm)
QPSK	831.5	26865	15	1	0	18.63
				1	74	18.54
				40	18	17.56
				75	0	17.41
	836.5	26915		1	0	18.55
				1	74	18.59
				40	18	17.41
				75	0	17.44
	841.5	26965		1	0	18.52
				1	74	18.66
				40	18	17.58
				75	0	17.44
16QAM	831.5	26865	15	1	0	17.48
				1	74	17.34
				40	18	16.49
				75	0	16.45
	836.5	26915		1	0	17.60
				1	74	17.65
				40	18	16.50
				75	0	16.32
	841.5	26965		1	0	17.37
				1	74	17.61
				40	18	16.45
				75	0	16.51

LTE Band 41

Test results conducted power measurement (Full Power)

Modulation	Carrier frequency (MHz)	UL Channel	BW	RB Size	RB Offset	Conducted Average (dBm)
QPSK	2537.5	40065	5	1	0	23.91
				1	24	23.90
				12	6	22.91
				25	0	22.87
	2593	40620		1	0	23.72
				1	24	23.72
				12	6	22.75
				25	0	22.71
	2652.5	41215		1	0	23.61
				1	24	23.58
				12	6	22.68
				25	0	22.66
16QAM	2537.5	40065	5	1	0	22.94
				1	24	22.95
				12	6	22.06
				25	0	21.84
	2593	40620		1	0	22.75
				1	24	22.70
				12	6	21.74
				25	0	21.69
	2652.5	41215		1	0	22.71
				1	24	22.63
				12	6	21.78
				25	0	21.70

Modulation	Carrier frequency (MHz)	UL Channel	BW	RB Size	RB Offset	Conducted Average (dBm)
QPSK	2540	40090	10	1	0	24.01
				1	49	23.94
				24	12	23.07
				50	0	23.01
	2593	40620		1	0	23.84
				1	49	23.80
				24	12	22.83
				50	0	22.82
	2650	41190		1	0	23.77
				1	49	23.62
				24	12	22.78
				50	0	22.72
16QAM	2540	40090	10	1	0	23.00
				1	49	22.93
				24	12	22.12
				50	0	21.97
	2593	40620		1	0	22.81
				1	49	22.76
				24	12	21.81
				50	0	21.84
	2650	41190		1	0	22.76
				1	49	22.67
				24	12	21.85
				50	0	21.77

Modulation	Carrier frequency (MHz)	UL Channel	BW	RB Size	RB Offset	Conducted Average (dBm)
QPSK	2542.5	40115	15	1	0	23.98
				1	74	23.97
				40	18	23.12
				75	0	22.97
	2593	40620		1	0	23.88
				1	74	23.76
				40	18	22.81
				75	0	22.87
	2647.5	41165		1	0	23.76
				1	74	23.71
				40	18	22.84
				75	0	22.70
16QAM	2542.5	40115	15	1	0	23.04
				1	74	23.04
				40	18	22.07
				75	0	21.96
	2593	40620		1	0	22.89
				1	74	22.83
				40	18	21.92
				75	0	21.85
	2647.5	41165		1	0	22.73
				1	74	22.66
				40	18	21.85
				75	0	21.75

Modulation	Carrier frequency (MHz)	UL Channel	BW	RB Size	RB Offset	Conducted Average (dBm)
QPSK	2545	40140	20	1	0	24.11
				1	99	24.05
				50	25	23.17
				100	0	23.12
	2593	40620		1	0	23.95
				1	99	23.91
				50	25	22.95
				100	0	22.92
	2645	41140		1	0	23.85
				1	99	23.79
				50	25	22.89
				100	0	22.84
16QAM	2545	40140	20	1	0	23.13
				1	99	23.09
				50	25	22.21
				100	0	22.11
	2593	40620		1	0	22.95
				1	99	22.94
				50	25	21.98
				100	0	21.92
	2645	41140		1	0	22.85
				1	99	22.80
				50	25	21.93
				100	0	21.88

Test results conducted power measurement (Reduced Power)

Modulation	Carrier frequency (MHz)	UL Channel	BW	RB Size	RB Offset	Conducted Average (dBm)
QPSK	2537.5	40065	5	1	0	18.91
				1	24	18.90
				12	6	17.91
				25	0	17.87
	2593	40620		1	0	18.72
				1	24	18.72
				12	6	17.75
				25	0	17.71
	2652.5	41215		1	0	18.61
				1	24	18.58
				12	6	17.68
				25	0	17.66
16QAM	2537.5	40065	5	1	0	17.94
				1	24	17.95
				12	6	17.06
				25	0	16.84
	2593	40620		1	0	17.75
				1	24	17.70
				12	6	16.74
				25	0	16.69
	2652.5	41215		1	0	17.71
				1	24	17.63
				12	6	16.78
				25	0	16.70

Modulation	Carrier frequency (MHz)	UL Channel	BW	RB Size	RB Offset	Conducted Average (dBm)
QPSK	2540	40090	10	1	0	19.01
				1	49	18.94
				24	12	18.07
				50	0	18.01
	2593	40620		1	0	18.84
				1	49	18.80
				24	12	17.83
				50	0	17.82
	2650	41190		1	0	18.77
				1	49	18.62
				24	12	17.78
				50	0	17.72
16QAM	2540	40090	10	1	0	18.00
				1	49	17.93
				24	12	17.12
				50	0	16.97
	2593	40620		1	0	17.81
				1	49	17.76
				24	12	16.81
				50	0	16.84
	2650	41190		1	0	17.76
				1	49	17.67
				24	12	16.85
				50	0	16.77

Modulation	Carrier frequency (MHz)	UL Channel	BW	RB Size	RB Offset	Conducted Average (dBm)
QPSK	2542.5	40115	15	1	0	18.98
				1	74	18.97
				40	18	18.12
				75	0	17.97
	2593	40620		1	0	18.88
				1	74	18.76
				40	18	17.81
				75	0	17.87
	2647.5	41165		1	0	18.76
				1	74	18.71
				40	18	17.84
				75	0	17.70
16QAM	2542.5	40115	15	1	0	18.04
				1	74	18.04
				40	18	17.07
				75	0	16.96
	2593	40620		1	0	17.89
				1	74	17.83
				40	18	16.92
				75	0	16.85
	2647.5	41165		1	0	17.73
				1	74	17.66
				40	18	16.85
				75	0	16.75

Modulation	Carrier frequency (MHz)	UL Channel	BW	RB Size	RB Offset	Conducted Average (dBm)
QPSK	2545	40140	20	1	0	19.11
				1	99	19.05
				50	25	18.17
				100	0	18.12
	2593	40620		1	0	18.95
				1	99	18.91
				50	25	17.95
				100	0	17.92
	2645	41140		1	0	18.85
				1	99	18.79
				50	25	17.89
				100	0	17.84
16QAM	2545	40140	20	1	0	18.13
				1	99	18.09
				50	25	17.21
				100	0	17.11
	2593	40620		1	0	17.95
				1	99	17.94
				50	25	16.98
				100	0	16.92
	2645	41140		1	0	17.85
				1	99	17.80
				50	25	16.93
				100	0	16.88

LTE Band 66

Test results conducted power measurement (Full Power)

Modulation	Carrier frequency (MHz)	UL Channel	BW	RB Size	RB Offset	Conducted power (dBm)
QPSK	1710.7	131979	1.4	1	0	23.90
				1	5	23.83
				3	2	22.76
				6	0	22.70
	1745	132322		1	0	23.97
				1	5	23.91
				3	2	22.88
				6	0	22.83
	1779.3	132665		1	0	23.47
				1	5	23.49
				3	2	22.58
				6	0	22.54
16QAM	1710.7	131979	1.4	1	0	22.87
				1	5	22.82
				3	2	21.72
				6	0	21.68
	1745	132322		1	0	23.05
				1	5	22.98
				3	2	21.99
				6	0	21.88
	1779.3	132665		1	0	22.52
				1	5	22.49
				3	2	21.62
				6	0	21.56

Modulation	Carrier frequency (MHz)	UL Channel	BW	RB Size	RB Offset	Conducted power (dBm)
QPSK	1711.5	131987	3	1	0	23.83
				1	14	23.85
				8	4	22.74
				15	0	22.66
	1745	132322		1	0	23.98
				1	14	23.97
				8	4	22.92
				15	0	22.90
	1778.5	132657		1	0	23.48
				1	14	23.53
				8	4	22.60
				15	0	22.53
16QAM	1711.5	131987	3	1	0	22.89
				1	14	22.87
				8	4	21.73
				15	0	21.66
	1745	132322		1	0	22.98
				1	14	22.99
				8	4	22.02
				15	0	21.90
	1778.5	132657		1	0	22.51
				1	14	22.52
				8	4	21.59
				15	0	21.64

Modulation	Carrier frequency (MHz)	UL Channel	BW	RB Size	RB Offset	Conducted power (dBm)
QPSK	1712.5	131997	5	1	0	23.97
				1	24	23.92
				12	6	22.84
				25	0	22.66
	1745	132322		1	0	24.03
				1	24	23.99
				12	6	22.97
				25	0	22.93
	1777.5	132647		1	0	23.60
				1	24	23.58
				12	6	22.62
				25	0	22.59
16QAM	1712.5	131997	5	1	0	22.91
				1	24	22.87
				12	6	21.79
				25	0	21.76
	1745	132322		1	0	23.10
				1	24	23.11
				12	6	21.97
				25	0	21.90
	1777.5	132647		1	0	22.58
				1	24	22.47
				12	6	21.71
				25	0	21.67

Modulation	Carrier frequency (MHz)	UL Channel	BW	RB Size	RB Offset	Conducted power (dBm)
QPSK	1715	132022	10	1	0	23.96
				1	49	23.90
				24	12	22.88
				50	0	22.74
	1745	132322		1	0	24.18
				1	49	24.07
				24	12	23.08
				50	0	22.93
	1775	132622		1	0	23.65
				1	49	23.59
				24	12	22.77
				50	0	22.65
16QAM	1715	132022	10	1	0	23.07
				1	49	22.89
				24	12	21.88
				50	0	21.80
	1745	132322		1	0	23.10
				1	49	23.08
				24	12	22.06
				50	0	22.01
	1775	132622		1	0	22.72
				1	49	22.56
				24	12	21.74
				50	0	21.72

Modulation	Carrier frequency (MHz)	UL Channel	BW	RB Size	RB Offset	Conducted power (dBm)
QPSK	1717.5	132047	15	1	0	23.97
				1	74	23.99
				40	18	22.92
				75	0	22.77
	1745	132322		1	0	24.14
				1	74	24.14
				40	18	23.12
				75	0	23.01
	1772.5	132597		1	0	23.66
				1	74	23.60
				40	18	22.77
				75	0	22.71
16QAM	1717.5	132047	15	1	0	23.07
				1	74	22.93
				40	18	21.92
				75	0	21.78
	1745	132322		1	0	23.14
				1	74	23.17
				40	18	22.08
				75	0	21.97
	1772.5	132597		1	0	22.69
				1	74	22.65
				40	18	21.81
				75	0	21.73

Modulation	Carrier frequency (MHz)	UL Channel	BW	RB Size	RB Offset	Conducted power (dBm)
QPSK	1720	132072	20	1	0	24.12
				1	99	24.07
				50	25	22.98
				100	0	22.92
	1745	132322		1	0	24.27
				1	99	24.21
				50	25	23.18
				100	0	23.11
	1770	132572		1	0	23.77
				1	99	23.74
				50	25	22.88
				100	0	22.83
16QAM	1720	132072	20	1	0	23.17
				1	99	23.07
				50	25	22.02
				100	0	21.91
	1745	132322		1	0	23.27
				1	99	23.25
				50	25	22.23
				100	0	22.11
	1770	132572		1	0	22.80
				1	99	22.73
				50	25	21.90
				100	0	21.87

Test results conducted power measurement (Reduced Power)

Modulation	Carrier frequency (MHz)	UL Channel	BW	RB Size	RB Offset	Conducted power (dBm)
QPSK	1710.7	131979	1.4	1	0	14.90
				1	5	14.83
				3	2	13.76
				6	0	13.70
	1745	132322		1	0	14.97
				1	5	14.91
				3	2	13.88
				6	0	13.83
	1779.3	132665		1	0	14.47
				1	5	14.49
				3	2	13.58
				6	0	13.54
16QAM	1710.7	131979	1.4	1	0	13.87
				1	5	13.82
				3	2	12.72
				6	0	12.68
	1745	132322		1	0	14.05
				1	5	13.98
				3	2	12.99
				6	0	12.88
	1779.3	132665		1	0	13.52
				1	5	13.49
				3	2	12.62
				6	0	12.56

Modulation	Carrier frequency (MHz)	UL Channel	BW	RB Size	RB Offset	Conducted power (dBm)
QPSK	1711.5	131987	3	1	0	14.83
				1	14	14.85
				8	4	13.74
				15	0	13.66
	1745	132322		1	0	14.98
				1	14	14.97
				8	4	13.92
				15	0	13.90
	1778.5	132657		1	0	14.48
				1	14	14.53
				8	4	13.60
				15	0	13.53
16QAM	1711.5	131987	3	1	0	13.89
				1	14	13.87
				8	4	12.73
				15	0	12.66
	1745	132322		1	0	13.98
				1	14	13.99
				8	4	13.02
				15	0	12.90
	1778.5	132657		1	0	13.51
				1	14	13.52
				8	4	12.59
				15	0	12.64

Modulation	Carrier frequency (MHz)	UL Channel	BW	RB Size	RB Offset	Conducted power (dBm)
QPSK	1712.5	131997	5	1	0	14.97
				1	24	14.92
				12	6	13.84
				25	0	13.66
	1745	132322		1	0	15.03
				1	24	14.99
				12	6	13.97
				25	0	13.93
	1777.5	132647		1	0	14.60
				1	24	14.58
				12	6	13.62
				25	0	13.59
16QAM	1712.5	131997	5	1	0	13.91
				1	24	13.87
				12	6	12.79
				25	0	12.76
	1745	132322		1	0	14.10
				1	24	14.11
				12	6	12.97
				25	0	12.90
	1777.5	132647		1	0	13.58
				1	24	13.47
				12	6	12.71
				25	0	12.67

Modulation	Carrier frequency (MHz)	UL Channel	BW	RB Size	RB Offset	Conducted power (dBm)
QPSK	1715	132022	10	1	0	14.96
				1	49	14.90
				24	12	13.88
				50	0	13.74
	1745	132322		1	0	15.18
				1	49	15.07
				24	12	14.08
				50	0	13.93
	1775	132622		1	0	14.65
				1	49	14.59
				24	12	13.77
				50	0	13.65
16QAM	1715	132022	10	1	0	14.07
				1	49	13.89
				24	12	12.88
				50	0	12.80
	1745	132322		1	0	14.10
				1	49	14.08
				24	12	13.06
				50	0	13.01
	1775	132622		1	0	13.72
				1	49	13.56
				24	12	12.74
				50	0	12.72

Modulation	Carrier frequency (MHz)	UL Channel	BW	RB Size	RB Offset	Conducted power (dBm)
QPSK	1717.5	132047	15	1	0	14.97
				1	74	14.99
				40	18	13.92
				75	0	13.77
	1745	132322		1	0	15.14
				1	74	15.14
				40	18	14.12
				75	0	14.01
	1772.5	132597		1	0	14.66
				1	74	14.60
				40	18	13.77
				75	0	13.71
16QAM	1717.5	132047	15	1	0	14.07
				1	74	13.93
				40	18	12.92
				75	0	12.78
	1745	132322		1	0	14.14
				1	74	14.17
				40	18	13.08
				75	0	12.97
	1772.5	132597		1	0	13.69
				1	74	13.65
				40	18	12.81
				75	0	12.73

Modulation	Carrier frequency (MHz)	UL Channel	BW	RB Size	RB Offset	Conducted power (dBm)
QPSK	1720	132072	20	1	0	15.12
				1	99	15.07
				50	25	13.98
				100	0	13.92
	1745	132322		1	0	15.27
				1	99	15.21
				50	25	14.18
				100	0	14.11
	1770	132572		1	0	14.77
				1	99	14.74
				50	25	13.88
				100	0	13.83
16QAM	1720	132072	20	1	0	14.17
				1	99	14.07
				50	25	13.02
				100	0	12.91
	1745	132322		1	0	14.27
				1	99	14.25
				50	25	13.23
				100	0	13.11
	1770	132572		1	0	13.80
				1	99	13.73
				50	25	12.90
				100	0	12.87

LTE Band 71

Test results conducted power measurement (Full Power)

Modulation	Carrier frequency (MHz)	UL Channel	B W	RB Size	RB Offset	Conducted power (dBm)
QPSK	665.5	133147	5	1	0	23.69
				1	24	23.59
				12	6	22.83
				25	0	22.73
	680.5	133297		1	0	23.86
				1	24	23.82
				12	6	23.02
				25	0	22.88
	695.5	133447		1	0	23.75
				1	24	23.71
				12	6	22.94
				25	0	22.88
16QAM	665.5	133147	5	1	0	22.67
				1	24	22.69
				12	6	21.79
				25	0	21.70
	680.5	133297		1	0	22.89
				1	24	22.80
				12	6	21.96
				25	0	21.97
	695.5	133447		1	0	22.81
				1	24	22.74
				12	6	21.98
				25	0	21.84

Modulation	Carrier frequency (MHz)	UL Channel	B W	RB Size	RB Offset	Conducted power (dBm)
QPSK	668	133172	10	1	0	23.75
				1	49	23.64
				24	12	22.91
				50	0	22.76
	680.5	133297		1	0	23.95
				1	49	23.93
				24	12	22.99
				50	0	22.99
	693	133422		1	0	23.83
				1	49	23.73
				24	12	23.03
				50	0	22.95
16QAM	668	133172	10	1	0	22.81
				1	49	22.65
				24	12	21.81
				50	0	21.86
	680.5	133297		1	0	23.02
				1	49	22.92
				24	12	22.02
				50	0	22.05
	693	133422		1	0	22.77
				1	49	22.78
				24	12	22.03
				50	0	21.95

Modulation	Carrier frequency (MHz)	UL Channel	B W	RB Size	RB Offset	Conducted power (dBm)
QPSK	670.5	133197	15	1	0	23.81
				1	74	23.80
				40	18	22.92
				75	0	22.92
	680.5	133297		1	0	23.99
				1	74	23.96
				40	18	23.10
				75	0	23.00
	690.5	133397		1	0	23.89
				1	74	23.89
				40	18	23.03
				75	0	22.95
16QAM	670.5	133197	15	1	0	22.80
				1	74	22.76
				40	18	21.95
				75	0	21.93
	680.5	133297		1	0	23.06
				1	74	23.01
				40	18	22.09
				75	0	22.02
	690.5	133397		1	0	22.87
				1	74	22.78
				40	18	22.07
				75	0	22.05

Modulation	Carrier frequency (MHz)	UL Channel	BW	RB Size	RB Offset	Conducted power (dBm)
QPSK	673	133222	20	1	0	23.95
				1	99	23.90
				50	25	23.07
				100	0	23.01
	683	133322		1	0	24.11
				1	99	24.07
				50	25	23.23
				100	0	23.16
	688	133372		1	0	24.06
				1	99	23.98
				50	25	23.19
				100	0	23.11
16QAM	673	133222	20	1	0	22.98
				1	99	22.92
				50	25	22.07
				100	0	22.01
	683	133322		1	0	23.16
				1	99	23.11
				50	25	22.23
				100	0	22.20
	688	133372		1	0	23.04
				1	99	22.95
				50	25	22.19
				100	0	22.14

Test results conducted power measurement (Reduced Power)

Modulation	Carrier frequency (MHz)	UL Channel	B W	RB Size	RB Offset	Conducted power (dBm)
QPSK	665.5	133147	5	1	0	19.69
				1	24	19.59
				12	6	18.83
				25	0	18.73
	680.5	133297		1	0	19.86
				1	24	19.82
				12	6	19.02
				25	0	18.88
	695.5	133447		1	0	19.75
				1	24	19.71
				12	6	18.94
				25	0	18.88
16QAM	665.5	133147	5	1	0	18.67
				1	24	18.69
				12	6	17.79
				25	0	17.70
	680.5	133297		1	0	18.89
				1	24	18.80
				12	6	17.96
				25	0	17.97
	695.5	133447		1	0	18.81
				1	24	18.74
				12	6	17.98
				25	0	17.84

Modulation	Carrier frequency (MHz)	UL Channel	B W	RB Size	RB Offset	Conducted power (dBm)
QPSK	668	133172	10	1	0	19.75
				1	49	19.64
				24	12	18.91
				50	0	18.76
	680.5	133297		1	0	19.95
				1	49	19.93
				24	12	18.99
				50	0	18.99
	693	133422		1	0	19.83
				1	49	19.73
				24	12	19.03
				50	0	18.95
16QAM	668	133172	10	1	0	18.81
				1	49	18.65
				24	12	17.81
				50	0	17.86
	680.5	133297		1	0	19.02
				1	49	18.92
				24	12	18.02
				50	0	18.05
	693	133422		1	0	18.77
				1	49	18.78
				24	12	18.03
				50	0	17.95

Modulation	Carrier frequency (MHz)	UL Channel	B W	RB Size	RB Offset	Conducted power (dBm)
QPSK	670.5	133197	15	1	0	19.81
				1	74	19.80
				40	18	18.92
				75	0	18.92
	680.5	133297		1	0	19.99
				1	74	19.96
				40	18	19.10
				75	0	19.00
	690.5	133397		1	0	19.89
				1	74	19.89
				40	18	19.03
				75	0	18.95
16QAM	670.5	133197	15	1	0	18.80
				1	74	18.76
				40	18	17.95
				75	0	17.93
	680.5	133297		1	0	19.06
				1	74	19.01
				40	18	18.09
				75	0	18.02
	690.5	133397		1	0	18.87
				1	74	18.78
				40	18	18.07
				75	0	18.05

Modulation	Carrier frequency (MHz)	UL Channel	BW	RB Size	RB Offset	Conducted power (dBm)
QPSK	673	133222	20	1	0	19.95
				1	99	19.90
				50	25	19.07
				100	0	19.01
	683	133322		1	0	20.11
				1	99	20.07
				50	25	19.23
				100	0	19.16
	688	133372		1	0	20.06
				1	99	19.98
				50	25	19.19
				100	0	19.11
16QAM	673	133222	20	1	0	18.98
				1	99	18.92
				50	25	18.07
				100	0	18.01
	683	133322		1	0	19.16
				1	99	19.11
				50	25	18.23
				100	0	18.20
	688	133372		1	0	19.04
				1	99	18.95
				50	25	18.19
				100	0	18.14

6.4 Wi-Fi Measurement result

Test results conducted power measurement (Full Power)

Modulation type	Average power output (dBm)		
	2412MHz	2437MHz	2462MHz
802.11b	15.15	15.02	15.56
802.11g	13.88	13.58	13.94
11n HT20	12.99	12.28	12.88
Modulation type	Average power output (dBm)		
	2422MHz	2437MHz	2452MHz
11n HT40	11.89	11.49	11.05

6.5 Standalone SAR Test Exclusion Considerations

Standalone 1-g head or body SAR evaluation by measurement or numerical simulation is not required when the corresponding SAR Exclusion Threshold condition, listed below, is satisfied.

SAR Test Exclusion Thresholds for 100 MHz – 6 GHz and ≤ 50 mm

Method1:

According to the KDB447498 4.3.1 (1)

For 100 MHz to 6 GHz and test separation distances ≤ 50 mm, the 1-g and 10-g SAR test exclusion thresholds are determined by the following:

$[(\text{max. power of channel, including tune-up tolerance, mW}) / (\text{min. test separation distance, mm})] \cdot [\sqrt{f} (\text{GHz})] \leq 3.0$ for 1-g SAR, where

- $f(\text{GHz})$ is the RF channel transmit frequency in GHz
- Power and distance are rounded to the nearest mW and mm before calculation
- The result is rounded to one decimal place for comparison

The test exclusions are applicable only when the minimum test separation distance is ≤ 50 mm, and for transmission frequencies between 100 MHz and 6 GHz. When the minimum test separation distance is < 5 mm, a distance of 5 mm is applied to determine SAR test exclusion.

This is equivalent to $[(\text{max. power of channel, including tune-up tolerance, mW}) / (60 / \sqrt{f} (\text{GHz}) \text{ mW})] \cdot [20 \text{ mm} / (\text{min. test separation distance, mm})] \leq 1.0$ for 1-g SAR; also see Appendix A for approximate exclusion threshold values at selected frequencies and distances.

Method2:

According to the KDB447498 appendix A

Approximate SAR Test Exclusion Power Thresholds at Selected Frequencies and Test Separation Distances are illustrated in the following Table.

MHz	5	10	15	20	25	mm
150	39	77	116	155	194	<i>SAR Test Exclusion Threshold (mW)</i>
300	27	55	82	110	137	
450	22	45	67	89	112	
835	16	33	49	66	82	
900	16	32	47	63	79	
1500	12	24	37	49	61	
1900	11	22	33	44	54	
2450	10	19	29	38	48	
3600	8	16	24	32	40	
5200	7	13	20	26	33	
5400	6	13	19	26	32	
5800	6	12	19	25	31	

6.6 RF exposure conditions

Refer to the follow picture “Antenna information”.

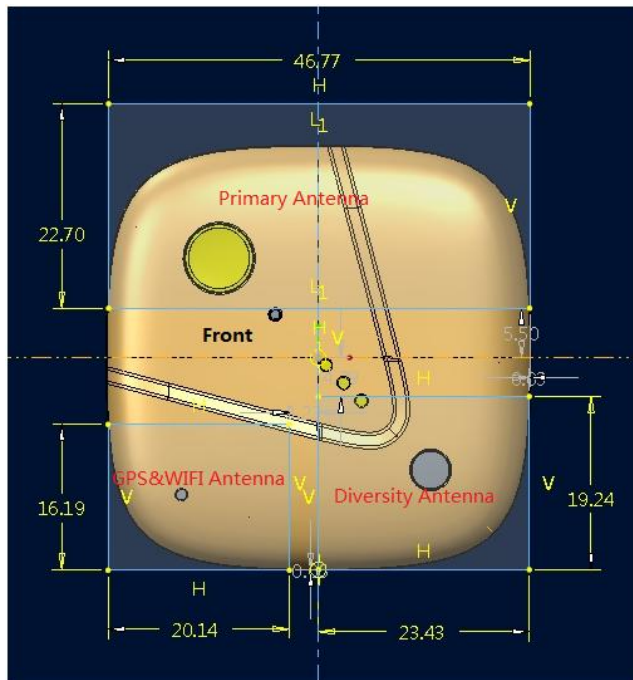

Primary ANT	Max Gain
LTE BAND 2	-1.61dBi
LTE BAND 4	-1.10dBi
LTE BAND 5	-6.20dBi
LTE BAND 12	-6.51dBi
LTE BAND 13	-6.00dBi
LTE BAND 25	-1.61dBi
LTE BAND 26	-6.20dBi
LTE BAND 41	-2.50dBi
LTE BAND 66	-1.10dBi
LTE BAND 71	-6.56dBi
WCDMA B2	-1.61dBi
WCDMA B4	-1.10dBi
WCDMA B5	-6.20dBi

GPS&WIFI ANT	Max Gain
GPS	-1.21dBi
WIFI	-1.35dBi

Note: we defined these positions when we face the screen of EUT.

**Body Exposure conditions
 For WWAN**

Test Configurations	SAR Required
Back	Yes
Front	Yes
Top	Yes
Bottom	Yes
Left	Yes
Right	Yes

For WLAN

Test Configurations	SAR Required
Back	Yes
Front	Yes
Top	Yes
Bottom	Yes
Left	Yes
Right	Yes

6.7 System Checking

System checking for the first test

The manufacturer calibrates the probes annually. Dielectric parameters of the tissue simulants were measured every day using the dielectric probe kit and the network analyser.

For the measurement of the following parameters the SPEAG DAKS-3.5 dielectric parameter probe is used, representing the open-ended coaxial probe measurement procedure.

Date Tested	Freq. (MHz)	Liquid parameters	measured	Target	Delta (%)	Tolerance (%)
2020.09.10	750	ϵ_r	41.391	41.90	-1.2	± 10
		σ [S/m]	0.917	0.89	3.0	± 10
2020.09.11	835	ϵ_r	40.254	41.50	-3.0	± 10
		σ [S/m]	0.917	0.90	1.9	± 10
2020.09.13	1800	ϵ_r	40.688	40.00	1.7	± 10
		σ [S/m]	1.418	1.40	1.3	± 10
2020.09.15	2000	ϵ_r	39.844	40.00	-0.4	± 10
		σ [S/m]	1.427	1.40	1.9	± 10
2020.09.16	2450	ϵ_r	38.477	39.20	-1.8	± 10
		σ [S/m]	1.841	1.80	2.3	± 10
2020.09.21	2600	ϵ_r	39.566	39.00	1.5	± 10
		σ [S/m]	1.944	1.96	-0.8	± 10

Note: For DASY system, the conservative tolerance 5% could expand to 10% when the frequency under 3GHz

A system check measurement was made following once the determination of the dielectric parameters of the simulant, using the dipole validation kit. The system checking results (dielectric parameters and SAR values) are given in the table below.

Date Tested	System dipole	T.S. Liquid	SAR measured (normalized to 1W)		Target (Ref. Value)	Delta (%)	Tolerance (%)
2020.09.10	D750V3	Head	1g	8.36	8.26	1.2	± 10
2020.09.11	D835V2	Head	1g	9.60	9.37	2.5	± 10
2020.09.13	D1800V2	Head	1g	37.96	38.9	-2.4	± 10
2020.09.15	D2000V2	Head	1g	39.28	40.3	-2.5	± 10
2020.09.16	D2450V2	Head	1g	53.6	52.4	2.3	± 10
2020.09.21	D2600V2	Head	1g	56.0	56.6	-1.1	± 10

System checking for the Second test

The manufacturer calibrates the probes annually. Dielectric parameters of the tissue stimulants were measured every day using the dielectric probe kit and the network analyser. For the measurement of the following parameters the SPEAG DAKS-3.5 dielectric parameter probe is used, representing the open-ended coaxial probe measurement procedure. All tests were carried out within 24 hours of measuring the dielectric parameters.

Freq.(MHz)	Date	Liquid parameters	Measured	Target	Delta (%)	Tolerance (%)	Verdit
750	2023/7/16	ϵ_r	41.935	41.9	0.08	± 10	Pass
	2023/7/16	σ [S/m]	0.867	0.89	-2.63	± 10	Pass
835	2023/7/16	ϵ_r	42.639	41.5	2.75	± 10	Pass
	2023/7/16	σ [S/m]	0.902	0.9	0.22	± 10	Pass
1800	2023/7/16	ϵ_r	39.083	40	-2.29	± 10	Pass
	2023/7/16	σ [S/m]	1.419	1.4	1.37	± 10	Pass
2000	2023/7/17	ϵ_r	40.135	40	0.34	± 10	Pass
	2023/7/17	σ [S/m]	1.470	1.4	4.98	± 10	Pass
2450	2023/7/17	ϵ_r	40.70	39.2	3.84	± 10	Pass
	2023/7/17	σ [S/m]	1.89	1.8	4.86	± 10	Pass
2600	2023/7/17	ϵ_r	38.12	39	-2.27	± 10	Pass
	2023/7/17	σ [S/m]	1.95	1.96	-0.57	± 10	Pass

A system check measurement was made following the determination of the dielectric parameters of the stimulant, using the dipole validation kit. Dipole was placed under the flat section of the twin SAM phantom. The system checking results (dielectric parameters and SAR values) are given in the table below. All tests were carried out within 24 hours of checking system. Plots of the system checking scans are given in Annex A. Tissue Stimulants used in the Measurements. **For the same frequency range, SAR measurement is the same day with system check, and there is no need to manually add test date in ANNEX A.**

Freq.(MHz)	Date	SAR measured (normalized to 1W)		Target (Ref. Value)	Delta(%)	Tolerance(%)	Verdict
750	2023/7/16	1g	8.08	8.40	-3.81	± 10	Pass
	2023/7/16	10g	5.32	5.70	-6.67	± 10	Pass
835	2023/7/16	1g	9.92	9.38	5.76	± 10	Pass
	2023/7/16	10g	6.48	6.25	3.68	± 10	Pass
1800	2023/7/16	1g	37.68	38.90	-3.14	± 10	Pass
	2023/7/16	10g	18.60	20.30	-8.37	± 10	Pass
2000	2023/7/17	1g	38.92	41.00	-5.07	± 10	Pass
	2023/7/17	10g	19.80	20.50	-3.41	± 10	Pass
2450	2023/7/17	1g	51.60	53.00	-2.64	± 10	Pass
	2023/7/17	10g	24.28	24.50	-0.90	± 10	Pass
2600	2023/7/17	1g	55.20	55.30	-0.18	± 10	Pass
	2023/7/17	10g	24.84	25.00	-0.64	± 10	Pass

6.8 SAR TEST RESULT

In order to determine the largest value of the peak spatial-average SAR of a handset, all device positions, configurations, and operational modes should be tested for each frequency band according to Steps 1 to 3 below.

Step 1: The tests should be performed at the channel that is closest to the center of the transmit frequency band.

a) All device positions (cheek and tilt, for both left and right sides of the SAM phantom),
b) All configurations for each device position in a), e.g., antenna extended and retracted, and
c) All operational modes for each device position in item a) and configuration in item b) in each frequency band, e.g., analog and digital, If more than three frequencies need to be tested (i.e., $N_c > 3$), then all frequencies, configurations and modes shall be tested for all of the above test conditions.

Step 2: For the condition providing the highest peak spatial-average SAR determined in Step 1 for each frequency, perform all tests at all other test frequency channels, e.g., lowest and highest frequencies. In addition, for all other conditions (device position, configuration, and operational mode) where the peak spatial-average SAR value determined in Step 1 is within 3 dB of the applicable SAR limit, it is recommended that all other test frequencies should be tested as well.

Step 3: Examine all data to determine the largest value of the peak.

Note:

1. Per KDB 447498 D01v06, the reported SAR is the measured SAR value adjusted for maximum tune-up tolerance.

Scaling Factor = tune-up limit power (mW) / EUT RF power (mW), where tune-up limit is the maximum rated power among all production units.

Duty Factor = 1 / Duty Cycle(%)

For cellular network:

Reported SAR (W/kg) = Measured SAR (W/kg) * Scaling Factor

For WLAN

Reported SAR (W/kg) = Measured SAR (W/kg) * Scaling Factor * Duty factor

2. Per KDB 447498 D01v06, for each exposure position, if the highest output channel reported SAR ≤ 0.8 W/kg, other channels SAR testing are not necessary.

3. The distance between the EUT and the phantom bottom is 0mm.

Mode		Duty cycle	Duty factor	Note
Licensed Frequency	WCDMA Band	100%	NA	According to the theory, we configured duty cycle with relevant value on the communication tester, so correction factor do not need such as "duty factor"
	FDD-LTE Band	100%		
Unlicensed Frequency	WIFI 2.4GHz 802.11b	98.1%	1.02	SRTC perform SAR test with non-signaling mode, and duty cycle is variant in practice, so duty factor shall be considered because of the uncertainty of data traffic.

Refers to KDB 616217 D04 Section6 procedure for determining triggering distances/ sensor coverage/ tilt angle influences

Note: the furthest detection distance of sensor is greater than trigger distance (with power reduction) to avoid the uncertainty, when the backlight off (not intend to use), sensor remain previous state, and manufacturer reserves the right to interpret.

1: Proximity sensor triggering distances



Band	Trigger distance-Front Side		Trigger distance-Back Side		Trigger distance-Top Side		Trigger distance-Left Side		Trigger distance-Right Side	
	Moving toward phantom	Moving away from phantom	Moving toward phantom	Moving away from phantom	Moving toward phantom	Moving away from phantom	Moving toward phantom	Moving away from phantom	Moving toward phantom	Moving away from phantom
W2	15	15	15	15	15	15	10	10	10	10
W4	15	15	15	15	15	15	10	10	10	10
W5	15	15	15	15	15	15	10	10	10	10
L2	15	15	15	15	15	15	10	10	10	10
L4	15	15	15	15	15	15	10	10	10	10
L5	15	15	15	15	15	15	10	10	10	10
L12	15	15	15	15	15	15	10	10	10	10
L13	15	15	15	15	15	15	10	10	10	10
L25	15	15	15	15	15	15	10	10	10	10
L26	15	15	15	15	15	15	10	10	10	10
L41	15	15	15	15	15	15	10	10	10	10
L66	15	15	15	15	15	15	10	10	10	10
L71	15	15	15	15	15	15	10	10	10	10

WWAN

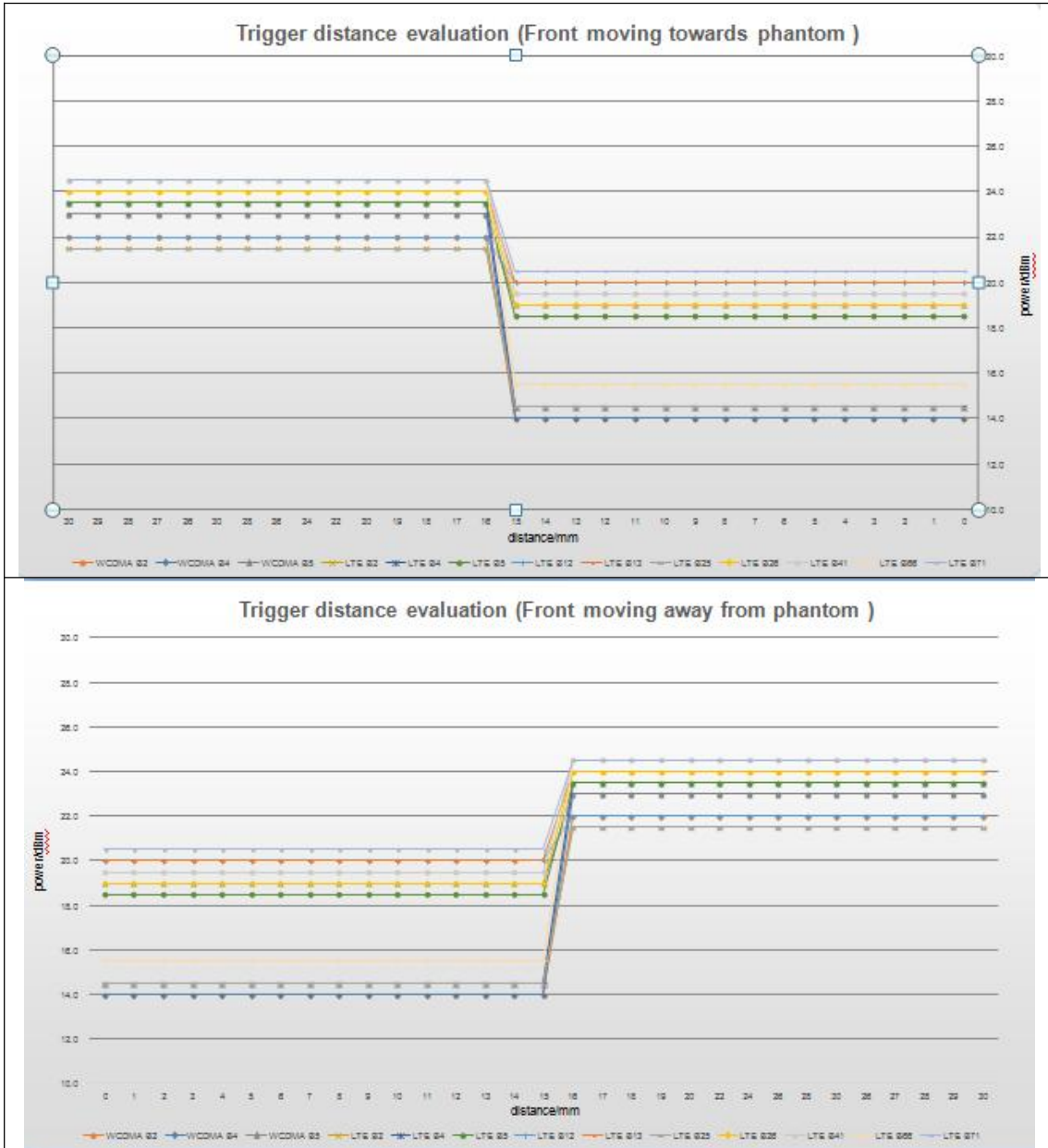





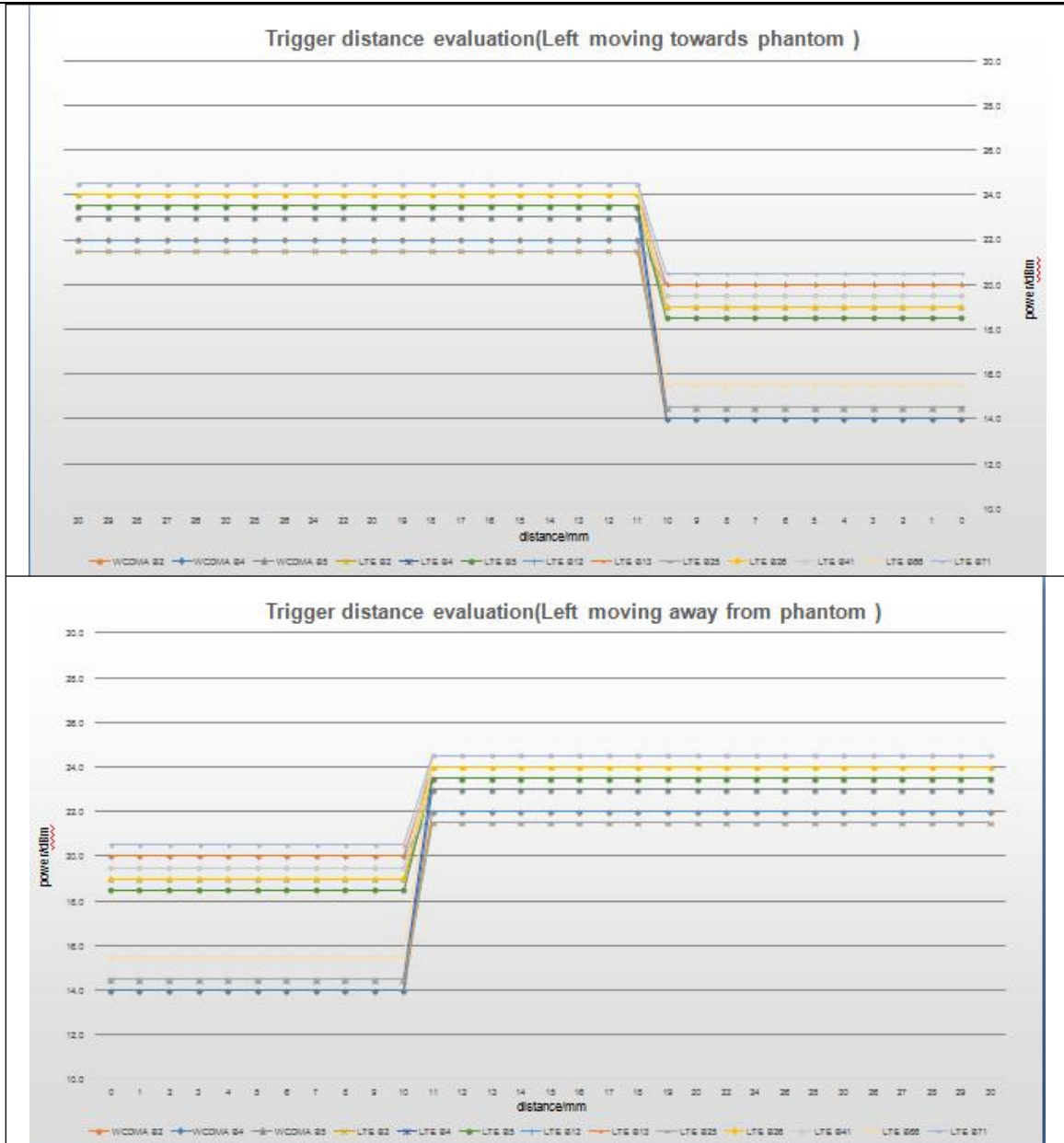



2: Proximity sensor coverage

Proximity sensor cannot fully overwrite antenna (physically), so the proximity sensor coverage need to be assessed. There is tiny difference of peak SAR location of each frequency band but at least the sensor trigger coverage area contain peak SAR.

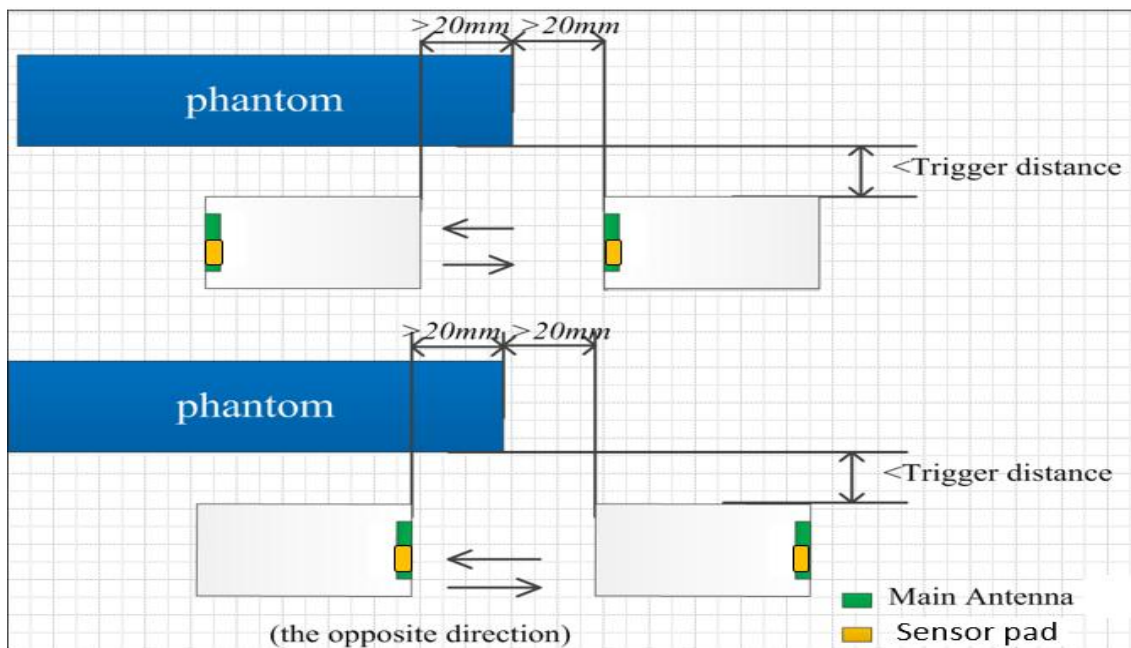
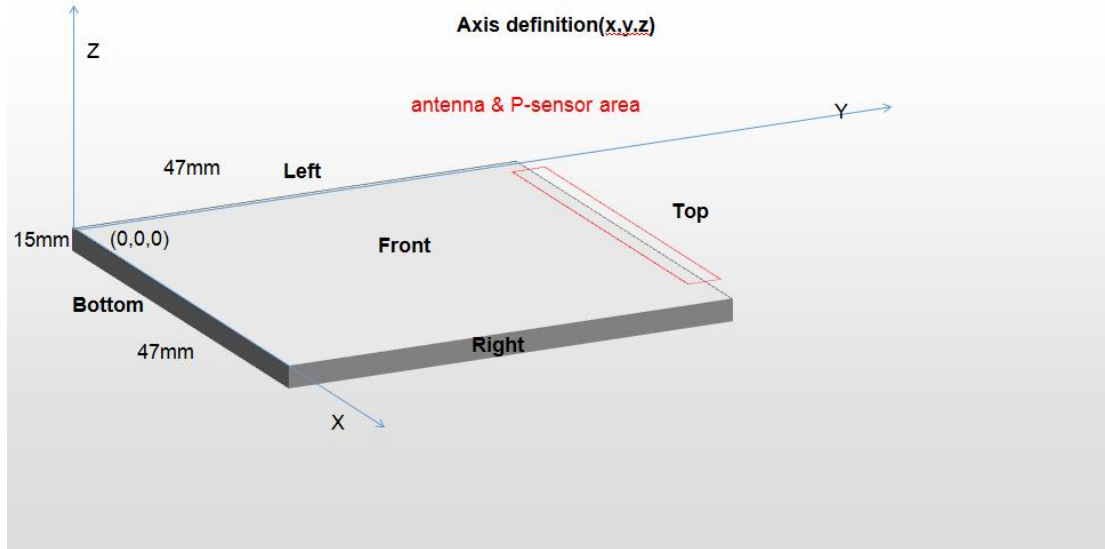

Figure: proximity sensor coverage assesment (Y coordinate direction)

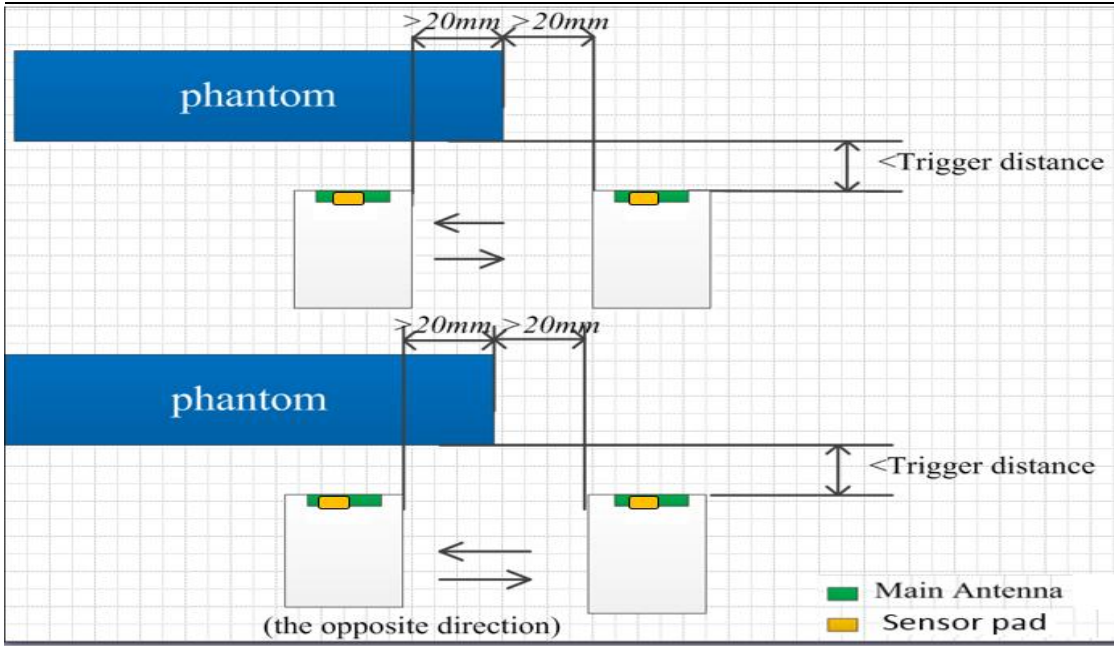
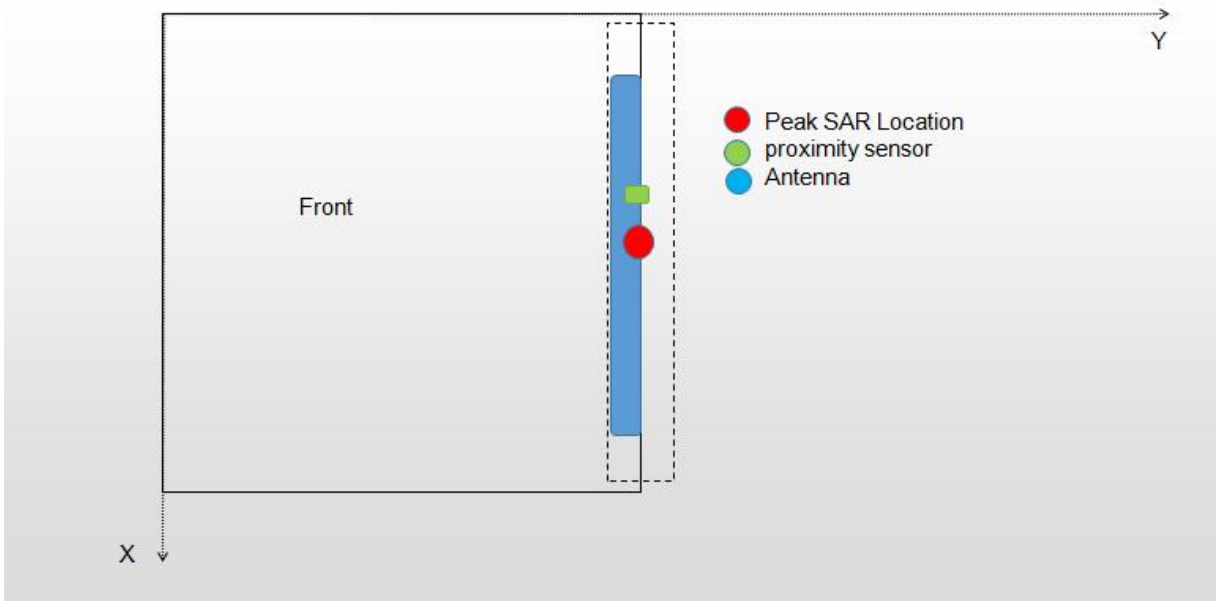
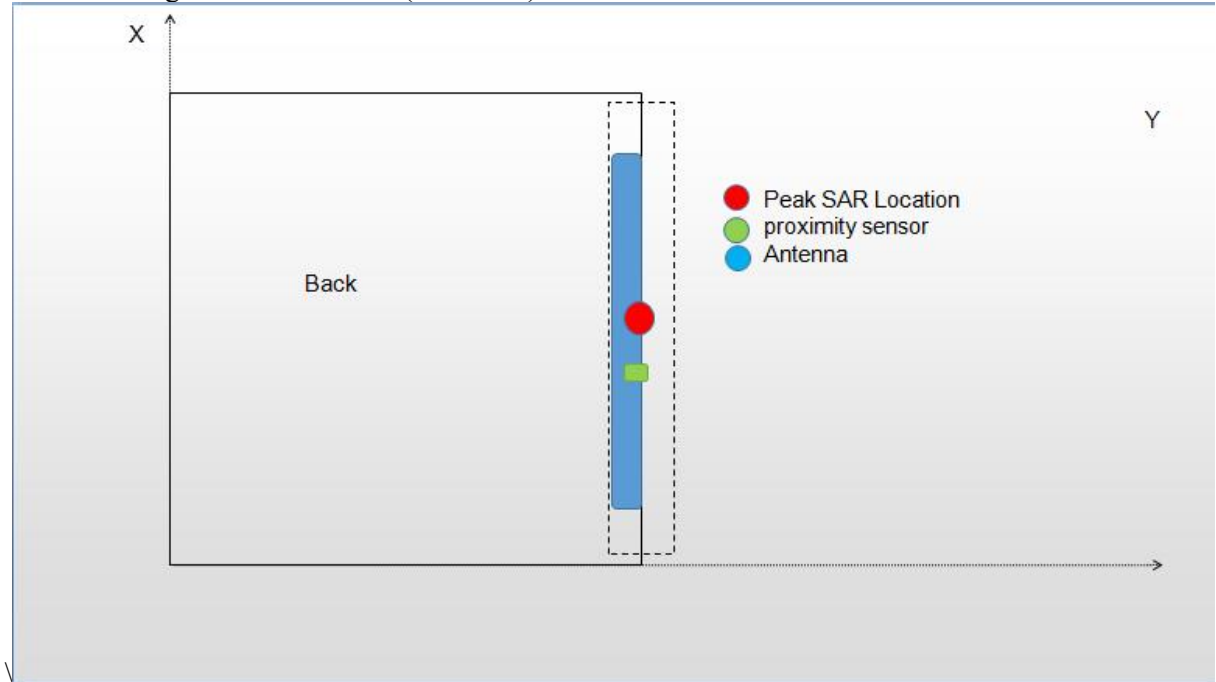

Figure: proximity sensor coverage assesment (X coordinate direction)

sensor coverage assesment results(Front side):



sensor coverage assesment results(Back side):



sensor coverage assesment results(Top side):

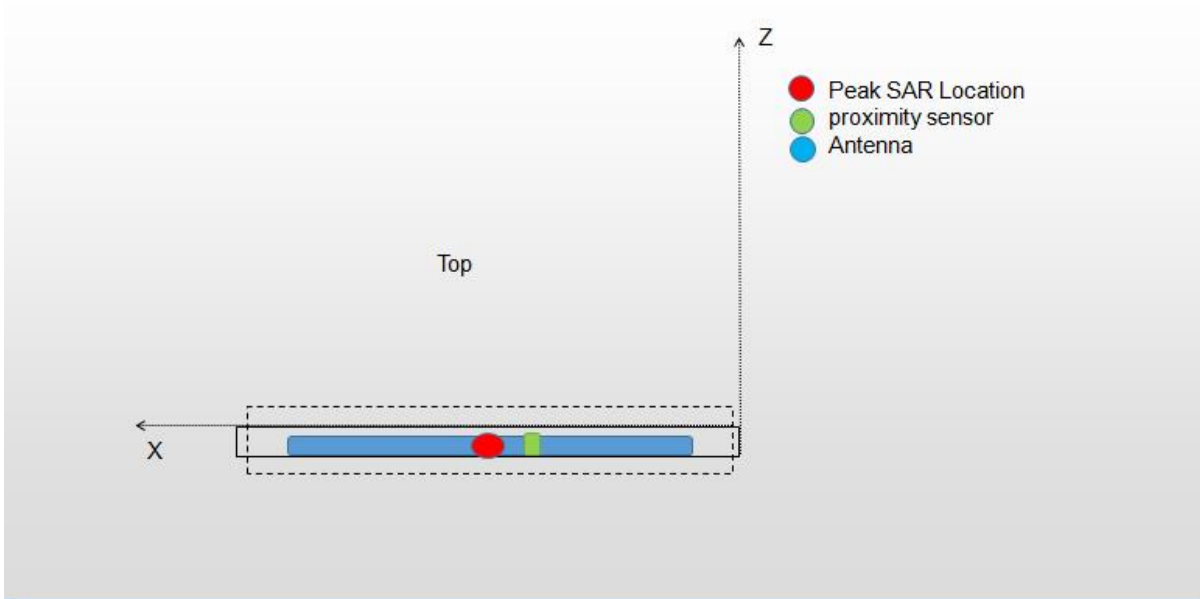

sensor coverage assesment results(Right side):

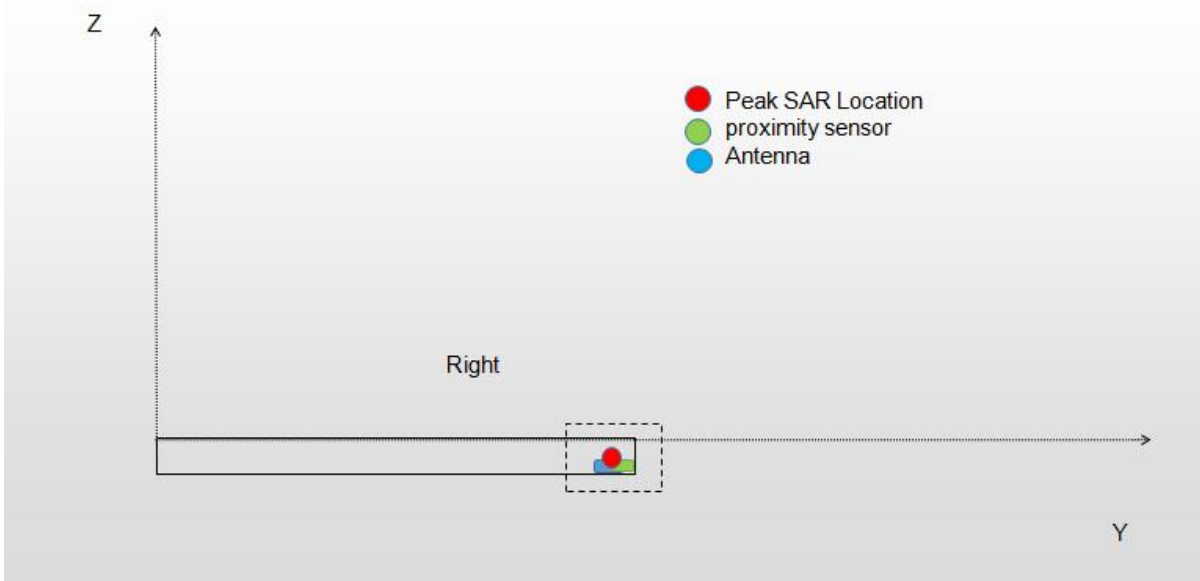

sensor coverage assesment results(Right side):

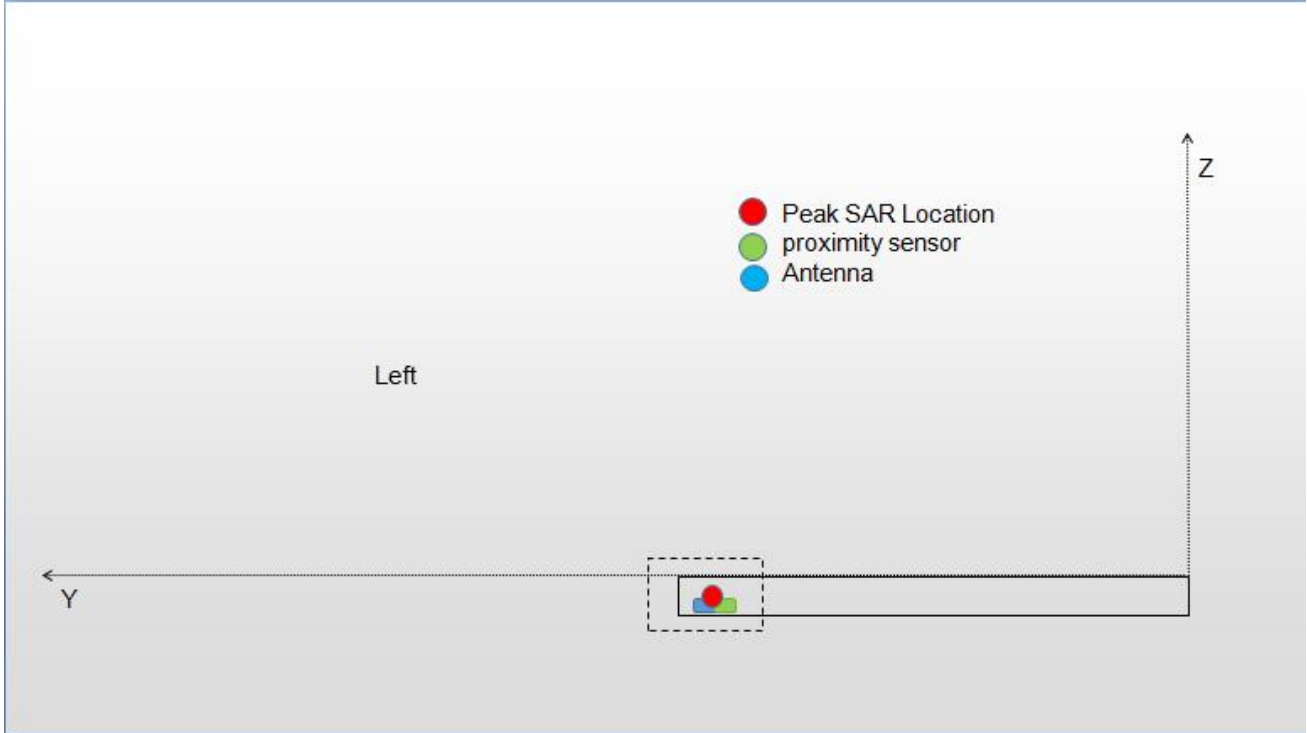

Conclusion: As the subsequently measured peak SAR location for the antenna is between the triggering points, additional SAR tests are not required for proximity sensor coverage.

3: Tilt angle influences to proximity sensor triggering

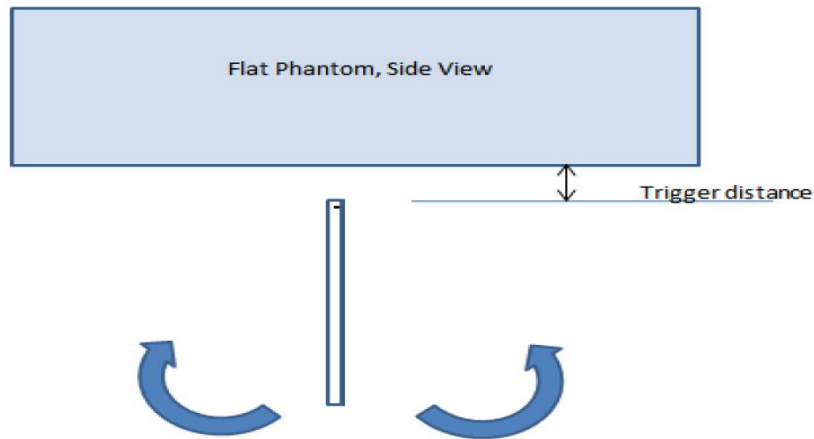

Position	Band(MHz)	Minimum trigger distance at which power reduction was maintained over $\pm 45^\circ$	Power Reduction Status										
			-45°	-35°	-25°	-15°	-5°	0°	5°	15°	25°	35°	45°
Top	W2	15	on	on	on	on	on	on	on	on	on	on	on
	W4	15	on	on	on	on	on	on	on	on	on	on	on
	W5	15	on	on	on	on	on	on	on	on	on	on	on
	L2	15	on	on	on	on	on	on	on	on	on	on	on
	L4	15	on	on	on	on	on	on	on	on	on	on	on
	L5	15	on	on	on	on	on	on	on	on	on	on	on
	L12	15	on	on	on	on	on	on	on	on	on	on	on
	L13	15	on	on	on	on	on	on	on	on	on	on	on
	L25	15	on	on	on	on	on	on	on	on	on	on	on
	L26	15	on	on	on	on	on	on	on	on	on	on	on
	L41	15	on	on	on	on	on	on	on	on	on	on	on
	L66	15	on	on	on	on	on	on	on	on	on	on	on
L71	15	on	on	on	on	on	on	on	on	on	on	on	

Position	Band(MHz)	Minimum trigger distance at which power reduction was maintained over $\pm 45^\circ$	Power Reduction Status										
			-45°	-35°	-25°	-15°	-5°	0°	5°	15°	25°	35°	45°
Left	W2	10	on	on	on	on	on	on	on	on	on	on	on
	W4	10	on	on	on	on	on	on	on	on	on	on	on
	W5	10	on	on	on	on	on	on	on	on	on	on	on
	L2	10	on	on	on	on	on	on	on	on	on	on	on
	L4	10	on	on	on	on	on	on	on	on	on	on	on
	L5	10	on	on	on	on	on	on	on	on	on	on	on
	L12	10	on	on	on	on	on	on	on	on	on	on	on
	L13	10	on	on	on	on	on	on	on	on	on	on	on
	L25	10	on	on	on	on	on	on	on	on	on	on	on
	L26	10	on	on	on	on	on	on	on	on	on	on	on
	L41	10	on	on	on	on	on	on	on	on	on	on	on
	L66	10	on	on	on	on	on	on	on	on	on	on	on
L71	10	on	on	on	on	on	on	on	on	on	on	on	

Position	Band(MHz)	Minimum trigger distance at which power reduction was maintained over $\pm 45^\circ$	Power Reduction Status										
			-45°	-35°	-25°	-15°	-5°	0°	5°	15°	25°	35°	45°
Right	W2	10	on	on	on	on	on	on	on	on	on	on	on
	W4	10	on	on	on	on	on	on	on	on	on	on	on
	W5	10	on	on	on	on	on	on	on	on	on	on	on
	L2	10	on	on	on	on	on	on	on	on	on	on	on
	L4	10	on	on	on	on	on	on	on	on	on	on	on
	L5	10	on	on	on	on	on	on	on	on	on	on	on
	L12	10	on	on	on	on	on	on	on	on	on	on	on
	L13	10	on	on	on	on	on	on	on	on	on	on	on
	L25	10	on	on	on	on	on	on	on	on	on	on	on
	L26	10	on	on	on	on	on	on	on	on	on	on	on
	L41	10	on	on	on	on	on	on	on	on	on	on	on
	L66	10	on	on	on	on	on	on	on	on	on	on	on
L71	10	on	on	on	on	on	on	on	on	on	on	on	

Proximity sensor Power Reduction Scheme

Mode	Power reduction symbol	Power reduction amount(dB)	Note
WWAN	D0	0	Full power
	D1	2	Reduced power
	D2	4	
	D3	5	
	D4	7	
	D5	8	
	D6	9	

WWAN antenna			
Band	Test position	Sensor Trigger	Power
		Distance range(DUT to Phantom)	Reduction symbol
WCDMA Band2	Back side	$0 \leq \text{distance} \leq 15\text{mm}$	D5
		$15 < \text{distance}$	D0
	Front side	$0 \leq \text{distance} \leq 15\text{mm}$	D5
		$15 < \text{distance}$	D0
	Bottom side	ALL	D0
	Top side	$0 \leq \text{distance} \leq 15\text{mm}$	D5
		$15 < \text{distance}$	D0
	Left side	$0 \leq \text{distance} \leq 10\text{mm}$	D5
		$10 < \text{distance}$	D0
	Right side	$0 \leq \text{distance} \leq 10\text{mm}$	D5
		$10 < \text{distance}$	D0
	WCDMA Band4	Back side	$0 \leq \text{distance} \leq 15\text{mm}$
$15 < \text{distance}$			D0
Front side		$0 \leq \text{distance} \leq 15\text{mm}$	D6

		15<distance	D0
	Bottom side	ALL	D0
	Top side	0≤distance≤15mm	D6
		15<distance	D0
	Left side	0≤distance≤10mm	D6
		10<distance	D0
	Right side	0≤distance≤10mm	D6
		10<distance	D0
WCDMA Band5	Back side	0≤distance≤15mm	D2
		15<distance	D0
	Front side	0≤distance≤15mm	D2
		15<distance	D0
	Bottom side	ALL	D0
	Top side	0≤distance≤15mm	D2
		15<distance	D0
	Left side	0≤distance≤10mm	D2
		10<distance	D0
	Right side	0≤distance≤10mm	D2
		10<distance	D0
	LTE Band2	Back side	0≤distance≤15mm
15<distance			D0
Front side		0≤distance≤15mm	D4
		15<distance	D0
Bottom side		ALL	D0
Top side		0≤distance≤15mm	D4
		15<distance	D0

	Left side	$0 \leq \text{distance} \leq 10\text{mm}$	D4
		$10 < \text{distance}$	D0
	Right side	$0 \leq \text{distance} \leq 10\text{mm}$	D4
		$10 < \text{distance}$	D0
LTE Band4	Back side	$0 \leq \text{distance} \leq 15\text{mm}$	D5
		$15 < \text{distance}$	D0
	Front side	$0 \leq \text{distance} \leq 15\text{mm}$	D5
		$15 < \text{distance}$	D0
	Bottom side	ALL	D0
	Top side	$0 \leq \text{distance} \leq 15\text{mm}$	D5
		$15 < \text{distance}$	D0
	Left side	$0 \leq \text{distance} \leq 10\text{mm}$	D5
		$10 < \text{distance}$	D0
	Right side	$0 \leq \text{distance} \leq 10\text{mm}$	D5
		$10 < \text{distance}$	D0
	LTE Band5	Back side	$0 \leq \text{distance} \leq 15\text{mm}$
$15 < \text{distance}$			D0
Front side		$0 \leq \text{distance} \leq 15\text{mm}$	D3
		$15 < \text{distance}$	D0
Bottom side		ALL	D0
Top side		$0 \leq \text{distance} \leq 15\text{mm}$	D3
		$15 < \text{distance}$	D0
Left side		$0 \leq \text{distance} \leq 10\text{mm}$	D3
		$10 < \text{distance}$	D0
Right side		$0 \leq \text{distance} \leq 10\text{mm}$	D3

		10<distance	D0
LTE Band12	Back side	0≤distance≤15mm	D1
		15<distance	D0
	Front side	0≤distance≤15mm	D1
		15<distance	D0
	Bottom side	ALL	D0
	Top side	0≤distance≤15mm	D1
		15<distance	D0
	Left side	0≤distance≤10mm	D1
		10<distance	D0
	Right side	0≤distance≤10mm	D1
		10<distance	D0
	LTE Band13	Back side	0≤distance≤15mm
15<distance			D0
Front side		0≤distance≤15mm	D2
		15<distance	D0
Bottom side		ALL	D0
Top side		0≤distance≤15mm	D2
		15<distance	D0
Left side		0≤distance≤10mm	D2
		10<distance	D0
Right side		0≤distance≤10mm	D2
		10<distance	D0
LTE Band25		Back side	0≤distance≤15mm
	15<distance		D0

	Front side	$0 \leq \text{distance} \leq 15\text{mm}$	D4	
		$15 < \text{distance}$	D0	
	Bottom side	ALL	D0	
	Top side	$0 \leq \text{distance} \leq 15\text{mm}$	D4	
		$15 < \text{distance}$	D0	
	Left side	$0 \leq \text{distance} \leq 10\text{mm}$	D4	
		$10 < \text{distance}$	D0	
	Right side	$0 \leq \text{distance} \leq 10\text{mm}$	D4	
		$10 < \text{distance}$	D0	
	LTE Band26	Back side	$0 \leq \text{distance} \leq 15\text{mm}$	D3
			$15 < \text{distance}$	D0
Front side		$0 \leq \text{distance} \leq 15\text{mm}$	D3	
		$15 < \text{distance}$	D0	
Bottom side		ALL	D0	
Top side		$0 \leq \text{distance} \leq 15\text{mm}$	D3	
		$15 < \text{distance}$	D0	
Left side		$0 \leq \text{distance} \leq 10\text{mm}$	D3	
		$10 < \text{distance}$	D0	
Right side		$0 \leq \text{distance} \leq 10\text{mm}$	D3	
		$10 < \text{distance}$	D0	
LTE Band41		Back side	$0 \leq \text{distance} \leq 15\text{mm}$	D3
	$15 < \text{distance}$		D0	
	Front side	$0 \leq \text{distance} \leq 15\text{mm}$	D3	
		$15 < \text{distance}$	D0	
	Bottom side	ALL	D0	
	Top side	$0 \leq \text{distance} \leq 15\text{mm}$	D3	

		15<distance	D0	
		0≤distance≤10mm	D3	
	Left side	10<distance	D0	
		0≤distance≤10mm	D3	
		10<distance	D0	
Right side	0≤distance≤10mm	D3		
	10<distance	D0		
LTE Band66	Back side	0≤distance≤15mm	D6	
		15<distance	D0	
	Front side	0≤distance≤15mm	D6	
		15<distance	D0	
	Bottom side	ALL	D0	
	Top side	0≤distance≤15mm	D6	
		15<distance	D0	
	Left side	0≤distance≤10mm	D6	
		10<distance	D0	
	Right side	0≤distance≤10mm	D6	
		10<distance	D0	
	LTE Band71	Back side	0≤distance≤15mm	D2
			15<distance	D0
		Front side	0≤distance≤15mm	D2
15<distance			D0	
Bottom side		ALL	D0	
Top side		0≤distance≤15mm	D2	
		15<distance	D0	
Left side		0≤distance≤10mm	D2	

		10<distance	D0
	Right side	0≤distance≤10mm	D2
		10<distance	D0

The measured and reported body SAR values for the test device are tabulated below: Power reduction scheme works well under trigger distance when product unit suddenly approach or away from torso, and SRTC also evaluated the SAR value under separation distance equal to trigger distance-1 (different for each surface) with full power mode, there is no risk for this condition .

Mode: WCDMA BAND II

fL (MHz)= 1852.4MHz fM (MHz)= 1880.0MHz fH (MHz)= 1907.6MHz

Limit of SAR (W/kg): <1.6W/kg (1g Average)

0mm with p-sensor on (reduced power for relevant surfaces)

Test case			Meas power (dBm)	Tune-up (dBm)	Scaling factor	Meas SAR(w/kg)		Report SAR(w/kg)	
Mode	Position	Channel				First	Second	First	Second
Rel.99	Back	L	13.86	14.00	1.03	---	---	---	---
		M	13.88	14.00	1.03	0.598	---	0.616	---
		H	13.75	14.00	1.06	---	---	---	---
	Front	L	13.86	14.00	1.03	---	---	---	---
		M	13.88	14.00	1.03	0.557	---	0.574	---
		H	13.75	14.00	1.06	---	---	---	---
	Top	L	13.86	14.00	1.03	0.767	0.771	0.790	0.794
		M	13.88	14.00	1.03	0.812	0.803	0.836	0.827
		H	13.75	14.00	1.06	0.748	0.737	0.793	0.781
	Bottom	L	21.86	22.00	1.03	0.834	0.827	0.859	0.852
		M	21.88	22.00	1.03	0.906	0.901	0.933	0.928
		H	21.75	22.00	1.06	0.823	0.819	0.872	0.868
	Left	L	13.86	14.00	1.03	---	---	---	---
		M	13.88	14.00	1.03	0.385	---	0.397	---
		H	13.75	14.00	1.06	---	---	---	---
	Right	L	13.86	14.00	1.03	---	---	---	---
		M	13.88	14.00	1.03	0.245	---	0.252	---
		H	13.75	14.00	1.06	---	---	---	---

(Trigger distance-1) mm with p-sensor off (full power for all surfaces)

Test case			Meas power (dBm)	Tune-up (dBm)	Scaling factor	Meas SAR(w/kg)		Report SAR(w/kg)	
Mode	Position	Channel				First	Second	First	Second
Rel.99	Back	L	21.86	22.00	1.03	---	---	---	---
		M	21.88	22.00	1.03	0.607	---	0.625	---
		H	21.75	22.00	1.06	---	---	---	---
	Front	L	21.86	22.00	1.03	---	---	---	---
		M	21.88	22.00	1.03	0.571	---	0.588	---
		H	21.75	22.00	1.06	---	---	---	---
	Top	L	21.86	22.00	1.03	---	---	---	---
		M	21.88	22.00	1.03	0.715	---	0.736	---
		H	21.75	22.00	1.06	---	---	---	---
	Bottom	L	21.86	22.00	1.03	---	---	---	---
		M	21.88	22.00	1.03	---	---	---	---
		H	21.75	22.00	1.06	---	---	---	---
	Left	L	21.86	22.00	1.03	---	---	---	---
		M	21.88	22.00	1.03	0.403	---	0.415	---
		H	21.75	22.00	1.06	---	---	---	---
	Right	L	21.86	22.00	1.03	---	---	---	---
		M	21.88	22.00	1.03	0.063	---	0.065	---
		H	21.75	22.00	1.06	---	---	---	---

Mode: WCDMA BAND IV

fL (MHz)=1712.4MHz fM (MHz)=1732.4MHz fH (MHz)= 1752.6MHz

Limit of SAR (W/kg): <1.6W/kg (1g Average)

0mm with p-sensor on (reduced power for relevant surfaces)

Test case			Meas power (dBm)	Tune-up (dBm)	Scaling factor	Meas SAR(w/kg)		Report SAR(w/kg)	
Mode	Position	Channel				First	Second	First	Second
Rel.99	Back	L	13.61	14.00	1.09	---	---	---	---
		M	13.64	14.00	1.09	0.708	---	0.772	---
		H	13.65	14.00	1.08	---	---	---	---
	Front	L	13.61	14.00	1.09	---	---	---	---
		M	13.64	14.00	1.09	0.479	---	0.522	---
		H	13.65	14.00	1.08	---	---	---	---
	Top	L	13.61	14.00	1.09	1.090	1.020	1.188	1.112
		M	13.64	14.00	1.09	0.995	1.010	1.085	1.101
		H	13.65	14.00	1.08	0.905	0.912	0.977	0.985
	Bottom	L	22.61	23.00	1.09	---	---	---	---
		M	22.64	23.00	1.09	0.493	---	0.537	---
		H	22.65	23.00	1.08	---	---	---	---
	Left	L	13.61	14.00	1.09	---	---	---	---
		M	13.64	14.00	1.09	0.626	---	0.682	---
		H	13.65	14.00	1.08	---	---	---	---
	Right	L	13.61	14.00	1.09	---	---	---	---
		M	13.64	14.00	1.09	0.215	---	0.234	---
		H	13.65	14.00	1.08	---	---	---	---

Secondary test : Improved model measurement results

Test case			Meas power (dBm)	Tune-up (dBm)	Scaling factor	Meas SAR(w/kg)		Report SAR(w/kg)	
Mode	Position	Channel				First	Second	First	Second
Rel.99	Back	L	13.61	14.00	1.09	---	---	---	---
		M	13.64	14.00	1.09	0.708	---	0.772	---
		H	13.65	14.00	1.08	---	---	---	---
	Front	L	13.61	14.00	1.09	---	---	---	---
		M	13.64	14.00	1.09	0.479	---	0.522	---
		H	13.65	14.00	1.08	---	---	---	---
	Top	L	13.61	14.00	1.09	---	---	---	---
		M	13.64	14.00	1.09	0.780	---	0.850	---
		H	13.65	14.00	1.08	---	---	---	---
	Bottom	L	22.61	23.00	1.09	---	---	---	---
		M	22.64	23.00	1.09	0.493	---	0.537	---
		H	22.65	23.00	1.08	---	---	---	---

	Left	L	13.61	14.00	1.09	---	---	---	---
		M	13.64	14.00	1.09	0.626	---	0.682	---
		H	13.65	14.00	1.08	---	---	---	---
	Right	L	13.61	14.00	1.09	---	---	---	---
		M	13.64	14.00	1.09	0.215	---	0.234	---
		H	13.65	14.00	1.08	---	---	---	---

(Trigger distance-1) mm with p-sensor off (full power for all surfaces)

Test case			Meas power (dBm)	Tune-up (dBm)	Scaling factor	Meas SAR(w/kg)		Report SAR(w/kg)	
Mode	Position	Channel				First	Second	First	Second
Rel.99	Back	L	22.61	23.00	1.09	---	---	---	---
		M	22.64	23.00	1.09	0.727	---	0.792	---
		H	22.65	23.00	1.08	---	---	---	---
	Front	L	22.61	23.00	1.09	---	---	---	---
		M	22.64	23.00	1.09	0.606	---	0.661	---
		H	22.65	23.00	1.08	---	---	---	---
	Top	L	22.61	23.00	1.09	1.030	1.010	1.123	1.101
		M	22.64	23.00	1.09	0.918	0.931	1.001	1.015
		H	22.65	23.00	1.08	0.881	0.873	0.951	0.943
	Bottom	L	22.61	23.00	1.09	---	---	---	---
		M	22.64	23.00	1.09	---	---	---	---
		H	22.65	23.00	1.08	---	---	---	---
	Left	L	22.61	23.00	1.09	---	---	---	---
		M	22.64	23.00	1.09	0.325	---	0.354	---
		H	22.65	23.00	1.08	---	---	---	---
	Right	L	22.61	23.00	1.09	---	---	---	---
		M	22.64	23.00	1.09	0.185	---	0.202	---
		H	22.65	23.00	1.08	---	---	---	---

Mode: WCDMA BAND V

fL (MHz)=826.4MHz fM (MHz)=836.4MHz fH (MHz)= 846.6MHz

Limit of SAR (W/kg): <1.6W/kg (1g Average)

0mm with p-sensor on (reduced power for relevant surfaces)

Test case			Meas power (dBm)	Tune-up (dBm)	Scaling factor	Meas SAR(w/kg)		Report SAR(w/kg)	
Mode	Position	Channel				First	Second	First	Second
Rel.99	Back	L	18.57	19.00	1.10	---	---	---	---
		M	18.58	19.00	1.10	0.128	---	0.141	---
		H	18.68	19.00	1.08	---	---	---	---
	Front	L	18.57	19.00	1.10	---	---	---	---
		M	18.58	19.00	1.10	0.462	---	0.508	---
		H	18.68	19.00	1.08	---	---	---	---
	Top	L	18.57	19.00	1.10	---	---	---	---
		M	18.58	19.00	1.10	0.333	---	0.366	---
		H	18.68	19.00	1.08	---	---	---	---
	Bottom	L	22.57	23.00	1.10	0.721	---	0.793	---
		M	22.58	23.00	1.10	0.735	---	0.809	---
		H	22.68	23.00	1.08	0.718	---	0.775	---
	Left	L	18.57	19.00	1.10	---	---	---	---
		M	18.58	19.00	1.10	0.424	---	0.466	---
		H	18.68	19.00	1.08	---	---	---	---
	Right	L	18.57	19.00	1.10	---	---	---	---
		M	18.58	19.00	1.10	0.631	---	0.694	---
		H	18.68	19.00	1.08	---	---	---	---

(Trigger distance-1) mm with p-sensor off (full power for all surfaces)

Test case			Meas power (dBm)	Tune-up (dBm)	Scaling factor	Meas SAR(w/kg)		Report SAR(w/kg)	
Mode	Position	Channel				First	Second	First	Second
Rel.99	Back	L	22.57	23.00	1.10	---	---	---	---
		M	22.58	23.00	1.10	0.244	---	0.268	---
		H	22.68	23.00	1.08	---	---	---	---
	Front	L	22.57	23.00	1.10	---	---	---	---
		M	22.58	23.00	1.10	0.289	---	0.318	---
		H	22.68	23.00	1.08	---	---	---	---
	Top	L	22.57	23.00	1.10	---	---	---	---
		M	22.58	23.00	1.10	0.143	---	0.157	---
		H	22.68	23.00	1.08	---	---	---	---
	Bottom	L	22.57	23.00	1.10	---	---	---	---
		M	22.58	23.00	1.10	---	---	---	---
		H	22.68	23.00	1.08	---	---	---	---
	Left	L	22.57	23.00	1.10	---	---	---	---
		M	22.58	23.00	1.10	0.247	---	0.272	---
		H	22.68	23.00	1.08	---	---	---	---
	Right	L	22.57	23.00	1.10	---	---	---	---
		M	22.58	23.00	1.10	0.196	---	0.216	---
		H	22.68	23.00	1.08	---	---	---	---

Mode: LTE Band 2

fL (MHz)= 1860MHz fM (MHz)= 1880MHz fH (MHz)= 1900MHz

Limit of SAR (W/kg): <1.6W/kg (1g Average)

0mm with p-sensor on (reduced power for relevant surfaces)

Test case			Meas power (dBm)	Tune-up (dBm)	Scaling factor	Meas SAR(w/kg)		Report SAR(w/kg)	
Mode	Position	Channel				First	Second	First	Second
QPSK 1RB	Back	L	14.17	14.50	1.08	---	---	---	---
		M	14.28	14.50	1.05	0.484	---	0.508	---
		H	14.33	14.50	1.04	---	---	---	---
	Front	L	14.17	14.50	1.08	---	---	---	---
		M	14.28	14.50	1.05	0.450	---	0.473	---
		H	14.33	14.50	1.04	---	---	---	---
	Top	L	14.17	14.50	1.08	---	---	---	---
		M	14.28	14.50	1.05	0.686	---	0.720	---
		H	14.33	14.50	1.04	---	---	---	---
	Bottom	L	21.17	21.50	1.08	0.716	---	0.773	---
		M	21.28	21.50	1.05	0.877	0.868	0.921	0.911
		H	21.33	21.50	1.04	0.727	---	0.756	---
	Left	L	14.17	14.50	1.08	---	---	---	---
		M	14.28	14.50	1.05	0.297	---	0.312	---
		H	14.33	14.50	1.04	---	---	---	---
Right	L	14.17	14.50	1.08	---	---	---	---	
	M	14.28	14.50	1.05	0.149	---	0.156	---	
	H	14.33	14.50	1.04	---	---	---	---	
QPSK 50%RB	Back	L	13.33	13.50	1.04	---	---	---	---
		M	13.29	13.50	1.05	0.381	---	0.400	---
		H	13.47	13.50	1.01	---	---	---	---
	Front	L	13.33	13.50	1.04	---	---	---	---
		M	13.29	13.50	1.05	0.367	---	0.385	---
		H	13.47	13.50	1.01	---	---	---	---
	Top	L	13.33	13.50	1.04	---	---	---	---
		M	13.29	13.50	1.05	0.513	---	0.539	---
		H	13.47	13.50	1.01	---	---	---	---
	Bottom	L	20.33	20.50	1.04	---	---	---	---
		M	20.29	20.50	1.05	0.655	---	0.688	---
		H	20.47	20.50	1.01	---	---	---	---
	Left	L	13.33	13.50	1.04	---	---	---	---
		M	13.29	13.50	1.05	0.212	---	0.223	---
		H	13.47	13.50	1.01	---	---	---	---
Right	L	13.33	13.50	1.04	---	---	---	---	
	M	13.29	13.50	1.05	0.103	---	0.108	---	
	H	13.47	13.50	1.01	---	---	---	---	

QPSK 100%RB	Back	L	13.25	13.50	1.06	---	---	---	---
		M	13.22	13.50	1.07	---	---	---	---
		H	13.41	13.50	1.02	---	---	---	---
	Front	L	13.25	13.50	1.06	---	---	---	---
		M	13.22	13.50	1.07	---	---	---	---
		H	13.41	13.50	1.02	---	---	---	---
	Top	L	13.25	13.50	1.06	---	---	---	---
		M	13.22	13.50	1.07	---	---	---	---
		H	13.41	13.50	1.02	---	---	---	---
	Bottom	L	20.25	20.50	1.06	---	---	---	---
		M	20.22	20.50	1.07	0.646	---	0.691	---
		H	20.41	20.50	1.02	---	---	---	---
	Left	L	13.25	13.50	1.06	---	---	---	---
		M	13.22	13.50	1.07	---	---	---	---
		H	13.41	13.50	1.02	---	---	---	---
	Right	L	13.25	13.50	1.06	---	---	---	---
		M	13.22	13.50	1.07	---	---	---	---
		H	13.41	13.50	1.02	---	---	---	---

(Trigger distance-1) mm with p-sensor off (full power for all surfaces)

Test case			Meas power (dBm)	Tune-up (dBm)	Scaling factor	Meas SAR(w/kg)		Report SAR(w/kg)	
Mode	Position	Channel				First	Second	First	Second
QPSK 1RB	Back	L	21.17	21.50	1.08	---	---	---	---
		M	21.28	21.50	1.05	0.537	---	0.564	---
		H	21.33	21.50	1.04	---	---	---	---
	Front	L	21.17	21.50	1.08	---	---	---	---
		M	21.28	21.50	1.05	0.511	---	---	---
		H	21.33	21.50	1.04	---	---	---	---
	Top	L	21.17	21.50	1.08	---	---	---	---
		M	21.28	21.50	1.05	0.758	---	0.796	---
		H	21.33	21.50	1.04	---	---	---	---
	Bottom	L	21.17	21.50	1.08	---	---	---	---
		M	21.28	21.50	1.05	0.402	---	0.422	---
		H	21.33	21.50	1.04	---	---	---	---
	Left	L	21.17	21.50	1.08	---	---	---	---
		M	21.28	21.50	1.05	0.370	---	0.389	---
		H	21.33	21.50	1.04	---	---	---	---
Right	L	21.17	21.50	1.08	---	---	---	---	
	M	21.28	21.50	1.05	0.057	---	0.060	---	
	H	21.33	21.50	1.04	---	---	---	---	
QPSK 50%RB	Back	L	20.33	20.50	1.04	---	---	---	---
		M	20.29	20.50	1.05	0.431	---	0.453	---
		H	20.47	20.50	1.01	---	---	---	---
	Front	L	20.33	20.50	1.04	---	---	---	---
		M	20.29	20.50	1.05	0.402	---	0.422	---
		H	20.47	20.50	1.01	---	---	---	---
	Top	L	20.33	20.50	1.04	---	---	---	---
		M	20.29	20.50	1.05	0.633	---	0.665	---
		H	20.47	20.50	1.01	---	---	---	---
	Bottom	L	20.33	20.50	1.04	---	---	---	---
		M	20.29	20.50	1.05	---	---	---	---
		H	20.47	20.50	1.01	---	---	---	---
	Left	L	20.33	20.50	1.04	---	---	---	---
		M	20.29	20.50	1.05	0.281	---	0.295	---
		H	20.47	20.50	1.01	---	---	---	---
Right	L	20.33	20.50	1.04	---	---	---	---	
	M	20.29	20.50	1.05	0.037	---	0.039	---	
	H	20.47	20.50	1.01	---	---	---	---	

Mode: LTE Band 4

fL (MHz)= 1720MHz fM (MHz)= 1732.5MHz fH (MHz)= 1745MHz

Limit of SAR (W/kg): <1.6W/kg (1g Average)

0mm with p-sensor on (reduced power for relevant surfaces)

Test case			Meas power (dBm)	Tune-up (dBm)	Scaling factor	Meas SAR(w/kg)		Report SAR(w/kg)	
Mode	Position	Channel				First	Second	First	Second
QPSK 1RB	Back	L	13.95	14.50	1.14	---	---	---	---
		M	13.97	14.50	1.13	0.629	---	0.711	---
		H	14.11	14.50	1.09	---	---	---	---
	Front	L	13.95	14.50	1.14	---	---	---	---
		M	13.97	14.50	1.13	0.441	---	0.498	---
		H	14.11	14.50	1.09	---	---	---	---
	Top	L	13.95	14.50	1.14	0.812	0.815	0.926	0.929
		M	13.97	14.50	1.13	0.844	0.848	0.954	0.958
		H	14.11	14.50	1.09	0.899	0.890	0.980	0.970
	Bottom	L	22.95	23.50	1.14	---	---	---	---
		M	22.97	23.50	1.13	0.520	---	0.588	---
		H	23.11	23.50	1.09	---	---	---	---
Left	L	13.95	14.50	1.14	---	---	---	---	
	M	13.97	14.50	1.13	0.465	---	0.525	---	
	H	14.11	14.50	1.09	---	---	---	---	
Right	L	13.95	14.50	1.14	---	---	---	---	
	M	13.97	14.50	1.13	0.180	---	0.203	---	
	H	14.11	14.50	1.09	---	---	---	---	
QPSK 50%RB	Back	L	12.87	13.50	1.16	---	---	---	---
		M	12.92	13.50	1.14	0.542	---	0.618	---
		H	13.18	13.50	1.08	---	---	---	---
	Front	L	12.87	13.50	1.16	---	---	---	---
		M	12.92	13.50	1.14	0.357	---	0.407	---
		H	13.18	13.50	1.08	---	---	---	---
	Top	L	12.87	13.50	1.16	---	---	---	---
		M	12.92	13.50	1.14	0.681	---	0.776	---
		H	13.18	13.50	1.08	---	---	---	---
	Bottom	L	21.87	22.50	1.16	---	---	---	---
		M	21.92	22.50	1.14	0.411	---	0.469	---
		H	22.18	22.50	1.08	---	---	---	---
Left	L	12.87	13.50	1.16	---	---	---	---	
	M	12.92	13.50	1.14	0.383	---	0.437	---	
	H	13.18	13.50	1.08	---	---	---	---	
Right	L	12.87	13.50	1.16	---	---	---	---	
	M	12.92	13.50	1.14	0.114	---	0.130	---	
	H	13.18	13.50	1.08	---	---	---	---	

QPSK 100%RB	Back	L	12.83	13.50	1.17	---	---	---	---
		M	12.87	13.50	1.16		---	0.000	---
		H	13.06	13.50	1.11	---	---	---	---
	Front	L	12.83	13.50	1.17	---	---	---	---
		M	12.87	13.50	1.16	---	---	---	---
		H	13.06	13.50	1.11	---	---	---	---
	Top	L	12.83	13.50	1.17	---	---	---	---
		M	12.87	13.50	1.16	0.658	---	0.763	---
		H	13.06	13.50	1.11	---	---	---	---
	Bottom	L	21.83	22.50	1.17	---	---	---	---
		M	21.87	22.50	1.16		---	---	---
		H	22.06	22.50	1.11	---	---	---	---
	Left	L	12.83	13.50	1.17	---	---	---	---
		M	12.87	13.50	1.16		---	---	---
		H	13.06	13.50	1.11	---	---	---	---
	Right	L	12.83	13.50	1.17	---	---	---	---
		M	12.87	13.50	1.16		---	---	---
		H	13.06	13.50	1.11	---	---	---	---

(Trigger distance-1) mm with p-sensor off (full power for all surfaces)

Test case			Meas power (dBm)	Tune-up (dBm)	Scaling factor	Meas SAR(w/kg)		Report SAR(w/kg)	
Mode	Position	Channel				First	Second	First	Second
QPSK 1RB	Back	L	22.95	23.50	1.14	---	---	---	---
		M	22.97	23.50	1.13	0.703	---	0.794	---
		H	23.11	23.50	1.09	---	---	---	---
	Front	L	22.95	23.50	1.14	---	---	---	---
		M	22.97	23.50	1.13	0.573	---	0.647	---
		H	23.11	23.50	1.09	---	---	---	---
	Top	L	22.95	23.50	1.14	0.934	0.928	1.065	1.058
		M	22.97	23.50	1.13	0.976	0.966	1.103	1.092
		H	23.11	23.50	1.09	1.040	1.010	1.134	1.101
	Bottom	L	22.95	23.50	1.14	---	---	---	---
		M	22.97	23.50	1.13	---	---	---	---
		H	23.11	23.50	1.09	---	---	---	---
	Left	L	22.95	23.50	1.14	---	---	---	---
		M	22.97	23.50	1.13	0.331	---	0.374	---
		H	23.11	23.50	1.09	---	---	---	---
	Right	L	22.95	23.50	1.14	---	---	---	---
		M	22.97	23.50	1.13	0.144	---	0.163	---
		H	23.11	23.50	1.09	---	---	---	---
QPSK 50%RB	Back	L	21.87	22.50	1.16	---	---	---	---
		M	21.92	22.50	1.14	0.563	---	0.642	---
		H	22.18	22.50	1.08	---	---	---	---
	Front	L	21.87	22.50	1.16	---	---	---	---
		M	21.92	22.50	1.14	0.434	---	---	---
		H	22.18	22.50	1.08	---	---	---	---
	Top	L	21.87	22.50	1.16	0.723	0.727	0.839	0.843
		M	21.92	22.50	1.14	0.757	0.764	0.863	0.871
		H	22.18	22.50	1.08	0.811	0.802	0.876	0.866
	Bottom	L	21.87	22.50	1.16	---	---	---	---
		M	21.92	22.50	1.14	---	---	---	---
		H	22.18	22.50	1.08	---	---	---	---
	Left	L	21.87	22.50	1.16	---	---	---	---
		M	21.92	22.50	1.14	0.266	---	0.303	---
		H	22.18	22.50	1.08	---	---	---	---
Right	L	21.87	22.50	1.16	---	---	---	---	
	M	21.92	22.50	1.14	0.118	---	0.135	---	
	H	22.18	22.50	1.08	---	---	---	---	
QPSK	Back	L	21.83	22.50	1.17	---	---	---	---

100%RB		M	21.87	22.50	1.16	---	---	---	---	
		H	22.06	22.50	1.11	---	---	---	---	
	Front	L	21.83	22.50	1.17	---	---	---	---	
		M	21.87	22.50	1.16	---	---	---	---	
	Top	H	22.06	22.50	1.11	---	---	---	---	
		L	21.83	22.50	1.17	0.702	0.710	0.821	0.831	
		M	21.87	22.50	1.16	0.725	0.731	0.841	0.848	
	Bottom	H	22.06	22.50	1.11	0.779	0.787	0.865	0.874	
		L	21.83	22.50	1.17	---	---	---	---	
		M	21.87	22.50	1.16	---	---	---	---	
	Left	H	22.06	22.50	1.11	---	---	---	---	
		L	21.83	22.50	1.17	---	---	---	---	
		M	21.87	22.50	1.16	---	---	---	---	
	Right	H	22.06	22.50	1.11	---	---	---	---	
		L	21.83	22.50	1.17	---	---	---	---	
		M	21.87	22.50	1.16	---	---	---	---	
			H	22.06	22.50	1.11	---	---	---	---

Mode: LTE Band 5

fL (MHz)=829 MHz fM (MHz)=836.5MHz fH (MHz)= 844MHz

Limit of SAR (W/kg) : <1.6W/kg (1g Average)

0mm with p-sensor on (reduced power for relevant surfaces)

Test case			Meas power (dBm)	Tune-up (dBm)	Scaling factor	Meas SAR(w/kg)		Report SAR(w/kg)	
Mode	Position	Channel				First	Second	First	Second
QPSK 1RB	Back	L	18.17	18.50	1.08	---	---	---	---
		M	18.07	18.50	1.10	0.151	---	0.166	---
		H	17.99	18.50	1.12	---	---	---	---
	Front	L	18.17	18.50	1.08	---	---	---	---
		M	18.07	18.50	1.10	0.358	---	0.394	---
		H	17.99	18.50	1.12	---	---	---	---
	Top	L	18.17	18.50	1.08	---	---	---	---
		M	18.07	18.50	1.10	0.365	---	0.402	---
		H	17.99	18.50	1.12	---	---	---	---
	Bottom	L	23.17	23.50	1.08	0.732	0.741	0.791	0.800
		M	23.07	23.50	1.10	0.751	0.748	0.826	0.823
		H	22.99	23.50	1.12	0.723	0.731	0.810	0.819
	Left	L	18.17	18.50	1.08	---	---	---	---
		M	18.07	18.50	1.10	0.418	---	0.460	---
		H	17.99	18.50	1.12	---	---	---	---
Right	L	18.17	18.50	1.08	---	---	---	---	
	M	18.07	18.50	1.10	0.685	---	0.754	---	
	H	17.99	18.50	1.12	---	---	---	---	
QPSK 50%RB	Back	L	17.19	17.50	1.07	---	---	---	---
		M	17.17	17.50	1.08	0.112	---	0.121	---
		H	17.07	17.50	1.10	---	---	---	---
	Front	L	17.19	17.50	1.07	---	---	---	---
		M	17.17	17.50	1.08	0.271	---	0.293	---
		H	17.07	17.50	1.10	---	---	---	---
	Top	L	17.19	17.50	1.07	---	---	---	---
		M	17.17	17.50	1.08	0.284	---	0.307	---
		H	17.07	17.50	1.10	---	---	---	---
	Bottom	L	22.19	22.50	1.07	---	---	---	---
		M	22.17	22.50	1.08	0.615	---	0.664	---
		H	22.07	22.50	1.10	---	---	---	---
	Left	L	17.19	17.50	1.07	---	---	---	---
		M	17.17	17.50	1.08	0.328	---	0.354	---
		H	17.07	17.50	1.10	---	---	---	---
Right	L	17.19	17.50	1.07	---	---	---	---	
	M	17.17	17.50	1.08	0.577	---	0.623	---	
	H	17.07	17.50	1.10	---	---	---	---	

QPSK 100%RB	Back	L	17.18	17.50	1.08	---	---	---	---
		M	17.14	17.50	1.09		---	---	---
		H	17.02	17.50	1.12	---	---	---	---
	Front	L	17.18	17.50	1.08	---	---	---	---
		M	17.14	17.50	1.09	---	---	---	---
		H	17.02	17.50	1.12	---	---	---	---
	Top	L	17.18	17.50	1.08	---	---	---	---
		M	17.14	17.50	1.09		---	---	---
		H	17.02	17.50	1.12	---	---	---	---
	Bottom	L	22.18	22.50	1.08	---	---	---	---
		M	22.14	22.50	1.09	0.598	---	0.652	---
		H	22.02	22.50	1.12	---	---	---	---
	Left	L	17.18	17.50	1.08	---	---	---	---
		M	17.14	17.50	1.09		---	---	---
		H	17.02	17.50	1.12	---	---	---	---
	Right	L	17.18	17.50	1.08	---	---	---	---
		M	17.14	17.50	1.09		---	---	---
		H	17.02	17.50	1.12	---	---	---	---

(Trigger distance-1) mm with p-sensor off (full power for all surfaces)

Test case			Meas power (dBm)	Tune-up (dBm)	Scaling factor	Meas SAR(w/kg)		Report SAR(w/kg)	
Mode	Position	Channel				First	Second	First	Second
QPSK 1RB	Back	L	23.17	23.50	1.08	---	---	---	---
		M	23.07	23.50	1.10	0.256	---	0.282	---
		H	22.99	23.50	1.12	---	---	---	---
	Front	L	23.17	23.50	1.08	---	---	---	---
		M	23.07	23.50	1.10	0.249	---	---	---
		H	22.99	23.50	1.12	---	---	---	---
	Top	L	23.17	23.50	1.08	---	---	---	---
		M	23.07	23.50	1.10	0.143	---	0.157	---
		H	22.99	23.50	1.12	---	---	---	---
	Bottom	L	23.17	23.50	1.08	---	---	---	---
		M	23.07	23.50	1.10	---	---	---	---
		H	22.99	23.50	1.12	---	---	---	---
	Left	L	23.17	23.50	1.08	---	---	---	---
		M	23.07	23.50	1.10	0.199	---	0.219	---
		H	22.99	23.50	1.12	---	---	---	---
	Right	L	23.17	23.50	1.08	---	---	---	---
		M	23.07	23.50	1.10	0.142	---	0.156	---
		H	22.99	23.50	1.12	---	---	---	---
QPSK 50%RB	Back	L	22.19	22.50	1.07	---	---	---	---
		M	22.17	22.50	1.08	0.194	---	0.210	---
		H	22.07	22.50	1.10	---	---	---	---
	Front	L	22.19	22.50	1.07	---	---	---	---
		M	22.17	22.50	1.08	0.181	---	---	---
		H	22.07	22.50	1.10	---	---	---	---
	Top	L	22.19	22.50	1.07	---	---	---	---
		M	22.17	22.50	1.08	0.112	---	0.121	---
		H	22.07	22.50	1.10	---	---	---	---
	Bottom	L	22.19	22.50	1.07	---	---	---	---
		M	22.17	22.50	1.08	---	---	---	---
		H	22.07	22.50	1.10	---	---	---	---
	Left	L	22.19	22.50	1.07	---	---	---	---
		M	22.17	22.50	1.08	0.133	---	0.144	---
		H	22.07	22.50	1.10	---	---	---	---
	Right	L	22.19	22.50	1.07	---	---	---	---
		M	22.17	22.50	1.08	0.103	---	0.111	---
		H	23.17	23.50	1.08	---	---	---	---

Mode: LTE Band 12

fL (MHz)=704 MHz

fM (MHz)=707.5MHz

fH (MHz)= 711MHz

Limit of SAR (W/kg): <1.6W/kg (1g Average)
0mm with p-sensor on (reduced power for relevant surfaces)

Test case			Meas power (dBm)	Tune-up (dBm)	Scaling factor	Meas SAR(w/kg)		Report SAR(w/kg)	
Mode	Position	Channel				First	Second	First	Second
QPSK 1RB	Back	L	19.66	20.00	1.08	0.863	0.866	0.932	0.935
		M	19.78	20.00	1.05	0.881	0.875	0.925	0.919
		H	19.85	20.00	1.04	0.927	0.919	0.964	0.956
	Front	L	19.66	20.00	1.08	---	---	---	---
		M	19.78	20.00	1.05	0.436	---	0.458	---
		H	19.85	20.00	1.04	---	---	---	---
	Top	L	19.66	20.00	1.08	---	---	---	---
		M	19.78	20.00	1.05	0.422	---	0.443	---
		H	19.85	20.00	1.04	---	---	---	---
	Bottom	L	21.66	22.00	1.08	---	---	---	---
		M	21.78	22.00	1.05	0.675	---	0.709	---
		H	21.85	22.00	1.04	---	---	---	---
	Left	L	19.66	20.00	1.08	---	---	---	---
		M	19.78	20.00	1.05	0.588	---	0.617	---
		H	19.85	20.00	1.04	---	---	---	---
	Right	L	19.66	20.00	1.08	---	---	---	---
		M	19.78	20.00	1.05	0.584	---	0.613	---
		H	19.85	20.00	1.04	---	---	---	---
QPSK 50%RB	Back	L	18.68	19.00	1.08	---	---	---	---
		M	18.59	19.00	1.10	0.687	---	0.756	---
		H	18.79	19.00	1.05	---	---	---	---
	Front	L	18.68	19.00	1.08	---	---	---	---
		M	18.59	19.00	1.10	0.357	---	0.393	---
		H	18.79	19.00	1.05	---	---	---	---
	Top	L	18.68	19.00	1.08	---	---	---	---
		M	18.59	19.00	1.10	0.341	---	0.375	---
		H	18.79	19.00	1.05	---	---	---	---
	Bottom	L	20.68	21.00	1.08	---	---	---	---
		M	20.59	21.00	1.10	0.521	---	0.573	---
		H	20.79	21.00	1.05	---	---	---	---
	Left	L	18.68	19.00	1.08	---	---	---	---
		M	18.59	19.00	1.10	0.461	---	0.507	---
		H	18.79	19.00	1.05	---	---	---	---
	Right	L	18.68	19.00	1.08	---	---	---	---
		M	18.59	19.00	1.10	0.473	---	0.520	---
		H	18.79	19.00	1.05	---	---	---	---
QPSK 100%RB	Back	L	18.63	19.00	1.09	---	---	---	---
		M	18.52	19.00	1.12	0.638	---	0.715	---

	Front	H	18.73	19.00	1.06	---	---	---	---
		L	18.63	19.00	1.09	---	---	---	---
		M	18.52	19.00	1.12	---	---	---	---
	Top	H	18.73	19.00	1.06	---	---	---	---
		L	18.63	19.00	1.09	---	---	---	---
		M	18.52	19.00	1.12	---	---	---	---
	Bottom	H	20.73	21.00	1.06	---	---	---	---
		L	20.63	21.00	1.09	---	---	---	---
		M	20.52	21.00	1.12	---	---	---	---
	Left	H	18.73	19.00	1.06	---	---	---	---
		L	18.63	19.00	1.09	---	---	---	---
		M	18.52	19.00	1.12	---	---	---	---
	Right	H	18.73	19.00	1.06	---	---	---	---
		L	18.63	19.00	1.09	---	---	---	---
		M	18.52	19.00	1.12	---	---	---	---

(Trigger distance-1) mm with p-sensor off (full power for all surfaces)

Test case			Meas power (dBm)	Tune-up (dBm)	Scaling factor	Meas SAR(w/kg)		Report SAR(w/kg)	
Mode	Position	Channel				First	Second	First	Second
QPSK 1RB	Back	L	21.66	22.00	1.08	---	---	---	---
		M	21.78	22.00	1.05	0.141	---	0.148	---
		H	21.85	22.00	1.04	---	---	---	---
	Front	L	21.66	22.00	1.08	---	---	---	---
		M	21.78	22.00	1.05	0.120	---	0.126	---
		H	21.85	22.00	1.04	---	---	---	---
	Top	L	21.66	22.00	1.08	---	---	---	---
		M	21.78	22.00	1.05	0.041	---	0.043	---
		H	21.85	22.00	1.04	---	---	---	---
	Bottom	L	21.66	22.00	1.08	---	---	---	---
		M	21.78	22.00	1.05	---	---	---	---
		H	21.85	22.00	1.04	---	---	---	---
	Left	L	21.66	22.00	1.08	---	---	---	---
		M	21.78	22.00	1.05	0.046	---	0.048	---
		H	21.85	22.00	1.04	---	---	---	---
	Right	L	21.66	22.00	1.08	---	---	---	---
		M	21.78	22.00	1.05	0.088	---	0.092	---
		H	21.85	22.00	1.04	---	---	---	---
QPSK 50%RB	Back	L	20.68	21.00	1.08	---	---	---	---
		M	20.59	21.00	1.10	0.108	---	0.119	---
		H	20.79	21.00	1.05	---	---	---	---
	Front	L	20.68	21.00	1.08	---	---	---	---
		M	20.59	21.00	1.10	0.091	---	---	---
		H	20.79	21.00	1.05	---	---	---	---
	Top	L	20.68	21.00	1.08	---	---	---	---
		M	20.59	21.00	1.10	0.033	---	0.036	---
		H	20.79	21.00	1.05	---	---	---	---
	Bottom	L	20.68	21.00	1.08	---	---	---	---
		M	20.59	21.00	1.10	---	---	---	---
		H	20.79	21.00	1.05	---	---	---	---
	Left	L	20.68	21.00	1.08	---	---	---	---
		M	20.59	21.00	1.10	0.037	---	0.041	---
		H	20.79	21.00	1.05	---	---	---	---
	Right	L	20.68	21.00	1.08	---	---	---	---
		M	20.59	21.00	1.10	0.072	---	0.079	---
		H	21.66	22.00	1.08	---	---	---	---

Mode: LTE Band 13

fL (MHz)=782 MHz fM (MHz)=782MHz fH (MHz)= 782MHz

Limit of SAR (W/kg): <1.6W/kg (1g Average)

0mm with p-sensor on (reduced power for relevant surfaces)

Test case			Meas power (dBm)	Tune-up (dBm)	Scaling factor	Meas SAR(w/kg)		Report SAR(w/kg)	
Mode	Position	Channel				First	Second	First	Second
QPSK 1RB	Back	L	19.87	20.00	1.03		---	---	---
		M	19.87	20.00	1.03	0.416	---	0.428	---
		H	19.87	20.00	1.03	---	---	---	---
	Front	L	19.87	20.00	1.03	---	---	---	---
		M	19.87	20.00	1.03	0.280	---	0.288	---
		H	19.87	20.00	1.03	---	---	---	---
	Top	L	19.87	20.00	1.03	---	---	---	---
		M	19.87	20.00	1.03	0.305	---	0.314	---
		H	19.87	20.00	1.03	---	---	---	---
	Bottom	L	23.87	24.00	1.03	---	---	---	---
		M	23.87	24.00	1.03	0.901	0.887	0.928	0.914
		H	23.87	24.00	1.03	---	---	---	---
	Left	L	19.87	20.00	1.03	---	---	---	---
		M	19.87	20.00	1.03	0.189	---	0.195	---
		H	19.87	20.00	1.03	---	---	---	---
Right	L	19.87	20.00	1.03	---	---	---	---	
	M	19.87	20.00	1.03	0.731	---	0.753	---	
	H	19.87	20.00	1.03	---	---	---	---	
QPSK 50%RB	Back	L	18.76	19.00	1.06	---	---	---	---
		M	18.76	19.00	1.06	0.337	---	0.357	---
		H	18.76	19.00	1.06	---	---	---	---
	Front	L	18.76	19.00	1.06	---	---	---	---
		M	18.76	19.00	1.06	0.228	---	0.242	---
		H	18.76	19.00	1.06	---	---	---	---
	Top	L	18.76	19.00	1.06	---	---	---	---
		M	18.76	19.00	1.06	0.237	---	0.251	---
		H	18.76	19.00	1.06	---	---	---	---
	Bottom	L	22.76	23.00	1.06	---	---	---	---
		M	22.76	23.00	1.06	0.712	---	0.755	---
		H	22.76	23.00	1.06	---	---	---	---
	Left	L	18.76	19.00	1.06	---	---	---	---
		M	18.76	19.00	1.06	0.138	---	0.146	---
		H	18.76	19.00	1.06	---	---	---	---
Right	L	18.76	19.00	1.06	---	---	---	---	
	M	18.76	19.00	1.06	---	---	---	---	
	H	18.76	19.00	1.06	---	---	---	---	

QPSK 100%RB	Back	L	18.73	19.00	1.06	---	---	---	---
		M	18.73	19.00	1.06	---	---	---	---
		H	18.73	19.00	1.06	---	---	---	---
	Front	L	18.73	19.00	1.06	---	---	---	---
		M	18.73	19.00	1.06	---	---	---	---
		H	18.73	19.00	1.06	---	---	---	---
	Top	L	18.73	19.00	1.06	---	---	---	---
		M	18.73	19.00	1.06	0.714	---	0.757	---
		H	18.73	19.00	1.06	---	---	---	---
	Bottom	L	22.73	23.00	1.06	---	---	---	---
		M	22.73	23.00	1.06	---	---	---	---
		H	22.73	23.00	1.06	---	---	---	---
	Left	L	18.73	19.00	1.06	---	---	---	---
		M	18.73	19.00	1.06	---	---	---	---
		H	18.73	19.00	1.06	---	---	---	---
	Right	L	18.73	19.00	1.06	---	---	---	---
		M	18.73	19.00	1.06	---	---	---	---
		H	18.73	19.00	1.06	---	---	---	---

(Trigger distance-1) mm with p-sensor off (full power for all surfaces)

Test case			Meas power (dBm)	Tune-up (dBm)	Scaling factor	Meas SAR(w/kg)		Report SAR(w/kg)	
Mode	Position	Channel				First	Second	First	Second
QPSK 1RB	Back	L	23.87	24.00	1.03	---	---	---	---
		M	23.87	24.00	1.03	0.112	---	0.115	---
		H	23.87	24.00	1.03	---	---	---	---
	Front	L	23.87	24.00	1.03	---	---	---	---
		M	23.87	24.00	1.03	0.101	---	---	---
		H	23.87	24.00	1.03	---	---	---	---
	Top	L	23.87	24.00	1.03	---	---	---	---
		M	23.87	24.00	1.03	0.072	---	0.074	---
		H	23.87	24.00	1.03	---	---	---	---
	Bottom	L	23.87	24.00	1.03	---	---	---	---
		M	23.87	24.00	1.03	---	---	---	---
		H	23.87	24.00	1.03	---	---	---	---
	Left	L	23.87	24.00	1.03	---	---	---	---
		M	23.87	24.00	1.03	0.153	---	0.158	---
		H	23.87	24.00	1.03	---	---	---	---
	Right	L	23.87	24.00	1.03	---	---	---	---
		M	23.87	24.00	1.03	0.075	---	0.077	---
		H	23.87	24.00	1.03	---	---	---	---
QPSK 50%RB	Back	L	22.76	23.00	1.06	---	---	---	---
		M	22.76	23.00	1.06	0.089	---	0.094	---
		H	22.76	23.00	1.06	---	---	---	---
	Front	L	22.76	23.00	1.06	---	---	---	---
		M	22.76	23.00	1.06	0.077	---	---	---
		H	22.76	23.00	1.06	---	---	---	---
	Top	L	22.76	23.00	1.06	---	---	---	---
		M	22.76	23.00	1.06	0.058	---	0.061	---
		H	22.76	23.00	1.06	---	---	---	---
	Bottom	L	22.76	23.00	1.06	---	---	---	---
		M	22.76	23.00	1.06	---	---	---	---
		H	22.76	23.00	1.06	---	---	---	---
	Left	L	22.76	23.00	1.06	---	---	---	---
		M	22.76	23.00	1.06	0.121	---	0.128	---
		H	22.76	23.00	1.06	---	---	---	---
	Right	L	22.76	23.00	1.06	---	---	---	---
		M	22.76	23.00	1.06	0.061	---	0.065	---
		H	22.76	23.00	1.06	---	---	---	---

Mode: LTE Band 25

fL (MHz)=1860 MHz fM (MHz)=1882.5MHz fH (MHz)= 1905MHz

Limit of SAR (W/kg): <1.6W/kg (1g Average)

0mm with p-sensor on (reduced power for relevant surfaces)

Test case			Meas power (dBm)	Tune-up (dBm)	Scaling factor	Meas SAR(w/kg)		Report SAR(w/kg)	
Mode	Position	Channel				First	Second	First	Second
QPSK 1RB	Back	L	14.37	14.50	1.03	---	---	---	---
		M	14.33	14.50	1.04	0.428	---	0.445	---
		H	14.40	14.50	1.02	---	---	---	---
	Front	L	14.37	14.50	1.03	---	---	---	---
		M	14.33	14.50	1.04	0.421	---	0.438	---
		H	14.40	14.50	1.02	---	---	---	---
	Top	L	14.37	14.50	1.03	---	---	---	---
		M	14.33	14.50	1.04	0.711	---	0.739	---
		H	14.40	14.50	1.02	---	---	---	---
	Bottom	L	21.37	21.50	1.03	0.787	0.779	0.811	0.802
		M	21.33	21.50	1.04	0.773	0.762	0.804	0.792
		H	21.40	21.50	1.02	0.804	0.791	0.820	0.807
	Left	L	14.37	14.50	1.03	---	---	---	---
		M	14.33	14.50	1.04	0.279	---	0.290	---
		H	14.40	14.50	1.02	---	---	---	---
	Right	L	14.37	14.50	1.03	---	---	---	---
		M	14.33	14.50	1.04	0.115	---	0.120	---
		H	14.40	14.50	1.02	---	---	---	---
QPSK 50%RB	Back	L	13.32	13.50	1.04	---	---	---	---
		M	13.37	13.50	1.03	0.338	---	0.348	---
		H	13.38	13.50	1.03	---	---	---	---
	Front	L	13.32	13.50	1.04	---	---	---	---
		M	13.37	13.50	1.03	0.321	---	0.331	---
		H	13.38	13.50	1.03	---	---	---	---
	Top	L	13.32	13.50	1.04	---	---	---	---
		M	13.37	13.50	1.03	0.572	---	0.589	---
		H	13.38	13.50	1.03	---	---	---	---
	Bottom	L	20.32	20.50	1.04	---	---	---	---
		M	20.37	20.50	1.03	0.667	---	0.687	---
		H	20.38	20.50	1.03	---	---	---	---
	Left	L	13.32	13.50	1.04	---	---	---	---
		M	13.37	13.50	1.03	0.209	---	0.215	---
		H	13.38	13.50	1.03	---	---	---	---
	Right	L	13.32	13.50	1.04	---	---	---	---
		M	13.37	13.50	1.03	0.081	---	0.083	---
		H	13.38	13.50	1.03	---	---	---	---

QPSK 100%RB	Back	L	13.26	13.50	1.06	---	---	---	---
		M	13.31	13.50	1.04	---	---	---	---
		H	13.36	13.50	1.03	---	---	---	---
	Front	L	13.26	13.50	1.06	---	---	---	---
		M	13.31	13.50	1.04	---	---	---	---
		H	13.36	13.50	1.03	---	---	---	---
	Top	L	13.26	13.50	1.06	---	---	---	---
		M	13.31	13.50	1.04	---	---	---	---
		H	13.36	13.50	1.03	---	---	---	---
	Bottom	L	20.26	20.50	1.06	---	---	---	---
		M	20.31	20.50	1.04	0.648	---	0.674	---
		H	20.36	20.50	1.03	---	---	---	---
	Left	L	13.26	13.50	1.06	---	---	---	---
		M	13.31	13.50	1.04	---	---	---	---
		H	13.36	13.50	1.03	---	---	---	---
	Right	L	13.26	13.50	1.06	---	---	---	---
		M	13.31	13.50	1.04	---	---	---	---
		H	13.36	13.50	1.03	---	---	---	---

(Trigger distance-1) mm with p-sensor off (full power for all surfaces)

Test case			Meas power (dBm)	Tune-up (dBm)	Scaling factor	Meas SAR(w/kg)		Report SAR(w/kg)	
Mode	Position	Channel				First	Second	First	Second
QPSK 1RB	Back	L	21.37	21.50	1.03	---	---	---	---
		M	21.33	21.50	1.04	0.638	---	0.664	---
		H	21.40	21.50	1.02	---	---	---	---
	Front	L	21.37	21.50	1.03	---	---	---	---
		M	21.33	21.50	1.04	0.597	---	0.621	---
		H	21.40	21.50	1.02	---	---	---	---
	Top	L	21.37	21.50	1.03	---	---	---	---
		M	21.33	21.50	1.04	0.712	---	0.740	---
		H	21.40	21.50	1.02	---	---	---	---
	Bottom	L	21.37	21.50	1.03	---	---	---	---
		M	21.33	21.50	1.04	---	---	---	---
		H	21.40	21.50	1.02	---	---	---	---
	Left	L	21.37	21.50	1.03	---	---	---	---
		M	21.33	21.50	1.04	0.372	---	0.387	---
		H	21.40	21.50	1.02	---	---	---	---
	Right	L	21.37	21.50	1.03	---	---	---	---
		M	21.33	21.50	1.04	0.062	---	0.064	---
		H	21.40	21.50	1.02	---	---	---	---
QPSK 50%RB	Back	L	20.32	20.50	1.04	---	---	---	---
		M	20.37	20.50	1.03	0.511	---	0.526	---
		H	20.38	20.50	1.03	---	---	---	---
	Front	L	20.32	20.50	1.04	---	---	---	---
		M	20.37	20.50	1.03	0.488	---	0.503	---
		H	20.38	20.50	1.03	---	---	---	---
	Top	L	20.32	20.50	1.04	---	---	---	---
		M	20.37	20.50	1.03	0.535	---	0.551	---
		H	20.38	20.50	1.03	---	---	---	---
	Bottom	L	20.32	20.50	1.04	---	---	---	---
		M	20.37	20.50	1.03	---	---	---	---
		H	20.38	20.50	1.03	---	---	---	---
	Left	L	20.32	20.50	1.04	---	---	---	---
		M	20.37	20.50	1.03	0.289	---	0.298	---
		H	20.38	20.50	1.03	---	---	---	---
	Right	L	20.32	20.50	1.04	---	---	---	---
		M	20.37	20.50	1.03	0.046	---	0.047	---
		H	20.38	20.50	1.03	---	---	---	---

Mode: LTE Band 26

fL (MHz)=821.5 MHz fM (MHz)=831.5MHz fH (MHz)= 841.5MHz

Limit of SAR (W/kg): <1.6W/kg (1g Average)

0mm with p-sensor on (reduced power for relevant surfaces)

Test case			Meas power (dBm)	Tune-up (dBm)	Scaling factor	Meas SAR(w/kg)		Report SAR(w/kg)	
Mode	Position	Channel				First	Second	First	Second
QPSK 1RB	Back	L	18.63	19.00	1.09	---	---	---	---
		M	18.55	19.00	1.11	0.195	---	0.216	---
		H	18.52	19.00	1.12	---	---	---	---
	Front	L	18.63	19.00	1.09	---	---	---	---
		M	18.55	19.00	1.11	0.286	---	0.317	---
		H	18.52	19.00	1.12	---	---	---	---
	Top	L	18.63	19.00	1.09	---	---	---	---
		M	18.55	19.00	1.11	0.451	---	0.501	---
		H	18.52	19.00	1.12	---	---	---	---
	Bottom	L	23.63	24.00	1.09	0.711	0.715	0.775	0.779
		M	23.55	24.00	1.11	0.785	0.769	0.871	0.854
		H	23.52	24.00	1.12	0.736	0.728	0.824	0.815
	Left	L	18.63	19.00	1.09	---	---	---	---
		M	18.55	19.00	1.11	0.272	---	0.302	---
		H	18.52	19.00	1.12	---	---	---	---
	Right	L	18.63	19.00	1.09	---	---	---	---
		M	18.55	19.00	1.11	0.611	---	0.678	---
		H	18.52	19.00	1.12	---	---	---	---
QPSK 50%RB	Back	L	17.56	18.00	1.11	---	---	---	---
		M	17.41	18.00	1.15	0.148	---	0.170	---
		H	17.58	18.00	1.10	---	---	---	---
	Front	L	17.56	18.00	1.11	---	---	---	---
		M	17.41	18.00	1.15	0.223	---	0.256	---
		H	17.58	18.00	1.10	---	---	---	---
	Top	L	17.56	18.00	1.11	---	---	---	---
		M	17.41	18.00	1.15	0.367	---	0.422	---
		H	17.58	18.00	1.10	---	---	---	---
	Bottom	L	22.56	23.00	1.11	---	---	---	---
		M	22.41	23.00	1.15	0.679	---	0.781	---
		H	22.58	23.00	1.10	---	---	---	---
	Left	L	17.56	18.00	1.11	---	---	---	---
		M	17.41	18.00	1.15	0.211	---	0.243	---
		H	17.58	18.00	1.10	---	---	---	---
	Right	L	17.56	18.00	1.11	---	---	---	---
		M	17.41	18.00	1.15	0.487	---	0.560	---
		H	17.58	18.00	1.10	---	---	---	---

QPSK 100%RB	Back	L	17.41	18.00	1.15	---	---	---	---
		M	17.44	18.00	1.14	---	---	---	---
		H	17.44	18.00	1.14	---	---	---	---
	Front	L	17.41	18.00	1.15	---	---	---	---
		M	17.44	18.00	1.14	---	---	---	---
		H	17.44	18.00	1.14	---	---	---	---
	Top	L	17.41	18.00	1.15	---	---	---	---
		M	17.44	18.00	1.14	---	---	---	---
		H	17.44	18.00	1.14	---	---	---	---
	Bottom	L	22.41	23.00	1.15	---	---	---	---
		M	22.44	23.00	1.14	0.658	---	0.750	---
		H	22.44	23.00	1.14	---	---	---	---
	Left	L	17.41	18.00	1.15	---	---	---	---
		M	17.44	18.00	1.14	---	---	---	---
		H	17.44	18.00	1.14	---	---	---	---
	Right	L	17.41	18.00	1.15	---	---	---	---
		M	17.44	18.00	1.14	---	---	---	---
		H	17.44	18.00	1.14	---	---	---	---

(Trigger distance-1) mm with p-sensor off (full power for all surfaces)

Test case			Meas power (dBm)	Tune-up (dBm)	Scaling factor	Meas SAR(w/kg)		Report SAR(w/kg)	
Mode	Position	Channel				First	Second	First	Second
QPSK 1RB	Back	L	23.63	24.00	1.09	---	---	---	---
		M	23.55	24.00	1.11	0.240	---	0.266	---
		H	23.52	24.00	1.12	---	---	---	---
	Front	L	23.63	24.00	1.09	---	---	---	---
		M	23.55	24.00	1.11	0.212	---	0.235	---
		H	23.52	24.00	1.12	---	---	---	---
	Top	L	23.63	24.00	1.09	---	---	---	---
		M	23.55	24.00	1.11	0.143	---	0.159	---
		H	23.52	24.00	1.12	---	---	---	---
	Bottom	L	23.63	24.00	1.09	---	---	---	---
		M	23.55	24.00	1.11	---	---	---	---
		H	23.52	24.00	1.12	---	---	---	---
	Left	L	23.63	24.00	1.09	---	---	---	---
		M	23.55	24.00	1.11	0.196	---	0.218	---
		H	23.52	24.00	1.12	---	---	---	---
	Right	L	23.63	24.00	1.09	---	---	---	---
		M	23.55	24.00	1.11	0.114	---	0.127	---
		H	23.52	24.00	1.12	---	---	---	---
QPSK 50%RB	Back	L	22.56	23.00	1.11	---	---	---	---
		M	22.41	23.00	1.15	0.192	---	0.221	---
		H	22.58	23.00	1.10	---	---	---	---
	Front	L	22.56	23.00	1.11	---	---	---	---
		M	22.41	23.00	1.15	0.166	---	0.191	---
		H	22.58	23.00	1.10	---	---	---	---
	Top	L	22.56	23.00	1.11	---	---	---	---
		M	22.41	23.00	1.15	0.118	---	0.136	---
		H	22.58	23.00	1.10	---	---	---	---
	Bottom	L	22.56	23.00	1.11	---	---	---	---
		M	22.41	23.00	1.15	---	---	---	---
		H	22.58	23.00	1.10	---	---	---	---
	Left	L	22.56	23.00	1.11	---	---	---	---
		M	22.41	23.00	1.15	0.144	---	0.166	---
		H	22.58	23.00	1.10	---	---	---	---
	Right	L	22.56	23.00	1.11	---	---	---	---
		M	22.41	23.00	1.15	0.089	---	0.102	---
		H	22.58	23.00	1.10	---	---	---	---

Mode: LTE Band 41

fL (MHz)=2506 MHz fM (MHz)=2593MHz fH (MHz)=2680MHz

Limit of SAR (W/kg): <1.6W/kg (1g Average)

0mm with p-sensor on (reduced power for relevant surfaces)

Test case			Meas power (dBm)	Tune-up (dBm)	Scaling factor	Meas SAR(w/kg)		Report SAR(w/kg)	
Mode	Position	Channel				First	Second	First	Second
QPSK 1RB	Back	L	19.11	19.50	1.09	---	---	---	---
		M	18.95	19.50	1.14	0.432	---	0.492	---
		H	18.85	19.50	1.16	---	---	---	---
	Front	L	19.11	19.50	1.09	---	---	---	---
		M	18.95	19.50	1.14	0.634	---	0.723	---
		H	18.85	19.50	1.16	---	---	---	---
	Top	L	19.11	19.50	1.09	---	---	---	---
		M	18.95	19.50	1.14	0.618	---	0.705	---
		H	18.85	19.50	1.16	---	---	---	---
	Bottom	L	24.11	24.50	1.09	---	---	---	---
		M	23.95	24.50	1.14	0.311	---	0.355	---
		H	23.85	24.50	1.16	---	---	---	---
Left	L	19.11	19.50	1.09	0.721	0.730	0.786	0.796	
	M	18.95	19.50	1.14	0.766	0.757	0.873	0.863	
	H	18.85	19.50	1.16	0.711	0.718	0.825	0.833	
Right	L	19.11	19.50	1.09	---	---	---	---	
	M	18.95	19.50	1.14	0.044	---	0.050	---	
	H	18.85	19.50	1.16	---	---	---	---	
QPSK 50%RB	Back	L	18.17	18.50	1.08	---	---	---	---
		M	17.95	18.50	1.14	0.347	---	0.396	---
		H	17.89	18.50	1.15	---	---	---	---
	Front	L	18.17	18.50	1.08	---	---	---	---
		M	17.95	18.50	1.14	0.510	---	---	---
		H	17.89	18.50	1.15	---	---	---	---
	Top	L	18.17	18.50	1.08	---	---	---	---
		M	17.95	18.50	1.14	0.489	---	0.557	---
		H	17.89	18.50	1.15	---	---	---	---
	Bottom	L	23.17	23.50	1.08	---	---	---	---
		M	22.95	23.50	1.14	0.243	---	0.277	---
		H	22.89	23.50	1.15	---	---	---	---
Left	L	18.17	18.50	1.08	---	---	---	---	
	M	17.95	18.50	1.14	0.648	---	0.739	---	
	H	17.89	18.50	1.15	---	---	---	---	
Right	L	18.17	18.50	1.08	---	---	---	---	
	M	17.95	18.50	1.14	0.031	---	0.035	---	
	H	17.89	18.50	1.15	---	---	---	---	

QPSK 100%RB	Back	L	18.12	18.50	1.09	---	---	---	---
		M	17.92	18.50	1.14	---	---	---	---
		H	17.84	18.50	1.16	---	---	---	---
	Front	L	18.12	18.50	1.09	---	---	---	---
		M	17.92	18.50	1.14	---	---	---	---
		H	17.84	18.50	1.16	---	---	---	---
	Top	L	18.12	18.50	1.09	---	---	---	---
		M	17.92	18.50	1.14	---	---	---	---
		H	17.84	18.50	1.16	---	---	---	---
	Bottom	L	23.12	23.50	1.09	---	---	---	---
		M	22.92	23.50	1.14	0.621	---	0.708	---
		H	22.84	23.50	1.16	---	---	---	---
	Left	L	18.12	18.50	1.09	---	---	---	---
		M	17.92	18.50	1.14	---	---	---	---
		H	17.84	18.50	1.16	---	---	---	---
	Right	L	18.12	18.50	1.09	---	---	---	---
		M	17.92	18.50	1.14	---	---	---	---
		H	17.84	18.50	1.16	---	---	---	---

(Trigger distance-1) mm with p-sensor off (full power for all surfaces)

Test case			Meas power (dBm)	Tune-up (dBm)	Scaling factor	Meas SAR(w/kg)		Report SAR(w/kg)	
Mode	Position	Channel				First	Second	First	Second
QPSK 1RB	Back	L	24.11	24.50	1.09	---	---	---	---
		M	23.95	24.50	1.14	0.111	---	0.127	---
		H	23.85	24.50	1.16	---	---	---	---
	Front	L	24.11	24.50	1.09	---	---	---	---
		M	23.95	24.50	1.14	0.134	---	0.153	---
		H	23.85	24.50	1.16	---	---	---	---
	Top	L	24.11	24.50	1.09	---	---	---	---
		M	23.95	24.50	1.14	0.123	---	0.140	---
		H	23.85	24.50	1.16	---	---	---	---
	Bottom	L	24.11	24.50	1.09	---	---	---	---
		M	23.95	24.50	1.14	---	---	---	---
		H	23.85	24.50	1.16	---	---	---	---
	Left	L	24.11	24.50	1.09	---	---	---	---
		M	23.95	24.50	1.14	0.152	---	0.173	---
		H	23.85	24.50	1.16	---	---	---	---
	Right	L	24.11	24.50	1.09	---	---	---	---
		M	23.95	24.50	1.14	0.005	---	0.006	---
		H	23.85	24.50	1.16	---	---	---	---
QPSK 50%RB	Back	L	23.17	23.50	1.08	---	---	---	---
		M	22.95	23.50	1.14	0.083	---	0.095	---
		H	22.89	23.50	1.15	---	---	---	---
	Front	L	23.17	23.50	1.08	---	---	---	---
		M	22.95	23.50	1.14	0.114	---	---	---
		H	22.89	23.50	1.15	---	---	---	---
	Top	L	23.17	23.50	1.08	---	---	---	---
		M	22.95	23.50	1.14	0.101	---	0.115	---
		H	22.89	23.50	1.15	---	---	---	---
	Bottom	L	23.17	23.50	1.08	---	---	---	---
		M	22.95	23.50	1.14	---	---	---	---
		H	22.89	23.50	1.15	---	---	---	---
	Left	L	23.17	23.50	1.08	---	---	---	---
		M	22.95	23.50	1.14	0.122	---	0.139	---
		H	22.89	23.50	1.15	---	---	---	---
	Right	L	23.17	23.50	1.08	---	---	---	---
		M	22.95	23.50	1.14	0.002	---	0.002	---
		H	22.89	23.50	1.15	---	---	---	---

Mode: LTE Band 66

fL (MHz)=1720 MHz

fM (MHz)=1745MHz

fH (MHz)=1770MHz

Limit of SAR (W/kg): <1.6W/kg (1g Average)

0mm with p-sensor on (reduced power for relevant surfaces)

Test case			Meas power (dBm)	Tune-up (dBm)	Scaling factor	Meas SAR(w/kg)		Report SAR(w/kg)	
Mode	Position	Channel				First	Second	First	Second
QPSK 1RB	Back	L	15.12	15.50	1.09	---	---	---	---
		M	15.27	15.50	1.05	0.681	---	0.715	---
		H	14.77	15.50	1.18	---	---	---	---
	Front	L	15.12	15.50	1.09	---	---	---	---
		M	15.27	15.50	1.05	0.596	---	0.626	---
		H	14.77	15.50	1.18	---	---	---	---
	Top	L	15.12	15.50	1.09	0.757	0.749	0.825	0.816
		M	15.27	15.50	1.05	0.811	0.803	0.852	0.843
		H	14.77	15.50	1.18	0.731	0.723	0.863	0.853
	Bottom	L	24.12	24.50	1.09	---	---	---	---
		M	24.27	24.50	1.05	0.516	---	0.542	---
		H	23.77	24.50	1.18	---	---	---	---
	Left	L	15.12	15.50	1.09	---	---	---	---
		M	15.27	15.50	1.05	0.404	---	0.424	---
		H	14.77	15.50	1.18	---	---	---	---
Right	L	15.12	15.50	1.09	---	---	---	---	
	M	15.27	15.50	1.05	0.178	---	0.187	---	
	H	14.77	15.50	1.18	---	---	---	---	
QPSK 50%RB	Back	L	13.98	14.50	1.13	---	---	---	---
		M	14.13	14.50	1.09	0.551	---	0.601	---
		H	13.88	14.50	1.15	---	---	---	---
	Front	L	13.98	14.50	1.13	---	---	---	---
		M	14.13	14.50	1.09	0.479	---	---	---
		H	13.88	14.50	1.15	---	---	---	---
	Top	L	13.98	14.50	1.13	---	---	---	---
		M	14.13	14.50	1.09	0.688	---	0.750	---
		H	13.88	14.50	1.15	---	---	---	---
	Bottom	L	22.98	23.50	1.13	---	---	---	---
		M	23.13	23.50	1.09	0.423	---	0.461	---
		H	22.88	23.50	1.15	---	---	---	---
	Left	L	13.98	14.50	1.13	---	---	---	---
		M	14.13	14.50	1.09	0.312	---	0.340	---
		H	13.88	14.50	1.15	---	---	---	---
Right	L	13.98	14.50	1.13	---	---	---	---	
	M	14.13	14.50	1.09	0.129	---	0.141	---	
	H	13.88	14.50	1.15	---	---	---	---	

QPSK 100%RB	Back	L	13.92	14.50	1.14	---	---	---	---
		M	14.11	14.50	1.09	---	---	---	---
		H	13.83	14.50	1.17	---	---	---	---
	Front	L	13.92	14.50	1.14	---	---	---	---
		M	14.11	14.50	1.09	---	---	---	---
		H	13.83	14.50	1.17	---	---	---	---
	Top	L	13.92	14.50	1.14	---	---	---	---
		M	14.11	14.50	1.09	---	---	---	---
		H	13.83	14.50	1.17	---	---	---	---
	Bottom	L	22.92	23.50	1.14	---	---	---	---
		M	23.11	23.50	1.09	0.664	---	0.724	---
		H	22.83	23.50	1.17	---	---	---	---
	Left	L	13.92	14.50	1.14	---	---	---	---
		M	14.11	14.50	1.09	---	---	---	---
		H	13.83	14.50	1.17	---	---	---	---
	Right	L	13.92	14.50	1.14	---	---	---	---
		M	14.11	14.50	1.09	---	---	---	---
		H	13.83	14.50	1.17	---	---	---	---

(Trigger distance-1) mm with p-sensor off (full power for all surfaces)

Test case			Meas power (dBm)	Tune-up (dBm)	Scaling factor	Meas SAR(w/kg)		Report SAR(w/kg)	
Mode	Position	Channel				First	Second	First	Second
QPSK 1RB	Back	L	24.12	24.50	1.09	---	---	---	---
		M	24.27	24.50	1.05	0.640	---	0.672	---
		H	23.77	24.50	1.18	---	---	---	---
	Front	L	24.12	24.50	1.09	---	---	---	---
		M	24.27	24.50	1.05	0.463	---	0.486	---
		H	23.77	24.50	1.18	---	---	---	---
	Top	L	24.12	24.50	1.09	0.834	0.823	0.909	0.897
		M	24.27	24.50	1.05	0.874	0.866	0.918	0.909
		H	23.77	24.50	1.18	0.771	0.766	0.910	0.904
	Bottom	L	24.12	24.50	1.09	---	---	---	---
		M	24.27	24.50	1.05	---	---	---	---
		H	23.77	24.50	1.18	---	---	---	---
	Left	L	24.12	24.50	1.09	---	---	---	---
		M	24.27	24.50	1.05	0.269	---	0.282	---
		H	23.77	24.50	1.18	---	---	---	---
Right	L	24.12	24.50	1.09	---	---	---	---	
	M	24.27	24.50	1.05	0.099	---	0.104	---	
	H	23.77	24.50	1.18	---	---	---	---	
QPSK 50%RB	Back	L	22.98	23.50	1.13	---	---	---	---
		M	23.13	23.50	1.09	0.511	---	0.557	---
		H	22.88	23.50	1.15	---	---	---	---
	Front	L	22.98	23.50	1.13	---	---	---	---
		M	23.13	23.50	1.09	0.357	---	---	---
		H	22.88	23.50	1.15	---	---	---	---
	Top	L	22.98	23.50	1.13	---	---	---	---
		M	23.13	23.50	1.09	0.692	---	0.754	---
		H	22.88	23.50	1.15	---	---	---	---
	Bottom	L	22.98	23.50	1.13	---	---	---	---
		M	23.13	23.50	1.09	---	---	---	---
		H	22.88	23.50	1.15	---	---	---	---
	Left	L	22.98	23.50	1.13	---	---	---	---
		M	23.13	23.50	1.09	0.205	---	0.223	---
		H	22.88	23.50	1.15	---	---	---	---
Right	L	22.98	23.50	1.13	---	---	---	---	
	M	23.13	23.50	1.09	0.079	---	0.086	---	
	H	22.88	23.50	1.15	---	---	---	---	
QPSK	Back	L	22.92	23.50	1.14	---	---	---	---

100%RB		M	23.11	23.50	1.09	---	---	---	---	
		H	22.83	23.50	1.17	---	---	---	---	
	Front	L	22.92	23.50	1.14	---	---	---	---	
		M	23.11	23.50	1.09	---	---	---	---	
	Top	H	22.83	23.50	1.17	---	---	---	---	
		L	22.92	23.50	1.14	---	---	---	---	
		M	23.11	23.50	1.09	0.673	---	0.734	---	
	Bottom	H	22.83	23.50	1.17	---	---	---	---	
		L	22.92	23.50	1.14	---	---	---	---	
		M	23.11	23.50	1.09	---	---	---	---	
	Left	H	22.83	23.50	1.17	---	---	---	---	
		L	22.92	23.50	1.14	---	---	---	---	
		M	23.11	23.50	1.09	---	---	---	---	
	Right	H	22.83	23.50	1.17	---	---	---	---	
		L	22.92	23.50	1.14	---	---	---	---	
		M	23.11	23.50	1.09	---	---	---	---	
			H	22.83	23.50	1.17	---	---	---	---

Mode: LTE Band 71

fL (MHz)=673 MHz fM (MHz)=683MHz fH (MHz)=688MHz

Limit of SAR (W/kg): <1.6W/kg (1g Average)

0mm with p-sensor on (reduced power for relevant surfaces)

Test case			Meas power (dBm)	Tune-up (dBm)	Scaling factor	Meas SAR(w/kg)		Report SAR(w/kg)	
Mode	Position	Channel				First	Second	First	Second
QPSK 1RB	Back	L	19.95	20.50	1.14	---	---	---	---
		M	20.11	20.50	1.09	0.554	---	0.604	---
		H	20.06	20.50	1.11	---	---	---	---
	Front	L	19.95	20.50	1.14	---	---	---	---
		M	20.11	20.50	1.09	0.327	---	0.356	---
		H	20.06	20.50	1.11	---	---	---	---
	Top	L	19.95	20.50	1.14	---	---	---	---
		M	20.11	20.50	1.09	0.494	---	0.538	---
		H	20.06	20.50	1.11	---	---	---	---
	Bottom	L	23.95	24.50	1.14	0.828	0.819	0.944	0.934
		M	24.11	24.50	1.09	0.872	0.865	0.950	0.943
		Bottom H	24.06	24.50	1.11	0.853	0.846	0.947	0.939
	Left	L	19.95	20.50	1.14	---	---	---	---
		M	20.11	20.50	1.09	0.309	---	0.337	---
		H	20.06	20.50	1.11	---	---	---	---
	Right	L	19.95	20.50	1.14	---	---	---	---
		M	20.11	20.50	1.09	0.582	---	0.634	---
		H	20.06	20.50	1.11	---	---	---	---
QPSK 50%RB	Back	L	19.07	19.50	1.10	---	---	---	---
		M	19.23	19.50	1.06	0.457	---	0.484	---
		H	19.19	19.50	1.07	---	---	---	---
	Front	L	19.07	19.50	1.10	---	---	---	---
		M	19.23	19.50	1.06	0.279	---	---	---
		H	19.19	19.50	1.07	---	---	---	---
	Top	L	19.07	19.50	1.10	---	---	---	---
		M	19.23	19.50	1.06	0.387	---	0.410	---
		H	19.19	19.50	1.07	---	---	---	---
	Bottom	L	23.07	23.50	1.10	---	---	---	---
		M	23.23	23.50	1.06	0.726	---	0.770	---
		H	23.19	23.50	1.07	---	---	---	---
	Left	L	19.07	19.50	1.10	---	---	---	---
		M	19.23	19.50	1.06	0.257	---	0.272	---
		H	19.19	19.50	1.07	---	---	---	---
	Right	L	19.07	19.50	1.10	---	---	---	---
		M	19.23	19.50	1.06	0.468	---	0.496	---

QPSK 100%RB	Back	H	19.19	19.50	1.07	---	---	---	---
		L	19.01	19.50	1.12	---	---	---	---
		M	19.16	19.50	1.08	---	---	---	---
	Front	H	19.11	19.50	1.09	---	---	---	---
		L	19.01	19.50	1.12	---	---	---	---
		M	19.16	19.50	1.08	---	---	---	---
	Top	H	19.11	19.50	1.09	---	---	---	---
		L	19.01	19.50	1.12	---	---	---	---
		M	19.16	19.50	1.08	---	---	---	---
	Bottom	L	23.01	23.50	1.12	---	---	---	---
		M	23.16	23.50	1.08	0.710	---	0.767	---
		H	23.11	23.50	1.09	---	---	---	---
	Left	L	19.01	19.50	1.12	---	---	---	---
		M	19.16	19.50	1.08	---	---	---	---
		H	19.11	19.50	1.09	---	---	---	---
	Right	L	19.01	19.50	1.12	---	---	---	---
		M	19.16	19.50	1.08	---	---	---	---
		H	19.11	19.50	1.09	---	---	---	---

Secondary test : Improved model measurement results

Test case			Meas power (dBm)	Tune-up (dBm)	Scaling factor	Meas SAR(w/kg)		Report SAR(w/kg)	
Mode	Position	Channel				First	Second	First	Second
QPSK 1RB	Back	L	19.95	20.50	1.14	---	---	---	---
		M	20.11	20.50	1.09	0.554	---	0.604	---
		H	20.06	20.50	1.11	---	---	---	---
	Front	L	19.95	20.50	1.14	---	---	---	---
		M	20.11	20.50	1.09	0.327	---	0.356	---
		H	20.06	20.50	1.11	---	---	---	---
	Top	L	19.95	20.50	1.14	---	---	---	---
		M	20.11	20.50	1.09	0.494	---	0.538	---
		H	20.06	20.50	1.11	---	---	---	---
	Bottom	L	23.95	24.50	1.14	---	---	---	---
		M	24.11	24.50	1.09	0.342	---	0.373	---
		H	24.06	24.50	1.11	---	---	---	---
	Left	L	19.95	20.50	1.14	---	---	---	---
		M	20.11	20.50	1.09	0.309	---	0.337	---
		H	20.06	20.50	1.11	---	---	---	---
Right	L	19.95	20.50	1.14	---	---	---	---	
	M	20.11	20.50	1.09	0.582	---	0.634	---	
	H	20.06	20.50	1.11	---	---	---	---	
QPSK	Back	L	19.07	19.50	1.10	---	---	---	---

50%RB		M	19.23	19.50	1.06	0.457	---	0.484	---
		H	19.19	19.50	1.07	---	---	---	---
	Front	L	19.07	19.50	1.10	---	---	---	---
		M	19.23	19.50	1.06	0.279	---	---	---
	Top	H	19.19	19.50	1.07	---	---	---	---
		L	19.07	19.50	1.10	---	---	---	---
		M	19.23	19.50	1.06	0.387	---	0.410	---
	Bottom	H	19.19	19.50	1.07	---	---	---	---
		L	23.07	23.50	1.10	---	---	---	---
		M	23.23	23.50	1.06	0.726	---	0.770	---
	Left	H	23.19	23.50	1.07	---	---	---	---
		L	19.07	19.50	1.10	---	---	---	---
		M	19.23	19.50	1.06	0.257	---	0.272	---
	Right	H	19.19	19.50	1.07	---	---	---	---
		L	19.07	19.50	1.10	---	---	---	---
M		19.23	19.50	1.06	0.468	---	0.496	---	
QPSK 100%RB	Back	H	19.19	19.50	1.07	---	---	---	---
		L	19.01	19.50	1.12	---	---	---	---
		M	19.16	19.50	1.08	---	---	---	---
	Front	H	19.11	19.50	1.09	---	---	---	---
		L	19.01	19.50	1.12	---	---	---	---
		M	19.16	19.50	1.08	---	---	---	---
	Top	H	19.11	19.50	1.09	---	---	---	---
		L	19.01	19.50	1.12	---	---	---	---
		M	19.16	19.50	1.08	---	---	---	---
	Bottom	H	23.11	23.50	1.09	---	---	---	---
		L	23.01	23.50	1.12	---	---	---	---
		M	23.16	23.50	1.08	0.710	---	0.767	---
	Left	H	19.11	19.50	1.09	---	---	---	---
		L	19.01	19.50	1.12	---	---	---	---
		M	19.16	19.50	1.08	---	---	---	---
Right	H	19.11	19.50	1.09	---	---	---	---	
	L	19.01	19.50	1.12	---	---	---	---	
	M	19.16	19.50	1.08	---	---	---	---	

(Trigger distance-1) mm with p-sensor off (full power for all surfaces)

Test case			Meas power (dBm)	Tune-up (dBm)	Scaling factor	Meas SAR(w/kg)		Report SAR(w/kg)	
Mode	Position	Channel				First	Second	First	Second
QPSK 1RB	Back	L	23.95	24.50	1.14	---	---	---	---
		M	24.11	24.50	1.09	0.156	---	0.170	---

	Front	H	24.06	24.50	1.11	---	---	---	---
		L	23.95	24.50	1.14	---	---	---	---
		M	24.11	24.50	1.09	0.144	---	0.157	---
	Top	H	24.06	24.50	1.11	---	---	---	---
		L	23.95	24.50	1.14	---	---	---	---
		M	24.11	24.50	1.09	0.101	---	0.110	---
	Bottom	H	24.06	24.50	1.11	---	---	---	---
		L	23.95	24.50	1.14	---	---	---	---
		M	24.11	24.50	1.09	---	---	---	---
	Left	H	24.06	24.50	1.11	---	---	---	---
		L	23.95	24.50	1.14	---	---	---	---
		M	24.11	24.50	1.09	0.130	---	0.142	---
	Right	H	24.06	24.50	1.11	---	---	---	---
		L	23.95	24.50	1.14	---	---	---	---
		M	24.11	24.50	1.09	0.141	---	0.154	---
QPSK 50%RB	Back	H	24.06	24.50	1.11	---	---	---	---
		L	23.07	23.50	1.10	---	---	---	---
		M	23.23	23.50	1.06	0.121	---	0.128	---
	Front	H	23.19	23.50	1.07	---	---	---	---
		L	23.07	23.50	1.10	---	---	---	---
		M	23.23	23.50	1.06	0.115	---	---	---
	Top	H	23.19	23.50	1.07	---	---	---	---
		L	23.07	23.50	1.10	---	---	---	---
		M	23.23	23.50	1.06	0.079	---	0.084	---
	Bottom	H	23.19	23.50	1.07	---	---	---	---
		L	23.07	23.50	1.10	---	---	---	---
		M	23.23	23.50	1.06	---	---	---	---
	Left	H	23.19	23.50	1.07	---	---	---	---
		L	23.07	23.50	1.10	---	---	---	---
		M	23.23	23.50	1.06	0.111	---	0.118	---
Right	H	23.19	23.50	1.07	---	---	---	---	
	L	23.07	23.50	1.10	---	---	---	---	
	M	23.23	23.50	1.06	0.118	---	0.125	---	
		H	23.19	23.50	1.07	---	---	---	---

Mode: Wi-Fi 2.4GHz

fL (MHz)=2412MHz fM (MHz)=2437MHz

fH (MHz)= 2462MHz

Limit of SAR (W/kg): <1.6W/kg (1g Average)

0mm (full power for relevant surfaces)

Test case			Meas power (dBm)	Tune-up (dBm)	Scaling factor	Meas SAR(w/kg)		Report SAR(w/kg)	
Mode	Position	Channel				First	Second	First	Second

802.11b	Back	L	15.15	16.00	1.22	1.02	---	---	---
		M	15.02	16.00	1.25	1.02	0.140	---	0.179
		H	15.56	16.00	1.11	1.02	---	---	---
	Front	L	15.15	16.00	1.22	1.02	0.444	---	0.553
		M	15.02	16.00	1.25	1.02	---	---	---
		H	15.56	16.00	1.11	1.02	---	---	---
	Top	L	15.15	16.00	1.22	1.02	---	---	---
		M	15.02	16.00	1.25	1.02	0.084	---	0.107
		H	15.56	16.00	1.11	1.02	---	---	---
	Bottom	L	15.15	16.00	1.22	1.02	---	---	---
		M	15.02	16.00	1.25	1.02	0.370	---	0.472
		H	15.56	16.00	1.11	1.02	---	---	---
	Left	L	15.15	16.00	1.22	1.02	---	---	---
		M	15.02	16.00	1.25	1.02	0.177	---	0.226
		H	15.56	16.00	1.11	1.02	---	---	---
	Right	L	15.15	16.00	1.22	1.02	---	---	---
		M	15.02	16.00	1.25	1.02	0.071	---	0.091
		H	15.56	16.00	1.11	1.02	---	---	---

Secondary test : Improved model measurement results

Test case			Meas power (dBm)	Tune-up (dBm)	Scaling factor	Meas SAR(w/kg)		Report SAR(w/kg)	
Mode	Position	Channel				First	Second	First	Second
802.11b	Back	L	15.15	16.00	1.22	1.02	---	---	---
		M	15.02	16.00	1.25	1.02	0.140	---	0.179
		H	15.56	16.00	1.11	1.02	---	---	---
	Front	L	15.15	16.00	1.22	1.02	0.444	---	0.553
		M	15.02	16.00	1.25	1.02	---	---	---
		H	15.56	16.00	1.11	1.02	---	---	---
	Top	L	15.15	16.00	1.22	1.02	---	---	---
		M	15.02	16.00	1.25	1.02	0.084	---	0.107
		H	15.56	16.00	1.11	1.02	---	---	---
	Bottom	L	15.15	16.00	1.22	1.02	---	---	---
		M	15.02	16.00	1.25	1.02	0.216	---	0.270
		H	15.56	16.00	1.11	1.02	---	---	---
	Left	L	15.15	16.00	1.22	1.02	---	---	---
		M	15.02	16.00	1.25	1.02	0.177	---	0.226
		H	15.56	16.00	1.11	1.02	---	---	---
	Right	L	15.15	16.00	1.22	1.02	---	---	---
		M	15.02	16.00	1.25	1.02	0.071	---	0.091
		H	15.56	16.00	1.11	1.02	---	---	---

6.9 SAR Measurement Variability

SAR measurement variability must be assessed for each frequency band, which is determined by the SAR probe calibration point and tissue-equivalent medium used for the device measurements. When both head and body tissue-equivalent media are required for SAR measurements in a frequency band, the variability measurement procedures should be applied to the tissue medium with the highest measured SAR, using the highest measured SAR configuration for that tissue-equivalent medium.

The following procedures are applied to determine if repeated measurements are required.

- 1) Repeated measurement is not required when the original highest measured SAR is < 0.80 W/kg; steps 2) through 4) do not apply.
- 2) When the original highest measured SAR is ≥ 0.80 W/kg, repeat that measurement once.
- 3) Perform a second repeated measurement only if the ratio of largest to smallest SAR for the original and first repeated measurements is > 1.20 or when the original or repeated measurement is ≥ 1.45 W/kg (~ 10% from the 1-g SAR limit).
- 4) Perform a third repeated measurement only if the original, first or second repeated measurement is ≥ 1.5 W/kg and the ratio of largest to smallest SAR for the original, first and second repeated measurements is > 1.20 .

The Highest Reported/Estimated SAR configuration in Each Frequency Band

Frequency band	Air interface	Max Body SAR(w/kg)
Below 1GHz	WCDMA BANDV LTE BAND5 LTE BAND12 LTE BAND13 LTE BAND26 LTE BAND71	>0.8
1GHz-2GHz	WCDMA BANDII WCDMA BANDIV LTE BAND2 LTE BAND4 LTE BAND25 LTE BAND66	>0.8
2GHz-3GHz	LTE BAND41 WIFI 2.4GHz	>0.8

6.10 Simultaneous Transmission SAR Analysis

Antenna numbers of Simultaneous Transmission	Antennas of Simultaneous Transmission	Simultaneous Transmission Modes
2	MAIN ANT+ WLAN ANT	Celluar3/4G+ WIFI 2.4GHz

The worst case for 2TX simultaneous transmission happened in back position

Body-worn exposure

Position of worst case	Licenased band/ SAR(w/kg)	Unlicensed band/ SAR(w/kg)	Simultaneous SAR(w/kg)
Bottom	LTE Band71 /0.95	WIFI 2.4G/0.47	1.42

Improved model measurement results

Position of worst case	Licensed band/ SAR(w/kg)	Unlicensed band/ SAR(w/kg)	Simultaneous SAR(w/kg)
Bottom	LTE Band71 /0.373	WIFI 2.4G/0.27	0.643

According to the above tables, SAR values < 1.6W/kg meet the compliance.

7 MEASUREMENT UNCERTAINTY

(0.3 - 3 GHz range)								
Error Description	Uncert. value	Prob. Dist.	Div.	(c_i) 1g	(c_i) 10g	Std. Unc. (1g)	Std. Unc. (10g)	(v_i) v_{eff}
Measurement System								
Probe Calibration	±6.0 %	N	1	1	1	±6.0 %	±6.0 %	∞
Axial Isotropy	±4.7 %	R	$\sqrt{3}$	0.7	0.7	±1.9 %	±1.9 %	∞
Hemispherical Isotropy	±9.6 %	R	$\sqrt{3}$	0.7	0.7	±3.9 %	±3.9 %	∞
Boundary Effects	±1.0 %	R	$\sqrt{3}$	1	1	±0.6 %	±0.6 %	∞
Linearity	±4.7 %	R	$\sqrt{3}$	1	1	±2.7 %	±2.7 %	∞
System Detection Limits	±1.0 %	R	$\sqrt{3}$	1	1	±0.6 %	±0.6 %	∞
Modulation Response ^m	±2.4 %	R	$\sqrt{3}$	1	1	±1.4 %	±1.4 %	∞
Readout Electronics	±0.3 %	N	1	1	1	±0.3 %	±0.3 %	∞
Response Time	±0.8 %	R	$\sqrt{3}$	1	1	±0.5 %	±0.5 %	∞
Integration Time	±2.6 %	R	$\sqrt{3}$	1	1	±1.5 %	±1.5 %	∞
RF Ambient Noise	±3.0 %	R	$\sqrt{3}$	1	1	±1.7 %	±1.7 %	∞
RF Ambient Reflections	±3.0 %	R	$\sqrt{3}$	1	1	±1.7 %	±1.7 %	∞
Probe Positioner	±0.4 %	R	$\sqrt{3}$	1	1	±0.2 %	±0.2 %	∞
Probe Positioning	±2.9 %	R	$\sqrt{3}$	1	1	±1.7 %	±1.7 %	∞
Max. SAR Eval.	±2.0 %	R	$\sqrt{3}$	1	1	±1.2 %	±1.2 %	∞
Test Sample Related								
Device Positioning	±2.9 %	N	1	1	1	±2.9 %	±2.9 %	145
Device Holder	±3.6 %	N	1	1	1	±3.6 %	±3.6 %	5
Power Drift	±5.0 %	R	$\sqrt{3}$	1	1	±2.9 %	±2.9 %	∞
Power Scaling ^p	±0 %	R	$\sqrt{3}$	1	1	±0.0 %	±0.0 %	∞
Phantom and Setup								
Phantom Uncertainty	±6.1 %	R	$\sqrt{3}$	1	1	±3.5 %	±3.5 %	∞
SAR correction	±1.9 %	R	$\sqrt{3}$	1	0.84	±1.1 %	±0.9 %	∞
Liquid Conductivity (mea.) ^{DAK}	±2.5 %	R	$\sqrt{3}$	0.78	0.71	±1.1 %	±1.0 %	∞
Liquid Permittivity (mea.) ^{DAK}	±2.5 %	R	$\sqrt{3}$	0.26	0.26	±0.3 %	±0.4 %	∞
Temp. unc. - Conductivity ^{BB}	±3.4 %	R	$\sqrt{3}$	0.78	0.71	±1.5 %	±1.4 %	∞
Temp. unc. - Permittivity ^{BB}	±0.4 %	R	$\sqrt{3}$	0.23	0.26	±0.1 %	±0.1 %	∞
Combined Std. Uncertainty						±11.2 %	±11.1 %	361
Expanded STD Uncertainty						±22.3 %	±22.2 %	

(3 - 6 GHz range)								
Error Description	Uncert. value	Prob. Dist.	Div.	(c _i) 1g	(c _i) 10g	Std. Unc. (1g)	Std. Unc. (10g)	(v _i) v _{eff}
Measurement System								
Probe Calibration	±6.55 %	N	1	1	1	±6.55 %	±6.55 %	∞
Axial Isotropy	±4.7 %	R	√3	0.7	0.7	±1.9 %	±1.9 %	∞
Hemispherical Isotropy	±9.6 %	R	√3	0.7	0.7	±3.9 %	±3.9 %	∞
Boundary Effects	±2.0 %	R	√3	1	1	±1.2 %	±1.2 %	∞
Linearity	±4.7 %	R	√3	1	1	±2.7 %	±2.7 %	∞
System Detection Limits	±1.0 %	R	√3	1	1	±0.6 %	±0.6 %	∞
Modulation Response ^{ms}	±2.4 %	R	√3	1	1	±1.4 %	±1.4 %	∞
Readout Electronics	±0.3 %	N	1	1	1	±0.3 %	±0.3 %	∞
Response Time	±0.8 %	R	√3	1	1	±0.5 %	±0.5 %	∞
Integration Time	±2.6 %	R	√3	1	1	±1.5 %	±1.5 %	∞
RF Ambient Noise	±3.0 %	R	√3	1	1	±1.7 %	±1.7 %	∞
RF Ambient Reflections	±3.0 %	R	√3	1	1	±1.7 %	±1.7 %	∞
Probe Positioner	±0.8 %	R	√3	1	1	±0.5 %	±0.5 %	∞
Probe Positioning	±6.7 %	R	√3	1	1	±3.9 %	±3.9 %	∞
Max. SAR Eval.	±4.0 %	R	√3	1	1	±2.3 %	±2.3 %	∞
Test Sample Related								
Device Positioning	±2.9 %	N	1	1	1	±2.9 %	±2.9 %	145
Device Holder	±3.6 %	N	1	1	1	±3.6 %	±3.6 %	5
Power Drift	±5.0 %	R	√3	1	1	±2.9 %	±2.9 %	∞
Power Scaling ^P	±0 %	R	√3	1	1	±0.0 %	±0.0 %	∞
Phantom and Setup								
Phantom Uncertainty	±6.6 %	R	√3	1	1	±3.8 %	±3.8 %	∞
SAR correction	±1.9 %	R	√3	1	0.84	±1.1 %	±0.9 %	∞
Liquid Conductivity (mea.) ^{DAK}	±2.5 %	R	√3	0.78	0.71	±1.1 %	±1.0 %	∞
Liquid Permittivity (mea.) ^{DAK}	±2.5 %	R	√3	0.26	0.26	±0.3 %	±0.4 %	∞
Temp. unc. - Conductivity ^{BB}	±3.4 %	R	√3	0.78	0.71	±1.5 %	±1.4 %	∞
Temp. unc. - Permittivity ^{BB}	±0.4 %	R	√3	0.23	0.26	±0.1 %	±0.1 %	∞
Combined Std. Uncertainty						±12.3 %	±12.2 %	748
Expanded STD Uncertainty						±24.6 %	±24.5 %	

Relevant parameters of the second test

Uncertainty Budget								
(Frequency band: 300 MHz–10 GHz range)								
Symbol	Error Description	Uncert. value	Prob. Dist.	Div.	(c _i) (1g)	(c _i) (10g)	Std. Unc. (1g)	Std. Unc. (10g)
Measurement System Errors								
CF	Probe Calibration	±18.6%	N	2	1	1	±9.3%	±9.3%
CF _{drift}	Probe Calibration Drift	±1.7%	R	√3	1	1	±0.98%	±0.98%
LIN	Probe Linearity	±4.7%	R	√3	1	1	±2.71%	±2.71%
BBS	Broadband Signal	±2.8%	R	√3	1	1	±1.62%	±1.62%

ISO	Probe Isotropy (axial)	±9.6%	R	$\sqrt{3}$	1	1	±5.54%	±5.54%
DAE	Other Probe+Electronic	±2.4%	N	1	1	1	±2.4%	±2.4%
AMB	RF Ambient	±0.0%	N	1	1	1	±0.0%	±0.0%
Δ_{sys}	Probe Positioning	±0.005mm	N	1	0.5	0.5	±0.25%	±0.25%
DAT	Data Processing	±4.0%	N	1	1	1	±4.0%	±4.0%
Phantom and Device Errors								
LIQ(σ)	Conductivity (meas.) ^{DAK}	±3.0%	N	1	0.78	0.71	±2.34%	±2.13%
LIQ(T_{σ})	Conductivity (temp.) ^{BB}	±2.43%	R	$\sqrt{3}$	0.78	0.71	±1.09%	±1.00%
EPS	Phantom Permittivity	±14.0%	R	$\sqrt{3}$	0.5	0.5	±4.04%	±4.04%
DIS	Distance DUT – TSL	±2.6%	N	1	2	2	±1.30%	±1.30%
D_{xyz}	Device Positioning	±0.9%	N	1	1	1	±0.9%	±0.9%
H	Device Holder	±2.8%	N	1	1	1	±2.8%	±2.8%
MOD	DUT Modulation	±2.4%	R	$\sqrt{3}$	1	1	±1.39%	±1.39%
TAS	Time-average SAR	±1.73%	R	$\sqrt{3}$	1	1	±1.00%	±1.00%
RF_{drift}	DUT drift	±1.78%	N	1	1	1	±1.78%	±1.78%
VAL	Validation antenna	±3.2%	N	1	1	1	±3.2%	±3.2%
P_{in}	Accepted power	±2.0%	N	1	1	1	±2.0%	±2.0%
Correction to the SAR results								
$C(\epsilon, \sigma)$	Deviation to Target	±1.9%	N	1	1	0.84	±1.9%	±1.60%
C(R)	SAR scaling ^p	±0%	R	$\sqrt{3}$	1	1	±0%	±0%
$u(\Delta SAR)$	Combined Uncertainty						14.39	14.32
U	Expanded Uncertainty						28.78	28.64

Note: SRTC evaluate the components of uncertainty periodically to make sure there is no influence on SAR result.

8 TEST EQUIPMENTS

The measurements were performed using an automated near-field scanning system, DASY, manufactured by Schmid & Partner Engineering AG (SPEAG) in Switzerland, all the components and supplement devices listed below.

The following table lists calibration dates of SPEAG components:

Test Equipment	Model	Serial Number	Calibration date	Calibration Due data
DAE	DAE4	546	2020.08.13	2021.08.12
Dosimetric E-field Probe	ES3DV3	3127	2020.09.01	2021.08.31
Dipole Validation Kit	D750V3	1101	2017.09.13	2020.09.12
Dipole Validation Kit	D835V2	4d023	2017.09.13	2020.09.12
Dipole Validation Kit	D1800V2	2d084	2017.09.15	2020.09.14
Dipole Validation Kit	D2000V2	1009	2018.02.01	2021.01.31
Dipole Validation Kit	D2450V2	738	2017.09.18	2020.09.17
Dipole Validation Kit	D2600V2	1166	2019.11.08	2022.11.08

Additional test equipment used in testing:

Test Equipment	Model	Serial Number	Calibration date	Calibration Due data
Signal Generator	E4428C	MY45280865	2020.08.20	2021.08.19
Signal Generator	SML 03	103514	2020.08.20	2021.08.19
Power meter	E4417A	MY45101182	2020.08.20	2021.08.19
Power Sensor	E4412A	MY41502214	2020.08.20	2021.08.19
Power Sensor	E4412A	MY41502130	2020.08.20	2021.08.19
Power meter	E4417A	MY45101004	2020.08.20	2021.08.19
Power Sensor	E9300B	MY41496001	2020.08.20	2021.08.19
Power Sensor	E9300B	MY41496003	2020.08.20	2021.08.19
Communication Tester	E5515C	MY48367401	2020.08.20	2021.08.19
Communication Tester	MT8820C	6201300660	2020.08.20	2021.08.19
Communication Tester	MT8821C	6201547819	2020.08.20	2021.08.19
Vector Network Analyzer	VNA R140	0011213	2020.09.18	2021.09.17
Dielectric Parameter Probe	DAKS-3.5	1042	2020.09.17	2021.09.16

Detailed information of Isotropic E-field Probe Type ES3DV3

Construction	Symmetrical design with triangular core Interleaved sensors Built-in shielding against static charges PEEK enclosure material (resistant to organic solvents, e.g., DGBE)
Calibration	Calibration certificate in Appendix C
Frequency	10 MHz to 4 GHz; Linearity: ± 0.2 dB (30 MHz to 4 GHz)
Optical Surface Detection	± 0.2 mm repeatability in air and clear liquids over diffuse reflecting surfaces
Dimensions	Overall length: 337 mm (Tip: 20 mm) Tip diameter: 3.9 mm (Body: 12 mm) Distance from probe tip to dipole centers: 2.0 mm
Dynamic Range	5 μ W/g to > 100 W/kg; Linearity: ± 0.2 dB
Application	General dosimetry up to 4 GHz Dosimetry in strong gradient fields Compliance tests of mobile phones

Detailed information of Isotropic E-field Probe Type EX3DV4

Construction	Symmetrical design with triangular core Built-in shielding against static charges PEEK enclosure material (resistant to organic solvents, e.g., DGBE)
Calibration	Calibration certificate in Appendix C
Frequency	10 MHz to > 6 GHz Linearity: ± 0.2 dB (30 MHz to 6 GHz)
Optical Surface Detection	± 0.3 mm repeatability in air and clear liquids over diffuse reflecting surfaces
Dimensions	Overall length: 337 mm (Tip: 20 mm) Tip diameter: 2.5 mm (Body: 12 mm) Typical distance from probe tip to dipole centers: 1 mm
Dynamic Range	10 μ W/g to > 100 W/kg Linearity: ± 0.2 dB (noise: typically < 1 μ W/g)
Application	High precision dosimetric measurements in any exposure scenario (e.g., very strong gradient fields); the only probe that enables compliance testing for frequencies up to 6 GHz with precision of better 30%.

Relevant parameters of the second test

Test Equipment	Model	Serial Number	Calibration date	Calibration due data
DAE	DAE4	546	2023/09/15	2024/09/14
Dosimetric E-field Probe	EX3DV4	3708	2023/10/30	2024/10/29
Dipole Validation Kit	D750V3	1101	2023/10/19	2026/10/18
Dipole Validation Kit	D835V2	4d023	2023/10/25	2026/10/24
Dipole Validation Kit	D900V2	171	2023/09/19	2026/09/18
Dipole Validation Kit	D1450V2	1065	2023/10/17	2026/10/16
Dipole Validation Kit	D1800V2	2d084	2023/09/18	2026/09/17
Dipole Validation Kit	D2000V2	1009	2023/10/23	2026/10/22
Dipole Validation Kit	D2450V2	738	2023/10/23	2026/10/22
Dipole Validation Kit	D2600V2	1166	2022/10/19	2025/10/18

Note: Longer calibration intervals of up to **3 years is acceptable** when it is demonstrated that the SAR target, impedance and return loss of a dipole have remain stable.

Test Equipment	Model	Serial Number	Calibration within 1year
Signal Generator	E8257dD	MY46522016	Comply
Power meter	E4417A	MY45101004	Comply
Power Sensor	E9300B	MY41496001	Comply
Power Sensor	E9300B	MY41496003	Comply
Vector Network Analyzer	VNA R140	0011213	Comply
Dielectric Parameter Probe	DAKS-3.5	1042	Comply
Communication Tester	E5515C	MY48367401	Comply
Communication Tester	CMW500	161702	Comply
Communication Tester	MT8820C	6201300660	Comply
Communication Tester	SP9500	20334	Comply

Software	Version
DASY5	52.10.4.1527
SEMCAD X	14.6.14
DAK	3.0.4.1

Detailed information of Isotropic E-field Probe Type EX3DV4

Construction	Symmetrical design with triangular core Built-in shielding against static charges PEEK enclosure material (resistant to organic solvents, e.g., DGBE)
Calibration	Calibration certificate in Appendix C
Frequency	10 MHz to > 6 GHz Linearity: ± 0.2 dB (30 MHz to 6 GHz)
Optical Surface Detection	± 0.3 mm repeatability in air and clear liquids over diffuse reflecting surfaces
Dimensions	Overall length: 337 mm (Tip: 20 mm) Tip diameter: 2.5 mm (Body: 12 mm) Typical distance from probe tip to dipole centers: 1 mm
Dynamic Range	10 μ W/g to > 100 W/kg Linearity: ± 0.2 dB (noise: typically < 1 μ W/g)
Application	High precision dosimetric measurements in any exposure scenario

(e.g., very strong gradient fields); the only probe that enables compliance testing for frequencies up to 6 GHz with precision of better 30%.

According to KDB 865664 D01 section 3.2.2, instead of the typical annual calibration recommended by measurement standards, longer calibration intervals of up to three years may be considered when it is demonstrated that the **SAR target, impedance and return loss** of a dipole have remain stable according to the following requirements.

- 1) The test laboratory must ensure that the required supporting information and documentation are included in the SAR report to qualify for the three-year extended calibration interval; otherwise, the IEEE Std 1528-2013 recommended annual calibration applies.
- 2) Immediate re-calibration is required for the following conditions.
 - a) After a dipole is damaged and properly repaired to meet required specifications.
 - b) When the measured SAR deviates from the calibrated SAR value by more than 10% due to changes in physical, mechanical, electrical or other relevant dipole conditions; i.e., the error is not introduced by incorrect measurement procedures or other issues relating to the SAR measurement system.
 - c) When the most recent return-loss result, measured at least annually, deviates by more than 20% from the previous measurement (i.e. value in dB×0.2) or not meeting the required 20 dB minimum return-loss requirement.
 - d) When the most recent measurement of the real or imaginary parts of the impedance, measured at least annually, deviates by more than 5 Ω from the previous measurement.

Dipole 750 (2020)

SAR target

Refers to system check, measured SAR (1g and 10g) deviates from the Target SAR value of calibration report within 10%.

Impedance and Return loss measured by Network analyzer

The most recent measurement of the real or imaginary parts of the impedance, deviates within 5 Ω from the previous measurement. (Data from the last calibration report)

The most recent return-loss result deviates within 20% from the previous measurement. (Data from the last calibration report)

Head TSL Parameters			
Parameters	Target (Ref. Value)	Measured data	Deviation
Impedance	53.9Ω+0.24jΩ	49.5Ω-2.15jΩ	<5Ω
Return loss	-28.4dB	-29.8dB	<20%

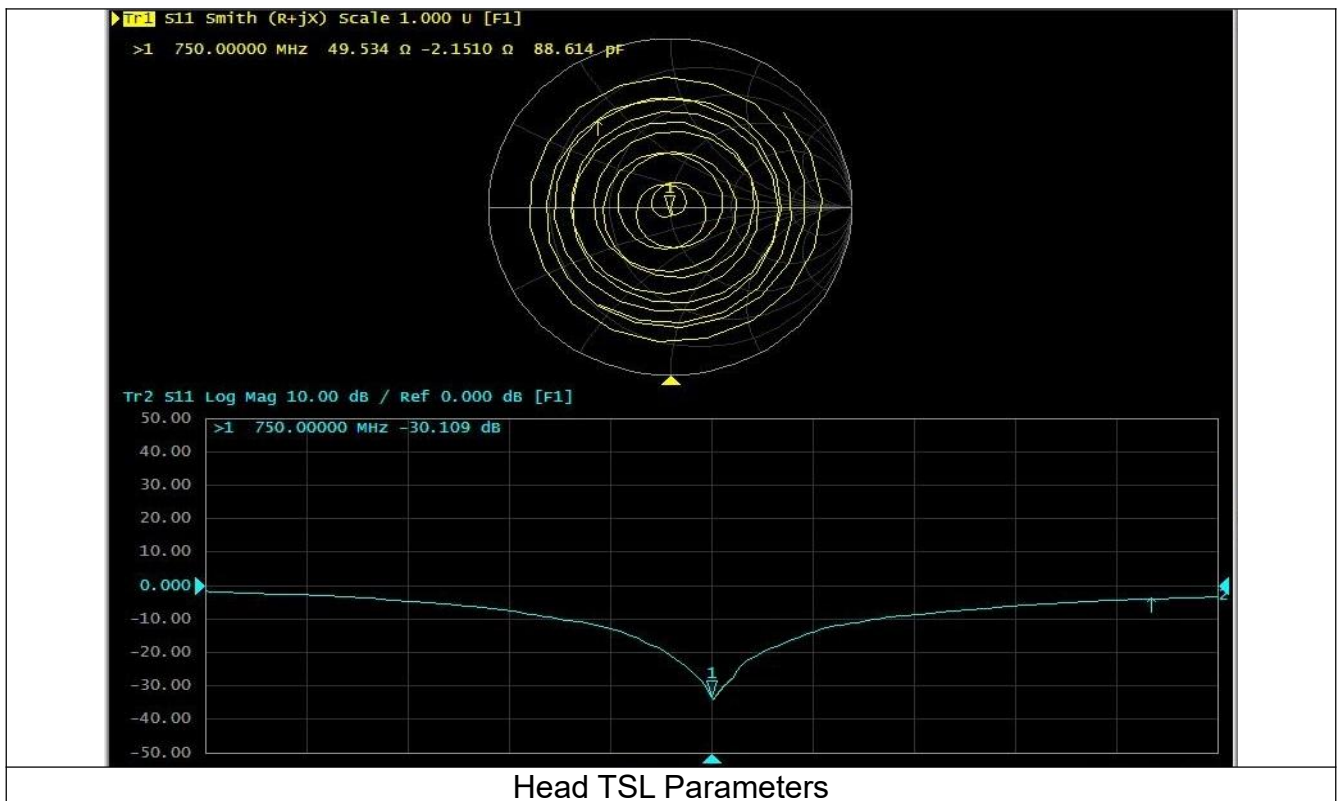

Dipole 835 (2020)

SAR target

Refers to system check, measured SAR (1g and 10g) deviates from the Target SAR value of calibration report within 10%.

Impedance and Return loss measured by Network analyzer

The most recent measurement of the real or imaginary parts of the impedance, deviates within 5 Ω from the previous measurement. (Data from the last calibration report)

The most recent return-loss result deviates within 20% from the previous measurement. (Data from the last calibration report)

TSL Parameters			
Parameters	Target (Ref. Value)	Measured data	Deviation
Impedance	51.0Ω-2.79jΩ	49.5Ω-2.15jΩ	<5Ω
Return loss	-30.7 dB	-33.1 dB	<20%

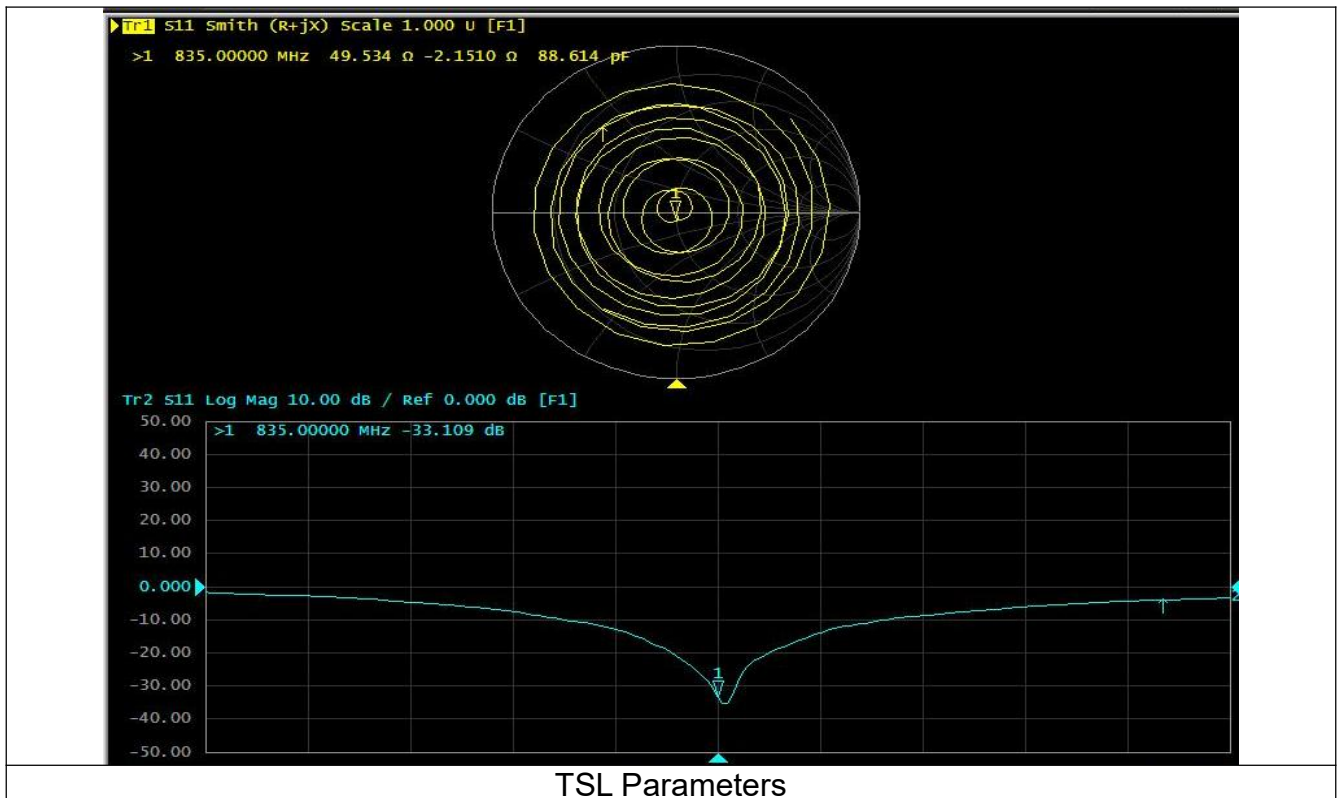

TSL Parameters

Dipole1800 (2020)

SAR target

Refers to system check, measured SAR (1g and 10g) deviates from the Target SAR value of calibration report within 10%.

Impedance and Return loss measured by Network analyzer

The most recent measurement of the real or imaginary parts of the impedance, deviates within 5 Ω from the previous measurement. (Data from the last calibration report)

The most recent return-loss result deviates within 20% from the previous measurement. (Data from the last calibration report)

TSL Parameters			
Parameters	Target (Ref. Value)	Measured data	Deviation
Impedance	49.3Ω-1.55jΩ	51.9Ω-4.41jΩ	<5Ω
Return loss	-35.4 dB	-36.0dB	<20%

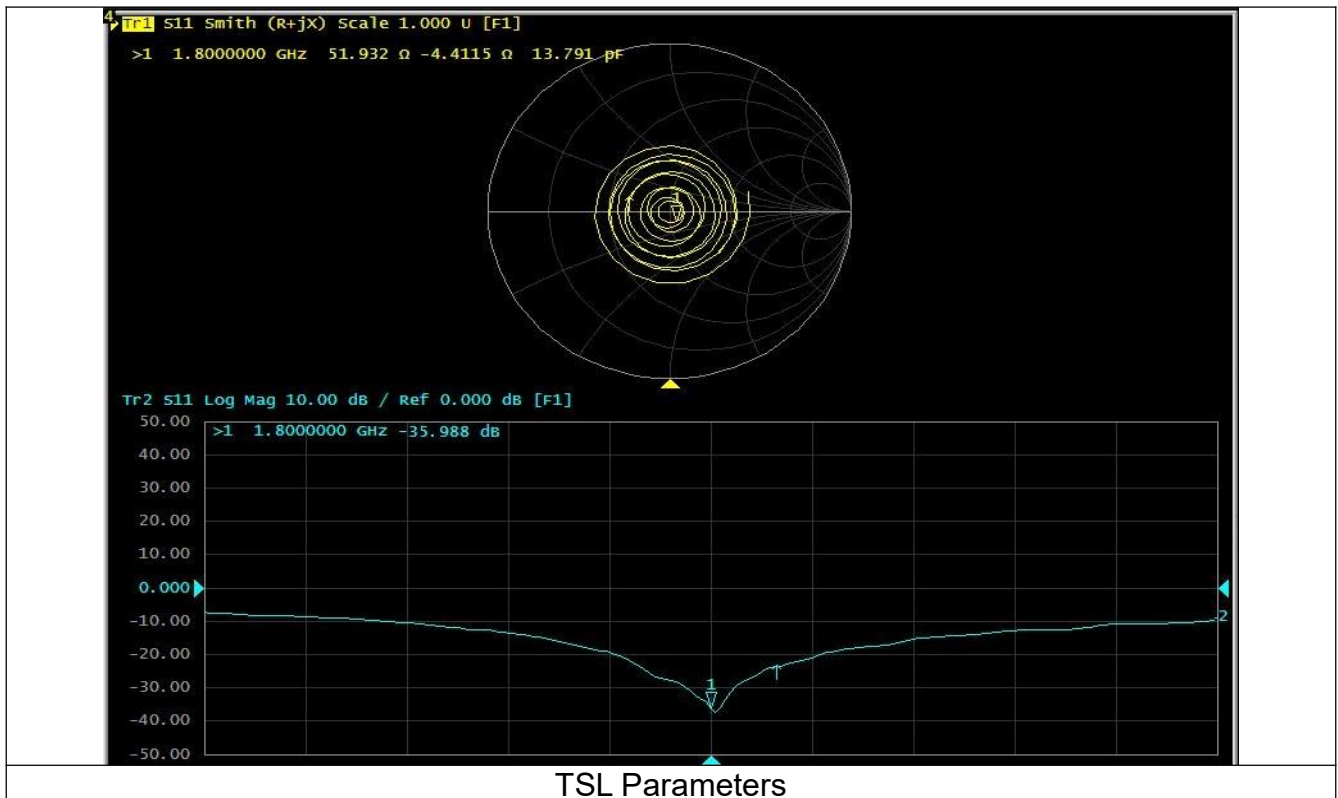

TSL Parameters

Dipole2000 (2020)

SAR target

Refers to system check, measured SAR (1g and 10g) deviates from the Target SAR value of calibration report within 10%.

Impedance and Return loss measured by Network analyzer

The most recent measurement of the real or imaginary parts of the impedance, deviates within 5 Ω from the previous measurement. (Data from the last calibration report)
 The most recent return-loss result deviates within 20% from the previous measurement. (Data from the last calibration report)

TSL Parameters			
Parameters	Target (Ref. Value)	Measured data	Deviation
Impedance	49.8Ω-2.08jΩ	52.6Ω-3.44jΩ	<5Ω
Return loss	-33.6dB	-36.0dB	<20%

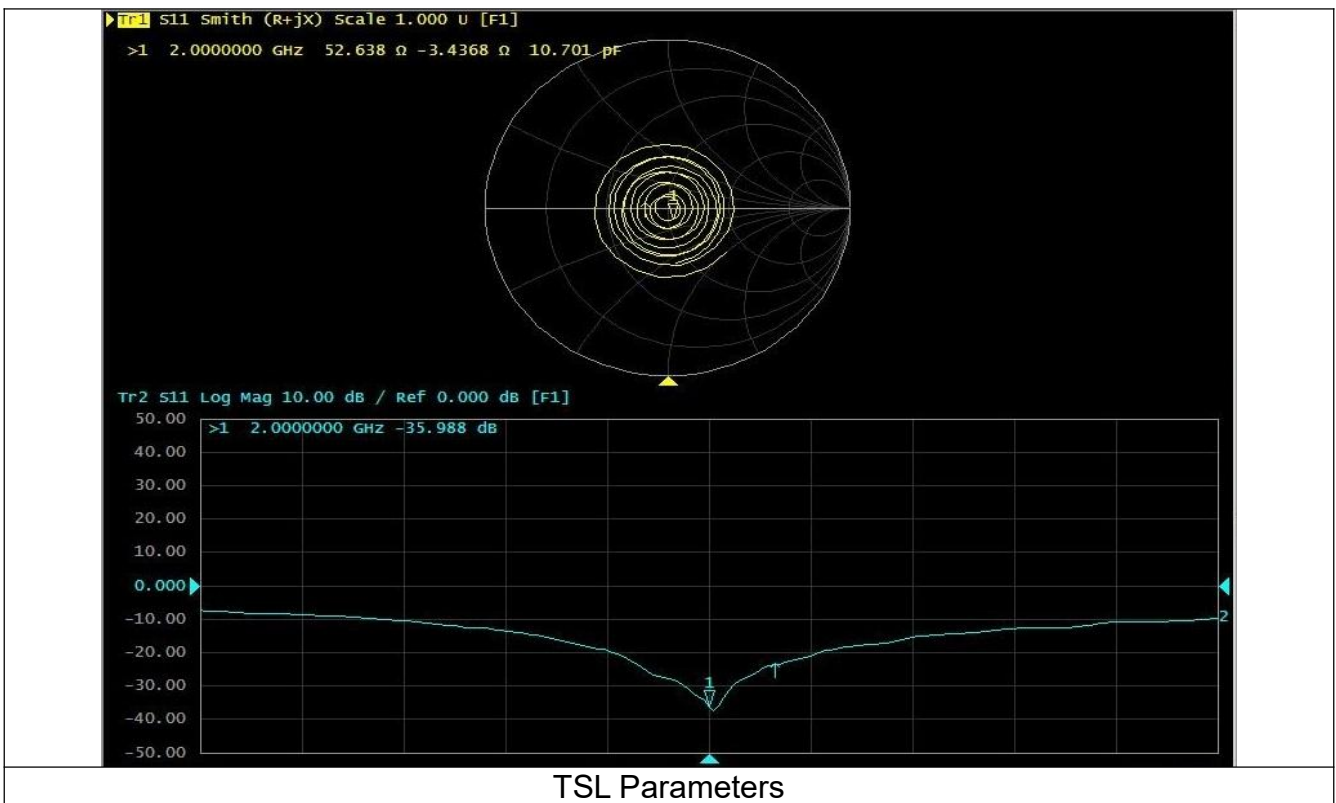

Dipole2450 (2020)

SAR target

Refers to system check, measured SAR (1g and 10g) deviates from the Target SAR value of calibration report within 10%.

Impedance and Return loss measured by Network analyzer

The most recent measurement of the real or imaginary parts of the impedance deviates within 5 Ω from the previous measurement. (Data from the last calibration report)

The most recent return-loss result deviates within 20% from the previous measurement. (Data from the last calibration report)

TSL Parameters			
Parameters	Target (Ref. Value)	Measured data	Deviation
Impedance	51.3Ω+5.92jΩ	48.9Ω+4.78jΩ	<5Ω
Return loss	-24.5 dB	-22.6dB	<20%

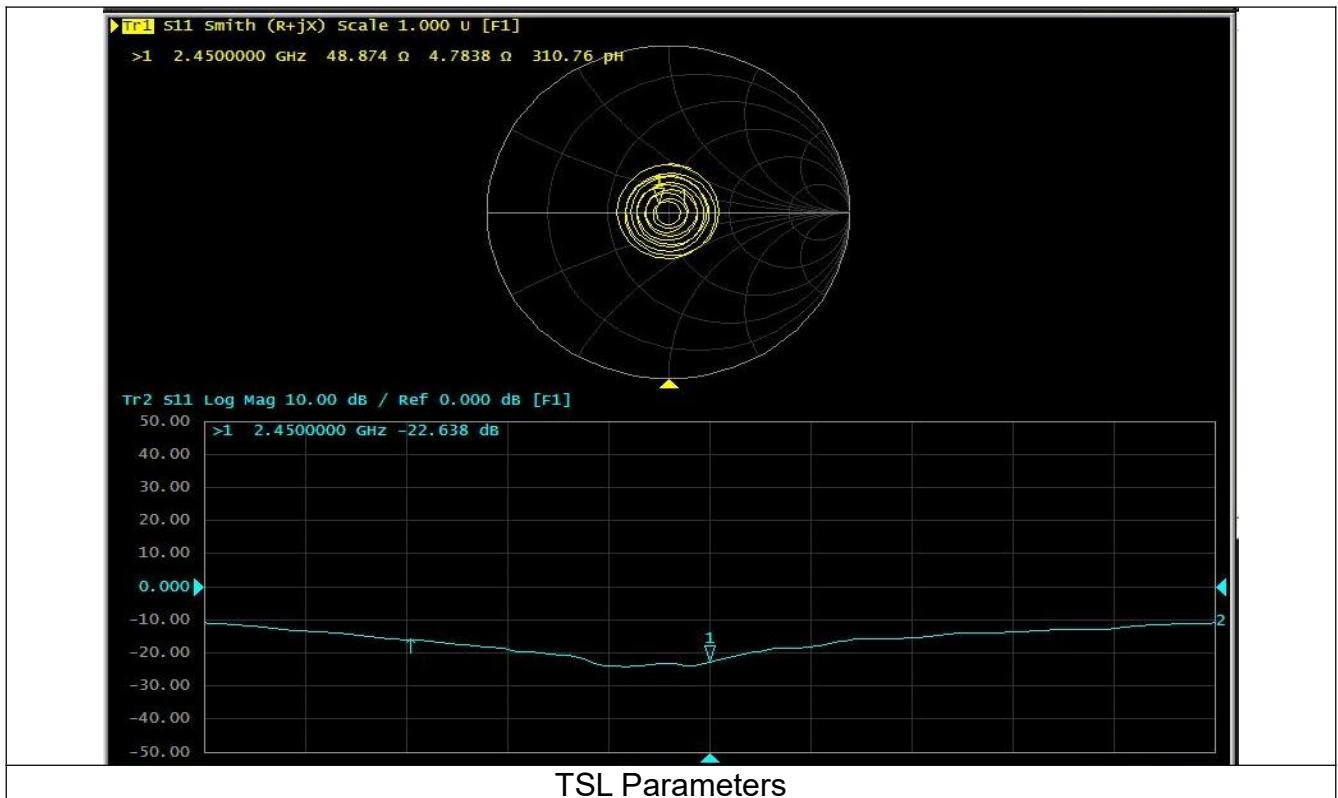

TSL Parameters

The latest test data (2023.11)

SAR Target: Refers to system check, measured SAR (1g and 10g) deviates from the Target SAR value of calibration report within 10%.

Impedance and Return loss measured by Network analyzer: The most recent measurement of the real or imaginary parts of the impedance deviates within 5 Ω from the previous measurement. The most recent return-loss result deviates within 20% from the previous measurement. (Target from the last calibration report, Return loss<20db)

Dipole450 TSL Parameters (feed point 450MHz)		
Parameters	Measured data	Target (Ref. Value)
Impedance	56.1 Ω +6.06j Ω	55.5 Ω +6.40j Ω
Return loss	-21.6 dB	-21.9 dB
Dipole750 TSL Parameters (feed point 750MHz)		
Parameters	Measured data	Target (Ref. Value)
Impedance	53.9 Ω -2.02j Ω	53.7 Ω -1.63j Ω
Return loss	-27.5 dB	-28.2dB
Dipole835 TSL Parameters (feed point 835MHz)		
Parameters	Measured data	Target (Ref. Value)
Impedance	53.4 Ω -3.16j Ω	52.6 Ω -2.37j Ω
Return loss	-30.1 dB	-29.3dB
Dipole900 TSL Parameters (feed point 900MHz)		
Parameters	Measured data	Target (Ref. Value)
Impedance	50.6 Ω -5.24j Ω	49.1 Ω -6.69j Ω
Return loss	-23.8 dB	-23.4dB
Dipole1450 TSL Parameters (feed point 1450MHz)		
Parameters	Measured data	Target (Ref. Value)
Impedance	53.7 Ω -2.95j Ω	52.4 Ω -1.35j Ω
Return loss	-32.1 dB	-31.5dB
Dipole1800 TSL Parameters (feed point 1800MHz)		
Parameters	Measured data	Target (Ref. Value)
Impedance	47.8 Ω -3.06j Ω	48.9 Ω -2.71j Ω
Return loss	-31.3 dB	-30.6dB
Dipole2000 TSL Parameters (feed point 2000MHz)		
Parameters	Measured data	Target (Ref. Value)
Impedance	51.1 Ω -3.37j Ω	49.4 Ω -2.46j Ω
Return loss	-30.6 dB	-31.9dB
Dipole2450 TSL Parameters (feed point 2450MHz)		
Parameters	Measured data	Target (Ref. Value)
Impedance	54.2 Ω +5.98j Ω	53.3 Ω +6.38j Ω
Return loss	-22.9 dB	-23.1dB
Dipole2600 TSL Parameters (feed point 2600MHz)		
Parameters	Measured data	Target (Ref. Value)
Impedance	48.4 Ω -6.71j Ω	47.9 Ω -7.80j Ω
Return loss	-22.5 dB	-21.7dB
Dipole3300 TSL Parameters (feed point 3300MHz)		
Parameters	Measured data	Target (Ref. Value)

Impedance	54.2Ω-6.1jΩ	54.7Ω-6.3jΩ
Return loss	-23.1dB	-22.5dB
Dipole3500 TSL Parameters		
(feed point 3500MHz)		
Parameters	Measured data	Target (Ref. Value)
Impedance	53.3Ω+4.48jΩ	52.6Ω+3.5jΩ
Return loss	-29.1 dB	-27.4dB
Dipole3700 TSL Parameters		
(feed point 3700MHz)		
Parameters	Measured data	Target (Ref. Value)
Impedance	47.6Ω+1.99jΩ	48.3Ω+1.1jΩ
Return loss	-34.5 dB	-33.6dB
Dipole3900 TSL Parameters		
(feed point 3900MHz)		
Parameters	Measured data	Target (Ref. Value)
Impedance	50.1Ω-5.48jΩ	48.3Ω-4.9jΩ
Return loss	-26.7 dB	-25.6dB
(feed point 4100MHz)		
Parameters	Measured data	Target (Ref. Value)
Impedance	57.6Ω-1.70jΩ	59.0Ω-0.8jΩ
Return loss	-20.8 dB	-21.6dB
Dipole4200 TSL Parameters		
(feed point 4300MHz)		
Parameters	Measured data	Target (Ref. Value)
Impedance	53.9Ω-1.52jΩ	52.1Ω-1.6jΩ
Return loss	-33.5 dB	-31.7dB
Dipole4600 TSL Parameters		
(feed point 4500MHz)		
Parameters	Measured data	Target (Ref. Value)
Impedance	46.9Ω-5.14jΩ	46.4Ω-4.5jΩ
Return loss	-25.2 dB	-24.5dB
(feed point 4700MHz)		
Parameters	Measured data	Target (Ref. Value)
Impedance	54.8Ω-2.91jΩ	55.9Ω-3.20jΩ
Return loss	-25.4 dB	-24.0dB
Dipole4900 TSL Parameters		
(feed point 4900MHz)		
Parameters	Measured data	Target (Ref. Value)
Impedance	51.8Ω-4.40jΩ	50.6Ω-5.2jΩ
Return loss	-26.9 dB	-25.7dB
Dipole5GHz TSL Parameters		
(feed point 5200MHz)		
Parameters	Measured data	Target (Ref. Value)
Impedance	51.2Ω-11.89jΩ	50.2Ω-10.0jΩ
Return loss	-21.2 dB	-20.0dB
(feed point 5300MHz)		
Parameters	Measured data	Target (Ref. Value)
Impedance	49.0Ω-6.40jΩ	47.2Ω-7.33jΩ
Return loss	-22.4 dB	-21.9dB
(feed point 5500MHz)		
Parameters	Measured data	Target (Ref. Value)
Impedance	51.6Ω-6.61jΩ	52.0Ω-7.96jΩ
Return loss	-22.2 dB	-21.9dB
(feed point 5600MHz)		
Parameters	Measured data	Target (Ref. Value)
Impedance	53.6Ω-4.31jΩ	55.7Ω-3.78jΩ
Return loss	-23.1 dB	-23.8dB

(feed point 5800MHz)		
Parameters	Measured data	Target (Ref. Value)
Impedance	51.8Ω-6.96jΩ	53.7Ω-5.87jΩ
Return loss	-22.9 dB	-23.5dB
Dipole6500 TSL Parameters		
(feed point 6500MHz)		
Parameters	Measured data	Target (Ref. Value)
Impedance	52.3Ω-3.6jΩ	51.1Ω-2.2jΩ
Return loss	-31.1 dB	-32.3dB

ANNEX A – TEST PLOTS

Please refer to the attachment.

TUNE UP – RELEVANT PAGES FROM CALIBRATION REPORTS

Please refer to the attachment.