



TEST REPORT

No.I21N03655-SAR

For

TCL Communication Ltd.

Tablet PC

Model Name: 9132S

With

Hardware Version: 03

Software Version: AM3S

FCC ID: 2ACCJB171

Issued Date: 2022-02-21

Designation Number: CN1210

Note:

The test results in this test report relate only to the devices specified in this report. This report shall not be reproduced except in full without the written approval of SAICT.

Test Laboratory:

SAICT, Shenzhen Academy of Information and Communications Technology

Building G, Shenzhen International Innovation Center, No.1006 Shennan Road, Futian District, Shenzhen, Guangdong, P. R. China 518000.

Tel:+86(0)755-33322000, Fax:+86(0)755-33322001

Email: yewu@caict.ac.cn. www.saict.ac.cn



REPORT HISTORY

Report Number	Revision	Description	Issue Date
I21N03655-SAR	Rev.0	1st edition	2022-02-21



TCONTENTS

1. SUMMARY OF TEST REPORT	5
1.1. TEST ITEMS	5
1.2. TEST STANDARDS	5
1.3. TEST RESULT	5
1.4. TESTING LOCATION	5
1.5. PROJECT DATA	5
1.6. SIGNATURE	5
2. STATEMENT OF COMPLIANCE	6
3. CLIENT INFORMATION	8
3.1. APPLICANT INFORMATION.....	8
3.2. MANUFACTURER INFORMATION	8
4. EQUIPMENT UNDER TEST (EUT) AND ANCILLARY EQUIPMENT (AE)	9
4.1. ABOUT EUT	9
4.2. INTERNAL IDENTIFICATION OF EUT USED DURING THE TEST	10
4.3. INTERNAL IDENTIFICATION OF AE USED DURING THE TEST	10
5. TEST METHODOLOGY	11
5.1. APPLICABLE LIMIT REGULATIONS.....	11
5.2. APPLICABLE MEASUREMENT STANDARDS	11
6. SPECIFIC ABSORPTION RATE (SAR).....	12
6.1. INTRODUCTION.....	12
6.2. SAR DEFINITION.....	12
7. TISSUE SIMULATING LIQUIDS	13
7.1. TARGETS FOR TISSUE SIMULATING LIQUID	13
7.2. DIELECTRIC PERFORMANCE	13
8. SYSTEM VERIFICATION	18
8.1. SYSTEM SETUP.....	18
8.2. SYSTEM VERIFICATION	19
9. MEASUREMENT PROCEDURES	20
9.1. TESTS TO BE PERFORMED.....	20
9.2. GENERAL MEASUREMENT PROCEDURE	22
9.3. WCDMA MEASUREMENT PROCEDURES FOR SAR	23
9.4. LTE MEASUREMENT PROCEDURES FOR SAR.....	24
9.5 LTE (TDD) CONSIDERATIONS.....	24
9.6. BLUETOOTH & WLAN MEASUREMENT PROCEDURES FOR SAR.....	25
9.7. POWER DRIFT.....	26
9.8. PROXIMITY SENSOR CONSIDERATIONS	26



10. CONDUCTED OUTPUT POWER27

10.1. GSM MEASUREMENT RESULT 27

10.2. WCDMA MEASUREMENT RESULT 29

10.3. LTE MEASUREMENT RESULT 32

10.4. BLUETOOTH AND WLAN MEASUREMENT RESULT 112

11. SIMULTANEOUS TX SAR CONSIDERATIONS 115

11.1. INTRODUCTION 115

11.2. TRANSMIT ANTENNA SEPARATION DISTANCES 115

11.3. SAR MEASUREMENT POSITIONS 116

12. EVALUATION OF SIMULTANEOUS 117

13. SUMMARY OF TEST RESULTS 125

13.1. TESTING ENVIRONMENT 125

13.2. SAR RESULTS 126

13.3. WLAN EVALUATION FOR 2.4G 138

13.4. WLAN EVALUATION FOR 5G 139

14. SAR MEASUREMENT VARIABILITY 141

15. MEASUREMENT UNCERTAINTY 143

15.1. MEASUREMENT UNCERTAINTY FOR NORMAL SAR TESTS (300MHz~3GHz) 143

15.2. MEASUREMENT UNCERTAINTY FOR NORMAL SAR TESTS (3GHz~6GHz) 144

16. MAIN TEST INSTRUMENTS 145

ANNEX A: GRAPH RESULTS 146

ANNEX B: SYSTEM VERIFICATION RESULTS 163

ANNEX C: SAR MEASUREMENT SETUP 172

ANNEX D: POSITION OF THE WIRELESS DEVICE IN RELATION TO THE PHANTOM 178

ANNEX E: EQUIVALENT MEDIA RECIPES 181

ANNEX F: SYSTEM VALIDATION 182

ANNEX G: DAE CALIBRATION CERTIFICATE 183

ANNEX H: PROBE CALIBRATION CERTIFICATE 186

ANNEX I: DIPOLE CALIBRATION CERTIFICATE 204

ANNEX J: EXTENDED CALIBRATION SAR DIPOLE 266

ANNEX K: SENSOR TRIGGERING DATA SUMMARY 267

ANNEX L: LTE BAND 41 POWER CLASS 2 AND POWER CLASS 3 LINEARITY 272



1. Summary of Test Report

1.1. Test Items

Description: Tablet PC
Model Name: 9132S
Applicant's Name: TCL Communication Ltd.
Manufacturer's Name: TCL Communication Ltd.

1.2. Test Standards

ANSI C95.1-1992, IEEE 1528-2013

1.3. Test Result

Pass. Please refer to "13. Summary of Test Results"

1.4. Testing Location

Address: Building G, Shenzhen International Innovation Center, No.1006 Shennan Road, Futian District, Shenzhen, Guangdong, P. R. China

1.5. Project Data

Testing Start Date: 2022-01-20

Testing End Date: 2022-02-18

1.6. Signature

Li Yongfu

(Prepared this test report)

Zhang Yunzhan

(Reviewed this test report)

Cao Junfei

(Approved this test report)

2. Statement of Compliance

The maximum results of Specific Absorption Rate (SAR) found during testing for TCL Communication Ltd. Tablet PC 9132S are as follows:

Table 2.1: Highest Reported SAR for Body (1g)

Exposure Configuration	Technology Band	Highest Reported SAR 1g(W/Kg)	Equipment Class
Body	GSM850	0.82	PCT
	GSM1900	1.18	
	WCDMA Band 2	1.02	
	WCDMA Band 4	1.17	
	WCDMA Band 5	0.77	
	LTE Band 7	1.38	
	LTE Band 12	0.66	
	LTE Band 13	0.62	
	LTE Band 25	1.22	
	LTE Band 26	0.67	
	LTE Band 30	1.37	
	LTE Band 41	1.23	
	LTE Band 66	1.31	
	LTE Band 71	0.88	
	Bluetooth	0.28	DSS
	WLAN 24GHz	1.03	DTS
	WLAN 5GHz	1.08	NII

The SAR values found for the Mobile Phone are below the maximum recommended levels of 1.6 W/Kg as averaged over any 1g tissue according to the ANSI C95.1-1992.

The EUT battery must be fully charged and checked periodically during the test to ascertain uniform power output.

The measurement together with the test system set-up is described in annex C of this test report. A detailed description of the equipment under test can be found in chapter 4 of this test report.

The highest reported SAR value is obtained at the case of (Table 2.1), and the value is: **1.38 W/kg (1g)**.

**Table2.2: The sum of reported SAR values for main antenna and WLAN/BT**

/	Position	Main Antenna (W/kg)	WLAN (W/kg)	Sum (W/kg)
Highest reported SAR value for Body	Top	0.51	1.08	1.59

Note: the test positions of above tables are for the worse case that has been evaluated.

According to the above tables, the highest sum of reported SAR values is **1.59 W/kg (1g)**.

The detail for simultaneous transmission consideration is described in chapter 12.



3. Client Information

3.1. Applicant Information

Company Name:	TCL Communication Ltd.
Address:	5/F, Building 22E, 22 Science Park East Avenue, Hong Kong Science Park, Shatin, NT, Hong Kong
City:	Hong Kong
Country:	China
Telephone:	+86 755 3664 5759

3.2. Manufacturer Information

Company Name:	TCL Communication Ltd.
Address:	5/F, Building 22E, 22 Science Park East Avenue, Hong Kong Science Park, Shatin, NT, Hong Kong
City:	Hong Kong
Country:	China
Telephone:	+86 755 3664 5759

4. Equipment under Test (EUT) and Ancillary Equipment (AE)

4.1. About EUT

Description:	Tablet PC
Model Name:	9132S
Condition of EUT as received:	No obvious damage in appearance
Frequency Bands:	GSM850/1900, WCDMA Band 2/4/5, LTE Band 2/4/5/7/12/13/17/25/26/30/66/71/41, Bluetooth, WLAN 2.4G/5G
Tested Tx Frequency:	824 - 849MHz (GSM 850)
	1850 -1910MHz (GSM 1900)
	1850 -1910MHz (WCDMA Band 2)
	1710 -1755MHz (WCDMA Band 4)
	824 - 849MHz (WCDMA Band 5)
	1850 - 1910MHz (LTE Band 2)
	1710 - 1755MHz (LTE Band 4)
	824 - 849MHz (LTE Band 5)
	2500 - 2570MHz (LTE Band 7)
	699 - 716MHz (LTE Band 12)
	777 - 787MHz (LTE Band 13)
	704 - 716MHz (LTE Band 17)
	1850 - 1915MHz (LTE Band 25)
	814 - 849MHz (LTE Band 26)
	2305 - 2315MHz (LTE Band 30)
	1710 - 1780MHz (LTE Band 66)
	663 - 698MHz (LTE Band 71)
2496 - 2690MHz (LTE Band 41)	
2402 - 2480MHz (Bluetooth)	
2412 - 2462MHz (WLAN 2.4G)	
5150 - 5350MHz, 5725 - 5850MHz (WLAN 5G)	
GPRS / EGPRS Multislot Class:	12
GPRS capability Class:	B
Test device Production information:	Production unit
Device type:	Portable device
Antenna type:	Integrated antenna
Product Dimensions:	Long 209.4mm; Wide 124.8mm; Overall Diagonal 225mm

**4.2. Internal Identification of EUT used during the test**

EUT ID*	IMEI	HW Version	SW Version	Receipt Date
UT09aa	016178001001151	03	AM3S	2022-01-12
UT10aa	016178001001623	03	AM3S	2022-01-12
UT11aa	016178001001599	03	AM3S	2022-01-12
UT12aa	016178001001649	03	AM3S	2022-01-12

*EUT ID: is used to identify the test sample in the lab internally.

Note: It is performed to test SAR with the UT09aa & UT10aa, and conducted power with the UT11aa & UT12aa.

4.3. Internal Identification of AE used during the test

AE ID*	Description	Type	Manufacturer
AE1	Battery	TLp040M7	VEKEN

*AE ID: is used to identify the test sample in the lab internally.



5. Test Methodology

5.1. Applicable Limit Regulations

ANSI C95.1–1992 IEEE Standard for Safety Levels with Respect to Human Exposure to Radio Frequency Electromagnetic Fields, 3 kHz to 300 GHz

It specifies the maximum exposure limit of **1.60 W/kg** as averaged over any 1 gram of tissue for portable devices being used within 20 cm of the user in the uncontrolled environment.

5.2. Applicable Measurement Standards

IEEE 1528–2013 Recommended Practice for Determining the Peak Spatial-Average Specific Absorption Rate (SAR) in the Human Head from Wireless Communications Devices: Experimental Techniques

KDB 447498 D01 General RF Exposure Guidance v06 Mobile and Portable Devices RF Exposure Procedures and Equipment Authorization Policies

KDB 616217 D04 SAR for laptop and tablets v01r02 SAR Evaluation Considerations for Laptop, Notebook, Notebook and Tablet Computers

KDB 941225 D01 SAR test for 3G devices v03r01 SAR Measurement Procedures for 3G Devices

KDB 941225 D05 SAR for LTE Devices v02r05 SAR Evaluation Considerations for LTE Devices

KDB 248227 D01 802.11 Wi-Fi SAR v02r02 SAR Guidance for IEEE 802.11 (Wi-Fi) Transmitters

KDB 865664 D01 SAR measurement 100 MHz to 6 GHz v01r04 SAR Measurement Requirements for 100 MHz to 6 GHz

KDB 865664 D02 RF Exposure Reporting v01r02 RF Exposure Compliance Reporting and Documentation Considerations

TCB workshop November 2017; RF Exposure Procedures (LTE UL/DL Carrier Aggregation SAR)

TCB workshop May 2017; RF Exposure Procedures (LTE Band 41 Power Class 2)

TCB workshop April 2019; RF Exposure Procedures (Tissue Simulating Liquids)

6. Specific Absorption Rate (SAR)

6.1. Introduction

SAR is related to the rate at which energy is absorbed per unit mass in an object exposed to a radio field. The SAR distribution in a biological body is complicated and is usually carried out by experimental techniques or numerical modeling. The standard recommends limits for two tiers of groups, occupational/controlled and general population/uncontrolled, based on a person's awareness and ability to exercise control over his or her exposure. In general, occupational/controlled exposure limits are higher than the limits for general population/uncontrolled.

6.2. SAR Definition

The SAR definition is the time derivative (rate) of the incremental energy (dW) absorbed by (dissipated in) an incremental mass (dm) contained in a volume element (dv) of a given density (ρ). The equation description is as below:

$$SAR = \frac{d}{dt} \left(\frac{dW}{dm} \right) = \frac{d}{dt} \left(\frac{dW}{\rho dv} \right)$$

SAR is expressed in units of Watts per kilogram (W/kg)

SAR measurement can be either related to the temperature elevation in tissue by

$$SAR = c \left(\frac{\delta T}{\delta t} \right)$$

Where: C is the specific heat capacity, δT is the temperature rise and δt is the exposure duration, or related to the electrical field in the tissue by

$$SAR = \frac{\sigma |E|^2}{\rho}$$

Where: σ is the conductivity of the tissue, ρ is the mass density of tissue and E is the RMS electrical field strength.

However for evaluating SAR of low power transmitter, electrical field measurement is typically applied.

7. Tissue Simulating Liquids

7.1. Targets for tissue simulating liquid

Table 7.1: Targets for tissue simulating liquid

Frequency (MHz)	Liquid Type	Conductivity (σ)	$\pm 5\%$ Range	Permittivity (ϵ)	$\pm 5\%$ Range
750	Head	0.89	0.85~0.93	41.9	39.8~44.0
835	Head	0.90	0.86~0.95	41.5	39.4~43.6
1750	Head	1.37	1.30~1.44	40.1	38.1~42.1
1900	Head	1.40	1.33~1.47	40.0	38.0~42.0
2300	Head	1.67	1.57~1.75	39.5	37.5~41.4
2450	Head	1.80	1.71~1.89	39.2	37.2~41.2
2550	Head	1.91	1.81~2.01	39.1	37.1~41.0
5250	Head	4.71	4.47~4.95	35.9	34.1~37.7
5750	Head	5.22	4.96~5.48	35.4	33.6~37.1

7.2. Dielectric Performance

Table 7.2: Dielectric Performance of Tissue Simulating Liquid

Measurement Date (yyyy-mm-dd)	Type	Frequency	Conductivity σ (S/m)	Drift (%)	Permittivity ϵ	Drift (%)
2022-02-14	Head	750	0.907	1.91	41.35	-1.41
2022-02-12	Head	835	0.885	-1.67	41.94	1.06
2022-01-20	Head	1750	1.379	0.66	39.51	-1.42
2022-02-15	Head	1900	1.381	-1.36	39.28	-1.80
2022-01-24	Head	2300	1.655	-0.90	39.93	1.09
2022-02-17	Head	2450	1.844	2.44	38.44	-1.94
2022-01-28	Head	2550	1.947	1.94	38.19	-2.33
2022-02-18	Head	5250	4.655	-1.17	36.77	2.34
2022-02-18	Head	5750	5.336	2.22	34.51	-2.40



Picture 7-1: Liquid depth in the Flat Phantom (750MHz)



Picture 7-2: Liquid depth in the Flat Phantom (835MHz)

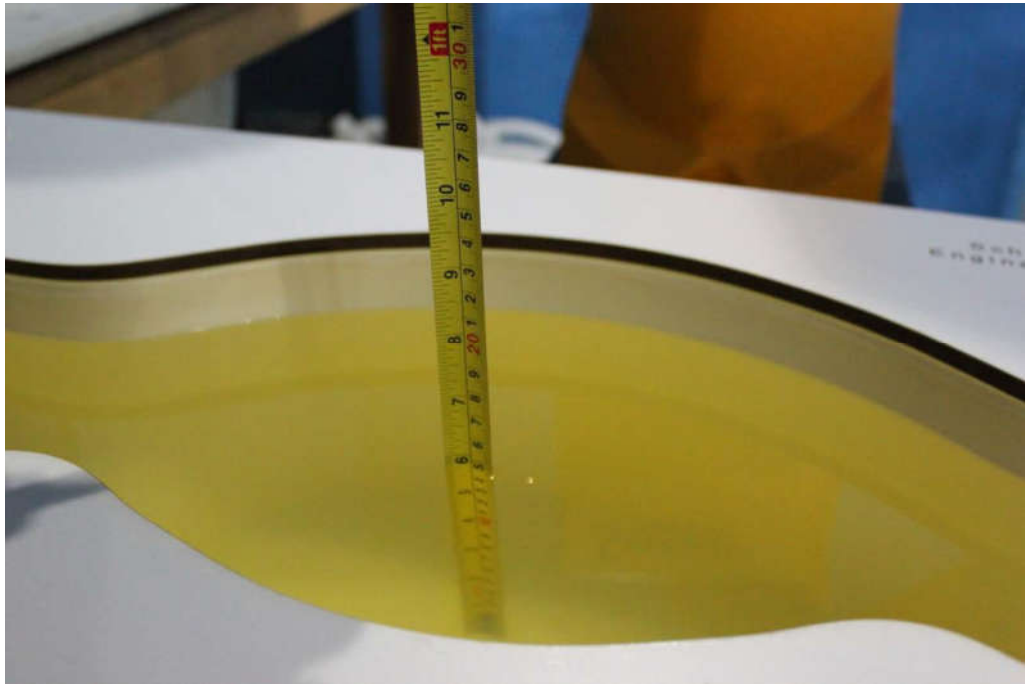

Picture 7-3: Liquid depth in the Flat Phantom (1750MHz)



Picture 7-4: Liquid depth in the Flat Phantom (1900MHz)



Picture 7-5: Liquid depth in the Flat Phantom (2300MHz)

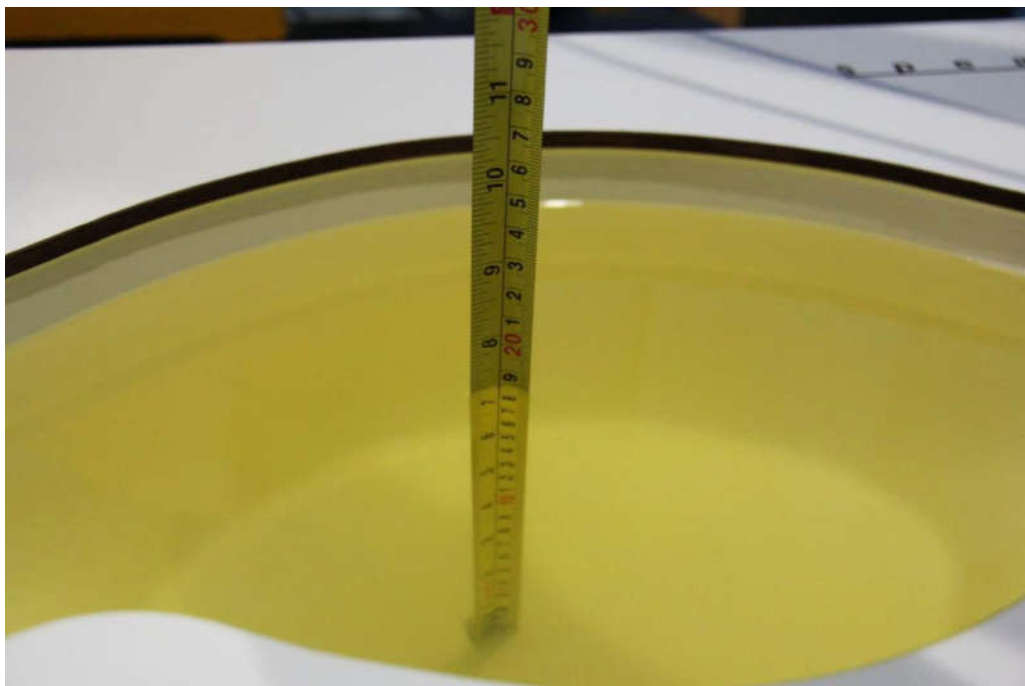

Picture 7-6: Liquid depth in the Flat Phantom(2450MHz)

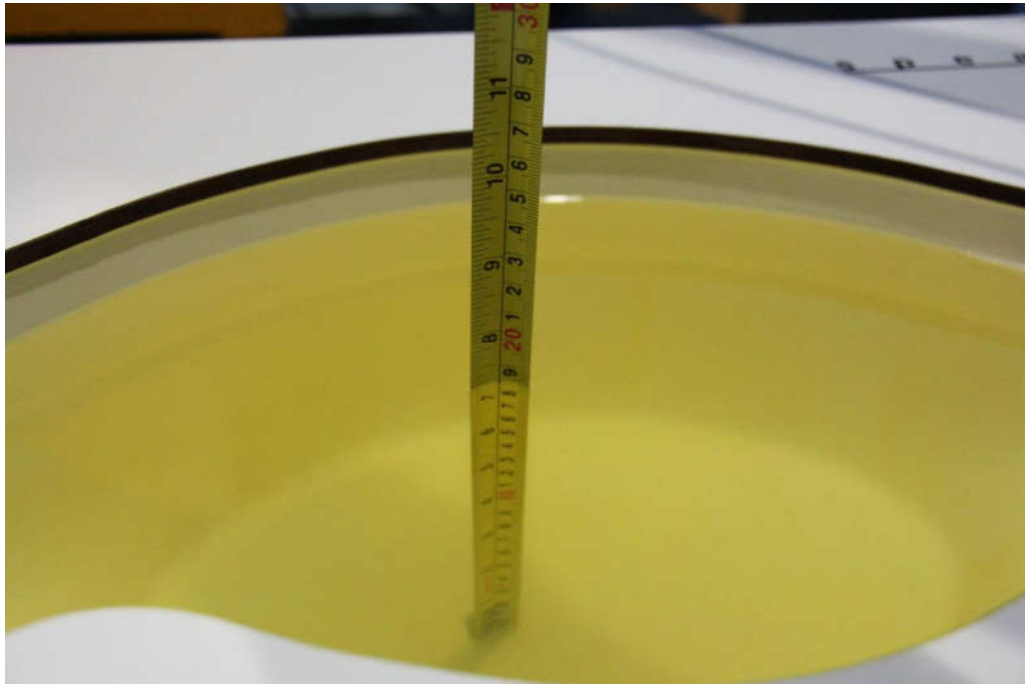

Picture 7-7: Liquid depth in the Flat Phantom(2550MHz)



Picture 7-8: Liquid depth in the Flat Phantom(5GHz)

8. System verification

8.1. System Setup

In the simplified setup for system evaluation, the DUT is replaced by a calibrated dipole and the power source is replaced by a continuous wave that comes from a signal generator. The calibrated dipole must be placed beneath the flat phantom section of the SAM twin phantom with the correct distance holder. The distance holder should touch the phantom surface with a light pressure at the reference marking and be oriented parallel to the long side of the phantom. The equipment setup is shown below:

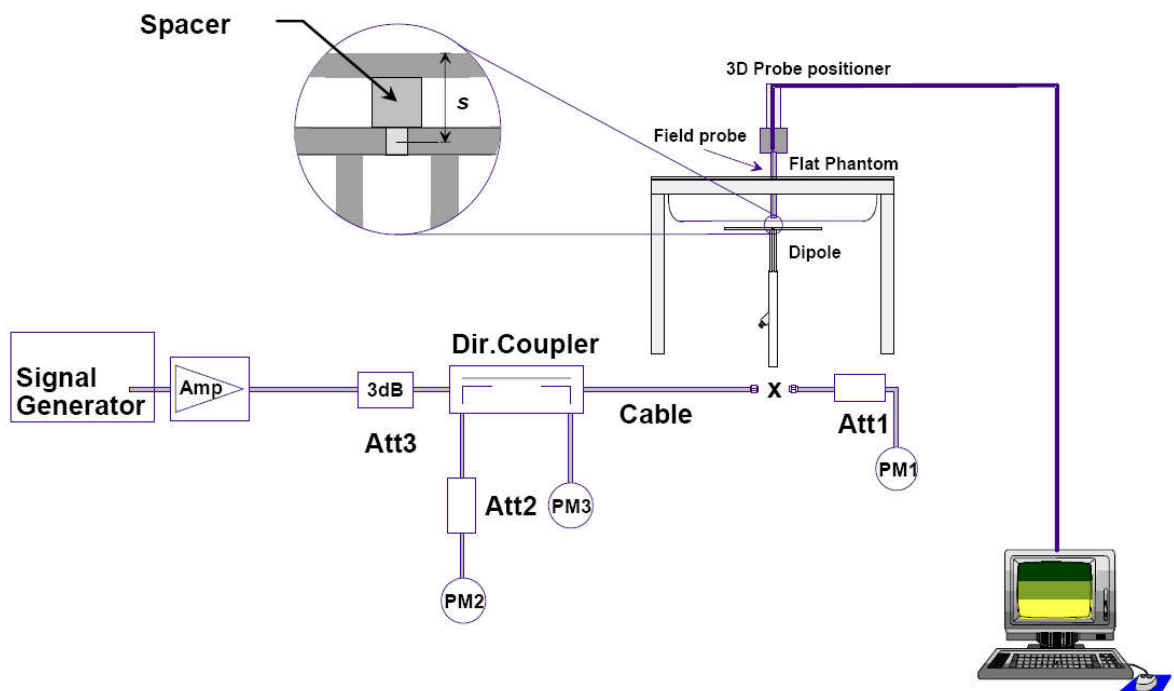

Picture 8.1 System Setup for System Evaluation

For the dipole below 3GHz, the output power on dipole port must be calibrated to 24 dBm (250mW) before dipole is connected.

For the dipole above 3GHz, the output power on dipole port must be calibrated to 20 dBm (100mW) before dipole is connected.



Picture 8.2 Photo of Dipole Setup

8.2. System Verification

SAR system verification is required to confirm measurement accuracy, according to the tissue dielectric media, probe calibration points and other system operating parameters required for measuring the SAR of a test device. The system verification must be performed for each frequency band and within the valid range of each probe calibration point required for testing the device.

Table 8.1: System Verification of Head

Measurement Date	Frequency (MHz)	Target value (W/kg)		Measured value (W/kg)				Deviation (%)	
		10 g	1 g	/		Normalize to 1W		10 g	1 g
				10 g	1 g	10 g	1 g		
2022-02-14	750	5.70	8.53	1.45	2.21	5.82	8.84	2.11	3.63
2022-02-12	835	6.29	9.64	1.54	2.32	6.16	9.28	-2.07	-3.73
2022-01-20	1750	19.30	36.40	4.88	9.32	19.52	37.28	1.14	2.42
2022-02-15	1900	20.50	40.20	5.12	9.70	20.48	38.80	-0.10	-3.48
2022-01-24	2300	22.70	48.30	5.61	11.7	22.44	46.80	-1.15	-3.11
2022-02-17	2450	24.20	53.20	6.23	13.6	24.92	54.40	2.98	3.76
2022-01-28	2550	25.20	55.90	6.47	14.5	25.88	58.00	2.70	3.76
2022-02-18	5250	22.30	78.00	2.16	7.44	21.60	74.40	-3.14	-4.62
2022-02-18	5750	22.20	78.40	2.28	8.18	22.80	81.80	2.70	4.34

9. Measurement Procedures

9.1. Tests to be performed

In order to determine the highest value of the peak spatial-average SAR of a handset, all device positions, configurations and operational modes shall be tested for each frequency band according to steps 1 to 3 below. A flowchart of the test process is shown in picture 9.1.

Step 1: The tests described in 9.2 shall be performed at the channel that is closest to the center of the transmit frequency band (f_c) for:

- a) all device positions (cheek and tilt, for both left and right sides of the SAM phantom, as described in annex D),
- b) all configurations for each device position in a), e.g., antenna extended and retracted, and
- c) all operational modes, e.g., analogue and digital, for each device position in a) and configuration in b) in each frequency band.

If more than three frequencies need to be tested according to 11.1 (i.e., $N_c > 3$), then all frequencies, configurations and modes shall be tested for all of the above test conditions.

Step 2: For the condition providing highest peak spatial-average SAR determined in Step 1, perform all tests described in 9.2 at all other test frequencies, i.e., lowest and highest frequencies. In addition, for all other conditions (device position, configuration and operational mode) where the peak spatial-average SAR value determined in Step 1 is within 3 dB of the applicable SAR limit, it is recommended that all other test frequencies shall be tested as well.

Step 3: Examine all data to determine the highest value of the peak spatial-average SAR found in Steps 1 to 2.

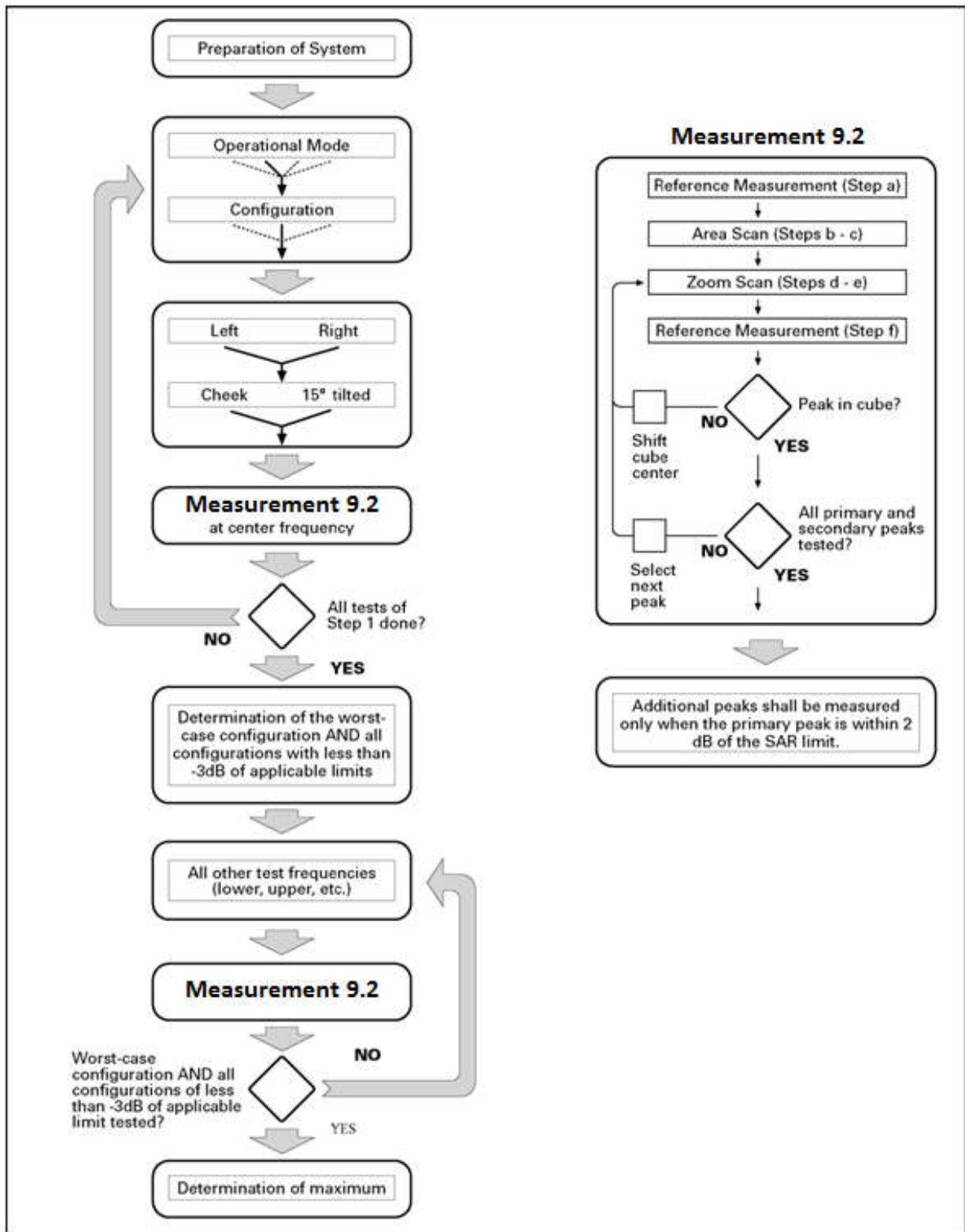

Picture 9.1 Block diagram of the tests to be performed

9.2. General Measurement Procedure

The area and zoom scan resolutions specified in the table below must be applied to the SAR measurements and fully documented in SAR reports to qualify for TCB approval. Probe boundary effect error compensation is required for measurements with the probe tip closer than half a probe tip diameter to the phantom surface. Both the probe tip diameter and sensor offset distance must satisfy measurement protocols; to ensure probe boundary effect errors are minimized and the higher fields closest to the phantom surface can be correctly measured and extrapolated to the phantom surface for computing 1-g SAR. Tolerances of the post-processing algorithms must be verified by the test laboratory for the scan resolutions used in the SAR measurements, according to the reference distribution functions specified in IEEE Std 1528-2013. The results should be documented as part of the system validation records and may be requested to support test results when all the measurement parameters in the following table are not satisfied.

		≤ 3 GHz	> 3 GHz	
Maximum distance from closest measurement point (geometric center of probe sensors) to phantom surface		5 ± 1 mm	$\frac{1}{2} \cdot \delta \cdot \ln(2) \pm 0.5$ mm	
Maximum probe angle from probe axis to phantom surface normal at the measurement location		$30^\circ \pm 1^\circ$	$20^\circ \pm 1^\circ$	
Maximum area scan spatial resolution: Δx_{Area} , Δy_{Area}		≤ 2 GHz: ≤ 15 mm 2 – 3 GHz: ≤ 12 mm	3 – 4 GHz: ≤ 12 mm 4 – 6 GHz: ≤ 10 mm	
		When the x or y dimension of the test device, in the measurement plane orientation, is smaller than the above, the measurement resolution must be \leq the corresponding x or y dimension of the test device with at least one measurement point on the test device.		
Maximum zoom scan spatial resolution: Δx_{Zoom} , Δy_{Zoom}		≤ 2 GHz: ≤ 8 mm 2 – 3 GHz: ≤ 5 mm*	3 – 4 GHz: ≤ 5 mm* 4 – 6 GHz: ≤ 4 mm*	
Maximum zoom scan spatial resolution, normal to phantom surface	uniform grid: $\Delta z_{Zoom}(n)$	≤ 5 mm	3 – 4 GHz: ≤ 4 mm 4 – 5 GHz: ≤ 3 mm 5 – 6 GHz: ≤ 2 mm	
	graded grid	$\Delta z_{Zoom}(1)$: between 1 st two points closest to phantom surface	≤ 4 mm	3 – 4 GHz: ≤ 3 mm 4 – 5 GHz: ≤ 2.5 mm 5 – 6 GHz: ≤ 2 mm
		$\Delta z_{Zoom}(n>1)$: between subsequent points	$\leq 1.5 \cdot \Delta z_{Zoom}(n-1)$	
Minimum zoom scan volume	x, y, z	≥ 30 mm	3 – 4 GHz: ≥ 28 mm 4 – 5 GHz: ≥ 25 mm 5 – 6 GHz: ≥ 22 mm	
Note: δ is the penetration depth of a plane-wave at normal incidence to the tissue medium; see draft standard IEEE P1528-2011 for details. * When zoom scan is required and the <i>reported</i> SAR from the area scan based 1-g SAR estimation procedures of KDB 447498 is ≤ 1.4 W/kg, ≤ 8 mm, ≤ 7 mm and ≤ 5 mm zoom scan resolution may be applied, respectively, for 2 GHz to 3 GHz, 3 GHz to 4 GHz and 4 GHz to 6 GHz.				

9.3. WCDMA Measurement Procedures for SAR

The following procedures are applicable to WCDMA handsets operating under 3GPP Release99, Release 5 and Release 6. The default test configuration is to measure SAR with an established radio link between the DUT and a communication test set using a 12.2kbps RMC (reference measurement channel) configured in Test Loop Mode 1. SAR is selectively confirmed for other physical channel configurations (DPCCH & DPDCH_n), HSDPA and HSPA (HSUPA/HSDPA) modes according to output power, exposure conditions and device operating capabilities. Both uplink and downlink should be configured with the same RMC or AMR, when required. SAR for Release 5 HSDPA and Release 6 HSPA are measured using the applicable FRC (fixed reference channel) and E-DCH reference channel configurations. Maximum output power is verified according to applicable versions of 3GPP TS 34.121 and SAR must be measured according to these maximum output conditions. When Maximum Power Reduction (MPR) is not implemented according to Cubic Metric (CM) requirements for Release 6 HSPA, the following procedures do not apply.

For Release 5 HSDPA Data Devices:

Sub-test	β_c	β_d	β_d (SF)	β_c / β_d	β_{hs}	CM/dB
1	2/15	15/15	64	2/15	4/15	0.0
2	12/15	15/15	64	12/15	24/25	1.0
3	15/15	8/15	64	15/8	30/15	1.5
4	15/15	4/15	64	15/4	30/15	1.5

For Release 6 HSPA Data Devices

Sub-test	β_c	β_d	β_d (SF)	β_c / β_d	β_{hs}	β_{ec}	β_{ed}	β_{ed} (SF)	β_{ed} (codes)	CM (dB)	MPR (dB)	AG Index	E-TFCI
1	11/15	15/15	64	11/15	22/15	209/225	1039/225	4	1	1.0	0.0	20	75
2	6/15	15/15	64	6/15	12/15	12/15	12/15	4	1	3.0	2.0	12	67
3	15/15	9/15	64	15/9	30/15	30/15	$\beta_{ed1}:47/1$ 5 $\beta_{ed2}:47/15$	4	2	2.0	1.0	15	92
4	2/15	15/15	64	2/15	4/15	4/15	56/75	4	1	3.0	2.0	17	71
5	15/15	15/15	64	15/15	24/15	30/15	134/15	4	1	1.0	0.0	21	81

9.4. LTE Measurement Procedures for SAR

SAR tests for LTE are performed with a base station simulator, Anristu MT8820C. Closed loop power control was used so the UE transmits with maximum output power during SAR testing. All powers were measured with the Anristu MT8820C. It is performed for conducted power and SAR based on the KDB941225 D05.

SAR is evaluated separately according to the following procedures for the different test positions in each exposure condition – head, body, body-worn accessories and other use conditions. The procedures in the following subsections are applied separately to test each LTE frequency band.

1) QPSK with 1 RB allocation

Start with the largest channel bandwidth and measure SAR for QPSK with 1 RB allocation, using the RB offset and required test channel combination with the highest maximum output power among RB offsets at the upper edge, middle and lower edge of each required test channel. When the reported SAR is ≤ 0.8 W/kg, testing of the remaining RB offset configurations and required test channels is not required for 1 RB allocation; otherwise, SAR is required for the remaining required test channels and only for the RB offset configuration with the highest output power for that channel. When the reported SAR of a required test channel is > 1.45 W/kg, SAR is required for all three RB offset configurations for that required test channel.

2) QPSK with 50% RB allocation

The procedures required for 1 RB allocation in 1) are applied to measure the SAR for QPSK with 50% RB allocation.

3) QPSK with 100% RB allocation

For QPSK with 100% RB allocation, SAR is not required when the highest maximum output power for 100 % RB allocation is less than the highest maximum output power in 50% and 1 RB allocations and the highest reported SAR for 1 RB and 50% RB allocation in 1) and 2) are ≤ 0.8 W/kg. Otherwise, SAR is measured for the highest output power channel; and if the reported SAR is > 1.45 W/kg, the remaining required test channels must also be tested.

9.5 LTE (TDD) Considerations

According to KDB 941225 D05 SAR for LTE Devices, for Time-Division Duplex (TDD) systems, SAR must be tested using a fixed periodic duty factor according to the highest transmission duty factor implemented for the device and supported by the defined 3GPP LTE TDD configurations.

SAR was tested with the highest transmission duty factor (63.33%) using Uplink-downlink configuration 0 and Special subframe configuration 7.

LTE TDD Band 41 support 3GPP TS 36.211 section 4.2 for Type 2 Frame Structure and Table 4.2-2 for uplink-downlink configurations and Table 4.2-1 for Special subframe configurations.

Special subframe configuration	Normal cyclic prefix in downlink			Extended cyclic prefix in downlink		
	DwPTS	UpPTS		DwPTS	UpPTS	
		Normal cyclic prefix in uplink	Extended cyclic prefix in uplink		Normal cyclic prefix in uplink	Extended cyclic prefix in uplink
0	$6592 \cdot T_s$	$2192 \cdot T_s$	$2560 \cdot T_s$	$7680 \cdot T_s$	$2192 \cdot T_s$	$2560 \cdot T_s$
1	$19760 \cdot T_s$			$20480 \cdot T_s$		
2	$21952 \cdot T_s$			$23040 \cdot T_s$		
3	$24144 \cdot T_s$			$25600 \cdot T_s$		
4	$26336 \cdot T_s$			$7680 \cdot T_s$		
5	$6592 \cdot T_s$	$4384 \cdot T_s$	$5120 \cdot T_s$	$20480 \cdot T_s$	$4384 \cdot T_s$	$5120 \cdot T_s$
6	$19760 \cdot T_s$			$23040 \cdot T_s$		
7	$21952 \cdot T_s$			$12800 \cdot T_s$		
8	$24144 \cdot T_s$			-		
9	$13168 \cdot T_s$			-		

Configuration of special subframe (lengths of DwPTS/GP/UpPTS)

Uplink-Downlink Configuration	Downlink-to-Uplink Switch-point Periodicity	Subframe Number										Calculated Duty Cycle (%)
		0	1	2	3	4	5	6	7	8	9	
0	5 ms	D	S	U	U	U	D	S	U	U	U	63.33
1	5 ms	D	S	U	U	D	D	S	U	U	D	43.33
2	5 ms	D	S	U	D	D	D	S	U	D	D	23.33
3	10 ms	D	S	U	U	U	D	D	D	D	D	31.67
4	10 ms	D	S	U	U	D	D	D	D	D	D	21.67
5	10 ms	D	S	U	D	D	D	D	D	D	D	11.67
6	5 ms	D	S	U	U	U	D	S	U	U	D	53.33

Calculated Duty Cycle

Calculated Duty Cycle = Extended cyclic prefix in uplink x (Ts) x # of S + # of U

Example for Calculated Duty Cycle for Uplink-Downlink Configuration 0:

Calculated Duty Cycle = $5120 \times [1/(15000 \times 2048)] \times 2 + 6 \text{ ms} = 63.33\%$

Where

$T_s = 1/(15000 \times 2048)$ seconds

Note:

1. From May 2017 TCB Workshop, HPUE does not support uplink-downlink configurations 0 and 6.
2. This device supports uplink-downlink configurations 0-6. The configuration with highest duty cycle was used for SAR Testing: configuration 0 at 63.3% (Power Class 3) and configuration 1 at 43.3% (Power Class 2) duty cycle.

9.6. Bluetooth & WLAN Measurement Procedures for SAR

Normal network operating configurations are not suitable for measuring the SAR of 802.11 transmitters in general. Unpredictable fluctuations in network traffic and antenna diversity conditions can introduce undesirable variations in SAR results. The SAR for these devices should be measured using chipset based test mode software to ensure that the results are consistent and reliable.

Chipset based test mode software is hardware dependent and generally varies among



manufacturers. The device operating parameters established in a test mode for SAR measurements must be identical to those programmed in production units, including output power levels, amplifier gain settings and other RF performance tuning parameters. The test frequencies should correspond to actual channel frequencies defined for domestic use. SAR for devices with switched diversity should be measured with only one antenna transmitting at a time during each SAR measurement, according to a fixed modulation and data rate. The same data pattern should be used for all measurements.

9.7. Power Drift

To control the output power stability during the SAR test, DASY5 system calculates the power drift by measuring the E-field at the same location at the beginning and at the end of the measurement for each test position. These drift values can be found in Section 14 labeled as: (Power Drift [dB]). This ensures that the power drift during one measurement is within 5%.

9.8. Proximity Sensor Considerations

This device uses a proximity sensor that share the same metallic electrode as the transmitting antenna to facilitate triggering in typical user interactivity with the device. Due to the operating configurations and exposure conditions required by the device, the proximity sensor is used to indicate when the tablet is held close to a user's body exposure condition. It utilizes the proximity sensor to reduce the output power in specific wireless and operating modes to ensure SAR compliance for the following scenarios: To reduce the output power of main antennas during body operating configurations. . It is also set an output power leveled to the lowest one to make sure that in any case of SAR sensor hardware failure the SAR requirements can still be satisfied.

Sensor triggering distance summary data is included in Appendix K.

10. Conducted Output Power

10.1. GSM Measurement result

During the process of testing, the EUT was controlled via Agilent Digital Radio Communication tester (E5515C) to ensure the maximum power transmission and proper modulation. This result contains conducted output power for the EUT. In all cases, the measured peak output power should be greater and within 5% than EMI measurement.

Table 10.1: The conducted power measurement results for GPRS and EGPRS

Full Power								
GPRS850/ EGPRS850	Tune up	Measured Power (dBm)			calculation	Average Power (dBm)		
		251	190	128		251	190	128
1Tx-slots	34.0	32.84	32.87	32.86	-9.03dB	23.81	23.84	23.83
2Tx-slots	33.5	32.16	32.17	32.16	-6.02dB	26.14	26.15	26.14
3Tx-slots	31.5	30.45	30.44	30.47	-4.26dB	26.19	26.18	26.21
4Tx-slots	30.5	29.40	29.39	29.40	-3.01dB	26.39	26.38	26.39
EGPRS 850 (8PSK)	Tune up	Measured Power (dBm)			calculation	Measured Power (dBm)		
		251	190	128		251	190	128
1Tx-slots	28.5	27.51	27.35	27.38	-9.03dB	18.48	18.32	18.35
2Tx-slots	27.5	26.46	26.29	26.35	-6.02dB	20.44	20.27	20.33
3Tx-slots	25.5	24.29	24.13	24.21	-4.26dB	20.03	19.87	19.95
4Tx-slots	24.5	23.18	23.07	23.14	-3.01dB	20.17	20.06	20.13
Sensor on								
GPRS850/ EGPRS850	Tune up	Measured Power (dBm)			calculation	Average Power (dBm)		
		251	190	128		251	190	128
1Tx-slots	28.5	27.86	27.87	27.93	-9.03dB	18.83	18.84	18.90
2Tx-slots	27.0	26.55	26.55	26.63	-6.02dB	20.53	20.53	20.61
3Tx-slots	23.5	22.81	22.80	22.94	-4.26dB	18.55	18.54	18.68
4Tx-slots	20.5	20.02	20.02	20.08	-3.01dB	17.01	17.01	17.07
EGPRS 850 (8PSK)	Tune up	Measured Power (dBm)			calculation	Measured Power (dBm)		
		251	190	128		251	190	128
1Tx-slots	23.5	22.42	22.47	22.39	-9.03dB	13.39	13.44	13.36
2Tx-slots	22.5	21.45	21.24	21.30	-6.02dB	15.43	15.22	15.28
3Tx-slots	20.5	19.36	19.22	19.26	-4.26dB	15.10	14.96	15.00
4Tx-slots	19.5	18.32	18.22	18.25	-3.01dB	15.31	15.21	15.24

Full Power								
GPRS1900/ EGPRS1900	Tune up	Measured Power (dBm)			calculation	Average Power (dBm)		
		810	661	512		810	661	512
1Tx-slots	31.5	30.09	30.27	30.41	-9.03dB	21.06	21.24	21.38
2Tx-slots	30.5	29.44	29.61	29.75	-6.02dB	23.42	23.59	23.73
3Tx-slots	29.5	28.24	28.35	28.49	-4.26dB	23.47	23.59	23.73
4Tx-slots	29.0	27.73	27.85	27.99	-3.01dB	24.72	24.84	24.98
EGPRS1900 (8PSK)	Tune up	Measured Power (dBm)			calculation	Measured Power (dBm)		
		810	661	512		810	661	512
1Tx-slots	27.5	26.73	26.51	26.52	-9.03dB	17.70	17.48	17.49
2Tx-slots	26.5	25.79	25.74	25.70	-6.02dB	19.77	19.72	19.68
3Tx-slots	25.5	24.20	23.96	23.91	-4.26dB	19.94	19.70	19.65
4Tx-slots	24.5	23.25	23.03	22.96	-3.01dB	20.24	20.02	19.95
Sensor on								
GPRS1900/ EGPRS1900	Tune up	Measured Power (dBm)			calculation	Average Power (dBm)		
		810	661	512		810	661	512
1Tx-slots	24.5	23.35	23.54	23.76	-9.03dB	14.32	14.51	14.73
2Tx-slots	23.0	21.91	22.10	22.33	-6.02dB	15.89	16.08	16.31
3Tx-slots	18.5	17.39	17.51	17.77	-4.26dB	13.13	13.25	13.51
4Tx-slots	14.5	13.08	13.25	13.56	-3.01dB	10.07	10.24	10.55
EGPRS1900 (8PSK)	Tune up	Measured Power (dBm)			calculation	Measured Power (dBm)		
		810	661	512		810	661	512
1Tx-slots	20.5	19.94	19.70	19.60	-9.03dB	10.91	10.67	10.57
2Tx-slots	19.5	18.95	18.74	18.61	-6.02dB	12.93	12.72	12.59
3Tx-slots	17.5	16.98	16.88	16.62	-4.26dB	12.72	12.62	12.36
4Tx-slots	16.5	15.96	15.76	15.59	-3.01dB	12.95	12.75	12.58

Note:

1) Division Factors

To average the power, the division factor is as follows:

1TX-slot = 1 transmit time slot out of 8 time slots=> conducted power divided by (8/1) => -9.03dB

2TX-slots = 2 transmit time slots out of 8 time slots=> conducted power divided by (8/2) => -6.02dB

3TX-slots = 3 transmit time slots out of 8 time slots=> conducted power divided by (8/3) => -4.26dB

4TX-slots = 4 transmit time slots out of 8 time slots=> conducted power divided by (8/4) => -3.01dB

According to the conducted power as above, the body full power mode measurements are performed with 4Tx slots for 850MHz and 1900MHz, the body sensor on mode measurements are performed with 2Tx slots for 850MHz and 1900MHz.

10.2. WCDMA Measurement result

Table 10.2: The conducted power measurement results WCDMA

Full Power					
Item	band	WCDMA Band 2			
	ARFCN	Tune up	Ch. 9538 (1907.6MHz)	Ch. 9400 (1880MHz)	Ch. 9262 (1852.4MHz)
WCDMA	\	24.5	23.7	23.8	23.8
HSUPA	1	22.0	21.2	21.3	21.3
	2	21.5	20.8	20.8	20.9
	3	22.5	21.8	21.7	21.8
	4	21.0	20.3	20.3	20.4
	5	22.5	21.8	21.8	21.8
HSDPA	1	23.5	22.8	22.8	22.8
	2	23.5	22.7	22.8	22.8
	3	23.0	22.2	22.3	22.3
	4	23.0	22.2	22.2	22.2
DC-HSDPA	1	23.5	22.7	22.7	22.7
	2	23.5	22.6	22.7	22.7
	3	23.0	22.1	22.2	22.2
	4	23.0	22.1	22.1	22.1
Sensor on					
Item	band	WCDMA Band 2			
	ARFCN	Tune up	Ch. 9538 (1907.6MHz)	Ch. 9400 (1880MHz)	Ch. 9262 (1852.4MHz)
WCDMA	\	15.5	14.9	14.9	15.0
HSUPA	1	14.0	13.4	13.5	13.5
	2	14.5	13.9	13.9	14.0
	3	14.0	13.4	12.9	13.0
	4	14.5	13.9	14.0	14.0
	5	13.5	12.8	12.9	13.0
HSDPA	1	14.5	13.9	14.0	14.0
	2	14.5	13.9	13.9	14.0
	3	14.0	13.4	13.5	13.5
	4	14.0	13.4	13.4	13.5
DC-HSDPA	1	14.5	13.8	13.9	13.9
	2	14.5	13.8	13.8	13.9
	3	14.0	13.3	13.4	13.4
	4	14.0	13.3	13.3	13.4

Full Power					
Item	band	WCDMA Band 4			
	ARFCN	Tune up	Ch. 1513 (1752.6MHz)	Ch. 1413 (1732.6MHz)	Ch. 1312 (1712.4MHz)
WCDMA	\	24.5	23.5	23.6	23.5
HSUPA	1	22.0	21.0	21.1	21.1
	2	21.5	20.6	20.5	20.7
	3	22.5	21.5	21.5	21.6
	4	21.0	20.1	20.1	20.1
	5	22.5	21.4	21.4	21.5
HSDPA	1	23.5	22.5	22.6	22.6
	2	23.5	22.5	22.5	22.6
	3	23.0	22.0	22.1	22.1
	4	23.0	21.9	22.0	22.1
DC-HSDPA	1	23.5	22.4	22.5	22.5
	2	23.5	22.4	22.4	22.5
	3	23.0	21.9	22.0	22.0
	4	23.0	21.8	21.9	22.0
Sensor on					
Item	band	WCDMA Band 4			
	ARFCN	Tune up	Ch. 1513 (1752.6MHz)	Ch. 1413 (1732.6MHz)	Ch. 1312 (1712.4MHz)
WCDMA	\	15.5	14.7	14.7	14.8
HSUPA	1	14.0	13.2	13.3	13.3
	2	14.5	13.7	13.7	13.8
	3	14.0	12.7	12.8	12.8
	4	14.5	13.7	13.8	13.7
	5	13.5	12.7	12.7	12.7
HSDPA	1	14.5	13.7	13.7	13.8
	2	14.5	13.6	13.7	13.7
	3	14.0	13.1	13.2	13.2
	4	14.0	13.1	13.2	13.2
DC-HSDPA	1	14.5	13.6	13.6	13.7
	2	14.5	13.5	13.6	13.6
	3	14.0	13.0	13.1	13.1
	4	14.0	13.0	13.1	13.1

Full Power					
Item	band	WCDMA Band 5			
	ARFCN	Tune up	Ch. 4233 (846.6MHz)	Ch. 4182 (836.4MHz)	Ch. 4132 (826.4MHz)
WCDMA	\	24.5	23.7	23.7	23.6
HSUPA	1	22.0	21.2	21.1	21.2
	2	21.5	20.7	20.7	20.7
	3	22.5	21.6	21.7	21.7
	4	21.0	20.2	20.2	20.2
	5	22.5	21.7	21.7	21.6
HSDPA	1	23.5	22.7	22.7	22.7
	2	23.5	22.6	22.6	22.6
	3	23.0	22.1	22.1	22.2
	4	23.0	22.1	22.1	22.1
DC-HSDPA	1	23.5	22.6	22.6	22.6
	2	23.5	22.5	22.5	22.5
	3	23.0	22.0	22.0	22.1
	4	23.0	22.0	22.0	22.0
Sensor on					
Item	band	WCDMA Band 5			
	ARFCN	Tune up	Ch. 4233 (846.6MHz)	Ch. 4182 (836.4MHz)	Ch. 4132 (826.4MHz)
WCDMA	\	19.5	18.4	18.4	18.5
HSUPA	1	17.5	16.9	15.9	16.0
	2	16.5	15.5	15.5	15.6
	3	17.5	16.4	16.5	16.5
	4	16.0	15.0	15.0	15.1
	5	17.5	16.5	16.4	16.6
HSDPA	1	18.5	17.4	17.5	17.6
	2	18.5	17.4	17.5	17.5
	3	18.0	17.0	17.0	17.0
	4	18.0	16.9	17.0	17.0
DC-HSDPA	1	18.5	17.3	17.4	17.5
	2	18.5	17.3	17.4	17.4
	3	18.0	16.9	16.9	16.9
	4	18.0	16.8	16.9	16.9

10.3. LTE Measurement result

According to April 2015 TCB workshop, SAR Test exclusion can be applied for testing overlapping LTE Bands as follows:

- a) The maximum out power, including tolerance, for the smaller band must be \leq the larger band to qualify for SAR test exclusion.
- b) The channel bandwidth and other operating parameters for the smaller band must be fully supported by the larger band.

LTE Band 2 (1850-1910MHz) is covered by LTE Band 25 (1850-1915MHz)

LTE Band 4 (1710-1755MHz) is covered by LTE Band 66 (1710-1780MHz)

LTE Band 5 (824-849MHz) is covered by LTE Band 26 (814-849MHz)

LTE Band 17 (704-716MHz) is covered by LTE Band 12 (699-716MHz)

Table 10.3: The conducted Power for LTE

Full Power								
LTE Band 7			Actual output Power (dBm)			Tune up		
Band -width	RB No. / RB offset	Frequency	Modulation			Modulation		
			QPSK	16QAM	64QAM	QPSK	16QAM	64QAM
5 MHz	1RB_24	2567.4MHz	21.83	21.07	/	22.5	22.0	/
		2535MHz	21.82	21.10	/	22.5	22.0	/
		2502.5MHz	21.89	21.16	/	22.5	22.0	/
	1RB_12	2567.4MHz	22.12	21.37	/	22.5	22.0	/
		2535MHz	22.13	21.40	/	22.5	22.0	/
		2502.5MHz	22.14	21.44	/	22.5	22.0	/
	1RB_0	2567.4MHz	21.75	21.07	/	22.5	22.0	/
		2535MHz	21.81	21.04	/	22.5	22.0	/
		2502.5MHz	21.87	21.12	/	22.5	22.0	/
	12RB_13	2567.4MHz	20.93	19.97	/	22.0	21.0	/
		2535MHz	20.97	19.96	/	22.0	21.0	/
		2502.5MHz	21.00	20.04	/	22.0	21.0	/
	12RB_6	2567.4MHz	21.00	20.03	/	22.0	21.0	/
		2535MHz	21.02	20.04	/	22.0	21.0	/
		2502.5MHz	21.11	20.08	/	22.0	21.0	/
	12RB_0	2567.4MHz	20.93	19.95	/	22.0	21.0	/
		2535MHz	20.95	19.97	/	22.0	21.0	/
		2502.5MHz	21.03	20.01	/	22.0	21.0	/
	25RB_0	2567.4MHz	20.94	19.97	/	22.0	21.0	/
		2535MHz	21.01	19.98	/	22.0	21.0	/
		2502.5MHz	21.07	20.08	/	22.0	21.0	/



Full Power								
LTE Band 7			Actual output Power (dBm)			Tune up		
Band -width	RB No. / RB offset	Frequency	Modulation			Modulation		
			QPSK	16QAM	64QAM	QPSK	16QAM	64QAM
10 MHz	1RB_49	2565MHz	21.87	21.17	/	22.5	22.0	/
		2535MHz	21.89	21.22	/	22.5	22.0	/
		2505MHz	21.93	21.23	/	22.5	22.0	/
	1RB_24	2565MHz	22.03	21.30	/	22.5	22.0	/
		2535MHz	22.04	21.34	/	22.5	22.0	/
		2505MHz	22.11	21.38	/	22.5	22.0	/
	1RB_0	2565MHz	21.84	21.13	/	22.5	22.0	/
		2535MHz	21.84	21.13	/	22.5	22.0	/
		2505MHz	21.91	21.19	/	22.5	22.0	/
	25RB_25	2565MHz	20.97	19.99	/	22.0	21.0	/
		2535MHz	20.99	20.00	/	22.0	21.0	/
		2505MHz	21.09	20.08	/	22.0	21.0	/
	25RB_12	2565MHz	21.00	20.01	/	22.0	21.0	/
		2535MHz	21.04	20.03	/	22.0	21.0	/
		2505MHz	21.05	20.08	/	22.0	21.0	/
	25RB_0	2565MHz	20.98	20.01	/	22.0	21.0	/
		2535MHz	21.00	20.01	/	22.0	21.0	/
		2505MHz	21.09	20.09	/	22.0	21.0	/
	50RB_0	2565MHz	20.96	20.00	/	22.0	21.0	/
		2535MHz	20.99	20.01	/	22.0	21.0	/
		2505MHz	21.04	20.08	/	22.0	21.0	/



Full Power								
LTE Band 7			Actual output Power (dBm)			Tune up		
Band -width	RB No. / RB offset	Frequency	Modulation			Modulation		
			QPSK	16QAM	64QAM	QPSK	16QAM	64QAM
15 MHz	1RB_74	2562.5MHz	21.88	21.23	/	22.5	22.0	/
		2535MHz	21.90	21.25	/	22.5	22.0	/
		2507.5MHz	21.89	21.21	/	22.5	22.0	/
	1RB_37	2562.5MHz	21.96	21.27	/	22.5	22.0	/
		2535MHz	21.92	21.27	/	22.5	22.0	/
		2507.5MHz	22.02	21.34	/	22.5	22.0	/
	1RB_0	2562.5MHz	21.80	21.17	/	22.5	22.0	/
		2535MHz	21.79	21.11	/	22.5	22.0	/
		2507.5MHz	21.89	21.19	/	22.5	22.0	/
	36RB_38	2562.5MHz	21.00	19.99	/	22.0	21.0	/
		2535MHz	20.97	19.96	/	22.0	21.0	/
		2507.5MHz	21.06	20.06	/	22.0	21.0	/
	36RB_19	2562.5MHz	21.00	20.02	/	22.0	21.0	/
		2535MHz	20.98	20.00	/	22.0	21.0	/
		2507.5MHz	21.08	20.09	/	22.0	21.0	/
	36RB_0	2562.5MHz	20.95	19.96	/	22.0	21.0	/
		2535MHz	20.98	19.96	/	22.0	21.0	/
		2507.5MHz	21.06	20.04	/	22.0	21.0	/
	75RB_0	2562.5MHz	20.98	20.01	/	22.0	21.0	/
		2535MHz	20.97	19.99	/	22.0	21.0	/
		2507.5MHz	21.07	20.08	/	22.0	21.0	/



Full Power								
LTE Band 7			Actual output Power (dBm)			Tune up		
Band -width	RB No. / RB offset	Frequency	Modulation			Modulation		
			QPSK	16QAM	64QAM	QPSK	16QAM	64QAM
20 MHz	1RB_99	2560MHz	21.89	21.11	/	22.5	22.0	/
		2535MHz	21.85	21.21	/	22.5	22.0	/
		2510MHz	21.89	21.21	/	22.5	22.0	/
	1RB_50	2560MHz	22.00	21.38	/	22.5	22.0	/
		2535MHz	22.03	21.37	/	22.5	22.0	/
		2510MHz	22.06	21.46	/	22.5	22.0	/
	1RB_0	2560MHz	21.74	21.06	/	22.5	22.0	/
		2535MHz	21.72	21.05	/	22.5	22.0	/
		2510MHz	21.87	21.15	/	22.5	22.0	/
	50RB_50	2560MHz	20.95	20.02	/	22.0	21.0	/
		2535MHz	20.92	19.95	/	22.0	21.0	/
		2510MHz	21.11	20.12	/	22.0	21.0	/
	50RB_25	2560MHz	20.99	20.02	/	22.0	21.0	/
		2535MHz	20.99	20.02	/	22.0	21.0	/
		2510MHz	20.58	20.11	/	22.0	21.0	/
	50RB_0	2560MHz	20.92	19.94	/	22.0	21.0	/
		2535MHz	20.97	19.98	/	22.0	21.0	/
		2510MHz	20.98	20.03	/	22.0	21.0	/
100RB_0	2560MHz	20.97	19.97	/	22.0	21.0	/	
	2535MHz	20.93	19.98	/	22.0	21.0	/	
	2510MHz	21.07	20.09	/	22.0	21.0	/	



Sensor on								
LTE Band 7			Actual output Power (dBm)			Tune up		
Band -width	RB No. / RB offset	Frequency	Modulation			Modulation		
			QPSK	16QAM	64QAM	QPSK	16QAM	64QAM
5 MHz	1RB_24	2567.4MHz	13.73	13.15	/	14.5	14.0	/
		2535MHz	13.74	13.14	/	14.5	14.0	/
		2502.5MHz	13.80	13.14	/	14.5	14.0	/
	1RB_12	2567.4MHz	13.96	13.35	/	14.5	14.0	/
		2535MHz	14.03	13.37	/	14.5	14.0	/
		2502.5MHz	14.01	13.35	/	14.5	14.0	/
	1RB_0	2567.4MHz	13.74	13.16	/	14.5	14.0	/
		2535MHz	13.74	13.08	/	14.5	14.0	/
		2502.5MHz	13.73	13.10	/	14.5	14.0	/
	12RB_13	2567.4MHz	12.87	11.86	/	14.0	13.0	/
		2535MHz	12.90	11.89	/	14.0	13.0	/
		2502.5MHz	12.76	11.74	/	14.0	13.0	/
	12RB_6	2567.4MHz	12.93	11.92	/	14.0	13.0	/
		2535MHz	12.95	11.92	/	14.0	13.0	/
		2502.5MHz	12.97	11.96	/	14.0	13.0	/
	12RB_0	2567.4MHz	12.86	11.84	/	14.0	13.0	/
		2535MHz	12.92	11.91	/	14.0	13.0	/
		2502.5MHz	12.88	11.86	/	14.0	13.0	/
	25RB_0	2567.4MHz	12.36	11.35	/	14.0	13.0	/
		2535MHz	12.89	11.90	/	14.0	13.0	/
		2502.5MHz	12.82	11.83	/	14.0	13.0	/



Sensor on								
LTE Band 7			Actual output Power (dBm)			Tune up		
Band -width	RB No. / RB offset	Frequency	Modulation			Modulation		
			QPSK	16QAM	64QAM	QPSK	16QAM	64QAM
10 MHz	1RB_49	2565MHz	13.83	13.20	/	14.5	14.0	/
		2535MHz	13.81	13.23	/	14.5	14.0	/
		2505MHz	13.82	13.25	/	14.5	14.0	/
	1RB_24	2565MHz	13.91	13.26	/	14.5	14.0	/
		2535MHz	13.97	13.35	/	14.5	14.0	/
		2505MHz	14.00	13.35	/	14.5	14.0	/
	1RB_0	2565MHz	13.75	13.15	/	14.5	14.0	/
		2535MHz	13.81	13.19	/	14.5	14.0	/
		2505MHz	13.78	13.20	/	14.5	14.0	/
	25RB_25	2565MHz	12.89	11.91	/	14.0	13.0	/
		2535MHz	12.91	11.96	/	14.0	13.0	/
		2505MHz	12.82	11.81	/	14.0	13.0	/
	25RB_12	2565MHz	12.93	11.93	/	14.0	13.0	/
		2535MHz	12.93	11.93	/	14.0	13.0	/
		2505MHz	12.92	11.91	/	14.0	13.0	/
	25RB_0	2565MHz	12.93	11.91	/	14.0	13.0	/
		2535MHz	12.94	11.98	/	14.0	13.0	/
		2505MHz	12.95	11.96	/	14.0	13.0	/
	50RB_0	2565MHz	12.39	11.37	/	14.0	13.0	/
		2535MHz	12.90	11.93	/	14.0	13.0	/
		2505MHz	12.84	11.84	/	14.0	13.0	/



Sensor on								
LTE Band 7			Actual output Power (dBm)			Tune up		
Band -width	RB No. / RB offset	Frequency	Modulation			Modulation		
			QPSK	16QAM	64QAM	QPSK	16QAM	64QAM
15 MHz	1RB_74	2562.5MHz	13.85	13.22	/	14.5	14.0	/
		2535MHz	13.86	13.17	/	14.5	14.0	/
		2507.5MHz	13.81	13.17	/	14.5	14.0	/
	1RB_37	2562.5MHz	13.84	13.20	/	14.5	14.0	/
		2535MHz	13.86	13.18	/	14.5	14.0	/
		2507.5MHz	13.90	13.26	/	14.5	14.0	/
	1RB_0	2562.5MHz	13.75	13.16	/	14.5	14.0	/
		2535MHz	13.79	13.15	/	14.5	14.0	/
		2507.5MHz	13.75	13.10	/	14.5	14.0	/
	36RB_38	2562.5MHz	12.93	11.91	/	14.0	13.0	/
		2535MHz	12.88	11.92	/	14.0	13.0	/
		2507.5MHz	12.82	11.78	/	14.0	13.0	/
	36RB_19	2562.5MHz	12.94	11.91	/	14.0	13.0	/
		2535MHz	12.91	11.89	/	14.0	13.0	/
		2507.5MHz	12.94	11.93	/	14.0	13.0	/
	36RB_0	2562.5MHz	12.89	11.89	/	14.0	13.0	/
		2535MHz	12.93	11.89	/	14.0	13.0	/
		2507.5MHz	12.93	11.91	/	14.0	13.0	/
	75RB_0	2562.5MHz	12.40	11.38	/	14.0	13.0	/
		2535MHz	12.91	11.89	/	14.0	13.0	/
		2507.5MHz	12.85	11.86	/	14.0	13.0	/



Sensor on								
LTE Band 7			Actual output Power (dBm)			Tune up		
Band -width	RB No. / RB offset	Frequency	Modulation			Modulation		
			QPSK	16QAM	64QAM	QPSK	16QAM	64QAM
20 MHz	1RB_99	2560MHz	13.80	13.23	/	14.5	14.0	/
		2535MHz	13.79	13.15	/	14.5	14.0	/
		2510MHz	13.82	13.16	/	14.5	14.0	/
	1RB_50	2560MHz	13.96	13.31	/	14.5	14.0	/
		2535MHz	13.95	13.29	/	14.5	14.0	/
		2510MHz	13.98	13.31	/	14.5	14.0	/
	1RB_0	2560MHz	13.67	13.06	/	14.5	14.0	/
		2535MHz	13.71	13.04	/	14.5	14.0	/
		2510MHz	13.68	13.09	/	14.5	14.0	/
	50RB_50	2560MHz	12.93	11.91	/	14.0	13.0	/
		2535MHz	12.94	11.86	/	14.0	13.0	/
		2510MHz	12.95	11.89	/	14.0	13.0	/
	50RB_25	2560MHz	12.92	11.94	/	14.0	13.0	/
		2535MHz	12.90	11.90	/	14.0	13.0	/
		2510MHz	12.92	11.94	/	14.0	13.0	/
	50RB_0	2560MHz	12.88	11.88	/	14.0	13.0	/
		2535MHz	12.90	11.88	/	14.0	13.0	/
		2510MHz	12.87	11.92	/	14.0	13.0	/
	100RB_0	2560MHz	12.39	11.37	/	14.0	13.0	/
		2535MHz	12.85	11.86	/	14.0	13.0	/
		2510MHz	12.87	11.88	/	14.0	13.0	/



Full Power								
LTE Band 12			Actual output Power (dBm)			Tune up		
Band -width	RB No. / RB offset	Frequency	Modulation			Modulation		
			QPSK	16QAM	64QAM	QPSK	16QAM	64QAM
1.4 MHz	1RB_5	715.3MHz	23.11	22.32	/	24.0	23.0	/
		707.5MHz	23.13	22.43	/	24.0	23.0	/
		699.7MHz	23.17	22.43	/	24.0	23.0	/
	1RB_3	715.3MHz	23.28	22.48	/	24.0	23.0	/
		707.5MHz	23.26	22.51	/	24.0	23.0	/
		699.7MHz	23.26	22.52	/	24.0	23.0	/
	1RB_0	715.3MHz	23.15	22.32	/	24.0	23.0	/
		707.5MHz	23.13	22.42	/	24.0	23.0	/
		699.7MHz	23.09	22.38	/	24.0	23.0	/
	3RB_3	715.3MHz	23.26	22.21	/	24.0	23.0	/
		707.5MHz	23.25	22.19	/	24.0	23.0	/
		699.7MHz	23.27	22.22	/	24.0	23.0	/
	3RB_1	715.3MHz	23.33	22.24	/	24.0	23.0	/
		707.5MHz	23.33	22.23	/	24.0	23.0	/
		699.7MHz	23.27	22.26	/	24.0	23.0	/
	3RB_0	715.3MHz	23.27	22.17	/	24.0	23.0	/
		707.5MHz	23.26	22.19	/	24.0	23.0	/
		699.7MHz	23.20	22.14	/	24.0	23.0	/
	6RB_0	715.3MHz	22.29	21.29	/	23.0	22.0	/
		707.5MHz	22.25	21.32	/	23.0	22.0	/
		699.7MHz	22.26	21.32	/	23.0	22.0	/



Full Power								
LTE Band 12			Actual output Power (dBm)			Tune up		
Band -width	RB No. / RB offset	Frequency	Modulation			Modulation		
			QPSK	16QAM	64QAM	QPSK	16QAM	64QAM
3 MHz	1RB_14	714.5MHz	23.21	22.36	/	24.0	23.0	/
		707.5MHz	23.21	22.46	/	24.0	23.0	/
		700.5MHz	23.20	22.38	/	24.0	23.0	/
	1RB_7	714.5MHz	23.40	22.52	/	24.0	23.0	/
		707.5MHz	23.31	22.61	/	24.0	23.0	/
		700.5MHz	23.32	22.55	/	24.0	23.0	/
	1RB_0	714.5MHz	23.16	22.35	/	24.0	23.0	/
		707.5MHz	23.18	22.44	/	24.0	23.0	/
		700.5MHz	23.14	22.34	/	24.0	23.0	/
	8RB_7	714.5MHz	22.22	21.26	/	23.0	22.0	/
		707.5MHz	22.22	21.26	/	23.0	22.0	/
		700.5MHz	22.21	21.35	/	23.0	22.0	/
	8RB_4	714.5MHz	22.26	21.30	/	23.0	22.0	/
		707.5MHz	22.24	21.32	/	23.0	22.0	/
		700.5MHz	22.28	21.34	/	23.0	22.0	/
	8RB_0	714.5MHz	22.23	21.28	/	23.0	22.0	/
		707.5MHz	22.22	21.27	/	23.0	22.0	/
		700.5MHz	22.20	21.24	/	23.0	22.0	/
	15RB_0	714.5MHz	22.27	21.23	/	23.0	22.0	/
		707.5MHz	22.22	21.29	/	23.0	22.0	/
		700.5MHz	22.25	21.24	/	23.0	22.0	/



Full Power								
LTE Band 12			Actual output Power (dBm)			Tune up		
Band -width	RB No. / RB offset	Frequency	Modulation			Modulation		
			QPSK	16QAM	64QAM	QPSK	16QAM	64QAM
5 MHz	1RB_24	713.5MHz	23.10	22.32	/	24.0	23.0	/
		707.5MHz	23.11	22.38	/	24.0	23.0	/
		701.5MHz	23.12	22.41	/	24.0	23.0	/
	1RB_12	713.5MHz	23.27	22.55	/	24.0	23.0	/
		707.5MHz	23.39	22.67	/	24.0	23.0	/
		701.5MHz	23.34	22.67	/	24.0	23.0	/
	1RB_0	713.5MHz	23.05	22.27	/	24.0	23.0	/
		707.5MHz	23.07	22.33	/	24.0	23.0	/
		701.5MHz	23.04	22.32	/	24.0	23.0	/
	12RB_13	713.5MHz	22.24	21.22	/	23.0	22.0	/
		707.5MHz	22.23	21.25	/	23.0	22.0	/
		701.5MHz	22.27	21.25	/	23.0	22.0	/
	12RB_6	713.5MHz	22.27	21.24	/	23.0	22.0	/
		707.5MHz	22.30	21.27	/	23.0	22.0	/
		701.5MHz	22.29	21.28	/	23.0	22.0	/
	12RB_0	713.5MHz	22.20	21.20	/	23.0	22.0	/
		707.5MHz	22.25	21.24	/	23.0	22.0	/
		701.5MHz	22.23	21.20	/	23.0	22.0	/
	25RB_0	713.5MHz	22.26	21.25	/	23.0	22.0	/
		707.5MHz	22.22	21.22	/	23.0	22.0	/
		701.5MHz	22.24	21.22	/	23.0	22.0	/



Full Power								
LTE Band 12			Actual output Power (dBm)			Tune up		
Band -width	RB No. / RB offset	Frequency	Modulation			Modulation		
			QPSK	16QAM	64QAM	QPSK	16QAM	64QAM
10 MHz	1RB_49	711MHz	23.24	22.44	/	24.0	23.0	/
		707.5MHz	23.27	22.49	/	24.0	23.0	/
		704MHz	23.11	22.47	/	24.0	23.0	/
	1RB_24	711MHz	23.31	22.58	/	24.0	23.0	/
		707.5MHz	23.32	22.60	/	24.0	23.0	/
		704MHz	23.36	22.55	/	24.0	23.0	/
	1RB_0	711MHz	23.16	22.38	/	24.0	23.0	/
		707.5MHz	23.16	22.37	/	24.0	23.0	/
		704MHz	23.12	22.34	/	24.0	23.0	/
	25RB_25	711MHz	22.37	21.36	/	23.0	22.0	/
		707.5MHz	22.33	21.34	/	23.0	22.0	/
		704MHz	22.30	21.34	/	23.0	22.0	/
	25RB_12	711MHz	22.31	21.31	/	23.0	22.0	/
		707.5MHz	22.30	21.30	/	23.0	22.0	/
		704MHz	22.31	21.31	/	23.0	22.0	/
	25RB_0	711MHz	22.34	21.36	/	23.0	22.0	/
		707.5MHz	22.33	21.32	/	23.0	22.0	/
		704MHz	22.26	21.28	/	23.0	22.0	/
	50RB_0	711MHz	22.36	21.36	/	23.0	22.0	/
		707.5MHz	22.32	21.31	/	23.0	22.0	/
		704MHz	22.28	21.27	/	23.0	22.0	/



Sensor on								
LTE Band 12			Actual output Power (dBm)			Tune up		
Band -width	RB No. / RB offset	Frequency	Modulation			Modulation		
			QPSK	16QAM	64QAM	QPSK	16QAM	64QAM
1.4 MHz	1RB_5	715.3MHz	18.22	17.50	/	19.0	18.0	/
		707.5MHz	18.28	17.57	/	19.0	18.0	/
		699.7MHz	18.25	17.57	/	19.0	18.0	/
	1RB_3	715.3MHz	18.33	17.60	/	19.0	18.0	/
		707.5MHz	18.33	17.64	/	19.0	18.0	/
		699.7MHz	18.36	17.68	/	19.0	18.0	/
	1RB_0	715.3MHz	18.24	17.50	/	19.0	18.0	/
		707.5MHz	18.22	17.55	/	19.0	18.0	/
		699.7MHz	18.18	17.54	/	19.0	18.0	/
	3RB_3	715.3MHz	18.36	17.38	/	19.0	18.0	/
		707.5MHz	18.36	17.35	/	19.0	18.0	/
		699.7MHz	18.32	17.31	/	19.0	18.0	/
	3RB_1	715.3MHz	18.40	17.45	/	19.0	18.0	/
		707.5MHz	18.38	17.41	/	19.0	18.0	/
		699.7MHz	18.36	17.41	/	19.0	18.0	/
	3RB_0	715.3MHz	18.38	17.34	/	19.0	18.0	/
		707.5MHz	18.32	17.33	/	19.0	18.0	/
		699.7MHz	18.28	17.32	/	19.0	18.0	/
	6RB_0	715.3MHz	17.29	16.45	/	18.0	17.0	/
		707.5MHz	17.33	16.43	/	18.0	17.0	/
		699.7MHz	17.30	16.40	/	18.0	17.0	/



Sensor on								
LTE Band 12			Actual output Power (dBm)			Tune up		
Band -width	RB No. / RB offset	Frequency	Modulation			Modulation		
			QPSK	16QAM	64QAM	QPSK	16QAM	64QAM
3 MHz	1RB_14	714.5MHz	18.34	17.60	/	19.0	18.0	/
		707.5MHz	18.36	17.62	/	19.0	18.0	/
		700.5MHz	18.32	17.58	/	19.0	18.0	/
	1RB_7	714.5MHz	18.46	17.76	/	19.0	18.0	/
		707.5MHz	18.48	17.74	/	19.0	18.0	/
		700.5MHz	18.44	17.76	/	19.0	18.0	/
	1RB_0	714.5MHz	18.32	17.56	/	19.0	18.0	/
		707.5MHz	18.30	17.55	/	19.0	18.0	/
		700.5MHz	18.27	17.56	/	19.0	18.0	/
	8RB_7	714.5MHz	17.35	16.41	/	18.0	17.0	/
		707.5MHz	17.33	16.44	/	18.0	17.0	/
		700.5MHz	17.33	16.41	/	18.0	17.0	/
	8RB_4	714.5MHz	17.37	16.48	/	18.0	17.0	/
		707.5MHz	17.39	16.49	/	18.0	17.0	/
		700.5MHz	17.36	16.46	/	18.0	17.0	/
	8RB_0	714.5MHz	17.30	16.46	/	18.0	17.0	/
		707.5MHz	17.34	16.41	/	18.0	17.0	/
		700.5MHz	17.28	16.38	/	18.0	17.0	/
	15RB_0	714.5MHz	17.31	16.42	/	18.0	17.0	/
		707.5MHz	17.33	16.39	/	18.0	17.0	/
		700.5MHz	17.29	16.36	/	18.0	17.0	/



Sensor on								
LTE Band 12			Actual output Power (dBm)			Tune up		
Band -width	RB No. / RB offset	Frequency	Modulation			Modulation		
			QPSK	16QAM	64QAM	QPSK	16QAM	64QAM
5 MHz	1RB_24	713.5MHz	18.24	17.56	/	19.0	18.0	/
		707.5MHz	18.26	17.56	/	19.0	18.0	/
		701.5MHz	18.23	17.59	/	19.0	18.0	/
	1RB_12	713.5MHz	18.46	17.77	/	19.0	18.0	/
		707.5MHz	18.41	17.76	/	19.0	18.0	/
		701.5MHz	18.45	17.82	/	19.0	18.0	/
	1RB_0	713.5MHz	18.17	17.49	/	19.0	18.0	/
		707.5MHz	18.19	17.47	/	19.0	18.0	/
		701.5MHz	18.20	17.50	/	19.0	18.0	/
	12RB_13	713.5MHz	17.39	16.36	/	18.0	17.0	/
		707.5MHz	17.34	16.35	/	18.0	17.0	/
		701.5MHz	17.37	16.37	/	18.0	17.0	/
	12RB_6	713.5MHz	17.37	16.40	/	18.0	17.0	/
		707.5MHz	17.42	16.44	/	18.0	17.0	/
		701.5MHz	17.37	16.37	/	18.0	17.0	/
	12RB_0	713.5MHz	17.29	16.30	/	18.0	17.0	/
		707.5MHz	17.37	16.37	/	18.0	17.0	/
		701.5MHz	17.32	16.33	/	18.0	17.0	/
	25RB_0	713.5MHz	17.34	16.36	/	18.0	17.0	/
		707.5MHz	17.33	16.36	/	18.0	17.0	/
		701.5MHz	17.33	16.34	/	18.0	17.0	/



Sensor on								
LTE Band 12			Actual output Power (dBm)			Tune up		
Band -width	RB No. / RB offset	Frequency	Modulation			Modulation		
			QPSK	16QAM	64QAM	QPSK	16QAM	64QAM
10 MHz	1RB_49	711MHz	18.46	17.69	/	19.0	18.0	/
		707.5MHz	18.42	17.72	/	19.0	18.0	/
		704MHz	18.42	17.70	/	19.0	18.0	/
	1RB_24	711MHz	18.42	17.75	/	19.0	18.0	/
		707.5MHz	18.33	17.72	/	19.0	18.0	/
		704MHz	18.41	17.71	/	19.0	18.0	/
	1RB_0	711MHz	18.29	17.56	/	19.0	18.0	/
		707.5MHz	18.32	17.60	/	19.0	18.0	/
		704MHz	18.25	17.53	/	19.0	18.0	/
	25RB_25	711MHz	17.46	16.46	/	18.0	17.0	/
		707.5MHz	17.35	16.44	/	18.0	17.0	/
		704MHz	17.37	16.42	/	18.0	17.0	/
	25RB_12	711MHz	17.38	16.42	/	18.0	17.0	/
		707.5MHz	17.39	16.43	/	18.0	17.0	/
		704MHz	17.38	16.43	/	18.0	17.0	/
	25RB_0	711MHz	17.44	16.46	/	18.0	17.0	/
		707.5MHz	17.39	16.39	/	18.0	17.0	/
		704MHz	17.33	16.34	/	18.0	17.0	/
	50RB_0	711MHz	17.46	16.47	/	18.0	17.0	/
		707.5MHz	17.43	16.44	/	18.0	17.0	/
		704MHz	17.35	16.39	/	18.0	17.0	/



Full Power								
LTE Band 13			Actual output Power (dBm)			Tune up		
Band -width	RB No. / RB offset	Frequency	Modulation			Modulation		
			QPSK	16QAM	64QAM	QPSK	16QAM	64QAM
5 MHz	1RB_24	784.5MHz	23.02	22.25	/	24.0	23.0	/
		782MHz	23.05	22.34	/	24.0	23.0	/
		779.5MHz	23.07	22.37	/	24.0	23.0	/
	1RB_12	784.5MHz	23.27	22.58	/	24.0	23.0	/
		782MHz	23.31	22.61	/	24.0	23.0	/
		779.5MHz	23.30	22.59	/	24.0	23.0	/
	1RB_0	784.5MHz	23.06	22.31	/	24.0	23.0	/
		782MHz	23.07	22.33	/	24.0	23.0	/
		779.5MHz	23.06	22.33	/	24.0	23.0	/
	12RB_13	784.5MHz	22.16	21.16	/	23.0	22.0	/
		782MHz	22.21	21.20	/	23.0	22.0	/
		779.5MHz	22.20	21.21	/	23.0	22.0	/
	12RB_6	784.5MHz	22.23	21.23	/	23.0	22.0	/
		782MHz	22.25	21.23	/	23.0	22.0	/
		779.5MHz	22.26	21.26	/	23.0	22.0	/
	12RB_0	784.5MHz	22.18	21.19	/	23.0	22.0	/
		782MHz	22.21	21.20	/	23.0	22.0	/
		779.5MHz	22.20	21.19	/	23.0	22.0	/
25RB_0	784.5MHz	22.19	21.18	/	23.0	22.0	/	
	782MHz	22.23	21.25	/	23.0	22.0	/	
	779.5MHz	22.20	21.20	/	23.0	22.0	/	
Full Power								
LTE Band 13			Actual output Power (dBm)			Tune up		
Band -width	RB No. / RB offset	Frequency	Modulation			Modulation		
			QPSK	16QAM	64QAM	QPSK	16QAM	64QAM
10 MHz	1RB_49	782MHz	23.13	22.32	/	24.0	23.0	/
	1RB_24	782MHz	23.29	22.51	/	24.0	23.0	/
	1RB_0	782MHz	23.13	22.43	/	24.0	23.0	/
	25RB_25	782MHz	22.28	21.25	/	23.0	22.0	/
	25RB_12	782MHz	22.27	21.27	/	23.0	22.0	/
	25RB_0	782MHz	22.25	21.24	/	23.0	22.0	/
	50RB_0	782MHz	22.29	21.27	/	23.0	22.0	/

Sensor on								
LTE Band 13			Actual output Power (dBm)			Tune up		
Band -width	RB No. / RB offset	Frequency	Modulation			Modulation		
			QPSK	16QAM	64QAM	QPSK	16QAM	64QAM
5 MHz	1RB_24	784.5MHz	18.06	17.40	/	19.0	18.0	/
		782MHz	18.08	17.39	/	19.0	18.0	/
		779.5MHz	18.12	17.44	/	19.0	18.0	/
	1RB_12	784.5MHz	18.33	17.69	/	19.0	18.0	/
		782MHz	18.41	17.80	/	19.0	18.0	/
		779.5MHz	18.40	17.78	/	19.0	18.0	/
	1RB_0	784.5MHz	18.06	17.41	/	19.0	18.0	/
		782MHz	18.10	17.45	/	19.0	18.0	/
		779.5MHz	18.13	17.44	/	19.0	18.0	/
	12RB_13	784.5MHz	17.25	16.24	/	18.0	17.0	/
		782MHz	17.27	16.22	/	18.0	17.0	/
		779.5MHz	17.24	16.22	/	18.0	17.0	/
	12RB_6	784.5MHz	17.30	16.28	/	18.0	17.0	/
		782MHz	17.32	16.27	/	18.0	17.0	/
		779.5MHz	17.27	16.28	/	18.0	17.0	/
	12RB_0	784.5MHz	17.20	16.19	/	18.0	17.0	/
		782MHz	17.30	16.27	/	18.0	17.0	/
		779.5MHz	17.24	16.20	/	18.0	17.0	/
25RB_0	784.5MHz	17.22	16.25	/	18.0	17.0	/	
	782MHz	17.26	16.26	/	18.0	17.0	/	
	779.5MHz	17.22	16.22	/	18.0	17.0	/	
Sensor on								
LTE Band 13			Actual output Power (dBm)			Tune up		
Band -width	RB No. / RB offset	Frequency	Modulation			Modulation		
			QPSK	16QAM	64QAM	QPSK	16QAM	64QAM
10 MHz	1RB_49	782MHz	18.18	17.48	/	19.0	18.0	/
	1RB_24	782MHz	18.36	17.65	/	19.0	18.0	/
	1RB_0	782MHz	18.19	17.48	/	19.0	18.0	/
	25RB_25	782MHz	17.34	16.34	/	18.0	17.0	/
	25RB_12	782MHz	17.29	16.32	/	18.0	17.0	/
	25RB_0	782MHz	17.30	16.30	/	18.0	17.0	/
	50RB_0	782MHz	17.34	16.32	/	18.0	17.0	/



Full Power								
LTE Band 25			Actual output Power (dBm)			Tune up		
Band -width	RB No. / RB offset	Frequency	Modulation			Modulation		
			QPSK	16QAM	64QAM	QPSK	16QAM	64QAM
1.4 MHz	1RB_5	1914.3MHz	23.08	22.31	/	24.0	23.0	/
		1882.5MHz	23.11	22.35	/	24.0	23.0	/
		1850.7MHz	23.17	22.42	/	24.0	23.0	/
	1RB_3	1914.3MHz	23.19	22.46	/	24.0	23.0	/
		1882.5MHz	23.21	22.49	/	24.0	23.0	/
		1850.7MHz	23.32	22.61	/	24.0	23.0	/
	1RB_0	1914.3MHz	23.10	22.36	/	24.0	23.0	/
		1882.5MHz	23.06	22.36	/	24.0	23.0	/
		1850.7MHz	23.18	22.48	/	24.0	23.0	/
	3RB_3	1914.3MHz	23.17	22.17	/	24.0	23.0	/
		1882.5MHz	23.19	22.17	/	24.0	23.0	/
		1850.7MHz	23.26	22.25	/	24.0	23.0	/
	3RB_1	1914.3MHz	23.24	22.26	/	24.0	23.0	/
		1882.5MHz	23.27	22.24	/	24.0	23.0	/
		1850.7MHz	23.36	22.38	/	24.0	23.0	/
	3RB_0	1914.3MHz	23.21	22.18	/	24.0	23.0	/
		1882.5MHz	23.19	22.18	/	24.0	23.0	/
		1850.7MHz	23.30	22.29	/	24.0	23.0	/
	6RB_0	1914.3MHz	22.20	21.30	/	23.0	22.0	/
		1882.5MHz	22.18	21.24	/	23.0	22.0	/
		1850.7MHz	22.28	21.34	/	23.0	22.0	/



Full Power								
LTE Band 25			Actual output Power (dBm)			Tune up		
Band -width	RB No. / RB offset	Frequency	Modulation			Modulation		
			QPSK	16QAM	64QAM	QPSK	16QAM	64QAM
3 MHz	1RB_14	1913.5MHz	23.15	22.37	/	24.0	23.0	/
		1882.5MHz	23.11	22.40	/	24.0	23.0	/
		1851.5MHz	23.19	22.44	/	24.0	23.0	/
	1RB_7	1913.5MHz	23.31	22.54	/	24.0	23.0	/
		1882.5MHz	23.27	22.52	/	24.0	23.0	/
		1851.5MHz	23.37	22.62	/	24.0	23.0	/
	1RB_0	1913.5MHz	23.17	22.35	/	24.0	23.0	/
		1882.5MHz	23.12	22.42	/	24.0	23.0	/
		1851.5MHz	23.24	22.48	/	24.0	23.0	/
	8RB_7	1913.5MHz	22.16	21.23	/	23.0	22.0	/
		1882.5MHz	22.15	21.23	/	23.0	22.0	/
		1851.5MHz	22.23	21.31	/	23.0	22.0	/
	8RB_4	1913.5MHz	22.23	21.33	/	23.0	22.0	/
		1882.5MHz	22.18	21.23	/	23.0	22.0	/
		1851.5MHz	22.25	21.32	/	23.0	22.0	/
	8RB_0	1913.5MHz	22.23	21.29	/	23.0	22.0	/
		1882.5MHz	22.14	21.23	/	23.0	22.0	/
		1851.5MHz	22.22	21.32	/	23.0	22.0	/
	15RB_0	1913.5MHz	22.21	21.23	/	23.0	22.0	/
		1882.5MHz	22.15	21.14	/	23.0	22.0	/
		1851.5MHz	22.22	21.25	/	23.0	22.0	/



Full Power								
LTE Band 25			Actual output Power (dBm)			Tune up		
Band -width	RB No. / RB offset	Frequency	Modulation			Modulation		
			QPSK	16QAM	64QAM	QPSK	16QAM	64QAM
5 MHz	1RB_24	1912.5MHz	23.01	22.26	/	24.0	23.0	/
		1882.5MHz	22.98	22.28	/	24.0	23.0	/
		1852.5MHz	23.02	22.32	/	24.0	23.0	/
	1RB_12	1912.5MHz	23.31	22.53	/	24.0	23.0	/
		1882.5MHz	23.31	22.57	/	24.0	23.0	/
		1852.5MHz	23.34	22.64	/	24.0	23.0	/
	1RB_0	1912.5MHz	23.05	22.33	/	24.0	23.0	/
		1882.5MHz	23.01	22.32	/	24.0	23.0	/
		1852.5MHz	23.14	22.39	/	24.0	23.0	/
	12RB_13	1912.5MHz	22.11	21.10	/	23.0	22.0	/
		1882.5MHz	22.14	21.12	/	23.0	22.0	/
		1852.5MHz	22.20	21.19	/	23.0	22.0	/
	12RB_6	1912.5MHz	22.25	21.25	/	23.0	22.0	/
		1882.5MHz	22.21	21.18	/	23.0	22.0	/
		1852.5MHz	22.22	21.24	/	23.0	22.0	/
	12RB_0	1912.5MHz	22.20	21.20	/	23.0	22.0	/
		1882.5MHz	22.17	21.14	/	23.0	22.0	/
		1852.5MHz	22.15	21.14	/	23.0	22.0	/
	25RB_0	1912.5MHz	22.16	21.19	/	23.0	22.0	/
		1882.5MHz	22.18	21.15	/	23.0	22.0	/
		1852.5MHz	22.22	21.22	/	23.0	22.0	/



Full Power								
LTE Band 25			Actual output Power (dBm)			Tune up		
Band -width	RB No. / RB offset	Frequency	Modulation			Modulation		
			QPSK	16QAM	64QAM	QPSK	16QAM	64QAM
10 MHz	1RB_49	1910MHz	23.09	22.37	/	24.0	23.0	/
		1882.5MHz	23.05	22.37	/	24.0	23.0	/
		1855MHz	23.10	22.45	/	24.0	23.0	/
	1RB_24	1910MHz	23.32	22.53	/	24.0	23.0	/
		1882.5MHz	23.22	22.51	/	24.0	23.0	/
		1855MHz	23.27	22.57	/	24.0	23.0	/
	1RB_0	1910MHz	23.09	22.42	/	24.0	23.0	/
		1882.5MHz	23.14	22.45	/	24.0	23.0	/
		1855MHz	23.24	22.55	/	24.0	23.0	/
	25RB_25	1910MHz	22.19	21.18	/	23.0	22.0	/
		1882.5MHz	22.17	21.19	/	23.0	22.0	/
		1855MHz	22.20	21.20	/	23.0	22.0	/
	25RB_12	1910MHz	22.26	21.25	/	23.0	22.0	/
		1882.5MHz	22.20	21.18	/	23.0	22.0	/
		1855MHz	22.21	21.23	/	23.0	22.0	/
	25RB_0	1910MHz	22.28	21.25	/	23.0	22.0	/
		1882.5MHz	22.18	21.15	/	23.0	22.0	/
		1855MHz	22.18	21.17	/	23.0	22.0	/
	50RB_0	1910MHz	22.21	21.22	/	23.0	22.0	/
		1882.5MHz	22.20	21.18	/	23.0	22.0	/
		1855MHz	22.19	21.19	/	23.0	22.0	/



Full Power								
LTE Band 25			Actual output Power (dBm)			Tune up		
Band -width	RB No. / RB offset	Frequency	Modulation			Modulation		
			QPSK	16QAM	64QAM	QPSK	16QAM	64QAM
15 MHz	1RB_74	1907.5MHz	23.06	22.27	/	24.0	23.0	/
		1882.5MHz	23.06	22.33	/	24.0	23.0	/
		1857.5MHz	23.07	22.38	/	24.0	23.0	/
	1RB_37	1907.5MHz	23.16	22.42	/	24.0	23.0	/
		1882.5MHz	23.14	22.42	/	24.0	23.0	/
		1857.5MHz	23.19	22.51	/	24.0	23.0	/
	1RB_0	1907.5MHz	23.06	22.30	/	24.0	23.0	/
		1882.5MHz	23.14	22.40	/	24.0	23.0	/
		1857.5MHz	23.22	22.52	/	24.0	23.0	/
	36RB_38	1907.5MHz	22.20	21.14	/	23.0	22.0	/
		1882.5MHz	22.16	21.11	/	23.0	22.0	/
		1857.5MHz	22.20	21.16	/	23.0	22.0	/
	36RB_19	1907.5MHz	22.23	21.19	/	23.0	22.0	/
		1882.5MHz	22.20	21.14	/	23.0	22.0	/
		1857.5MHz	22.23	21.21	/	23.0	22.0	/
	36RB_0	1907.5MHz	22.18	21.14	/	23.0	22.0	/
		1882.5MHz	22.17	21.13	/	23.0	22.0	/
		1857.5MHz	22.22	21.18	/	23.0	22.0	/
	75RB_0	1907.5MHz	22.17	21.17	/	23.0	22.0	/
		1882.5MHz	22.18	21.13	/	23.0	22.0	/
		1857.5MHz	22.20	21.19	/	23.0	22.0	/



Full Power								
LTE Band 25			Actual output Power (dBm)			Tune up		
Band -width	RB No. / RB offset	Frequency	Modulation			Modulation		
			QPSK	16QAM	64QAM	QPSK	16QAM	64QAM
20 MHz	1RB_99	1905MHz	23.02	22.21	/	24.0	23.0	/
		1882.5MHz	22.97	22.24	/	24.0	23.0	/
		1860MHz	23.01	22.28	/	24.0	23.0	/
	1RB_50	1905MHz	23.20	22.46	/	24.0	23.0	/
		1882.5MHz	23.22	22.47	/	24.0	23.0	/
		1860MHz	23.27	22.47	/	24.0	23.0	/
	1RB_0	1905MHz	23.02	22.33	/	24.0	23.0	/
		1882.5MHz	23.02	22.27	/	24.0	23.0	/
		1860MHz	23.16	22.42	/	24.0	23.0	/
	50RB_50	1905MHz	22.11	21.08	/	23.0	22.0	/
		1882.5MHz	22.14	21.12	/	23.0	22.0	/
		1860MHz	22.14	21.16	/	23.0	22.0	/
	50RB_25	1905MHz	22.18	21.17	/	23.0	22.0	/
		1882.5MHz	22.19	21.17	/	23.0	22.0	/
		1860MHz	22.23	21.22	/	23.0	22.0	/
	50RB_0	1905MHz	22.17	21.18	/	23.0	22.0	/
		1882.5MHz	22.16	21.16	/	23.0	22.0	/
		1860MHz	22.14	21.14	/	23.0	22.0	/
	100RB_0	1905MHz	22.19	21.16	/	23.0	22.0	/
		1882.5MHz	22.13	21.10	/	23.0	22.0	/
		1860MHz	22.14	21.11	/	23.0	22.0	/



Sensor on								
LTE Band 25			Actual output Power (dBm)			Tune up		
Band -width	RB No. / RB offset	Frequency	Modulation			Modulation		
			QPSK	16QAM	64QAM	QPSK	16QAM	64QAM
1.4 MHz	1RB_5	1914.3MHz	15.19	14.46	/	16.0	15.0	/
		1882.5MHz	15.16	14.46	/	16.0	15.0	/
		1850.7MHz	15.20	14.52	/	16.0	15.0	/
	1RB_3	1914.3MHz	15.30	14.55	/	16.0	15.0	/
		1882.5MHz	15.28	14.55	/	16.0	15.0	/
		1850.7MHz	15.35	14.67	/	16.0	15.0	/
	1RB_0	1914.3MHz	15.15	14.42	/	16.0	15.0	/
		1882.5MHz	15.13	14.44	/	16.0	15.0	/
		1850.7MHz	15.22	14.53	/	16.0	15.0	/
	3RB_3	1914.3MHz	15.27	14.27	/	16.0	15.0	/
		1882.5MHz	15.25	14.26	/	16.0	15.0	/
		1850.7MHz	15.35	14.36	/	16.0	15.0	/
	3RB_1	1914.3MHz	15.31	14.35	/	16.0	15.0	/
		1882.5MHz	15.33	14.33	/	16.0	15.0	/
		1850.7MHz	15.41	14.45	/	16.0	15.0	/
	3RB_0	1914.3MHz	15.27	14.26	/	16.0	15.0	/
		1882.5MHz	15.27	14.24	/	16.0	15.0	/
		1850.7MHz	15.34	14.37	/	16.0	15.0	/
	6RB_0	1914.3MHz	14.27	13.39	/	15.0	14.0	/
		1882.5MHz	14.25	13.35	/	15.0	14.0	/
		1850.7MHz	14.31	13.44	/	15.0	14.0	/



Sensor on								
LTE Band 25			Actual output Power (dBm)			Tune up		
Band -width	RB No. / RB offset	Frequency	Modulation			Modulation		
			QPSK	16QAM	64QAM	QPSK	16QAM	64QAM
3 MHz	1RB_14	1913.5MHz	15.21	14.51	/	16.0	15.0	/
		1882.5MHz	15.18	14.49	/	16.0	15.0	/
		1851.5MHz	15.24	14.53	/	16.0	15.0	/
	1RB_7	1913.5MHz	15.38	14.71	/	16.0	15.0	/
		1882.5MHz	15.31	14.68	/	16.0	15.0	/
		1851.5MHz	15.39	14.74	/	16.0	15.0	/
	1RB_0	1913.5MHz	15.24	14.54	/	16.0	15.0	/
		1882.5MHz	15.21	14.41	/	16.0	15.0	/
		1851.5MHz	15.24	14.54	/	16.0	15.0	/
	8RB_7	1913.5MHz	14.20	13.31	/	15.0	14.0	/
		1882.5MHz	14.22	13.30	/	15.0	14.0	/
		1851.5MHz	14.26	13.38	/	15.0	14.0	/
	8RB_4	1913.5MHz	14.25	13.36	/	15.0	14.0	/
		1882.5MHz	14.22	13.34	/	15.0	14.0	/
		1851.5MHz	14.27	13.42	/	15.0	14.0	/
	8RB_0	1913.5MHz	14.26	13.36	/	15.0	14.0	/
		1882.5MHz	14.23	13.30	/	15.0	14.0	/
		1851.5MHz	14.30	13.42	/	15.0	14.0	/
	15RB_0	1913.5MHz	14.21	13.28	/	15.0	14.0	/
		1882.5MHz	14.21	13.27	/	15.0	14.0	/
		1851.5MHz	14.23	13.32	/	15.0	14.0	/



Sensor on								
LTE Band 25			Actual output Power (dBm)			Tune up		
Band -width	RB No. / RB offset	Frequency	Modulation			Modulation		
			QPSK	16QAM	64QAM	QPSK	16QAM	64QAM
5 MHz	1RB_24	1912.5MHz	15.06	14.39	/	16.0	15.0	/
		1882.5MHz	15.05	14.35	/	16.0	15.0	/
		1852.5MHz	15.06	14.38	/	16.0	15.0	/
	1RB_12	1912.5MHz	15.39	14.66	/	16.0	15.0	/
		1882.5MHz	15.42	14.69	/	16.0	15.0	/
		1852.5MHz	15.45	14.78	/	16.0	15.0	/
	1RB_0	1912.5MHz	15.09	14.42	/	16.0	15.0	/
		1882.5MHz	15.08	14.39	/	16.0	15.0	/
		1852.5MHz	15.19	14.46	/	16.0	15.0	/
	12RB_13	1912.5MHz	14.18	13.21	/	15.0	14.0	/
		1882.5MHz	14.22	13.23	/	15.0	14.0	/
		1852.5MHz	14.28	13.28	/	15.0	14.0	/
	12RB_6	1912.5MHz	14.28	13.35	/	15.0	14.0	/
		1882.5MHz	14.28	13.29	/	15.0	14.0	/
		1852.5MHz	14.31	13.35	/	15.0	14.0	/
	12RB_0	1912.5MHz	14.26	13.29	/	15.0	14.0	/
		1882.5MHz	14.24	13.23	/	15.0	14.0	/
		1852.5MHz	14.20	13.25	/	15.0	14.0	/
	25RB_0	1912.5MHz	14.20	13.26	/	15.0	14.0	/
		1882.5MHz	14.23	13.22	/	15.0	14.0	/
		1852.5MHz	14.26	13.27	/	15.0	14.0	/



Sensor on								
LTE Band 25			Actual output Power (dBm)			Tune up		
Band -width	RB No. / RB offset	Frequency	Modulation			Modulation		
			QPSK	16QAM	64QAM	QPSK	16QAM	64QAM
10 MHz	1RB_49	1910MHz	15.20	14.51	/	16.0	15.0	/
		1882.5MHz	15.17	14.47	/	16.0	15.0	/
		1855MHz	15.19	14.52	/	16.0	15.0	/
	1RB_24	1910MHz	15.36	14.71	/	16.0	15.0	/
		1882.5MHz	15.30	14.65	/	16.0	15.0	/
		1855MHz	15.39	14.64	/	16.0	15.0	/
	1RB_0	1910MHz	15.20	14.55	/	16.0	15.0	/
		1882.5MHz	15.20	14.55	/	16.0	15.0	/
		1855MHz	15.30	14.61	/	16.0	15.0	/
	25RB_25	1910MHz	14.27	13.30	/	15.0	14.0	/
		1882.5MHz	14.25	13.28	/	15.0	14.0	/
		1855MHz	14.27	13.30	/	15.0	14.0	/
	25RB_12	1910MHz	14.35	13.36	/	15.0	14.0	/
		1882.5MHz	14.28	13.33	/	15.0	14.0	/
		1855MHz	14.28	13.32	/	15.0	14.0	/
	25RB_0	1910MHz	14.36	13.37	/	15.0	14.0	/
		1882.5MHz	14.27	13.31	/	15.0	14.0	/
		1855MHz	14.27	13.28	/	15.0	14.0	/
	50RB_0	1910MHz	14.31	13.33	/	15.0	14.0	/
		1882.5MHz	14.27	13.29	/	15.0	14.0	/
		1855MHz	14.24	13.27	/	15.0	14.0	/



Sensor on								
LTE Band 25			Actual output Power (dBm)			Tune up		
Band -width	RB No. / RB offset	Frequency	Modulation			Modulation		
			QPSK	16QAM	64QAM	QPSK	16QAM	64QAM
15 MHz	1RB_74	1907.5MHz	15.19	14.47	/	16.0	15.0	/
		1882.5MHz	15.13	14.46	/	16.0	15.0	/
		1857.5MHz	15.14	14.46	/	16.0	15.0	/
	1RB_37	1907.5MHz	15.26	14.58	/	16.0	15.0	/
		1882.5MHz	15.24	14.56	/	16.0	15.0	/
		1857.5MHz	15.34	14.63	/	16.0	15.0	/
	1RB_0	1907.5MHz	15.18	14.50	/	16.0	15.0	/
		1882.5MHz	15.25	14.48	/	16.0	15.0	/
		1857.5MHz	15.30	14.62	/	16.0	15.0	/
	36RB_38	1907.5MHz	14.28	13.27	/	15.0	14.0	/
		1882.5MHz	14.25	13.28	/	15.0	14.0	/
		1857.5MHz	14.27	13.29	/	15.0	14.0	/
	36RB_19	1907.5MHz	14.31	13.29	/	15.0	14.0	/
		1882.5MHz	14.28	13.28	/	15.0	14.0	/
		1857.5MHz	14.30	13.30	/	15.0	14.0	/
	36RB_0	1907.5MHz	14.30	13.35	/	15.0	14.0	/
		1882.5MHz	14.28	13.29	/	15.0	14.0	/
		1857.5MHz	14.28	13.32	/	15.0	14.0	/
	75RB_0	1907.5MHz	14.31	13.34	/	15.0	14.0	/
		1882.5MHz	14.26	13.28	/	15.0	14.0	/
		1857.5MHz	14.26	13.28	/	15.0	14.0	/



Sensor on								
LTE Band 25			Actual output Power (dBm)			Tune up		
Band -width	RB No. / RB offset	Frequency	Modulation			Modulation		
			QPSK	16QAM	64QAM	QPSK	16QAM	64QAM
20 MHz	1RB_99	1905MHz	15.15	14.45	/	16.0	15.0	/
		1882.5MHz	15.05	14.37	/	16.0	15.0	/
		1860MHz	15.21	14.43	/	16.0	15.0	/
	1RB_50	1905MHz	15.34	14.67	/	16.0	15.0	/
		1882.5MHz	15.33	14.65	/	16.0	15.0	/
		1860MHz	15.38	14.64	/	16.0	15.0	/
	1RB_0	1905MHz	15.16	14.47	/	16.0	15.0	/
		1882.5MHz	15.15	14.44	/	16.0	15.0	/
		1860MHz	15.26	14.54	/	16.0	15.0	/
	50RB_50	1905MHz	14.26	13.35	/	15.0	14.0	/
		1882.5MHz	14.21	13.22	/	15.0	14.0	/
		1860MHz	14.22	13.25	/	15.0	14.0	/
	50RB_25	1905MHz	14.27	13.31	/	15.0	14.0	/
		1882.5MHz	14.26	13.31	/	15.0	14.0	/
		1860MHz	14.31	13.35	/	15.0	14.0	/
	50RB_0	1905MHz	14.12	13.32	/	15.0	14.0	/
		1882.5MHz	14.30	13.34	/	15.0	14.0	/
		1860MHz	14.22	13.27	/	15.0	14.0	/
	100RB_0	1905MHz	14.25	13.31	/	15.0	14.0	/
		1882.5MHz	14.27	13.24	/	15.0	14.0	/
		1860MHz	14.21	13.24	/	15.0	14.0	/



Full power								
LTE Band 26			Actual output Power (dBm)			Tune up		
Band -width	RB No. / RB offset	Frequency	Modulation			Modulation		
			QPSK	16QAM	64QAM	QPSK	16QAM	64QAM
1.4 MHz	1RB_5	848.3MHz	23.22	22.42	/	24.0	23.0	/
		831.5MHz	23.24	22.40	/	24.0	23.0	/
		814.7MHz	23.30	22.39	/	24.0	23.0	/
	1RB_3	848.3MHz	23.32	22.50	/	24.0	23.0	/
		831.5MHz	23.30	22.55	/	24.0	23.0	/
		814.7MHz	23.39	22.50	/	24.0	23.0	/
	1RB_0	848.3MHz	23.21	22.43	/	24.0	23.0	/
		831.5MHz	23.22	22.48	/	24.0	23.0	/
		814.7MHz	23.25	22.40	/	24.0	23.0	/
	3RB_3	848.3MHz	23.33	22.23	/	24.0	23.0	/
		831.5MHz	23.32	22.26	/	24.0	23.0	/
		814.7MHz	23.41	22.33	/	24.0	23.0	/
	3RB_1	848.3MHz	23.39	22.26	/	24.0	23.0	/
		831.5MHz	23.44	22.34	/	24.0	23.0	/
		814.7MHz	23.40	22.40	/	24.0	23.0	/
	3RB_0	848.3MHz	23.34	22.20	/	24.0	23.0	/
		831.5MHz	23.36	22.28	/	24.0	23.0	/
		814.7MHz	23.37	22.31	/	24.0	23.0	/
	6RB_0	848.3MHz	22.32	21.29	/	23.0	22.0	/
		831.5MHz	22.35	21.37	/	23.0	22.0	/
		814.7MHz	22.37	21.38	/	23.0	22.0	/



Full power								
LTE Band 26			Actual output Power (dBm)			Tune up		
Band -width	RB No. / RB offset	Frequency	Modulation			Modulation		
			QPSK	16QAM	64QAM	QPSK	16QAM	64QAM
3 MHz	1RB_14	847.5MHz	23.19	22.33	/	24.0	23.0	/
		831.5MHz	23.21	22.43	/	24.0	23.0	/
		815.5MHz	22.21	22.42	/	24.0	23.0	/
	1RB_7	847.5MHz	23.33	22.53	/	24.0	23.0	/
		831.5MHz	23.42	22.56	/	24.0	23.0	/
		815.5MHz	22.22	22.62	/	24.0	23.0	/
	1RB_0	847.5MHz	23.16	22.37	/	24.0	23.0	/
		831.5MHz	23.21	22.48	/	24.0	23.0	/
		815.5MHz	22.23	22.44	/	24.0	23.0	/
	8RB_7	847.5MHz	22.23	21.32	/	23.0	22.0	/
		831.5MHz	22.24	21.27	/	23.0	22.0	/
		815.5MHz	22.17	21.39	/	23.0	22.0	/
	8RB_4	847.5MHz	22.26	21.32	/	23.0	22.0	/
		831.5MHz	22.27	21.33	/	23.0	22.0	/
		815.5MHz	22.19	21.41	/	23.0	22.0	/
	8RB_0	847.5MHz	22.25	21.32	/	23.0	22.0	/
		831.5MHz	22.22	21.29	/	23.0	22.0	/
		815.5MHz	22.22	21.35	/	23.0	22.0	/
	15RB_0	847.5MHz	22.25	21.26	/	23.0	22.0	/
		831.5MHz	22.20	21.26	/	23.0	22.0	/
		815.5MHz	22.20	21.28	/	23.0	22.0	/



Full power								
LTE Band 26			Actual output Power (dBm)			Tune up		
Band -width	RB No. / RB offset	Frequency	Modulation			Modulation		
			QPSK	16QAM	64QAM	QPSK	16QAM	64QAM
5 MHz	1RB_24	846.5MHz	23.10	22.26	/	24.0	23.0	/
		831.5MHz	23.14	22.39	/	24.0	23.0	/
		816.5MHz	23.10	22.41	/	24.0	23.0	/
	1RB_12	846.5MHz	23.50	22.55	/	24.0	23.0	/
		831.5MHz	23.43	22.59	/	24.0	23.0	/
		816.5MHz	23.41	22.65	/	24.0	23.0	/
	1RB_0	846.5MHz	23.02	22.33	/	24.0	23.0	/
		831.5MHz	23.11	22.42	/	24.0	23.0	/
		816.5MHz	23.15	22.43	/	24.0	23.0	/
	12RB_13	846.5MHz	22.27	21.25	/	23.0	22.0	/
		831.5MHz	22.24	21.18	/	23.0	22.0	/
		816.5MHz	22.27	21.20	/	23.0	22.0	/
	12RB_6	846.5MHz	22.26	21.25	/	23.0	22.0	/
		831.5MHz	22.29	21.30	/	23.0	22.0	/
		816.5MHz	22.32	21.21	/	23.0	22.0	/
	12RB_0	846.5MHz	22.21	21.20	/	23.0	22.0	/
		831.5MHz	22.21	21.16	/	23.0	22.0	/
		816.5MHz	22.27	21.22	/	23.0	22.0	/
	25RB_0	846.5MHz	22.27	21.26	/	23.0	22.0	/
		831.5MHz	22.27	21.25	/	23.0	22.0	/
		816.5MHz	22.28	21.28	/	23.0	22.0	/



Full power								
LTE Band 26			Actual output Power (dBm)			Tune up		
Band -width	RB No. / RB offset	Frequency	Modulation			Modulation		
			QPSK	16QAM	64QAM	QPSK	16QAM	64QAM
10 MHz	1RB_49	844.0MHz	23.21	22.47	/	24.0	23.0	/
		831.5MHz	23.22	22.50	/	24.0	23.0	/
		820.0MHz	23.25	22.50	/	24.0	23.0	/
	1RB_24	844.0MHz	23.21	22.63	/	24.0	23.0	/
		831.5MHz	23.37	22.63	/	24.0	23.0	/
		820.0MHz	23.32	22.58	/	24.0	23.0	/
	1RB_0	844.0MHz	23.17	22.49	/	24.0	23.0	/
		831.5MHz	23.20	22.50	/	24.0	23.0	/
		820.0MHz	23.20	22.47	/	24.0	23.0	/
	25RB_25	844.0MHz	22.32	21.31	/	23.0	22.0	/
		831.5MHz	22.35	21.35	/	23.0	22.0	/
		820.0MHz	22.23	21.24	/	23.0	22.0	/
	25RB_12	844.0MHz	22.30	21.28	/	23.0	22.0	/
		831.5MHz	22.32	21.31	/	23.0	22.0	/
		820.0MHz	22.27	21.28	/	23.0	22.0	/
	25RB_0	844.0MHz	22.34	21.35	/	23.0	22.0	/
		831.5MHz	22.30	21.26	/	23.0	22.0	/
		820.0MHz	22.25	21.26	/	23.0	22.0	/
	50RB_0	844.0MHz	22.33	21.29	/	23.0	22.0	/
		831.5MHz	22.35	21.28	/	23.0	22.0	/
		820.0MHz	22.25	21.26	/	23.0	22.0	/



Full power								
LTE Band 26			Actual output Power (dBm)			Tune up		
Band -width	RB No. / RB offset	Frequency	Modulation			Modulation		
			QPSK	16QAM	64QAM	QPSK	16QAM	64QAM
15 MHz	1RB_74	841.5MHz	23.16	22.30	/	24.0	23.0	/
		831.5MHz	23.14	22.37	/	24.0	23.0	/
		822.5MHz	23.21	22.46	/	24.0	23.0	/
	1RB_37	841.5MHz	23.20	22.38	/	24.0	23.0	/
		831.5MHz	23.25	22.42	/	24.0	23.0	/
		822.5MHz	23.24	22.51	/	24.0	23.0	/
	1RB_0	841.5MHz	23.05	22.21	/	24.0	23.0	/
		831.5MHz	23.06	22.31	/	24.0	23.0	/
		822.5MHz	23.11	22.33	/	24.0	23.0	/
	36RB_38	841.5MHz	22.28	21.26	/	23.0	22.0	/
		831.5MHz	22.34	21.30	/	23.0	22.0	/
		822.5MHz	22.30	21.28	/	23.0	22.0	/
	36RB_19	841.5MHz	22.27	21.24	/	23.0	22.0	/
		831.5MHz	22.31	21.29	/	23.0	22.0	/
		822.5MHz	22.28	21.29	/	23.0	22.0	/
	36RB_0	841.5MHz	22.25	21.25	/	23.0	22.0	/
		831.5MHz	22.28	21.25	/	23.0	22.0	/
		822.5MHz	22.23	21.17	/	23.0	22.0	/
	75RB_0	841.5MHz	22.29	21.26	/	23.0	22.0	/
		831.5MHz	22.32	21.28	/	23.0	22.0	/
		822.5MHz	22.25	21.24	/	23.0	22.0	/



Sensor on								
LTE Band 26			Actual output Power (dBm)			Tune up		
Band -width	RB No. / RB offset	Frequency	Modulation			Modulation		
			QPSK	16QAM	64QAM	QPSK	16QAM	64QAM
1.4 MHz	1RB_5	848.3MHz	17.96	17.25	/	19.0	18.0	/
		831.5MHz	17.99	17.25	/	19.0	18.0	/
		814.7MHz	18.01	17.24	/	19.0	18.0	/
	1RB_3	848.3MHz	18.07	17.36	/	19.0	18.0	/
		831.5MHz	18.05	17.37	/	19.0	18.0	/
		814.7MHz	18.11	17.33	/	19.0	18.0	/
	1RB_0	848.3MHz	17.96	17.24	/	19.0	18.0	/
		831.5MHz	17.99	17.24	/	19.0	18.0	/
		814.7MHz	18.01	17.24	/	19.0	18.0	/
	3RB_3	848.3MHz	18.04	17.05	/	19.0	18.0	/
		831.5MHz	18.09	17.08	/	19.0	18.0	/
		814.7MHz	18.10	17.07	/	19.0	18.0	/
	3RB_1	848.3MHz	18.10	17.11	/	19.0	18.0	/
		831.5MHz	18.12	17.15	/	19.0	18.0	/
		814.7MHz	18.15	17.14	/	19.0	18.0	/
	3RB_0	848.3MHz	18.06	17.08	/	19.0	18.0	/
		831.5MHz	18.07	17.07	/	19.0	18.0	/
		814.7MHz	18.09	17.09	/	19.0	18.0	/
	6RB_0	848.3MHz	17.04	16.06	/	18.0	17.0	/
		831.5MHz	17.08	16.12	/	18.0	17.0	/
		814.7MHz	17.07	16.16	/	18.0	17.0	/



Sensor on								
LTE Band 26			Actual output Power (dBm)			Tune up		
Band -width	RB No. / RB offset	Frequency	Modulation			Modulation		
			QPSK	16QAM	64QAM	QPSK	16QAM	64QAM
3 MHz	1RB_14	847.5MHz	18.05	17.34	/	19.0	18.0	/
		831.5MHz	18.11	17.39	/	19.0	18.0	/
		815.5MHz	18.12	17.40	/	19.0	18.0	/
	1RB_7	847.5MHz	18.28	17.46	/	19.0	18.0	/
		831.5MHz	18.23	17.43	/	19.0	18.0	/
		815.5MHz	18.23	17.49	/	19.0	18.0	/
	1RB_0	847.5MHz	18.07	17.34	/	19.0	18.0	/
		831.5MHz	18.10	17.30	/	19.0	18.0	/
		815.5MHz	18.05	17.31	/	19.0	18.0	/
	8RB_7	847.5MHz	17.10	16.12	/	18.0	17.0	/
		831.5MHz	17.12	16.17	/	18.0	17.0	/
		815.5MHz	17.07	16.13	/	18.0	17.0	/
	8RB_4	847.5MHz	17.11	16.18	/	18.0	17.0	/
		831.5MHz	17.12	16.16	/	18.0	17.0	/
		815.5MHz	17.11	16.15	/	18.0	17.0	/
	8RB_0	847.5MHz	17.11	16.14	/	18.0	17.0	/
		831.5MHz	17.11	16.14	/	18.0	17.0	/
		815.5MHz	17.13	16.12	/	18.0	17.0	/
	15RB_0	847.5MHz	17.06	16.06	/	18.0	17.0	/
		831.5MHz	17.13	16.11	/	18.0	17.0	/
		815.5MHz	17.05	16.10	/	18.0	17.0	/



Sensor on								
LTE Band 26			Actual output Power (dBm)			Tune up		
Band -width	RB No. / RB offset	Frequency	Modulation			Modulation		
			QPSK	16QAM	64QAM	QPSK	16QAM	64QAM
5 MHz	1RB_24	846.5 MHz	17.94	17.28	/	19.0	18.0	/
		831.5 MHz	18.00	17.28	/	19.0	18.0	/
		816.5 MHz	18.01	17.32	/	19.0	18.0	/
	1RB_12	846.5 MHz	18.23	17.53	/	19.0	18.0	/
		831.5 MHz	18.23	17.51	/	19.0	18.0	/
		816.5 MHz	18.30	17.61	/	19.0	18.0	/
	1RB_0	846.5 MHz	17.97	17.27	/	19.0	18.0	/
		831.5 MHz	17.98	17.22	/	19.0	18.0	/
		816.5 MHz	17.98	17.33	/	19.0	18.0	/
	12RB_13	846.5 MHz	17.06	16.03	/	18.0	17.0	/
		831.5 MHz	17.15	16.09	/	18.0	17.0	/
		816.5 MHz	17.10	16.04	/	18.0	17.0	/
	12RB_6	846.5 MHz	17.13	16.09	/	18.0	17.0	/
		831.5 MHz	17.14	16.12	/	18.0	17.0	/
		816.5 MHz	17.17	16.14	/	18.0	17.0	/
	12RB_0	846.5 MHz	17.11	16.07	/	18.0	17.0	/
		831.5 MHz	17.08	16.05	/	18.0	17.0	/
		816.5 MHz	17.10	16.07	/	18.0	17.0	/
	25RB_0	846.5 MHz	17.08	16.07	/	18.0	17.0	/
		831.5 MHz	17.09	16.08	/	18.0	17.0	/
		816.5 MHz	17.09	16.07	/	18.0	17.0	/



Sensor on								
LTE Band 26			Actual output Power (dBm)			Tune up		
Band -width	RB No. / RB offset	Frequency	Modulation			Modulation		
			QPSK	16QAM	64QAM	QPSK	16QAM	64QAM
10 MHz	1RB_49	844.0MHz	18.05	17.36	/	19.0	18.0	/
		831.5MHz	18.11	17.38	/	19.0	18.0	/
		820.0MHz	18.15	17.36	/	19.0	18.0	/
	1RB_24	844.0MHz	18.21	17.52	/	19.0	18.0	/
		831.5MHz	18.24	17.51	/	19.0	18.0	/
		820.0MHz	18.24	17.48	/	19.0	18.0	/
	1RB_0	844.0MHz	18.07	17.38	/	19.0	18.0	/
		831.5MHz	18.09	17.36	/	19.0	18.0	/
		820.0MHz	18.12	17.32	/	19.0	18.0	/
	25RB_25	844.0MHz	17.11	16.09	/	18.0	17.0	/
		831.5MHz	17.18	16.15	/	18.0	17.0	/
		820.0MHz	17.17	16.17	/	18.0	17.0	/
	25RB_12	844.0MHz	17.19	16.18	/	18.0	17.0	/
		831.5MHz	17.20	16.18	/	18.0	17.0	/
		820.0MHz	17.18	16.18	/	18.0	17.0	/
	25RB_0	844.0MHz	17.21	16.23	/	18.0	17.0	/
		831.5MHz	17.14	16.13	/	18.0	17.0	/
		820.0MHz	17.16	16.18	/	18.0	17.0	/
	50RB_0	844.0MHz	17.16	16.13	/	18.0	17.0	/
		831.5MHz	17.16	16.15	/	18.0	17.0	/
		820.0MHz	17.15	16.14	/	18.0	17.0	/



Sensor on								
LTE Band 26			Actual output Power (dBm)			Tune up		
Band -width	RB No. / RB offset	Frequency	Modulation			Modulation		
			QPSK	16QAM	64QAM	QPSK	16QAM	64QAM
15 MHz	1RB_74	841.5MHz	18.10	17.39	/	19.0	18.0	/
		831.5MHz	18.16	17.40	/	19.0	18.0	/
		822.5MHz	18.12	17.37	/	19.0	18.0	/
	1RB_37	841.5MHz	18.15	17.40	/	19.0	18.0	/
		831.5MHz	18.13	17.40	/	19.0	18.0	/
		822.5MHz	18.11	17.39	/	19.0	18.0	/
	1RB_0	841.5MHz	18.02	17.32	/	19.0	18.0	/
		831.5MHz	18.04	17.25	/	19.0	18.0	/
		822.5MHz	18.08	17.33	/	19.0	18.0	/
	36RB_38	841.5MHz	17.12	16.09	/	18.0	17.0	/
		831.5MHz	17.17	16.12	/	18.0	17.0	/
		822.5MHz	17.18	16.11	/	18.0	17.0	/
	36RB_19	841.5MHz	17.19	16.15	/	18.0	17.0	/
		831.5MHz	17.18	16.14	/	18.0	17.0	/
		822.5MHz	17.18	16.11	/	18.0	17.0	/
	36RB_0	841.5MHz	17.17	16.10	/	18.0	17.0	/
		831.5MHz	17.14	16.09	/	18.0	17.0	/
		822.5MHz	17.14	16.08	/	18.0	17.0	/
	75RB_0	841.5MHz	17.14	16.13	/	18.0	17.0	/
		831.5MHz	17.15	16.09	/	18.0	17.0	/
		822.5MHz	17.14	16.10	/	18.0	17.0	/



Full Power								
LTE Band 30			Actual output Power (dBm)			Tune up		
Band -width	RB No. / RB offset	Frequency	Modulation			Modulation		
			QPSK	16QAM	64QAM	QPSK	16QAM	64QAM
5 MHz	1RB_24	2312.5MHz	21.88	21.21	/	22.5	22.0	/
		2310MHz	21.85	21.18	/	22.5	22.0	/
		2307.5MHz	21.86	21.19	/	22.5	22.0	/
	1RB_12	2312.5MHz	22.11	21.45	/	22.5	22.0	/
		2310MHz	22.16	21.47	/	22.5	22.0	/
		2307.5MHz	22.18	21.55	/	22.5	22.0	/
	1RB_0	2312.5MHz	21.87	21.24	/	22.5	22.0	/
		2310MHz	21.85	21.21	/	22.5	22.0	/
		2307.5MHz	21.86	21.18	/	22.5	22.0	/
	12RB_13	2312.5MHz	21.02	20.04	/	22.0	21.0	/
		2310MHz	20.98	20.00	/	22.0	21.0	/
		2307.5MHz	21.03	20.02	/	22.0	21.0	/
	12RB_6	2312.5MHz	21.06	20.09	/	22.0	21.0	/
		2310MHz	21.06	20.11	/	22.0	21.0	/
		2307.5MHz	21.04	20.11	/	22.0	21.0	/
	12RB_0	2312.5MHz	21.03	20.05	/	22.0	21.0	/
		2310MHz	21.02	20.07	/	22.0	21.0	/
		2307.5MHz	21.02	20.03	/	22.0	21.0	/
25RB_0	2312.5MHz	21.01	20.06	/	22.0	21.0	/	
	2310MHz	21.03	20.08	/	22.0	21.0	/	
	2307.5MHz	21.02	20.08	/	22.0	21.0	/	
Full Power								
LTE Band 30			Actual output Power (dBm)			Tune up		
Band -width	RB No. / RB offset	Frequency	Modulation			Modulation		
			QPSK	16QAM	64QAM	QPSK	16QAM	64QAM
10 MHz	1RB_49	2310MHz	21.95	21.31	/	22.5	22.0	/
	1RB_24	2310MHz	22.04	21.40	/	22.5	22.0	/
	1RB_0	2310MHz	21.95	21.31	/	22.5	22.0	/
	25RB_25	2310MHz	21.04	20.07	/	22.0	21.0	/
	25RB_12	2310MHz	21.02	20.08	/	22.0	21.0	/
	25RB_0	2310MHz	21.06	20.07	/	22.0	21.0	/
	50RB_0	2310MHz	21.06	20.04	/	22.0	21.0	/

Sensor on								
LTE Band 30			Actual output Power (dBm)			Tune up		
Band -width	RB No. / RB offset	Frequency	Modulation			Modulation		
			QPSK	16QAM	64QAM	QPSK	16QAM	64QAM
5 MHz	1RB_24	2312.5MHz	15.91	15.26	/	16.5	16.0	/
		2310MHz	15.87	15.28	/	16.5	16.0	/
		2307.5MHz	15.89	15.22	/	16.5	16.0	/
	1RB_12	2312.5MHz	16.18	15.60	/	16.5	16.0	/
		2310MHz	16.18	15.56	/	16.5	16.0	/
		2307.5MHz	16.19	15.54	/	16.5	16.0	/
	1RB_0	2312.5MHz	15.89	15.28	/	16.5	16.0	/
		2310MHz	15.86	15.26	/	16.5	16.0	/
		2307.5MHz	15.90	15.22	/	16.5	16.0	/
	12RB_13	2312.5MHz	15.01	14.08	/	16.0	15.0	/
		2310MHz	15.02	14.05	/	16.0	15.0	/
		2307.5MHz	14.99	14.02	/	16.0	15.0	/
	12RB_6	2312.5MHz	15.06	14.12	/	16.0	15.0	/
		2310MHz	15.11	14.11	/	16.0	15.0	/
		2307.5MHz	15.05	14.10	/	16.0	15.0	/
	12RB_0	2312.5MHz	15.03	14.08	/	16.0	15.0	/
		2310MHz	15.02	14.07	/	16.0	15.0	/
		2307.5MHz	15.01	14.05	/	16.0	15.0	/
25RB_0	2312.5MHz	15.01	14.05	/	16.0	15.0	/	
	2310MHz	15.00	14.07	/	16.0	15.0	/	
	2307.5MHz	15.01	14.06	/	16.0	15.0	/	
Sensor on								
LTE Band 30			Actual output Power (dBm)			Tune up		
Band -width	RB No. / RB offset	Frequency	Modulation			Modulation		
			QPSK	16QAM	64QAM	QPSK	16QAM	64QAM
10 MHz	1RB_49	2310MHz	15.96	15.33	/	16.5	16.0	/
	1RB_24	2310MHz	16.11	15.39	/	16.5	16.0	/
	1RB_0	2310MHz	15.98	15.32	/	16.5	16.0	/
	25RB_25	2310MHz	15.03	14.06	/	16.0	15.0	/
	25RB_12	2310MHz	15.03	14.11	/	16.0	15.0	/
	25RB_0	2310MHz	15.04	14.10	/	16.0	15.0	/
	50RB_0	2310MHz	15.02	14.09	/	16.0	15.0	/



Full Power								
LTE Band 66			Actual output Power (dBm)			Tune up		
Band -width	RB No. / RB offset	Frequency	Modulation			Modulation		
			QPSK	16QAM	64QAM	QPSK	16QAM	64QAM
1.4 MHz	1RB_5	1779.3MHz	22.91	22.12	/	24.0	23.0	/
		1745MHz	22.86	22.08	/	24.0	23.0	/
		1710.7MHz	22.87	22.12	/	24.0	23.0	/
	1RB_3	1779.3MHz	22.99	22.28	/	24.0	23.0	/
		1745MHz	22.98	22.19	/	24.0	23.0	/
		1710.7MHz	23.04	22.30	/	24.0	23.0	/
	1RB_0	1779.3MHz	22.89	22.18	/	24.0	23.0	/
		1745MHz	22.84	22.07	/	24.0	23.0	/
		1710.7MHz	22.91	22.15	/	24.0	23.0	/
	3RB_3	1779.3MHz	23.00	21.98	/	24.0	23.0	/
		1745MHz	22.96	21.98	/	24.0	23.0	/
		1710.7MHz	22.99	21.95	/	24.0	23.0	/
	3RB_1	1779.3MHz	23.07	22.04	/	24.0	23.0	/
		1745MHz	23.04	22.00	/	24.0	23.0	/
		1710.7MHz	23.08	22.03	/	24.0	23.0	/
	3RB_0	1779.3MHz	23.02	21.98	/	24.0	23.0	/
		1745MHz	22.96	21.93	/	24.0	23.0	/
		1710.7MHz	23.00	21.98	/	24.0	23.0	/
	6RB_0	1779.3MHz	22.01	21.07	/	23.0	22.0	/
		1745MHz	21.96	21.05	/	23.0	22.0	/
		1710.7MHz	22.02	21.04	/	23.0	22.0	/



Full Power								
LTE Band 66			Actual output Power (dBm)			Tune up		
Band -width	RB No. / RB offset	Frequency	Modulation			Modulation		
			QPSK	16QAM	64QAM	QPSK	16QAM	64QAM
3 MHz	1RB_14	1778.5MHz	22.93	22.15	/	24.0	23.0	/
		1745MHz	22.86	22.16	/	24.0	23.0	/
		1711.5MHz	22.91	22.18	/	24.0	23.0	/
	1RB_7	1778.5MHz	23.05	22.44	/	24.0	23.0	/
		1745MHz	23.07	22.26	/	24.0	23.0	/
		1711.5MHz	23.01	22.34	/	24.0	23.0	/
	1RB_0	1778.5MHz	22.91	22.15	/	24.0	23.0	/
		1745MHz	22.90	22.11	/	24.0	23.0	/
		1711.5MHz	22.95	22.26	/	24.0	23.0	/
	8RB_7	1778.5MHz	21.95	20.96	/	23.0	22.0	/
		1745MHz	21.92	20.98	/	23.0	22.0	/
		1711.5MHz	21.95	21.00	/	23.0	22.0	/
	8RB_4	1778.5MHz	21.98	21.03	/	23.0	22.0	/
		1745MHz	21.95	21.01	/	23.0	22.0	/
		1711.5MHz	22.00	21.03	/	23.0	22.0	/
	8RB_0	1778.5MHz	21.95	21.00	/	23.0	22.0	/
		1745MHz	21.93	20.99	/	23.0	22.0	/
		1711.5MHz	21.95	21.02	/	23.0	22.0	/
	15RB_0	1778.5MHz	21.94	20.97	/	23.0	22.0	/
		1745MHz	21.93	20.95	/	23.0	22.0	/
		1711.5MHz	21.96	20.96	/	23.0	22.0	/



Full Power								
LTE Band 66			Actual output Power (dBm)			Tune up		
Band -width	RB No. / RB offset	Frequency	Modulation			Modulation		
			QPSK	16QAM	64QAM	QPSK	16QAM	64QAM
5 MHz	1RB_24	1777.5MHz	22.77	22.06	/	24.0	23.0	/
		1745MHz	22.71	21.98	/	24.0	23.0	/
		1712.5MHz	22.73	22.02	/	24.0	23.0	/
	1RB_12	1777.5MHz	23.05	22.32	/	24.0	23.0	/
		1745MHz	23.02	22.29	/	24.0	23.0	/
		1712.5MHz	23.10	22.39	/	24.0	23.0	/
	1RB_0	1777.5MHz	22.77	22.07	/	24.0	23.0	/
		1745MHz	22.75	22.03	/	24.0	23.0	/
		1712.5MHz	22.82	22.10	/	24.0	23.0	/
	12RB_13	1777.5MHz	21.86	20.87	/	23.0	22.0	/
		1745MHz	21.88	20.88	/	23.0	22.0	/
		1712.5MHz	21.92	20.89	/	23.0	22.0	/
	12RB_6	1777.5MHz	22.01	20.99	/	23.0	22.0	/
		1745MHz	21.97	20.97	/	23.0	22.0	/
		1712.5MHz	21.98	20.96	/	23.0	22.0	/
	12RB_0	1777.5MHz	21.96	20.93	/	23.0	22.0	/
		1745MHz	21.92	20.90	/	23.0	22.0	/
		1712.5MHz	21.90	20.86	/	23.0	22.0	/
	25RB_0	1777.5MHz	21.93	20.94	/	23.0	22.0	/
		1745MHz	21.93	20.90	/	23.0	22.0	/
		1712.5MHz	21.91	20.94	/	23.0	22.0	/



Full Power								
LTE Band 66			Actual output Power (dBm)			Tune up		
Band -width	RB No. / RB offset	Frequency	Modulation			Modulation		
			QPSK	16QAM	64QAM	QPSK	16QAM	64QAM
10 MHz	1RB_49	1715MHz	22.85	22.07	/	24.0	23.0	/
		1715MHz	22.82	22.07	/	24.0	23.0	/
		1715MHz	22.88	22.14	/	24.0	23.0	/
	1RB_24	1715MHz	23.01	22.23	/	24.0	23.0	/
		1715MHz	22.97	22.21	/	24.0	23.0	/
		1715MHz	22.95	22.19	/	24.0	23.0	/
	1RB_0	1715MHz	22.90	22.13	/	24.0	23.0	/
		1715MHz	22.91	22.14	/	24.0	23.0	/
		1715MHz	22.93	22.15	/	24.0	23.0	/
	25RB_25	1715MHz	21.94	20.92	/	23.0	22.0	/
		1715MHz	21.96	20.96	/	23.0	22.0	/
		1715MHz	21.96	20.95	/	23.0	22.0	/
	25RB_12	1715MHz	21.98	20.95	/	23.0	22.0	/
		1715MHz	21.96	20.97	/	23.0	22.0	/
		1715MHz	21.97	20.94	/	23.0	22.0	/
	25RB_0	1715MHz	21.96	20.97	/	23.0	22.0	/
		1715MHz	21.96	20.94	/	23.0	22.0	/
		1715MHz	21.95	20.91	/	23.0	22.0	/
	50RB_0	1715MHz	21.96	20.96	/	23.0	22.0	/
		1715MHz	22.00	21.00	/	23.0	22.0	/
		1715MHz	21.97	20.95	/	23.0	22.0	/



Full Power								
LTE Band 66			Actual output Power (dBm)			Tune up		
Band -width	RB No. / RB offset	Frequency	Modulation			Modulation		
			QPSK	16QAM	64QAM	QPSK	16QAM	64QAM
15 MHz	1RB_74	1772.5MHz	22.79	22.03	/	24.0	23.0	/
		1745MHz	22.77	22.06	/	24.0	23.0	/
		1717.5MHz	22.81	22.11	/	24.0	23.0	/
	1RB_37	1772.5MHz	22.95	22.16	/	24.0	23.0	/
		1745MHz	22.93	22.18	/	24.0	23.0	/
		1717.5MHz	22.93	22.20	/	24.0	23.0	/
	1RB_0	1772.5MHz	22.89	22.16	/	24.0	23.0	/
		1745MHz	22.91	22.15	/	24.0	23.0	/
		1717.5MHz	22.91	22.19	/	24.0	23.0	/
	36RB_38	1772.5MHz	21.98	20.94	/	23.0	22.0	/
		1745MHz	21.94	20.89	/	23.0	22.0	/
		1717.5MHz	21.95	20.91	/	23.0	22.0	/
	36RB_19	1772.5MHz	22.01	20.95	/	23.0	22.0	/
		1745MHz	22.02	20.97	/	23.0	22.0	/
		1717.5MHz	21.97	20.97	/	23.0	22.0	/
	36RB_0	1772.5MHz	21.99	20.93	/	23.0	22.0	/
		1745MHz	21.98	20.93	/	23.0	22.0	/
		1717.5MHz	21.95	20.91	/	23.0	22.0	/
	75RB_0	1772.5MHz	21.94	20.97	/	23.0	22.0	/
		1745MHz	21.97	20.95	/	23.0	22.0	/
		1717.5MHz	21.93	20.90	/	23.0	22.0	/



Full Power								
LTE Band 66			Actual output Power (dBm)			Tune up		
Band -width	RB No. / RB offset	Frequency	Modulation			Modulation		
			QPSK	16QAM	64QAM	QPSK	16QAM	64QAM
20 MHz	1RB_99	1770MHz	22.71	21.99	/	24.0	23.0	/
		1745MHz	22.71	21.99	/	24.0	23.0	/
		1720MHz	22.75	22.00	/	24.0	23.0	/
	1RB_50	1770MHz	23.05	22.24	/	24.0	23.0	/
		1745MHz	22.96	22.23	/	24.0	23.0	/
		1720MHz	23.03	22.26	/	24.0	23.0	/
	1RB_0	1770MHz	22.81	22.14	/	24.0	23.0	/
		1745MHz	22.82	22.11	/	24.0	23.0	/
		1720MHz	22.84	22.10	/	24.0	23.0	/
	50RB_50	1770MHz	21.92	20.90	/	23.0	22.0	/
		1745MHz	21.88	20.88	/	23.0	22.0	/
		1720MHz	21.86	20.85	/	23.0	22.0	/
	50RB_25	1770MHz	22.03	20.96	/	23.0	22.0	/
		1745MHz	22.01	20.97	/	23.0	22.0	/
		1720MHz	21.96	20.95	/	23.0	22.0	/
	50RB_0	1770MHz	21.99	20.99	/	23.0	22.0	/
		1745MHz	21.92	20.88	/	23.0	22.0	/
		1720MHz	21.94	20.94	/	23.0	22.0	/
	100RB_0	1770MHz	21.96	20.93	/	23.0	22.0	/
		1745MHz	21.85	20.83	/	23.0	22.0	/
		1720MHz	21.91	20.88	/	23.0	22.0	/



Sensor on								
LTE Band 66			Actual output Power (dBm)			Tune up		
Band -width	RB No. / RB offset	Frequency	Modulation			Modulation		
			QPSK	16QAM	64QAM	QPSK	16QAM	64QAM
1.4 MHz	1RB_5	1779.3MHz	14.39	13.75	/	15.5	14.5	/
		1745MHz	14.29	13.64	/	15.5	14.5	/
		1710.7MHz	14.32	13.71	/	15.5	14.5	/
	1RB_3	1779.3MHz	14.43	13.82	/	15.5	14.5	/
		1745MHz	14.44	13.81	/	15.5	14.5	/
		1710.7MHz	14.47	13.86	/	15.5	14.5	/
	1RB_0	1779.3MHz	14.38	13.74	/	15.5	14.5	/
		1745MHz	14.31	13.64	/	15.5	14.5	/
		1710.7MHz	14.38	13.79	/	15.5	14.5	/
	3RB_3	1779.3MHz	14.47	13.51	/	15.5	14.5	/
		1745MHz	14.39	13.42	/	15.5	14.5	/
		1710.7MHz	14.41	13.49	/	15.5	14.5	/
	3RB_1	1779.3MHz	14.58	13.61	/	15.5	14.5	/
		1745MHz	14.45	13.44	/	15.5	14.5	/
		1710.7MHz	14.50	13.50	/	15.5	14.5	/
	3RB_0	1779.3MHz	14.49	13.53	/	15.5	14.5	/
		1745MHz	14.41	13.43	/	15.5	14.5	/
		1710.7MHz	14.43	13.50	/	15.5	14.5	/
	6RB_0	1779.3MHz	13.51	12.59	/	14.5	13.5	/
		1745MHz	13.39	12.53	/	14.5	13.5	/
		1710.7MHz	13.43	12.51	/	14.5	13.5	/



Sensor on								
LTE Band 66			Actual output Power (dBm)			Tune up		
Band -width	RB No. / RB offset	Frequency	Modulation			Modulation		
			QPSK	16QAM	64QAM	QPSK	16QAM	64QAM
3 MHz	1RB_14	1778.5MHz	14.41	13.77	/	15.5	14.5	/
		1745MHz	14.34	13.76	/	15.5	14.5	/
		1711.5MHz	14.41	13.76	/	15.5	14.5	/
	1RB_7	1778.5MHz	14.74	13.93	/	15.5	14.5	/
		1745MHz	14.63	13.95	/	15.5	14.5	/
		1711.5MHz	14.58	13.96	/	15.5	14.5	/
	1RB_0	1778.5MHz	14.43	13.78	/	15.5	14.5	/
		1745MHz	14.38	13.72	/	15.5	14.5	/
		1711.5MHz	14.45	13.80	/	15.5	14.5	/
	8RB_7	1778.5MHz	13.47	12.55	/	14.5	13.5	/
		1745MHz	13.42	12.50	/	14.5	13.5	/
		1711.5MHz	13.49	12.55	/	14.5	13.5	/
	8RB_4	1778.5MHz	13.53	12.60	/	14.5	13.5	/
		1745MHz	13.45	12.53	/	14.5	13.5	/
		1711.5MHz	13.49	12.59	/	14.5	13.5	/
	8RB_0	1778.5MHz	13.53	12.57	/	14.5	13.5	/
		1745MHz	13.42	12.52	/	14.5	13.5	/
		1711.5MHz	13.46	12.56	/	14.5	13.5	/
	15RB_0	1778.5MHz	13.48	12.49	/	14.5	13.5	/
		1745MHz	13.43	12.44	/	14.5	13.5	/
		1711.5MHz	13.47	12.46	/	14.5	13.5	/



Sensor on								
LTE Band 66			Actual output Power (dBm)			Tune up		
Band -width	RB No. / RB offset	Frequency	Modulation			Modulation		
			QPSK	16QAM	64QAM	QPSK	16QAM	64QAM
5 MHz	1RB_24	1777.5MHz	14.29	13.63	/	15.5	14.5	/
		1745MHz	14.20	13.57	/	15.5	14.5	/
		1712.5MHz	14.24	13.58	/	15.5	14.5	/
	1RB_12	1777.5MHz	14.62	13.95	/	15.5	14.5	/
		1745MHz	14.53	13.91	/	15.5	14.5	/
		1712.5MHz	14.59	13.93	/	15.5	14.5	/
	1RB_0	1777.5MHz	14.29	13.63	/	15.5	14.5	/
		1745MHz	14.29	13.62	/	15.5	14.5	/
		1712.5MHz	14.32	13.67	/	15.5	14.5	/
	12RB_13	1777.5MHz	13.47	12.43	/	14.5	13.5	/
		1745MHz	13.41	12.39	/	14.5	13.5	/
		1712.5MHz	13.47	12.42	/	14.5	13.5	/
	12RB_6	1777.5MHz	13.55	12.54	/	14.5	13.5	/
		1745MHz	13.48	12.50	/	14.5	13.5	/
		1712.5MHz	13.49	12.48	/	14.5	13.5	/
	12RB_0	1777.5MHz	13.53	12.50	/	14.5	13.5	/
		1745MHz	13.43	12.41	/	14.5	13.5	/
		1712.5MHz	13.39	12.38	/	14.5	13.5	/
	25RB_0	1777.5MHz	13.50	12.49	/	14.5	13.5	/
		1745MHz	13.41	12.45	/	14.5	13.5	/
		1712.5MHz	13.45	12.45	/	14.5	13.5	/



Sensor on								
LTE Band 66			Actual output Power (dBm)			Tune up		
Band -width	RB No. / RB offset	Frequency	Modulation			Modulation		
			QPSK	16QAM	64QAM	QPSK	16QAM	64QAM
10 MHz	1RB_49	1715MHz	14.43	13.79	/	15.5	14.5	/
		1715MHz	14.35	13.67	/	15.5	14.5	/
		1715MHz	14.33	13.72	/	15.5	14.5	/
	1RB_24	1715MHz	14.50	13.89	/	15.5	14.5	/
		1715MHz	14.48	13.81	/	15.5	14.5	/
		1715MHz	14.45	13.77	/	15.5	14.5	/
	1RB_0	1715MHz	14.48	13.81	/	15.5	14.5	/
		1715MHz	14.40	13.72	/	15.5	14.5	/
		1715MHz	14.45	13.84	/	15.5	14.5	/
	25RB_25	1715MHz	13.50	12.51	/	14.5	13.5	/
		1715MHz	13.49	12.48	/	14.5	13.5	/
		1715MHz	13.46	12.45	/	14.5	13.5	/
	25RB_12	1715MHz	13.54	12.52	/	14.5	13.5	/
		1715MHz	13.51	12.47	/	14.5	13.5	/
		1715MHz	13.46	12.46	/	14.5	13.5	/
	25RB_0	1715MHz	13.52	12.53	/	14.5	13.5	/
		1715MHz	13.44	12.42	/	14.5	13.5	/
		1715MHz	13.43	12.45	/	14.5	13.5	/
	50RB_0	1715MHz	13.48	12.51	/	14.5	13.5	/
		1715MHz	13.43	12.45	/	14.5	13.5	/
		1715MHz	13.45	12.47	/	14.5	13.5	/



Sensor on								
LTE Band 66			Actual output Power (dBm)			Tune up		
Band -width	RB No. / RB offset	Frequency	Modulation			Modulation		
			QPSK	16QAM	64QAM	QPSK	16QAM	64QAM
15 MHz	1RB_74	1772.5MHz	14.40	13.77	/	15.5	14.5	/
		1745MHz	14.28	13.63	/	15.5	14.5	/
		1717.5MHz	14.30	13.73	/	15.5	14.5	/
	1RB_37	1772.5MHz	14.44	13.81	/	15.5	14.5	/
		1745MHz	14.40	13.80	/	15.5	14.5	/
		1717.5MHz	14.36	13.79	/	15.5	14.5	/
	1RB_0	1772.5MHz	14.41	13.78	/	15.5	14.5	/
		1745MHz	14.40	13.75	/	15.5	14.5	/
		1717.5MHz	14.41	13.88	/	15.5	14.5	/
	36RB_38	1772.5MHz	13.56	12.49	/	14.5	13.5	/
		1745MHz	13.42	12.42	/	14.5	13.5	/
		1717.5MHz	13.38	12.41	/	14.5	13.5	/
	36RB_19	1772.5MHz	13.54	12.49	/	14.5	13.5	/
		1745MHz	13.44	12.43	/	14.5	13.5	/
		1717.5MHz	13.46	12.40	/	14.5	13.5	/
	36RB_0	1772.5MHz	13.52	12.47	/	14.5	13.5	/
		1745MHz	13.43	12.41	/	14.5	13.5	/
		1717.5MHz	13.45	12.44	/	14.5	13.5	/
	75RB_0	1772.5MHz	13.52	12.53	/	14.5	13.5	/
		1745MHz	13.45	12.44	/	14.5	13.5	/
		1717.5MHz	13.40	12.40	/	14.5	13.5	/



Sensor on								
LTE Band 66			Actual output Power (dBm)			Tune up		
Band -width	RB No. / RB offset	Frequency	Modulation			Modulation		
			QPSK	16QAM	64QAM	QPSK	16QAM	64QAM
20 MHz	1RB_99	1770MHz	14.35	13.60	/	15.5	14.5	/
		1745MHz	14.23	13.53	/	15.5	14.5	/
		1720MHz	14.21	14.36	/	15.5	14.5	/
	1RB_50	1770MHz	14.54	13.85	/	15.5	14.5	/
		1745MHz	14.46	13.78	/	15.5	14.5	/
		1720MHz	14.43	14.42	/	15.5	14.5	/
	1RB_0	1770MHz	14.38	13.67	/	15.5	14.5	/
		1745MHz	14.33	13.67	/	15.5	14.5	/
		1720MHz	14.33	14.41	/	15.5	14.5	/
	50RB_50	1770MHz	13.47	12.48	/	14.5	13.5	/
		1745MHz	13.36	12.38	/	14.5	13.5	/
		1720MHz	13.30	12.30	/	14.5	13.5	/
	50RB_25	1770MHz	13.52	12.55	/	14.5	13.5	/
		1745MHz	13.44	12.44	/	14.5	13.5	/
		1720MHz	13.44	12.42	/	14.5	13.5	/
	50RB_0	1770MHz	13.51	12.53	/	14.5	13.5	/
		1745MHz	13.38	12.38	/	14.5	13.5	/
		1720MHz	13.37	12.37	/	14.5	13.5	/
	100RB_0	1770MHz	13.52	12.49	/	14.5	13.5	/
		1745MHz	13.39	12.37	/	14.5	13.5	/
		1720MHz	13.34	12.35	/	14.5	13.5	/



Full power								
LTE Band 71			Actual output Power (dBm)			Tune up		
Band -width	RB No. / RB offset	Frequency	Modulation			Modulation		
			QPSK	16QAM	64QAM	QPSK	16QAM	64QAM
5 MHz	1RB_24	695.5MHz	23.19	22.47	/	24.0	23.0	/
		680.5MHz	23.00	22.30	/	24.0	23.0	/
		665.5MHz	23.03	22.36	/	24.0	23.0	/
	1RB_12	695.5MHz	23.30	22.61	/	24.0	23.0	/
		680.5MHz	23.29	22.62	/	24.0	23.0	/
		665.5MHz	23.16	22.53	/	24.0	23.0	/
	1RB_0	695.5MHz	23.01	22.33	/	24.0	23.0	/
		680.5MHz	23.02	22.33	/	24.0	23.0	/
		665.5MHz	22.96	22.24	/	24.0	23.0	/
	12RB_13	695.5MHz	22.26	21.21	/	23.0	22.0	/
		680.5MHz	22.16	21.14	/	23.0	22.0	/
		665.5MHz	22.23	21.22	/	23.0	22.0	/
	12RB_6	695.5MHz	22.27	21.24	/	23.0	22.0	/
		680.5MHz	22.22	21.21	/	23.0	22.0	/
		665.5MHz	22.20	21.19	/	23.0	22.0	/
	12RB_0	695.5MHz	22.15	21.15	/	23.0	22.0	/
		680.5MHz	22.12	21.08	/	23.0	22.0	/
		665.5MHz	22.08	21.08	/	23.0	22.0	/
	25RB_0	695.5MHz	22.25	21.20	/	23.0	22.0	/
		680.5MHz	22.14	21.11	/	23.0	22.0	/
		665.5MHz	22.13	21.13	/	23.0	22.0	/



Full power								
LTE Band 71			Actual output Power (dBm)			Tune up		
Band -width	RB No. / RB offset	Frequency	Modulation			Modulation		
			QPSK	16QAM	64QAM	QPSK	16QAM	64QAM
10 MHz	1RB_49	693.0MHz	23.28	22.59	/	24.0	23.0	/
		680.5MHz	23.10	22.40	/	24.0	23.0	/
		668.0MHz	23.10	22.42	/	24.0	23.0	/
	1RB_24	693.0MHz	23.22	22.50	/	24.0	23.0	/
		680.5MHz	23.22	22.58	/	24.0	23.0	/
		668.0MHz	23.14	22.43	/	24.0	23.0	/
	1RB_0	693.0MHz	23.09	22.41	/	24.0	23.0	/
		680.5MHz	23.10	22.42	/	24.0	23.0	/
		668.0MHz	23.08	22.34	/	24.0	23.0	/
	25RB_25	693.0MHz	22.26	21.29	/	23.0	22.0	/
		680.5MHz	22.23	21.24	/	23.0	22.0	/
		668.0MHz	22.21	21.21	/	23.0	22.0	/
	25RB_12	693.0MHz	22.20	21.24	/	23.0	22.0	/
		680.5MHz	22.17	21.18	/	23.0	22.0	/
		668.0MHz	22.14	21.16	/	23.0	22.0	/
	25RB_0	693.0MHz	22.32	21.27	/	23.0	22.0	/
		680.5MHz	22.12	21.09	/	23.0	22.0	/
		668.0MHz	22.04	21.05	/	23.0	22.0	/
	50RB_0	693.0MHz	22.29	21.26	/	23.0	22.0	/
		680.5MHz	22.21	21.20	/	23.0	22.0	/
		668.0MHz	22.10	21.11	/	23.0	22.0	/



Full power								
LTE Band 71			Actual output Power (dBm)			Tune up		
Band -width	RB No. / RB offset	Frequency	Modulation			Modulation		
			QPSK	16QAM	64QAM	QPSK	16QAM	64QAM
15 MHz	1RB_74	690.5MHz	23.28	22.52	/	24.0	23.0	/
		680.5MHz	23.03	22.29	/	24.0	23.0	/
		670.5MHz	23.17	22.40	/	24.0	23.0	/
	1RB_37	690.5MHz	23.18	22.46	/	24.0	23.0	/
		680.5MHz	23.17	22.46	/	24.0	23.0	/
		670.5MHz	23.09	22.41	/	24.0	23.0	/
	1RB_0	690.5MHz	23.02	22.28	/	24.0	23.0	/
		680.5MHz	23.06	22.33	/	24.0	23.0	/
		670.5MHz	23.01	22.28	/	24.0	23.0	/
	36RB_38	690.5MHz	22.27	21.22	/	23.0	22.0	/
		680.5MHz	22.21	21.17	/	23.0	22.0	/
		670.5MHz	22.20	21.15	/	23.0	22.0	/
	36RB_19	690.5MHz	22.27	21.21	/	23.0	22.0	/
		680.5MHz	22.23	21.15	/	23.0	22.0	/
		670.5MHz	22.23	21.16	/	23.0	22.0	/
	36RB_0	690.5MHz	22.20	21.18	/	23.0	22.0	/
		680.5MHz	22.18	21.07	/	23.0	22.0	/
		670.5MHz	22.06	21.00	/	23.0	22.0	/
	75RB_0	690.5MHz	22.22	21.17	/	23.0	22.0	/
		680.5MHz	22.19	21.17	/	23.0	22.0	/
		670.5MHz	22.07	21.05	/	23.0	22.0	/



Full power								
LTE Band 71			Actual output Power (dBm)			Tune up		
Band -width	RB No. / RB offset	Frequency	Modulation			Modulation		
			QPSK	16QAM	64QAM	QPSK	16QAM	64QAM
20 MHz	1RB_99	688.0MHz	23.16	22.59	/	24.0	23.0	/
		683.0MHz	23.12	22.44	/	24.0	23.0	/
		673.0MHz	23.14	22.49	/	24.0	23.0	/
	1RB_50	688.0MHz	23.28	22.64	/	24.0	23.0	/
		683.0MHz	23.31	22.69	/	24.0	23.0	/
		673.0MHz	23.25	22.58	/	24.0	23.0	/
	1RB_0	688.0MHz	23.04	22.35	/	24.0	23.0	/
		683.0MHz	23.04	22.35	/	24.0	23.0	/
		673.0MHz	23.03	22.39	/	24.0	23.0	/
	50RB_50	688.0MHz	22.25	21.28	/	23.0	22.0	/
		683.0MHz	22.16	21.19	/	23.0	22.0	/
		673.0MHz	22.29	21.32	/	23.0	22.0	/
	50RB_25	688.0MHz	22.30	21.36	/	23.0	22.0	/
		683.0MHz	22.27	21.30	/	23.0	22.0	/
		673.0MHz	22.26	21.33	/	23.0	22.0	/
	50RB_0	688.0MHz	22.17	21.19	/	23.0	22.0	/
		683.0MHz	22.20	21.22	/	23.0	22.0	/
		673.0MHz	22.04	21.06	/	23.0	22.0	/
	100RB_0	688.0MHz	22.19	21.22	/	23.0	22.0	/
		683.0MHz	22.16	21.19	/	23.0	22.0	/
		673.0MHz	22.15	21.13	/	23.0	22.0	/



Sensor on								
LTE Band 71			Actual output Power (dBm)			Tune up		
Band -width	RB No. / RB offset	Frequency	Modulation			Modulation		
			QPSK	16QAM	64QAM	QPSK	16QAM	64QAM
5 MHz	1RB_24	695.5MHz	18.10	17.37	/	19.0	18.0	/
		680.5MHz	18.05	17.36	/	19.0	18.0	/
		665.5MHz	17.99	17.30	/	19.0	18.0	/
	1RB_12	695.5MHz	18.39	17.57	/	19.0	18.0	/
		680.5MHz	18.31	17.57	/	19.0	18.0	/
		665.5MHz	18.24	17.56	/	19.0	18.0	/
	1RB_0	695.5MHz	18.04	17.36	/	19.0	18.0	/
		680.5MHz	18.01	17.33	/	19.0	18.0	/
		665.5MHz	18.01	17.28	/	19.0	18.0	/
	12RB_13	695.5MHz	17.22	16.23	/	18.0	17.0	/
		680.5MHz	17.18	16.16	/	18.0	17.0	/
		665.5MHz	17.18	16.13	/	18.0	17.0	/
	12RB_6	695.5MHz	17.21	16.22	/	18.0	17.0	/
		680.5MHz	17.21	16.17	/	18.0	17.0	/
		665.5MHz	17.17	16.13	/	18.0	17.0	/
	12RB_0	695.5MHz	17.14	16.16	/	18.0	17.0	/
		680.5MHz	17.14	16.11	/	18.0	17.0	/
		665.5MHz	17.10	16.08	/	18.0	17.0	/
	25RB_0	695.5MHz	17.20	16.22	/	18.0	17.0	/
		680.5MHz	17.15	16.17	/	18.0	17.0	/
		665.5MHz	17.13	16.14	/	18.0	17.0	/



Sensor on								
LTE Band 71			Actual output Power (dBm)			Tune up		
Band -width	RB No. / RB offset	Frequency	Modulation			Modulation		
			QPSK	16QAM	64QAM	QPSK	16QAM	64QAM
10 MHz	1RB_49	693.0MHz	18.21	17.47	/	19.0	18.0	/
		680.5MHz	18.12	17.40	/	19.0	18.0	/
		668.0MHz	18.10	17.42	/	19.0	18.0	/
	1RB_24	693.0MHz	18.23	17.57	/	19.0	18.0	/
		680.5MHz	18.24	17.55	/	19.0	18.0	/
		668.0MHz	18.14	17.47	/	19.0	18.0	/
	1RB_0	693.0MHz	18.11	17.43	/	19.0	18.0	/
		680.5MHz	18.11	17.40	/	19.0	18.0	/
		668.0MHz	18.10	17.40	/	19.0	18.0	/
	25RB_25	693.0MHz	17.26	16.26	/	18.0	17.0	/
		680.5MHz	17.29	16.29	/	18.0	17.0	/
		668.0MHz	17.27	16.23	/	18.0	17.0	/
	25RB_12	693.0MHz	17.22	16.23	/	18.0	17.0	/
		680.5MHz	17.21	16.18	/	18.0	17.0	/
		668.0MHz	17.18	16.15	/	18.0	17.0	/
	25RB_0	693.0MHz	17.32	16.33	/	18.0	17.0	/
		680.5MHz	17.22	16.22	/	18.0	17.0	/
		668.0MHz	17.10	16.08	/	18.0	17.0	/
	50RB_0	693.0MHz	17.28	16.29	/	18.0	17.0	/
		680.5MHz	17.28	16.23	/	18.0	17.0	/
		668.0MHz	17.17	16.17	/	18.0	17.0	/



Sensor on								
LTE Band 71			Actual output Power (dBm)			Tune up		
Band -width	RB No. / RB offset	Frequency	Modulation			Modulation		
			QPSK	16QAM	64QAM	QPSK	16QAM	64QAM
15 MHz	1RB_74	690.5MHz	18.17	17.42	/	19.0	18.0	/
		680.5MHz	18.09	17.42	/	19.0	18.0	/
		670.5MHz	18.16	17.46	/	19.0	18.0	/
	1RB_37	690.5MHz	18.18	17.49	/	19.0	18.0	/
		680.5MHz	18.16	17.48	/	19.0	18.0	/
		670.5MHz	18.13	17.42	/	19.0	18.0	/
	1RB_0	690.5MHz	18.03	17.35	/	19.0	18.0	/
		680.5MHz	18.06	17.38	/	19.0	18.0	/
		670.5MHz	18.05	17.38	/	19.0	18.0	/
	36RB_38	690.5MHz	17.27	16.25	/	18.0	17.0	/
		680.5MHz	17.24	16.21	/	18.0	17.0	/
		670.5MHz	17.22	16.18	/	18.0	17.0	/
	36RB_19	690.5MHz	17.18	16.20	/	18.0	17.0	/
		680.5MHz	17.18	16.14	/	18.0	17.0	/
		670.5MHz	17.19	16.14	/	18.0	17.0	/
	36RB_0	690.5MHz	17.22	16.17	/	18.0	17.0	/
		680.5MHz	17.20	16.19	/	18.0	17.0	/
		670.5MHz	17.09	16.02	/	18.0	17.0	/
	75RB_0	690.5MHz	17.21	16.24	/	18.0	17.0	/
		680.5MHz	17.24	16.19	/	18.0	17.0	/
		670.5MHz	17.11	16.06	/	18.0	17.0	/



Sensor on								
LTE Band 71			Actual output Power (dBm)			Tune up		
Band -width	RB No. / RB offset	Frequency	Modulation			Modulation		
			QPSK	16QAM	64QAM	QPSK	16QAM	64QAM
20 MHz	1RB_99	688.0MHz	18.10	17.33	/	19.0	18.0	/
		683.0MHz	18.10	17.32	/	19.0	18.0	/
		673.0MHz	18.04	17.38	/	19.0	18.0	/
	1RB_50	688.0MHz	18.23	17.44	/	19.0	18.0	/
		683.0MHz	18.25	17.54	/	19.0	18.0	/
		673.0MHz	18.23	17.52	/	19.0	18.0	/
	1RB_0	688.0MHz	18.02	17.30	/	19.0	18.0	/
		683.0MHz	17.99	17.28	/	19.0	18.0	/
		673.0MHz	18.00	17.35	/	19.0	18.0	/
	50RB_50	688.0MHz	17.22	16.20	/	18.0	17.0	/
		683.0MHz	17.19	16.15	/	18.0	17.0	/
		673.0MHz	17.25	16.21	/	18.0	17.0	/
	50RB_25	688.0MHz	17.27	16.20	/	18.0	17.0	/
		683.0MHz	17.23	16.20	/	18.0	17.0	/
		673.0MHz	17.21	16.18	/	18.0	17.0	/
	50RB_0	688.0MHz	17.16	16.10	/	18.0	17.0	/
		683.0MHz	17.14	16.15	/	18.0	17.0	/
		673.0MHz	16.97	15.95	/	18.0	17.0	/
	100RB_0	688.0MHz	17.20	16.15	/	18.0	17.0	/
		683.0MHz	17.16	16.11	/	18.0	17.0	/
		673.0MHz	17.08	16.09	/	18.0	17.0	/



Full power								
LTE Band 41 (PC3)			Actual output Power (dBm)			Tune up		
Band -width	RB No. / RB offset	Frequency	Modulation			Modulation		
			QPSK	16QAM	64QAM	QPSK	16QAM	64QAM
5 MHz	1RB_24	2687.5MHz	23.16	22.16	/	24.0	23.0	/
		2640.3MHz	23.17	22.19	/	24.0	23.0	/
		2593.0MHz	22.78	21.83	/	24.0	23.0	/
		2545.8MHz	23.14	22.18	/	24.0	23.0	/
		2498.5MHz	23.22	22.27	/	24.0	23.0	/
	1RB_12	2687.5MHz	23.37	22.40	/	24.0	23.0	/
		2640.3MHz	23.34	22.42	/	24.0	23.0	/
		2593.0MHz	22.91	21.92	/	24.0	23.0	/
		2545.8MHz	23.35	22.40	/	24.0	23.0	/
		2498.5MHz	23.40	22.48	/	24.0	23.0	/
	1RB_0	2687.5MHz	23.14	22.17	/	24.0	23.0	/
		2640.3MHz	23.19	22.20	/	24.0	23.0	/
		2593.0MHz	22.77	21.80	/	24.0	23.0	/
		2545.8MHz	23.16	22.20	/	24.0	23.0	/
		2498.5MHz	23.26	22.29	/	24.0	23.0	/
	12RB_13	2687.5MHz	22.23	21.17	/	23.0	22.0	/
		2640.3MHz	22.20	21.18	/	23.0	22.0	/
		2593.0MHz	21.82	20.75	/	23.0	22.0	/
		2545.8MHz	22.25	21.22	/	23.0	22.0	/
		2498.5MHz	22.32	21.27	/	23.0	22.0	/
	12RB_6	2687.5MHz	22.31	21.24	/	23.0	22.0	/
		2640.3MHz	22.24	21.25	/	23.0	22.0	/
		2593.0MHz	21.90	20.83	/	23.0	22.0	/
		2545.8MHz	22.34	21.27	/	23.0	22.0	/
		2498.5MHz	22.39	21.32	/	23.0	22.0	/
	12RB_0	2687.5MHz	22.25	21.18	/	23.0	22.0	/
		2640.3MHz	22.24	21.19	/	23.0	22.0	/
		2593.0MHz	21.85	20.77	/	23.0	22.0	/
		2545.8MHz	22.24	21.20	/	23.0	22.0	/
		2498.5MHz	22.35	21.31	/	23.0	22.0	/
25RB_0	2687.5MHz	22.24	21.26	/	23.0	22.0	/	
	2640.3MHz	22.24	21.25	/	23.0	22.0	/	
	2593.0MHz	21.84	20.85	/	23.0	22.0	/	
	2545.8MHz	22.27	21.29	/	23.0	22.0	/	
	2498.5MHz	22.34	21.35	/	23.0	22.0	/	



Full power								
LTE Band 41 (PC3)			Actual output Power (dBm)			Tune up		
Band -width	RB No. / RB offset	Frequency	Modulation			Modulation		
			QPSK	16QAM	64QAM	QPSK	16QAM	64QAM
10 MHz	1RB_49	2685.0MHz	23.24	22.26	/	24.0	23.0	/
		2639.0MHz	23.28	22.27	/	24.0	23.0	/
		2593.0MHz	22.94	21.99	/	24.0	23.0	/
		2547.0MHz	23.26	22.31	/	24.0	23.0	/
		2501.0MHz	23.33	22.34	/	24.0	23.0	/
	1RB_24	2685.0MHz	23.33	22.38	/	24.0	23.0	/
		2639.0MHz	23.39	22.41	/	24.0	23.0	/
		2593.0MHz	22.90	21.96	/	24.0	23.0	/
		2547.0MHz	23.36	22.43	/	24.0	23.0	/
		2501.0MHz	23.44	22.48	/	24.0	23.0	/
	1RB_0	2685.0MHz	23.24	22.26	/	24.0	23.0	/
		2639.0MHz	23.31	22.33	/	24.0	23.0	/
		2593.0MHz	22.94	21.98	/	24.0	23.0	/
		2547.0MHz	23.26	22.34	/	24.0	23.0	/
		2501.0MHz	23.34	22.40	/	24.0	23.0	/
	25RB_25	2685.0MHz	22.27	21.27	/	23.0	22.0	/
		2639.0MHz	22.30	21.26	/	23.0	22.0	/
		2593.0MHz	21.90	20.92	/	23.0	22.0	/
		2547.0MHz	22.33	21.33	/	23.0	22.0	/
		2501.0MHz	22.35	21.35	/	23.0	22.0	/
	25RB_12	2685.0MHz	22.29	21.30	/	23.0	22.0	/
		2639.0MHz	22.33	21.35	/	23.0	22.0	/
		2593.0MHz	21.88	20.90	/	23.0	22.0	/
		2547.0MHz	22.35	21.33	/	23.0	22.0	/
		2501.0MHz	22.39	21.39	/	23.0	22.0	/
	25RB_0	2685.0MHz	22.27	21.24	/	23.0	22.0	/
		2639.0MHz	22.36	21.36	/	23.0	22.0	/
		2593.0MHz	21.93	20.92	/	23.0	22.0	/
		2547.0MHz	22.32	21.34	/	23.0	22.0	/
		2501.0MHz	22.39	21.41	/	23.0	22.0	/
50RB_0	2685.0MHz	22.25	21.23	/	23.0	22.0	/	
	2639.0MHz	22.31	21.30	/	23.0	22.0	/	
	2593.0MHz	21.88	20.90	/	23.0	22.0	/	
	2547.0MHz	22.26	21.29	/	23.0	22.0	/	
	2501.0MHz	22.30	21.34	/	23.0	22.0	/	



Full power								
LTE Band 41 (PC3)			Actual output Power (dBm)			Tune up		
Band -width	RB No. / RB offset	Frequency	Modulation			Modulation		
			QPSK	16QAM	64QAM	QPSK	16QAM	64QAM
15 MHz	1RB_74	2682.5MHz	23.13	22.16	/	24.0	23.0	/
		2637.8MHz	23.15	22.18	/	24.0	23.0	/
		2593.0MHz	22.92	21.96	/	24.0	23.0	/
		2548.3MHz	23.15	22.19	/	24.0	23.0	/
		2503.5MHz	23.28	22.29	/	24.0	23.0	/
	1RB_37	2682.5MHz	23.20	22.27	/	24.0	23.0	/
		2637.8MHz	23.30	22.37	/	24.0	23.0	/
		2593.0MHz	22.83	21.86	/	24.0	23.0	/
		2548.3MHz	23.26	22.30	/	24.0	23.0	/
		2503.5MHz	23.36	22.41	/	24.0	23.0	/
	1RB_0	2682.5MHz	23.10	22.12	/	24.0	23.0	/
		2637.8MHz	23.20	22.24	/	24.0	23.0	/
		2593.0MHz	22.94	21.97	/	24.0	23.0	/
		2548.3MHz	23.20	22.24	/	24.0	23.0	/
		2503.5MHz	23.30	22.35	/	24.0	23.0	/
	36RB_38	2682.5MHz	22.23	21.16	/	23.0	22.0	/
		2637.8MHz	22.27	21.18	/	23.0	22.0	/
		2593.0MHz	21.91	20.82	/	23.0	22.0	/
		2548.3MHz	22.27	21.21	/	23.0	22.0	/
		2503.5MHz	22.35	21.28	/	23.0	22.0	/
	36RB_19	2682.5MHz	22.23	21.14	/	23.0	22.0	/
		2637.8MHz	22.32	21.23	/	23.0	22.0	/
		2593.0MHz	21.93	20.83	/	23.0	22.0	/
		2548.3MHz	22.30	21.25	/	23.0	22.0	/
		2503.5MHz	22.40	21.32	/	23.0	22.0	/
36RB_0	2682.5MHz	22.21	21.11	/	23.0	22.0	/	
	2637.8MHz	22.31	21.23	/	23.0	22.0	/	
	2593.0MHz	21.97	20.89	/	23.0	22.0	/	
	2548.3MHz	22.27	21.22	/	23.0	22.0	/	
	2503.5MHz	22.40	21.34	/	23.0	22.0	/	
75RB_0	2682.5MHz	22.18	21.18	/	23.0	22.0	/	
	2637.8MHz	22.24	21.26	/	23.0	22.0	/	
	2593.0MHz	21.87	20.88	/	23.0	22.0	/	
	2548.3MHz	22.26	21.26	/	23.0	22.0	/	
	2503.5MHz	22.34	21.35	/	23.0	22.0	/	



Full power								
LTE Band 41 (PC3)			Actual output Power (dBm)			Tune up		
Band -width	RB No. / RB offset	Frequency	Modulation			Modulation		
			QPSK	16QAM	64QAM	QPSK	16QAM	64QAM
20 MHz	1RB_99	2680.0MHz	23.08	22.12	/	24.0	23.0	/
		2636.5MHz	23.08	22.11	/	24.0	23.0	/
		2593.0MHz	22.96	21.95	/	24.0	23.0	/
		2549.5MHz	23.13	22.16	/	24.0	23.0	/
		2506.0MHz	23.18	22.22	/	24.0	23.0	/
	1RB_50	2680.0MHz	23.34	22.30	/	24.0	23.0	/
		2636.5MHz	23.38	22.38	/	24.0	23.0	/
		2593.0MHz	22.97	21.93	/	24.0	23.0	/
		2549.5MHz	23.40	22.39	/	24.0	23.0	/
		2506.0MHz	23.44	22.46	/	24.0	23.0	/
	1RB_0	2680.0MHz	23.06	22.05	/	24.0	23.0	/
		2636.5MHz	23.17	22.19	/	24.0	23.0	/
		2593.0MHz	22.96	21.98	/	24.0	23.0	/
		2549.5MHz	23.18	22.22	/	24.0	23.0	/
		2506.0MHz	23.26	22.29	/	24.0	23.0	/
	50RB_50	2680.0MHz	22.18	21.17	/	23.0	22.0	/
		2636.5MHz	22.16	21.20	/	23.0	22.0	/
		2593.0MHz	21.86	20.87	/	23.0	22.0	/
		2549.5MHz	22.22	21.24	/	23.0	22.0	/
		2506.0MHz	22.26	21.30	/	23.0	22.0	/
	50RB_25	2680.0MHz	22.15	21.15	/	23.0	22.0	/
		2636.5MHz	22.22	21.26	/	23.0	22.0	/
		2593.0MHz	21.84	20.88	/	23.0	22.0	/
		2549.5MHz	22.28	21.31	/	23.0	22.0	/
		2506.0MHz	22.31	21.36	/	23.0	22.0	/
50RB_0	2680.0MHz	22.07	21.07	/	23.0	22.0	/	
	2636.5MHz	22.26	21.27	/	23.0	22.0	/	
	2593.0MHz	21.93	20.96	/	23.0	22.0	/	
	2549.5MHz	22.23	21.27	/	23.0	22.0	/	
	2506.0MHz	22.37	21.40	/	23.0	22.0	/	
100RB_0	2680.0MHz	22.17	21.20	/	23.0	22.0	/	
	2636.5MHz	22.26	21.24	/	23.0	22.0	/	
	2593.0MHz	21.94	20.96	/	23.0	22.0	/	
	2549.5MHz	22.30	21.28	/	23.0	22.0	/	
	2506.0MHz	22.36	21.36	/	23.0	22.0	/	



Sensor on								
LTE Band 41 (PC3)			Actual output Power (dBm)			Tune up		
Band -width	RB No. / RB offset	Frequency	Modulation			Modulation		
			QPSK	16QAM	64QAM	QPSK	16QAM	64QAM
5 MHz	1RB_24	2687.5MHz	15.07	14.18	/	16.0	15.0	/
		2640.3MHz	14.86	14.00	/	16.0	15.0	/
		2593.0MHz	14.80	13.91	/	16.0	15.0	/
		2545.8MHz	14.79	13.90	/	16.0	15.0	/
		2498.5MHz	14.90	13.99	/	16.0	15.0	/
	1RB_12	2687.5MHz	15.24	14.31	/	16.0	15.0	/
		2640.3MHz	14.99	14.10	/	16.0	15.0	/
		2593.0MHz	14.96	14.06	/	16.0	15.0	/
		2545.8MHz	15.01	14.10	/	16.0	15.0	/
		2498.5MHz	15.09	14.17	/	16.0	15.0	/
	1RB_0	2687.5MHz	15.04	14.15	/	16.0	15.0	/
		2640.3MHz	14.84	13.96	/	16.0	15.0	/
		2593.0MHz	14.79	13.93	/	16.0	15.0	/
		2545.8MHz	14.82	13.95	/	16.0	15.0	/
		2498.5MHz	14.90	14.01	/	16.0	15.0	/
	12RB_13	2687.5MHz	14.15	13.10	/	15.0	14.0	/
		2640.3MHz	13.93	12.94	/	15.0	14.0	/
		2593.0MHz	13.88	12.84	/	15.0	14.0	/
		2545.8MHz	13.91	12.87	/	15.0	14.0	/
		2498.5MHz	14.00	12.95	/	15.0	14.0	/
	12RB_6	2687.5MHz	14.18	13.13	/	15.0	14.0	/
		2640.3MHz	13.97	12.91	/	15.0	14.0	/
		2593.0MHz	13.93	12.88	/	15.0	14.0	/
		2545.8MHz	13.94	12.91	/	15.0	14.0	/
		2498.5MHz	14.02	12.96	/	15.0	14.0	/
12RB_0	2687.5MHz	14.13	13.12	/	15.0	14.0	/	
	2640.3MHz	13.91	12.88	/	15.0	14.0	/	
	2593.0MHz	13.88	12.86	/	15.0	14.0	/	
	2545.8MHz	13.92	12.89	/	15.0	14.0	/	
	2498.5MHz	14.02	12.95	/	15.0	14.0	/	
25RB_0	2687.5MHz	14.17	13.20	/	15.0	14.0	/	
	2640.3MHz	14.00	13.03	/	15.0	14.0	/	
	2593.0MHz	13.91	12.93	/	15.0	14.0	/	
	2545.8MHz	13.92	12.96	/	15.0	14.0	/	
	2498.5MHz	13.97	13.03	/	15.0	14.0	/	

Sensor on								
LTE Band 41 (PC3)			Actual output Power (dBm)			Tune up		
Band -width	RB No. / RB offset	Frequency	Modulation			Modulation		
			QPSK	16QAM	64QAM	QPSK	16QAM	64QAM
10 MHz	1RB_49	2685.0MHz	15.15	14.26	/	16.0	15.0	/
		2639.0MHz	14.98	14.10	/	16.0	15.0	/
		2593.0MHz	14.92	14.01	/	16.0	15.0	/
		2547.0MHz	14.92	14.06	/	16.0	15.0	/
		2501.0MHz	15.00	14.12	/	16.0	15.0	/
	1RB_24	2685.0MHz	15.25	14.35	/	16.0	15.0	/
		2639.0MHz	15.07	14.15	/	16.0	15.0	/
		2593.0MHz	15.03	14.13	/	16.0	15.0	/
		2547.0MHz	15.05	14.15	/	16.0	15.0	/
		2501.0MHz	15.14	14.24	/	16.0	15.0	/
	1RB_0	2685.0MHz	15.16	14.26	/	16.0	15.0	/
		2639.0MHz	14.96	14.06	/	16.0	15.0	/
		2593.0MHz	14.91	14.04	/	16.0	15.0	/
		2547.0MHz	14.93	14.06	/	16.0	15.0	/
		2501.0MHz	15.00	14.15	/	16.0	15.0	/
	25RB_25	2685.0MHz	14.27	13.23	/	15.0	14.0	/
		2639.0MHz	14.06	13.05	/	15.0	14.0	/
		2593.0MHz	13.94	13.01	/	15.0	14.0	/
		2547.0MHz	13.99	13.07	/	15.0	14.0	/
		2501.0MHz	14.04	13.03	/	15.0	14.0	/
	25RB_12	2685.0MHz	14.23	13.26	/	15.0	14.0	/
		2639.0MHz	14.04	13.06	/	15.0	14.0	/
		2593.0MHz	13.99	12.98	/	15.0	14.0	/
		2547.0MHz	14.00	13.06	/	15.0	14.0	/
		2501.0MHz	14.08	13.07	/	15.0	14.0	/
	25RB_0	2685.0MHz	14.23	13.24	/	15.0	14.0	/
		2639.0MHz	14.01	13.04	/	15.0	14.0	/
		2593.0MHz	13.99	13.01	/	15.0	14.0	/
		2547.0MHz	14.02	13.03	/	15.0	14.0	/
		2501.0MHz	14.10	13.14	/	15.0	14.0	/
50RB_0	2685.0MHz	14.22	13.23	/	15.0	14.0	/	
	2639.0MHz	14.07	13.11	/	15.0	14.0	/	
	2593.0MHz	14.00	13.02	/	15.0	14.0	/	
	2547.0MHz	14.03	13.04	/	15.0	14.0	/	
	2501.0MHz	14.06	13.07	/	15.0	14.0	/	



Sensor on								
LTE Band 41 (PC3)			Actual output Power (dBm)			Tune up		
Band -width	RB No. / RB offset	Frequency	Modulation			Modulation		
			QPSK	16QAM	64QAM	QPSK	16QAM	64QAM
15 MHz	1RB_74	2682.5MHz	15.03	14.17	/	16.0	15.0	/
		2637.8MHz	14.90	13.96	/	16.0	15.0	/
		2593.0MHz	14.83	13.93	/	16.0	15.0	/
		2548.3MHz	14.81	13.94	/	16.0	15.0	/
		2503.5MHz	14.93	14.10	/	16.0	15.0	/
	1RB_37	2682.5MHz	15.12	14.24	/	16.0	15.0	/
		2637.8MHz	14.91	14.03	/	16.0	15.0	/
		2593.0MHz	14.91	13.99	/	16.0	15.0	/
		2548.3MHz	14.93	14.01	/	16.0	15.0	/
		2503.5MHz	15.01	14.16	/	16.0	15.0	/
	1RB_0	2682.5MHz	15.01	14.12	/	16.0	15.0	/
		2637.8MHz	14.85	13.94	/	16.0	15.0	/
		2593.0MHz	14.81	13.91	/	16.0	15.0	/
		2548.3MHz	14.90	13.96	/	16.0	15.0	/
		2503.5MHz	14.94	14.08	/	16.0	15.0	/
	36RB_38	2682.5MHz	14.17	13.11	/	15.0	14.0	/
		2637.8MHz	14.00	12.96	/	15.0	14.0	/
		2593.0MHz	13.92	12.89	/	15.0	14.0	/
		2548.3MHz	13.99	12.90	/	15.0	14.0	/
		2503.5MHz	14.03	12.99	/	15.0	14.0	/
	36RB_19	2682.5MHz	14.21	13.11	/	15.0	14.0	/
		2637.8MHz	13.94	12.89	/	15.0	14.0	/
		2593.0MHz	13.99	12.87	/	15.0	14.0	/
		2548.3MHz	14.00	12.92	/	15.0	14.0	/
		2503.5MHz	14.06	13.01	/	15.0	14.0	/
36RB_0	2682.5MHz	14.14	13.07	/	15.0	14.0	/	
	2637.8MHz	13.95	12.92	/	15.0	14.0	/	
	2593.0MHz	13.92	12.86	/	15.0	14.0	/	
	2548.3MHz	14.02	12.97	/	15.0	14.0	/	
	2503.5MHz	14.07	12.99	/	15.0	14.0	/	
75RB_0	2682.5MHz	14.14	13.17	/	15.0	14.0	/	
	2637.8MHz	13.99	13.03	/	15.0	14.0	/	
	2593.0MHz	13.92	12.89	/	15.0	14.0	/	
	2548.3MHz	13.99	12.97	/	15.0	14.0	/	
	2503.5MHz	14.05	13.04	/	15.0	14.0	/	



Sensor on								
LTE Band 41 (PC3)			Actual output Power (dBm)			Tune up		
Band -width	RB No. / RB offset	Frequency	Modulation			Modulation		
			QPSK	16QAM	64QAM	QPSK	16QAM	64QAM
20 MHz	1RB_99	2680.0MHz	15.00	14.14	/	16.0	15.0	/
		2636.5MHz	14.82	13.93	/	16.0	15.0	/
		2593.0MHz	14.74	13.90	/	16.0	15.0	/
		2549.5MHz	14.78	13.92	/	16.0	15.0	/
		2506.0MHz	14.86	14.00	/	16.0	15.0	/
	1RB_50	2680.0MHz	15.18	14.29	/	16.0	15.0	/
		2636.5MHz	15.01	14.11	/	16.0	15.0	/
		2593.0MHz	15.01	14.07	/	16.0	15.0	/
		2549.5MHz	15.04	14.12	/	16.0	15.0	/
		2506.0MHz	15.09	14.23	/	16.0	15.0	/
	1RB_0	2680.0MHz	14.98	14.12	/	16.0	15.0	/
		2636.5MHz	14.79	13.94	/	16.0	15.0	/
		2593.0MHz	14.78	13.89	/	16.0	15.0	/
		2549.5MHz	14.85	14.00	/	16.0	15.0	/
		2506.0MHz	14.91	14.01	/	16.0	15.0	/
	50RB_50	2680.0MHz	14.15	13.16	/	15.0	14.0	/
		2636.5MHz	13.97	12.95	/	15.0	14.0	/
		2593.0MHz	13.91	12.91	/	15.0	14.0	/
		2549.5MHz	13.94	12.94	/	15.0	14.0	/
		2506.0MHz	14.05	13.04	/	15.0	14.0	/
	50RB_25	2680.0MHz	14.13	13.14	/	15.0	14.0	/
		2636.5MHz	13.97	12.98	/	15.0	14.0	/
		2593.0MHz	13.94	12.94	/	15.0	14.0	/
		2549.5MHz	13.98	13.01	/	15.0	14.0	/
		2506.0MHz	14.06	13.09	/	15.0	14.0	/
	50RB_0	2680.0MHz	14.12	13.12	/	15.0	14.0	/
		2636.5MHz	13.97	13.00	/	15.0	14.0	/
		2593.0MHz	13.94	12.98	/	15.0	14.0	/
		2549.5MHz	14.01	13.02	/	15.0	14.0	/
		2506.0MHz	14.08	13.11	/	15.0	14.0	/
100RB_0	2680.0MHz	14.17	13.17	/	15.0	14.0	/	
	2636.5MHz	14.00	13.02	/	15.0	14.0	/	
	2593.0MHz	13.94	12.97	/	15.0	14.0	/	
	2549.5MHz	13.98	13.04	/	15.0	14.0	/	
	2506.0MHz	14.08	13.10	/	15.0	14.0	/	

Full power								
LTE Band 41 (PC2)			Actual output Power (dBm)			Tune up		
Band -width	RB No. / RB offset	Frequency	Modulation			Modulation		
			QPSK	16QAM	64QAM	QPSK	16QAM	64QAM
5 MHz	1RB_24	2687.5MHz	26.05	25.16	/	27.0	26.0	/
		2640.3MHz	26.06	25.17	/	27.0	26.0	/
		2593.0MHz	25.66	24.78	/	27.0	26.0	/
		2545.8MHz	26.09	25.15	/	27.0	26.0	/
		2498.5MHz	26.10	25.21	/	27.0	26.0	/
	1RB_12	2687.5MHz	26.19	25.31	/	27.0	26.0	/
		2640.3MHz	26.20	25.31	/	27.0	26.0	/
		2593.0MHz	25.72	24.87	/	27.0	26.0	/
		2545.8MHz	26.19	25.32	/	27.0	26.0	/
		2498.5MHz	26.22	25.36	/	27.0	26.0	/
	1RB_0	2687.5MHz	26.01	25.12	/	27.0	26.0	/
		2640.3MHz	26.05	25.16	/	27.0	26.0	/
		2593.0MHz	25.74	24.81	/	27.0	26.0	/
		2545.8MHz	26.13	25.19	/	27.0	26.0	/
		2498.5MHz	26.10	25.26	/	27.0	26.0	/
	12RB_13	2687.5MHz	25.17	24.12	/	26.0	25.0	/
		2640.3MHz	25.17	24.07	/	26.0	25.0	/
		2593.0MHz	24.75	23.68	/	26.0	25.0	/
		2545.8MHz	25.13	24.14	/	26.0	25.0	/
		2498.5MHz	25.25	24.22	/	26.0	25.0	/
	12RB_6	2687.5MHz	25.21	24.14	/	26.0	25.0	/
		2640.3MHz	25.23	24.16	/	26.0	25.0	/
		2593.0MHz	24.76	23.77	/	26.0	25.0	/
		2545.8MHz	25.22	24.20	/	26.0	25.0	/
		2498.5MHz	25.31	24.23	/	26.0	25.0	/
	12RB_0	2687.5MHz	25.16	24.10	/	26.0	25.0	/
		2640.3MHz	25.19	24.14	/	26.0	25.0	/
		2593.0MHz	24.73	23.75	/	26.0	25.0	/
		2545.8MHz	25.16	24.16	/	26.0	25.0	/
		2498.5MHz	25.29	24.18	/	26.0	25.0	/
25RB_0	2687.5MHz	25.15	24.13	/	26.0	25.0	/	
	2640.3MHz	25.17	24.24	/	26.0	25.0	/	
	2593.0MHz	24.69	23.75	/	26.0	25.0	/	
	2545.8MHz	25.15	24.17	/	26.0	25.0	/	
	2498.5MHz	25.23	24.26	/	26.0	25.0	/	

Full power								
LTE Band 41 (PC2)			Actual output Power (dBm)			Tune up		
Band -width	RB No. / RB offset	Frequency	Modulation			Modulation		
			QPSK	16QAM	64QAM	QPSK	16QAM	64QAM
10 MHz	1RB_49	2685.0MHz	26.14	25.30	/	27.0	26.0	/
		2639.0MHz	26.14	25.29	/	27.0	26.0	/
		2593.0MHz	25.86	24.95	/	27.0	26.0	/
		2547.0MHz	26.17	25.30	/	27.0	26.0	/
		2501.0MHz	26.19	25.31	/	27.0	26.0	/
	1RB_24	2685.0MHz	26.20	25.34	/	27.0	26.0	/
		2639.0MHz	26.23	25.38	/	27.0	26.0	/
		2593.0MHz	25.78	24.94	/	27.0	26.0	/
		2547.0MHz	26.25	25.39	/	27.0	26.0	/
		2501.0MHz	26.29	25.41	/	27.0	26.0	/
	1RB_0	2685.0MHz	26.14	25.26	/	27.0	26.0	/
		2639.0MHz	26.19	25.32	/	27.0	26.0	/
		2593.0MHz	25.84	24.97	/	27.0	26.0	/
		2547.0MHz	26.16	25.51	/	27.0	26.0	/
		2501.0MHz	26.23	25.37	/	27.0	26.0	/
	25RB_25	2685.0MHz	25.22	24.22	/	26.0	25.0	/
		2639.0MHz	25.23	24.23	/	26.0	25.0	/
		2593.0MHz	24.83	23.79	/	26.0	25.0	/
		2547.0MHz	25.25	24.23	/	26.0	25.0	/
		2501.0MHz	25.26	24.28	/	26.0	25.0	/
	25RB_12	2685.0MHz	25.22	24.20	/	26.0	25.0	/
		2639.0MHz	25.30	24.29	/	26.0	25.0	/
		2593.0MHz	24.81	23.81	/	26.0	25.0	/
		2547.0MHz	25.22	24.24	/	26.0	25.0	/
		2501.0MHz	25.29	24.32	/	26.0	25.0	/
	25RB_0	2685.0MHz	25.20	24.21	/	26.0	25.0	/
		2639.0MHz	25.31	24.27	/	26.0	25.0	/
		2593.0MHz	24.86	23.87	/	26.0	25.0	/
		2547.0MHz	25.24	24.24	/	26.0	25.0	/
		2501.0MHz	25.33	24.33	/	26.0	25.0	/
50RB_0	2685.0MHz	25.23	24.23	/	26.0	25.0	/	
	2639.0MHz	25.31	24.28	/	26.0	25.0	/	
	2593.0MHz	24.88	23.87	/	26.0	25.0	/	
	2547.0MHz	25.27	24.28	/	26.0	25.0	/	
	2501.0MHz	25.33	24.32	/	26.0	25.0	/	

Full power								
LTE Band 41 (PC2)			Actual output Power (dBm)			Tune up		
Band -width	RB No. / RB offset	Frequency	Modulation			Modulation		
			QPSK	16QAM	64QAM	QPSK	16QAM	64QAM
15 MHz	1RB_74	2682.5MHz	26.03	25.15	/	27.0	26.0	/
		2637.8MHz	26.05	25.19	/	27.0	26.0	/
		2593.0MHz	25.83	24.95	/	27.0	26.0	/
		2548.3MHz	26.07	25.18	/	27.0	26.0	/
		2503.5MHz	26.18	25.28	/	27.0	26.0	/
	1RB_37	2682.5MHz	26.11	25.25	/	27.0	26.0	/
		2637.8MHz	26.21	25.28	/	27.0	26.0	/
		2593.0MHz	25.75	24.85	/	27.0	26.0	/
		2548.3MHz	26.16	25.31	/	27.0	26.0	/
		2503.5MHz	26.26	25.36	/	27.0	26.0	/
	1RB_0	2682.5MHz	25.99	25.11	/	27.0	26.0	/
		2637.8MHz	26.10	25.23	/	27.0	26.0	/
		2593.0MHz	25.84	25.00	/	27.0	26.0	/
		2548.3MHz	26.09	25.21	/	27.0	26.0	/
		2503.5MHz	26.16	25.28	/	27.0	26.0	/
	36RB_38	2682.5MHz	25.17	24.07	/	26.0	25.0	/
		2637.8MHz	25.18	24.13	/	26.0	25.0	/
		2593.0MHz	24.85	23.76	/	26.0	25.0	/
		2548.3MHz	25.20	24.12	/	26.0	25.0	/
		2503.5MHz	25.28	24.21	/	26.0	25.0	/
	36RB_19	2682.5MHz	25.16	24.09	/	26.0	25.0	/
		2637.8MHz	25.23	24.18	/	26.0	25.0	/
		2593.0MHz	24.85	23.79	/	26.0	25.0	/
		2548.3MHz	25.29	24.17	/	26.0	25.0	/
		2503.5MHz	25.32	24.24	/	26.0	25.0	/
	36RB_0	2682.5MHz	25.14	24.05	/	26.0	25.0	/
		2637.8MHz	25.23	24.16	/	26.0	25.0	/
		2593.0MHz	24.90	23.81	/	26.0	25.0	/
		2548.3MHz	25.22	24.17	/	26.0	25.0	/
		2503.5MHz	25.30	24.25	/	26.0	25.0	/
75RB_0	2682.5MHz	25.12	24.10	/	26.0	25.0	/	
	2637.8MHz	25.20	24.22	/	26.0	25.0	/	
	2593.0MHz	24.84	23.83	/	26.0	25.0	/	
	2548.3MHz	25.21	24.20	/	26.0	25.0	/	
	2503.5MHz	25.30	24.26	/	26.0	25.0	/	

Full power								
LTE Band 41 (PC2)			Actual output Power (dBm)			Tune up		
Band -width	RB No. / RB offset	Frequency	Modulation			Modulation		
			QPSK	16QAM	64QAM	QPSK	16QAM	64QAM
20 MHz	1RB_99	2680.0MHz	25.93	25.07	/	27.0	26.0	/
		2636.5MHz	25.96	25.08	/	27.0	26.0	/
		2593.0MHz	25.80	24.94	/	27.0	26.0	/
		2549.5MHz	26.01	25.16	/	27.0	26.0	/
		2506.0MHz	26.06	25.17	/	27.0	26.0	/
	1RB_50	2680.0MHz	26.19	25.30	/	27.0	26.0	/
		2636.5MHz	26.26	25.40	/	27.0	26.0	/
		2593.0MHz	25.81	24.95	/	27.0	26.0	/
		2549.5MHz	26.27	25.39	/	27.0	26.0	/
		2506.0MHz	26.31	25.44	/	27.0	26.0	/
	1RB_0	2680.0MHz	25.94	25.08	/	27.0	26.0	/
		2636.5MHz	26.05	25.18	/	27.0	26.0	/
		2593.0MHz	25.87	25.00	/	27.0	26.0	/
		2549.5MHz	26.08	25.23	/	27.0	26.0	/
		2506.0MHz	26.14	25.27	/	27.0	26.0	/
	50RB_50	2680.0MHz	25.16	24.15	/	26.0	25.0	/
		2636.5MHz	25.13	24.16	/	26.0	25.0	/
		2593.0MHz	24.85	23.83	/	26.0	25.0	/
		2549.5MHz	25.20	24.21	/	26.0	25.0	/
		2506.0MHz	25.28	24.27	/	26.0	25.0	/
	50RB_25	2680.0MHz	25.15	24.17	/	26.0	25.0	/
		2636.5MHz	25.27	24.24	/	26.0	25.0	/
		2593.0MHz	24.83	23.85	/	26.0	25.0	/
		2549.5MHz	25.27	24.26	/	26.0	25.0	/
		2506.0MHz	25.36	24.33	/	26.0	25.0	/
	50RB_0	2680.0MHz	25.06	24.05	/	26.0	25.0	/
		2636.5MHz	25.27	24.26	/	26.0	25.0	/
		2593.0MHz	24.94	23.91	/	26.0	25.0	/
		2549.5MHz	25.22	24.22	/	26.0	25.0	/
		2506.0MHz	25.38	24.35	/	26.0	25.0	/
100RB_0	2680.0MHz	25.09	24.11	/	26.0	25.0	/	
	2636.5MHz	25.21	24.19	/	26.0	25.0	/	
	2593.0MHz	24.87	23.89	/	26.0	25.0	/	
	2549.5MHz	25.24	24.23	/	26.0	25.0	/	
	2506.0MHz	25.36	24.33	/	26.0	25.0	/	



Sensor on								
LTE Band 41 (PC2)			Actual output Power (dBm)			Tune up		
Band -width	RB No. / RB offset	Frequency	Modulation			Modulation		
			QPSK	16QAM	64QAM	QPSK	16QAM	64QAM
5 MHz	1RB_24	2687.5MHz	18.13	17.33	/	19.0	18.0	/
		2640.3MHz	17.93	17.21	/	19.0	18.0	/
		2593.0MHz	17.86	17.10	/	19.0	18.0	/
		2545.8MHz	17.85	17.09	/	19.0	18.0	/
		2498.5MHz	17.95	17.15	/	19.0	18.0	/
	1RB_12	2687.5MHz	18.16	17.39	/	19.0	18.0	/
		2640.3MHz	17.96	17.19	/	19.0	18.0	/
		2593.0MHz	17.90	17.17	/	19.0	18.0	/
		2545.8MHz	17.96	17.21	/	19.0	18.0	/
		2498.5MHz	18.04	17.26	/	19.0	18.0	/
	1RB_0	2687.5MHz	18.08	17.32	/	19.0	18.0	/
		2640.3MHz	17.86	17.12	/	19.0	18.0	/
		2593.0MHz	17.83	17.09	/	19.0	18.0	/
		2545.8MHz	17.89	17.13	/	19.0	18.0	/
		2498.5MHz	17.94	17.18	/	19.0	18.0	/
	12RB_13	2687.5MHz	17.19	16.20	/	18.0	17.0	/
		2640.3MHz	16.97	15.99	/	18.0	17.0	/
		2593.0MHz	16.89	15.96	/	18.0	17.0	/
		2545.8MHz	16.92	16.00	/	18.0	17.0	/
		2498.5MHz	17.03	16.04	/	18.0	17.0	/
	12RB_6	2687.5MHz	17.22	16.25	/	18.0	17.0	/
		2640.3MHz	17.00	16.01	/	18.0	17.0	/
		2593.0MHz	17.01	16.03	/	18.0	17.0	/
		2545.8MHz	17.03	16.02	/	18.0	17.0	/
		2498.5MHz	17.05	16.11	/	18.0	17.0	/
	12RB_0	2687.5MHz	17.20	16.23	/	18.0	17.0	/
		2640.3MHz	16.96	15.96	/	18.0	17.0	/
		2593.0MHz	16.92	15.96	/	18.0	17.0	/
		2545.8MHz	16.95	15.97	/	18.0	17.0	/
		2498.5MHz	17.03	16.08	/	18.0	17.0	/
25RB_0	2687.5MHz	17.19	16.27	/	18.0	17.0	/	
	2640.3MHz	17.03	16.05	/	18.0	17.0	/	
	2593.0MHz	16.93	15.99	/	18.0	17.0	/	
	2545.8MHz	16.97	16.04	/	18.0	17.0	/	
	2498.5MHz	17.03	16.10	/	18.0	17.0	/	



Sensor on								
LTE Band 41 (PC2)			Actual output Power (dBm)			Tune up		
Band -width	RB No. / RB offset	Frequency	Modulation			Modulation		
			QPSK	16QAM	64QAM	QPSK	16QAM	64QAM
10 MHz	1RB_49	2685.0MHz	18.22	17.46	/	19.0	18.0	/
		2639.0MHz	18.03	17.29	/	19.0	18.0	/
		2593.0MHz	17.97	17.21	/	19.0	18.0	/
		2547.0MHz	17.97	17.23	/	19.0	18.0	/
		2501.0MHz	18.05	17.31	/	19.0	18.0	/
	1RB_24	2685.0MHz	18.30	17.53	/	19.0	18.0	/
		2639.0MHz	18.11	17.36	/	19.0	18.0	/
		2593.0MHz	18.07	17.35	/	19.0	18.0	/
		2547.0MHz	18.10	17.37	/	19.0	18.0	/
		2501.0MHz	18.15	17.43	/	19.0	18.0	/
	1RB_0	2685.0MHz	18.21	17.44	/	19.0	18.0	/
		2639.0MHz	18.00	17.28	/	19.0	18.0	/
		2593.0MHz	17.95	17.23	/	19.0	18.0	/
		2547.0MHz	18.00	17.24	/	19.0	18.0	/
		2501.0MHz	18.06	17.35	/	19.0	18.0	/
	25RB_25	2685.0MHz	17.30	16.35	/	18.0	17.0	/
		2639.0MHz	17.09	16.13	/	18.0	17.0	/
		2593.0MHz	17.01	16.07	/	18.0	17.0	/
		2547.0MHz	17.05	16.13	/	18.0	17.0	/
		2501.0MHz	17.11	16.16	/	18.0	17.0	/
	25RB_12	2685.0MHz	17.26	16.33	/	18.0	17.0	/
		2639.0MHz	17.05	16.14	/	18.0	17.0	/
		2593.0MHz	17.02	16.16	/	18.0	17.0	/
		2547.0MHz	17.06	16.11	/	18.0	17.0	/
		2501.0MHz	17.12	16.17	/	18.0	17.0	/
	25RB_0	2685.0MHz	17.23	16.31	/	18.0	17.0	/
		2639.0MHz	17.04	16.15	/	18.0	17.0	/
		2593.0MHz	17.06	16.11	/	18.0	17.0	/
		2547.0MHz	17.05	16.12	/	18.0	17.0	/
		2501.0MHz	17.17	16.17	/	18.0	17.0	/
50RB_0	2685.0MHz	17.26	16.31	/	18.0	17.0	/	
	2639.0MHz	17.05	16.13	/	18.0	17.0	/	
	2593.0MHz	17.02	16.06	/	18.0	17.0	/	
	2547.0MHz	17.05	16.10	/	18.0	17.0	/	
	2501.0MHz	17.12	16.14	/	18.0	17.0	/	

Sensor on								
LTE Band 41 (PC2)			Actual output Power (dBm)			Tune up		
Band -width	RB No. / RB offset	Frequency	Modulation			Modulation		
			QPSK	16QAM	64QAM	QPSK	16QAM	64QAM
15 MHz	1RB_74	2682.5MHz	18.08	17.33	/	19.0	18.0	/
		2637.8MHz	17.90	17.17	/	19.0	18.0	/
		2593.0MHz	17.83	17.09	/	19.0	18.0	/
		2548.3MHz	17.87	17.14	/	19.0	18.0	/
		2503.5MHz	17.94	17.24	/	19.0	18.0	/
	1RB_37	2682.5MHz	18.11	17.37	/	19.0	18.0	/
		2637.8MHz	17.96	17.20	/	19.0	18.0	/
		2593.0MHz	17.95	17.21	/	19.0	18.0	/
		2548.3MHz	17.96	17.24	/	19.0	18.0	/
		2503.5MHz	18.09	17.34	/	19.0	18.0	/
	1RB_0	2682.5MHz	18.06	17.28	/	19.0	18.0	/
		2637.8MHz	17.86	17.14	/	19.0	18.0	/
		2593.0MHz	17.85	17.13	/	19.0	18.0	/
		2548.3MHz	17.89	17.18	/	19.0	18.0	/
		2503.5MHz	17.98	17.25	/	19.0	18.0	/
	36RB_38	2682.5MHz	17.16	16.11	/	18.0	17.0	/
		2637.8MHz	16.97	15.96	/	18.0	17.0	/
		2593.0MHz	16.92	15.89	/	18.0	17.0	/
		2548.3MHz	16.93	15.88	/	18.0	17.0	/
		2503.5MHz	17.02	16.03	/	18.0	17.0	/
	36RB_19	2682.5MHz	17.14	16.11	/	18.0	17.0	/
		2637.8MHz	16.94	15.93	/	18.0	17.0	/
		2593.0MHz	16.92	15.92	/	18.0	17.0	/
		2548.3MHz	16.95	15.97	/	18.0	17.0	/
		2503.5MHz	17.04	16.06	/	18.0	17.0	/
	36RB_0	2682.5MHz	17.12	16.11	/	18.0	17.0	/
		2637.8MHz	16.92	15.96	/	18.0	17.0	/
		2593.0MHz	16.92	15.93	/	18.0	17.0	/
		2548.3MHz	16.97	15.97	/	18.0	17.0	/
		2503.5MHz	17.05	16.03	/	18.0	17.0	/
75RB_0	2682.5MHz	17.12	16.16	/	18.0	17.0	/	
	2637.8MHz	16.98	16.03	/	18.0	17.0	/	
	2593.0MHz	16.90	15.98	/	18.0	17.0	/	
	2548.3MHz	16.94	16.01	/	18.0	17.0	/	
	2503.5MHz	17.03	16.08	/	18.0	17.0	/	



Sensor on								
LTE Band 41 (PC2)			Actual output Power (dBm)			Tune up		
Band -width	RB No. / RB offset	Frequency	Modulation			Modulation		
			QPSK	16QAM	64QAM	QPSK	16QAM	64QAM
20 MHz	1RB_99	2680.0MHz	17.97	17.23	/	19.0	18.0	/
		2636.5MHz	17.83	17.06	/	19.0	18.0	/
		2593.0MHz	17.79	17.06	/	19.0	18.0	/
		2549.5MHz	17.80	17.04	/	19.0	18.0	/
		2506.0MHz	17.88	17.17	/	19.0	18.0	/
	1RB_50	2680.0MHz	18.21	17.45	/	19.0	18.0	/
		2636.5MHz	18.03	17.26	/	19.0	18.0	/
		2593.0MHz	18.00	17.24	/	19.0	18.0	/
		2549.5MHz	18.03	17.30	/	19.0	18.0	/
		2506.0MHz	18.13	17.35	/	19.0	18.0	/
	1RB_0	2680.0MHz	17.95	17.20	/	19.0	18.0	/
		2636.5MHz	17.80	17.04	/	19.0	18.0	/
		2593.0MHz	17.81	17.04	/	19.0	18.0	/
		2549.5MHz	17.86	17.14	/	19.0	18.0	/
		2506.0MHz	17.93	17.18	/	19.0	18.0	/
	50RB_50	2680.0MHz	17.10	16.17	/	18.0	17.0	/
		2636.5MHz	16.90	16.00	/	18.0	17.0	/
		2593.0MHz	16.83	15.91	/	18.0	17.0	/
		2549.5MHz	16.90	15.96	/	18.0	17.0	/
		2506.0MHz	17.01	16.01	/	18.0	17.0	/
	50RB_25	2680.0MHz	17.10	16.15	/	18.0	17.0	/
		2636.5MHz	16.95	16.00	/	18.0	17.0	/
		2593.0MHz	16.91	15.96	/	18.0	17.0	/
		2549.5MHz	16.97	16.00	/	18.0	17.0	/
		2506.0MHz	17.05	16.09	/	18.0	17.0	/
	50RB_0	2680.0MHz	17.04	16.10	/	18.0	17.0	/
		2636.5MHz	16.94	16.01	/	18.0	17.0	/
		2593.0MHz	16.89	15.97	/	18.0	17.0	/
		2549.5MHz	16.97	16.02	/	18.0	17.0	/
		2506.0MHz	17.05	16.08	/	18.0	17.0	/
100RB_0	2680.0MHz	17.07	16.10	/	18.0	17.0	/	
	2636.5MHz	16.93	15.96	/	18.0	17.0	/	
	2593.0MHz	16.85	15.90	/	18.0	17.0	/	
	2549.5MHz	16.91	15.97	/	18.0	17.0	/	
	2506.0MHz	17.03	16.05	/	18.0	17.0	/	

The measurement results of downlink LTE 2CA Conducted Power are as below:

	CA List	PCC							SCC				Power		
		LTE	BW	UL	UL	Mod.	UL#	UL	LTE	BW	DL	DL	With CA	Without CA	
		Band	(MHz)	Freq. (MHz)	Channel		RB	RB Offset	Band	(MHz)	Freq. (MHz)	Channel	Tx. Power (dBm)	Tx. Power (dBm)	
Inter-Band	CA_2A-5A	Band 2	20M	1860	18700	QPSK	1	50	Band 5	10M	881.5	2525	23.20	23.24	
	CA_2A-12A	Band 2	20M	1860	18700	QPSK	1	50	Band 12	10M	737.5	5095	23.19	23.24	
	CA_2A-29A	Band 2	20M	1860	18700	QPSK	1	50	Band 29	10M	722.5	9715	23.22	23.24	
	CA_4A-2A	Band 4	20M	1745	20300	QPSK	1	50	Band 2	20M	1960	900	22.96	23.01	
	CA_4A-5A	Band 4	20M	1745	20300	QPSK	1	50	Band 5	10M	881.5	2525	22.98	23.01	
	CA_4A-12A	Band 4	20M	1745	20300	QPSK	1	50	Band 12	10M	737.5	5095	22.95	23.01	
	CA_4A-29A	Band 4	20M	1745	20300	QPSK	1	50	Band 29	10M	722.5	9715	22.30	23.01	
	CA_5A-30A	Band 5	10M	836.5	20525	QPSK	1	24	Band 30	10M	2355	9820	23.16	23.20	
	CA_12A-30A	Band 12	10M	704	23060	QPSK	1	24	Band 30	10M	2355	9820	23.28	23.33	
	CA_25A-26A	Band 25	20M	1860	26140	QPSK	1	50	Band 26	15M	876.5	8865	23.22	23.27	
	CA_25A-41A	Band 25	20M	1860	26140	QPSK	1	50	Band 41	20M	2593	40620	23.24	23.27	
	CA_30A-29A	Band 30	10M	782	23230	QPSK	1	24	Band 29	10M	722.5	9715	22.02	22.04	
	CA_66A-2A	Band 66	20M	1770	132572	QPSK	1	50	Band 2	20M	1960	900	23.03	23.05	
	CA_66A-5A	Band 66	20M	1770	132572	QPSK	1	50	Band 5	10M	881.5	2525	22.99	23.05	
	CA_66A-12A	Band 66	20M	1770	132572	QPSK	1	50	Band 12	10M	737.5	5095	23.02	23.05	
	CA_66A-29A	Band 66	20M	1770	132572	QPSK	1	50	Band 29	10M	722.5	9715	22.97	23.05	
	CA_71A-2A	Band 77	20M	683	133322	QPSK	1	50	Band 2	20M	1960	900	23.27	23.31	
	CA_71A-4A	Band 71	20M	683	133322	QPSK	1	50	Band 4	20M	2132.5	2175	23.25	23.31	
CA_71A-66A	Band 71	20M	683	133322	QPSK	1	50	Band 66	20M	2155	66886	23.30	23.31		
Intra-Band	Contiguous	CA_2C	Band 2	20M	1860	18700	QPSK	1	50	Band 2	20M	1959.8	898	23.21	23.24
		CA_41C	Band 41	20M	2510	39790	QPSK	1	50	Band 41	20M	2529.8	39988	23.39	23.44
		CA_66B	Band 66	15M	1772.5	132597	QPSK	1	37	Band 66	5M	2188.2	67218	22.92	22.95
		CA_66C	Band 66	20M	1770	132572	QPSK	1	50	Band 66	20M	2170.2	67038	23.03	23.05
	Non-Contiguous	CA_2A-2A	Band 2	20M	1860	18700	QPSK	1	50	Band 2	5M	1987.5	1175	23.20	23.24
		CA_4A-4A	Band 4	20M	1745	20300	QPSK	1	50	Band 4	5M	2112.5	1975	22.96	23.01
		CA_25A-25A	Band 25	20M	1860	26140	QPSK	1	50	Band 25	5M	1992.5	8665	23.22	23.27
		CA_41A-41A	Band 41	20M	2506	39750	QPSK	1	50	Band 41	5M	2687.5	41565	23.40	23.44
CA_66A-66A	Band 66	20M	1770	132572	QPSK	1	50	Band 66	5M	2112.5	66461	22.96	23.05		

10.4. Bluetooth and WLAN Measurement result

Table 10.5: The conducted Power measurement results for Bluetooth

Bluetooth Mode	Tune up	Averaged Power (dBm)		
		Ch.0 (2402MHz)	Ch.39 (2441MHz)	Ch.78 (2480MHz)
GFSK	10.5	9.19	9.48	9.90
EDR2M-4_DQPSK	10.0	8.38	8.53	9.01
EDR3M-8DPSK	10.0	8.36	8.51	9.01
/	/	Ch.0 (2402MHz)	Ch.19 (2440MHz)	Ch.39 (2480MHz)
BLE(1M)	-1.5	-3.27	-2.05	-3.01
BLE(2M)	-1.5	-3.43	-2.19	-3.09

Table 10.6: The conducted Power measurement results for WLAN 2.4G

Full power				
WLAN 2.4GHz Mode	Tune up	Averaged Power (dBm) Duty Cycle: 100%		
		Ch.1 (2412MHz)	Ch.6 (2437MHz)	Ch.11 (2462MHz)
802.11b	20.5	19.41	19.02	18.89
802.11g	18.5	17.26	17.01	16.59
802.11n(20MHz)	17.0	16.23	15.79	15.46
802.11n(40MHz)	/	Ch.3 (2422MHz)	Ch.6 (2437Mhz)	Ch.9 (2452MHz)
	17.0	9.55	15.96	9.92
Sensor on				
WLAN 2.4GHz Mode	Tune up	Averaged Power (dBm) Duty Cycle: 100%		
		Ch.1 (2412MHz)	Ch.6 (2437MHz)	Ch.11 (2462MHz)
802.11b	14.0	13.29	13.20	12.84
802.11g	11.5	10.53	10.45	10.72
802.11n(20MHz)	10.5	9.21	9.58	9.63
802.11n(40MHz)	/	Ch.3 (2422MHz)	Ch.6 (2437Mhz)	Ch.9 (2452MHz)
	10.5	9.55	9.43	9.92

Table 10.7: The conducted Power measurement results for WLAN 5G

Full power								
Averaged Power (dBm) Duty Cycle: 100%								
Mode	802.11a	802.11n -20MHz	802.11ac -20MHz	Mode	802.11n -40MHz	802.11ac -40MHz	Mode	802.11ac -80MHz
Channel	6Mbps	MCS0	MCS0	Channel	MCS0	MCS0	Channel	MCS0
<U-NII-1>								
Tune up	19.0	18.0	16.5	/	17.0	16.5	/	16.5
36(5180MHz)	18.07	16.51	15.23	38(5190MHz)	15.74	15.37	42(5210MHz)	15.57
40(5200MHz)	18.11	16.74	15.31	46(5230MHz)	15.93	15.77	/	/
44(5220MHz)	18.08	16.77	15.50	/	/	/	/	/
48(5240MHz)	18.19	16.87	15.94	/	/	/	/	/
<U-NII-2A>								
Tune up	19.0	18.0	16.5	/	17.0	16.5	/	16.5
52(5260MHz)	18.16	17.05	16.13	54(5270MHz)	16.20	15.71	58(5290MHz)	15.88
56(5280MHz)	18.26	17.11	16.15	62(5310MHz)	16.14	15.97	/	/
60(5300MHz)	18.14	16.61	16.11	/	/	/	/	/
64(5320MHz)	18.22	17.27	16.23	/	/	/	/	/
<U-NII-3>								
Tune up	19.0	18.0	16.5	/	17.0	16.5	/	16.5
149(5745MHz)	17.89	17.02	15.87	151(5755MHz)	16.05	15.71	155(5775MHz)	15.57
157(5785MHz)	17.88	16.45	15.93	159(5795MHz)	15.93	15.54	/	/
165(5825MHz)	17.85	16.48	16.04	/	/	/	/	/



Sensor on								
Averaged Power (dBm) Duty Cycle: 100%								
Mode	802.11a	802.11n -20MHz	802.11ac -20MHz	Mode	802.11n -40MHz	802.11ac -40MHz	Mode	802.11ac -80MHz
Channel	6Mbps	MCS0	MCS0	Channel	MCS0	MCS0	Channel	MCS0
<U-NII-1>								
Tune up	10.0	9.0	7.5	/	8.0	7.5	/	7.5
36(5180MHz)	8.48	7.51	6.42	38(5190MHz)	7.28	6.39	42(5210MHz)	6.56
40(5200MHz)	8.50	7.54	6.60	46(5230MHz)	7.30	6.55	/	/
44(5220MHz)	8.73	7.81	6.75	/	/	/	/	/
48(5240MHz)	8.77	7.80	6.73	/	/	/	/	/
<U-NII-2A>								
Tune up	10.0	9.0	7.5	/	8.0	7.5	/	7.5
52(5260MHz)	8.81	8.00	6.73	54(5270MHz)	7.51	6.64	58(5290MHz)	6.77
56(5280MHz)	8.96	7.99	6.95	62(5310MHz)	7.69	6.81	/	/
60(5300MHz)	8.97	8.03	6.91	/	/	/	/	/
64(5320MHz)	9.11	8.15	6.89	/	/	/	/	/
<U-NII-3>								
Tune up	10.0	9.0	7.5	/	8.0	7.5	/	7.5
149(5745MHz)	8.68	7.75	6.67	151(5755MHz)	7.35	6.58	155(5775MHz)	6.61
157(5785MHz)	8.77	7.80	6.75	159(5795MHz)	7.49	6.54	/	/
165(5825MHz)	8.88	7.74	6.79	/	/	/	/	/

11. Simultaneous TX SAR Considerations

11.1. Introduction

The following procedures adopted from “FCC SAR Considerations for Cell Phones with Multiple Transmitters” are applicable to handsets with built-in unlicensed transmitters such as 802.11 a/b/g and Bluetooth devices which may simultaneously transmit with the licensed transmitter. For this device, the BT and WLAN can transmit simultaneous with other transmitters.

11.2. Transmit Antenna Separation Distances



Picture 11.1 Antenna Locations (Back View)

11.3. SAR Measurement Positions

SAR measurement positions					
Antenna	Rear	Left edge	Right edge	Top edge	Bottom edge
WWAN	Yes	Yes	Yes	Yes	No
WLAN/BT	Yes	Yes	Yes	Yes	No

Note:

1. Per KDB 447498 D01v06, the 1-g SAR test exclusion thresholds for 100 MHz to 6 GHz at *test separation distances* ≤ 50 mm are determined by:

$[(\text{max. power of channel, including tune-up tolerance, mW}) / (\text{min. test separation distance, mm})] \cdot [\sqrt{f(\text{GHz})}] \leq 3.0$ for 1-g SAR, where

f(GHz) is the RF channel transmit frequency in GHz

Power and distance are rounded to the nearest mW and mm before calculation

2. Per KDB 447498 D01v06, For 100 MHz to 6 GHz and *test separation distances* > 50 mm, the 1-g and 10-g SAR test exclusion thresholds are determined by the following

1) $\{[\text{Power allowed at numeric threshold for 50 mm in step a}]\} + \{[(\text{test separation distance} - 50 \text{ mm}) \cdot (f(\text{MHz})/150)]\}$ mW, for 100 MHz to 1500 MHz

2) $\{[\text{Power allowed at numeric threshold for 50 mm in step a}]\} + \{[(\text{test separation distance} - 50 \text{ mm}) \cdot 10]\}$ mW, for > 1500 MHz and ≤ 6 GHz

12. Evaluation of Simultaneous

According to the KDB 447498 D01, when the sum of SAR is larger than the limit, SAR test exclusion is determined by the SAR to peak location separation ratio. The ratio is determined by $(SAR1 + SAR2)^{1.5}/R_i$, rounded to two decimal digits, and must be ≤ 0.04 for all antenna pairs in the configuration to qualify for 1-g SAR test exclusion.

The sum of SAR values for Main Antenna and WLAN2.4G					
Position	Main Antenna (W/kg)		WLAN 2.4G (W/kg)	Sum (W/kg)	SPLSR
Rear	GSM850	0.71	1.03	1.74	Yes
	GSM1900	1.18	1.03	2.21	Yes
	WCDMA Band 2	1.02	1.03	2.05	Yes
	WCDMA Band 4	1.08	1.03	2.11	Yes
	WCDMA Band 5	0.77	1.03	1.80	Yes
	LTE Band 7	0.89	1.03	1.92	Yes
	LTE Band 12	0.66	1.03	1.69	Yes
	LTE Band 13	0.62	1.03	1.65	Yes
	LTE Band 25	1.22	1.03	2.25	Yes
	LTE Band 25	1.19	0.41	1.60	Yes
	LTE Band 26	0.67	1.03	1.70	Yes
	LTE Band 30	0.90	1.03	1.93	Yes
	LTE Band 41(PC3)	0.78	1.03	1.81	Yes
	LTE Band 66	1.18	1.03	2.21	Yes
	LTE Band 66	1.31	0.41	1.72	Yes
LTE Band 71	0.88	1.03	1.91	Yes	
Top	LTE Band 41(PC2)	1.22	0.48	1.70	Yes
The sum of SAR values for Main Antenna and WLAN5G					
Position	Main Antenna (W/kg)		WLAN 5G (W/kg)	Sum (W/kg)	SPLSR
Rear	GSM1900	1.18	0.82	2.00	Yes
	GSM1900	1.07	0.64	1.71	Yes
	WCDMA Band 2	1.02	0.82	1.84	Yes
	WCDMA Band 4	1.08	0.82	1.90	Yes
	LTE Band 7	0.89	0.82	1.71	Yes
	LTE Band 25	1.22	0.82	2.04	Yes
	LTE Band 25	1.19	0.64	1.83	Yes
	LTE Band 30	0.90	0.82	1.72	Yes
	LTE Band 41(PC3)	0.78	0.82	1.60	Yes
	LTE Band 66	1.18	0.82	2.00	Yes
	LTE Band 66	1.31	0.64	1.95	Yes
	LTE Band 71	0.88	0.82	1.70	Yes



Top	GSM850	0.82	1.08	1.90	Yes
	GSM1900	0.61	1.08	1.69	Yes
	WCDMA Band 2	0.56	1.08	1.64	Yes
	WCDMA Band 5	0.70	1.08	1.78	Yes
	LTE Band 7	1.07	1.08	2.15	Yes
	LTE Band 13	0.52	1.08	1.60	Yes
	LTE Band 25	0.61	1.08	1.69	Yes
	LTE Band 26	0.59	1.08	1.67	Yes
	LTE Band 30	1.03	1.08	2.11	Yes
	LTE Band 41(PC3)	0.99	1.08	2.07	Yes
	LTE Band 41(PC2)	1.22	1.08	2.30	Yes

Band	Position	SAR (W/kg)	Gap (cm)	SAR peak location (m)			3D distance (mm)	Pair SAR sum (W/kg)	SPLSR	Simultaneous SAR
				X	Y	Z				
GSM850	Rear	0.71	0	0.104	0.0195	-0.171	76.4	1.74	0.030	Not required
WLAN 2.4G		1.03	0	0.0925	-0.056	-0.171				

Band	Position	SAR (W/kg)	Gap (cm)	SAR peak location (m)			3D distance (mm)	Pair SAR sum (W/kg)	SPLSR	Simultaneous SAR
				X	Y	Z				
GSM1900	Rear	1.18	0	0.104	0.0085	-0.171	92.2	2.21	0.036	Not required
WLAN 2.4G		1.03	0	0.0925	-0.056	-0.171				

Band	Position	SAR (W/kg)	Gap (cm)	SAR peak location (m)			3D distance (mm)	Pair SAR sum (W/kg)	SPLSR	Simultaneous SAR
				X	Y	Z				
WCDMA Band 2	Rear	1.02	0	0.104	0.0355	-0.171	92.2	2.05	0.032	Not required
WLAN 2.4G		1.03	0	0.0925	-0.056	-0.171				

Band	Position	SAR (W/kg)	Gap (cm)	SAR peak location (m)			3D distance (mm)	Pair SAR sum (W/kg)	SPLSR	Simultaneous SAR
				X	Y	Z				
WCDMA Band 4	Rear	1.08	0	0.104	0.0315	-0.17	88.3	2.11	0.035	Not required
WLAN 2.4G		1.03	0	0.0925	-0.056	-0.171				

Band	Position	SAR (W/kg)	Gap (cm)	SAR peak location (m)			3D distance (mm)	Pair SAR sum (W/kg)	SPLSR	Simultaneous SAR
				X	Y	Z				
WCDMA Band 5	Rear	0.77	0	0.104	0.0085	-0.171	65.5	1.80	0.037	Not required
WLAN 2.4G		1.03	0	0.0925	-0.056	-0.171				



Band	Position	SAR (W/kg)	Gap (cm)	SAR peak location (m)			3D distance (mm)	Pair SAR sum (W/kg)	SPLSR	Simultaneous SAR
				X	Y	Z				
LTE Band 7	Rear	0.89	0	0.101	0.054	-0.17	110.3	1.92	0.024	Not required
WLAN 2.4G		1.03	0	0.0925	-0.056	-0.171				

Band	Position	SAR (W/kg)	Gap (cm)	SAR peak location (m)			3D distance (mm)	Pair SAR sum (W/kg)	SPLSR	Simultaneous SAR
				X	Y	Z				
LTE Band 12	Rear	0.66	0	0.09	0.022	-0.171	78.0	1.69	0.028	Not required
WLAN 2.4G		1.03	0	0.0925	-0.056	-0.171				

Band	Position	SAR (W/kg)	Gap (cm)	SAR peak location (m)			3D distance (mm)	Pair SAR sum (W/kg)	SPLSR	Simultaneous SAR
				X	Y	Z				
LTE Band 13	Rear	0.62	0	0.09	0.022	-0.171	78.0	1.65	0.027	Not required
WLAN 2.4G		1.03	0	0.0925	-0.056	-0.171				

Band	Position	SAR (W/kg)	Gap (cm)	SAR peak location (m)			3D distance (mm)	Pair SAR sum (W/kg)	SPLSR	Simultaneous SAR
				X	Y	Z				
LTE Band 25	Rear	1.22	0	0.105	0.0315	-0.17	88.4	2.25	0.038	Not required
WLAN 2.4G		1.03	0	0.0925	-0.056	-0.171				

Band	Position	SAR (W/kg)	Gap (cm)	SAR peak location (m)			3D distance (mm)	Pair SAR sum (W/kg)	SPLSR	Simultaneous SAR
				X	Y	Z				
LTE Band 25	Rear	1.19	1.2	0.102	0.034	-0.171	72.1	1.60	0.028	Not required
WLAN 2.4G		0.41	1.2	0.099	-0.038	-0.171				

Band	Position	SAR (W/kg)	Gap (cm)	SAR peak location (m)			3D distance (mm)	Pair SAR sum (W/kg)	SPLSR	Simultaneous SAR
				X	Y	Z				
LTE Band 26	Rear	0.67	0	0.101	0.022	-0.171	78.5	1.70	0.028	Not required
WLAN 2.4G		1.03	0	0.0925	-0.056	-0.171				

Band	Position	SAR (W/kg)	Gap (cm)	SAR peak location (m)			3D distance (mm)	Pair SAR sum (W/kg)	SPLSR	Simultaneous SAR
				X	Y	Z				
LTE Band 30	Rear	0.9	0	0.099	0.053	-0.17	109.2	1.93	0.025	Not required
WLAN 2.4G		1.03	0	0.0925	-0.056	-0.171				



Band	Position	SAR (W/kg)	Gap (cm)	SAR peak location (m)			3D distance (mm)	Pair SAR sum (W/kg)	SPLSR	Simultaneous SAR
				X	Y	Z				
LTE Band 41(PC3)	Rear	0.78	0	0.099	0.054	-0.17	110.2	1.81	0.022	Not required
WLAN 2.4G		1.03	0	0.0925	-0.056	-0.171				

Band	Position	SAR (W/kg)	Gap (cm)	SAR peak location (m)			3D distance (mm)	Pair SAR sum (W/kg)	SPLSR	Simultaneous SAR
				X	Y	Z				
LTE Band 66	Rear	1.18	0	0.104	0.03	-0.17	86.8	2.21	0.038	Not required
WLAN 2.4G		1.03	0	0.0925	-0.056	-0.171				

Band	Position	SAR (W/kg)	Gap (cm)	SAR peak location (m)			3D distance (mm)	Pair SAR sum (W/kg)	SPLSR	Simultaneous SAR
				X	Y	Z				
LTE Band 66	Rear	1.31	1.2	0.112	0.0315	-0.171	70.7	1.72	0.032	Not required
WLAN 2.4G		0.41	1.2	0.099	-0.038	-0.171				

Band	Position	SAR (W/kg)	Gap (cm)	SAR peak location (m)			3D distance (mm)	Pair SAR sum (W/kg)	SPLSR	Simultaneous SAR
				X	Y	Z				
LTE Band 71	Rear	0.88	0	0.099	0.025	-0.171	81.3	1.91	0.033	Not required
WLAN 2.4G		1.03	0	0.0925	-0.056	-0.171				

Band	Position	SAR (W/kg)	Gap (cm)	SAR peak location (m)			3D distance (mm)	Pair SAR sum (W/kg)	SPLSR	Simultaneous SAR
				X	Y	Z				
LTE Band 41(PC2)	Top	1.22	0	-0.0045	0.05	-0.171	81.7	1.70	0.027	Not required
WLAN 2.4G		0.48	0	-0.015	-0.031	-0.171				

Band	Position	SAR (W/kg)	Gap (cm)	SAR peak location (m)			3D distance (mm)	Pair SAR sum (W/kg)	SPLSR	Simultaneous SAR
				X	Y	Z				
GSM1900	Rear	1.18	0	0.104	0.0085	-0.171	89.5	2.00	0.032	Not required
WLAN 5G		0.82	0	0.104	-0.054	-0.171				

Band	Position	SAR (W/kg)	Gap (cm)	SAR peak location (m)			3D distance (mm)	Pair SAR sum (W/kg)	SPLSR	Simultaneous SAR
				X	Y	Z				
GSM1900	Rear	1.07	1.2	0.102	0.03	-0.171	75.8	1.71	0.030	Not required
WLAN 5G		0.64	1.2	0.107	-0.0456	-0.171				



Band	Position	SAR (W/kg)	Gap (cm)	SAR peak location (m)			3D distance (mm)	Pair SAR sum (W/kg)	SPLSR	Simultaneous SAR
				X	Y	Z				
WCDMA Band 2	Rear	1.02	0	0.104	0.0355	-0.171	89.5	1.84	0.028	Not required
WLAN 5G		0.82	0	0.104	-0.054	-0.171				

Band	Position	SAR (W/kg)	Gap (cm)	SAR peak location (m)			3D distance (mm)	Pair SAR sum (W/kg)	SPLSR	Simultaneous SAR
				X	Y	Z				
WCDMA Band 4	Rear	1.08	0	0.104	0.0315	-0.17	85.5	1.90	0.031	Not required
WLAN 5G		0.82	0	0.104	-0.054	-0.171				

Band	Position	SAR (W/kg)	Gap (cm)	SAR peak location (m)			3D distance (mm)	Pair SAR sum (W/kg)	SPLSR	Simultaneous SAR
				X	Y	Z				
LTE Band 7	Rear	0.89	0	0.101	0.054	-0.17	108.0	1.71	0.021	Not required
WLAN 5G		0.82	0	0.104	-0.054	-0.171				

Band	Position	SAR (W/kg)	Gap (cm)	SAR peak location (m)			3D distance (mm)	Pair SAR sum (W/kg)	SPLSR	Simultaneous SAR
				X	Y	Z				
LTE Band 25	Rear	1.22	0	0.105	0.0315	-0.17	85.5	2.04	0.034	Not required
WLAN 5G		0.82	0	0.104	-0.054	-0.171				

Band	Position	SAR (W/kg)	Gap (cm)	SAR peak location (m)			3D distance (mm)	Pair SAR sum (W/kg)	SPLSR	Simultaneous SAR
				X	Y	Z				
LTE Band 25	Rear	1.19	1.2	0.102	0.034	-0.171	79.8	1.83	0.031	Not required
WLAN 5G		0.64	1.2	0.107	-0.0456	-0.171				

Band	Position	SAR (W/kg)	Gap (cm)	SAR peak location (m)			3D distance (mm)	Pair SAR sum (W/kg)	SPLSR	Simultaneous SAR
				X	Y	Z				
LTE Band 30	Rear	0.9	0	0.099	0.053	-0.17	107.1	1.72	0.021	Not required
WLAN 5G		0.82	0	0.104	-0.054	-0.171				

Band	Position	SAR (W/kg)	Gap (cm)	SAR peak location (m)			3D distance (mm)	Pair SAR sum (W/kg)	SPLSR	Simultaneous SAR
				X	Y	Z				
LTE Band 41(PC3)	Rear	0.78	0	0.099	0.054	-0.17	108.1	1.60	0.019	Not required
WLAN 5G		0.82	0	0.104	-0.054	-0.171				



Band	Position	SAR (W/kg)	Gap (cm)	SAR peak location (m)			3D distance (mm)	Pair SAR sum (W/kg)	SPLSR	Simultaneous SAR
				X	Y	Z				
LTE Band 66	Rear	1.18	0	0.104	0.03	-0.17	84.0	2.00	0.034	Not required
WLAN 5G		0.82	0	0.104	-0.054	-0.171				

Band	Position	SAR (W/kg)	Gap (cm)	SAR peak location (m)			3D distance (mm)	Pair SAR sum (W/kg)	SPLSR	Simultaneous SAR
				X	Y	Z				
LTE Band 66	Rear	1.31	1.2	0.112	0.0315	-0.171	77.3	1.95	0.035	Not required
WLAN 5G		0.64	1.2	0.107	-0.0456	-0.171				

Band	Position	SAR (W/kg)	Gap (cm)	SAR peak location (m)			3D distance (mm)	Pair SAR sum (W/kg)	SPLSR	Simultaneous SAR
				X	Y	Z				
LTE Band 71	Rear	0.88	0	0.099	0.025	-0.171	79.2	1.70	0.028	Not required
WLAN 5G		0.82	0	0.104	-0.054	-0.171				

Band	Position	SAR (W/kg)	Gap (cm)	SAR peak location (m)			3D distance (mm)	Pair SAR sum (W/kg)	SPLSR	Simultaneous SAR
				X	Y	Z				
GSM850	Top	0.82	0	0.0045	0.015	-0.171	69.6	1.90	0.038	Not required
WLAN 5G		1.08	0	-0.0048	-0.054	-0.171				

Band	Position	SAR (W/kg)	Gap (cm)	SAR peak location (m)			3D distance (mm)	Pair SAR sum (W/kg)	SPLSR	Simultaneous SAR
				X	Y	Z				
GSM1900	Top	0.61	0	8.74E-11	0.042	-0.171	96.1	1.69	0.023	Not required
WLAN 5G		1.08	0	-0.0048	-0.054	-0.171				

Band	Position	SAR (W/kg)	Gap (cm)	SAR peak location (m)			3D distance (mm)	Pair SAR sum (W/kg)	SPLSR	Simultaneous SAR
				X	Y	Z				
WCDMA Band 2	Top	0.56	0	-0.0105	0.0345	-0.172	88.7	1.64	0.024	Not required
WLAN 5G		1.08	0	-0.0048	-0.054	-0.171				

Band	Position	SAR (W/kg)	Gap (cm)	SAR peak location (m)			3D distance (mm)	Pair SAR sum (W/kg)	SPLSR	Simultaneous SAR
				X	Y	Z				
WCDMA Band 5	Top	0.70	0	-0.0015	0.015	-0.171	69.1	1.78	0.034	Not required
WLAN 5G		1.08	0	-0.0048	-0.054	-0.171				



Band	Position	SAR (W/kg)	Gap (cm)	SAR peak location (m)			3D distance (mm)	Pair SAR sum (W/kg)	SPLSR	Simultaneous SAR
				X	Y	Z				
LTE Band 7	Top	1.07	0	-0.0105	0.0405	-0.171	94.7	2.15	0.033	Not required
WLAN 5G		1.08	0	-0.0048	-0.054	-0.171				

Band	Position	SAR (W/kg)	Gap (cm)	SAR peak location (m)			3D distance (mm)	Pair SAR sum (W/kg)	SPLSR	Simultaneous SAR
				X	Y	Z				
LTE Band 13	Top	0.52	0	-0.0045	0.015	-0.171	69.0	1.60	0.029	Not required
WLAN 5G		1.08	0	-0.0048	-0.054	-0.171				

Band	Position	SAR (W/kg)	Gap (cm)	SAR peak location (m)			3D distance (mm)	Pair SAR sum (W/kg)	SPLSR	Simultaneous SAR
				X	Y	Z				
LTE Band 25	Top	0.66	0	-0.0135	0.0345	-0.171	88.9	1.74	0.026	Not required
WLAN 5G		1.08	0	-0.0048	-0.054	-0.171				

Band	Position	SAR (W/kg)	Gap (cm)	SAR peak location (m)			3D distance (mm)	Pair SAR sum (W/kg)	SPLSR	Simultaneous SAR
				X	Y	Z				
LTE Band 26	Top	0.59	0	-0.0045	0.0165	-0.171	70.5	1.67	0.031	Not required
WLAN 5G		1.08	0	-0.0048	-0.054	-0.171				

Band	Position	SAR (W/kg)	Gap (cm)	SAR peak location (m)			3D distance (mm)	Pair SAR sum (W/kg)	SPLSR	Simultaneous SAR
				X	Y	Z				
LTE Band 30	Top	1.03	0	-0.006	0.047	-0.171	101.0	2.11	0.030	Not required
WLAN 5G		1.08	0	-0.0048	-0.054	-0.171				

Band	Position	SAR (W/kg)	Gap (cm)	SAR peak location (m)			3D distance (mm)	Pair SAR sum (W/kg)	SPLSR	Simultaneous SAR
				X	Y	Z				
LTE Band 41(PC3)	Top	0.99	0	-0.0075	0.036	-0.171	90.0	2.07	0.033	Not required
WLAN 5G		1.08	0	-0.0048	-0.054	-0.171				

Band	Position	SAR (W/kg)	Gap (cm)	SAR peak location (m)			3D distance (mm)	Pair SAR sum (W/kg)	SPLSR	Simultaneous SAR
				X	Y	Z				
LTE Band 41(PC2)	Top	1.22	0	-0.0045	0.05	-0.171	104.0	2.30	0.034	Not required
WLAN 5G		1.08	0	-0.0048	-0.054	-0.171				

Table 12.1: The sum of reported SAR values for main antenna and WLAN/BT

/	Position	Main Antenna (W/kg)	WLAN (W/kg)	Sum (W/kg)
Highest reported SAR value for Body	Top	0.51	1.08	1.59

Note: the test positions of above tables are for the worse case that has been evaluated.

Conclusion:

According to the above tables, the sum of reported SAR values is 1.59 W/kg. So the simultaneous transmission SAR with volume scans is not required.

13. Summary of Test Results

According to the client's decision rule in the test registration form, which is "based on the measurement results as the basis of the conformity statement", the test conclusion of this report meets the limit requirements.

The calculated SAR is obtained by the following formula:

$$\text{Reported SAR} = \text{Measured SAR} \times 10^{(P_{\text{Target}} - P_{\text{Measured}})/10}$$

Where P_{Target} is the power of manufacturing upper limit;

P_{Measured} is the measured power in chapter 10.

Duty Cycle

Mode	Duty Cycle
GPRS for GSM850/1900	1:4/1:2
WCDMA Band	1:1
LTE_FDD Band	1:1
LTE_TDD Band	1:1.58/1:2.31
Bluetooth	1:1

13.1. Testing Environment

Temperature:	18°C~25°C
Relative humidity:	30%~70%
Ground system resistance:	<4Ω
Ambient noise & Reflection:	< 0.012 W/kg

13.2. SAR results

Table 13.1: SAR Values (GSM 850 - Body)

Frequency		Test Mode	Test Position	Figure No./ Note	Conducted Power (dBm)	Max. tune-up Power (dBm)	Measured SAR(1g) (W/kg)	Reported SAR(1g) (W/kg)	Power Drift(dB)
Ch.	MHz								
0mm Test Data									
190	836.6	GPRS-2	Rear	/	26.55	27.0	0.638	0.71	0.07
190	836.6	GPRS-2	Left	/	26.55	27.0	0.199	0.22	0.14
190	836.6	GPRS-2	Right	/	26.55	27.0	0.059	0.07	0.18
190	836.6	GPRS-2	Top	/	26.55	27.0	0.677	0.75	-0.01
251	848.8	GPRS-2	Top	/	26.55	27.0	0.707	0.78	0.03
128	824.2	GPRS-2	Top	1	26.63	27.0	0.752	0.82	-0.03
Sensor off Test Data									
190	836.6	GPRS-4	Rear	Note1	29.39	30.5	0.494	0.64	0.18
190	836.6	GPRS-4	Left	Note2	29.39	30.5	0.424	0.55	0.10
190	836.6	GPRS-4	Right	Note3	29.39	30.5	0.104	0.13	-0.14
190	836.6	GPRS-4	Top	Note4	29.39	30.5	0.421	0.54	0.02

Note1: The distance between the EUT's side and the phantom is 12mm.

Note2: The distance between the EUT's side and the phantom is 3mm.

Note3: The distance between the EUT's side and the phantom is 6mm.

Note4: The distance between the EUT's side and the phantom is 14mm.

Table 13.2: SAR Values (GSM 1900 - Body)

Frequency		Test Mode	Test Position	Figure No./ Note	Conducted Power (dBm)	Max. tune-up Power (dBm)	Measured SAR(1g) (W/kg)	Reported SAR(1g) (W/kg)	Power Drift(dB)
Ch.	MHz								
0mm Test Data									
661	1880.0	GPRS-2	Rear	/	22.10	23.0	0.865	1.06	0.09
661	1880.0	GPRS-2	Left	/	22.10	23.0	0.107	0.13	0.03
661	1880.0	GPRS-2	Right	/	22.10	23.0	0.024	0.03	0.03
661	1880.0	GPRS-2	Top	/	22.10	23.0	0.499	0.61	0.06
810	1909.8	GPRS-2	Rear	2	21.91	23.0	0.921	1.18	0.03
512	1850.2	GPRS-2	Rear	/	22.33	23.0	0.870	1.02	0.07
Sensor off Test Data									
661	1880.0	GPRS-4	Rear	Note1	27.85	29.0	0.725	0.94	0.08
661	1880.0	GPRS-4	Left	Note2	27.85	29.0	0.395	0.51	0.07
661	1880.0	GPRS-4	Right	Note3	27.85	29.0	0.079	0.10	-0.13
661	1880.0	GPRS-4	Top	Note4	27.85	29.0	0.389	0.51	0.07
810	1909.8	GPRS-4	Rear	Note1	27.73	29.0	0.802	1.07	0.05
512	1850.2	GPRS-4	Rear	Note1	27.99	29.0	0.713	0.90	0.09

Note1: The distance between the EUT's side and the phantom is 12mm.

Note2: The distance between the EUT's side and the phantom is 3mm.

Note3: The distance between the EUT's side and the phantom is 6mm.

Note4: The distance between the EUT's side and the phantom is 14mm.

Table 13.3: SAR Values (WCDMA Band 2 - Body)

Frequency		Test Mode	Test Position	Figure No./ Note	Conducted Power (dBm)	Max. tune-up Power (dBm)	Measured SAR(1g) (W/kg)	Reported SAR(1g) (W/kg)	Power Drift(dB)
Ch.	MHz								
0mm Test Data									
9400	1880.0	RMC	Rear	/	14.90	15.5	0.856	0.98	0.03
9400	1880.0	RMC	Left	/	14.90	15.5	0.110	0.13	0.17
9400	1880.0	RMC	Right	/	14.90	15.5	0.030	0.03	-0.14
9400	1880.0	RMC	Top	/	14.90	15.5	0.488	0.56	0.09
9538	1907.6	RMC	Rear	3	14.90	15.5	0.887	1.02	0.18
9262	1852.4	RMC	Rear	/	15.00	15.5	0.843	0.95	0.02
Sensor off Test Data									
9400	1880.0	RMC	Rear	Note1	23.80	24.5	0.138	0.16	3.00
9400	1880.0	RMC	Left	Note2	23.80	24.5	0.532	0.63	-0.08
9400	1880.0	RMC	Right	Note3	23.80	24.5	0.106	0.12	-0.06
9400	1880.0	RMC	Top	Note4	23.80	24.5	0.080	0.09	-0.10

Note1: The distance between the EUT's side and the phantom is 12mm.

Note2: The distance between the EUT's side and the phantom is 3mm.

Note3: The distance between the EUT's side and the phantom is 6mm.

Note4: The distance between the EUT's side and the phantom is 14mm.

Table 13.4: SAR Values (WCDMA Band 4 - Body)

Frequency		Test Mode	Test Position	Figure No./ Note	Conducted Power (dBm)	Max. tune-up Power (dBm)	Measured SAR(1g) (W/kg)	Reported SAR(1g) (W/kg)	Power Drift(dB)
Ch.	MHz								
0mm Test Data									
1413	1732.6	RMC	Rear	/	14.70	15.5	0.845	1.02	0.09
1413	1732.6	RMC	Left	/	14.70	15.5	0.170	0.20	0.00
1413	1732.6	RMC	Right	/	14.70	15.5	0.022	0.03	-0.18
1413	1732.6	RMC	Top	/	14.70	15.5	0.318	0.38	0.14
1513	1752.6	RMC	Rear	/	14.70	15.5	0.900	1.08	-0.18
1312	1712.4	RMC	Rear	/	14.80	15.5	0.801	0.94	0.04
Sensor off Test Data									
1413	1732.6	RMC	Rear	Note1	23.60	24.5	0.150	0.18	0.05
1413	1732.6	RMC	Left	Note2	23.60	24.5	0.903	1.11	0.00
1413	1732.6	RMC	Right	Note3	23.60	24.5	0.095	0.12	-0.04
1413	1732.6	RMC	Top	Note4	23.60	24.5	0.067	0.08	0.14
1513	1752.6	RMC	Left	4/Note2	23.50	24.5	0.929	1.17	-0.13
1312	1712.4	RMC	Left	Note2	23.50	24.5	0.830	1.04	-0.15

Note1: The distance between the EUT's side and the phantom is 12mm.

Note2: The distance between the EUT's side and the phantom is 3mm.

Note3: The distance between the EUT's side and the phantom is 6mm.

Note4: The distance between the EUT's side and the phantom is 14mm.

Table 13.5: SAR Values (WCDMA Band 5 -Body)

Frequency		Test Mode	Test Position	Figure No./ Note	Conducted Power (dBm)	Max. tune-up Power (dBm)	Measured SAR(1g) (W/kg)	Reported SAR(1g) (W/kg)	Power Drift(dB)
Ch.	MHz								
0mm Test Data									
4182	836.4	RMC	Rear	5	18.40	19.5	0.601	0.77	0.07
4182	836.4	RMC	Left	/	18.40	19.5	0.149	0.19	0.05
4182	836.4	RMC	Right	/	18.40	19.5	0.036	0.05	0.12
4182	836.4	RMC	Top	/	18.40	19.5	0.546	0.70	-0.03
Sensor off Test Data									
4182	836.4	RMC	Rear	Note1	23.70	24.5	0.132	0.16	0.06
4182	836.4	RMC	Left	Note2	23.70	24.5	0.271	0.33	0.14
4182	836.4	RMC	Right	Note3	23.70	24.5	0.068	0.08	-0.06
4182	836.4	RMC	Top	Note4	23.70	24.5	0.105	0.13	0.03

Note1: The distance between the EUT's side and the phantom is 12mm.

Note2: The distance between the EUT's side and the phantom is 3mm.

Note3: The distance between the EUT's side and the phantom is 6mm.

Note4: The distance between the EUT's side and the phantom is 14mm.

Table 13.6: SAR Values (LTE Band 7 - Body)

Frequency		Test Mode	Test Position	Figure No./ Note	Conducted Power (dBm)	Max. tune-up Power (dBm)	Measured SAR(1g) (W/kg)	Reported SAR(1g) (W/kg)	Power Drift(dB)
Ch.	MHz								
0mm Test Data									
20850	2510.0	1RB50	Rear	/	13.98	14.5	0.791	0.89	0.03
20850	2510.0	50RB50	Rear	/	12.95	14.0	0.657	0.84	0.04
20850	2510.0	1RB50	Left	/	13.98	14.5	0.372	0.42	0.18
20850	2510.0	50RB50	Left	/	12.95	14.0	0.298	0.38	0.05
20850	2510.0	1RB50	Right	/	13.98	14.5	0.051	0.06	-0.01
20850	2510.0	50RB50	Right	/	12.95	14.0	0.041	0.05	-0.17
20850	2510.0	1RB50	Top	/	13.98	14.5	0.943	1.06	0.14
20850	2510.0	50RB50	Top	/	12.95	14.0	0.742	0.94	0.03
21350	2560.0	1RB50	Rear	/	13.96	14.5	0.729	0.83	-0.17
21100	2535.0	1RB50	Rear	/	13.95	14.5	0.742	0.84	0.14
21350	2560.0	1RB50	Top	/	13.96	14.5	0.854	0.97	0.07
21100	2535.0	1RB50	Top	/	13.95	14.5	0.945	1.07	0.11
21350	2560.0	1RB50	Top	/	12.93	14.0	0.712	0.91	-0.19
21100	2535.0	1RB50	Top	/	12.94	14.0	0.730	0.93	-0.16
20850	2510.0	100RB	Top	/	12.87	14.0	0.724	0.94	0.15
Sensor off Test Data									
20850	2510.0	1RB50	Rear	Note1	22.06	22.5	0.717	0.79	0.03
20850	2510.0	50RB50	Rear	Note1	21.11	22.0	0.550	0.68	0.08
20850	2510.0	1RB50	Left	6 /Note2	22.06	22.5	1.250	1.38	-0.06
20850	2510.0	50RB50	Left	Note2	21.11	22.0	0.992	1.22	-0.02
20850	2510.0	1RB50	Right	Note3	22.06	22.5	0.153	0.17	0.12
20850	2510.0	50RB50	Right	Note3	21.11	22.0	0.122	0.15	-0.14
20850	2510.0	1RB50	Top	Note4	22.06	22.5	0.336	0.37	0.16
20850	2510.0	50RB50	Top	Note4	21.11	22.0	0.245	0.30	0.00
21350	2560.0	1RB50	Rear	Note1	22.00	22.5	0.557	0.62	-0.06
21100	2535.0	1RB50	Rear	Note1	22.03	22.0	0.642	0.64	-0.18
21350	2560.0	1RB50	Left	Note2	22.00	22.5	0.972	1.09	-0.15
21100	2535.0	1RB50	Left	Note2	22.03	22.5	1.120	1.25	-0.16
21350	2560.0	50RB25	Left	Note2	20.99	22.0	0.772	0.97	0.12
21100	2535.0	50RB25	Left	Note2	20.99	22.0	0.888	1.12	0.02
20850	2510.0	100RB	Left	Note2	21.07	22.0	1.020	1.26	-0.09

Note1: The distance between the EUT's side and the phantom is 12mm.

Note2: The distance between the EUT's side and the phantom is 3mm.

Note3: The distance between the EUT's side and the phantom is 6mm.

Note4: The distance between the EUT's side and the phantom is 14mm.

Table 13.7: SAR Values (LTE Band 12 - Body)

Frequency		Test Mode	Test Position	Figure No./ Note	Conducted Power (dBm)	Max. tune-up Power (dBm)	Measured SAR(1g) (W/kg)	Reported SAR(1g) (W/kg)	Power Drift(dB)
Ch.	MHz								
0mm Test Data									
23130	711.0	1RB49	Rear	7	18.46	19.0	0.583	0.66	0.08
23130	711.0	25RB25	Rear	/	17.46	18.0	0.503	0.57	0.04
23130	711.0	1RB49	Left	/	18.46	19.0	0.148	0.17	0.02
23130	711.0	25RB25	Left	/	17.46	18.0	0.117	0.13	-0.08
23130	711.0	1RB49	Right	/	18.46	19.0	0.047	0.05	0.00
23130	711.0	25RB25	Right	/	17.46	18.0	0.035	0.04	0.14
23130	711.0	1RB49	Top	/	18.46	19.0	0.391	0.44	-0.10
23130	711.0	25RB25	Top	/	17.46	18.0	0.342	0.39	-0.11
Sensor off Test Data									
23060	704.0	1RB24	Rear	Note1	23.36	24.0	0.339	0.39	0.05
23130	711.0	25RB25	Rear	Note1	22.37	23.0	0.271	0.31	0.02
23060	704.0	1RB24	Left	Note2	23.36	24.0	0.278	0.32	0.05
23130	711.0	25RB25	Left	Note2	22.37	23.0	0.199	0.23	0.11
23060	704.0	1RB24	Right	Note3	23.36	24.0	0.076	0.09	0.11
23130	711.0	25RB25	Right	Note3	22.37	23.0	0.069	0.08	-0.08
23060	704.0	1RB24	Top	Note4	23.36	24.0	0.232	0.27	0.03
23130	711.0	25RB25	Top	Note4	22.37	23.0	0.176	0.20	-0.01

Note1: The distance between the EUT's side and the phantom is 12mm.

Note2: The distance between the EUT's side and the phantom is 3mm.

Note3: The distance between the EUT's side and the phantom is 6mm.

Note4: The distance between the EUT's side and the phantom is 14mm.

Note5: SAR for LTE Band 17 is covered by LTE Band 12 due to similar frequency range, same maximum tune-up limit and same channel bandwidth.

Table 13.8: SAR Values (LTE Band 13 - Body)

Frequency		Test Mode	Test Position	Figure No./ Note	Conducted Power (dBm)	Max. tune-up Power (dBm)	Measured SAR(1g) (W/kg)	Reported SAR(1g) (W/kg)	Power Drift(dB)
Ch.	MHz								
0mm Test Data									
23230	782.0	1RB24	Rear	8	18.36	19.0	0.532	0.62	0.05
23230	782.0	25RB25	Rear	/	17.34	18.0	0.455	0.53	-0.19
23230	782.0	1RB24	Left	/	18.36	19.0	0.110	0.13	-0.08
23230	782.0	25RB25	Left	/	17.34	18.0	0.088	0.10	0.03
23230	782.0	1RB24	Right	/	18.36	19.0	0.024	0.03	0.13
23230	782.0	25RB25	Right	/	17.34	18.0	0.019	0.02	0.05
23230	782.0	1RB24	Top	/	18.36	19.0	0.453	0.52	0.00
23230	782.0	25RB25	Top	/	17.34	18.0	0.347	0.40	-0.01
Sensor off Test Data									
23230	782.0	1RB24	Rear	Note1	23.29	24.0	0.258	0.30	-0.04
23230	782.0	25RB25	Rear	Note1	22.28	23.0	0.223	0.26	0.08
23230	782.0	1RB24	Left	Note2	23.29	24.0	0.206	0.24	0.03
23230	782.0	25RB25	Left	Note2	22.28	23.0	0.168	0.20	-0.20
23230	782.0	1RB24	Right	Note3	23.29	24.0	0.077	0.09	0.09
23230	782.0	25RB25	Right	Note3	22.28	23.0	0.061	0.07	-0.19
23230	782.0	1RB24	Top	Note4	23.29	24.0	0.218	0.26	-0.03
23230	782.0	25RB25	Top	Note4	22.28	23.0	0.182	0.21	0.10

Note1: The distance between the EUT's side and the phantom is 12mm.

Note2: The distance between the EUT's side and the phantom is 3mm.

Note3: The distance between the EUT's side and the phantom is 6mm.

Note4: The distance between the EUT's side and the phantom is 14mm.

Table 13.9: SAR Values (LTE Band 25 - Body)

Frequency		Test Mode	Test Position	Figure No./ Note	Conducted Power (dBm)	Max. tune-up Power (dBm)	Measured SAR(1g) (W/kg)	Reported SAR(1g) (W/kg)	Power Drift(dB)
Ch.	MHz								
0mm Test Data									
26140	1860.0	1RB50	Rear	/	15.38	16.0	1.020	1.18	-0.16
26140	1860.0	50RB25	Rear	/	14.31	15.0	0.835	0.98	0.00
26140	1860.0	1RB50	Left	/	15.38	16.0	0.101	0.12	-0.08
26140	1860.0	50RB25	Left	/	14.31	15.0	0.080	0.09	-0.19
26140	1860.0	1RB50	Right	/	15.38	16.0	0.031	0.04	0.12
26140	1860.0	50RB25	Right	/	14.31	15.0	0.023	0.03	0.05
26140	1860.0	1RB50	Top	/	15.38	16.0	0.527	0.61	0.13
26140	1860.0	50RB25	Top	/	14.31	15.0	0.455	0.53	-0.07
26590	1905.0	1RB50	Rear	9	15.34	16.0	1.050	1.22	0.01
26365	1882.5	1RB50	Rear	/	15.33	16.0	1.030	1.20	-0.18
26590	1905.0	50RB25	Rear	/	14.27	15.0	0.864	1.02	-0.02
26365	1882.5	50RB25	Rear	/	14.26	15.0	0.882	1.05	-0.12
26365	1882.5	100RB	Rear	/	14.27	15.0	0.817	0.97	0.07
Sensor off Test Data									
26140	1860.0	1RB50	Rear	Note1	23.27	24.0	0.926	1.10	0.10
26140	1860.0	50RB25	Rear	Note1	22.23	23.0	0.720	0.86	0.05
26140	1860.0	1RB50	Left	Note2	23.27	24.0	0.512	0.61	0.18
26140	1860.0	50RB25	Left	Note2	22.23	23.0	0.408	0.49	0.03
26140	1860.0	1RB50	Right	Note3	23.27	24.0	0.129	0.15	0.05
26140	1860.0	50RB25	Right	Note3	22.23	23.0	0.102	0.12	-0.09
26140	1860.0	1RB50	Top	Note4	23.27	24.0	0.447	0.53	0.10
26140	1860.0	50RB25	Top	Note4	22.23	23.0	0.343	0.41	0.10
26590	1905.0	1RB50	Rear	Note1	23.20	24.0	0.991	1.19	0.01
26365	1882.5	1RB50	Rear	Note1	23.22	24.0	0.883	1.06	0.10
26590	1905.0	50RB25	Rear	Note1	22.18	23.0	0.747	0.90	0.06
26365	1882.5	50RB25	Rear	Note1	22.19	23.0	0.758	0.91	0.09
26590	1905.0	100RB	Rear	Note1	22.19	23.0	0.782	0.94	0.09

Note1: The distance between the EUT's side and the phantom is 12mm.

Note2: The distance between the EUT's side and the phantom is 3mm.

Note3: The distance between the EUT's side and the phantom is 6mm.

Note4: The distance between the EUT's side and the phantom is 14mm.

Note5: SAR for LTE Band 2 is covered by LTE Band 25 due to similar frequency range, same maximum tune-up limit and same channel bandwidth.

Table 13.10: SAR Values (LTE Band 26 - Body)

Frequency		Test Mode	Test Position	Figure No./ Note	Conducted Power (dBm)	Max. tune-up Power (dBm)	Measured SAR(1g) (W/kg)	Reported SAR(1g) (W/kg)	Power Drift(dB)
Ch.	MHz								
0mm Test Data									
26965	841.5	1RB74	Rear	10	18.16	19.0	0.550	0.67	0.08
26965	841.5	36RB19	Rear	/	17.19	18.0	0.432	0.52	-0.03
26965	841.5	1RB37	Left	/	18.16	19.0	0.162	0.20	0.19
26965	841.5	36RB19	Left	/	17.19	18.0	0.123	0.15	0.03
26965	841.5	1RB37	Right	/	18.16	19.0	0.042	0.05	-0.19
26965	841.5	36RB19	Right	/	17.19	18.0	0.032	0.04	-0.07
26965	841.5	1RB37	Top	/	18.16	19.0	0.490	0.59	-0.09
26965	841.5	36RB19	Top	/	17.19	18.0	0.403	0.49	-0.10
Sensor off Test Data									
26865	831.5	1RB37	Rear	Note1	23.25	24.0	0.331	0.39	0.06
26865	831.5	36RB19	Rear	Note1	22.34	23.0	0.250	0.29	0.07
26865	831.5	1RB37	Left	Note2	23.25	24.0	0.220	0.26	0.11
26865	831.5	36RB19	Left	Note2	22.34	23.0	0.161	0.19	0.04
26865	831.5	1RB37	Right	Note3	23.25	24.0	0.066	0.08	-0.15
26865	831.5	36RB19	Right	Note3	22.34	23.0	0.050	0.06	0.05
26865	831.5	1RB37	Top	Note4	23.25	24.0	0.259	0.31	0.02
26865	831.5	36RB19	Top	Note4	22.34	23.0	0.202	0.24	0.01

Note1: The distance between the EUT's side and the phantom is 12mm.

Note2: The distance between the EUT's side and the phantom is 3mm.

Note3: The distance between the EUT's side and the phantom is 6mm.

Note4: The distance between the EUT's side and the phantom is 14mm.

Note5: SAR for LTE Band 5 is covered by LTE Band 26 due to similar frequency range, same maximum tune-up limit and same channel bandwidth.

Table 13.11: SAR Values (LTE Band 30 - Body)

Frequency		Test Mode	Test Position	Figure No./ Note	Conducted Power (dBm)	Max. tune-up Power (dBm)	Measured SAR(1g) (W/kg)	Reported SAR(1g) (W/kg)	Power Drift(dB)
Ch.	MHz								
0mm Test Data									
27710	2310.0	1RB24	Rear	/	16.11	16.5	0.823	0.90	-0.18
27710	2310.0	25RB0	Rear	/	15.04	16.0	0.765	0.95	-0.20
27710	2310.0	1RB24	Left	/	16.11	16.5	0.493	0.54	-0.11
27710	2310.0	25RB0	Left	/	15.04	16.0	0.410	0.51	0.10
27710	2310.0	1RB24	Right	/	16.11	16.5	0.041	0.04	-0.15
27710	2310.0	25RB0	Right	/	15.04	16.0	0.032	0.04	0.07
27710	2310.0	1RB24	Top	/	16.11	16.5	0.940	1.03	0.02
27710	2310.0	25RB0	Top	/	15.04	16.0	0.748	0.93	-0.06
27710	2310.0	50RB0	Top	/	15.02	16.0	0.742	0.93	-0.02
Sensor off Test Data									
27710	2310.0	1RB24	Rear	Note1	22.04	22.5	0.586	0.65	0.18
27710	2310.0	25RB0	Rear	Note1	21.06	22.0	0.481	0.60	0.01
27710	2310.0	1RB24	Left	11 /Note2	22.04	22.5	1.230	1.37	0.02
27710	2310.0	25RB0	Left	Note2	21.06	22.0	0.946	1.17	-0.20
27710	2310.0	1RB24	Right	Note3	22.04	22.5	0.131	0.15	0.14
27710	2310.0	25RB0	Right	Note3	21.06	22.0	0.103	0.13	0.06
27710	2310.0	1RB24	Top	Note4	22.04	22.5	0.352	0.39	0.01
27710	2310.0	25RB0	Top	Note4	21.06	22.0	0.280	0.35	0.10
27710	2310.0	50RB	Left	Note2	21.06	22.0	1.010	1.25	0.04

Note1: The distance between the EUT's side and the phantom is 12mm.

Note2: The distance between the EUT's side and the phantom is 3mm.

Note3: The distance between the EUT's side and the phantom is 6mm.

Note4: The distance between the EUT's side and the phantom is 14mm.

Table 13.12: SAR Values (LTE Band 41 - Body)

Frequency		Test Mode	Test Position	Figure No./ Note	Conducted Power (dBm)	Max. tune-up Power (dBm)	Measured SAR(1g) (W/kg)	Reported SAR(1g) (W/kg)	Power Drift(dB)
Ch.	MHz								
0mm Test Data									
41490	2680.0	1RB50	Rear	/	15.18	16.0	0.646	0.78	0.03
41490	2680.0	50RB50	Rear	/	14.15	15.0	0.574	0.70	0.13
41490	2680.0	1RB50	Left	/	15.18	16.0	0.353	0.43	0.04
41490	2680.0	50RB50	Left	/	14.15	15.0	0.273	0.33	-0.16
41490	2680.0	1RB50	Right	/	15.18	16.0	0.031	0.04	0.11
41490	2680.0	50RB50	Right	/	14.15	15.0	0.027	0.03	0.02
41490	2680.0	1RB50	Top	/	15.18	16.0	0.793	0.96	-0.09
41490	2680.0	50RB50	Top	/	14.15	15.0	0.642	0.78	-0.04
41055	2636.5	1RB50	Top	/	15.01	16.0	0.766	0.96	0.11
40620	2593.0	1RB50	Top	/	15.01	16.0	0.772	0.97	0.08
40185	2549.5	1RB50	Top	/	15.04	16.0	0.791	0.99	0.05
39750	2506.0	1RB50	Top	/	15.09	16.0	0.789	0.97	0.12
0mm Test Data - The worst case with PC2									
40185	2549.5	1RB50	Top	/	18.03	19.0	0.972	1.22	0.15
Sensor off Test Data									
39750	2506.0	1RB50	Rear	Note1	23.44	24.0	0.458	0.52	0.04
39750	2506.0	50RB0	Rear	Note1	22.37	23.0	0.357	0.41	0.03
39750	2506.0	1RB50	Left	Note2	23.44	24.0	0.717	0.82	0.06
39750	2506.0	50RB0	Left	Note2	22.37	23.0	0.605	0.70	0.12
39750	2506.0	1RB50	Right	Note3	23.44	24.0	0.081	0.09	0.11
39750	2506.0	50RB0	Right	Note3	22.37	23.0	0.048	0.06	-0.12
39750	2506.0	1RB50	Top	Note4	23.44	24.0	0.208	0.24	-0.09
39750	2506.0	50RB0	Top	Note4	22.37	23.0	0.162	0.19	0.01
41490	2680.0	1RB50	Left	Note2	23.34	24.0	0.466	0.54	-0.05
41055	2636.5	1RB50	Left	Note2	23.38	24.0	0.632	0.73	-0.17
40620	2593.0	1RB50	Left	Note2	22.97	24.0	0.541	0.69	-0.05
40185	2549.5	1RB50	Left	Note2	23.40	24.0	0.790	0.91	-0.11
39750	2506.0	100RB	Left	Note2	22.36	23.0	0.577	0.67	-0.08
Sensor off Test Data - The worst case with PC2									
40185	2549.5	1RB50	Left	12/Note2	26.27	27.0	1.040	1.23	0.15

Note1: The distance between the EUT's side and the phantom is 12mm.

Note2: The distance between the EUT's side and the phantom is 3mm.

Note3: The distance between the EUT's side and the phantom is 6mm.

Note4: The distance between the EUT's side and the phantom is 14mm.

Table 13.13: SAR Values (LTE Band 66 - Body)

Frequency		Test Mode	Test Position	Figure No./ Note	Conducted Power (dBm)	Max. tune-up Power (dBm)	Measured SAR(1g) (W/kg)	Reported SAR(1g) (W/kg)	Power Drift(dB)
Ch.	MHz								
0mm Test Data									
132572	1770.0	1RB50	Rear	/	14.54	15.5	0.948	1.18	0.19
132572	1770.0	50RB25	Rear	/	13.52	14.5	0.757	0.95	-0.20
132572	1770.0	1RB50	Left	/	14.54	15.5	0.244	0.30	-0.18
132572	1770.0	50RB25	Left	/	13.52	14.5	0.192	0.24	0.15
132572	1770.0	1RB50	Right	/	14.54	15.5	0.061	0.08	-0.04
132572	1770.0	50RB25	Right	/	13.52	14.5	0.015	0.02	0.13
132572	1770.0	1RB50	Top	/	14.54	15.5	0.407	0.51	0.11
132572	1770.0	50RB25	Top	/	13.52	14.5	0.296	0.37	-0.13
132322	1745.0	1RB50	Rear	/	14.46	15.5	0.878	1.12	-0.09
132072	1720.0	1RB50	Rear	/	14.43	15.5	0.802	1.03	-0.12
132322	1745.0	50RB0	Rear	/	13.44	14.5	0.657	0.84	-0.20
132072	1720.0	50RB0	Rear	/	13.44	14.5	0.588	0.75	-0.18
132572	1770.0	100RB	Rear	/	13.52	14.5	0.703	0.88	-0.03
Sensor off Test Data									
132572	1770.0	1RB50	Rear	13/Note1	23.05	24.0	1.050	1.31	0.10
132572	1770.0	50RB25	Rear	Note1	22.03	23.0	0.815	1.02	0.08
132572	1770.0	1RB50	Left	Note2	23.05	24.0	0.722	0.90	-0.06
132572	1770.0	50RB25	Left	Note2	22.03	23.0	0.589	0.74	0.08
132572	1770.0	1RB50	Right	Note3	23.05	24.0	0.106	0.13	0.12
132572	1770.0	50RB25	Right	Note3	22.03	23.0	0.093	0.12	-0.08
132572	1770.0	1RB50	Top	Note4	23.05	24.0	0.463	0.58	-0.02
132572	1770.0	50RB25	Top	Note4	22.03	23.0	0.370	0.46	-0.01
132322	1745.0	1RB50	Rear	Note1	22.96	24.0	0.968	1.23	0.01
132072	1720.0	1RB50	Rear	Note1	23.03	24.0	0.819	1.02	0.08
132322	1745.0	50RB25	Rear	Note1	22.01	23.0	0.751	0.94	-0.04
132072	1720.0	50RB25	Rear	Note1	21.96	23.0	0.636	0.81	-0.09
132572	1770.0	1RB50	Rear	Note1	21.96	23.0	0.763	0.97	0.03
132322	1745.0	1RB50	Left	Note2	22.96	24.0	0.860	1.09	-0.17
132072	1720.0	1RB50	Left	Note2	23.03	24.0	0.829	1.04	-0.10
132572	1770.0	100RB	Left	Note2	21.96	23.0	0.682	0.87	0.00

Note1: The distance between the EUT's side and the phantom is 12mm.

Note2: The distance between the EUT's side and the phantom is 3mm.

Note3: The distance between the EUT's side and the phantom is 6mm.

Note4: The distance between the EUT's side and the phantom is 14mm.

Note5: SAR for LTE Band 4 is covered by LTE Band 66 due to similar frequency range, same maximum tune-up limit and same channel bandwidth.

Table 13.14: SAR Values (LTE Band 71 - Body)

Frequency		Test Mode	Test Position	Figure No./ Note	Conducted Power (dBm)	Max. tune-up Power (dBm)	Measured SAR(1g) (W/kg)	Reported SAR(1g) (W/kg)	Power Drift(dB)
Ch.	MHz								
0mm Test Data									
133322	683.0	1RB50	Rear	14	18.25	19.0	0.744	0.88	-0.10
133372	688.0	50RB25	Rear	/	17.27	18.0	0.531	0.63	-0.05
133322	683.0	1RB50	Left	/	18.25	19.0	0.155	0.18	-0.13
133372	688.0	50RB25	Left	/	17.27	18.0	0.126	0.15	0.14
133322	683.0	1RB50	Right	/	18.25	19.0	0.046	0.05	0.10
133372	688.0	50RB25	Right	/	17.27	18.0	0.034	0.04	-0.14
133322	683.0	1RB50	Top	/	18.25	19.0	0.343	0.41	0.03
133372	688.0	50RB25	Top	/	17.27	18.0	0.270	0.32	-0.16
133372	688.0	1RB50	Rear	/	18.23	19.0	0.703	0.84	-0.12
133222	673.0	1RB50	Rear	/	18.23	19.0	0.737	0.88	-0.18
133372	688.0	100RB0	Rear	/	17.20	18.0	0.516	0.62	0.03
Sensor off Test Data									
133322	683.0	1RB50	Rear	Note1	23.31	24.0	0.354	0.41	0.03
133372	688.0	50RB25	Rear	Note1	22.30	23.0	0.298	0.35	0.03
133322	683.0	1RB50	Left	Note2	23.31	24.0	0.220	0.26	0.06
133372	688.0	50RB25	Left	Note2	22.30	23.0	0.182	0.21	0.12
133322	683.0	1RB50	Right	Note3	23.31	24.0	0.083	0.10	-0.17
133372	688.0	50RB25	Right	Note3	22.30	23.0	0.063	0.07	0.17
133322	683.0	1RB50	Top	Note4	23.31	24.0	0.227	0.27	0.03
133372	688.0	50RB25	Top	Note4	22.30	23.0	0.179	0.21	0.02

Note1: The distance between the EUT's side and the phantom is 12mm.

Note2: The distance between the EUT's side and the phantom is 3mm.

Note3: The distance between the EUT's side and the phantom is 6mm.

Note4: The distance between the EUT's side and the phantom is 14mm.

Table 13.15: SAR Values (Bluetooth - Body)

Frequency		Test Mode	Test Position	Figure No./ Note	Conducted Power (dBm)	Max. tune-up Power (dBm)	Measured SAR(1g) (W/kg)	Reported SAR(1g) (W/kg)	Power Drift(dB)
Ch.	MHz								
0mm Test Data									
78	2480.0	GFSK	Rear	15	9.90	10.5	0.246	0.28	0.00
78	2480.0	GFSK	Left	/	9.90	10.5	0.097	0.11	0.19
78	2480.0	GFSK	Right	/	9.90	10.5	0.023	0.03	0.05
78	2480.0	GFSK	Top	/	9.90	10.5	0.170	0.20	0.03

13.3. WLAN Evaluation for 2.4G

According to the KDB248227 D01, SAR is measured for 2.4GHz 802.11b DSSS using the initial test position procedure.

Table 13.16: SAR Values (WLAN 2.4G - Body)

Frequency		Test Mode	Test Position	Figure No./ Note	Conducted Power (dBm)	Max. tune-up Power (dBm)	Measured SAR(1g) (W/kg)	Reported SAR(1g) (W/kg)	Power Drift(dB)
Ch.	MHz								
0mm Test Data									
1	2412.0	802.11b	Rear	16	13.29	14.0	0.802	0.94	0.09
1	2412.0	802.11b	Left	/	13.29	14.0	0.082	0.10	-0.07
1	2412.0	802.11b	Right	/	13.29	14.0	0.266	0.31	-0.12
1	2412.0	802.11b	Top	/	13.29	14.0	0.404	0.48	0.16
6	2437.0	802.11b	Rear	/	12.84	14.0	0.790	1.03	0.09
Sensor off Test Data									
1	2412.0	802.11b	Rear	Note1	19.41	20.5	0.397	0.51	0.04
1	2412.0	802.11b	Left	Note2	19.41	20.5	0.107	0.14	0.14
1	2412.0	802.11b	Right	Note3	19.41	20.5	0.369	0.47	-0.10
1	2412.0	802.11b	Top	Note4	19.41	20.5	0.240	0.31	0.07
1	2412.0	802.11b	Rear	Note5	19.41	20.5	0.318	0.41	0.06
1	2412.0	802.11b	Top	Note6	19.41	20.5	0.217	0.28	-0.06

Note1: The distance between the EUT's side and the phantom is 10mm.

Note2: The distance between the EUT's side and the phantom is 2mm.

Note3: The distance between the EUT's side and the phantom is 6mm.

Note4: The distance between the EUT's side and the phantom is 12mm.

Note5: The distance between the EUT's side and the phantom is 12mm.

Note6: The distance between the EUT's side and the phantom is 14mm.

Note7: For all positions/configurations tested using the initial test position and subsequent test positions, when the reported SAR is > 0.8 W/kg, SAR is measured for these test positions/configurations on the subsequent next highest measured output power channel until the reported SAR is ≤ 1.2 W/kg or all required channels are tested.

According to the KDB248227 D01, The reported SAR must be scaled to 100% transmission duty factor to determine compliance at the maximum tune-up tolerance limit.

Table 13.17: SAR Values (WLAN - Body) – 802.11b (Scaled Reported SAR)

Frequency		Test Position	Actual duty factor	maximum duty factor	Reported SAR (1g)(W/kg)	Scaled reported SAR (1g)(W/kg)
Ch.	MHz					
6	2437.0	Rear	100%	100%	1.03	1.03

SAR is not required for OFDM because the 802.11b adjusted SAR ≤ 1.2 W/kg.

13.4. WLAN Evaluation for 5G

Table 13.18: SAR Values (WLAN 5G - Body)

Frequency		Test Mode	Test Position	Figure No./ Note	Conducted Power (dBm)	Max. tune-up Power (dBm)	Measured SAR(1g) (W/kg)	Reported SAR(1g) (W/kg)	Power Drift(dB)
Ch.	MHz								
U-NII-2A - 0mm Test Data									
64	5320.0	802.11a	Rear	/	9.11	10.0	0.666	0.82	0.11
64	5320.0	802.11a	Left	/	9.11	10.0	<0.01	<0.01	0.05
64	5320.0	802.11a	Right	/	9.11	10.0	0.134	0.16	0.13
64	5320.0	802.11a	Top	/	9.11	10.0	0.865	1.06	0.09
60	5320.0	802.11a	Rear	/	8.97	10.0	0.650	0.82	0.13
60	5320.0	802.11a	Top	/	8.97	10.0	0.849	1.08	0.07
U-NII-2A - Sensor off Test Data									
56	5280.0	802.11a	Rear	Note1	18.26	19.0	0.613	0.73	0.06
56	5280.0	802.11a	Left	Note2	18.26	19.0	0.006	0.01	0.07
56	5280.0	802.11a	Right	Note3	18.26	19.0	0.449	0.53	0.05
56	5280.0	802.11a	Top	Note4	18.26	19.0	0.843	1.00	-0.14
64	5320.0	802.11a	Top	17/Note4	18.22	19.0	0.883	1.06	0.09
56	5280.0	802.11a	Rear	Note5	18.26	19.0	0.542	0.64	0.09
64	5320.0	802.11a	Top	Note6	18.22	19.0	0.740	0.89	0.06
56	5280.0	802.11a	Top	Note6	18.26	19.0	0.794	0.94	0.07
U-NII-3 - 0mm Test Data									
165	5825.0	802.11a	Rear	/	8.88	10.0	0.372	0.48	0.05
165	5825.0	802.11a	Left	/	8.88	10.0	<0.01	<0.01	0.04
165	5825.0	802.11a	Right	/	8.88	10.0	0.066	0.09	0.10
165	5825.0	802.11a	Top	/	8.88	10.0	0.583	0.75	0.07
U-NII-3 - Sensor off Test Data									
149	5745.0	802.11a	Rear	Note1	17.89	19.0	0.395	0.51	0.09
149	5745.0	802.11a	Left	Note2	17.89	19.0	0.003	<0.01	0.06
149	5745.0	802.11a	Right	Note3	17.89	19.0	0.366	0.47	0.11
149	5745.0	802.11a	Top	Note4	17.89	19.0	0.457	0.59	0.06
149	5745.0	802.11a	Rear	Note5	17.89	19.0	0.324	0.42	0.09
149	5745.0	802.11a	Top	Note6	17.89	19.0	0.398	0.51	0.06

Note1: The distance between the EUT's side and the phantom is 10mm.

Note2: The distance between the EUT's side and the phantom is 2mm.

Note3: The distance between the EUT's side and the phantom is 6mm.

Note4: The distance between the EUT's side and the phantom is 12mm.

Note5: The distance between the EUT's side and the phantom is 12mm.

Note6: The distance between the EUT's side and the phantom is 14mm.

Note7: U-NII-1 and U-NII-2A bands have the same specified maximum output and tolerance; SAR is measured for U-NII-2A band first. Adjusted SAR of U-NII-2A band is $\leq 1.2\text{W/kg}$, SAR is not required for U-NII-1 band.



Note8: For all positions/configurations tested using the initial test position and subsequent test positions, when the reported SAR is > 0.8 W/kg, SAR is measured for these test positions/configurations on the subsequent next highest measured output power channel until the reported SAR is ≤ 1.2 W/kg or all required channels are tested.

According to the KDB248227 D01, The reported SAR must be scaled to 100% transmission duty factor to determine compliance at the maximum tune-up tolerance limit.

Table 13.19: SAR Values (WLAN - Body) – 802.11a (Scaled Reported SAR)

Frequency		Test Position	Actual duty factor	maximum duty factor	Reported SAR (1g)(W/kg)	Scaled reported SAR (1g)(W/kg)
Ch.	MHz					
60	5320.0	Top	100%	100%	1.08	1.08

14. SAR Measurement Variability

SAR measurement variability must be assessed for each frequency band, which is determined by the SAR probe calibration point and tissue-equivalent medium used for the device measurements. When both head and body tissue-equivalent media are required for SAR measurements in a frequency band, the variability measurement procedures should be applied to the tissue medium with the highest measured SAR, using the highest measured SAR configuration for that tissue-equivalent medium.

The following procedures are applied to determine if repeated measurements are required.

- 1) Repeated measurement is not required when the original highest measured SAR is < 0.80 W/kg; steps 2) through 4) do not apply.
- 2) When the original highest measured SAR is ≥ 0.80 W/kg, repeat that measurement once.
- 3) Perform a second repeated measurement only if the ratio of largest to smallest SAR for the original and first repeated measurements is > 1.20 or when the original or repeated measurement is ≥ 1.45 W/kg (~ 10% from the 1-g SAR limit).
- 4) Perform a third repeated measurement only if the original, first or second repeated measurement is ≥ 1.5 W/kg and the ratio of largest to smallest SAR for the original, first and second repeated measurements is > 1.20 .

Table 14.1: SAR Measurement Variability for Body – GSM1900

Frequency		Test Position	Original	1 st Repeated	Ratio	2 nd Repeated
Ch.	MHz		SAR (W/kg)	SAR (W/kg)		SAR (W/kg)
810	1909.8	Rear	0.921	0.908	1.01	/

Table 14.2: SAR Measurement Variability for Body – WCDMA Band 2

Frequency		Test Position	Original	1 st Repeated	Ratio	2 nd Repeated
Ch.	MHz		SAR (W/kg)	SAR (W/kg)		SAR (W/kg)
9538	1907.6	Rear	0.887	0.869	1.02	/

Table 14.3: SAR Measurement Variability for Body – WCDMA Band 4

Frequency		Test Position	Original	1 st Repeated	Ratio	2 nd Repeated
Ch.	MHz		SAR (W/kg)	SAR (W/kg)		SAR (W/kg)
1513	1752.6	Left	0.929	0.907	1.02	/

Table 14.4: SAR Measurement Variability for Body – LTE Band 7

Frequency		Test Position	Original	1 st Repeated	Ratio	2 nd Repeated
Ch.	MHz		SAR (W/kg)	SAR (W/kg)		SAR (W/kg)
20850	2510.0	Left	1.25	1.20	1.04	/

Table 14.5: SAR Measurement Variability for Body – LTE Band 25

Frequency		Test Position	Original	1 st Repeated	Ratio	2 nd Repeated
Ch.	MHz		SAR (W/kg)	SAR (W/kg)		SAR (W/kg)
26590	1905.0	Rear	1.05	1.02	1.03	/

Table 14.6: SAR Measurement Variability for Body – LTE Band 30

Frequency		Test Position	Original	1 st Repeated	Ratio	2 nd Repeated
Ch.	MHz		SAR (W/kg)	SAR (W/kg)		SAR (W/kg)
27710	2310.0	Left	1.23	1.19	1.03	/

Table 14.7: SAR Measurement Variability for Body – LTE Band 41

Frequency		Test Position	Original	1 st Repeated	Ratio	2 nd Repeated
Ch.	MHz		SAR (W/kg)	SAR (W/kg)		SAR (W/kg)
40185	2549.5	Left	1.04	1.02	1.02	/

Table 14.8: SAR Measurement Variability for Body – LTE Band 66

Frequency		Test Position	Original	1 st Repeated	Ratio	2 nd Repeated
Ch.	MHz		SAR (W/kg)	SAR (W/kg)		SAR (W/kg)
132572	1770.0	Rear	1.05	1.01	1.04	/

Table 14.9: SAR Measurement Variability for Body – WLAN 5G

Frequency		Test Position	Original	1 st Repeated	Ratio	2 nd Repeated
Ch.	MHz		SAR (W/kg)	SAR (W/kg)		SAR (W/kg)
64	5320.0	Top	0.883	0.874	1.01	/

15. Measurement Uncertainty

15.1. Measurement Uncertainty for Normal SAR Tests (300MHz~3GHz)

No.	Error Description	Type	Uncertainty value	Probably Distribution	Div.	(Ci) 1g	(Ci) 10g	Std. Unc. (1g)	Std. Unc. (10g)	Degree of freedom
Measurement system										
1	Probe calibration	B	12	N	2	1	1	6.0	6.0	∞
2	Axial isotropy	B	4.7	R	$\sqrt{3}$	$\sqrt{0.5}$	$\sqrt{0.5}$	4.3	4.3	∞
3	Hemispherical isotropy	B	9.6	R	$\sqrt{3}$	1	1	4.8	4.8	∞
4	Boundary effect	B	1.1	R	$\sqrt{3}$	1	1	0.6	0.6	∞
5	Linearity	B	4.7	R	$\sqrt{3}$	1	1	2.7	2.7	∞
6	Detection limit	B	1.0	R	$\sqrt{3}$	1	1	0.6	0.6	∞
7	Modulation response	B	4.0	R	$\sqrt{3}$	1	1	2.3	2.3	∞
8	Readout electronics	B	1.0	N	1	1	1	1.0	1.0	∞
9	Response time	B	0.8	R	$\sqrt{3}$	1	1	0.5	0.5	∞
10	Integration time	B	1.7	R	$\sqrt{3}$	1	1	1.0	1.0	∞
11	RF ambient conditions-noise	B	3.0	R	$\sqrt{3}$	1	1	1.7	1.7	∞
12	RF ambient conditions-reflection	B	3.0	R	$\sqrt{3}$	1	1	1.7	1.7	∞
13	Probe positioned mech. restrictions	B	0.35	R	$\sqrt{3}$	1	1	0.2	0.2	∞
14	Probe positioning with respect to phantom shell	B	2.9	R	$\sqrt{3}$	1	1	1.7	1.7	∞
15	Post-processing	B	1.0	R	$\sqrt{3}$	1	1	0.6	0.6	∞
Test sample related										
16	Test sample positioning	A	3.3	N	1	1	1	3.3	3.3	5
17	Device holder uncertainty	A	3.4	N	1	1	1	3.4	3.4	5
18	Drift of output power	B	5.0	R	$\sqrt{3}$	1	1	2.9	2.9	∞
Phantom and set-up										
19	Phantom uncertainty	B	1.0	R	$\sqrt{3}$	1	1	0.6	0.6	∞
20	Liquid conductivity (target)	B	5.0	R	$\sqrt{3}$	0.64	0.43	1.8	1.2	∞
21	Liquid conductivity (meas.)	A	1.3	N	1	0.64	0.43	0.83	0.56	9
22	Liquid permittivity (target)	B	5.0	R	$\sqrt{3}$	0.6	0.49	1.7	1.4	∞
23	Liquid permittivity (meas.)	A	1.6	N	1	0.6	0.49	0.96	0.78	9
Combined standard uncertainty		$u_c = \sqrt{\sum_{i=1}^{23} c_i^2 u_i^2}$						11.3	11.2	95.5
Expanded uncertainty (Confidence interval of 95 %)		$u_e = 2u_c$						22.6	22.4	

15.2. Measurement Uncertainty for Normal SAR Tests (3GHz~6GHz)

No.	Error Description	Type	Uncertainty value	Probably Distribution	Div.	(Ci) 1g	(Ci) 10g	Std. Unc. (1g)	Std. Unc. (10g)	Degree of freedom
Measurement system										
1	Probe calibration	B	13.1	N	2	1	1	6.65	6.65	∞
2	Axial isotropy	B	4.7	R	$\sqrt{3}$	$\sqrt{0.5}$	$\sqrt{0.5}$	4.3	4.3	∞
3	Hemispherical isotropy	B	9.6	R	$\sqrt{3}$	1	1	4.8	4.8	∞
4	Boundary effect	B	1.1	R	$\sqrt{3}$	1	1	0.6	0.6	∞
5	Linearity	B	4.7	R	$\sqrt{3}$	1	1	2.7	2.7	∞
6	Detection limit	B	1.0	R	$\sqrt{3}$	1	1	0.6	0.6	∞
7	modulation response	B	4.0	R	$\sqrt{3}$	1	1	2.3	2.3	∞
8	Readout electronics	B	1.0	N	1	1	1	1.0	1.0	∞
9	Response time	B	0.0	R	$\sqrt{3}$	1	1	0.0	0.0	∞
10	Integration time	B	1.7	R	$\sqrt{3}$	1	1	1.0	1.0	∞
11	RF ambient conditions-noise	B	3.0	R	$\sqrt{3}$	1	1	1.7	1.7	∞
12	RF ambient conditions-reflection	B	3.0	R	$\sqrt{3}$	1	1	1.7	1.7	∞
13	Probe positioned mech. Restrictions	B	0.35	R	$\sqrt{3}$	1	1	0.2	0.2	∞
14	Probe positioning with respect to phantom shell	B	2.9	R	$\sqrt{3}$	1	1	1.7	1.7	∞
15	Post-processing	B	1.0	R	$\sqrt{3}$	1	1	0.6	0.6	∞
Test sample related										
16	Test sample positioning	A	3.3	N	1	1	1	3.3	3.3	5
17	Device holder uncertainty	A	3.4	N	1	1	1	3.4	3.4	5
18	Drift of output power	B	5.0	R	$\sqrt{3}$	1	1	2.9	2.9	∞
Phantom and set-up										
19	Phantom uncertainty	B	1.0	R	$\sqrt{3}$	1	1	0.6	0.6	∞
20	Liquid conductivity (target)	B	5.0	R	$\sqrt{3}$	0.64	0.43	1.8	1.2	∞
21	Liquid conductivity (meas.)	A	1.3	N	1	0.64	0.43	0.83	0.56	43
22	Liquid permittivity (target)	B	5.0	R	$\sqrt{3}$	0.6	0.49	1.7	1.4	∞
23	Liquid permittivity (meas.)	A	1.6	N	1	0.6	0.49	0.96	0.78	521
Combined standard uncertainty		$u_c = \sqrt{\sum_{i=1}^{22} c_i^2 u_i^2}$						11.6	11.5	257
Expanded uncertainty (Confidence interval of 95 %)		$u_e = 2u_c$						23.2	23.0	

16. Main Test Instruments

Table 16.1: List of Main Instruments

No.	Name	Type	Serial Number	Calibration Date	Valid Period
01	Network analyzer	E5071C	MY46103759	2021-11-15	One year
02	Dielectric probe	85070E	MY44300317	/	/
03	Power meter	E4418B	MY50000366	2021-12-13	One year
04	Power sensor	E9304A	MY50000188		
05	Power meter	NRP	101460	2022-01-15	One year
06	Power sensor	NRP-Z91	100553		
07	Signal Generator	E8257D	MY47461211	2022-01-15	One year
08	Amplifier	VTL5400	0404	/	/
09	E-field Probe	EX3DV4	7683	2021-12-29 & 2021-09-22	One year
10	DAE	DAE4	786	2021-04-09	One year
11	Dipole Validation Kit	D750V3	1163	2019-09-03	Three years
12	Dipole Validation Kit	D835V2	4d057	2021-10-18	Three years
13	Dipole Validation Kit	D1750V2	1152	2019-08-30	Three years
14	Dipole Validation Kit	D1900V2	5d088	2021-10-18	Three years
15	Dipole Validation Kit	D2300V2	1059	2021-09-22	Three years
16	Dipole Validation Kit	D2450V2	873	2021-10-21	Three years
17	Dipole Validation Kit	D2550V2	1010	2021-05-21	Three years
18	Dipole Validation Kit	D5GHzV2	1238	2019-08-29	Three years
19	BTS	MT8820C	6201341853	2022-01-15	One year
20	BTS	E5515C	GB46110722	2022-01-15	One year
21	BTS	CMW500	152499	2021-07-16	One year
22	Software	DASY5	/	/	/

ANNEX A: Graph Results

GSM850 Body

Date: 2022-2-12

Electronics: DAE4 Sn786

Medium: Head 835MHz

Medium parameters used (interpolated): $f = 824.2$ MHz; $\sigma = 0.875$ S/m; $\epsilon_r = 42.069$; $\rho = 1000$ kg/m³

Communication System: UID 0, 2 slot GPRS (0) Frequency: 824.2 MHz Duty Cycle: 1:4

Probe: EX3DV4 – SN7683 ConvF (10.34, 10.34, 10.34);

Top Side Low/Area Scan (41x71x1): Interpolated grid: dx=1.500 mm, dy=1.500 mm

Maximum value of SAR (interpolated) = 0.935 W/kg

Top Side Low/Zoom Scan (5x5x7)/Cube 0: Measurement grid: dx=8mm, dy=8mm, dz=5mm

Reference Value = 23.15 V/m; Power Drift = -0.03 dB

Peak SAR (extrapolated) = 1.54 W/kg

SAR(1 g) = 0.752 W/kg; SAR(10 g) = 0.390 W/kg

Maximum value of SAR (measured) = 1.14 W/kg

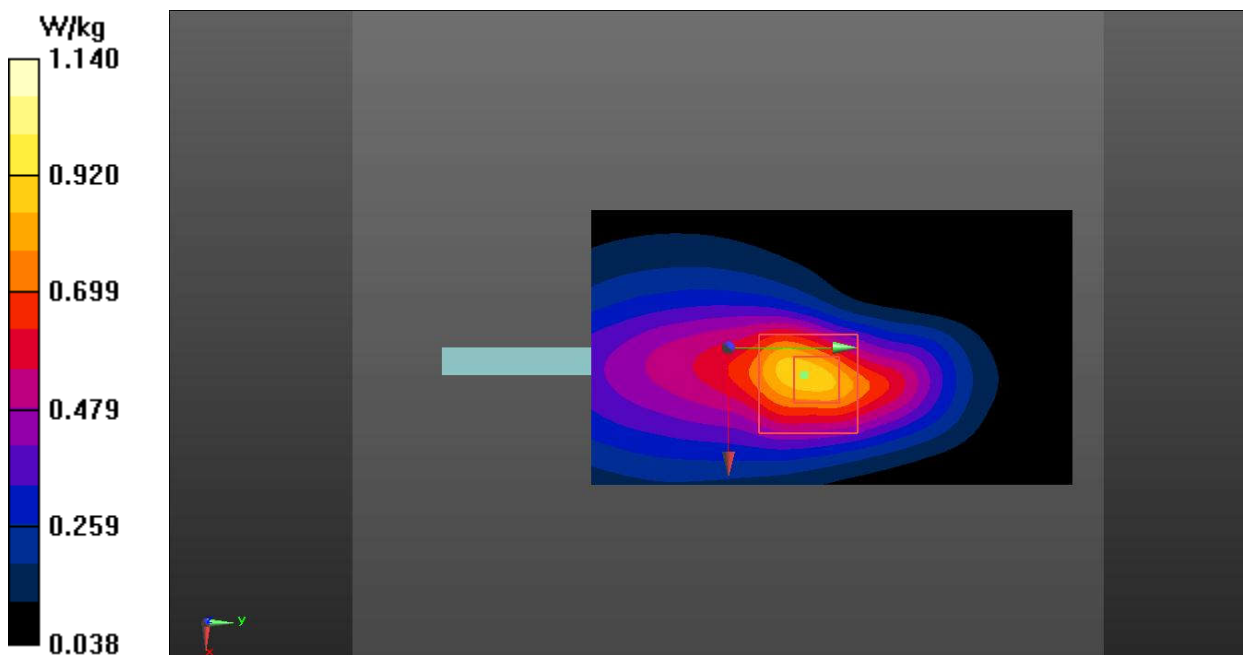

Fig.1 GSM 850 Body

GSM1900 Body

Date: 2022-2-15

Electronics: DAE4 Sn786

Medium: Head 1900MHz

Medium parameters used: $f = 1910$ MHz; $\sigma = 1.39$ S/m; $\epsilon_r = 39.244$; $\rho = 1000$ kg/m³

Communication System: UID 0, 2 slot GPRS (0) Frequency: 1909.8 MHz Duty Cycle: 1:4

Probe: EX3DV4 – SN7683 ConvF (8.33, 8.33, 8.33);

Rear Side High/Area Scan (61x61x1): Interpolated grid: $dx=1.500$ mm, $dy=1.500$ mm

Maximum value of SAR (interpolated) = 1.44 W/kg

Rear Side High/Zoom Scan (5x5x7)/Cube 0: Measurement grid: $dx=8$ mm, $dy=8$ mm, $dz=5$ mm

Reference Value = 0.7800 V/m; Power Drift = 0.03 dB

Peak SAR (extrapolated) = 2.01 W/kg

SAR(1 g) = 0.921 W/kg; SAR(10 g) = 0.399 W/kg

Maximum value of SAR (measured) = 1.62 W/kg

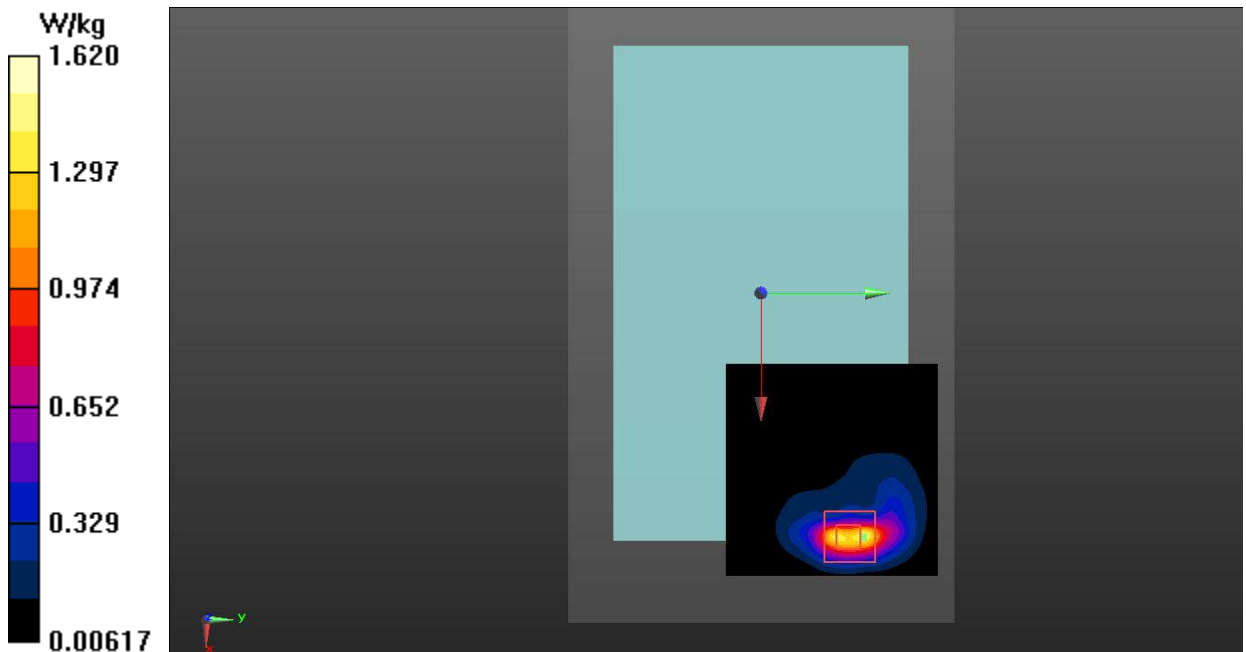
**Fig.2 GSM 1900 Body**

WCDMA Band 2 Body

Date: 2022-2-15

Electronics: DAE4 Sn786

Medium: Head 1900MHz

Medium parameters used: $f = 1908$ MHz; $\sigma = 1.388$ S/m; $\epsilon_r = 39.252$; $\rho = 1000$ kg/m³

Communication System: UID 0, WCDMA (0) Frequency: 1907.6 MHz Duty Cycle: 1:1

Probe: EX3DV4 – SN7683 ConvF (8.33, 8.33, 8.33);

Rear Side High/Area Scan (61x61x1): Interpolated grid: dx=1.500 mm, dy=1.500 mm

Maximum value of SAR (interpolated) = 1.27 W/kg

Rear Side High/Zoom Scan (5x5x7)/Cube 0: Measurement grid: dx=8mm, dy=8mm, dz=5mm

Reference Value = 0.7080 V/m; Power Drift = 0.18 dB

Peak SAR (extrapolated) = 1.91 W/kg

SAR(1 g) = 0.887 W/kg; SAR(10 g) = 0.385 W/kg

Maximum value of SAR (measured) = 1.53 W/kg

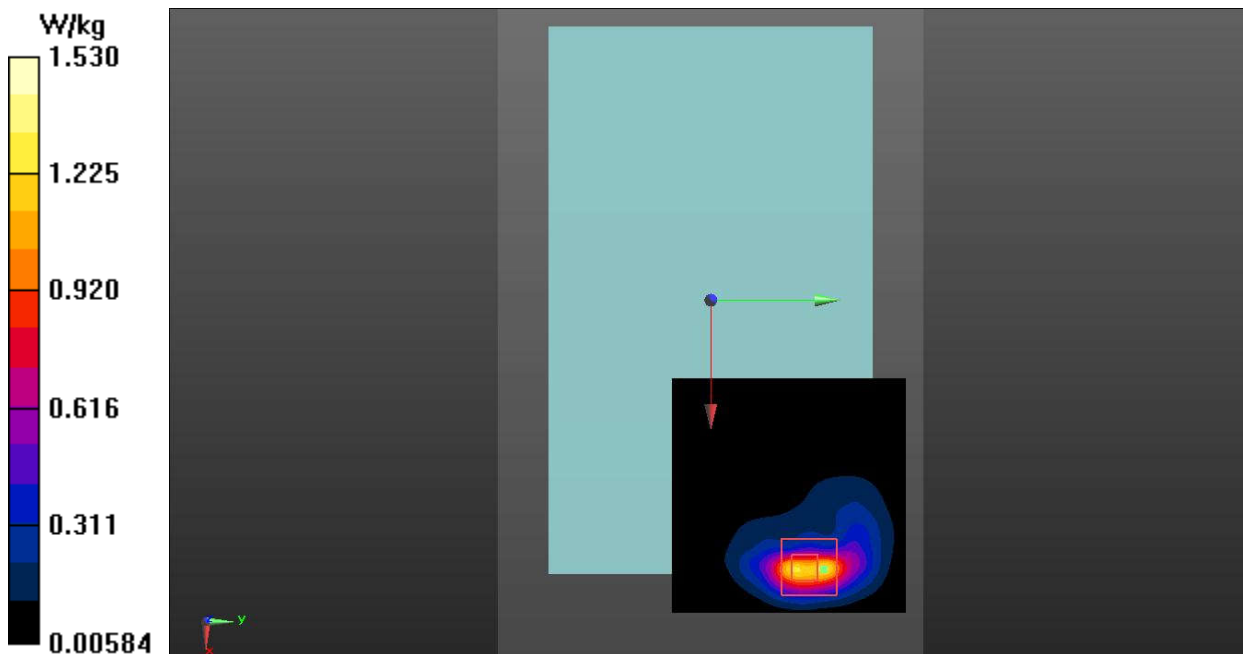

Fig.3 WCDMA Band 2 Body

WCDMA Band 4 Body

Date: 2022-1-20

Electronics: DAE4 Sn786

Medium: Head 1750MHz

Medium parameters used: $f = 1753$ MHz; $\sigma = 1.382$ S/m; $\epsilon_r = 39.494$; $\rho = 1000$ kg/m³

Communication System: UID 0, WCDMA (0) Frequency: 1752.6 MHz Duty Cycle: 1:1

Probe: EX3DV4 – SN7683 ConvF (8.58, 8.58, 8.58);

Left Side High/Area Scan (81x41x1): Interpolated grid: dx=1.500 mm, dy=1.500 mm

Maximum value of SAR (interpolated) = 1.37 W/kg

Left Side High/Zoom Scan (5x5x7)/Cube 0: Measurement grid: dx=8mm, dy=8mm, dz=5mm

Reference Value = 18.68 V/m; Power Drift = -0.13 dB

Peak SAR (extrapolated) = 1.67 W/kg

SAR(1 g) = 0.929 W/kg; SAR(10 g) = 0.515 W/kg

Maximum value of SAR (measured) = 1.16 W/kg

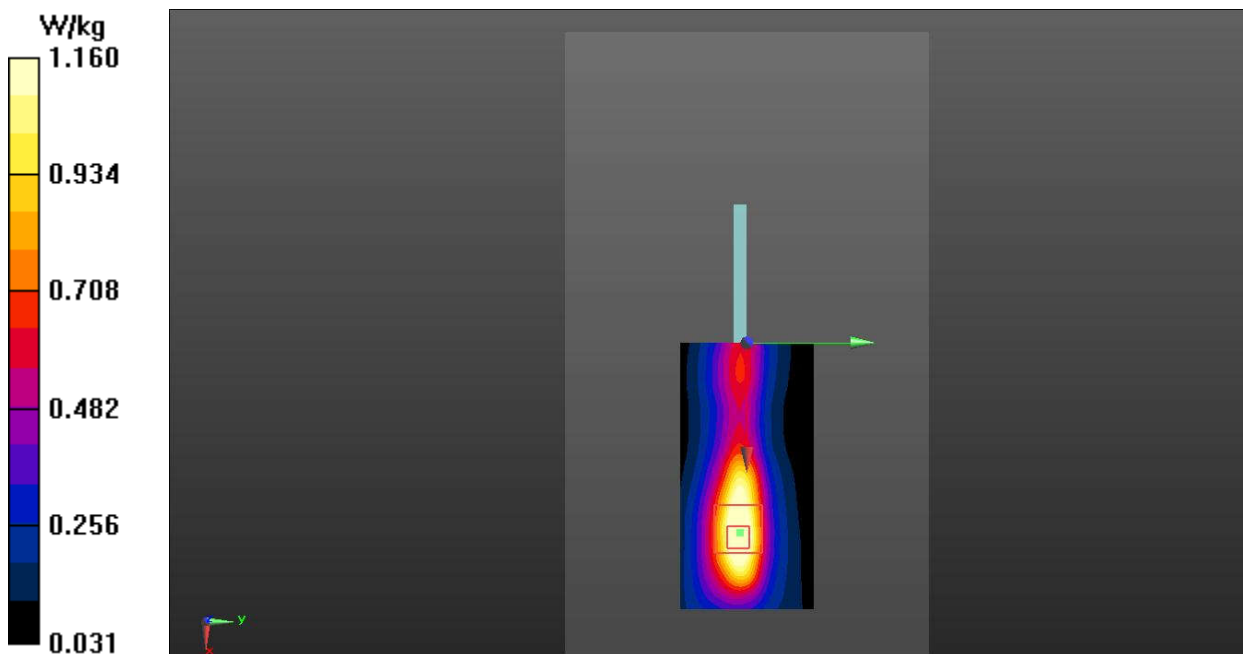

Fig.4 WCDMA Band 4 Body

WCDMA Band 5 Body

Date: 2022-2-12

Electronics: DAE4 Sn786

Medium: Head 835MHz

Medium parameters used (interpolated): $f = 836.4$ MHz; $\sigma = 0.886$ S/m; $\epsilon_r = 41.922$; $\rho = 1000$ kg/m³

Communication System: UID 0, WCDMA (0) Frequency: 836.4 MHz Duty Cycle: 1:1

Probe: EX3DV4 – SN7683 ConvF (10.34, 10.34, 10.34);

Rear Side Middle/Area Scan (61x61x1): Interpolated grid: dx=1.500 mm, dy=1.500 mm

Maximum value of SAR (interpolated) = 1.02 W/kg

Rear Side Middle/Zoom Scan (5x5x7)/Cube 0: Measurement grid: dx=8mm, dy=8mm, dz=5mm

Reference Value = 2.742 V/m; Power Drift = 0.07 dB

Peak SAR (extrapolated) = 1.90 W/kg

SAR(1 g) = 0.601 W/kg; SAR(10 g) = 0.270 W/kg

Maximum value of SAR (measured) = 1.08 W/kg

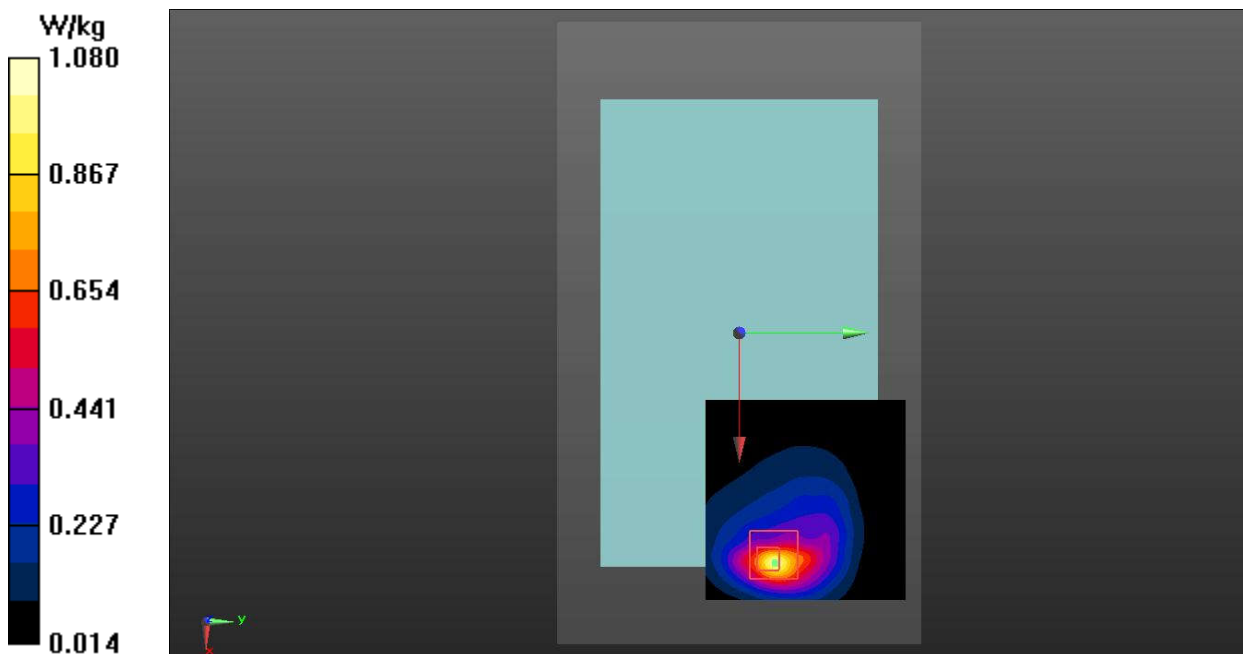

Fig.5 WCDMA Band 5 Body

LTE Band 7 Body

Date: 2022-1-28

Electronics: DAE4 Sn786

Medium: Head 2550MHz

Medium parameters used: $f = 2510$ MHz; $\sigma = 1.901$ S/m; $\epsilon_r = 38.317$; $\rho = 1000$ kg/m³

Communication System: UID 0, LTE_FDD (0) Frequency: 2510 MHz Duty Cycle: 1:1

Probe: EX3DV4 – SN7683 ConvF (7.85, 7.85, 7.85);

Left Side Low 1RB50/Area Scan (121x61x1): Interpolated grid: dx=1.000 mm, dy=1.000 mm

Maximum value of SAR (interpolated) = 1.95 W/kg

Left Side Low 1RB50/Zoom Scan (7x7x7)/Cube 0: Measurement grid: dx=5mm, dy=5mm, dz=5mm

Reference Value = 12.82 V/m; Power Drift = -0.06 dB

Peak SAR (extrapolated) = 2.60 W/kg

SAR(1 g) = 1.25 W/kg; SAR(10 g) = 0.622 W/kg

Maximum value of SAR (measured) = 1.38 W/kg

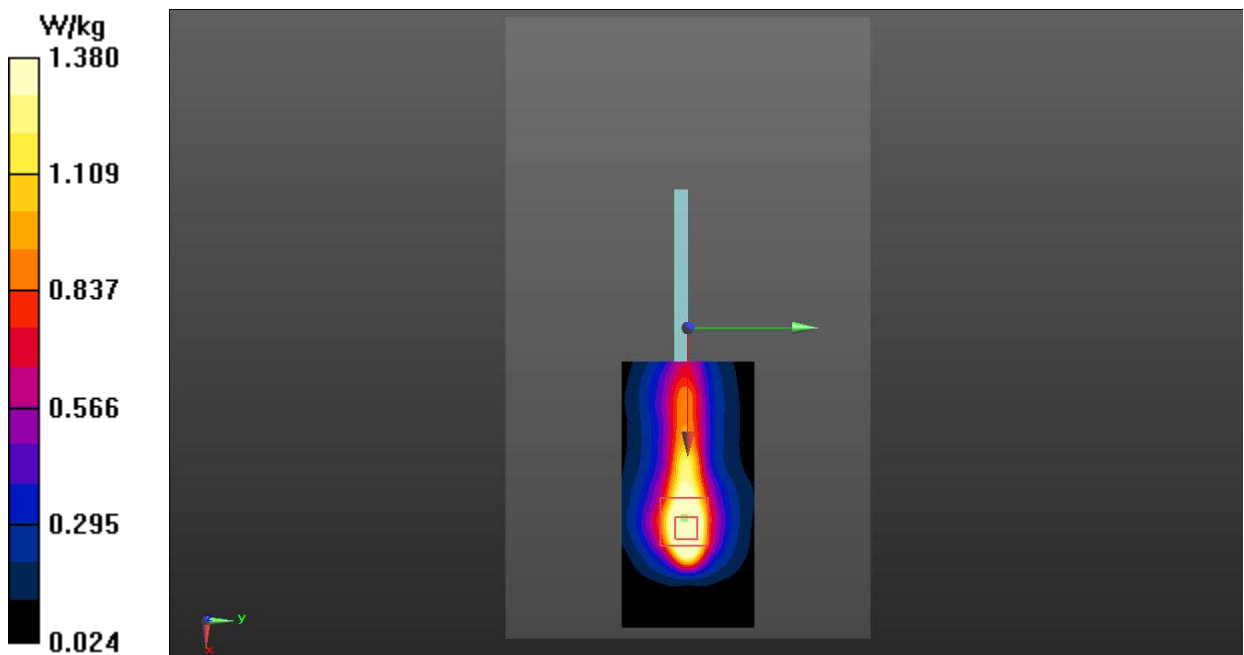

Fig.6 LTE Band 7 Body

LTE Band 12 Body

Date: 2022-2-14

Electronics: DAE4 Sn786

Medium: Head 750MHz

Medium parameters used (interpolated): $f = 711$ MHz; $\sigma = 0.882$ S/m; $\epsilon_r = 41.813$; $\rho = 1000$ kg/m³

Communication System: UID 0, LTE_FDD (0) Frequency: 711 MHz Duty Cycle: 1:1

Probe: EX3DV4 – SN7683 ConvF (10.34, 10.34, 10.34);

Rear Side High 1RB24/Area Scan (61x61x1): Interpolated grid: dx=1.500 mm, dy=1.500 mm
Maximum value of SAR (interpolated) = 0.826 W/kg**Rear Side High 1RB24/Zoom Scan (5x5x7)/Cube 0:** Measurement grid: dx=8mm, dy=8mm, dz=5mm

Reference Value = 3.594 V/m; Power Drift = 0.08 dB

Peak SAR (extrapolated) = 1.64 W/kg

SAR(1 g) = 0.583 W/kg; SAR(10 g) = 0.275 W/kg

Maximum value of SAR (measured) = 0.887 W/kg

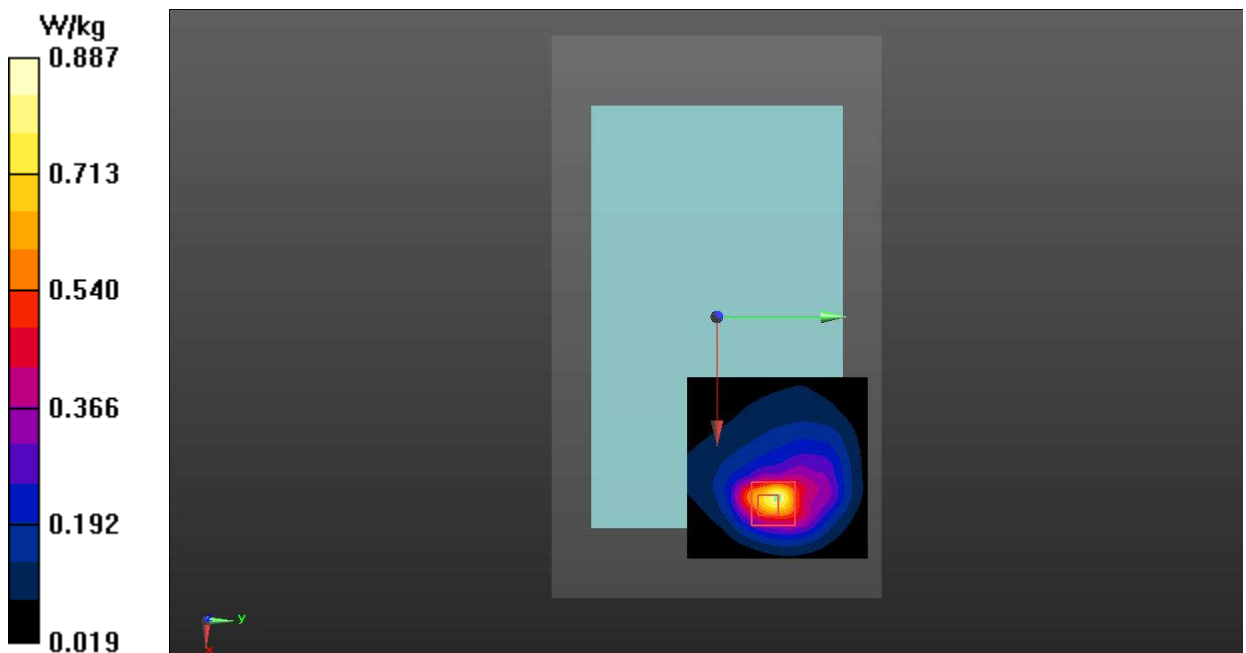

Fig.7 LTE Band 12 Body

LTE Band 13 Body

Date: 2022-2-14

Electronics: DAE4 Sn786

Medium: Head 750MHz

Medium parameters used: $f = 782$ MHz; $\sigma = 0.927$ S/m; $\epsilon_r = 40.961$; $\rho = 1000$ kg/m³

Communication System: UID 0, LTE_FDD (0) Frequency: 782 MHz Duty Cycle: 1:1

Probe: EX3DV4 – SN7683 ConvF (10.34, 10.34, 10.34);

Rear Side Middle 1RB24/Area Scan (61x61x1): Interpolated grid: dx=1.500 mm, dy=1.500 mm
Maximum value of SAR (interpolated) = 0.725 W/kg**Rear Side Middle 1RB24/Zoom Scan (5x5x7)/Cube 0:** Measurement grid: dx=8mm, dy=8mm, dz=5mm

Reference Value = 3.087 V/m; Power Drift = 0.05 dB

Peak SAR (extrapolated) = 1.59 W/kg

SAR(1 g) = 0.532 W/kg; SAR(10 g) = 0.249 W/kg

Maximum value of SAR (measured) = 0.766 W/kg

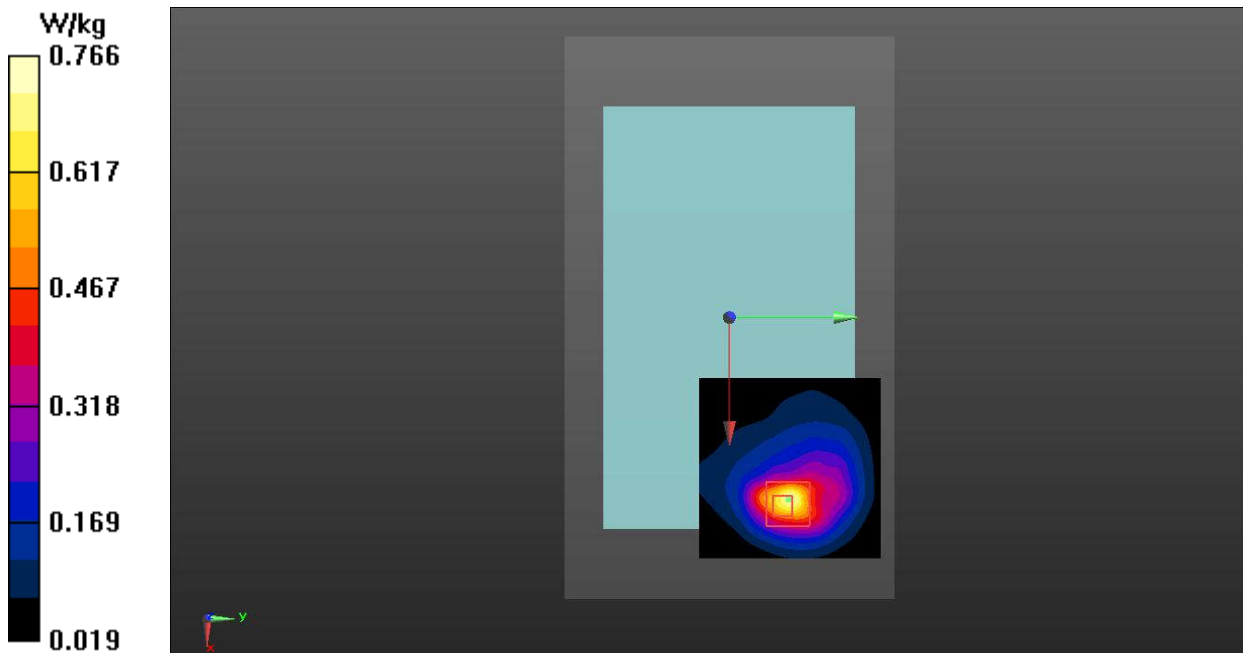
**Fig.8 LTE Band 13 Body**

LTE Band 25 Body

Date: 2022-2-15

Electronics: DAE4 Sn786

Medium: Head 1900MHz

Medium parameters used: $f = 1905$ MHz; $\sigma = 1.385$ S/m; $\epsilon_r = 39.264$; $\rho = 1000$ kg/m³

Communication System: UID 0, LTE_FDD (0) Frequency: 1905 MHz Duty Cycle: 1:1

Probe: EX3DV4 – SN7683 ConvF (8.33, 8.33, 8.33);

Rear Side High 1RB50/Area Scan (61x61x1): Interpolated grid: dx=1.500 mm, dy=1.500 mm
Maximum value of SAR (interpolated) = 1.84 W/kg**Rear Side High 1RB50/Zoom Scan (5x5x7)/Cube 0:** Measurement grid: dx=8mm, dy=8mm, dz=5mm

Reference Value = 0.2990 V/m; Power Drift = 0.01 dB

Peak SAR (extrapolated) = 2.33 W/kg

SAR(1 g) = 1.05 W/kg; SAR(10 g) = 0.449 W/kg

Maximum value of SAR (measured) = 1.84 W/kg

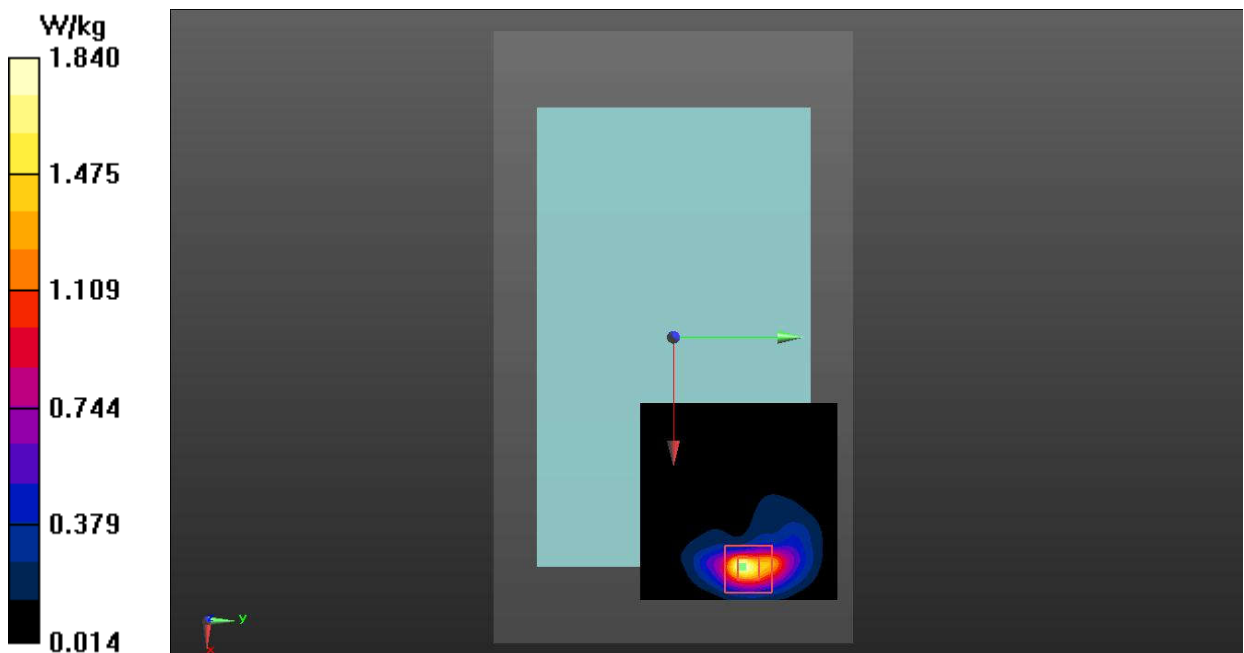
**Fig.9 LTE Band 25 Body**

LTE Band 26 Body

Date: 2022-2-12

Electronics: DAE4 Sn786

Medium: Head 835MHz

Medium parameters used: $f = 842$ MHz; $\sigma = 0.891$ S/m; $\epsilon_r = 41.855$; $\rho = 1000$ kg/m³

Communication System: UID 0, LTE_FDD (0) Frequency: 841.5 MHz Duty Cycle: 1:1

Probe: EX3DV4 – SN7683 ConvF (10.34, 10.34, 10.34);

Rear Side High 1RB74/Area Scan (61x61x1): Interpolated grid: $dx=1.500$ mm, $dy=1.500$ mm
Maximum value of SAR (interpolated) = 0.639 W/kg**Rear Side High 1RB74/Zoom Scan (5x5x7)/Cube 0:** Measurement grid: $dx=8$ mm, $dy=8$ mm, $dz=5$ mm

Reference Value = 2.155 V/m; Power Drift = 0.08 dB

Peak SAR (extrapolated) = 1.71 W/kg

SAR(1 g) = 0.550 W/kg; SAR(10 g) = 0.251 W/kg

Maximum value of SAR (measured) = 0.973 W/kg

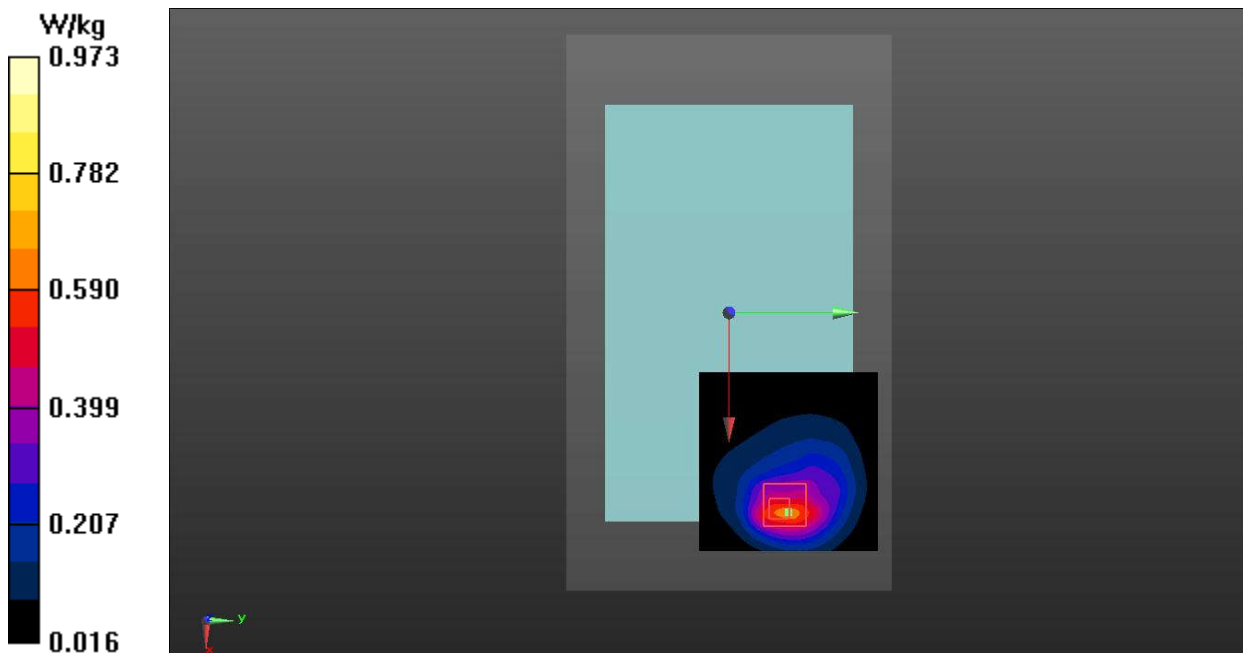
**Fig.10 LTE Band 26 Body**

LTE Band 30 Body

Date: 2022-1-24

Electronics: DAE4 Sn786

Medium: Head 2300MHz

Medium parameters used: $f = 2310$ MHz; $\sigma = 1.667$ S/m; $\epsilon_r = 39.898$; $\rho = 1000$ kg/m³

Communication System: UID 0, LTE_FDD (0) Frequency: 2310 MHz Duty Cycle: 1:1

Probe: EX3DV4 – SN7683 ConvF (8.07, 8.07, 8.07);

Left Side Middle 1RB24/Area Scan (121x61x1): Interpolated grid: $dx=1.000$ mm, $dy=1.000$ mm
Maximum value of SAR (interpolated) = 1.95 W/kg**Left Side Middle 1RB24/Zoom Scan (7x7x7)/Cube 0:** Measurement grid: $dx=5$ mm, $dy=5$ mm, $dz=5$ mm

Reference Value = 13.78 V/m; Power Drift = 0.02 dB

Peak SAR (extrapolated) = 2.60 W/kg

SAR(1 g) = 1.23 W/kg; SAR(10 g) = 0.604 W/kg

Maximum value of SAR (measured) = 1.35 W/kg

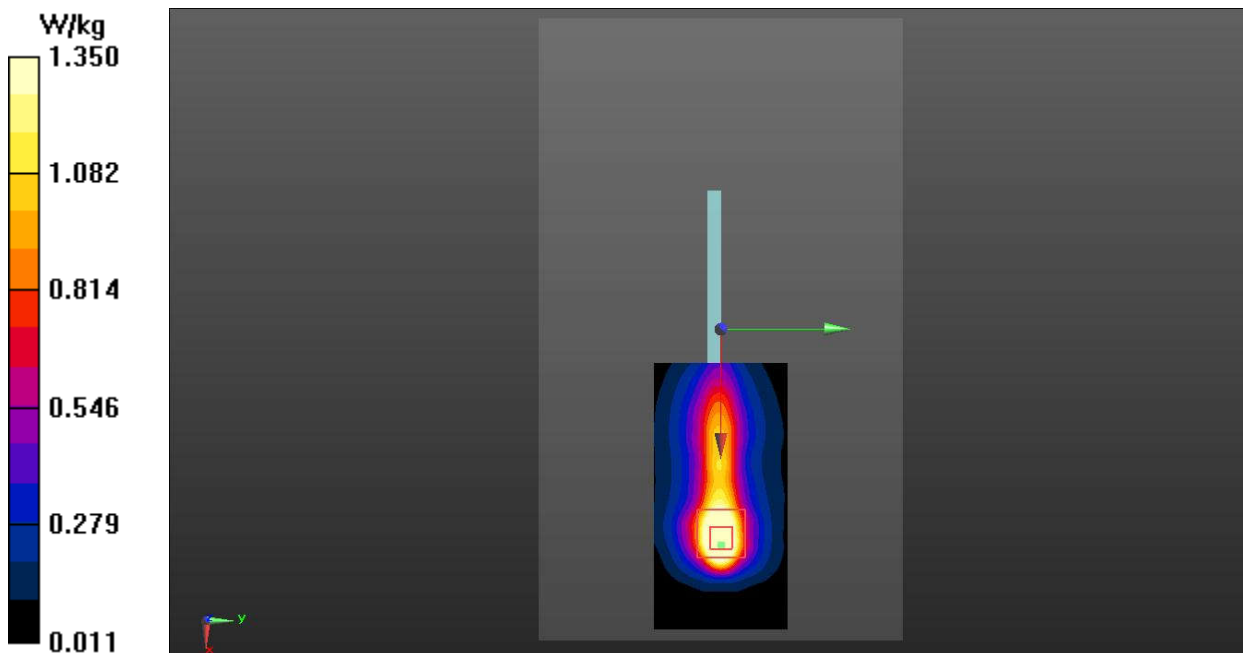

Fig.11 LTE Band 30 Body

LTE Band 41 Body

Date: 2022-1-28

Electronics: DAE4 Sn786

Medium: Head 2550MHz

Medium parameters used: $f = 2550$ MHz; $\sigma = 1.947$ S/m; $\epsilon_r = 38.185$; $\rho = 1000$ kg/m³

Communication System: UID 0, LTE TDD 41 (0) Frequency: 2549.5 MHz Duty Cycle: 1:2.31

Probe: EX3DV4 – SN7683 ConvF (7.55, 7.55, 7.55);

Left Side Low-Mid 1RB50/Area Scan (121x61x1): Interpolated grid: $dx=1.000$ mm, $dy=1.000$ mm
Maximum value of SAR (interpolated) = 1.64 W/kg**Left Side Low-Mid 1RB50/Zoom Scan (7x7x7)/Cube 0:** Measurement grid: $dx=5$ mm, $dy=5$ mm, $dz=5$ mm

Reference Value = 12.29 V/m; Power Drift = 0.15 dB

Peak SAR (extrapolated) = 2.25 W/kg

SAR(1 g) = 1.04 W/kg; SAR(10 g) = 0.497 W/kg

Maximum value of SAR (measured) = 1.56 W/kg

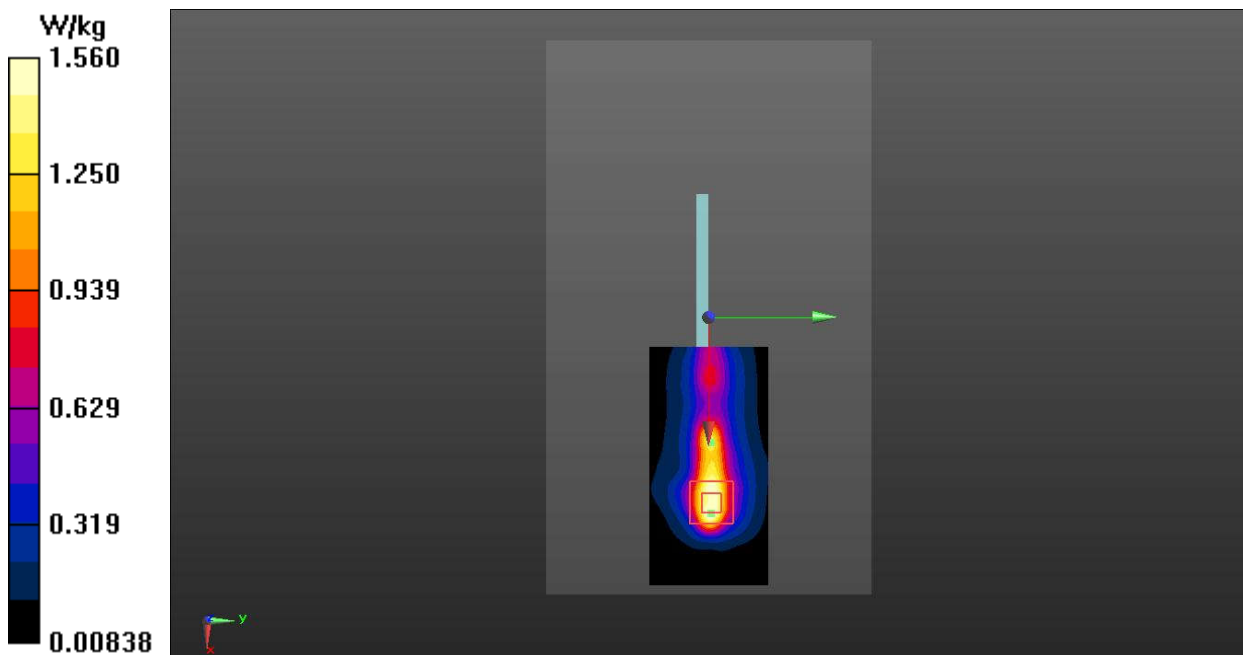

Fig.12 LTE Band 41 Body

LTE Band 66 Body

Date: 2022-1-20

Electronics: DAE4 Sn786

Medium: Head 1750MHz

Medium parameters used: $f = 1770$ MHz; $\sigma = 1.397$ S/m; $\epsilon_r = 39.428$; $\rho = 1000$ kg/m³

Communication System: UID 0, LTE_FDD (0) Frequency: 1770 MHz Duty Cycle: 1:1

Probe: EX3DV4 – SN7683 ConvF (8.58, 8.58, 8.58);

Rear Side High 1RB50/Area Scan (61x61x1): Interpolated grid: dx=1.500 mm, dy=1.500 mm
Maximum value of SAR (interpolated) = 1.41 W/kg**Rear Side High 1RB50/Zoom Scan (5x5x7)/Cube 0:** Measurement grid: dx=8mm, dy=8mm, dz=5mm

Reference Value = 8.252 V/m; Power Drift = 0.10 dB

Peak SAR (extrapolated) = 1.76 W/kg

SAR(1 g) = 1.05 W/kg; SAR(10 g) = 0.585 W/kg

Maximum value of SAR (measured) = 1.33 W/kg

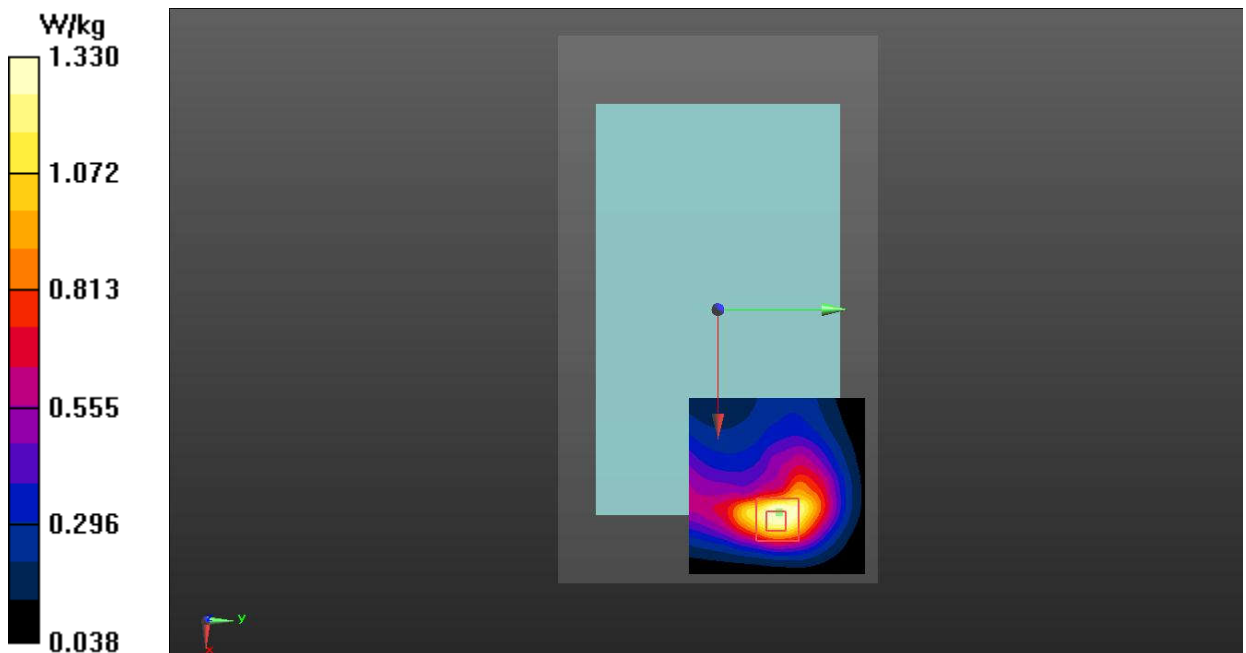

Fig.13 LTE Band 66 Body

LTE Band 71 Body

Date: 2022-2-14

Electronics: DAE4 Sn786

Medium: Head 750MHz

Medium parameters used (extrapolated): $f = 680.5$ MHz; $\sigma = 0.683$ S/m; $\epsilon_r = 42.179$; $\rho = 1000$ kg/m³

Communication System: UID 0, LTE_FDD (0) Frequency: 680.5 MHz Duty Cycle: 1:1

Probe: EX3DV4 – SN7683 ConvF (10.34, 10.34, 10.34);

Rear Side Middle 1RB50/Area Scan (61x61x1): Interpolated grid: $dx=1.500$ mm, $dy=1.500$ mm
Maximum value of SAR (interpolated) = 0.730 W/kg**Rear Side Middle 1RB50/Zoom Scan (5x5x7)/Cube 0:** Measurement grid: $dx=8$ mm, $dy=8$ mm, $dz=5$ mm

Reference Value = 2.553 V/m; Power Drift = -0.10 dB

Peak SAR (extrapolated) = 2.60 W/kg

SAR(1 g) = 0.744 W/kg; SAR(10 g) = 0.315 W/kg

Maximum value of SAR (measured) = 1.36 W/kg

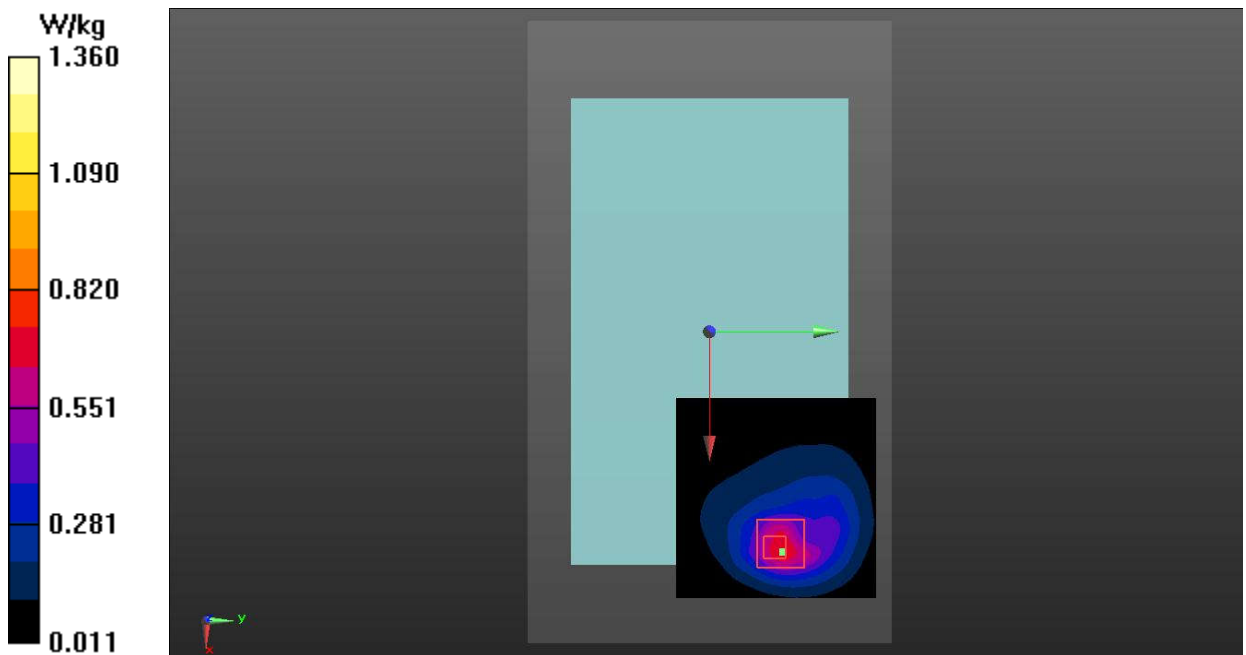

Fig.14 LTE Band 71 Body

Bluetooth Body

Date: 2022-2-17

Electronics: DAE4 Sn786

Medium: Head 2450MHz

Medium parameters used: $f = 2480$ MHz; $\sigma = 1.879$ S/m; $\epsilon_r = 38.34$; $\rho = 1000$ kg/m³

Communication System: UID 0, BT (0) Frequency: 2480 MHz Duty Cycle: 1:1

Probe: EX3DV4 – SN7683 ConvF (7.85, 7.85, 7.85);

Rear Side Ch.78/Area Scan (91x91x1): Interpolated grid: dx=1.000 mm, dy=1.000 mm

Maximum value of SAR (interpolated) = 0.492 W/kg

Rear Side Ch.78/Zoom Scan (7x7x7)/Cube 0: Measurement grid: dx=5mm, dy=5mm, dz=5mm

Reference Value = 0 V/m; Power Drift = 0.00 dB

Peak SAR (extrapolated) = 0.625 W/kg

SAR(1 g) = 0.246 W/kg; SAR(10 g) = 0.111 W/kg

Maximum value of SAR (measured) = 0.365 W/kg

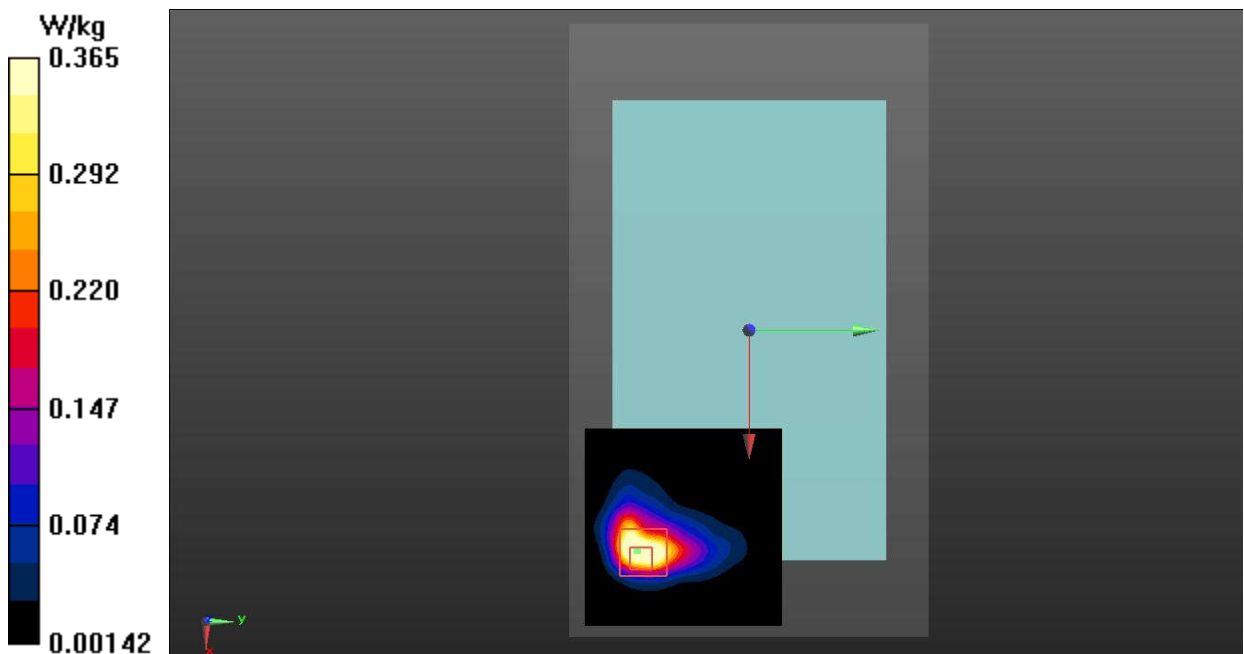
**Fig.15 Bluetooth Body**

WLAN 2.4G Body

Date: 2022-2-17

Electronics: DAE4 Sn786

Medium: Head 2450MHz

Medium parameters used: $f = 2412$ MHz; $\sigma = 1.799$ S/m; $\epsilon_r = 38.564$; $\rho = 1000$ kg/m³

Communication System: UID 0, WiFi (0) Frequency: 2412 MHz Duty Cycle: 1:1

Probe: EX3DV4 – SN7683 ConvF (7.85, 7.85, 7.85);

Rear Side Ch.1/Area Scan (91x91x1): Interpolated grid: dx=1.000 mm, dy=1.000 mm

Maximum value of SAR (interpolated) = 1.77 W/kg

Rear Side Ch.1/Zoom Scan (7x7x7)/Cube 0: Measurement grid: dx=5mm, dy=5mm, dz=5mm

Reference Value = 0 V/m; Power Drift = 0.09 dB

Peak SAR (extrapolated) = 1.94 W/kg

SAR(1 g) = 0.802 W/kg; SAR(10 g) = 0.375 W/kg

Maximum value of SAR (measured) = 1.26 W/kg

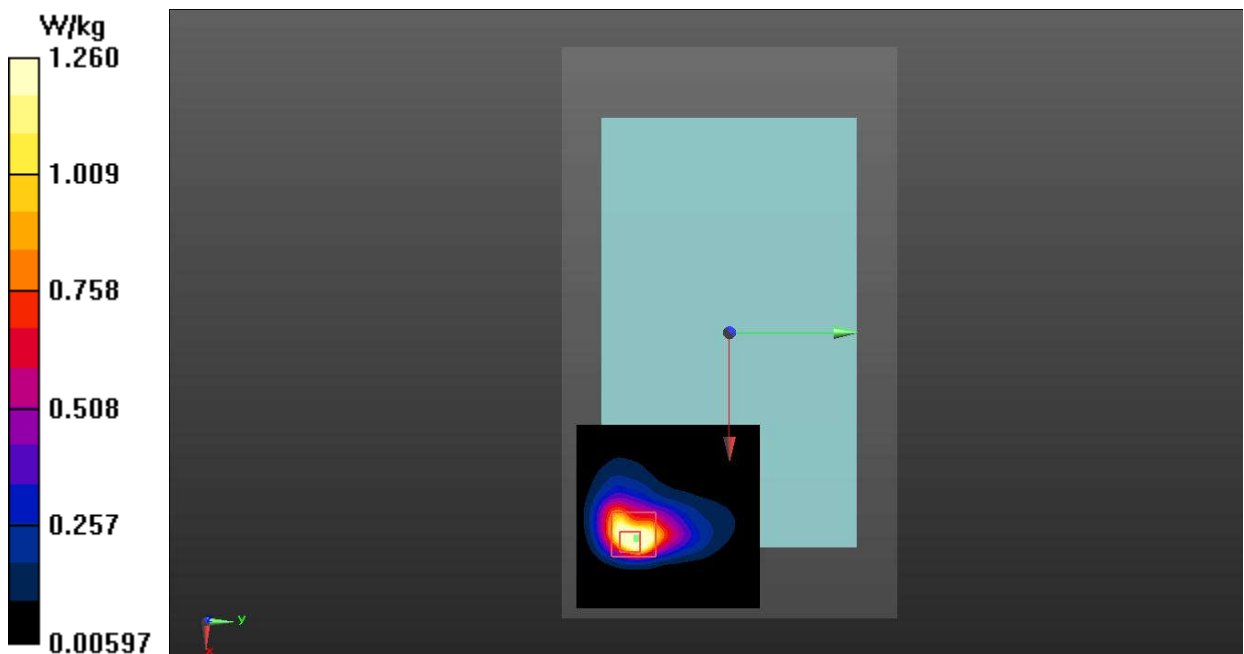
**Fig.16 WLAN 2.4G Body**

WLAN 5G Body

Date: 2022-2-18

Electronics: DAE4 Sn786

Medium: Head 5250MHz

Medium parameters used: $f = 5320$ MHz; $\sigma = 4.751$ S/m; $\epsilon_r = 36.583$; $\rho = 1000$ kg/m³

Communication System: UID 0, WIFI 5G (0) Frequency: 5320 MHz Duty Cycle: 1:1

Probe: EX3DV4 – SN7683 ConvF (5.56, 5.56, 5.56);

Top Side CH.64/Area Scan (81x111x1): Interpolated grid: dx=1.000 mm, dy=1.000 mm

Maximum value of SAR (interpolated) = 1.46 W/kg

Top Side CH.64/Zoom Scan (8x8x21)/Cube 0: Measurement grid: dx=4mm, dy=4mm, dz=1.4mm

Reference Value = 0.3570 V/m; Power Drift = 0.09 dB

Peak SAR (extrapolated) = 3.93 W/kg

SAR(1 g) = 0.883 W/kg; SAR(10 g) = 0.352 W/kg

Maximum value of SAR (measured) = 1.91 W/kg

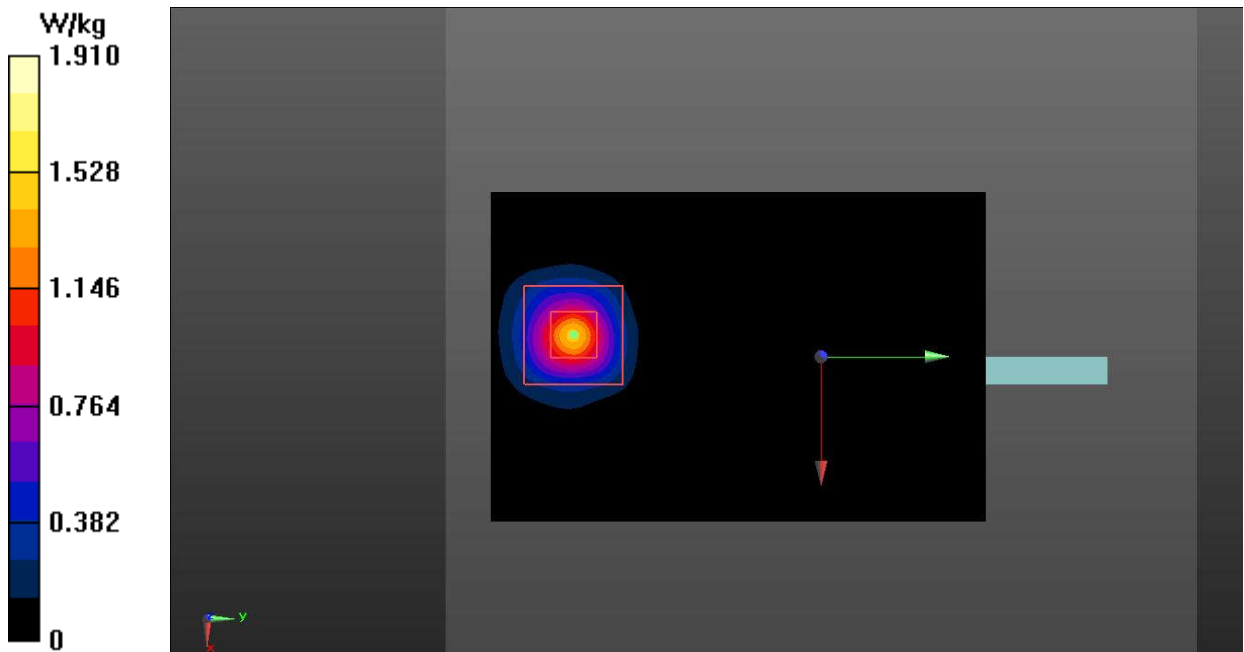

Fig.17 WLAN 5G Body

ANNEX B: SystemVerification Results

750MHz

Date: 2022-2-14

Electronics: DAE4 Sn786

Medium: Head 750MHz

Medium parameters used: $f = 750 \text{ MHz}$; $\sigma = 0.907 \text{ S/m}$; $\epsilon_r = 41.345$; $\rho = 1000 \text{ kg/m}^3$

Communication System: CW_TMC Frequency: 750 MHz Duty Cycle: 1:1

Probe: EX3DV4 – SN7683 ConvF (10.34, 10.34, 10.34);

System Validation/Area Scan (81x161x1): Interpolated grid: $dx=1.000 \text{ mm}$, $dy=1.000 \text{ mm}$

Reference Value = 60.582 V/m; Power Drift = 0.08 dB

SAR(1 g) = 2.18 W/kg; SAR(10 g) = 1.44 W/kg

Maximum value of SAR (interpolated) = 2.76 W/kg

System Validation/Zoom Scan (7x7x7)/Cube 0: Measurement grid: $dx=5\text{mm}$, $dy=5\text{mm}$, $dz=5\text{mm}$

Reference Value = 60.582 V/m; Power Drift = 0.08 dB

Peak SAR (extrapolated) = 3.14 W/kg

SAR(1 g) = 2.21 W/kg; SAR(10 g) = 1.45 W/kg

Maximum value of SAR (measured) = 2.80 W/kg

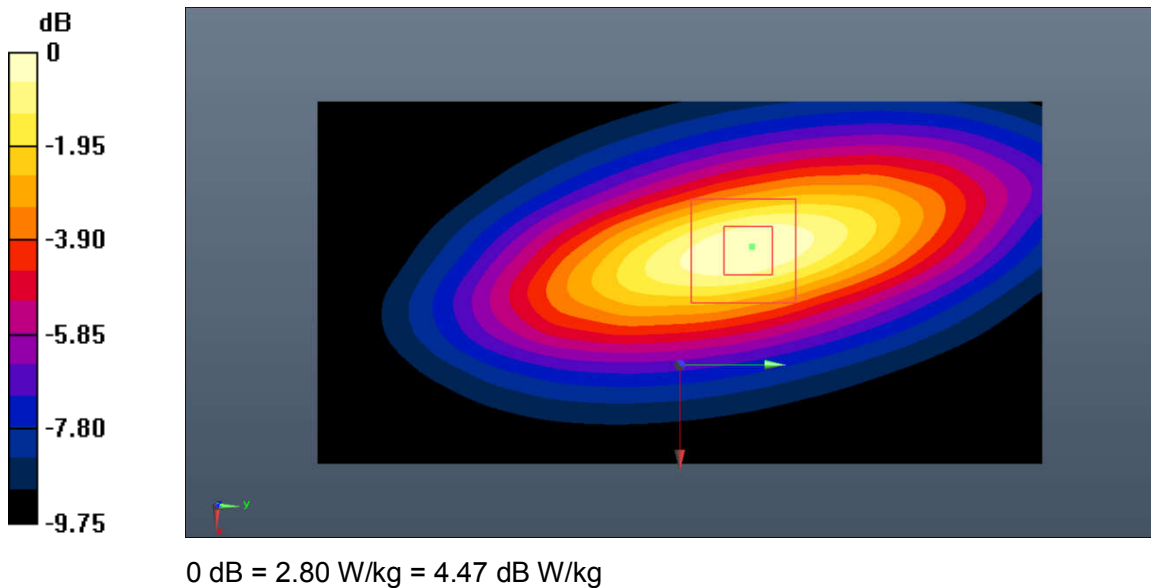

Fig.B.1. Validation 750MHz 250mW

835MHz

Date: 2022-2-12

Electronics: DAE4 Sn786

Medium: Head 835MHz

Medium parameters used: $f = 835 \text{ MHz}$; $\sigma = 0.885 \text{ S/m}$; $\epsilon_r = 41.939$; $\rho = 1000 \text{ kg/m}^3$

Communication System: CW_TMC Frequency: 835 MHz Duty Cycle: 1:1

Probe: EX3DV4 – SN7683 ConvF (10.34, 10.34, 10.34);

System Validation/Area Scan (91x161x1): Interpolated grid: $dx=1.000 \text{ mm}$, $dy=1.000 \text{ mm}$

Reference Value = 63.224 V/m; Power Drift = -0.07 dB

SAR(1 g) = 2.38 W/kg; SAR(10 g) = 1.57 W/kg

Maximum value of SAR (interpolated) = 3.36 W/kg

System Validation/Zoom Scan (7x7x7)/Cube 0: Measurement grid: $dx=5\text{mm}$, $dy=5\text{mm}$, $dz=5\text{mm}$

Reference Value = 63.224 V/m; Power Drift = -0.07 dB

Peak SAR (extrapolated) = 4.21 W/kg

SAR(1 g) = 2.32 W/kg; SAR(10 g) = 1.54 W/kg

Maximum value of SAR (measured) = 3.31 W/kg

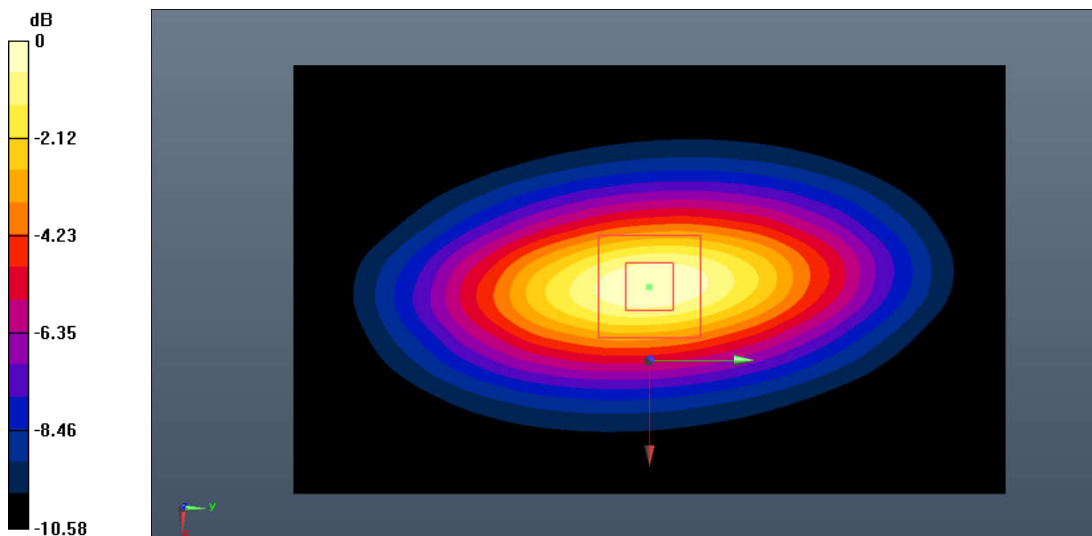

0 dB = 3.31 W/kg = 5.20 dB W/kg

Fig.B.2. Validation 835MHz 250mW

1750MHz

Date: 2022-1-20

Electronics: DAE4 Sn786

Medium: Head 1750MHz

Medium parameters used: $f = 1750$ MHz; $\sigma = 1.379$ S/m; $\epsilon_r = 39.506$; $\rho = 1000$ kg/m³

Communication System: CW_TMC Frequency: 1750 MHz Duty Cycle: 1:1

Probe: EX3DV4 – SN7683 ConvF (8.58, 8.58, 8.58);

System Validation/Area Scan (81x121x1): Interpolated grid: dx=1.000 mm, dy=1.000 mm

Reference Value = 78.764 V/m; Power Drift = 0.07 dB

SAR(1 g) = 9.17 W/kg; SAR(10 g) = 4.81 W/kg

Maximum value of SAR (interpolated) = 11.0 W/kg

System Validation/Zoom Scan (7x7x7)/Cube0: Measurement grid: dx=5mm, dy=5mm, dz=5mm

Reference Value = 78.764 V/m; Power Drift = 0.07 dB

Peak SAR (extrapolated) = 22.4 W/kg

SAR(1 g) = 9.32 W/kg; SAR(10 g) = 4.88 W/kg

Maximum value of SAR (measured) = 11.2 W/kg

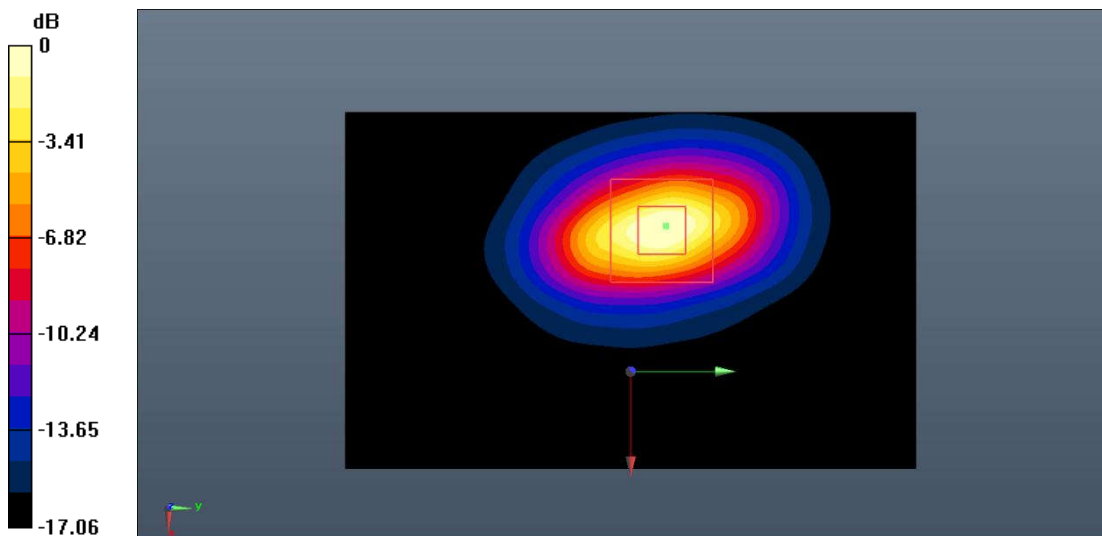

0 dB = 11.2 W/kg = 10.49 dB W/kg

Fig.B.3. Validation 1750MHz 250mW

1900MHz

Date: 2022-2-15

Electronics: DAE4 Sn786

Medium: Head 1900MHz

Medium parameters used: $f = 1900$ MHz; $\sigma = 1.381$ S/m; $\epsilon_r = 39.283$; $\rho = 1000$ kg/m³

Communication System: CW_TMC Frequency: 1900 MHz Duty Cycle: 1:1

Probe: EX3DV4 – SN7683 ConvF (8.33, 8.33, 8.33);

System Validation/Area Scan (91x91x1): Interpolated grid: dx=1.000 mm, dy=1.000 mm

Reference Value = 80.911 V/m; Power Drift = -0.06 dB

SAR(1 g) = 9.93 W/kg; SAR(10 g) = 5.21 W/kg

Maximum value of SAR (interpolated) = 12.3 W/kg

System Validation/Zoom Scan (7x7x7)/Cube0: Measurement grid: dx=5mm, dy=5mm, dz=5mm

Reference Value = 80.911 V/m; Power Drift = -0.06 dB

Peak SAR (extrapolated) = 24.2 W/kg

SAR(1 g) = 9.70 W/kg; SAR(10 g) = 5.12 W/kg

Maximum value of SAR (measured) = 12.0 W/kg

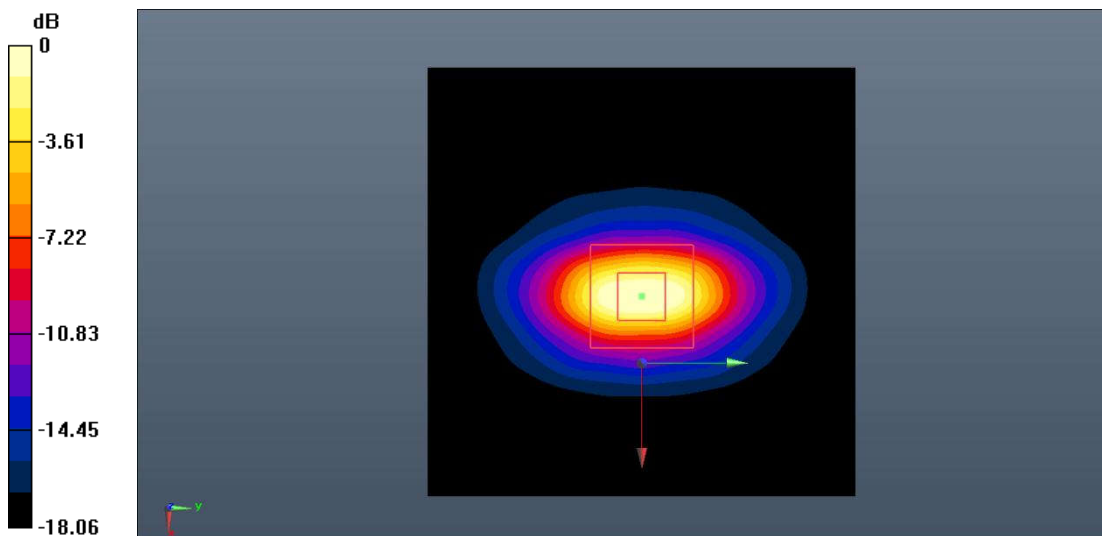

0 dB = 12.0 W/kg = 10.79 dB W/kg

Fig.B.4. Validation 1900MHz 250mW

2300MHz

Date: 2022-1-24

Electronics: DAE4 Sn786

Medium: Head 2300MHz

Medium parameters used: $f = 2300$ MHz; $\sigma = 1.655$ S/m; $\epsilon_r = 39.931$; $\rho = 1000$ kg/m³

Communication System: CW_TMC Frequency: 2300 MHz Duty Cycle: 1:1

Probe: EX3DV4 – SN7683 ConvF (8.07, 8.07, 8.07);

System Validation/Area Scan (81x121x1): Interpolated grid: dx=1.000 mm, dy=1.000 mm

Reference Value = 85.139 V/m; Power Drift = -0.11 dB

SAR(1 g) = 11.9 W/kg; SAR(10 g) = 5.67 W/kg

Maximum value of SAR (interpolated) = 13.8 W/kg

System Validation/Zoom Scan (7x7x7)/Cube0: Measurement grid: dx=5mm, dy=5mm, dz=5mm

Reference Value = 85.139 V/m; Power Drift = -0.11 dB

Peak SAR (extrapolated) = 26.6 W/kg

SAR(1 g) = 11.7 W/kg; SAR(10 g) = 5.61 W/kg

Maximum value of SAR (measured) = 13.6 W/kg

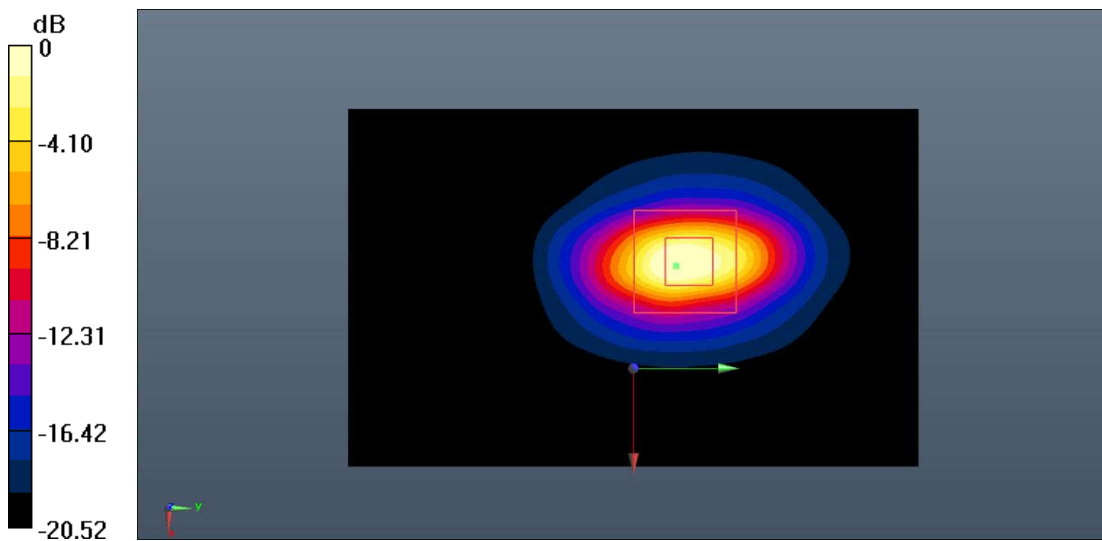

0 dB = 13.6 W/kg = 11.34 dB W/kg

Fig.B.5. Validation 2300MHz 250mW

2450MHz

Date: 2022-2-17

Electronics: DAE4 Sn786

Medium: Head 2450MHz

Medium parameters used: $f = 2450$ MHz; $\sigma = 1.844$ S/m; $\epsilon_r = 38.439$; $\rho = 1000$ kg/m³

Communication System: CW_TMC Frequency: 2450 MHz Duty Cycle: 1:1

Probe: EX3DV4 – SN7683 ConvF (7.85, 7.85, 7.85);

System Validation/Area Scan (81x121x1): Interpolated grid: dx=1.000 mm, dy=1.000 mm

Reference Value = 91.569 V/m; Power Drift = 0.12 dB

SAR(1 g) = 13.5 W/kg; SAR(10 g) = 6.11 W/kg

Maximum value of SAR (interpolated) = 15.5 W/kg

System Validation/Zoom Scan (7x7x7)/Cube0: Measurement grid: dx=5mm, dy=5mm, dz=5mm

Reference Value = 91.569 V/m; Power Drift = 0.12 dB

Peak SAR (extrapolated) = 33.1 W/kg

SAR(1 g) = 13.8 W/kg; SAR(10 g) = 6.23 W/kg

Maximum value of SAR (measured) = 15.8 W/kg

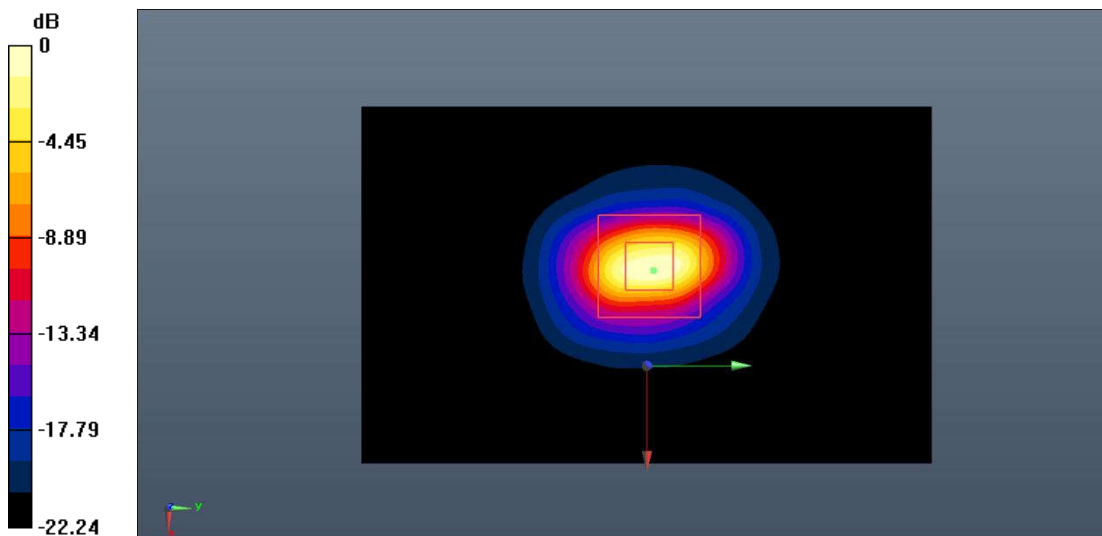

0 dB = 15.8 W/kg = 11.99 dB W/kg

Fig.B.6. Validation 2450MHz 250mW

2550MHz

Date: 2022-1-28

Electronics: DAE4 Sn786

Medium: Head 2550MHz

Medium parameters used: $f = 2550$ MHz; $\sigma = 1.947$ S/m; $\epsilon_r = 38.185$; $\rho = 1000$ kg/m³

Communication System: CW_TMC Frequency: 2550 MHz Duty Cycle: 1:1

Probe: EX3DV4 – SN7683 ConvF (7.85, 7.85, 7.85);

System Validation/Area Scan (91x91x1): Interpolated grid: dx=1.000 mm, dy=1.000 mm

Reference Value = 93.712 V/m; Power Drift = 0.10 dB

SAR(1 g) = 14.2 W/kg; SAR(10 g) = 6.38 W/kg

Maximum value of SAR (interpolated) = 16.2 W/kg

System Validation/Zoom Scan (7x7x7)/Cube0: Measurement grid: dx=5mm, dy=5mm, dz=5mm

Reference Value = 93.712 V/m; Power Drift = 0.10 dB

Peak SAR (extrapolated) = 39.1 W/kg

SAR(1 g) = 14.5 W/kg; SAR(10 g) = 6.47 W/kg

Maximum value of SAR (measured) = 16.4 W/kg

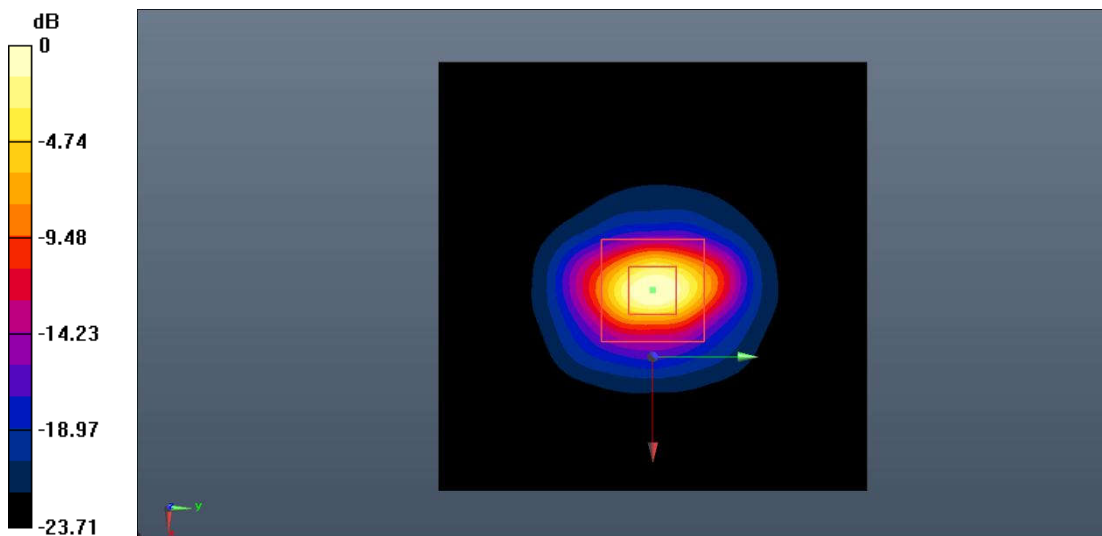

0 dB = 16.4 W/kg = 12.15 dB W/kg

Fig.B.7. Validation 2550MHz 250mW

5250MHz

Date: 2022-2-18

Electronics: DAE4 Sn786

Medium: Head 5250MHz

Medium parameters used: $f = 5250$ MHz; $\sigma = 4.655$ S/m; $\epsilon_r = 36.773$; $\rho = 1000$ kg/m³

Communication System: CW Frequency: 5250 MHz Duty Cycle: 1:1

Probe: EX3DV4 – SN7683 ConvF (5.56, 5.56, 5.56);

System Validation/Area Scan (61x91x1): Interpolated grid: dx=1.000 mm, dy=1.000 mm

Reference Value = 63.545 V/m; Power Drift = -0.09 dB

SAR(1 g) = 7.58 W/kg; SAR(10 g) = 2.20 W/kg

Maximum value of SAR (interpolated) = 9.74 W/kg

System Validation/Zoom Scan (8x8x21)/Cube0: Measurement grid: dx=4mm, dy=4mm, dz=1.4mm

Reference Value = 63.545 V/m; Power Drift = -0.09 dB

Peak SAR (extrapolated) = 22.5 W/kg

SAR(1 g) = 7.44 W/kg; SAR(10 g) = 2.16 W/kg

Maximum value of SAR (measured) = 9.69 W/kg

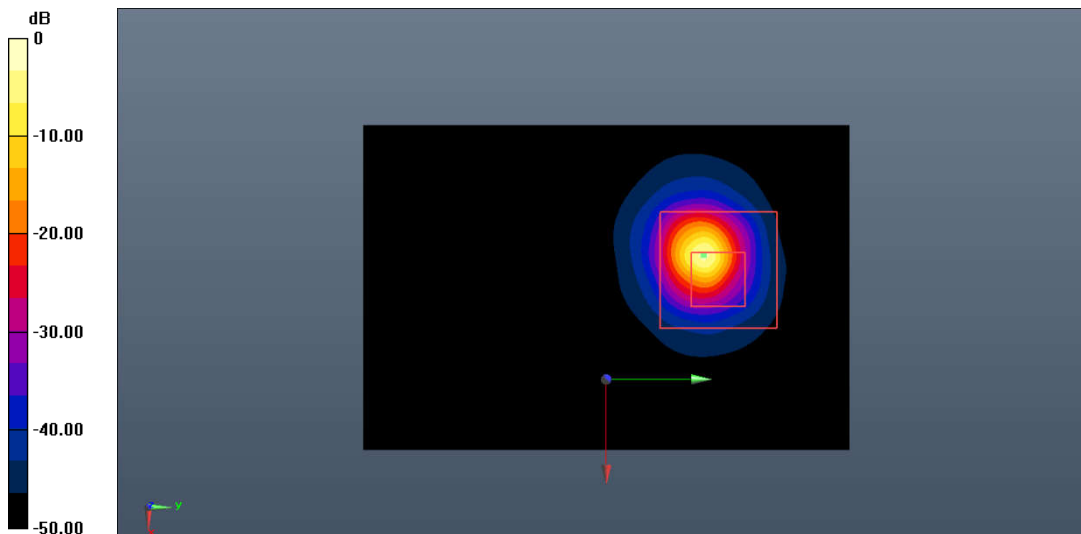

0 dB = 9.69 W/kg = 9.86 dB W/kg

Fig.B.8. Validation 5250MHz 100mW

5750MHz

Date: 2022-2-18

Electronics: DAE4 Sn786

Medium: Head 5750 MHz

Medium parameters used: $f = 5750$ MHz; $\sigma = 5.336$ S/m; $\epsilon_r = 34.513$; $\rho = 1000$ kg/m³

Communication System: CW Frequency: 5750 MHz Duty Cycle: 1:1

Probe: EX3DV4 – SN7683 ConvF (5.21, 5.21, 5.21);

System Validation/Area Scan (61x91x1): Interpolated grid: dx=1.000 mm, dy=1.000 mm

Reference Value = 65.944 V/m; Power Drift = 0.02 dB

SAR(1 g) = 7.98 W/kg; SAR(10 g) = 2.24 W/kg

Maximum value of SAR (interpolated) = 9.98 W/kg

System Validation/Zoom Scan (8x8x21)/Cube0: Measurement grid: dx=4mm, dy=4mm, dz=1.4mm

Reference Value = 65.944 V/m; Power Drift = 0.02 dB

Peak SAR (extrapolated) = 27.5 W/kg

SAR(1 g) = 8.18 W/kg; SAR(10 g) = 2.28 W/kg

Maximum value of SAR (measured) = 10.2 W/kg

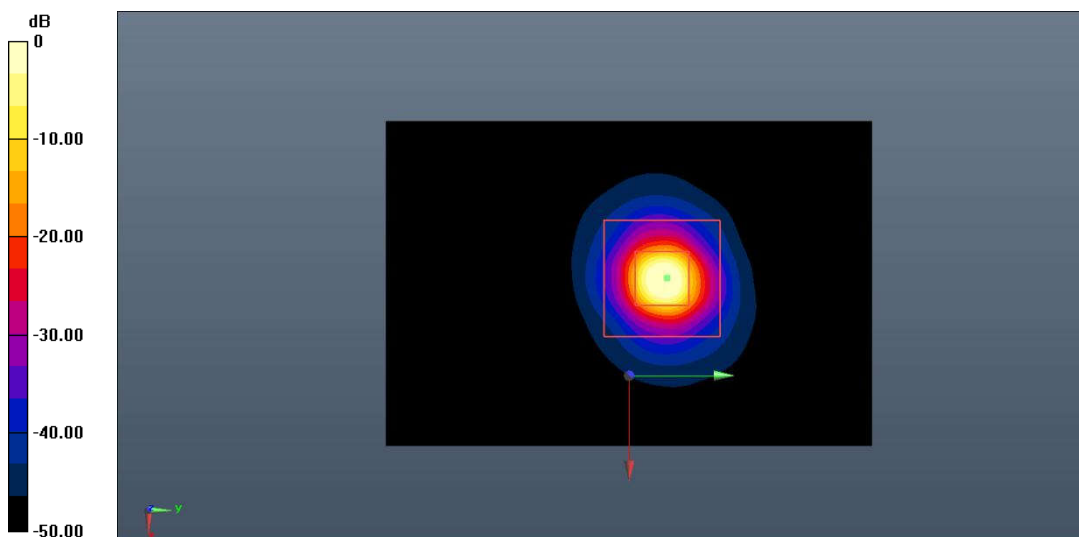

0 dB = 10.2 W/kg = 10.09 dB W/kg

Fig.B.9. Validation 5750MHz 100mW

ANNEX C: SAR Measurement Setup

C.1. Measurement Set-up

DASY5 system for performing compliance tests is illustrated above graphically. This system consists of the following items:

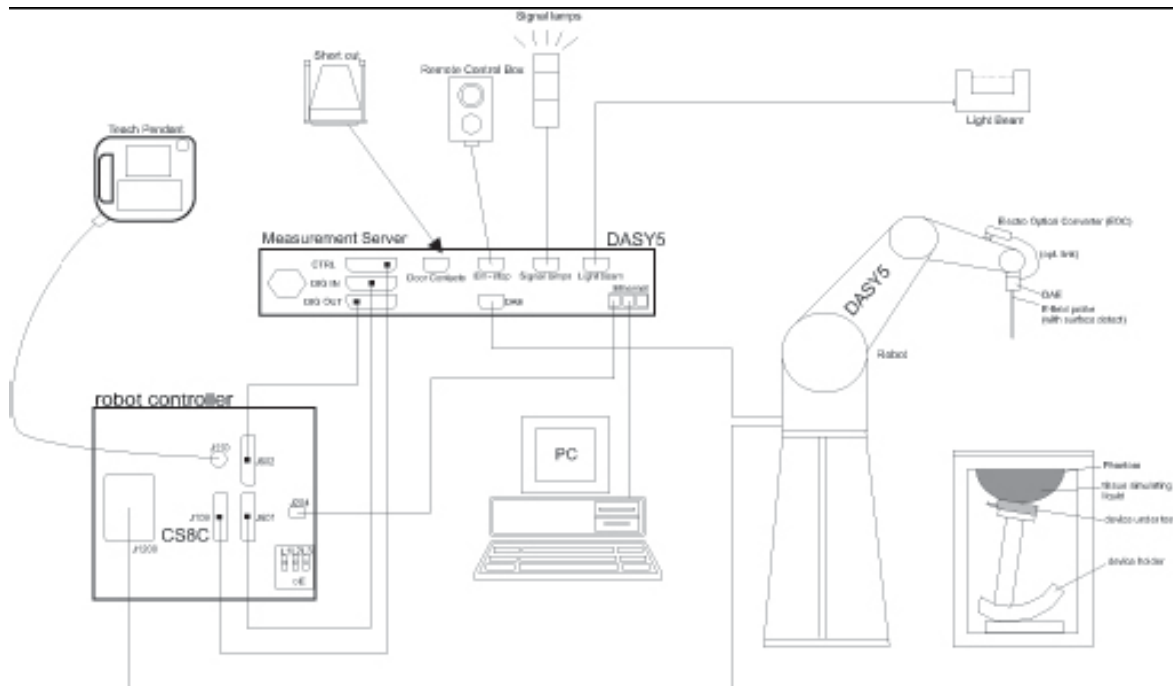

Picture C.1 SAR Lab Test Measurement Set-up

- A standard high precision 6-axis robot (Stäubli TX=RX family) with controller, teach pendant and software. An arm extension for accommodating the data acquisition electronics (DAE).
- An isotropic field probe optimized and calibrated for the targeted measurement.
- A data acquisition electronics (DAE) which performs the signal amplification, signal multiplexing, AD-conversion, offset measurements, mechanical surface detection, collision detection, etc. The unit is battery powered with standard or rechargeable batteries. The signal is optically transmitted to the EOC.
- The Electro-optical converter (EOC) performs the conversion from optical to electrical signals for the digital communication to the DAE. To use optical surface detection, a special version of the EOC is required. The EOC signal is transmitted to the measurement server.
- The function of the measurement server is to perform the time critical tasks such as signal filtering, control of the robot operation and fast movement interrupts.
- The Light Beam used is for probe alignment. This improves the (absolute) accuracy of the probe positioning.
- A computer running WinXP and the DASY5 software.
- Remote control and teach pendant as well as additional circuitry for robot safety such as warning lamps, etc.
- The phantom, the device holder and other accessories according to the targeted measurement.

C.2. DASY5 E-field Probe System

The SAR measurements were conducted with the dosimetric probe designed in the classical triangular configuration and optimized for dosimetric evaluation. The probe is constructed using the thick film technique; with printed resistive lines on ceramic substrates. The probe is equipped with an optical multifiber line ending at the front of the probe tip. It is connected to the EOC box on the robot arm and provides an automatic detection of the phantom surface. Half of the fibers are connected to a pulsed infrared transmitter, the other half to a synchronized receiver. As the probe approaches the surface, the reflection from the surface produces a coupling from the transmitting to the receiving fibers. This reflection increases first during the approach, reaches maximum and then decreases. If the probe is flatly touching the surface, the coupling is zero. The distance of the coupling maximum to the surface is independent of the surface reflectivity and largely independent of the surface to probe angle. The DASY5 software reads the reflection during a software approach and looks for the maximum using 2nd order curve fitting. The approach is stopped at reaching the maximum.

Probe Specifications:

Model:	ES3DV3, EX3DV4
Frequency	10MHz — 6.0GHz(EX3DV4)
Range:	10MHz — 4GHz(ES3DV3)
Calibration:	In head and body simulating tissue at Frequencies from 835 up to 5800MHz
Linearity:	± 0.2 dB(30 MHz to 6 GHz) for EX3DV4 ± 0.2 dB(30 MHz to 4 GHz) for ES3DV3
Dynamic Range:	10 mW/kg — 100W/kg
Probe Length:	330 mm
Probe Tip	
Length:	20 mm
Body Diameter:	12 mm
Tip Diameter:	2.5 mm (3.9 mm for ES3DV3)
Tip-Center:	1 mm (2.0mm for ES3DV3)
Application:	SAR Dosimetry Testing Compliance tests of mobile phones Dosimetry in strong gradient fields



Picture C.2 Near-field Probe



Picture C.3 E-field Probe

C.3. E-field Probe Calibration

Each E-Probe/Probe Amplifier combination has unique calibration parameters. A TEM cell calibration procedure is conducted to determine the proper amplifier settings to enter in the probe parameters. The amplifier settings are determined for a given frequency by subjecting the probe to a known E-field density (1 mW/cm²) using an RF Signal generator, TEM cell, and RF Power Meter.

The free space E-field from amplified probe outputs is determined in a test chamber. This calibration can be performed in a TEM cell if the frequency is below 1 GHz and in a waveguide or other methodologies above 1 GHz for free space. For the free space calibration, the probe is placed in the volumetric center of the cavity and at the proper orientation with the field. The probe is then rotated 360 degrees until the three channels show the maximum reading. The power density readings equate to 1 mW/cm².

E-field temperature correlation calibration is performed in a flat phantom filled with the appropriate simulated brain tissue. The E-field in the medium correlates with the temperature rise in the dielectric medium. For temperature correlation calibration a RF transparent thermistor-based temperature probe is used in conjunction with the E-field probe.

$$SAR = C \frac{\Delta T}{\Delta t}$$

Where:

Δt = Exposure time (30 seconds),

C = Heat capacity of tissue (brain or muscle),

ΔT = Temperature increase due to RF exposure.

$$SAR = \frac{|E|^2 \cdot \sigma}{\rho}$$

Where:

σ = Simulated tissue conductivity,

ρ = Tissue density (kg/m³).

C.4. Other Test Equipment

C.4.1. Data Acquisition Electronics (DAE)

The data acquisition electronics consist of a highly sensitive electrometer-grade preamplifier with auto-zeroing, a channel and gain-switching multiplexer, a fast 16 bit AD-converter and a command decoder with a control logic unit. Transmission to the measurement server is accomplished through an optical downlink for data and status information, as well as an optical uplink for commands and the clock.

The mechanical probe mounting device includes two different sensor systems for frontal and sideways probe contacts. They are used for mechanical surface detection and probe collision detection.

The input impedance of the DAE is 200 MOhm; the inputs are symmetrical and floating. Common mode rejection is above 80 dB.



PictureC.4: DAE

C.4.2. Robot

The SPEAG DASY system uses the high precision robots (DASY5: RX160L) type from Stäubli SA (France). For the 6-axis controller system, the robot controller version from Stäubli is used. The Stäubli robot series have many features that are important for our application:

- High precision (repeatability 0.02mm)
- High reliability (industrial design)
- Low maintenance costs (virtually maintenance free due to direct drive gears; no belt drives)
- Jerk-free straight movements (brushless synchron motors; no stepper motors)
- Low ELF interference (motor control fields shielded via the closed metallic construction shields)



Picture C.5 DASY 5

C.4.3. Measurement Server

The Measurement server is based on a PC/104 CPU board with CPU (DASY5: 400 MHz, Intel Celeron), chipdisk (DASY5:128MB), RAM (DASY5:128MB). The necessary circuits for communication with the DAE electronic box, as well as the 16 bit AD converter system for optical detection and digital I/O interface are contained on the DASY I/O board, which is directly connected to the PC/104 bus of the CPU board.

The measurement server performs all real-time data evaluation of field measurements and surface detection, controls robot movements and handles safety operation. The PC operating system cannot interfere with these time critical processes. All connections are supervised by a watchdog, and disconnection of any of the cables to the measurement server will automatically disarm the robot and disable all program-controlled robot movements. Furthermore, the measurement server is equipped with an expansion port which is reserved for future applications. Please note that this expansion port does not have a standardized pinout, and therefore only devices provided by SPEAG can be connected. Devices from any other supplier could seriously damage the measurement server.



Picture C.6 Server for DASY 5

C.4.4. Device Holder for Phantom

The SAR in the phantom is approximately inversely proportional to the square of the distance between the source and the liquid surface. For a source at 5mm distance, a positioning uncertainty of $\pm 0.5\text{mm}$ would produce a SAR uncertainty of $\pm 20\%$. Accurate device positioning is therefore crucial for accurate and repeatable measurements. The positions in which the devices must be measured are defined by the standards.

The DASY device holder is designed to cope with the different positions given in the standard. It has two scales for device rotation (with respect to the body axis) and device inclination (with respect to the line between the ear reference points). The rotation centers for both scales is the ear reference point (ERP). Thus the device needs no repositioning when changing the angles.

The DASY device holder is constructed of low-loss POM material having the following dielectric

parameters: relative permittivity $\epsilon = 3$ and loss tangent $\delta = 0.02$. The amount of dielectric material has been reduced in the closest vicinity of the device, since measurements have suggested that the influence of the clamp on the test results could thus be lowered.

<Laptop Extension Kit>

The extension is lightweight and made of POM, acrylic glass and foam. It fits easily on the upper part of the Mounting Device in place of the phone positioner. The extension is fully compatible with the Twin-SAM and ELI phantoms.



Picture C.7-1: Device Holder

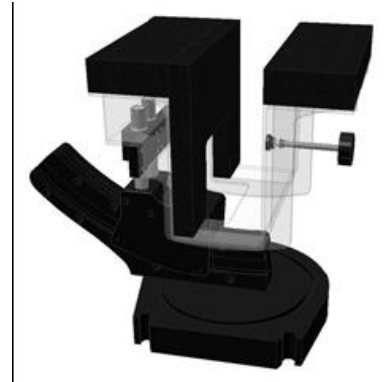

Picture C.7-2: Laptop Extension Kit

C.4.5. Phantom

The SAM Twin Phantom V4.0 is constructed of a fiberglass shell integrated in a table. The shape of the shell is based on data from an anatomical study designed to represent the 90th percentile of the population. The phantom enables the dissymmetric evaluation of SAR for both left and right handed handset usage, as well as body-worn usage using the flat phantom region. Reference markings on the Phantom allow the complete setup of all predefined phantom positions and measurement grids by manually teaching three points in the robot. The shell phantom has a 2mm shell thickness (except the ear region where shell thickness increases to 6 mm).

Shell Thickness: 2 ± 0.2 mm
Filling Volume: Approx. 25 liters
Dimensions: 810 x 1000 x 500 mm (H x L x W)
Available: Special



Picture C.8: SAM Twin Phantom

ANNEX D: Position of the wireless device in relation to the phantom

D.1. General considerations

This standard specifies two handset test positions against the head phantom – the “cheek” position and the “tilt” position.

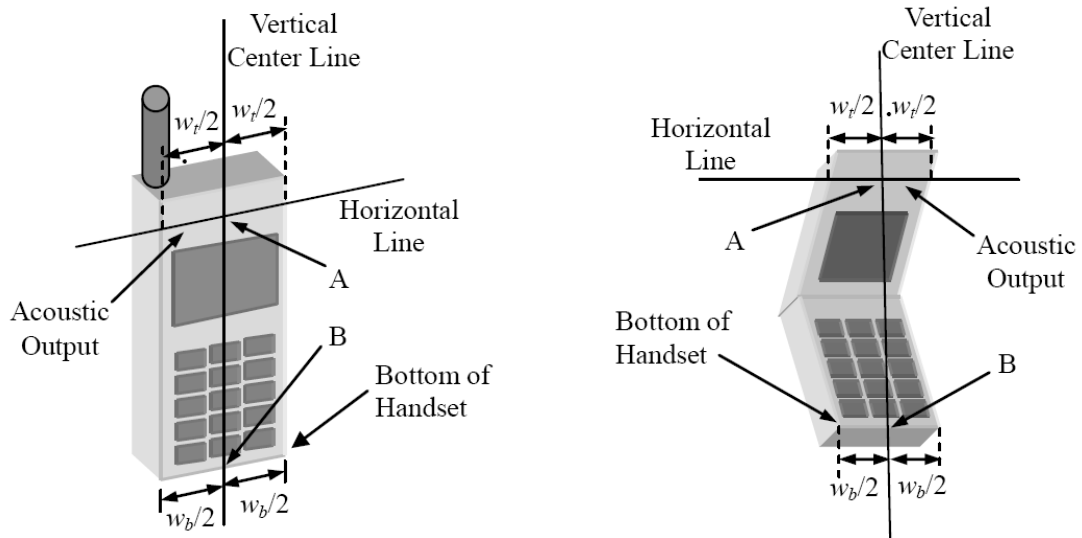

- w_t Width of the handset at the level of the acoustic
- w_b Width of the bottom of the handset
- A Midpoint of the width w_t of the handset at the level of the acoustic output
- B Midpoint of the width w_b of the bottom of the handset

Picture D.1-a Typical “fixed” case handset Picture D.1-b Typical “clam-shell” case handset

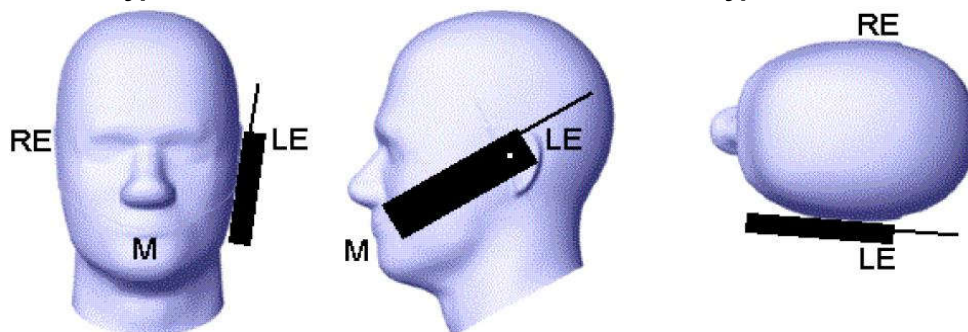

Picture D.2 Cheek position of the wireless device on the left side of SAM

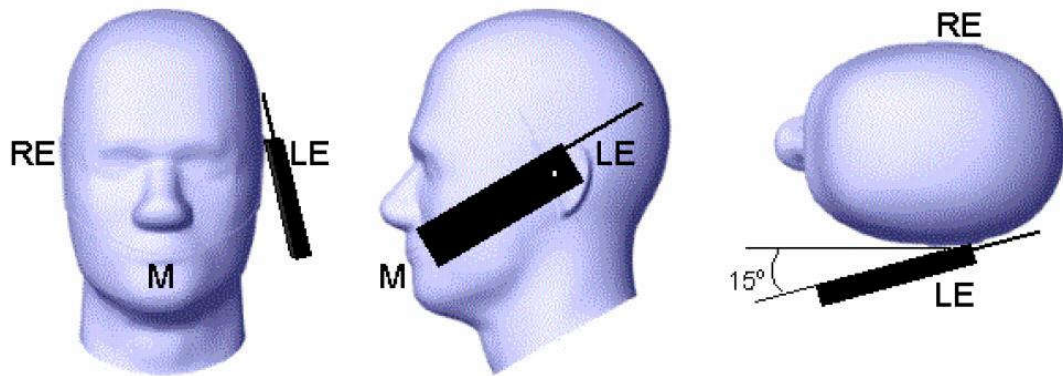

Picture D.3 Tilt position of the wireless device on the left side of SAM

D.2. Body-worn device

A typical example of a body-worn device is a mobile phone, wireless enabled PDA or other battery operated wireless device with the ability to transmit while mounted on a person's body using a carry accessory approved by the wireless device manufacturer.

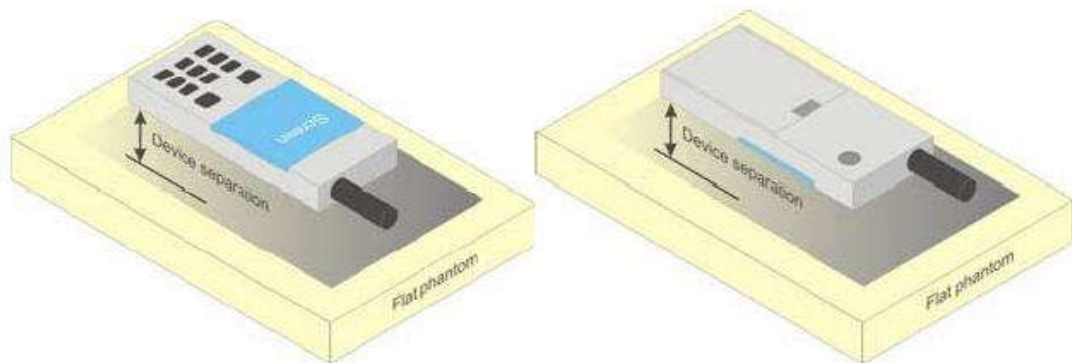

Picture D.4 Test positions for body-worn devices

D.3. Desktop device

A typical example of a desktop device is a wireless enabled desktop computer placed on a table or desk when used.

The DUT shall be positioned at the distance and in the orientation to the phantom that corresponds to the intended use as specified by the manufacturer in the user instructions. For devices that employ an external antenna with variable positions, tests shall be performed for all antenna positions specified. Picture 8.5 show positions for desktop device SAR tests. If the intended use is not specified, the device shall be tested directly against the flat phantom.

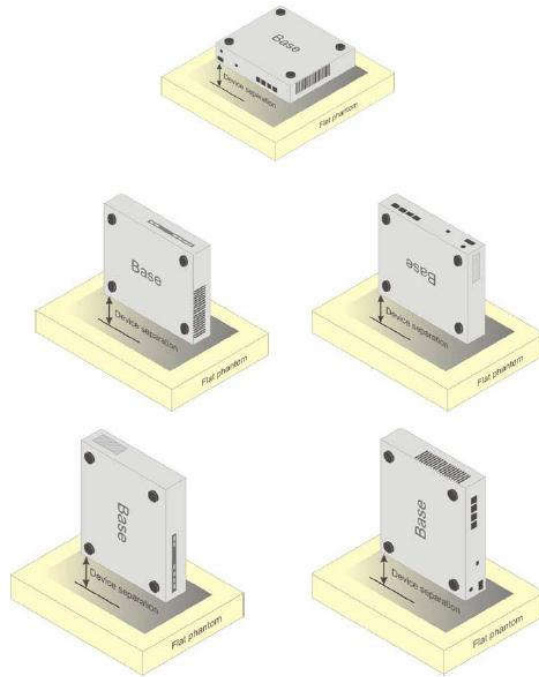

Picture D.5 Test positions for desktop devices

D.4. DUT Setup Photos



Picture D.6

ANNEX E: Equivalent Media Recipes

The liquid used for the frequency range of 700-6000 MHz consisted of water, sugar, salt, preventol, glycol monobutyl and Cellulose. The liquid has been previously proven to be suited for worst-case. The Table E.1 shows the detail solution. It's satisfying the latest tissue dielectric parameters requirements proposed by the IEEE 1528 and IEC 62209.

Table E.1: Composition of the Tissue Equivalent Matter

Frequency (MHz)	835	1750	1900	2450	2600	5200	5800
Water	41.45	55.242	55.242	58.79	58.79	65.53	66.10
Sugar	56.0	/	/	/	/	/	/
Salt	1.45	0.306	0.306	0.06	0.06		
Preventol	0.1	/	/	/	/	17.24	16.95
Cellulose	1.0	/	/	/	/	17.24	16.95
Glycol Monobutyl	/	44.452	44.452	41.15	41.15	/	/
Diethylenglycol monohexylether	/	/	/	/	/	/	/
Triton X-100	/	/	/	/	/	/	/
Dielectric Parameters Target Value	$\epsilon=41.5$ $\sigma=0.90$	$\epsilon=40.08$ $\sigma=1.37$	$\epsilon=40.0$ $\sigma=1.40$	$\epsilon=39.20$ $\sigma=1.80$	$\epsilon=39.01$ $\sigma=1.96$	$\epsilon=35.99$ $\sigma=4.66$	$\epsilon=35.30$ $\sigma=5.27$

Note: There is a little adjustment respectively for 750, 5300 and 5600, based on the recipe of closest frequency in table E.1

ANNEX F: System Validation

The SAR system must be validated against its performance specifications before it is deployed. When SAR probes, system components or software are changed, upgraded or recalibrated, these must be validated with the SAR system(s) that operates with such components.

Table F.1: System Validation

Probe SN.	Liquid name	Validation date	Frequency point	Status (OK or Not)
7683	Head 750MHz	2022-01-02	750 MHz	OK
7683	Head 835MHz	2022-01-02	835 MHz	OK
7683	Head 1750MHz	2021-09-30	1750 MHz	OK
7683	Head 1900MHz	2022-01-02	1900 MHz	OK
7683	Head 2300MHz	2022-01-02	2300 MHz	OK
7683	Head 2450MHz	2022-01-02	2450 MHz	OK
7683	Head 2550MHz	2022-01-02	2550 MHz	OK
7683	Head 5200MHz	2022-01-02	5250 MHz	OK
7683	Head 5600MHz	2022-01-02	5600 MHz	OK
7683	Head 5750MHz	2022-01-02	5750 MHz	OK



ANNEX G: DAE Calibration Certificate

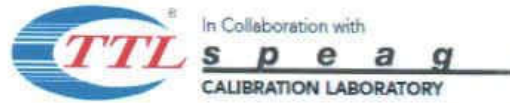

Add: No.52 HuaYuanBei Road, Haidian District, Beijing, 100191, China;
Tel: +86-10-62304633-2512 Fax: +86-10-62304633-2504
E-mail: cttl@chinattl.com [Http://www.chinattl.cn](http://www.chinattl.cn)



中国认可
国际互认
校准
CALIBRATION
CNAS L0570

Client : **CTTL(South Branch)**

Certificate No: **Z21-60093**

CALIBRATION CERTIFICATE			
Object	DAE4 - SN: 786		
Calibration Procedure(s)	FF-Z11-002-01 Calibration Procedure for the Data Acquisition Electronics (DAEx)		
Calibration date:	April 09, 2021		
This calibration Certificate documents the traceability to national standards, which realize the physical units of measurements(SI). The measurements and the uncertainties with confidence probability are given on the following pages and are part of the certificate.			
All calibrations have been conducted in the closed laboratory facility: environment temperature(22±3)°C and humidity<70%.			
Calibration Equipment used (M&TE critical for calibration)			
Primary Standards	ID #	Cal Date(Calibrated by, Certificate No.)	Scheduled Calibration
Process Calibrator 753	1971018	16-Jun-20 (CTTL, No.J20X04342)	Jun-21
Calibrated by:	Name	Function	Signature
	Yu Zongying	SAR Test Engineer	
Reviewed by:	Lin Hao	SAR Test Engineer	
Approved by:	Qi Dianyuan	SAR Project Leader	
			Issued: April 11, 2021
This calibration certificate shall not be reproduced except in full without written approval of the laboratory.			



Add: No.52 HuaYuanBei Road, Haidian District, Beijing, 100191, China
Tel: +86-10-62304633-2512 Fax: +86-10-62304633-2504
E-mail: ttl@chinatl.com Http://www.chinatl.cn

Glossary:

DAE data acquisition electronics
Connector angle information used in DASY system to align probe sensor X to the robot coordinate system.

Methods Applied and Interpretation of Parameters:

- *DC Voltage Measurement:* Calibration Factor assessed for use in DASY system by comparison with a calibrated instrument traceable to national standards. The figure given corresponds to the full scale range of the voltmeter in the respective range.
- *Connector angle:* The angle of the connector is assessed measuring the angle mechanically by a tool inserted. Uncertainty is not required.
- The report provide only calibration results for DAE, it does not contain other performance test results.



Add: No.52 HuaYuanBei Road, Haidian District, Beijing, 100191, China
Tel: +86-10-62304633-2512 Fax: +86-10-62304633-2504
E-mail: ttl@chinatl.com Http: www.chinatl.cn

DC Voltage Measurement

A/D - Converter Resolution nominal
High Range: 1LSB = 6.1μV, full range = -100...+300 mV
Low Range: 1LSB = 61nV, full range = -1.....+3mV
DASY measurement parameters: Auto Zero Time: 3 sec; Measuring time: 3 sec

Calibration Factors	X	Y	Z
High Range	404.112 ± 0.15% (k=2)	404.269 ± 0.15% (k=2)	404.666 ± 0.15% (k=2)
Low Range	3.97192 ± 0.7% (k=2)	3.97396 ± 0.7% (k=2)	3.95762 ± 0.7% (k=2)

Connector Angle

Connector Angle to be used in DASY system	229° ± 1°
-------------------------------------------	-----------



ANNEX H: Probe Calibration Certificate

Probe EX3DV4-SN: 7683 Calibration Certificate (2021-12-29)



In Collaboration with
s p e a g
CALIBRATION LABORATORY



中国认可
国际互认
校准
CALIBRATION
CNAS L0570

Add: No.52 HuaYuanBei Road, Haidian District, Beijing, 100191, China
Tel: +86-10-62304633-2512 Fax: +86-10-62304633-2504
E-mail: cttl@chinattl.com [Http://www.chinattl.cn](http://www.chinattl.cn)

Client

SAICT

Certificate No: Z21-60444

CALIBRATION CERTIFICATE

Object EX3DV4 - SN : 7683

Calibration Procedure(s) FF-Z11-004-02
Calibration Procedures for Dosimetric E-field Probes

Calibration date: December 29, 2021

This calibration Certificate documents the traceability to national standards, which realize the physical units of measurements(SI). The measurements and the uncertainties with confidence probability are given on the following pages and are part of the certificate.

All calibrations have been conducted in the closed laboratory facility: environment temperature(22±3)°C and humidity<70%.

Calibration Equipment used (M&TE critical for calibration)

Primary Standards	ID #	Cal Date(Calibrated by, Certificate No.)	Scheduled Calibration
Power Meter NRP2	101919	15-Jun-21(CTTL, No.J21X04466)	Jun-22
Power sensor NRP-Z91	101547	15-Jun-21(CTTL, No.J21X04466)	Jun-22
Power sensor NRP-Z91	101548	15-Jun-21(CTTL, No.J21X04466)	Jun-22
Reference 10dBAttenuator	18N50W-10dB	10-Feb-20(CTTL, No.J20X00525)	Feb-22
Reference 20dBAttenuator	18N50W-20dB	10-Feb-20(CTTL, No.J20X00526)	Feb-22
Reference Probe EX3DV4	SN 3617	27-Jan-21(SPEAG, No.EX3-3617_Jan21)	Jan-22
DAE4	SN 1555	20-Aug-21(SPEAG, No.DAE4-1555_Aug21/2)	Aug-22

Secondary Standards	ID #	Cal Date(Calibrated by, Certificate No.)	Scheduled Calibration
SignalGenerator MG3700A	6201052605	16-Jun-21(CTTL, No.J21X04467)	Jun-22
Network Analyzer E5071C	MY46110673	21-Jan-21(CTTL, No.J20X00515)	Jan-22

	Name	Function	Signature
Calibrated by:	Yu Zongying	SAR Test Engineer	
Reviewed by:	Lin Hao	SAR Test Engineer	
Approved by:	Qi Dianyuan	SAR Project Leader	

Issued: December 31, 2021

This calibration certificate shall not be reproduced except in full without written approval of the laboratory.



In Collaboration with
s p e a g
CALIBRATION LABORATORY

Add: No.52 HuaYuanBei Road, Haidian District, Beijing, 100191, China
Tel: +86-10-62304633-2512 Fax: +86-10-62304633-2504
E-mail: ctl@chinattl.com [Http://www.chinattl.cn](http://www.chinattl.cn)

Glossary:

TSL	tissue simulating liquid
NORM _{x,y,z}	sensitivity in free space
ConvF	sensitivity in TSL / NORM _{x,y,z}
DCP	diode compression point
CF	crest factor (1/duty_cycle) of the RF signal
A,B,C,D	modulation dependent linearization parameters
Polarization Φ	Φ rotation around probe axis
Polarization θ	θ rotation around an axis that is in the plane normal to probe axis (at measurement center), i $\theta=0$ is normal to probe axis

Connector Angle: information used in DASY system to align probe sensor X to the robot coordinate system

Calibration is Performed According to the Following Standards:

- IEEE Std 1528-2013, "IEEE Recommended Practice for Determining the Peak Spatial-Averaged Specific Absorption Rate (SAR) in the Human Head from Wireless Communications Devices: Measurement Techniques", June 2013
- IEC 62209-1, "Measurement procedure for the assessment of Specific Absorption Rate (SAR) from hand-held and body-mounted devices used next to the ear (frequency range of 300 MHz to 6 GHz)", July 2016
- IEC 62209-2, "Procedure to determine the Specific Absorption Rate (SAR) for wireless communication devices used in close proximity to the human body (frequency range of 30 MHz to 6 GHz)", March 2010
- KDB 865664, "SAR Measurement Requirements for 100 MHz to 6 GHz"

Methods Applied and Interpretation of Parameters:

- NORM_{x,y,z}**: Assessed for E-field polarization $\theta=0$ ($f \leq 900$ MHz in TEM-cell; $f > 1800$ MHz: waveguide). NORM_{x,y,z} are only intermediate values, i.e., the uncertainties of NORM_{x,y,z} does not effect the E^2 -field uncertainty inside TSL (see below ConvF).
- NORM(f)_{x,y,z} = NORM_{x,y,z} * frequency_response** (see Frequency Response Chart). This linearization is implemented in DASY4 software versions later than 4.2. The uncertainty of the frequency response is included in the stated uncertainty of ConvF.
- DCP_{x,y,z}**: DCP are numerical linearization parameters assessed based on the data of power sweep (no uncertainty required). DCP does not depend on frequency nor media.
- PAR**: PAR is the Peak to Average Ratio that is not calibrated but determined based on the signal characteristics.
- A_{x,y,z}; B_{x,y,z}; C_{x,y,z}; VR_{x,y,z}; A,B,C** are numerical linearization parameters assessed based on the data of power sweep for specific modulation signal. The parameters do not depend on frequency nor media. VR is the maximum calibration range expressed in RMS voltage across the diode.
- ConvF and Boundary Effect Parameters**: Assessed in flat phantom using E-field (or Temperature Transfer Standard for $f \leq 800$ MHz) and inside waveguide using analytical field distributions based on power measurements for $f > 800$ MHz. The same setups are used for assessment of the parameters applied for boundary compensation (alpha, depth) of which typical uncertainty valued are given. These parameters are used in DASY4 software to improve probe accuracy close to the boundary. The sensitivity in TSL corresponds to NORM_{x,y,z} * ConvF whereby the uncertainty corresponds to that given for ConvF. A frequency dependent ConvF is used in DASY version 4.4 and higher which allows extending the validity from ± 50 MHz to ± 100 MHz.
- Spherical isotropy (3D deviation from isotropy)**: in a field of low gradients realized using a flat phantom exposed by a patch antenna.
- Sensor Offset**: The sensor offset corresponds to the offset of virtual measurement center from the probe tip (on probe axis). No tolerance required.
- Connector Angle**: The angle is assessed using the information gained by determining the NORM_x (no uncertainty required).



In Collaboration with
s p e a g
CALIBRATION LABORATORY

Add: No.52 HuaYuanBei Road, Haidian District, Beijing, 100191, China
Tel: +86-10-62304633-2512 Fax: +86-10-62304633-2504
E-mail: cttl@chinattl.com [Http://www.chinattl.cn](http://www.chinattl.cn)

DASY/EASY – Parameters of Probe: EX3DV4 – SN:7683

Basic Calibration Parameters

	Sensor X	Sensor Y	Sensor Z	Unc (k=2)
Norm($\mu\text{V}/(\text{V}/\text{m})^2$) ^A	0.63	0.65	0.64	$\pm 10.0\%$
DCP(mV) ^B	107.2	107.6	107.5	

Modulation Calibration Parameters

UID	Communication System Name		A dB	B dB· μV	C	D dB	VR mV	Unc ^E (k=2)
0	CW	X	0.0	0.0	1.0	0.00	203.5	$\pm 2.1\%$
		Y	0.0	0.0	1.0		205.8	
		Z	0.0	0.0	1.0		203.8	

The reported uncertainty of measurement is stated as the standard uncertainty of Measurement multiplied by the coverage factor $k=2$, which for a normal distribution Corresponds to a coverage probability of approximately 95%.

^A The uncertainties of Norm X, Y, Z do not affect the E²-field uncertainty inside TSL (see Page 4).

^B Numerical linearization parameter: uncertainty not required.

^E Uncertainty is determined using the max. deviation from linear response applying rectangular distribution and is expressed for the square of the field value.



Add: No.52 HuaYuanBei Road, Haidian District, Beijing, 100191, China
 Tel: +86-10-62304633-2512 Fax: +86-10-62304633-2504
 E-mail: cttl@chinattl.com [Http://www.chinattl.cn](http://www.chinattl.cn)

DASY/EASY – Parameters of Probe: EX3DV4 – SN:7683

Calibration Parameter Determined in Head Tissue Simulating Media

f [MHz] ^C	Relative Permittivity ^F	Conductivity (S/m) ^F	ConvF X	ConvF Y	ConvF Z	Alpha ^G	Depth ^G (mm)	Unct. (k=2)
750	41.9	0.89	10.34	10.34	10.34	0.20	1.19	±12.1%
1640	40.3	1.29	8.72	8.72	8.72	0.24	0.94	±12.1%
1900	40.0	1.40	8.33	8.33	8.33	0.29	0.95	±12.1%
2100	39.8	1.49	8.23	8.23	8.23	0.20	1.12	±12.1%
2300	39.5	1.67	8.07	8.07	8.07	0.62	0.69	±12.1%
2450	39.2	1.80	7.85	7.85	7.85	0.63	0.69	±12.1%
2600	39.0	1.96	7.55	7.55	7.55	0.49	0.83	±12.1%
3300	38.2	2.71	7.30	7.30	7.30	0.42	0.96	±13.3%
3500	37.9	2.91	7.01	7.01	7.01	0.42	1.00	±13.3%
3700	37.7	3.12	6.73	6.73	6.73	0.39	1.06	±13.3%
3900	37.5	3.32	6.61	6.61	6.61	0.40	1.25	±13.3%
4100	37.2	3.53	6.80	6.80	6.80	0.40	1.15	±13.3%
4400	36.9	3.84	6.61	6.61	6.61	0.35	1.35	±13.3%
4600	36.7	4.04	6.51	6.51	6.51	0.45	1.20	±13.3%
4800	36.4	4.25	6.46	6.46	6.46	0.45	1.20	±13.3%
4950	36.3	4.40	6.25	6.25	6.25	0.40	1.35	±13.3%
5250	35.9	4.71	5.56	5.56	5.56	0.45	1.40	±13.3%
5600	35.5	5.07	5.17	5.17	5.17	0.45	1.35	±13.3%
5750	35.4	5.22	5.21	5.21	5.21	0.55	1.20	±13.3%

^C Frequency validity above 300 MHz of ±100MHz only applies for DASY v4.4 and higher (Page 2), else it is restricted to ±50MHz. The uncertainty is the RSS of ConvF uncertainty at calibration frequency and the uncertainty for the indicated frequency band. Frequency validity below 300 MHz is ± 10, 25, 40, 50 and 70 MHz for ConvF assessments at 30, 64, 128, 150 and 220 MHz respectively. Above 5 GHz frequency validity can be extended to ± 110 MHz.

^F At frequency below 3 GHz, the validity of tissue parameters (ϵ and σ) can be relaxed to ±10% if liquid compensation formula is applied to measured SAR values. At frequencies above 3 GHz, the validity of tissue parameters (ϵ and σ) is restricted to ±5%. The uncertainty is the RSS of the ConvF uncertainty for indicated target tissue parameters.

^G Alpha/Depth are determined during calibration. SPEAG warrants that the remaining deviation due to the boundary effect after compensation is always less than ± 1% for frequencies below 3 GHz and below ± 2% for the frequencies between 3-6 GHz at any distance larger than half the probe tip diameter from the boundary.



Add: No.52 HuaYuanBei Road, Haidian District, Beijing, 100191, China
Tel: +86-10-62304633-2512 Fax: +86-10-62304633-2504
E-mail: cttl@chinattl.com [Http://www.chinattl.cn](http://www.chinattl.cn)

Frequency Response of E-Field (TEM-Cell: ifi110 EXX, Waveguide: R22)

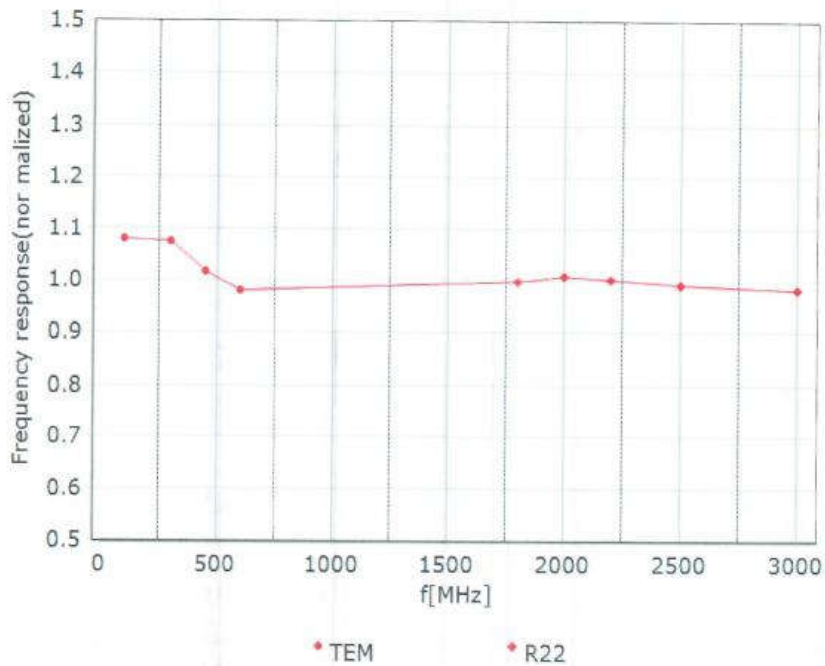

Uncertainty of Frequency Response of E-field: $\pm 7.4\%$ ($k=2$)



Add: No.52 HuaYuanBei Road, Haidian District, Beijing: 100191, China
 Tel: +86-10-62304633-2512 Fax: +86-10-62304633-2504
 E-mail: cttl@chinattl.com [Http://www.chinattl.cn](http://www.chinattl.cn)

Receiving Pattern (Φ), $\theta=0^\circ$

f=600 MHz, TEM

f=1800 MHz, R22

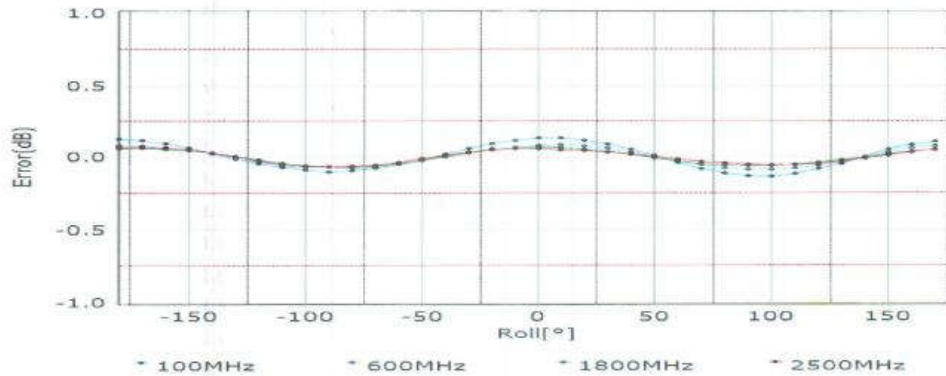
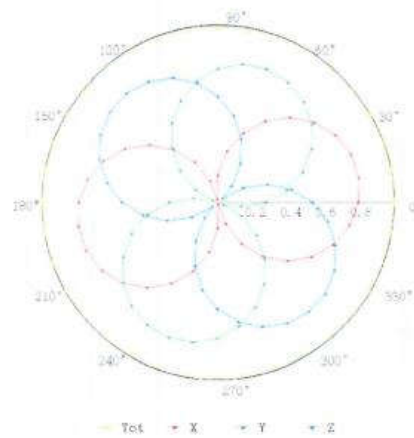
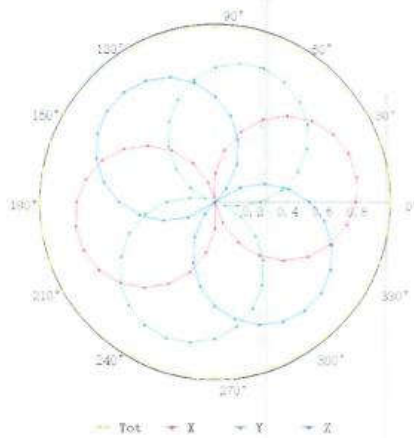

Uncertainty of Axial Isotropy Assessment: $\pm 1.2\%$ ($k=2$)

Dynamic Range f(SAR_{head}) (TEM cell, f = 900 MHz)

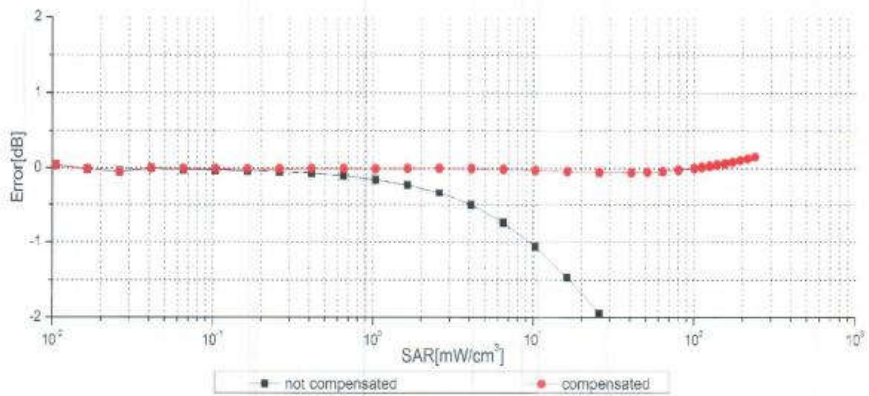
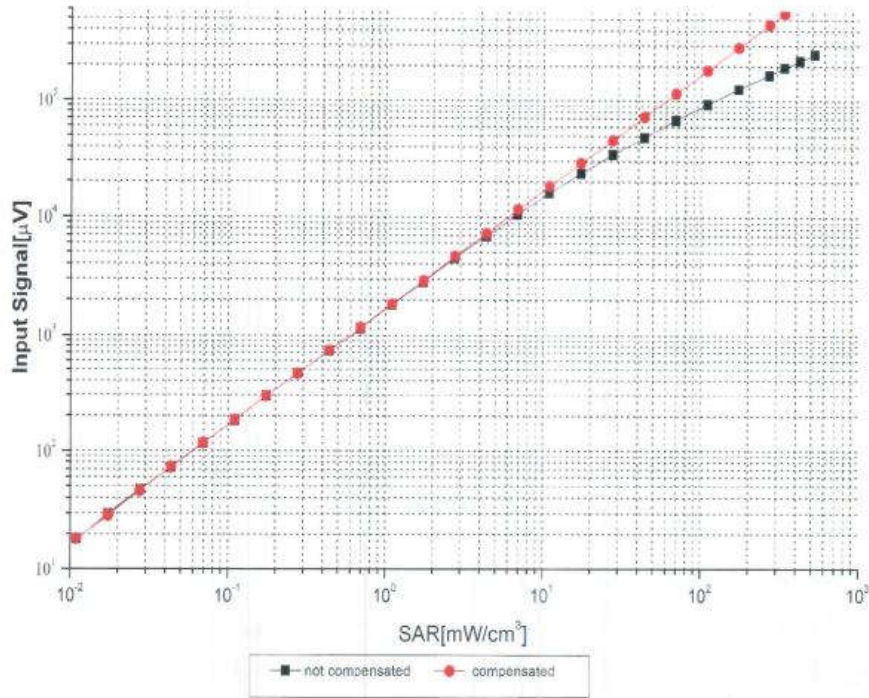

Uncertainty of Linearity Assessment: $\pm 0.9\%$ ($k=2$)