



TEST REPORT

No.I21N02978-SAR

For

TCL Communication Ltd.

LTE/UMTS/GSM Smartphone

Model Name: 4165F

With

Hardware Version: Proto

Software Version: V1.0

FCC ID: 2ACCJB156

Issued Date: 2021-09-26

Designation Number: CN1210

Note:

The test results in this test report relate only to the devices specified in this report. This report shall not be reproduced except in full without the written approval of SAICT.

Test Laboratory:

SAICT, Shenzhen Academy of Information and Communications Technology

Building G, Shenzhen International Innovation Center, No.1006 Shennan Road, Futian District, Shenzhen, Guangdong, P. R. China 518000.

Tel:+86(0)755-33322000, Fax:+86(0)755-33322001

Email: yewu@caict.ac.cn. www.saict.ac.cn



REPORT HISTORY

Report Number	Revision	Description	Issue Date
I21N02978-SAR	Rev.0	1st edition	2021-09-26



TCONTENTS

1. SUMMARY OF TEST REPORT	5
1.1. TEST ITEMS	5
1.2. TEST STANDARDS	5
1.3. TEST RESULT.....	5
1.4. TESTING LOCATION	5
1.5. PROJECT DATA	5
1.6. SIGNATURE.....	5
2. STATEMENT OF COMPLIANCE	6
3. CLIENT INFORMATION	9
3.1. APPLICANT INFORMATION.....	9
3.2. MANUFACTURER INFORMATION	9
4. EQUIPMENT UNDER TEST (EUT) AND ANCILLARY EQUIPMENT (AE)	10
4.1. ABOUT EUT.....	10
4.2. INTERNAL IDENTIFICATION OF EUT USED DURING THE TEST	11
4.3. INTERNAL IDENTIFICATION OF AE USED DURING THE TEST.....	11
5. TEST METHODOLOGY	12
5.1. APPLICABLE LIMIT REGULATIONS.....	12
5.2. APPLICABLE MEASUREMENT STANDARDS	12
6. SPECIFIC ABSORPTION RATE (SAR).....	13
6.1. INTRODUCTION.....	13
6.2. SAR DEFINITION.....	13
7. TISSUE SIMULATING LIQUIDS	14
7.1. TARGETS FOR TISSUE SIMULATING LIQUID	14
7.2. DIELECTRIC PERFORMANCE	14
8. SYSTEM VERIFICATION	18
8.1. SYSTEM SETUP.....	18
8.2. SYSTEM VERIFICATION	19
9. MEASUREMENT PROCEDURES	20
9.1. TESTS TO BE PERFORMED.....	20
9.2. GENERAL MEASUREMENT PROCEDURE	22
9.3. WCDMA MEASUREMENT PROCEDURES FOR SAR	23
9.4. SAR MEASUREMENT FOR LTE.....	24
9.5. BLUETOOTH & WLAN MEASUREMENT PROCEDURES FOR SAR.....	24
9.6. POWER DRIFT.....	25
10. CONDUCTED OUTPUT POWER	26
10.1. GSM MEASUREMENT RESULT	26



10.2. WCDMA MEASUREMENT RESULT 28

10.3. LTE MEASUREMENT RESULT 31

10.4. BLUETOOTH AND WLAN MEASUREMENT RESULT 67

11. SIMULTANEOUS TX SAR CONSIDERATIONS68

11.1. INTRODUCTION 68

11.2. TRANSMIT ANTENNA SEPARATION DISTANCES 68

11.3. SAR MEASUREMENT POSITIONS..... 69

11.4. STANDALONE SAR TEST EXCLUSION CONSIDERATIONS 69

12. EVALUATION OF SIMULTANEOUS.....70

13. SUMMARY OF TEST RESULTS.....71

13.1. TESTING ENVIRONMENT 71

13.2. SAR RESULTS..... 72

13.3. WLAN EVALUATION FOR 2.4G 84

13.4. PRODUCT SPECIFIC 10G SAR 86

14. SAR MEASUREMENT VARIABILITY87

15. MEASUREMENT UNCERTAINTY89

15.1. MEASUREMENT UNCERTAINTY FOR NORMAL SAR TESTS (300MHZ~3GHZ) 89

16. MAIN TEST INSTRUMENTS.....90

ANNEX A: GRAPH RESULTS91

ANNEX B: SYSTEMVERIFICATION RESULTS..... 113

ANNEX C: SAR MEASUREMENT SETUP..... 119

ANNEX D: POSITION OF THE WIRELESS DEVICE IN RELATION TO THE PHANTOM.....125

ANNEX E: EQUIVALENT MEDIA RECIPES128

ANNEX F: SYSTEM VALIDATION.....129

ANNEX G: DAE CALIBRATION CERTIFICATE130

ANNEX H: PROBE CALIBRATION CERTIFICATE133

ANNEX I: DIPOLE CALIBRATION CERTIFICATE151

ANNEX J: EXTENDED CALIBRATION SAR DIPOLE.....207

ANNEX K: SPOT CHECK TEST.....209

K.1. INTERNAL IDENTIFICATION OF EUT USED DURING THE SPOT CHECK TEST 209

K.2. MEASUREMENT RESULTS..... 209

K.3. GRAPH RESULTS FOR SPOT CHECK..... 213

K.4. SYSTEM VERIFICATION RESULTS FOR SPOT CHECK..... 235



1. Summary of Test Report

1.1. Test Items

Description: LTE/UMTS/GSM Smartphone
Model Name: 4165F
Applicant's name: TCL Communication Ltd.
Manufacturer's Name: TCL Communication Ltd.

1.2. Test Standards

ANSI C95.1:1992, IEEE 1528:2013

1.3. Test Result

Pass. Please refer to "13. Summary of Test Results" and "ANNEX K: Spot Check Test"

1.4. Testing Location

Address: Building G, Shenzhen International Innovation Center, No.1006 Shennan Road,
Futian District, Shenzhen, Guangdong, P. R. China

1.5. Project Data

Testing Start Date: 2021-06-06

Testing End Date: 2021-08-22

1.6. Signature

Li Yongfu

(Prepared this test report)

Zhang Yunzhan

(Reviewed this test report)

Cao Junfei

(Approved this test report)

2. Statement of Compliance

This EUT is a variant product and the report of original sample is No.I21N02462-SAR. According to the client request, only model name and brand name changed, all test results are cited from the initial model.

The maximum results of Specific Absorption Rate (SAR) found during testing for TCL Communication Ltd. LTE/UMTS/GSM Smartphone 4165F are as follows:

Table 2.1: Highest Reported SAR for Head (1g)

Exposure Configuration	Technology Band	Highest Reported SAR 1g(W/Kg)	Equipment Class
Head (Separation Distance 0mm)	GSM850	0.32	PCE
	GSM1900	0.69	
	WCDMA Band 2	1.19	
	WCDMA Band 4	1.06	
	WCDMA Band 5	0.29	
	LTE Band 2	1.20	
	LTE Band 5	0.26	
	LTE Band 7	0.09	
	LTE Band 12	0.22	
	LTE Band 66	1.26	
WLAN 2.4GHz	0.44	DTS	

Table 2.2: Highest Reported SAR for Hotspot (1g)

Exposure Configuration	Technology Band	Highest Reported SAR 1g(W/Kg)	Equipment Class
Hotspot (Separation Distance 10mm)	GSM850	0.61	PCE
	GSM1900	1.07	
	WCDMA Band 2	0.98	
	WCDMA Band 4	1.07	
	WCDMA Band 5	0.43	
	LTE Band 2	0.91	
	LTE Band 5	0.45	
	LTE Band 7	1.26	
	LTE Band 12	0.49	
	LTE Band 66	1.16	
	WLAN 2.4GHz	0.22	DTS

Table 2.3: Highest Reported SAR for Body-worn (1g)

Exposure Configuration	Technology Band	Highest Reported SAR 1g(W/Kg)	Equipment Class
Body-worn (Separation Distance 10mm)	GSM850	0.61	PCE
	GSM1900	1.07	
	WCDMA Band 2	0.98	
	WCDMA Band 4	1.07	
	WCDMA Band 5	0.43	
	LTE Band 2	0.91	
	LTE Band 5	0.45	
	LTE Band 7	0.61	
	LTE Band 12	0.49	
	LTE Band 66	1.16	
	WLAN 2.4GHz	0.22	DTS

The SAR values found for the Mobile Phone are below the maximum recommended levels of 1.6 W/Kg as averaged over any 1g tissue according to the ANSI C95.1-1992.

The measurement together with the test system set-up is described in annex C of this test report. A detailed description of the equipment under test can be found in chapter 4 of this test report.

The highest reported SAR value is obtained at the case of **(Table 2.1 & 2.2 & 2.3)**, and the value is: **1.26 W/kg (1g)**.

Table2.4: The sum of reported SAR values for WWAN antenna and WLAN antenna

/	Position	WWAN (W/kg)	WLAN (W/kg)	Sum (W/kg)
Highest reported SAR value for Head	Right Cheek	1.26	0.23	1.49
Highest reported SAR value for Hotspot	Rear	1.16	0.22	1.38
Highest reported SAR value for Body-worn	Rear	1.16	0.22	1.38
Highest reported SAR value for extremity SAR	Bottom	3.58	/	3.58

Note: the test positions of above tables are for the worse case that has been evaluated.

Table2.5: The sum of reported SAR values for WWAN antenna and Bluetooth antenna

/	Position	WWAN (W/kg)	Bluetooth (W/kg)	Sum (W/kg)
Highest reported SAR value for Head	Right Cheek	1.26	0.21	1.47
Highest reported SAR value for Hotspot	Bottom	1.26	0.10	1.36
Highest reported SAR value for Body-worn	Rear	1.16	0.10	1.26
Highest reported SAR value for extremity SAR	Bottom	3.58	0.21	3.79

Note: the test positions of above tables are for the worse case that has been evaluated.

According to the above tables, the highest sum of reported SAR values is **1.49 W/kg (1g)**.

The detail for simultaneous transmission consideration is described in chapter 12.



3. Client Information

3.1. Applicant Information

Company Name:	TCL Communication Ltd.
Address:	5/F, Building 22E, 22 Science Park East Avenue, Hong Kong Science Park, Shatin, NT, Hong Kong
City:	Hong Kong
Country:	China
Telephone:	0086-755-36611722

3.2. Manufacturer Information

Company Name:	TCL Communication Ltd.
Address:	5/F, Building 22E, 22 Science Park East Avenue, Hong Kong Science Park, Shatin, NT, Hong Kong
City:	Hong Kong
Country:	China
Telephone:	0086-755-36611722

4. Equipment under Test (EUT) and Ancillary Equipment (AE)

4.1. About EUT

Description:	LTE/UMTS/GSM Smartphone
Model Name:	4165F
Operating mode(s):	GSM850/1900, WCDMA Band 2/4/5, LTE Band 2/4/5/7/12/17/66, Bluetooth, WLAN 2.4G
Condition of EUT as received:	No obvious damage in appearance
Tested Tx Frequency:	824 – 849MHz (GSM 850)
	1850 – 1910MHz (GSM 1900)
	1850 – 1910MHz (WCDMA Band 2)
	1710 – 1755MHz (WCDMA Band 4)
	824 – 849MHz (WCDMA Band 5)
	1850 – 1910MHz (LTE Band 2)
	1700 – 1755MHz (LTE Band 4)
	824 – 849MHz (LTE Band 5)
	2500 – 2570MHz (LTE Band 7)
	699 – 716MHz (LTE Band 12)
	704 – 716MHz (LTE Band 17)
	1710 – 1780MHz (LTE Band 66)
	2402 – 2480MHz (Bluetooth)
2412 – 2462MHz (WLAN 2.4G)	
GPRS / EGPRS Multislot Class:	12
GPRS capability Class:	B
Test device Production information:	Production unit
Device type:	Portable device
Antenna type:	Integrated antenna
Hotspot mode:	Support
Product Dimensions:	Long 156.4mm; Wide 74.8mm; Overall Diagonal 164mm
<p>Remark:</p> <ol style="list-style-type: none"> 1. This device does not support DTM operation. 2. There is one power reduction level of WWAN antenna. 3. For WWAN transmitter. <p>Head exposure conditions: Reduced power level 1 – GSM1900, WCDMA Band 2/4, LTE Band 2/4/66 While the device WWAN is transmitting at the WWAN antenna and the audio is actively routed through the receiver, power reduction enabled for those bands.</p>	

4.2. Internal Identification of EUT used during the test

EUT ID*	IMEI	HW Version	SW Version	Receipt Date
UT08aa	355246690000062	Proto	V1.0	2021-06-01
UT09aa	355246690000187	Proto	V1.0	2021-06-01
UT10aa	355246690000047	Proto	V1.0	2021-06-01
UT14aa	355246690000195	Proto	V1.0	2021-06-01
UT15aa	355246690000054	Proto	V1.0	2021-06-01
UT03aa	355246690000617	Proto	V1.0	2021-08-11
UT05aa	355246690000609	Proto	V1.0	2021-08-11
UT06aa	355246690000591	Proto	V1.0	2021-08-11
UT07aa	355246690001664	Proto	V1.0	2021-08-11

*EUT ID: is used to identify the test sample in the lab internally.

Note: It is performed to test SAR with the UT08aa & UT09aa & UT14aa & UT15aa & UT03aa & UT05aa & UT06aa & UT07aa, and conducted power with the UT10aa.

4.3. Internal Identification of AE used during the test

AE ID*	Description	Model	Manufacturer
AE1	Battery	TLp029D7	VEKEN
AE2	Battery	TLp029D1	BYD
AE3	Headset	CCB0046A10C1 (alcatel logo)	DALIN
AE4	Headset	CCB0046A10C4 (alcatel logo)	MEIHAO
AE5	Headset	CCB0046A15C1 (no logo)	DALIN
AE6	Headset	CCB0046A15C4 (no logo)	MEIHAO

*AE ID: is used to identify the test sample in the lab internally.

Note: The device has two types of batteries. We'll perform the SAR measurement with AE1 and Spot check test with AE2.



5. Test Methodology

5.1. Applicable Limit Regulations

ANSI C95.1:1992 IEEE Standard for Safety Levels with Respect to Human Exposure to Radio Frequency Electromagnetic Fields, 3 kHz to 300 GHz.

It specifies the maximum exposure limit of **1.6 W/kg** as averaged over any 1 gram of tissue for portable devices being used within 20 cm of the user in the uncontrolled environment.

5.2. Applicable Measurement Standards

IEEE 1528:2013 Recommended Practice for Determining the Peak Spatial-Average Specific Absorption Rate (SAR) in the Human Head from Wireless Communications Devices: Experimental Techniques.

KDB 447498 D01 General RF Exposure Guidance v06 RF Exposure Procedures and Equipment Authorization Policies for Mobile and Portable Devices

KDB 648474 D04 Handset SAR v01r03 SAR Evaluation Considerations for Wireless Handsets.

KDB 941225 D01 SAR test for 3G devices v03r01 SAR Measurement Procedures for 3G Devices

KDB 941225 D05 SAR for LTE Devices v02r05 SAR Evaluation Considerations for LTE Devices

KDB 941225 D06 Hot Spot SAR v02r01 SAR Evaluation Procedures for Portable Devices with Wireless Router Capabilities

KDB 248227 D01 802.11 Wi-Fi SAR v02r02 SAR Guidance for IEEE 802.11 (Wi-Fi) Transmitters.

KDB 865664 D01 SAR measurement 100 MHz to 6 GHz v01r04 SAR Measurement Requirements for 100 MHz to 6 GHz

KDB 865664 D02 RF Exposure Reporting v01r02 RF Exposure Compliance Reporting and Documentation Considerations

KDB 941225 D07 UMPC Mini Tablet v01r02 SAR Evaluation Procedures for UMPC Mini-Tablet Devices

TCB workshop April 2019; RF Exposure Procedures (Tissue Simulating Liquids)

6. Specific Absorption Rate (SAR)

6.1. Introduction

SAR is related to the rate at which energy is absorbed per unit mass in an object exposed to a radio field. The SAR distribution in a biological body is complicated and is usually carried out by experimental techniques or numerical modeling. The standard recommends limits for two tiers of groups, occupational/controlled and general population/uncontrolled, based on a person's awareness and ability to exercise control over his or her exposure. In general, occupational/controlled exposure limits are higher than the limits for general population/uncontrolled.

6.2. SAR Definition

The SAR definition is the time derivative (rate) of the incremental energy (dW) absorbed by (dissipated in) an incremental mass (dm) contained in a volume element (dv) of a given density (ρ). The equation description is as below:

$$SAR = \frac{d}{dt} \left(\frac{dW}{dm} \right) = \frac{d}{dt} \left(\frac{dW}{\rho dv} \right)$$

SAR is expressed in units of Watts per kilogram (W/kg)

SAR measurement can be either related to the temperature elevation in tissue by

$$SAR = c \left(\frac{\delta T}{\delta t} \right)$$

Where: C is the specific heat capacity, δT is the temperature rise and δt is the exposure duration, or related to the electrical field in the tissue by

$$SAR = \frac{\sigma |E|^2}{\rho}$$

Where: σ is the conductivity of the tissue, ρ is the mass density of tissue and E is the RMS electrical field strength.

However for evaluating SAR of low power transmitter, electrical field measurement is typically applied.

7. Tissue Simulating Liquids

7.1. Targets for tissue simulating liquid

Table 7.1: Targets for tissue simulating liquid

Frequency (MHz)	Liquid Type	Conductivity (σ)	$\pm 5\%$ Range	Permittivity (ϵ)	$\pm 5\%$ Range
750	Head	0.89	0.85~0.93	41.9	39.8~44.0
835	Head	0.90	0.86~0.95	41.5	39.4~43.6
1750	Head	1.37	1.30~1.44	40.1	38.1~42.1
1900	Head	1.40	1.33~1.47	40.0	38.0~42.0
2450	Head	1.80	1.71~1.89	39.2	37.2~41.2
2550	Head	1.91	1.81~2.01	39.1	37.1~41.0

7.2. Dielectric Performance

Table 7.2: Dielectric Performance of Tissue Simulating Liquid

Measurement Date (yyyy-mm-dd)	Type	Frequency (MHz)	Conductivity σ (S/m)	Drift (%)	Permittivity ϵ	Drift (%)
2021-06-08	Head	750	0.912	2.47	41.16	-1.77
2021-06-06	Head	835	0.888	-1.33	41.95	1.08
2021-06-23	Head	1750	1.359	-0.80	40.89	1.97
2021-06-27	Head	1900	1.425	1.79	39.47	-1.33
2021-06-07	Head	2450	1.841	2.28	38.22	-2.50
2021-06-24	Head	2550	1.957	2.46	38.03	-2.74
2021-08-20	Head	750	0.925	3.93	41.33	-1.52
2021-08-22	Head	835	0.931	3.44	40.87	-2.12
2021-08-18	Head	1750	1.363	-0.51	40.39	0.72
2021-08-18	Head	1900	1.388	-0.86	40.23	0.57
2021-08-13	Head	2450	1.856	3.11	38.28	-2.35
2021-08-15	Head	2550	1.938	1.47	38.13	-2.48

Note: The liquid temperature is 22.0°C.

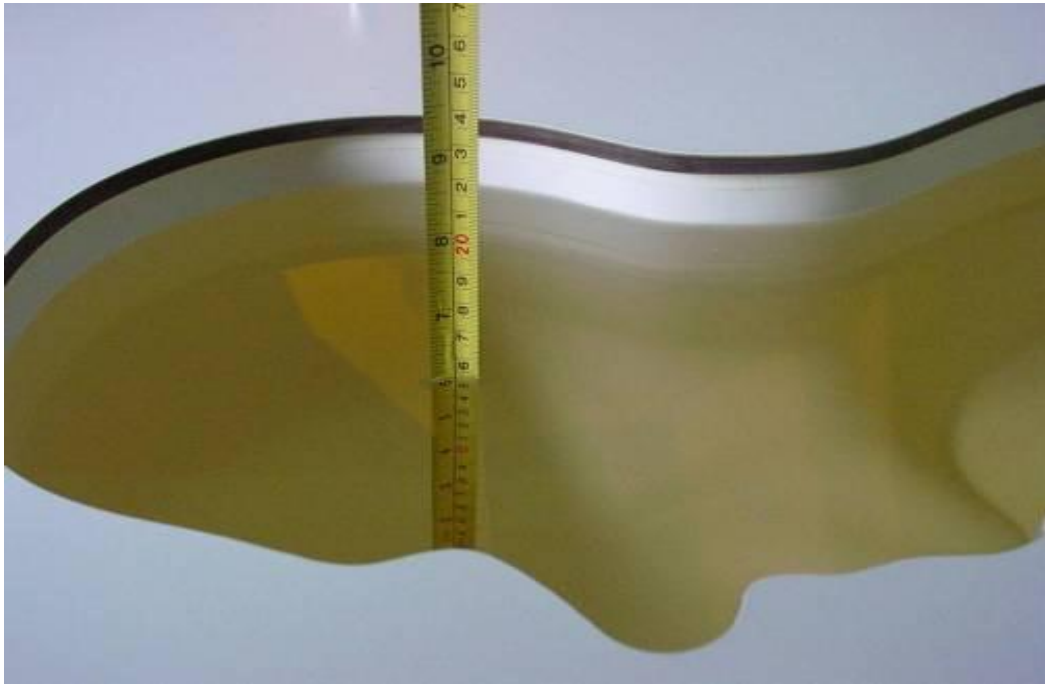

Picture 7-1: Liquid depth in the Head Phantom (750MHz)



Picture 7-2: Liquid depth in the Head Phantom (835MHz)

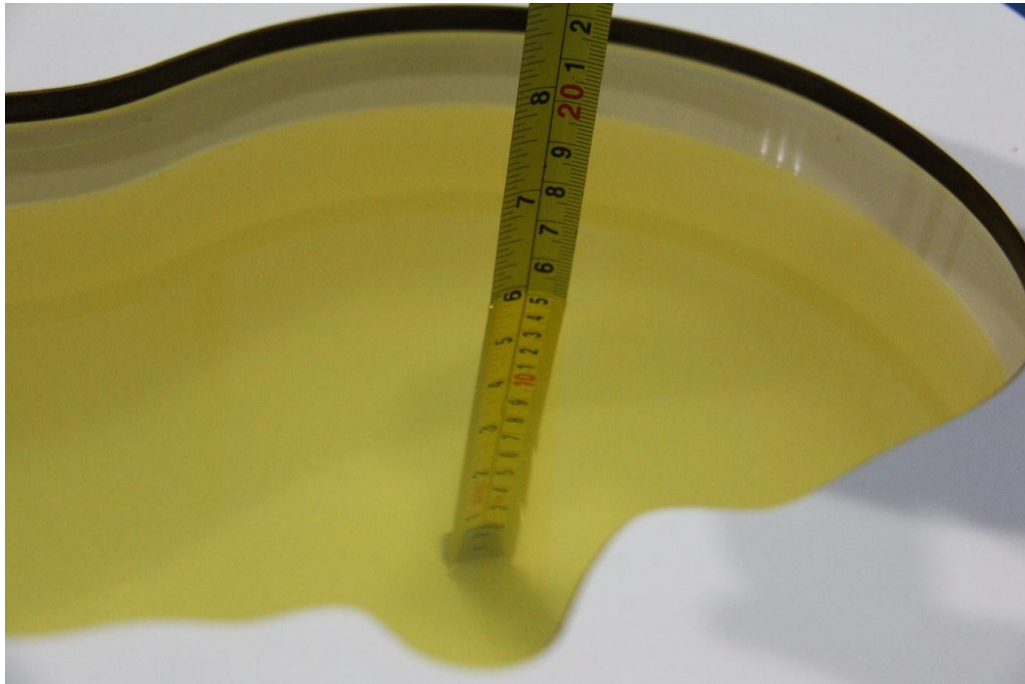

Picture 7-3: Liquid depth in the Head Phantom (1750MHz)



Picture 7-4: Liquid depth in the Head Phantom (1900MHz)

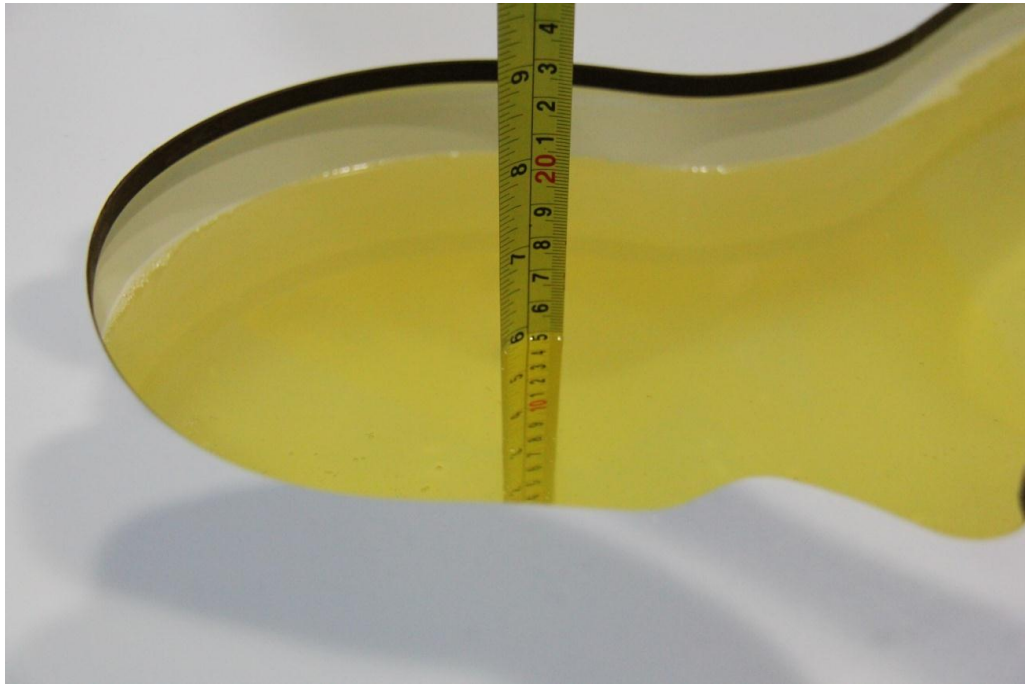

Picture 7-5: Liquid depth in the Head Phantom(2450MHz)

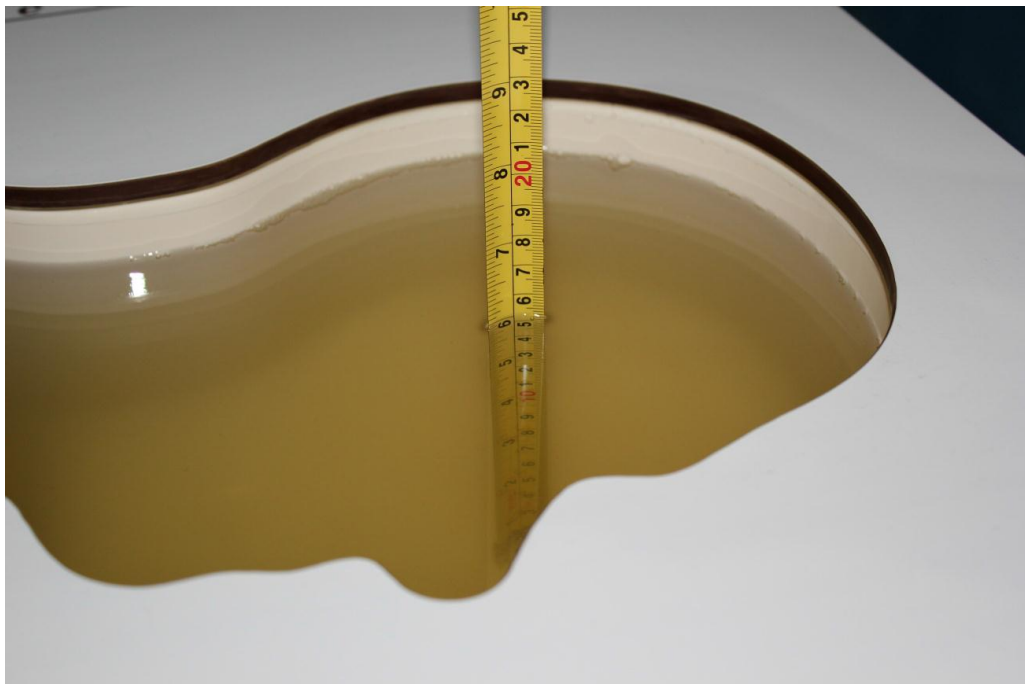

Picture 7-6: Liquid depth in the Head Phantom(2550MHz)

8. System verification

8.1. System Setup

In the simplified setup for system evaluation, the DUT is replaced by a calibrated dipole and the power source is replaced by a continuous wave that comes from a signal generator. The calibrated dipole must be placed beneath the flat phantom section of the SAM twin phantom with the correct distance holder. The distance holder should touch the phantom surface with a light pressure at the reference marking and be oriented parallel to the long side of the phantom. The equipment setup is shown below:

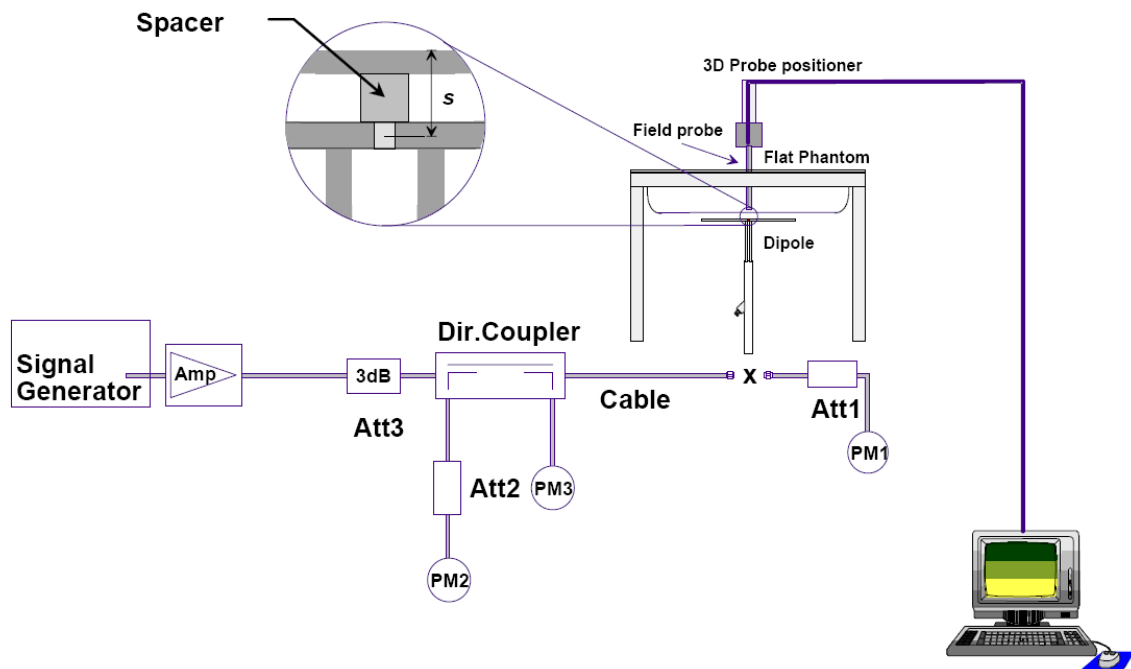

Picture 8.1 System Setup for System Evaluation

For the dipole below 3GHz, the output power on dipole port must be calibrated to 24 dBm (250mW) before dipole is connected.

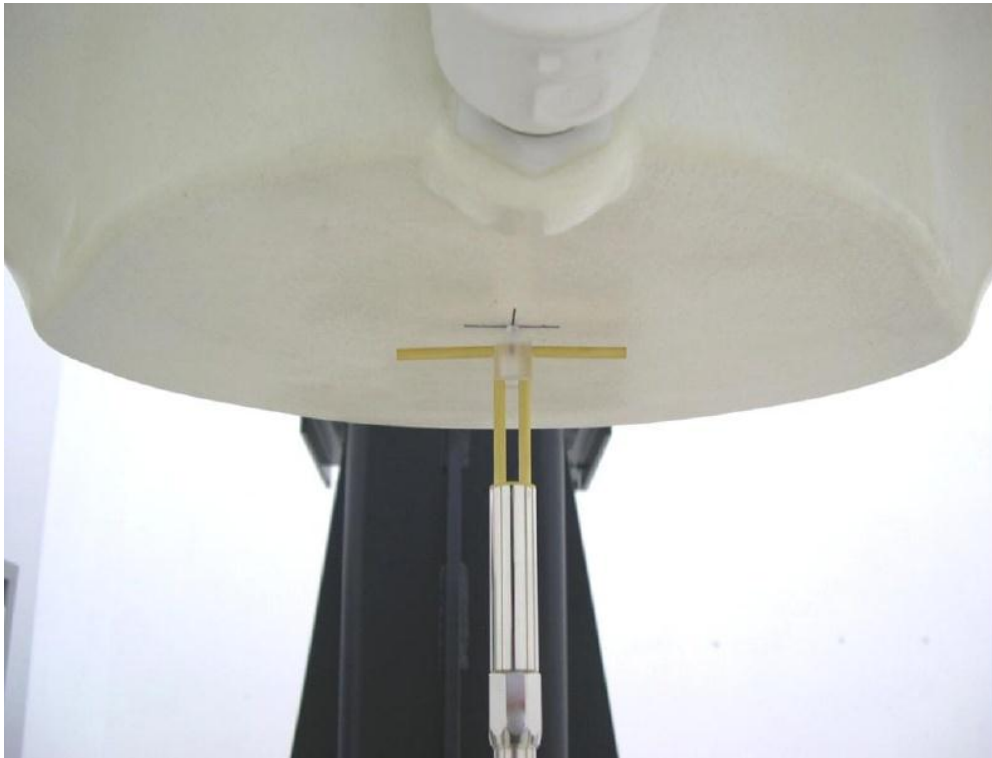

Picture 8.2 Photo of Dipole Setup

8.2. System Verification

SAR system verification is required to confirm measurement accuracy, according to the tissue dielectric media, probe calibration points and other system operating parameters required for measuring the SAR of a test device. The system verification must be performed for each frequency band and within the valid range of each probe calibration point required for testing the device.

Table 8.1: System Verification of Head

Measurement Date	Frequency (MHz)	Target value (W/kg)		Measured value (W/kg)				Deviation (%)	
		10 g	1 g	/		Normalize to 1W		10 g	1 g
				10 g	1 g	10 g	1 g		
2021-06-08	750	5.70	8.53	1.47	2.23	5.88	8.92	3.16	4.57
2021-06-06	835	6.29	9.62	1.55	2.31	6.20	9.24	-1.43	-3.95
2021-06-23	1750	19.30	36.40	4.72	8.70	18.88	34.80	-2.18	-4.40
2021-06-27	1900	21.00	40.50	5.36	10.5	21.44	42.00	2.10	3.70
2021-06-07	2450	24.10	52.00	6.18	13.6	24.72	54.40	2.57	4.62
2021-06-24	2550	26.50	57.80	6.79	15.0	27.16	60.00	2.49	3.81
2021-08-20	750	5.70	8.53	1.45	2.21	5.80	8.84	1.75	3.63
2021-08-22	835	6.29	9.62	1.61	2.50	6.44	10.00	2.38	3.95
2021-08-18	1750	19.30	36.40	4.71	8.73	18.84	34.92	-2.38	-4.07
2021-08-18	1900	21.00	40.50	5.15	9.77	20.60	39.08	-1.90	-3.51
2021-08-13	2450	24.10	52.00	6.19	13.5	24.76	54.00	2.74	3.85
2021-08-15	2550	25.20	55.90	6.47	14.5	25.88	57.92	2.70	3.61

9. Measurement Procedures

9.1. Tests to be performed

In order to determine the highest value of the peak spatial-average SAR of a handset, all device positions, configurations and operational modes shall be tested for each frequency band according to steps 1 to 3 below. A flowchart of the test process is shown in picture 9.1.

Step 1: The tests described in 9.2 shall be performed at the channel that is closest to the center of the transmit frequency band (f_c) for:

- a) all device positions (cheek and tilt, for both left and right sides of the SAM phantom, as described in annex D),
- b) all configurations for each device position in a), e.g., antenna extended and retracted, and
- c) all operational modes, e.g., analogue and digital, for each device position in a) and configuration in b) in each frequency band.

If more than three frequencies need to be tested according to 11.1 (i.e., $N_c > 3$), then all frequencies, configurations and modes shall be tested for all of the above test conditions.

Step 2: For the condition providing highest peak spatial-average SAR determined in Step 1, perform all tests described in 9.2 at all other test frequencies, i.e., lowest and highest frequencies. In addition, for all other conditions (device position, configuration and operational mode) where the peak spatial-average SAR value determined in Step 1 is within 3 dB of the applicable SAR limit, it is recommended that all other test frequencies shall be tested as well.

Step 3: Examine all data to determine the highest value of the peak spatial-average SAR found in Steps 1 to 2.

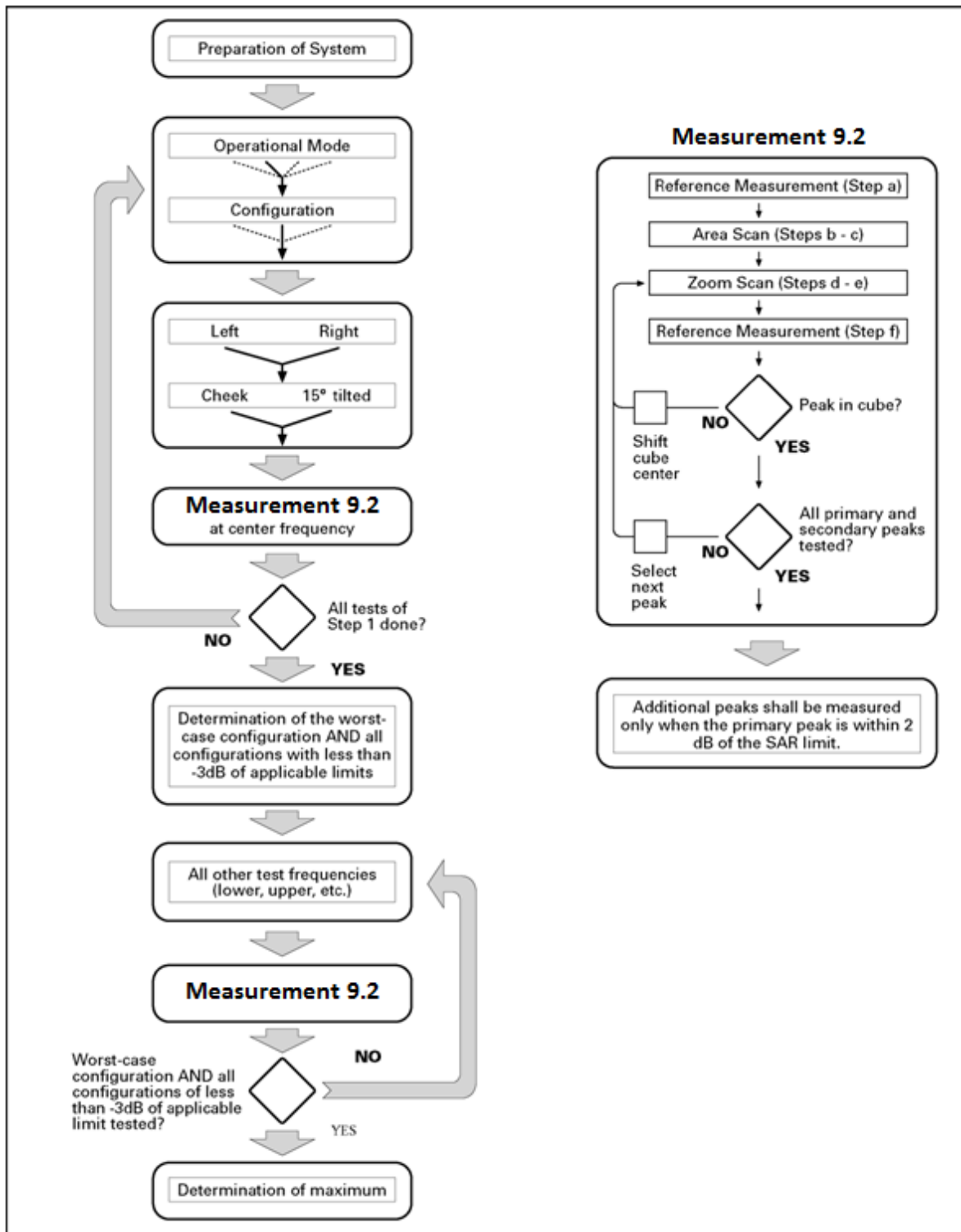

Picture 9.1 Block diagram of the tests to be performed

9.2. General Measurement Procedure

The area and zoom scan resolutions specified in the table below must be applied to the SAR measurements and fully documented in SAR reports to qualify for TCB approval. Probe boundary effect error compensation is required for measurements with the probe tip closer than half a probe tip diameter to the phantom surface. Both the probe tip diameter and sensor offset distance must satisfy measurement protocols; to ensure probe boundary effect errors are minimized and the higher fields closest to the phantom surface can be correctly measured and extrapolated to the phantom surface for computing 1-g SAR. Tolerances of the post-processing algorithms must be verified by the test laboratory for the scan resolutions used in the SAR measurements, according to the reference distribution functions specified in IEEE Std 1528-2013. The results should be documented as part of the system validation records and may be requested to support test results when all the measurement parameters in the following table are not satisfied.

		≤ 3 GHz	> 3 GHz	
Maximum distance from closest measurement point (geometric center of probe sensors) to phantom surface		5 ± 1 mm	$\frac{1}{2} \cdot \delta \cdot \ln(2) \pm 0.5$ mm	
Maximum probe angle from probe axis to phantom surface normal at the measurement location		$30^\circ \pm 1^\circ$	$20^\circ \pm 1^\circ$	
Maximum area scan spatial resolution: Δx_{Area} , Δy_{Area}		≤ 2 GHz: ≤ 15 mm 2 – 3 GHz: ≤ 12 mm	3 – 4 GHz: ≤ 12 mm 4 – 6 GHz: ≤ 10 mm	
		When the x or y dimension of the test device, in the measurement plane orientation, is smaller than the above, the measurement resolution must be \leq the corresponding x or y dimension of the test device with at least one measurement point on the test device.		
Maximum zoom scan spatial resolution: Δx_{Zoom} , Δy_{Zoom}		≤ 2 GHz: ≤ 8 mm 2 – 3 GHz: ≤ 5 mm*	3 – 4 GHz: ≤ 5 mm* 4 – 6 GHz: ≤ 4 mm*	
Maximum zoom scan spatial resolution, normal to phantom surface	uniform grid: $\Delta z_{Zoom}(n)$	≤ 5 mm	3 – 4 GHz: ≤ 4 mm 4 – 5 GHz: ≤ 3 mm 5 – 6 GHz: ≤ 2 mm	
	graded grid	$\Delta z_{Zoom}(1)$: between 1 st two points closest to phantom surface	≤ 4 mm	3 – 4 GHz: ≤ 3 mm 4 – 5 GHz: ≤ 2.5 mm 5 – 6 GHz: ≤ 2 mm
		$\Delta z_{Zoom}(n>1)$: between subsequent points	$\leq 1.5 \cdot \Delta z_{Zoom}(n-1)$	
Minimum zoom scan volume	x, y, z	≥ 30 mm	3 – 4 GHz: ≥ 28 mm 4 – 5 GHz: ≥ 25 mm 5 – 6 GHz: ≥ 22 mm	
Note: δ is the penetration depth of a plane-wave at normal incidence to the tissue medium; see draft standard IEEE P1528-2011 for details. * When zoom scan is required and the <i>reported</i> SAR from the area scan based 1-g SAR estimation procedures of KDB 447498 is ≤ 1.4 W/kg, ≤ 8 mm, ≤ 7 mm and ≤ 5 mm zoom scan resolution may be applied, respectively, for 2 GHz to 3 GHz, 3 GHz to 4 GHz and 4 GHz to 6 GHz.				

9.3. WCDMA Measurement Procedures for SAR

The following procedures are applicable to WCDMA handsets operating under 3GPP Release99, Release 5 and Release 6. The default test configuration is to measure SAR with an established radio link between the DUT and a communication test set using a 12.2kbps RMC (reference measurement channel) configured in Test Loop Mode 1. SAR is selectively confirmed for other physical channel configurations (DPCCH & DPDCH_n), HSDPA and HSPA (HSUPA/HSDPA) modes according to output power, exposure conditions and device operating capabilities. Both uplink and downlink should be configured with the same RMC or AMR, when required. SAR for Release 5 HSDPA and Release 6 HSPA are measured using the applicable FRC (fixed reference channel) and E-DCH reference channel configurations. Maximum output power is verified according to applicable versions of 3GPP TS 34.121 and SAR must be measured according to these maximum output conditions. When Maximum Power Reduction (MPR) is not implemented according to Cubic Metric (CM) requirements for Release 6 HSPA, the following procedures do not apply.

For Release 5 HSDPA Data Devices:

Sub-test	β_c	β_d	β_d (SF)	β_c / β_d	β_{hs}	CM/dB
1	2/15	15/15	64	2/15	4/15	0.0
2	12/15	15/15	64	12/15	24/25	1.0
3	15/15	8/15	64	15/8	30/15	1.5
4	15/15	4/15	64	15/4	30/15	1.5

For Release 6 HSPA Data Devices

Sub-test	β_c	β_d	β_d (SF)	β_c / β_d	β_{hs}	β_{ec}	β_{ed}	β_{ed} (SF)	β_{ed} (codes)	CM (dB)	MPR (dB)	AG Index	E-TFCI
1	11/15	15/15	64	11/15	22/15	209/225	1039/225	4	1	1.0	0.0	20	75
2	6/15	15/15	64	6/15	12/15	12/15	12/15	4	1	3.0	2.0	12	67
3	15/15	9/15	64	15/9	30/15	30/15	$\beta_{ed1}:47/15$ $\beta_{ed2}:47/15$	4	2	2.0	1.0	15	92
4	2/15	15/15	64	2/15	4/15	4/15	56/75	4	1	3.0	2.0	17	71
5	15/15	15/15	64	15/15	24/15	30/15	134/15	4	1	1.0	0.0	21	81

9.4. SAR Measurement for LTE

SAR tests for LTE are performed with a base station simulator, Anristu MT8820C. Closed loop power control was used so the UE transmits with maximum output power during SAR testing. All powers were measured with the Anristu MT8820C. It is performed for conducted power and SAR based on the KDB941225 D05.

SAR is evaluated separately according to the following procedures for the different test positions in each exposure condition – head, body, body-worn accessories and other use conditions. The procedures in the following subsections are applied separately to test each LTE frequency band.

1) QPSK with 1 RB allocation

Start with the largest channel bandwidth and measure SAR for QPSK with 1 RB allocation, using the RB offset and required test channel combination with the highest maximum output power among RB offsets at the upper edge, middle and lower edge of each required test channel. When the reported SAR is ≤ 0.8 W/kg, testing of the remaining RB offset configurations and required test channels is not required for 1 RB allocation; otherwise, SAR is required for the remaining required test channels and only for the RB offset configuration with the highest output power for that channel. When the reported SAR of a required test channel is > 1.45 W/kg, SAR is required for all three RB offset configurations for that required test channel.

2) QPSK with 50% RB allocation

The procedures required for 1 RB allocation in 1) are applied to measure the SAR for QPSK with 50% RB allocation.

3) QPSK with 100% RB allocation

For QPSK with 100% RB allocation, SAR is not required when the highest maximum output power for 100 % RB allocation is less than the highest maximum output power in 50% and 1 RB allocations and the highest reported SAR for 1 RB and 50% RB allocation in 1) and 2) are ≤ 0.8 W/kg. Otherwise, SAR is measured for the highest output power channel; and if the reported SAR is > 1.45 W/kg, the remaining required test channels must also be tested.

9.5. Bluetooth & WLAN Measurement Procedures for SAR

Normal network operating configurations are not suitable for measuring the SAR of 802.11 transmitters in general. Unpredictable fluctuations in network traffic and antenna diversity conditions can introduce undesirable variations in SAR results. The SAR for these devices should be measured using chipset based test mode software to ensure that the results are consistent and reliable.

Chipset based test mode software is hardware dependent and generally varies among manufacturers. The device operating parameters established in a test mode for SAR measurements must be identical to those programmed in production units, including output power levels, amplifier gain settings and other RF performance tuning parameters. The test frequencies should correspond to actual channel frequencies defined for domestic use. SAR for devices with switched diversity should be measured with only one antenna transmitting at a time during each SAR measurement, according to a fixed modulation and data rate. The same data pattern should be used for all measurements.



9.6. Power Drift

To control the output power stability during the SAR test, DASY5 system calculates the power drift by measuring the E-field at the same location at the beginning and at the end of the measurement for each test position. These drift values can be found in Section 14 labeled as: (Power Drift [dB]). This ensures that the power drift during one measurement is within 5%.

10. Conducted Output Power

10.1. GSM Measurement result

During the process of testing, the EUT was controlled via Agilent Digital Radio Communication tester (E5515C) to ensure the maximum power transmission and proper modulation. This result contains conducted output power for the EUT. In all cases, the measured peak output power should be greater and within 5% than EMI measurement.

Table 10.1: The conducted power measurement results for GSM

GSM850	Tune up	Conducted Power(dBm)		
		Ch.251 (848.8MHz)	Ch.190 (836.6MHz)	Ch.128 (824.2MHz)
	33.5	33.42	33.30	33.43
Full Power				
GSM1900	Tune up	Conducted Power(dBm)		
		Ch.810 (1909.8MHz)	Ch.661 (1880MHz)	Ch.512 (1850.2MHz)
	30.5	30.20	30.35	30.35
Reduced power level 1				
GSM1900	Tune up	Conducted Power(dBm)		
		Ch.810 (1909.8MHz)	Ch.661 (1880MHz)	Ch.512 (1850.2MHz)
	27.5	26.51	26.76	27.00

Table 10.2: The conducted power measurement results for GPRS and EGPRS

GPRS850/ EGPRS850	Tune up	Measured Power (dBm)			calculation	Average Power (dBm)		
		251	190	128		251	190	128
1Tx-slots	33.5	33.41	33.27	33.41	-9.03dB	24.38	24.24	24.38
2Tx-slots	32.0	31.38	31.33	31.54	-6.02dB	25.36	25.31	25.52
3Tx-slots	30.0	29.57	29.51	29.72	-4.26dB	25.31	25.25	25.46
4Tx-slots	28.5	27.61	27.63	27.74	-3.01dB	24.60	24.62	24.73
EGPRS850 (8PSK)	Tune up	Measured Power (dBm)			calculation	Measured Power (dBm)		
		251	190	128		251	190	128
1Tx-slots	27.5	26.38	26.49	26.52	-9.03dB	17.35	17.46	17.49
2Tx-slots	27.5	26.17	26.15	26.48	-6.02dB	20.15	20.13	20.46
3Tx-slots	26.0	25.14	25.16	25.44	-4.26dB	20.88	20.90	21.18
4Tx-slots	24.0	22.71	22.70	23.06	-3.01dB	19.70	19.69	20.05
GPRS1900/ EGPRS1900	Tune up	Measured Power (dBm)			calculation	Average Power (dBm)		
		810	661	512		810	661	512
1Tx-slots	31.0	30.17	30.32	30.33	-9.03dB	21.14	21.29	21.30
2Tx-slots	29.5	27.83	27.99	28.29	-6.02dB	21.81	21.97	22.27
3Tx-slots	28.0	26.26	26.42	26.72	-4.26dB	22.00	22.16	22.46
4Tx-slots	25.5	24.17	24.36	24.66	-3.01dB	21.16	21.35	21.65
EGPRS1900 (8PSK)	Tune up	Measured Power (dBm)			calculation	Measured Power (dBm)		
		810	661	512		810	661	512
1Tx-slots	27.5	26.48	26.54	26.14	-9.03dB	17.45	17.51	17.11
2Tx-slots	27.5	26.32	26.37	26.12	-6.02dB	20.30	20.35	20.10
3Tx-slots	25.5	24.58	24.69	24.23	-4.26dB	20.32	20.43	19.97
4Tx-slots	23.0	21.80	22.09	21.71	-3.01dB	18.79	19.08	18.70

Note:

1) Division Factors

To average the power, the division factor is as follows:

1TX-slot = 1 transmit time slot out of 8 time slots=> conducted power divided by (8/1) => -9.03dB

2TX-slots = 2 transmit time slots out of 8 time slots=> conducted power divided by (8/2) => -6.02dB

3TX-slots = 3 transmit time slots out of 8 time slots=> conducted power divided by (8/3) => -4.26dB

4TX-slots = 4 transmit time slots out of 8 time slots=> conducted power divided by (8/4) => -3.01dB

According to the conducted power as above, the body measurements are performed with 2Txslots for 850MHz and 3Txslots 1900MHz.

10.2. WCDMA Measurement result

Table 10.3: T The conducted power measurement results WCDMA

Full Power					
Item	band	WCDMA Band 2			
	ARFCN	Tune up	Ch.9538 (1907.6MHz)	Ch.9400 (1880MHz)	Ch.9262 (1852.4MHz)
WCDMA	\	23.5	22.6	22.6	22.3
HSUPA	1	21.5	19.9	19.8	19.7
	2	21.5	20.4	20.4	20.3
	3	21.5	20.2	20.1	19.9
	4	21.5	20.7	20.8	20.5
	5	23.5	22.4	22.5	22.4
HSDPA	1	23.5	22.6	22.6	22.5
	2	23.5	22.2	22.2	22.1
	3	23.5	22.1	22.1	21.9
	4	23.5	22.1	22.1	22.0
DC-HSDPA	1	23.5	22.6	22.6	22.5
	2	23.5	22.2	22.2	22.1
	3	23.5	22.1	22.1	21.9
	4	23.5	22.1	22.1	22.0
Reduced power level 1					
Item	band	WCDMA Band 2			
	ARFCN	Tune up	Ch.9538 (1907.6MHz)	Ch.9400 (1880MHz)	Ch.9262 (1852.4MHz)
WCDMA	\	19.5	18.8	18.6	18.4
HSUPA	1	18.0	16.8	16.5	16.3
	2	18.0	17.1	16.8	16.5
	3	18.0	17.1	16.9	16.5
	4	18.0	17.1	16.9	16.4
	5	19.5	18.7	18.6	18.3
HSDPA	1	19.5	18.6	18.5	18.3
	2	19.5	18.3	18.3	18.0
	3	19.5	18.2	18.1	17.8
	4	19.5	18.2	18.1	17.8
DC-HSDPA	1	19.5	18.5	18.4	18.3
	2	19.5	18.3	18.3	18.3
	3	19.5	18.2	18.1	18.0
	4	19.5	18.1	18.1	18.0

Full Power					
Item	band	WCDMA Band 4			
	ARFCN	Tune up	Ch.1513 (1752.6MHz)	Ch.1413 (1732.6MHz)	Ch.1312 (1712.4MHz)
WCDMA	\	24.0	23.3	23.5	23.6
HSUPA	1	21.5	20.0	20.3	20.1
	2	21.5	19.8	20.1	19.9
	3	21.5	20.1	20.3	21.0
	4	21.5	20.2	20.4	12.7
	5	23.5	22.3	22.4	22.3
HSDPA	1	23.5	21.8	21.9	22.0
	2	23.5	22.4	22.5	22.5
	3	23.5	22.3	22.5	22.4
	4	23.5	22.3	22.5	22.5
DC-HSDPA	1	23.5	21.8	21.9	22.0
	2	23.5	22.4	22.5	22.5
	3	23.5	22.3	22.5	22.4
	4	23.5	22.3	22.5	22.5
Reduced power level 1					
Item	band	WCDMA Band 4			
	ARFCN	Tune up	Ch.1513 (1752.6MHz)	Ch.1413 (1732.6MHz)	Ch.1312 (1712.4MHz)
WCDMA	\	19.5	18.4	18.5	18.4
HSUPA	1	17.0	15.8	16.0	15.9
	2	17.0	15.3	15.4	15.3
	3	17.0	15.9	16.0	16.0
	4	17.0	15.3	15.3	15.3
	5	18.5	17.4	17.4	17.4
HSDPA	1	18.5	16.9	16.9	16.9
	2	18.5	17.5	17.6	17.5
	3	18.5	17.5	17.6	17.5
	4	18.5	17.5	17.6	17.5
DC-HSDPA	1	18.5	17.0	17.1	17.0
	2	18.5	17.6	17.6	17.6
	3	18.5	17.4	17.6	17.3
	4	18.5	17.5	17.5	17.5

Item	band	WCDMA Band 5			
	ARFCN	Tune up	Ch.4233 (846.6MHz)	Ch.4182 (836.4MHz)	Ch.4132 (826.4MHz)
WCDMA	\	24.0	23.3	23.2	23.4
HSUPA	1	21.5	20.4	20.4	20.9
	2	21.5	20.8	20.6	21.1
	3	21.5	20.4	20.5	20.8
	4	21.5	20.4	20.5	20.9
	5	23.5	22.2	22.1	22.4
HSDPA	1	23.5	22.5	22.3	22.8
	2	23.5	22.1	22.0	22.4
	3	23.5	21.8	21.7	22.0
	4	23.5	21.8	21.7	22.1
DC-HSDPA	1	23.5	22.5	22.4	22.6
	2	23.5	22.1	22.0	22.3
	3	23.5	21.8	21.8	22.0
	4	23.5	21.8	21.7	21.9

10.3. LTE Measurement result

According to April 2015 TCB workshop, SAR Test exclusion can be applied for testing overlapping LTE Bands as follows:

- The maximum out power, including tolerance, for the smaller band must be \leq the larger band to qualify for SAR test exclusion.
- The channel bandwidth and other operating parameters for the smaller band must be fully supported by the larger band.

LTE Band 4 (1710-1755 MHz) is covered by LTE Band 66 (1710-1780 MHz)

LTE Band 17 (704-716 MHz) is covered by LTE Band 12 (699-716 MHz)

Table 10.4: The conducted Power for LTE

Full Power								
LTE Band 2			Actual output Power (dBm)			Tune up		
Band -width	RB No. / RB offset	Frequency	Modulation			Modulation		
			QPSK	16QAM	64QAM	QPSK	16QAM	64QAM
1.4 MHz	1RB_5	1909.3MHz	22.06	21.74	/	23.0	22.0	/
		1880.0MHz	21.97	21.18	/	23.0	22.0	/
		1850.7MHz	21.74	21.28	/	23.0	22.0	/
	1RB_3	1909.3MHz	22.10	21.78	/	23.0	22.0	/
		1880.0MHz	21.97	21.12	/	23.0	22.0	/
		1850.7MHz	21.79	21.28	/	23.0	22.0	/
	1RB_0	1909.3MHz	22.14	21.70	/	23.0	22.0	/
		1880.0MHz	22.00	21.11	/	23.0	22.0	/
		1850.7MHz	21.74	21.31	/	23.0	22.0	/
	3RB_3	1909.3MHz	22.26	21.43	/	23.0	22.0	/
		1880.0MHz	22.06	21.15	/	23.0	22.0	/
		1850.7MHz	21.73	21.07	/	23.0	22.0	/
	3RB_1	1909.3MHz	22.26	21.51	/	23.0	22.0	/
		1880.0MHz	22.12	21.15	/	23.0	22.0	/
		1850.7MHz	21.80	21.14	/	23.0	22.0	/
	3RB_0	1909.3MHz	22.24	21.44	/	23.0	22.0	/
		1880.0MHz	22.07	21.10	/	23.0	22.0	/
		1850.7MHz	21.75	21.06	/	23.0	22.0	/
	6RB_0	1909.3MHz	21.18	20.99	/	22.0	21.0	/
		1880.0MHz	20.90	21.48	/	22.0	21.0	/
		1850.7MHz	20.79	20.92	/	22.0	21.0	/



Full Power								
LTE Band 2			Actual output Power (dBm)			Tune up		
Band -width	RB No. / RB offset	Frequency	Modulation			Modulation		
			QPSK	16QAM	64QAM	QPSK	16QAM	64QAM
3 MHz	1RB_14	1908.5MHz	22.10	21.76	/	23.0	22.0	/
		1880.0MHz	22.00	21.24	/	23.0	22.0	/
		1851.5MHz	21.74	21.33	/	23.0	22.0	/
	1RB_7	1908.5MHz	22.14	21.88	/	23.0	22.0	/
		1880.0MHz	22.04	21.18	/	23.0	22.0	/
		1851.5MHz	21.73	21.32	/	23.0	22.0	/
	1RB_0	1908.5MHz	22.17	21.77	/	23.0	22.0	/
		1880.0MHz	21.90	21.19	/	23.0	22.0	/
		1851.5MHz	21.79	21.38	/	23.0	22.0	/
	8RB_7	1908.5MHz	21.17	20.86	/	22.0	21.0	/
		1880.0MHz	21.07	20.87	/	22.0	21.0	/
		1851.5MHz	20.80	20.88	/	22.0	21.0	/
	8RB_4	1908.5MHz	21.17	20.82	/	22.0	21.0	/
		1880.0MHz	21.12	20.88	/	22.0	21.0	/
		1851.5MHz	20.86	20.94	/	22.0	21.0	/
	8RB_0	1908.5MHz	21.27	20.89	/	22.0	21.0	/
		1880.0MHz	20.98	20.91	/	22.0	21.0	/
		1851.5MHz	20.84	20.92	/	22.0	21.0	/
	15RB_0	1908.5MHz	21.14	20.85	/	22.0	21.0	/
		1880.0MHz	20.97	20.91	/	22.0	21.0	/
		1851.5MHz	20.83	20.87	/	22.0	21.0	/



Full Power								
LTE Band 2			Actual output Power (dBm)			Tune up		
Band -width	RB No. / RB offset	Frequency	Modulation			Modulation		
			QPSK	16QAM	64QAM	QPSK	16QAM	64QAM
5 MHz	1RB_24	1907.5MHz	22.20	21.80	/	23.0	22.0	/
		1880.0MHz	22.03	21.66	/	23.0	22.0	/
		1852.5MHz	21.56	21.31	/	23.0	22.0	/
	1RB_12	1907.5MHz	22.11	21.83	/	23.0	22.0	/
		1880.0MHz	21.92	21.69	/	23.0	22.0	/
		1852.5MHz	21.62	21.38	/	23.0	22.0	/
	1RB_0	1907.5MHz	22.14	21.83	/	23.0	22.0	/
		1880.0MHz	21.92	21.60	/	23.0	22.0	/
		1852.5MHz	21.62	21.39	/	23.0	22.0	/
	12RB_13	1907.5MHz	21.22	20.54	/	22.0	21.0	/
		1880.0MHz	21.10	20.86	/	22.0	21.0	/
		1852.5MHz	20.75	20.54	/	22.0	21.0	/
	12RB_6	1907.5MHz	21.22	20.90	/	22.0	21.0	/
		1880.0MHz	21.00	20.87	/	22.0	21.0	/
		1852.5MHz	20.67	20.70	/	22.0	21.0	/
	12RB_0	1907.5MHz	21.23	20.92	/	22.0	21.0	/
		1880.0MHz	21.03	20.92	/	22.0	21.0	/
		1852.5MHz	20.79	20.60	/	22.0	21.0	/
	25RB_0	1907.5MHz	21.18	20.74	/	22.0	21.0	/
		1880.0MHz	21.01	20.89	/	22.0	21.0	/
		1852.5MHz	20.77	20.56	/	22.0	21.0	/



Full Power								
LTE Band 2			Actual output Power (dBm)			Tune up		
Band -width	RB No. / RB offset	Frequency	Modulation			Modulation		
			QPSK	16QAM	64QAM	QPSK	16QAM	64QAM
10 MHz	1RB_49	1905.0MHz	22.10	21.56	/	23.0	22.0	/
		1880.0MHz	21.89	21.56	/	23.0	22.0	/
		1855.0MHz	21.71	21.24	/	23.0	22.0	/
	1RB_24	1905.0MHz	22.05	21.63	/	23.0	22.0	/
		1880.0MHz	21.82	21.44	/	23.0	22.0	/
		1855.0MHz	21.83	21.21	/	23.0	22.0	/
	1RB_0	1905.0MHz	22.06	21.51	/	23.0	22.0	/
		1880.0MHz	21.80	21.41	/	23.0	22.0	/
		1855.0MHz	21.72	21.22	/	23.0	22.0	/
	25RB_25	1905.0MHz	21.26	20.84	/	22.0	21.0	/
		1880.0MHz	21.12	20.99	/	22.0	21.0	/
		1855.0MHz	20.73	20.98	/	22.0	21.0	/
	25RB_12	1905.0MHz	21.23	20.97	/	22.0	21.0	/
		1880.0MHz	20.98	20.86	/	22.0	21.0	/
		1855.0MHz	20.79	20.65	/	22.0	21.0	/
	25RB_0	1905.0MHz	21.25	20.93	/	22.0	21.0	/
		1880.0MHz	20.99	20.84	/	22.0	21.0	/
		1855.0MHz	20.84	20.56	/	22.0	21.0	/
	50RB_0	1905.0MHz	21.23	20.99	/	22.0	21.0	/
		1880.0MHz	20.94	20.92	/	22.0	21.0	/
		1855.0MHz	20.76	20.77	/	22.0	21.0	/



Full Power								
LTE Band 2			Actual output Power (dBm)			Tune up		
Band -width	RB No. / RB offset	Frequency	Modulation			Modulation		
			QPSK	16QAM	64QAM	QPSK	16QAM	64QAM
15 MHz	1RB_74	1902.5MHz	22.19	21.83	/	23.0	22.0	/
		1880.0MHz	21.88	21.54	/	23.0	22.0	/
		1857.5MHz	21.68	21.42	/	23.0	22.0	/
	1RB_37	1902.5MHz	22.13	21.80	/	23.0	22.0	/
		1880.0MHz	21.81	21.38	/	23.0	22.0	/
		1857.5MHz	21.62	21.28	/	23.0	22.0	/
	1RB_0	1902.5MHz	22.05	21.74	/	23.0	22.0	/
		1880.0MHz	21.79	21.37	/	23.0	22.0	/
		1857.5MHz	21.67	21.41	/	23.0	22.0	/
	36RB_38	1902.5MHz	21.30	20.66	/	22.0	21.0	/
		1880.0MHz	21.06	20.85	/	22.0	21.0	/
		1857.5MHz	20.74	20.96	/	22.0	21.0	/
	36RB_19	1902.5MHz	21.27	20.93	/	22.0	21.0	/
		1880.0MHz	21.03	20.80	/	22.0	21.0	/
		1857.5MHz	20.85	20.73	/	22.0	21.0	/
	36RB_0	1902.5MHz	21.24	20.88	/	22.0	21.0	/
		1880.0MHz	20.95	20.98	/	22.0	21.0	/
		1857.5MHz	20.83	20.69	/	22.0	21.0	/
	75RB_0	1902.5MHz	21.12	20.77	/	22.0	21.0	/
		1880.0MHz	20.92	20.90	/	22.0	21.0	/
		1857.5MHz	20.82	20.83	/	22.0	21.0	/

Full Power								
LTE Band 2			Actual output Power (dBm)			Tune up		
Band -width	RB No. / RB offset	Frequency	Modulation			Modulation		
			QPSK	16QAM	64QAM	QPSK	16QAM	64QAM
20 MHz	1RB_99	1900.0MHz	22.05	21.63	/	23.0	22.0	/
		1880.0MHz	22.18	21.06	/	23.0	22.0	/
		1860.0MHz	21.69	21.40	/	23.0	22.0	/
	1RB_50	1900.0MHz	22.06	21.61	/	23.0	22.0	/
		1880.0MHz	21.93	20.78	/	23.0	22.0	/
		1860.0MHz	21.67	21.33	/	23.0	22.0	/
	1RB_0	1900.0MHz	21.97	21.52	/	23.0	22.0	/
		1880.0MHz	21.90	20.72	/	23.0	22.0	/
		1860.0MHz	21.72	21.34	/	23.0	22.0	/
	50RB_50	1900.0MHz	21.21	20.87	/	22.0	21.0	/
		1880.0MHz	21.14	20.85	/	22.0	21.0	/
		1860.0MHz	20.86	20.63	/	22.0	21.0	/
	50RB_25	1900.0MHz	21.23	20.95	/	22.0	21.0	/
		1880.0MHz	20.90	20.65	/	22.0	21.0	/
		1860.0MHz	20.75	20.89	/	22.0	21.0	/
	50RB_0	1900.0MHz	21.19	20.93	/	22.0	21.0	/
		1880.0MHz	21.04	20.81	/	22.0	21.0	/
		1860.0MHz	20.72	20.65	/	22.0	21.0	/
	100RB_0	1900.0MHz	21.17	20.98	/	22.0	21.0	/
		1880.0MHz	21.03	20.90	/	22.0	21.0	/
		1860.0MHz	20.87	20.98	/	22.0	21.0	/



Reduced power level 1								
LTE Band 2			Actual output Power (dBm)			Tune up		
Band -width	RB No. / RB offset	Frequency	Modulation			Modulation		
			QPSK	16QAM	64QAM	QPSK	16QAM	64QAM
1.4 MHz	1RB_5	1909.3MHz	18.67	17.73	/	20.5	19.5	/
		1880.0MHz	18.79	18.11	/	20.5	19.5	/
		1850.7MHz	18.64	17.62	/	20.5	19.5	/
	1RB_3	1909.3MHz	18.60	18.04	/	20.5	19.5	/
		1880.0MHz	18.99	18.31	/	20.5	19.5	/
		1850.7MHz	18.63	17.82	/	20.5	19.5	/
	1RB_0	1909.3MHz	18.53	17.95	/	20.5	19.5	/
		1880.0MHz	18.84	18.11	/	20.5	19.5	/
		1850.7MHz	18.74	17.59	/	20.5	19.5	/
	3RB_3	1909.3MHz	18.51	17.58	/	20.5	19.5	/
		1880.0MHz	18.94	17.91	/	20.5	19.5	/
		1850.7MHz	18.59	17.58	/	20.5	19.5	/
	3RB_1	1909.3MHz	18.64	17.72	/	20.5	19.5	/
		1880.0MHz	19.02	17.98	/	20.5	19.5	/
		1850.7MHz	18.65	17.55	/	20.5	19.5	/
	3RB_0	1909.3MHz	18.61	17.70	/	20.5	19.5	/
		1880.0MHz	18.97	17.93	/	20.5	19.5	/
		1850.7MHz	18.59	17.57	/	20.5	19.5	/
	6RB_0	1909.3MHz	17.67	16.93	/	19.5	18.5	/
		1880.0MHz	17.90	17.21	/	19.5	18.5	/
		1850.7MHz	17.60	16.73	/	19.5	18.5	/



Reduced power level 1								
LTE Band 2			Actual output Power (dBm)			Tune up		
Band -width	RB No. / RB offset	Frequency	Modulation			Modulation		
			QPSK	16QAM	64QAM	QPSK	16QAM	64QAM
3 MHz	1RB_14	1908.5MHz	18.77	17.78	/	20.5	19.5	/
		1880.0MHz	18.83	18.03	/	20.5	19.5	/
		1851.5MHz	18.67	17.60	/	20.5	19.5	/
	1RB_7	1908.5MHz	18.80	18.15	/	20.5	19.5	/
		1880.0MHz	19.03	18.21	/	20.5	19.5	/
		1851.5MHz	18.66	17.80	/	20.5	19.5	/
	1RB_0	1908.5MHz	18.78	18.15	/	20.5	19.5	/
		1880.0MHz	18.89	18.14	/	20.5	19.5	/
		1851.5MHz	18.67	17.62	/	20.5	19.5	/
	8RB_7	1908.5MHz	17.75	16.98	/	19.5	18.5	/
		1880.0MHz	17.90	17.18	/	19.5	18.5	/
		1851.5MHz	17.62	16.70	/	19.5	18.5	/
	8RB_4	1908.5MHz	17.87	17.11	/	19.5	18.5	/
		1880.0MHz	17.96	17.24	/	19.5	18.5	/
		1851.5MHz	17.63	16.74	/	19.5	18.5	/
	8RB_0	1908.5MHz	17.94	17.18	/	19.5	18.5	/
		1880.0MHz	17.95	17.23	/	19.5	18.5	/
		1851.5MHz	17.54	16.71	/	19.5	18.5	/
	15RB_0	1908.5MHz	17.84	17.07	/	19.5	18.5	/
		1880.0MHz	17.93	17.17	/	19.5	18.5	/
		1851.5MHz	17.69	16.68	/	19.5	18.5	/

Reduced power level 1								
LTE Band 2			Actual output Power (dBm)			Tune up		
Band -width	RB No. / RB offset	Frequency	Modulation			Modulation		
			QPSK	16QAM	64QAM	QPSK	16QAM	64QAM
5 MHz	1RB_24	1907.5MHz	18.68	17.69	/	20.5	19.5	/
		1880.0MHz	18.59	17.75	/	20.5	19.5	/
		1852.5MHz	18.77	17.62	/	20.5	19.5	/
	1RB_12	1907.5MHz	18.93	18.31	/	20.5	19.5	/
		1880.0MHz	19.11	18.29	/	20.5	19.5	/
		1852.5MHz	18.63	17.83	/	20.5	19.5	/
	1RB_0	1907.5MHz	18.73	18.11	/	20.5	19.5	/
		1880.0MHz	18.67	17.85	/	20.5	19.5	/
		1852.5MHz	18.76	17.55	/	20.5	19.5	/
	12RB_13	1907.5MHz	17.74	16.90	/	19.5	18.5	/
		1880.0MHz	17.81	17.04	/	19.5	18.5	/
		1852.5MHz	17.68	16.53	/	19.5	18.5	/
	12RB_6	1907.5MHz	18.07	17.20	/	19.5	18.5	/
		1880.0MHz	17.99	17.22	/	19.5	18.5	/
		1852.5MHz	17.69	16.71	/	19.5	18.5	/
	12RB_0	1907.5MHz	18.07	17.23	/	19.5	18.5	/
		1880.0MHz	17.88	17.11	/	19.5	18.5	/
		1852.5MHz	17.66	16.59	/	19.5	18.5	/
	25RB_0	1907.5MHz	17.91	17.01	/	19.5	18.5	/
		1880.0MHz	17.86	17.07	/	19.5	18.5	/
		1852.5MHz	17.75	16.55	/	19.5	18.5	/



Reduced power level 1								
LTE Band 2			Actual output Power (dBm)			Tune up		
Band -width	RB No. / RB offset	Frequency	Modulation			Modulation		
			QPSK	16QAM	64QAM	QPSK	16QAM	64QAM
10 MHz	1RB_49	1905.0MHz	18.95	18.33	/	20.5	19.5	/
		1880.0MHz	19.34	18.48	/	20.5	19.5	/
		1855.0MHz	19.13	18.20	/	20.5	19.5	/
	1RB_24	1905.0MHz	19.20	18.59	/	20.5	19.5	/
		1880.0MHz	19.08	18.24	/	20.5	19.5	/
		1855.0MHz	18.52	17.58	/	20.5	19.5	/
	1RB_0	1905.0MHz	19.52	18.87	/	20.5	19.5	/
		1880.0MHz	19.01	18.13	/	20.5	19.5	/
		1855.0MHz	18.70	17.68	/	20.5	19.5	/
	25RB_25	1905.0MHz	18.31	17.50	/	19.5	18.5	/
		1880.0MHz	18.20	17.38	/	19.5	18.5	/
		1855.0MHz	17.76	16.90	/	19.5	18.5	/
	25RB_12	1905.0MHz	18.42	17.58	/	19.5	18.5	/
		1880.0MHz	18.03	17.23	/	19.5	18.5	/
		1855.0MHz	17.64	16.60	/	19.5	18.5	/
	25RB_0	1905.0MHz	18.60	17.75	/	19.5	18.5	/
		1880.0MHz	18.01	17.23	/	19.5	18.5	/
		1855.0MHz	17.73	16.59	/	19.5	18.5	/
	50RB_0	1905.0MHz	18.46	17.64	/	19.5	18.5	/
		1880.0MHz	18.09	17.30	/	19.5	18.5	/
		1855.0MHz	17.55	16.71	/	19.5	18.5	/



Reduced power level 1								
LTE Band 2			Actual output Power (dBm)			Tune up		
Band -width	RB No. / RB offset	Frequency	Modulation			Modulation		
			QPSK	16QAM	64QAM	QPSK	16QAM	64QAM
15 MHz	1RB_74	1902.5MHz	18.98	17.54	/	20.5	19.5	/
		1880.0MHz	18.96	18.43	/	20.5	19.5	/
		1857.5MHz	18.80	18.27	/	20.5	19.5	/
	1RB_37	1902.5MHz	18.83	18.26	/	20.5	19.5	/
		1880.0MHz	18.99	18.26	/	20.5	19.5	/
		1857.5MHz	18.58	17.84	/	20.5	19.5	/
	1RB_0	1902.5MHz	19.22	18.79	/	20.5	19.5	/
		1880.0MHz	19.05	18.51	/	20.5	19.5	/
		1857.5MHz	18.94	17.85	/	20.5	19.5	/
	36RB_38	1902.5MHz	17.69	16.75	/	19.5	18.5	/
		1880.0MHz	18.07	17.25	/	19.5	18.5	/
		1857.5MHz	17.80	16.93	/	19.5	18.5	/
	36RB_19	1902.5MHz	17.94	17.02	/	19.5	18.5	/
		1880.0MHz	17.99	17.19	/	19.5	18.5	/
		1857.5MHz	17.51	16.67	/	19.5	18.5	/
	36RB_0	1902.5MHz	18.32	17.40	/	19.5	18.5	/
		1880.0MHz	18.18	17.38	/	19.5	18.5	/
		1857.5MHz	17.51	16.64	/	19.5	18.5	/
	75RB_0	1902.5MHz	18.01	17.08	/	19.5	18.5	/
		1880.0MHz	18.12	17.32	/	19.5	18.5	/
		1857.5MHz	17.66	16.80	/	19.5	18.5	/

Reduced power level 1								
LTE Band 2			Actual output Power (dBm)			Tune up		
Band -width	RB No. / RB offset	Frequency	Modulation			Modulation		
			QPSK	16QAM	64QAM	QPSK	16QAM	64QAM
20 MHz	1RB_99	1900.0MHz	18.76	18.29	/	20.5	19.5	/
		1880.0MHz	19.85	19.03	/	20.5	19.5	/
		1860.0MHz	19.32	18.95	/	20.5	19.5	/
	1RB_50	1900.0MHz	19.00	18.31	/	20.5	19.5	/
		1880.0MHz	18.84	18.21	/	20.5	19.5	/
		1860.0MHz	18.52	17.80	/	20.5	19.5	/
	1RB_0	1900.0MHz	19.37	18.96	/	20.5	19.5	/
		1880.0MHz	19.37	19.02	/	20.5	19.5	/
		1860.0MHz	19.11	17.92	/	20.5	19.5	/
	50RB_50	1900.0MHz	18.17	17.19	/	19.5	18.5	/
		1880.0MHz	18.43	17.69	/	19.5	18.5	/
		1860.0MHz	18.14	17.19	/	19.5	18.5	/
	50RB_25	1900.0MHz	18.21	17.23	/	19.5	18.5	/
		1880.0MHz	17.97	17.25	/	19.5	18.5	/
		1860.0MHz	17.63	16.70	/	19.5	18.5	/
	50RB_0	1900.0MHz	18.41	17.43	/	19.5	18.5	/
		1880.0MHz	18.17	17.43	/	19.5	18.5	/
		1860.0MHz	18.25	16.50	/	19.5	18.5	/
	100RB_0	1900.0MHz	18.28	17.29	/	19.5	18.5	/
		1880.0MHz	18.29	17.54	/	19.5	18.5	/
		1860.0MHz	17.79	16.83	/	19.5	18.5	/



LTE Band 5			Actual output Power (dBm)			Tune up		
Band -width	RB No. / RB offset	Frequency	Modulation			Modulation		
			QPSK	16QAM	64QAM	QPSK	16QAM	64QAM
1.4 MHz	1RB_5	848.3MHz	23.06	22.38	/	24.0	23.0	/
		836.5MHz	22.71	22.28	/	24.0	23.0	/
		824.7MHz	23.02	22.47	/	24.0	23.0	/
	1RB_3	848.3MHz	23.06	22.40	/	24.0	23.0	/
		836.5MHz	22.72	22.36	/	24.0	23.0	/
		824.7MHz	23.01	22.43	/	24.0	23.0	/
	1RB_0	848.3MHz	23.04	22.42	/	24.0	23.0	/
		836.5MHz	22.61	22.15	/	24.0	23.0	/
		824.7MHz	23.01	22.38	/	24.0	23.0	/
	3RB_3	848.3MHz	23.17	22.21	/	24.0	23.0	/
		836.5MHz	22.92	22.03	/	24.0	23.0	/
		824.7MHz	23.19	22.20	/	24.0	23.0	/
	3RB_1	848.3MHz	23.12	22.27	/	24.0	23.0	/
		836.5MHz	22.96	22.00	/	24.0	23.0	/
		824.7MHz	23.20	22.21	/	24.0	23.0	/
	3RB_0	848.3MHz	23.09	22.24	/	24.0	23.0	/
		836.5MHz	22.93	22.00	/	24.0	23.0	/
		824.7MHz	23.23	22.15	/	24.0	23.0	/
	6RB_0	848.3MHz	22.02	20.72	/	23.0	22.0	/
		836.5MHz	21.94	21.18	/	23.0	22.0	/
		824.7MHz	22.11	20.94	/	23.0	22.0	/



LTE Band 5			Actual output Power (dBm)			Tune up		
Band -width	RB No. / RB offset	Frequency	Modulation			Modulation		
			QPSK	16QAM	64QAM	QPSK	16QAM	64QAM
3 MHz	1RB_14	847.5MHz	23.08	22.50	/	24.0	23.0	/
		836.5MHz	22.80	22.31	/	24.0	23.0	/
		825.5MHz	22.81	22.46	/	24.0	23.0	/
	1RB_7	847.5MHz	23.05	22.52	/	24.0	23.0	/
		836.5MHz	22.71	22.30	/	24.0	23.0	/
		825.5MHz	23.01	22.51	/	24.0	23.0	/
	1RB_0	847.5MHz	23.00	22.54	/	24.0	23.0	/
		836.5MHz	22.65	22.15	/	24.0	23.0	/
		825.5MHz	22.97	22.53	/	24.0	23.0	/
	8RB_7	847.5MHz	22.04	21.10	/	23.0	22.0	/
		836.5MHz	21.80	21.42	/	23.0	22.0	/
		825.5MHz	22.12	21.14	/	23.0	22.0	/
	8RB_4	847.5MHz	22.03	21.21	/	23.0	22.0	/
		836.5MHz	21.98	21.44	/	23.0	22.0	/
		825.5MHz	22.15	21.12	/	23.0	22.0	/
	8RB_0	847.5MHz	22.05	21.16	/	23.0	22.0	/
		836.5MHz	21.69	21.36	/	23.0	22.0	/
		825.5MHz	22.07	21.25	/	23.0	22.0	/
15RB_0	847.5MHz	22.10	21.23	/	23.0	22.0	/	
	836.5MHz	21.97	21.41	/	23.0	22.0	/	
	825.5MHz	22.16	21.20	/	23.0	22.0	/	



LTE Band 5			Actual output Power (dBm)			Tune up		
Band -width	RB No. / RB offset	Frequency	Modulation			Modulation		
			QPSK	16QAM	64QAM	QPSK	16QAM	64QAM
5 MHz	1RB_24	846.5MHz	22.93	22.42	/	24.0	23.0	/
		836.5MHz	22.71	22.11	/	24.0	23.0	/
		826.5MHz	22.92	22.19	/	24.0	23.0	/
	1RB_12	846.5MHz	22.94	22.42	/	24.0	23.0	/
		836.5MHz	22.79	22.20	/	24.0	23.0	/
		826.5MHz	22.98	22.25	/	24.0	23.0	/
	1RB_0	846.5MHz	22.90	22.41	/	24.0	23.0	/
		836.5MHz	22.63	22.08	/	24.0	23.0	/
		826.5MHz	23.09	22.40	/	24.0	23.0	/
	12RB_13	846.5MHz	22.08	21.04	/	23.0	22.0	/
		836.5MHz	21.83	21.31	/	23.0	22.0	/
		826.5MHz	22.13	21.12	/	23.0	22.0	/
	12RB_6	846.5MHz	22.04	21.07	/	23.0	22.0	/
		836.5MHz	21.93	21.39	/	23.0	22.0	/
		826.5MHz	21.99	21.08	/	23.0	22.0	/
	12RB_0	846.5MHz	22.07	21.28	/	23.0	22.0	/
		836.5MHz	21.73	21.34	/	23.0	22.0	/
		826.5MHz	22.09	21.09	/	23.0	22.0	/
	25RB_0	846.5MHz	22.05	20.98	/	23.0	22.0	/
		836.5MHz	21.88	21.49	/	23.0	22.0	/
		826.5MHz	22.12	21.26	/	23.0	22.0	/



LTE Band 5			Actual output Power (dBm)			Tune up		
Band -width	RB No. / RB offset	Frequency	Modulation			Modulation		
			QPSK	16QAM	64QAM	QPSK	16QAM	64QAM
10 MHz	1RB_49	844.0MHz	22.97	22.44	/	24.0	23.0	/
		836.5MHz	22.76	22.46	/	24.0	23.0	/
		829.0MHz	22.88	22.30	/	24.0	23.0	/
	1RB_24	844.0MHz	22.92	22.35	/	24.0	23.0	/
		836.5MHz	22.80	22.40	/	24.0	23.0	/
		829.0MHz	22.91	22.35	/	24.0	23.0	/
	1RB_0	844.0MHz	22.99	22.12	/	24.0	23.0	/
		836.5MHz	22.82	22.19	/	24.0	23.0	/
		829.0MHz	23.12	22.49	/	24.0	23.0	/
	25RB_25	844.0MHz	21.98	21.04	/	23.0	22.0	/
		836.5MHz	21.87	21.05	/	23.0	22.0	/
		829.0MHz	21.78	21.16	/	23.0	22.0	/
	25RB_12	844.0MHz	21.93	20.99	/	23.0	22.0	/
		836.5MHz	21.98	21.47	/	23.0	22.0	/
		829.0MHz	21.96	20.93	/	23.0	22.0	/
	25RB_0	844.0MHz	21.99	21.27	/	23.0	22.0	/
		836.5MHz	22.07	21.44	/	23.0	22.0	/
		829.0MHz	22.17	20.99	/	23.0	22.0	/
	50RB_0	844.0MHz	21.93	21.08	/	23.0	22.0	/
		836.5MHz	21.84	21.31	/	23.0	22.0	/
		829.0MHz	21.94	20.91	/	23.0	22.0	/



LTE Band 7			Actual output Power (dBm)			Tune up		
Band -width	RB No. / RB offset	Frequency	Modulation			Modulation		
			QPSK	16QAM	64QAM	QPSK	16QAM	64QAM
5 MHz	1RB_24	2567.4MHz	21.59	21.43	/	22.5	22.5	/
		2535.0MHz	21.91	21.68	/	22.5	22.5	/
		2502.5MHz	21.80	21.70	/	22.5	22.5	/
	1RB_12	2567.4MHz	21.69	21.54	/	22.5	22.5	/
		2535.0MHz	21.81	21.64	/	22.5	22.5	/
		2502.5MHz	21.90	21.61	/	22.5	22.5	/
	1RB_0	2567.4MHz	21.80	21.54	/	22.5	22.5	/
		2535.0MHz	21.91	21.67	/	22.5	22.5	/
		2502.5MHz	21.85	21.56	/	22.5	22.5	/
	12RB_13	2567.4MHz	20.90	20.73	/	21.5	21.5	/
		2535.0MHz	20.94	20.97	/	21.5	21.5	/
		2502.5MHz	20.98	21.00	/	21.5	21.5	/
	12RB_6	2567.4MHz	20.88	20.93	/	21.5	21.5	/
		2535.0MHz	21.08	21.11	/	21.5	21.5	/
		2502.5MHz	21.00	21.06	/	21.5	21.5	/
	12RB_0	2567.4MHz	20.84	20.85	/	21.5	21.5	/
		2535.0MHz	20.98	21.01	/	21.5	21.5	/
		2502.5MHz	21.08	20.86	/	21.5	21.5	/
	25RB_0	2567.4MHz	20.81	20.73	/	21.5	21.5	/
		2535.0MHz	20.98	21.00	/	21.5	21.5	/
		2502.5MHz	20.99	20.92	/	21.5	21.5	/



LTE Band 7			Actual output Power (dBm)			Tune up		
Band -width	RB No. / RB offset	Frequency	Modulation			Modulation		
			QPSK	16QAM	64QAM	QPSK	16QAM	64QAM
10 MHz	1RB_49	2565.0MHz	21.72	21.33	/	22.5	22.5	/
		2535.0MHz	21.92	21.67	/	22.5	22.5	/
		2505.0MHz	21.84	21.51	/	22.5	22.5	/
	1RB_24	2565.0MHz	21.76	21.34	/	22.5	22.5	/
		2535.0MHz	21.81	21.66	/	22.5	22.5	/
		2505.0MHz	21.83	21.51	/	22.5	22.5	/
	1RB_0	2565.0MHz	21.77	21.40	/	22.5	22.5	/
		2535.0MHz	21.94	21.68	/	22.5	22.5	/
		2505.0MHz	21.89	21.48	/	22.5	22.5	/
	25RB_25	2565.0MHz	20.90	21.16	/	21.5	21.5	/
		2535.0MHz	20.98	21.37	/	21.5	21.5	/
		2505.0MHz	20.97	21.28	/	21.5	21.5	/
	25RB_12	2565.0MHz	20.90	21.13	/	21.5	21.5	/
		2535.0MHz	21.01	21.17	/	21.5	21.5	/
		2505.0MHz	21.02	20.92	/	21.5	21.5	/
	25RB_0	2565.0MHz	20.87	21.25	/	21.5	21.5	/
		2535.0MHz	20.99	21.15	/	21.5	21.5	/
		2505.0MHz	21.02	20.72	/	21.5	21.5	/
50RB_0	2565.0MHz	20.97	21.20	/	21.5	21.5	/	
	2535.0MHz	21.12	21.26	/	21.5	21.5	/	
	2505.0MHz	21.00	21.00	/	21.5	21.5	/	



LTE Band 7			Actual output Power (dBm)			Tune up		
Band -width	RB No. / RB offset	Frequency	Modulation			Modulation		
			QPSK	16QAM	64QAM	QPSK	16QAM	64QAM
15 MHz	1RB_74	2562.5MHz	21.74	21.59	/	22.5	22.5	/
		2535.0MHz	22.03	21.75	/	22.5	22.5	/
		2507.5MHz	21.97	21.79	/	22.5	22.5	/
	1RB_37	2562.5MHz	21.85	21.63	/	22.5	22.5	/
		2535.0MHz	21.87	21.68	/	22.5	22.5	/
		2507.5MHz	21.86	21.69	/	22.5	22.5	/
	1RB_0	2562.5MHz	21.87	21.64	/	22.5	22.5	/
		2535.0MHz	21.93	21.71	/	22.5	22.5	/
		2507.5MHz	21.85	21.72	/	22.5	22.5	/
	36RB_38	2562.5MHz	21.00	20.61	/	21.5	21.5	/
		2535.0MHz	21.03	21.34	/	21.5	21.5	/
		2507.5MHz	20.99	21.41	/	21.5	21.5	/
	36RB_19	2562.5MHz	21.01	20.75	/	21.5	21.5	/
		2535.0MHz	21.04	21.19	/	21.5	21.5	/
		2507.5MHz	21.07	21.07	/	21.5	21.5	/
	36RB_0	2562.5MHz	20.93	21.08	/	21.5	21.5	/
		2535.0MHz	20.96	21.35	/	21.5	21.5	/
		2507.5MHz	21.05	20.94	/	21.5	21.5	/
	75RB_0	2562.5MHz	20.87	20.84	/	21.5	21.5	/
		2535.0MHz	21.04	21.14	/	21.5	21.5	/
		2507.5MHz	21.07	21.19	/	21.5	21.5	/



LTE Band 7			Actual output Power (dBm)			Tune up		
Band -width	RB No. / RB offset	Frequency	Modulation			Modulation		
			QPSK	16QAM	64QAM	QPSK	16QAM	64QAM
20 MHz	1RB_99	2560.0MHz	21.89	21.20	/	22.5	22.5	/
		2535.0MHz	22.04	21.41	/	22.5	22.5	/
		2510.0MHz	22.14	21.72	/	22.5	22.5	/
	1RB_50	2560.0MHz	22.00	21.28	/	22.5	22.5	/
		2535.0MHz	21.94	21.30	/	22.5	22.5	/
		2510.0MHz	21.90	21.52	/	22.5	22.5	/
	1RB_0	2560.0MHz	21.89	21.24	/	22.5	22.5	/
		2535.0MHz	21.87	21.28	/	22.5	22.5	/
		2510.0MHz	22.01	21.55	/	22.5	22.5	/
	50RB_50	2560.0MHz	20.89	21.08	/	21.5	21.5	/
		2535.0MHz	21.02	21.75	/	21.5	21.5	/
		2510.0MHz	21.10	21.48	/	21.5	21.5	/
	50RB_25	2560.0MHz	20.94	21.03	/	21.5	21.5	/
		2535.0MHz	20.99	21.29	/	21.5	21.5	/
		2510.0MHz	21.05	20.88	/	21.5	21.5	/
	50RB_0	2560.0MHz	20.86	21.19	/	21.5	21.5	/
		2535.0MHz	21.05	21.35	/	21.5	21.5	/
		2510.0MHz	21.08	20.57	/	21.5	21.5	/
	100RB_0	2560.0MHz	21.03	21.11	/	21.5	21.5	/
		2535.0MHz	21.09	21.13	/	21.5	21.5	/
		2510.0MHz	21.06	21.02	/	21.5	21.5	/



LTE Band 12			Actual output Power (dBm)			Tune up		
Band -width	RB No. / RB offset	Frequency	Modulation			Modulation		
			QPSK	16QAM	64QAM	QPSK	16QAM	64QAM
1.4 MHz	1RB_5	715.3MHz	23.02	22.32	/	24.0	23.0	/
		707.5MHz	22.15	21.60	/	24.0	23.0	/
		699.7MHz	22.97	22.17	/	24.0	23.0	/
	1RB_3	715.3MHz	23.00	22.30	/	24.0	23.0	/
		707.5MHz	22.15	21.68	/	24.0	23.0	/
		699.7MHz	22.93	22.25	/	24.0	23.0	/
	1RB_0	715.3MHz	22.91	22.22	/	24.0	23.0	/
		707.5MHz	22.23	21.57	/	24.0	23.0	/
		699.7MHz	22.90	22.23	/	24.0	23.0	/
	3RB_3	715.3MHz	23.09	22.13	/	24.0	23.0	/
		707.5MHz	22.38	21.56	/	24.0	23.0	/
		699.7MHz	23.01	22.20	/	24.0	23.0	/
	3RB_1	715.3MHz	23.11	22.18	/	24.0	23.0	/
		707.5MHz	22.39	21.59	/	24.0	23.0	/
		699.7MHz	23.06	22.23	/	24.0	23.0	/
	3RB_0	715.3MHz	23.02	22.12	/	24.0	23.0	/
		707.5MHz	22.42	21.62	/	24.0	23.0	/
		699.7MHz	22.98	22.21	/	24.0	23.0	/
	6RB_0	715.3MHz	21.98	20.95	/	23.0	22.0	/
		707.5MHz	21.36	20.15	/	23.0	22.0	/
		699.7MHz	22.00	20.74	/	23.0	22.0	/



LTE Band 12			Actual output Power (dBm)			Tune up		
Band -width	RB No. / RB offset	Frequency	Modulation			Modulation		
			QPSK	16QAM	64QAM	QPSK	16QAM	64QAM
3 MHz	1RB_14	714.5MHz	23.08	22.32	/	24.0	23.0	/
		707.5MHz	22.22	21.74	/	24.0	23.0	/
		700.5MHz	23.05	22.34	/	24.0	23.0	/
	1RB_7	714.5MHz	22.98	22.25	/	24.0	23.0	/
		707.5MHz	22.14	21.81	/	24.0	23.0	/
		700.5MHz	22.93	22.23	/	24.0	23.0	/
	1RB_0	714.5MHz	22.97	22.24	/	24.0	23.0	/
		707.5MHz	22.20	21.69	/	24.0	23.0	/
		700.5MHz	22.99	22.18	/	24.0	23.0	/
	8RB_7	714.5MHz	22.00	21.18	/	23.0	22.0	/
		707.5MHz	21.30	20.44	/	23.0	22.0	/
		700.5MHz	21.98	21.24	/	23.0	22.0	/
	8RB_4	714.5MHz	21.90	21.00	/	23.0	22.0	/
		707.5MHz	21.42	20.39	/	23.0	22.0	/
		700.5MHz	21.97	21.08	/	23.0	22.0	/
	8RB_0	714.5MHz	21.95	21.03	/	23.0	22.0	/
		707.5MHz	21.37	20.99	/	23.0	22.0	/
		700.5MHz	21.88	21.09	/	23.0	22.0	/
15RB_0	714.5MHz	22.02	21.05	/	23.0	22.0	/	
	707.5MHz	21.38	20.35	/	23.0	22.0	/	
	700.5MHz	22.01	20.99	/	23.0	22.0	/	



LTE Band 12			Actual output Power (dBm)			Tune up		
Band -width	RB No. / RB offset	Frequency	Modulation			Modulation		
			QPSK	16QAM	64QAM	QPSK	16QAM	64QAM
5 MHz	1RB_24	713.5MHz	22.92	22.37	/	24.0	23.0	/
		707.5MHz	22.48	21.79	/	24.0	23.0	/
		701.5MHz	22.74	22.16	/	24.0	23.0	/
	1RB_12	713.5MHz	22.88	22.23	/	24.0	23.0	/
		707.5MHz	22.14	21.63	/	24.0	23.0	/
		701.5MHz	22.94	22.35	/	24.0	23.0	/
	1RB_0	713.5MHz	22.59	22.07	/	24.0	23.0	/
		707.5MHz	22.24	21.63	/	24.0	23.0	/
		701.5MHz	22.81	22.26	/	24.0	23.0	/
	12RB_13	713.5MHz	21.87	20.81	/	23.0	22.0	/
		707.5MHz	21.40	20.34	/	23.0	22.0	/
		701.5MHz	21.83	21.06	/	23.0	22.0	/
	12RB_6	713.5MHz	21.91	20.84	/	23.0	22.0	/
		707.5MHz	21.38	20.32	/	23.0	22.0	/
		701.5MHz	21.98	21.02	/	23.0	22.0	/
	12RB_0	713.5MHz	21.67	20.42	/	23.0	22.0	/
		707.5MHz	21.31	20.89	/	23.0	22.0	/
		701.5MHz	21.91	20.87	/	23.0	22.0	/
	25RB_0	713.5MHz	21.90	20.73	/	23.0	22.0	/
		707.5MHz	21.26	20.28	/	23.0	22.0	/
		701.5MHz	21.84	21.18	/	23.0	22.0	/



LTE Band 12			Actual output Power (dBm)			Tune up		
Band -width	RB No. / RB offset	Frequency	Modulation			Modulation		
			QPSK	16QAM	64QAM	QPSK	16QAM	64QAM
10 MHz	1RB_49	711.0MHz	22.88	22.31	/	24.0	23.0	/
		707.5MHz	22.61	22.13	/	24.0	23.0	/
		704.0MHz	22.30	21.75	/	24.0	23.0	/
	1RB_24	711.0MHz	22.45	21.87	/	24.0	23.0	/
		707.5MHz	22.24	21.69	/	24.0	23.0	/
		704.0MHz	22.71	22.14	/	24.0	23.0	/
	1RB_0	711.0MHz	22.96	21.67	/	24.0	23.0	/
		707.5MHz	22.95	22.29	/	24.0	23.0	/
		704.0MHz	22.97	22.26	/	24.0	23.0	/
	25RB_25	711.0MHz	21.52	21.04	/	23.0	22.0	/
		707.5MHz	21.63	21.15	/	23.0	22.0	/
		704.0MHz	21.37	21.14	/	23.0	22.0	/
	25RB_12	711.0MHz	21.68	21.05	/	23.0	22.0	/
		707.5MHz	21.33	20.56	/	23.0	22.0	/
		704.0MHz	21.70	21.43	/	23.0	22.0	/
	25RB_0	711.0MHz	21.92	20.46	/	23.0	22.0	/
		707.5MHz	21.78	21.07	/	23.0	22.0	/
		704.0MHz	21.96	21.20	/	23.0	22.0	/
	50RB_0	711.0MHz	21.70	20.91	/	23.0	22.0	/
		707.5MHz	21.29	20.38	/	23.0	22.0	/
		704.0MHz	21.77	21.25	/	23.0	22.0	/



Full Power								
LTE Band 66			Actual output Power (dBm)			Tune up		
Band -width	RB No. / RB offset	Frequency	Modulation			Modulation		
			QPSK	16QAM	64QAM	QPSK	16QAM	64QAM
1.4 MHz	1RB_5	1779.3MHz	23.42	22.84	/	24.0	23.0	/
		1745.0MHz	23.22	22.89	/	24.0	23.0	/
		1710.7MHz	23.46	22.98	/	24.0	23.0	/
	1RB_3	1779.3MHz	23.38	22.82	/	24.0	23.0	/
		1745.0MHz	23.21	22.91	/	24.0	23.0	/
		1710.7MHz	23.51	22.73	/	24.0	23.0	/
	1RB_0	1779.3MHz	23.40	22.81	/	24.0	23.0	/
		1745.0MHz	23.19	22.96	/	24.0	23.0	/
		1710.7MHz	23.55	22.75	/	24.0	23.0	/
	3RB_3	1779.3MHz	23.51	22.87	/	24.0	23.0	/
		1745.0MHz	23.43	22.62	/	24.0	23.0	/
		1710.7MHz	23.70	22.99	/	24.0	23.0	/
	3RB_1	1779.3MHz	23.53	22.82	/	24.0	23.0	/
		1745.0MHz	23.38	22.70	/	24.0	23.0	/
		1710.7MHz	23.73	22.72	/	24.0	23.0	/
	3RB_0	1779.3MHz	23.55	22.88	/	24.0	23.0	/
		1745.0MHz	23.45	22.66	/	24.0	23.0	/
		1710.7MHz	23.67	22.76	/	24.0	23.0	/
	6RB_0	1779.3MHz	22.65	21.48	/	23.0	22.0	/
		1745.0MHz	22.27	21.33	/	23.0	22.0	/
		1710.7MHz	22.60	21.56	/	23.0	22.0	/



Full Power								
LTE Band 66			Actual output Power (dBm)			Tune up		
Band -width	RB No. / RB offset	Frequency	Modulation			Modulation		
			QPSK	16QAM	64QAM	QPSK	16QAM	64QAM
3 MHz	1RB_14	1778.5MHz	23.51	22.73	/	24.0	23.0	/
		1745.0MHz	23.18	22.55	/	24.0	23.0	/
		1711.5MHz	23.47	22.85	/	24.0	23.0	/
	1RB_7	1778.5MHz	23.55	22.71	/	24.0	23.0	/
		1745.0MHz	23.22	22.58	/	24.0	23.0	/
		1711.5MHz	23.55	22.91	/	24.0	23.0	/
	1RB_0	1778.5MHz	23.47	22.75	/	24.0	23.0	/
		1745.0MHz	23.21	22.47	/	24.0	23.0	/
		1711.5MHz	23.53	22.95	/	24.0	23.0	/
	8RB_7	1778.5MHz	22.54	21.76	/	23.0	22.0	/
		1745.0MHz	22.34	21.64	/	23.0	22.0	/
		1711.5MHz	22.62	21.87	/	23.0	22.0	/
	8RB_4	1778.5MHz	22.62	21.77	/	23.0	22.0	/
		1745.0MHz	22.39	21.65	/	23.0	22.0	/
		1711.5MHz	22.64	21.88	/	23.0	22.0	/
	8RB_0	1778.5MHz	22.63	21.80	/	23.0	22.0	/
		1745.0MHz	22.39	21.60	/	23.0	22.0	/
		1711.5MHz	22.68	21.83	/	23.0	22.0	/
	15RB_0	1778.5MHz	22.59	21.70	/	23.0	22.0	/
		1745.0MHz	22.37	21.59	/	23.0	22.0	/
		1711.5MHz	22.65	21.82	/	23.0	22.0	/



Full Power								
LTE Band 66			Actual output Power (dBm)			Tune up		
Band -width	RB No. / RB offset	Frequency	Modulation			Modulation		
			QPSK	16QAM	64QAM	QPSK	16QAM	64QAM
5 MHz	1RB_24	1777.5MHz	23.44	22.82	/	24.0	23.0	/
		1745.0MHz	23.21	22.85	/	24.0	23.0	/
		1712.5MHz	23.41	22.84	/	24.0	23.0	/
	1RB_12	1777.5MHz	23.43	22.87	/	24.0	23.0	/
		1745.0MHz	23.12	22.87	/	24.0	23.0	/
		1712.5MHz	23.47	22.86	/	24.0	23.0	/
	1RB_0	1777.5MHz	23.47	22.92	/	24.0	23.0	/
		1745.0MHz	23.18	22.93	/	24.0	23.0	/
		1712.5MHz	23.49	22.89	/	24.0	23.0	/
	12RB_13	1777.5MHz	22.60	21.63	/	23.0	22.0	/
		1745.0MHz	22.27	21.49	/	23.0	22.0	/
		1712.5MHz	22.65	21.73	/	23.0	22.0	/
	12RB_6	1777.5MHz	22.58	21.71	/	23.0	22.0	/
		1745.0MHz	22.36	21.44	/	23.0	22.0	/
		1712.5MHz	22.55	21.71	/	23.0	22.0	/
	12RB_0	1777.5MHz	22.56	21.75	/	23.0	22.0	/
		1745.0MHz	22.26	21.50	/	23.0	22.0	/
		1712.5MHz	22.62	21.83	/	23.0	22.0	/
	25RB_0	1777.5MHz	22.61	21.90	/	23.0	22.0	/
		1745.0MHz	22.32	21.65	/	23.0	22.0	/
		1712.5MHz	22.65	21.92	/	23.0	22.0	/



Full Power								
LTE Band 66			Actual output Power (dBm)			Tune up		
Band -width	RB No. / RB offset	Frequency	Modulation			Modulation		
			QPSK	16QAM	64QAM	QPSK	16QAM	64QAM
10 MHz	1RB_49	1775.0MHz	23.48	22.93	/	24.0	23.0	/
		1745.0MHz	23.51	22.83	/	24.0	23.0	/
		1715.0MHz	23.47	22.90	/	24.0	23.0	/
	1RB_24	1775.0MHz	23.47	22.77	/	24.0	23.0	/
		1745.0MHz	23.32	22.95	/	24.0	23.0	/
		1715.0MHz	23.47	22.91	/	24.0	23.0	/
	1RB_0	1775.0MHz	23.65	22.79	/	24.0	23.0	/
		1745.0MHz	23.34	22.73	/	24.0	23.0	/
		1715.0MHz	23.58	22.84	/	24.0	23.0	/
	25RB_25	1775.0MHz	22.53	21.89	/	23.0	22.0	/
		1745.0MHz	22.26	21.39	/	23.0	22.0	/
		1715.0MHz	22.59	21.88	/	23.0	22.0	/
	25RB_12	1775.0MHz	22.54	21.96	/	23.0	22.0	/
		1745.0MHz	22.27	21.44	/	23.0	22.0	/
		1715.0MHz	22.55	21.89	/	23.0	22.0	/
	25RB_0	1775.0MHz	22.49	21.89	/	23.0	22.0	/
		1745.0MHz	22.29	21.45	/	23.0	22.0	/
		1715.0MHz	22.60	21.92	/	23.0	22.0	/
	50RB_0	1775.0MHz	22.56	21.70	/	23.0	22.0	/
		1745.0MHz	22.38	21.44	/	23.0	22.0	/
		1715.0MHz	22.51	21.65	/	23.0	22.0	/



Full Power								
LTE Band 66			Actual output Power (dBm)			Tune up		
Band -width	RB No. / RB offset	Frequency	Modulation			Modulation		
			QPSK	16QAM	64QAM	QPSK	16QAM	64QAM
15 MHz	1RB_74	1772.5MHz	23.50	22.84	/	24.0	23.0	/
		1745.0MHz	23.37	22.75	/	24.0	23.0	/
		1717.5MHz	23.21	22.93	/	24.0	23.0	/
	1RB_37	1772.5MHz	23.52	22.88	/	24.0	23.0	/
		1745.0MHz	23.27	22.63	/	24.0	23.0	/
		1717.5MHz	23.32	22.87	/	24.0	23.0	/
	1RB_0	1772.5MHz	23.60	22.72	/	24.0	23.0	/
		1745.0MHz	23.27	22.72	/	24.0	23.0	/
		1717.5MHz	23.49	22.95	/	24.0	23.0	/
	36RB_38	1772.5MHz	22.56	21.61	/	23.0	22.0	/
		1745.0MHz	22.43	21.58	/	23.0	22.0	/
		1717.5MHz	22.33	21.50	/	23.0	22.0	/
	36RB_19	1772.5MHz	22.57	21.63	/	23.0	22.0	/
		1745.0MHz	22.33	21.36	/	23.0	22.0	/
		1717.5MHz	22.49	21.54	/	23.0	22.0	/
	36RB_0	1772.5MHz	22.53	21.71	/	23.0	22.0	/
		1745.0MHz	22.29	21.41	/	23.0	22.0	/
		1717.5MHz	22.51	21.66	/	23.0	22.0	/
	75RB_0	1772.5MHz	22.60	21.70	/	23.0	22.0	/
		1745.0MHz	22.30	21.37	/	23.0	22.0	/
		1717.5MHz	22.50	21.65	/	23.0	22.0	/



Full Power								
LTE Band 66			Actual output Power (dBm)			Tune up		
Band -width	RB No. / RB offset	Frequency	Modulation			Modulation		
			QPSK	16QAM	64QAM	QPSK	16QAM	64QAM
20 MHz	1RB_99	1770.0MHz	23.42	23.00	/	24.0	23.0	/
		1745.0MHz	23.37	22.80	/	24.0	23.0	/
		1720.0MHz	23.20	22.89	/	24.0	23.0	/
	1RB_50	1770.0MHz	23.55	22.98	/	24.0	23.0	/
		1745.0MHz	23.32	22.87	/	24.0	23.0	/
		1720.0MHz	23.39	22.74	/	24.0	23.0	/
	1RB_0	1770.0MHz	23.59	22.83	/	24.0	23.0	/
		1745.0MHz	23.39	22.97	/	24.0	23.0	/
		1720.0MHz	23.56	22.94	/	24.0	23.0	/
	50RB_50	1770.0MHz	22.57	21.58	/	23.0	22.0	/
		1745.0MHz	22.41	21.56	/	23.0	22.0	/
		1720.0MHz	22.41	21.45	/	23.0	22.0	/
	50RB_25	1770.0MHz	22.45	21.61	/	23.0	22.0	/
		1745.0MHz	22.38	21.46	/	23.0	22.0	/
		1720.0MHz	22.37	21.55	/	23.0	22.0	/
	50RB_0	1770.0MHz	22.65	21.73	/	23.0	22.0	/
		1745.0MHz	22.43	21.50	/	23.0	22.0	/
		1720.0MHz	22.59	21.65	/	23.0	22.0	/
	100RB_0	1770.0MHz	22.54	21.73	/	23.0	22.0	/
		1745.0MHz	22.22	21.43	/	23.0	22.0	/
		1720.0MHz	22.43	21.62	/	23.0	22.0	/



Reduced power level 1								
LTE Band 66			Actual output Power (dBm)			Tune up		
Band -width	RB No. / RB offset	Frequency	Modulation			Modulation		
			QPSK	16QAM	64QAM	QPSK	16QAM	64QAM
1.4 MHz	1RB_5	1779.3MHz	18.14	17.40	/	20.0	19.0	/
		1745.0MHz	18.15	17.43	/	20.0	19.0	/
		1710.7MHz	18.34	17.60	/	20.0	19.0	/
	1RB_3	1779.3MHz	18.35	17.62	/	20.0	19.0	/
		1745.0MHz	18.32	17.65	/	20.0	19.0	/
		1710.7MHz	18.18	17.48	/	20.0	19.0	/
	1RB_0	1779.3MHz	18.15	17.43	/	20.0	19.0	/
		1745.0MHz	18.13	17.44	/	20.0	19.0	/
		1710.7MHz	18.27	17.27	/	20.0	19.0	/
	3RB_3	1779.3MHz	18.29	17.26	/	20.0	19.0	/
		1745.0MHz	18.29	17.28	/	20.0	19.0	/
		1710.7MHz	18.36	17.36	/	20.0	19.0	/
	3RB_1	1779.3MHz	18.37	17.31	/	20.0	19.0	/
		1745.0MHz	18.35	17.31	/	20.0	19.0	/
		1710.7MHz	18.31	17.31	/	20.0	19.0	/
	3RB_0	1779.3MHz	18.30	17.28	/	20.0	19.0	/
		1745.0MHz	18.27	17.27	/	20.0	19.0	/
		1710.7MHz	17.25	16.39	/	20.0	19.0	/
	6RB_0	1779.3MHz	17.19	16.42	/	19.0	18.0	/
		1745.0MHz	17.20	16.31	/	19.0	18.0	/
		1710.7MHz	18.14	17.40	/	19.0	18.0	/

Reduced power level 1								
LTE Band 66			Actual output Power (dBm)			Tune up		
Band -width	RB No. / RB offset	Frequency	Modulation			Modulation		
			QPSK	16QAM	64QAM	QPSK	16QAM	64QAM
3 MHz	1RB_14	1778.5MHz	18.16	17.41	/	20.0	19.0	/
		1745.0MHz	18.18	17.38	/	20.0	19.0	/
		1711.5MHz	18.28	17.54	/	20.0	19.0	/
	1RB_7	1778.5MHz	18.40	17.71	/	20.0	19.0	/
		1745.0MHz	18.39	17.61	/	20.0	19.0	/
		1711.5MHz	18.40	17.66	/	20.0	19.0	/
	1RB_0	1778.5MHz	18.24	17.50	/	20.0	19.0	/
		1745.0MHz	18.21	17.43	/	20.0	19.0	/
		1711.5MHz	18.18	17.47	/	20.0	19.0	/
	8RB_7	1778.5MHz	17.27	16.39	/	19.0	18.0	/
		1745.0MHz	17.21	16.40	/	19.0	18.0	/
		1711.5MHz	17.29	16.38	/	19.0	18.0	/
	8RB_4	1778.5MHz	17.34	16.44	/	19.0	18.0	/
		1745.0MHz	17.26	16.45	/	19.0	18.0	/
		1711.5MHz	17.31	16.42	/	19.0	18.0	/
	8RB_0	1778.5MHz	17.32	16.44	/	19.0	18.0	/
		1745.0MHz	17.22	16.41	/	19.0	18.0	/
		1711.5MHz	17.25	16.35	/	19.0	18.0	/
	15RB_0	1778.5MHz	17.30	16.40	/	19.0	18.0	/
		1745.0MHz	17.22	16.39	/	19.0	18.0	/
		1711.5MHz	17.27	16.34	/	19.0	18.0	/

Reduced power level 1								
LTE Band 66			Actual output Power (dBm)			Tune up		
Band -width	RB No. / RB offset	Frequency	Modulation			Modulation		
			QPSK	16QAM	64QAM	QPSK	16QAM	64QAM
5 MHz	1RB_24	1777.5MHz	18.13	17.13	/	20.0	19.0	/
		1745.0MHz	18.17	17.08	/	20.0	19.0	/
		1712.5MHz	18.29	17.25	/	20.0	19.0	/
	1RB_12	1777.5MHz	18.43	17.76	/	20.0	19.0	/
		1745.0MHz	18.39	17.59	/	20.0	19.0	/
		1712.5MHz	18.45	17.70	/	20.0	19.0	/
	1RB_0	1777.5MHz	18.04	17.32	/	20.0	19.0	/
		1745.0MHz	18.19	17.14	/	20.0	19.0	/
		1712.5MHz	18.14	17.17	/	20.0	19.0	/
	12RB_13	1777.5MHz	17.21	16.26	/	19.0	18.0	/
		1745.0MHz	17.13	16.25	/	19.0	18.0	/
		1712.5MHz	17.27	16.31	/	19.0	18.0	/
	12RB_6	1777.5MHz	17.42	16.47	/	19.0	18.0	/
		1745.0MHz	17.30	16.41	/	19.0	18.0	/
		1712.5MHz	17.38	16.40	/	19.0	18.0	/
	12RB_0	1777.5MHz	17.32	16.38	/	19.0	18.0	/
		1745.0MHz	17.16	16.28	/	19.0	18.0	/
		1712.5MHz	17.18	16.22	/	19.0	18.0	/
	25RB_0	1777.5MHz	17.27	16.33	/	19.0	18.0	/
		1745.0MHz	17.16	16.26	/	19.0	18.0	/
		1712.5MHz	17.24	16.26	/	19.0	18.0	/

Reduced power level 1								
LTE Band 66			Actual output Power (dBm)			Tune up		
Band -width	RB No. / RB offset	Frequency	Modulation			Modulation		
			QPSK	16QAM	64QAM	QPSK	16QAM	64QAM
10 MHz	1RB_49	1775.0MHz	18.69	17.94	/	20.0	19.0	/
		1745.0MHz	18.74	17.99	/	20.0	19.0	/
		1715.0MHz	18.81	18.09	/	20.0	19.0	/
	1RB_24	1775.0MHz	18.53	17.81	/	20.0	19.0	/
		1745.0MHz	18.33	17.58	/	20.0	19.0	/
		1715.0MHz	18.47	17.76	/	20.0	19.0	/
	1RB_0	1775.0MHz	18.48	17.70	/	20.0	19.0	/
		1745.0MHz	18.18	17.44	/	20.0	19.0	/
		1715.0MHz	18.16	17.37	/	20.0	19.0	/
	25RB_25	1775.0MHz	17.66	16.70	/	19.0	18.0	/
		1745.0MHz	17.56	16.67	/	19.0	18.0	/
		1715.0MHz	17.69	16.73	/	19.0	18.0	/
	25RB_12	1775.0MHz	17.60	16.64	/	19.0	18.0	/
		1745.0MHz	17.34	16.45	/	19.0	18.0	/
		1715.0MHz	17.48	16.51	/	19.0	18.0	/
	25RB_0	1775.0MHz	17.64	16.69	/	19.0	18.0	/
		1745.0MHz	17.30	16.41	/	19.0	18.0	/
		1715.0MHz	17.35	16.38	/	19.0	18.0	/
	50RB_0	1775.0MHz	17.65	16.70	/	19.0	18.0	/
		1745.0MHz	17.43	16.55	/	19.0	18.0	/
		1715.0MHz	17.52	16.56	/	19.0	18.0	/



Reduced power level 1								
LTE Band 66			Actual output Power (dBm)			Tune up		
Band -width	RB No. / RB offset	Frequency	Modulation			Modulation		
			QPSK	16QAM	64QAM	QPSK	16QAM	64QAM
15 MHz	1RB_74	1772.5MHz	18.02	17.55	/	20.0	19.0	/
		1745.0MHz	18.40	17.66	/	20.0	19.0	/
		1717.5MHz	18.50	17.70	/	20.0	19.0	/
	1RB_37	1772.5MHz	18.37	17.72	/	20.0	19.0	/
		1745.0MHz	18.33	17.58	/	20.0	19.0	/
		1717.5MHz	18.47	17.77	/	20.0	19.0	/
	1RB_0	1772.5MHz	18.54	18.07	/	20.0	19.0	/
		1745.0MHz	18.41	17.68	/	20.0	19.0	/
		1717.5MHz	18.34	17.48	/	20.0	19.0	/
	36RB_38	1772.5MHz	17.36	16.42	/	19.0	18.0	/
		1745.0MHz	17.41	16.52	/	19.0	18.0	/
		1717.5MHz	17.44	16.59	/	19.0	18.0	/
	36RB_19	1772.5MHz	17.37	16.43	/	19.0	18.0	/
		1745.0MHz	17.29	16.41	/	19.0	18.0	/
		1717.5MHz	17.40	16.47	/	19.0	18.0	/
	36RB_0	1772.5MHz	17.51	16.58	/	19.0	18.0	/
		1745.0MHz	17.41	16.51	/	19.0	18.0	/
		1717.5MHz	17.42	16.57	/	19.0	18.0	/
	75RB_0	1772.5MHz	17.44	16.50	/	19.0	18.0	/
		1745.0MHz	17.41	16.51	/	19.0	18.0	/
		1717.5MHz	17.42	16.57	/	19.0	18.0	/



Reduced power level 1								
LTE Band 66			Actual output Power (dBm)			Tune up		
Band -width	RB No. / RB offset	Frequency	Modulation			Modulation		
			QPSK	16QAM	64QAM	QPSK	16QAM	64QAM
20 MHz	1RB_99	1770.0MHz	18.65	18.36	/	20.0	19.0	/
		1745.0MHz	19.26	18.61	/	20.0	19.0	/
		1720.0MHz	19.15	18.55	/	20.0	19.0	/
	1RB_50	1770.0MHz	18.20	17.60	/	20.0	19.0	/
		1745.0MHz	18.16	17.57	/	20.0	19.0	/
		1720.0MHz	18.15	17.70	/	20.0	19.0	/
	1RB_0	1770.0MHz	18.75	18.47	/	20.0	19.0	/
		1745.0MHz	18.67	18.07	/	20.0	19.0	/
		1720.0MHz	18.22	17.61	/	20.0	19.0	/
	50RB_50	1770.0MHz	17.66	16.77	/	19.0	18.0	/
		1745.0MHz	17.70	16.84	/	19.0	18.0	/
		1720.0MHz	17.77	16.93	/	19.0	18.0	/
	50RB_25	1770.0MHz	17.37	16.49	/	19.0	18.0	/
		1745.0MHz	17.31	16.46	/	19.0	18.0	/
		1720.0MHz	17.33	16.48	/	19.0	18.0	/
	50RB_0	1770.0MHz	17.55	16.67	/	19.0	18.0	/
		1745.0MHz	17.30	16.44	/	19.0	18.0	/
		1720.0MHz	17.31	16.49	/	19.0	18.0	/
	100RB_0	1770.0MHz	17.59	16.69	/	19.0	18.0	/
		1745.0MHz	17.49	16.62	/	19.0	18.0	/
		1720.0MHz	17.53	16.69	/	19.0	18.0	/

10.4. Bluetooth and WLAN Measurement result

Table 10.5: The conducted Power measurement results for Bluetooth

Bluetooth Mode	/	Averaged Power (dBm)		
		Ch.0 (2402MHz)	Ch.39 (2441MHz)	Ch.78 (2480MHz)
GFSK	Tune up	7.0	7.0	6.0
	/	5.33	6.04	4.49
EDR2M-4_DQPSK	Tune up	7.0	7.0	6.0
	/	5.99	5.96	4.87
EDR3M-8DPSK	Tune up	7.0	7.0	6.0
	/	6.19	6.17	5.11
BLE	/	Ch.0 (2402MHz)	Ch.19 (2440MHz)	Ch.39 (2480MHz)
	Tune up	-0.5	1.0	0.5
	/	-1.46	-0.03	-0.60

Table 10.6: The conducted Power measurement results for WLAN 2.4G

Mode	/	Averaged Power (dBm) Duty Cycle: 100%		
		Ch.1 (2412MHz)	Ch.6 (2437MHz)	Ch.11 (2462MHz)
802.11b	Tune up	19.0	19.5	18.5
	/	17.62	18.37	17.04
802.11g	Tune up	15.0	16.5	15.0
	/	13.83	15.41	13.34
802.11n(20MHz)	Tune up	13.5	15.0	13.5
	/	12.25	13.45	12.01

11. Simultaneous TX SAR Considerations

11.1. Introduction

The following procedures adopted from “FCC SAR Considerations for Cell Phones with Multiple Transmitters” are applicable to handsets with built-in unlicensed transmitters such as 802.11 a/b/g and Bluetooth devices which may simultaneously transmit with the licensed transmitter.

For this device, the Bluetooth and WLAN can transmit simultaneous with other transmitters.

11.2. Transmit Antenna Separation Distances

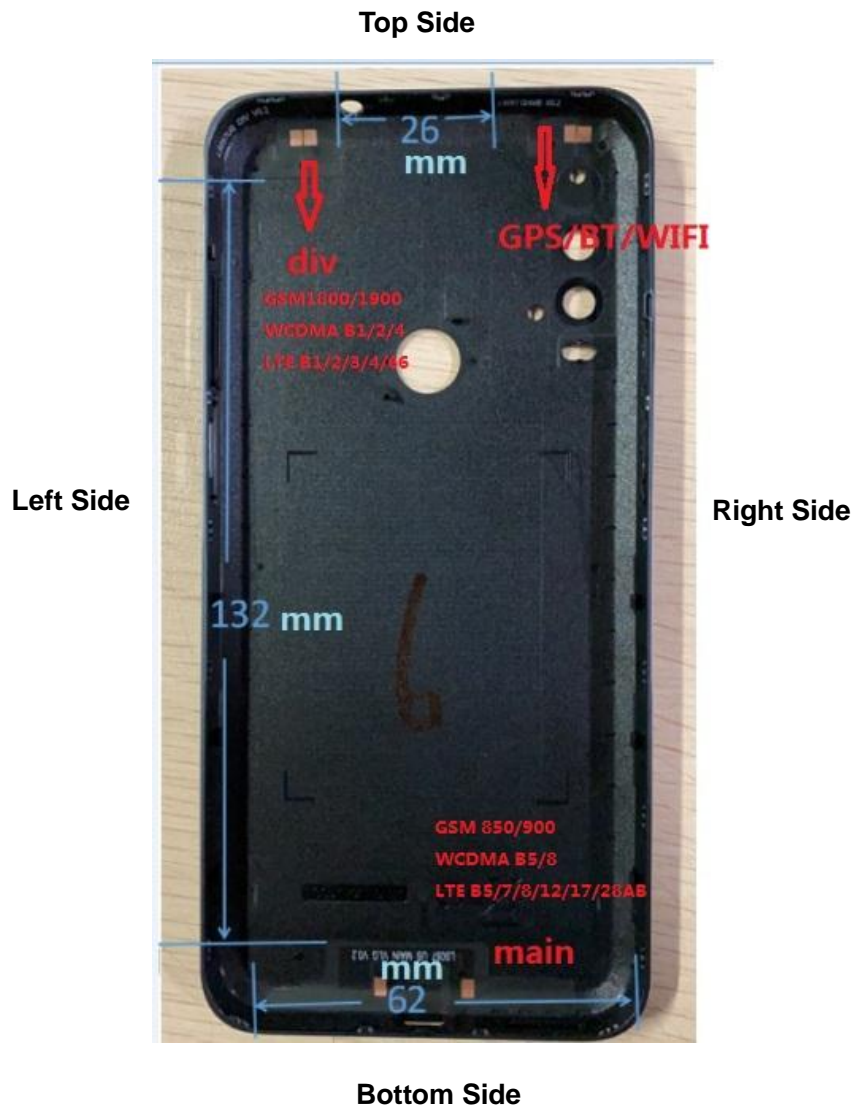

Picture 11.1 Antenna Locations (Front View)

/	Frequency Bands
div Antenna	GSM1900, WCDMA Band2/4, LTE Band 2/4/66
main Antenna	GSM850, WCDMA Band5, LTE Band 5/7/12/17

11.3. SAR Measurement Positions

According to the KDB941225 D06 Hot Spot SAR, the edges with less than 25mm distance to the antennas need to be tested for SAR.

SAR measurement positions						
Mode	Front	Rear	Left edge	Right edge	Top edge	Bottom edge
div antenna	Yes	Yes	Yes	Yes	Yes	No
main antenna	Yes	Yes	Yes	Yes	No	Yes
WLAN antenna	Yes	Yes	Yes	Yes	Yes	No

11.4. Standalone SAR Test Exclusion Considerations

Standalone 1-g head or body SAR evaluation by measurement or numerical simulation is not required when the corresponding SAR Exclusion Threshold condition, listed below, is satisfied.

The 1-g SAR test exclusion threshold for 100 MHz to 6 GHz at test separation distances ≤ 50 mm are determined by:

$[(\text{max. power of channel, including tune-up tolerance, mW}) / (\text{min. test separation distance, mm})] \cdot [\sqrt{f(\text{GHz})}] \leq 3.0$ for 1-g SAR, where

- $f(\text{GHz})$ is the RF channel transmit frequency in GHz
- Power and distance are rounded to the nearest mW and mm before calculation
- The result is rounded to one decimal place for comparison

Table 11.1: Standalone SAR test exclusion considerations

Band	f(GHz)	Position	SAR test exclusion threshold (mW)	RF output power		SAR test exclusion
				dBm	mW	
Bluetooth	2.441	Head	9.60	7.0	5.01	Yes
		Body	19.20	7.0	5.01	Yes
WLAN 2.4G	2.45	Head	9.58	19.5	89.13	No
		Body	19.17	19.5	89.13	No

12. Evaluation of Simultaneous

Table 12.1: The sum of reported SAR values for WWAN antenna and WLAN antenna

/	Position	WWAN (W/kg)	WLAN (W/kg)	Sum (W/kg)
Highest reported SAR value for Head	Right Cheek	1.26	0.23	1.49
Highest reported SAR value for Hotspot	Rear	1.16	0.22	1.38
Highest reported SAR value for Body-worn	Rear	1.16	0.22	1.38
Highest reported SAR value for extremity SAR	Bottom	3.58	/	3.58

Note: The test positions of above tables are for the worse case that has been evaluated. According to Section 11.3, WLAN bottom SAR does not need to be tested

Table 12.2: The sum of reported SAR values for WWAN antenna and Bluetooth antenna

/	Position	WWAN (W/kg)	Bluetooth (W/kg)	Sum (W/kg)
Highest reported SAR value for Head	Right Cheek	1.26	0.21	1.47
Highest reported SAR value for Hotspot	Bottom	1.26	0.10	1.36
Highest reported SAR value for Body-worn	Rear	1.16	0.10	1.26
Highest reported SAR value for extremity SAR	Bottom	3.58	0.21	3.79

Note: the test positions of above tables are for the worse case that has been evaluated.

Table 12.3: Estimated SAR for Bluetooth

Position	f (GHz)	Distance (mm)	Upper limit of power *		Estimated _{1g} (W/kg)
			dBm	mW	
Head	2.441	5	7.0	5.01	0.21
Body	2.441	10	7.0	5.01	0.10

* - Maximum possible output power declared by manufacturer

When standalone SAR test exclusion applies to an antenna that transmits simultaneously with other antennas, the standalone SAR must be estimated according to following to determine simultaneous transmission SAR test exclusion:

(max. power of channel, including tune-up tolerance, mW) / (min. test separation distance, mm)] · [√f(GHz)/x] W/kg for test separation distances ≤ 50 mm;

Where x = 7.5 for 1-g SAR.

When the minimum test separation distance is < 5 mm, a distance of 5 mm is applied to determine SAR test exclusion

Conclusion:

According to the above tables, the sum of reported SAR values is < 1.6W/kg. So the simultaneous transmission SAR with volume scans is not required.

13. Summary of Test Results

According to the client's decision rule in the test registration form, which is "based on the measurement results as the basis of the conformity statement", the test conclusion of this report meets the limit requirements.

The calculated SAR is obtained by the following formula:

$$\text{Reported SAR} = \text{Measured SAR} \times 10^{(P_{\text{Target}} - P_{\text{Measured}})/10}$$

Where P_{Target} is the power of manufacturing upper limit;

P_{Measured} is the measured power in chapter 10.

Note:

B2: Battery (BYD)

Duty Cycle

Mode	Duty Cycle
Speech for GSM850/1900	1:8.3
GPRS for GSM850	1:4
GPRS for GSM1900	1:2.67
WCDMA Band2/4/5	1:1
FDD_LTE Band 2/4/5/7/12/17/66	1:1

13.1. Testing Environment

Temperature:	18°C~25°C
Relative humidity:	30%~70%
Ground system resistance:	<4Ω
Ambient noise & Reflection:	< 0.012 W/kg

13.2. SAR results

Table 13.1: SAR Values (GSM 850 - Head)

Frequency		Test Mode	Test Position	Figure No./ Note	Conducted Power (dBm)	Max. tune-up Power (dBm)	Measured SAR(1g) (W/kg)	Reported SAR(1g) (W/kg)	Power Drift(dB)
Ch.	MHz								
Ambient Temperature: 22.8°C		Liquid Temperature: 22.3°C							
190	836.6	Speech	Left Cheek	/	33.30	33.5	0.279	0.29	-0.03
190	836.6	Speech	Left Tilt	/	33.30	33.5	0.139	0.15	0.05
190	836.6	Speech	Right Cheek	1	33.30	33.5	0.307	0.32	0.04
190	836.6	Speech	Right Tilt	/	33.30	33.5	0.151	0.16	0.11
190	836.6	Speech	Right Cheek	B2	33.30	33.5	0.245	0.26	0.01

Table 13.2: SAR Values (GSM 850 - Body)

Frequency		Test Mode	Test Position	Figure No./ Note	Conducted Power (dBm)	Max. tune-up Power (dBm)	Measured SAR(1g) (W/kg)	Reported SAR(1g) (W/kg)	Power Drift(dB)
Ch.	MHz								
Ambient Temperature: 22.8°C		Liquid Temperature: 22.3°C							
Hotspot / Body-Worn Test Data (10mm)									
190	836.6	GPRS	Front	/	31.33	32.0	0.355	0.41	0.00
190	836.6	GPRS	Rear	2	31.33	32.0	0.524	0.61	-0.02
190	836.6	GPRS	Rear	B2	31.33	32.0	0.447	0.52	-0.02
Hotspot Test Data (10mm)									
190	836.6	GPRS	Left	/	31.33	32.0	0.282	0.33	-0.04
190	836.6	GPRS	Right	/	31.33	32.0	0.347	0.40	-0.03
190	836.6	GPRS	Bottom	/	31.33	32.0	0.201	0.23	0.05

Table 13.3: SAR Values (GSM 1900 - Head)

Frequency		Test Mode	Test Position	Figure No./ Note	Conducted Power (dBm)	Max. tune-up Power (dBm)	Measured SAR(1g) (W/kg)	Reported SAR(1g) (W/kg)	Power Drift(dB)
Ch.	MHz								
Ambient Temperature: 22.7°C Liquid Temperature: 22.2°C									
Reduced power level 1									
661	1880	Speech	Left Cheek	/	26.76	27.5	0.306	0.36	-0.02
661	1880	Speech	Left Tilt	/	26.76	27.5	0.253	0.30	-0.05
661	1880	Speech	Right Cheek	/	26.76	27.5	0.573	0.68	0.06
661	1880	Speech	Right Tilt	/	26.76	27.5	0.387	0.46	0.12
661	1880	Speech	Right Cheek	3/B2	26.76	27.5	0.582	0.69	0.08

Table 13.4: SAR Values (GSM 1900 - Body)

Frequency		Test Mode	Test Position	Figure No./ Note	Conducted Power (dBm)	Max. tune-up Power (dBm)	Measured SAR(1g) (W/kg)	Reported SAR(1g) (W/kg)	Power Drift(dB)
Ch.	MHz								
Ambient Temperature: 22.7°C Liquid Temperature: 22.2°C									
Hotspot / Body-Worn Test Data (10mm)									
661	1880	GPRS	Front	/	26.42	28.0	0.270	0.39	-0.04
661	1880	GPRS	Rear	/	26.42	28.0	0.686	0.99	-0.03
810	1909.8	GPRS	Rear	/	26.26	28.0	0.683	1.02	0.11
512	1850.2	GPRS	Rear	/	26.72	28.0	0.678	0.91	0.04
810	1909.8	GPRS	Rear	4/B2	26.26	28.0	0.714	1.07	0.02
Hotspot Test Data (10mm)									
661	1880	GPRS	Left	/	26.42	28.0	0.338	0.49	-0.05
661	1880	GPRS	Right	/	26.42	28.0	0.109	0.16	0.17
661	1880	GPRS	Top	/	26.42	28.0	0.217	0.31	0.01

Table 13.5: SAR Values (WCDMA Band 2 - Head)

Frequency		Test Mode	Test Position	Figure No./ Note	Conducted Power (dBm)	Max. tune-up Power (dBm)	Measured SAR(1g) (W/kg)	Reported SAR(1g) (W/kg)	Power Drift(dB)
Ch.	MHz								
Ambient Temperature: 22.7°C Liquid Temperature: 22.2°C									
Reduced power level 1									
9400	1880	RMC	Left Cheek	/	18.60	19.5	0.358	0.44	0.01
9400	1880	RMC	Left Tilt	/	18.60	19.5	0.281	0.35	0.09
9400	1880	RMC	Right Cheek	/	18.60	19.5	0.568	0.70	0.05
9400	1880	RMC	Right Tilt	/	18.60	19.5	0.381	0.47	0.06
9400	1880	RMC	Right Cheek	B2	18.60	19.5	0.699	0.86	0.13
9538	1907.6	RMC	Right Cheek	B2	18.80	19.5	0.660	0.78	0.13
9262	1852.4	RMC	Right Cheek	5/B2	18.40	19.5	0.750	0.97	-0.07

Table 13.6: SAR Values (WCDMA Band 2 - Body)

Frequency		Test Mode	Test Position	Figure No./ Note	Conducted Power (dBm)	Max. tune-up Power (dBm)	Measured SAR(1g) (W/kg)	Reported SAR(1g) (W/kg)	Power Drift(dB)
Ch.	MHz								
Ambient Temperature: 22.7°C Liquid Temperature: 22.2°C									
Hotspot / Body-Worn Test Data (10mm)									
9400	1880	RMC	Front	/	22.60	23.5	0.330	0.41	0.15
9400	1880	RMC	Rear	/	22.60	23.5	0.751	0.92	0.14
9538	1907.6	RMC	Rear	6	22.60	23.5	0.796	0.98	0.08
9262	1852.4	RMC	Rear	/	22.30	23.5	0.661	0.87	0.17
9538	1907.6	RMC	Rear	B2	22.60	23.5	0.726	0.89	0.09
Hotspot Test Data (10mm)									
9400	1880	RMC	Left	/	22.60	23.5	0.409	0.50	-0.12
9400	1880	RMC	Right	/	22.60	23.5	0.096	0.12	0.11
9400	1880	RMC	Top	/	22.60	23.5	0.237	0.29	-0.08

Table 13.7: SAR Values (WCDMA Band 4 - Head)

Frequency		Test Mode	Test Position	Figure No./ Note	Conducted Power (dBm)	Max. tune-up Power (dBm)	Measured SAR(1g) (W/kg)	Reported SAR(1g) (W/kg)	Power Drift(dB)
Ch.	MHz								
Ambient Temperature: 22.5°C Liquid Temperature: 22.0°C									
Reduced power level 1									
1413	1732.6	RMC	Left Cheek	/	18.50	19.5	0.392	0.49	0.02
1413	1732.6	RMC	Left Tilt	/	18.50	19.5	0.317	0.40	0.04
1413	1732.6	RMC	Right Cheek	/	18.50	19.5	0.720	0.91	0.08
1413	1732.6	RMC	Right Tilt	/	18.50	19.5	0.399	0.50	0.01
1513	1752.6	RMC	Right Cheek	/	18.40	19.5	0.696	0.90	0.01
1312	1712.4	RMC	Right Cheek	/	18.40	19.5	0.679	0.87	0.06
1413	1732.6	RMC	Right Cheek	7/B2	18.50	19.5	0.842	1.06	0.18

Table 13.8: SAR Values (WCDMA Band 4 - Body)

Frequency		Test Mode	Test Position	Figure No./ Note	Conducted Power (dBm)	Max. tune-up Power (dBm)	Measured SAR(1g) (W/kg)	Reported SAR(1g) (W/kg)	Power Drift(dB)
Ch.	MHz								
Ambient Temperature: 22.5°C Liquid Temperature: 22.0°C									
Hotspot / Body-Worn Test Data (10mm)									
1413	1732.6	RMC	Front	/	23.50	24.0	0.457	0.51	-0.11
1413	1732.6	RMC	Rear	/	23.50	24.0	0.811	0.91	0.06
1513	1752.6	RMC	Rear	/	23.30	24.0	0.778	0.91	0.07
1312	1712.4	RMC	Rear	/	23.60	24.0	0.704	0.77	0.08
1413	1732.6	RMC	Rear	8/B2	23.50	24.0	0.958	1.07	0.11
Hotspot Test Data (10mm)									
1413	1732.6	RMC	Left	/	23.50	24.0	0.499	0.56	0.12
1413	1732.6	RMC	Right	/	23.50	24.0	0.070	0.08	0.06
1413	1732.6	RMC	Top	/	23.50	24.0	0.248	0.28	-0.07

Table 13.9: SAR Values (WCDMA Band 5 - Head)

Frequency		Test Mode	Test Position	Figure No./ Note	Conducted Power (dBm)	Max. tune-up Power (dBm)	Measured SAR(1g) (W/kg)	Reported SAR(1g) (W/kg)	Power Drift(dB)
Ch.	MHz								
Ambient Temperature: 22.8°C		Liquid Temperature: 22.3°C							
4182	836.4	RMC	Left Cheek	/	23.20	24.0	0.222	0.27	0.06
4182	836.4	RMC	Left Tilt	/	23.20	24.0	0.107	0.13	0.01
4182	836.4	RMC	Right Cheek	9	23.20	24.0	0.243	0.29	0.09
4182	836.4	RMC	Right Tilt	/	23.20	24.0	0.119	0.14	0.08
4182	836.4	RMC	Right Cheek	B2	23.20	24.0	0.204	0.25	0.03

Table 13.10: SAR Values (WCDMA Band 5 - Body)

Frequency		Test Mode	Test Position	Figure No./ Note	Conducted Power (dBm)	Max. tune-up Power (dBm)	Measured SAR(1g) (W/kg)	Reported SAR(1g) (W/kg)	Power Drift(dB)
Ch.	MHz								
Ambient Temperature: 22.8°C		Liquid Temperature: 22.3°C							
Hotspot / Body-Worn Test Data (10mm)									
4182	836.4	RMC	Front	/	23.20	24.0	0.220	0.26	-0.02
4182	836.4	RMC	Rear	10	23.20	24.0	0.354	0.43	0.02
4182	836.4	RMC	Rear	B2	23.20	24.0	0.324	0.39	0.07
Hotspot Test Data (10mm)									
4182	836.4	RMC	Left	/	23.20	24.0	0.209	0.25	0.06
4182	836.4	RMC	Right	/	23.20	24.0	0.272	0.33	0.02
4182	836.4	RMC	Bottom	/	23.20	24.0	0.150	0.18	0.13

Table 13.11: SAR Values (LTE Band 2 - Head)

Frequency		Test Mode	Test Position	Figure No./ Note	Conducted Power (dBm)	Max. tune-up Power (dBm)	Measured SAR(1g) (W/kg)	Reported SAR(1g) (W/kg)	Power Drift(dB)
Ch.	MHz								
Ambient Temperature: 22.7°C Liquid Temperature: 22.2°C									
Reduced power level 1									
18900	1880	1RB99	Left Cheek	/	19.85	20.5	0.594	0.69	0.02
18900	1880	50RB50	Left Cheek	/	18.43	19.5	0.418	0.53	-0.03
18900	1880	1RB99	Left Tilt	/	19.85	20.5	0.397	0.46	0.17
18900	1880	50RB50	Left Tilt	/	18.43	19.5	0.307	0.39	0.03
18900	1880	1RB99	Right Cheek	11	19.85	20.5	0.963	1.12	0.01
18900	1880	50RB50	Right Cheek	/	18.43	19.5	0.745	0.95	0.05
18900	1880	1RB99	Right Tilt	/	19.85	20.5	0.626	0.73	0.06
18900	1880	50RB50	Right Tilt	/	18.43	19.5	0.449	0.57	0.11
19100	1900	1RB0	Right Cheek	/	19.37	20.5	0.927	1.20	0.04
18700	1860	1RB99	Right Cheek	/	19.32	20.5	0.743	0.97	0.06
19100	1900	50RB0	Right Cheek	/	18.41	19.5	0.746	0.96	0.08
18700	1860	50RB50	Right Cheek	/	18.14	19.5	0.608	0.83	0.04
18900	1880	100RB	Right Cheek	/	18.29	19.5	0.672	0.89	0.07
19100	1900	1RB0	Right Cheek	B2	19.37	20.5	0.925	1.20	0.03

Table 13.12: SAR Values (LTE Band 2 - Body)

Frequency		Test Mode	Test Position	Figure No./ Note	Conducted Power (dBm)	Max. tune-up Power (dBm)	Measured SAR(1g) (W/kg)	Reported SAR(1g) (W/kg)	Power Drift(dB)
Ch.	MHz								
Ambient Temperature: 22.7°C					Liquid Temperature: 22.2°C				
Hotspot / Body-Worn Test Data (10mm)									
18900	1880	1RB99	Front	/	22.18	23.0	0.284	0.34	-0.10
19100	1900	50RB25	Front	/	21.23	22.0	0.231	0.28	0.06
18900	1880	1RB99	Rear	/	22.18	23.0	0.679	0.82	0.04
19100	1900	50RB25	Rear	/	21.23	22.0	0.572	0.68	-0.19
19100	1900	1RB50	Rear	12	22.06	23.0	0.717	0.89	-0.01
18700	1860	1RB0	Rear	/	21.72	22.0	0.563	0.60	-0.04
19100	1900	100RB	Rear	/	21.17	22.0	0.564	0.68	-0.07
19100	1900	1RB50	Rear	B2	22.06	23.0	0.685	0.85	-0.05
Hotspot Test Data (10mm)									
18900	1880	1RB99	Left	/	22.18	23.0	0.368	0.44	-0.03
19100	1900	50RB25	Left	/	21.23	22.0	0.294	0.35	0.08
18900	1880	1RB99	Right	/	22.18	23.0	0.093	0.11	0.03
19100	1900	50RB25	Right	/	21.23	22.0	0.074	0.09	0.19
18900	1880	1RB99	Top	/	22.18	23.0	0.243	0.29	0.00
19100	1900	50RB25	Top	/	21.23	22.0	0.200	0.24	-0.05

Table 13.13: SAR Values (LTE Band 5 - Head)

Frequency		Test Mode	Test Position	Figure No./ Note	Conducted Power (dBm)	Max. tune-up Power (dBm)	Measured SAR(1g) (W/kg)	Reported SAR(1g) (W/kg)	Power Drift(dB)
Ch.	MHz								
Ambient Temperature: 22.8°C Liquid Temperature: 22.3°C									
20450	829	1RB0	Left Cheek	/	23.12	24.0	0.191	0.23	0.19
20450	829	25RB0	Left Cheek	/	22.17	23.0	0.148	0.18	0.17
20450	829	1RB0	Left Tilt	/	23.12	24.0	0.085	0.10	0.16
20450	829	25RB0	Left Tilt	/	22.17	23.0	0.067	0.08	0.17
20450	829	1RB0	Right Cheek	13	23.12	24.0	0.213	0.26	0.08
20450	829	25RB0	Right Cheek	/	22.17	23.0	0.165	0.20	0.09
20450	829	1RB0	Right Tilt	/	23.12	24.0	0.103	0.13	0.06
20450	829	25RB0	Right Tilt	/	22.17	23.0	0.083	0.10	0.08
20450	829	1RB0	Right Cheek	B2	23.12	24.0	0.185	0.23	-0.02

Table 13.14: SAR Values (LTE Band 5 - Body)

Frequency		Test Mode	Test Position	Figure No./ Note	Conducted Power (dBm)	Max. tune-up Power (dBm)	Measured SAR(1g) (W/kg)	Reported SAR(1g) (W/kg)	Power Drift(dB)
Ch.	MHz								
Ambient Temperature: 22.8°C Liquid Temperature: 22.3°C									
Hotspot / Body-Worn Test Data (10mm)									
20450	829	1RB0	Front	/	23.12	24.0	0.225	0.28	0.05
20450	829	25RB0	Front	/	22.17	23.0	0.177	0.21	0.03
20450	829	1RB0	Rear	14	23.12	24.0	0.365	0.45	0.05
20450	829	25RB0	Rear	/	22.17	23.0	0.279	0.34	-0.02
20450	829	1RB0	Rear	B2	23.12	24.0	0.263	0.32	0.06
Hotspot Test Data (10mm)									
20450	829	1RB0	Left	/	23.12	24.0	0.170	0.21	-0.10
20450	829	25RB0	Left	/	22.17	23.0	0.135	0.16	-0.05
20450	829	1RB0	Right	/	23.12	24.0	0.243	0.30	0.00
20450	829	25RB0	Right	/	22.17	23.0	0.187	0.23	-0.02
20450	829	1RB0	Bottom	/	23.12	24.0	0.135	0.17	0.07
20450	829	25RB0	Bottom	/	22.17	23.0	0.111	0.13	0.02

Table 13.15: SAR Values (LTE Band 7 - Head)

Frequency		Test Mode	Test Position	Figure No./ Note	Conducted Power (dBm)	Max. tune-up Power (dBm)	Measured SAR(1g) (W/kg)	Reported SAR(1g) (W/kg)	Power Drift(dB)
Ch.	MHz								
		Ambient Temperature: 22.9°C			Liquid Temperature: 22.4°C				
20850	2510	1RB99	Left Cheek	/	22.14	22.5	0.059	0.06	-0.06
20850	2510	50RB50	Left Cheek	/	21.10	21.5	0.045	0.05	0.01
20850	2510	1RB99	Left Tilt	/	22.14	22.5	0.051	0.06	0.02
20850	2510	50RB50	Left Tilt	/	21.10	21.5	0.039	0.04	-0.06
20850	2510	1RB99	Right Cheek	15	22.14	22.5	0.072	0.08	0.07
20850	2510	50RB50	Right Cheek	/	21.10	21.5	0.058	0.06	0.07
20850	2510	1RB99	Right Tilt	/	22.14	22.5	0.036	0.04	0.12
20850	2510	50RB50	Right Tilt	/	21.10	21.5	0.029	0.03	0.13
20850	2510	1RB99	Right Cheek	B2	22.14	22.5	0.071	0.08	0.08

Table 13.16: SAR Values (LTE Band 7 - Body)

Frequency		Test Mode	Test Position	Figure No./ Note	Conducted Power (dBm)	Max. tune-up Power (dBm)	Measured SAR(1g) (W/kg)	Reported SAR(1g) (W/kg)	Power Drift(dB)
Ch.	MHz								
		Ambient Temperature: 22.9°C			Liquid Temperature: 22.4°C				
Hotspot / Body-Worn Test Data (10mm)									
20850	2510	1RB99	Front	/	22.14	22.5	0.220	0.24	0.19
20850	2510	50RB50	Front	/	21.10	21.5	0.185	0.20	0.05
20850	2510	1RB99	Rear	/	22.14	22.5	0.562	0.61	0.05
20850	2510	50RB50	Rear	/	21.10	21.5	0.470	0.52	0.09
Hotspot Test Data (10mm)									
20850	2510	1RB99	Left	/	22.14	22.5	0.053	0.06	0.09
20850	2510	50RB50	Left	/	21.10	21.5	0.050	0.05	0.19
20850	2510	1RB99	Right	/	22.14	22.5	0.041	0.04	0.14
20850	2510	50RB50	Right	/	21.10	21.5	0.034	0.04	0.03
20850	2510	1RB99	Bottom	/	22.14	22.5	0.741	0.81	0.09
20850	2510	50RB50	Bottom	/	21.10	21.5	0.590	0.65	0.04
21350	2560	1RB50	Bottom	/	22.00	22.5	0.561	0.63	0.06
21100	2535	1RB99	Bottom	/	22.04	22.5	1.050	1.17	0.03
21100	2535	100RB	Bottom	/	21.09	21.5	0.545	0.60	0.09
21100	2535	1RB99	Bottom	16/B2	22.04	22.5	1.130	1.26	0.15

Table 13.17: SAR Values (LTE Band 12 - Head)

Frequency		Test Mode	Test Position	Figure No./ Note	Conducted Power (dBm)	Max. tune-up Power (dBm)	Measured SAR(1g) (W/kg)	Reported SAR(1g) (W/kg)	Power Drift(dB)
Ch.	MHz								
		Ambient Temperature: 23.0°C			Liquid Temperature: 22.5°C				
23060	704	1RB0	Left Cheek	/	22.97	24.0	0.148	0.19	0.01
23060	704	25RB0	Left Cheek	/	21.96	23.0	0.122	0.16	0.07
23060	704	1RB0	Left Tilt	/	22.97	24.0	0.060	0.08	0.18
23060	704	25RB0	Left Tilt	/	21.96	23.0	0.052	0.07	0.14
23060	704	1RB0	Right Cheek	/	22.97	24.0	0.152	0.19	0.08
23060	704	25RB0	Right Cheek	/	21.96	23.0	0.124	0.16	0.07
23060	704	1RB0	Right Tilt	/	22.97	24.0	0.062	0.08	0.07
23060	704	25RB0	Right Tilt	/	21.96	23.0	0.052	0.07	0.05
23060	704	1RB0	Right Cheek	17/B2	22.97	24.0	0.170	0.22	0.03

Table 13.18: SAR Values (LTE Band 12 - Body)

Frequency		Test Mode	Test Position	Figure No./ Note	Conducted Power (dBm)	Max. tune-up Power (dBm)	Measured SAR(1g) (W/kg)	Reported SAR(1g) (W/kg)	Power Drift(dB)
Ch.	MHz								
		Ambient Temperature: 23.0°C			Liquid Temperature: 22.5°C				
Hotspot / Body-Worn Test Data (10mm)									
23060	704	1RB0	Front	/	22.97	24.0	0.248	0.31	0.02
23060	704	25RB0	Front	/	21.96	23.0	0.204	0.26	-0.02
23060	704	1RB0	Rear	18	22.97	24.0	0.388	0.49	0.02
23060	704	25RB0	Rear	/	21.96	23.0	0.320	0.41	0.07
23060	704	1RB0	Rear	B2	22.97	24.0	0.238	0.30	0.06
Hotspot Test Data (10mm)									
23060	704	1RB0	Left	/	22.97	24.0	0.166	0.21	-0.07
23060	704	25RB0	Left	/	21.96	23.0	0.135	0.17	-0.13
23060	704	1RB0	Right	/	22.97	24.0	0.291	0.37	-0.01
23060	704	25RB0	Right	/	21.96	23.0	0.249	0.32	0.07
23060	704	1RB0	Bottom	/	22.97	24.0	0.095	0.12	0.18
23060	704	25RB0	Bottom	/	21.96	23.0	0.079	0.10	0.07

Note: SAR for LTE Band 17 is covered by LTE Band 12 due to similar frequency range, same maximum tune-up limit and same channel bandwidth.

Table 13.19: SAR Values (LTE Band 66 - Head)

Frequency		Test Mode	Test Position	Figure No./ Note	Conducted Power (dBm)	Max. tune-up Power (dBm)	Measured SAR(1g) (W/kg)	Reported SAR(1g) (W/kg)	Power Drift(dB)
Ch.	MHz								
Ambient Temperature: 22.3°C Liquid Temperature: 21.8°C									
Reduced power level 1									
132322	1745	1RB99	Left Cheek	/	19.26	20.0	0.628	0.74	0.09
132072	1720	50RB50	Left Cheek	/	17.77	19.0	0.422	0.56	0.06
132322	1745	1RB99	Left Tilt	/	19.26	20.0	0.418	0.50	0.01
132072	1720	50RB50	Left Tilt	/	17.77	19.0	0.279	0.37	-0.01
132322	1745	1RB99	Right Cheek	19	19.26	20.0	1.060	1.26	0.06
132072	1720	50RB50	Right Cheek	/	17.77	19.0	0.795	1.06	0.11
132322	1745	1RB99	Right Tilt	/	19.26	20.0	0.623	0.74	0.04
132072	1720	50RB50	Right Tilt	/	17.77	19.0	0.406	0.54	0.03
132572	1770	1RB0	Right Cheek	/	18.75	20.0	0.901	1.20	0.10
132072	1720	1RB99	Right Cheek	/	19.15	19.0	0.996	0.96	0.06
132572	1770	50RB50	Right Cheek	/	17.66	20.0	0.718	1.23	0.06
132322	1745	50RB50	Right Cheek	/	17.70	19.0	0.805	1.09	0.07
132572	1770	100RB	Right Cheek	/	17.59	19.0	0.705	0.98	-0.07
132322	1745	1RB99	Right Cheek	B2	19.26	20.0	1.020	1.21	0.02

Note: SAR for LTE Band 4 is covered by LTE Band 66 due to similar frequency range, same maximum tune-up limit and same channel bandwidth.

Table 13.20: SAR Values (LTE Band 66 - Body)

Frequency		Test Mode	Test Position	Figure No./ Note	Conducted Power (dBm)	Max. tune-up Power (dBm)	Measured SAR(1g) (W/kg)	Reported SAR(1g) (W/kg)	Power Drift(dB)
Ch.	MHz								
Ambient Temperature: 22.3°C					Liquid Temperature: 21.8°C				
Hotspot / Body-Worn Test Data (10mm)									
132572	1770	1RB0	Front	/	23.59	24.0	0.440	0.48	-0.11
132572	1770	50RB0	Front	/	22.65	23.0	0.356	0.39	-0.02
132572	1770	1RB0	Rear	/	23.59	24.0	0.864	0.95	0.01
132572	1770	50RB0	Rear	/	22.65	23.0	0.674	0.73	0.05
132322	1745	1RB0	Rear	/	23.39	24.0	0.725	0.83	0.19
132072	1720	1RB0	Rear	/	23.56	24.0	0.741	0.82	0.07
132322	1745	50RB0	Rear	/	22.43	23.0	0.573	0.65	0.03
132072	1720	50RB0	Rear	/	22.59	23.0	0.585	0.64	0.03
132572	1770	100RB	Rear	/	22.54	23.0	0.652	0.72	0.09
132572	1770	1RB0	Rear	20/B2	23.59	24.0	1.060	1.16	0.03
Hotspot Test Data (10mm)									
132572	1770	1RB0	Left	/	23.59	24.0	0.540	0.59	0.03
132572	1770	50RB0	Left	/	22.65	23.0	0.417	0.45	-0.05
132572	1770	1RB0	Right	/	23.59	24.0	0.061	0.07	0.19
132572	1770	50RB0	Right	/	22.65	23.0	0.049	0.05	0.04
132572	1770	1RB0	Top	/	23.59	24.0	0.254	0.28	0.05
132572	1770	50RB0	Top	/	22.65	23.0	0.189	0.20	0.07

Note: SAR for LTE Band 4 is covered by LTE Band 66 due to similar frequency range, same maximum tune-up limit and same channel bandwidth.

13.3. WLAN Evaluation for 2.4G

According to the KDB248227 D01, SAR is measured for 2.4GHz 802.11b DSSS using the initial test position procedure.

Table 13.21: SAR Values (WLAN 2.4G - Head)

Frequency		Test Mode	Test Position	Figure No./ Note	Ambient Temperature: 22.4°C		Liquid Temperature: 21.9°C		
Ch.	MHz				Conducted Power (dBm)	Max. tune-up Power (dBm)	Measured SAR(1g) (W/kg)	Reported SAR(1g) (W/kg)	Power Drift(dB)
6	2437	802.11b	Left Cheek	/	18.37	19.5	0.332	0.43	0.07
6	2437	802.11b	Left Tilt	/	18.37	19.5	0.206	0.27	-0.05
6	2437	802.11b	Right Cheek	/	18.37	19.5	0.179	0.23	0.03
6	2437	802.11b	Right Tilt	/	18.37	19.5	0.148	0.19	-0.03
6	2437	802.11b	Left Cheek	21/B2	18.37	19.5	0.340	0.44	0.03

Note1: For all positions/configurations tested using the initial test position and subsequent test positions, when the reported SAR is > 0.8 W/kg, SAR is measured for these test positions/configurations on the subsequent next highest measured output power channel until the reported SAR is ≤ 1.2 W/kg or all required channels are tested.

According to the KDB248227 D01, The reported SAR must be scaled to 100% transmission duty factor to determine compliance at the maximum tune-up tolerance limit.

Table 13.22: SAR Values (WLAN - Head) – 802.11b (Scaled Reported SAR)

Frequency		Test Position	Actual duty factor	maximum duty factor	Reported SAR (1g)(W/kg)	Scaled reported SAR (1g)(W/kg)
Ch.	MHz					
6	2437	Left Cheek	100%	100%	0.44	0.44

SAR is not required for OFDM because the 802.11b adjusted SAR ≤ 1.2 W/kg.

Table 13.23: SAR Values (WLAN 2.4G - Body)

Frequency		Test Mode	Test Position	Figure No./ Note	Conducted Power (dBm)	Max. tune-up Power (dBm)	Measured SAR(1g) (W/kg)	Reported SAR(1g) (W/kg)	Power Drift(dB)
Ch.	MHz								
Ambient Temperature: 22.4°C Liquid Temperature: 21.9°C									
Test Data (10mm)									
6	2437	802.11b	Front	/	18.37	19.5	0.073	0.10	0.03
6	2437	802.11b	Rear	22	18.37	19.5	0.172	0.22	-0.08
6	2437	802.11b	Left	/	18.37	19.5	0.021	0.03	0.01
6	2437	802.11b	Right	/	18.37	19.5	0.088	0.11	0.17
6	2437	802.11b	Top	/	18.37	19.5	0.092	0.12	0.03
6	2437	802.11b	Rear	B2	18.37	19.5	0.102	0.13	0.01

Note1: For all positions/configurations tested using the initial test position and subsequent test positions, when the reported SAR is > 0.8 W/kg, SAR is measured for these test positions/configurations on the subsequent next highest measured output power channel until the reported SAR is ≤ 1.2 W/kg or all required channels are tested.

According to the KDB248227 D01, The reported SAR must be scaled to 100% transmission duty factor to determine compliance at the maximum tune-up tolerance limit.

Table 13.24: SAR Values (WLAN - Body) – 802.11b (Scaled Reported SAR)

Frequency		Test Position	Actual duty factor	maximum duty factor	Reported SAR (1g)(W/kg)	Scaled reported SAR (1g)(W/kg)
Ch.	MHz					
6	2437	Rear	100%	100%	0.22	0.22

SAR is not required for OFDM because the 802.11b adjusted SAR ≤ 1.2 W/kg.



13.4. Product specific 10g SAR

According to the KDB648474 D04, the UMPC mini-tablet procedures must also be applied to test the SAR of all surfaces and edges with an antenna located at ≤ 25 mm from that surface or edge, in direct contact with a flat phantom, for 10-g extremity SAR according to the body-equivalent tissue dielectric parameters in KDB Publication 865664 D01 to address interactive hand use exposure conditions. When hotspot mode applies, 10-g extremity SAR is required only for the surfaces and edges with hotspot mode 1-g reported SAR > 1.2 W/kg.

Table 13.25: SAR Values (LTE Band 7 - Body)

Frequency		Test Mode	Test Position	Figure No./ Note	Conducted Power (dBm)	Max. tune-up Power (dBm)	Measured SAR(10g) (W/kg)	Reported SAR(10g) (W/kg)	Power Drift(dB)
Ch.	MHz								
Ambient Temperature: 22.3°C					Liquid Temperature: 21.8°C				
Test Data (0mm)									
21100	2535	1RB99	Bottom	B2	22.04	22.5	3.220	3.58	-0.03

14. SAR Measurement Variability

SAR measurement variability must be assessed for each frequency band, which is determined by the SAR probe calibration point and tissue-equivalent medium used for the device measurements. When both head and body tissue-equivalent media are required for SAR measurements in a frequency band, the variability measurement procedures should be applied to the tissue medium with the highest measured SAR, using the highest measured SAR configuration for that tissue-equivalent medium.

The following procedures are applied to determine if repeated measurements are required.

- 1) Repeated measurement is not required when the original highest measured SAR is < 0.80 W/kg; steps 2) through 4) do not apply.
- 2) When the original highest measured SAR is ≥ 0.80 W/kg, repeat that measurement once.
- 3) Perform a second repeated measurement only if the ratio of largest to smallest SAR for the original and first repeated measurements is > 1.20 or when the original or repeated measurement is ≥ 1.45 W/kg (~ 10% from the 1-g SAR limit).
- 4) Perform a third repeated measurement only if the original, first or second repeated measurement is ≥ 1.5 W/kg and the ratio of largest to smallest SAR for the original, first and second repeated measurements is > 1.20 .

Table 14.1: SAR Measurement Variability for Head – WCDMA Band 4

Frequency		Test Position	Original	1 st Repeated	Ratio	2 nd Repeated
Ch.	MHz		SAR (W/kg)	SAR (W/kg)		SAR (W/kg)
1413	1732.6	Right Cheek	0.842	0.831	1.01	/

Table 14.2: SAR Measurement Variability for Body – WCDMA Band 4

Frequency		Test Position	Original	1 st Repeated	Ratio	2 nd Repeated
Ch.	MHz		SAR (W/kg)	SAR (W/kg)		SAR (W/kg)
1413	1732.6	Rear	0.958	0.936	1.02	/

Table 14.3: SAR Measurement Variability for Head – LTE Band 2

Frequency		Test Position	Original	1 st Repeated	Ratio	2 nd Repeated
Ch.	MHz		SAR (W/kg)	SAR (W/kg)		SAR (W/kg)
18900	1880	Right Cheek	0.963	0.939	1.03	/

Table 14.4: SAR Measurement Variability for Body – LTE Band 7

Frequency		Test Position	Original	1 st Repeated	Ratio	2 nd Repeated
Ch.	MHz		SAR (W/kg)	SAR (W/kg)		SAR (W/kg)
21100	2535	Bottom	1.130	1.090	1.04	/

Table 14.5: SAR Measurement Variability for Head – LTE Band 66

Frequency		Test Position	Original	1 st Repeated	Ratio	2 nd Repeated
Ch.	MHz		SAR (W/kg)	SAR (W/kg)		SAR (W/kg)
132322	1745	Right Cheek	1.060	1.02	1.04	/



Table 14.6: SAR Measurement Variability for Body – LTE Band 66

Frequency		Test Position	Original	1 st Repeated	Ratio	2 nd Repeated
Ch.	MHz		SAR (W/kg)	SAR (W/kg)		SAR (W/kg)
132572	1770	Rear	1.060	1.040	1.02	/

15. Measurement Uncertainty

15.1. Measurement Uncertainty for Normal SAR Tests (300MHz~3GHz)

No.	Error Description	Type	Uncertainty value	Probably Distribution	Div.	(Ci) 1g	(Ci) 10g	Std. Unc. (1g)	Std. Unc. (10g)	Degree of freedom
Measurement system										
1	Probe calibration	B	12.0	N	2	1	1	6.0	6.0	∞
2	Axial isotropy	B	4.7	R	$\sqrt{3}$	$\sqrt{0.5}$	$\sqrt{0.5}$	4.3	4.3	∞
3	Hemispherical isotropy	B	9.6	R	$\sqrt{3}$	1	1	4.8	4.8	∞
4	Boundary effect	B	1.1	R	$\sqrt{3}$	1	1	0.6	0.6	∞
5	Linearity	B	4.7	R	$\sqrt{3}$	1	1	2.7	2.7	∞
6	Detection limit	B	1.0	R	$\sqrt{3}$	1	1	0.6	0.6	∞
7	Modulation response	B	4.0	R	$\sqrt{3}$	1	1	2.3	2.3	∞
8	Readout electronics	B	1.0	N	1	1	1	1.0	1.0	∞
9	Response time	B	0.8	R	$\sqrt{3}$	1	1	0.5	0.5	∞
10	Integration time	B	1.7	R	$\sqrt{3}$	1	1	1.0	1.0	∞
11	RF ambient conditions-noise	B	3.0	R	$\sqrt{3}$	1	1	1.7	1.7	∞
12	RF ambient conditions-reflection	B	3.0	R	$\sqrt{3}$	1	1	1.7	1.7	∞
13	Probe positioned mech. restrictions	B	0.35	R	$\sqrt{3}$	1	1	0.2	0.2	∞
14	Probe positioning with respect to phantom shell	B	2.9	R	$\sqrt{3}$	1	1	1.7	1.7	∞
15	Post-processing	B	1.0	R	$\sqrt{3}$	1	1	0.6	0.6	∞
Test sample related										
16	Test sample positioning	A	3.3	N	1	1	1	3.3	3.3	5
17	Device holder uncertainty	A	3.4	N	1	1	1	3.4	3.4	5
18	Drift of output power	B	5.0	R	$\sqrt{3}$	1	1	2.9	2.9	∞
Phantom and set-up										
19	Phantom uncertainty	B	1.0	R	$\sqrt{3}$	1	1	0.6	0.6	∞
20	Liquid conductivity (target)	B	5.0	R	$\sqrt{3}$	0.64	0.43	1.8	1.2	∞
21	Liquid conductivity (meas.)	A	1.3	N	1	0.64	0.43	0.83	0.56	9
22	Liquid permittivity (target)	B	5.0	R	$\sqrt{3}$	0.6	0.49	1.7	1.4	∞
23	Liquid permittivity (meas.)	A	1.6	N	1	0.6	0.49	0.96	0.78	9
Combined standard uncertainty		$u_c = \sqrt{\sum_{i=1}^{23} c_i^2 u_i^2}$						11.3	11.2	95.5
Expanded uncertainty (Confidence interval of 95 %)		$u_e = 2u_c$						22.6	22.4	

16. Main Test Instruments

Table 16.1: List of Main Instruments

No.	Name	Type	Serial Number	Calibration Date	Valid Period
01	Network analyzer	E5071C	MY46103759	2020-11-15	One year
02	Dielectric probe	85070E	MY44300317	/	/
03	Power meter	E4418B	MY50000366	2020-12-13	One year
04	Power sensor	E9304A	MY50000188		
05	Power meter	NRP	101460	2021-01-15	One year
06	Power sensor	NRP-Z91	100553		
07	Signal Generator	E8257D	MY47461211	2021-01-15	One year
08	Amplifier	VTL5400	0404	/	/
09	E-field Probe	EX3DV4	7621	2020-10-05 & 2020-11-30	One year
10	DAE	DAE4	1527	2020-11-06	One year
11	Dipole Validation Kit	D750V3	1163	2019-09-03	Three year
12	Dipole Validation Kit	D835V2	4d057	2018-10-09	Three year
13	Dipole Validation Kit	D1750V2	1152	2019-08-30	Three year
14	Dipole Validation Kit	D1900V2	5d088	2018-10-24	Three year
15	Dipole Validation Kit	D2450V2	873	2018-10-26	Three year
16	Dipole Validation Kit	D2550V2	1010	2021-05-21	Three year
17	BTS	MT8820C	6201341853	2021-01-15	One year
18	BTS	E5515C	GB46110722	2021-01-15	One year
19	BTS	CMW500	158344	2021-07-17	One year
20	Software	DASY5	52.8.8.1222	/	/

ANNEX A: Graph Results

GSM850 Head

Date: 2021-6-6

Electronics: DAE4 Sn1527

Medium: Head 835MHz

Medium parameters used (interpolated): $f = 836.6$ MHz; $\sigma = 0.889$ S/m; $\epsilon_r = 41.935$; $\rho = 1000$ kg/m³

Communication System: UID 0, GSM (0) Frequency: 836.6 MHz Duty Cycle: 1:8.3

Probe: EX3DV4 – SN7621 ConvF (10.35, 10.35, 10.35);

Right Cheek Middle/Area Scan (61x61x1): Interpolated grid: dx=1.500 mm, dy=1.500 mm

Maximum value of SAR (interpolated) = 0.337 W/kg

Right Cheek Middle/Zoom Scan (5x5x7)/Cube 0: Measurement grid: dx=8mm, dy=8mm, dz=5mm

Reference Value = 3.559 V/m; Power Drift = 0.04 dB

Peak SAR (extrapolated) = 0.388 W/kg

SAR(1 g) = 0.307 W/kg; SAR(10 g) = 0.236 W/kg

Maximum value of SAR (measured) = 0.337 W/kg

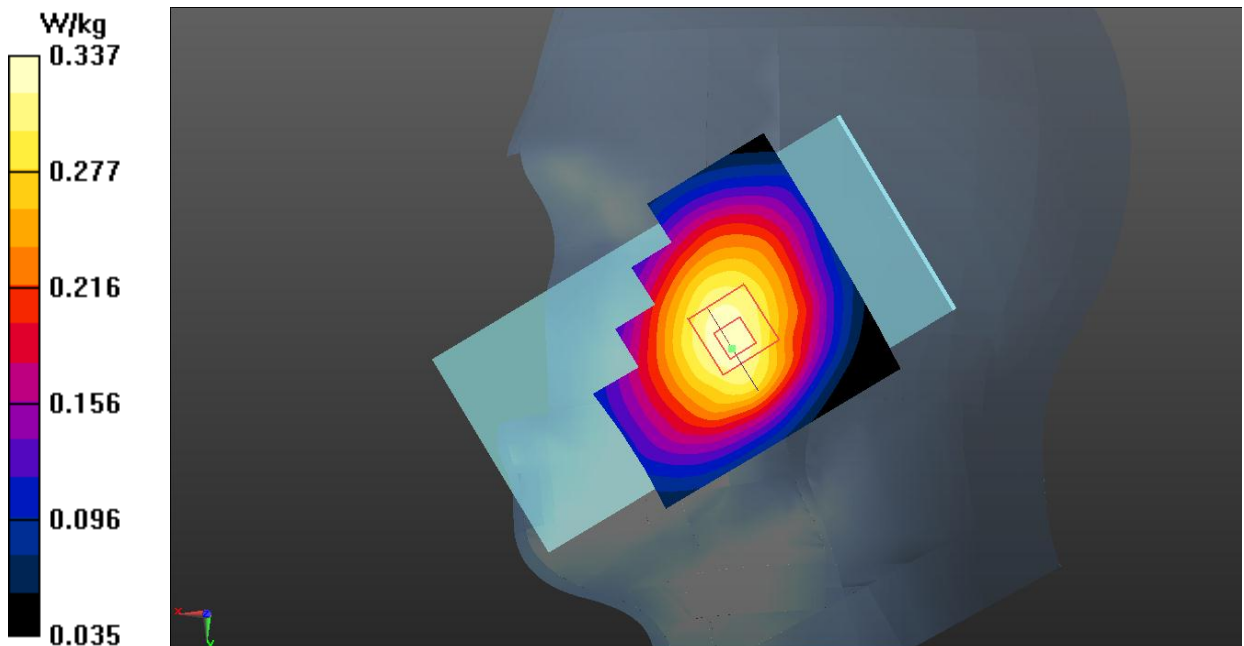

Fig.1 GSM 850 Head

GSM850 Body

Date: 2021-6-6

Electronics: DAE4 Sn1527

Medium: Head 835MHz

Medium parameters used (interpolated): $f = 836.6$ MHz; $\sigma = 0.889$ S/m; $\epsilon_r = 41.935$; $\rho = 1000$ kg/m³

Communication System: UID 0, GPRS 2Txslot (0) Frequency: 836.6 MHz Duty Cycle: 1:4

Probe: EX3DV4 – SN7621 ConvF (10.35, 10.35, 10.35);

Rear Side Middle/Area Scan (61x61x1): Interpolated grid: dx=1.500 mm, dy=1.500 mm

Maximum value of SAR (interpolated) = 0.577 W/kg

Rear Side Middle/Zoom Scan (5x5x7)/Cube 0: Measurement grid: dx=8mm, dy=8mm, dz=5mm

Reference Value = 24.09 V/m; Power Drift = -0.02 dB

Peak SAR (extrapolated) = 0.672 W/kg

SAR(1 g) = 0.524 W/kg; SAR(10 g) = 0.393 W/kg

Maximum value of SAR (measured) = 0.577 W/kg

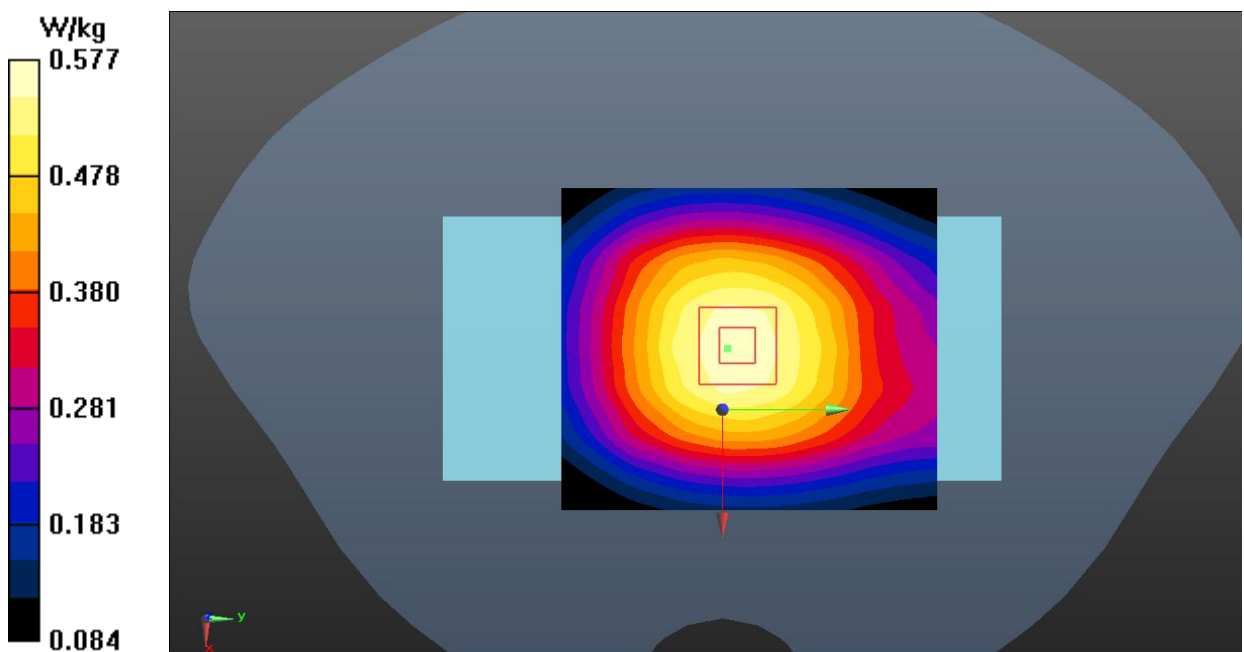

Fig.2 GSM 850 Body

GSM1900 Head

Date: 2021-6-27

Electronics: DAE4 Sn1527

Medium: Head 1900MHz

Medium parameters used: $f = 1880$ MHz; $\sigma = 1.407$ S/m; $\epsilon_r = 39.551$; $\rho = 1000$ kg/m³

Communication System: UID 0, GSM (0) Frequency: 1880 MHz Duty Cycle: 1:8.3

Probe: EX3DV4 – SN7621 ConvF (8.77, 8.77, 8.77);

Right Cheek Middle/Area Scan (61x61x1): Interpolated grid: dx=1.500 mm, dy=1.500 mm

Maximum value of SAR (interpolated) = 0.886 W/kg

Right Cheek Middle/Zoom Scan (5x5x7)/Cube 0: Measurement grid: dx=8mm, dy=8mm, dz=5mm

Reference Value = 9.407 V/m; Power Drift = 0.08 dB

Peak SAR (extrapolated) = 1.01 W/kg

SAR(1 g) = 0.582 W/kg; SAR(10 g) = 0.335 W/kg

Maximum value of SAR (measured) = 0.604 W/kg

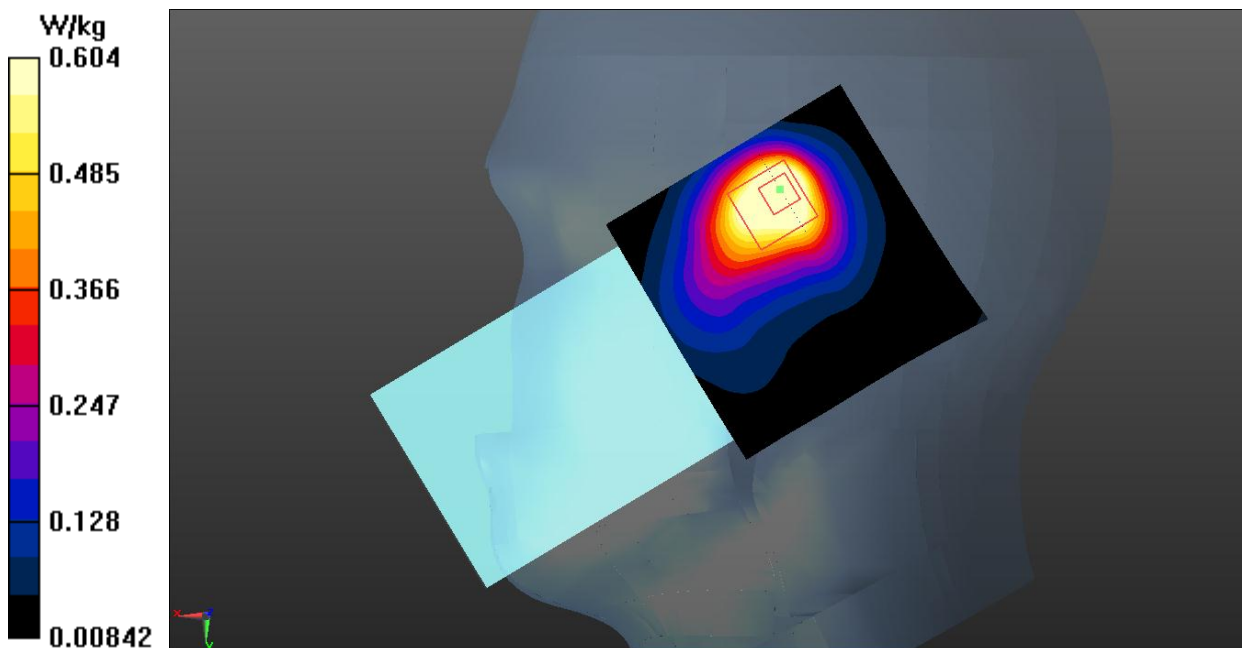

Fig.3 GSM 1900 Head

GSM1900 Body

Date: 2021-6-27

Electronics: DAE4 Sn1527

Medium: Head 1900MHz

Medium parameters used: $f = 1910$ MHz; $\sigma = 1.434$ S/m; $\epsilon_r = 39.434$; $\rho = 1000$ kg/m³

Communication System: UID 0, GPRS 3Txslot (0) Frequency: 1909.8 MHz Duty Cycle: 1:2.67

Probe: EX3DV4 – SN7621 ConvF (8.77, 8.77, 8.77);

Rear Side High/Area Scan (71x61x1): Interpolated grid: dx=1.500 mm, dy=1.500 mm

Maximum value of SAR (interpolated) = 0.824 W/kg

Rear Side High BYD 0609/Zoom Scan (5x5x7)/Cube 0: Measurement grid: dx=8mm, dy=8mm, dz=5mm

Reference Value = 9.262 V/m; Power Drift = 0.02 dB

Peak SAR (extrapolated) = 1.42 W/kg

SAR(1 g) = 0.714 W/kg; SAR(10 g) = 0.354 W/kg

Maximum value of SAR (measured) = 0.869 W/kg

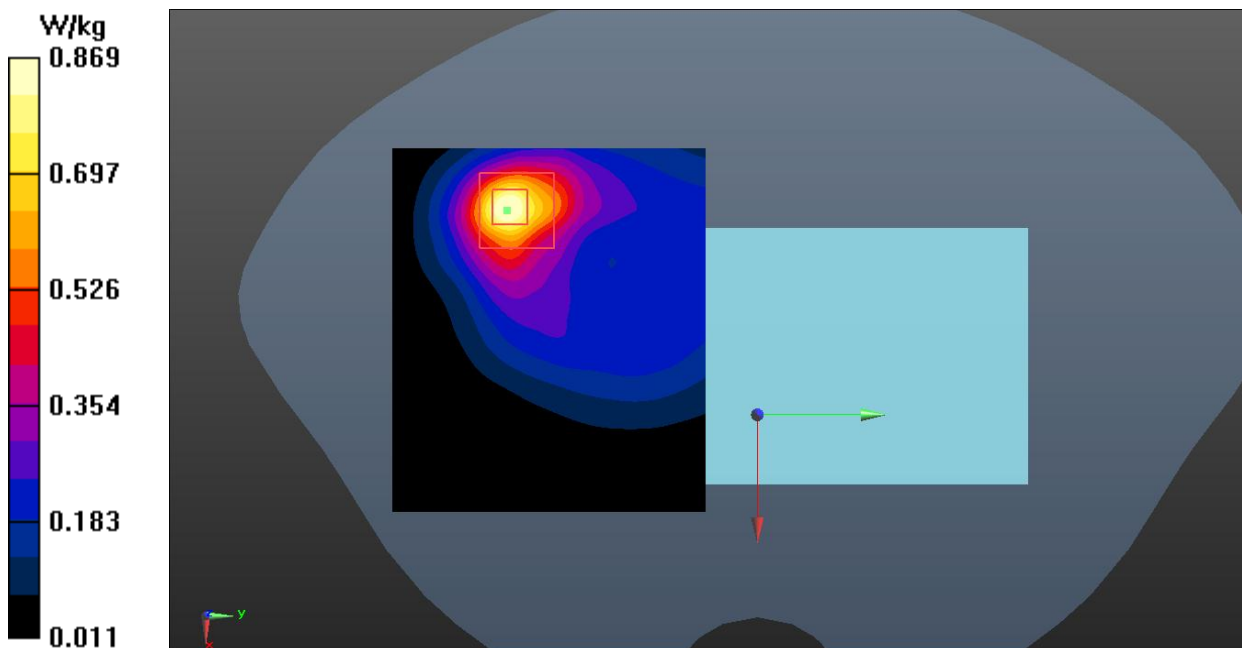

Fig.4 GSM 1900 Body

WCDMA Band 2 Head

Date: 2021-6-27

Electronics: DAE4 Sn1527

Medium: Head 1900MHz

Medium parameters used (interpolated): $f = 1852.4$ MHz; $\sigma = 1.383$ S/m; $\epsilon_r = 39.659$; $\rho = 1000$ kg/m³

Communication System: UID 0, WCDMA (0) Frequency: 1852.4 MHz Duty Cycle: 1:1

Probe: EX3DV4 – SN7621 ConvF (8.77, 8.77, 8.77);

Right Cheek Low/Area Scan (61x61x1): Interpolated grid: dx=1.500 mm, dy=1.500 mm

Maximum value of SAR (interpolated) = 1.27 W/kg

Right Cheek Low/Zoom Scan (5x5x7)/Cube 0: Measurement grid: dx=8mm, dy=8mm, dz=5mm

Reference Value = 14.50 V/m; Power Drift = -0.07 dB

Peak SAR (extrapolated) = 1.31 W/kg

SAR(1 g) = 0.750 W/kg; SAR(10 g) = 0.435 W/kg

Maximum value of SAR (measured) = 0.807 W/kg

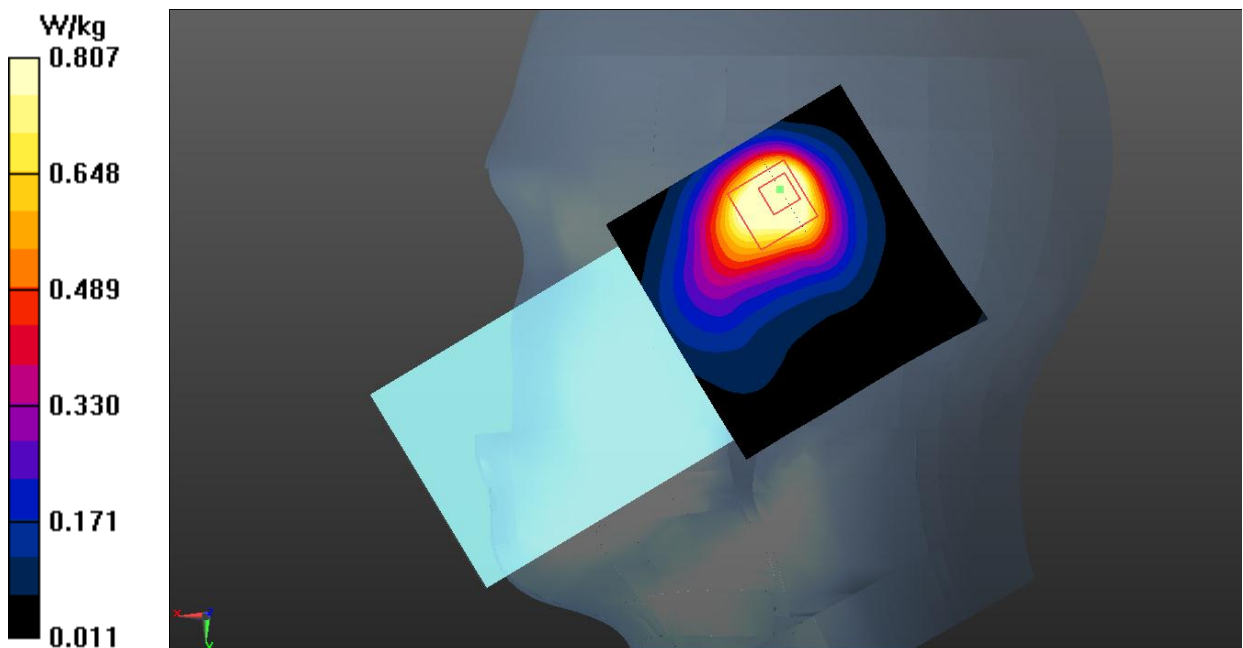

Fig.5 WCDMA Band 2 Head

WCDMA Band 2 Body

Date: 2021-6-27

Electronics: DAE4 Sn1527

Medium: Head 1900MHz

Medium parameters used: $f = 1908$ MHz; $\sigma = 1.432$ S/m; $\epsilon_r = 39.442$; $\rho = 1000$ kg/m³

Communication System: UID 0, WCDMA (0) Frequency: 1907.6 MHz Duty Cycle: 1:1

Probe: EX3DV4 – SN7621 ConvF (8.77, 8.77, 8.77);

Rear Side High/Area Scan (71x61x1): Interpolated grid: $dx=1.500$ mm, $dy=1.500$ mm

Maximum value of SAR (interpolated) = 1.19 W/kg

Rear Side High/Zoom Scan (5x5x7)/Cube 0: Measurement grid: $dx=8$ mm, $dy=8$ mm, $dz=5$ mm

Reference Value = 8.693 V/m; Power Drift = 0.08 dB

Peak SAR (extrapolated) = 1.53 W/kg

SAR(1 g) = 0.796 W/kg; SAR(10 g) = 0.414 W/kg

Maximum value of SAR (measured) = 1.17 W/kg

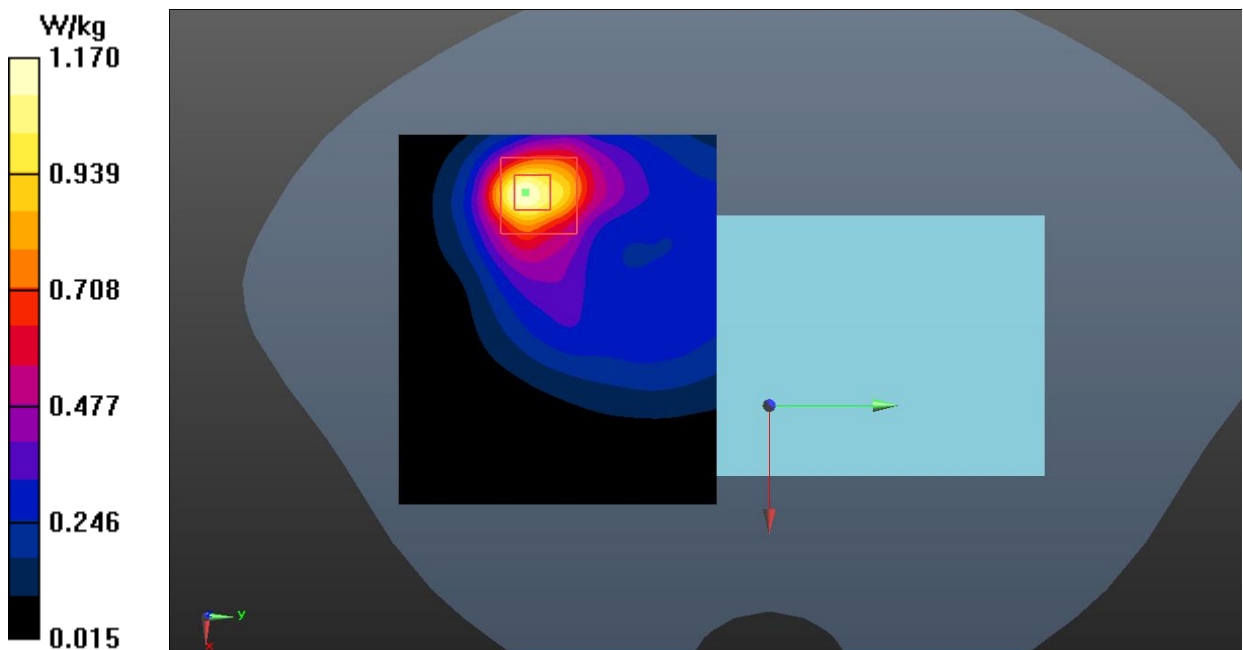

Fig.6 WCDMA Band 2 Body

WCDMA Band 4 Head

Date: 2021-6-23

Electronics: DAE4 Sn1527

Medium: Head 1750MHz

Medium parameters used: $f = 1733$ MHz; $\sigma = 1.344$ S/m; $\epsilon_r = 40.953$; $\rho = 1000$ kg/m³

Communication System: UID 0, WCDMA (0) Frequency: 1732.6 MHz Duty Cycle: 1:1

Probe: EX3DV4 – SN7621 ConvF (9.14, 9.14, 9.14);

Right Cheek Middle/Area Scan (61x61x1): Interpolated grid: dx=1.500 mm, dy=1.500 mm
Maximum value of SAR (interpolated) = 1.27 W/kg

Right Cheek Middle/Zoom Scan (5x5x7)/Cube 0: Measurement grid: dx=8mm, dy=8mm, dz=5mm

Reference Value = 12.56 V/m; Power Drift = 0.18 dB

Peak SAR (extrapolated) = 1.53 W/kg

SAR(1 g) = 0.842 W/kg; SAR(10 g) = 0.466 W/kg

Maximum value of SAR (measured) = 0.911 W/kg

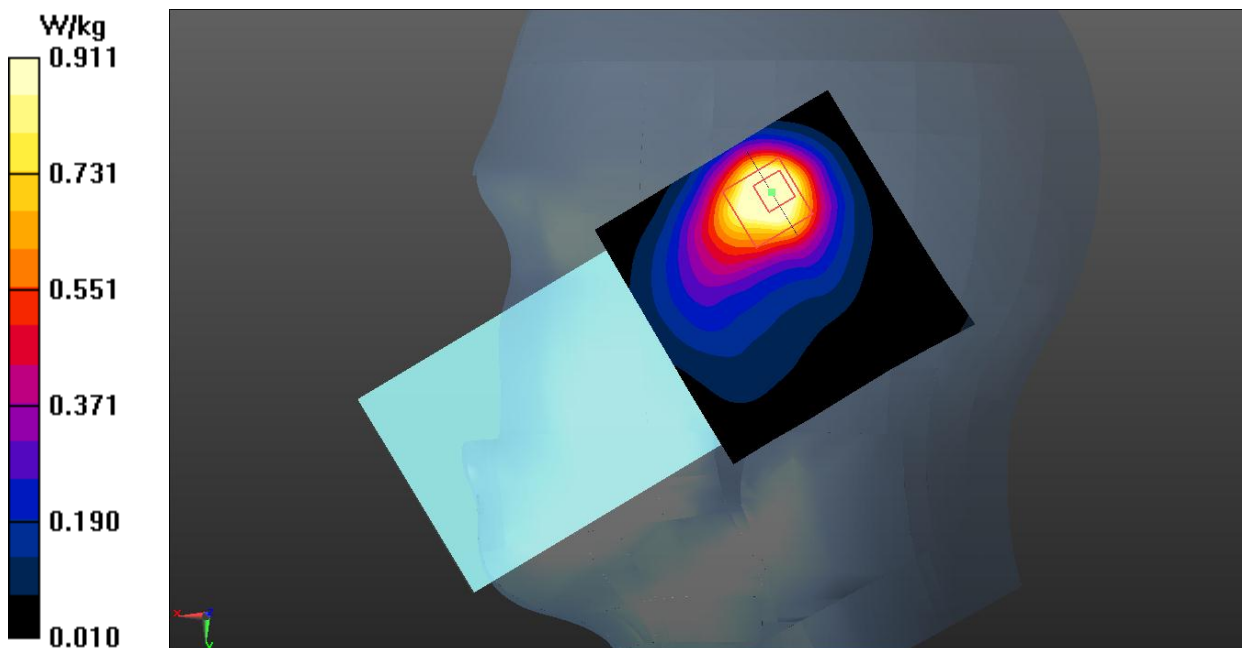

Fig.7 WCDMA Band 4 Head

WCDMA Band 4 Body

Date: 2021-6-23

Electronics: DAE4 Sn1527

Medium: Head 1750MHz

Medium parameters used: $f = 1733 \text{ MHz}$; $\sigma = 1.344 \text{ S/m}$; $\epsilon_r = 40.953$; $\rho = 1000 \text{ kg/m}^3$

Communication System: UID 0, WCDMA (0) Frequency: 1732.6 MHz Duty Cycle: 1:1

Probe: EX3DV4 – SN7621 ConvF (9.14, 9.14, 9.14);

Rear Side Middle/Area Scan (61x61x1): Interpolated grid: $dx=1.500 \text{ mm}$, $dy=1.500 \text{ mm}$

Maximum value of SAR (interpolated) = 1.13 W/kg

Rear Side Middle/Zoom Scan (5x5x7)/Cube 0: Measurement grid: $dx=8\text{mm}$, $dy=8\text{mm}$, $dz=5\text{mm}$

Reference Value = 10.05 V/m; Power Drift = 0.11 dB

Peak SAR (extrapolated) = 1.84 W/kg

SAR(1 g) = 0.958 W/kg; SAR(10 g) = 0.494 W/kg

Maximum value of SAR (measured) = 1.17 W/kg

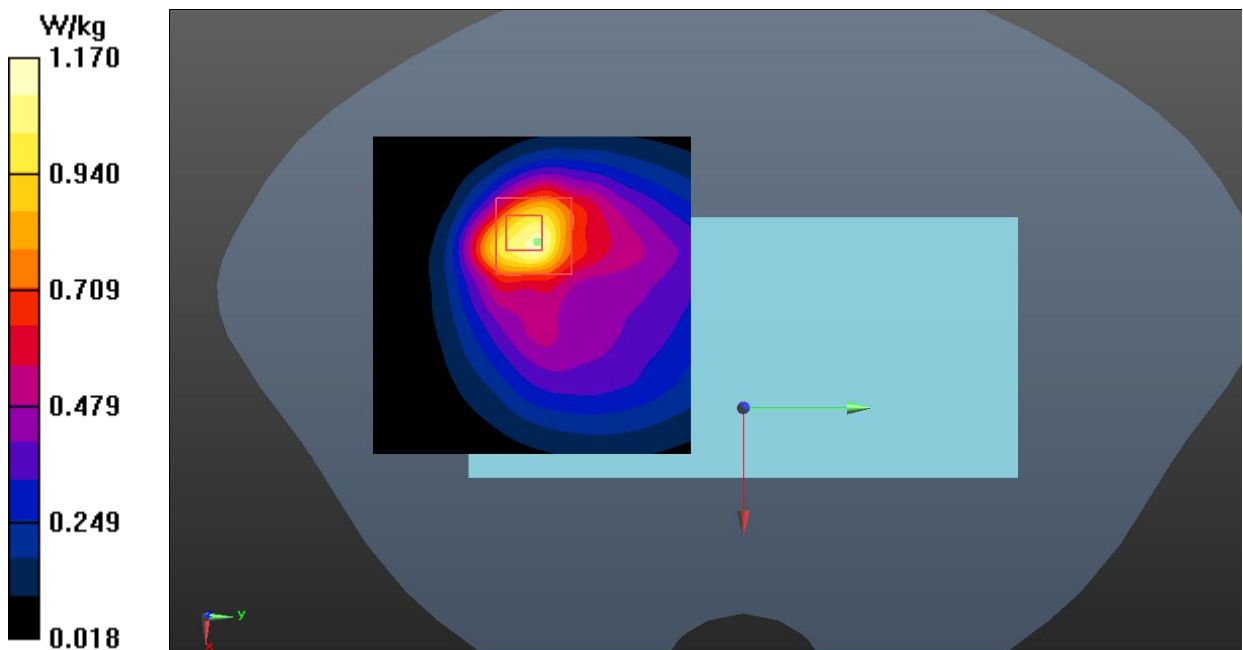

Fig.8 WCDMA Band 4 Body

WCDMA Band 5 Head

Date: 2021-6-6

Electronics: DAE4 Sn1527

Medium: Head 835MHz

Medium parameters used (interpolated): $f = 836.4$ MHz; $\sigma = 0.889$ S/m; $\epsilon_r = 41.937$; $\rho = 1000$ kg/m³

Communication System: UID 0, WCDMA (0) Frequency: 836.4 MHz Duty Cycle: 1:1

Probe: EX3DV4 – SN7621 ConvF (10.35, 10.35, 10.35);

Right Cheek Middle/Area Scan (61x61x1): Interpolated grid: $dx=1.500$ mm, $dy=1.500$ mm

Maximum value of SAR (interpolated) = 0.266 W/kg

Right Cheek Middle/Zoom Scan (5x5x7)/Cube 0: Measurement grid: $dx=8$ mm, $dy=8$ mm, $dz=5$ mm

Reference Value = 3.555 V/m; Power Drift = 0.09 dB

Peak SAR (extrapolated) = 0.308 W/kg

SAR(1 g) = 0.243 W/kg; SAR(10 g) = 0.187 W/kg

Maximum value of SAR (measured) = 0.266 W/kg

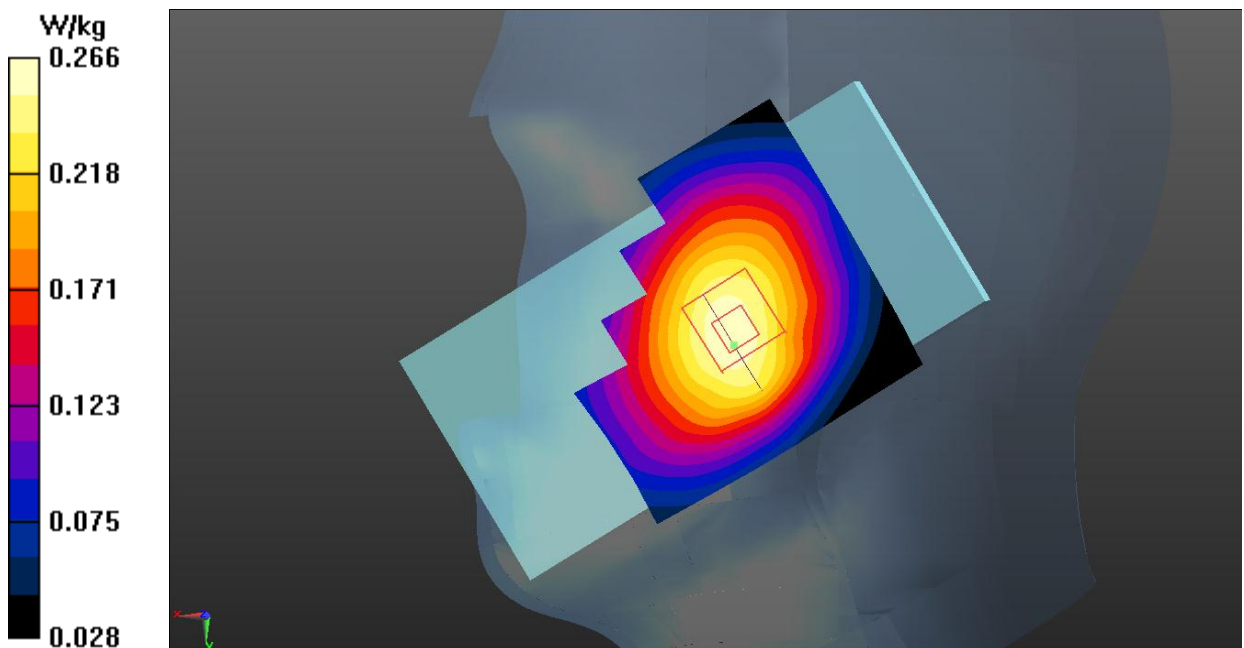

Fig.9 WCDMA Band 5 Head

WCDMA Band 5 Body

Date: 2021-6-6

Electronics: DAE4 Sn1527

Medium: Head 835MHz

Medium parameters used (interpolated): $f = 836.4$ MHz; $\sigma = 0.889$ S/m; $\epsilon_r = 41.937$; $\rho = 1000$ kg/m³

Communication System: UID 0, WCDMA (0) Frequency: 836.4 MHz Duty Cycle: 1:1

Probe: EX3DV4 – SN7621 ConvF (10.35, 10.35, 10.35);

Rear Side Middle/Area Scan (61x61x1): Interpolated grid: dx=1.500 mm, dy=1.500 mm

Maximum value of SAR (interpolated) = 0.391 W/kg

Rear Side Middle/Zoom Scan (5x5x7)/Cube 0: Measurement grid: dx=8mm, dy=8mm, dz=5mm

Reference Value = 19.67 V/m; Power Drift = 0.02 dB

Peak SAR (extrapolated) = 0.460 W/kg

SAR(1 g) = 0.354 W/kg; SAR(10 g) = 0.265 W/kg

Maximum value of SAR (measured) = 0.392 W/kg

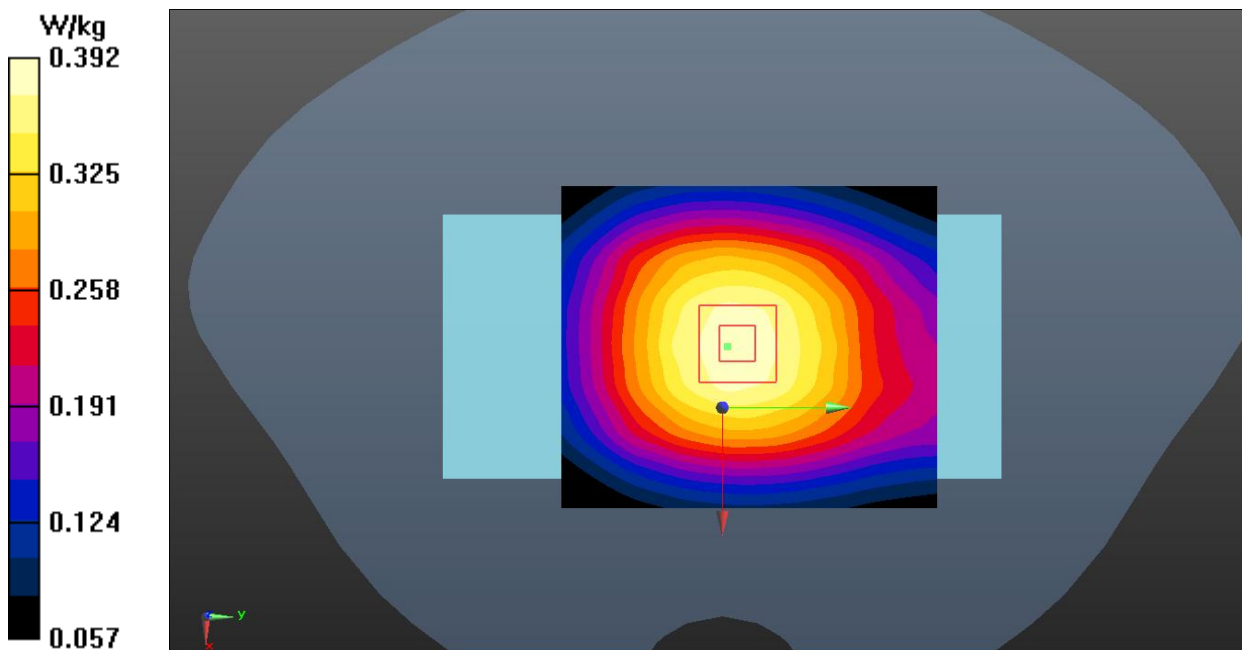

Fig.10 WCDMA Band 5 Body

LTE Band 2 Head

Date: 2021-6-27

Electronics: DAE4 Sn1527

Medium: Head 1900MHz

Medium parameters used: $f = 1880$ MHz; $\sigma = 1.407$ S/m; $\epsilon_r = 39.551$; $\rho = 1000$ kg/m³

Communication System: UID 0, LTE_FDD (0) Frequency: 1880 MHz Duty Cycle: 1:1

Probe: EX3DV4 – SN7621 ConvF (8.77, 8.77, 8.77);

Right Cheek Middle 1RB99/Area Scan (61x61x1): Interpolated grid: dx=1.500 mm, dy=1.500 mm
Maximum value of SAR (interpolated) = 1.66 W/kg**Right Cheek Middle 1RB99/Zoom Scan (5x5x7)/Cube 0:** Measurement grid: dx=8mm, dy=8mm, dz=5mm

Reference Value = 16.84 V/m; Power Drift = 0.01 dB

Peak SAR (extrapolated) = 1.75 W/kg

SAR(1 g) = 0.963 W/kg; SAR(10 g) = 0.542 W/kg

Maximum value of SAR (measured) = 1.08 W/kg

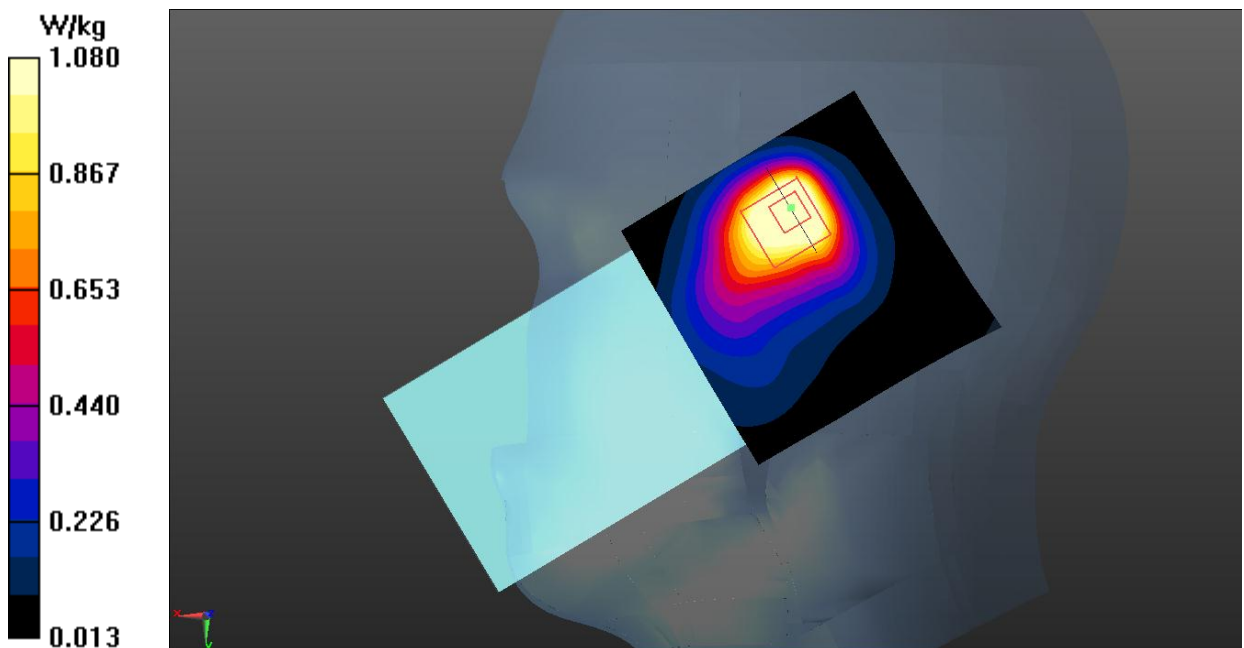

Fig.11 LTE Band 2 Head

LTE Band 2 Body

Date: 2021-6-27

Electronics: DAE4 Sn1527

Medium: Head 1900MHz

Medium parameters used: $f = 1900$ MHz; $\sigma = 1.425$ S/m; $\epsilon_r = 39.473$; $\rho = 1000$ kg/m³

Communication System: UID 0, LTE_FDD (0) Frequency: 1900 MHz Duty Cycle: 1:1

Probe: EX3DV4 – SN7621 ConvF (8.77, 8.77, 8.77);

Rear Side High 1RB50/Area Scan (71x61x1): Interpolated grid: dx=1.500 mm, dy=1.500 mm
Maximum value of SAR (interpolated) = 1.10 W/kg**Rear Side High 1RB50/Zoom Scan (5x5x7)/Cube 0:** Measurement grid: dx=8mm, dy=8mm, dz=5mm

Reference Value = 7.934 V/m; Power Drift = -0.01 dB

Peak SAR (extrapolated) = 1.36 W/kg

SAR(1 g) = 0.717 W/kg; SAR(10 g) = 0.374 W/kg

Maximum value of SAR (measured) = 1.05 W/kg

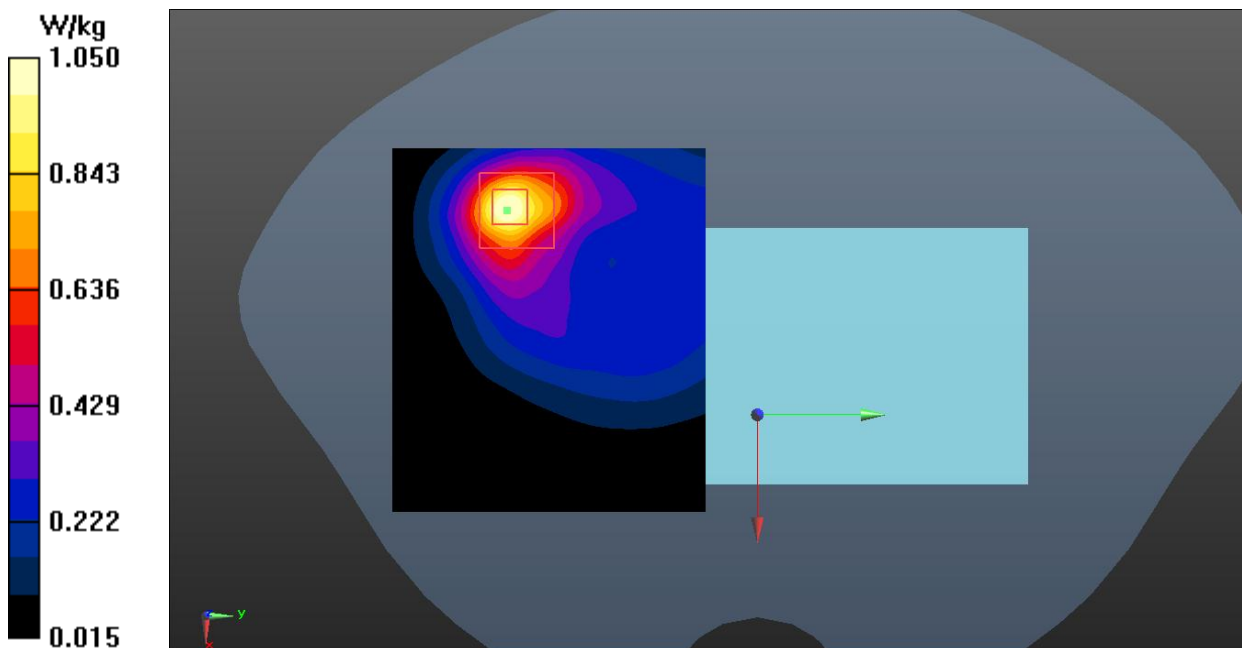

Fig.12 LTE Band 2 Body

LTE Band 5 Head

Date: 2021-6-6

Electronics: DAE4 Sn1527

Medium: Head 835MHz

Medium parameters used (interpolated): $f = 829$ MHz; $\sigma = 0.883$ S/m; $\epsilon_r = 42.026$; $\rho = 1000$ kg/m³

Communication System: UID 0, LTE_FDD (0) Frequency: 829 MHz Duty Cycle: 1:1

Probe: EX3DV4 – SN7621 ConvF (10.35, 10.35, 10.35);

Right Cheek Low 1RB0/Area Scan (61x61x1): Interpolated grid: $dx=1.500$ mm, $dy=1.500$ mm
Maximum value of SAR (interpolated) = 0.239 W/kg**Right Cheek Low 1RB0/Zoom Scan (5x5x7)/Cube 0:** Measurement grid: $dx=8$ mm, $dy=8$ mm, $dz=5$ mm

Reference Value = 2.668 V/m; Power Drift = 0.08 dB

Peak SAR (extrapolated) = 0.274 W/kg

SAR(1 g) = 0.213 W/kg; SAR(10 g) = 0.163 W/kg

Maximum value of SAR (measured) = 0.232 W/kg

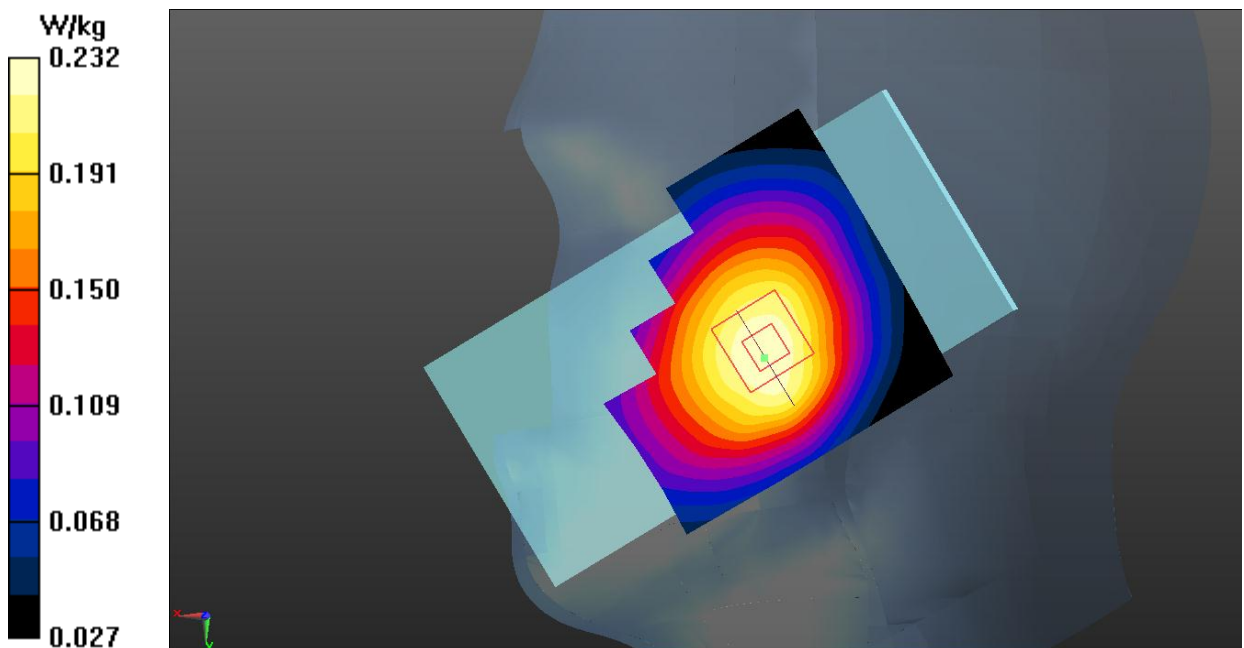

Fig.13 LTE Band 5 Head

LTE Band 5 Body

Date: 2021-6-6

Electronics: DAE4 Sn1527

Medium: Head 835MHz

Medium parameters used (interpolated): $f = 829$ MHz; $\sigma = 0.883$ S/m; $\epsilon_r = 42.026$; $\rho = 1000$ kg/m³

Communication System: UID 0, LTE_FDD (0) Frequency: 829 MHz Duty Cycle: 1:1

Probe: EX3DV4 – SN7621 ConvF (10.35, 10.35, 10.35);

Rear Side Low 1RB0/Area Scan (61x71x1): Interpolated grid: $dx=1.500$ mm, $dy=1.500$ mm

Maximum value of SAR (interpolated) = 0.397 W/kg

Rear Side Low 1RB0/Zoom Scan (5x5x7)/Cube 0: Measurement grid: $dx=8$ mm, $dy=8$ mm, $dz=5$ mm

Reference Value = 19.95 V/m; Power Drift = 0.05 dB

Peak SAR (extrapolated) = 0.471 W/kg

SAR(1 g) = 0.365 W/kg; SAR(10 g) = 0.275 W/kg

Maximum value of SAR (measured) = 0.402 W/kg

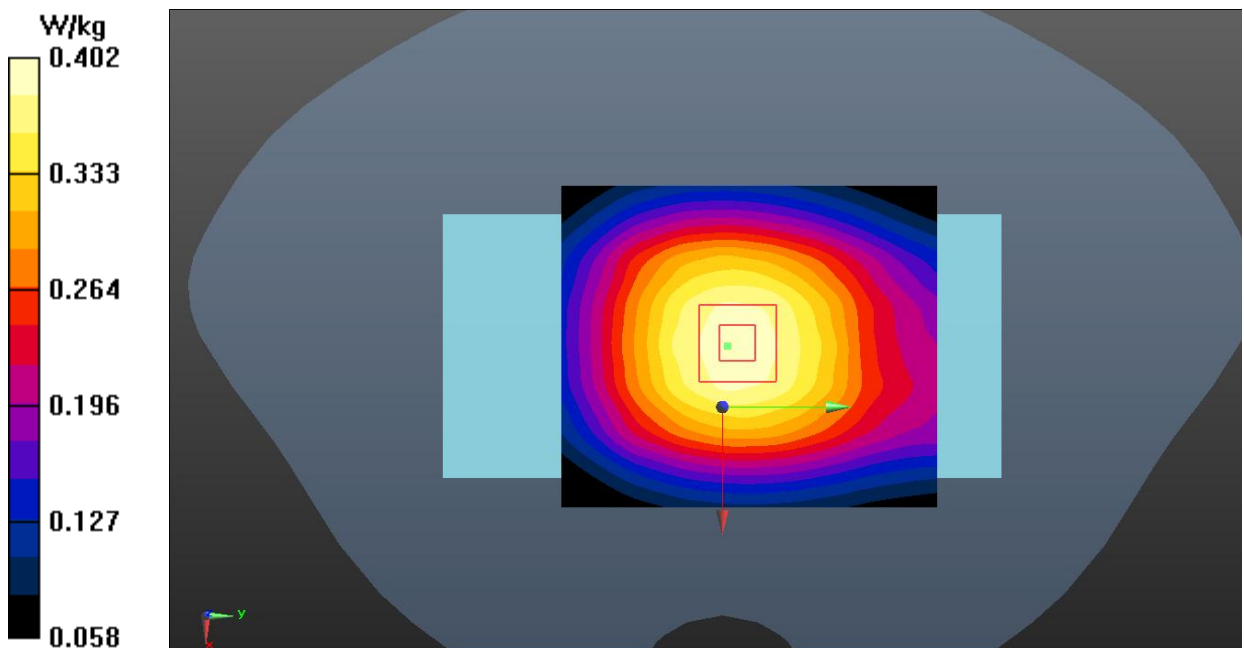

Fig.14 LTE Band 5 Body

LTE Band 7 Head

Date: 2021-6-24

Electronics: DAE4 Sn1527

Medium: Head 2550MHz

Medium parameters used: $f = 2510$ MHz; $\sigma = 1.91$ S/m; $\epsilon_r = 38.163$; $\rho = 1000$ kg/m³

Communication System: UID 0, LTE_FDD (0) Frequency: 2510 MHz Duty Cycle: 1:1

Probe: EX3DV4 – SN7621 ConvF (8.01, 8.01, 8.01);

Right Cheek Low 1RB99/Area Scan (91x91x1): Interpolated grid: dx=1.000 mm, dy=1.000 mm
Maximum value of SAR (interpolated) = 0.155 W/kg**Right Cheek Low 1RB99/Zoom Scan (7x7x7)/Cube 0:** Measurement grid: dx=5mm, dy=5mm, dz=5mm

Reference Value = 2.113 V/m; Power Drift = 0.07 dB

Peak SAR (extrapolated) = 0.178 W/kg

SAR(1 g) = 0.072 W/kg; SAR(10 g) = 0.039 W/kg

Maximum value of SAR (measured) = 0.123 W/kg

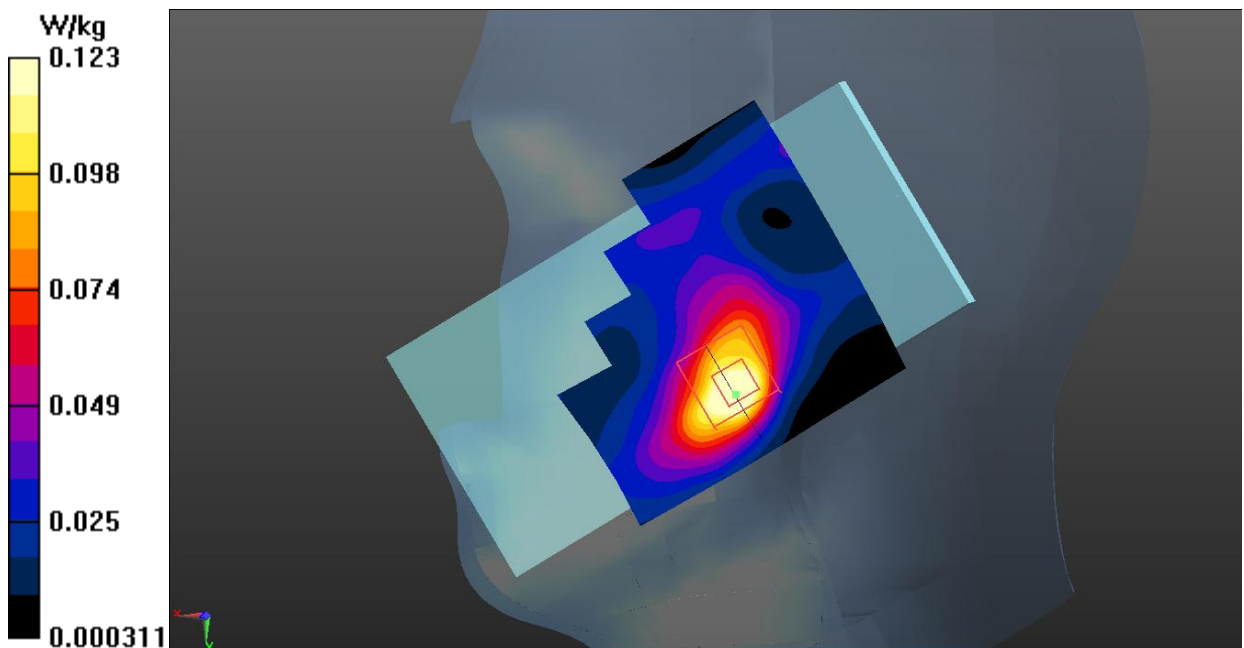

Fig.15 LTE Band 7 Head

LTE Band 7 Body

Date: 2021-6-24

Electronics: DAE4 Sn1527

Medium: Head 2550MHz

Medium parameters used (interpolated): $f = 2535$ MHz; $\sigma = 1.939$ S/m; $\epsilon_r = 38.082$; $\rho = 1000$ kg/m³

Communication System: UID 0, LTE_FDD (0) Frequency: 2535 MHz Duty Cycle: 1:1

Probe: EX3DV4 – SN7621 ConvF (8.01, 8.01, 8.01);

Bottom Side Middle 1RB99/Area Scan (61x91x1): Interpolated grid: dx=1.000 mm, dy=1.000 mm
Maximum value of SAR (interpolated) = 1.73 W/kg**Bottom Side Middle 1RB99/Zoom Scan (7x7x7)/Cube 0:** Measurement grid: dx=5mm, dy=5mm, dz=5mm

Reference Value = 17.38 V/m; Power Drift = 0.15 dB

Peak SAR (extrapolated) = 2.23 W/kg

SAR(1 g) = 1.13 W/kg; SAR(10 g) = 0.543 W/kg

Maximum value of SAR (measured) = 1.69 W/kg

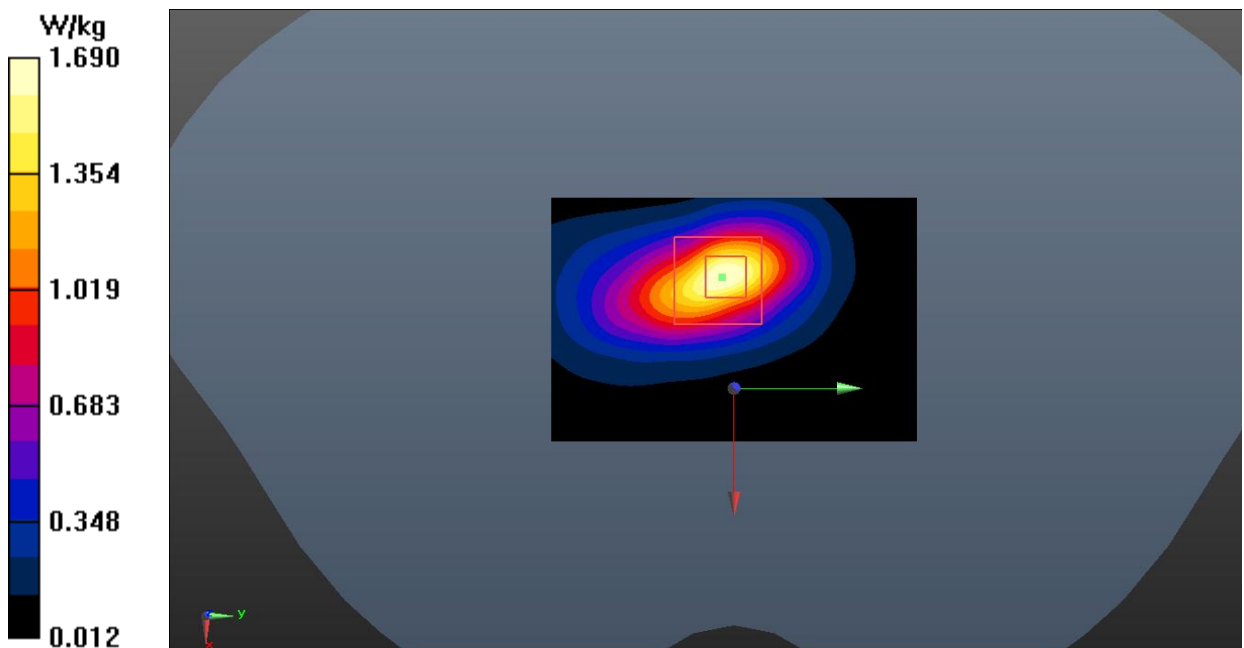

Fig.16 LTE Band 7 Body

LTE Band 12 Head

Date: 2021-6-8

Electronics: DAE4 Sn1527

Medium: Head 750MHz

Medium parameters used: $f = 704$ MHz; $\sigma = 0.883$ S/m; $\epsilon_r = 41.71$; $\rho = 1000$ kg/m³

Communication System: UID 0, LTE_FDD (0) Frequency: 704 MHz Duty Cycle: 1:1

Probe: EX3DV4 – SN7621 ConvF (10.88, 10.88, 10.88);

Right Cheek Low 1RB0/Area Scan (61x61x1): Interpolated grid: $dx=1.500$ mm, $dy=1.500$ mm
Maximum value of SAR (interpolated) = 0.186 W/kg**Right Cheek Low 1RB0/Zoom Scan (5x5x7)/Cube 0:** Measurement grid: $dx=8$ mm, $dy=8$ mm, $dz=5$ mm

Reference Value = 3.648 V/m; Power Drift = 0.03 dB

Peak SAR (extrapolated) = 0.215 W/kg

SAR(1 g) = 0.170 W/kg; SAR(10 g) = 0.132 W/kg

Maximum value of SAR (measured) = 0.186 W/kg

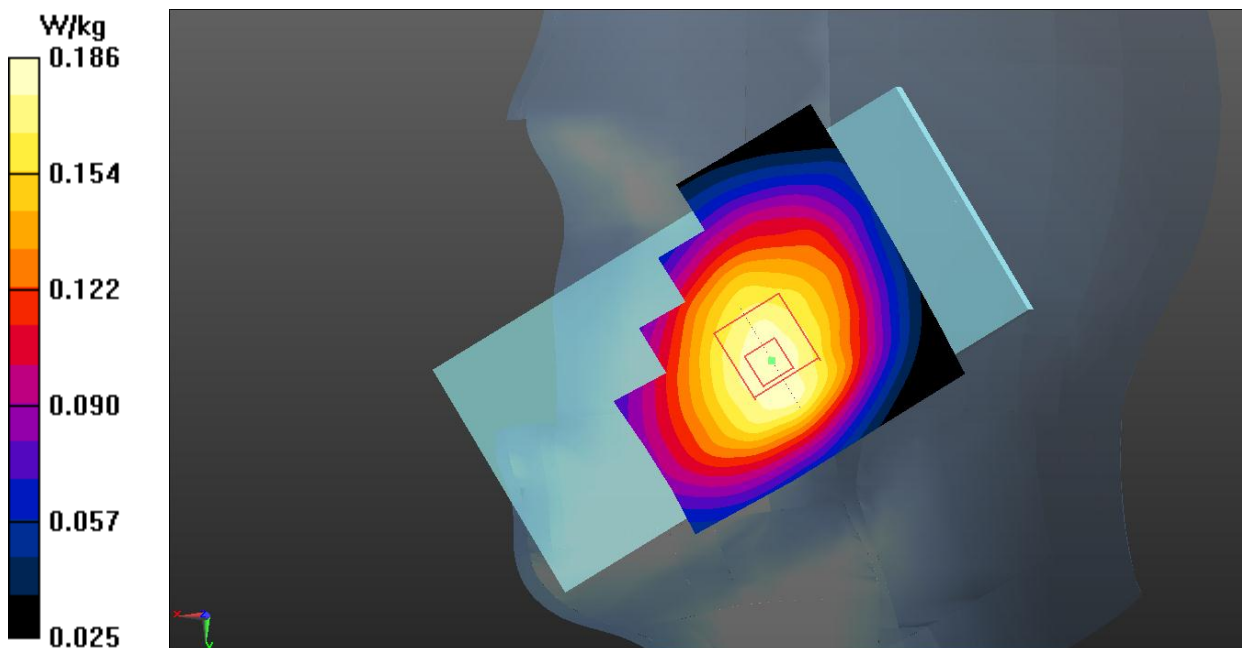

Fig.17 LTE Band 12 Head

LTE Band 12 Body

Date: 2021-6-8

Electronics: DAE4 Sn1527

Medium: Head 750MHz

Medium parameters used: $f = 704$ MHz; $\sigma = 0.883$ S/m; $\epsilon_r = 41.71$; $\rho = 1000$ kg/m³

Communication System: UID 0, LTE_FDD (0) Frequency: 704 MHz Duty Cycle: 1:1

Probe: EX3DV4 – SN7621 ConvF (10.88, 10.88, 10.88);

Rear Side Low 1RB0/Area Scan (61x111x1): Interpolated grid: dx=1.500 mm, dy=1.500 mm

Maximum value of SAR (interpolated) = 0.428 W/kg

Rear Side Low 1RB0/Zoom Scan (5x5x7)/Cube 0: Measurement grid: dx=8mm, dy=8mm, dz=5mm

Reference Value = 19.97 V/m; Power Drift = 0.02 dB

Peak SAR (extrapolated) = 0.498 W/kg

SAR(1 g) = 0.388 W/kg; SAR(10 g) = 0.294 W/kg

Maximum value of SAR (measured) = 0.427 W/kg

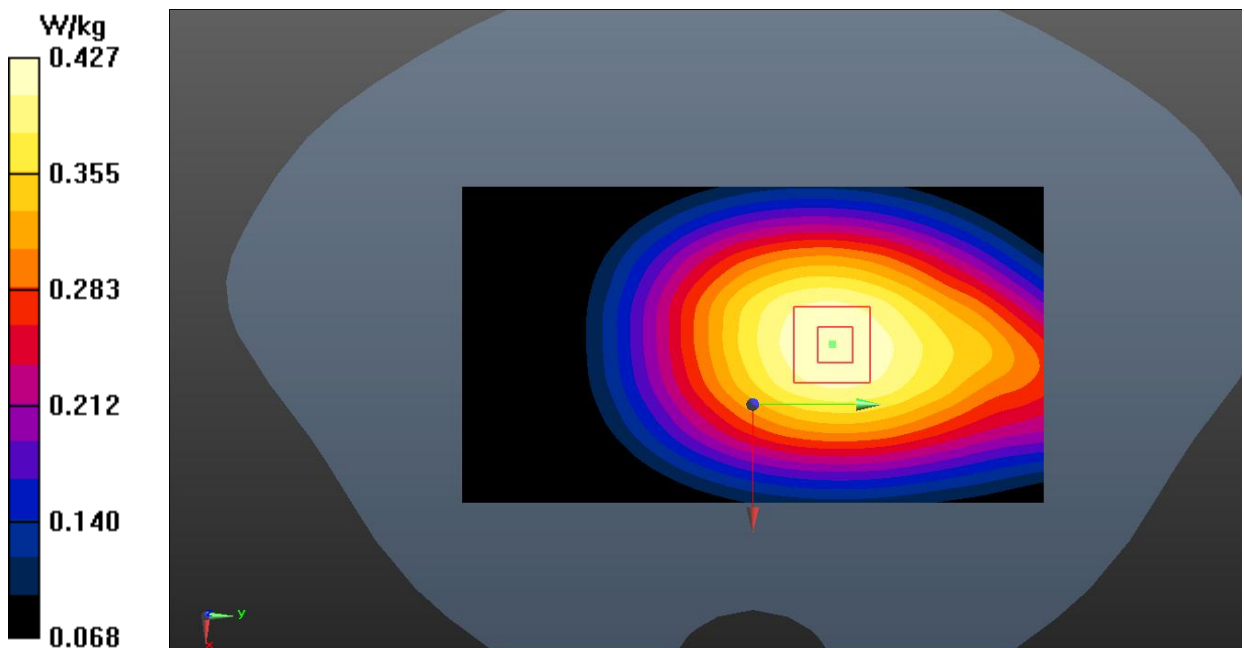

Fig.18 LTE Band 12 Body

LTE Band 66 Head

Date: 2021-6-23

Electronics: DAE4 Sn1527

Medium: Head 1750MHz

Medium parameters used (interpolated): $f = 1745$ MHz; $\sigma = 1.355$ S/m; $\epsilon_r = 40.907$; $\rho = 1000$ kg/m³

Communication System: UID 0, LTE_FDD (0) Frequency: 1745 MHz Duty Cycle: 1:1

Probe: EX3DV4 – SN7621 ConvF (9.14, 9.14, 9.14);

Right Cheek Middle 1RB99/Area Scan (61x61x1): Interpolated grid: $dx=1.500$ mm, $dy=1.500$ mm
Maximum value of SAR (interpolated) = 1.50 W/kg**Right Cheek Middle 1RB99/Zoom Scan (5x5x7)/Cube 0:** Measurement grid: $dx=8$ mm, $dy=8$ mm, $dz=5$ mm

Reference Value = 15.93 V/m; Power Drift = 0.06 dB

Peak SAR (extrapolated) = 1.89 W/kg

SAR(1 g) = 1.06 W/kg; SAR(10 g) = 0.606 W/kg

Maximum value of SAR (measured) = 1.26 W/kg

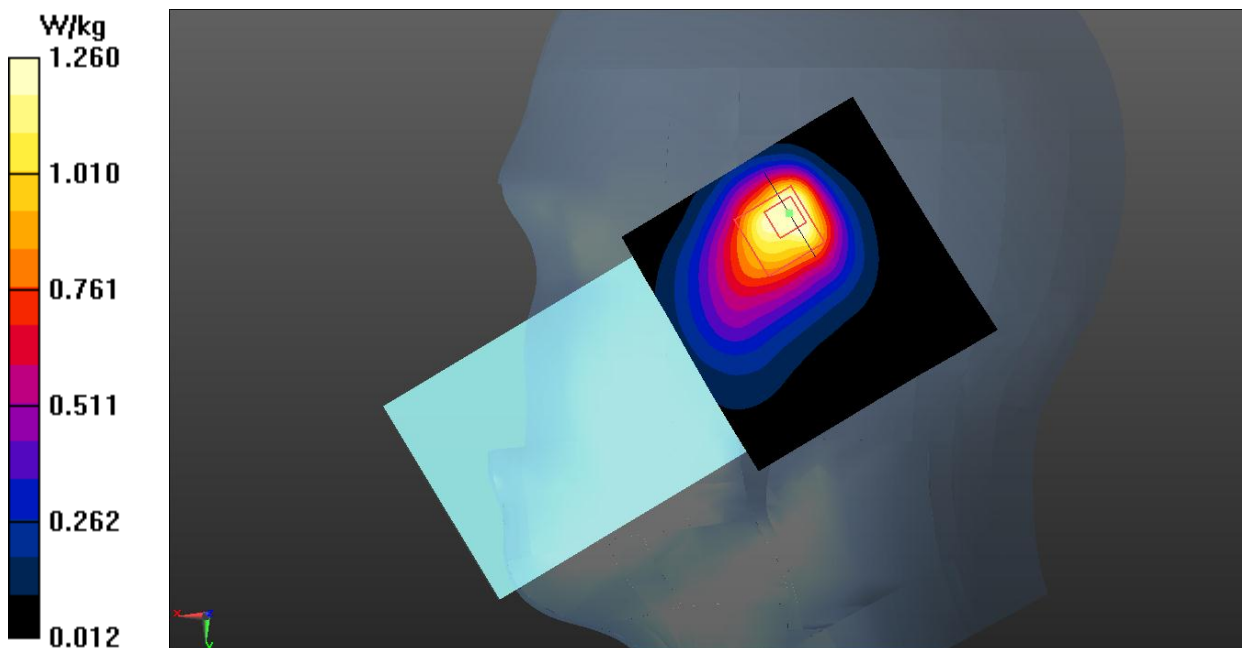
**Fig.19 LTE Band 66 Head**

LTE Band 66 Body

Date: 2021-6-23

Electronics: DAE4 Sn1527

Medium: Head 1750MHz

Medium parameters used: $f = 1770$ MHz; $\sigma = 1.377$ S/m; $\epsilon_r = 40.808$; $\rho = 1000$ kg/m³

Communication System: UID 0, LTE_FDD (0) Frequency: 1770 MHz Duty Cycle: 1:1

Probe: EX3DV4 – SN7621 ConvF (9.14, 9.14, 9.14);

Rear Side High 1RB0/Area Scan (61x61x1): Interpolated grid: dx=1.500 mm, dy=1.500 mm

Maximum value of SAR (interpolated) = 1.42 W/kg

Rear Side High 1RB0/Zoom Scan (5x5x7)/Cube 0: Measurement grid: dx=8mm, dy=8mm, dz=5mm

Reference Value = 11.37 V/m; Power Drift = 0.03 dB

Peak SAR (extrapolated) = 2.02 W/kg

SAR(1 g) = 1.06 W/kg; SAR(10 g) = 0.561 W/kg

Maximum value of SAR (measured) = 1.30 W/kg

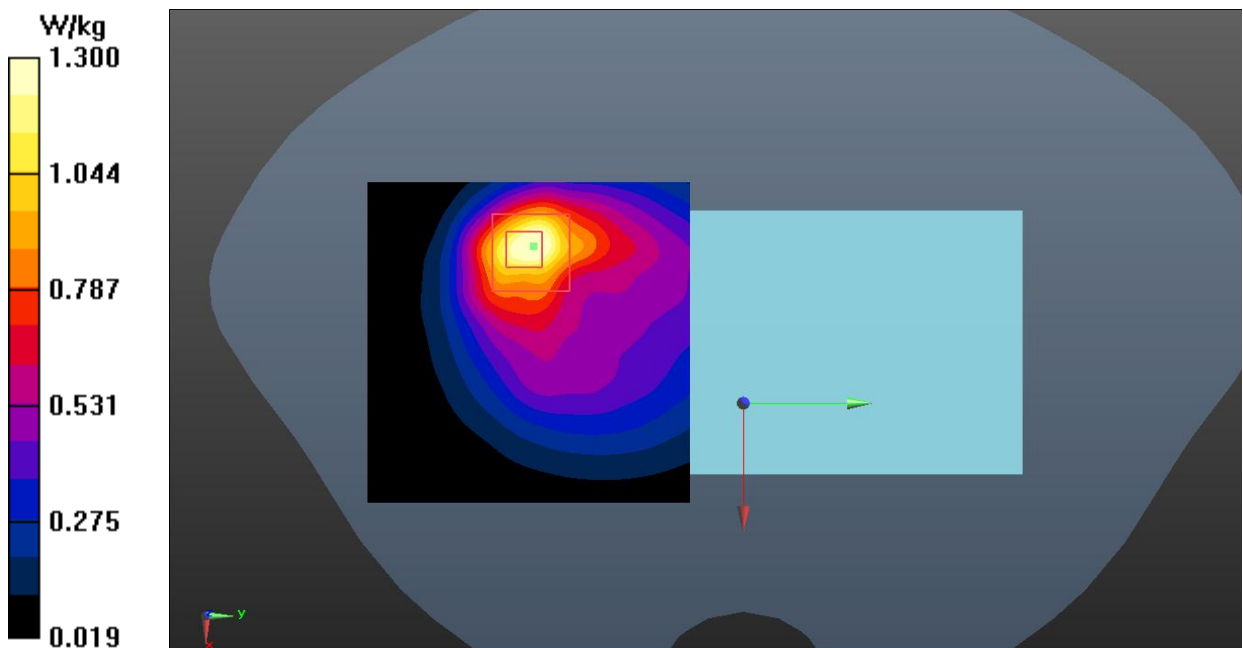
**Fig.20 LTE Band 66 Body**

WLAN 2.4G Head

Date: 2021-6-7

Electronics: DAE4 Sn1527

Medium: Head 2450MHz

Medium parameters used (interpolated): $f = 2437$ MHz; $\sigma = 1.826$ S/m; $\epsilon_r = 38.266$; $\rho = 1000$ kg/m³

Communication System: UID 0, WiFi (0) Frequency: 2437 MHz Duty Cycle: 1:1

Probe: EX3DV4 – SN7621 ConvF (8.01, 8.01, 8.01);

Left Cheek Middle/Area Scan (91x91x1): Interpolated grid: dx=1.000 mm, dy=1.000 mm

Maximum value of SAR (interpolated) = 0.451 W/kg

Left Cheek Middle/Zoom Scan (7x7x7)/Cube 0: Measurement grid: dx=5mm, dy=5mm, dz=5mm

Reference Value = 8.636 V/m; Power Drift = 0.03 dB

Peak SAR (extrapolated) = 0.697 W/kg

SAR(1 g) = 0.340 W/kg; SAR(10 g) = 0.178 W/kg

Maximum value of SAR (measured) = 0.427 W/kg

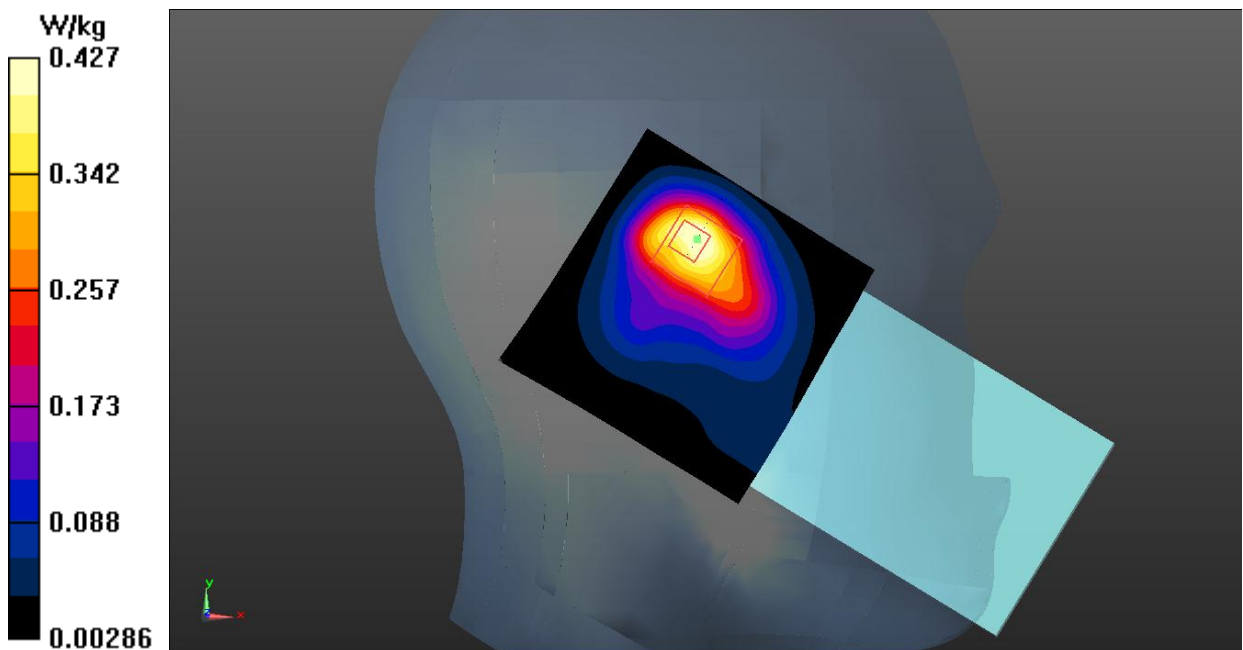

Fig.21 WLAN 2.4G Head

WLAN 2.4G Body

Date: 2021-6-7

Electronics: DAE4 Sn1527

Medium: Head 2450MHz

Medium parameters used (interpolated): $f = 2437$ MHz; $\sigma = 1.826$ S/m; $\epsilon_r = 38.266$; $\rho = 1000$ kg/m³

Communication System: UID 0, WiFi (0) Frequency: 2437 MHz Duty Cycle: 1:1

Probe: EX3DV4 – SN7621 ConvF (8.01, 8.01, 8.01);

Rear Side Middle/Area Scan (91x91x1): Interpolated grid: dx=1.000 mm, dy=1.000 mm

Maximum value of SAR (interpolated) = 0.226 W/kg

Rear Side Middle/Zoom Scan (7x7x7)/Cube 0: Measurement grid: dx=5mm, dy=5mm, dz=5mm

Reference Value = 4.992 V/m; Power Drift = -0.08 dB

Peak SAR (extrapolated) = 0.388 W/kg

SAR(1 g) = 0.172 W/kg; SAR(10 g) = 0.084 W/kg

Maximum value of SAR (measured) = 0.227 W/kg

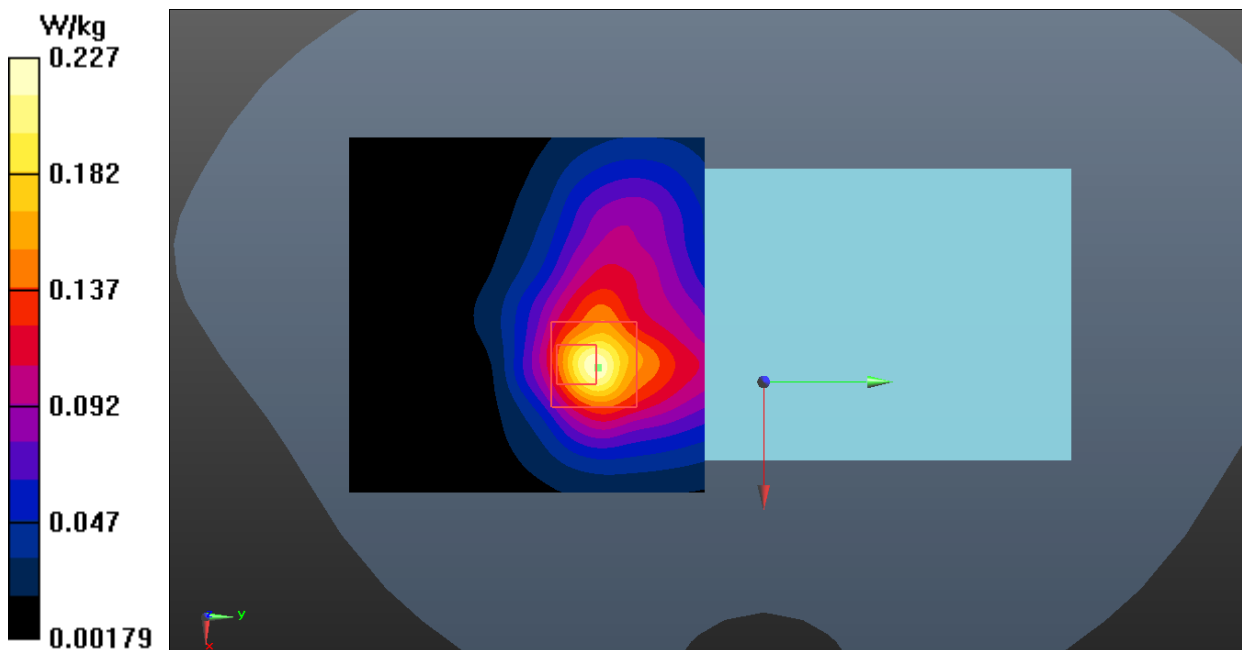

Fig.22 WLAN 2.4G Body

ANNEX B: SystemVerification Results

750MHz

Date: 2021-6-8

Electronics: DAE4 Sn1527

Medium: Head 750MHz

Medium parameters used: $f = 750 \text{ MHz}$; $\sigma = 0.912 \text{ S/m}$; $\epsilon_r = 41.158$; $\rho = 1000 \text{ kg/m}^3$

Communication System: CW_TMC Frequency: 750 MHz Duty Cycle: 1:1

Probe: EX3DV4 – SN7621 ConvF (10.88, 10.88, 10.88);

System Validation /Area Scan (81x161x1): Interpolated grid: $dx=1.000 \text{ mm}$, $dy=1.000 \text{ mm}$

Reference Value = 63.218 V/m; Power Drift = 0.03 dB

SAR(1 g) = 2.19 W/kg; SAR(10 g) = 1.45 W/kg

Maximum value of SAR (interpolated) = 2.91 W/kg

System Validation /Zoom Scan (7x7x7)/Cube 0: Measurement grid: $dx=5\text{mm}$, $dy=5\text{mm}$, $dz=5\text{mm}$

Reference Value = 63.218 V/m; Power Drift = 0.03 dB

Peak SAR (extrapolated) = 3.37 W/kg

SAR(1 g) = 2.23 W/kg; SAR(10 g) = 1.47 W/kg

Maximum value of SAR (measured) = 2.95 W/kg

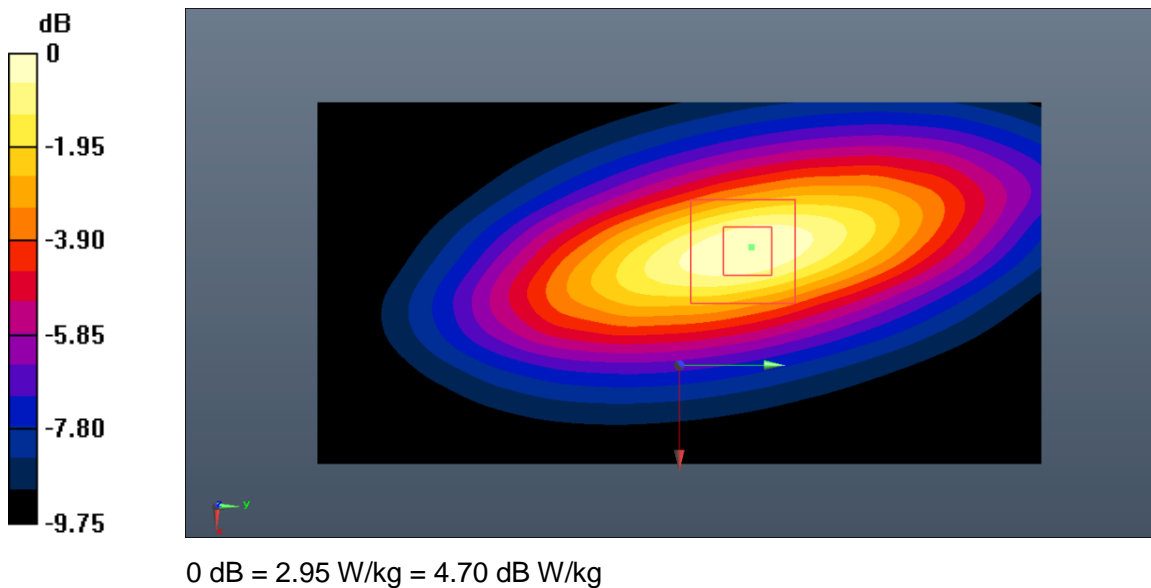

Fig.B.1. Validation 750MHz 250mW

835MHz

Date: 2021-6-6

Electronics: DAE4 Sn1527

Medium: Head 835MHz

Medium parameters used: $f = 835 \text{ MHz}$; $\sigma = 0.888 \text{ S/m}$; $\epsilon_r = 41.954$; $\rho = 1000 \text{ kg/m}^3$

Communication System: CW Frequency: 835 MHz Duty Cycle: 1:1

Probe: EX3DV4 – SN7621 ConvF (10.35, 10.35, 10.35);

System Validation /Area Scan (91x161x1): Interpolated grid: $dx=1.000 \text{ mm}$, $dy=1.000 \text{ mm}$

Reference Value = 64.426 V/m; Power Drift = -0.06 dB

SAR(1 g) = 2.39 W/kg; SAR(10 g) = 1.58 W/kg

Maximum value of SAR (interpolated) = 3.38 W/kg

System Validation /Zoom Scan (7x7x7)/Cube 0: Measurement grid: $dx=5\text{mm}$, $dy=5\text{mm}$, $dz=5\text{mm}$

Reference Value = 64.426 V/m; Power Drift = -0.06 dB

Peak SAR (extrapolated) = 3.94 W/kg

SAR(1 g) = 2.31 W/kg; SAR(10 g) = 1.55 W/kg

Maximum value of SAR (measured) = 3.34 W/kg

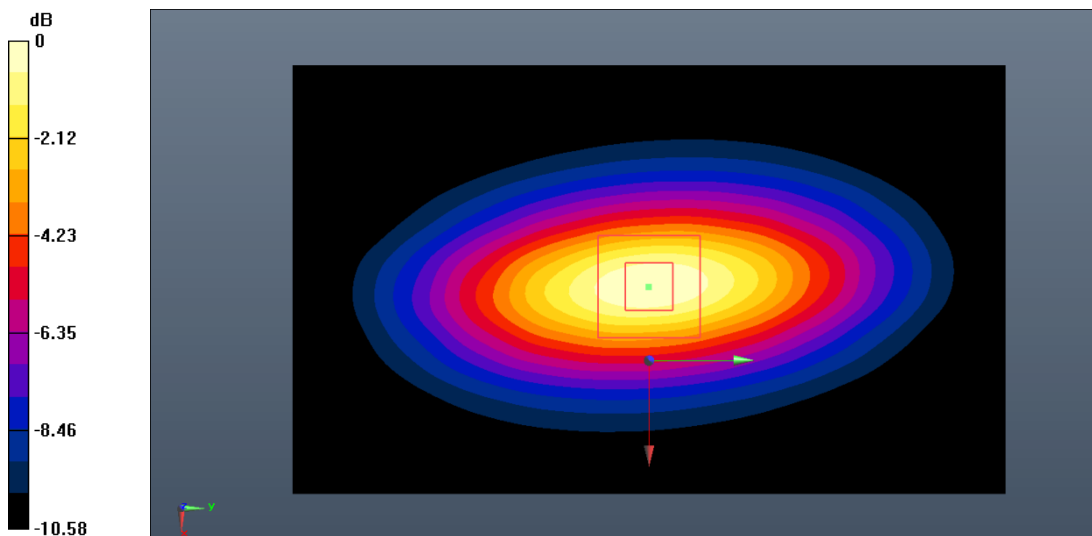

0 dB = 3.34 W/kg = 5.24 dB W/kg

Fig.B.2. Validation 835MHz 250mW

1750MHz

Date: 2021-6-23

Electronics: DAE4 Sn1527

Medium: Head 1750MHz

Medium parameters used: $f = 1750 \text{ MHz}$; $\sigma = 1.359 \text{ S/m}$; $\epsilon_r = 40.887$; $\rho = 1000 \text{ kg/m}^3$

Communication System: CW_TMC Frequency: 1750 MHz Duty Cycle: 1:1

Probe: EX3DV4 – SN7621 ConvF (9.14, 9.14, 9.14);

System Validation /Area Scan (81x121x1): Interpolated grid: $dx=1.000 \text{ mm}$, $dy=1.000 \text{ mm}$

Reference Value = 78.045 V/m; Power Drift = -0.12 dB

SAR(1 g) = 8.83 W/kg; SAR(10 g) = 4.81 W/kg

Maximum value of SAR (interpolated) = 10.5 W/kg

System Validation /Zoom Scan (7x7x7)/Cube0: Measurement grid: $dx=5\text{mm}$, $dy=5\text{mm}$, $dz=5\text{mm}$

Reference Value = 78.045 V/m; Power Drift = -0.12 dB

Peak SAR (extrapolated) = 19.3 W/kg

SAR(1 g) = 8.70 W/kg; SAR(10 g) = 4.72 W/kg

Maximum value of SAR (measured) = 10.2 W/kg

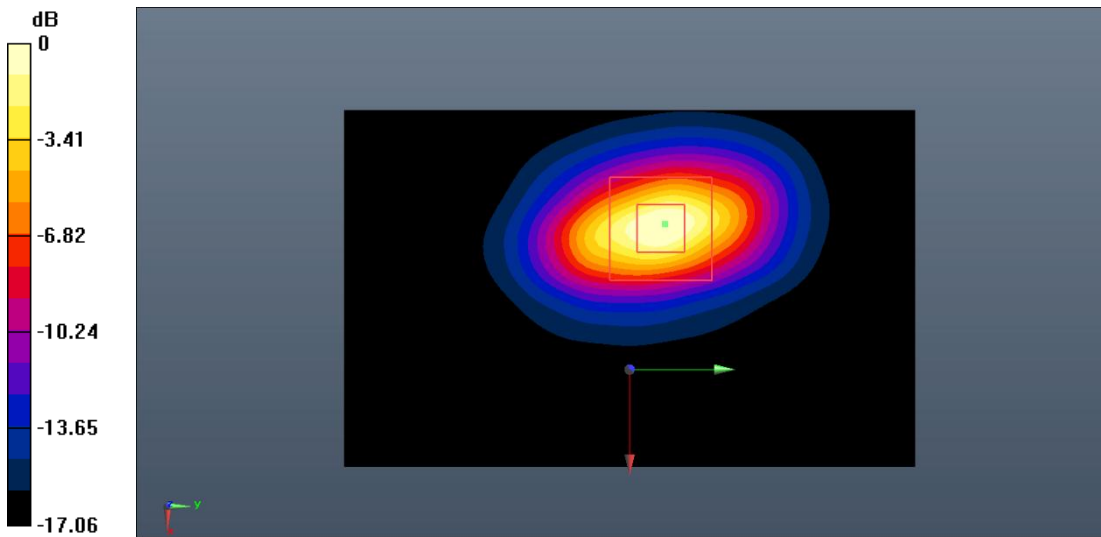

0 dB = 10.2 W/kg = 10.09 dB W/kg

Fig.B.3. Validation 1750MHz 250mW

1900MHz

Date: 2021-6-27

Electronics: DAE4 Sn1527

Medium: Head 1900MHz

Medium parameters used: $f = 1900 \text{ MHz}$; $\sigma = 1.425 \text{ S/m}$; $\epsilon_r = 39.473$; $\rho = 1000 \text{ kg/m}^3$

Communication System: CW_TMC Frequency: 1900 MHz Duty Cycle: 1:1

Probe: EX3DV4 – SN7621 ConvF (8.77, 8.77, 8.77);

System Validation /Area Scan (91x91x1): Interpolated grid: $dx=1.000 \text{ mm}$, $dy=1.000 \text{ mm}$

Reference Value = 85.466 V/m; Power Drift = 0.09 dB

SAR(1 g) = 10.2 W/kg; SAR(10 g) = 5.24 W/kg

Maximum value of SAR (interpolated) = 12.3 W/kg

System Validation /Zoom Scan (7x7x7)/Cube0: Measurement grid: $dx=5\text{mm}$, $dy=5\text{mm}$, $dz=5\text{mm}$

Reference Value = 85.466 V/m; Power Drift = 0.09 dB

Peak SAR (extrapolated) = 26.1 W/kg

SAR(1 g) = 10.5 W/kg; SAR(10 g) = 5.36 W/kg

Maximum value of SAR (measured) = 12.4 W/kg

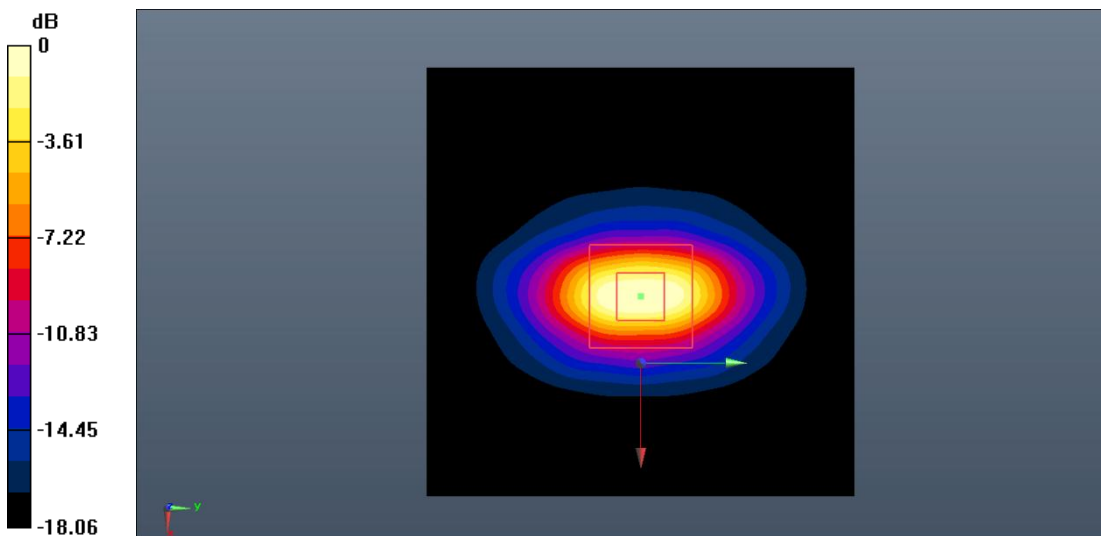

0 dB = 12.4 W/kg = 10.93 dB W/kg

Fig.B.4. Validation 1900MHz 250mW

2450MHz

Date: 2021-6-7

Electronics: DAE4 Sn1527

Medium: Head 2450MHz

Medium parameters used: $f = 2450 \text{ MHz}$; $\sigma = 1.841 \text{ S/m}$; $\epsilon_r = 38.223$; $\rho = 1000 \text{ kg/m}^3$

Communication System: CW_TMC Frequency: 2450 MHz Duty Cycle: 1:1

Probe: EX3DV4 – SN7621 ConvF (8.01, 8.01, 8.01);

System Validation /Area Scan (81x121x1): Interpolated grid: $dx=1.000 \text{ mm}$, $dy=1.000 \text{ mm}$

Reference Value = 90.105 V/m; Power Drift = 0.10 dB

SAR(1 g) = 13.4 W/kg; SAR(10 g) = 6.06 W/kg

Maximum value of SAR (interpolated) = 15.4 W/kg

System Validation /Zoom Scan (7x7x7)/Cube0: Measurement grid: $dx=5\text{mm}$, $dy=5\text{mm}$, $dz=5\text{mm}$

Reference Value = 90.105 V/m; Power Drift = 0.10 dB

Peak SAR (extrapolated) = 29.2 W/kg

SAR(1 g) = 13.6 W/kg; SAR(10 g) = 6.18 W/kg

Maximum value of SAR (measured) = 15.7 W/kg

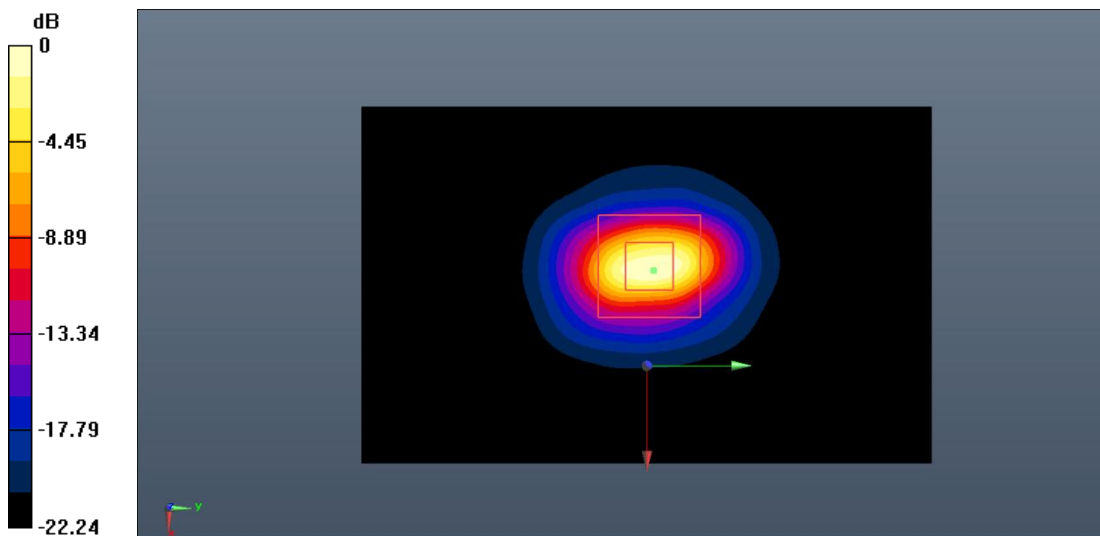

0 dB = 15.7 W/kg = 11.96 dB W/kg

Fig.B.5. Validation 2450MHz 250mW

2550MHz

Date: 2021-6-24

Electronics: DAE4 Sn1527

Medium: Head 2550MHz

Medium parameters used: $f = 2550$ MHz; $\sigma = 1.957$ S/m; $\epsilon_r = 38.031$; $\rho = 1000$ kg/m³

Communication System: CW_TMC Frequency: 2550 MHz Duty Cycle: 1:1

Probe: EX3DV4 – SN7621 ConvF (8.01, 8.01, 8.01);

System Validation /Area Scan (91x91x1): Interpolated grid: dx=1.000 mm, dy=1.000 mm

Reference Value = 94.721 V/m; Power Drift = 0.08 dB

SAR(1 g) = 14.8 W/kg; SAR(10 g) = 6.70 W/kg

Maximum value of SAR (interpolated) = 16.9 W/kg

System Validation /Zoom Scan (7x7x7)/Cube0: Measurement grid: dx=5mm, dy=5mm, dz=5mm

Reference Value = 94.721 V/m; Power Drift = 0.08 dB

Peak SAR (extrapolated) = 35.7 W/kg

SAR(1 g) = 15.0 W/kg; SAR(10 g) = 6.79 W/kg

Maximum value of SAR (measured) = 17.1 W/kg

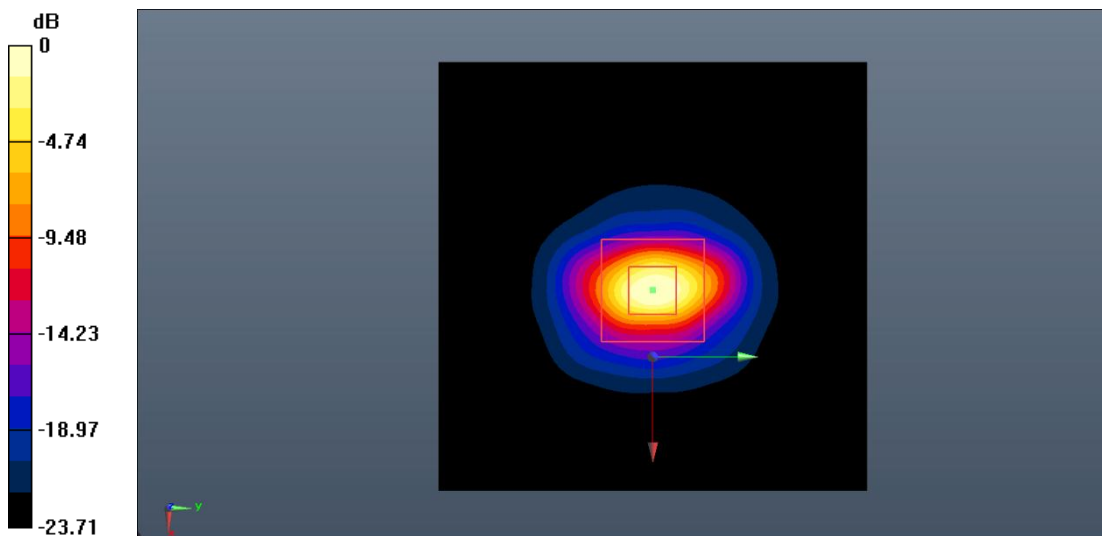

0 dB = 17.1 W/kg = 12.33 dB W/kg

Fig.B.6. Validation 2550MHz 250mW

ANNEX C: SAR Measurement Setup

C.1. Measurement Set-up

DASY5 system for performing compliance tests is illustrated above graphically. This system consists of the following items:

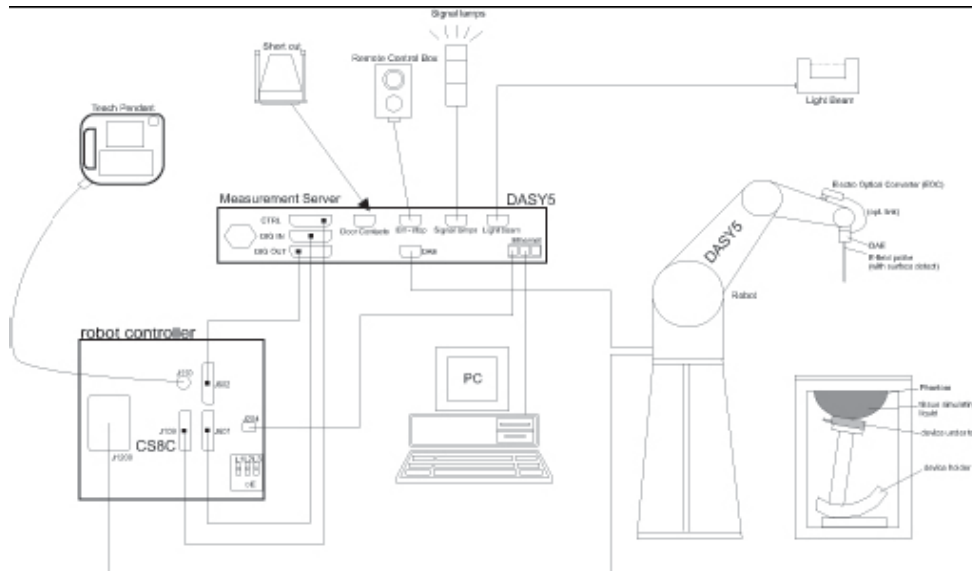

Picture C.1 SAR Lab Test Measurement Set-up

- A standard high precision 6-axis robot (Stäubli TX=RX family) with controller, teach pendant and software. An arm extension for accommodating the data acquisition electronics (DAE).
- An isotropic field probe optimized and calibrated for the targeted measurement.
- A data acquisition electronics (DAE) which performs the signal amplification, signal multiplexing, AD-conversion, offset measurements, mechanical surface detection, collision detection, etc. The unit is battery powered with standard or rechargeable batteries. The signal is optically transmitted to the EOC.
- The Electro-optical converter (EOC) performs the conversion from optical to electrical signals for the digital communication to the DAE. To use optical surface detection, a special version of the EOC is required. The EOC signal is transmitted to the measurement server.
- The function of the measurement server is to perform the time critical tasks such as signal filtering, control of the robot operation and fast movement interrupts.
- The Light Beam used is for probe alignment. This improves the (absolute) accuracy of the probe positioning.
- A computer running WinXP and the DASY5 software.
- Remote control and teach pendant as well as additional circuitry for robot safety such as
- warning lamps, etc.
- The phantom, the device holder and other accessories according to the targeted measurement.

C.2. DASY5 E-field Probe System

The SAR measurements were conducted with the dosimetric probe designed in the classical triangular configuration and optimized for dosimetric evaluation. The probe is constructed using the thick film technique; with printed resistive lines on ceramic substrates. The probe is equipped with an optical multifiber line ending at the front of the probe tip. It is connected to the EOC box on the robot arm and provides an automatic detection of the phantom surface. Half of the fibers are connected to a pulsed infrared transmitter, the other half to a synchronized receiver. As the probe approaches the surface, the reflection from the surface produces a coupling from the transmitting to the receiving fibers. This reflection increases first during the approach, reaches maximum and then decreases. If the probe is flatly touching the surface, the coupling is zero. The distance of the coupling maximum to the surface is independent of the surface reflectivity and largely independent of the surface to probe angle. The DASY5 software reads the reflection during a software approach and looks for the maximum using 2nd order curve fitting. The approach is stopped at reaching the maximum.

Probe Specifications:

Model:	ES3DV3, EX3DV4
Frequency	10MHz — 6.0GHz(EX3DV4)
Range:	10MHz — 4GHz(ES3DV3)
Calibration:	In head and body simulating tissue at Frequencies from 835 up to 5800MHz
Linearity:	± 0.2 dB(30 MHz to 6 GHz) for EX3DV4 ± 0.2 dB(30 MHz to 4 GHz) for ES3DV3
Dynamic Range:	10 mW/kg — 100W/kg
Probe Length:	330 mm
Probe Tip	
Length:	20 mm
Body Diameter:	12 mm
Tip Diameter:	2.5 mm (3.9 mm for ES3DV3)
Tip-Center:	1 mm (2.0mm for ES3DV3)
Application:	SAR Dosimetry Testing Compliance tests of mobile phones Dosimetry in strong gradient fields



Picture C.2 Near-field Probe



Picture C.3 E-field Probe

C.3. E-field Probe Calibration

Each E-Probe/Probe Amplifier combination has unique calibration parameters. A TEM cell calibration procedure is conducted to determine the proper amplifier settings to enter in the probe parameters. The amplifier settings are determined for a given frequency by subjecting the probe to a known E-field density (1 mW/cm²) using an RF Signal generator, TEM cell, and RF Power Meter.

The free space E-field from amplified probe outputs is determined in a test chamber. This calibration can be performed in a TEM cell if the frequency is below 1 GHz and in a waveguide or other methodologies above 1 GHz for free space. For the free space calibration, the probe is placed in the volumetric center of the cavity and at the proper orientation with the field. The probe is then rotated 360 degrees until the three channels show the maximum reading. The power density readings equates to 1 mW/ cm².

E-field temperature correlation calibration is performed in a flat phantom filled with the appropriate simulated brain tissue. The E-field in the medium correlates with the temperature rise in the dielectric medium. For temperature correlation calibration a RF transparent thermistor-based temperature probe is used in conjunction with the E-field probe.

$$SAR = C \frac{\Delta T}{\Delta t}$$

Where:

Δt = Exposure time (30 seconds),

C = Heat capacity of tissue (brain or muscle),

ΔT = Temperature increase due to RF exposure.

$$SAR = \frac{|E|^2 \cdot \sigma}{\rho}$$

Where:

σ = Simulated tissue conductivity,

ρ = Tissue density (kg/m³).

C.4. Other Test Equipment

C.4.1. Data Acquisition Electronics (DAE)

The data acquisition electronics consist of a highly sensitive electrometer-grade preamplifier with auto-zeroing, a channel and gain-switching multiplexer, a fast 16 bit AD-converter and a command decoder with a control logic unit. Transmission to the measurement server is accomplished through an optical downlink for data and status information, as well as an optical uplink for commands and the clock.

The mechanical probe mounting device includes two different sensor systems for frontal and sideways probe contacts. They are used for mechanical surface detection and probe collision detection.

The input impedance of the DAE is 200 MOhm; the inputs are symmetrical and floating. Common mode rejection is above 80 dB.



PictureC.4: DAE

C.4.2. Robot

The SPEAG DASY system uses the high precision robots (DASY5: RX160L) type from Stäubli SA (France). For the 6-axis controller system, the robot controller version from Stäubli is used. The Stäubli robot series have many features that are important for our application:

- High precision (repeatability 0.02mm)
- High reliability (industrial design)
- Low maintenance costs (virtually maintenance free due to direct drive gears; no belt drives)
- Jerk-free straight movements (brushless synchron motors; no stepper motors)
- Low ELF interference (motor control fields shielded via the closed metallic construction shields)



Picture C.5 DASY 5

C.4.3. Measurement Server

The Measurement server is based on a PC/104 CPU board with CPU (DASY5: 400 MHz, Intel Celeron), chipdisk (DASY5:128MB), RAM (DASY5:128MB). The necessary circuits for communication with the DAE electronic box, as well as the 16 bit AD converter system for optical detection and digital I/O interface are contained on the DASY I/O board, which is directly connected to the PC/104 bus of the CPU board.

The measurement server performs all real-time data evaluation of field measurements and surface detection, controls robot movements and handles safety operation. The PC operating system cannot interfere with these time critical processes. All connections are supervised by a watchdog, and disconnection of any of the cables to the measurement server will automatically disarm the robot and disable all program-controlled robot movements. Furthermore, the measurement server is equipped with an expansion port which is reserved for future applications. Please note that this expansion port does not have a standardized pinout, and therefore only devices provided by SPEAG can be connected. Devices from any other supplier could seriously damage the measurement server.



Picture C.6 Server for DASY 5

C.4.4. Device Holder for Phantom

The SAR in the phantom is approximately inversely proportional to the square of the distance between the source and the liquid surface. For a source at 5mm distance, a positioning uncertainty of $\pm 0.5\text{mm}$ would produce a SAR uncertainty of $\pm 20\%$. Accurate device positioning is therefore crucial for accurate and repeatable measurements. The positions in which the devices must be measured are defined by the standards.

The DASY device holder is designed to cope with the different positions given in the standard. It has two scales for device rotation (with respect to the body axis) and device inclination (with respect to the line between the ear reference points). The rotation centers for both scales is the ear reference point (ERP). Thus the device needs no repositioning when changing the angles.

The DASY device holder is constructed of low-loss POM material having the following dielectric

parameters: relative permittivity $\epsilon = 3$ and loss tangent $\delta = 0.02$. The amount of dielectric material has been reduced in the closest vicinity of the device, since measurements have suggested that the influence of the clamp on the test results could thus be lowered.

<Laptop Extension Kit>

The extension is lightweight and made of POM, acrylic glass and foam. It fits easily on the upper part of the Mounting Device in place of the phone positioner. The extension is fully compatible with the Twin-SAM and ELI phantoms.



Picture C.7-1: Device Holder



Picture C.7-2: Laptop Extension Kit

C.4.5. Phantom

The SAM Twin Phantom V4.0 is constructed of a fiberglass shell integrated in a table. The shape of the shell is based on data from an anatomical study designed to represent the 90th percentile of the population. The phantom enables the dissymmetric evaluation of SAR for both left and right handed handset usage, as well as body-worn usage using the flat phantom region. Reference markings on the Phantom allow the complete setup of all predefined phantom positions and measurement grids by manually teaching three points in the robot. The shell phantom has a 2mm shell thickness (except the ear region where shell thickness increases to 6 mm).

Shell Thickness: 2 ± 0.2 mm
Filling Volume: Approx. 25 liters
Dimensions: 810 x 1000 x 500 mm (H x L x W)
Available: Special



Picture C.8: SAM Twin Phantom

ANNEX D: Position of the wireless device in relation to the phantom

D.1. General considerations

This standard specifies two handset test positions against the head phantom – the “cheek” position and the “tilt” position.

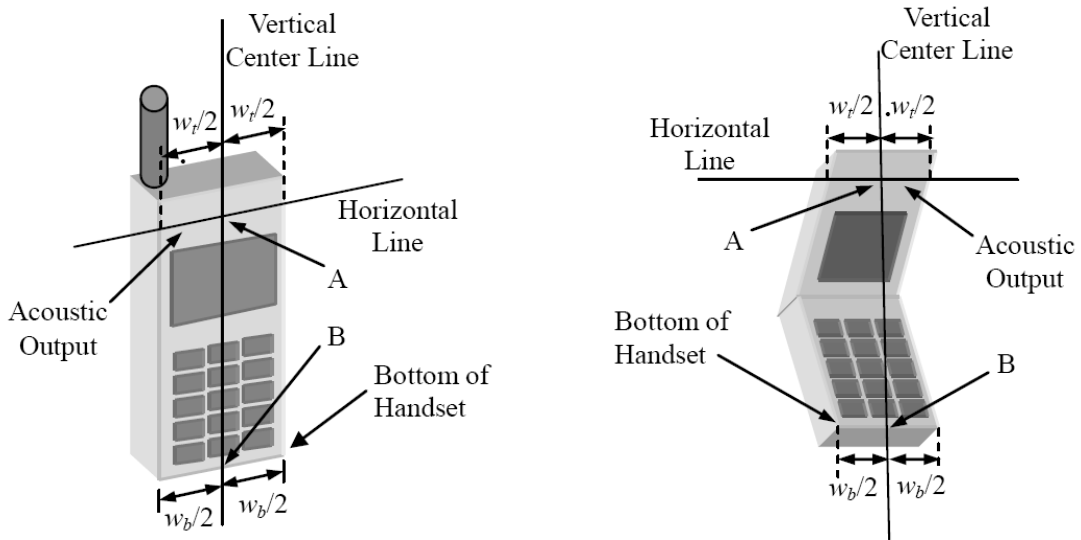

- w_t Width of the handset at the level of the acoustic
- w_b Width of the bottom of the handset
- A Midpoint of the width w_t of the handset at the level of the acoustic output
- B Midpoint of the width w_b of the bottom of the handset

Picture D.1-a Typical “fixed” case handset Picture D.1-b Typical “clam-shell” case handset

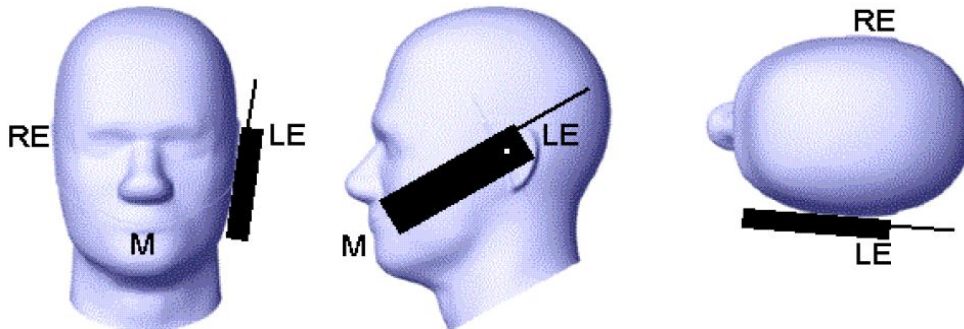

Picture D.2 Cheek position of the wireless device on the left side of SAM

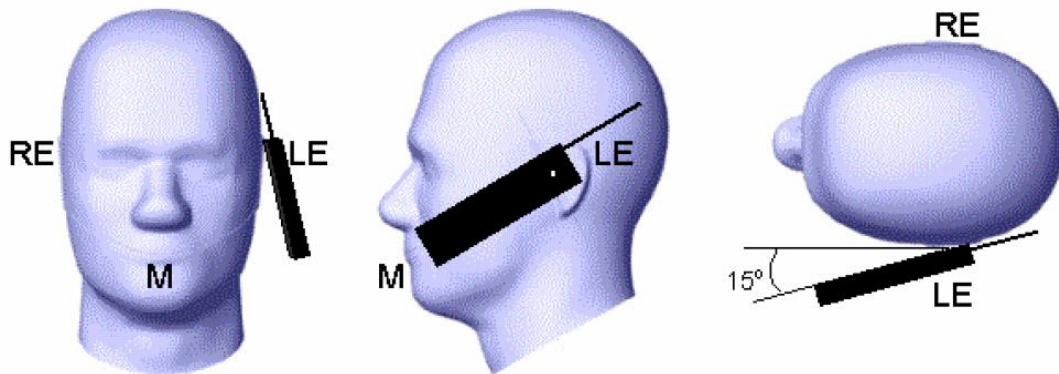

Picture D.3 Tilt position of the wireless device on the left side of SAM

D.2. Body-worn device

A typical example of a body-worn device is a mobile phone, wireless enabled PDA or other battery operated wireless device with the ability to transmit while mounted on a person's body using a carry accessory approved by the wireless device manufacturer.

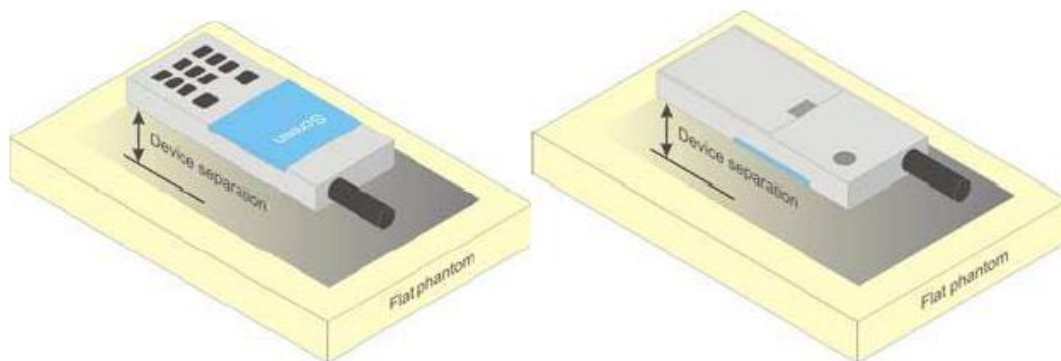

Picture D.4 Test positions for body-worn devices

D.3. Desktop device

A typical example of a desktop device is a wireless enabled desktop computer placed on a table or desk when used.

The DUT shall be positioned at the distance and in the orientation to the phantom that corresponds to the intended use as specified by the manufacturer in the user instructions. For devices that employ an external antenna with variable positions, tests shall be performed for all antenna positions specified. Picture 8.5 show positions for desktop device SAR tests. If the intended use is not specified, the device shall be tested directly against the flat phantom.

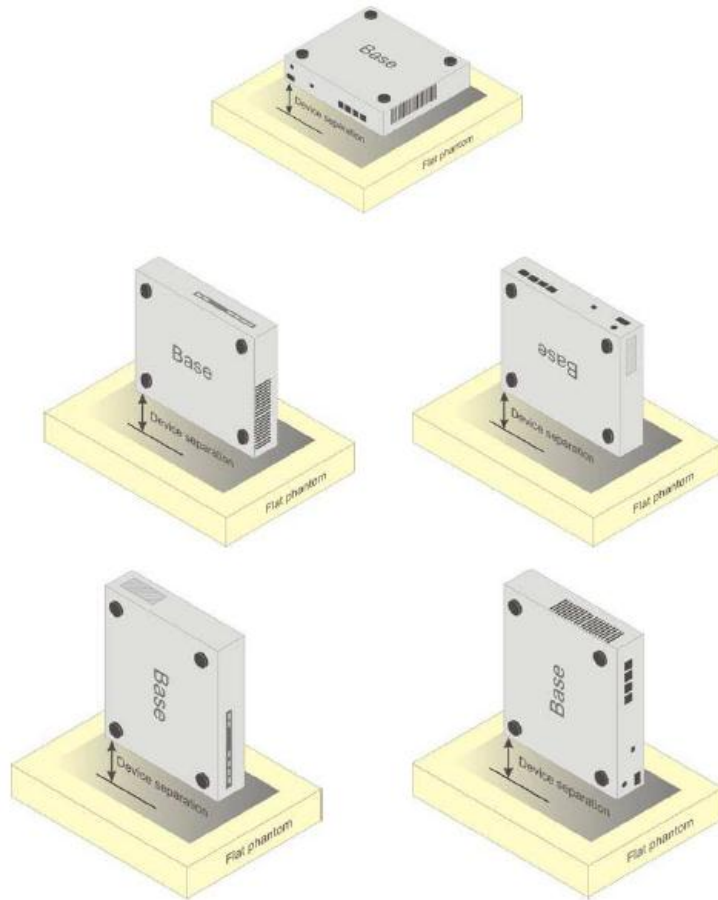

Picture D.5 Test positions for desktop devices

D.4. DUT Setup Photos

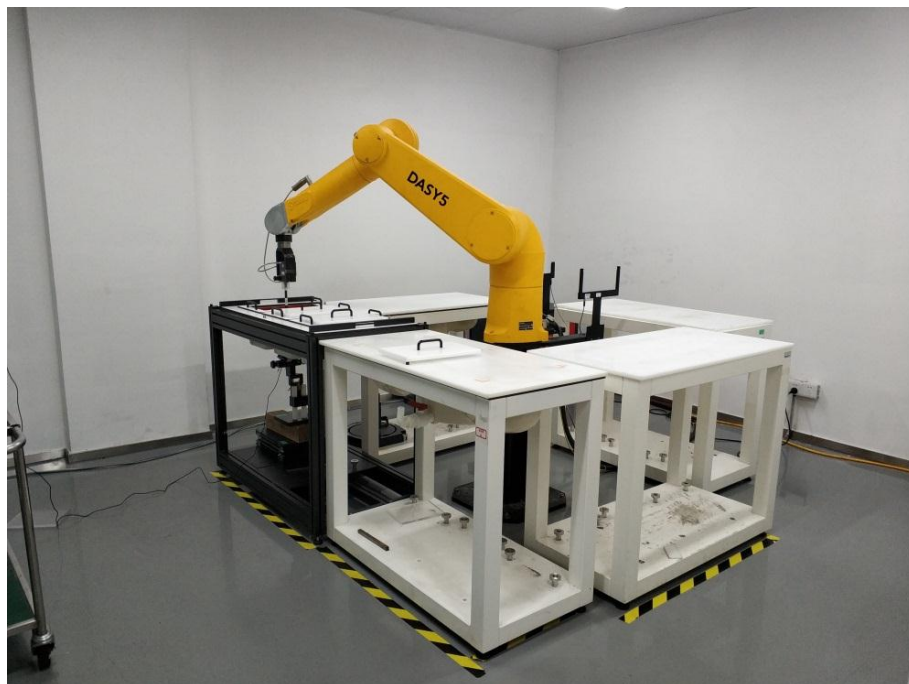

Picture D.6

ANNEX E: Equivalent Media Recipes

The liquid used for the frequency range of 700-6000 MHz consisted of water, sugar, salt, preventol, glycol monobutyl and Cellulose. The liquid has been previously proven to be suited for worst-case. The Table E.1 shows the detail solution. It's satisfying the latest tissue dielectric parameters requirements proposed by the IEEE 1528 and IEC 62209.

Table E.1: Composition of the Tissue Equivalent Matter

Frequency (MHz)	835	1750	1900	2450	2600	5200	5800
Water	41.45	55.242	55.242	58.79	58.79	65.53	66.10
Sugar	56.0	/	/	/	/	/	/
Salt	1.45	0.306	0.306	0.06	0.06		
Preventol	0.1	/	/	/	/	17.24	16.95
Cellulose	1.0	/	/	/	/	17.24	16.95
Glycol Monobutyl	/	44.452	44.452	41.15	41.15	/	/
Diethylenglycol monohexylether	/	/	/	/	/	/	/
Triton X-100	/	/	/	/	/	/	/
Dielectric Parameters Target Value	$\epsilon=41.5$ $\sigma=0.90$	$\epsilon=40.08$ $\sigma=1.37$	$\epsilon=40.0$ $\sigma=1.40$	$\epsilon=39.20$ $\sigma=1.80$	$\epsilon=39.01$ $\sigma=1.96$	$\epsilon=35.99$ $\sigma=4.66$	$\epsilon=35.30$ $\sigma=5.27$

Note: There is a little adjustment respectively for 750, 5300 and 5600, based on the recipe of closest frequency in table E.1

ANNEX F: System Validation

The SAR system must be validated against its performance specifications before it is deployed. When SAR probes, system components or software are changed, upgraded or recalibrated, these must be validated with the SAR system(s) that operates with such components.

Table F.1: System Validation

Probe SN.	Liquid name	Validation date	Frequency point	Status (OK or Not)
7621	Head 750MHz	2020-12-02	750 MHz	OK
7621	Head 835MHz	2020-04-03	835 MHz	OK
7621	Head 1750MHz	2020-10-20	1750 MHz	OK
7621	Head 1900MHz	2020-12-02	1900 MHz	OK
7621	Head 2300MHz	2020-12-03	2300 MHz	OK
7621	Head 2450MHz	2020-12-03	2450 MHz	OK
7621	Head 2550MHz	2020-12-03	2550 MHz	OK
7621	Head 5200MHz	2020-12-04	5250 MHz	OK
7621	Head 5600MHz	2020-12-04	5600 MHz	OK
7621	Head 5750MHz	2020-12-04	5750 MHz	OK



ANNEX G: DAE Calibration Certificate

DAE4 SN: 1527 Calibration Certificate



Add: No.51 Xueyuan Road, Haidian District, Beijing, 100191, China
Tel: +86-10-62304633-2512 Fax: +86-10-62304633-2504
E-mail: cttl@chinattl.com Http://www.chinattl.cn



中国认可
国际互认
校准
CALIBRATION
CNAS L0570

Client : **CTTL(South Branch)**

Certificate No: **Z20-60433**

CALIBRATION CERTIFICATE			
Object	DAE4 - SN: 1527		
Calibration Procedure(s)	FF-Z11-002-01 Calibration Procedure for the Data Acquisition Electronics (DAEx)		
Calibration date:	November 06, 2020		
<p>This calibration Certificate documents the traceability to national standards, which realize the physical units of measurements(SI). The measurements and the uncertainties with confidence probability are given on the following pages and are part of the certificate.</p> <p>All calibrations have been conducted in the closed laboratory facility: environment temperature(22±3)°C and humidity<70%.</p> <p>Calibration Equipment used (M&TE critical for calibration)</p>			
Primary Standards	ID #	Cal Date(Calibrated by, Certificate No.)	Scheduled Calibration
Process Calibrator 753	1971018	16-Jun-20 (CTTL, No.J20X04342)	Jun-21
Calibrated by:	Name	Function	Signature
	Yu Zongying	SAR Test Engineer	
Reviewed by:	Lin Hao	SAR Test Engineer	
Approved by:	Qi Dianyuan	SAR Project Leader	
Issued: November 08, 2020			
This calibration certificate shall not be reproduced except in full without written approval of the laboratory.			



Add: No.51 Xueyuan Road, Haidian District, Beijing, 100191, China
Tel: +86-10-62304633-2512 Fax: +86-10-62304633-2504
E-mail: cttl@chinattl.com Http://www.chinattl.cn

Glossary:

DAE data acquisition electronics
Connector angle information used in DASY system to align probe sensor X to the robot coordinate system.

Methods Applied and Interpretation of Parameters:

- *DC Voltage Measurement:* Calibration Factor assessed for use in DASY system by comparison with a calibrated instrument traceable to national standards. The figure given corresponds to the full scale range of the voltmeter in the respective range.
- *Connector angle:* The angle of the connector is assessed measuring the angle mechanically by a tool inserted. Uncertainty is not required.
- The report provide only calibration results for DAE, it does not contain other performance test results.



Add: No.51 Xueyuan Road, Haidian District, Beijing, 100191, China
Tel: +86-10-62304633-2512 Fax: +86-10-62304633-2504
E-mail: cttl@chinattl.com Http://www.chinattl.cn

DC Voltage Measurement

A/D - Converter Resolution nominal
High Range: 1LSB = 6.1μV, full range = -100...+300 mV
Low Range: 1LSB = 61nV, full range = -1.....+3mV
DASY measurement parameters: Auto Zero Time: 3 sec; Measuring time: 3 sec

Calibration Factors	X	Y	Z
High Range	403.863 ± 0.15% (k=2)	403.582 ± 0.15% (k=2)	403.801 ± 0.15% (k=2)
Low Range	3.95875 ± 0.7% (k=2)	3.98892 ± 0.7% (k=2)	3.96720 ± 0.7% (k=2)

Connector Angle

Connector Angle to be used in DASY system	223.5° ± 1 °
---	--------------