



# TEST REPORT

No. I20N02496-DFS

**TCL Communication Ltd.**

**Tablet PC**

**Model Name: 8094X**

**with**

**Hardware Version: PIO**

**Software Version: 2C51**

**FCC ID: 2ACCJB140**

**Issued Date: 2020-09-30**

**Note:**

The test results in this test report relate only to the devices specified in this report. This report shall not be reproduced except in full without the written approval of SAICT.

**Test Laboratory:**

**Shenzhen Academy of Information and Communications Technology**

Building G, Shenzhen International Innovation Center, No.1006 Shennan Road, Futian District, Shenzhen, Guangdong, P. R. China 518026.

Tel: +86(0)755-33322000, Fax: +86(0)755-33322001

Email: [yewu@caict.ac.cn](mailto:yewu@caict.ac.cn), website: [www.cszit.com](http://www.cszit.com)

## **CONTENTS**

<b>1.</b>	<b>SUMMARY OF TEST REPORT.....</b>	<b>3</b>
1.1.	TEST ITEMS.....	3
1.2.	TEST STANDARDS .....	3
1.3.	TEST RESULT .....	3
1.4.	TESTING LOCATION .....	3
1.5.	PROJECT DATA .....	3
1.6.	SIGNATURE .....	3
<b>2.</b>	<b>CLIENT INFORMATION.....</b>	<b>4</b>
2.1.	APPLICANT INFORMATION .....	4
2.2.	MANUFACTURER INFORMATION .....	4
<b>3.</b>	<b>EQUIPMENT UNDER TEST (EUT) AND ANCILLARY EQUIPMENT(AE) .....</b>	<b>5</b>
3.1.	ABOUT EUT .....	5
3.2.	INTERNAL IDENTIFICATION OF EUT USED DURING THE TEST .....	5
3.3.	INTERNAL IDENTIFICATION OF AE USED DURING THE TEST .....	5
3.4.	GENERAL DESCRIPTION.....	5
<b>4.</b>	<b>REFERENCE DOCUMENTS .....</b>	<b>7</b>
4.1.	DOCUMENTS SUPPLIED BY APPLICANT .....	7
4.2.	REFERENCE DOCUMENTS FOR TESTING.....	7
<b>5.</b>	<b>TEST RESULTS.....</b>	<b>8</b>
5.1.	TESTING ENVIRONMENT.....	8
5.2.	TEST RESULTS .....	8
5.3.	STATEMENTS.....	8
<b>6.</b>	<b>TEST EQUIPMENTS UTILIZED .....</b>	<b>9</b>
<b>7.</b>	<b>LABORATORY ENVIRONMENT.....</b>	<b>10</b>
	<b>ANNEX A: MEASUREMENT RESULTS.....</b>	<b>11</b>
A.1.	MEASUREMENT METHOD .....	11
A.2.	CHANNEL MOVE TIME AND CHANNEL CLOSING TRANSMISSION TIME .....	13
A.3.	NON-OCCUPANCY PERIOD .....	16
	<b>ANNEX B: PHOTOGRAPHS OF THE TEST SET-UP .....</b>	<b>18</b>

## 1. Summary of Test Report

### 1.1. Test Items

Description	Tablet PC
Model Name	8094X
Applicant's name	TCL Communication Ltd.
Manufacturer's Name	TCL Communication Ltd.

### 1.2. Test Standards

FCC Part15-2019; FCC 06-96-2006; KDB 905462-D02

### 1.3. Test Result

**Pass**

### 1.4. Testing Location

Address: Building G, Shenzhen International Innovation Center, No.1006 Shennan Road, Futian District, Shenzhen, Guangdong, P. R. China

### 1.5. Project data

Testing Start Date:	2020-07-22
Testing End Date:	2020-08-21

### 1.6. Signature

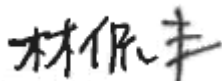

---

Lin Kanfeng  
(Prepared this test report)



---

Tang Weisheng  
(Reviewed this test report)



---

Zhang Bojun  
(Approved this test report)



## **2. Client Information**

### **2.1. Applicant Information**

Company Name: TCL Communication Ltd.  
Address: 5/F, Building 22E, 22 Science Park East Avenue, Hong Kong Science Park, Shatin, NT, Hong Kong  
Contact Person: Gong Zhizhou  
E-Mail: zhizhou.gong@tcl.com  
Telephone: 0086-755-36611722  
Fax: 0086-755-36612000-81722

### **2.2. Manufacturer Information**

Company Name: TCL Communication Ltd.  
Address: 5/F, Building 22E, 22 Science Park East Avenue, Hong Kong Science Park, Shatin, NT, Hong Kong  
Contact Person: Gong Zhizhou  
E-Mail: zhizhou.gong@tcl.com  
Telephone: 0086-755-36611722  
Fax: 0086-755-36612000-81722

### **3. Equipment Under Test (EUT) and Ancillary Equipment(AE)**

#### **3.1.About EUT**

Description	Tablet PC
Model name	8094X
Brand Name	/
RLAN Frequency Range	ISM Bands: 5250MHz~5350MHz
RLAN Protocol	IEEE 802.11a,802.11n-HT20/40,802.11ac-VHT20/40/80
Type of modulation	OFDM
Antenna	Integrated
Antenna Gain	1.03dBi
Power Supply	3.9V DC by Battery
FCC ID	2ACCJB140
Device Type (DFS)	Client without radar detection (only support client mode)
Condition of EUT as received	No abnormality in appearance

#### **3.2.Internal Identification of EUT used during the test**

<b>EUT ID*</b>	<b>IMEI</b>	<b>HW Version</b>	<b>SW Version</b>	<b>Receive Date</b>
EUT1	357153340000096	PIO	2C51	2020-07-22
EUT2	357153340000104	PIO	2C51	2020-07-22
EUT3	357153340000088	PIO	2C51	2020-07-22
EUT4	357153340000070	PIO	2C51	2020-07-22

\*EUT ID: is used to identify the test sample in the lab internally.

#### **3.3.Internal Identification of AE used during the test**

<b>AE ID*</b>	<b>Description</b>	<b>SN</b>
AE1	Battery	CAC5360006C1
AE2	Charger	CBA0059AGAC5

AE1

Model	TLp053C1
Manufacturer	BYD
Capacity	5500mAh
Nominal Voltage	3.85v

AE2

Model	UC13US
Manufacturer	PUAN

\*AE ID: is used to identify the test sample in the lab internally.

#### **3.4.General Description**

The Equipment under Test (EUT) is a model of Tablet PC with integrated antenna and battery.

It consists of normal options: Lithium Battery and Charger.

Manual and specifications of the EUT were provided to fulfil the test.



Samples undergoing test were selected by the client.



#### **4. Reference Documents**

##### **4.1. Documents supplied by applicant**

EUT feature information is supplied by the applicant or manufacturer, which is the basis of testing.

##### **4.2. Reference Documents for testing**

The following documents listed in this section are referred for testing.

<b>Reference</b>	<b>Title</b>	<b>Version</b>
FCC Part15	Title 47 of the Code of Federal Regulations; Chapter I Part 15 - Radio frequency devices Subpart E – UNII Devices	2019
FCC 06-96	Revision of Parts 2 and 15 of the Commission’s Rules to Permit Unlicensed National Information Infrastructure (U-NII) devices in the 5 GHz band	2006
KDB 905462	Compliance Measurement Procedures for Unlicensed-national Information Infrastructure Devices Operating in the 5250-5350 MHz and 5470-5725 MHz Bands Incorporating Dynamic Frequency Selection	D02

Note: This report is only for DFS

## 5. Test Results

### 5.1. Testing Environment

Normal Temperature: 15~35°C

Relative Humidity: 20~75%

### 5.2. Test Results

No	Test cases	Sub-clause of Part15E	Verdict
1	Channel move time and channel closing transmission time	15.407 (h)(2)(iii)	P
2	Non-Occupancy Period	15.407 (h)(2) (iv)	P

Please refer to **ANNEX A** for detail.

### 5.3. Statements

SAICT has evaluated the test cases requested by the applicant/manufacture as listed in section 5.2 of this report, for the EUT specified in section 3, according to the standards or reference documents listed in section 4.2.

This report only deal with the UNII DFS functions among the features described in section 3, and The EUT met all requirements of the reference documents.

The end user is not available to get and modify the parameters of the detected Radar Waveforms in this product.



## 6. Test Equipments Utilized

### Conducted test system

No.	Equipment	Model	Serial Number	Manufacturer	Calibration Due date	Calibration Period
1	Vector Signal Analyzer	FSV40	100903	Rohde & Schwarz	2021-01-15	1 year
2	Vector Signal General	SMU200A	104096	Rohde & Schwarz	2021-01-01	1 year
3	Shielding Room	S81	/	ETS-Lindgren	2022-11-14	3 year
No.	Equipment	Model	FCC ID	Manufacturer	Calibration Due date	Calibration Period
4	Master AP	BCM94709R	QDS-BR CM1091	BROADCOM	/	/

## 7. Laboratory Environment

Measurement is performed in shielding room.

### Shielded room

Temperature	Min. = 15 °C, Max. = 35 °C
Relative humidity	Min. = 20 %, Max. = 75 %
Shielding effectiveness	0.014 MHz - 1 MHz, > 60 dB; 1 MHz - 1000 MHz, > 90 dB.
Electrical insulation	> 2 MΩ
Ground system resistance	< 4 Ω

## **ANNEX A: MEASUREMENT RESULTS**

### **A.1. Measurement Method**

#### **A.1.1. Conducted Measurements**

The below figure shows the DFS setup, where the EUT is a WLAN device operating in slave mode, without Radar Interference Detection function. This setup also contains a device operating in master mode. The radar test signals are injected into the master device. The EUT (slave device) is associated with the master device. WLAN traffic is generated by streaming the mpeg file from the master to the slave in full monitor video mode using the media player.

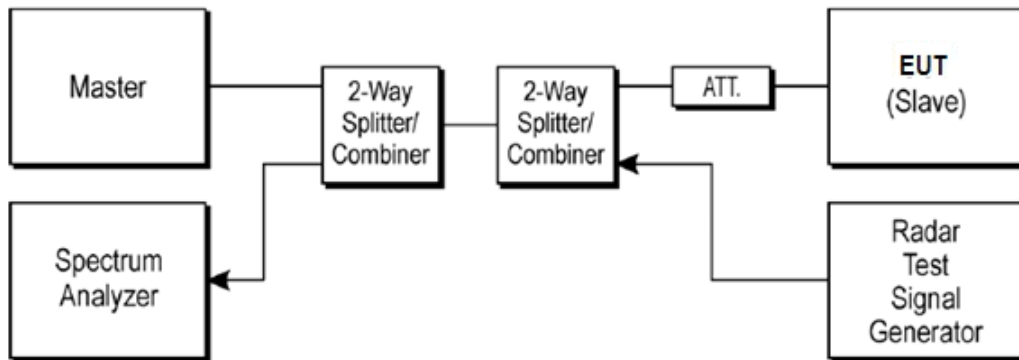

#### **A.1.2. Parameters of DFS test signal**

1). Interference threshold values, master or client incorporation in service monitoring. For device Power less than 23 dBm (E.I.R.P.), the threshold level is -62 dBm at the antenna port after Correction for antenna gain and procedural adjustments.

Because of conducted measurement performed, the calibration power from radar signal generator to antenna port of DFS test equipment is -62 dBm.

Maximum Transmit Power	Value
> 200 mW	-64 dBm
< 200 mW	-62 dBm

2). DFS requirement values

The required values are as the following table.

Parameter	Value
Non-occupancy	> 1800 s
Channel Availability Check Time	60 s
Channel Move Time	10 s
Channel Closing Transmission Time	200 ms + 60 ms
U-NII Detection Bandwidth	Minimum 80% of the 99% transmission power bandwidth

As the EUT is IP based system, the MPEG video file from NTIA website is used to steam to EUT via the Master device.

3). Parameters of the reference DFS test signal

Pulse width W ( $\mu$ s)	Pulse repetition frequency PRF (PPS)	Pulses per burst (PPB)
1	700	18

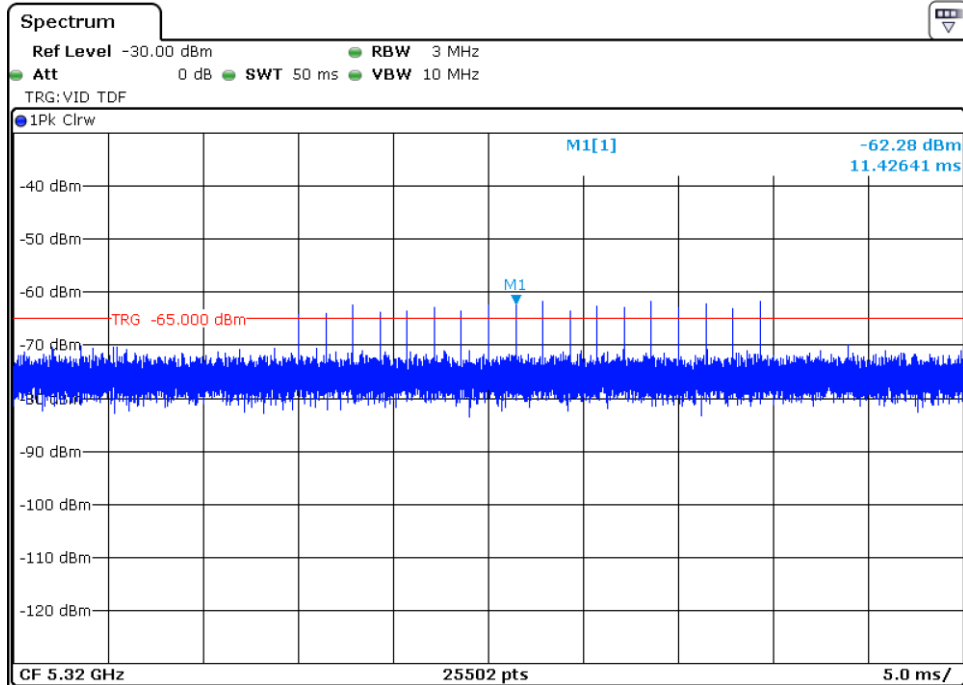

**Radar Signal (Type 0)**

## A.2. Channel move time and channel closing transmission time

### Measurement Limit:

Test Items	Limit
channel closing transmission time	< 200 ms + 60 ms
Channel move time	< 10 s

### Measurement Results:

#### HT20 Frequency Band: 5250MHz ~ 5350MHz

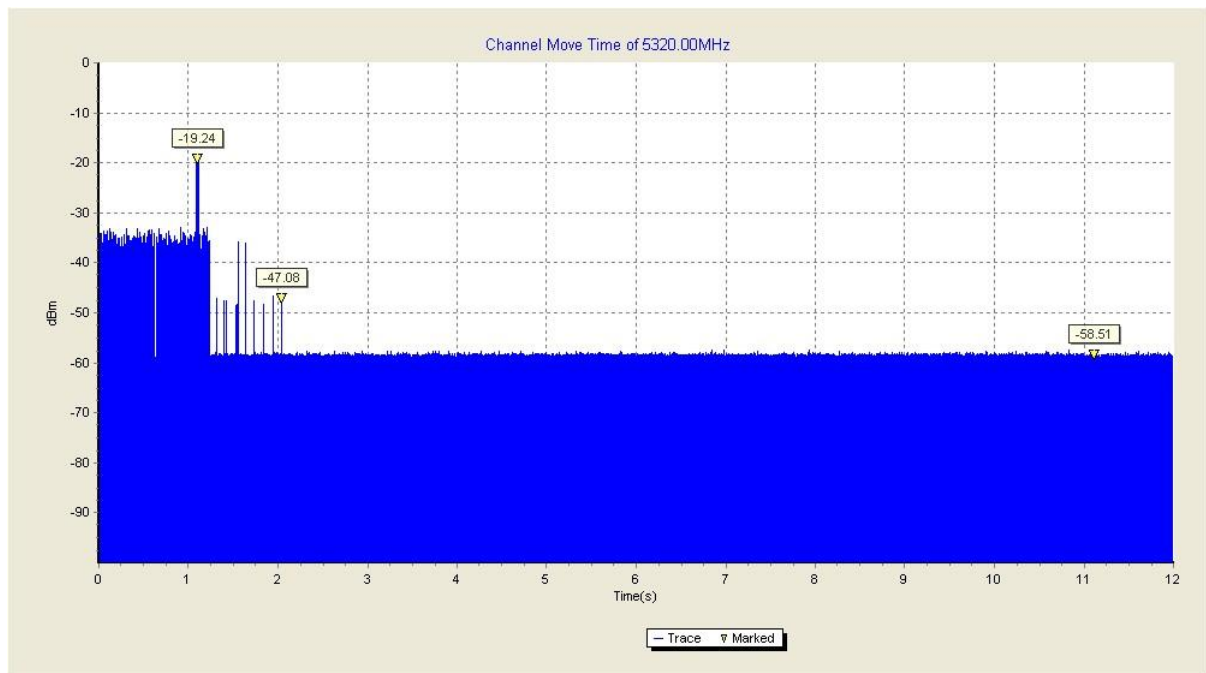

**Fig.1 channel move time (HT20 Frequency Band: 5250MHz ~ 5350MHz)**

The channel move time is as the figure. It shows the time of the radar and the client pulses. The figure shows that the client stops transmission within 10 seconds, and no transmissions occur after 10 seconds later of the radar burst signal.

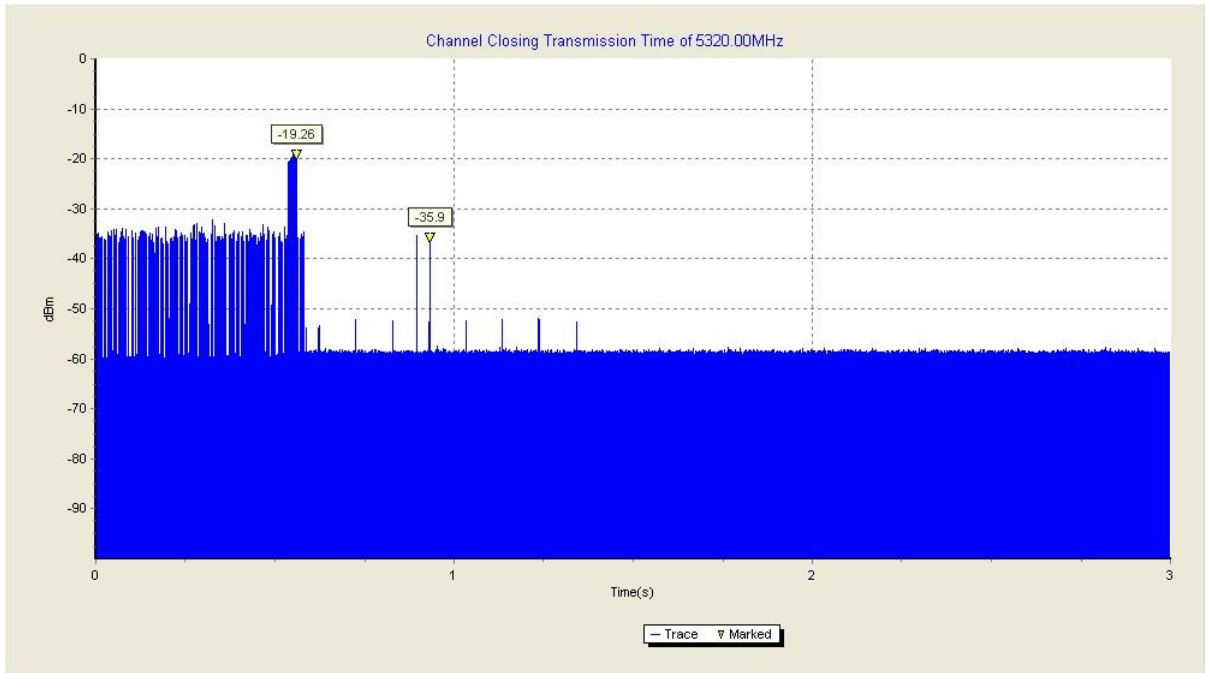

**Fig.2 channel closing transmission time (HT20 Frequency Band: 5250MHz ~ 5350MHz)**

The closing transmission time is as the figure, and the result is 18ms.

**HT80 Frequency Band: 5250MHz ~ 5350MHz**

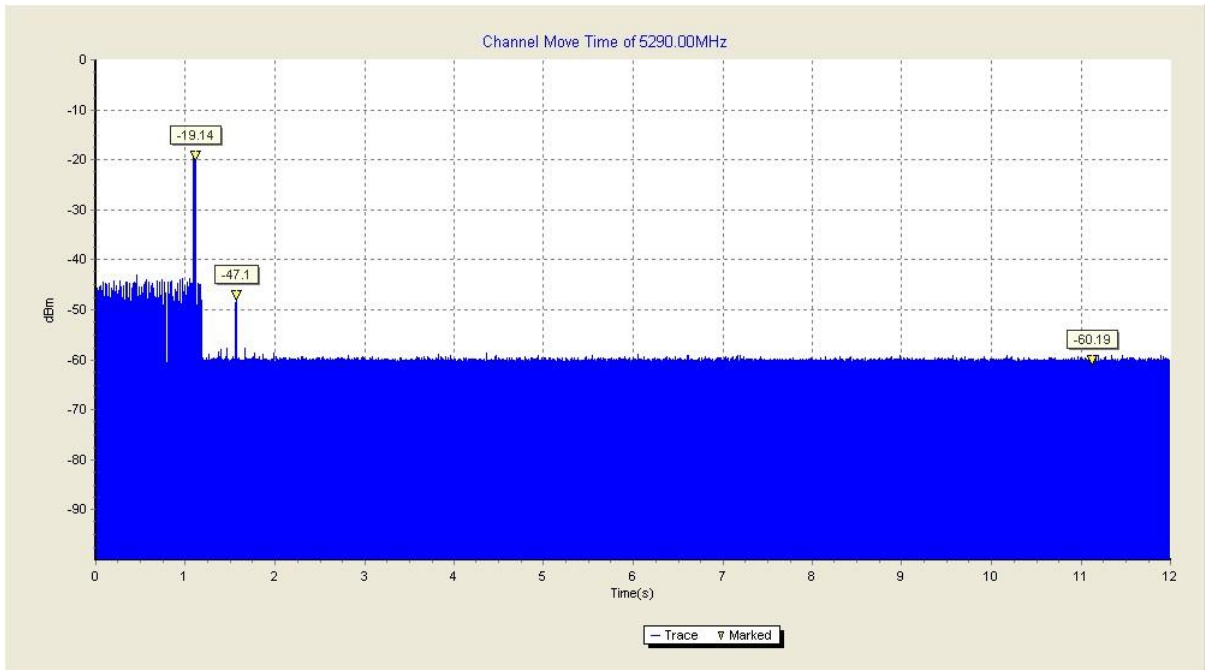

**Fig.3 channel move time (HT80 Frequency Band: 5250MHz ~ 5350MHz)**

The channel move time is as the figure. It shows the time of the radar and the client pulses. The figure shows that the client stops transmission within 10 seconds, and no transmissions occur

after 10 seconds later of the radar burst signal.

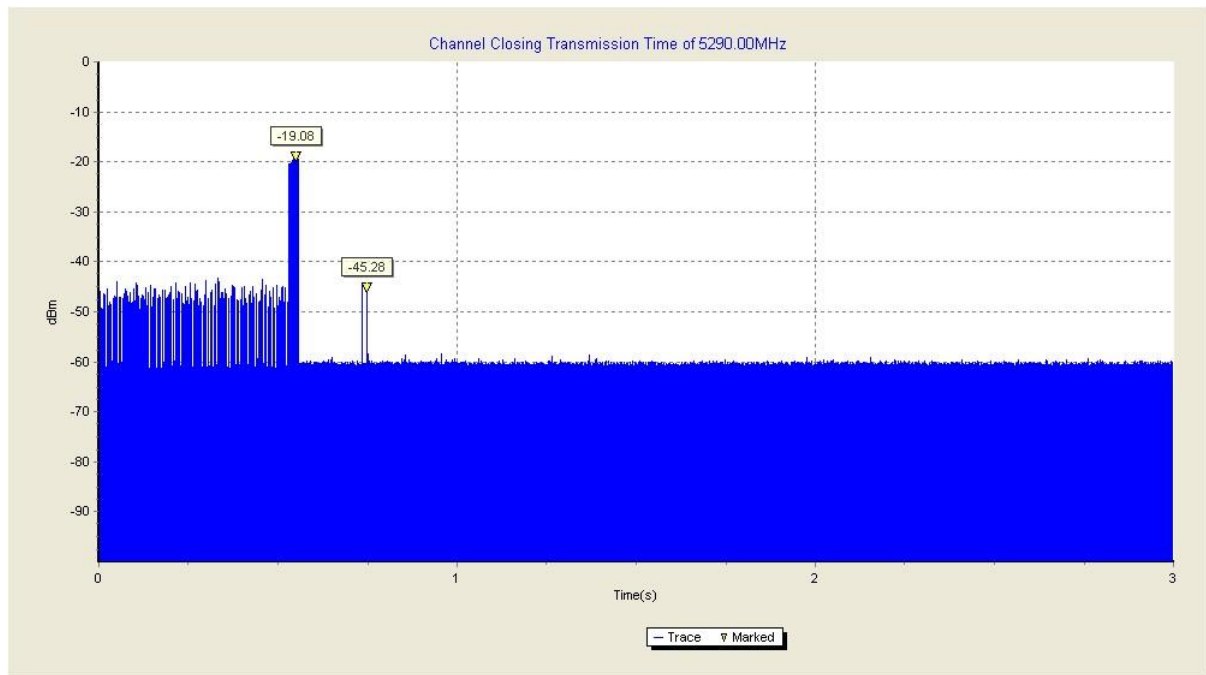

**Fig.4** channel closing transmission time (HT80 Frequency Band: 5250MHz ~ 5350MHz)

The closing transmission time is as the figure, and the result is 4ms.

**Conclusion: PASS**

### A.3. Non-Occupancy Period

#### Measurement Limit:

Test Items	Limit
Non-Occupancy Period	> 1800 s

#### Associated test

Associate the master and client, transmit specified stream between the master and client; monitor the analyzer on the operating frequency to make sure no beacons have been transmitted for 1800 seconds.

#### HT20 Frequency Band: 5250MHz ~ 5350MHz

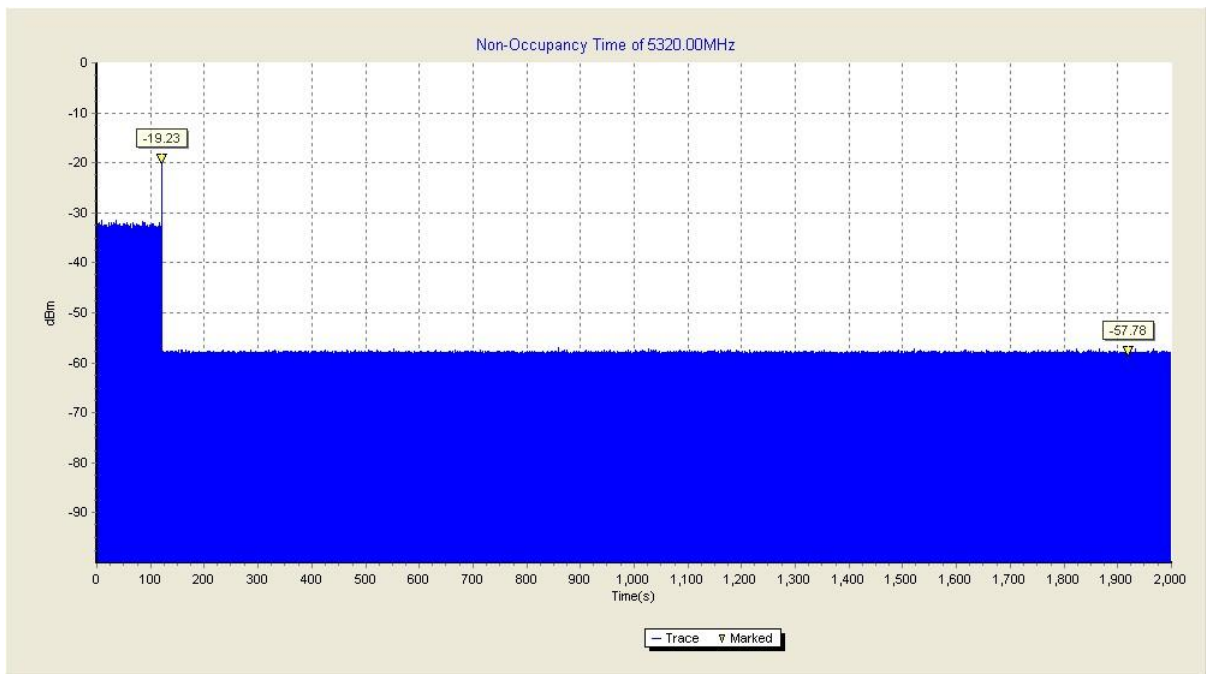
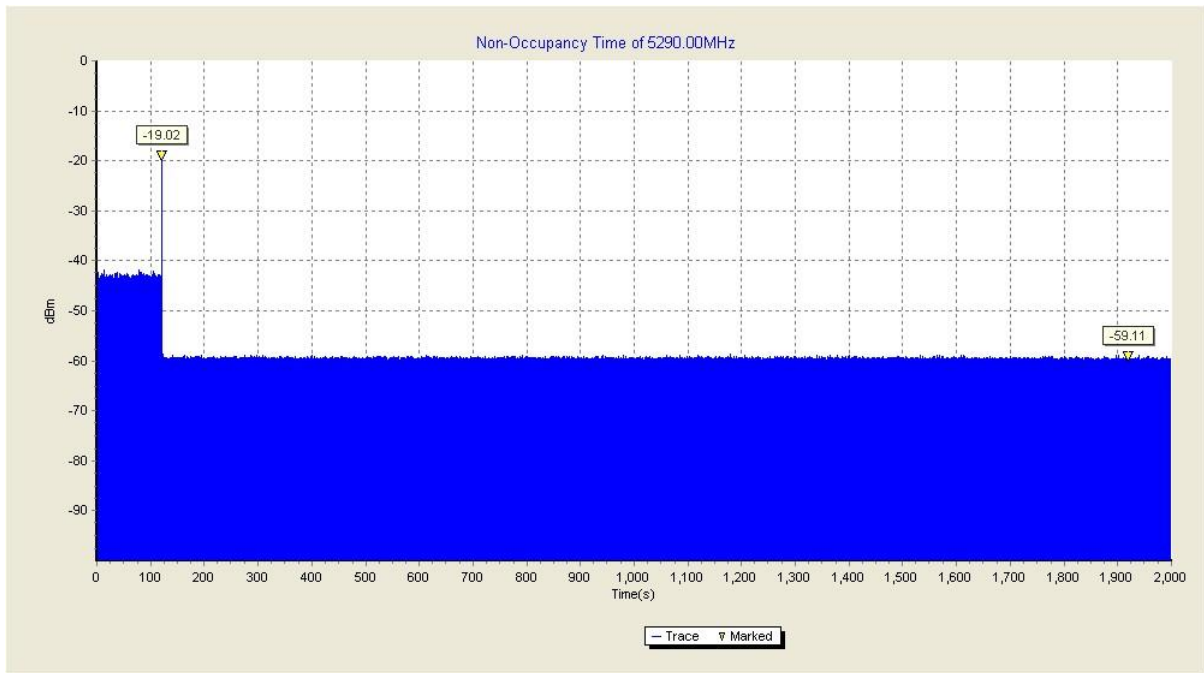

**Fig.5 Non-Occupancy Period (HT20 Frequency Band: 5250MHz ~ 5350MHz)**

The figure above shows that the client does not transmit any emission within 1800 seconds after getting the order of "stop transmits" from the DFS master (access point).

#### HT80 Frequency Band: 5250MHz ~ 5350MHz





**Fig.6 Non-Occupancy Period (HT80 Frequency Band: 5250MHz ~ 5350MHz)**

The figure above shows that the client does not transmit any emission within 1800 seconds after getting the order of "stop transmits" from the DFS master (access point).

**Conclusion: PASS**

## ANNEX B: PHOTOGRAPHS OF THE TEST SET-UP

### Layout of Conducted Test



\*\*\* END OF REPORT BODY \*\*\*