



**CFR 47 FCC PART 15 SUBPART C  
ISED RSS-247 ISSUE 2**

**CERTIFICATION TEST REPORT**

*For*

**True Wireless Headphones**

**MODEL NUMBER: TW10**

**FCC ID: 2ACCJB138**

**IC: 9238A-0105**

**REPORT NUMBER: 4789619874.5-7**

**ISSUE DATE: September 10, 2020**

*Prepared for*

**TCL Communication Ltd.  
5/F, Building 22E, 22 Science Park East Avenue, Hong Kong Science Park, Shatin,  
NT, Hong Kong**

*Prepared by*

**UL Verification Services (Guangzhou) Co., Ltd, Song Shan Lake Branch**

**Building 10, Innovation Technology Park, No. 1, Li Bin Road, Song Shan Lake Hi-  
Tech Development Zone Dongguan, 523808, People's Republic of China**

**Tel: +86 769 22038881**

**Fax: +86 769 33244054**

**Website: [www.ul.com](http://www.ul.com)**



Revision History

<u>Rev.</u>	<u>Issue Date</u>	<u>Revisions</u>	<u>Revised By</u>
V0	09/10/2020	Initial Issue	



Summary of Test Results			
Clause	Test Items	FCC/ISED Rules	Test Results
1	6dB Bandwidth and 99% Occupied Bandwidth	FCC Part 15.247 (a) (2) RSS-247 Clause 5.2 (a) ISED RSS-Gen Clause 6.7	Pass
2	Peak Conducted Output Power	FCC Part 15.247 (b) (3) RSS-247 Clause 5.4 (d)	Pass
3	Power Spectral Density	FCC Part 15.247 (e) RSS-247 Clause 5.2 (b)	Pass
4	Conducted Bandedge and Spurious Emission	FCC Part 15.247 (d) RSS-247 Clause 5.5	Pass
5	Radiated Bandedge and Spurious Emission	FCC Part 15.247 (d) FCC Part 15.209 FCC Part 15.205 RSS-247 Clause 5.5 RSS-GEN Clause 8.9	Pass
6	Conducted Emission Test for AC Power Port	FCC Part 15.207 RSS-GEN Clause 8.8	Pass
7	Antenna Requirement	FCC Part 15.203 RSS-GEN Clause 6.8	Pass
Note: 1. This test report is only published to and used by the applicant, and it is not for evidence purpose in China. 2. The measurement result for the sample received is <Pass> according to < CFR 47 FCC PART 15 SUBPART C >< ISED RSS-247 > when <Accuracy Method> decision rule is applied.			

## TABLE OF CONTENTS

<b>1. ATTESTATION OF TEST RESULTS .....</b>	<b>6</b>
<b>2. TEST METHODOLOGY .....</b>	<b>7</b>
<b>3. FACILITIES AND ACCREDITATION .....</b>	<b>7</b>
<b>4. CALIBRATION AND UNCERTAINTY .....</b>	<b>8</b>
4.1. <i>MEASURING INSTRUMENT CALIBRATION .....</i>	<i>8</i>
4.2. <i>MEASUREMENT UNCERTAINTY.....</i>	<i>8</i>
<b>5. EQUIPMENT UNDER TEST .....</b>	<b>9</b>
5.1. <i>DESCRIPTION OF EUT .....</i>	<i>9</i>
5.2. <i>CHANNEL LIST .....</i>	<i>9</i>
5.3. <i>MAXIMUM PEAK OUTPUT POWER.....</i>	<i>9</i>
5.4. <i>TEST CHANNEL CONFIGURATION.....</i>	<i>9</i>
5.5. <i>THE WORSE CASE POWER SETTING PARAMETER.....</i>	<i>10</i>
5.6. <i>DESCRIPTION OF AVAILABLE ANTENNAS .....</i>	<i>10</i>
5.7. <i>DESCRIPTION OF TEST SETUP.....</i>	<i>11</i>
<b>6. MEASURING INSTRUMENT AND SOFTWARE USED .....</b>	<b>12</b>
<b>7. ANTENNA PORT TEST RESULTS .....</b>	<b>14</b>
7.1. <i>ON TIME AND DUTY CYCLE.....</i>	<i>14</i>
7.2. <i>6 dB DTS BANDWIDTH AND 99 % OCCUPIED BANDWIDTH .....</i>	<i>15</i>
7.3. <i>CONDUCTED OUTPUT POWER.....</i>	<i>17</i>
7.4. <i>POWER SPECTRAL DENSITY.....</i>	<i>18</i>
7.5. <i>CONDUCTED BANDEDGE AND SPURIOUS EMISSIONS.....</i>	<i>20</i>
<b>8. RADIATED TEST RESULTS.....</b>	<b>22</b>
8.1. <i>RESTRICTED BANDEDGE.....</i>	<i>28</i>
8.1.1. <i>LE 1M MODE.....</i>	<i>28</i>
8.2. <i>SPURIOUS EMISSIONS (1 GHz ~ 3 GHz).....</i>	<i>36</i>
8.2.1. <i>LE 1M MODE.....</i>	<i>36</i>
8.3. <i>SPURIOUS EMISSIONS (3 GHz ~ 18 GHz).....</i>	<i>42</i>
8.3.1. <i>LE 1M MODE.....</i>	<i>42</i>
8.4. <i>SPURIOUS EMISSIONS (18 GHz ~ 26 GHz).....</i>	<i>48</i>
8.4.1. <i>LE 1M MODE.....</i>	<i>48</i>
8.5. <i>SPURIOUS EMISSIONS (30 MHz ~ 1 GHz).....</i>	<i>50</i>
8.5.1. <i>LE 1M MODE.....</i>	<i>50</i>
8.6. <i>SPURIOUS EMISSIONS BELOW 30 MHz .....</i>	<i>52</i>
8.6.1. <i>LE 1M MODE.....</i>	<i>52</i>



<b>9. AC POWER LINE CONDUCTED EMISSIONS</b> .....	<b>55</b>
9.1. LE 1M MODE.....	56
<b>10. ANTENNA REQUIREMENTS</b> .....	<b>58</b>
<b>11. APPENDIX</b> .....	<b>59</b>
11.1. Appendix A: DTS Bandwidth .....	59
11.1.1. Test Result .....	59
11.1.2. Test Graphs .....	60
11.2. Appendix B: Occupied Channel Bandwidth .....	62
11.2.1. Test Result .....	62
11.2.2. Test Graphs .....	63
11.3. Appendix C: Maximum conducted output power.....	65
11.3.1. Test Result .....	65
11.4. Appendix D: Maximum power spectral density .....	66
11.4.1. Test Result .....	66
11.4.2. Test Graphs .....	67
11.5. Appendix E: Band edge measurements .....	69
11.5.1. Test Result .....	69
11.5.2. Test Graphs .....	70
11.6. Appendix F: Conducted Spurious Emission.....	71
11.6.1. Test Result .....	71
11.6.2. Test Graphs .....	72
11.7. Appendix G: Duty Cycle .....	77
11.7.1. Test Result .....	77
11.7.2. Test Graphs .....	78



# 1. ATTESTATION OF TEST RESULTS

## Applicant Information

Company Name: TCL Communication Ltd.  
Address: 5/F, Building 22E, 22 Science Park East Avenue, Hong Kong  
Science Park, Shatin, NT, Hong Kong

## Manufacturer Information

Company Name: TCL Communication Ltd.  
Address: 5/F, Building 22E, 22 Science Park East Avenue, Hong Kong  
Science Park, Shatin, NT, Hong Kong

## EUT Information

EUT Name: True Wireless Headphones  
Model: TW10  
Brand: TCL/Alcatel  
Sample Received Date: September 01, 2020  
Sample Status: Normal  
Sample ID: 3304233  
Date of Tested: September 01~07, 2020

APPLICABLE STANDARDS	
STANDARD	TEST RESULTS
CFR 47 FCC PART 15 SUBPART C	PASS
ISED RSS-247 Issue 2	PASS
ISED RSS-GEN Issue 5	PASS

Prepared By:

Kebo Zhang  
Project Engineer

Checked By:

Shawn Wen  
Laboratory Leader

Approved By:

Stephen Guo  
Laboratory Manager



## 2. TEST METHODOLOGY

The tests documented in this report were performed in accordance with KDB 558074 D01 15.247 Meas Guidance v05r02, 414788 D01 Radiated Test Site v01r01, CFR 47 FCC Part 2, CFR 47 FCC Part 15, ANSI C63.10-2013, ISED RSS-247 Issue 2 and ISED RSS-GEN Issue 5.

## 3. FACILITIES AND ACCREDITATION

Accreditation Certificate	<p><b>A2LA (Certificate No.: 4102.01)</b> UL Verification Services (Guangzhou) Co., Ltd. Song Shan Lake Branch. has been assessed and proved to be in compliance with A2LA.</p> <p><b>FCC (FCC Designation No.: CN1187)</b> UL Verification Services (Guangzhou) Co., Ltd. Song Shan Lake Branch. Has been recognized to perform compliance testing on equipment subject to the Commission's Delcaration of Conformity (DoC) and Certification rules</p> <p><b>ISED (Company No.: 21320)</b> UL Verification Services (Guangzhou) Co., Ltd. Song Shan Lake Branch. has been registered and fully described in a report filed with ISED. The Company Number is 21320.</p> <p><b>VCCI (Registration No.: G-20019, R-20004, C-20012 and T-20011)</b> UL Verification Services (Guangzhou) Co., Ltd. Song Shan Lake Branch. has been assessed and proved to be in compliance with VCCI, the Membership No. is 3793. Facility Name: Chamber D, the VCCI registration No. is G-20019 and R-20004 Shielding Room B , the VCCI registration No. is C-20012 and T-20011</p>
---------------------------	--

Note 1: All tests measurement facilities use to collect the measurement data are located at Building 10, Innovation Technology Park, Song Shan Lake Hi tech Development Zone, Dongguan, 523808, China

Note 2: The test anechoic chamber in UL Verification Services (Guangzhou) Co., Ltd. Song Shan Lake Branch had been calibrated and compared to the open field sites and the test anechoic chamber is shown to be equivalent to or worst case from the open field site.

Note 3: For below 30 MHz, lab had performed measurements at test anechoic chamber and comparing to measurements obtained on an open field site. And these measurements below 30 MHz had been correlated to measurements performed on an OFS.



## 4. CALIBRATION AND UNCERTAINTY

### 4.1. MEASURING INSTRUMENT CALIBRATION

The measuring equipment utilized to perform the tests documented in this report has been calibrated in accordance with the manufacturer's recommendations and is traceable to recognize national standards.

### 4.2. MEASUREMENT UNCERTAINTY

Where relevant, the following measurement uncertainty levels have been estimated for tests performed on the apparatus:

Test Item	Uncertainty
Conduction emission	3.62 dB
Radiated Emission (Included Fundamental Emission) (9 kHz ~ 30 MHz)	2.2 dB
Radiated Emission (Included Fundamental Emission) (30 MHz ~ 1 GHz)	4.00 dB
Radiated Emission (Included Fundamental Emission) (1 GHz to 26 GHz)	5.78 dB (1 GHz ~ 18 GHz)
	5.23 dB (18 GHz ~ 26 GHz)

Note: This uncertainty represents an expanded uncertainty expressed at approximately the 95 % confidence level using a coverage factor of k=2.



## 5. EQUIPMENT UNDER TEST

### 5.1. DESCRIPTION OF EUT

EUT Name	True Wireless Headphones	
Model	TW10	
Technology	Bluetooth - Low Energy	
Transmit Frequency Range	2402 MHz ~ 2480 MHz	
Modulation	GFSK	
Data Rate	LE	1Mbps
Power Supply	Battery	DC 3.7V

### 5.2. CHANNEL LIST

Channel	Frequency (MHz)	Channel	Frequency (MHz)	Channel	Frequency (MHz)	Channel	Frequency (MHz)
0	2402	11	2424	22	2446	33	2468
1	2404	12	2426	23	2448	34	2470
2	2406	13	2428	24	2450	35	2472
3	2408	14	2430	25	2452	36	2474
4	2410	15	2432	26	2454	37	2476
5	2412	16	2434	27	2456	38	2478
6	2414	17	2436	28	2458	39	2480
7	2416	18	2438	29	2460	/	/
8	2418	19	2440	30	2462	/	/
9	2420	20	2442	31	2464	/	/
10	2422	21	2444	32	2468	/	/

### 5.3. MAXIMUM PEAK OUTPUT POWER

Test Mode	Frequency (MHz)	Channel Number	Maximum Peak Output Power (dBm)	Maximum EIRP (dBm)
BLE_1M	2402 ~ 2480	0-39[40]	-0.38	1.23

### 5.4. TEST CHANNEL CONFIGURATION

Test Mode	Test Channel	Frequency
BLE_1M	CH 0(Low Channel), CH 19(MID Channel), CH 39(High Channel)	2402 MHz, 2440 MHz, 2480 MHz



## 5.5. THE WORSE CASE POWER SETTING PARAMETER

The Worst Case Power Setting Parameter under 2400 ~ 2483.5MHz Band				
Test Software Version		BQB Test Tool		
Test Mode	Transmit Antenna Number	Test Software setting value		
		CH 0	CH 19	CH 39
BLE_1M	1	default	default	default

## 5.6. DESCRIPTION OF AVAILABLE ANTENNAS

Antenna	Frequency (MHz)	Antenna Type	MAX Antenna Gain (dBi)
1	2402-2480	FPC	1.61

Test Mode	Transmit and Receive Mode	Description
BLE_1M	<input checked="" type="checkbox"/> 1TX, 1RX	Antenna 1 can be used as transmitting/receiving antenna.

Note: The value of the antenna gain was declared by customer.

## 5.7. DESCRIPTION OF TEST SETUP

### SUPPORT EQUIPMENT

Item	Equipment	Brand Name	Model Name	Remarks
1	Laptop	Lenovo	TP00094A	/
2	UART	/	/	/
3	Adapter	SAMSUNG	ETA0U83CBC	5Vdc,1A

### I/O CABLES

Cable No	Port	Connector Type	Cable Type	Cable Length(m)	Remarks
1	USB	TYPE C	/	1.0	/
2	USB	USB Type-C	USB cable	0.2	/

Note: Cable#2 provide by manufacturer.

### ACCESSORY

Item	Accessory	Brand Name	Model Name	Description
/	/	/	/	/

### TEST SETUP

The EUT can work in engineering mode with a software through Laptop.

### SETUP DIAGRAM FOR TESTS

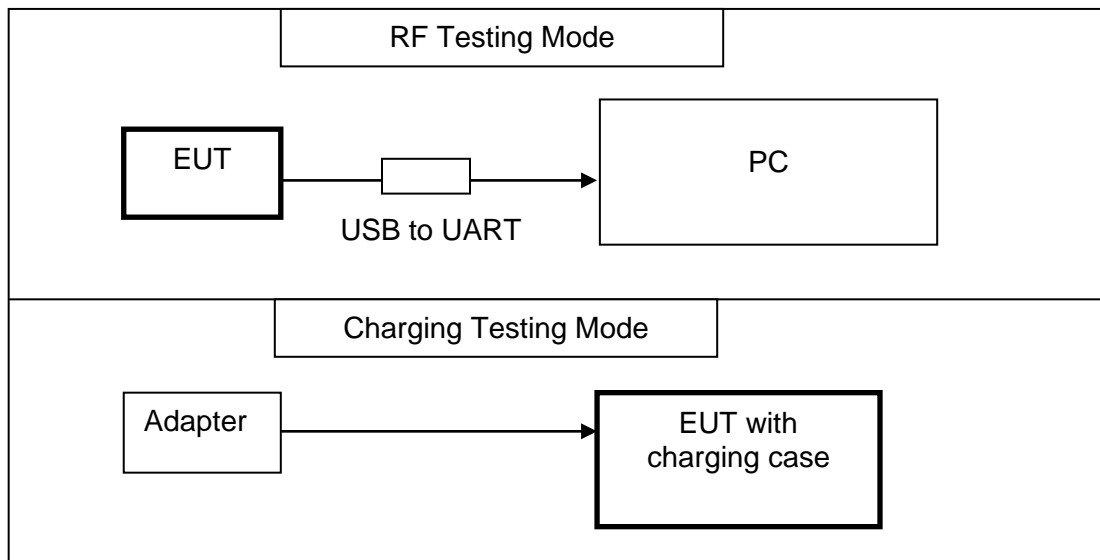

**5.8. MEASURING INSTRUMENT AND SOFTWARE USED**

Conducted Emissions						
Instrument						
Used	Equipment	Manufacturer	Model No.	Serial No.	Last Cal.	Next Cal.
<input checked="" type="checkbox"/>	EMI Test Receiver	R&S	ESR3	101961	Dec.05,2019	Dec.05,2020
<input checked="" type="checkbox"/>	Two-Line V-Network	R&S	ENV216	101983	Dec.05,2019	Dec.05,2020
Software						
Used	Description	Manufacturer	Name	Version		
<input checked="" type="checkbox"/>	Test Software for Conducted disturbance	Farad	EZ-EMC	Ver. UL-3A1		
Radiated Emissions						
Instrument						
Used	Equipment	Manufacturer	Model No.	Serial No.	Last Cal.	Next Cal.
<input checked="" type="checkbox"/>	MXE EMI Receiver	KESIGHT	N9038A	MY56400036	Dec.06,2019	Dec.06,2020
<input checked="" type="checkbox"/>	Hybrid Log Periodic Antenna	TDK	HLP-3003C	130960	Sep.17, 2018	Sep.17, 2021
<input checked="" type="checkbox"/>	Preamplifier	HP	8447D	2944A09099	Dec.05,2019	Dec.05,2020
<input checked="" type="checkbox"/>	EMI Measurement Receiver	R&S	ESR26	101377	Dec.05,2019	Dec.05,2020
<input checked="" type="checkbox"/>	Horn Antenna	TDK	HRN-0118	130939	Sep.17, 2018	Sep.17, 2021
<input checked="" type="checkbox"/>	High Gain Horn Antenna	Schwarzbeck	BBHA-9170	691	Aug.11, 2018	Aug.11, 2021
<input checked="" type="checkbox"/>	Preamplifier	TDK	PA-02-0118	TRS-305-00066	Dec.05,2019	Dec.05,2020
<input checked="" type="checkbox"/>	Preamplifier	TDK	PA-02-2	TRS-307-00003	Dec.05,2019	Dec.05,2020
<input checked="" type="checkbox"/>	Loop antenna	Schwarzbeck	1519B	00008	Jan.07, 2019	Jan.07, 2022
<input checked="" type="checkbox"/>	Preamplifier	TDK	PA-02-001-3000	TRS-302-00050	Dec.5, 2019	Dec.5, 2020
<input checked="" type="checkbox"/>	High Pass Filter	Wi	WHKX10-2700-3000-18000-40SS	23	Dec.05,2019	Dec.05,2020
Software						
Used	Description	Manufacturer	Name	Version		
<input checked="" type="checkbox"/>	Test Software for Radiated disturbance	Farad	EZ-EMC	Ver. UL-3A1		



Other instruments						
Used	Equipment	Manufacturer	Model No.	Serial No.	Last Cal.	Next Cal.
<input checked="" type="checkbox"/>	Spectrum Analyzer	Keysight	N9030A	MY55410512	Dec.06,2019	Dec.06,2020
<input checked="" type="checkbox"/>	Spectrum Analyzer	Keysight	N9020A	MY49100060	Dec.06,2019	Dec.06,2020
<input checked="" type="checkbox"/>	Power Meter	Keysight	N1911A	MY55416024	Dec.06,2019	Dec.06,2020
<input checked="" type="checkbox"/>	Power Sensor	Keysight	U2021XA	MY5100022	Dec.06,2019	Dec.06,2020

## 6. ANTENNA PORT TEST RESULTS

### 6.1. ON TIME AND DUTY CYCLE

#### LIMITS

None; for reporting purposes only.

#### PROCEDURE

Refer to ANSI C63.10-2013 clause 11.6 Zero – Span Spectrum Analyzer method.

#### TEST SETUP

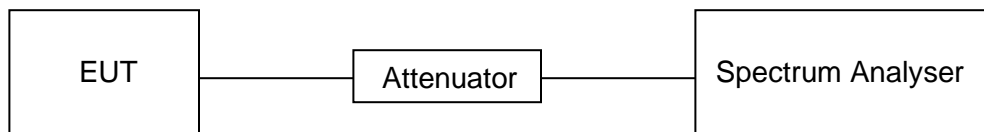

#### TEST ENVIRONMENT

Temperature	25.2 °C	Relative Humidity	65.5 %
Atmosphere Pressure	101 kPa	Test Voltage	DC 3.7 V

#### RESULTS

Please refer to appendix G.

## 6.2. 6 dB DTS BANDWIDTH AND 99 % OCCUPIED BANDWIDTH

### LIMITS

CFR 47FCC Part15 (15.247) Subpart C ISED RSS-247 ISSUE 2			
Section	Test Item	Limit	Frequency Range (MHz)
CFR 47 FCC 15.247(a)(2) ISED RSS-247 5.2 (a)	6dB Bandwidth	≥ 500 kHz	2400-2483.5
ISED RSS-Gen Clause 6.7	99 % Occupied Bandwidth	None; for reporting purposes only.	2400-2483.5

### TEST PROCEDURE

Refer to ANSI C63.10-2013 clause 11.8 for DTS bandwidth and clause 6.9 for Occupied Bandwidth.

Connect the EUT to the spectrum analyser and use the following settings:

Center Frequency	The center frequency of the channel under test
Frequency Span	Between 1.5 times and 5.0 times the OBW
Detector	Peak
RBW	For 6 dB Bandwidth: 100 kHz For 99 % Occupied Bandwidth: 1 % to 5 % of the occupied bandwidth
VBW	For 6 dB Bandwidth: ≥3 × RBW For 99 % Occupied Bandwidth: ≥3 × RBW
Trace	Max hold
Sweep	Auto couple

a) Use the 99 % power bandwidth function of the instrument, allow the trace to stabilize and report the measured bandwidth.

b) Allow the trace to stabilize and measure the maximum width of the emission that is constrained by the frequencies associated with the two outermost amplitude points (upper and lower frequencies) that are attenuated by 6 dB relative to the maximum level measured in the fundamental emission.

### TEST SETUP

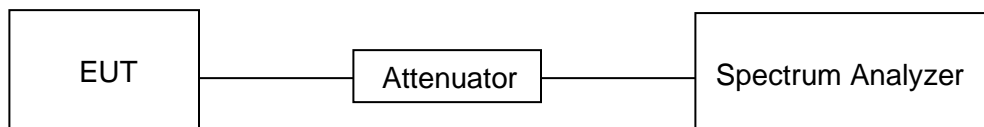



**TEST ENVIRONMENT**

Temperature	25.2 °C	Relative Humidity	65.5 %
Atmosphere Pressure	101 kPa	Test Voltage	DC 3.7 V

**RESULTS**

Please refer to appendix A & B.



### 6.3. CONDUCTED OUTPUT POWER

#### LIMITS

CFR 47 FCC Part15 (15.247) Subpart C ISED RSS-247 ISSUE 2			
Section	Test Item	Limit	Frequency Range (MHz)
CFR 47 FCC 15.247(b)(3) ISED RSS-247 5.4 (d)	Peak Conducted Output Power	1 watt or 30 dBm	2400-2483.5

#### TEST PROCEDURE

Connect the EUT to a low loss RF cable from the antenna port to the power sensor (video bandwidth is greater than the occupied bandwidth). Measure peak emission level, the indicated level is the peak output power, after any corrections for external attenuators and cables.

#### TEST SETUP

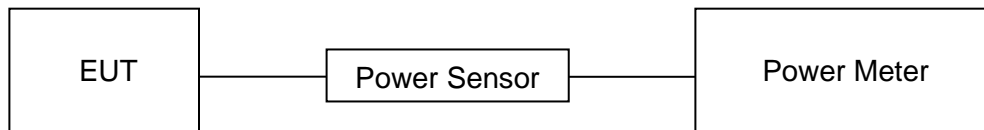

#### TEST ENVIRONMENT

Temperature	25.2 °C	Relative Humidity	65.5 %
Atmosphere Pressure	101 kPa	Test Voltage	DC 3.7 V

#### RESULTS

Please refer to appendix C.

## 6.4. POWER SPECTRAL DENSITY

### LIMITS

CFR 47 FCC Part15 (15.247) Subpart C ISED RSS-247 ISSUE 2			
Section	Test Item	Limit	Frequency Range (MHz)
CFR 47 FCC §15.247 (e) ISED RSS-247 5.2 (b)	Power Spectral Density	8 dBm in any 3 kHz band	2400-2483.5

### TEST PROCEDURE

Refer to ANSI C63.10-2013 clause 11.10.

Connect the EUT to the spectrum analyser and use the following settings:

Center Frequency	The center frequency of the channel under test
Detector	Peak
RBW	$3 \text{ kHz} \leq \text{RBW} \leq 100 \text{ kHz}$
VBW	$\geq 3 \times \text{RBW}$
Span	1.5 x DTS bandwidth
Trace	Max hold
Sweep time	Auto couple

Allow trace to fully stabilize and use the peak marker function to determine the maximum amplitude level within the RBW.

If measured value exceeds limit, reduce RBW (no less than 3 kHz) and repeat.

### TEST SETUP

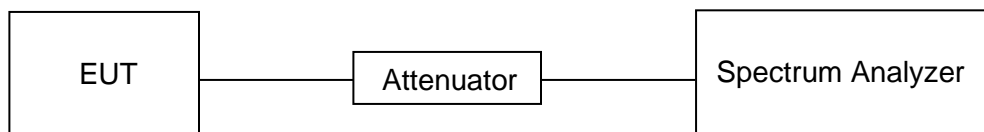

### TEST ENVIRONMENT

Temperature	25.2 °C	Relative Humidity	65.5 %
Atmosphere Pressure	101 kPa	Test Voltage	DC 3.7 V



**RESULTS**

Please refer to appendix D.

## 6.5. CONDUCTED BANDEGE AND SPURIOUS EMISSIONS

### LIMITS

CFR 47 FCC Part15 (15.247) Subpart C ISED RSS-247 ISSUE 2		
Section	Test Item	Limit
CFR 47 FCC §15.247 (d) ISED RSS-247 5.5	Conducted Bandedge and Spurious Emissions	at least 20 dB below that in the 100 kHz bandwidth within the band that contains the highest level of the desired power

### TEST PROCEDURE

Refer to ANSI C63.10-2013 clause 11.11 and 11.13.

Connect the EUT to the spectrum analyser and use the following settings for reference level measurement:

Center Frequency	The center frequency of the channel under test
Detector	Peak
RBW	100 kHz
VBW	$\geq 3 \times \text{RBW}$
Span	1.5 x DTS bandwidth
Trace	Max hold
Sweep time	Auto couple.

Allow trace to fully stabilize and use the peak marker function to determine the maximum PSD level.

Change the settings for emission level measurement:

Span	Set the center frequency and span to encompass frequency range to be measured
Detector	Peak
RBW	100 kHz
VBW	$\geq 3 \times \text{RBW}$
measurement points	$\geq \text{span}/\text{RBW}$
Trace	Max hold
Sweep time	Auto couple.

Allow trace to fully stabilize and use the peak marker function to determine the maximum PSD level. Ensure that the amplitude of all unwanted emissions outside of the authorized frequency band (excluding restricted frequency bands) is attenuated by at least the minimum requirements specified in 11.11.



**TEST SETUP**

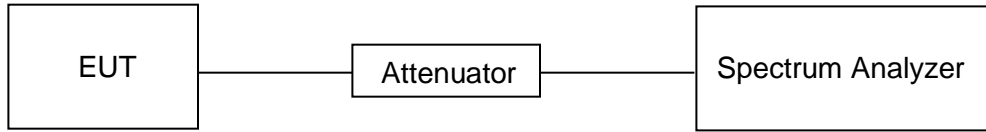

**TEST ENVIRONMENT**

Temperature	25.2 °C	Relative Humidity	65.5 %
Atmosphere Pressure	101 kPa	Test Voltage	DC 3.7 V

**RESULTS**

Please refer to appendix F & E.

## 7. RADIATED TEST RESULTS

### LIMITS

Please refer to CFR 47 FCC §15.205 and §15.209.

Please refer to ISED RSS-GEN Clause 8.9 and Clause 8.10.

Radiation Disturbance Test Limit for FCC (Class B) (9 kHz-1 GHz)

Emissions radiated outside of the specified frequency bands above 30 MHz			
Frequency Range (MHz)	Field Strength Limit (uV/m) at 3 m	Field Strength Limit (dBuV/m) at 3 m	
		Quasi-Peak	
30 - 88	100	40	
88 - 216	150	43.5	
216 - 960	200	46	
Above 960	500	54	
Above 1000	500	Peak	Average
		74	54

FCC Emissions radiated outside of the specified frequency bands below 30 MHz		
Frequency (MHz)	Field strength (microvolts/meter)	Measurement distance (meters)
0.009-0.490	2400/F(kHz)	300
0.490-1.705	24000/F(kHz)	30
1.705-30.0	30	30

ISED General field strength limits at frequencies below 30 MHz

Table 6 – General field strength limits at frequencies below 30 MHz		
Frequency	Magnetic field strength (H-Field) (µA/m)	Measurement distance (m)
9 - 490 kHz <sup>Note 1</sup>	6.37/F (F in kHz)	300
490 - 1705 kHz	63.7/F (F in kHz)	30
1.705 - 30 MHz	0.08	30

**Note 1:** The emission limits for the ranges 9-90 kHz and 110-490 kHz are based on measurements employing a linear average detector.



ISED Restricted bands please refer to ISED RSS-GEN Clause 8.10

**Table 7 – Restricted frequency bands<sup>note 1</sup>**

MHz	MHz	GHz
0.090 - 0.110	149.9 - 150.05	9.0 - 9.2
0.495 - 0.505	156.52475 - 156.52525	9.3 - 9.5
2.1735 - 2.1905	156.7 - 156.9	10.6 - 12.7
3.020 - 3.026	162.0125 - 167.17	13.25 - 13.4
4.125 - 4.128	167.72 - 173.2	14.47 - 14.5
4.17725 - 4.17775	240 - 285	15.35 - 16.2
4.20725 - 4.20775	322 - 335.4	17.7 - 21.4
5.677 - 5.683	399.9 - 410	22.01 - 23.12
6.215 - 6.218	608 - 614	23.6 - 24.0
6.26775 - 6.26825	960 - 1427	31.2 - 31.8
6.31175 - 6.31225	1435 - 1626.5	36.43 - 36.5
8.291 - 8.294	1645.5 - 1646.5	Above 38.6
8.362 - 8.366	1660 - 1710	
8.37625 - 8.38675	1718.8 - 1722.2	
8.41425 - 8.41475	2200 - 2300	
12.29 - 12.293	2310 - 2390	
12.51975 - 12.52025	2483.5 - 2500	
12.57675 - 12.57725	2655 - 2900	
13.36 - 13.41	3260 - 3267	
16.42 - 16.423	3332 - 3339	
16.80475 - 16.80525	3345.8 - 3358	
16.80425 - 16.80475	3500 - 4400	
25.5 - 25.67	4500 - 5150	
37.5 - 38.25	5350 - 5460	
73 - 74.6	7250 - 7750	
74.8 - 75.2	8025 - 8500	
108 - 138		

**Note 1:** Certain frequency bands listed in table 7 and in bands above 38.6 GHz are designated for licence-exempt applications. These frequency bands and the requirements that apply to related devices are set out in the 200 and 300 series of RSSs.

FCC Restricted bands of operation refer to FCC §15.205 (a):

MHz	MHz	MHz	GHz
0.090-0.110	16.42-16.423	399.9-410	4.5-5.15
<sup>1</sup> 0.495-0.505	16.69475-16.69525	608-614	5.35-5.46
2.1735-2.1905	16.80425-16.80475	960-1240	7.25-7.75
4.125-4.128	25.5-25.67	1300-1427	8.025-8.5
4.17725-4.17775	37.5-38.25	1435-1626.5	9.0-9.2
4.20725-4.20775	73-74.6	1645.5-1646.5	9.3-9.5
6.215-6.218	74.8-75.2	1660-1710	10.6-12.7
6.26775-6.26825	108-121.94	1718.8-1722.2	13.25-13.4
6.31175-6.31225	123-138	2200-2300	14.47-14.5
8.291-8.294	149.9-150.05	2310-2390	15.35-16.2
8.362-8.366	156.52475-156.52525	2483.5-2500	17.7-21.4
8.37625-8.38675	156.7-156.9	2690-2900	22.01-23.12
8.41425-8.41475	162.0125-167.17	3260-3267	23.6-24.0
12.29-12.293	167.72-173.2	3332-3339	31.2-31.8
12.51975-12.52025	240-285	3345.8-3358	36.43-36.5
12.57675-12.57725	322-335.4	3600-4400	( <sup>2</sup> )
13.36-13.41			

Note: <sup>1</sup>Until February 1, 1999, this restricted band shall be 0.490-0.510 MHz.

<sup>2</sup>Above 38.6c

**TEST SETUP AND PROCEDURE**

Below 30MHz

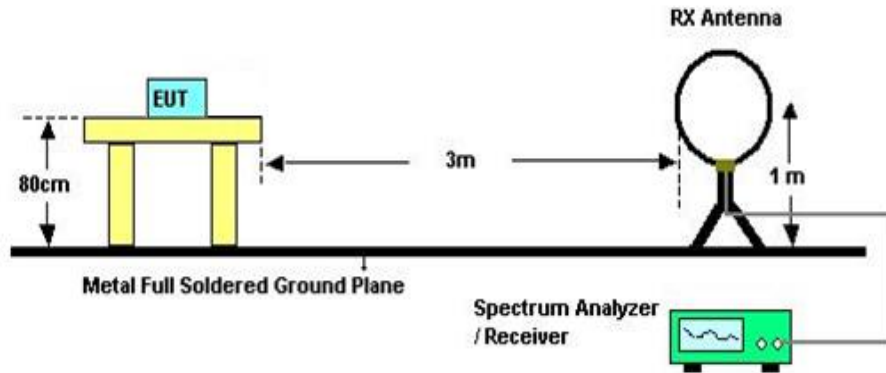

The setting of the spectrum analyser

RBW	200 Hz (From 9 kHz to 0.15 MHz)/ 9 kHz (From 0.15 MHz to 30 MHz)
VBW	200 Hz (From 9 kHz to 0.15 MHz)/ 9 kHz (From 0.15 MHz to 30 MHz)
Sweep	Auto
Trace	Max hold

1. The testing follows the guidelines in ANSI C63.10-2013 clause 6.4.
2. The EUT was arranged to its worst case and then turntable (from 0 degree to 360 degrees) to find the maximum reading. A pre-amp and a high pass filter are used for the test in order to get better signal level. Both Horizontal, Face-on and Face-off polarizations of the antenna are set to make the measurement.
3. The EUT was placed on a turntable with 80 cm above ground.
4. The EUT was set 3 meters from the interference receiving antenna, which was mounted on the top of a 1 m height antenna tower.
5. The radiated emission limits are based on measurements employing a CISPR quasi-peak detector except for the frequency bands 9-90 kHz, 110-490 kHz and above 1000 MHz. Radiated emission limits in these three bands are based on measurements employing an average detector.
6. For measurement below 1 GHz, the initial step in collecting conducted emission data is a spectrum analyzer peak detector mode pre-scanning the measurement frequency range. Significant peaks are then marked and then Quasi Peak and average detector mode re-measured. If the emission level of the EUT measured by the peak detector is 3 dB lower than the applicable limit, the peak emission level will be reported. Otherwise, the emission measurement will be repeated using the quasi-peak and average detector and reported.
7. Although these tests were performed other than open field site, adequate comparison measurements were confirmed against 30m open field site. Therefore sufficient tests were made to demonstrate that the alternative site produces results that correlate with the ones of tests made in an open field site based on KDB 414788.



Below 1GHz and above 30 MHz

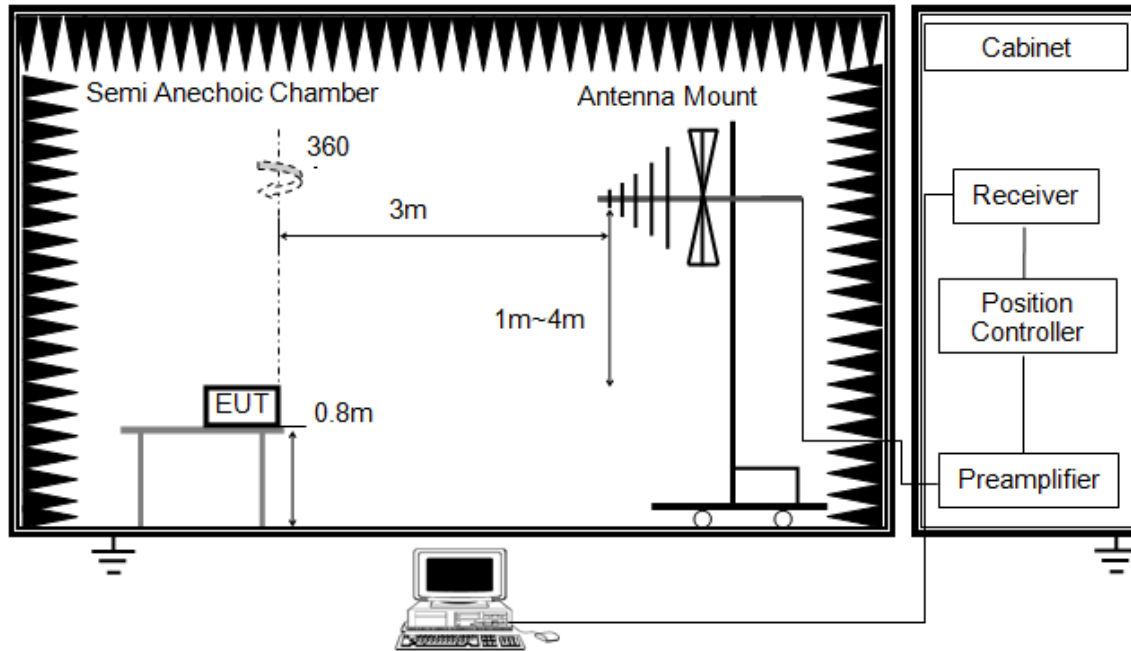

The setting of the spectrum analyser

RBW	120 kHz
VBW	300 kHz
Sweep	Auto
Detector	Peak/QP
Trace	Max hold

1. The testing follows the guidelines in ANSI C63.10-2013 clause 6.5.
2. The EUT was arranged to its worst case and then tune the antenna tower (from 1 m to 4 m) and turntable (from 0 degree to 360 degrees) to find the maximum reading. A pre-amp and a high pass filter are used for the test in order to get better signal level. Both horizontal and vertical polarizations of the antenna are set to make the measurement.
3. The EUT was placed on a turntable with 80 cm above ground.
4. The EUT was set 3 meters from the interference receiving antenna, which was mounted on the top of a variable height antenna tower.
5. For measurement below 1 GHz, the initial step in collecting conducted emission data is a spectrum analyzer peak detector mode pre-scanning the measurement frequency range. Significant peaks are then marked and then Quasi Peak detector mode re-measured. If the emission level of the EUT measured by the peak detector is 3 dB lower than the applicable limit, the peak emission level will be reported. Otherwise, the emission measurement will be repeated using the quasi-peak detector and reported.

Above 1G

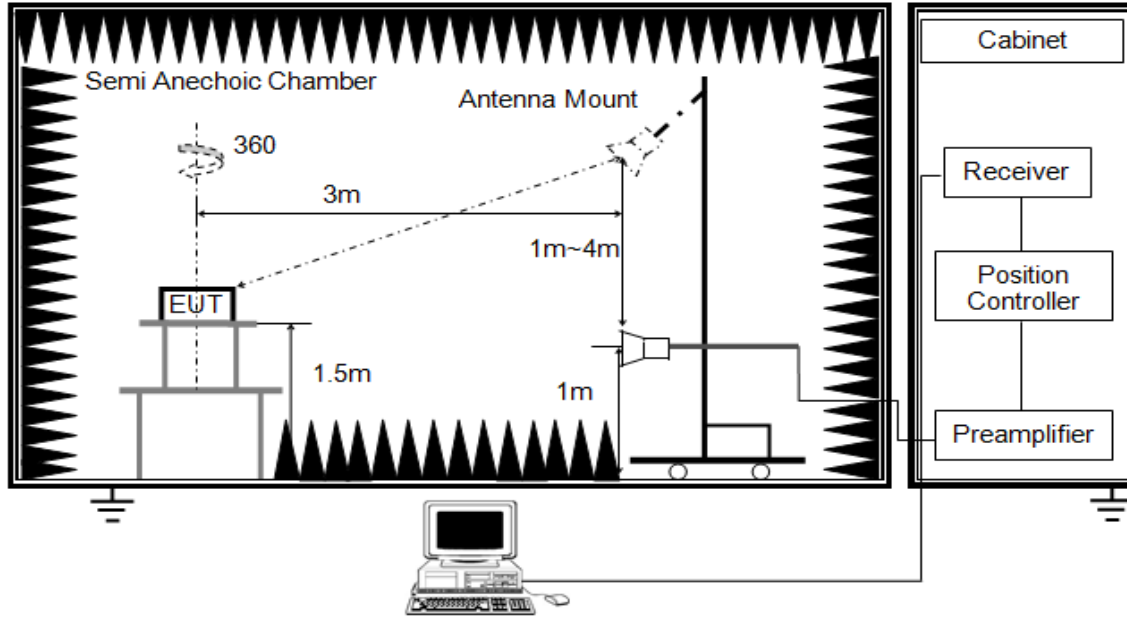

The setting of the spectrum analyser

RBW	1 MHz
VBW	PEAK: 3 MHz AVG: see note 6
Sweep	Auto
Detector	Peak
Trace	Max hold

1. The testing follows the guidelines in ANSI C63.10-2013 clause 6.6.
2. The EUT was arranged to its worst case and then tune the antenna tower (1.5 m) and turntable (from 0 degree to 360 degrees) to find the maximum reading. A pre-amp and a high pass filter are used for the test in order to get better signal level. Both horizontal and vertical polarizations of the antenna are set to make the measurement.
3. The EUT was placed on a turntable with 1.5 m above ground.
4. The EUT was set 3 meters from the interference receiving antenna, which was mounted on the top of a variable height antenna tower.
5. For measurement above 1 GHz, the emission measurement will be measured by the peak detector. This peak level, once corrected, must comply with the limit specified in Section 15.209.
6. For measurements above 1 GHz the resolution bandwidth is set to 1 MHz, then the video bandwidth is set to 3 MHz for peak measurements and 1 MHz resolution bandwidth with 1/T video bandwidth with peak detector for average measurements. For the Duty Cycle please refer to clause 7.1.ON TIME AND DUTY CYCLE.

X axis, Y axis, Z axis positions:

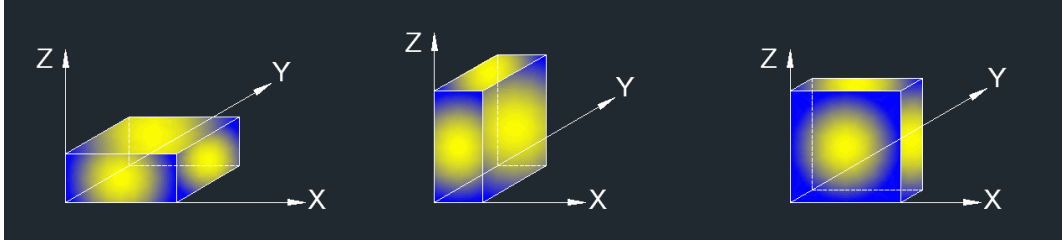

Note 1: For all radiated test, EUT in each of three orthogonal axis emissions had been tested, but only the worst case (X axis) data recorded in the report.

Note 2: The EUT was fully exercised with external accessories during the test. In the case of multiple accessory external ports, an external accessory shall be connected to one of each type of port.

**TEST ENVIRONMENT**

Temperature	24.4 °C	Relative Humidity	57.4 %
Atmosphere Pressure	101 kPa	Test Voltage	DC 3.7 V

**RESULTS**

## 7.1. RESTRICTED BANDEDGE

### 7.1.1. LE 1M MODE

#### RESTRICTED BANDEDGE (LOW CHANNEL, HORIZONTAL)

#### PEAK

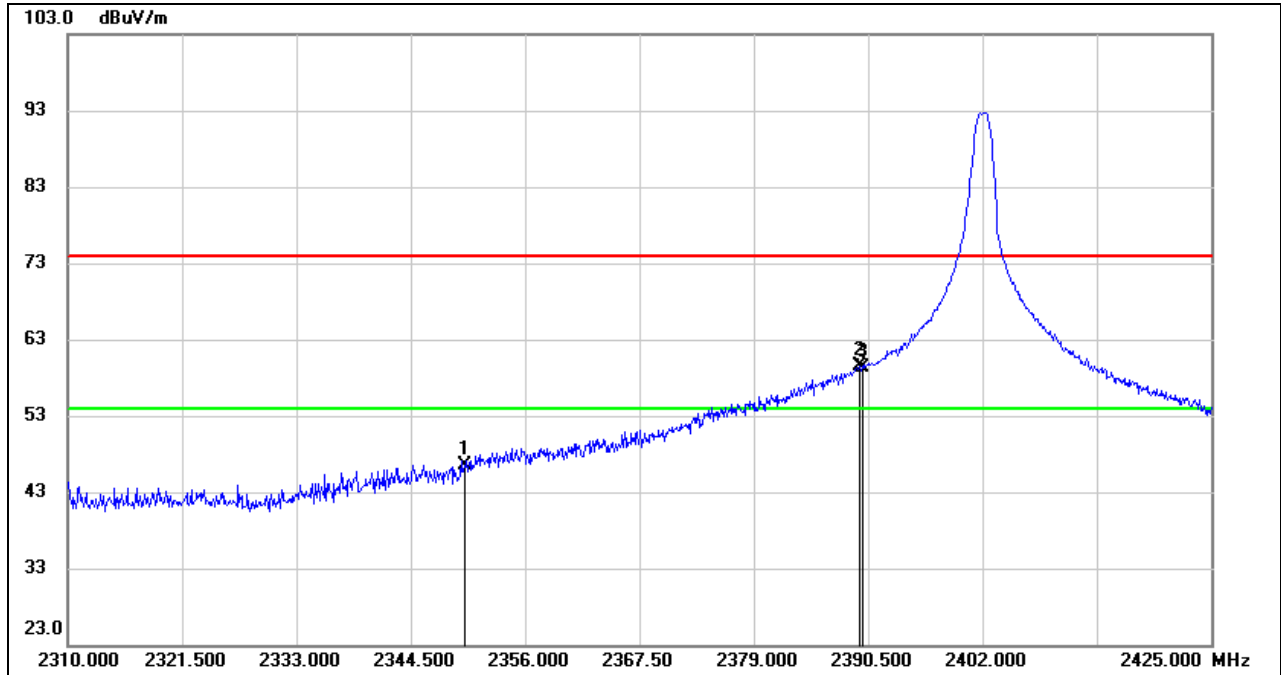

No.	Frequency (MHz)	Reading (dBuV)	Correct (dB/m)	Result (dBuV/m)	Limit (dBuV/m)	Margin (dB)	Remark
1	2349.905	34.73	11.68	46.41	74.00	-27.59	peak
2	2389.695	47.57	11.96	59.53	74.00	-14.47	peak
3	2390.000	47.28	11.96	59.24	74.00	-14.76	peak

- Note: 1. Measurement = Reading Level + Correct Factor.  
 2. If Peak Result complies with AV limit, AV Result is deemed to comply with AV limit.  
 3. Peak: Peak detector.  
 4. Only the worst data was recorded, if it complies with the limit, the other emissions deemed to comply with the limit.

**AVG**

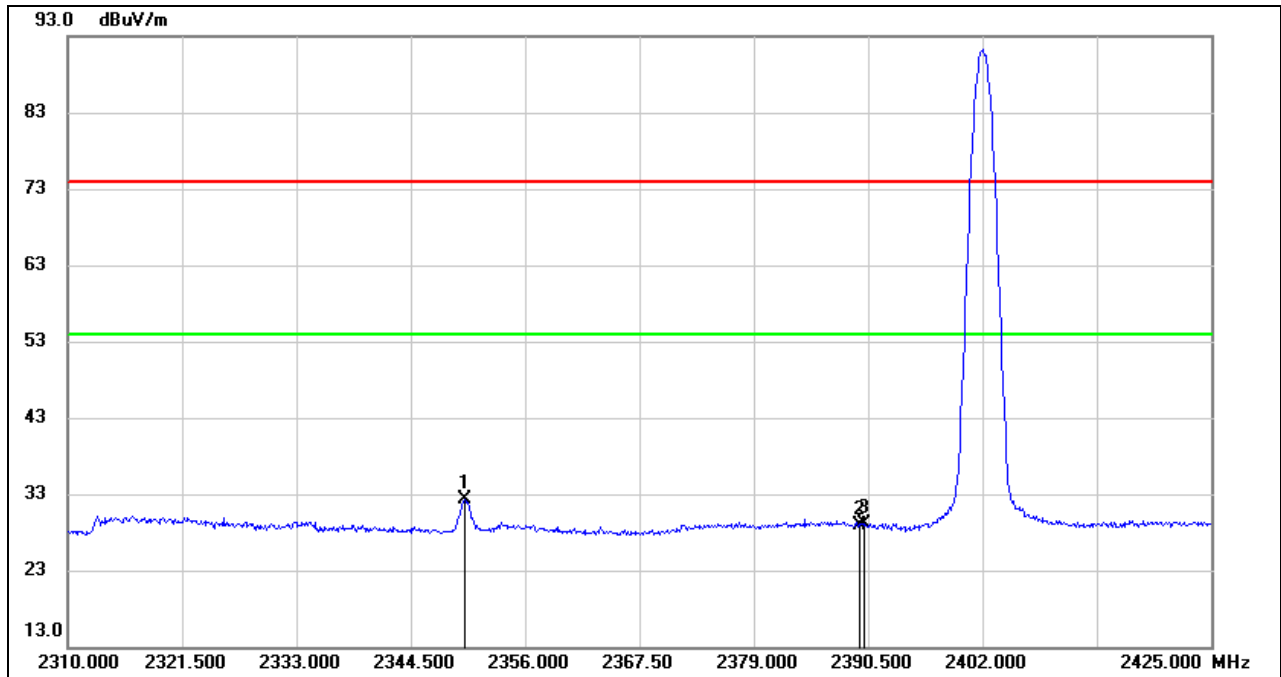

No.	Frequency (MHz)	Reading (dBuV)	Correct (dB/m)	Result (dBuV/m)	Limit (dBuV/m)	Margin (dB)	Remark
1	2349.905	20.53	11.68	32.21	54.00	-21.79	AVG
2	2389.695	16.96	11.96	28.92	54.00	-25.08	AVG
3	2390.000	17.22	11.96	29.18	54.00	-24.82	AVG

- Note: 1. Measurement = Reading Level + Correct Factor.  
 2. If Peak Result complies with AV limit, AV Result is deemed to comply with AV limit.  
 3. Peak: Peak detector.  
 4. AVG:  $VBW=1/T_{on}$ , where:  $T_{on}$  is the transmitting duration.  
 5. For the transmitting duration, please refer to clause 7.1.  
 6. Only the worst data was recorded, if it complies with the limit, the other emissions deemed to comply with the limit.



**RESTRICTED BANDEDGE (LOW CHANNEL, VERTICAL)**

**PEAK**

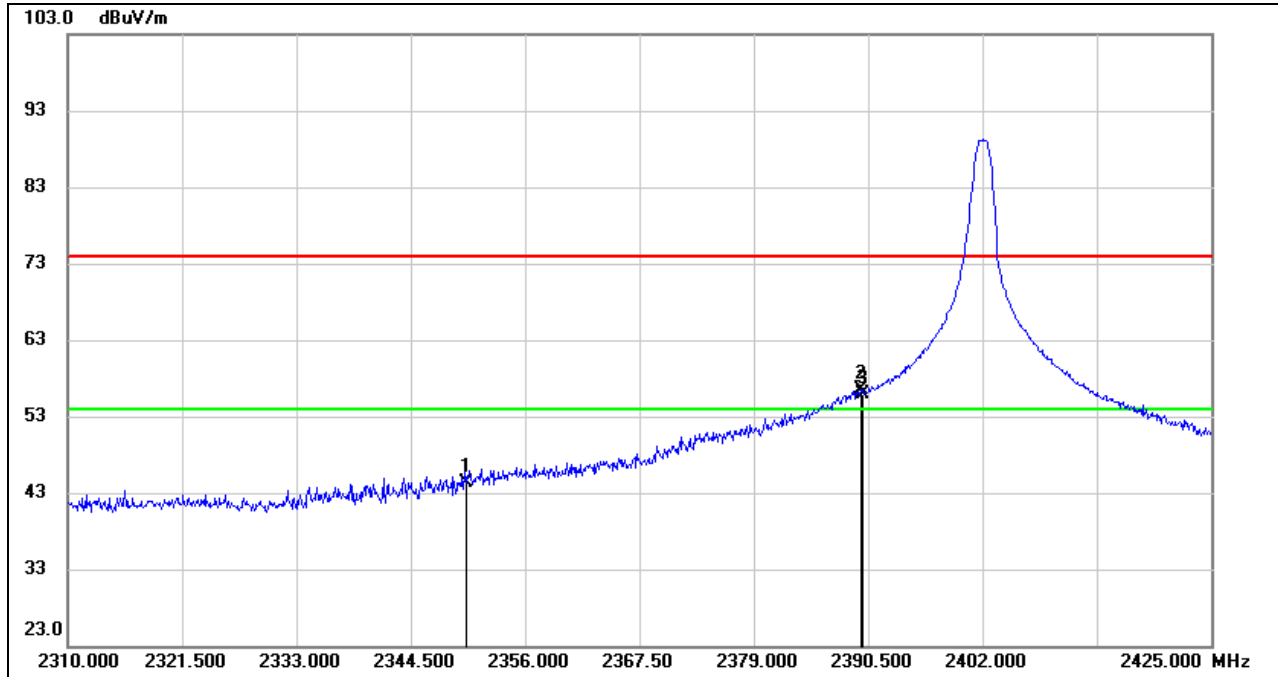

No.	Frequency (MHz)	Reading (dBuV)	Correct (dB/m)	Result (dBuV/m)	Limit (dBuV/m)	Margin (dB)	Remark
1	2350.020	32.57	11.68	44.25	74.00	-29.75	peak
2	2389.810	44.62	11.96	56.58	74.00	-17.42	peak
3	2390.000	44.03	11.96	55.99	74.00	-18.01	peak

- Note: 1. Measurement = Reading Level + Correct Factor.  
 2. If Peak Result complies with AV limit, AV Result is deemed to comply with AV limit.  
 3. Peak: Peak detector.  
 4. Only the worst data was recorded, if it complies with the limit, the other emissions deemed to comply with the limit.



**AVG**

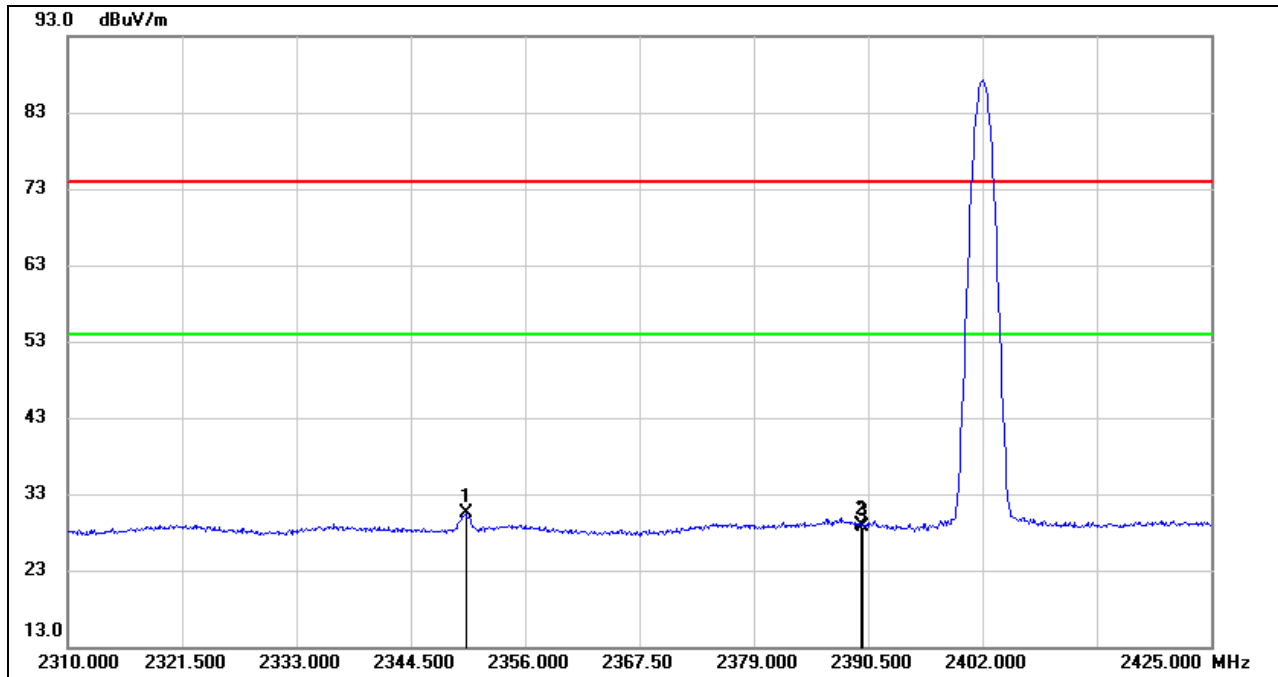

No.	Frequency (MHz)	Reading (dBuV)	Correct (dB/m)	Result (dBuV/m)	Limit (dBuV/m)	Margin (dB)	Remark
1	2350.020	18.79	11.68	30.47	54.00	-23.53	AVG
2	2389.810	16.88	11.96	28.84	54.00	-25.16	AVG
3	2390.000	16.80	11.96	28.76	54.00	-25.24	AVG

- Note: 1. Measurement = Reading Level + Correct Factor.  
 2. If Peak Result complies with AV limit, AV Result is deemed to comply with AV limit.  
 3. Peak: Peak detector.  
 4. AVG:  $VBW=1/Ton$ , where: Ton is the transmitting duration.  
 5. For the transmitting duration, please refer to clause 7.1.  
 6. Only the worst data was recorded, if it complies with the limit, the other emissions deemed to comply with the limit.



**RESTRICTED BANDEDGE (HIGH CHANNEL, HORIZONTAL)**  
**Peak**

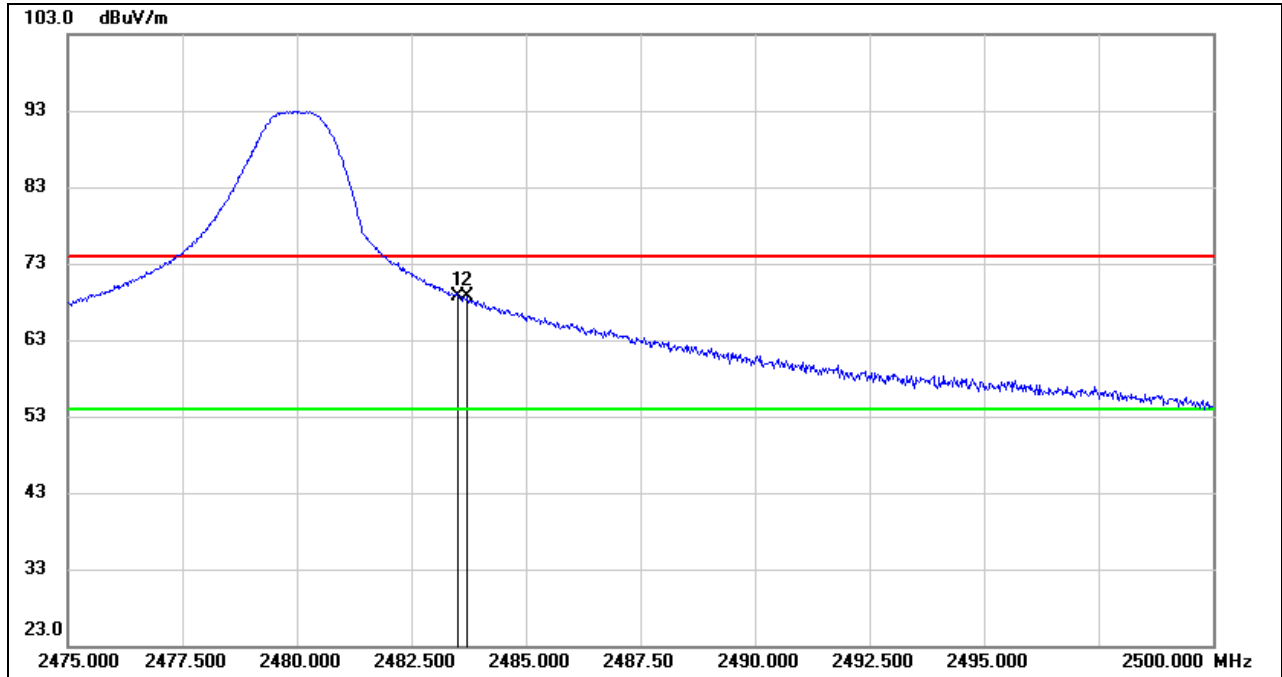

No.	Frequency (MHz)	Reading (dBuV)	Correct (dB/m)	Result (dBuV/m)	Limit (dBuV/m)	Margin (dB)	Remark
1	2483.500	56.30	12.38	68.68	74.00	-5.32	peak
2	2483.725	56.30	12.38	68.68	74.00	-5.32	peak

Note: 1. Measurement = Reading Level + Correct Factor.  
 2. If Peak Result complies with AV limit, AV Result is deemed to comply with AV limit.  
 3. Peak: Peak detector.  
 4. Only the worst data was recorded, if it complies with the limit, the other emissions deemed to comply with the limit.

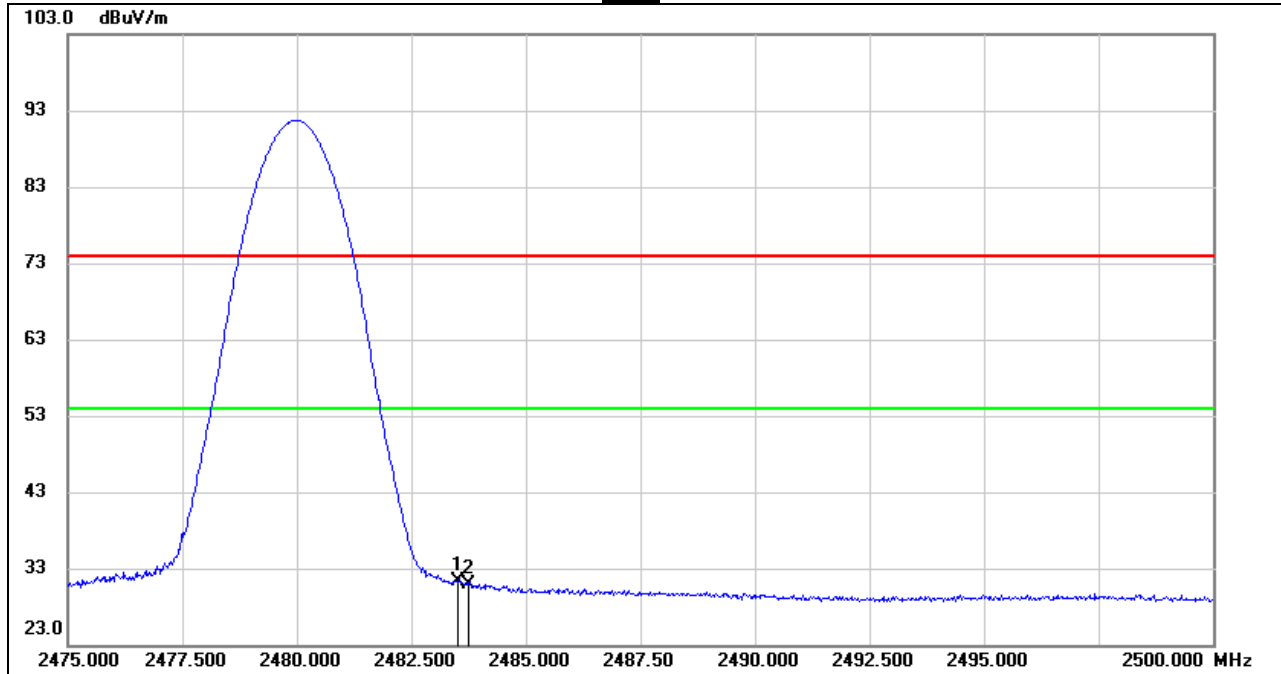

**AVG**

No.	Frequency (MHz)	Reading (dBuV)	Correct (dB/m)	Result (dBuV/m)	Limit (dBuV/m)	Margin (dB)	Remark
1	2483.500	18.83	12.38	31.21	54.00	-22.79	AVG
2	2483.725	18.59	12.38	30.97	54.00	-23.03	AVG

- Note:
1. Measurement = Reading Level + Correct Factor.
  2. If Peak Result complies with AV limit, AV Result is deemed to comply with AV limit.
  3. Peak: Peak detector.
  4. AVG:  $VBW=1/T_{on}$ , where:  $T_{on}$  is the transmitting duration.
  5. For the transmitting duration, please refer to clause 7.1.
  6. Only the worst data was recorded, if it complies with the limit, the other emissions deemed to comply with the limit.

**RESTRICTED BANDEDGE (HIGH CHANNEL, VERTICAL)**  
**PEAK**

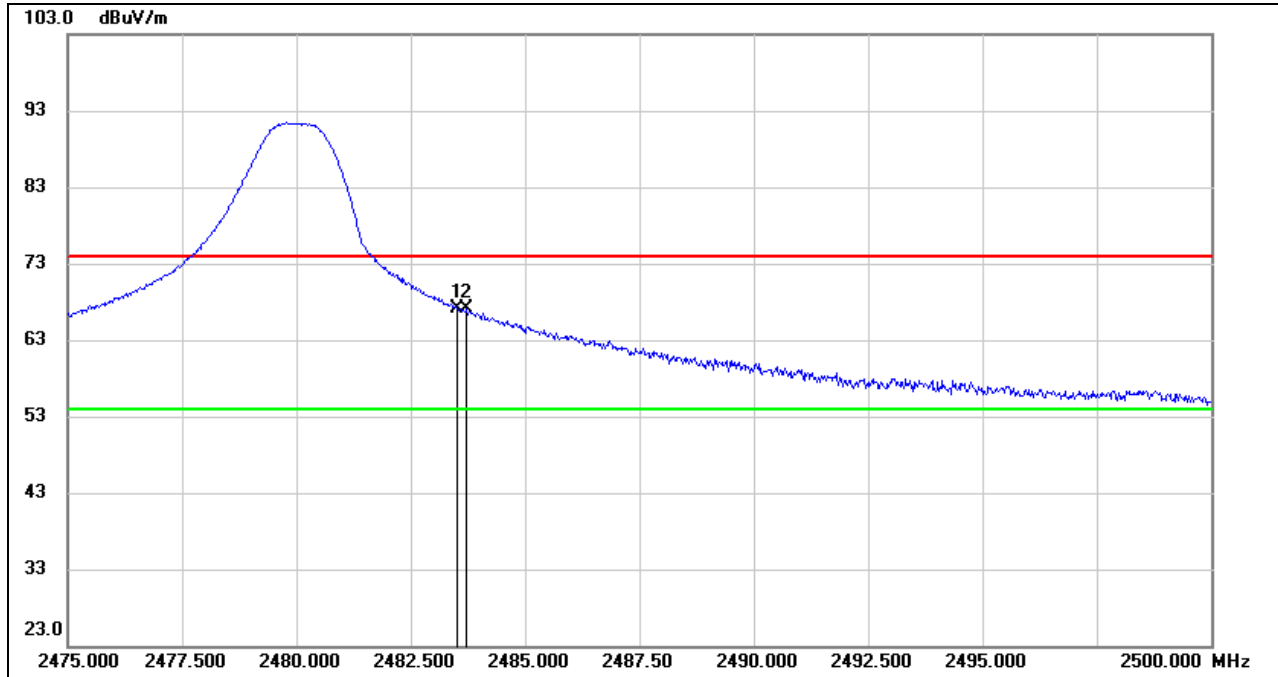

No.	Frequency (MHz)	Reading (dBuV)	Correct (dB/m)	Result (dBuV/m)	Limit (dBuV/m)	Margin (dB)	Remark
1	2483.500	54.80	12.38	67.18	74.00	-6.82	peak
2	2483.725	54.80	12.38	67.18	74.00	-6.82	peak

- Note: 1. Measurement = Reading Level + Correct Factor.  
 2. If Peak Result complies with AV limit, AV Result is deemed to comply with AV limit.  
 3. Peak: Peak detector.  
 4. Only the worst data was recorded, if it complies with the limit, the other emissions deemed to comply with the limit.

**AVG**

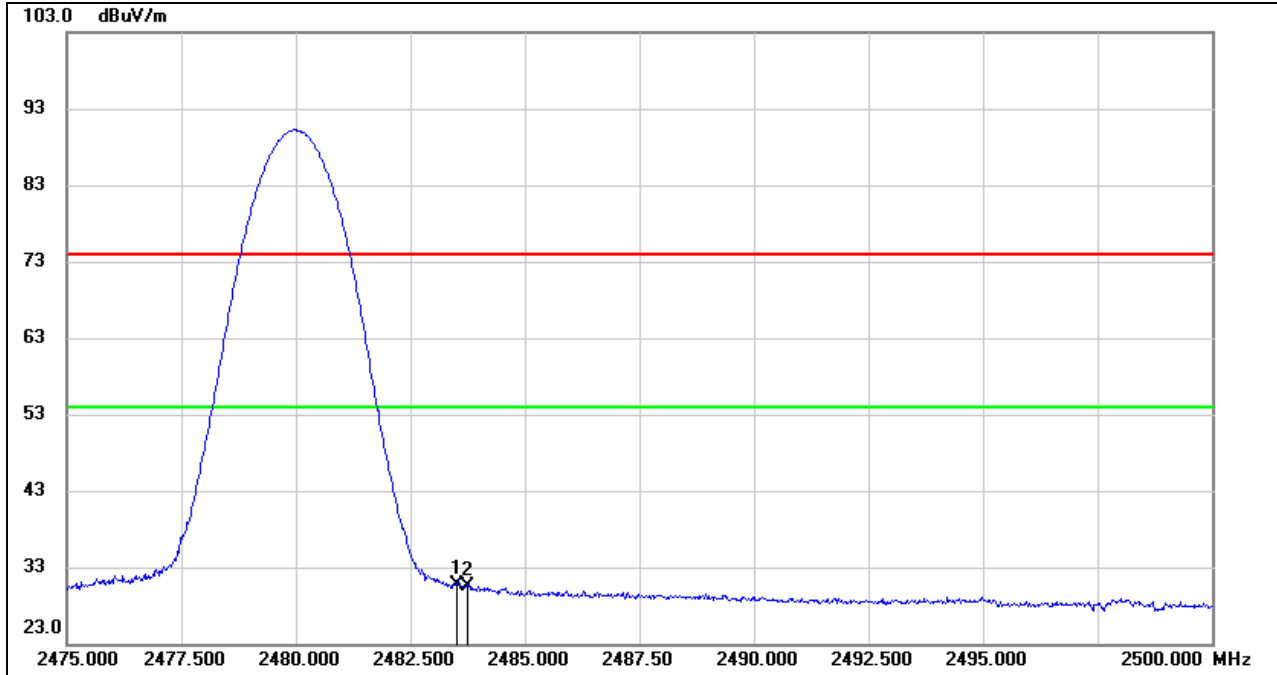

No.	Frequency (MHz)	Reading (dBuV)	Correct (dB/m)	Result (dBuV/m)	Limit (dBuV/m)	Margin (dB)	Remark
1	2483.500	18.33	12.38	30.71	54.00	-23.29	AVG
2	2483.725	18.09	12.38	30.47	54.00	-23.53	AVG

- Note:
1. Measurement = Reading Level + Correct Factor.
  2. If Peak Result complies with AV limit, AV Result is deemed to comply with AV limit.
  3. Peak: Peak detector.
  4. AVG:  $VBW=1/T_{on}$ , where:  $T_{on}$  is the transmitting duration.
  5. For the transmitting duration, please refer to clause 7.1.
  6. Only the worst data was recorded, if it complies with the limit, the other emissions deemed to comply with the limit.

## 7.2. SPURIOUS EMISSIONS (1 GHz ~ 3 GHz)

### 7.2.1. LE 1M MODE

#### HARMONICS AND SPURIOUS EMISSIONS (LOW CHANNEL, HORIZONTAL)

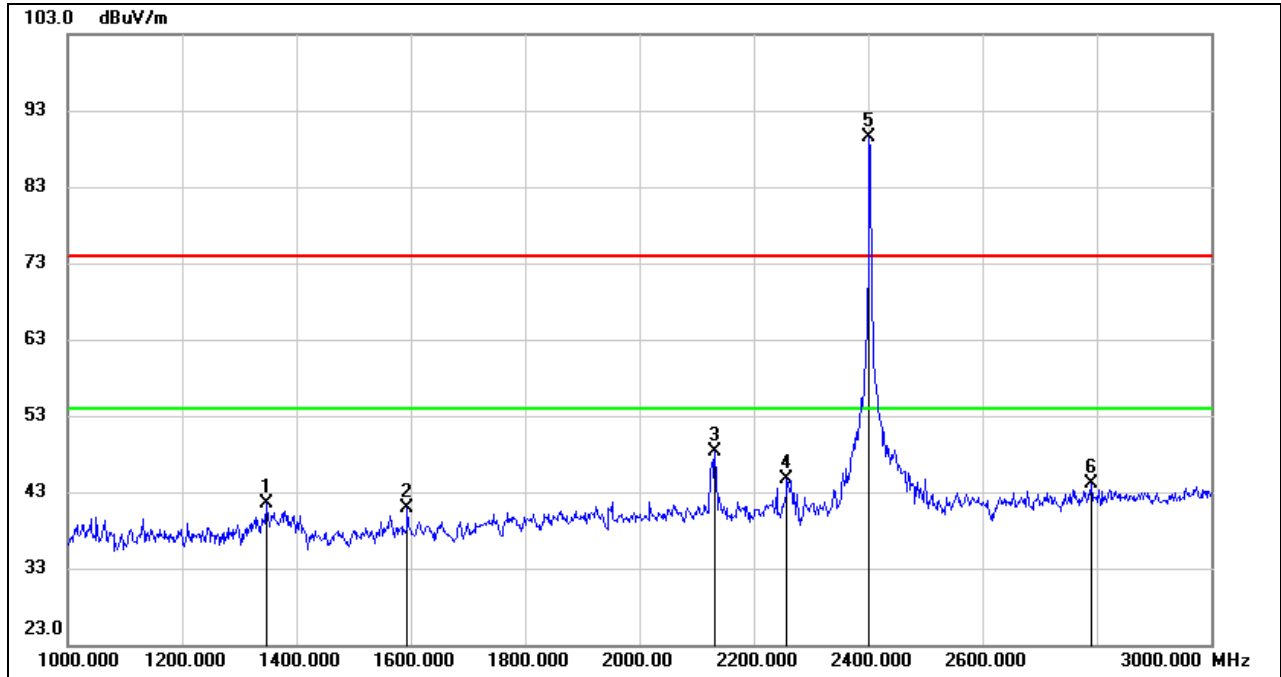

No.	Frequency (MHz)	Reading (dBuV)	Correct (dB/m)	Result (dBuV/m)	Limit (dBuV/m)	Margin (dB)	Remark
1	1348.000	34.78	6.65	41.43	74.00	-32.57	peak
2	1594.000	32.95	7.92	40.87	74.00	-33.13	peak
3	2132.000	37.13	11.13	48.26	74.00	-25.74	peak
4	2258.000	33.41	11.32	44.73	74.00	-29.27	peak
5	2402.000	77.43	12.03	89.46	/	/	fundamental
6	2790.000	30.46	13.68	44.14	74.00	-29.86	peak

- Note: 1. Peak Result = Reading Level + Correct Factor.  
 2. If Peak Result complies with AV limit, AV Result is deemed to comply with AV limit.  
 3. Peak: Peak detector.

**HARMONICS AND SPURIOUS EMISSIONS (LOW CHANNEL, VERTICAL)**

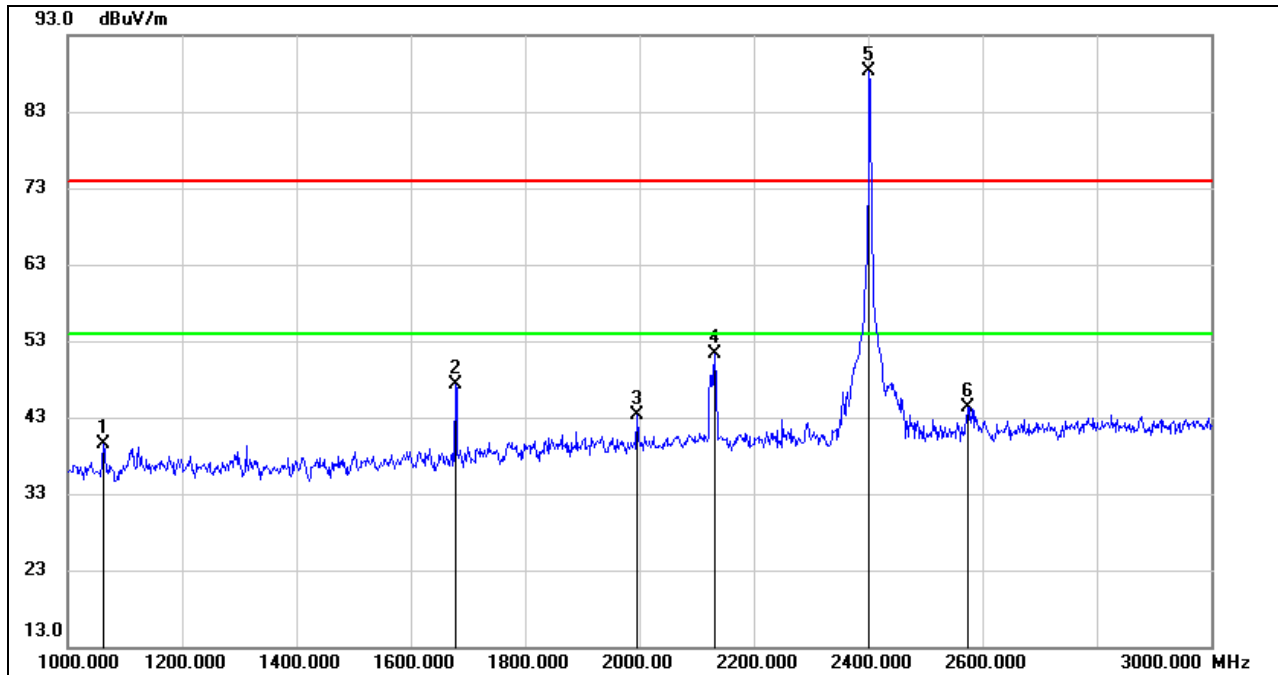

No.	Frequency (MHz)	Reading (dBuV)	Correct (dB/m)	Result (dBuV/m)	Limit (dBuV/m)	Margin (dB)	Remark
1	1062.000	34.42	5.14	39.56	74.00	-34.44	peak
2	1678.000	39.16	8.16	47.32	74.00	-26.68	peak
3	1996.000	33.03	10.24	43.27	74.00	-30.73	peak
4	2132.000	40.11	11.13	51.24	74.00	-22.76	peak
5	2402.000	76.28	12.03	88.31	/	/	fundamental
6	2574.000	31.86	12.42	44.28	74.00	-29.72	peak

Note: 1. Peak Result = Reading Level + Correct Factor.  
 2. If Peak Result complies with AV limit, AV Result is deemed to comply with AV limit.  
 3. Peak: Peak detector.

**HARMONICS AND SPURIOUS EMISSIONS (MID CHANNEL, HORIZONTAL)**

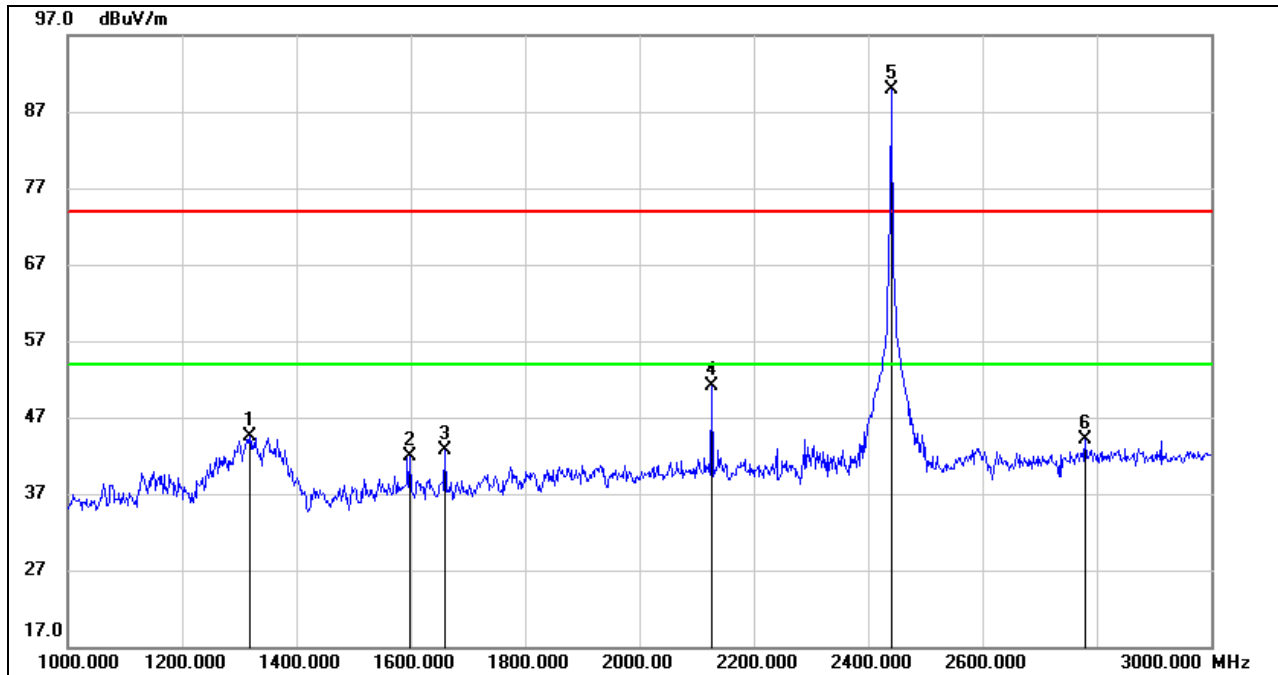

No.	Frequency (MHz)	Reading (dBuV)	Correct (dB/m)	Result (dBuV/m)	Limit (dBuV/m)	Margin (dB)	Remark
1	1318.000	37.93	6.63	44.56	74.00	-29.44	peak
2	1598.000	33.98	7.95	41.93	74.00	-32.07	peak
3	1660.000	34.59	8.11	42.70	74.00	-31.30	peak
4	2126.000	39.96	11.11	51.07	74.00	-22.93	peak
5	2440.000	77.70	12.19	89.89	/	/	fundamental
6	2780.000	30.58	13.61	44.19	74.00	-29.81	peak

Note: 1. Peak Result = Reading Level + Correct Factor.  
 2. If Peak Result complies with AV limit, AV Result is deemed to comply with AV limit.  
 3. Peak: Peak detector.



**HARMONICS AND SPURIOUS EMISSIONS (MID CHANNEL, VERTICAL)**

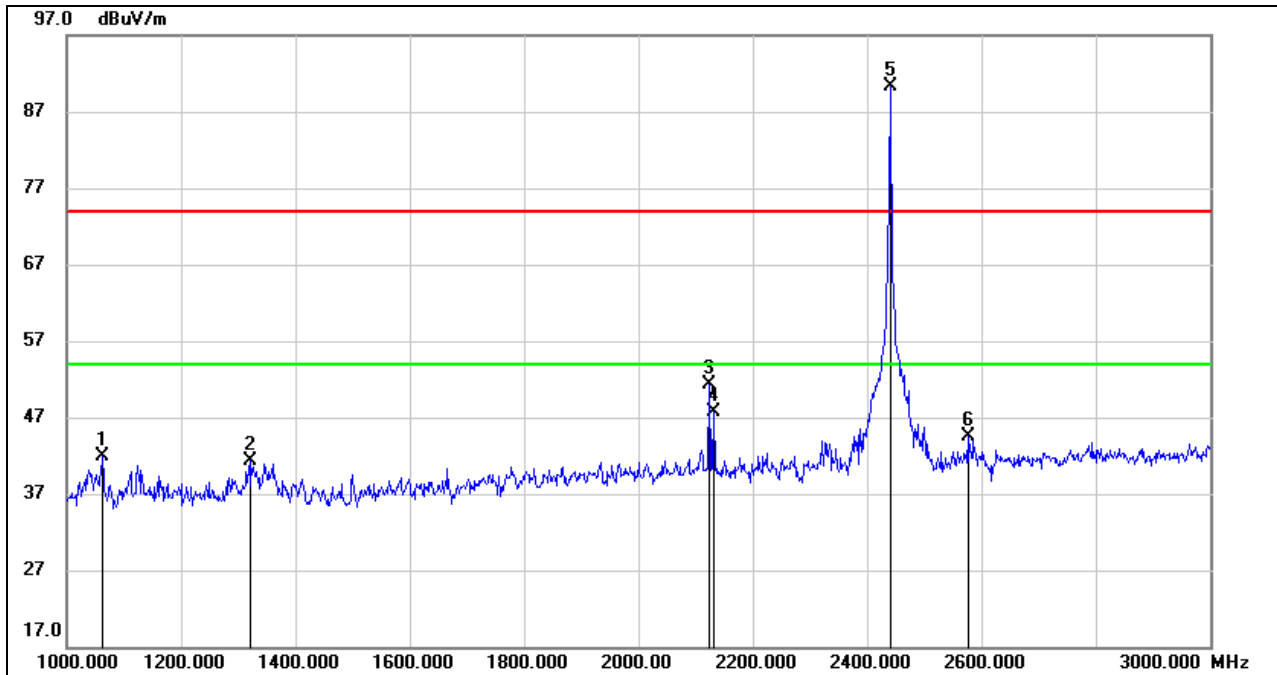

No.	Frequency (MHz)	Reading (dBuV)	Correct (dB/m)	Result (dBuV/m)	Limit (dBuV/m)	Margin (dB)	Remark
1	1062.000	36.77	5.14	41.91	74.00	-32.09	peak
2	1322.000	34.77	6.63	41.40	74.00	-32.60	peak
3	2124.000	40.28	11.10	51.38	74.00	-22.62	peak
4	2132.000	36.48	11.13	47.61	74.00	-26.39	peak
5	2440.000	78.15	12.19	90.34	/	/	fundamental
6	2576.000	32.01	12.41	44.42	74.00	-29.58	peak

- Note: 1. Peak Result = Reading Level + Correct Factor.  
 2. If Peak Result complies with AV limit, AV Result is deemed to comply with AV limit.  
 3. Peak: Peak detector.



**HARMONICS AND SPURIOUS EMISSIONS (HIGH CHANNEL, HORIZONTAL)**

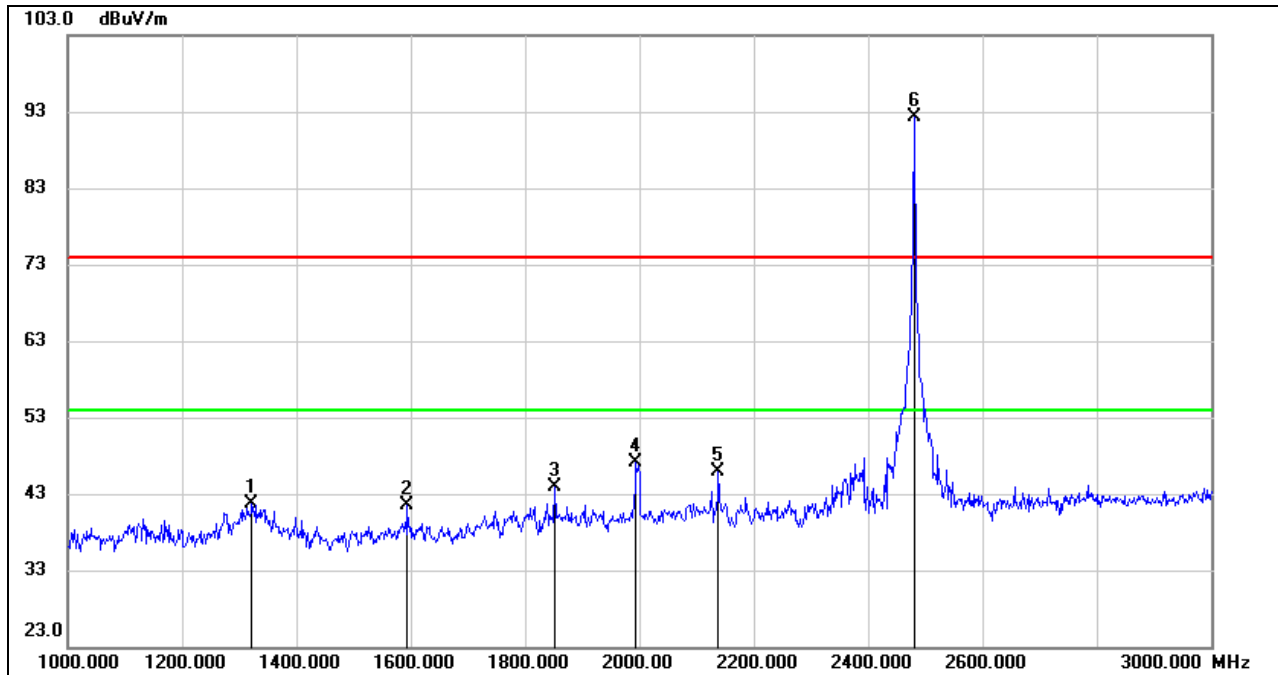

No.	Frequency (MHz)	Reading (dBuV)	Correct (dB/m)	Result (dBuV/m)	Limit (dBuV/m)	Margin (dB)	Remark
1	1322.000	35.07	6.63	41.70	74.00	-32.30	peak
2	1594.000	33.49	7.92	41.41	74.00	-32.59	peak
3	1852.000	34.10	9.88	43.98	74.00	-30.02	peak
4	1994.000	36.93	10.24	47.17	74.00	-26.83	peak
5	2138.000	34.72	11.14	45.86	74.00	-28.14	peak
6	2480.000	79.91	12.35	92.26	/	/	fundamental

Note: 1. Peak Result = Reading Level + Correct Factor.  
 2. If Peak Result complies with AV limit, AV Result is deemed to comply with AV limit.  
 3. Peak: Peak detector.





**HARMONICS AND SPURIOUS EMISSIONS (HIGH CHANNEL, VERTICAL)**

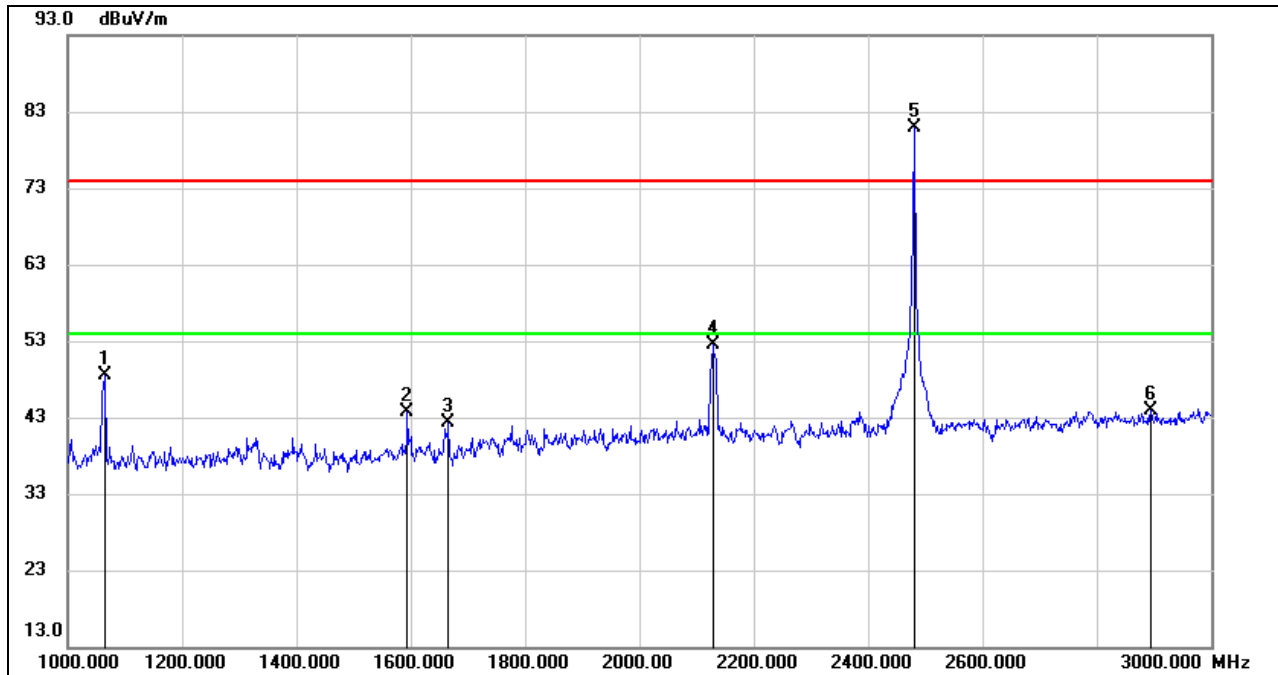

No.	Frequency (MHz)	Reading (dBuV)	Correct (dB/m)	Result (dBuV/m)	Limit (dBuV/m)	Margin (dB)	Remark
1	1066.000	43.28	5.15	48.43	74.00	-25.57	peak
2	1594.000	35.75	7.92	43.67	74.00	-30.33	peak
3	1666.000	34.22	8.13	42.35	74.00	-31.65	peak
4	2128.000	41.37	11.11	52.48	74.00	-21.52	peak
5	2480.000	68.59	12.35	80.94	/	/	fundamental
6	2894.000	29.86	14.02	43.88	74.00	-30.12	peak

Note: 1. Peak Result = Reading Level + Correct Factor.  
 2. If Peak Result complies with AV limit, AV Result is deemed to comply with AV limit.  
 3. Peak: Peak detector.

### 7.3. SPURIOUS EMISSIONS (3 GHz ~ 18 GHz)

#### 7.3.1. LE 1M MODE

##### HARMONICS AND SPURIOUS EMISSIONS (LOW CHANNEL, HORIZONTAL)

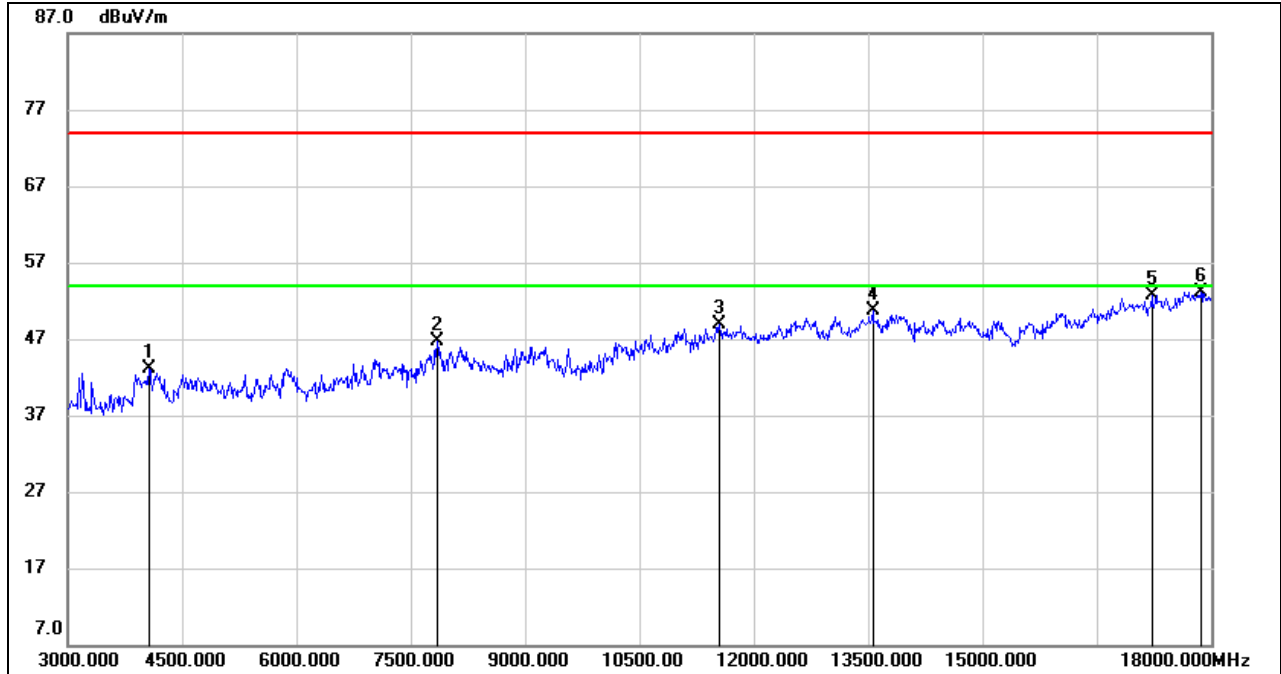

No.	Frequency (MHz)	Reading (dBuV)	Correct (dB/m)	Result (dBuV/m)	Limit (dBuV/m)	Margin (dB)	Remark
1	4065.000	45.93	-2.88	43.05	74.00	-30.95	peak
2	7845.000	39.01	7.62	46.63	74.00	-27.37	peak
3	11550.000	35.56	13.30	48.86	74.00	-25.14	peak
4	13560.000	34.69	15.93	50.62	74.00	-23.38	peak
5	17220.000	31.58	21.08	52.66	74.00	-21.34	peak
6	17865.000	29.85	23.33	53.18	74.00	-20.82	peak

Note: 1. Peak Result = Reading Level + Correct Factor.

2. If Peak Result complies with AV limit, AV Result is deemed to comply with AV limit.

3. Peak: Peak detector.

4. Filter losses were only considered in the spurious frequency bands and the authorized band was not corrected for High Pass Filter losses.

5. Proper operation of the transmitter prior to adding the filter to the measurement chain.



**HARMONICS AND SPURIOUS EMISSIONS (LOW CHANNEL, VERTICAL)**

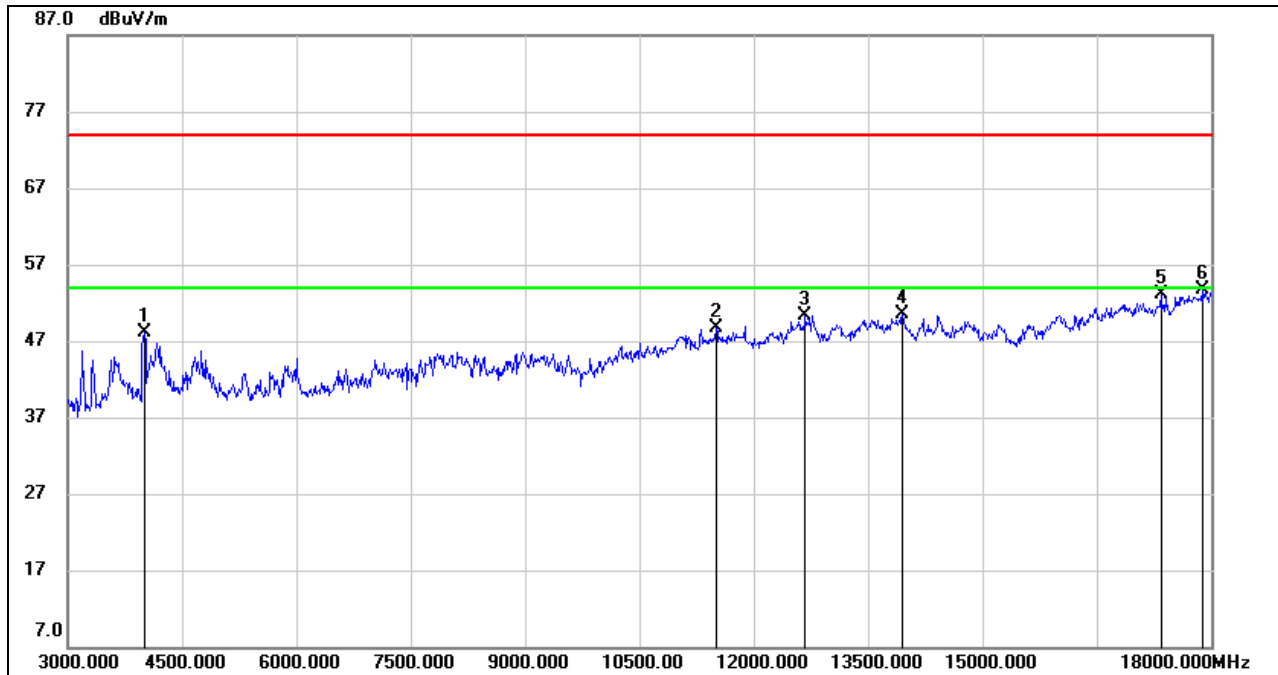

No.	Frequency (MHz)	Reading (dBuV)	Correct (dB/m)	Result (dBuV/m)	Limit (dBuV/m)	Margin (dB)	Remark
1	4005.000	51.02	-2.89	48.13	74.00	-25.87	peak
2	11505.000	35.28	13.42	48.70	74.00	-25.30	peak
3	12675.000	36.17	14.21	50.38	74.00	-23.62	peak
4	13950.000	34.30	16.11	50.41	74.00	-23.59	peak
5	17340.000	31.54	21.61	53.15	74.00	-20.85	peak
6	17880.000	30.28	23.34	53.62	74.00	-20.38	peak

- Note: 1. Peak Result = Reading Level + Correct Factor.  
 2. If Peak Result complies with AV limit, AV Result is deemed to comply with AV limit.  
 3. Peak: Peak detector.  
 4. Filter losses were only considered in the spurious frequency bands and the authorized band was not corrected for High Pass Filter losses.  
 5. Proper operation of the transmitter prior to adding the filter to the measurement chain.

**HARMONICS AND SPURIOUS EMISSIONS (MID CHANNEL, HORIZONTAL)**

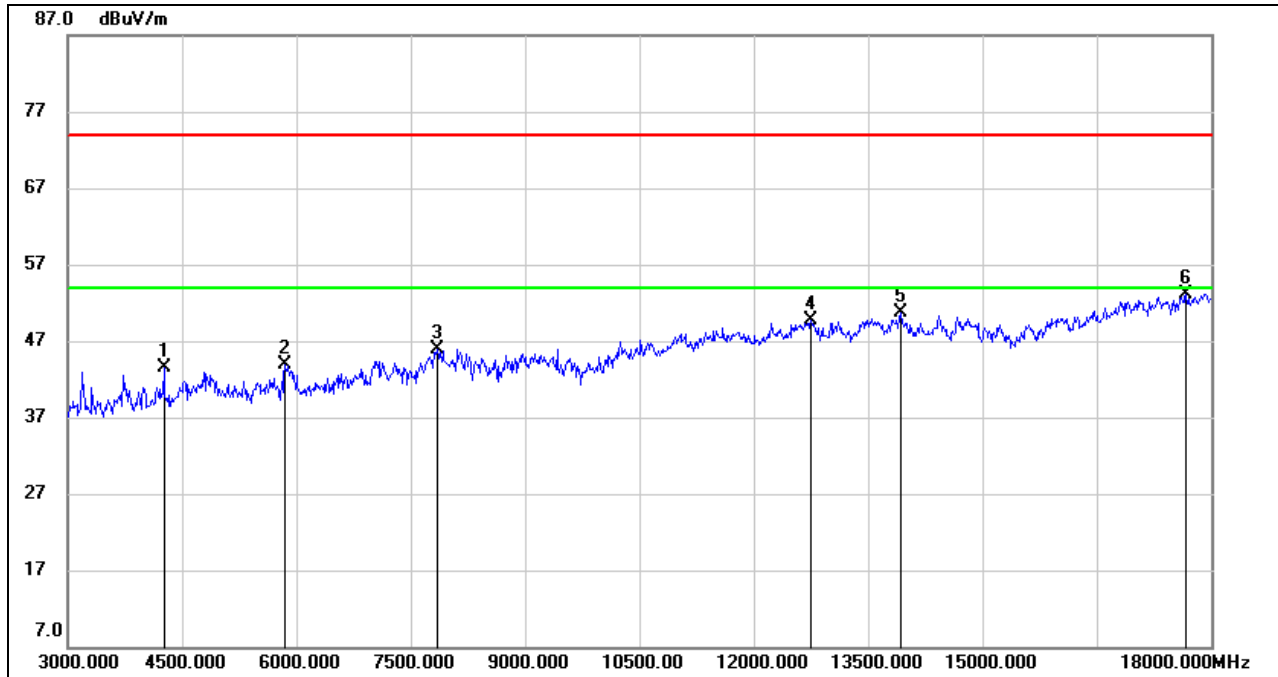

No.	Frequency (MHz)	Reading (dBuV)	Correct (dB/m)	Result (dBuV/m)	Limit (dBuV/m)	Margin (dB)	Remark
1	4260.000	45.16	-1.71	43.45	74.00	-30.55	peak
2	5850.000	39.97	4.02	43.99	74.00	-30.01	peak
3	7845.000	38.33	7.62	45.95	74.00	-28.05	peak
4	12750.000	34.70	14.98	49.68	74.00	-24.32	peak
5	13920.000	34.49	16.17	50.66	74.00	-23.34	peak
6	17670.000	30.77	22.24	53.01	74.00	-20.99	peak

Note: 1. Peak Result = Reading Level + Correct Factor.  
 2. If Peak Result complies with AV limit, AV Result is deemed to comply with AV limit.  
 3. Peak: Peak detector.  
 4. Filter losses were only considered in the spurious frequency bands and the authorized band was not corrected for High Pass Filter losses.  
 5. Proper operation of the transmitter prior to adding the filter to the measurement chain.



**HARMONICS AND SPURIOUS EMISSIONS (MID CHANNEL, VERTICAL)**

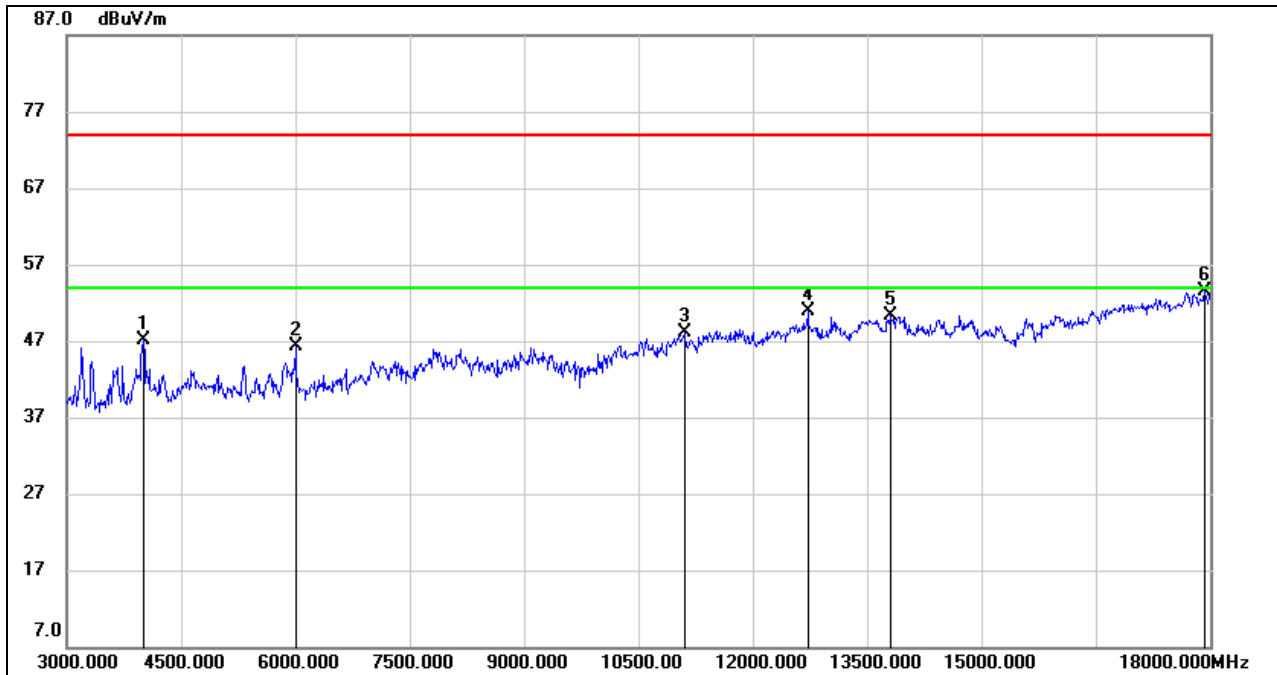

No.	Frequency (MHz)	Reading (dBuV)	Correct (dB/m)	Result (dBuV/m)	Limit (dBuV/m)	Margin (dB)	Remark
1	4005.000	50.04	-2.89	47.15	74.00	-26.85	peak
2	6000.000	43.03	3.29	46.32	74.00	-27.68	peak
3	11100.000	35.57	12.56	48.13	74.00	-25.87	peak
4	12720.000	36.37	14.57	50.94	74.00	-23.06	peak
5	13800.000	33.12	17.10	50.22	74.00	-23.78	peak
6	17925.000	30.15	23.37	53.52	74.00	-20.48	peak

- Note: 1. Peak Result = Reading Level + Correct Factor.  
 2. If Peak Result complies with AV limit, AV Result is deemed to comply with AV limit.  
 3. Peak: Peak detector.  
 4. Filter losses were only considered in the spurious frequency bands and the authorized band was not corrected for High Pass Filter losses.  
 5. Proper operation of the transmitter prior to adding the filter to the measurement chain.

**HARMONICS AND SPURIOUS EMISSIONS (HIGH CHANNEL, HORIZONTAL)**

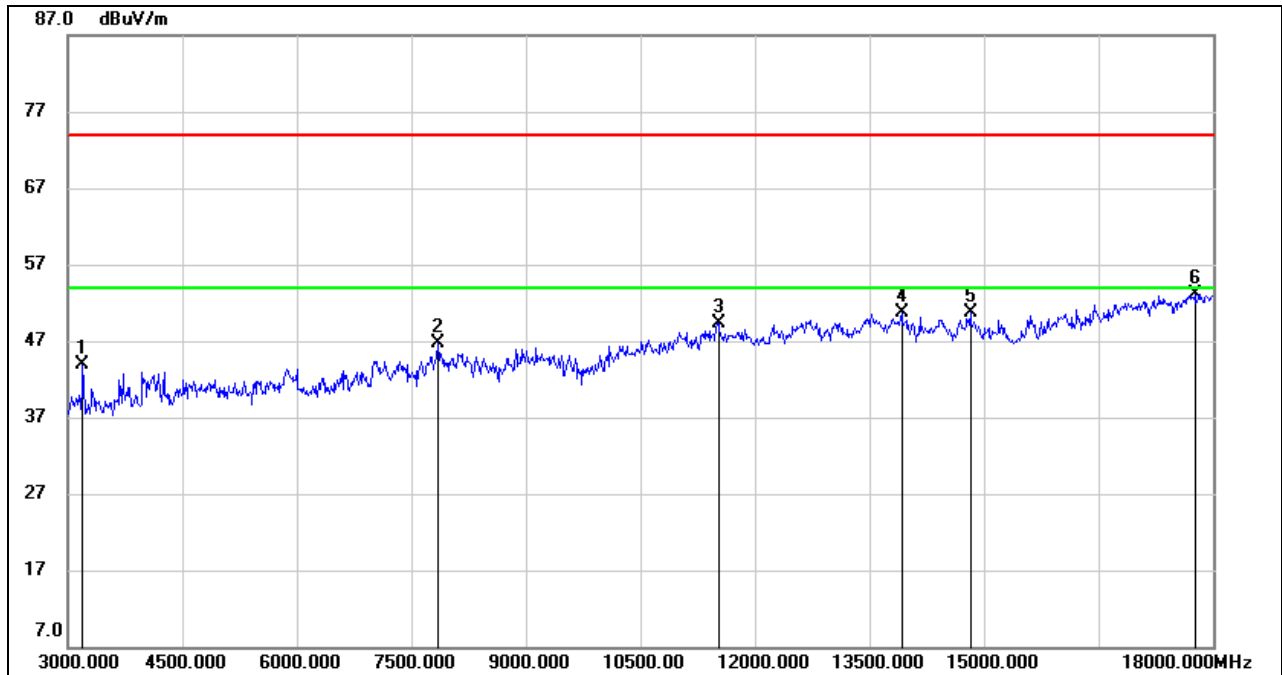

No.	Frequency (MHz)	Reading (dBuV)	Correct (dB/m)	Result (dBuV/m)	Limit (dBuV/m)	Margin (dB)	Remark
1	3195.000	48.33	-4.42	43.91	74.00	-30.09	peak
2	7845.000	39.17	7.62	46.79	74.00	-27.21	peak
3	11520.000	36.02	13.38	49.40	74.00	-24.60	peak
4	13920.000	34.47	16.17	50.64	74.00	-23.36	peak
5	14820.000	34.79	15.94	50.73	74.00	-23.27	peak
6	17760.000	30.11	22.95	53.06	74.00	-20.94	peak

- Note: 1. Peak Result = Reading Level + Correct Factor.  
 2. If Peak Result complies with AV limit, AV Result is deemed to comply with AV limit.  
 3. Peak: Peak detector.  
 4. Filter losses were only considered in the spurious frequency bands and the authorized band was not corrected for High Pass Filter losses.  
 5. Proper operation of the transmitter prior to adding the filter to the measurement chain.

**HARMONICS AND SPURIOUS EMISSIONS (HIGH CHANNEL, VERTICAL)**

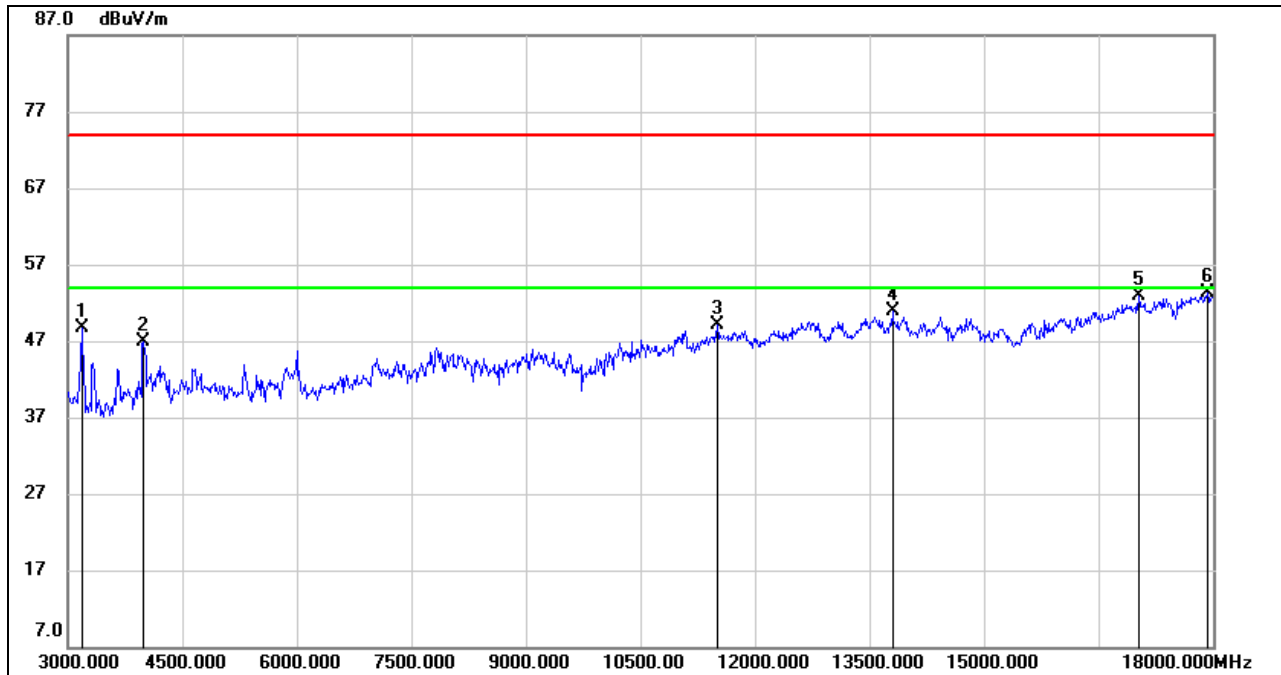

No.	Frequency (MHz)	Reading (dBuV)	Correct (dB/m)	Result (dBuV/m)	Limit (dBuV/m)	Margin (dB)	Remark
1	3180.000	52.98	-4.33	48.65	74.00	-25.35	peak
2	3990.000	49.81	-2.89	46.92	74.00	-27.08	peak
3	11505.000	35.74	13.42	49.16	74.00	-24.84	peak
4	13800.000	33.79	17.10	50.89	74.00	-23.11	peak
5	17025.000	32.42	20.46	52.88	74.00	-21.12	peak
6	17925.000	29.86	23.37	53.23	74.00	-20.77	peak

- Note: 1. Peak Result = Reading Level + Correct Factor.  
 2. If Peak Result complies with AV limit, AV Result is deemed to comply with AV limit.  
 3. Peak: Peak detector.  
 4. Filter losses were only considered in the spurious frequency bands and the authorized band was not corrected for High Pass Filter losses.  
 5. Proper operation of the transmitter prior to adding the filter to the measurement chain.

## 7.4. SPURIOUS EMISSIONS (18 GHz ~ 26 GHz)

### 7.4.1. LE 1M MODE

#### SPURIOUS EMISSIONS (LOW CHANNEL, WORST-CASE CONFIGURATION, HORIZONTAL)

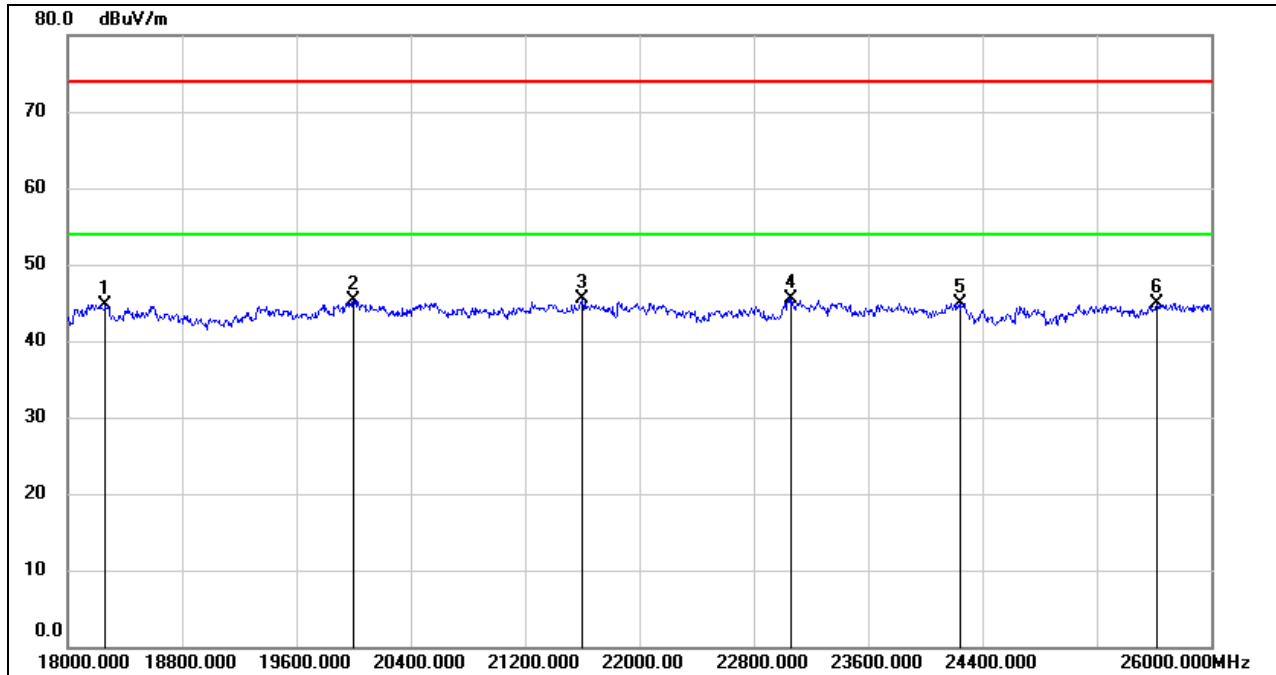

No.	Frequency (MHz)	Reading (dBuV)	Correct (dB/m)	Result (dBuV/m)	Limit (dBuV/m)	Margin (dB)	Remark
1	18264.000	50.15	-5.53	44.62	74.00	-29.38	peak
2	20000.000	50.81	-5.45	45.36	74.00	-28.64	peak
3	21600.000	50.02	-4.54	45.48	74.00	-28.52	peak
4	23064.000	48.99	-3.42	45.57	74.00	-28.43	peak
5	24248.000	47.82	-2.83	44.99	74.00	-29.01	peak
6	25616.000	46.18	-1.24	44.94	74.00	-29.06	peak

Note: 1. Peak Result = Reading Level + Correct Factor.

2. If Peak Result complies with AV limit, AV Result is deemed to comply with AV limit.

3. Peak: Peak detector.



**SPURIOUS EMISSIONS (LOW CHANNEL, WORST-CASE CONFIGURATION, VERTICAL)**

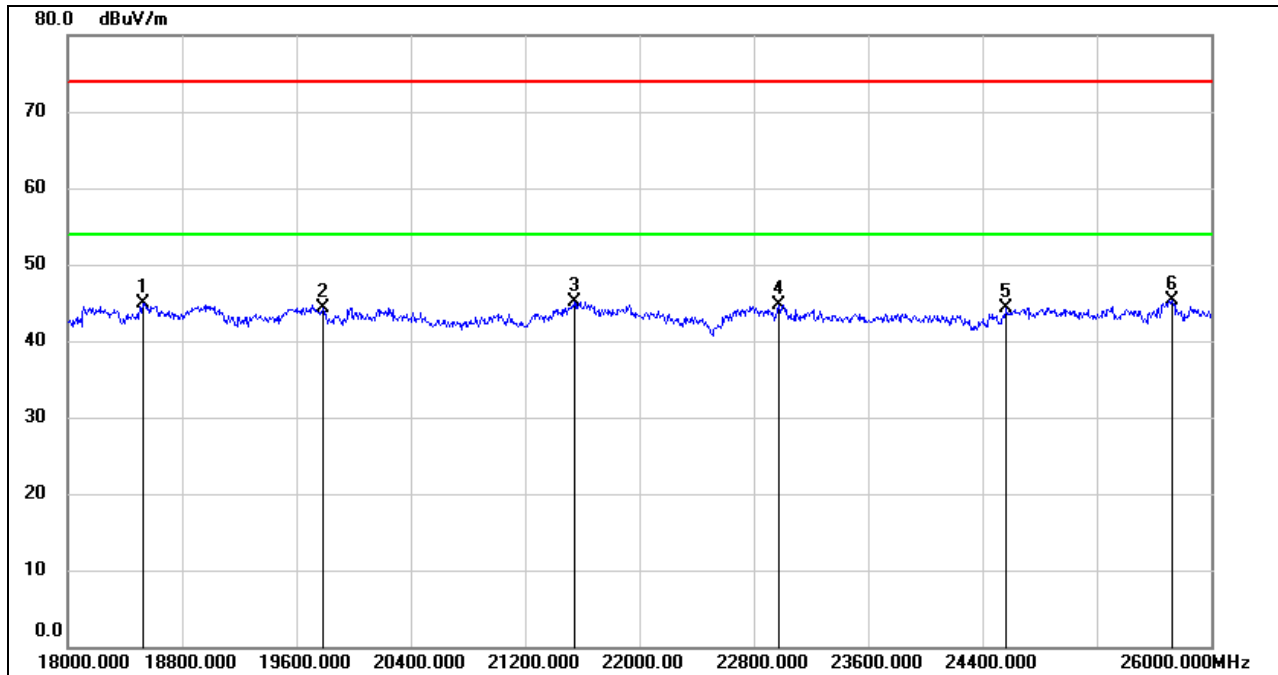

No.	Frequency (MHz)	Reading (dBuV)	Correct (dB/m)	Result (dBuV/m)	Limit (dBuV/m)	Margin (dB)	Remark
1	18528.000	50.11	-5.26	44.85	74.00	-29.15	peak
2	19784.000	49.57	-5.28	44.29	74.00	-29.71	peak
3	21544.000	49.76	-4.63	45.13	74.00	-28.87	peak
4	22976.000	48.26	-3.46	44.80	74.00	-29.20	peak
5	24568.000	46.60	-2.33	44.27	74.00	-29.73	peak
6	25728.000	46.11	-0.72	45.39	74.00	-28.61	peak

- Note: 1. Peak Result = Reading Level + Correct Factor.  
 2. If Peak Result complies with AV limit, AV Result is deemed to comply with AV limit.  
 3. Peak: Peak detector.

Note: All the modes have been tested, only the worst data was recorded in the report.

## 7.5. SPURIOUS EMISSIONS (30 MHz ~ 1 GHz)

### 7.5.1. LE 1M MODE

#### SPURIOUS EMISSIONS (LOW CHANNEL, WORST-CASE CONFIGURATION, HORIZONTAL)

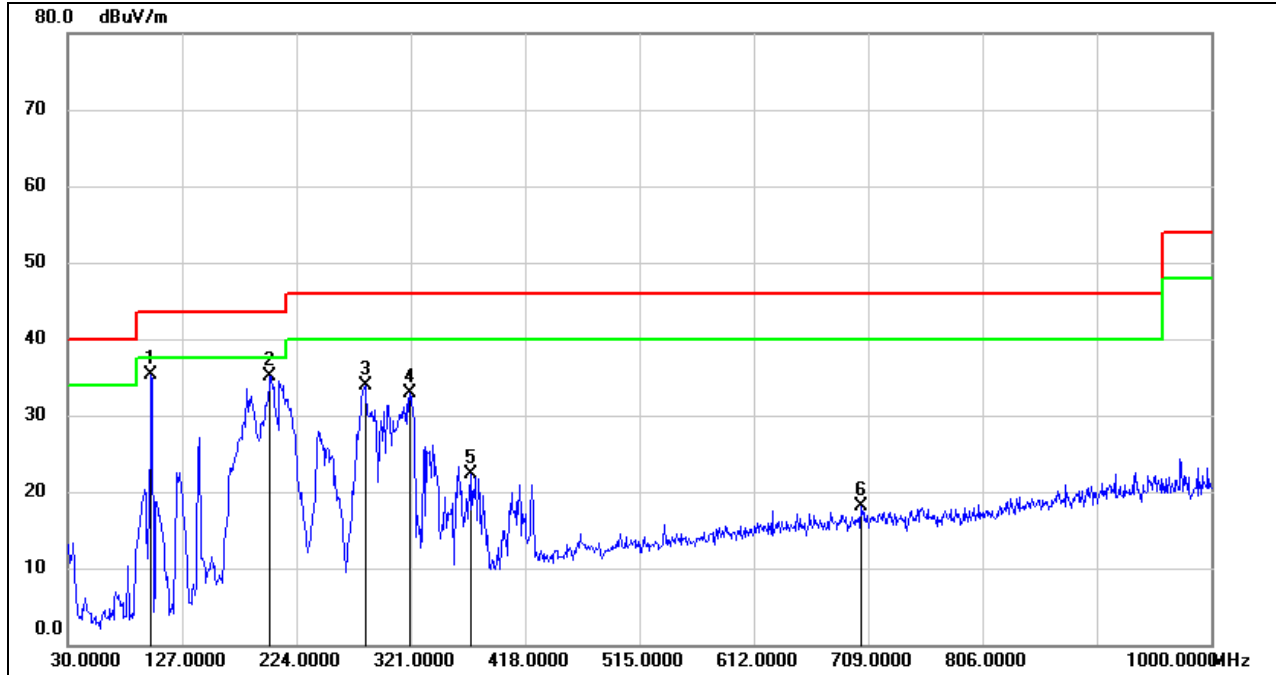

No.	Frequency (MHz)	Reading (dBuV)	Correct (dB/m)	Result (dBuV/m)	Limit (dBuV/m)	Margin (dB)	Remark
1	100.8100	56.41	-21.20	35.21	43.50	-8.29	QP
2	201.6900	51.83	-16.68	35.15	43.50	-8.35	QP
3	282.2000	50.88	-16.96	33.92	46.00	-12.08	QP
4	320.0300	47.95	-15.11	32.84	46.00	-13.16	QP
5	372.4100	36.38	-14.01	22.37	46.00	-23.63	QP
6	703.1800	26.91	-8.71	18.20	46.00	-27.80	QP

- Note: 1. Result Level = Read Level + Correct Factor.  
 2. If Peak Result complies with QP limit, QP Result is deemed to comply with QP limit.  
 3. Test setup: RBW: 120 kHz, VBW: 300 kHz, Sweep time: auto.

**SPURIOUS EMISSIONS (LOW CHANNEL, WORST-CASE CONFIGURATION, VERTICAL)**

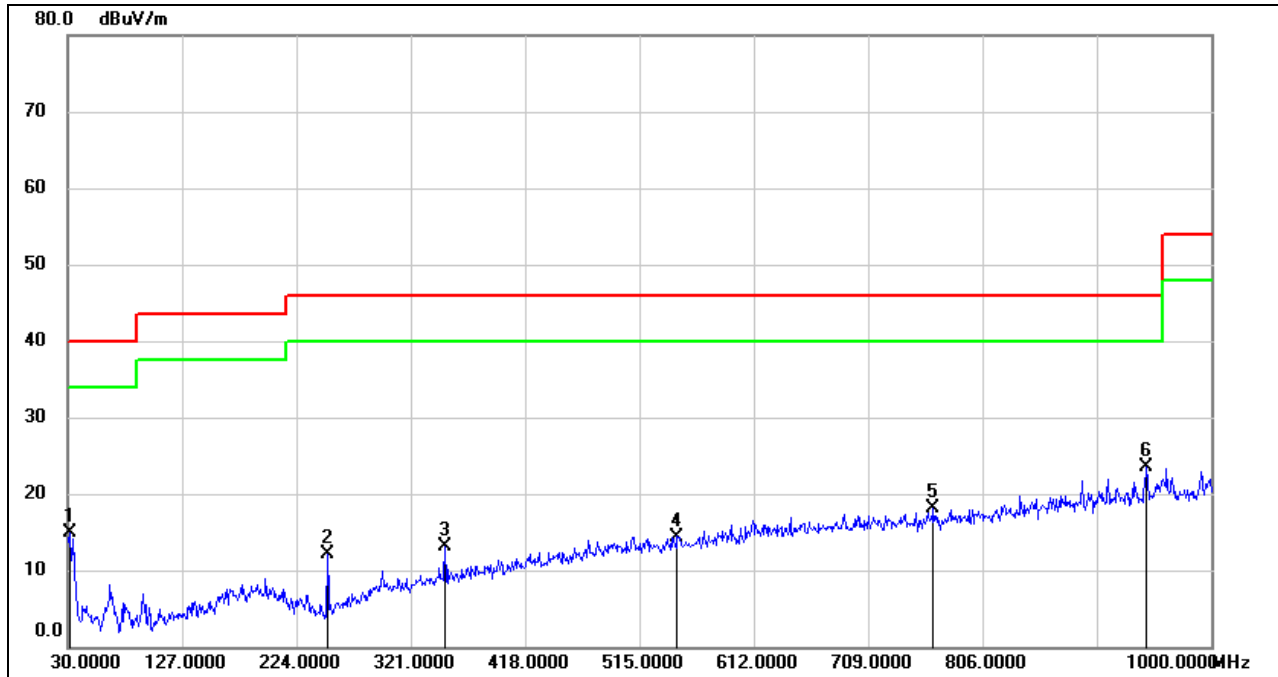

No.	Frequency (MHz)	Reading (dBuV)	Correct (dB/m)	Result (dBuV/m)	Limit (dBuV/m)	Margin (dB)	Remark
1	31.9400	34.21	-19.25	14.96	40.00	-25.04	QP
2	250.1900	31.31	-19.19	12.12	46.00	-33.88	QP
3	350.1000	27.74	-14.57	13.17	46.00	-32.83	QP
4	547.0100	25.21	-10.81	14.40	46.00	-31.60	QP
5	764.2900	26.25	-8.12	18.13	46.00	-27.87	QP
6	944.7100	28.69	-5.20	23.49	46.00	-22.51	QP

- Note: 1. Result Level = Read Level + Correct Factor.  
 2. If Peak Result complies with QP limit, QP Result is deemed to comply with QP limit.  
 3. Test setup: RBW: 120 kHz, VBW: 300 kHz, Sweep time: auto

Note: All the modes have been tested, only the worst data was recorded in the report.

## 7.6. SPURIOUS EMISSIONS BELOW 30 MHz

### 7.6.1. LE 1M MODE

#### SPURIOUS EMISSIONS (LOW CHANNEL, LOOP ANTENNA FACE ON TO THE EUT, WORST-CASE CONFIGURATION)

9 kHz~ 150 kHz

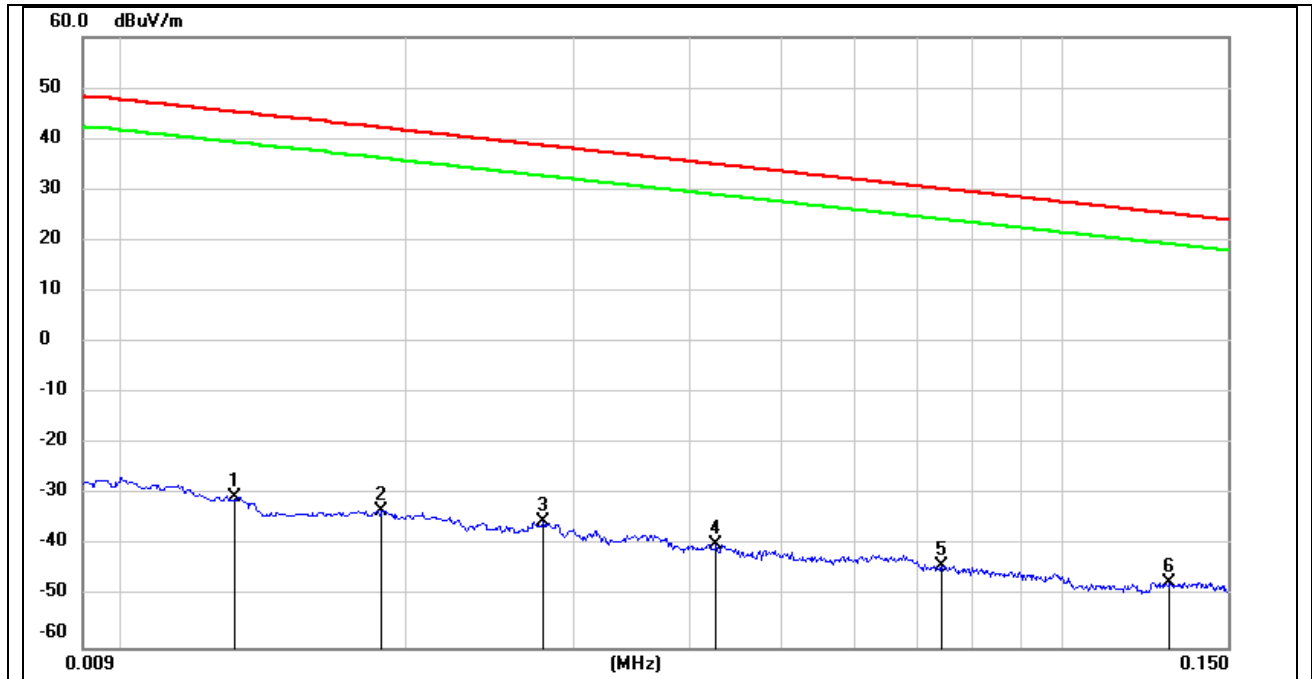

No.	Frequency (MHz)	Reading (dBuV)	Correct (dB/m)	Result (dBuV/m)	Limit (dBuV/m)	ISED Result (dBuA/m)	ISED Limit (dBuA/m)	Margin (dB)	Remark
1	0.0131	70.97	-101.38	-30.41	45.25	-81.91	-6.25	-75.66	peak
2	0.0188	68.14	-101.35	-33.21	42.12	-84.71	-9.38	-75.33	peak
3	0.0279	66.17	-101.38	-35.21	38.69	-86.71	-12.81	-73.90	peak
4	0.0427	61.64	-101.45	-39.81	34.99	-91.31	-16.51	-74.80	peak
5	0.0743	57.58	-101.59	-44.01	30.18	-95.51	-21.32	-74.19	peak
6	0.1300	54.43	-101.70	-47.27	25.33	-98.77	-26.17	-72.60	peak

Note: 1. Measurement = Reading Level + Correct Factor (dBuA/m= dBuV/m- 20Log10[120π] = dBuV/m- 51.5).

2. If Peak Result complies with AV and QP limit, AV and QP Result are deemed to comply with AV limit.

3. All 3 polarizations (Horizontal, Face-on and Face-off) of the loop antenna had been tested, but only the worst data recorded in the report.

**150 kHz ~ 490 kHz**

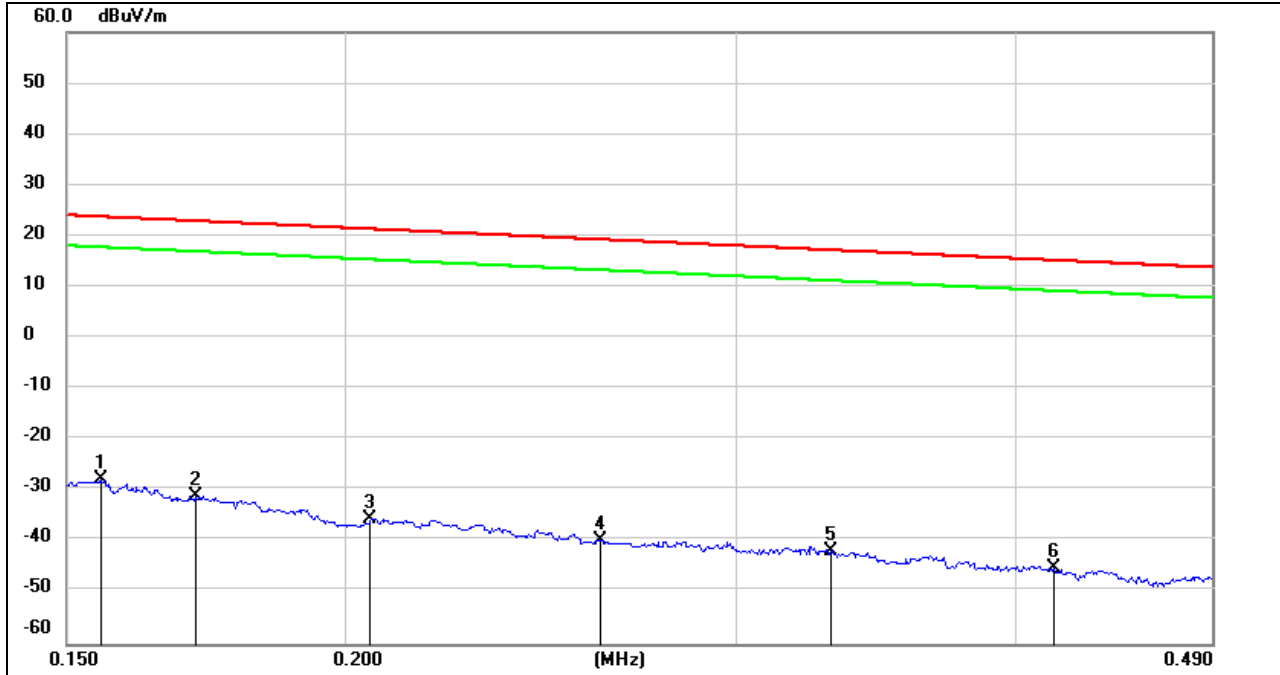

No.	Frequency (MHz)	Reading (dBuV)	Correct (dB/m)	Result (dBuV/m)	Limit (dBuV/m)	ISED Result (dBuA/m)	ISED Limit (dBuA/m)	Margin (dB)	Remark
1	0.1554	73.77	-101.65	-27.88	23.77	-79.38	-27.73	-51.65	peak
2	0.1713	70.67	-101.67	-31.00	22.93	-82.50	-28.57	-53.93	peak
3	0.2053	66.29	-101.73	-35.44	21.35	-86.94	-30.15	-56.79	peak
4	0.2605	62.14	-101.81	-39.67	19.29	-91.17	-32.21	-58.96	peak
5	0.3305	60.03	-101.88	-41.85	17.22	-93.35	-34.28	-59.07	peak
6	0.4162	56.68	-101.98	-45.30	15.22	-96.80	-36.28	-60.52	peak

Note: 1. Measurement = Reading Level + Correct Factor (dBuA/m= dBuV/m- 20Log10[120π] = dBuV/m- 51.5).

2. If Peak Result complies with AV and QP limit, AV and QP Result are deemed to comply with AV limit.

3. All 3 polarizations (Horizontal, Face-on and Face-off) of the loop antenna had been tested, but only the worst data recorded in the report.

**490 kHz ~ 30 MHz**

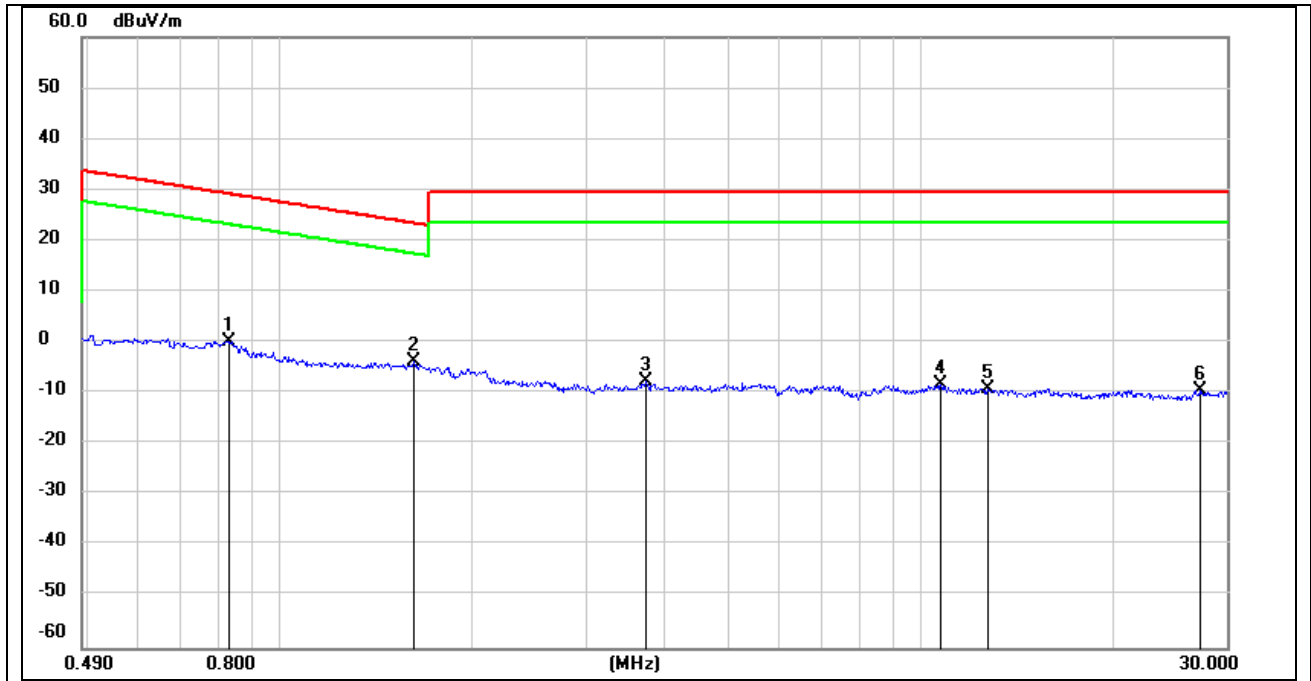

No.	Frequency (MHz)	Reading (dBuV)	Correct (dB/m)	Result (dBuV/m)	Limit (dBuV/m)	ISED Result (dBuA/m)	ISED Limit (dBuA/m)	Margin (dB)	Remark
1	0.8296	62.44	-62.17	0.27	29.23	-51.23	-22.27	-28.96	peak
2	1.6150	58.12	-62.00	-3.88	23.44	-55.38	-28.06	-27.32	peak
3	3.7100	53.70	-61.41	-7.71	29.54	-59.21	-21.96	-37.25	peak
4	10.7299	52.48	-60.83	-8.35	29.54	-59.85	-21.96	-37.89	peak
5	12.7367	51.79	-60.92	-9.13	29.54	-60.63	-21.96	-38.67	peak
6	27.1966	50.81	-60.24	-9.43	29.54	-60.93	-21.96	-38.97	peak

Note: 1. Measurement = Reading Level + Correct Factor (dBuA/m= dBuV/m- 20Log10[120π] = dBuV/m- 51.5).

2. If Peak Result complies with AV and QP limit, AV and QP Result are deemed to comply with AV limit.

3. All 3 polarizations (Horizontal, Face-on and Face-off) of the loop antenna had been tested, but only the worst data recorded in the report.

Note: All the modes have been tested, only the worst data was recorded in the report.

## 8. AC POWER LINE CONDUCTED EMISSIONS

### LIMITS

Please refer to CFR 47 FCC §15.207 (a) and ISED RSS-Gen Clause 8.8

FREQUENCY (MHz)	Quasi-peak	Average
0.15 -0.5	66 - 56 *	56 - 46 *
0.50 -5.0	56.00	46.00
5.0 -30.0	60.00	50.00

### TEST SETUP AND PROCEDURE

Refer to ANSI C63.10-2013 clause 6.2.

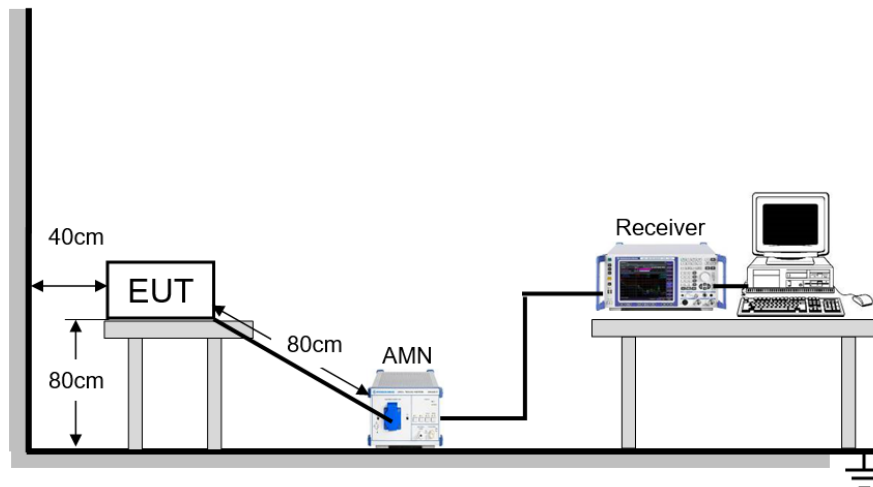

The EUT is put on a table of non-conducting material that is 80 cm high. The vertical conducting wall of shielding is located 40 cm to the rear of the EUT. The power line of the EUT is connected to the AC mains through a Artificial Mains Network (A.M.N.). A EMI Measurement Receiver (R&S Test Receiver ESR3) is used to test the emissions from both sides of AC line. According to the requirements in Section 6.2 of ANSI C63.10-2013. Conducted emissions from the EUT measured in the frequency range between 0.15 MHz and 30 MHz using CISPR Quasi-Peak and average detector mode. The bandwidth of EMI test receiver is set at 9 kHz.

The arrangement of the equipment is installed to meet the standards and operating in a manner, which tends to maximize its emission characteristics in a normal application.

### TEST ENVIRONMENT

Temperature	23.4 °C	Relative Humidity	60.2 %
Atmosphere Pressure	101 kPa	Test Voltage	DC 3.7 V

**RESULTS**

**8.1. LE 1M MODE**

**LINE L RESULTS (LOW CHANNEL, WORST-CASE CONFIGURATION)**

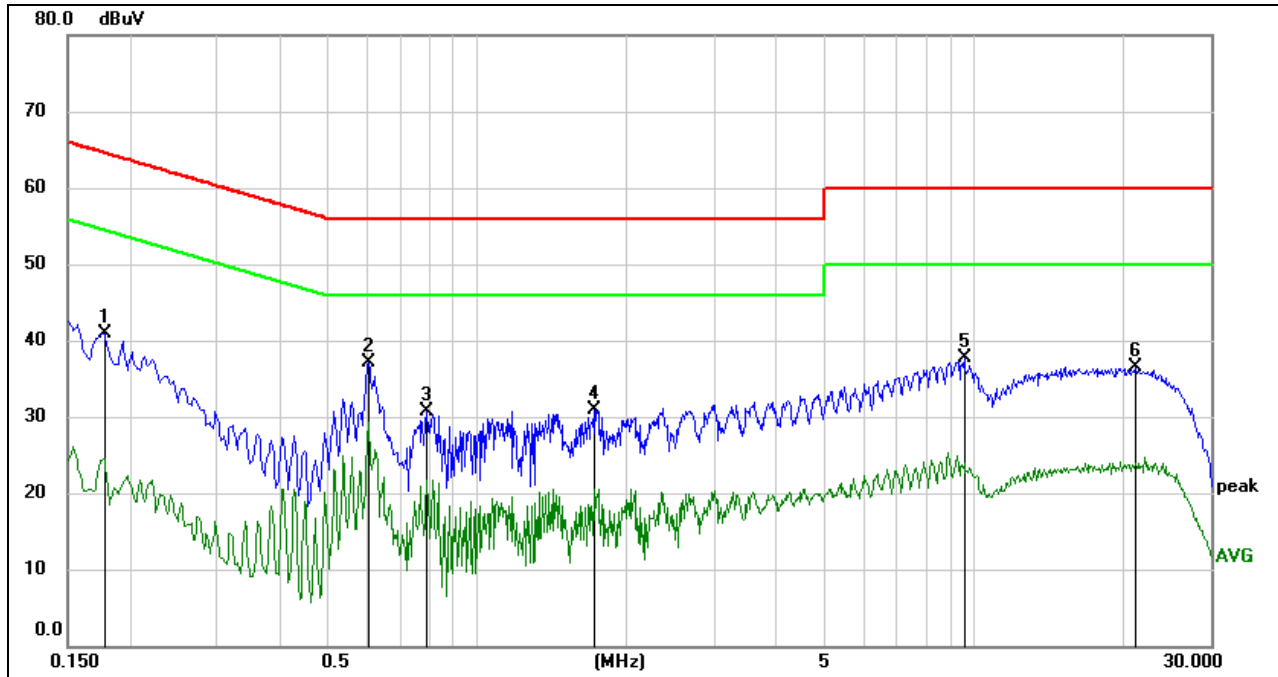

No.	Frequency (MHz)	Reading (dBuV)	Correct (dB)	Result (dBuV)	Limit (dBuV)	Margin (dB)	Remark
1	0.1780	31.31	9.61	40.92	64.58	-23.66	peak
2	0.6060	27.54	9.60	37.14	56.00	-18.86	peak
3	0.7940	21.13	9.61	30.74	56.00	-25.26	peak
4	1.7180	21.36	9.62	30.98	56.00	-25.02	peak
5	9.5540	27.89	9.74	37.63	60.00	-22.37	peak
6	21.2380	26.50	10.08	36.58	60.00	-23.42	peak

- Note: 1. Result = Reading + Correct Factor.  
 2. If QP Result complies with AV limit, AV Result is deemed to comply with AV limit.  
 3. Test setup: RBW: 200 Hz (9 kHz ~ 150 kHz), 9 kHz (150 kHz ~ 30 MHz).  
 4. Step size: 80 Hz (0.009 MHz ~ 0.15 MHz), 4 kHz (0.15 MHz ~ 30 MHz), Scan time: auto.

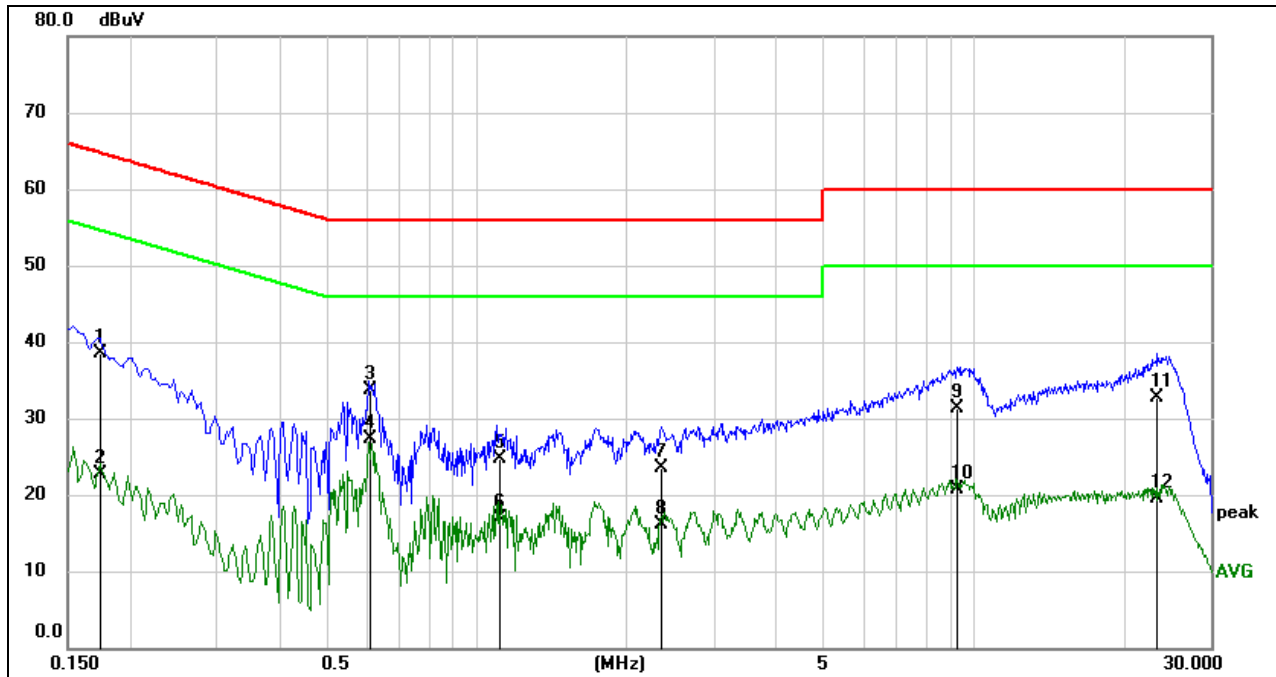

**LINE N RESULTS (LOW CHANNEL, WORST-CASE CONFIGURATION)**

No.	Frequency (MHz)	Reading (dBuV)	Correct (dB)	Result (dBuV)	Limit (dBuV)	Margin (dB)	Remark
1	0.1740	28.96	9.60	38.56	64.77	-26.21	QP
2	0.1740	13.03	9.60	22.63	54.77	-32.14	AVG
3	0.6105	24.06	9.60	33.66	56.00	-22.34	QP
4	0.6105	17.63	9.60	27.23	46.00	-18.77	AVG
5	1.1088	15.06	9.61	24.67	56.00	-31.33	QP
6	1.1088	7.25	9.61	16.86	46.00	-29.14	AVG
7	2.3689	13.94	9.63	23.57	56.00	-32.43	QP
8	2.3689	6.51	9.63	16.14	46.00	-29.86	AVG
9	9.2852	21.62	9.75	31.37	60.00	-28.63	QP
10	9.2852	10.91	9.75	20.66	50.00	-29.34	AVG
11	23.4484	22.68	10.12	32.80	60.00	-27.20	QP
12	23.4484	9.38	10.12	19.50	50.00	-30.50	AVG

Note: 1. Result = Reading + Correct Factor.

2. If QP Result complies with AV limit, AV Result is deemed to comply with AV limit.

3. Test setup: RBW: 200 Hz (9 kHz ~ 150 kHz), 9 kHz (150 kHz ~ 30 MHz).

4. Step size: 80 Hz (0.009 MHz ~ 0.15 MHz), 4 kHz (0.15 MHz ~ 30 MHz), Scan time: auto.

Note: All the modes have been tested, only the worst data was recorded in the report.



## 9. ANTENNA REQUIREMENTS

### APPLICABLE REQUIREMENTS

Please refer to FCC §15.203

An intentional radiator shall be designed to ensure that no antenna other than that furnished by the responsible party shall be used with the device. The use of a permanently attached antenna or of an antenna that uses a unique coupling to the intentional radiator shall be considered sufficient to comply with the provisions of this section. The manufacturer may design the unit so that a broken antenna can be replaced by the user, but the use of a standard antenna jack or electrical connector is prohibited.

Please refer to FCC §15.247(b)(4)

The conducted output power limit specified in paragraph (b) of this section is based on the use of antennas with directional gains that do not exceed 6 dBi. Except as shown in paragraph (c) of this section, if transmitting antennas of directional gain greater than 6 dBi are used, the conducted output power from the intentional radiator shall be reduced below the stated values in paragraphs (b)(1), (b)(2), and (b)(3) of this section, as appropriate, by the amount in dB that the directional gain of the antenna exceeds 6 dBi.

### RESULTS

Complies



## 10. APPENDIX

### 10.1. Appendix A: DTS Bandwidth

#### 10.1.1. Test Result

Test Mode	Antenna	Channel	DTS BW [MHz]	FL[MHz]	FH[MHz]	Limit[MHz]	Verdict
BLE_1M	Ant1	2402	0.704	2401.648	2402.352	0.5	PASS
		2440	0.704	2439.648	2440.352	0.5	PASS
		2480	0.696	2479.648	2480.344	0.5	PASS

### 10.1.2. Test Graphs

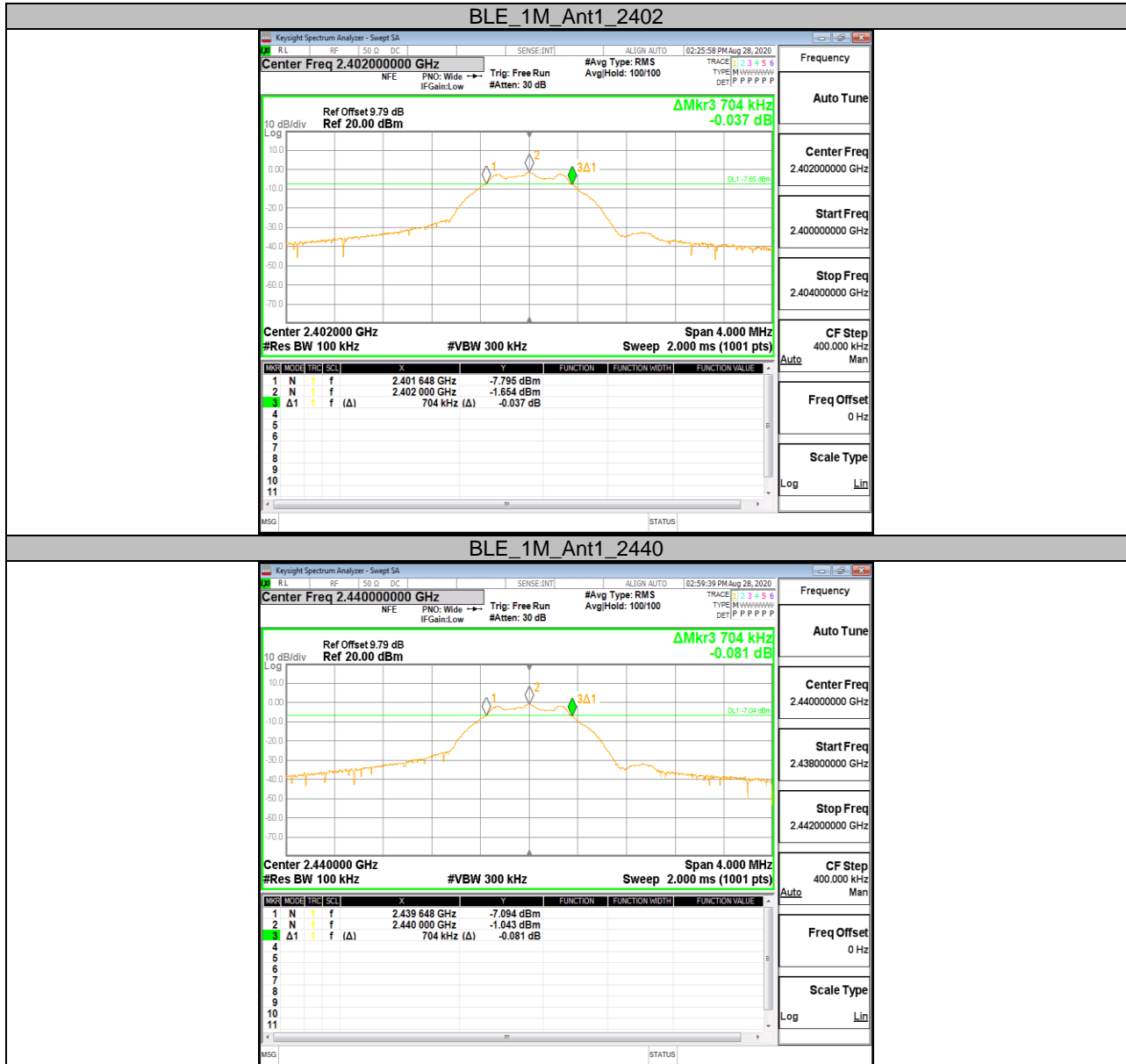

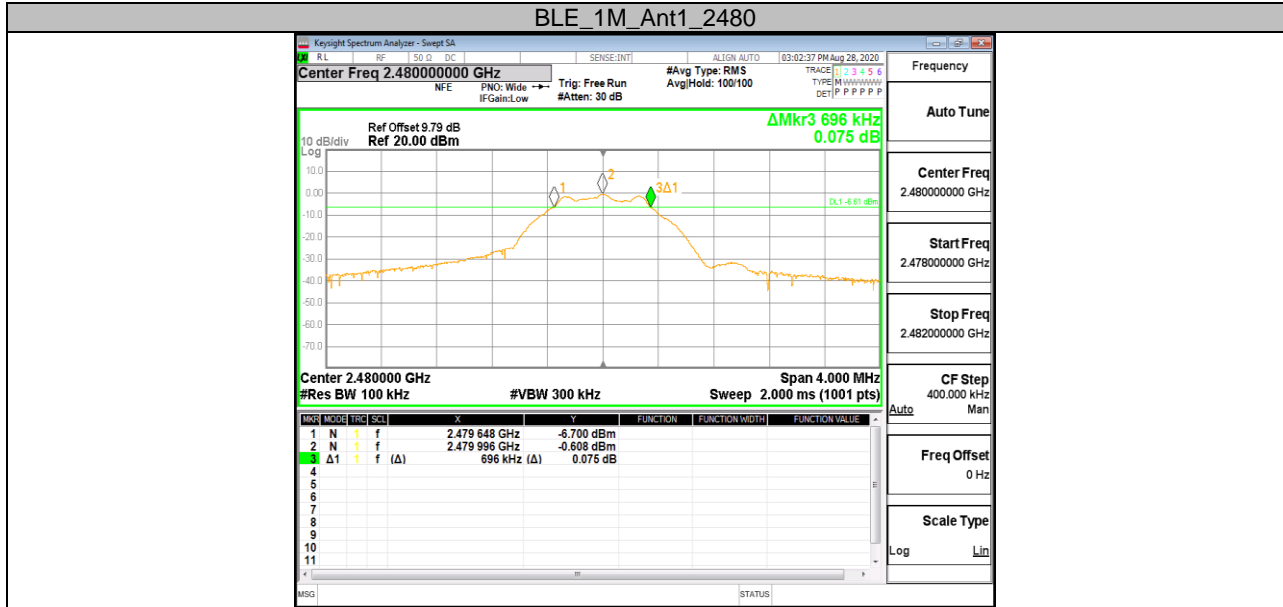



## 10.2. Appendix B: Occupied Channel Bandwidth

### 10.2.1. Test Result

Test Mode	Antenna	Channel	OCB [MHz]	FL[MHz]	FH[MHz]	Verdict
BLE_1M	Ant1	2402	1.0295	2401.487	2402.517	PASS
		2440	1.0293	2439.487	2440.516	PASS
		2480	1.0278	2479.487	2480.515	PASS



### 10.2.2. Test Graphs

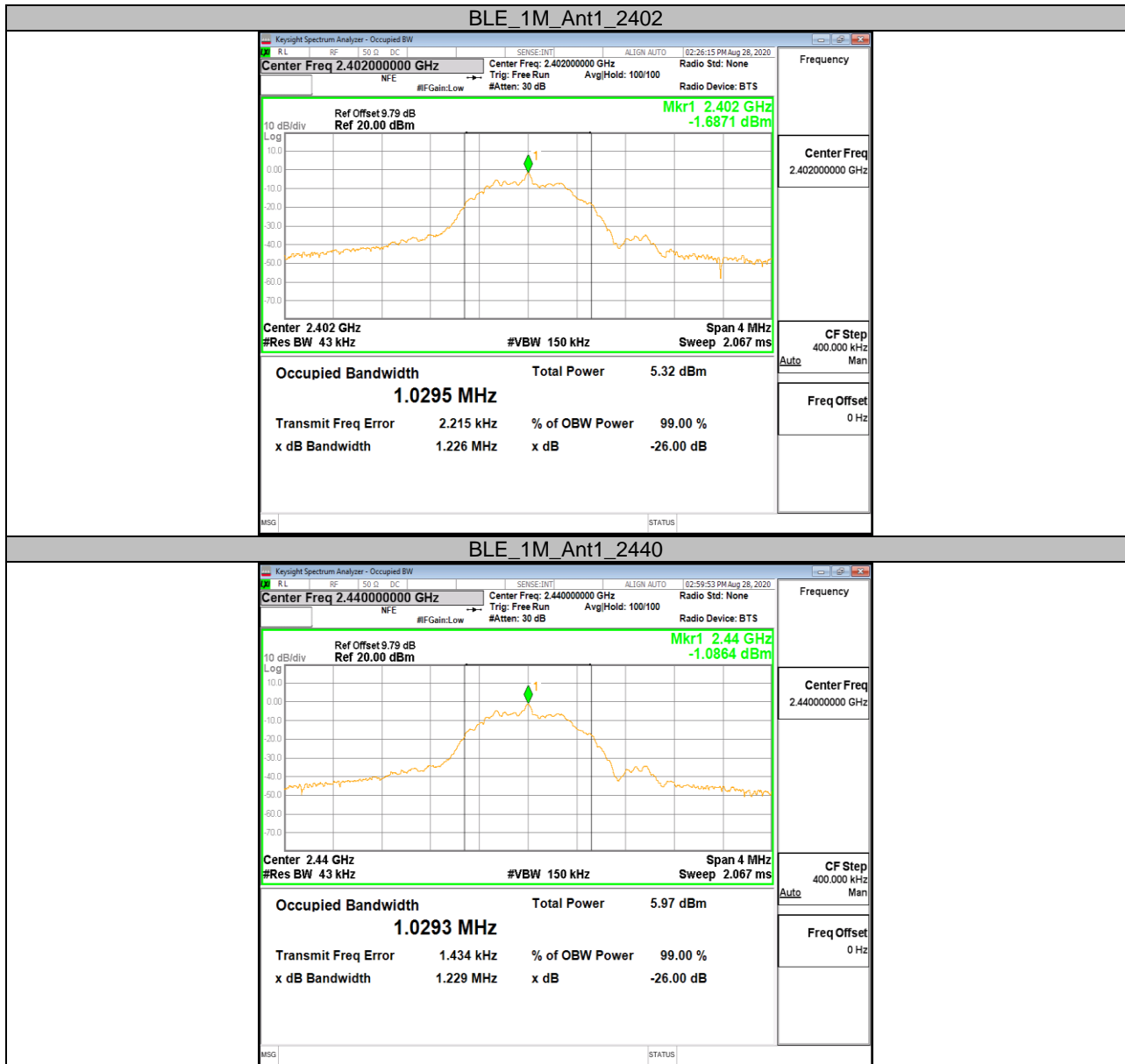

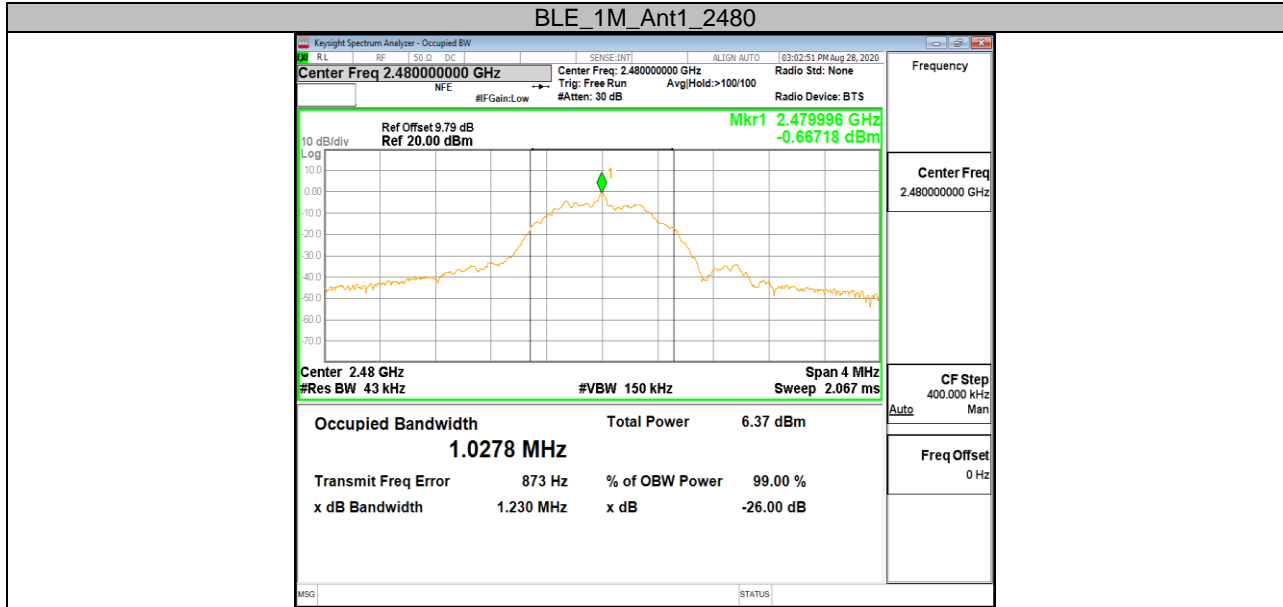





### 10.3. Appendix C: Maximum conducted output power

#### 10.3.1. Test Result

Test Mode	Antenna	Channel	Result[dBm]	Limit[dBm]	Verdict
BLE_1M	Ant1	2402	-1.45	30	PASS
		2440	-0.79	30	PASS
		2480	-0.38	30	PASS



## 10.4. Appendix D: Maximum power spectral density

### 10.4.1. Test Result

Test Mode	Antenna	Channel	Result[dBm/3kHz]	Limit[dBm/3kHz]	Verdict
BLE_1M	Ant1	2402	-15.59	<=8	PASS
		2440	-14.92	<=8	PASS
		2480	-14.56	<=8	PASS

### 10.4.2. Test Graphs

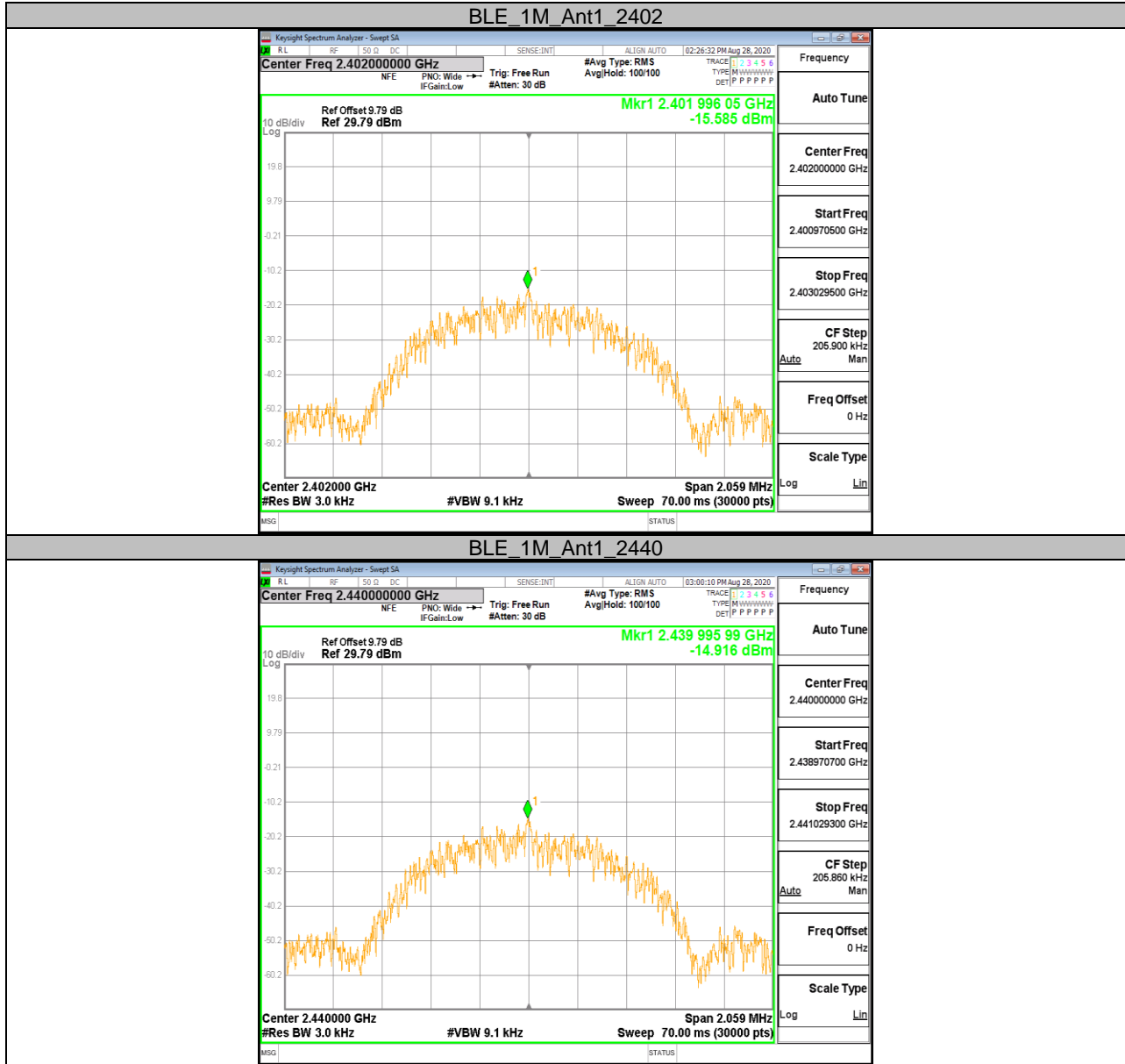

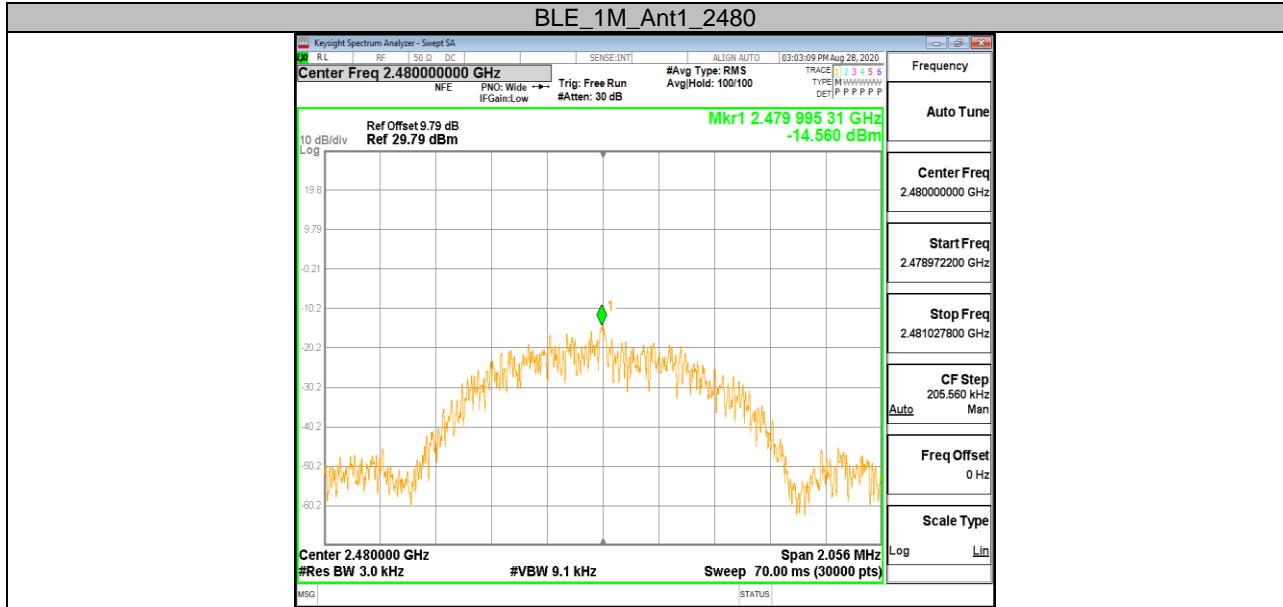



**10.5. Appendix E: Band edge measurements**  
**10.5.1. Test Result**

Test Mode	Antenna	ChName	Channel	Ref Level[dBm]	Result[dBm]	Limit[dBm]	Verdict
BLE_1M	Ant1	Low	2402	-1.64	-38.75	<=-21.64	PASS
		High	2480	-0.64	-43.83	<=-20.64	PASS



### 10.5.2. Test Graphs





## 10.6. Appendix F: Conducted Spurious Emission

### 10.6.1. Test Result

Test Mode	Antenna	Channel	Freq Range [MHz]	Ref Level [dBm]	Result[dBm]	Limit[dBm]	Verdict
BLE_1M	Ant1	2402	Reference	-1.65	-1.65	---	PASS
			30~1000	30~1000	-60.816	<=-21.65	PASS
			1000~26500	1000~26500	-54.284	<=-21.65	PASS
		2440	Reference	-1.05	-1.05	---	PASS
			30~1000	30~1000	-62.733	<=-21.049	PASS
			1000~26500	1000~26500	-53.961	<=-21.049	PASS
		2480	Reference	-0.65	-0.65	---	PASS
			30~1000	30~1000	-62.424	<=-20.653	PASS
			1000~26500	1000~26500	-54.435	<=-20.653	PASS



### 10.6.2. Test Graphs





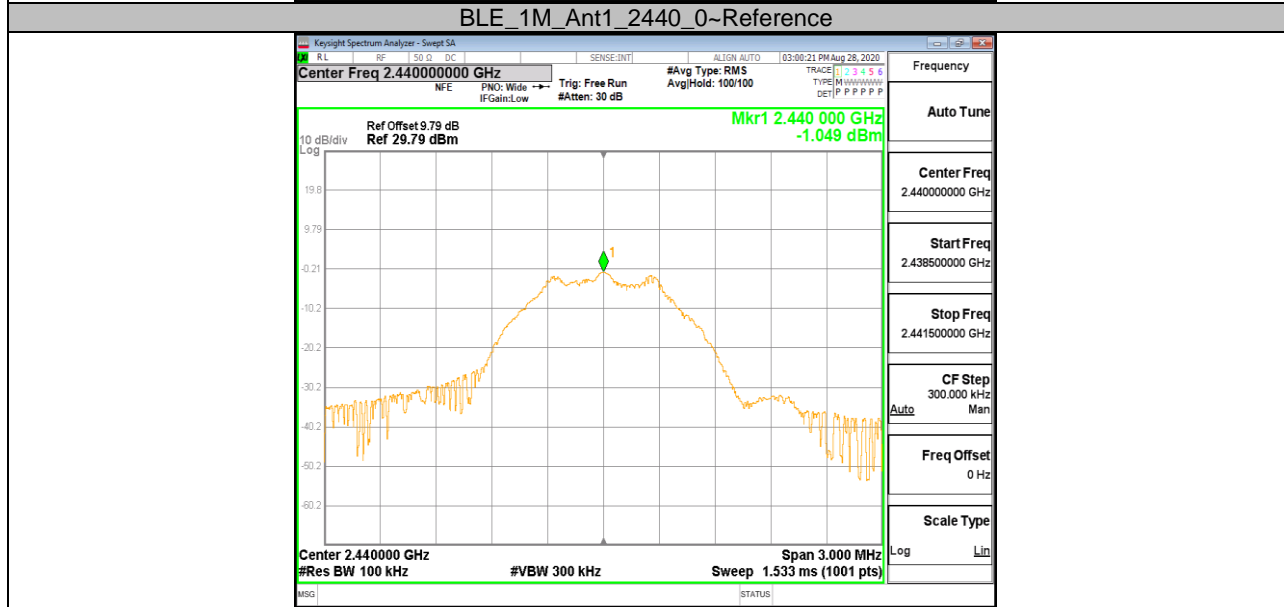
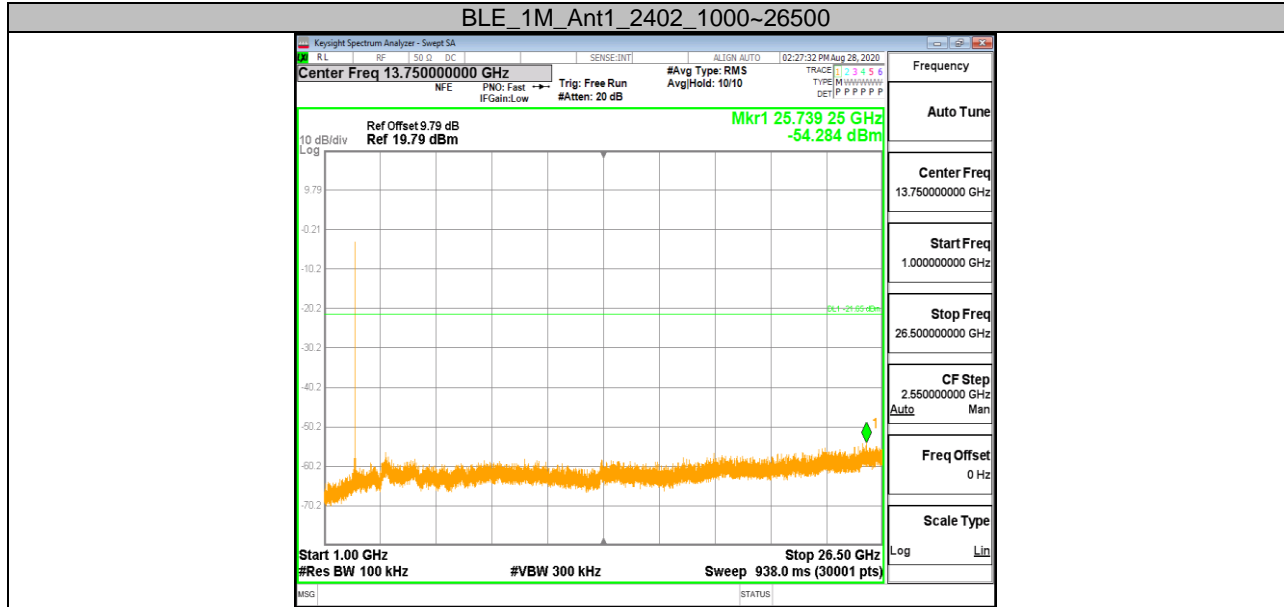

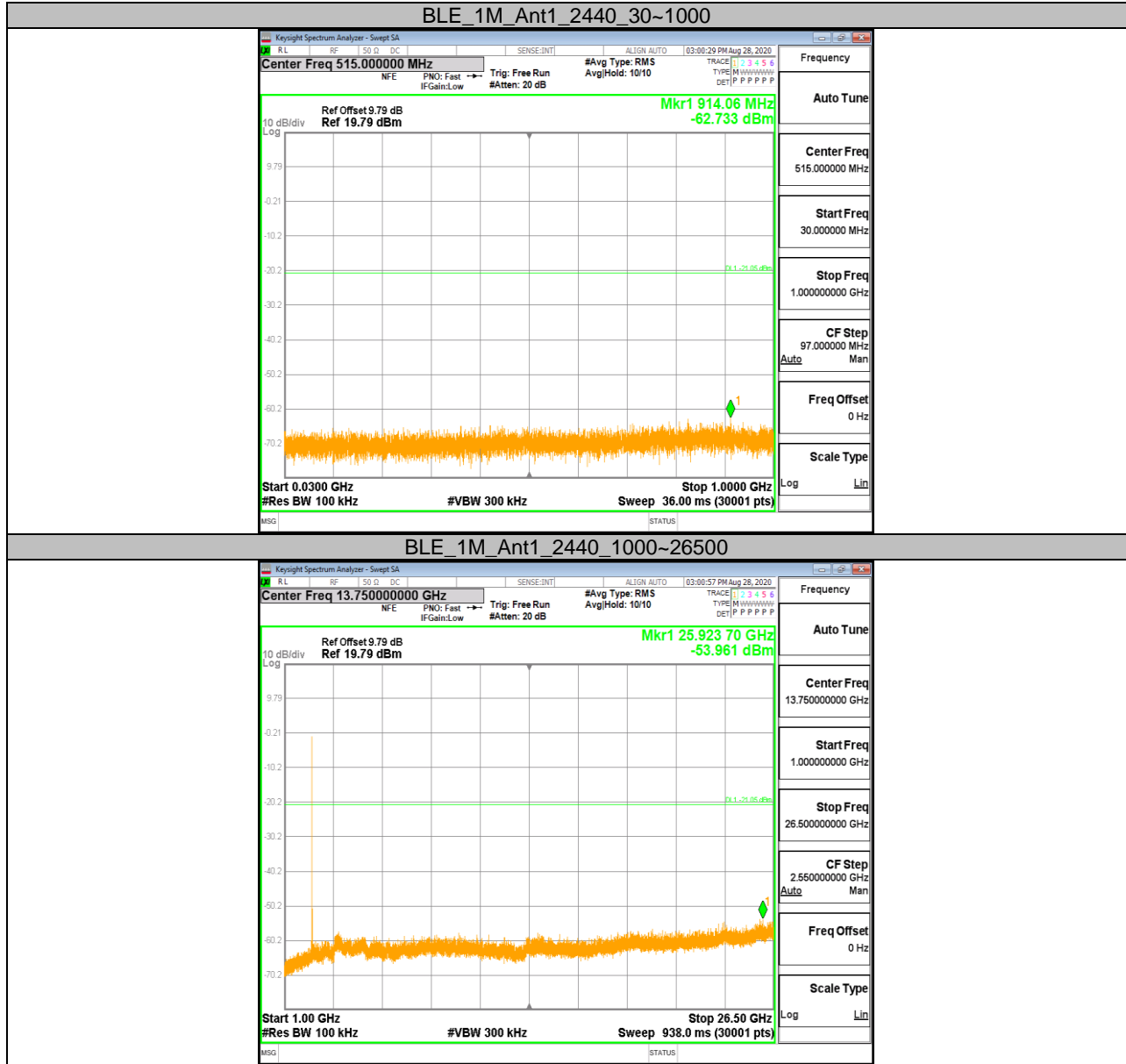

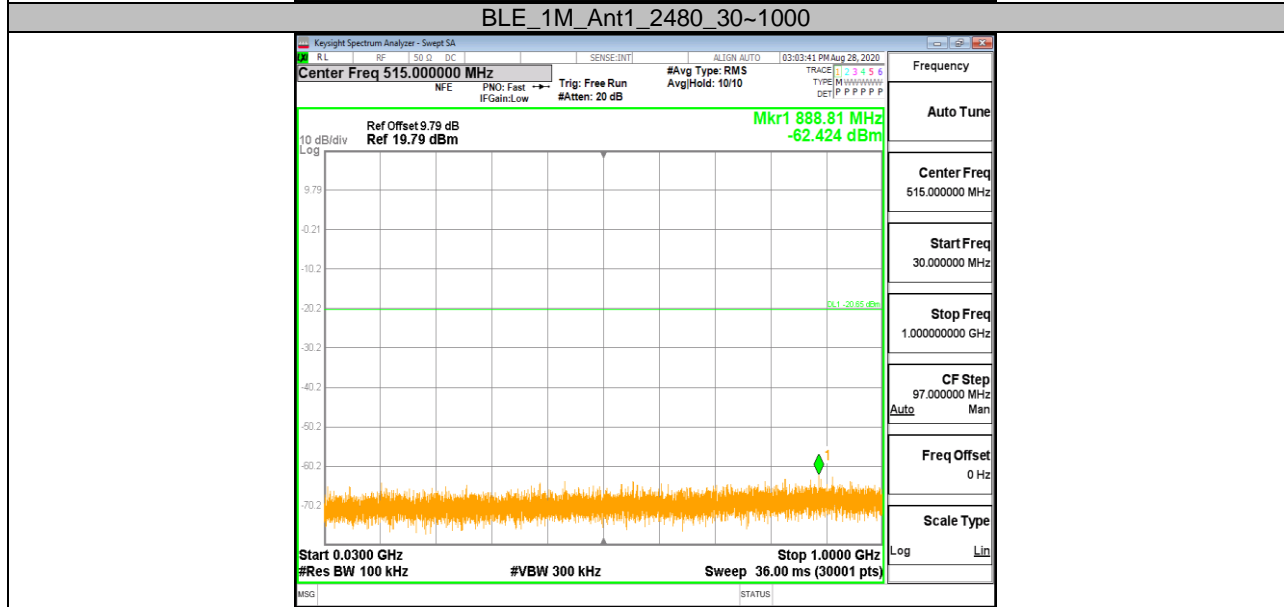
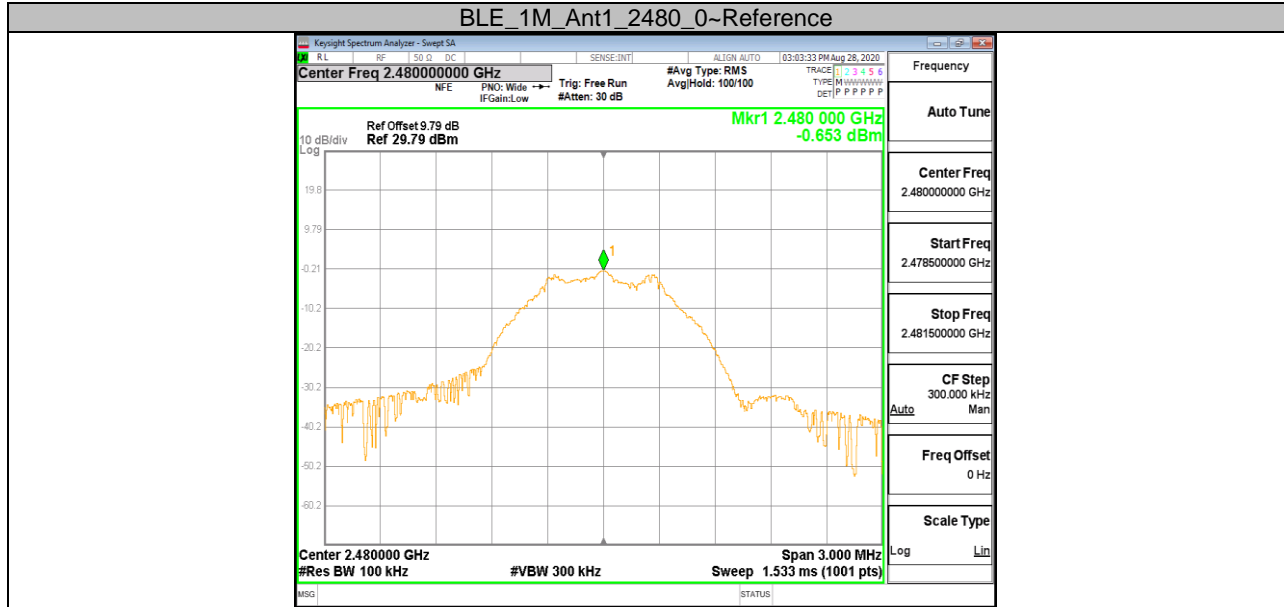

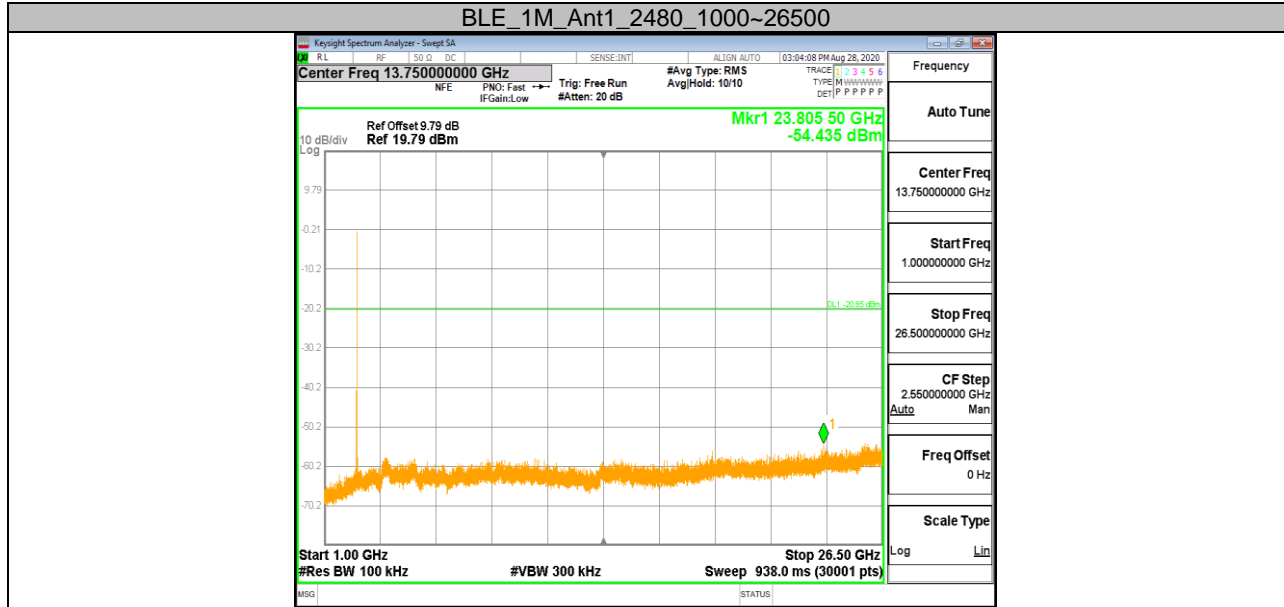



**10.7. Appendix G: Duty Cycle**  
**10.7.1. Test Result**

Mode	On Time (msec)	Period (msec)	Duty Cycle x (Linear)	Duty Cycle (%)	Duty Cycle Correction Factor (db)	1/T Minimum VBW (kHz)	Final setting For VBW (kHz)
BLE_1M	0.42	0.63	0.667	66.7	1.76	2.4	2.5

Note:

Duty Cycle Correction Factor= $10\log(1/x)$ .

Where: x is Duty Cycle (Linear)

Where: T is On Time (transmit duration)

If that calculated VBW is not available on the analyzer then the next higher value should be used.



### 10.7.2. Test Graphs

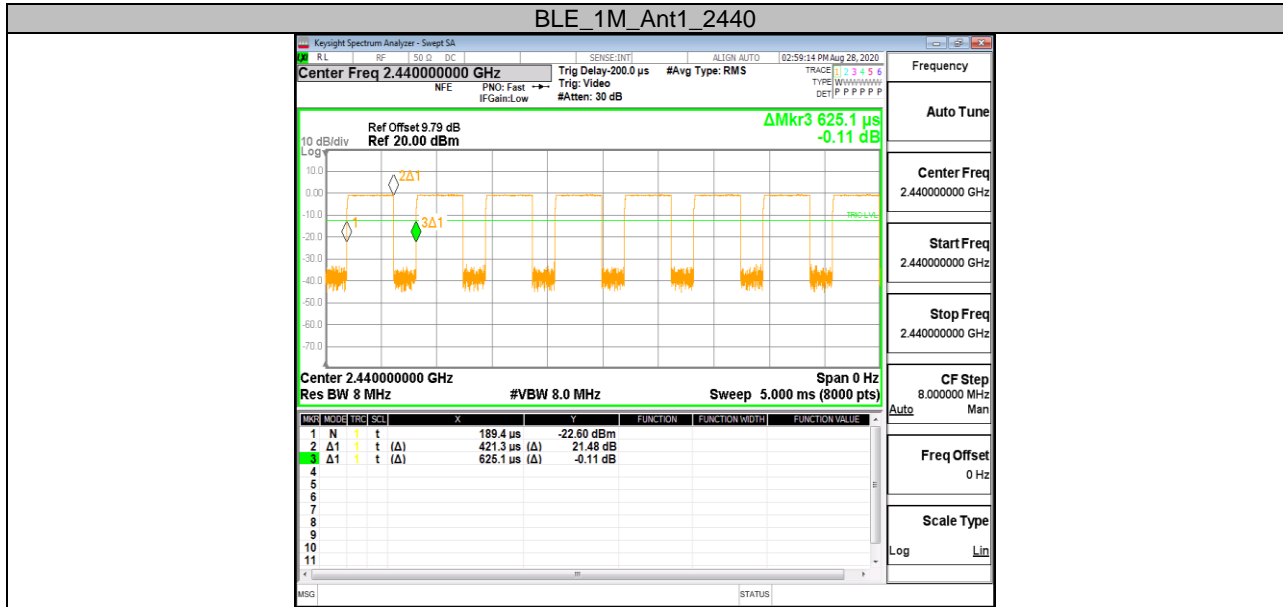

END OF REPORT