



TEST REPORT

No.I20N02443-SAR

For

TCL Communication Ltd.

LTE/UMTS/GSM Smartphone

Model Name: 5030A

With

Hardware Version: FS180-MB-V2.1

Software Version: 5030A_TGMX_1SIM_V1.6_20200908

FCC ID: 2ACCJB135

Issued Date: 2020-09-28

Note:

The test results in this test report relate only to the devices specified in this report. This report shall not be reproduced except in full without the written approval of SAICT.

Test Laboratory:

SAICT, Shenzhen Academy of Information and Communications Technology

Building G, Shenzhen International Innovation Center, No.1006 Shennan Road, Futian District, Shenzhen, Guangdong, P. R. China 518026.

Tel:+86(0)755-33322000, Fax:+86(0)755-33322001

Email: yewu@caict.ac.cn. www.saict.ac.cn



REPORT HISTORY

Report Number	Revision	Description	Issue Date
I20N02443-SAR	Rev.0	1st edition	2020-09-28

TCONTENTS

1. SUMMARY OF TEST REPORT	5
1.1. TEST ITEMS	5
1.2. TEST STANDARDS	5
1.3. TEST RESULT	5
1.4. TESTING LOCATION	5
1.5. PROJECT DATA	5
1.6. SIGNATURE	5
2. STATEMENT OF COMPLIANCE	6
3. CLIENT INFORMATION	8
3.1. APPLICANT INFORMATION.....	8
3.2. MANUFACTURER INFORMATION	8
4. EQUIPMENT UNDER TEST (EUT) AND ANCILLARY EQUIPMENT (AE)	9
4.1. ABOUT EUT	9
4.2. INTERNAL IDENTIFICATION OF EUT USED DURING THE TEST	10
4.3. INTERNAL IDENTIFICATION OF AE USED DURING THE TEST	10
5. TEST METHODOLOGY	11
5.1. APPLICABLE LIMIT REGULATIONS.....	11
5.2. APPLICABLE MEASUREMENT STANDARDS	11
6. SPECIFIC ABSORPTION RATE (SAR).....	12
6.1. INTRODUCTION.....	12
6.2. SAR DEFINITION.....	12
7. TISSUE SIMULATING LIQUIDS	13
7.1. TARGETS FOR TISSUE SIMULATING LIQUID	13
7.2. DIELECTRIC PERFORMANCE	13
8. SYSTEM VERIFICATION	17
8.1. SYSTEM SETUP.....	17
8.2. SYSTEM VERIFICATION	18
9. MEASUREMENT PROCEDURES	19
9.1. TESTS TO BE PERFORMED.....	19
9.2. GENERAL MEASUREMENT PROCEDURE	21
9.3. WCDMA MEASUREMENT PROCEDURES FOR SAR	22
9.4. BLUETOOTH & WLAN MEASUREMENT PROCEDURES FOR SAR.....	23
9.5. SAR MEASUREMENT FOR LTE.....	23
9.6. POWER DRIFT.....	24
10. CONDUCTED OUTPUT POWER	25
10.1. GSM MEASUREMENT RESULT	25
10.2. WCDMA MEASUREMENT RESULT	27
10.3. LTE MEASUREMENT RESULT	30
10.4. BLUETOOTH AND WLAN MEASUREMENT RESULT	68



11. SIMULTANEOUS TX SAR CONSIDERATIONS	69
11.1. INTRODUCTION.....	69
11.2. TRANSMIT ANTENNA SEPARATION DISTANCES.....	69
11.3. SAR MEASUREMENT POSITIONS.....	70
11.4. STANDALONE SAR TEST EXCLUSION CONSIDERATIONS.....	70
12. EVALUATION OF SIMULTANEOUS	71
13. SUMMARY OF TEST RESULTS	72
13.1. TESTING ENVIRONMENT.....	72
13.2. SAR RESULTS.....	73
13.3. WLAN EVALUATION FOR 2.4G.....	84
14. SAR MEASUREMENT VARIABILITY	86
15. MEASUREMENT UNCERTAINTY	88
15.1. MEASUREMENT UNCERTAINTY FOR NORMAL SAR TESTS (300MHZ~3GHZ).....	88
16. MAIN TEST INSTRUMENTS	89
ANNEX A: GRAPH RESULTS	90
ANNEX B: SYSTEMVERIFICATION RESULTS	114
ANNEX C: SAR MEASUREMENT SETUP	120
C.1. MEASUREMENT SET-UP.....	120
C.2. DASY5 E-FIELD PROBE SYSTEM.....	121
C.3. E-FIELD PROBE CALIBRATION.....	121
C.4. OTHER TEST EQUIPMENT.....	122
ANNEX D: POSITION OF THE WIRELESS DEVICE IN RELATION TO THE PHANTOM	126
D.1. GENERAL CONSIDERATIONS.....	126
D.2. BODY-WORN DEVICE.....	127
D.3. DESKTOP DEVICE.....	127
D.4. DUT SETUP PHOTOS.....	128
ANNEX E: EQUIVALENT MEDIA RECIPES	129
ANNEX F: SYSTEM VALIDATION	130
ANNEX G: DAE CALIBRATION CERTIFICATE	131
ANNEX H: PROBE CALIBRATION CERTIFICATE	134
ANNEX I: DIPOLE CALIBRATION CERTIFICATE	144
ANNEX J: EXTENDED CALIBRATION SAR DIPOLE	192
ANNEX K: ACCREDITATION CERTIFICATE	194



1. Summary of Test Report

1.1. Test Items

Description: LTE/UMTS/GSM Smartphone
Model Name: 5030A
Applicant's name: TCL Communication Ltd.
Manufacturer's Name: TCL Communication Ltd.

1.2. Test Standards

ANSI C95.1-1992, IEEE 1528-2013

1.3. Test Result

Pass. Please refer to "13. Summary of Test Results"

1.4. Testing Location

Address: Building G, Shenzhen International Innovation Center, No.1006 Shennan Road, Futian District, Shenzhen, Guangdong, P. R. China

1.5. Project Data

Testing Start Date: 2020-09-11

Testing End Date: 2020-09-23

1.6. Signature

Li Yongfu

(Prepared this test report)

Zhang Yunzhan

(Reviewed this test report)

Cao Junfei

(Approved this test report)

2. Statement of Compliance

The maximum results of Specific Absorption Rate (SAR) found during testing for TCL Communication Ltd. LTE/UMTS/GSM Smartphone 5030A are as follows:

Table 2.1: Highest Reported SAR for Head (1g)

Exposure Configuration	Technology Band	Highest Reported SAR 1g(W/Kg)	Equipment Class
Head	GSM850	0.40	PCE
	GSM1900	1.15	
	WCDMA Band 2	1.08	
	WCDMA Band 4	1.11	
	WCDMA Band 5	0.35	
	LTE Band 2	1.15	
	LTE Band 7	0.73	
	LTE Band 12	0.20	
	LTE Band 13	0.24	
	LTE Band 26	0.26	
	LTE Band 66	1.15	
	WLAN 2.4GHz	0.42	DTS

Table 2.2: Highest Reported SAR for Body (1g)

Exposure Configuration	Technology Band	Highest Reported SAR 1g(W/Kg)	Equipment Class
Hotspot/Body-worn	GSM850	0.58	PCE
	GSM1900	0.73	
	WCDMA Band 2	1.11	
	WCDMA Band 4	0.88	
	WCDMA Band 5	0.43	
	LTE Band 2	1.05	
	LTE Band 7	0.87	
	LTE Band 12	0.29	
	LTE Band 13	0.34	
	LTE Band 26	0.43	
	LTE Band 66	1.05	
	WLAN 2.4GHz	0.22	DTS

The SAR values found for the Mobile Phone are below the maximum recommended levels of 1.6 W/Kg as averaged over any 1g tissue according to the ANSI C95.1-1992.

The EUT battery must be fully charged and checked periodically during the test to ascertain uniform power output.

The measurement together with the test system set-up is described in annex C of this test report. A detailed description of the equipment under test can be found in chapter 4 of this test report.

The highest reported SAR value is obtained at the case of **(Table 2.1 & 2.2)**, and the value is: **1.15 W/kg (1g)**.

Table2.3: The sum of reported SAR values for main antenna and WLAN

<i>/</i>	Position	WWAN Antenna (W/kg)	WLAN (W/kg)	Sum (W/kg)
Highest reported SAR value for Head	Right Touch	1.15	0.20	1.35
Highest reported SAR value for Body	Rear	1.11	0.22	1.33

Note: the test positions of above tables are for the worse case that has been evaluated.

Table2.4: The sum of reported SAR values for main antenna and Bluetooth

<i>/</i>	Position	WWAN Antenna (W/kg)	Bluetooth (W/kg)	Sum (W/kg)
Highest reported SAR value for Head	Right Touch	1.15	0.23	1.38
Highest reported SAR value for Body	Rear	1.11	0.12	1.23

Note: the test positions of above tables are for the worse case that has been evaluated.

According to the above tables, the highest sum of reported SAR values is **1.38 W/kg (1g)**.

The detail for simultaneous transmission consideration is described in chapter 12.



3. Client Information

3.1. Applicant Information

Company Name:	TCL Communication Ltd.
Address:	5/F, Building 22E, 22 Science Park East Avenue, Hong Kong Science Park, Shatin, NT, Hong Kong
City:	/
Country:	/
Telephone:	0086-755-36611722

3.2. Manufacturer Information

Company Name:	TCL Communication Ltd.
Address:	5/F, Building 22E, 22 Science Park East Avenue, Hong Kong Science Park, Shatin, NT, Hong Kong
City:	/
Country:	/
Telephone:	0086-755-36611722

4. Equipment under Test (EUT) and Ancillary Equipment (AE)

4.1. About EUT

Description:	LTE/UMTS/GSM Smartphone
Model Name:	5030A
Marketing Name:	/
Operating mode(s):	GSM850/1900, WCDMA Band2/4/5, LTE Band2/7/12/13/26/66, Bluetooth, WLAN2.4G
Condition of EUT as received:	No obvious damage in appearance
Tested Tx Frequency:	825 – 848.8MHz (GSM 850)
	1850.2 – 1910MHz (GSM 1900)
	1852.4 – 1907.6MHz (WCDMA Band 2)
	1712.4 – 1752.6MHz (WCDMA Band 4)
	826.4 – 846.6MHz (WCDMA Band 5)
	1850.7 – 1909.3MHz (LTE Band 2)
	2502.5 – 2567.5MHz (LTE Band 7)
	699.7 – 715.3MHz (LTE Band 12)
	779.5 – 784.5MHz (LTE Band 13)
	814.7 – 848.3MHz (LTE Band 26)
	1710.7 – 1779.3MHz (LTE Band 66)
	2402 – 2480MHz (Bluetooth 2.4G)
2412 – 2462MHz (WLAN 2.4G)	
GPRS / EGPRS Multislot Class:	12
GPRS capability Class:	B
Test device Production information:	Production unit
Device type:	Portable device
Antenna type:	Integrated antenna
Hotspot mode:	Support
Product Dimensions:	Long 159.1mm ;Wide 75.2mm ; Overall Diagonal 168mm
Display Diagonal:	151mm
Remark: 1. This device does not support DTM operation. 2. There is one power reduction level of WWAN antenna. 3. For WWAN transmitter Head exposure conditions: Reduced power level 1 – GSM1900, WCDMA Band 2/4, LTE Band 2/66 While the device WWAN is transmitting at the WWAN antenna and the audio is actively routed through the earpiece receiver, power reduction enabled for those bands.	

4.2. Internal Identification of EUT used during the test

EUT ID*	IMEI	HW Version	SW Version
UT01aa	350770410000537	FS180-MB-V2.1	5030A_TGMX_1SIM_V1.6_20200908
UT02aa	350770410000545	FS180-MB-V2.1	5030A_TGMX_1SIM_V1.6_20200908
UT05aa	350770410000602	FS180-MB-V2.1	5030A_TGMX_1SIM_V1.6_20200908
UT10aa	350770410001774	FS180-MB-V2.1	5030A_TGMX_1SIM_V1.6_20200908

*EUT ID: is used to identify the test sample in the lab internally.

Note: It is performed to test SAR with the UT01aa&08aa, and conducted power with the UT05aa&10aa.

4.3. Internal Identification of AE used during the test

AE ID*	Description	Type	Manufacturer
AE1	Battery	LI-Polymer Battery	VENKE
AE2	Battery	LI-Polymer Battery	TIANMAO
AE3	Headset	WH15/CCB0046A10C1	JUWEI
AE4	Headset	WH15/CCB0046A10C4	MEIHAO

*AE ID: is used to identify the test sample in the lab internally.

Note: The device has two types of batteries and headsets. AE1 battery was used for the initial test, AE2 battery was used for verification tests with the worst configuration.

5. Test Methodology

5.1. Applicable Limit Regulations

ANSI C95.1–1992: IEEE Standard for Safety Levels with Respect to Human Exposure to Radio Frequency Electromagnetic Fields, 3 kHz to 300 GHz.

It specifies the maximum exposure limit of **1.6 W/kg** as averaged over any 1 gram of tissue for portable devices being used within 20 cm of the user in the uncontrolled environment.

5.2. Applicable Measurement Standards

IEEE 1528–2013: Recommended Practice for Determining the Peak Spatial-Average Specific Absorption Rate (SAR) in the Human Head from Wireless Communications Devices: Experimental Techniques.

KDB 447498 D01 General RF Exposure Guidance v06: Mobile and Portable Devices RF Exposure Procedures and Equipment Authorization Policies.

KDB 648474 D04 Handset SAR v01r03: SAR Evaluation Considerations for Wireless Handsets.

KDB 941225 D01 SAR test for 3G devices v03r01: SAR Measurement Procedures for 3G Devices

KDB 941225 D05 SAR for LTE Devices v02r05: SAR Evaluation Considerations for LTE Devices

KDB 941225 D06 Hot Spot SAR v02r01: SAR Evaluation Procedures for Portable Devices with Wireless Router Capabilities

KDB 248227 D01 802.11 Wi-Fi SAR v02r02: SAR Guidance for IEEE 802.11 (Wi-Fi) Transmitters.

KDB 865664 D01 SAR measurement 100 MHz to 6 GHz v01r04: SAR Measurement Requirements for 100 MHz to 6 GHz.

KDB 865664 D02 RF Exposure Reporting v01r02: RF Exposure Compliance Reporting and Documentation Considerations

TCB workshop April 2019; RF Exposure Procedures (Tissue Simulating Liquids)

6. Specific Absorption Rate (SAR)

6.1. Introduction

SAR is related to the rate at which energy is absorbed per unit mass in an object exposed to a radio field. The SAR distribution in a biological body is complicated and is usually carried out by experimental techniques or numerical modeling. The standard recommends limits for two tiers of groups, occupational/controlled and general population/uncontrolled, based on a person's awareness and ability to exercise control over his or her exposure. In general, occupational/controlled exposure limits are higher than the limits for general population/uncontrolled.

6.2. SAR Definition

The SAR definition is the time derivative (rate) of the incremental energy (dW) absorbed by (dissipated in) an incremental mass (dm) contained in a volume element (dv) of a given density (ρ). The equation description is as below:

$$SAR = \frac{d}{dt} \left(\frac{dW}{dm} \right) = \frac{d}{dt} \left(\frac{dW}{\rho dv} \right)$$

SAR is expressed in units of Watts per kilogram (W/kg)

SAR measurement can be either related to the temperature elevation in tissue by

$$SAR = c \left(\frac{\delta T}{\delta t} \right)$$

Where: C is the specific heat capacity, δT is the temperature rise and δt is the exposure duration, or related to the electrical field in the tissue by

$$SAR = \frac{\sigma |E|^2}{\rho}$$

Where: σ is the conductivity of the tissue, ρ is the mass density of tissue and E is the RMS electrical field strength.

However for evaluating SAR of low power transmitter, electrical field measurement is typically applied.

7. Tissue Simulating Liquids

7.1. Targets for tissue simulating liquid

Table 7.1: Targets for tissue simulating liquid

Frequency (MHz)	Liquid Type	Conductivity (σ)	$\pm 5\%$ Range	Permittivity (ϵ)	$\pm 5\%$ Range
750	Head	0.89	0.85~0.93	41.9	39.8~44.0
835	Head	0.90	0.86~0.95	41.5	39.4~43.6
1750	Head	1.37	1.30~1.44	40.1	38.1~42.1
1900	Head	1.40	1.33~1.47	40.0	38.0~42.0
2450	Head	1.80	1.71~1.89	39.2	37.2~41.2
2550	Head	1.91	1.81~2.01	39.1	37.1~41.0

7.2. Dielectric Performance

Table 7.2: Dielectric Performance of Tissue Simulating Liquid

Measurement Date (yyyy-mm-dd)	Type	Frequency	Conductivity σ (S/m)	Drift (%)	Permittivity ϵ	Drift (%)
2020-09-11	Head	750	0.902	1.35	40.84	-2.53
2020-09-14	Head	835	0.918	2.00	40.65	-2.05
2020-09-22	Head	1750	1.384	1.02	39.37	-1.82
2020-09-22	Head	1900	1.415	1.07	39.15	-2.13
2020-09-19	Head	2450	1.841	2.28	38.48	-1.84
2020-09-23	Head	2550	1.949	2.04	38.06	-2.66

Note: The liquid temperature is 22.0°C.

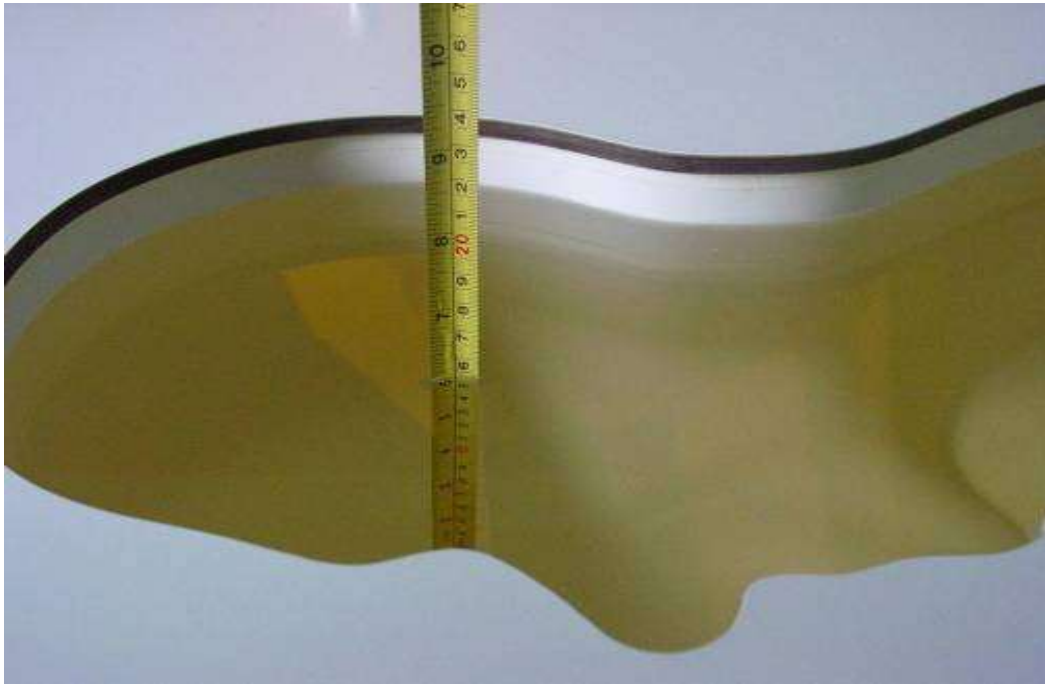

Picture 7-1: Liquid depth in the Head Phantom (750MHz)



Picture 7-2: Liquid depth in the Head Phantom (835MHz)



Picture 7-3: Liquid depth in the Head Phantom (1750MHz)



Picture 7-4: Liquid depth in the Head Phantom (1900MHz)



Picture 7-5: Liquid depth in the Head Phantom(2450MHz)

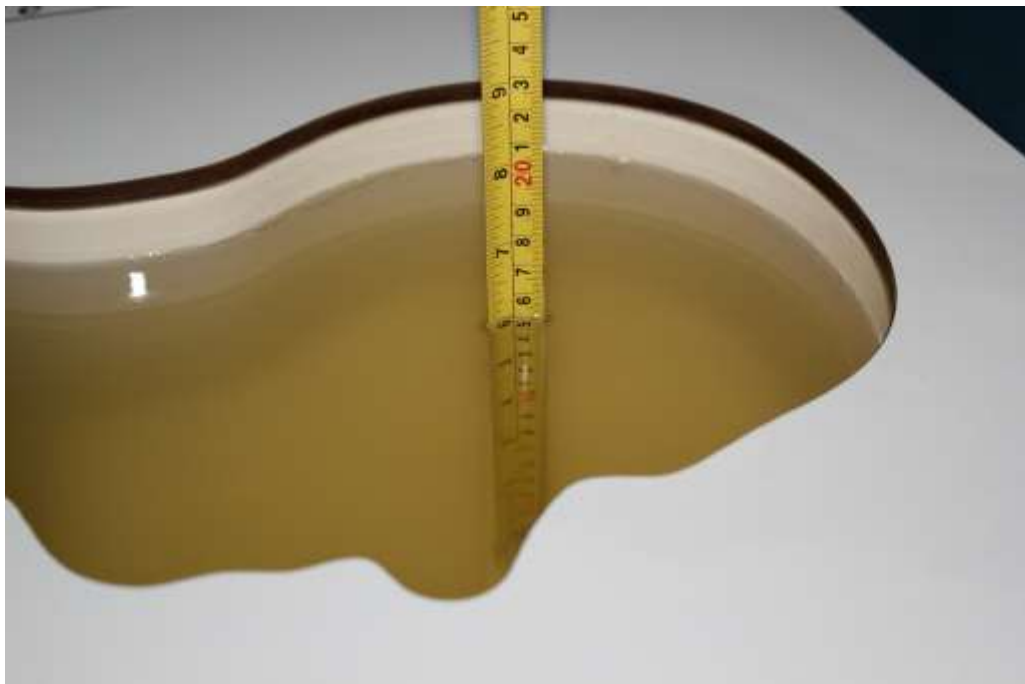

Picture 7-6: Liquid depth in the Head Phantom(2550MHz)

8. System verification

8.1. System Setup

In the simplified setup for system evaluation, the DUT is replaced by a calibrated dipole and the power source is replaced by a continuous wave that comes from a signal generator. The calibrated dipole must be placed beneath the flat phantom section of the SAM twin phantom with the correct distance holder. The distance holder should touch the phantom surface with a light pressure at the reference marking and be oriented parallel to the long side of the phantom. The equipment setup is shown below:

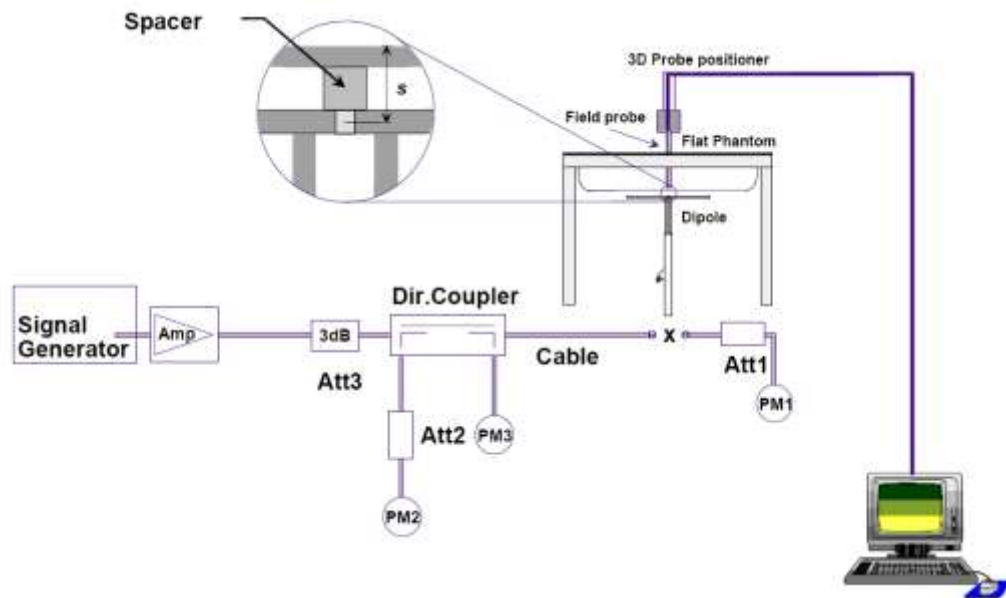

Picture 8.1 System Setup for System Evaluation



Picture 8.2 Photo of Dipole Setup

8.2. System Verification

SAR system verification is required to confirm measurement accuracy, according to the tissue dielectric media, probe calibration points and other system operating parameters required for measuring the SAR of a test device. The system verification must be performed for each frequency band and within the valid range of each probe calibration point required for testing the device.

Table 8.1: System Verification of Head

Measurement Date (yyyy-mm-dd)	Frequency	Target value (W/kg)		Measured value (W/kg)		Deviation (%)	
		10 g Average	1 g Average	10 g Average	1 g Average	10 g Average	1 g Average
2020-09-11	750 MHz	5.70	8.53	5.88	8.92	3.16	4.57
2020-09-14	835 MHz	6.29	9.62	6.44	9.96	2.38	3.53
2020-09-22	1750 MHz	19.30	36.40	19.52	37.44	1.14	2.86
2020-09-22	1900 MHz	21.00	40.50	21.32	41.60	1.52	2.72
2020-09-19	2450 MHz	24.10	52.00	24.80	54.40	2.90	4.62
2020-09-23	2550 MHz	26.50	57.80	27.00	60.00	1.89	3.81

9. Measurement Procedures

9.1. Tests to be performed

In order to determine the highest value of the peak spatial-average SAR of a handset, all device positions, configurations and operational modes shall be tested for each frequency band according to steps 1 to 3 below. A flowchart of the test process is shown in picture 9.1.

Step 1: The tests described in 9.2 shall be performed at the channel that is closest to the center of the transmit frequency band (f_c) for:

- a) all device positions (cheek and tilt, for both left and right sides of the SAM phantom, as described in annex D),
- b) all configurations for each device position in a), e.g., antenna extended and retracted, and
- c) all operational modes, e.g., analogue and digital, for each device position in a) and configuration in b) in each frequency band.

If more than three frequencies need to be tested according to 11.1 (i.e., $N_c > 3$), then all frequencies, configurations and modes shall be tested for all of the above test conditions.

Step 2: For the condition providing highest peak spatial-average SAR determined in Step 1, perform all tests described in 9.2 at all other test frequencies, i.e., lowest and highest frequencies. In addition, for all other conditions (device position, configuration and operational mode) where the peak spatial-average SAR value determined in Step 1 is within 3 dB of the applicable SAR limit, it is recommended that all other test frequencies shall be tested as well.

Step 3: Examine all data to determine the highest value of the peak spatial-average SAR found in Steps 1 to 2.

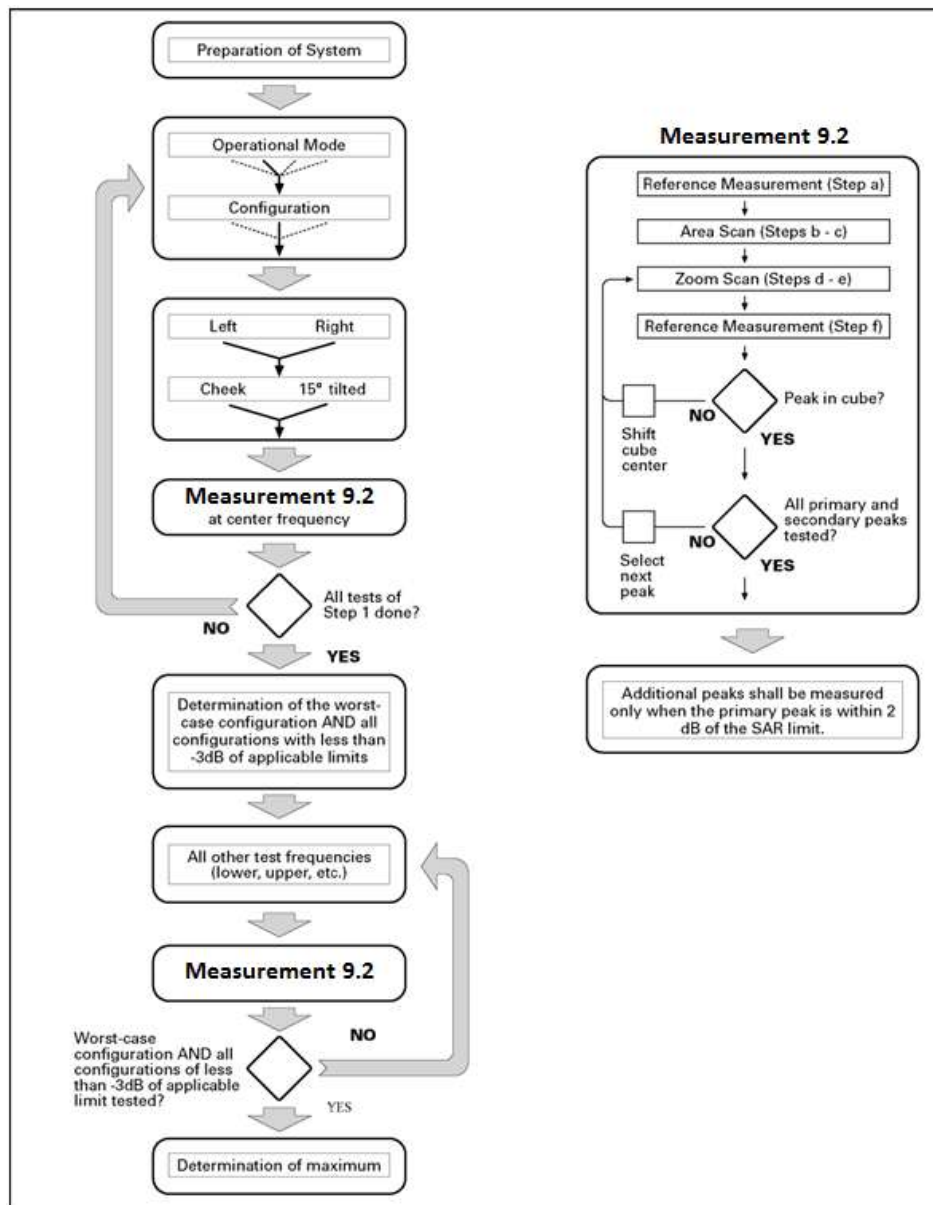

Picture 9.1 Block diagram of the tests to be performed

9.2. General Measurement Procedure

The area and zoom scan resolutions specified in the table below must be applied to the SAR measurements and fully documented in SAR reports to qualify for TCB approval. Probe boundary effect error compensation is required for measurements with the probe tip closer than half a probe tip diameter to the phantom surface. Both the probe tip diameter and sensor offset distance must satisfy measurement protocols; to ensure probe boundary effect errors are minimized and the higher fields closest to the phantom surface can be correctly measured and extrapolated to the phantom surface for computing 1-g SAR. Tolerances of the post-processing algorithms must be verified by the test laboratory for the scan resolutions used in the SAR measurements, according to the reference distribution functions specified in IEEE Std 1528-2013. The results should be documented as part of the system validation records and may be requested to support test results when all the measurement parameters in the following table are not satisfied.

		≤ 3 GHz	> 3 GHz
Maximum distance from closest measurement point (geometric center of probe sensors) to phantom surface		5 ± 1 mm	$\frac{1}{2} \cdot \delta \cdot \ln(2) \pm 0.5$ mm
Maximum probe angle from probe axis to phantom surface normal at the measurement location		$30^\circ \pm 1^\circ$	$20^\circ \pm 1^\circ$
Maximum area scan spatial resolution: $\Delta x_{Area}, \Delta y_{Area}$		≤ 2 GHz: ≤ 15 mm 2 – 3 GHz: ≤ 12 mm	3 – 4 GHz: ≤ 12 mm 4 – 6 GHz: ≤ 10 mm
		When the x or y dimension of the test device, in the measurement plane orientation, is smaller than the above, the measurement resolution must be \leq the corresponding x or y dimension of the test device with at least one measurement point on the test device.	
Maximum zoom scan spatial resolution: $\Delta x_{Zoom}, \Delta y_{Zoom}$		≤ 2 GHz: ≤ 8 mm 2 – 3 GHz: ≤ 5 mm*	3 – 4 GHz: ≤ 5 mm* 4 – 6 GHz: ≤ 4 mm*
Maximum zoom scan spatial resolution, normal to phantom surface	uniform grid: $\Delta z_{Zoom}(n)$	≤ 5 mm	3 – 4 GHz: ≤ 4 mm 4 – 5 GHz: ≤ 3 mm 5 – 6 GHz: ≤ 2 mm
	graded grid $\Delta z_{Zoom}(1)$: between 1 st two points closest to phantom surface	≤ 4 mm	3 – 4 GHz: ≤ 3 mm 4 – 5 GHz: ≤ 2.5 mm 5 – 6 GHz: ≤ 2 mm
	$\Delta z_{Zoom}(n>1)$: between subsequent points	$\leq 1.5 \cdot \Delta z_{Zoom}(n-1)$	
Minimum zoom scan volume	x, y, z	≥ 30 mm	3 – 4 GHz: ≥ 28 mm 4 – 5 GHz: ≥ 25 mm 5 – 6 GHz: ≥ 22 mm
Note: δ is the penetration depth of a plane-wave at normal incidence to the tissue medium; see draft standard IEEE P1528-2011 for details. * When zoom scan is required and the <i>reported</i> SAR from the area scan based 1-g SAR estimation procedures of KDB 447498 is ≤ 1.4 W/kg, ≤ 8 mm, ≤ 7 mm and ≤ 5 mm zoom scan resolution may be applied, respectively, for 2 GHz to 3 GHz, 3 GHz to 4 GHz and 4 GHz to 6 GHz.			

9.3. WCDMA Measurement Procedures for SAR

The following procedures are applicable to WCDMA handsets operating under 3GPP Release99, Release 5 and Release 6. The default test configuration is to measure SAR with an established radio link between the DUT and a communication test set using a 12.2kbps RMC (reference measurement channel) configured in Test Loop Mode 1. SAR is selectively confirmed for other physical channel configurations (DPCCH & DPDCH_n), HSDPA and HSPA (HSUPA/HSDPA) modes according to output power, exposure conditions and device operating capabilities. Both uplink and downlink should be configured with the same RMC or AMR, when required. SAR for Release 5 HSDPA and Release 6 HSPA are measured using the applicable FRC (fixed reference channel) and E-DCH reference channel configurations. Maximum output power is verified according to applicable versions of 3GPP TS 34.121 and SAR must be measured according to these maximum output conditions. When Maximum Power Reduction (MPR) is not implemented according to Cubic Metric (CM) requirements for Release 6 HSPA, the following procedures do not apply.

For Release 5 HSDPA Data Devices:

Sub-test	β_c	β_d	β_d (SF)	β_c / β_d	β_{hs}	CM/dB
1	2/15	15/15	64	2/15	4/15	0.0
2	12/15	15/15	64	12/15	24/25	1.0
3	15/15	8/15	64	15/8	30/15	1.5
4	15/15	4/15	64	15/4	30/15	1.5

For Release 6 HSPA Data Devices

Sub-test	β_c	β_d	β_d (SF)	β_c / β_d	β_{hs}	β_{ec}	β_{ed}	β_{ed} (SF)	β_{ed} (codes)	CM (dB)	MPR (dB)	AG Index	E-TFCI
1	11/15	15/15	64	11/15	22/15	209/225	1039/225	4	1	1.0	0.0	20	75
2	6/15	15/15	64	6/15	12/15	12/15	12/15	4	1	3.0	2.0	12	67
3	15/15	9/15	64	15/9	30/15	30/15	$\beta_{ed1}:47/15$ $\beta_{ed2}:47/15$	4	2	2.0	1.0	15	92
4	2/15	15/15	64	2/15	4/15	4/15	56/75	4	1	3.0	2.0	17	71
5	15/15	15/15	64	15/15	24/15	30/15	134/15	4	1	1.0	0.0	21	81

9.4. Bluetooth & WLAN Measurement Procedures for SAR

Normal network operating configurations are not suitable for measuring the SAR of 802.11 transmitters in general. Unpredictable fluctuations in network traffic and antenna diversity conditions can introduce undesirable variations in SAR results. The SAR for these devices should be measured using chipset based test mode software to ensure that the results are consistent and reliable.

Chipset based test mode software is hardware dependent and generally varies among manufacturers. The device operating parameters established in a test mode for SAR measurements must be identical to those programmed in production units, including output power levels, amplifier gain settings and other RF performance tuning parameters. The test frequencies should correspond to actual channel frequencies defined for domestic use. SAR for devices with switched diversity should be measured with only one antenna transmitting at a time during each SAR measurement, according to a fixed modulation and data rate. The same data pattern should be used for all measurements.

9.5. SAR Measurement for LTE

SAR tests for LTE are performed with a base station simulator, Anristu MT8820C. Closed loop power control was used so the UE transmits with maximum output power during SAR testing. All powers were measured with the Anristu MT8820C. It is performed for conducted power and SAR based on the KDB941225 D05.

SAR is evaluated separately according to the following procedures for the different test positions in each exposure condition – head, body, body-worn accessories and other use conditions. The procedures in the following subsections are applied separately to test each LTE frequency band.

1) QPSK with 1 RB allocation

Start with the largest channel bandwidth and measure SAR for QPSK with 1 RB allocation, using the RB offset and required test channel combination with the highest maximum output power among RB offsets at the upper edge, middle and lower edge of each required test channel. When the reported SAR is ≤ 0.8 W/kg, testing of the remaining RB offset configurations and required test channels is not required for 1 RB allocation; otherwise, SAR is required for the remaining required test channels and only for the RB offset configuration with the highest output power for that channel. When the reported SAR of a required test channel is > 1.45 W/kg, SAR is required for all three RB offset configurations for that required test channel.

2) QPSK with 50% RB allocation

The procedures required for 1 RB allocation in 1) are applied to measure the SAR for QPSK with 50% RB allocation.

3) QPSK with 100% RB allocation

For QPSK with 100% RB allocation, SAR is not required when the highest maximum output power for 100% RB allocation is less than the highest maximum output power in 50% and 1 RB allocations and the highest reported SAR for 1 RB and 50% RB allocation in 1) and 2) are ≤ 0.8 W/kg. Otherwise, SAR is measured for the highest output power channel; and if the reported SAR is > 1.45 W/kg, the remaining required test channels must also be tested.



9.6. Power Drift

To control the output power stability during the SAR test, DASY5 system calculates the power drift by measuring the E-field at the same location at the beginning and at the end of the measurement for each test position. These drift values can be found in Section 14 labeled as: (Power Drift [dB]). This ensures that the power drift during one measurement is within 5%.

10. Conducted Output Power

10.1. GSM Measurement result

During the process of testing, the EUT was controlled via Agilent Digital Radio Communication tester (E5515C) to ensure the maximum power transmission and proper modulation. This result contains conducted output power for the EUT. In all cases, the measured peak output power should be greater and within 5% than EMI measurement.

Table 10.1: The conducted power measurement results for GSM

Full Power				
GSM 850MHz	Tune up	Conducted Power(dBm)		
		Channel 251(848.8MHz)	Channel 190(836.6MHz)	Channel 128(824.2MHz)
	34.0	33.25	33.15	33.25
GSM 1900MHz	Tune up	Conducted Power(dBm)		
		Channel 810(1909.8MHz)	Channel 661(1880MHz)	Channel512(1850.2MHz)
	31.5	30.57	30.76	30.87
Reduced power level 1				
GSM 1900MHz	Tune up	Conducted Power(dBm)		
		Channel 810(1909.8MHz)	Channel 661(1880MHz)	Channel512(1850.2MHz)
	28.5	27.68	27.87	28.07

Table 10.2: The conducted power measurement results for GPRS and EGPRS

Full Power								
GPRS850/ EGPRS850	Tune up	Measured Power (dBm)			calculation	Average Power (dBm)		
		251	190	128		251	190	128
1Tx-slots	34.0	33.29	33.19	33.29	-9.03dB	24.26	24.16	24.26
2Tx-slots	32.0	30.98	31.04	31.14	-6.02dB	24.96	25.02	25.12
3Tx-slots	30.0	29.20	29.06	29.13	-4.26dB	24.94	24.80	24.87
4Tx-slots	28.0	26.88	26.97	27.00	-3.01dB	23.87	23.96	23.99
EGPRS 850 (8PSK)	Tune up	Measured Power (dBm)			calculation	Measured Power (dBm)		
		251	190	128		251	190	128
1Tx-slots	27.0	25.83	25.92	26.04	-9.03dB	16.80	16.89	17.01
2Tx-slots	26.0	24.84	24.77	25.03	-6.02dB	18.82	18.75	19.01
3Tx-slots	23.0	22.37	22.22	22.35	-4.26dB	18.11	17.96	18.09
4Tx-slots	21.0	19.59	19.61	19.80	-3.01dB	16.58	16.60	16.79

Full Power								
GPRS1900/ EGPRS1900	Tune up	Measured Power (dBm)			calculation	Average Power (dBm)		
		810	661	512		810	661	512
1Tx-slots	31.5	30.60	30.79	30.89	-9.03dB	21.57	21.76	21.86
2Tx-slots	29.0	28.24	28.44	28.54	-6.02dB	22.22	22.42	22.52
3Tx-slots	27.5	26.53	26.71	26.83	-4.26dB	22.27	22.45	22.57
4Tx-slots	25.5	24.42	24.65	24.78	-3.01dB	21.41	21.64	21.77
EGPRS 1900 (8PSK)	Tune up	Measured Power (dBm)			calculation	Measured Power (dBm)		
		810	661	512		810	661	512
1Tx-slots	27.5	27.20	27.24	26.60	-9.03dB	18.17	18.21	17.57
2Tx-slots	26.5	25.97	25.98	25.23	-6.02dB	19.95	19.96	19.21
3Tx-slots	24.0	23.51	23.48	22.49	-4.26dB	19.25	19.22	18.23
4Tx-slots	21.0	19.97	20.33	19.29	-3.01dB	16.96	17.32	16.28
Reduced power level 1								
GPRS1900/ EGPRS1900	Tune up	Measured Power (dBm)			calculation	Average Power (dBm)		
		810	661	512		810	661	512
1Tx-slots	28.5	27.18	27.45	27.70	-9.03dB	18.15	18.42	18.67
2Tx-slots	26.0	25.33	25.58	25.78	-6.02dB	19.31	19.56	19.76
3Tx-slots	24.5	23.16	23.43	23.73	-4.26dB	18.90	19.17	19.47
4Tx-slots	22.5	21.02	21.29	21.59	-3.01dB	18.01	18.28	18.58
EGPRS 1900 (8PSK)	Tune up	Measured Power (dBm)			calculation	Measured Power (dBm)		
		810	661	512		810	661	512
1Tx-slots	26.0	25.53	25.02	24.18	-9.03dB	16.50	15.99	15.15
2Tx-slots	23.5	23.11	22.59	21.73	-6.02dB	17.09	16.57	15.71
3Tx-slots	20.5	20.02	19.50	18.65	-4.26dB	15.76	15.24	14.39
4Tx-slots	16.5	16.23	15.78	14.82	-3.01dB	13.22	12.77	11.81

Note:

1) Division Factors

To average the power, the division factor is as follows:

1TX-slot = 1 transmit time slot out of 8 time slots=> conducted power divided by (8/1) => -9.03dB

2TX-slots = 2 transmit time slots out of 8 time slots=> conducted power divided by (8/2) => -6.02dB

3TX-slots = 3 transmit time slots out of 8 time slots=> conducted power divided by (8/3) => -4.26dB

4TX-slots = 4 transmit time slots out of 8 time slots=> conducted power divided by (8/4) => -3.01dB

According to the conducted power as above, the body measurements are performed with 2Txslots for 850MHz and 3Txslots for 1900MHz.

10.2. WCDMA Measurement result
Table 10.3: T The conducted power measurement results WCDMA

Full Power					
Item	band	WCDMA Band 2			
	ARFCN	Tune up	9538 (1907.6MHz)	9400 (1880MHz)	9262 (1852.4MHz)
WCDMA	\	23.5	22.6	22.5	22.7
HSUPA	1	19.5	18.1	18.7	18.2
	2	19.5	18.2	18.8	18.3
	3	19.5	18.9	18.5	18.4
	4	19.5	18.8	18.8	18.6
	5	23.0	22.2	22.3	22.6
HSDPA	1	23.0	22.3	22.4	22.7
	2	23.0	22.4	22.5	22.6
	3	22.5	21.7	21.9	22.1
	4	22.5	21.7	21.9	22.1
DC-HSDPA	1	23.0	22.2	22.2	22.5
	2	23.0	22.4	22.5	22.5
	3	22.5	21.8	21.9	22.0
	4	22.5	21.9	21.9	22.0
Reduced power level 1					
Item	band	WCDMA Band 2			
	ARFCN	Tune up	9538 (1907.6MHz)	9400 (1880MHz)	9262 (1852.4MHz)
WCDMA	\	18.5	17.8	17.6	18.0
HSUPA	1	13.5	12.3	13.0	12.8
	2	13.5	12.6	13.2	12.9
	3	13.5	13.2	12.9	13.0
	4	13.5	13.2	13.2	13.2
	5	18.5	17.4	17.6	18.0
HSDPA	1	18.5	17.5	17.5	18.0
	2	18.5	17.7	17.7	17.9
	3	18.0	17.0	17.3	17.4
	4	18.0	17.0	17.2	17.5
DC-HSDPA	1	18.5	17.5	17.6	17.9
	2	18.5	17.6	17.7	17.8
	3	18.0	17.2	17.3	17.3
	4	18.0	17.1	17.2	17.4

Full Power					
Item	band	WCDMA Band 4			
	ARFCN	Tune up	1513 (1752.6MHz)	1413 (1732.6MHz)	1312 (1712.4MHz)
WCDMA	\	24.5	23.5	23.7	23.4
HSUPA	1	20.5	19.1	19.0	19.1
	2	20.5	19.2	19.1	19.3
	3	20.5	19.2	19.0	19.1
	4	20.5	19.3	19.6	19.2
	5	23.0	22.3	22.5	22.3
HSDPA	1	23.0	21.9	22.3	22.1
	2	23.0	22.0	22.4	22.2
	3	23.0	22.4	22.6	22.5
	4	23.0	22.4	22.6	22.5
DC-HSDPA	1	23.0	21.9	22.3	22.1
	2	23.0	22.0	22.4	22.2
	3	23.0	22.4	22.6	22.5
	4	23.0	22.4	22.6	22.5
Reduced power level 1					
Item	band	WCDMA Band 4			
	ARFCN	Tune up	1513 (1752.6MHz)	1413 (1732.6MHz)	1312 (1712.4MHz)
WCDMA	\	18.5	17.5	17.9	17.4
HSUPA	1	14.5	14.0	14.0	14.0
	2	14.5	13.6	13.6	13.9
	3	14.5	14.2	13.9	14.0
	4	14.5	13.6	13.8	13.3
	5	17.5	16.5	16.5	16.4
HSDPA	1	17.5	15.9	16.2	16.0
	2	17.5	16.4	16.6	16.1
	3	17.5	16.7	16.8	16.6
	4	17.5	16.7	16.7	16.5
DC-HSDPA	1	17.5	16.0	16.2	16.1
	2	17.5	16.3	16.5	16.2
	3	17.5	16.6	16.6	16.6
	4	17.5	16.7	16.8	16.6

Full Power					
Item	band	WCDMA Band 5			
	ARFCN	Tune up	4233 (846.6MHz)	4182 (836.4MHz)	4132 (826.4MHz)
WCDMA	\	24.5	23.5	23.5	23.2
HSUPA	1	20.5	19.5	19.5	19.2
	2	20.5	19.6	19.6	19.3
	3	20.5	19.5	19.5	19.2
	4	20.5	19.6	19.6	19.2
	5	23.0	22.1	22.3	21.7
HSDPA	1	23.0	22.4	22.4	22.0
	2	23.0	22.5	22.5	22.1
	3	22.5	21.8	21.8	21.3
	4	22.5	21.8	21.8	21.3
DC-HSDPA	1	23.0	22.3	22.2	22.1
	2	23.0	22.4	22.3	22.2
	3	22.5	21.8	21.8	21.5
	4	22.5	21.7	21.6	21.4

10.3. LTE Measurement result
Table 10.4: The conducted Power for LTE

Full Power								
LTE Band 2			Actual output Power (dBm)			Tune up		
Band -width	RB No. / RB offset	Frequency	Modulation			Modulation		
			QPSK	16QAM	64QAM	QPSK	16QAM	64QAM
1.4 MHz	1RB_5	1909.3MHz	22.44	21.39	/	23.5	22.5	/
		1880MHz	22.32	20.78	/	23.5	22.5	/
		1850.7MHz	22.53	21.44	/	23.5	22.5	/
	1RB_3	1909.3MHz	22.48	21.37	/	23.5	22.5	/
		1880MHz	22.41	20.90	/	23.5	22.5	/
		1850.7MHz	22.47	21.38	/	23.5	22.5	/
	1RB_0	1909.3MHz	22.40	21.36	/	23.5	22.5	/
		1880MHz	22.36	20.85	/	23.5	22.5	/
		1850.7MHz	22.45	21.46	/	23.5	22.5	/
	3RB_3	1909.3MHz	22.49	21.29	/	23.5	21.5	/
		1880MHz	22.59	21.18	/	23.5	22.5	/
		1850.7MHz	22.51	21.34	/	23.5	22.5	/
	3RB_1	1909.3MHz	22.61	21.28	/	23.5	22.5	/
		1880MHz	22.50	21.19	/	23.5	22.5	/
		1850.7MHz	22.58	21.43	/	23.5	22.5	/
	3RB_0	1909.3MHz	22.56	21.38	/	23.5	22.5	/
		1880MHz	22.46	21.13	/	23.5	22.5	/
		1850.7MHz	22.52	21.33	/	23.5	22.5	/
	6RB_0	1909.3MHz	21.00	19.63	/	22.5	21.5	/
		1880MHz	20.94	19.83	/	22.5	21.5	/
		1850.7MHz	21.03	19.90	/	22.5	21.5	/

Full Power								
LTE Band 2			Actual output Power (dBm)			Tune up		
Band -width	RB No. / RB offset	Frequency	Modulation			Modulation		
			QPSK	16QAM	64QAM	QPSK	16QAM	64QAM
3 MHz	1RB_14	1908.5MHz	22.44	21.54	/	23.5	22.5	/
		1880MHz	22.34	20.78	/	23.5	22.5	/
		1851.5MHz	22.32	21.33	/	23.5	22.5	/
	1RB_7	1908.5MHz	22.48	21.59	/	23.5	22.5	/
		1880MHz	22.44	20.99	/	23.5	22.5	/
		1851.5MHz	22.47	21.45	/	23.5	22.5	/
	1RB_0	1908.5MHz	22.48	21.68	/	23.5	22.5	/
		1880MHz	22.41	20.85	/	23.5	22.5	/
		1851.5MHz	22.52	21.38	/	23.5	22.5	/
	8RB_7	1908.5MHz	20.99	19.59	/	22.5	21.5	/
		1880MHz	20.96	19.81	/	22.5	21.5	/
		1851.5MHz	20.86	19.88	/	22.5	21.5	/
	8RB_4	1908.5MHz	21.07	19.66	/	22.5	21.5	/
		1880MHz	21.02	19.89	/	22.5	21.5	/
		1851.5MHz	20.95	19.95	/	22.5	21.5	/
	8RB_0	1908.5MHz	21.04	19.76	/	22.5	21.5	/
		1880MHz	21.01	19.86	/	22.5	21.5	/
		1851.5MHz	21.07	19.95	/	22.5	21.5	/
	15RB_0	1908.5MHz	21.10	19.63	/	22.5	21.5	/
		1880MHz	21.00	19.79	/	22.5	21.5	/
		1851.5MHz	21.07	19.91	/	22.5	21.5	/

Full Power								
LTE Band 2			Actual output Power (dBm)			Tune up		
Band -width	RB No. / RB offset	Frequency	Modulation			Modulation		
			QPSK	16QAM	64QAM	QPSK	16QAM	64QAM
5 MHz	1RB_24	1907.5MHz	22.46	21.65	/	23.5	22.5	/
		1880MHz	22.33	21.58	/	23.5	22.5	/
		1852.5MHz	22.41	21.41	/	23.5	22.5	/
	1RB_12	1907.5MHz	22.38	21.52	/	23.5	22.5	/
		1880MHz	22.31	21.50	/	23.5	22.5	/
		1852.5MHz	22.44	21.33	/	23.5	22.5	/
	1RB_0	1907.5MHz	22.38	21.52	/	23.5	22.5	/
		1880MHz	22.33	21.48	/	23.5	22.5	/
		1852.5MHz	22.42	21.45	/	23.5	22.5	/
	12RB_13	1907.5MHz	21.01	19.54	/	22.5	21.5	/
		1880MHz	20.96	19.67	/	22.5	21.5	/
		1852.5MHz	20.93	19.77	/	22.5	21.5	/
	12RB_6	1907.5MHz	20.99	19.77	/	22.5	21.5	/
		1880MHz	20.91	19.87	/	22.5	21.5	/
		1852.5MHz	20.89	19.95	/	22.5	21.5	/
	12RB_0	1907.5MHz	20.98	19.67	/	22.5	21.5	/
		1880MHz	20.93	19.80	/	22.5	21.5	/
		1852.5MHz	20.99	19.83	/	22.5	21.5	/
	25RB_0	1907.5MHz	21.00	19.53	/	22.5	21.5	/
		1880MHz	20.91	19.74	/	22.5	21.5	/
		1852.5MHz	20.98	19.81	/	22.5	21.5	/

Full Power								
LTE Band 2			Actual output Power (dBm)			Tune up		
Band -width	RB No. / RB offset	Frequency	Modulation			Modulation		
			QPSK	16QAM	64QAM	QPSK	16QAM	64QAM
10 MHz	1RB_49	1905MHz	22.48	21.46	/	23.5	22.5	/
		1880MHz	22.41	21.37	/	23.5	22.5	/
		1855MHz	22.42	21.39	/	23.5	22.5	/
	1RB_24	1905MHz	22.41	21.50	/	23.5	22.5	/
		1880MHz	22.39	21.29	/	23.5	22.5	/
		1855MHz	22.42	21.33	/	23.5	22.5	/
	1RB_0	1905MHz	22.43	21.59	/	23.5	22.5	/
		1880MHz	22.40	21.39	/	23.5	22.5	/
		1855MHz	22.38	21.38	/	23.5	22.5	/
	25RB_25	1905MHz	21.01	19.60	/	22.5	21.5	/
		1880MHz	21.02	19.95	/	22.5	21.5	/
		1855MHz	20.94	19.93	/	22.5	21.5	/
	25RB_12	1905MHz	20.95	19.69	/	22.5	21.5	/
		1880MHz	20.94	19.88	/	22.5	21.5	/
		1855MHz	20.97	19.67	/	22.5	21.5	/
	25RB_0	1905MHz	20.98	19.80	/	22.5	21.5	/
		1880MHz	20.90	19.87	/	22.5	21.5	/
		1855MHz	20.88	19.60	/	22.5	21.5	/
	50RB_0	1905MHz	21.08	19.75	/	22.5	21.5	/
		1880MHz	20.97	19.93	/	22.5	21.5	/
		1855MHz	20.97	19.79	/	22.5	21.5	/

Full Power								
LTE Band 2			Actual output Power (dBm)			Tune up		
Band -width	RB No. / RB offset	Frequency	Modulation			Modulation		
			QPSK	16QAM	64QAM	QPSK	16QAM	64QAM
15 MHz	1RB_74	1902.5MHz	22.52	21.44	/	23.5	22.5	/
		1880MHz	22.37	21.64	/	23.5	22.5	/
		1857.5MHz	22.32	21.48	/	23.5	22.5	/
	1RB_37	1902.5MHz	22.58	21.54	/	23.5	22.5	/
		1880MHz	22.29	21.58	/	23.5	22.5	/
		1857.5MHz	22.47	21.54	/	23.5	22.5	/
	1RB_0	1902.5MHz	22.52	21.50	/	23.5	22.5	/
		1880MHz	22.32	21.61	/	23.5	22.5	/
		1857.5MHz	22.52	21.78	/	23.5	22.5	/
	36RB_38	1902.5MHz	20.97	19.58	/	22.5	21.5	/
		1880MHz	20.98	19.81	/	22.5	21.5	/
		1857.5MHz	20.96	19.94	/	22.5	21.5	/
	36RB_19	1902.5MHz	20.98	19.60	/	22.5	21.5	/
		1880MHz	20.99	19.83	/	22.5	21.5	/
		1857.5MHz	21.03	19.75	/	22.5	21.5	/
	36RB_0	1902.5MHz	21.02	19.67	/	22.5	21.5	/
		1880MHz	20.90	19.96	/	22.5	21.5	/
		1857.5MHz	20.99	19.70	/	22.5	21.5	/
	75RB_0	1902.5MHz	21.01	19.55	/	22.5	21.5	/
		1880MHz	20.93	19.89	/	22.5	21.5	/
		1857.5MHz	21.03	19.83	/	22.5	21.5	/

Full Power								
LTE Band 2			Actual output Power (dBm)			Tune up		
Band -width	RB No. / RB offset	Frequency	Modulation			Modulation		
			QPSK	16QAM	64QAM	QPSK	16QAM	64QAM
20 MHz	1RB_99	1900MHz	22.40	21.41	/	23.5	22.5	/
		1880MHz	22.40	21.14	/	23.5	22.5	/
		1860MHz	22.33	21.44	/	23.5	22.5	/
	1RB_50	1900MHz	22.41	21.45	/	23.5	22.5	/
		1880MHz	22.39	21.13	/	23.5	22.5	/
		1860MHz	22.34	21.60	/	23.5	22.5	/
	1RB_0	1900MHz	22.42	21.51	/	23.5	22.5	/
		1880MHz	22.45	21.15	/	23.5	22.5	/
		1860MHz	22.48	21.63	/	23.5	22.5	/
	50RB_50	1900MHz	20.95	19.66	/	22.5	21.5	/
		1880MHz	20.96	20.13	/	22.5	21.5	/
		1860MHz	20.90	20.01	/	22.5	21.5	/
	50RB_25	1900MHz	21.10	19.54	/	22.5	21.5	/
		1880MHz	21.01	19.87	/	22.5	21.5	/
		1860MHz	20.95	19.63	/	22.5	21.5	/
	50RB_0	1900MHz	20.99	19.70	/	22.5	21.5	/
		1880MHz	21.08	19.94	/	22.5	21.5	/
		1860MHz	20.92	19.59	/	22.5	21.5	/
	100RB_0	1900MHz	21.03	19.60	/	22.5	21.5	/
		1880MHz	20.97	20.04	/	22.5	21.5	/
		1860MHz	20.98	19.72	/	22.5	21.5	/

Reduced power level 1								
LTE Band 2			Actual output Power (dBm)			Tune up		
Band -width	RB No. / RB offset	Frequency	Modulation			Modulation		
			QPSK	16QAM	64QAM	QPSK	16QAM	64QAM
1.4 MHz	1RB_5	1909.3MHz	17.25	17.47	/	19.0	19.0	/
		1880MHz	18.02	18.23	/	19.0	19.0	/
		1850.7MHz	17.81	18.11	/	19.0	19.0	/
	1RB_3	1909.3MHz	17.49	17.71	/	19.0	19.0	/
		1880MHz	18.21	18.42	/	19.0	19.0	/
		1850.7MHz	18.01	18.30	/	19.0	19.0	/
	1RB_0	1909.3MHz	17.39	17.54	/	19.0	19.0	/
		1880MHz	18.04	18.25	/	19.0	19.0	/
		1850.7MHz	17.84	18.14	/	19.0	19.0	/
	3RB_3	1909.3MHz	17.43	17.40	/	19.0	19.0	/
		1880MHz	18.17	18.23	/	19.0	19.0	/
		1850.7MHz	17.96	18.01	/	19.0	19.0	/
	3RB_1	1909.3MHz	17.54	17.52	/	19.0	19.0	/
		1880MHz	18.23	18.29	/	19.0	19.0	/
		1850.7MHz	18.03	18.08	/	19.0	19.0	/
	3RB_0	1909.3MHz	17.51	17.53	/	19.0	19.0	/
		1880MHz	18.17	18.20	/	19.0	19.0	/
		1850.7MHz	17.98	18.01	/	19.0	19.0	/
	6RB_0	1909.3MHz	17.46	17.51	/	19.0	19.0	/
		1880MHz	18.16	18.28	/	19.0	19.0	/
		1850.7MHz	17.97	18.10	/	19.0	19.0	/

Reduced power level 1								
LTE Band 2			Actual output Power (dBm)			Tune up		
Band -width	RB No. / RB offset	Frequency	Modulation			Modulation		
			QPSK	16QAM	64QAM	QPSK	16QAM	64QAM
3 MHz	1RB_14	1908.5MHz	17.29	17.58	/	19.0	19.0	/
		1880MHz	18.05	18.37	/	19.0	19.0	/
		1851.5MHz	17.85	18.19	/	19.0	19.0	/
	1RB_7	1908.5MHz	17.64	17.91	/	19.0	19.0	/
		1880MHz	18.26	18.57	/	19.0	19.0	/
		1851.5MHz	18.05	18.31	/	19.0	19.0	/
	1RB_0	1908.5MHz	17.57	17.85	/	19.0	19.0	/
		1880MHz	18.10	18.42	/	19.0	19.0	/
		1851.5MHz	17.89	18.16	/	19.0	19.0	/
	8RB_7	1908.5MHz	17.51	17.54	/	19.0	19.0	/
		1880MHz	18.20	18.24	/	19.0	19.0	/
		1851.5MHz	18.00	18.08	/	19.0	19.0	/
	8RB_4	1908.5MHz	17.61	17.64	/	19.0	19.0	/
		1880MHz	18.25	18.29	/	19.0	19.0	/
		1851.5MHz	18.04	18.12	/	19.0	19.0	/
	8RB_0	1908.5MHz	17.65	17.67	/	19.0	19.0	/
		1880MHz	18.22	18.27	/	19.0	19.0	/
		1851.5MHz	18.02	18.11	/	19.0	19.0	/
	15RB_0	1908.5MHz	17.57	17.58	/	19.0	19.0	/
		1880MHz	18.21	18.22	/	19.0	19.0	/
		1851.5MHz	18.00	18.05	/	19.0	19.0	/

Reduced power level 1								
LTE Band 2			Actual output Power (dBm)			Tune up		
Band -width	RB No. / RB offset	Frequency	Modulation			Modulation		
			QPSK	16QAM	64QAM	QPSK	16QAM	64QAM
5 MHz	1RB_24	1907.5MHz	17.03	17.34	/	19.0	19.0	/
		1880MHz	17.66	17.90	/	19.0	19.0	/
		1852.5MHz	17.50	17.83	/	19.0	19.0	/
	1RB_12	1907.5MHz	17.71	18.04	/	19.0	19.0	/
		1880MHz	18.25	18.51	/	19.0	19.0	/
		1852.5MHz	18.04	18.35	/	19.0	19.0	/
	1RB_0	1907.5MHz	17.36	17.64	/	19.0	19.0	/
		1880MHz	17.78	18.08	/	19.0	19.0	/
		1852.5MHz	17.56	17.85	/	19.0	19.0	/
	12RB_13	1907.5MHz	17.47	17.43	/	19.0	19.0	/
		1880MHz	18.09	18.06	/	19.0	19.0	/
		1852.5MHz	17.89	17.91	/	19.0	19.0	/
	12RB_6	1907.5MHz	17.72	17.69	/	19.0	19.0	/
		1880MHz	18.27	18.23	/	19.0	19.0	/
		1852.5MHz	18.05	18.07	/	19.0	19.0	/
	12RB_0	1907.5MHz	17.67	17.63	/	19.0	19.0	/
		1880MHz	18.15	18.11	/	19.0	19.0	/
		1852.5MHz	17.93	17.94	/	19.0	19.0	/
	25RB_0	1907.5MHz	17.57	17.57	/	19.0	19.0	/
		1880MHz	18.13	18.10	/	19.0	19.0	/
		1852.5MHz	17.91	17.91	/	19.0	19.0	/

Reduced power level 1								
LTE Band 2			Actual output Power (dBm)			Tune up		
Band -width	RB No. / RB offset	Frequency	Modulation			Modulation		
			QPSK	16QAM	64QAM	QPSK	16QAM	64QAM
10 MHz	1RB_49	1905MHz	17.81	18.04	/	19.0	19.0	/
		1880MHz	18.25	18.50	/	19.0	19.0	/
		1855MHz	18.30	18.60	/	19.0	19.0	/
	1RB_24	1905MHz	17.81	18.05	/	19.0	19.0	/
		1880MHz	18.20	18.44	/	19.0	19.0	/
		1855MHz	17.72	18.04	/	19.0	19.0	/
	1RB_0	1905MHz	17.85	18.10	/	19.0	19.0	/
		1880MHz	18.00	18.26	/	19.0	19.0	/
		1855MHz	17.62	17.95	/	19.0	19.0	/
	25RB_25	1905MHz	17.96	17.92	/	19.0	19.0	/
		1880MHz	18.38	18.34	/	19.0	19.0	/
		1855MHz	18.11	18.10	/	19.0	19.0	/
	25RB_12	1905MHz	17.91	17.88	/	19.0	19.0	/
		1880MHz	18.29	18.26	/	19.0	19.0	/
		1855MHz	17.84	17.84	/	19.0	19.0	/
	25RB_0	1905MHz	17.96	17.92	/	19.0	19.0	/
		1880MHz	18.25	18.21	/	19.0	19.0	/
		1855MHz	17.79	17.79	/	19.0	19.0	/
	50RB_0	1905MHz	17.95	17.93	/	19.0	19.0	/
		1880MHz	18.31	18.29	/	19.0	19.0	/
		1855MHz	17.95	17.94	/	19.0	19.0	/

Reduced power level 1								
LTE Band 2			Actual output Power (dBm)			Tune up		
Band -width	RB No. / RB offset	Frequency	Modulation			Modulation		
			QPSK	16QAM	64QAM	QPSK	16QAM	64QAM
15 MHz	1RB_74	1902.5MHz	17.16	17.50	/	19.0	19.0	/
		1880MHz	18.10	18.47	/	19.0	19.0	/
		1857.5MHz	18.35	18.66	/	19.0	19.0	/
	1RB_37	1902.5MHz	17.53	17.86	/	19.0	19.0	/
		1880MHz	18.21	18.55	/	19.0	19.0	/
		1857.5MHz	17.79	18.12	/	19.0	19.0	/
	1RB_0	1902.5MHz	17.75	18.09	/	19.0	19.0	/
		1880MHz	18.28	18.56	/	19.0	19.0	/
		1857.5MHz	17.87	18.19	/	19.0	19.0	/
	36RB_38	1902.5MHz	17.47	17.45	/	19.0	19.0	/
		1880MHz	18.22	18.21	/	19.0	19.0	/
		1857.5MHz	18.19	18.19	/	19.0	19.0	/
	36RB_19	1902.5MHz	17.55	17.53	/	19.0	19.0	/
		1880MHz	18.24	18.23	/	19.0	19.0	/
		1857.5MHz	17.89	17.90	/	19.0	19.0	/
	36RB_0	1902.5MHz	17.76	17.74	/	19.0	19.0	/
		1880MHz	18.39	18.37	/	19.0	19.0	/
		1857.5MHz	17.91	17.93	/	19.0	19.0	/
	75RB_0	1902.5MHz	17.60	17.60	/	19.0	19.0	/
		1880MHz	18.30	18.28	/	19.0	19.0	/
		1857.5MHz	18.05	18.04	/	19.0	19.0	/

Reduced power level 1								
LTE Band 2			Actual output Power (dBm)			Tune up		
Band -width	RB No. / RB offset	Frequency	Modulation			Modulation		
			QPSK	16QAM	64QAM	QPSK	16QAM	64QAM
20 MHz	1RB_99	1900MHz	17.98	18.14	/	19.5	19.5	/
		1880MHz	19.02	19.25	/	19.5	19.5	/
		1860MHz	19.05	19.03	/	19.5	19.5	/
	1RB_50	1900MHz	17.58	17.82	/	19.5	19.5	/
		1880MHz	18.08	18.35	/	19.5	19.5	/
		1860MHz	17.56	17.85	/	19.5	19.5	/
	1RB_0	1900MHz	18.13	18.33	/	19.5	19.5	/
		1880MHz	18.64	18.88	/	19.5	19.5	/
		1860MHz	17.64	17.88	/	19.5	19.5	/
	50RB_50	1900MHz	17.84	17.74	/	19.5	19.5	/
		1880MHz	18.61	18.52	/	19.5	19.5	/
		1860MHz	18.31	18.21	/	19.5	19.5	/
	50RB_25	1900MHz	17.69	17.65	/	19.5	19.5	/
		1880MHz	18.23	18.24	/	19.5	19.5	/
		1860MHz	17.70	17.62	/	19.5	19.5	/
	50RB_0	1900MHz	17.80	17.73	/	19.5	19.5	/
		1880MHz	18.34	18.35	/	19.5	19.5	/
		1860MHz	17.68	17.69	/	19.5	19.5	/
	100RB_0	1900MHz	17.81	17.72	/	19.5	19.5	/
		1880MHz	18.43	18.42	/	19.5	19.5	/
		1860MHz	17.91	17.80	/	19.5	19.5	/



Full Power								
LTE Band 7			Actual output Power (dBm)			Tune up		
Band -width	RB No. / RB offset	Frequency	Modulation			Modulation		
			QPSK	16QAM	64QAM	QPSK	16QAM	64QAM
5 MHz	1RB_24	2567.4MHz	22.76	22.07	/	23.5	22.5	/
		2535MHz	22.70	21.94	/	23.5	22.5	/
		2502.5MHz	22.50	21.73	/	23.5	22.5	/
	1RB_12	2567.4MHz	22.71	22.11	/	23.5	22.5	/
		2535MHz	22.73	21.90	/	23.5	22.5	/
		2502.5MHz	22.42	21.74	/	23.5	22.5	/
	1RB_0	2567.4MHz	22.77	22.03	/	23.5	22.5	/
		2535MHz	22.71	21.95	/	23.5	22.5	/
		2502.5MHz	22.55	21.72	/	23.5	22.5	/
	12RB_13	2567.4MHz	21.44	20.02	/	22.5	21.5	/
		2535MHz	21.31	20.03	/	22.5	21.5	/
		2502.5MHz	21.19	19.98	/	22.5	21.5	/
	12RB_6	2567.4MHz	21.43	20.22	/	22.5	21.5	/
		2535MHz	21.25	20.21	/	22.5	21.5	/
		2502.5MHz	21.10	20.06	/	22.5	21.5	/
	12RB_0	2567.4MHz	21.37	20.13	/	22.5	21.5	/
		2535MHz	21.22	20.10	/	22.5	21.5	/
		2502.5MHz	21.09	19.88	/	22.5	21.5	/
	25RB_0	2567.4MHz	21.49	20.11	/	22.5	21.5	/
		2535MHz	21.37	20.09	/	22.5	21.5	/
		2502.5MHz	21.14	19.96	/	22.5	21.5	/

Full Power								
LTE Band 7			Actual output Power (dBm)			Tune up		
Band -width	RB No. / RB offset	Frequency	Modulation			Modulation		
			QPSK	16QAM	64QAM	QPSK	16QAM	64QAM
10 MHz	1RB_49	2565MHz	22.84	22.11	/	23.5	22.5	/
		2535MHz	22.67	21.97	/	23.5	22.5	/
		2505MHz	22.52	21.64	/	23.5	22.5	/
	1RB_24	2565MHz	22.84	22.03	/	23.5	22.5	/
		2535MHz	22.57	21.77	/	23.5	22.5	/
		2505MHz	22.41	21.58	/	23.5	22.5	/
	1RB_0	2565MHz	22.76	21.99	/	23.5	22.5	/
		2535MHz	22.65	21.78	/	23.5	22.5	/
		2505MHz	22.41	21.64	/	23.5	22.5	/
	25RB_25	2565MHz	21.53	20.42	/	22.5	21.5	/
		2535MHz	21.34	20.39	/	22.5	21.5	/
		2505MHz	21.18	20.29	/	22.5	21.5	/
	25RB_12	2565MHz	21.47	20.40	/	22.5	21.5	/
		2535MHz	21.39	20.23	/	22.5	21.5	/
		2505MHz	21.06	19.95	/	22.5	21.5	/
	25RB_0	2565MHz	21.39	20.45	/	22.5	21.5	/
		2535MHz	21.30	20.20	/	22.5	21.5	/
		2505MHz	21.06	19.71	/	22.5	21.5	/
	50RB_0	2565MHz	21.53	20.46	/	22.5	21.5	/
		2535MHz	21.25	20.32	/	22.5	21.5	/
		2505MHz	21.21	20.01	/	22.5	21.5	/

Full Power								
LTE Band 7			Actual output Power (dBm)			Tune up		
Band -width	RB No. / RB offset	Frequency	Modulation			Modulation		
			QPSK	16QAM	64QAM	QPSK	16QAM	64QAM
15 MHz	1RB_74	2562.5MHz	22.82	22.25	/	23.5	22.5	/
		2535MHz	22.83	21.81	/	23.5	22.5	/
		2507.5MHz	22.56	21.44	/	23.5	22.5	/
	1RB_37	2562.5MHz	22.89	22.10	/	23.5	22.5	/
		2535MHz	22.77	21.58	/	23.5	22.5	/
		2507.5MHz	22.44	21.32	/	23.5	22.5	/
	1RB_0	2562.5MHz	22.81	22.17	/	23.5	22.5	/
		2535MHz	22.58	21.48	/	23.5	22.5	/
		2507.5MHz	22.47	21.31	/	23.5	22.5	/
	36RB_38	2562.5MHz	21.53	19.94	/	22.5	21.5	/
		2535MHz	21.45	20.36	/	22.5	21.5	/
		2507.5MHz	21.27	20.47	/	22.5	21.5	/
	36RB_19	2562.5MHz	21.43	20.07	/	22.5	21.5	/
		2535MHz	21.38	20.26	/	22.5	21.5	/
		2507.5MHz	21.09	20.12	/	22.5	21.5	/
	36RB_0	2562.5MHz	21.47	20.34	/	22.5	21.5	/
		2535MHz	21.24	20.41	/	22.5	21.5	/
		2507.5MHz	21.05	19.93	/	22.5	21.5	/
	75RB_0	2562.5MHz	21.53	20.16	/	22.5	21.5	/
		2535MHz	21.25	20.39	/	22.5	21.5	/
		2507.5MHz	21.12	20.23	/	22.5	21.5	/

Full Power								
LTE Band 7			Actual output Power (dBm)			Tune up		
Band -width	RB No. / RB offset	Frequency	Modulation			Modulation		
			QPSK	16QAM	64QAM	QPSK	16QAM	64QAM
20 MHz	1RB_99	2560MHz	23.00	21.78	/	23.5	22.5	/
		2535MHz	22.84	21.78	/	23.5	22.5	/
		2510MHz	22.74	21.95	/	23.5	22.5	/
	1RB_50	2560MHz	22.90	21.65	/	23.5	22.5	/
		2535MHz	22.76	21.61	/	23.5	22.5	/
		2510MHz	22.55	21.75	/	23.5	22.5	/
	1RB_0	2560MHz	22.81	21.66	/	23.5	22.5	/
		2535MHz	22.61	21.44	/	23.5	22.5	/
		2510MHz	22.55	21.81	/	23.5	22.5	/
	50RB_50	2560MHz	21.52	20.34	/	22.5	21.5	/
		2535MHz	21.41	20.73	/	22.5	21.5	/
		2510MHz	21.16	20.52	/	22.5	21.5	/
	50RB_25	2560MHz	21.45	20.30	/	22.5	21.5	/
		2535MHz	21.27	20.33	/	22.5	21.5	/
		2510MHz	21.18	19.95	/	22.5	21.5	/
	50RB_0	2560MHz	21.35	20.42	/	22.5	21.5	/
		2535MHz	21.26	20.40	/	22.5	21.5	/
		2510MHz	21.02	19.52	/	22.5	21.5	/
	100RB_0	2560MHz	21.51	20.40	/	22.5	21.5	/
		2535MHz	21.41	20.56	/	22.5	21.5	/
		2510MHz	21.10	20.05	/	22.5	21.5	/

Full Power								
LTE Band 12			Actual output Power (dBm)			Tune up		
Band -width	RB No. / RB offset	Frequency	Modulation			Modulation		
			QPSK	16QAM	64QAM	QPSK	16QAM	64QAM
1.4 MHz	1RB_5	715.3MHz	23.42	22.64	/	24.0	23.0	/
		707.5MHz	22.62	22.11	/	24.0	23.0	/
		699.7MHz	23.21	22.71	/	24.0	23.0	/
	1RB_3	715.3MHz	23.41	22.51	/	24.0	23.0	/
		707.5MHz	22.72	22.06	/	24.0	23.0	/
		699.7MHz	23.20	22.66	/	24.0	23.0	/
	1RB_0	715.3MHz	23.29	22.56	/	24.0	23.0	/
		707.5MHz	22.74	22.23	/	24.0	23.0	/
		699.7MHz	23.18	22.68	/	24.0	23.0	/
	3RB_3	715.3MHz	23.40	22.30	/	24.0	23.0	/
		707.5MHz	22.82	22.08	/	24.0	23.0	/
		699.7MHz	23.41	22.46	/	24.0	23.0	/
	3RB_1	715.3MHz	23.47	22.37	/	24.0	23.0	/
		707.5MHz	22.91	22.04	/	24.0	23.0	/
		699.7MHz	23.30	22.52	/	24.0	23.0	/
	3RB_0	715.3MHz	23.25	22.31	/	24.0	23.0	/
		707.5MHz	22.94	22.12	/	24.0	23.0	/
		699.7MHz	23.32	22.46	/	24.0	23.0	/
	6RB_0	715.3MHz	22.32	21.07	/	23.0	22.0	/
		707.5MHz	21.83	20.72	/	23.0	22.0	/
		699.7MHz	22.36	21.01	/	23.0	22.0	/

Full Power								
LTE Band 12			Actual output Power (dBm)			Tune up		
Band -width	RB No. / RB offset	Frequency	Modulation			Modulation		
			QPSK	16QAM	64QAM	QPSK	16QAM	64QAM
3 MHz	1RB_14	714.5MHz	23.34	22.68	/	24.0	23.0	/
		707.5MHz	22.66	22.17	/	24.0	23.0	/
		700.5MHz	23.42	22.71	/	24.0	23.0	/
	1RB_7	714.5MHz	23.26	22.46	/	24.0	23.0	/
		707.5MHz	22.70	22.14	/	24.0	23.0	/
		700.5MHz	23.22	22.76	/	24.0	23.0	/
	1RB_0	714.5MHz	23.29	22.47	/	24.0	23.0	/
		707.5MHz	22.71	22.13	/	24.0	23.0	/
		700.5MHz	23.20	22.71	/	24.0	23.0	/
	8RB_7	714.5MHz	22.34	21.44	/	23.0	22.0	/
		707.5MHz	21.79	21.07	/	23.0	22.0	/
		700.5MHz	22.28	21.51	/	23.0	22.0	/
	8RB_4	714.5MHz	22.25	21.15	/	23.0	22.0	/
		707.5MHz	21.87	21.02	/	23.0	22.0	/
		700.5MHz	22.29	21.32	/	23.0	22.0	/
	8RB_0	714.5MHz	22.18	21.21	/	23.0	22.0	/
		707.5MHz	21.82	21.01	/	23.0	22.0	/
		700.5MHz	22.24	21.34	/	23.0	22.0	/
	15RB_0	714.5MHz	22.14	21.30	/	23.0	22.0	/
		707.5MHz	21.81	20.95	/	23.0	22.0	/
		700.5MHz	22.33	21.29	/	23.0	22.0	/



Full Power								
LTE Band 12			Actual output Power (dBm)			Tune up		
Band -width	RB No. / RB offset	Frequency	Modulation			Modulation		
			QPSK	16QAM	64QAM	QPSK	16QAM	64QAM
5 MHz	1RB_24	713.5MHz	23.31	22.73	/	24.0	23.0	/
		707.5MHz	22.96	22.33	/	24.0	23.0	/
		701.5MHz	23.18	22.47	/	24.0	23.0	/
	1RB_12	713.5MHz	23.25	22.69	/	24.0	23.0	/
		707.5MHz	22.67	22.14	/	24.0	23.0	/
		701.5MHz	23.23	22.62	/	24.0	23.0	/
	1RB_0	713.5MHz	22.99	22.43	/	24.0	23.0	/
		707.5MHz	22.77	22.08	/	24.0	23.0	/
		701.5MHz	23.11	22.68	/	24.0	23.0	/
	12RB_13	713.5MHz	22.23	21.13	/	23.0	22.0	/
		707.5MHz	21.80	20.89	/	23.0	22.0	/
		701.5MHz	22.35	21.39	/	23.0	22.0	/
	12RB_6	713.5MHz	22.25	21.11	/	23.0	22.0	/
		707.5MHz	21.88	20.90	/	23.0	22.0	/
		701.5MHz	22.34	21.34	/	23.0	22.0	/
	12RB_0	713.5MHz	22.20	21.35	/	23.0	22.0	/
		707.5MHz	21.84	20.90	/	23.0	22.0	/
		701.5MHz	22.38	21.14	/	23.0	22.0	/
	25RB_0	713.5MHz	22.29	21.29	/	23.0	22.0	/
		707.5MHz	21.84	21.17	/	23.0	22.0	/
		701.5MHz	22.34	21.60	/	23.0	22.0	/



Full Power								
LTE Band 12			Actual output Power (dBm)			Tune up		
Band -width	RB No. / RB offset	Frequency	Modulation			Modulation		
			QPSK	16QAM	64QAM	QPSK	16QAM	64QAM
10 MHz	1RB_49	711MHz	23.42	22.70	/	24.0	23.0	/
		707.5MHz	23.03	22.72	/	24.0	23.0	/
		704MHz	22.83	22.20	/	24.0	23.0	/
	1RB_24	711MHz	22.93	22.33	/	24.0	23.0	/
		707.5MHz	22.74	22.22	/	24.0	23.0	/
		704MHz	23.14	22.61	/	24.0	23.0	/
	1RB_0	711MHz	22.75	22.25	/	24.0	23.0	/
		707.5MHz	23.21	22.64	/	24.0	23.0	/
		704MHz	23.19	22.60	/	24.0	23.0	/
	25RB_25	711MHz	22.36	21.45	/	23.0	22.0	/
		707.5MHz	22.13	20.94	/	23.0	22.0	/
		704MHz	22.01	20.88	/	23.0	22.0	/
	25RB_12	711MHz	22.02	21.15	/	23.0	22.0	/
		707.5MHz	21.93	20.92	/	23.0	22.0	/
		704MHz	22.30	21.45	/	23.0	22.0	/
	25RB_0	711MHz	21.87	21.04	/	23.0	22.0	/
		707.5MHz	21.93	20.89	/	23.0	22.0	/
		704MHz	22.38	21.40	/	23.0	22.0	/
50RB_0	711MHz	21.95	20.95	/	23.0	22.0	/	
	707.5MHz	21.93	20.87	/	23.0	22.0	/	
	704MHz	22.20	21.51	/	23.0	22.0	/	

Full Power								
LTE Band 13			Actual output Power (dBm)			Tune up		
Band -width	RB No. / RB offset	Frequency	Modulation			Modulation		
			QPSK	16QAM	64QAM	QPSK	16QAM	64QAM
5 MHz	1RB_24	784.5MHz	23.25	22.53	/	24.0	23.0	/
		782MHz	23.11	22.36	/	24.0	23.0	/
		779.5MHz	23.00	22.42	/	24.0	23.0	/
	1RB_12	784.5MHz	23.10	22.39	/	24.0	23.0	/
		782MHz	23.05	22.50	/	24.0	23.0	/
		779.5MHz	22.83	22.28	/	24.0	23.0	/
	1RB_0	784.5MHz	23.03	22.46	/	24.0	23.0	/
		782MHz	22.87	22.25	/	24.0	23.0	/
		779.5MHz	22.84	22.19	/	24.0	23.0	/
	12RB_13	784.5MHz	22.07	21.16	/	23.0	22.0	/
		782MHz	22.01	21.31	/	23.0	22.0	/
		779.5MHz	21.89	20.93	/	23.0	22.0	/
	12RB_6	784.5MHz	22.02	21.33	/	23.0	22.0	/
		782MHz	22.13	21.11	/	23.0	22.0	/
		779.5MHz	21.84	20.92	/	23.0	22.0	/
	12RB_0	784.5MHz	22.01	21.32	/	23.0	22.0	/
		782MHz	22.00	20.89	/	23.0	22.0	/
		779.5MHz	21.82	20.91	/	23.0	22.0	/
25RB_0	784.5MHz	22.06	21.45	/	23.0	22.0	/	
	782MHz	22.17	21.01	/	23.0	22.0	/	
	779.5MHz	21.96	21.16	/	23.0	22.0	/	
10 MHz	1RB_49	782MHz	23.17	22.41	/	24.0	23.0	/
	1RB_24	782MHz	22.98	22.40	/	24.0	23.0	/
	1RB_0	782MHz	22.82	22.14	/	24.0	23.0	/
	25RB_25	782MHz	22.05	21.31	/	23.0	22.0	/
	25RB_12	782MHz	22.19	21.09	/	23.0	22.0	/
	25RB_0	782MHz	21.95	20.89	/	23.0	22.0	/
	50RB_0	782MHz	22.06	21.12	/	23.0	22.0	/



Full Power								
LTE Band 26			Actual output Power (dBm)			Tune up		
Band -width	RB No. / RB offset	Frequency	Modulation			Modulation		
			QPSK	16QAM	64QAM	QPSK	16QAM	64QAM
1.4 MHz	1RB_5	848.3MHz	23.41	22.62	/	24.5	23.5	/
		831.5MHz	23.48	23.00	/	24.5	23.5	/
		814.7MHz	23.71	23.11	/	24.5	23.5	/
	1RB_3	848.3MHz	23.46	22.69	/	24.5	23.5	/
		831.5MHz	23.43	22.92	/	24.5	23.5	/
		814.7MHz	23.83	23.17	/	24.5	23.5	/
	1RB_0	848.3MHz	23.40	22.74	/	24.5	23.5	/
		831.5MHz	23.47	22.95	/	24.5	23.5	/
		814.7MHz	23.79	23.08	/	24.5	23.5	/
	3RB_3	848.3MHz	23.51	22.56	/	24.5	23.5	/
		831.5MHz	23.62	22.92	/	24.5	23.5	/
		814.7MHz	23.79	22.98	/	24.5	23.5	/
	3RB_1	848.3MHz	23.64	22.56	/	24.5	23.5	/
		831.5MHz	23.66	22.97	/	24.5	23.5	/
		814.7MHz	23.78	22.94	/	24.5	23.5	/
	3RB_0	848.3MHz	23.60	22.59	/	24.5	23.5	/
		831.5MHz	23.60	22.97	/	24.5	23.5	/
		814.7MHz	23.82	22.88	/	24.5	23.5	/
	6RB_0	848.3MHz	22.47	21.14	/	23.5	22.5	/
		831.5MHz	22.56	21.48	/	23.5	22.5	/
		814.7MHz	22.75	21.59	/	23.5	22.5	/

Full Power								
LTE Band 26			Actual output Power (dBm)			Tune up		
Band -width	RB No. / RB offset	Frequency	Modulation			Modulation		
			QPSK	16QAM	64QAM	QPSK	16QAM	64QAM
3 MHz	1RB_14	847.5MHz	23.33	22.79	/	24.5	23.5	/
		831.5MHz	23.43	22.94	/	24.5	23.5	/
		815.5MHz	23.76	23.00	/	24.5	23.5	/
	1RB_7	847.5MHz	23.33	22.89	/	24.5	23.5	/
		831.5MHz	23.45	23.00	/	24.5	23.5	/
		815.5MHz	23.77	23.01	/	24.5	23.5	/
	1RB_0	847.5MHz	23.43	22.91	/	24.5	23.5	/
		831.5MHz	23.38	23.05	/	24.5	23.5	/
		815.5MHz	23.76	22.97	/	24.5	23.5	/
	8RB_7	847.5MHz	22.42	21.44	/	23.5	22.5	/
		831.5MHz	22.44	21.64	/	23.5	22.5	/
		815.5MHz	22.64	21.84	/	23.5	22.5	/
	8RB_4	847.5MHz	22.42	21.38	/	23.5	22.5	/
		831.5MHz	22.48	21.59	/	23.5	22.5	/
		815.5MHz	22.63	21.83	/	23.5	22.5	/
	8RB_0	847.5MHz	22.33	21.46	/	23.5	22.5	/
		831.5MHz	22.48	21.64	/	23.5	22.5	/
		815.5MHz	22.64	21.81	/	23.5	22.5	/
	15RB_0	847.5MHz	22.41	21.46	/	23.5	22.5	/
		831.5MHz	22.56	21.62	/	23.5	22.5	/
		815.5MHz	22.70	21.76	/	23.5	22.5	/

Full Power								
LTE Band 26			Actual output Power (dBm)			Tune up		
Band -width	RB No. / RB offset	Frequency	Modulation			Modulation		
			QPSK	16QAM	64QAM	QPSK	16QAM	64QAM
5 MHz	1RB_24	846.5MHz	23.30	22.76	/	24.5	23.5	/
		831.5MHz	23.53	22.85	/	24.5	23.5	/
		816.5MHz	23.61	22.99	/	24.5	23.5	/
	1RB_12	846.5MHz	23.24	22.85	/	24.5	23.5	/
		831.5MHz	23.50	22.92	/	24.5	23.5	/
		816.5MHz	23.60	22.99	/	24.5	23.5	/
	1RB_0	846.5MHz	23.36	22.88	/	24.5	23.5	/
		831.5MHz	23.51	23.01	/	24.5	23.5	/
		816.5MHz	23.60	23.04	/	24.5	23.5	/
	12RB_13	846.5MHz	22.29	21.39	/	23.5	22.5	/
		831.5MHz	22.48	21.46	/	23.5	22.5	/
		816.5MHz	22.74	21.64	/	23.5	22.5	/
	12RB_6	846.5MHz	22.49	21.34	/	23.5	22.5	/
		831.5MHz	22.49	21.43	/	23.5	22.5	/
		816.5MHz	22.59	21.59	/	23.5	22.5	/
	12RB_0	846.5MHz	22.38	21.43	/	23.5	22.5	/
		831.5MHz	22.48	21.41	/	23.5	22.5	/
		816.5MHz	22.63	21.65	/	23.5	22.5	/
	25RB_0	846.5MHz	22.36	21.55	/	23.5	22.5	/
		831.5MHz	22.50	21.71	/	23.5	22.5	/
		816.5MHz	22.60	21.83	/	23.5	22.5	/

Full Power								
LTE Band 26			Actual output Power (dBm)			Tune up		
Band -width	RB No. / RB offset	Frequency	Modulation			Modulation		
			QPSK	16QAM	64QAM	QPSK	16QAM	64QAM
10 MHz	1RB_49	844MHz	23.47	22.84	/	24.5	23.5	/
		831.5MHz	23.42	22.91	/	24.5	23.5	/
		820MHz	23.52	22.97	/	24.5	23.5	/
	1RB_24	844MHz	23.42	22.96	/	24.5	23.5	/
		831.5MHz	23.41	22.95	/	24.5	23.5	/
		820MHz	23.57	23.01	/	24.5	23.5	/
	1RB_0	844MHz	23.48	22.91	/	24.5	23.5	/
		831.5MHz	23.43	23.07	/	24.5	23.5	/
		820MHz	23.57	23.02	/	24.5	23.5	/
	25RB_25	844MHz	22.39	21.34	/	23.5	22.5	/
		831.5MHz	22.48	21.38	/	23.5	22.5	/
		820MHz	22.62	21.53	/	23.5	22.5	/
	25RB_12	844MHz	22.47	21.32	/	23.5	22.5	/
		831.5MHz	22.38	21.43	/	23.5	22.5	/
		820MHz	22.64	21.56	/	23.5	22.5	/
	25RB_0	844MHz	22.54	21.31	/	23.5	22.5	/
		831.5MHz	22.52	21.49	/	23.5	22.5	/
		820MHz	22.60	21.58	/	23.5	22.5	/
50RB_0	844MHz	22.52	21.43	/	23.5	22.5	/	
	831.5MHz	22.49	21.50	/	23.5	22.5	/	
	820MHz	22.62	21.56	/	23.5	22.5	/	

Full Power								
LTE Band 26			Actual output Power (dBm)			Tune up		
Band -width	RB No. / RB offset	Frequency	Modulation			Modulation		
			QPSK	16QAM	64QAM	QPSK	16QAM	64QAM
15 MHz	1RB_74	841.5MHz	23.40	22.84	/	24.5	23.5	/
		831.5MHz	23.40	23.06	/	24.5	23.5	/
		822.5MHz	23.50	23.12	/	24.5	23.5	/
	1RB_37	841.5MHz	23.31	22.93	/	24.5	23.5	/
		831.5MHz	23.41	22.93	/	24.5	23.5	/
		822.5MHz	23.49	23.10	/	24.5	23.5	/
	1RB_0	841.5MHz	23.36	22.91	/	24.5	23.5	/
		831.5MHz	23.43	23.01	/	24.5	23.5	/
		822.5MHz	23.51	23.11	/	24.5	23.5	/
	36RB_38	841.5MHz	22.52	21.32	/	23.5	22.5	/
		831.5MHz	22.54	21.45	/	23.5	22.5	/
		822.5MHz	22.59	21.50	/	23.5	22.5	/
	36RB_19	841.5MHz	22.42	21.39	/	23.5	22.5	/
		831.5MHz	22.60	21.50	/	23.5	22.5	/
		822.5MHz	22.69	21.52	/	23.5	22.5	/
	36RB_0	841.5MHz	22.38	21.36	/	23.5	22.5	/
		831.5MHz	22.49	21.39	/	23.5	22.5	/
		822.5MHz	22.67	21.54	/	23.5	22.5	/
	75RB_0	841.5MHz	22.45	21.42	/	23.5	22.5	/
		831.5MHz	22.45	21.52	/	23.5	22.5	/
		822.5MHz	22.51	21.54	/	23.5	22.5	/

Full Power								
LTE Band 66			Actual output Power (dBm)			Tune up		
Band -width	RB No. / RB offset	Frequency	Modulation			Modulation		
			QPSK	16QAM	64QAM	QPSK	16QAM	64QAM
1.4 MHz	1RB_5	1779.3MHz	23.42	23.05	/	24.5	23.5	/
		1745MHz	23.43	23.19	/	24.5	23.5	/
		1710.7MHz	23.57	23.18	/	24.5	23.5	/
	1RB_3	1779.3MHz	23.46	23.05	/	24.5	23.5	/
		1745MHz	23.46	23.22	/	24.5	23.5	/
		1710.7MHz	23.71	23.21	/	24.5	23.5	/
	1RB_0	1779.3MHz	23.46	23.03	/	24.5	23.5	/
		1745MHz	23.45	23.25	/	24.5	23.5	/
		1710.7MHz	23.64	23.26	/	24.5	23.5	/
	3RB_3	1779.3MHz	23.63	22.86	/	24.5	23.5	/
		1745MHz	23.61	22.85	/	24.5	23.5	/
		1710.7MHz	23.65	22.93	/	24.5	23.5	/
	3RB_1	1779.3MHz	23.58	22.88	/	24.5	23.5	/
		1745MHz	23.69	22.78	/	24.5	23.5	/
		1710.7MHz	23.70	22.97	/	24.5	23.5	/
	3RB_0	1779.3MHz	23.60	22.86	/	24.5	23.5	/
		1745MHz	23.62	22.78	/	24.5	23.5	/
		1710.7MHz	23.62	22.95	/	24.5	23.5	/
	6RB_0	1779.3MHz	22.54	21.52	/	23.5	22.5	/
		1745MHz	22.59	21.46	/	23.5	22.5	/
		1710.7MHz	22.64	21.47	/	23.5	22.5	/

Full Power								
LTE Band 66			Actual output Power (dBm)			Tune up		
Band -width	RB No. / RB offset	Frequency	Modulation			Modulation		
			QPSK	16QAM	64QAM	QPSK	16QAM	64QAM
3 MHz	1RB_14	1778.5MHz	23.54	23.06	/	24.5	23.5	/
		1745MHz	23.47	23.10	/	24.5	23.5	/
		1711.5MHz	23.62	23.00	/	24.5	23.5	/
	1RB_7	1778.5MHz	23.46	23.07	/	24.5	23.5	/
		1745MHz	23.44	23.19	/	24.5	23.5	/
		1711.5MHz	23.68	23.00	/	24.5	23.5	/
	1RB_0	1778.5MHz	23.51	23.06	/	24.5	23.5	/
		1745MHz	23.46	23.20	/	24.5	23.5	/
		1711.5MHz	23.67	22.97	/	24.5	23.5	/
	8RB_7	1778.5MHz	22.50	21.78	/	23.5	22.5	/
		1745MHz	22.58	21.79	/	23.5	22.5	/
		1711.5MHz	22.75	21.98	/	23.5	22.5	/
	8RB_4	1778.5MHz	22.60	21.76	/	23.5	22.5	/
		1745MHz	22.48	21.81	/	23.5	22.5	/
		1711.5MHz	22.77	21.93	/	23.5	22.5	/
	8RB_0	1778.5MHz	22.48	21.77	/	23.5	22.5	/
		1745MHz	22.50	21.83	/	23.5	22.5	/
		1711.5MHz	22.70	21.92	/	23.5	22.5	/
	15RB_0	1778.5MHz	22.60	21.73	/	23.5	22.5	/
		1745MHz	22.47	21.74	/	23.5	22.5	/
		1711.5MHz	22.61	21.90	/	23.5	22.5	/



Full Power								
LTE Band 66			Actual output Power (dBm)			Tune up		
Band -width	RB No. / RB offset	Frequency	Modulation			Modulation		
			QPSK	16QAM	64QAM	QPSK	16QAM	64QAM
5 MHz	1RB_24	1777.5MHz	23.42	22.97	/	24.5	23.5	/
		1745MHz	23.42	23.13	/	24.5	23.5	/
		1712.5MHz	23.56	23.20	/	24.5	23.5	/
	1RB_12	1777.5MHz	23.47	23.03	/	24.5	23.5	/
		1745MHz	23.47	23.16	/	24.5	23.5	/
		1712.5MHz	23.58	23.22	/	24.5	23.5	/
	1RB_0	1777.5MHz	23.48	23.02	/	24.5	23.5	/
		1745MHz	23.56	23.20	/	24.5	23.5	/
		1712.5MHz	23.61	23.24	/	24.5	23.5	/
	12RB_13	1777.5MHz	22.61	21.66	/	23.5	22.5	/
		1745MHz	22.49	21.71	/	23.5	22.5	/
		1712.5MHz	22.70	21.85	/	23.5	22.5	/
	12RB_6	1777.5MHz	22.52	21.65	/	23.5	22.5	/
		1745MHz	22.50	21.69	/	23.5	22.5	/
		1712.5MHz	22.71	21.86	/	23.5	22.5	/
	12RB_0	1777.5MHz	22.53	21.65	/	23.5	22.5	/
		1745MHz	22.50	21.75	/	23.5	22.5	/
		1712.5MHz	22.65	21.80	/	23.5	22.5	/
	25RB_0	1777.5MHz	22.60	21.79	/	23.5	22.5	/
		1745MHz	22.59	21.85	/	23.5	22.5	/
		1712.5MHz	22.57	21.68	/	23.5	22.5	/

Full Power								
LTE Band 66			Actual output Power (dBm)			Tune up		
Band -width	RB No. / RB offset	Frequency	Modulation			Modulation		
			QPSK	16QAM	64QAM	QPSK	16QAM	64QAM
10 MHz	1RB_49	1775MHz	23.43	22.89	/	24.5	23.5	/
		1745MHz	23.52	23.08	/	24.5	23.5	/
		1715MHz	23.55	23.09	/	24.5	23.5	/
	1RB_24	1775MHz	23.47	22.94	/	24.5	23.5	/
		1745MHz	23.58	23.04	/	24.5	23.5	/
		1715MHz	23.57	23.14	/	24.5	23.5	/
	1RB_0	1775MHz	23.56	22.93	/	24.5	23.5	/
		1745MHz	23.57	23.11	/	24.5	23.5	/
		1715MHz	23.58	23.10	/	24.5	23.5	/
	25RB_25	1775MHz	22.43	21.79	/	23.5	22.5	/
		1745MHz	22.50	21.59	/	23.5	22.5	/
		1715MHz	22.64	21.66	/	23.5	22.5	/
	25RB_12	1775MHz	22.50	21.81	/	23.5	22.5	/
		1745MHz	22.45	21.64	/	23.5	22.5	/
		1715MHz	22.61	21.69	/	23.5	22.5	/
	25RB_0	1775MHz	22.45	21.79	/	23.5	22.5	/
		1745MHz	22.54	21.67	/	23.5	22.5	/
		1715MHz	22.71	21.72	/	23.5	22.5	/
	50RB_0	1775MHz	22.45	21.66	/	23.5	22.5	/
		1745MHz	22.47	21.75	/	23.5	22.5	/
		1715MHz	22.66	21.74	/	23.5	22.5	/

Full Power								
LTE Band 66			Actual output Power (dBm)			Tune up		
Band -width	RB No. / RB offset	Frequency	Modulation			Modulation		
			QPSK	16QAM	64QAM	QPSK	16QAM	64QAM
15 MHz	1RB_74	1772.5MHz	23.41	23.04	/	24.5	23.5	/
		1745MHz	23.54	22.89	/	24.5	23.5	/
		1717.5MHz	23.55	23.07	/	24.5	23.5	/
	1RB_37	1772.5MHz	23.53	23.04	/	24.5	23.5	/
		1745MHz	23.51	22.92	/	24.5	23.5	/
		1717.5MHz	23.53	23.05	/	24.5	23.5	/
	1RB_0	1772.5MHz	23.52	23.20	/	24.5	23.5	/
		1745MHz	23.62	22.93	/	24.5	23.5	/
		1717.5MHz	23.64	23.18	/	24.5	23.5	/
	36RB_38	1772.5MHz	22.49	21.73	/	23.5	22.5	/
		1745MHz	22.45	21.51	/	23.5	22.5	/
		1717.5MHz	22.63	21.78	/	23.5	22.5	/
	36RB_19	1772.5MHz	22.54	21.74	/	23.5	22.5	/
		1745MHz	22.63	21.56	/	23.5	22.5	/
		1717.5MHz	22.61	21.78	/	23.5	22.5	/
	36RB_0	1772.5MHz	22.49	21.71	/	23.5	22.5	/
		1745MHz	22.53	21.58	/	23.5	22.5	/
		1717.5MHz	22.64	21.79	/	23.5	22.5	/
	75RB_0	1772.5MHz	22.49	21.62	/	23.5	22.5	/
		1745MHz	22.47	21.59	/	23.5	22.5	/
		1717.5MHz	22.70	21.74	/	23.5	22.5	/

Full Power								
LTE Band 66			Actual output Power (dBm)			Tune up		
Band -width	RB No. / RB offset	Frequency	Modulation			Modulation		
			QPSK	16QAM	64QAM	QPSK	16QAM	64QAM
20 MHz	1RB_99	1770MHz	23.47	23.05	/	24.5	23.5	/
		1745MHz	23.39	23.31	/	24.5	23.5	/
		1720MHz	23.50	22.99	/	24.5	23.5	/
	1RB_50	1770MHz	23.51	23.10	/	24.5	23.5	/
		1745MHz	23.53	23.19	/	24.5	23.5	/
		1720MHz	23.47	23.06	/	24.5	23.5	/
	1RB_0	1770MHz	23.50	23.15	/	24.5	23.5	/
		1745MHz	23.50	23.29	/	24.5	23.5	/
		1720MHz	23.64	23.27	/	24.5	23.5	/
	50RB_50	1770MHz	22.54	21.60	/	23.5	22.5	/
		1745MHz	22.50	21.63	/	23.5	22.5	/
		1720MHz	22.63	21.59	/	23.5	22.5	/
	50RB_25	1770MHz	22.57	21.66	/	23.5	22.5	/
		1745MHz	22.60	21.65	/	23.5	22.5	/
		1720MHz	22.49	21.64	/	23.5	22.5	/
	50RB_0	1770MHz	22.67	21.65	/	23.5	22.5	/
		1745MHz	22.50	21.68	/	23.5	22.5	/
		1720MHz	22.55	21.72	/	23.5	22.5	/
	100RB_0	1770MHz	22.62	21.72	/	23.5	22.5	/
		1745MHz	22.56	21.75	/	23.5	22.5	/
		1720MHz	22.63	21.69	/	23.5	22.5	/



Full Power								
LTE Band 66			Actual output Power (dBm)			Tune up		
Band -width	RB No. / RB offset	Frequency	Modulation			Modulation		
			QPSK	16QAM	64QAM	QPSK	16QAM	64QAM
1.4 MHz	1RB_5	1779.3MHz	16.51	16.90	/	18.5	18.5	/
		1745MHz	16.69	17.06	/	18.5	18.5	/
		1710.7MHz	17.39	17.77	/	18.5	18.5	/
	1RB_3	1779.3MHz	16.60	16.99	/	18.5	18.5	/
		1745MHz	16.92	17.30	/	18.5	18.5	/
		1710.7MHz	17.57	18.06	/	18.5	18.5	/
	1RB_0	1779.3MHz	16.59	16.81	/	18.5	18.5	/
		1745MHz	16.77	17.15	/	18.5	18.5	/
		1710.7MHz	17.45	17.83	/	18.5	18.5	/
	3RB_3	1779.3MHz	16.52	16.51	/	18.5	18.5	/
		1745MHz	16.87	16.92	/	18.5	18.5	/
		1710.7MHz	17.69	17.76	/	18.5	18.5	/
	3RB_1	1779.3MHz	16.65	16.65	/	18.5	18.5	/
		1745MHz	16.97	17.02	/	18.5	18.5	/
		1710.7MHz	17.75	17.80	/	18.5	18.5	/
	3RB_0	1779.3MHz	16.63	16.62	/	18.5	18.5	/
		1745MHz	16.93	16.97	/	18.5	18.5	/
		1710.7MHz	17.68	17.75	/	18.5	18.5	/
	6RB_0	1779.3MHz	16.57	16.66	/	18.5	18.5	/
		1745MHz	16.90	17.01	/	18.5	18.5	/
		1710.7MHz	17.67	17.79	/	18.5	18.5	/



Full Power								
LTE Band 66			Actual output Power (dBm)			Tune up		
Band -width	RB No. / RB offset	Frequency	Modulation			Modulation		
			QPSK	16QAM	64QAM	QPSK	16QAM	64QAM
3 MHz	1RB_14	1778.5MHz	16.52	16.78	/	18.5	18.5	/
		1745MHz	16.65	17.06	/	18.5	18.5	/
		1711.5MHz	17.51	17.90	/	18.5	18.5	/
	1RB_7	1778.5MHz	16.70	17.05	/	18.5	18.5	/
		1745MHz	16.94	17.27	/	18.5	18.5	/
		1711.5MHz	17.74	18.21	/	18.5	18.5	/
	1RB_0	1778.5MHz	16.70	17.05	/	18.5	18.5	/
		1745MHz	16.87	17.22	/	18.5	18.5	/
		1711.5MHz	17.54	17.91	/	18.5	18.5	/
	8RB_7	1778.5MHz	16.60	16.67	/	18.5	18.5	/
		1745MHz	16.85	16.96	/	18.5	18.5	/
		1711.5MHz	17.78	17.87	/	18.5	18.5	/
	8RB_4	1778.5MHz	16.71	16.79	/	18.5	18.5	/
		1745MHz	16.94	17.05	/	18.5	18.5	/
		1711.5MHz	17.80	17.87	/	18.5	18.5	/
	8RB_0	1778.5MHz	16.76	16.85	/	18.5	18.5	/
		1745MHz	16.97	17.07	/	18.5	18.5	/
		1711.5MHz	17.72	17.80	/	18.5	18.5	/
	15RB_0	1778.5MHz	16.69	16.71	/	18.5	18.5	/
		1745MHz	16.92	16.97	/	18.5	18.5	/
		1711.5MHz	17.75	17.77	/	18.5	18.5	/

Full Power								
LTE Band 66			Actual output Power (dBm)			Tune up		
Band -width	RB No. / RB offset	Frequency	Modulation			Modulation		
			QPSK	16QAM	64QAM	QPSK	16QAM	64QAM
5 MHz	1RB_24	1777.5MHz	16.61	16.84	/	18.5	18.5	/
		1745MHz	16.54	16.68	/	18.5	18.5	/
		1712.5MHz	17.30	17.60	/	18.5	18.5	/
	1RB_12	1777.5MHz	17.04	17.20	/	18.5	18.5	/
		1745MHz	16.94	17.15	/	18.5	18.5	/
		1712.5MHz	17.83	18.14	/	18.5	18.5	/
	1RB_0	1777.5MHz	16.60	17.06	/	18.5	18.5	/
		1745MHz	16.63	16.92	/	18.5	18.5	/
		1712.5MHz	17.16	17.52	/	18.5	18.5	/
	12RB_13	1777.5MHz	16.64	16.73	/	18.5	18.5	/
		1745MHz	16.73	16.77	/	18.5	18.5	/
		1712.5MHz	17.75	17.80	/	18.5	18.5	/
	12RB_6	1777.5MHz	16.89	16.92	/	18.5	18.5	/
		1745MHz	16.98	17.03	/	18.5	18.5	/
		1712.5MHz	17.84	17.88	/	18.5	18.5	/
	12RB_0	1777.5MHz	16.89	16.92	/	18.5	18.5	/
		1745MHz	16.92	16.97	/	18.5	18.5	/
		1712.5MHz	17.63	17.68	/	18.5	18.5	/
	25RB_0	1777.5MHz	16.74	16.75	/	18.5	18.5	/
		1745MHz	16.84	16.86	/	18.5	18.5	/
		1712.5MHz	17.69	17.73	/	18.5	18.5	/

Full Power								
LTE Band 66			Actual output Power (dBm)			Tune up		
Band -width	RB No. / RB offset	Frequency	Modulation			Modulation		
			QPSK	16QAM	64QAM	QPSK	16QAM	64QAM
10 MHz	1RB_49	1775MHz	17.05	17.40	/	18.5	18.5	/
		1745MHz	17.09	17.30	/	18.5	18.5	/
		1715MHz	18.03	18.30	/	18.5	18.5	/
	1RB_24	1775MHz	17.24	17.58	/	18.5	18.5	/
		1745MHz	17.08	17.29	/	18.5	18.5	/
		1715MHz	17.40	17.77	/	18.5	18.5	/
	1RB_0	1775MHz	17.04	17.36	/	18.5	18.5	/
		1745MHz	17.03	17.42	/	18.5	18.5	/
		1715MHz	17.05	17.34	/	18.5	18.5	/
	25RB_25	1775MHz	17.29	17.31	/	18.5	18.5	/
		1745MHz	17.02	17.05	/	18.5	18.5	/
		1715MHz	17.85	17.90	/	18.5	18.5	/
	25RB_12	1775MHz	17.31	17.23	/	18.5	18.5	/
		1745MHz	17.00	17.04	/	18.5	18.5	/
		1715MHz	17.50	17.56	/	18.5	18.5	/
	25RB_0	1775MHz	17.26	17.22	/	18.5	18.5	/
		1745MHz	17.11	17.14	/	18.5	18.5	/
		1715MHz	17.30	17.36	/	18.5	18.5	/
	50RB_0	1775MHz	17.29	17.08	/	18.5	18.5	/
		1745MHz	17.06	17.08	/	18.5	18.5	/
		1715MHz	17.57	17.63	/	18.5	18.5	/

Full Power								
LTE Band 66			Actual output Power (dBm)			Tune up		
Band -width	RB No. / RB offset	Frequency	Modulation			Modulation		
			QPSK	16QAM	64QAM	QPSK	16QAM	64QAM
15 MHz	1RB_74	1772.5MHz	17.00	17.30	/	18.5	18.5	/
		1745MHz	17.12	17.39	/	18.5	18.5	/
		1717.5MHz	18.04	18.40	/	18.5	18.5	/
	1RB_37	1772.5MHz	17.36	17.68	/	18.5	18.5	/
		1745MHz	17.11	17.35	/	18.5	18.5	/
		1717.5MHz	17.59	17.96	/	18.5	18.5	/
	1RB_0	1772.5MHz	17.25	17.63	/	18.5	18.5	/
		1745MHz	17.38	17.71	/	18.5	18.5	/
		1717.5MHz	17.10	17.46	/	18.5	18.5	/
	36RB_38	1772.5MHz	17.40	17.39	/	18.5	18.5	/
		1745MHz	17.08	17.22	/	18.5	18.5	/
		1717.5MHz	17.91	17.94	/	18.5	18.5	/
	36RB_19	1772.5MHz	17.38	17.37	/	18.5	18.5	/
		1745MHz	17.07	17.37	/	18.5	18.5	/
		1717.5MHz	17.59	17.63	/	18.5	18.5	/
	36RB_0	1772.5MHz	17.35	17.36	/	18.5	18.5	/
		1745MHz	17.32	17.32	/	18.5	18.5	/
		1717.5MHz	17.43	17.48	/	18.5	18.5	/
	75RB_0	1772.5MHz	17.38	17.39	/	18.5	18.5	/
		1745MHz	17.07	17.08	/	18.5	18.5	/
		1717.5MHz	17.67	17.70	/	18.5	18.5	/



Full Power								
LTE Band 66			Actual output Power (dBm)			Tune up		
Band -width	RB No. / RB offset	Frequency	Modulation			Modulation		
			QPSK	16QAM	64QAM	QPSK	16QAM	64QAM
20 MHz	1RB_99	1770MHz	17.76	18.11	/	19.0	19.0	/
		1745MHz	17.29	17.68	/	19.0	19.0	/
		1720MHz	18.77	18.90	/	19.0	19.0	/
	1RB_50	1770MHz	17.17	17.54	/	19.0	19.0	/
		1745MHz	17.09	17.26	/	19.0	19.0	/
		1720MHz	17.42	17.86	/	19.0	19.0	/
	1RB_0	1770MHz	17.30	17.69	/	19.0	19.0	/
		1745MHz	17.75	18.10	/	19.0	19.0	/
		1720MHz	17.04	17.32	/	19.0	19.0	/
	50RB_50	1770MHz	17.69	17.69	/	19.0	19.0	/
		1745MHz	17.06	17.10	/	19.0	19.0	/
		1720MHz	18.21	18.22	/	19.0	19.0	/
	50RB_25	1770MHz	17.32	17.34	/	19.0	19.0	/
		1745MHz	17.00	17.04	/	19.0	19.0	/
		1720MHz	17.56	17.59	/	19.0	19.0	/
	50RB_0	1770MHz	17.14	17.17	/	19.0	19.0	/
		1745MHz	17.31	17.34	/	19.0	19.0	/
		1720MHz	17.12	17.16	/	19.0	19.0	/
	100RB_0	1770MHz	17.42	17.42	/	19.0	19.0	/
		1745MHz	17.18	17.19	/	19.0	19.0	/
		1720MHz	17.68	17.69	/	19.0	19.0	/

10.4. Bluetooth and WLAN Measurement result

Table 10.5: The conducted Power measurement results for Bluetooth

Bluetooth	Tune up	Averaged Power (dBm)		
Mode		Ch.0 (2402 MHz)	Ch.39 (2441 MHz)	Ch.78 (2480 MHz)
GFSK	7.5	6.14	6.09	6.10
EDR2M-4_DQPSK	7.5	6.97	5.81	6.24
EDR3M-8DPSK	7.5	7.29	6.24	6.60
/	/	Ch.0 (2402MHz)	Ch.19 (2440MHz)	Ch.39 (2480MHz)
BLE	-5.0	-6.49	-5.86	-5.05

Table 10.6: The conducted Power measurement results for WLAN 2.4G

		Averaged Power (dBm)		Duty Cycle: 100%
Mode	Tune up	Ch.1 (2412 MHz)	Ch.7 (2442Mhz)	Ch.13 (2472MHz)
802.11b	14.5	13.32	13.76	13.11
802.11g	12.0	11.15	11.48	11.09
802.11n(20MHz)	11.5	10.25	10.63	10.27

11. Simultaneous TX SAR Considerations

11.1. Introduction

The following procedures adopted from “FCC SAR Considerations for Cell Phones with Multiple Transmitters” are applicable to handsets with built-in unlicensed transmitters such as 802.11 a/b/g and Bluetooth devices which may simultaneously transmit with the licensed transmitter.

For this device, the BT and WLAN can transmit simultaneous with other transmitters.

11.2. Transmit Antenna Separation Distances

Top Side

Left Side



Right Side

Bottom Side

Picture 11.1 Antenna Locations (Front View)

/	Frequency Bands
DRX Antenna	GSM1900, WCDMA Band2/4, LTE Band 2/66
Main Antenna	GSM850, WCDMA Band5, LTE Band 7/12/13/26

11.3. SAR Measurement Positions

According to the KDB941225 D06 Hot Spot SAR, the edges with less than 25mm distance to the antennas need to be tested for SAR.

SAR measurement positions						
Mode	Front	Rear	Left edge	Right edge	Top edge	Bottom edge
DRX antenna	Yes	Yes	Yes	Yes	Yes	No
Main antenna	Yes	Yes	Yes	Yes	No	Yes
WLAN antenna	Yes	Yes	No	Yes	Yes	No

11.4. Standalone SAR Test Exclusion Considerations

Standalone 1-g head or body SAR evaluation by measurement or numerical simulation is not required when the corresponding SAR Exclusion Threshold condition, listed below, is satisfied.

The 1-g SAR test exclusion threshold for 100 MHz to 6 GHz at test separation distances ≤ 50 mm are determined by:

$[(\text{max. power of channel, including tune-up tolerance, mW}) / (\text{min. test separation distance, mm})] \cdot [\sqrt{f(\text{GHz})}] \leq 3.0$ for 1-g SAR, where

- $f(\text{GHz})$ is the RF channel transmit frequency in GHz
- Power and distance are rounded to the nearest mW and mm before calculation
- The result is rounded to one decimal place for comparison

Table 11.1: Standalone SAR test exclusion considerations

Band/Mode	f(GHz)	Position	SAR test exclusion threshold (mW)	RF output power		SAR test exclusion
				dBm	mW	
Bluetooth	2.441	Head	9.60	7.5	5.62	Yes
		Body	19.20	7.5	5.62	Yes
WLAN 2.4GHz	2.45	Head	9.58	14.5	28.18	No
		Body	19.17	14.5	28.18	No

12. Evaluation of Simultaneous

Table 12.1: The sum of reported SAR values for main antenna and WLAN

/	Position	WWAN Antenna (W/kg)	WLAN (W/kg)	Sum (W/kg)
Highest reported SAR value for Head	Right Touch	1.15	0.20	1.35
Highest reported SAR value for Body	Rear	1.11	0.22	1.33

Note: the test positions of above tables are for the worse case that has been evaluated.

Table 12.2: The sum of reported SAR values for main antenna and Bluetooth

/	Position	WWAN Antenna (W/kg)	Bluetooth (W/kg)	Sum (W/kg)
Highest reported SAR value for Head	Right Touch	1.15	0.23	1.38
Highest reported SAR value for Body	Rear	1.11	0.12	1.23

Note: the test positions of above tables are for the worse case that has been evaluated.

Table 12.3: Estimated SAR for Bluetooth

Position	f (GHz)	Distance (mm)	Upper limit of power *		Estimated _{1g} (W/kg)
			dBm	mW	
Head	2.441	5	7.5	5.62	0.23
Body	2.441	10	7.5	5.62	0.12

* - Maximum possible output power declared by manufacturer

When standalone SAR test exclusion applies to an antenna that transmits simultaneously with other antennas, the standalone SAR must be estimated according to following to determine simultaneous transmission SAR test exclusion:

(max. power of channel, including tune-up tolerance, mW) / (min. test separation distance, mm) · [$\sqrt{f(\text{GHz})/x}$] W/kg for test separation distances ≤ 50 mm;

Where $x = 7.5$ for 1-g SAR.

When the minimum test separation distance is < 5 mm, a distance of 5 mm is applied to determine SAR test exclusion

Conclusion:

According to the above tables, the sum of reported SAR values is $< 1.6\text{W/kg}$. So the simultaneous transmission SAR with volume scans is not required.

13. Summary of Test Results

According to the client's decision rule in the test registration form, which is "based on the measurement results as the basis of the conformity statement", the test conclusion of this report meets the limit requirements.

The calculated SAR is obtained by the following formula:

$$\text{Reported SAR} = \text{Measured SAR} \times 10^{(P_{\text{Target}} - P_{\text{Measured}})/10}$$

Where P_{Target} is the power of manufacturing upper limit;

P_{Measured} is the measured power in chapter 10.

Note:

B2 (Battery): LI-Polymer Battery (TIANMAO)

Duty Cycle

Mode	Duty Cycle
Speech for GSM850/1900	1:8.3
GPRS for GSM850	1:4
GPRS for GSM1900	1:2.67
WCDMA850/1700/1900	1:1
FDD_LTE Band 2/4/5/7/12/13/17/26/66	1:1

13.1. Testing Environment

Temperature:	18°C~25°C
Relative humidity:	30%~70%
Ground system resistance:	<4Ω
Ambient noise & Reflection:	< 0.012 W/kg

13.2. SAR results

Table 13.1: SAR Values (GSM 850 - Head)

Frequency		Test Mode	Test Position	Figure No. / Note	Conducted Power (dBm)	Max. tune-up Power (dBm)	Measured SAR(1g) (W/kg)	Reported SAR(1g) (W/kg)	Power Drift(dB)
MHz	Ch.								
		Ambient Temperature: 22.6°C		Liquid Temperature: 22.0°C					
836.6	190	Speech	Left Touch	/	33.15	34.0	0.304	0.37	0.04
836.6	190	Speech	Left Tilt	/	33.15	34.0	0.186	0.23	0.00
836.6	190	Speech	Right Touch	1	33.15	34.0	0.327	0.40	0.01
836.6	190	Speech	Right Tilt	/	33.15	34.0	0.229	0.28	0.15
836.6	190	Speech	Right Touch	B2	33.15	34.0	0.321	0.39	0.08

Table 13.2: SAR Values (GSM 850 - Body)

Frequency		Test Mode	Test Position	Figure No. / Note	Conducted Power (dBm)	Max. tune-up Power (dBm)	Measured SAR(1g) (W/kg)	Reported SAR(1g) (W/kg)	Power Drift(dB)
MHz	Ch.								
		Ambient Temperature: 22.6°C		Liquid Temperature: 22.0°C					
Hotspot / Body-Worn Test Data (10mm)									
836.6	190	GPRS	Front	/	31.04	32.0	0.337	0.42	0.01
836.6	190	GPRS	Rear	2	31.04	32.0	0.467	0.58	0.05
836.6	190	GPRS	Left	/	31.04	32.0	0.396	0.49	0.09
836.6	190	GPRS	Right	/	31.04	32.0	0.427	0.53	0.05
836.6	190	GPRS	Bottom	/	31.04	32.0	0.073	0.09	0.04
836.6	190	GPRS	Rear	B2	31.04	32.0	0.455	0.57	0.06

Table 13.3: SAR Values (GSM 1900 - Head)

Frequency		Test Mode	Test Position	Figure No. / Note	Conducted Power (dBm)	Max. tune-up Power (dBm)	Measured SAR(1g) (W/kg)	Reported SAR(1g) (W/kg)	Power Drift(dB)
MHz	Ch.								
Ambient Temperature: 22.7°C Liquid Temperature: 22.2°C									
Reduced power level 1									
1880	661	Speech	Left Touch	/	27.87	28.5	0.508	0.59	-0.08
1880	661	Speech	Left Tilt	/	27.87	28.5	0.420	0.49	-0.06
1880	661	Speech	Right Touch	/	27.87	28.5	0.980	1.13	0.02
1880	661	Speech	Right Tilt	/	27.87	28.5	0.636	0.74	0.01
1909.8	810	Speech	Right Touch	/	27.68	28.5	0.902	1.09	0.12
1850.2	512	Speech	Right Touch	/	28.07	28.5	0.979	1.08	0.10
1880	661	Speech	Right Touch	3/ B2	27.87	28.5	0.992	1.15	0.09

Table 13.4: SAR Values (GSM 1900 - Body)

Frequency		Test Mode	Test Position	Figure No. / Note	Conducted Power (dBm)	Max. tune-up Power (dBm)	Measured SAR(1g) (W/kg)	Reported SAR(1g) (W/kg)	Power Drift(dB)
MHz	Ch.								
Ambient Temperature: 22.7°C Liquid Temperature: 22.2°C									
Hotspot / Body-Worn Test Data (10mm)									
1880	661	GPRS	Front	/	26.71	27.5	0.369	0.44	-0.03
1880	661	GPRS	Rear	4	26.71	27.5	0.609	0.73	-0.01
1880	661	GPRS	Left	/	26.71	27.5	0.396	0.48	0.09
1880	661	GPRS	Right	/	26.71	27.5	0.427	0.51	0.04
1880	661	GPRS	Top	/	26.71	27.5	0.274	0.33	0.02
1880	661	GPRS	Rear	B2	26.71	27.5	0.587	0.70	0.05

Table 13.5: SAR Values (WCDMA Band 2 - Head)

Frequency		Test Mode	Test Position	Figure No. / Note	Conducted Power (dBm)	Max. tune-up Power (dBm)	Measured SAR(1g) (W/kg)	Reported SAR(1g) (W/kg)	Power Drift(dB)
MHz	Ch.								
Ambient Temperature: 22.7°C Liquid Temperature: 22.2°C									
Reduced power level 1									
1880	9400	RMC	Left Touch	/	17.60	18.5	0.347	0.43	0.08
1880	9400	RMC	Left Tilt	/	17.60	18.5	0.295	0.36	0.10
1880	9400	RMC	Right Touch	/	17.60	18.5	0.680	0.84	0.10
1880	9400	RMC	Right Tilt	/	17.60	18.5	0.447	0.55	0.06
1907.6	9538	RMC	Right Touch	/	17.80	18.5	0.695	0.82	0.07
1852.4	9262	RMC	Right Touch	/	18.00	18.5	0.950	1.07	-0.05
1852.4	9262	RMC	Right Touch	5/ B2	18.00	18.5	0.967	1.08	0.09

Table 13.6: SAR Values (WCDMA Band 2 - Body)

Frequency		Test Mode	Test Position	Figure No. / Note	Conducted Power (dBm)	Max. tune-up Power (dBm)	Measured SAR(1g) (W/kg)	Reported SAR(1g) (W/kg)	Power Drift(dB)
MHz	Ch.								
Ambient Temperature: 22.7°C Liquid Temperature: 22.2°C									
Hotspot / Body-Worn Test Data (10mm)									
1880	9400	RMC	Front	/	22.50	23.5	0.567	0.71	0.00
1880	9400	RMC	Rear	/	22.50	23.5	0.863	1.09	-0.02
1880	9400	RMC	Left	/	22.50	23.5	0.537	0.68	0.04
1880	9400	RMC	Right	/	22.50	23.5	0.130	0.16	0.06
1880	9400	RMC	Top	/	22.50	23.5	0.358	0.45	0.03
1907.6	9538	RMC	Rear	/	22.60	23.5	0.814	1.00	0.05
1852.4	9262	RMC	Rear	/	22.70	23.5	0.750	0.90	0.04
1880	9400	RMC	Rear	6/ B2	22.50	23.5	0.878	1.11	0.08

Table 13.7: SAR Values (WCDMA Band 4 - Head)

Frequency		Test Mode	Test Position	Figure No. / Note	Conducted Power (dBm)	Max. tune-up Power (dBm)	Measured SAR(1g) (W/kg)	Reported SAR(1g) (W/kg)	Power Drift(dB)
MHz	Ch.								
Ambient Temperature: 22.7°C Liquid Temperature: 22.2°C									
Reduced power level 1									
1732.6	1413	RMC	Left Touch	/	17.90	18.5	0.491	0.56	-0.03
1732.6	1413	RMC	Left Tilt	/	17.90	18.5	0.418	0.48	-0.04
1732.6	1413	RMC	Right Touch	/	17.90	18.5	0.901	1.03	-0.01
1732.6	1413	RMC	Right Tilt	/	17.90	18.5	0.596	0.68	-0.02
1752.6	1513	RMC	Right Touch	/	17.50	18.5	0.777	0.98	0.11
1712.4	1312	RMC	Right Touch	/	17.40	18.5	0.842	1.08	0.13
1712.4	1312	RMC	Right Touch	7/ B2	17.40	18.5	0.859	1.11	0.07

Table 13.8: SAR Values (WCDMA Band 4 - Body)

Frequency		Test Mode	Test Position	Figure No. / Note	Conducted Power (dBm)	Max. tune-up Power (dBm)	Measured SAR(1g) (W/kg)	Reported SAR(1g) (W/kg)	Power Drift(dB)
MHz	Ch.								
Ambient Temperature: 22.7°C Liquid Temperature: 22.2°C									
Hotspot / Body-Worn Test Data (10mm)									
1732.6	1413	RMC	Front	/	23.70	24.5	0.651	0.78	-0.04
1732.6	1413	RMC	Rear	8	23.70	24.5	0.734	0.88	-0.03
1732.6	1413	RMC	Left	/	23.70	24.5	0.560	0.67	0.05
1732.6	1413	RMC	Right	/	23.70	24.5	0.162	0.19	0.03
1732.6	1413	RMC	Top	/	23.70	24.5	0.405	0.49	0.02
1752.6	1513	RMC	Rear	/	23.50	24.5	0.609	0.77	0.09
1712.4	1312	RMC	Rear	/	23.40	24.5	0.550	0.71	0.10
1732.6	1413	RMC	Rear	B2	23.70	24.5	0.725	0.87	0.12

Table 13.9: SAR Values (WCDMA Band 5 - Head)

Frequency		Test Mode	Test Position	Figure No. / Note	Conducted Power (dBm)	Max. tune-up Power (dBm)	Measured SAR(1g) (W/kg)	Reported SAR(1g) (W/kg)	Power Drift(dB)
MHz	Ch.								
Ambient Temperature: 22.6°C		Liquid Temperature: 22.0°C							
836.4	4182	RMC	Left Touch	/	23.50	24.5	0.239	0.30	-0.04
836.4	4182	RMC	Left Tilt	/	23.50	24.5	0.138	0.17	0.01
836.4	4182	RMC	Right Touch	/	23.50	24.5	0.254	0.32	0.00
836.4	4182	RMC	Right Tilt	/	23.50	24.5	0.141	0.18	0.17
836.4	4182	RMC	Right Touch	9/ B2	23.50	24.5	0.278	0.35	0.05

Table 13.10: SAR Values (WCDMA Band 5 - Body)

Frequency		Test Mode	Test Position	Figure No. / Note	Conducted Power (dBm)	Max. tune-up Power (dBm)	Measured SAR(1g) (W/kg)	Reported SAR(1g) (W/kg)	Power Drift(dB)
MHz	Ch.								
Ambient Temperature: 22.6°C		Liquid Temperature: 22.0°C							
Hotspot / Body-Worn Test Data (10mm)									
836.4	4182	RMC	Front	/	23.50	24.5	0.230	0.29	0.01
836.4	4182	RMC	Rear	10	23.50	24.5	0.339	0.43	0.04
836.4	4182	RMC	Left	/	23.50	24.5	0.260	0.33	0.02
836.4	4182	RMC	Right	/	23.50	24.5	0.264	0.33	0.04
836.4	4182	RMC	Bottom	/	23.50	24.5	0.039	0.05	0.11
836.4	4182	RMC	Rear	B2	23.50	24.5	0.327	0.41	0.08

Table 13.11: SAR Values (LTE Band 2 - Head)

Frequency		Test Mode	Test Position	Figure No. / Note	Conducted Power (dBm)	Max. tune-up Power (dBm)	Measured SAR(1g) (W/kg)	Reported SAR(1g) (W/kg)	Power Drift(dB)
MHz	Ch.								
Ambient Temperature: 22.7°C Liquid Temperature: 22.2°C									
Reduced power level 1									
1860	18700	1RB_99	Left Touch	/	19.05	19.5	0.514	0.57	-0.15
1880	18900	50RB_50	Left Touch	/	18.61	19.5	0.420	0.52	-0.01
1860	18700	1RB_99	Left Tilt	/	19.05	19.5	0.434	0.48	0.04
1880	18900	50RB_50	Left Tilt	/	18.61	19.5	0.357	0.44	0.04
1860	18700	1RB_99	Right Touch	/	19.05	19.5	0.908	1.01	0.01
1880	18900	50RB_50	Right Touch	/	18.61	19.5	0.735	0.90	0.01
1860	18700	1RB_99	Right Tilt	/	19.05	19.5	0.627	0.70	0.13
1880	18900	50RB_50	Right Tilt	/	18.61	19.5	0.507	0.62	-0.17
1900	19100	1RB_99	Right Touch	/	17.98	19.5	0.629	0.89	0.12
1880	18900	1RB_99	Right Touch	/	19.02	19.5	0.996	1.11	0.14
1900	19100	50RB_50	Right Tilt	/	17.84	19.5	0.628	0.92	0.05
1860	18700	50RB_50	Right Tilt	/	18.31	19.5	0.694	0.91	0.08
1880	18900	100RB	Right Touch	/	18.43	19.5	0.713	0.91	0.10
1880	18900	1RB_99	Right Touch	11/ B2	19.02	19.5	1.030	1.15	0.14

Table 13.12: SAR Values (LTE Band 2 - Body)

Frequency		Test Mode	Test Position	Figure No. / Note	Conducted Power (dBm)	Max. tune-up Power (dBm)	Measured SAR(1g) (W/kg)	Reported SAR(1g) (W/kg)	Power Drift(dB)
MHz	Ch.								
Ambient Temperature: 22.7°C Liquid Temperature: 22.2°C									
Hotspot / Body-Worn Test Data (10mm)									
1860	18700	1RB_0	Front	/	22.48	23.5	0.436	0.55	0.00
1900	19100	50RB_25	Front	/	21.10	22.5	0.330	0.46	0.00
1860	18700	1RB_0	Rear	/	22.48	23.5	0.740	0.94	-0.03
1900	19100	50RB_25	Rear	/	21.10	22.5	0.572	0.79	0.02
1860	18700	1RB_0	Left	/	22.48	23.5	0.503	0.64	0.07
1900	19100	50RB_25	Left	/	21.10	22.5	0.400	0.55	0.10
1860	18700	1RB_0	Right	/	22.48	23.5	0.120	0.15	0.02
1900	19100	50RB_25	Right	/	21.10	22.5	0.072	0.10	0.12
1860	18700	1RB_0	Top	/	22.48	23.5	0.359	0.45	0.06
1900	19100	50RB_25	Top	/	21.10	22.5	0.240	0.33	0.11
1900	19100	1RB_0	Rear	/	22.42	23.5	0.802	1.03	0.03
1880	18900	1RB_0	Rear	/	22.45	23.5	0.773	0.98	0.12
1900	19100	100RB	Rear	/	21.03	22.5	0.593	0.83	0.09
1900	19100	1RB_0	Rear	12/ B2	22.42	23.5	0.818	1.05	0.05

Table 13.13: SAR Values (LTE Band 7 - Head)

Frequency		Test Mode	Test Position	Figure No. / Note	Ambient Temperature: 22.2°C		Liquid Temperature: 21.8°C		Power Drift(dB)
MHz	Ch.				Conducted Power (dBm)	Max. tune-up Power (dBm)	Measured SAR(1g) (W/kg)	Reported SAR(1g) (W/kg)	
2560	21350	1RB_99	Left Touch	/	23.00	23.5	0.309	0.35	0.03
2560	21350	50RB_50	Left Touch	/	21.52	22.5	0.250	0.31	0.05
2560	21350	1RB_99	Left Tilt	/	23.00	23.5	0.301	0.34	0.04
2560	21350	50RB_50	Left Tilt	/	21.52	22.5	0.235	0.29	0.01
2560	21350	1RB_99	Right Touch	/	23.00	23.5	0.621	0.70	0.06
2560	21350	50RB_50	Right Touch	/	21.52	22.5	0.513	0.64	0.06
2560	21350	1RB_99	Right Tilt	/	23.00	23.5	0.239	0.27	0.15
2560	21350	50RB_50	Right Tilt	/	21.52	22.5	0.188	0.24	0.09
2560	21350	1RB_99	Right Touch	13/ B2	23.00	23.5	0.655	0.73	-0.02

Table 13.14: SAR Values (LTE Band 7 - Body)

Frequency		Test Mode	Test Position	Figure No. / Note	Ambient Temperature: 22.2°C		Liquid Temperature: 21.8°C		Power Drift(dB)
MHz	Ch.				Conducted Power (dBm)	Max. tune-up Power (dBm)	Measured SAR(1g) (W/kg)	Reported SAR(1g) (W/kg)	
Hotspot / Body-Worn Test Data (10mm)									
2560	21350	1RB_99	Front	/	23.00	23.5	0.749	0.84	0.10
2560	21350	50RB_50	Front	/	21.52	22.5	0.520	0.65	0.07
2560	21350	1RB_99	Rear	/	23.00	23.5	0.636	0.71	-0.02
2560	21350	50RB_50	Rear	/	21.52	22.5	0.385	0.48	-0.08
2560	21350	1RB_99	Left	/	23.00	23.5	0.087	0.10	-0.10
2560	21350	50RB_50	Left	/	21.52	22.5	0.064	0.08	0.02
2560	21350	1RB_99	Right	/	23.00	23.5	0.455	0.51	0.12
2560	21350	50RB_50	Right	/	21.52	22.5	0.351	0.44	0.09
2560	21350	1RB_99	Bottom	/	23.00	23.5	0.509	0.57	-0.05
2560	21350	50RB_50	Bottom	/	21.52	22.5	0.372	0.47	-0.07
2535	21100	1RB_99	Front	/	22.84	23.5	0.717	0.83	0.05
2510	20850	1RB_99	Front	/	22.74	23.5	0.690	0.82	0.11
2560	21350	100RB	Front	/	21.51	22.5	0.505	0.63	0.10
2560	21350	1RB_99	Front	14/ B2	23.00	23.5	0.774	0.87	0.01

Table 13.15: SAR Values (LTE Band 12 - Head)

Frequency		Test Mode	Test Position	Figure No. / Note	Ambient Temperature: 22.5°C		Liquid Temperature: 22.0°C		Power Drift(dB)
MHz	Ch.				Conducted Power (dBm)	Max. tune-up Power (dBm)	Measured SAR(1g) (W/kg)	Reported SAR(1g) (W/kg)	
711	23130	1RB_49	Left Touch	15	23.42	24.0	0.177	0.20	0.09
704	23060	25RB_0	Left Touch	/	22.38	23.0	0.122	0.14	0.07
711	23130	1RB_49	Left Tilt	/	23.42	24.0	0.083	0.09	0.08
704	23060	25RB_0	Left Tilt	/	22.38	23.0	0.061	0.07	0.14
711	23130	1RB_49	Right Touch	/	23.42	24.0	0.170	0.19	0.03
704	23060	25RB_0	Right Touch	/	22.38	23.0	0.116	0.13	0.06
711	23130	1RB_49	Right Tilt	/	23.42	24.0	0.087	0.10	0.02
704	23060	25RB_0	Right Tilt	/	22.38	23.0	0.063	0.07	0.02
711	23130	1RB_49	Left Touch	B2	23.42	24.0	0.168	0.19	0.13

Table 13.16: SAR Values (LTE Band 12 - Body)

Frequency		Test Mode	Test Position	Figure No. / Note	Ambient Temperature: 22.8°C		Liquid Temperature: 22.2°C		Power Drift(dB)
MHz	Ch.				Conducted Power (dBm)	Max. tune-up Power (dBm)	Measured SAR(1g) (W/kg)	Reported SAR(1g) (W/kg)	
Hotspot / Body-Worn Test Data (10mm)									
711	23130	1RB_49	Front	/	23.42	24.0	0.185	0.21	0.02
704	23060	25RB_0	Front	/	22.38	23.0	0.137	0.16	0.04
711	23130	1RB_49	Rear	/	23.42	24.0	0.246	0.28	0.07
704	23060	25RB_0	Rear	/	22.38	23.0	0.177	0.20	0.06
711	23130	1RB_49	Left	/	23.42	24.0	0.112	0.13	0.07
704	23060	25RB_0	Left	/	22.38	23.0	0.074	0.09	0.11
711	23130	1RB_49	Right	/	23.42	24.0	0.133	0.15	0.11
704	23060	25RB_0	Right	/	22.38	23.0	0.081	0.09	0.13
711	23130	1RB_49	Bottom	/	23.42	24.0	0.029	0.03	0.18
704	23060	25RB_0	Bottom	/	22.38	23.0	0.019	0.02	0.03
711	23130	1RB_49	Rear	16/ B2	23.42	24.0	0.255	0.29	0.10

Table 13.17: SAR Values (LTE Band 13 - Head)

Frequency		Test Mode	Test Position	Figure No. / Note	Conducted Power (dBm)	Max. tune-up Power (dBm)	Measured SAR(1g) (W/kg)	Reported SAR(1g) (W/kg)	Power Drift(dB)
MHz	Ch.								
Ambient Temperature: 22.5°C		Liquid Temperature: 22.0°C							
782	23230	1RB_49	Left Touch	/	23.17	24.0	0.187	0.23	-0.04
782	23230	25RB_12	Left Touch	/	22.19	23.0	0.140	0.17	0.12
782	23230	1RB_49	Left Tilt	/	23.17	24.0	0.108	0.13	0.10
782	23230	25RB_12	Left Tilt	/	22.19	23.0	0.080	0.10	0.13
782	23230	1RB_49	Right Touch	17	23.17	24.0	0.200	0.24	0.09
782	23230	25RB_12	Right Touch	/	22.19	23.0	0.155	0.19	0.13
782	23230	1RB_49	Right Tilt	/	23.17	24.0	0.105	0.13	0.08
782	23230	25RB_12	Right Tilt	/	22.19	23.0	0.084	0.10	0.08
782	23230	1RB_49	Right Touch	B2	23.17	24.0	0.182	0.22	0.05

Table 13.18: SAR Values (LTE Band 13 - Body)

Frequency		Test Mode	Test Position	Figure No. / Note	Conducted Power (dBm)	Max. tune-up Power (dBm)	Measured SAR(1g) (W/kg)	Reported SAR(1g) (W/kg)	Power Drift(dB)
MHz	Ch.								
Ambient Temperature: 22.8°C		Liquid Temperature: 22.2°C							
Hotspot / Body-Worn Test Data (10mm)									
782	23230	1RB_49	Front	/	23.17	24.0	0.198	0.24	0.04
782	23230	25RB_12	Front	/	22.19	23.0	0.170	0.20	0.02
782	23230	1RB_49	Rear	18	23.17	24.0	0.279	0.34	0.02
782	23230	25RB_12	Rear	/	22.19	23.0	0.224	0.27	0.01
782	23230	1RB_49	Left	/	23.17	24.0	0.191	0.23	0.03
782	23230	25RB_12	Left	/	22.19	23.0	0.158	0.19	0.00
782	23230	1RB_49	Right	/	23.17	24.0	0.274	0.33	0.02
782	23230	25RB_12	Right	/	22.19	23.0	0.218	0.26	0.07
782	23230	1RB_49	Bottom	/	23.17	24.0	0.036	0.04	0.06
782	23230	25RB_12	Bottom	/	22.19	23.0	0.030	0.04	0.09
782	23230	1RB_49	Rear	B2	23.17	24.0	0.266	0.32	0.08

Table 13.19: SAR Values (LTE Band 26 - Head)

Frequency		Test Mode	Test Position	Figure No. / Note	Conducted Power (dBm)	Max. tune-up Power (dBm)	Measured SAR(1g) (W/kg)	Reported SAR(1g) (W/kg)	Power Drift(dB)
MHz	Ch.								
Ambient Temperature: 22.6°C		Liquid Temperature: 22.0°C							
822.5	26775	1RB_0	Left Touch	19	23.51	24.5	0.204	0.26	0.09
822.5	26775	36RB_19	Left Touch	/	22.69	23.5	0.166	0.20	0.05
822.5	26775	1RB_0	Left Tilt	/	23.51	24.5	0.100	0.13	0.08
822.5	26775	36RB_19	Left Tilt	/	22.69	23.5	0.080	0.10	0.13
822.5	26775	1RB_0	Right Touch	/	23.51	24.5	0.199	0.25	0.12
822.5	26775	36RB_19	Right Touch	/	22.69	23.5	0.161	0.19	0.06
822.5	26775	1RB_0	Right Tilt	/	23.51	24.5	0.104	0.13	0.11
822.5	26775	36RB_19	Right Tilt	/	22.69	23.5	0.088	0.11	0.13
822.5	26775	1RB_0	Left Touch	B2	23.51	24.5	0.195	0.24	0.07

Table 13.20: SAR Values (LTE Band 26 - Body)

Frequency		Test Mode	Test Position	Figure No. / Note	Conducted Power (dBm)	Max. tune-up Power (dBm)	Measured SAR(1g) (W/kg)	Reported SAR(1g) (W/kg)	Power Drift(dB)
MHz	Ch.								
Ambient Temperature: 22.6°C		Liquid Temperature: 22.0°C							
Hotspot / Body-Worn Test Data (10mm)									
822.5	26775	1RB_0	Front	/	23.51	24.5	0.225	0.28	0.00
822.5	26775	36RB_19	Front	/	22.69	23.5	0.177	0.21	0.02
822.5	26775	1RB_0	Rear	20	23.51	24.5	0.344	0.43	0.05
822.5	26775	36RB_19	Rear	/	22.69	23.5	0.263	0.32	0.03
822.5	26775	1RB_0	Left	/	23.51	24.5	0.251	0.32	0.02
822.5	26775	36RB_19	Left	/	22.69	23.5	0.184	0.22	0.19
822.5	26775	1RB_0	Right	/	23.51	24.5	0.282	0.35	0.08
822.5	26775	36RB_19	Right	/	22.69	23.5	0.218	0.26	0.04
822.5	26775	1RB_0	Bottom	/	23.51	24.5	0.039	0.05	0.15
822.5	26775	36RB_19	Bottom	/	22.69	23.5	0.033	0.04	0.01
822.5	26775	1RB_0	Rear	B2	23.51	24.5	0.328	0.41	0.04

Table 13.21: SAR Values (LTE Band 66 - Head)

Frequency		Test Mode	Test Position	Figure No. / Note	Conducted Power (dBm)	Max. tune-up Power (dBm)	Measured SAR(1g) (W/kg)	Reported SAR(1g) (W/kg)	Power Drift(dB)
MHz	Ch.								
Ambient Temperature: 22.7°C Liquid Temperature: 22.2°C									
Reduced power level 1									
1720	132072	1RB_99	Left Touch	/	18.77	19.0	0.492	0.52	0.03
1720	132072	50RB_50	Left Touch	/	18.21	19.0	0.458	0.55	0.07
1720	132072	1RB_99	Left Tilt	/	18.77	19.0	0.457	0.48	0.10
1720	132072	50RB_50	Left Tilt	/	18.21	19.0	0.414	0.50	0.05
1720	132072	1RB_99	Right Touch	/	18.77	19.0	0.961	1.01	0.09
1720	132072	50RB_50	Right Touch	/	18.21	19.0	0.751	0.90	0.08
1720	132072	1RB_99	Right Tilt	/	18.77	19.0	0.615	0.65	0.07
1720	132072	50RB_50	Right Tilt	/	18.21	19.0	0.594	0.71	0.09
1770	132572	1RB_99	Right Touch	/	17.76	19.0	0.684	0.91	0.09
1745	132232	1RB_99	Right Touch	/	17.29	19.0	0.762	1.13	0.09
1770	132572	50RB_50	Right Tilt	/	17.69	19.0	0.742	1.00	0.08
1745	132232	50RB_0	Right Tilt	/	17.31	19.0	0.708	1.04	0.08
1720	132072	100RB	Right Touch	/	17.68	19.0	0.661	0.90	-0.03
1745	132232	1RB_99	Right Touch	21/ B2	17.29	19.0	0.778	1.15	-0.05

Table 13.22: SAR Values (LTE Band 66 - Body)

Frequency		Test Mode	Test Position	Figure No. / Note	Conducted Power (dBm)	Max. tune-up Power (dBm)	Measured SAR(1g) (W/kg)	Reported SAR(1g) (W/kg)	Power Drift(dB)
MHz	Ch.								
Ambient Temperature: 22.7°C Liquid Temperature: 22.2°C									
Hotspot / Body-Worn Test Data (10mm)									
1720	132072	1RB_0	Front	/	23.64	24.5	0.611	0.74	-0.03
1770	132572	50RB_0	Front	/	22.67	23.5	0.493	0.60	0.04
1720	132072	1RB_0	Rear	/	23.64	24.5	0.677	0.83	0.02
1770	132572	50RB_0	Rear	/	22.67	23.5	0.651	0.79	0.05
1720	132072	1RB_0	Left	/	23.64	24.5	0.556	0.68	-0.10
1770	132572	50RB_0	Left	/	22.67	23.5	0.494	0.60	0.05
1720	132072	1RB_0	Right	/	23.64	24.5	0.092	0.11	0.01
1770	132572	50RB_0	Right	/	22.67	23.5	0.114	0.14	0.06
1720	132072	1RB_0	Top	/	23.64	24.5	0.071	0.09	0.03
1770	132572	50RB_0	Top	/	22.67	23.5	0.270	0.33	0.06
1770	132572	1RB_50	Rear	/	23.51	24.5	0.821	1.03	0.07
1745	132322	1RB_50	Rear	/	23.53	24.5	0.733	0.92	0.08
1720	132072	100RB	Rear	/	22.63	23.5	0.530	0.65	0.11
1770	132572	1RB_99	Rear	22/ B2	23.51	24.5	0.839	1.05	0.08

13.3. WLAN Evaluation for 2.4G

According to the KDB248227 D01, SAR is measured for 2.4GHz 802.11b DSSS using the initial test position procedure.

Table 13.23: SAR Values (WLAN 2.4G - Head)

Frequency		Test Mode	Test Position	Figure No. / Note	Ambient Temperature: 22.4°C		Liquid Temperature: 21.8°C		
MHz	Ch.				Conducte d Power (dBm)	Max. tune-up Power (dBm)	Measured SAR(1g) (W/kg)	Reported SAR(1g) (W/kg)	Power Drift(dB)
2437	6	802.11 b	Left Touch	23	13.76	14.5	0.355	0.42	0.09
2437	6	802.11 b	Left Tilt	/	13.76	14.5	0.233	0.28	0.06
2437	6	802.11 b	Right Touch	/	13.76	14.5	0.171	0.20	0.05
2437	6	802.11 b	Right Tilt	/	13.76	14.5	0.147	0.17	0.06
2437	6	802.11 b	Left Touch	B2	13.76	14.5	0.346	0.41	0.12

Note1: For all positions/configurations tested using the initial test position and subsequent test positions, when the reported SAR is > 0.8 W/kg, SAR is measured for these test positions/configurations on the subsequent next highest measured output power channel until the reported SAR is ≤ 1.2 W/kg or all required channels are tested.

According to the KDB248227 D01, The reported SAR must be scaled to 100% transmission duty factor to determine compliance at the maximum tune-up tolerance limit.

Table 13.24: SAR Values (WLAN - Head) – 802.11b (Scaled Reported SAR)

Frequency		Test Position	Actual duty factor	maximum duty factor	Reported SAR (1g)(W/kg)	Scaled reported SAR (1g)(W/kg)
MHz	Ch.					
2437	6	Left Touch	100%	100%	0.42	0.42

SAR is not required for OFDM because the 802.11b adjusted SAR ≤ 1.2 W/kg.

Table 13.25: SAR Values (WLAN 2.4G - Body)

Frequency		Test Mode	Test Position	Figure No. / Note	Conducted Power (dBm)	Max. tune-up Power (dBm)	Measured SAR(1g) (W/kg)	Reported SAR(1g) (W/kg)	Power Drift(dB)
MHz	Ch.								
Ambient Temperature: 22.4°C Liquid Temperature: 21.8°C									
Test Data (10mm)									
2437	6	802.11 b	Front	/	13.76	14.5	0.085	0.10	0.03
2437	6	802.11 b	Rear	24	13.76	14.5	0.188	0.22	0.16
2437	6	802.11 b	Right	/	13.76	14.5	0.114	0.14	0.00
2437	6	802.11 b	Top	/	13.76	14.5	0.064	0.08	0.01
2437	6	802.11 b	Rear	B2	13.76	14.5	0.177	0.21	0.10

Note1: For all positions/configurations tested using the initial test position and subsequent test positions, when the reported SAR is > 0.8 W/kg, SAR is measured for these test positions/configurations on the subsequent next highest measured output power channel until the reported SAR is ≤ 1.2 W/kg or all required channels are tested.

According to the KDB248227 D01, The reported SAR must be scaled to 100% transmission duty factor to determine compliance at the maximum tune-up tolerance limit.

Table 13.26: SAR Values (WLAN - Body) – 802.11b (Scaled Reported SAR)

Frequency		Test Position	Actual duty factor	maximum duty factor	Reported SAR (1g)(W/kg)	Scaled reported SAR (1g)(W/kg)
MHz	Ch.					
2437	6	Rear	100%	100%	0.22	0.22

SAR is not required for OFDM because the 802.11b adjusted SAR ≤ 1.2 W/kg.

14. SAR Measurement Variability

SAR measurement variability must be assessed for each frequency band, which is determined by the SAR probe calibration point and tissue-equivalent medium used for the device measurements. When both head and body tissue-equivalent media are required for SAR measurements in a frequency band, the variability measurement procedures should be applied to the tissue medium with the highest measured SAR, using the highest measured SAR configuration for that tissue-equivalent medium.

The following procedures are applied to determine if repeated measurements are required.

- 1) Repeated measurement is not required when the original highest measured SAR is < 0.80 W/kg; steps 2) through 4) do not apply.
- 2) When the original highest measured SAR is ≥ 0.80 W/kg, repeat that measurement once.
- 3) Perform a second repeated measurement only if the ratio of largest to smallest SAR for the original and first repeated measurements is > 1.20 or when the original or repeated measurement is ≥ 1.45 W/kg (~ 10% from the 1-g SAR limit).
- 4) Perform a third repeated measurement only if the original, first or second repeated measurement is ≥ 1.5 W/kg and the ratio of largest to smallest SAR for the original, first and second repeated measurements is > 1.20 .

Table 14.1: SAR Measurement Variability for Head – GSM1900

Frequency		Test Position	Original	1 st Repeated	Ratio	2 nd Repeated
MHz	Ch.		SAR (W/kg)	SAR (W/kg)		SAR (W/kg)
1880	661	Right Touch	0.992	0.985	1.01	/

Table 14.2: SAR Measurement Variability for Head – WCDMA Band 2

Frequency		Test Position	Original	1 st Repeated	Ratio	2 nd Repeated
MHz	Ch.		SAR (W/kg)	SAR (W/kg)		SAR (W/kg)
1852.4	9262	Right Touch	0.967	0.954	1.01	/

Table 14.3: SAR Measurement Variability for Body – WCDMA Band 2

Frequency		Test Position	Original	1 st Repeated	Ratio	2 nd Repeated
MHz	Ch.		SAR (W/kg)	SAR (W/kg)		SAR (W/kg)
1880	9400	Rear	0.878	0.859	1.02	/

Table 14.4: SAR Measurement Variability for Head –WCDMA Band 4

Frequency		Test Position	Original	1 st Repeated	Ratio	2 nd Repeated
MHz	Ch.		SAR (W/kg)	SAR (W/kg)		SAR (W/kg)
1732.6	1413	Right Touch	0.901	0.884	1.02	/

Table 14.5: SAR Measurement Variability for Head – LTE Band 2

Frequency		Test Position	Original	1 st Repeated	Ratio	2 nd Repeated
MHz	Ch.		SAR (W/kg)	SAR (W/kg)		SAR (W/kg)
1880	18900	Right Touch	1.03	0.992	1.04	/

Table 14.6: SAR Measurement Variability for Body – LTE Band 2

Frequency		Test Position	Original	1 st Repeated	Ratio	2 nd Repeated
MHz	Ch.		SAR (W/kg)	SAR (W/kg)		SAR (W/kg)
1900	19100	Right Touch	0.818	0.787	1.04	/

Table 14.6: SAR Measurement Variability for Head – LTE Band 66

Frequency		Test Position	Original	1 st Repeated	Ratio	2 nd Repeated
MHz	Ch.		SAR (W/kg)	SAR (W/kg)		SAR (W/kg)
1720	132072	Right Touch	0.961	0.945	1.02	/

Table 14.7: SAR Measurement Variability for Body – LTE Band 66

Frequency		Test Position	Original	1 st Repeated	Ratio	2 nd Repeated
MHz	Ch.		SAR (W/kg)	SAR (W/kg)		SAR (W/kg)
1770	132572	Right Touch	0.839	0.945	1.02	/

15. Measurement Uncertainty

15.1. Measurement Uncertainty for Normal SAR Tests (300MHz~3GHz)

No.	Error Description	Type	Uncertainty value	Probably Distribution	Div.	(Ci) 1g	(Ci) 10g	Std. Unc. (1g)	Std. Unc. (10g)	Degree of freedom
Measurement system										
1	Probe calibration	B	12	N	2	1	1	6.0	6.0	∞
2	Axial isotropy	B	4.7	R	$\sqrt{3}$	$\sqrt{0.5}$	$\sqrt{0.5}$	4.3	4.3	∞
3	Hemispherical isotropy	B	9.6	R	$\sqrt{3}$	1	1	4.8	4.8	∞
4	Boundary effect	B	1.1	R	$\sqrt{3}$	1	1	0.6	0.6	∞
5	Linearity	B	4.7	R	$\sqrt{3}$	1	1	2.7	2.7	∞
6	Detection limit	B	1.0	R	$\sqrt{3}$	1	1	0.6	0.6	∞
7	Modulation response	B	4.0	R	$\sqrt{3}$	1	1	2.3	2.3	∞
8	Readout electronics	B	1.0	N	1	1	1	1.0	1.0	∞
9	Response time	B	0.8	R	$\sqrt{3}$	1	1	0.5	0.5	∞
10	Integration time	B	1.7	R	$\sqrt{3}$	1	1	1.0	1.0	∞
11	RF ambient conditions-noise	B	3.0	R	$\sqrt{3}$	1	1	1.7	1.7	∞
12	RF ambient conditions-reflection	B	3.0	R	$\sqrt{3}$	1	1	1.7	1.7	∞
13	Probe positioned mech. restrictions	B	0.35	R	$\sqrt{3}$	1	1	0.2	0.2	∞
14	Probe positioning with respect to phantom shell	B	2.9	R	$\sqrt{3}$	1	1	1.7	1.7	∞
15	Post-processing	B	1.0	R	$\sqrt{3}$	1	1	0.6	0.6	∞
Test sample related										
16	Test sample positioning	A	3.3	N	1	1	1	3.3	3.3	5
17	Device holder uncertainty	A	3.4	N	1	1	1	3.4	3.4	5
18	Drift of output power	B	5.0	R	$\sqrt{3}$	1	1	2.9	2.9	∞
Phantom and set-up										
19	Phantom uncertainty	B	1.0	R	$\sqrt{3}$	1	1	0.6	0.6	∞
20	Liquid conductivity (target)	B	5.0	R	$\sqrt{3}$	0.64	0.43	1.8	1.2	∞
21	Liquid conductivity (meas.)	A	1.3	N	1	0.64	0.43	0.83	0.56	9
22	Liquid permittivity (target)	B	5.0	R	$\sqrt{3}$	0.6	0.49	1.7	1.4	∞
23	Liquid permittivity (meas.)	A	1.6	N	1	0.6	0.49	0.96	0.78	9
Combined standard uncertainty		$u_c = \sqrt{\sum_{i=1}^{23} c_i^2 u_i^2}$						11.3	11.2	95.5
Expanded uncertainty (Confidence interval of 95 %)		$u_e = 2u_c$						22.6	22.4	

16. Main Test Instruments

Table 16.1: List of Main Instruments

No.	Name	Type	Serial Number	Calibration Date	Valid Period
01	Network analyzer	E5071C	MY46103759	2019-11-15	One year
02	Dielectric probe	85070E	MY44300317	/	/
03	Power meter	E4418B	MY50000366	2019-12-14	One year
04	Power sensor	E9304A	MY50000188		
05	Power meter	NRP	101460	2020-01-15	One year
06	Power sensor	NRP-Z91	100553		
07	Signal Generator	E8257D	MY47461211	2020-01-15	One year
08	Amplifier	VTL5400	0404	/	/
09	E-field Probe	ES3DV3	3151	2020-01-03	One year
11	DAE	DAE4	786	2020-03-03	One year
12	Dipole Validation Kit	D750V3	1163	2019-09-03	Three year
13	Dipole Validation Kit	D835V2	4d057	2018-10-09	Three year
14	Dipole Validation Kit	D1750V2	1152	2019-08-30	Three year
15	Dipole Validation Kit	D1900V2	5d088	2018-10-24	Three year
16	Dipole Validation Kit	D2450V2	873	2018-10-26	Three year
17	Dipole Validation Kit	D2550V2	1058	2018-08-24	Three year
18	BTS	E5515C	GB46110722	2020-01-05	One year
19	Radio Communication Analyzer	MT8820C	6201341853	2020-01-15	One year
20	Software	DASY5	52.8.8.1222	/	/

ANNEX A: Graph Results

GSM850 Head

Date: 2020-9-14

Electronics: DAE4 Sn786

Medium: Head 835MHz

Medium parameters used (interpolated): $f = 836.6$ MHz; $\sigma = 0.919$ S/m; $\epsilon_r = 40.632$; $\rho = 1000$ kg/m³

Ambient Temperature: 22.0°C Liquid Temperature: 21.5°C

Communication System: UID 0, GSM (0) Frequency: 836.6 MHz Duty Cycle: 1:8.3

Probe: ES3DV3 – SN3151 ConvF (6.41, 6.41, 6.41);

Right Cheek Middle/Area Scan (61x61x1): Interpolated grid: $dx=1.500$ mm, $dy=1.500$ mm

Maximum value of SAR (interpolated) = 0.365 W/kg

Right Cheek Middle/Zoom Scan (5x5x7)/Cube 0: Measurement grid: $dx=8$ mm, $dy=8$ mm, $dz=5$ mm

Reference Value = 3.626 V/m; Power Drift = 0.01 dB

Peak SAR (extrapolated) = 0.426 W/kg

SAR(1 g) = 0.327 W/kg; SAR(10 g) = 0.250 W/kg

Maximum value of SAR (measured) = 0.357 W/kg

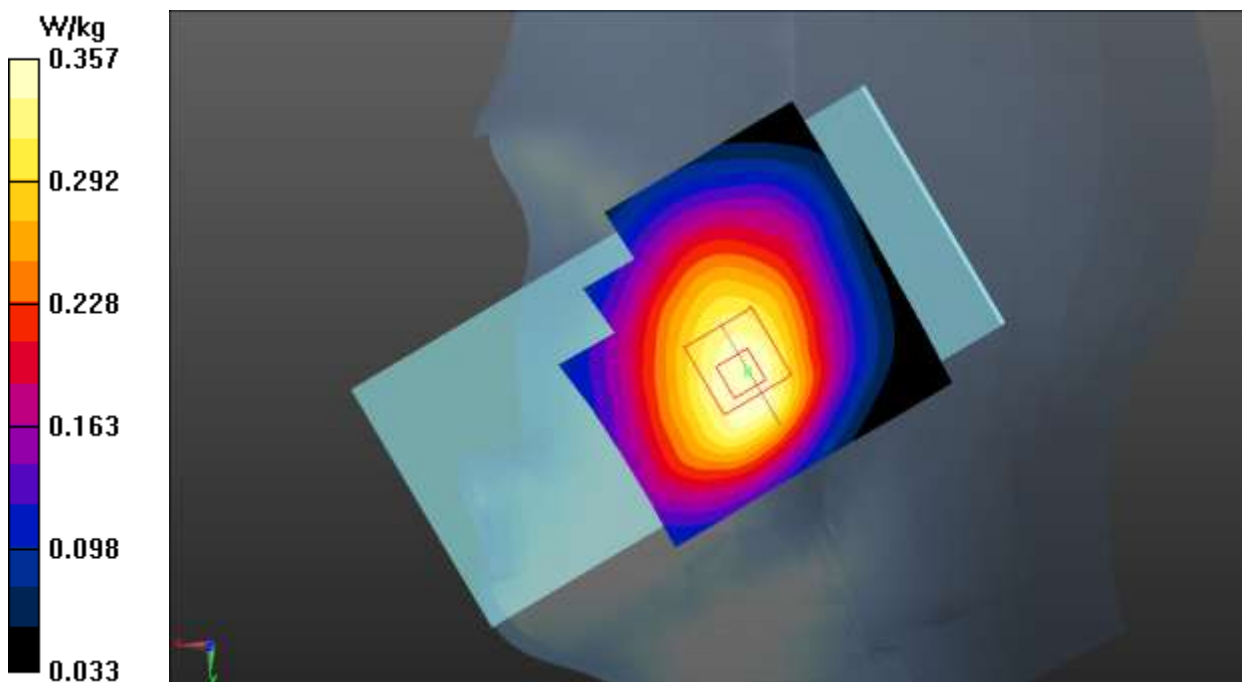

Fig.1 GSM 850 Head

GSM850 Body

Date: 2020-9-14

Electronics: DAE4 Sn786

Medium: Head 835MHz

Medium parameters used (interpolated): $f = 836.6$ MHz; $\sigma = 0.919$ S/m; $\epsilon_r = 40.632$; $\rho = 1000$ kg/m³

Ambient Temperature: 22.0°C Liquid Temperature: 21.5°C

Communication System: UID 0, GPRS 2Txslot (0) Frequency: 836.6 MHz Duty Cycle: 1:4

Probe: ES3DV3 – SN3151 ConvF (6.41, 6.41, 6.41);

Rear Side Middle/Area Scan (61x71x1): Interpolated grid: dx=1.500 mm, dy=1.500 mm

Maximum value of SAR (interpolated) = 0.518 W/kg

Rear Side Middle/Area Scan (61x71x1): Interpolated grid: dx=1.500 mm, dy=1.500 mm

Reference Value = 22.62 V/m; Power Drift = 0.05 dB

Peak SAR (extrapolated) = 0.726 W/kg

SAR(1 g) = 0.467 W/kg; SAR(10 g) = 0.331 W/kg

Maximum value of SAR (interpolated) = 0.525 W/kg

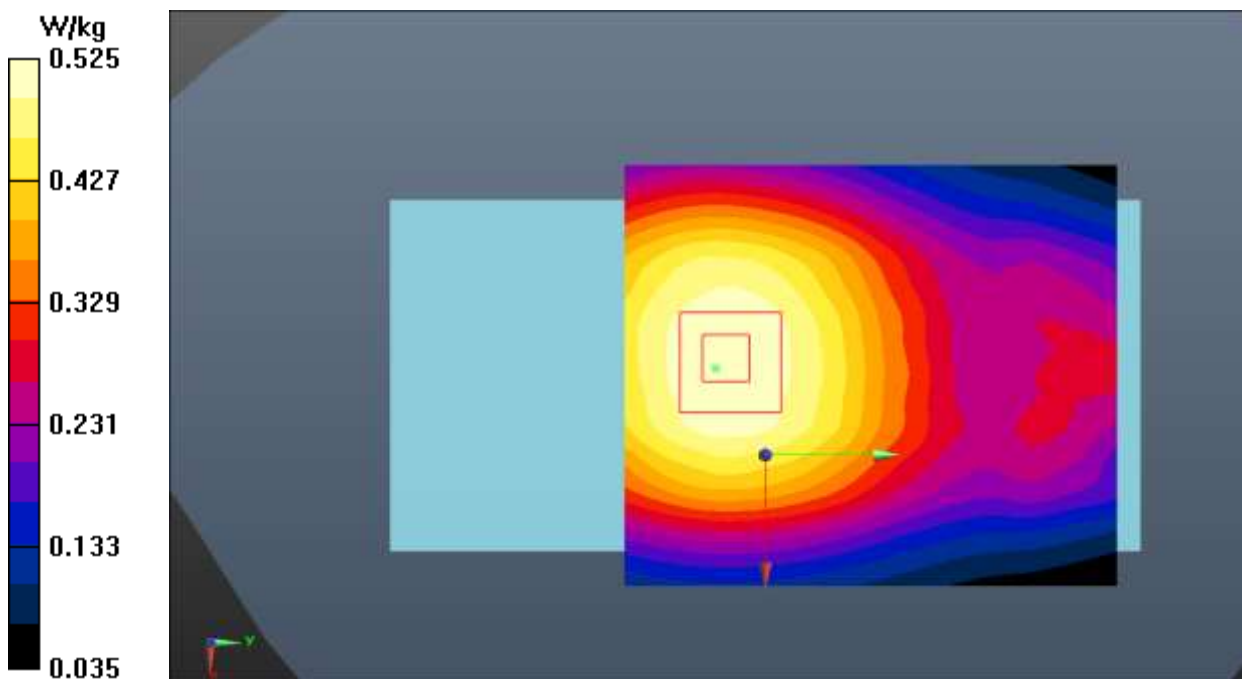

Fig.2 GSM 850 Body

GSM1900 Head

Date: 2020-9-22

Electronics: DAE4 Sn786

Medium: Head 1900MHz

Medium parameters used: $f = 1880$ MHz; $\sigma = 1.397$ S/m; $\epsilon_r = 39.232$; $\rho = 1000$ kg/m³

Ambient Temperature: 22.0°C Liquid Temperature: 21.5°C

Communication System: UID 0, GSM (0) Frequency: 1880 MHz Duty Cycle: 1:8.3

Probe: ES3DV3 – SN3151 ConvF (5.11, 5.11, 5.11);

Right Cheek Middle/Area Scan (61x61x1): Interpolated grid: dx=1.500 mm, dy=1.500 mm

Maximum value of SAR (interpolated) = 1.68 W/kg

Right Cheek Middle/Zoom Scan (5x5x7)/Cube 0: Measurement grid: dx=8mm, dy=8mm, dz=5mm

Reference Value = 13.38 V/m; Power Drift = 0.09 dB

Peak SAR (extrapolated) = 1.86 W/kg

SAR(1 g) = 0.992 W/kg; SAR(10 g) = 0.539 W/kg

Maximum value of SAR (measured) = 1.08 W/kg

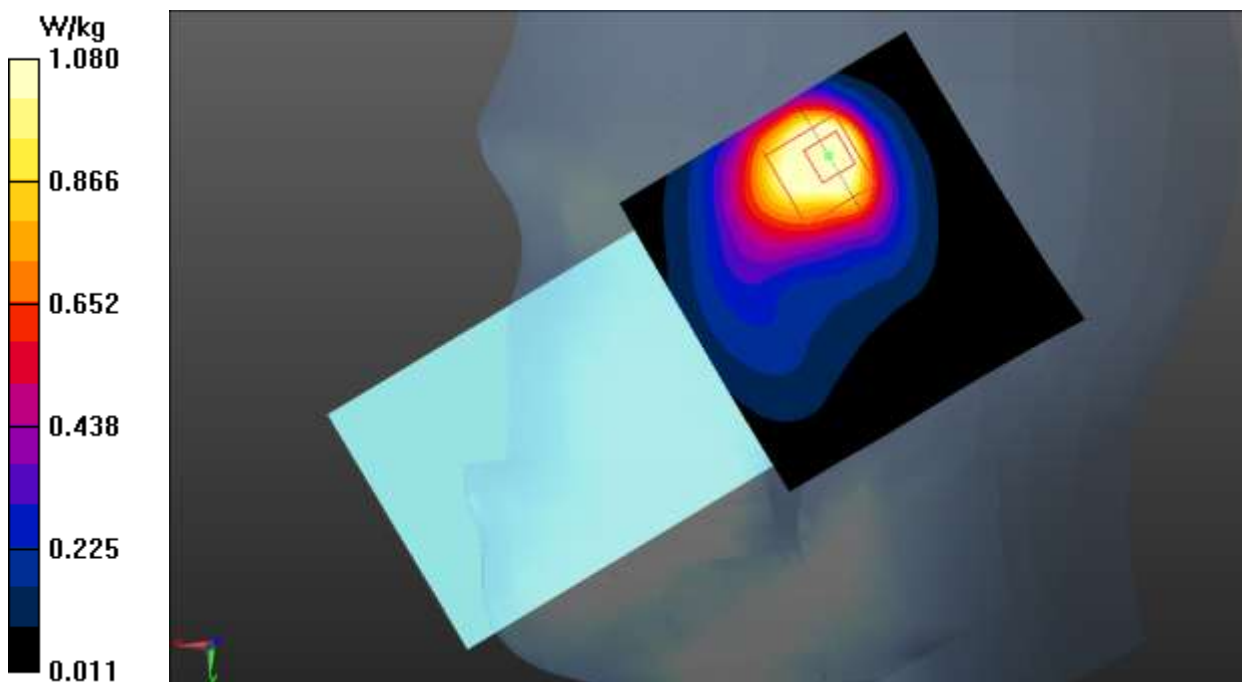
**Fig.3 GSM 1900 Head**

GSM1900 Body

Date: 2020-9-22

Electronics: DAE4 Sn786

Medium: Head 1900MHz

Medium parameters used: $f = 1880 \text{ MHz}$; $\sigma = 1.397 \text{ S/m}$; $\epsilon_r = 39.232$; $\rho = 1000 \text{ kg/m}^3$

Ambient Temperature: 22.0°C Liquid Temperature: 21.5°C

Communication System: UID 0, GPRS 3Txslot (0) Frequency: 1880 MHz Duty Cycle: 1:2.67

Probe: ES3DV3 – SN3151 ConvF (5.11, 5.11, 5.11);

Rear Side Middle/Area Scan (61x61x1): Interpolated grid: $dx=1.500 \text{ mm}$, $dy=1.500 \text{ mm}$

Maximum value of SAR (interpolated) = 0.784 W/kg

Rear Side Middle/Area Scan (61x61x1): Interpolated grid: $dx=1.500 \text{ mm}$, $dy=1.500 \text{ mm}$

Reference Value = 11.69 V/m ; Power Drift = -0.01 dB

Peak SAR (extrapolated) = 1.16 W/kg

SAR: SAR(1 g) = 0.609 W/kg ; SAR(10 g) = 0.333 W/kg

Maximum value of SAR (interpolated) = 0.767 W/kg

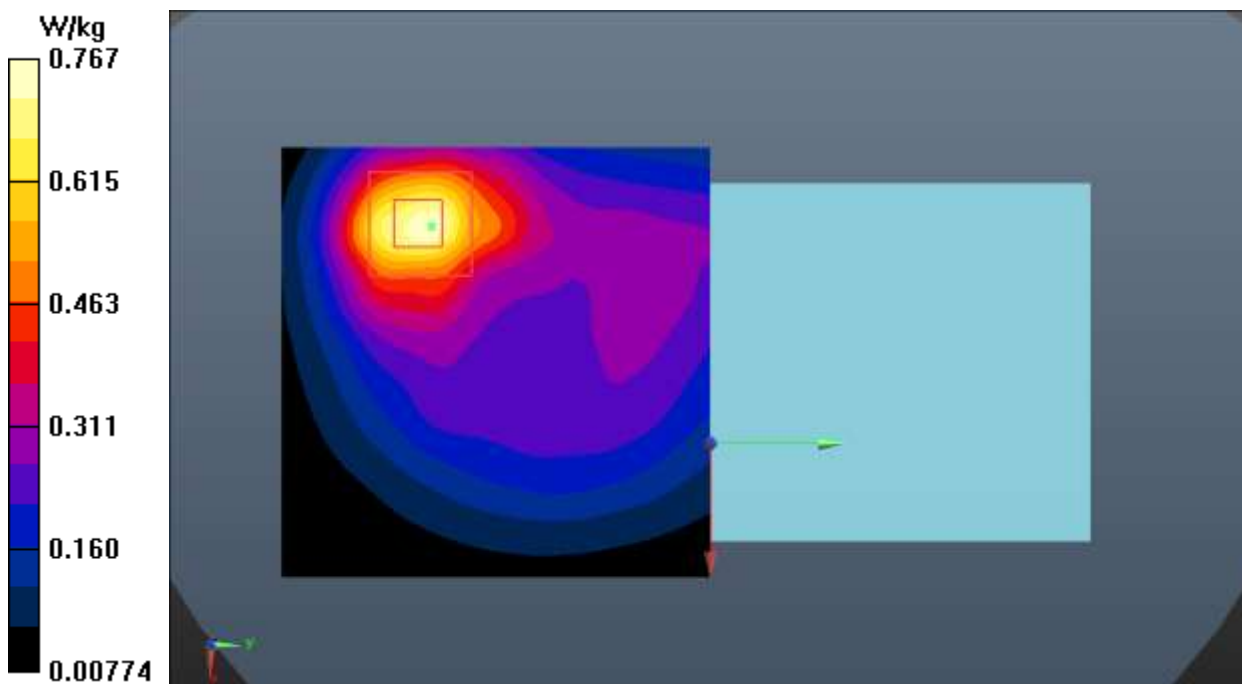

Fig.4 GSM 1900 Body

WCDMA Band 2 Head

Date: 2020-9-22

Electronics: DAE4 Sn786

Medium: Head 1900MHz

Medium parameters used (interpolated): $f = 1852.4$ MHz; $\sigma = 1.373$ S/m; $\epsilon_r = 39.34$; $\rho = 1000$ kg/m³

Ambient Temperature: 22.0°C Liquid Temperature: 21.5°C

Communication System: UID 0, WCDMA (0) Frequency: 1852.4 MHz Duty Cycle: 1:1

Probe: ES3DV3 – SN3151 ConvF (5.11, 5.11, 5.11);

Right Cheek Low/Area Scan (61x61x1): Interpolated grid: dx=1.500 mm, dy=1.500 mm

Maximum value of SAR (interpolated) = 1.68 W/kg

Right Cheek Low/Zoom Scan (5x5x7)/Cube 0: Measurement grid: dx=8mm, dy=8mm, dz=5mm

Reference Value = 12.62 V/m; Power Drift = 0.09 dB

Peak SAR (extrapolated) = 1.81 W/kg

SAR(1 g) = 0.967 W/kg; SAR(10 g) = 0.512 W/kg

Maximum value of SAR (measured) = 1.04 W/kg

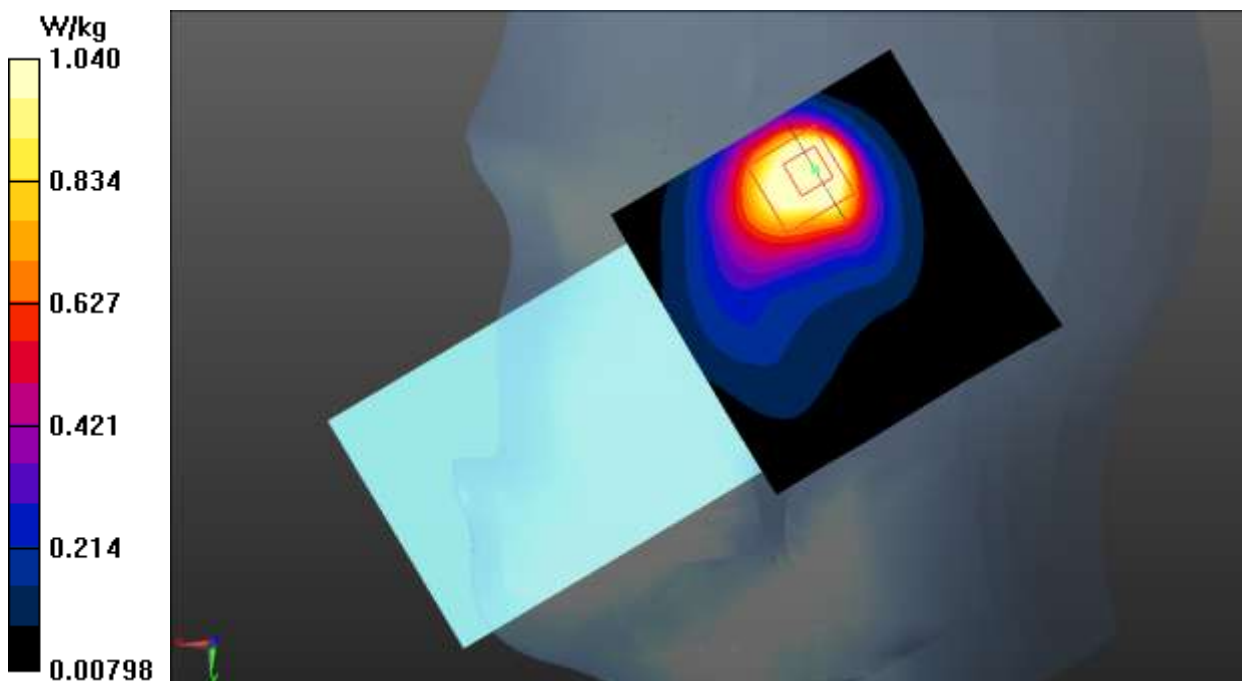

Fig.5 WCDMA Band 2 Head

WCDMA Band 2 Body

Date: 2020-9-22

Electronics: DAE4 Sn786

Medium: Head 1900MHz

Medium parameters used: $f = 1880 \text{ MHz}$; $\sigma = 1.397 \text{ S/m}$; $\epsilon_r = 39.232$; $\rho = 1000 \text{ kg/m}^3$

Ambient Temperature: 22.0°C Liquid Temperature: 21.5°C

Communication System: UID 0, WCDMA (0) Frequency: 1880 MHz Duty Cycle: 1:1

Probe: ES3DV3 – SN3151 ConvF (5.11, 5.11, 5.11);

Rear Side Middle/Area Scan (61x61x1): Interpolated grid: $dx=1.500 \text{ mm}$, $dy=1.500 \text{ mm}$

Maximum value of SAR (interpolated) = 1.07 W/kg

Rear Side Middle/Zoom Scan (5x5x7)/Cube 0: Measurement grid: $dx=8\text{mm}$, $dy=8\text{mm}$, $dz=5\text{mm}$

Reference Value = 15.28 V/m ; Power Drift = 0.08 dB

Peak SAR (extrapolated) = 1.61 W/kg

SAR(1 g) = 0.878 W/kg ; SAR(10 g) = 0.478 W/kg

Maximum value of SAR (measured) = 0.959 W/kg

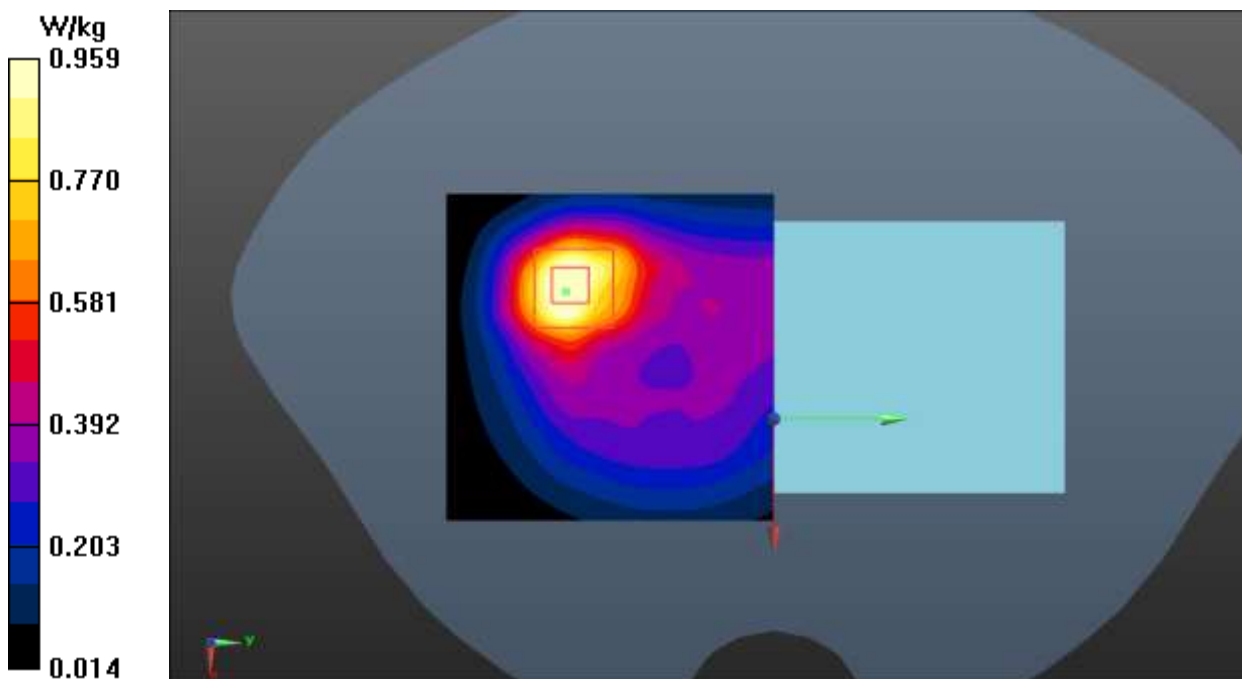

Fig.6 WCDMA Band 2 Body

WCDMA Band 4 Head

Date: 2020-9-22

Electronics: DAE4 Sn786

Medium: Head 1750MHz

Medium parameters used: $f = 1733$ MHz; $\sigma = 1.369$ S/m; $\epsilon_r = 39.438$; $\rho = 1000$ kg/m³

Ambient Temperature: 22.0°C Liquid Temperature: 21.5°C

Communication System: UID 0, WCDMA (0) Frequency: 1732.6 MHz Duty Cycle: 1:1

Probe: ES3DV3 – SN3151 ConvF (5.23, 5.23, 5.23);

Right Cheek Middle/Area Scan (61x61x1): Interpolated grid: dx=1.500 mm, dy=1.500 mm

Maximum value of SAR (interpolated) = 1.50 W/kg

Right Cheek Middle/Zoom Scan (5x5x7)/Cube 0: Measurement grid: dx=8mm, dy=8mm, dz=5mm

Reference Value = 11.24 V/m; Power Drift = -0.01 dB

Peak SAR (extrapolated) = 1.71 W/kg

SAR(1 g) = 0.901 W/kg; SAR(10 g) = 0.479 W/kg

Maximum value of SAR (measured) = 0.985 W/kg

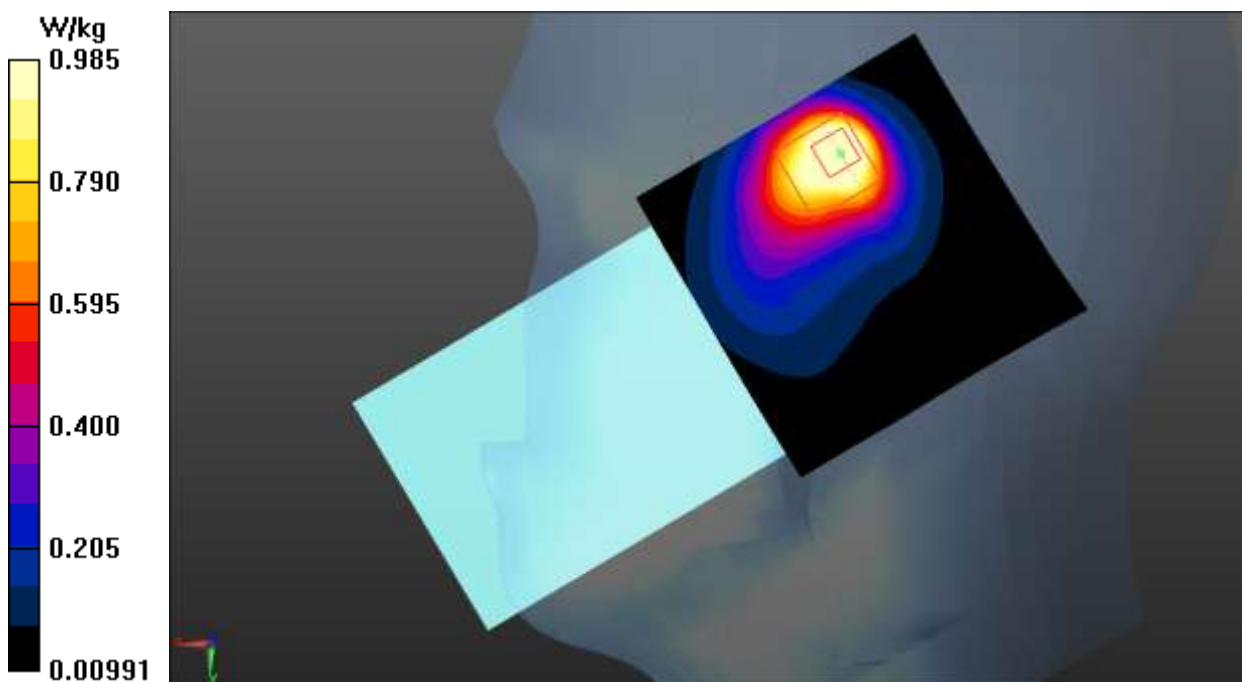

Fig.7 WCDMA Band 4 Head

WCDMA Band 4 Body

Date: 2020-9-22

Electronics: DAE4 Sn786

Medium: Head 1750MHz

Medium parameters used: $f = 1733$ MHz; $\sigma = 1.369$ S/m; $\epsilon_r = 39.438$; $\rho = 1000$ kg/m³

Ambient Temperature: 22.0°C Liquid Temperature: 21.5°C

Communication System: UID 0, WCDMA (0) Frequency: 1732.6 MHz Duty Cycle: 1:1

Probe: ES3DV3 – SN3151 ConvF (5.23, 5.23, 5.23);

Rear Side Middle/Area Scan (61x111x1): Interpolated grid: dx=1.500 mm, dy=1.500 mm

Maximum value of SAR (interpolated) = 0.807 W/kg

Rear Side Middle/Zoom Scan (5x5x7)/Cube 0: Measurement grid: dx=8mm, dy=8mm, dz=5mm

Reference Value = 7.760 V/m; Power Drift = -0.03 dB

Peak SAR (extrapolated) = 1.33 W/kg

SAR(1 g) = 0.734 W/kg; SAR(10 g) = 0.410 W/kg

Maximum value of SAR (measured) = 1.03 W/kg

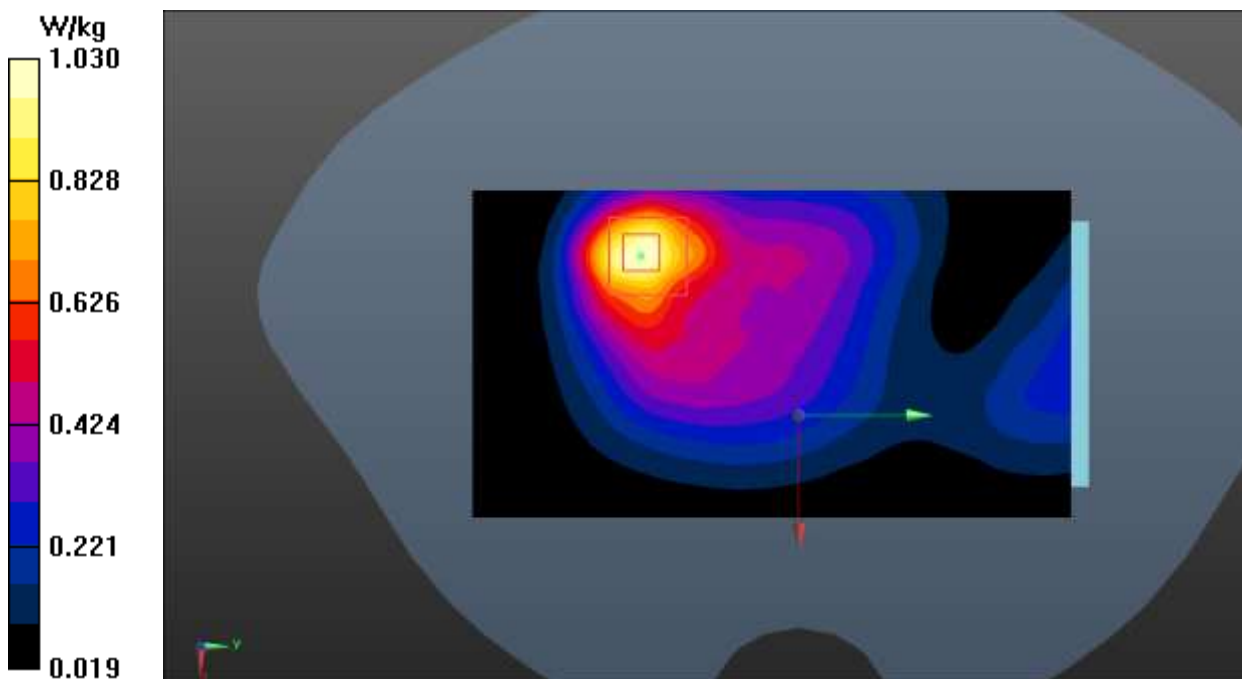
**Fig.8 WCDMA Band 4 Body**

WCDMA Band 5 Head

Date: 2020-9-14

Electronics: DAE4 Sn786

Medium: Head 835MHz

Medium parameters used (interpolated): $f = 836.4$ MHz; $\sigma = 0.919$ S/m; $\epsilon_r = 40.634$; $\rho = 1000$ kg/m³

Ambient Temperature: 22.0°C Liquid Temperature: 21.5°C

Communication System: UID 0, WCDMA (0) Frequency: 836.4 MHz Duty Cycle: 1:1

Probe: ES3DV3 – SN3151 ConvF (6.41, 6.41, 6.41);

Right Cheek Middle/Area Scan (61x61x1): Interpolated grid: dx=1.500 mm, dy=1.500 mm

Maximum value of SAR (interpolated) = 0.367 W/kg

Right Cheek Middle/Zoom Scan (5x5x7)/Cube 0: Measurement grid: dx=8mm, dy=8mm, dz=5mm

Reference Value = 3.663 V/m; Power Drift = 0.05 dB

Peak SAR (extrapolated) = 0.523 W/kg

SAR(1 g) = 0.278 W/kg; SAR(10 g) = 0.206 W/kg

Maximum value of SAR (measured) = 0.400 W/kg

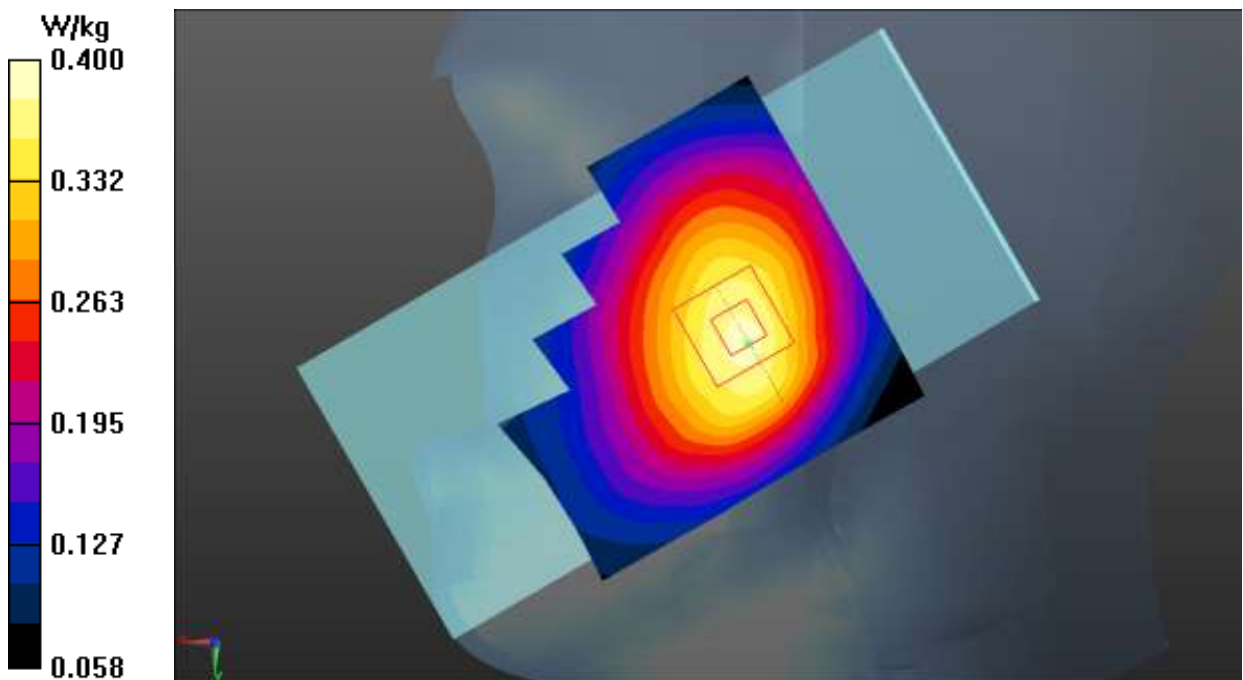
**Fig.9 WCDMA Band 5 Head**

WCDMA Band 5 Body

Date: 2020-9-14

Electronics: DAE4 Sn786

Medium: Head 835MHz

Medium parameters used (interpolated): $f = 836.4$ MHz; $\sigma = 0.919$ S/m; $\epsilon_r = 40.634$; $\rho = 1000$ kg/m³

Ambient Temperature: 22.0°C Liquid Temperature: 21.5°C

Communication System: UID 0, WCDMA (0) Frequency: 836.4 MHz Duty Cycle: 1:1

Probe: ES3DV3 – SN3151 ConvF (6.41, 6.41, 6.41);

Rear Side Middle /Area Scan (61x111x1): Interpolated grid: dx=1.500 mm, dy=1.500 mm

Maximum value of SAR (interpolated) = 0.372 W/kg

Rear Side Middle -PIC/Zoom Scan (5x5x7)/Cube 0: Measurement grid: dx=8mm, dy=8mm, dz=5mm

Reference Value = 17.65 V/m; Power Drift = 0.04 dB

Peak SAR (extrapolated) = 0.432 W/kg

SAR(1 g) = 0.339 W/kg; SAR(10 g) = 0.257 W/kg

Maximum value of SAR (measured) = 0.392 W/kg

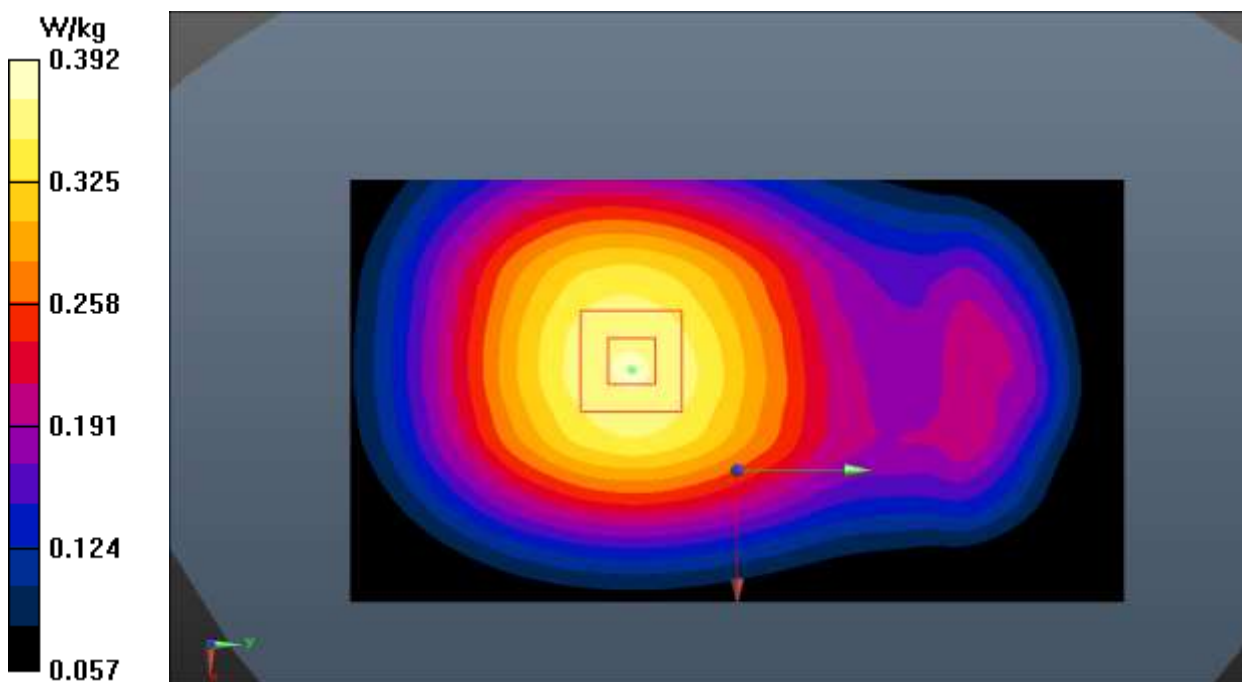

Fig.10 WCDMA Band 5 Body

LTE Band 2 Head

Date: 2020-9-22

Electronics: DAE4 Sn786

Medium: Head 1900MHz

Medium parameters used: $f = 1880$ MHz; $\sigma = 1.397$ S/m; $\epsilon_r = 39.232$; $\rho = 1000$ kg/m³

Ambient Temperature: 22.0°C Liquid Temperature: 21.5°C

Communication System: UID 0, LTE_FDD (0) Frequency: 1880 MHz Duty Cycle: 1:1

Probe: ES3DV3 – SN3151 ConvF (5.11, 5.11, 5.11);

Right Cheek Middle 1RB_99/Area Scan (61x61x1): Interpolated grid: dx=1.500 mm, dy=1.500 mm

Maximum value of SAR (interpolated) = 1.22 W/kg

Right Cheek Middle 1RB_99/Zoom Scan (5x5x7)/Cube 0: Measurement grid: dx=8mm, dy=8mm, dz=5mm

Reference Value = 12.69 V/m; Power Drift = 0.14 dB

Peak SAR (extrapolated) = 1.93 W/kg

SAR(1 g) = 1.03 W/kg; SAR(10 g) = 0.536 W/kg

Maximum value of SAR (measured) = 1.05 W/kg

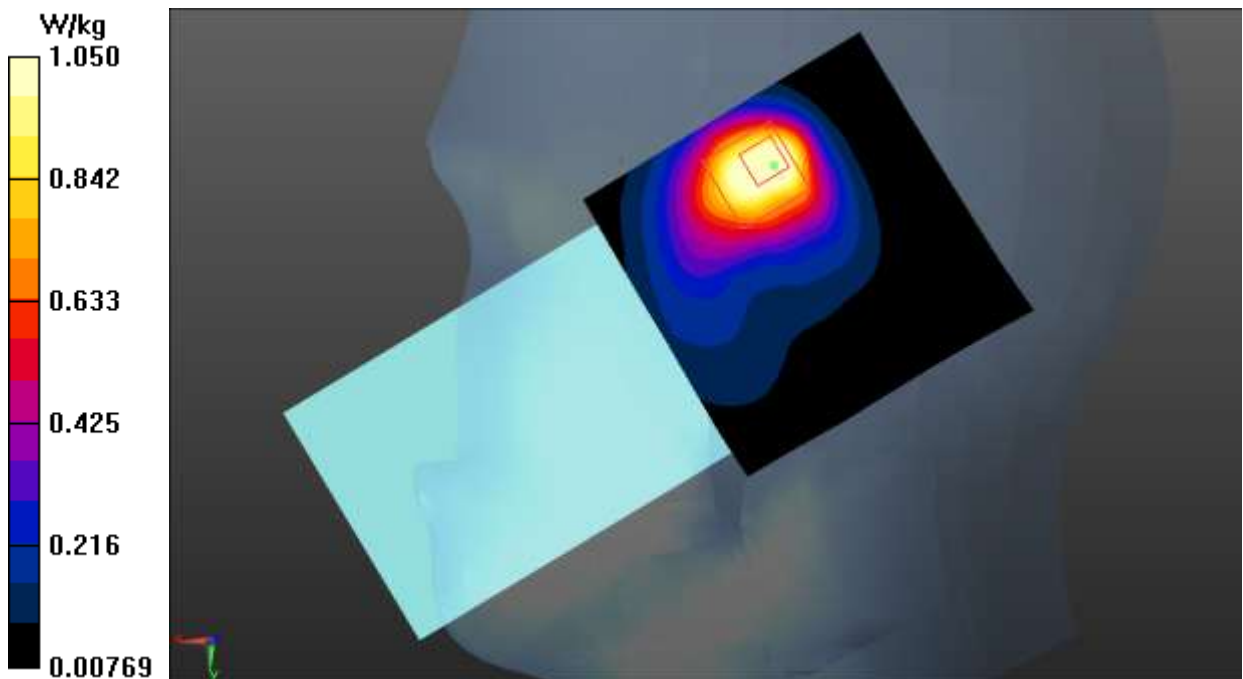
**Fig.11 LTE Band 2 Head**

LTE Band 2 Body

Date: 2020-9-22

Electronics: DAE4 Sn786

Medium: Head 1900MHz

Medium parameters used: $f = 1900 \text{ MHz}$; $\sigma = 1.415 \text{ S/m}$; $\epsilon_r = 39.154$; $\rho = 1000 \text{ kg/m}^3$

Ambient Temperature: 22.0°C Liquid Temperature: 21.5°C

Communication System: UID 0, LTE_FDD (0) Frequency: 1900 MHz Duty Cycle: 1:1

Probe: ES3DV3 – SN3151 ConvF (5.11, 5.11, 5.11);

Rear Side High 1RB_0/Area Scan (61x61x1): Interpolated grid: $dx=1.500 \text{ mm}$, $dy=1.500 \text{ mm}$

Maximum value of SAR (interpolated) = 1.02 W/kg

Rear Side High 1RB_0/Zoom Scan (5x5x7)/Cube 0: Measurement grid: $dx=8\text{mm}$, $dy=8\text{mm}$, $dz=5\text{mm}$

Reference Value = 1.095 V/m ; Power Drift = 0.05 dB

Peak SAR (extrapolated) = 1.53 W/kg

SAR(1 g) = 0.818 W/kg ; SAR(10 g) = 0.441 W/kg

Maximum value of SAR (measured) = 1.17 W/kg

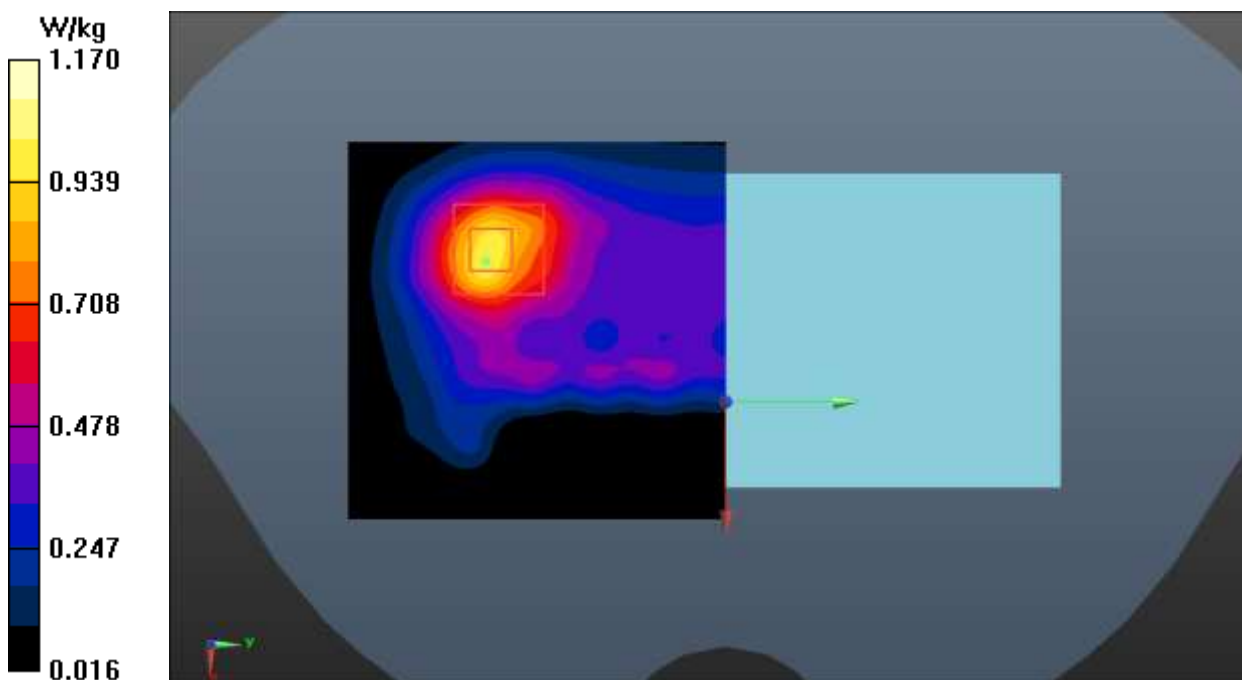

Fig.12 LTE Band 2 Body

LTE Band 7 Head

Date: 2020-9-23

Electronics: DAE4 Sn786

Medium: Head 2550MHz

Medium parameters used: $f = 2560$ MHz; $\sigma = 1.961$ S/m; $\epsilon_r = 38.025$; $\rho = 1000$ kg/m³

Ambient Temperature: 22.0°C Liquid Temperature: 21.5°C

Communication System: UID 0, LTE_FDD (0) Frequency: 2560 MHz Duty Cycle: 1:1

Probe: ES3DV3 – SN3151 ConvF (4.53, 4.53, 4.53);

Right Cheek High 1RB_99/Area Scan (71x71x1): Interpolated grid: dx=1.000 mm, dy=1.000 mm

Maximum value of SAR (interpolated) = 0.756 W/kg

Right Cheek High 1RB_99/Zoom Scan (7x7x7)/Cube 0: Measurement grid: dx=5mm, dy=5mm, dz=5mm

Reference Value = 2.526 V/m; Power Drift = -0.02 dB

Peak SAR (extrapolated) = 1.08 W/kg

SAR(1 g) = 0.655 W/kg; SAR(10 g) = 0.368 W/kg

Maximum value of SAR (measured) = 0.675 W/kg

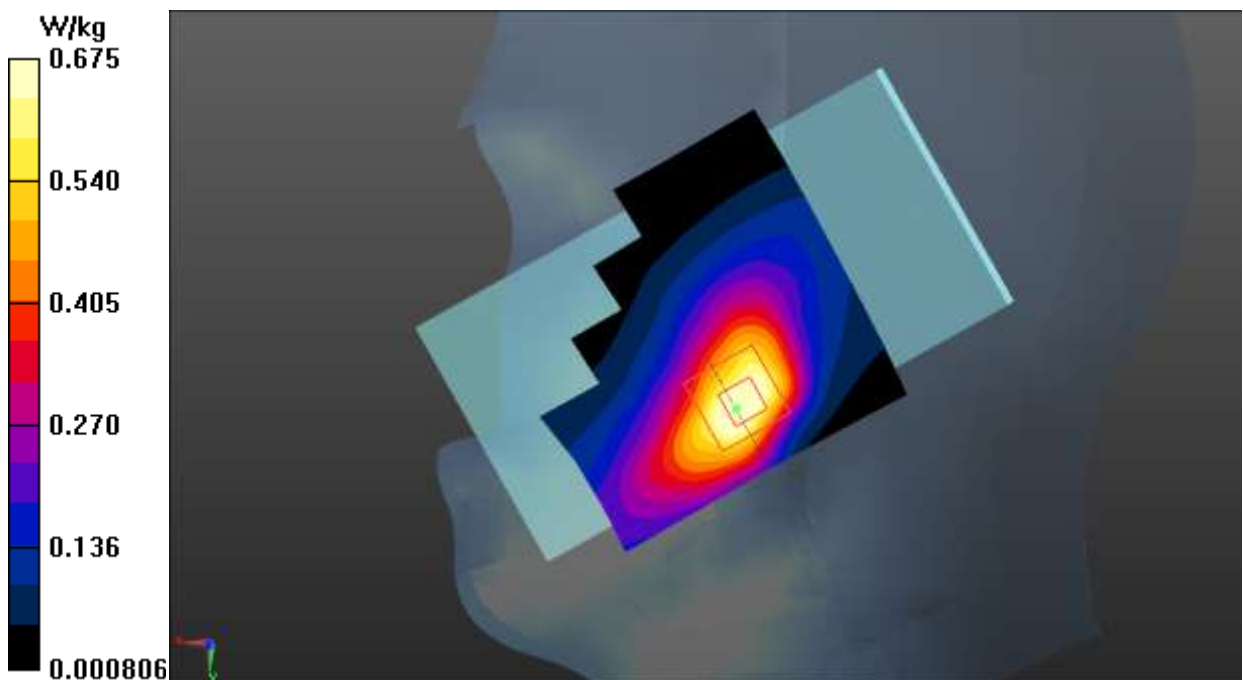

Fig.13 LTE Band 7 Head

LTE Band 7 Body

Date: 2020-9-23

Electronics: DAE4 Sn786

Medium: Head 2550MHz

Medium parameters used: $f = 2560$ MHz; $\sigma = 1.961$ S/m; $\epsilon_r = 38.025$; $\rho = 1000$ kg/m³

Ambient Temperature: 22.0°C Liquid Temperature: 21.5°C

Communication System: UID 0, LTE_FDD (0) Frequency: 2560 MHz Duty Cycle: 1:1

Probe: ES3DV3 – SN3151 ConvF (4.53, 4.53, 4.53);

Front Side High 1RB_99/Area Scan (91x91x1): Interpolated grid: dx=1.000 mm, dy=1.000 mm

Maximum value of SAR (interpolated) = 0.941 W/kg

Front Side High 1RB_99/Zoom Scan (7x7x7)/Cube 0: Measurement grid: dx=5mm, dy=5mm, dz=5mm

Reference Value = 10.60 V/m; Power Drift = 0.01 dB

Peak SAR (extrapolated) = 1.34 W/kg

SAR(1 g) = 0.774 W/kg; SAR(10 g) = 0.423 W/kg

Maximum value of SAR (measured) = 1.01 W/kg

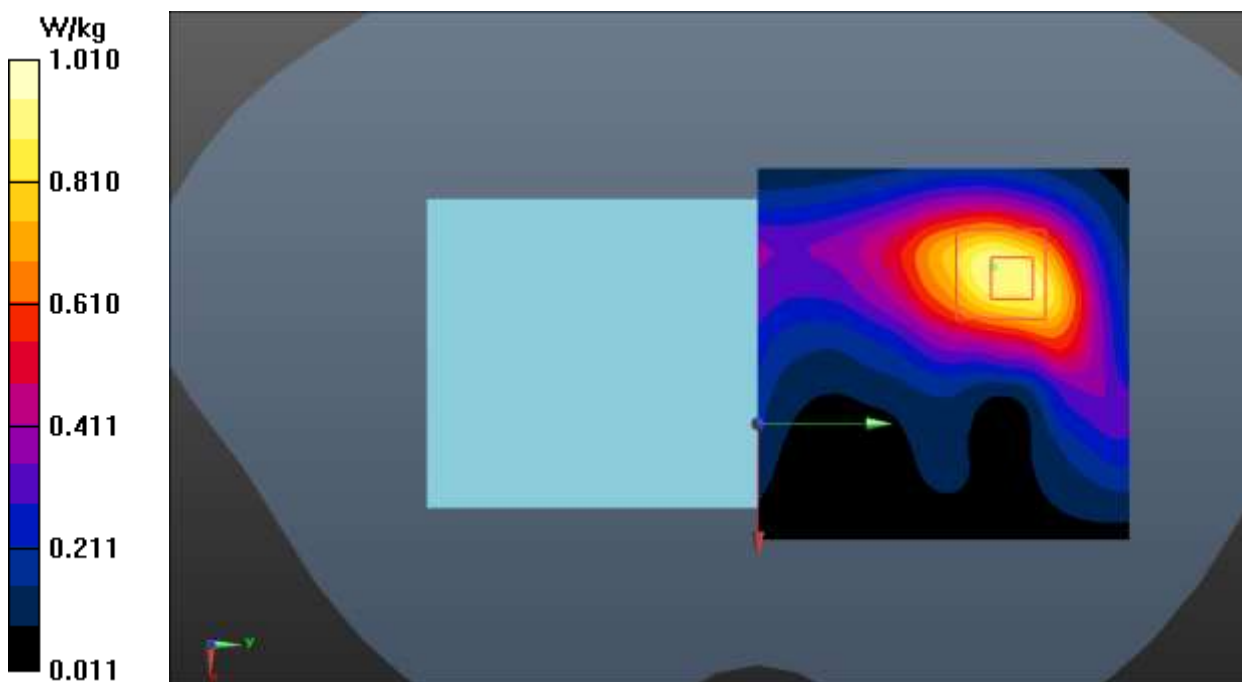

Fig.14 LTE Band 7 Body

LTE Band 12 Head

Date: 2020-9-11

Electronics: DAE4 Sn786

Medium: Head 750MHz

Medium parameters used (interpolated): $f = 711$ MHz; $\sigma = 0.877$ S/m; $\epsilon_r = 41.312$; $\rho = 1000$ kg/m³

Ambient Temperature: 22.0°C Liquid Temperature: 21.5°C

Communication System: UID 0, LTE_FDD (0) Frequency: 711 MHz Duty Cycle: 1:1

Probe: ES3DV3 – SN3151 ConvF (6.41, 6.41, 6.41);

Left Cheek High 1RB_49/Area Scan (61x61x1): Interpolated grid: dx=1.500 mm, dy=1.500 mm

Maximum value of SAR (interpolated) = 0.196 W/kg

Left Cheek High 1RB_49/Zoom Scan (5x5x7)/Cube 0: Measurement grid: dx=8mm, dy=8mm, dz=5mm

Reference Value = 2.963 V/m; Power Drift = 0.09 dB

Peak SAR (extrapolated) = 0.220 W/kg

SAR(1 g) = 0.177 W/kg; SAR(10 g) = 0.137 W/kg

Maximum value of SAR (measured) = 0.183 W/kg

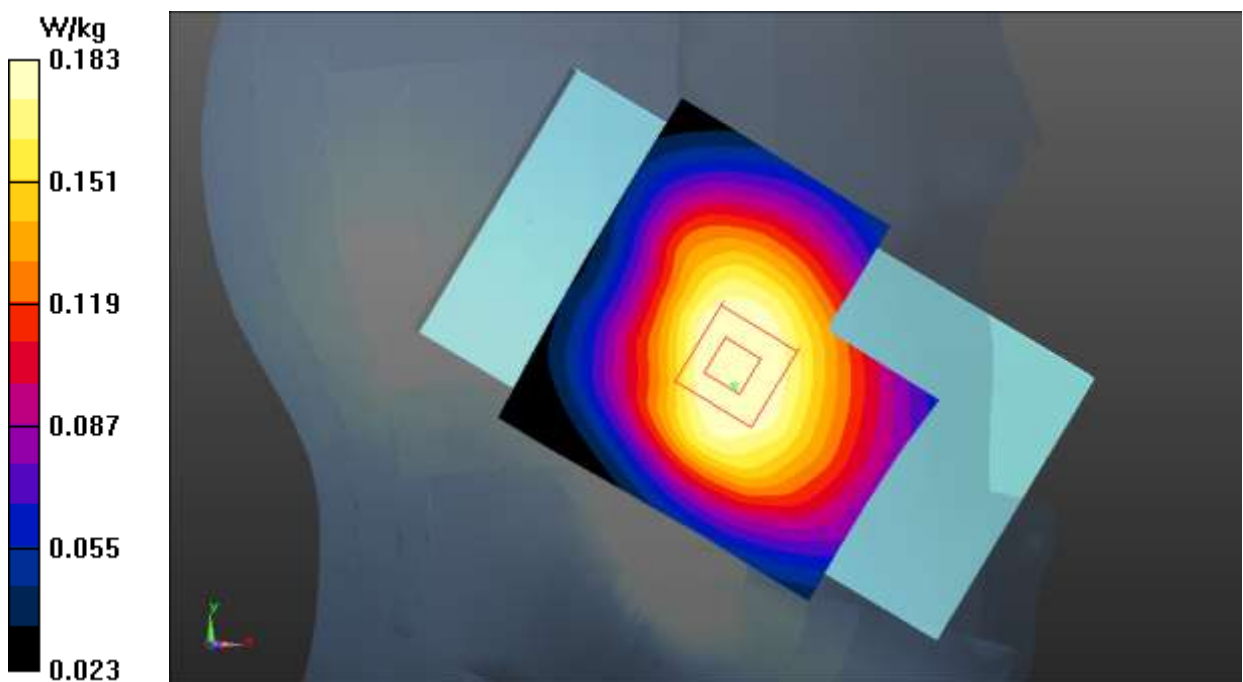
**Fig.15 LTE Band 12 Head**

LTE Band 12 Body

Date: 2020-9-11

Electronics: DAE4 Sn786

Medium: Head 835MHz

Medium parameters used (interpolated): $f = 711$ MHz; $\sigma = 0.877$ S/m; $\epsilon_r = 41.312$; $\rho = 1000$ kg/m³

Ambient Temperature: 22.0°C Liquid Temperature: 21.5°C

Communication System: UID 0, LTE_FDD (0) Frequency: 711 MHz Duty Cycle: 1:1

Probe: ES3DV3 – SN3151 ConvF (6.41, 6.41, 6.41);

Rear Side High 1RB_49/Area Scan (61x111x1): Interpolated grid: dx=1.500 mm, dy=1.500 mm

Maximum value of SAR (interpolated) = 0.268 W/kg

Rear Side High 1RB_49/Zoom Scan (5x5x7)/Cube 0: Measurement grid: dx=8mm, dy=8mm, dz=5mm

Reference Value = 16.46 V/m; Power Drift = 0.10 dB

Peak SAR (extrapolated) = 0.317 W/kg

SAR(1 g) = 0.255 W/kg; SAR(10 g) = 0.188 W/kg

Maximum value of SAR (measured) = 0.285 W/kg

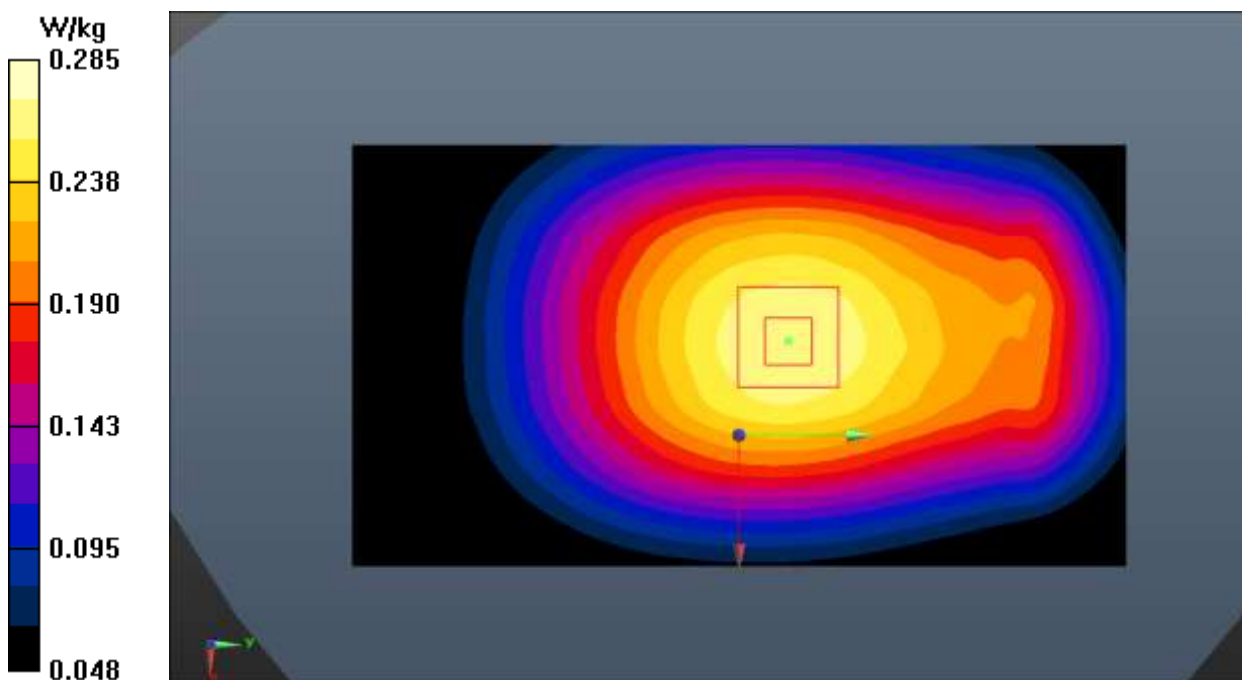

Fig.16 LTE Band 12 Body

LTE Band 13 Head

Date: 2020-9-11

Electronics: DAE4 Sn786

Medium: Head 750MHz

Medium parameters used: $f = 782 \text{ MHz}$; $\sigma = 0.922 \text{ S/m}$; $\epsilon_r = 40.46$; $\rho = 1000 \text{ kg/m}^3$

Ambient Temperature: 22.0°C Liquid Temperature: 21.5°C

Communication System: UID 0, LTE_FDD (0) Frequency: 782 MHz Duty Cycle: 1:1

Probe: ES3DV3 – SN3151 ConvF (6.41, 6.41, 6.41);

Right Cheek Middle 1RB_49/Area Scan (61x61x1): Interpolated grid: $dx=1.500 \text{ mm}$, $dy=1.500 \text{ mm}$

Maximum value of SAR (interpolated) = 0.211 W/kg

Right Cheek Middle 1RB_49/Zoom Scan (5x5x7)/Cube 0: Measurement grid: $dx=8\text{mm}$, $dy=8\text{mm}$, $dz=5\text{mm}$

Reference Value = 3.740 V/m; Power Drift = 0.09 dB

Peak SAR (extrapolated) = 0.249 W/kg

SAR(1 g) = 0.200 W/kg; SAR(10 g) = 0.156 W/kg

Maximum value of SAR (measured) = 0.209 W/kg

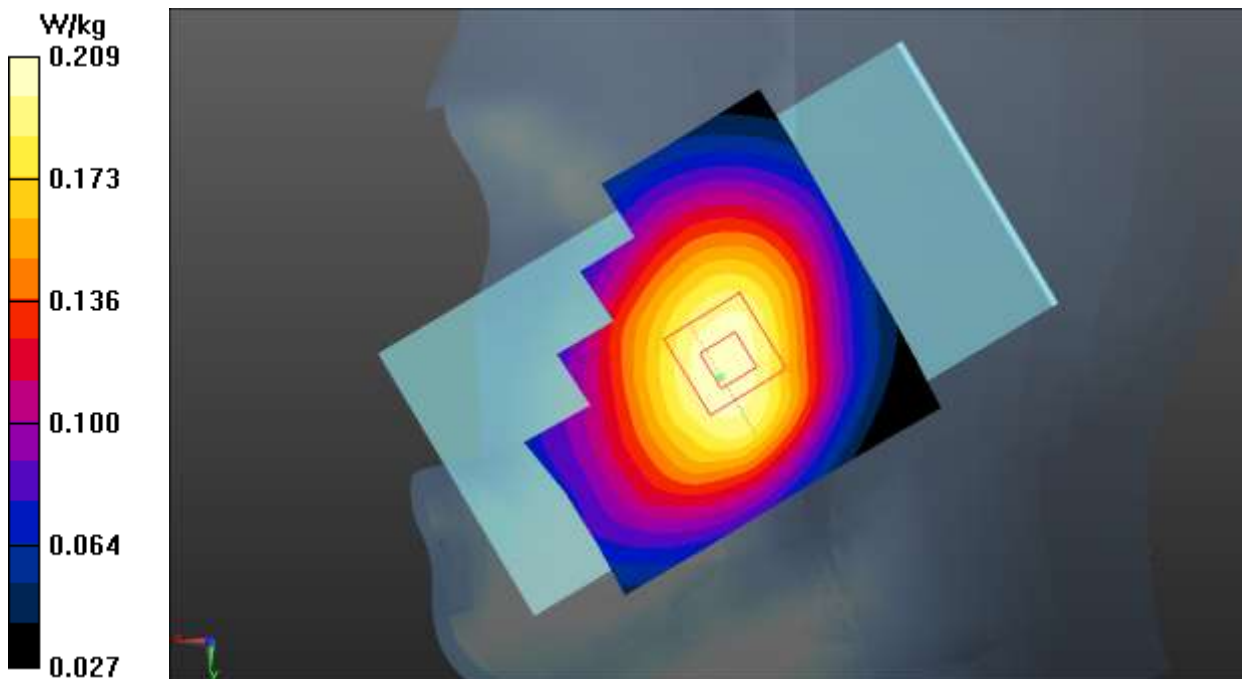

Fig.17 LTE Band 13 Head

LTE Band 13 Body

Date: 2020-9-11

Electronics: DAE4 Sn786

Medium: Head 750MHz

Medium parameters used: $f = 782 \text{ MHz}$; $\sigma = 0.922 \text{ S/m}$; $\epsilon_r = 40.46$; $\rho = 1000 \text{ kg/m}^3$

Ambient Temperature: 22.0°C Liquid Temperature: 21.5°C

Communication System: UID 0, LTE_FDD (0) Frequency: 782 MHz Duty Cycle: 1:1

Probe: ES3DV3 – SN3151 ConvF (6.41, 6.41, 6.41);

Rear Side Middle 1RB_49/Area Scan (61x111x1): Interpolated grid: $dx=1.500 \text{ mm}$, $dy=1.500 \text{ mm}$

Maximum value of SAR (interpolated) = 0.306 W/kg

Rear Side Middle 1RB_49/Zoom Scan (5x5x7)/Cube 0: Measurement grid: $dx=8\text{mm}$, $dy=8\text{mm}$, $dz=5\text{mm}$

Reference Value = 17.61 V/m ; Power Drift = 0.02 dB

Peak SAR (extrapolated) = 0.361 W/kg

SAR(1 g) = 0.279 W/kg ; SAR(10 g) = 0.212 W/kg

Maximum value of SAR (measured) = 0.324 W/kg

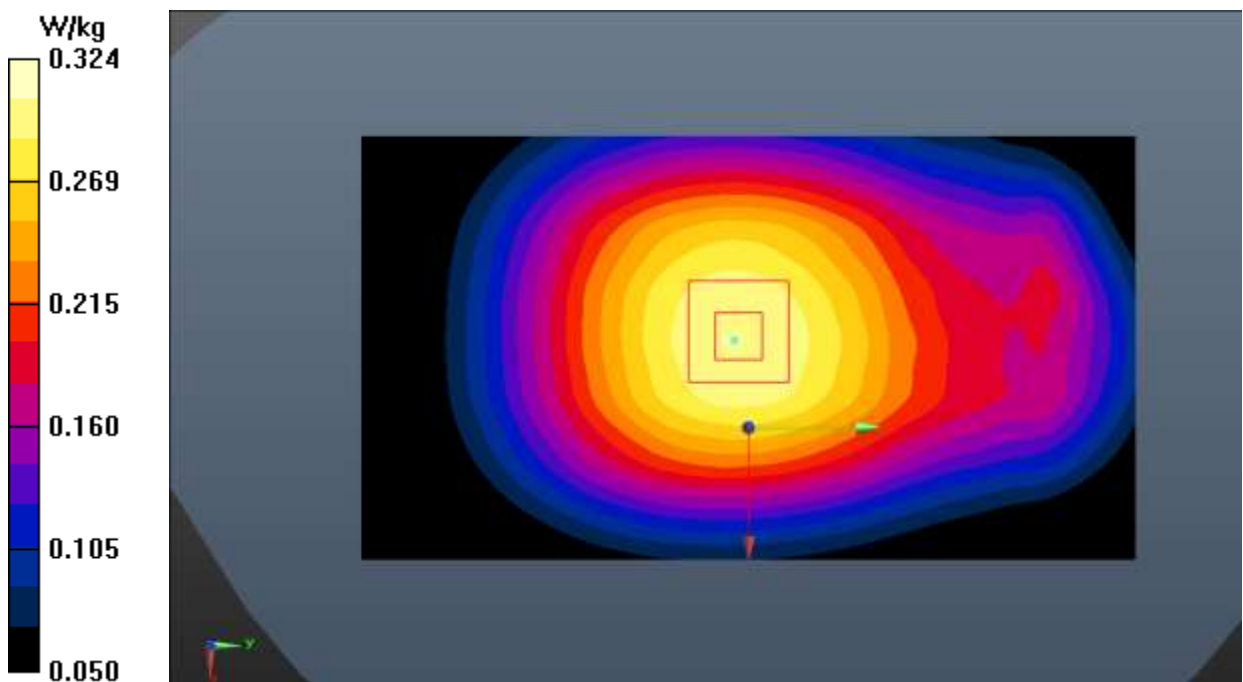

Fig.18 LTE Band 13 Body

LTE Band 26 Head

Date: 2020-9-14

Electronics: DAE4 Sn786

Medium: Head 835MHz

Medium parameters used (interpolated): $f = 822.5$ MHz; $\sigma = 0.907$ S/m; $\epsilon_r = 40.801$; $\rho = 1000$ kg/m³

Ambient Temperature: 22.0°C Liquid Temperature: 21.5°C

Communication System: UID 0, LTE_FDD (0) Frequency: 822.5 MHz Duty Cycle: 1:1

Probe: ES3DV3 – SN3151 ConvF (6.41, 6.41, 6.41);

Left Cheek Low 1RB_0/Area Scan (61x61x1): Interpolated grid: dx=1.500 mm, dy=1.500 mm

Maximum value of SAR (interpolated) = 0.224 W/kg

Left Cheek Low 1RB_0/Zoom Scan (5x5x7)/Cube 0: Measurement grid: dx=8mm, dy=8mm, dz=5mm

Reference Value = 2.650 V/m; Power Drift = 0.09 dB

Peak SAR (extrapolated) = 0.252 W/kg

SAR(1 g) = 0.204 W/kg; SAR(10 g) = 0.156 W/kg

Maximum value of SAR (measured) = 0.211 W/kg

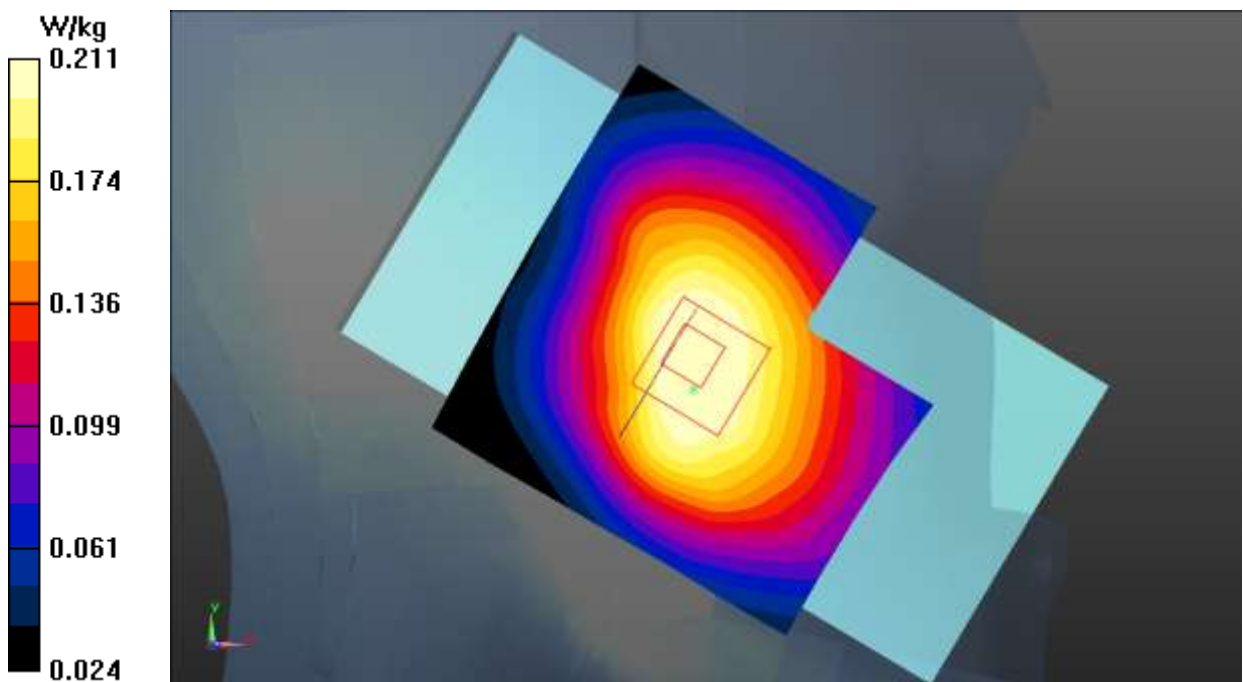
**Fig.19 LTE Band 26 Head**

LTE Band 26 Body

Date: 2020-9-14

Electronics: DAE4 Sn786

Medium: Head 835MHz

Medium parameters used (interpolated): $f = 822.5$ MHz; $\sigma = 0.907$ S/m; $\epsilon_r = 40.801$; $\rho = 1000$ kg/m³

Ambient Temperature: 22.0°C Liquid Temperature: 21.5°C

Communication System: UID 0, LTE_FDD (0) Frequency: 822.5 MHz Duty Cycle: 1:1

Probe: ES3DV3 – SN3151 ConvF (6.41, 6.41, 6.41);

Rear Side Low 1RB_0/Area Scan (61x61x1): Interpolated grid: dx=1.500 mm, dy=1.500 mm

Maximum value of SAR (interpolated) = 0.373 W/kg

Rear Side Low 1RB_0/Zoom Scan (5x5x7)/Cube 0: Measurement grid: dx=8mm, dy=8mm, dz=5mm

Reference Value = 18.83 V/m; Power Drift = 0.05 dB

Peak SAR (extrapolated) = 0.439 W/kg

SAR(1 g) = 0.344 W/kg; SAR(10 g) = 0.261 W/kg

Maximum value of SAR (measured) = 0.398 W/kg

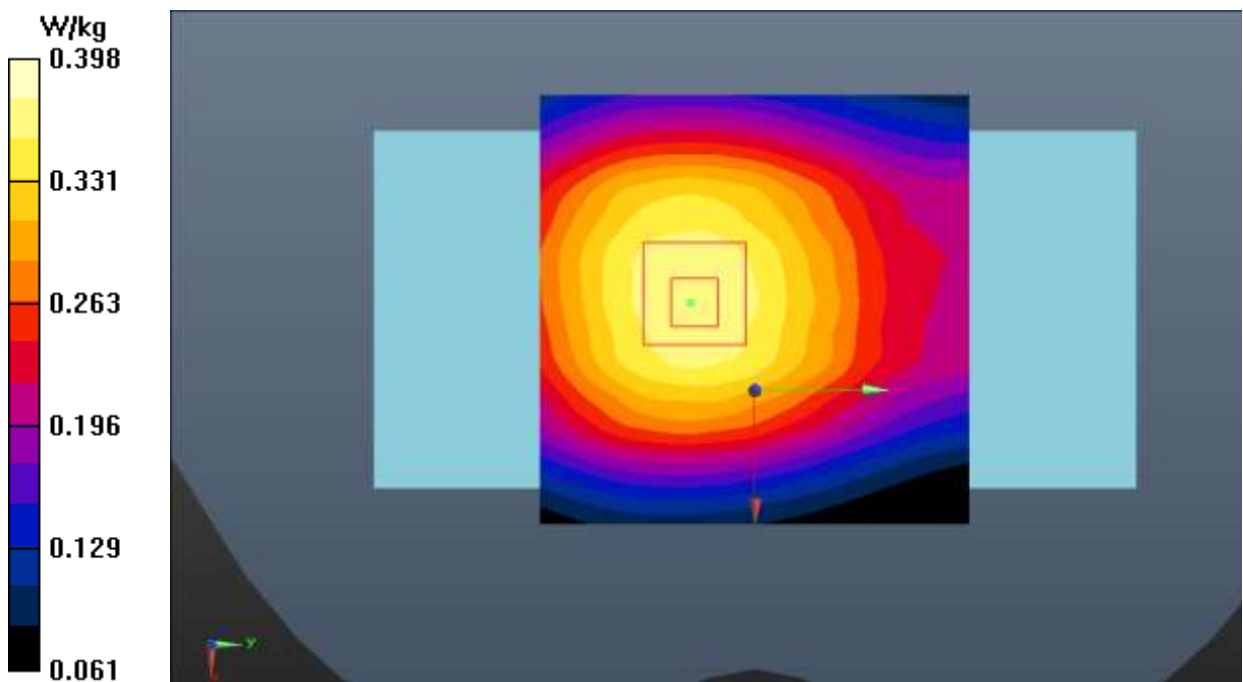
**Fig.20 LTE Band 26 Body**

LTE Band 66 Head

Date: 2020-9-22

Electronics: DAE4 Sn786

Medium: Head 1750MHz

Medium parameters used: $f = 1720 \text{ MHz}$; $\sigma = 1.358 \text{ S/m}$; $\epsilon_r = 39.489$; $\rho = 1000 \text{ kg/m}^3$

Ambient Temperature: 22.0°C Liquid Temperature: 21.5°C

Communication System: UID 0, LTE_FDD (0) Frequency: 1720 MHz Duty Cycle: 1:1

Probe: ES3DV3 – SN3151 ConvF (5.23, 5.23, 5.23);

Right Cheek Low 1RB_99/Area Scan (61x61x1): Interpolated grid: $dx=1.500 \text{ mm}$, $dy=1.500 \text{ mm}$

Maximum value of SAR (interpolated) = 1.32 W/kg

Right Cheek Low 1RB_99/Zoom Scan (5x5x7)/Cube 0: Measurement grid: $dx=8\text{mm}$, $dy=8\text{mm}$, $dz=5\text{mm}$

Reference Value = 13.12 V/m; Power Drift = 0.09 dB

Peak SAR (extrapolated) = 1.85 W/kg

SAR(1 g) = 0.961 W/kg; SAR(10 g) = 0.511 W/kg

Maximum value of SAR (measured) = 1.04 W/kg

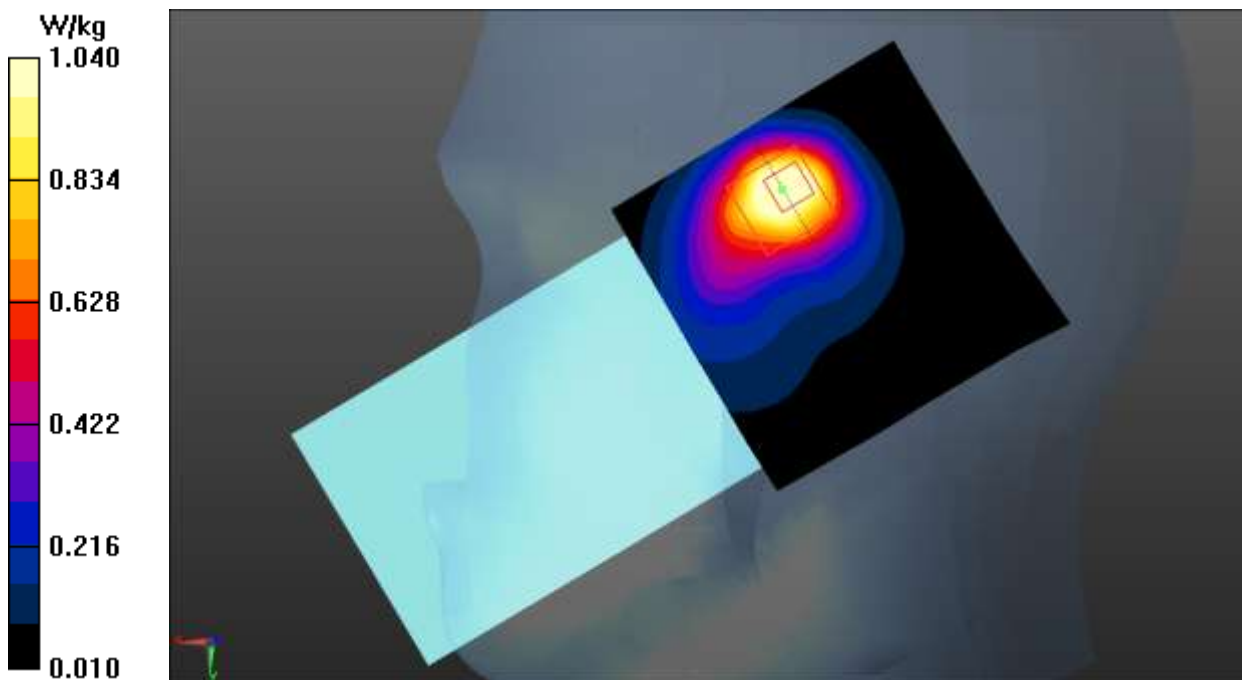

Fig.21 LTE Band 66 Head

LTE Band 66 Body

Date: 2020-9-22

Electronics: DAE4 Sn786

Medium: Head 1750MHz

Medium parameters used: $f = 1770$ MHz; $\sigma = 1.402$ S/m; $\epsilon_r = 39.294$; $\rho = 1000$ kg/m³

Ambient Temperature: 22.0°C Liquid Temperature: 21.5°C

Communication System: UID 0, LTE_FDD (0) Frequency: 1770 MHz Duty Cycle: 1:1

Probe: ES3DV3 – SN3151 ConvF (5.23, 5.23, 5.23);

Rear Side High 1RB_50/Area Scan (61x61x1): Interpolated grid: dx=1.500 mm, dy=1.500 mm

Maximum value of SAR (interpolated) = 1.03 W/kg

Rear Side High 1RB_50/Zoom Scan (5x5x7)/Cube 0: Measurement grid: dx=8mm, dy=8mm, dz=5mm

Reference Value = 16.59 V/m; Power Drift = 0.08 dB

Peak SAR (extrapolated) = 1.50 W/kg

SAR(1 g) = 0.839 W/kg; SAR(10 g) = 0.455 W/kg

Maximum value of SAR (measured) = 1.14 W/kg

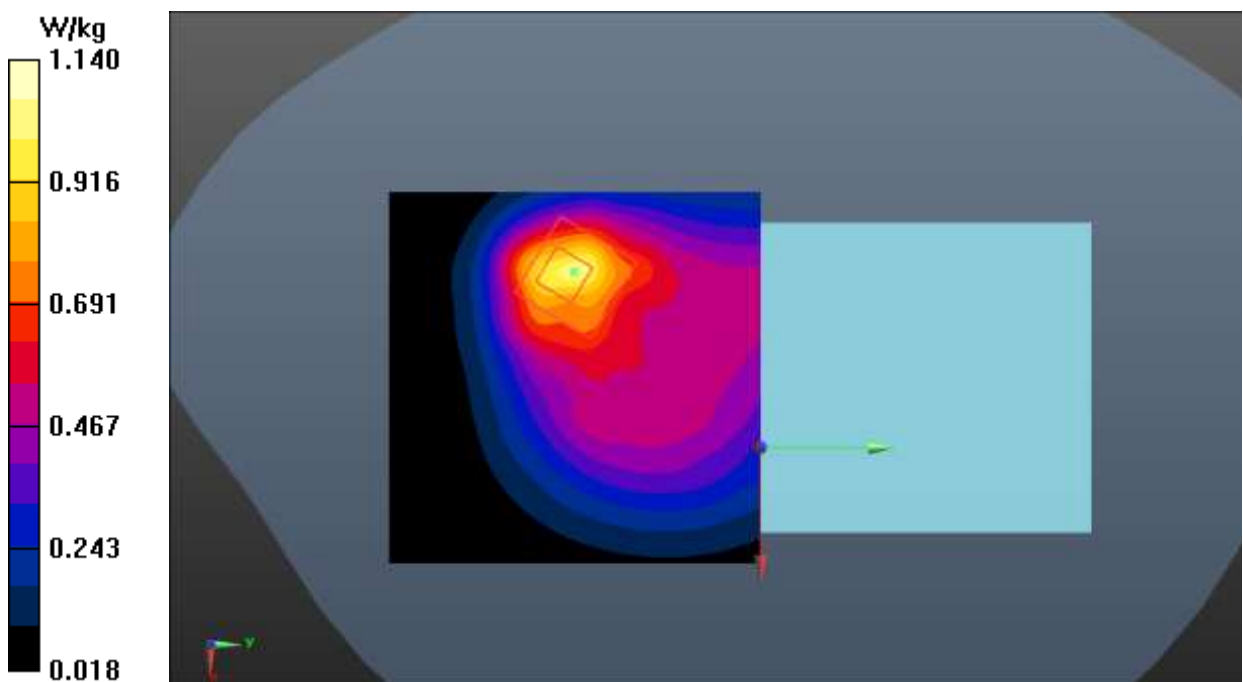

Fig.22 LTE Band 66 Body

WLAN 2.4G Head

Date: 2020-9-19

Electronics: DAE4 Sn786

Medium: Head 2450MHz

Medium parameters used (interpolated): $f = 2437$ MHz; $\sigma = 1.826$ S/m; $\epsilon_r = 38.525$; $\rho = 1000$ kg/m³

Ambient Temperature: 22.0°C Liquid Temperature: 21.5°C

Communication System: UID 0, WiFi (0) Frequency: 2437 MHz Duty Cycle: 1:1

Probe: ES3DV3 – SN3151 ConvF (4.68, 4.68, 4.68);

Left Cheek Middle/Area Scan (91x91x1): Interpolated grid: dx=1.000 mm, dy=1.000 mm

Maximum value of SAR (interpolated) = 0.526 W/kg

Left Cheek Middle/Zoom Scan (7x7x7)/Cube 0: Measurement grid: dx=5mm, dy=5mm, dz=5mm

Reference Value = 7.325 V/m; Power Drift = 0.09 dB

Peak SAR (extrapolated) = 0.684 W/kg

SAR(1 g) = 0.355 W/kg; SAR(10 g) = 0.187 W/kg

Maximum value of SAR (measured) = 0.504 W/kg

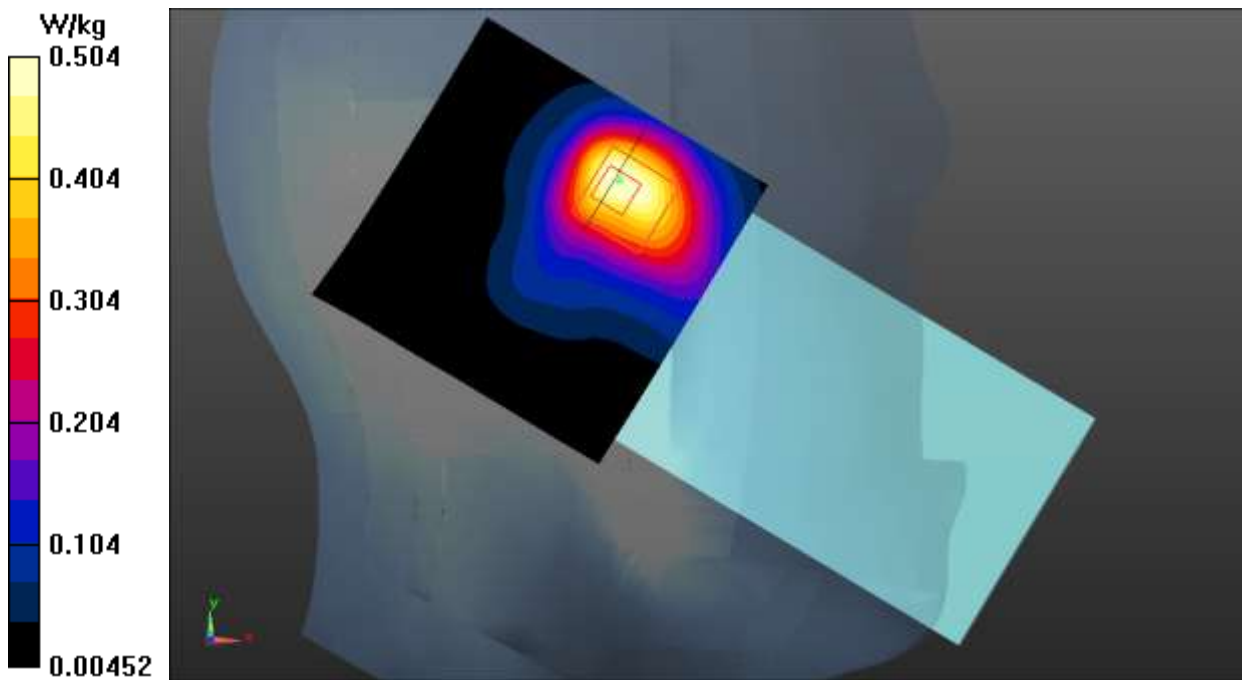

Fig.23 WLAN 2.4G Head

WLAN 2.4G Body

Date: 2020-9-19

Electronics: DAE4 Sn786

Medium: Head 2450MHz

Medium parameters used (interpolated): $f = 2437$ MHz; $\sigma = 1.826$ S/m; $\epsilon_r = 38.525$; $\rho = 1000$ kg/m³

Ambient Temperature: 22.0°C Liquid Temperature: 21.5°C

Communication System: UID 0, WiFi (0) Frequency: 2437 MHz Duty Cycle: 1:1

Probe: ES3DV3 – SN3151 ConvF (4.68, 4.68, 4.68);

Rear Side Middle/Area Scan (91x91x1): Interpolated grid: dx=1.000 mm, dy=1.000 mm

Maximum value of SAR (interpolated) = 0.289 W/kg

Rear Side Middle/Zoom Scan (7x7x7)/Cube 0: Measurement grid: dx=5mm, dy=5mm, dz=5mm

Reference Value = 3.768 V/m; Power Drift = 0.16 dB

Peak SAR (extrapolated) = 0.418 W/kg

SAR(1 g) = 0.188 W/kg; SAR(10 g) = 0.095 W/kg

Maximum value of SAR (measured) = 0.198 W/kg

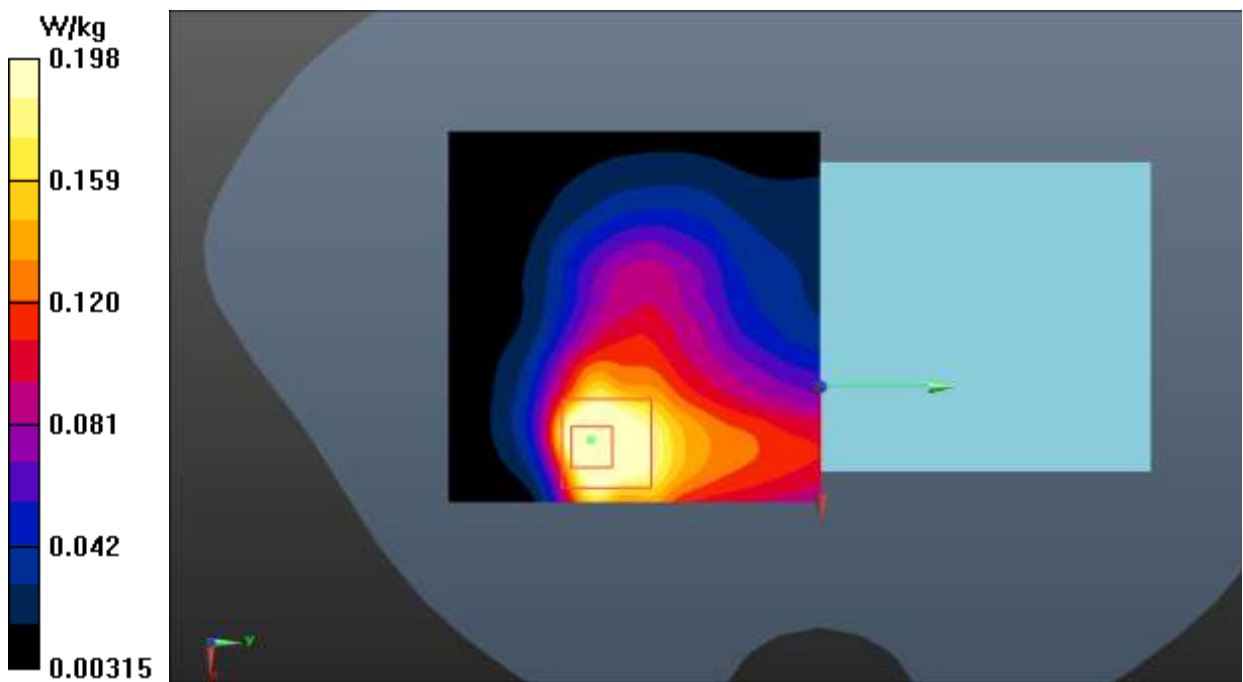

Fig.24 WLAN 2.4G Body

ANNEX B: System Verification Results

750MHz

Date: 2020-9-11

Electronics: DAE4 Sn786

Medium: Head 750MHz

Medium parameters used: $f = 750 \text{ MHz}$; $\sigma = 0.902 \text{ S/m}$; $\epsilon_r = 40.844$; $\rho = 1000 \text{ kg/m}^3$

Ambient Temperature: 22.5°C Liquid Temperature: 22.0°C

Communication System: CW_TMC Frequency: 750 MHz Duty Cycle: 1:1

Probe: ES3DV3 – SN3151 ConvF (6.41, 6.41, 6.41);

System Validation /Area Scan (81x161x1): Interpolated grid: $dx=1.000 \text{ mm}$, $dy=1.000 \text{ mm}$

Reference Value = 60.084 V/m ; Power Drift = 0.08 dB

SAR(1 g) = 2.19 W/kg; SAR(10 g) = 1.45 W/kg

Maximum value of SAR (interpolated) = 2.63 W/kg

System Validation /Zoom Scan (7x7x7)/Cube 0: Measurement grid: $dx=5\text{mm}$, $dy=5\text{mm}$, $dz=5\text{mm}$

Reference Value = 60.084 V/m ; Power Drift = 0.08 dB

Peak SAR (extrapolated) = 3.04 W/kg

SAR(1 g) = 2.23 W/kg; SAR(10 g) = 1.47 W/kg

Maximum value of SAR (measured) = 2.69 W/kg

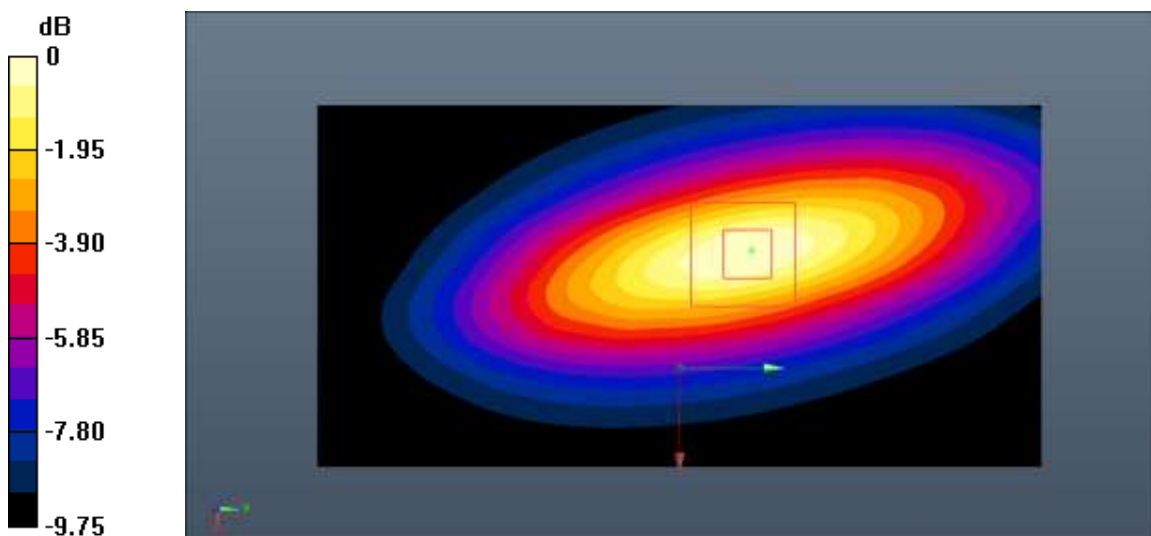

0 dB = $2.69 \text{ W/kg} = 4.30 \text{ dB W/kg}$

Fig.B.1. Validation 750MHz 250mW

835MHz

Date: 2020-9-14

Electronics: DAE4 Sn786

Medium: Head 835MHz

Medium parameters used: $f = 835 \text{ MHz}$; $\sigma = 0.918 \text{ S/m}$; $\epsilon_r = 40.651$; $\rho = 1000 \text{ kg/m}^3$

Ambient Temperature: 22.5°C Liquid Temperature: 22.0°C

Communication System: CW Frequency: 835 MHz Duty Cycle: 1:1

Probe: ES3DV3 – SN3151 ConvF (6.41, 6.41, 6.41);

System Validation /Area Scan (91x161x1): Interpolated grid: $dx=1.000 \text{ mm}$, $dy=1.000 \text{ mm}$

Reference Value = 62.448 V/m; Power Drift = 0.02 dB

SAR(1 g) = 2.42 W/kg; SAR(10 g) = 1.58 W/kg

Maximum value of SAR (interpolated) = 3.12 W/kg

System Validation /Zoom Scan (7x7x7)/Cube 0: Measurement grid: $dx=5\text{mm}$, $dy=5\text{mm}$, $dz=5\text{mm}$

Reference Value = 62.448 V/m; Power Drift = 0.02 dB

Peak SAR (extrapolated) = 3.85 W/kg

SAR(1 g) = 2.49 W/kg; SAR(10 g) = 1.61 W/kg

Maximum value of SAR (measured) = 3.18 W/kg

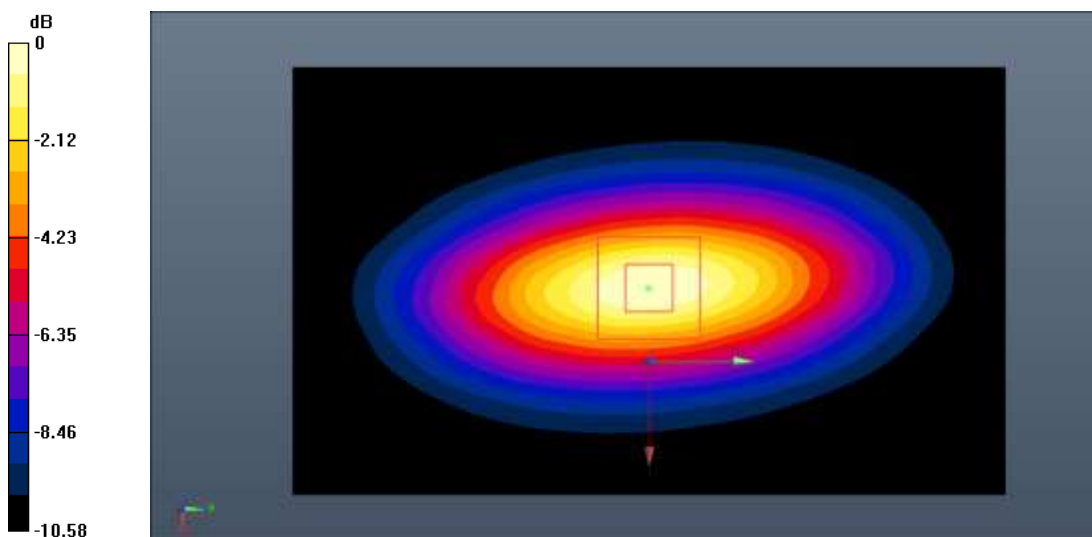

0 dB = 3.18 W/kg = 5.02 dB W/kg

Fig.B.2. Validation 835MHz 250mW

1750MHz

Date: 2020-9-22

Electronics: DAE4 Sn786

Medium: Head 1750MHz

Medium parameters used: $f = 1750 \text{ MHz}$; $\sigma = 1.384 \text{ S/m}$; $\epsilon_r = 39.372$; $\rho = 1000 \text{ kg/m}^3$

Ambient Temperature: 22.2°C Liquid Temperature: 21.7°C

Communication System: CW_TMC Frequency: 1750 MHz Duty Cycle: 1:1

Probe: ES3DV3 – SN3151 ConvF (5.23, 5.23, 5.23);

System Validation/Area Scan (81x121x1): Interpolated grid: $dx=1.000 \text{ mm}$, $dy=1.000 \text{ mm}$

Reference Value = 80.226 V/m ; Power Drift = 0.05 dB

SAR(1 g) = 9.20 W/kg; SAR(10 g) = 4.81 W/kg

Maximum value of SAR (interpolated) = 10.4 W/kg

System Validation/Zoom Scan (7x7x7)/Cube0: Measurement grid: $dx=5\text{mm}$, $dy=5\text{mm}$, $dz=5\text{mm}$

Reference Value = 80.226 V/m ; Power Drift = 0.05 dB

Peak SAR (extrapolated) = 20.5 W/kg

SAR(1 g) = 9.36 W/kg; SAR(10 g) = 4.88 W/kg

Maximum value of SAR (measured) = 10.7 W/kg

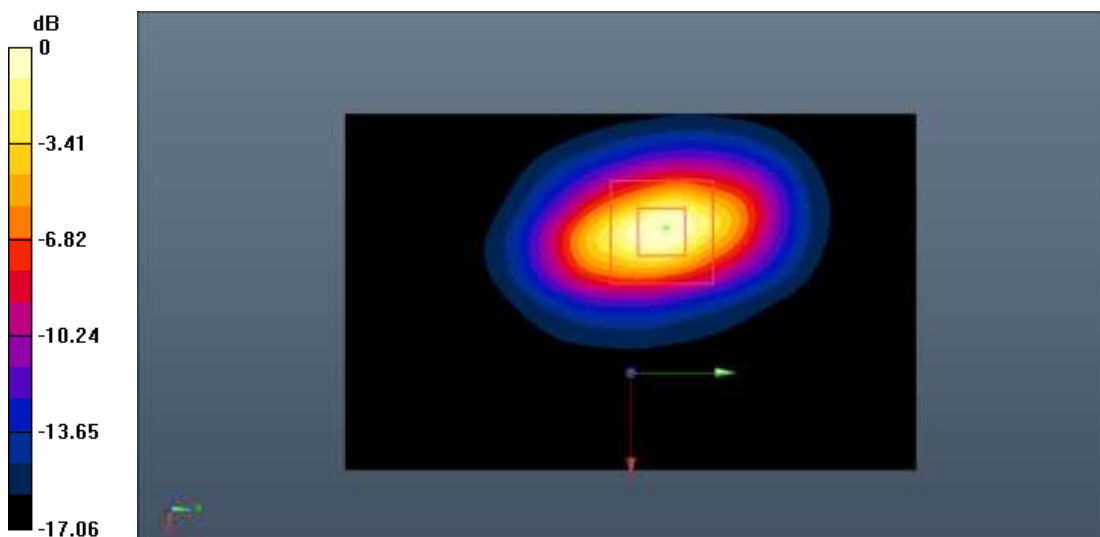

0 dB = 10.7 W/kg = 10.29 dB W/kg

Fig.B.3. Validation 1750MHz 250mW

1900MHz

Date: 2020-9-22

Electronics: DAE4 Sn786

Medium: Head 1900MHz

Medium parameters used: $f = 1900 \text{ MHz}$; $\sigma = 1.415 \text{ S/m}$; $\epsilon_r = 39.154$; $\rho = 1000 \text{ kg/m}^3$

Ambient Temperature: 22.5°C Liquid Temperature: 22.0°C

Communication System: CW_TMC Frequency: 1900 MHz Duty Cycle: 1:1

Probe: ES3DV3 – SN3151 ConvF (5.11, 5.11, 5.11);

System Validation/Area Scan (91x91x1): Interpolated grid: $dx=1.000 \text{ mm}$, $dy=1.000 \text{ mm}$

Reference Value = 83.625 V/m ; Power Drift = -0.06 dB

SAR(1 g) = 9.80 W/kg; SAR(10 g) = 5.14 W/kg

Maximum value of SAR (interpolated) = 11.1 W/kg

System Validation/Zoom Scan (7x7x7)/Cube0: Measurement grid: $dx=5\text{mm}$, $dy=5\text{mm}$, $dz=5\text{mm}$

Reference Value = 83.625 V/m ; Power Drift = -0.06 dB

Peak SAR (extrapolated) = 24.8 W/kg

SAR(1 g) = 10.4 W/kg; SAR(10 g) = 5.33 W/kg

Maximum value of SAR (measured) = 11.4 W/kg

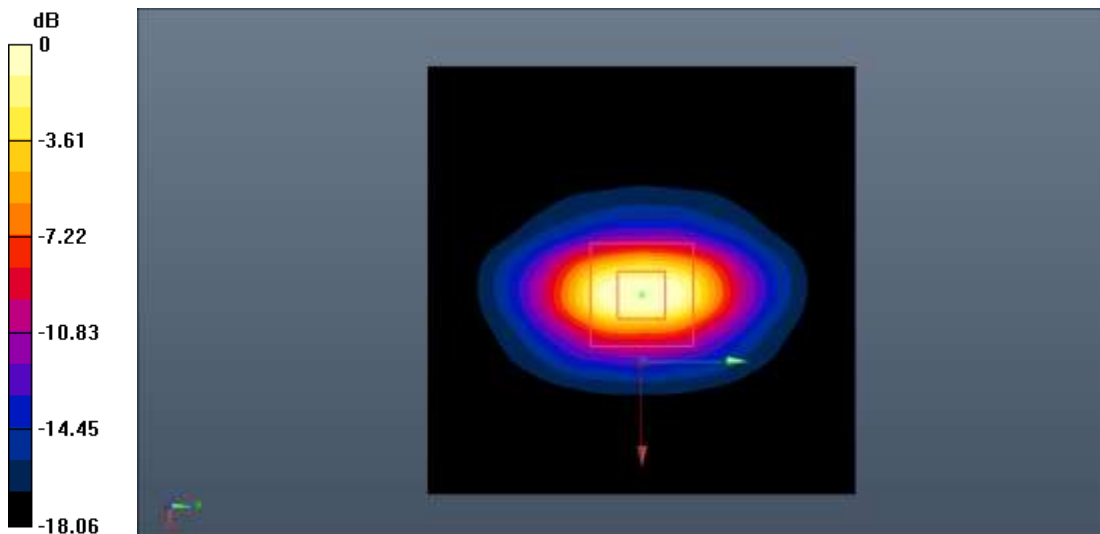

0 dB = 11.4 W/kg = 10.57 dB W/kg

Fig.B.4. Validation 1900MHz 250mW

2450MHz

Date: 2020-9-19

Electronics: DAE4 Sn786

Medium: Head 2450MHz

Medium parameters used: $f = 2450 \text{ MHz}$; $\sigma = 1.841 \text{ S/m}$; $\epsilon_r = 38.482$; $\rho = 1000 \text{ kg/m}^3$

Ambient Temperature: 22.3°C Liquid Temperature: 21.8°C

Communication System: CW_TMC Frequency: 2450 MHz Duty Cycle: 1:1

Probe: ES3DV3 – SN3151 ConvF (4.68, 4.68, 4.68);

System Validation /Area Scan (81x121x1): Interpolated grid: $dx=1.000 \text{ mm}$, $dy=1.000 \text{ mm}$

Reference Value = 88.456 V/m; Power Drift = 0.10 dB

SAR(1 g) = 13.4 W/kg; SAR(10 g) = 6.08 W/kg

Maximum value of SAR (interpolated) = 15.2 W/kg

System Validation/Zoom Scan (7x7x7)/Cube0: Measurement grid: $dx=5\text{mm}$, $dy=5\text{mm}$, $dz=5\text{mm}$

Reference Value = 88.456 V/m; Power Drift = 0.10 dB

Peak SAR (extrapolated) = 29.3 W/kg

SAR(1 g) = 13.6 W/kg; SAR(10 g) = 6.20 W/kg

Maximum value of SAR (measured) = 15.5 W/kg

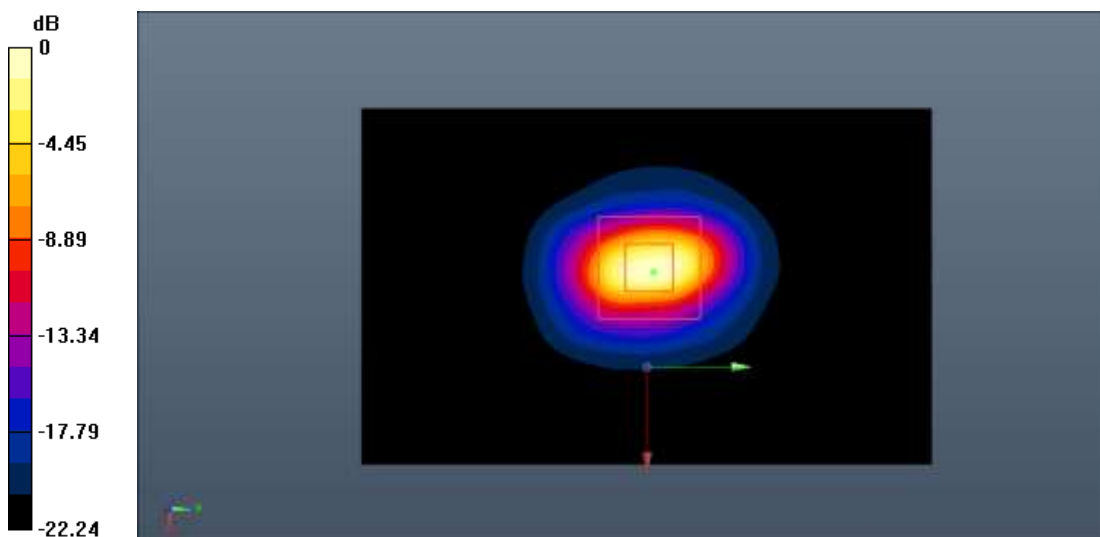

0 dB = 15.5 W/kg = 11.90 dB W/kg

Fig.B.5. Validation 2450MHz 250mW

2550MHz

Date: 2020-9-23

Electronics: DAE4 Sn786

Medium: Head 2550MHz

Medium parameters used: $f = 2550 \text{ MHz}$; $\sigma = 1.949 \text{ S/m}$; $\epsilon_r = 38.058$; $\rho = 1000 \text{ kg/m}^3$

Ambient Temperature: 22.5°C Liquid Temperature: 22.0°C

Communication System: CW_TMC Frequency: 2550 MHz Duty Cycle: 1:1

Probe: ES3DV3 – SN3151 ConvF (4.53, 4.53, 4.53);

System Validation/Area Scan (91x91x1): Interpolated grid: $dx=1.000 \text{ mm}$, $dy=1.000 \text{ mm}$

Reference Value = 93.118 V/m ; Power Drift = 0.09 dB

SAR(1 g) = 14.8 W/kg; SAR(10 g) = 6.59 W/kg

Maximum value of SAR (interpolated) = 16.8 W/kg

System Validation/Zoom Scan (7x7x7)/Cube0: Measurement grid: $dx=5\text{mm}$, $dy=5\text{mm}$, $dz=5\text{mm}$

Reference Value = 93.118 V/m ; Power Drift = 0.09 dB

Peak SAR (extrapolated) = 35.8 W/kg

SAR(1 g) = 15.0 W/kg; SAR(10 g) = 6.75 W/kg

Maximum value of SAR (measured) = 17.0 W/kg

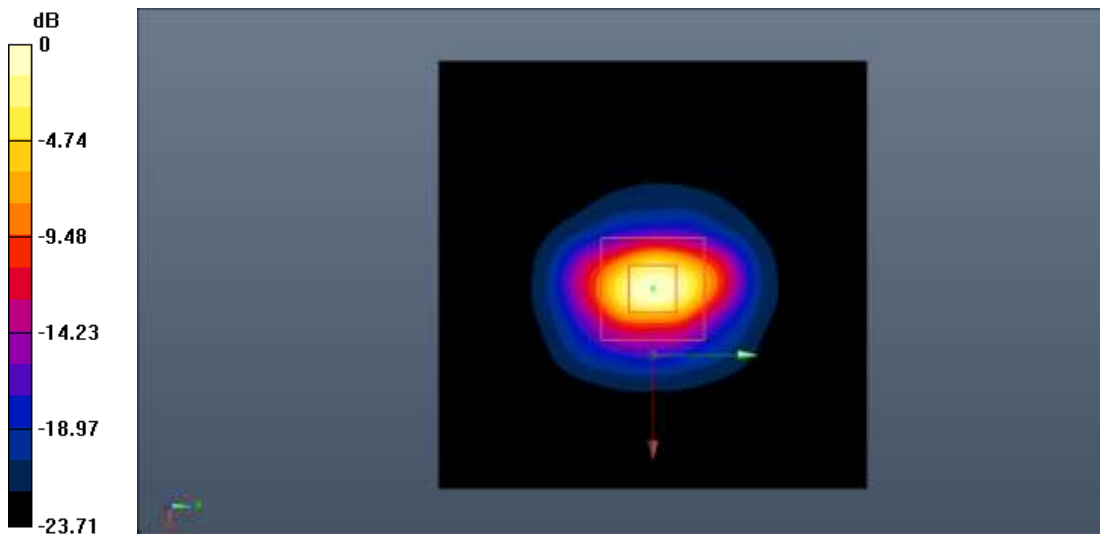

0 dB = 17.0 W/kg = 12.30 dB W/kg

Fig.B.6. Validation 2550MHz 250mW

ANNEX C: SAR Measurement Setup

C.1. Measurement Set-up

DASY5 system for performing compliance tests is illustrated above graphically. This system consists of the following items:

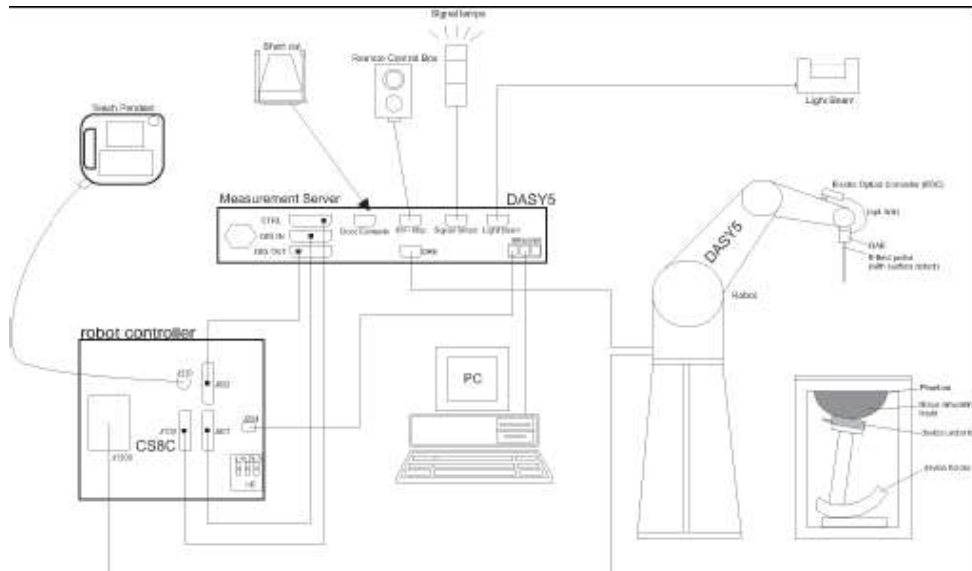

Picture C.1 SAR Lab Test Measurement Set-up

- A standard high precision 6-axis robot (Stäubli TX=RX family) with controller, teach pendant and software. An arm extension for accommodating the data acquisition electronics (DAE).
- An isotropic field probe optimized and calibrated for the targeted measurement.
- A data acquisition electronics (DAE) which performs the signal amplification, signal multiplexing, AD-conversion, offset measurements, mechanical surface detection, collision detection, etc. The unit is battery powered with standard or rechargeable batteries. The signal is optically transmitted to the EOC.
- The Electro-optical converter (EOC) performs the conversion from optical to electrical signals for the digital communication to the DAE. To use optical surface detection, a special version of the EOC is required. The EOC signal is transmitted to the measurement server.
- The function of the measurement server is to perform the time critical tasks such as signal filtering, control of the robot operation and fast movement interrupts.
- The Light Beam used is for probe alignment. This improves the (absolute) accuracy of the probe positioning.
- A computer running WinXP and the DASY5 software.
- Remote control and teach pendant as well as additional circuitry for robot safety such as
- warning lamps, etc.
- The phantom, the device holder and other accessories according to the targeted measurement.

C.2. DASY5 E-field Probe System

The SAR measurements were conducted with the dosimetric probe designed in the classical triangular configuration and optimized for dosimetric evaluation. The probe is constructed using the thick film technique; with printed resistive lines on ceramic substrates. The probe is equipped with an optical multifiber line ending at the front of the probe tip. It is connected to the EOC box on the robot arm and provides an automatic detection of the phantom surface. Half of the fibers are connected to a pulsed infrared transmitter, the other half to a synchronized receiver. As the probe approaches the surface, the reflection from the surface produces a coupling from the transmitting to the receiving fibers. This reflection increases first during the approach, reaches maximum and then decreases. If the probe is flatly touching the surface, the coupling is zero. The distance of the coupling maximum to the surface is independent of the surface reflectivity and largely independent of the surface to probe angle. The DASY5 software reads the reflection during a software approach and looks for the maximum using 2nd order curve fitting. The approach is stopped at reaching the maximum.

Probe Specifications:

Model:	ES3DV3, EX3DV4
Frequency	10MHz — 6.0GHz(EX3DV4)
Range:	10MHz — 4GHz(ES3DV3)
Calibration:	In head and body simulating tissue at Frequencies from 835 up to 5800MHz
Linearity:	± 0.2 dB(30 MHz to 6 GHz) for EX3DV4 ± 0.2 dB(30 MHz to 4 GHz) for ES3DV3
Dynamic Range:	10 mW/kg — 100W/kg
Probe Length:	330 mm
Probe Tip	
Length:	20 mm
Body Diameter:	12 mm
Tip Diameter:	2.5 mm (3.9 mm for ES3DV3)
Tip-Center:	1 mm (2.0mm for ES3DV3)
Application:	SAR Dosimetry Testing Compliance tests of mobile phones Dosimetry in strong gradient fields



Picture C.2 Near-field Probe



Picture C.3 E-field Probe

C.3. E-field Probe Calibration

Each E-Probe/Probe Amplifier combination has unique calibration parameters. A TEM cell calibration procedure is conducted to determine the proper amplifier settings to enter in the probe parameters. The amplifier settings are determined for a given frequency by subjecting the probe to a known E-field density (1 mW/cm^2) using an RF Signal generator, TEM cell, and RF Power Meter.

The free space E-field from amplified probe outputs is determined in a test chamber. This calibration can be performed in a TEM cell if the frequency is below 1 GHz and in a waveguide or other methodologies above 1 GHz for free space. For the free space calibration, the probe is placed

in the volumetric center of the cavity and at the proper orientation with the field. The probe is then rotated 360 degrees until the three channels show the maximum reading. The power density readings equates to 1 mW/ cm²:

E-field temperature correlation calibration is performed in a flat phantom filled with the appropriate simulated brain tissue. The E-field in the medium correlates with the temperature rise in the dielectric medium. For temperature correlation calibration a RF transparent thermistor-based temperature probe is used in conjunction with the E-field probe.

$$SAR = C \frac{\Delta T}{\Delta t}$$

Where:

Δt = Exposure time (30 seconds),

C = Heat capacity of tissue (brain or muscle),

ΔT = Temperature increase due to RF exposure.

$$SAR = \frac{|E|^2 \cdot \sigma}{\rho}$$

Where:

σ = Simulated tissue conductivity,

ρ = Tissue density (kg/m³).

C.4. Other Test Equipment

C.4.1. Data Acquisition Electronics (DAE)

The data acquisition electronics consist of a highly sensitive electrometer-grade preamplifier with auto-zeroing, a channel and gain-switching multiplexer, a fast 16 bit AD-converter and a command decoder with a control logic unit. Transmission to the measurement server is accomplished through an optical downlink for data and status information, as well as an optical uplink for commands and the clock.

The mechanical probe mounting device includes two different sensor systems for frontal and sideways probe contacts. They are used for mechanical surface detection and probe collision detection.

The input impedance of the DAE is 200 MOhm; the inputs are symmetrical and floating. Common mode rejection is above 80 dB.



PictureC.4: DAE

C.4.2. Robot

The SPEAG DASY system uses the high precision robots (DASY5: RX160L) type from Stäubli SA (France). For the 6-axis controller system, the robot controller version from Stäubli is used. The Stäubli robot series have many features that are important for our application:

- High precision (repeatability 0.02mm)
- High reliability (industrial design)
- Low maintenance costs (virtually maintenance free due to direct drive gears; no belt drives)
- Jerk-free straight movements (brushless synchron motors; no stepper motors)
- Low ELF interference (motor control fields shielded via the closed metallic construction shields)



Picture C.5 DASY 5

C.4.3. Measurement Server

The Measurement server is based on a PC/104 CPU board with CPU (DASY5: 400 MHz, Intel Celeron), chipdisk (DASY5:128MB), RAM (DASY5:128MB). The necessary circuits for communication with the DAE electronic box, as well as the 16 bit AD converter system for optical detection and digital I/O interface are contained on the DASY I/O board, which is directly connected to the PC/104 bus of the CPU board.

The measurement server performs all real-time data evaluation of field measurements and surface detection, controls robot movements and handles safety operation. The PC operating system cannot interfere with these time critical processes. All connections are supervised by a watchdog, and disconnection of any of the cables to the measurement server will automatically disarm the robot and disable all program-controlled robot movements. Furthermore, the measurement server is equipped with an expansion port which is reserved for future applications. Please note that this expansion port does not have a standardized pinout, and therefore only devices provided by SPEAG can be connected. Devices from any other supplier could seriously damage the measurement server.



Picture C.6 Server for DASY 5

C.4.4. Device Holder for Phantom

The SAR in the phantom is approximately inversely proportional to the square of the distance between the source and the liquid surface. For a source at 5mm distance, a positioning uncertainty of $\pm 0.5\text{mm}$ would produce a SAR uncertainty of $\pm 20\%$. Accurate device positioning is therefore crucial for accurate and repeatable measurements. The positions in which the devices must be measured are defined by the standards.

The DASY device holder is designed to cope with the different positions given in the standard. It has two scales for device rotation (with respect to the body axis) and device inclination (with respect to the line between the ear reference points). The rotation centers for both scales is the ear reference point (ERP). Thus the device needs no repositioning when changing the angles.

The DASY device holder is constructed of low-loss POM material having the following dielectric

parameters: relative permittivity $\epsilon = 3$ and loss tangent $\delta = 0.02$. The amount of dielectric material has been reduced in the closest vicinity of the device, since measurements have suggested that the influence of the clamp on the test results could thus be lowered.

<Laptop Extension Kit>

The extension is lightweight and made of POM, acrylic glass and foam. It fits easily on the upper part of the Mounting Device in place of the phone positioner. The extension is fully compatible with the Twin-SAM and ELI phantoms.



Picture C.7-1: Device Holder

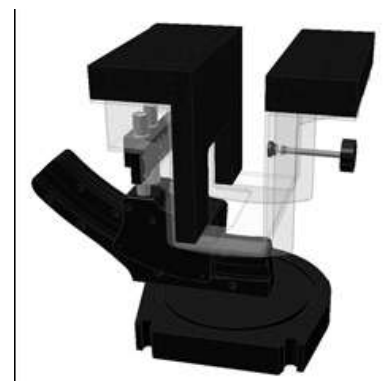

Picture C.7-2: Laptop Extension Kit

C.4.5. Phantom

The SAM Twin Phantom V4.0 is constructed of a fiberglass shell integrated in a table. The shape of the shell is based on data from an anatomical study designed to

Represent the 90th percentile of the population. The phantom enables the dissymmetric evaluation of SAR for both left and right handed handset usage, as well as body-worn usage using the flat phantom region. Reference markings on the Phantom allow the complete setup of all predefined phantom positions and measurement grids by manually teaching three points in the robot. The shell phantom has a 2mm shell thickness (except the ear region where shell thickness increases to 6 mm).



Shell Thickness: 2 ± 0.2 mm
Filling Volume: Approx. 25 liters
Dimensions: 810 x 1000 x 500 mm (H x L x W)
Available: Special



Picture C.8: SAM Twin Phantom

ANNEX D: Position of the wireless device in relation to the phantom

D.1. General considerations

This standard specifies two handset test positions against the head phantom – the “cheek” position and the “tilt” position.

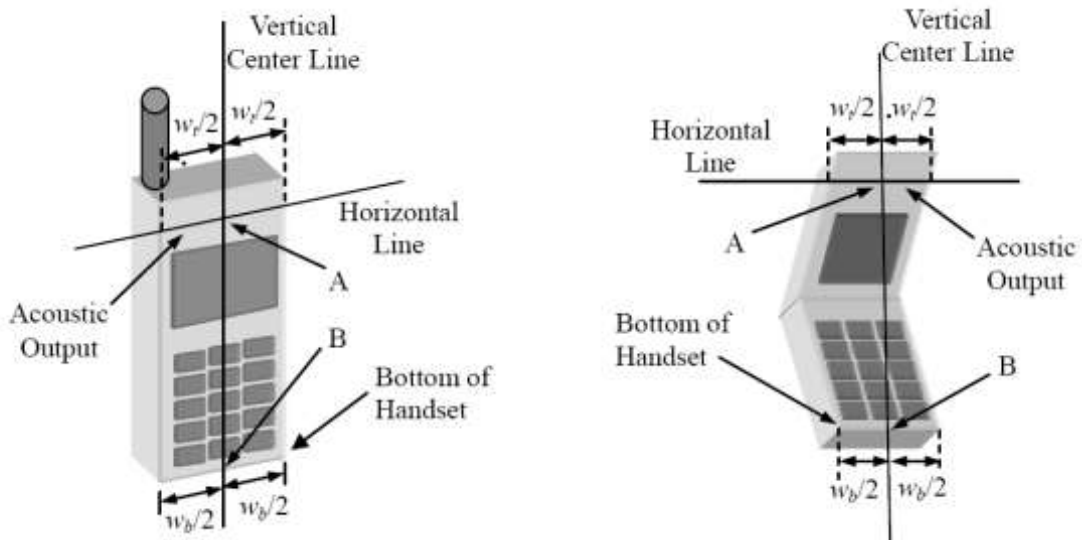

- w_t Width of the handset at the level of the acoustic
- w_b Width of the bottom of the handset
- A Midpoint of the width w_t of the handset at the level of the acoustic output
- B Midpoint of the width w_b of the bottom of the handset

Picture D.1-a Typical “fixed” case handset Picture D.1-b Typical “clam-shell” case handset

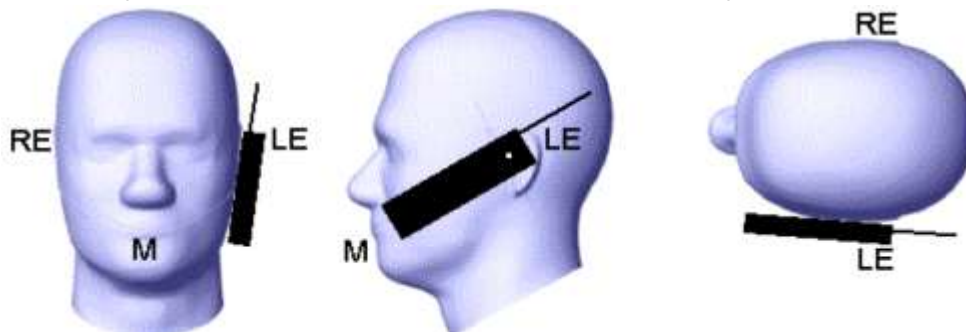

Picture D.2 Cheek position of the wireless device on the left side of SAM

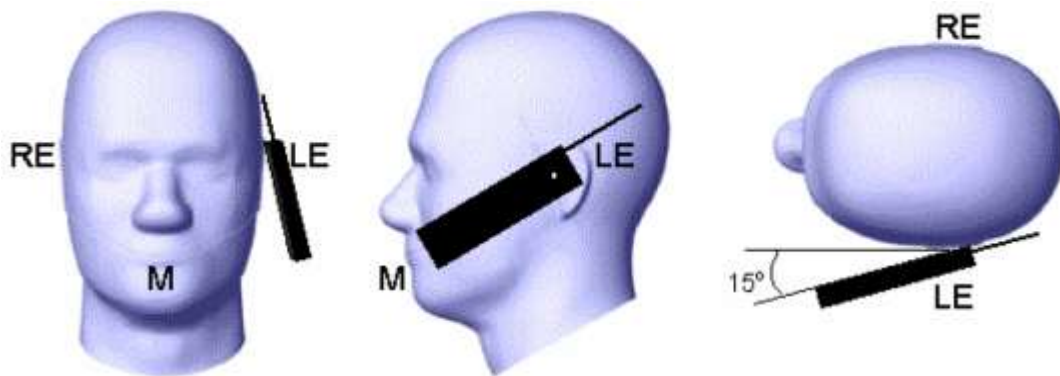

Picture D.3 Tilt position of the wireless device on the left side of SAM

D.2. Body-worn device

A typical example of a body-worn device is a mobile phone, wireless enabled PDA or other battery operated wireless device with the ability to transmit while mounted on a person's body using a carry accessory approved by the wireless device manufacturer.

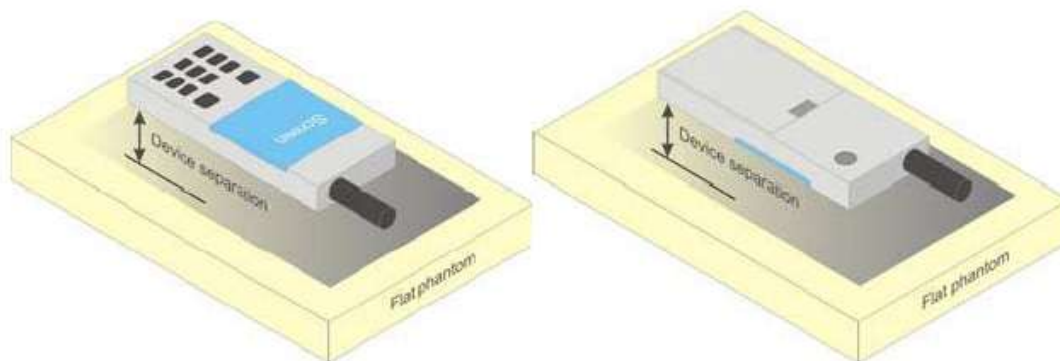

Picture D.4 Test positions for body-worn devices

D.3. Desktop device

A typical example of a desktop device is a wireless enabled desktop computer placed on a table or desk when used.

The DUT shall be positioned at the distance and in the orientation to the phantom that corresponds to the intended use as specified by the manufacturer in the user instructions. For devices that employ an external antenna with variable positions, tests shall be performed for all antenna positions specified. Picture 8.5 show positions for desktop device SAR tests. If the intended use is not specified, the device shall be tested directly against the flat phantom.

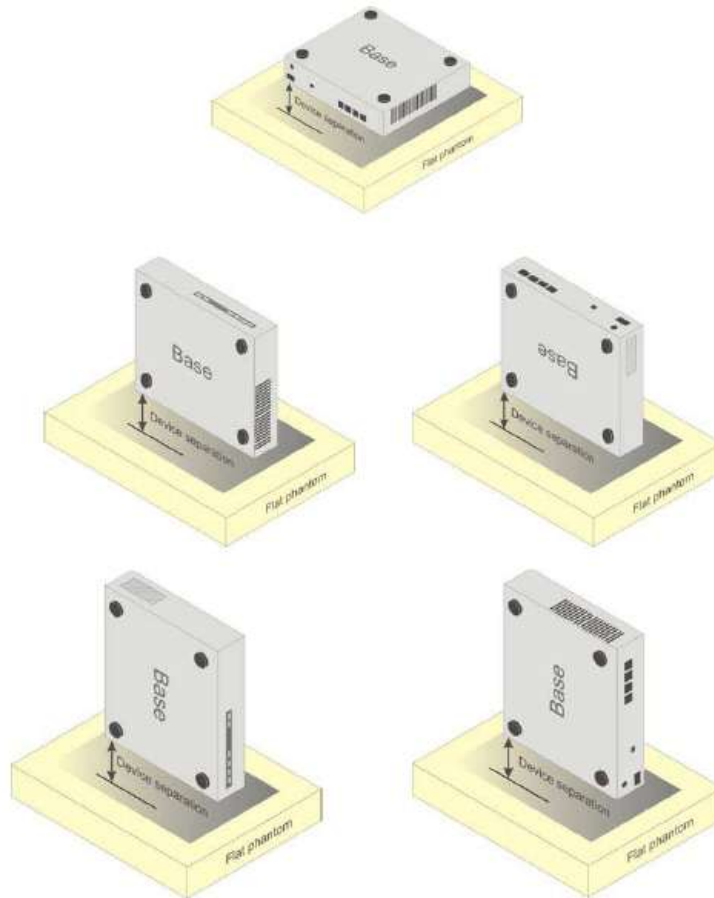

Picture D.5 Test positions for desktop devices

D.4. DUT Setup Photos



Picture D.6

ANNEX E: Equivalent Media Recipes

The liquid used for the frequency range of 700-6000 MHz consisted of water, sugar, salt, preventol, glycol monobutyl and Cellulose. The liquid has been previously proven to be suited for worst-case. The Table E.1 shows the detail solution. It's satisfying the latest tissue dielectric parameters requirements proposed by the IEEE 1528 and IEC 62209.

Table E.1: Composition of the Tissue Equivalent Matter

Frequency (MHz)	835 Head	835 Body	1900 Head	1900 Body	2450 Head	2450 Body	5800 Head	5800 Body
Ingredients (% by weight)								
Water	41.45	52.5	55.242	69.91	58.79	72.60	65.53	65.53
Sugar	56.0	45.0	\	\	\	\	\	\
Salt	1.45	1.4	0.306	0.13	0.06	0.18	\	\
Preventol	0.1	0.1	\	\	\	\	\	\
Cellulose	1.0	1.0	\	\	\	\	\	\
Glycol Monobutyl	\	\	44.452	29.96	41.15	27.22	\	\
Diethylenglycol monohexylether	\	\	\	\	\	\	17.24	17.24
Triton X-100	\	\	\	\	\	\	17.24	17.24
Dielectric Parameters Target Value	$\epsilon=41.5$ $\sigma=0.90$	$\epsilon=55.2$ $\sigma=0.97$	$\epsilon=40.0$ $\sigma=1.40$	$\epsilon=53.3$ $\sigma=1.52$	$\epsilon=39.2$ $\sigma=1.80$	$\epsilon=52.7$ $\sigma=1.95$	$\epsilon=35.3$ $\sigma=5.27$	$\epsilon=48.2$ $\sigma=6.00$

Note: There is a little adjustment respectively for 750, 1800, 2600, 5200, 5300, and 5600, based on the recipe of closest frequency in table E.1

ANNEX F: System Validation

The SAR system must be validated against its performance specifications before it is deployed. When SAR probes, system components or software are changed, upgraded or recalibrated, these must be validated with the SAR system(s) that operates with such components.

Table F.1: System Validation

Probe SN.	Liquid name	Validation date	Frequency point	Status (OK or Not)
3151	Head 750MHz	2020-01-06	750 MHz	OK
3151	Head 835MHz	2020-01-06	835 MHz	OK
3151	Head 1750MHz	2020-01-07	1750 MHz	OK
3151	Head 1900MHz	2020-01-07	1900 MHz	OK
3151	Head 2450MHz	2020-01-08	2450 MHz	OK
3151	Head 2550MHz	2020-01-08	2550 MHz	OK
3151	Body 750MHz	2020-01-06	750 MHz	OK
3151	Body 835MHz	2020-01-06	835 MHz	OK
3151	Body 1750MHz	2020-01-07	1750 MHz	OK
3151	Body 1900MHz	2020-01-07	1900 MHz	OK
3151	Body 2450MHz	2020-01-08	2450 MHz	OK
3151	Body 2550MHz	2020-01-08	5200 MHz	OK



ANNEX G: DAE Calibration Certificate

DAE4 SN: 786 Calibration Certificate



Add: No.51 Xueyuan Road, Haidian District, Beijing, 100191, China
Tel: +86-10-62304633-2512 Fax: +86-10-62304633-2504
E-mail: cttl@chinattl.com <http://www.chinattl.cn>



中国认可
国际互认
校准
CALIBRATION
CNAS L0570

Client : CTTL(South Branch)

Certificate No: Z20-60101

CALIBRATION CERTIFICATE			
Object	DAE4 - SN: 786		
Calibration Procedure(s)	FF-Z11-002-01 Calibration Procedure for the Data Acquisition Electronics (DAEx)		
Calibration date:	March 03, 2020		
This calibration Certificate documents the traceability to national standards, which realize the physical units of measurements(SI). The measurements and the uncertainties with confidence probability are given on the following pages and are part of the certificate.			
All calibrations have been conducted in the closed laboratory facility; environment temperature(22±3)°C and humidity<70%.			
Calibration Equipment used (M&TE critical for calibration)			
Primary Standards	ID #	Cal Date(Calibrated by, Certificate No.)	Scheduled Calibration
Process Calibrator 753	1971018	24-Jun-19 (CTTL, No.J19X05126)	Jun-20
Calibrated by:	Name Yu Zongying	Function SAR Test Engineer	Signature
Reviewed by:	Name Lin Hao	Function SAR Test Engineer	Signature
Approved by:	Name Qi Diaryuan	Function SAR Project Leader	Signature
Issued: March 05, 2020			
This calibration certificate shall not be reproduced except in full without written approval of the laboratory.			



Add: No.51 Xueyuan Road, Haidian District, Beijing, 100191, China
Tel: +86-10-62304633-2512 Fax: +86-10-62304633-2504
E-mail: cttl@chinattl.com Http://www.chinattl.cn

Glossary:

DAE data acquisition electronics
Connector angle information used in DASY system to align probe sensor X to the robot coordinate system.

Methods Applied and Interpretation of Parameters:

- *DC Voltage Measurement:* Calibration Factor assessed for use in DASY system by comparison with a calibrated instrument traceable to national standards. The figure given corresponds to the full scale range of the voltmeter in the respective range.
- *Connector angle:* The angle of the connector is assessed measuring the angle mechanically by a tool inserted. Uncertainty is not required.
- The report provide only calibration results for DAE, it does not contain other performance test results.



Add: No.51 Xueyuan Road, Haidian District, Beijing, 100191, China
Tel: +86-10-62304633-2512 Fax: +86-10-62304633-2504
E-mail: cttl@chinaatl.com Http://www.chinaatl.cn

DC Voltage Measurement

A/D - Converter Resolution nominal
High Range: 1LSB = 6.1µV ; full range = -100...+300 mV
Low Range: 1LSB = 61nV ; full range = -1.....+3mV
DASY measurement parameters: Auto Zero Time: 3 sec; Measuring time: 3 sec

Calibration Factors	X	Y	Z
High Range	404.081 ± 0.15% (k=2)	404.251 ± 0.15% (k=2)	404.649 ± 0.15% (k=2)
Low Range	3.97247 ± 0.7% (k=2)	3.97408 ± 0.7% (k=2)	3.95771 ± 0.7% (k=2)

Connector Angle

Connector Angle to be used in DASY system	229.5° ± 1 °
---	--------------



ANNEX H: Probe Calibration Certificate

Probe ES3DV3-SN: 3151 Calibration Certificate

In Collaboration with

TTL **s p e a g**
CALIBRATION LABORATORY

Add: No.51 Xueyuan Road, Haidian District, Beijing, 100191, China
 Tel: +86-10-62304633-2512 Fax: +86-10-62304633-2504
 E-mail: cntl@chinattl.com Http: www.chinattl.cn

中国认可
 国际互认
 校准
 CALIBRATION
 CNAS L0570

Client **CTTL(South Branch)** Certificate No: **Z20-60021**

CALIBRATION CERTIFICATE			
Object	ES3DV3 - SN : 3151		
Calibration Procedure(s)	FF-Z11-004-01 Calibration Procedures for Dosimetric E-field Probes.		
Calibration date:	January 03, 2020		
<p>This calibration Certificate documents the traceability to national standards, which realize the physical units of measurements(SI). The measurements and the uncertainties with confidence probability are given on the following pages and are part of the certificate.</p> <p>All calibrations have been conducted in the closed laboratory facility: environment temperature:(22±3)℃ and humidity<70%.</p> <p>Calibration Equipment used (M&TE critical for calibration)</p>			
Primary Standards	ID #	Cal Date(Calibrated by, Certificate No.)	Scheduled Calibration
Power Meter NRP2	101919	18-Jun-19(CTTL, No.J19X05125)	Jun-20
Power sensor NRP-Z91	101547	18-Jun-19(CTTL, No.J19X05125)	Jun-20
Power sensor NRP-Z91	101548	18-Jun-19(CTTL, No.J19X05125)	Jun-20
Reference 10dBAttenuator	18N50W-10dB	9-Feb-18(CTTL, No.J18X01133)	Feb-20
Reference 20dBAttenuator	18N50W-20dB	9-Feb-18(CTTL, No.J18X01132)	Feb-20
Reference Probe EX3DV4	SN 7307	24-May-19(SPEAG, No.EX3-7307_May19/2)	May-20
DAE4	SN 1525	26-Aug-19(SPEAG, No.DAE4-1525_Aug19)	Aug-20
Secondary Standards	ID #	Cal Date(Calibrated by, Certificate No.)	Scheduled Calibration
SignalGenerator MG3700A	6201052605	18-Jun-19(CTTL, No.J19X05127)	Jun-20
Network Analyzer E5071C	MY46110673	24-Jan-19(CTTL, No.J19X00547)	Jan-20
Calibrated by:	Name Yu Zongying	Function SAR Test Engineer	Signature
Reviewed by:	Lin Hao	SAR Test Engineer	
Approved by:	Qi Dianyuan	SAR Project Leader	
Issued: January 05, 2020			
This calibration certificate shall not be reproduced except in full without written approval of the laboratory.			



Add: No.51 Xueyuan Road, Haidian District, Beijing, 100191, China
 Tel: +86-10-62304633-2512 Fax: +86-10-62304633-2504
 E-mail: entl@chinattl.com <http://www.slmartl.cn>

Glossary:

TSL	tissue simulating liquid
NORM _{x,y,z}	sensitivity in free space
ConvF	sensitivity in TSL / NORM _{x,y,z}
DCP	diode compression point
CF	crest factor (1/duty_cycle) of the RF signal
A,B,C,D	modulation dependent linearization parameters
Polarization Φ	Φ rotation around probe axis
Polarization θ	θ rotation around an axis that is in the plane normal to probe axis (at measurement center), $\theta=0$ is normal to probe axis

Connector Angle: information used in DASY system to align probe sensor X to the robot coordinate system

Calibration is Performed According to the Following Standards:

- IEEE Std 1528-2013, "IEEE Recommended Practice for Determining the Peak Spatial-Averaged Specific Absorption Rate (SAR) in the Human Head from Wireless Communications Devices: Measurement Techniques", June 2013
- IEC 62209-1, "Measurement procedure for the assessment of Specific Absorption Rate (SAR) from hand-held and body-mounted devices used next to the ear (frequency range of 300 MHz to 6 GHz)", July 2016
- IEC 62209-2, "Procedure to determine the Specific Absorption Rate (SAR) for wireless communication devices used in close proximity to the human body (frequency range of 30 MHz to 6 GHz)", March 2010
- KDB 865664, "SAR Measurement Requirements for 100 MHz to 6 GHz"

Methods Applied and Interpretation of Parameters:

- NORM_{x,y,z}:** Assessed for E-field polarization $\theta=0$ ($f \leq 900$ MHz in TEM-cell; $f > 1800$ MHz: waveguide). NORM_{x,y,z} are only intermediate values, i.e., the uncertainties of NORM_{x,y,z} does not effect the E^2 -field uncertainty inside TSL (see below ConvF).
- NORM(f)_{x,y,z} = NORM_{x,y,z} * frequency_response** (see Frequency Response Chart). This linearization is implemented in DASY4 software versions later than 4.2. The uncertainty of the frequency response is included in the stated uncertainty of ConvF.
- DCP_{x,y,z}:** DCP are numerical linearization parameters assessed based on the data of power sweep (no uncertainty required). DCP does not depend on frequency nor media.
- PAR:** PAR is the Peak to Average Ratio that is not calibrated but determined based on the signal characteristics.
- A_{x,y,z}; B_{x,y,z}; C_{x,y,z}; VR_{x,y,z}; A,B,C** are numerical linearization parameters assessed based on the data of power sweep for specific modulation signal. The parameters do not depend on frequency nor media. VR is the maximum calibration range expressed in RMS voltage across the diode.
- ConvF and Boundary Effect Parameters:** Assessed in flat phantom using E-field (or Temperature Transfer Standard for $f \leq 800$ MHz) and inside waveguide using analytical field distributions based on power measurements for $f > 800$ MHz. The same setups are used for assessment of the parameters applied for boundary compensation (alpha, depth) of which typical uncertainty valued are given. These parameters are used in DASY4 software to improve probe accuracy close to the boundary. The sensitivity in TSL corresponds to NORM_{x,y,z} * ConvF whereby the uncertainty corresponds to that given for ConvF. A frequency dependent ConvF is used in DASY version 4.4 and higher which allows extending the validity from ± 50 MHz to ± 100 MHz.
- Spherical isotropy (3D deviation from isotropy):** in a field of low gradients realized using a flat phantom exposed by a patch antenna.
- Sensor Offset:** The sensor offset corresponds to the offset of virtual measurement center from the probe tip (on probe axis). No tolerance required.
- Connector Angle:** The angle is assessed using the information gained by determining the NORM_x (no uncertainty required).



Add: No.51 Xueyuan Road, Haidian District, Beijing, 100191, China
Tel: +86-10-62304633-2512 Fax: +86-10-62304633-2504
E-mail: entl@chinatl.com <http://www.chinatl.cn>

Probe ES3DV3

SN: 3151

Calibrated: January 03, 2020

Calibrated for DASY/EASY Systems

(Note: non-compatible with DASY2 system!)



Add: No.51 Xueyuan Road, Haidian District, Beijing, 100191, China
 Tel: +86-10-62304633-2512 Fax: +86-10-62304633-2504
 E-mail: cml@chinattl.com <http://www.chinattl.cn>

DASY/EASY – Parameters of Probe: ES3DV3 – SN:3151

Basic Calibration Parameters

	Sensor X	Sensor Y	Sensor Z	Unc (k=2)
Norm($\mu\text{V}/(\text{V}/\text{m})^2$) ^A	1.15	1.25	1.20	$\pm 10.0\%$
DCP(mV) ^B	104.7	104.8	103.2	

Modulation Calibration Parameters

UID	Communication System Name		A dB	B dB· μV	C	D dB	VR mV	Unc ^E (k=2)
0	CW	X	0.0	0.0	1.0	0.00	270.2	$\pm 2.2\%$
		Y	0.0	0.0	1.0		279.5	
		Z	0.0	0.0	1.0		271.5	

The reported uncertainty of measurement is stated as the standard uncertainty of Measurement multiplied by the coverage factor k=2, which for a normal distribution Corresponds to a coverage probability of approximately 95%.

^A The uncertainties of Norm X, Y, Z do not affect the E²-field uncertainty inside TSL (see Page 5).

^B Numerical linearization parameter; uncertainty not required.

^E Uncertainty is determined using the max. deviation from linear response applying rectangular distribution and is expressed for the square of the field value.

DASY/EASY – Parameters of Probe : ES3DV3 – SN:3151

Calibration Parameter Determined in Head Tissue Simulating Media

f [MHz] ^c	Relative Permittivity ^f	Conductivity (S/m) ^f	ConvF X	ConvF Y	ConvF Z	Alpha ^g	Depth ^g (mm)	Unct. (k=2)
750	41.9	0.89	6.41	6.41	6.41	0.40	1.35	±12.1%
900	41.5	0.97	6.23	6.23	6.23	0.40	1.46	±12.1%
1450	40.5	1.20	5.50	5.50	5.50	0.33	1.67	±12.1%
1750	40.1	1.37	5.23	5.23	5.23	0.54	1.35	±12.1%
1900	40.0	1.40	5.11	5.11	5.11	0.65	1.27	±12.1%
2000	40.0	1.40	5.07	5.07	5.07	0.60	1.35	±12.1%
2300	39.5	1.67	4.86	4.86	4.86	0.90	1.08	±12.1%
2450	39.2	1.80	4.68	4.68	4.68	0.90	1.08	±12.1%
2600	39.0	1.96	4.53	4.53	4.53	0.90	1.10	±12.1%

^c Frequency validity above 300 MHz of ±100MHz only applies for DASY v4.4 and higher (Page 2), else it is restricted to ±50MHz. The uncertainty is the RSS of ConvF uncertainty at calibration frequency and the uncertainty for the indicated frequency band. Frequency validity below 300 MHz is ± 10, 25, 40, 50 and 70 MHz for ConvF assessments at 30, 64, 128, 150 and 220 MHz respectively. Above 5 GHz frequency validity can be extended to ± 110 MHz.

^f At frequency below 3 GHz, the validity of tissue parameters (ϵ and σ) can be relaxed to ±10% if liquid compensation formula is applied to measured SAR values. At frequencies above 3 GHz, the validity of tissue parameters (ϵ and σ) is restricted to ±5%. The uncertainty is the RSS of the ConvF uncertainty for indicated target tissue parameters.

^g Alpha/Depth are determined during calibration. SPEAG warrants that the remaining deviation due to the boundary effect after compensation is always less than ± 1% for frequencies below 3 GHz and below ± 2% for the frequencies between 3-6 GHz at any distance larger than half the probe tip diameter from the boundary.

Frequency Response of E-Field (TEM-Cell: ifi110 EXX, Waveguide: R22)

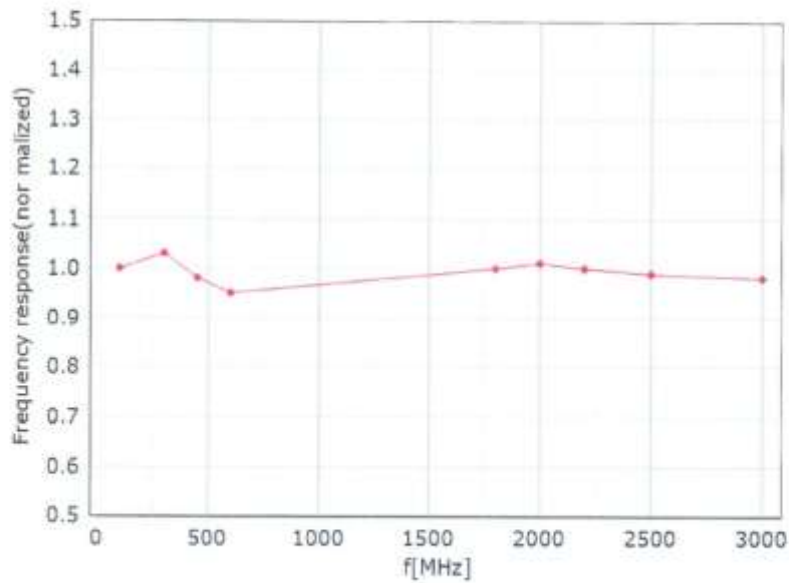

* TEM * R22

Uncertainty of Frequency Response of E-field: $\pm 7.4\%$ (k=2)



Add: No.51 Xueyuan Road, Haidian District, Beijing, 100191, China
 Tel: +86-10-62304633-2512 Fax: +86-10-62304633-2504
 E-mail: ctl@chinattl.com <http://www.chinattl.cn>

Receiving Pattern (Φ), $\theta=0^\circ$

f=600 MHz, TEM

f=1800 MHz, R22

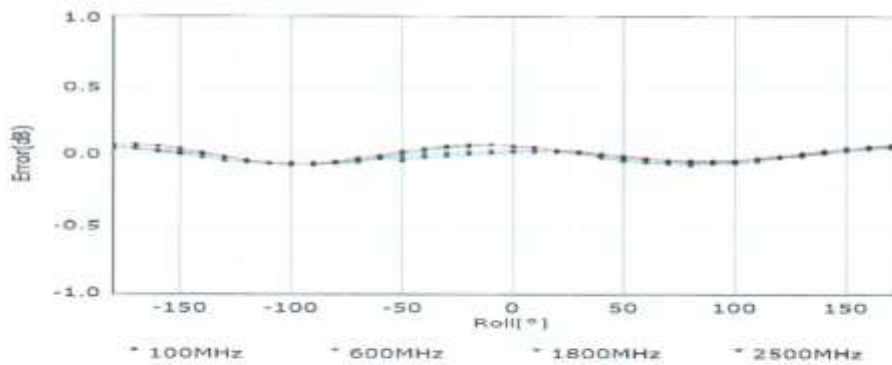
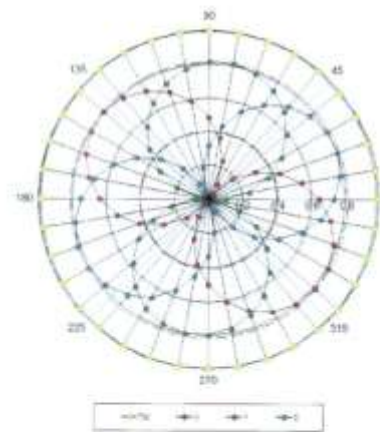
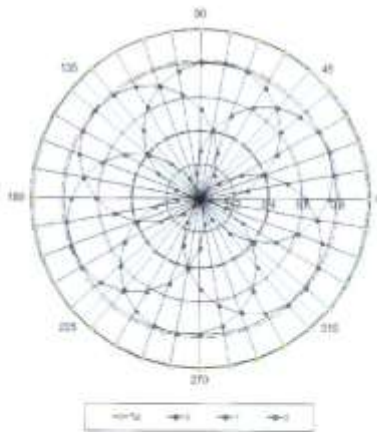

Uncertainty of Axial Isotropy Assessment: $\pm 1.2\%$ (k=2)



Add: No.51 Xueyuan Road, Haidian District, Beijing, 100191, China
 Tel: +86-10-62304633-2512 Fax: +86-10-62304633-2504
 E-mail: cttl@chinattl.com [Http://www.chinattl.cn](http://www.chinattl.cn)

Dynamic Range f(SAR_{head}) (TEM cell, f = 900 MHz)

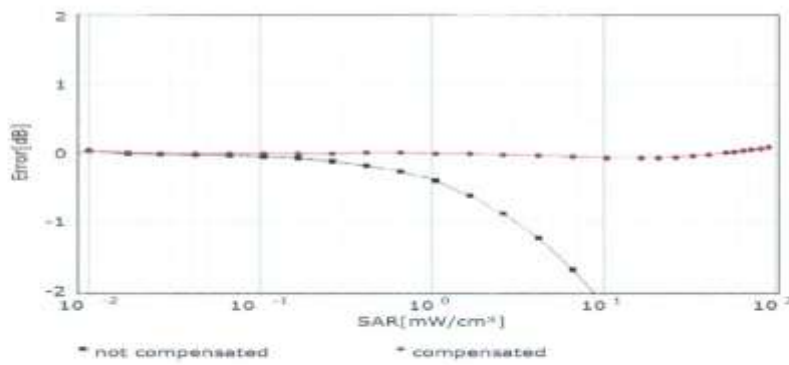
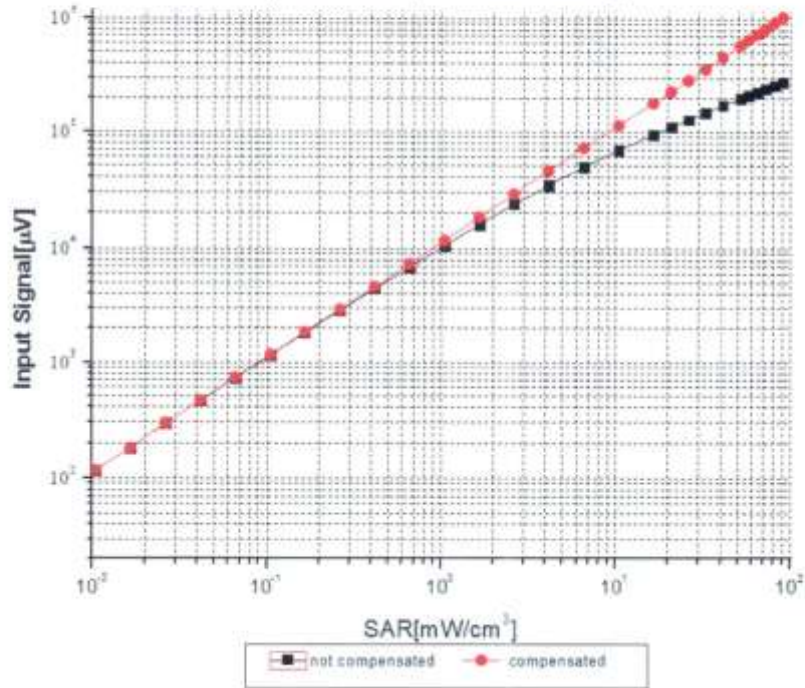

Uncertainty of Linearity Assessment: ±0.9% (k=2)



Add: No.51 Xueyuan Road, Haidian District, Beijing, 100191, China
 Tel: +86-10-62304633-2512 Fax: +86-10-62304633-2504
 E-mail: cttl@chinaml.com <http://www.chinaml.cn>

Conversion Factor Assessment

f=750 MHz,WGLS R9(H_convF)

f=1750 MHz,WGLS R22(H_convF)

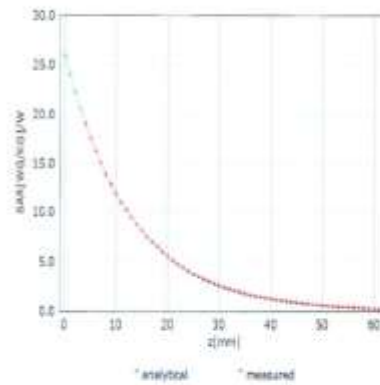
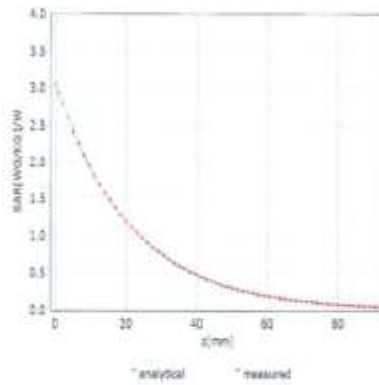

Deviation from Isotropy in Liquid

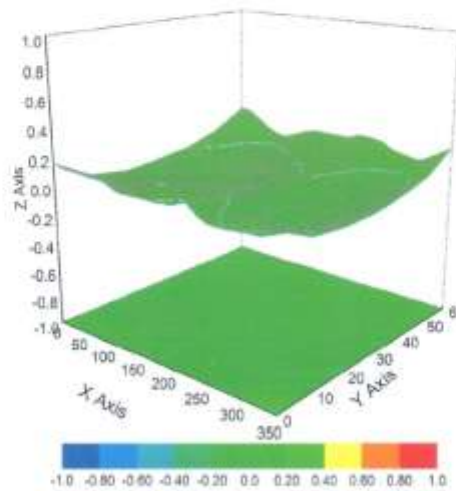

Uncertainty of Spherical Isotropy Assessment: $\pm 3.2\%$ (K=2)



Add: No.51 Xueyuan Road, Haidian District, Beijing, 100191, China
Tel: +86-10-62304633-2512 Fax: +86-10-62304633-2504
E-mail: cttl@chinattl.com <http://www.chinattl.cn>

DASY/EASY – Parameters of Probe: ES3DV3 – SN:3151

Other Probe Parameters

Sensor Arrangement	Triangular
Connector Angle (°)	89
Mechanical Surface Detection Mode	enabled
Optical Surface Detection Mode	disable
Probe Overall Length	337mm
Probe Body Diameter	10mm
Tip Length	10mm
Tip Diameter	4mm
Probe Tip to Sensor X Calibration Point	2mm
Probe Tip to Sensor Y Calibration Point	2mm
Probe Tip to Sensor Z Calibration Point	2mm
Recommended Measurement Distance from Surface	3mm



ANNEX I: Dipole Calibration Certificate

750MHz Dipole Calibration Certificate



Client **CTTL(South Branch)** Certificate No: **Z19-60291**

CALIBRATION CERTIFICATE			
Object	D750V3 - SN: 1163		
Calibration Procedure(s)	FF-Z11-003-01 Calibration Procedures for dipole validation kits		
Calibration date:	September 3, 2019		
<p>This calibration Certificate documents the traceability to national standards, which realize the physical units of measurements(SI). The measurements and the uncertainties with confidence probability are given on the following pages and are part of the certificate.</p> <p>All calibrations have been conducted in the closed laboratory facility: environment temperature(22±3)°C and humidity<70%.</p> <p>Calibration Equipment used (M&TE critical for calibration)</p>			
Primary Standards	ID #	Cal Date(Calibrated by, Certificate No.)	Scheduled Calibration
Power Meter NRP2	106276	11-Apr-19 (CTTL, No.J19X02605)	Apr-20
Power sensor NRP6A	101369	11-Apr-19 (CTTL, No.J19X02605)	Apr-20
Reference Probe EX30V4	SN 3617	31-Jan-19(SPEAG, No.EX3-3617_Jan19)	Jan-20
DAE4	6N 1555	22-Aug-19(CTTL-SPEAG, No.Z19-60295)	Aug-20
Secondary Standards	ID #	Cal Date(Calibrated by, Certificate No.)	Scheduled Calibration
Signal Generator E4438C	MY49071430	23-Jan-19 (CTTL, No.J19X00336)	Jan-20
NetworkAnalyzer E5071C	MY46110673	24-Jan-19 (CTTL, No.J19X00547)	Jan-20
Calibrated by:	Name Zhao Jing	Function SAR Test Engineer	Signature
Reviewed by:	Name Lin Hao	Function SAR Test Engineer	Signature
Approved by:	Name Qi Dianyuan	Function SAR Project Leader	Signature
Issued: September 6, 2019			
This calibration certificate shall not be reproduced except in full without written approval of the laboratory.			



Add: No.51 Xueyuan Road, Haidian District, Beijing, 100191, China
Tel: +86-10-62304633-2079 Fax: +86-10-62304633-2504
E-mail: cttf@chinattl.com http://www.chinattl.cn

Glossary:

TSL	tissue simulating liquid
ConvF	sensitivity in TSL / NORM _{x,y,z}
N/A	not applicable or not measured

Calibration is Performed According to the Following Standards:

- IEEE Std 1528-2013, "IEEE Recommended Practice for Determining the Peak Spatial-Averaged Specific Absorption Rate (SAR) in the Human Head from Wireless Communications Devices: Measurement Techniques", June 2013
- IEC 62209-1, "Measurement procedure for assessment of specific absorption rate of human exposure to radio frequency fields from hand-held and body-mounted wireless communication devices- Part 1: Device used next to the ear (Frequency range of 300MHz to 6GHz)", July 2016
- IEC 62209-2, "Procedure to measure the Specific Absorption Rate (SAR) For wireless communication devices used in close proximity to the human body (frequency range of 30MHz to 6GHz)", March 2010
- KDB865664, SAR Measurement Requirements for 100 MHz to 6 GHz

Additional Documentation:

- DASY4/5 System Handbook

Methods Applied and Interpretation of Parameters:

- Measurement Conditions:** Further details are available from the Validation Report at the end of the certificate. All figures stated in the certificate are valid at the frequency indicated.
- Antenna Parameters with TSL:** The dipole is mounted with the spacer to position its feed point exactly below the center marking of the flat phantom section, with the arms oriented parallel to the body axis.
- Feed Point Impedance and Return Loss:** These parameters are measured with the dipole positioned under the liquid filled phantom. The impedance stated is transformed from the measurement at the SMA connector to the feed point. The Return Loss ensures low reflected power. No uncertainty required.
- Electrical Delay:** One-way delay between the SMA connector and the antenna feed point. No uncertainty required.
- SAR measured:** SAR measured at the stated antenna input power.
- SAR normalized:** SAR as measured, normalized to an input power of 1 W at the antenna connector.
- SAR for nominal TSL parameters:** The measured TSL parameters are used to calculate the nominal SAR result.

The reported uncertainty of measurement is stated as the standard uncertainty of Measurement multiplied by the coverage factor $k=2$, which for a normal distribution Corresponds to a coverage probability of approximately 95%.



Add: No.51 Xueyuan Road, Haidian District, Beijing, 100191, China
 Tel: +86-10-62304633-2079 Fax: +86-10-62304633-2504
 E-mail: ttl@chinattl.com http://www.chinattl.cn

Measurement Conditions

DASY system configuration, as far as not given on page 1.

DASY Version	DASY52	V52.10.2
Extrapolation	Advanced Extrapolation	
Phantom	Triple Flat Phantom 5.1C	
Distance Dipole Center - TSL	15 mm	with Spacer
Zoom Scan Resolution	dx, dy, dz = 5 mm	
Frequency	750 MHz \pm 1 MHz	

Head TSL parameters

The following parameters and calculations were applied.

	Temperature	Permittivity	Conductivity
Nominal Head TSL parameters	22.0 °C	41.9	0.89 mho/m
Measured Head TSL parameters	(22.0 \pm 0.2) °C	41.6 \pm 6 %	0.90 mho/m \pm 6 %
Head TSL temperature change during test	<1.0 °C	---	---

SAR result with Head TSL

SAR averaged over 1 cm^3 (1 g) of Head TSL	Condition	
SAR measured	250 mW input power	2.16 W/kg
SAR for nominal Head TSL parameters	normalized to 1W	8.53 W/kg \pm 18.8 % (k=2)
SAR averaged over 10 cm^3 (10 g) of Head TSL	Condition	
SAR measured	250 mW input power	1.44 W/kg
SAR for nominal Head TSL parameters	normalized to 1W	5.70 W/kg \pm 18.7 % (k=2)

Body TSL parameters

The following parameters and calculations were applied.

	Temperature	Permittivity	Conductivity
Nominal Body TSL parameters	22.0 °C	55.5	0.96 mho/m
Measured Body TSL parameters	(22.0 \pm 0.2) °C	55.9 \pm 6 %	0.94 mho/m \pm 6 %
Body TSL temperature change during test	<1.0 °C	---	---

SAR result with Body TSL

SAR averaged over 1 cm^3 (1 g) of Body TSL	Condition	
SAR measured	250 mW input power	2.16 W/kg
SAR for nominal Body TSL parameters	normalized to 1W	8.78 W/kg \pm 18.8 % (k=2)
SAR averaged over 10 cm^3 (10 g) of Body TSL	Condition	
SAR measured	250 mW input power	1.45 W/kg
SAR for nominal Body TSL parameters	normalized to 1W	5.87 W/kg \pm 18.7 % (k=2)



Add: No.51 Xueyuan Road, Haidian District, Beijing, 100191, China
Tel: +86-10-62304633-2079 Fax: +86-10-62304633-2504
E-mail: cttl@chinattl.com http://www.chinattl.cn

Appendix (Additional assessments outside the scope of CNAS L0570)

Antenna Parameters with Head TSL

Impedance, transformed to feed point	50.5Ω- 4.53jΩ
Return Loss	- 26.9dB

Antenna Parameters with Body TSL

Impedance, transformed to feed point	48.5Ω- 3.38jΩ
Return Loss	- 28.5dB

General Antenna Parameters and Design

Electrical Delay (one direction)	0.900 ns
----------------------------------	----------

After long term use with 100W radiated power, only a slight warming of the dipole near the feedpoint can be measured.

The dipole is made of standard semirigid coaxial cable. The center conductor of the feeding line is directly connected to the second arm of the dipole. The antenna is therefore short-circuited for DC-signals. On some of the dipoles, small end caps are added to the dipole arms in order to improve matching when loaded according to the position as explained in the "Measurement Conditions" paragraph. The SAR data are not affected by this change. The overall dipole length is still according to the Standard. No excessive force must be applied to the dipole arms, because they might bend or the soldered connections near the feedpoint may be damaged.

Additional EUT Data

Manufactured by	SPEAG
-----------------	-------



Add: No.51 Xueyuan Road, Haidian District, Beijing, 100191, China
 Tel: +86-10-62304633-2079 Fax: +86-10-62304633-2504
 E-mail: ctfl@chinattl.com http://www.chinattl.cn

DASY5 Validation Report for Head TSL

Date: 09.03.2019

Test Laboratory: CTTL, Beijing, China

DUT: Dipole 750 MHz; Type: D750V3; Serial: D750V3 - SN: 1163

Communication System: UID 0, CW; Frequency: 750 MHz; Duty Cycle: 1:1

Medium parameters used: $f = 750$ MHz; $\sigma = 0.904$ S/m; $\epsilon_r = 41.62$; $\rho = 1000$ kg/m³

Phantom section: Right Section

DASY5 Configuration:

- Probe: EX3DV4 - SN3617; ConvF(10.03, 10.03, 10.03) @ 750 MHz; Calibrated: 1/31/2019
- Sensor-Surface: 1.4mm (Mechanical Surface Detection)
- Electronics: DAE4 Sn1555; Calibrated: 8/22/2019
- Phantom: MFP_V5.1C ; Type: QD 000 P51CA; Serial: 1062
- Measurement SW: DASY52, Version 52.10 (2); SEMCAD X Version 14.6.12 (7470)

Dipole Calibration/Zoom Scan (7x7x7) (7x7x7)/Cube 0: Measurement grid: dx=5mm, dy=5mm, dz=5mm

Reference Value = 55.16 V/m; Power Drift = -0.02 dB

Peak SAR (extrapolated) = 3.11 W/kg

SAR(1 g) = 2.16 W/kg; SAR(10 g) = 1.44 W/kg

Maximum value of SAR (measured) = 2.81 W/kg

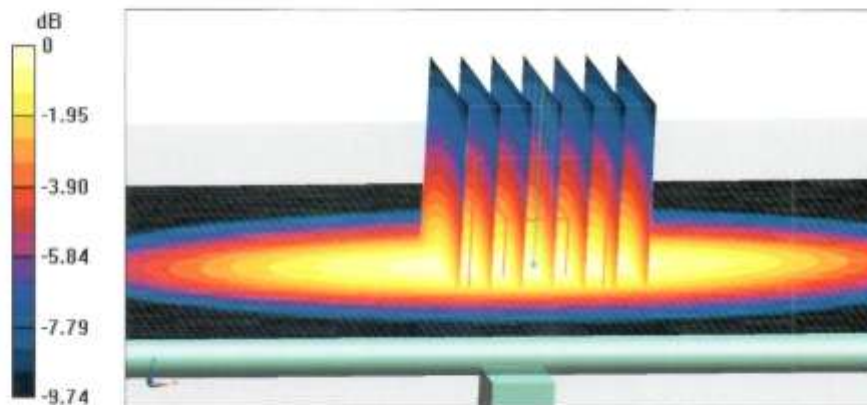



Add: No.51 Xueyuan Road, Haidian District, Beijing, 100191, China
Tel: +86-10-62304633-2079 Fax: +86-10-62304633-2504
E-mail: cntl@chinattl.com http://www.chinattl.cn

Impedance Measurement Plot for Head TSL

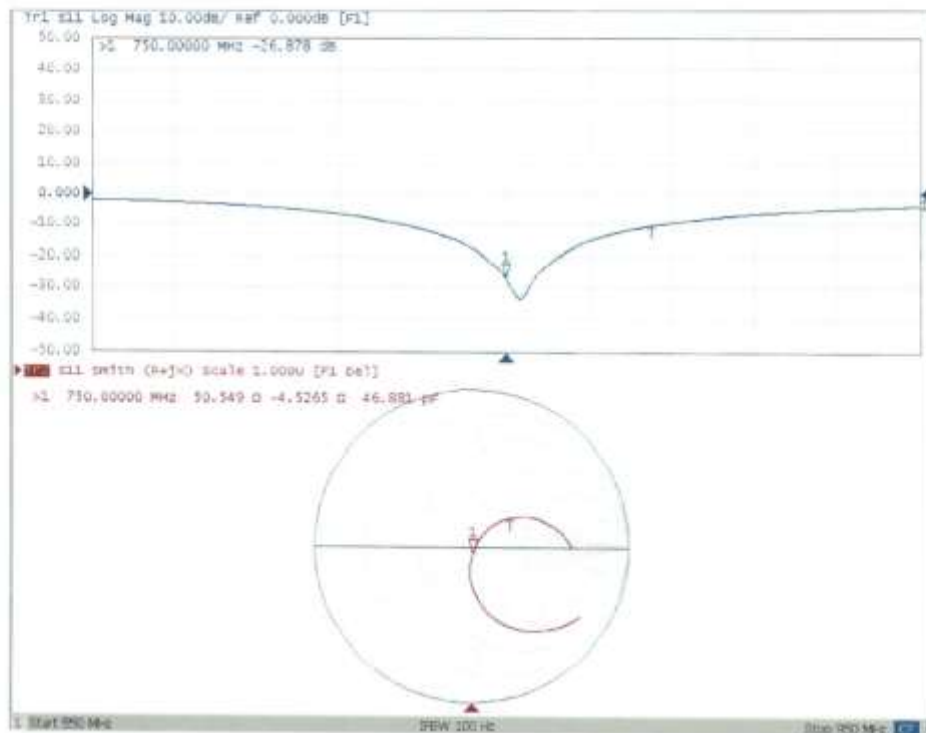



Add: No.51 Xueyuan Road, Haidian District, Beijing, 100191, China
Tel: +86-10-62304633-2079 Fax: +86-10-62304633-2504
E-mail: cttl@chinattl.com http://www.chinattl.cn

DASY5 Validation Report for Body TSL

Date: 09.03.2019

Test Laboratory: CTTL, Beijing, China

DUT: Dipole 750 MHz; Type: D750V3; Serial: D750V3 - SN: 1163

Communication System: UID 0, CW; Frequency: 750 MHz; Duty Cycle: 1:1

Medium parameters used: $f = 750$ MHz; $\sigma = 0.942$ S/m; $\epsilon_r = 55.87$; $\rho = 1000$ kg/m³

Phantom section: Center Section

DASY5 Configuration:

- Probe: EX3DV4 - SN3617; ConvF(9.85, 9.85, 9.85) @ 750 MHz; Calibrated: 1/31/2019
- Sensor-Surface: 1.4mm (Mechanical Surface Detection)
- Electronics: DAE4 Sn1555; Calibrated: 8/22/2019
- Phantom: MFP_V5.1C ; Type: QD 000 P51CA; Serial: 1062
- Measurement SW: DASY52, Version 52.10 (2); SEMCAD X Version 14.6.12 (7470)

Dipole Calibration/Zoom Scan (7x7x7) (7x7x7)/Cube 0: Measurement grid: dx=5mm, dy=5mm, dz=5mm

Reference Value = 52.88 V/m; Power Drift = 0.03 dB

Peak SAR (extrapolated) = 3.20 W/kg

SAR(1 g) = 2.16 W/kg; SAR(10 g) = 1.45 W/kg

Maximum value of SAR (measured) = 2.85 W/kg

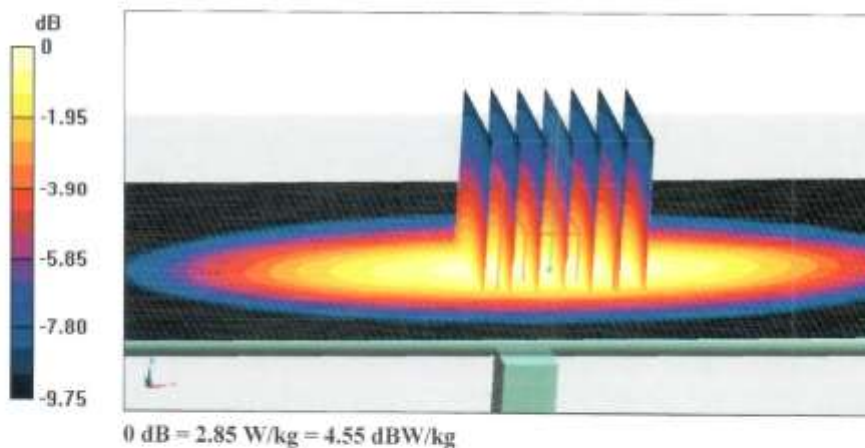



Add: No.51 Xueyuan Road, Haidian District, Beijing, 100191, China
Tel: +86-10-62304633-2079 Fax: +86-10-62304633-2504
E-mail: entl@chinantl.com <http://www.chinantl.cn>

Impedance Measurement Plot for Body TSL

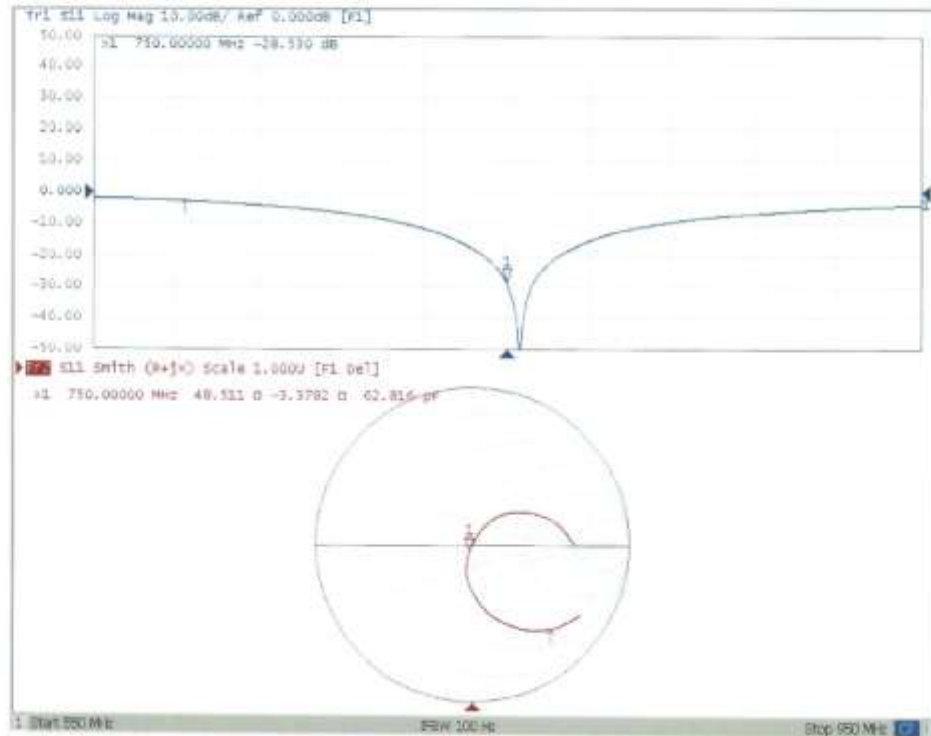



835 MHz Dipole Calibration Certificate



In Collaboration with
s p e a g
CALIBRATION LABORATORY



中国认可
国际互认
校准
CALIBRATION
CNAS LD570

Add: No.51 Xueyuan Road, Haidian District, Beijing, 100191, China
Tel: +86-10-62304633-2079 Fax: +86-10-62304633-2504
E-mail: cntl@chinattl.com http://www.chinattl.cn

Client **CTTL(South Branch)**

Certificate No: **Z18-60385**

CALIBRATION CERTIFICATE

Object **D835V2 - SN: 4d057**

Calibration Procedure(s) **FF-Z11-003-01**
Calibration Procedures for dipole validation kits

Calibration date: **October 9, 2018**

This calibration Certificate documents the traceability to national standards, which realize the physical units of measurements(SI). The measurements and the uncertainties with confidence probability are given on the following pages and are part of the certificate.

All calibrations have been conducted in the closed laboratory facility: environment temperature(22±3)°C and humidity<70%.

Calibration Equipment used (M&TE critical for calibration)

Primary Standards	ID #	Cal Date(Calibrated by, Certificate No.)	Scheduled Calibration
Power Meter NRVD	102083	01-Nov-17 (CTTL, No.J17X08756)	Oct-18
Power sensor NRV-Z5	100542	01-Nov-17 (CTTL, No.J17X08756)	Oct-18
Reference Probe EX3DV4 DAE4	SN 7514	27-Aug-18(SPEAG,No.EX3-7514_Aug18)	Aug-19
	SN 1555	20-Aug-18(SPEAG,No.DAE4-1555_Aug18)	Aug-19
Secondary Standards	ID #	Cal Date(Calibrated by, Certificate No.)	Scheduled Calibration
Signal Generator E4438C	MY49071430	23-Jan-18 (CTTL, No.J18X00560)	Jan-19
NetworkAnalyzer E5071C	MY46110673	24-Jan-18 (CTTL, No.J18X00561)	Jan-19

	Name	Function	Signature
Calibrated by:	Zhao Jing	SAR Test Engineer	
Reviewed by:	Lin Hao	SAR Test Engineer	
Approved by:	Qi Dianyuan	SAR Project Leader	

Issued: October 11, 2018

This calibration certificate shall not be reproduced except in full without written approval of the laboratory.



Add: No.51 Xueyuan Road, Haidian District, Beijing, 100191, China
Tel: +86-10-62304633-2079 Fax: +86-10-62304633-2504
E-mail: ctfj@chinattl.com http://www.chinattl.cn

Glossary:

TSL	tissue simulating liquid
ConvF	sensitivity in TSL / NORM _{x,y,z}
N/A	not applicable or not measured

Calibration is Performed According to the Following Standards:

- IEEE Std 1528-2013, "IEEE Recommended Practice for Determining the Peak Spatial-Averaged Specific Absorption Rate (SAR) in the Human Head from Wireless Communications Devices: Measurement Techniques", June 2013
- IEC 62209-1, "Measurement procedure for assessment of specific absorption rate of human exposure to radio frequency fields from hand-held and body-mounted wireless communication devices- Part 1: Device used next to the ear (Frequency range of 300MHz to 6GHz)", July 2016
- IEC 62209-2, "Procedure to measure the Specific Absorption Rate (SAR) For wireless communication devices used in close proximity to the human body (frequency range of 30MHz to 6GHz)", March 2010
- KDB865664, SAR Measurement Requirements for 100 MHz to 6 GHz

Additional Documentation:

- DASY4/5 System Handbook

Methods Applied and Interpretation of Parameters:

- Measurement Conditions:** Further details are available from the Validation Report at the end of the certificate. All figures stated in the certificate are valid at the frequency indicated.
- Antenna Parameters with TSL:** The dipole is mounted with the spacer to position its feed point exactly below the center marking of the flat phantom section, with the arms oriented parallel to the body axis.
- Feed Point Impedance and Return Loss:** These parameters are measured with the dipole positioned under the liquid filled phantom. The impedance stated is transformed from the measurement at the SMA connector to the feed point. The Return Loss ensures low reflected power. No uncertainty required.
- Electrical Delay:** One-way delay between the SMA connector and the antenna feed point. No uncertainty required.
- SAR measured:** SAR measured at the stated antenna input power.
- SAR normalized:** SAR as measured, normalized to an input power of 1 W at the antenna connector.
- SAR for nominal TSL parameters:** The measured TSL parameters are used to calculate the nominal SAR result.

The reported uncertainty of measurement is stated as the standard uncertainty of Measurement multiplied by the coverage factor $k=2$, which for a normal distribution Corresponds to a coverage probability of approximately 95%.



Add: No.51 Xueyuan Road, Haidian District, Beijing, 100191, China
 Tel: +86-10-62304633-2079 Fax: +86-10-62304633-2504
 E-mail: cntf@chinattl.com http://www.chinattl.cn

Measurement Conditions

DASY system configuration, as far as not given on page 1.

DASY Version	DASY52	52.10.1.1476
Extrapolation	Advanced Extrapolation	
Phantom	Triple Flat Phantom 5.1C	
Distance Dipole Center - TSL	15 mm	with Spacer
Zoom Scan Resolution	dx, dy, dz = 5 mm	
Frequency	835 MHz \pm 1 MHz	

Head TSL parameters

The following parameters and calculations were applied.

	Temperature	Permittivity	Conductivity
Nominal Head TSL parameters	22.0 °C	41.5	0.90 mho/m
Measured Head TSL parameters	(22.0 \pm 0.2) °C	42.2 \pm 6 %	0.91 mho/m \pm 6 %
Head TSL temperature change during test	<1.0 °C	---	---

SAR result with Head TSL

SAR averaged over 1 cm^3 (1 g) of Head TSL	Condition	
SAR measured	250 mW input power	2.42 mW / g
SAR for nominal Head TSL parameters	normalized to 1W	9.62 mW / g \pm 18.8 % (k=2)
SAR averaged over 10 cm^3 (10 g) of Head TSL	Condition	
SAR measured	250 mW input power	1.58 mW / g
SAR for nominal Head TSL parameters	normalized to 1W	6.29 mW / g \pm 18.7 % (k=2)

Body TSL parameters

The following parameters and calculations were applied.

	Temperature	Permittivity	Conductivity
Nominal Body TSL parameters	22.0 °C	55.2	0.97 mho/m
Measured Body TSL parameters	(22.0 \pm 0.2) °C	55.9 \pm 6 %	0.99 mho/m \pm 6 %
Body TSL temperature change during test	<1.0 °C	---	---

SAR result with Body TSL

SAR averaged over 1 cm^3 (1 g) of Body TSL	Condition	
SAR measured	250 mW input power	2.51 mW / g
SAR for nominal Body TSL parameters	normalized to 1W	9.90 mW / g \pm 18.8 % (k=2)
SAR averaged over 10 cm^3 (10 g) of Body TSL	Condition	
SAR measured	250 mW input power	1.66 mW / g
SAR for nominal Body TSL parameters	normalized to 1W	6.56 mW / g \pm 18.7 % (k=2)



Add: No.51 Xueyuan Road, Haidian District, Beijing, 100191, China
Tel: +86-10-62304633-2079 Fax: +86-10-62304633-2504
E-mail: cttl@chinatl.com http://www.chinatl.cn

Appendix (Additional assessments outside the scope of CNAS L0570)

Antenna Parameters with Head TSL

Table with 2 columns: Parameter, Value. Rows: Impedance, transformed to feed point (49.6Ω- 4.08jΩ), Return Loss (- 27.7dB)

Antenna Parameters with Body TSL

Table with 2 columns: Parameter, Value. Rows: Impedance, transformed to feed point (46.8Ω- 4.96jΩ), Return Loss (- 24.3dB)

General Antenna Parameters and Design

Table with 2 columns: Parameter, Value. Row: Electrical Delay (one direction) (1.260 ns)

After long term use with 100W radiated power, only a slight warming of the dipole near the feedpoint can be measured.

The dipole is made of standard semirigid coaxial cable. The center conductor of the feeding line is directly connected to the second arm of the dipole. The antenna is therefore short-circuited for DC-signals. On some of the dipoles, small end caps are added to the dipole arms in order to improve matching when loaded according to the position as explained in the "Measurement Conditions" paragraph. The SAR data are not affected by this change. The overall dipole length is still according to the Standard. No excessive force must be applied to the dipole arms, because they might bend or the soldered connections near the feedpoint may be damaged.

Additional EUT Data

Table with 2 columns: Parameter, Value. Row: Manufactured by (SPEAG)



Add: No.51 Xueyuan Road, Haidian District, Beijing, 100191, China
 Tel: +86-10-62304633-2079 Fax: +86-10-62304633-2504
 E-mail: cttl@chinattl.com http://www.chinattl.cn

DASY5 Validation Report for Head TSL

Date: 10.08.2018

Test Laboratory: CTTL, Beijing, China

DUT: Dipole 835 MHz; Type: D835V2; Serial: D835V2 - SN: 4d057

Communication System: UID 0, CW; Frequency: 835 MHz; Duty Cycle: 1:1

Medium parameters used: $f = 835$ MHz; $\sigma = 0.912$ S/m; $\epsilon_r = 42.22$; $\rho = 1000$ kg/m³

Phantom section: Center Section

DASY5 Configuration:

- Probe: EX3DV4 - SN7514; ConvF(9.09, 9.09, 9.09) @ 835 MHz; Calibrated: 8/27/2018
- Sensor-Surface: 1.4mm (Mechanical Surface Detection)
- Electronics: DAE4 Sn1555; Calibrated: 8/20/2018
- Phantom: MFP_V5.1C ; Type: QD 000 P51CA; Serial: 1062
- Measurement SW: DASY52, Version 52.10 (1); SEMCAD X Version 14.6.11 (7439)

Dipole Calibration/Zoom Scan (7x7x7) (7x7x7)/Cube 0: Measurement grid: dx=5mm, dy=5mm, dz=5mm

Reference Value = 55.57 V/m; Power Drift = -0.04 dB

Peak SAR (extrapolated) = 3.61 W/kg

SAR(1 g) = 2.42 W/kg; SAR(10 g) = 1.58 W/kg

Maximum value of SAR (measured) = 3.22 W/kg

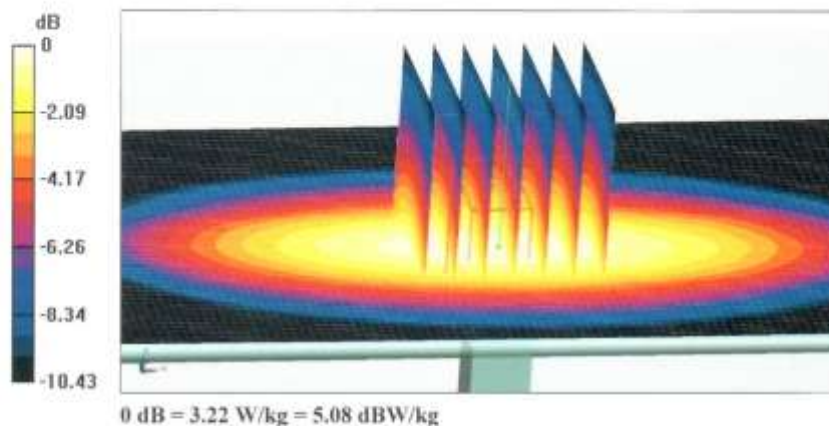



Add: No.51 Xueyuan Road, Haidian District, Beijing, 100191, China
Tel: +86-10-62304633-2079 Fax: +86-10-62304633-2504
E-mail: ttl@chinatl.com http://www.chinatl.cn

Impedance Measurement Plot for Head TSL

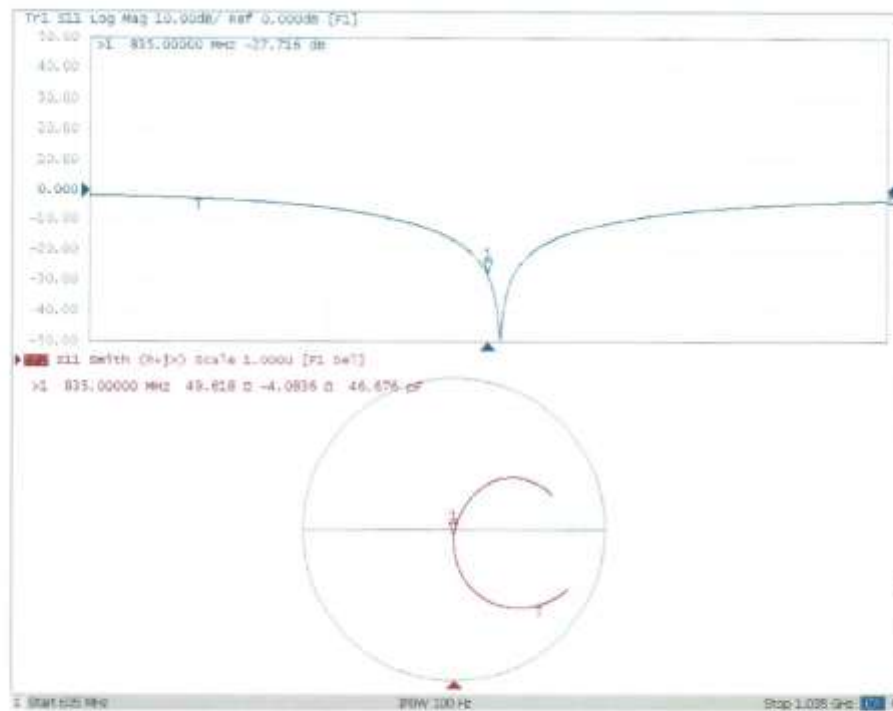

DASY5 Validation Report for Body TSL

Date: 10.08.2018

Test Laboratory: CTTL, Beijing, China

DUT: Dipole 835 MHz; Type: D835V2; Serial: D835V2 - SN: 4d057

Communication System: UID 0, CW; Frequency: 835 MHz; Duty Cycle: 1:1

Medium parameters used: $f = 835$ MHz; $\sigma = 0.992$ S/m; $\epsilon_r = 55.93$; $\rho = 1000$ kg/m³

Phantom section: Right Section

DASY5 Configuration:

- Probe: EX3DV4 - SN7514; ConvF(9.47, 9.47, 9.47) @ 835 MHz; Calibrated: 8/27/2018
- Sensor-Surface: 1.4mm (Mechanical Surface Detection)
- Electronics: DAE4 Sn1555; Calibrated: 8/20/2018
- Phantom: MFP_V5.1C ; Type: QD 000 P51CA; Serial: 1062
- Measurement SW: DASY52, Version 52.10 (1); SEMCAD X Version 14.6.11 (7439)

Dipole Calibration/Zoom Scan (7x7x7) (7x7x7)/Cube 0: Measurement grid: dx=5mm, dy=5mm, dz=5mm

Reference Value = 56.64 V/m; Power Drift = -0.01 dB

Peak SAR (extrapolated) = 3.83 W/kg

SAR(1 g) = 2.51 W/kg; SAR(10 g) = 1.66 W/kg

Maximum value of SAR (measured) = 3.36 W/kg

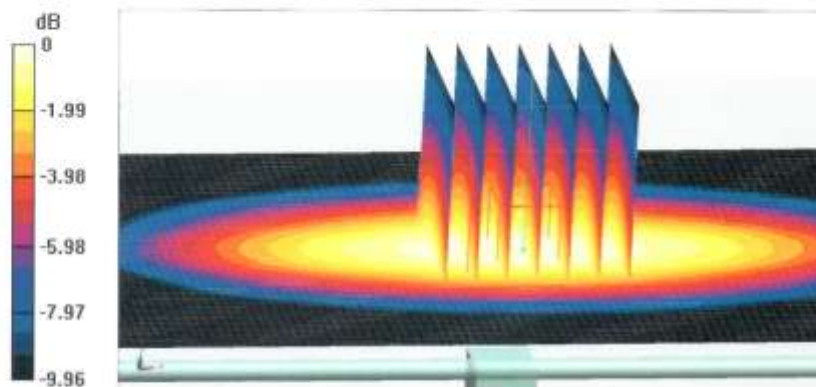

0 dB = 3.36 W/kg = 5.26 dBW/kg



1750 MHz Dipole Calibration Certificate

In Collaboration with



s p e a g
CALIBRATION LABORATORY

Address: No.51 Xueyuan Road, Haidian District, Beijing, 100191, China
Tel: +86-10-62304633-2079 Fax: +86-10-62304633-2504
E-mail: ctll@chinattl.com http://www.chinattl.cn



中国认可
国际互认
校准
CALIBRATION
CNAS L0570

Client **CTTL(South Branch)** Certificate No: **Z19-60292**

CALIBRATION CERTIFICATE

Object: **D1750V2 - SN: 1152**

Calibration Procedure(s): **FF-Z11-003-01**
Calibration Procedures for dipole validation kits

Calibration date: **August 30, 2019**

This calibration Certificate documents the traceability to national standards, which realize the physical units of measurements(SI). The measurements and the uncertainties with confidence probability are given on the following pages and are part of the certificate.

All calibrations have been conducted in the closed laboratory facility: environment temperature(22±3)℃ and humidity<70%.

Calibration Equipment used (M&TE critical for calibration)

Primary Standards	ID #	Cal Date(Calibrated by, Certificate No.)	Scheduled Calibration
Power Meter NRP2	106276	11-Apr-19 (CTTL, No.J19X02605)	Apr-20
Power sensor NRP6A	101369	11-Apr-19 (CTTL, No.J19X02605)	Apr-20
Reference Probe EX3DV4	SN 3617	31-Jan-19(SPEAG No.EX3-3617_Jan19)	Jan-20
DAE4	SN 1555	22-Aug-19(CTTL-SPEAG No.Z19-60295)	Aug-20
Secondary Standards	ID #	Cal Date(Calibrated by, Certificate No.)	Scheduled Calibration
Signal Generator E4438C	MY49071430	23-Jan-19 (CTTL, No.J19X00336)	Jan-20
NetworkAnalyzer E5071C	MY46110673	24-Jan-19 (CTTL, No.J19X00547)	Jan-20

	Name	Function	Signature
Calibrated by:	Zhao Jing	SAR Test Engineer	
Reviewed by:	Lin Hao	SAR Test Engineer	
Approved by:	Qi Dianyuan	SAR Project Leader	

Issued: September 2, 2019

This calibration certificate shall not be reproduced except in full without written approval of the laboratory.



Add: No.51 Xueyuan Road, Haidian District, Beijing, 100191, China
Tel: +86-10-62304633-2079 Fax: +86-10-62304633-2504
E-mail: cttf@chinantl.com http://www.chinantl.cn

Glossary:

TSL	tissue simulating liquid
ConvF	sensitivity in TSL / NORM _{x,y,z}
N/A	not applicable or not measured

Calibration is Performed According to the Following Standards:

- IEEE Std 1528-2013, "IEEE Recommended Practice for Determining the Peak Spatial-Averaged Specific Absorption Rate (SAR) in the Human Head from Wireless Communications Devices: Measurement Techniques", June 2013
- IEC 62209-1, "Measurement procedure for assessment of specific absorption rate of human exposure to radio frequency fields from hand-held and body-mounted wireless communication devices- Part 1: Device used next to the ear (Frequency range of 300MHz to 6GHz)", July 2016
- IEC 62209-2, "Procedure to measure the Specific Absorption Rate (SAR) For wireless communication devices used in close proximity to the human body (frequency range of 30MHz to 6GHz)", March 2010
- KDB865664, SAR Measurement Requirements for 100 MHz to 6 GHz

Additional Documentation:

- DASY4/5 System Handbook

Methods Applied and Interpretation of Parameters:

- Measurement Conditions:* Further details are available from the Validation Report at the end of the certificate. All figures stated in the certificate are valid at the frequency indicated.
- Antenna Parameters with TSL:* The dipole is mounted with the spacer to position its feed point exactly below the center marking of the flat phantom section, with the arms oriented parallel to the body axis.
- Feed Point Impedance and Return Loss:* These parameters are measured with the dipole positioned under the liquid filled phantom. The impedance stated is transformed from the measurement at the SMA connector to the feed point. The Return Loss ensures low reflected power. No uncertainty required.
- Electrical Delay:* One-way delay between the SMA connector and the antenna feed point. No uncertainty required.
- SAR measured:* SAR measured at the stated antenna input power.
- SAR normalized:* SAR as measured, normalized to an input power of 1 W at the antenna connector.
- SAR for nominal TSL parameters:* The measured TSL parameters are used to calculate the nominal SAR result.

The reported uncertainty of measurement is stated as the standard uncertainty of Measurement multiplied by the coverage factor $k=2$, which for a normal distribution Corresponds to a coverage probability of approximately 95%.



Add: No.51 Xueyuan Road, Haidian District, Beijing, 100191, China
 Tel: +86-10-62304633-2079 Fax: +86-10-62304633-2504
 E-mail: cttf@chinattl.com http://www.chinattl.cn

Measurement Conditions

DASY system configuration, as far as not given on page 1.

DASY Version	DASY52	V52.10.2
Extrapolation	Advanced Extrapolation	
Phantom	Triple Flat Phantom 5.1C	
Distance Dipole Center - TSL	10 mm	with Spacer
Zoom Scan Resolution	dx, dy, dz = 5 mm	
Frequency	1750 MHz ± 1 MHz	

Head TSL parameters

The following parameters and calculations were applied.

	Temperature	Permittivity	Conductivity
Nominal Head TSL parameters	22.0 °C	40.1	1.37 mho/m
Measured Head TSL parameters	(22.0 ± 0.2) °C	39.9 ± 6 %	1.36 mho/m ± 6 %
Head TSL temperature change during test	<1.0 °C	---	---

SAR result with Head TSL

SAR averaged over 1 cm^3 (1 g) of Head TSL	Condition	
SAR measured	250 mW input power	9.05 W/kg
SAR for nominal Head TSL parameters	normalized to 1W	36.4 W/kg ± 18.8 % (k=2)
SAR averaged over 10 cm^3 (10 g) of Head TSL	Condition	
SAR measured	250 mW input power	4.80 W/kg
SAR for nominal Head TSL parameters	normalized to 1W	19.3 W/kg ± 18.7 % (k=2)

Body TSL parameters

The following parameters and calculations were applied.

	Temperature	Permittivity	Conductivity
Nominal Body TSL parameters	22.0 °C	53.4	1.49 mho/m
Measured Body TSL parameters	(22.0 ± 0.2) °C	53.1 ± 6 %	1.52 mho/m ± 6 %
Body TSL temperature change during test	<1.0 °C	---	---

SAR result with Body TSL

SAR averaged over 1 cm^3 (1 g) of Body TSL	Condition	
SAR measured	250 mW input power	9.45 W/kg
SAR for nominal Body TSL parameters	normalized to 1W	37.3 W/kg ± 18.8 % (k=2)
SAR averaged over 10 cm^3 (10 g) of Body TSL	Condition	
SAR measured	250 mW input power	5.05 W/kg
SAR for nominal Body TSL parameters	normalized to 1W	20.0 W/kg ± 18.7 % (k=2)



Add: No.51 Xueyuan Road, Haidian District, Beijing, 100191, China
Tel: +86-10-62304633-2079 Fax: +86-10-62304633-2504
E-mail: ttl@chinantl.com http://www.chinantl.cn

Appendix (Additional assessments outside the scope of CNAS L0570)

Antenna Parameters with Head TSL

Impedance, transformed to feed point	49.1Ω- 0.84 jΩ
Return Loss	- 38.1 dB

Antenna Parameters with Body TSL

Impedance, transformed to feed point	45.2Ω- 1.37 jΩ
Return Loss	- 25.5 dB

General Antenna Parameters and Design

Electrical Delay (one direction)	1.084 ns
----------------------------------	----------

After long term use with 100W radiated power, only a slight warming of the dipole near the feedpoint can be measured.

The dipole is made of standard semirigid coaxial cable. The center conductor of the feeding line is directly connected to the second arm of the dipole. The antenna is therefore short-circuited for DC-signals. On some of the dipoles, small end caps are added to the dipole arms in order to improve matching when loaded according to the position as explained in the "Measurement Conditions" paragraph. The SAR data are not affected by this change. The overall dipole length is still according to the Standard. No excessive force must be applied to the dipole arms, because they might bend or the soldered connections near the feedpoint may be damaged.

Additional EUT Data

Manufactured by	SPEAG
-----------------	-------



Add: No.51 Xaoyuan Road, Haidian District, Beijing, 100191, China
 Tel: +86-10-62304633-2079 Fax: +86-10-62304633-2504
 E-mail: cttl@chinattl.com http://www.chinattl.cn

DASY5 Validation Report for Head TSL

Date: 08.30.2019

Test Laboratory: CTTL, Beijing, China

DUT: Dipole 1750 MHz; Type: D1750V2; Serial: D1750V2 - SN: 1152

Communication System: UID 0, CW; Frequency: 1750 MHz; Duty Cycle: 1:1

Medium parameters used: $f = 1750$ MHz; $\sigma = 1.358$ S/m; $\epsilon_r = 39.91$; $\rho = 1000$ kg/m³

Phantom section: Right Section

DASY5 Configuration:

- Probe: EX3DV4 - SN3617; ConvF(8.38, 8.38, 8.38) @ 1750 MHz; Calibrated: 1/31/2019
- Sensor-Surface: 1.4mm (Mechanical Surface Detection)
- Electronics: DAE4 Sn1555; Calibrated: 8/22/2019
- Phantom: MFP_V5.1C ; Type: QD 000 P51CA; Serial: 1062
- Measurement SW: DASY52, Version 52.10 (2); SEMCAD X Version 14.6.12 (7470)

System Performance Check/Zoom Scan (7x7x7) (7x7x7)/Cube 0: Measurement grid:

$dx=5$ mm, $dy=5$ mm, $dz=5$ mm

Reference Value = 97.38 V/m; Power Drift = -0.03 dB

Peak SAR (extrapolated) = 16.8 W/kg

SAR(1 g) = 9.05 W/kg; SAR(10 g) = 4.8 W/kg

Maximum value of SAR (measured) = 13.9 W/kg

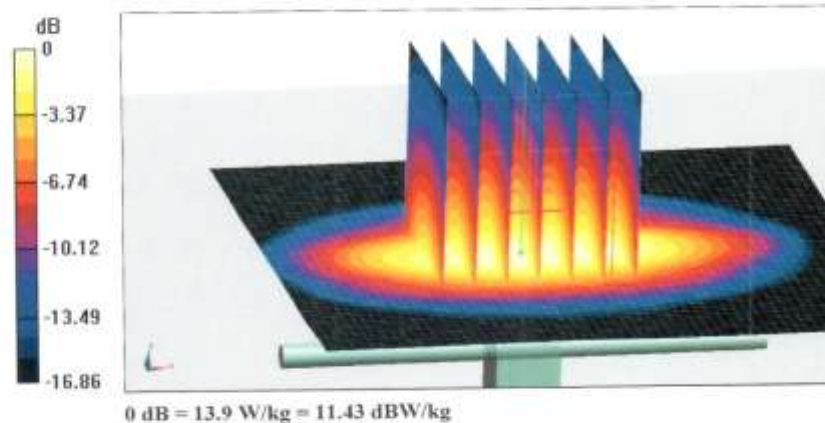



Add: No.51 Xueyuan Road, Haidian District, Beijing, 100191, China
Tel: +86-10-62304633-2079 Fax: +86-10-62304633-2504
E-mail: cntl@chinantl.com http://www.chinantl.cn

Impedance Measurement Plot for Head TSL

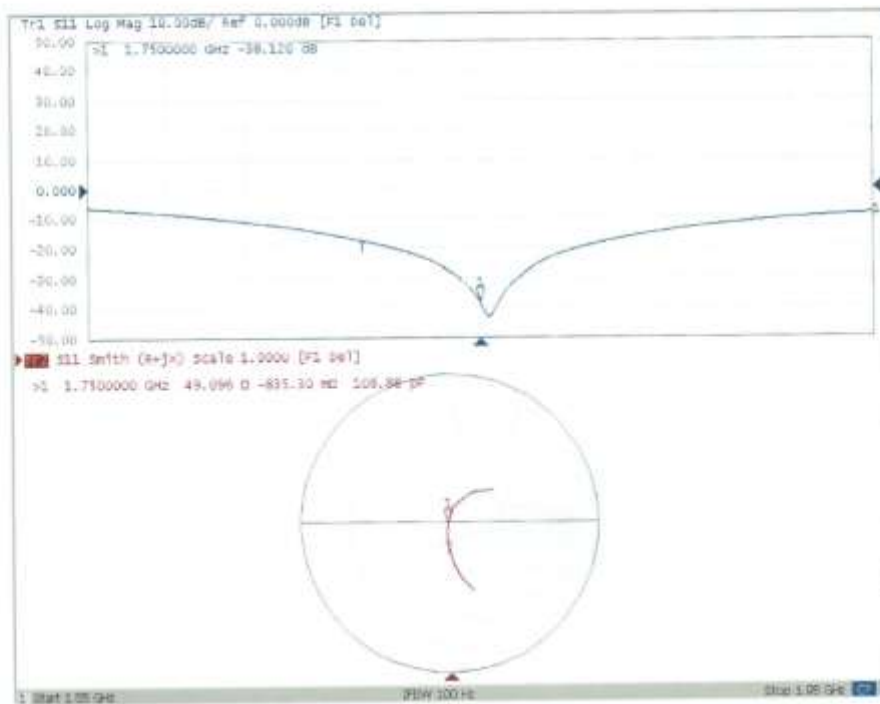



Add: No.51 Xueyuan Road, Haidian District, Beijing, 100191, China
 Tel: +86-10-62304633-2079 Fax: +86-10-62304633-2504
 E-mail: cttl@chinantl.com http://www.chinantl.cn

DASY5 Validation Report for Body TSL

Date: 08.30.2019

Test Laboratory: CTTL, Beijing, China

DUT: Dipole 1750 MHz; Type: D1750V2; Serial: D1750V2 - SN: 1152

Communication System: UID 0, CW; Frequency: 1750 MHz; Duty Cycle: 1:1

Medium parameters used: $f = 1750$ MHz; $\sigma = 1.516$ S/m; $\epsilon_r = 53.05$; $\rho = 1000$ kg/m³

Phantom section: Center Section

DASY5 Configuration:

- Probe: EX3DV4 - SN3617; ConvF(8.03, 8.03, 8.03) @ 1750 MHz; Calibrated: 1/31/2019
- Sensor-Surface: 1.4mm (Mechanical Surface Detection)
- Electronics: DAE4 Sn1555; Calibrated: 8/22/2019
- Phantom: MFP_V5.1C ; Type: QD 000 P51CA; Serial: 1062
- Measurement SW: DASY52, Version 52.10 (2); SEMCAD X Version 14.6.12 (7470)

System Performance Check/Zoom Scan (7x7x7) (7x7x7)/Cube 0: Measurement grid:

$dx=5$ mm, $dy=5$ mm, $dz=5$ mm

Reference Value = 87.16 V/m; Power Drift = 0.06 dB

Peak SAR (extrapolated) = 17.0 W/kg

SAR(1 g) = 9.45 W/kg; SAR(10 g) = 5.05 W/kg

Maximum value of SAR (measured) = 14.4 W/kg

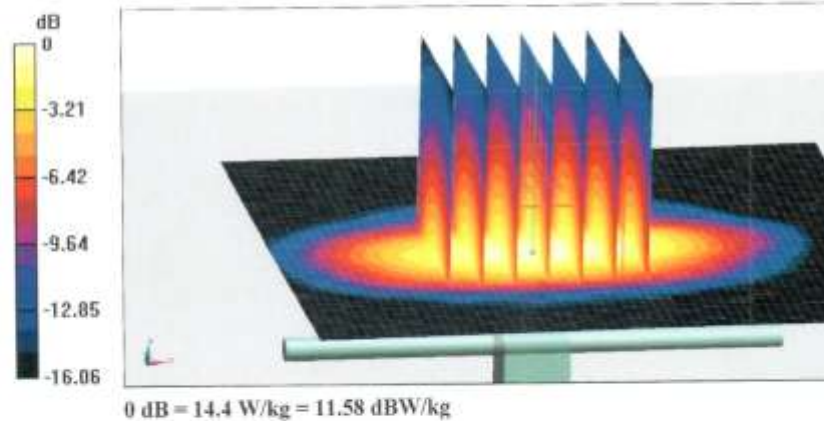

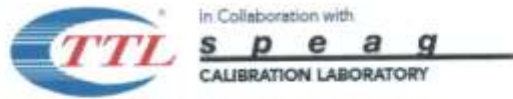

Add: No.51 Xueyuan Road, Haidian District, Beijing, 100191, China.
Tel: +86-10-62304633-2079 Fax: +86-10-62304633-2504
E-mail: cttl@chinattl.com http://www.chinattl.cn

Impedance Measurement Plot for Body TSL

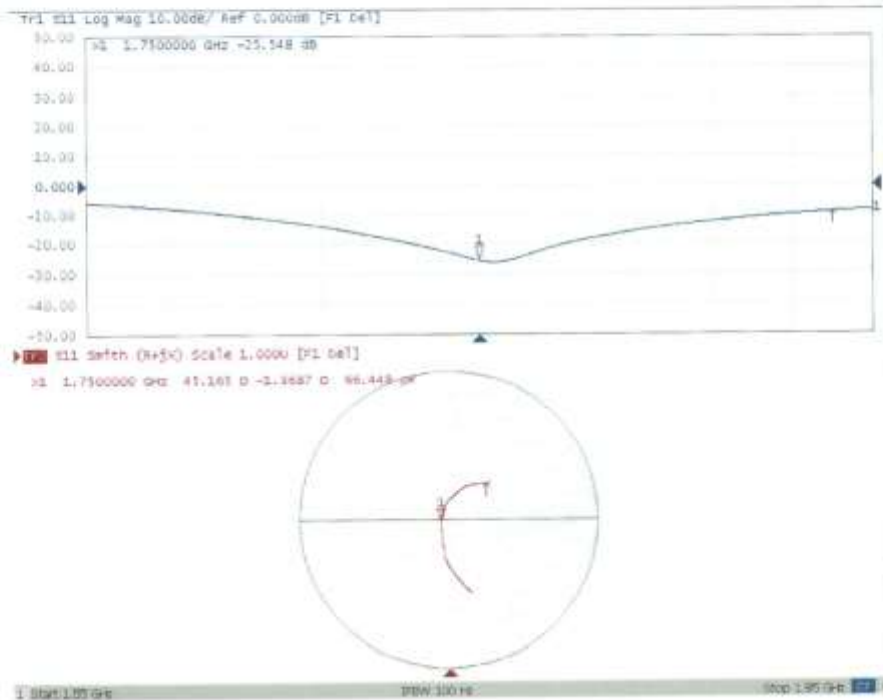



1900 MHz Dipole Calibration Certificate



In Collaboration with
s p e a g
CALIBRATION LABORATORY

Add: No.51 Xueyuan Road, Haidian District, Beijing, 100191, China
Tel: +86-10-62304633-2079 Fax: +86-10-62304633-2504
E-mail: cttl@chinattl.com http://www.chinattl.cn



中国认可
国际互认
校准
CALIBRATION
CNAS L0570

Client **CTTL(South Branch)**

Certificate No: **Z18-60387**

CALIBRATION CERTIFICATE

Object **D1900V2 - SN: 5d088**

Calibration Procedure(s) **FF-Z11-003-01**
Calibration Procedures for dipole validation kits

Calibration date: **October 24, 2018**

This calibration Certificate documents the traceability to national standards, which realize the physical units of measurements(SI). The measurements and the uncertainties with confidence probability are given on the following pages and are part of the certificate.

All calibrations have been conducted in the closed laboratory facility: environment temperature(22±3)°C and humidity<70%.

Calibration Equipment used (M&TE critical for calibration)

Primary Standards	ID #	Cal Date(Calibrated by, Certificate No.)	Scheduled Calibration
Power Meter NRVD	102083	01-Nov-17 (CTTL, No.J17X08756)	Oct-18
Power sensor NR-VZ5	100542	01-Nov-17 (CTTL, No.J17X08756)	Oct-18
Reference Probe EX3DV4 DAE4	SN 7514	27-Aug-18(SPEAG No.EX3-7514_Aug18)	Aug-19
	SN 1555	20-Aug-18(SPEAG No.DAE4-1555_Aug18)	Aug-19
Secondary Standards	ID #	Cal Date(Calibrated by, Certificate No.)	Scheduled Calibration
Signal Generator E4438C	MY49071430	23-Jan-18 (CTTL, No.J18X00560)	Jan-19
NetworkAnalyzer E5071C	MY46110673	24-Jan-18 (CTTL, No.J18X00561)	Jan-19

	Name	Function	Signature
Calibrated by:	Zhao Jing	SAR Test Engineer	
Reviewed by:	Lin Hao	SAR Test Engineer	
Approved by:	Qi Dianyuan	SAR Project Leader	

Issued: October 28, 2018

This calibration certificate shall not be reproduced except in full without written approval of the laboratory.



Add: No.51 Xueyuan Road, Haidian District, Beijing, 100191, China
Tel: +86-10-62304633-2079 Fax: +86-10-62304633-2504
E-mail: ctf@chinattl.com http://www.chinattl.cn

lossary:

TSL	tissue simulating liquid
ConvF	sensitivity in TSL / NORM _{x,y,z}
N/A	not applicable or not measured

Calibration is Performed According to the Following Standards:

- IEEE Std 1528-2013, "IEEE Recommended Practice for Determining the Peak Spatial-Averaged Specific Absorption Rate (SAR) in the Human Head from Wireless Communications Devices: Measurement Techniques", June 2013
- IEC 62209-1, "Measurement procedure for assessment of specific absorption rate of human exposure to radio frequency fields from hand-held and body-mounted wireless communication devices- Part 1: Device used next to the ear (Frequency range of 300MHz to 6GHz)", July 2016
- IEC 62209-2, "Procedure to measure the Specific Absorption Rate (SAR) For wireless communication devices used in close proximity to the human body (frequency range of 30MHz to 6GHz)", March 2010
- KDB865664, SAR Measurement Requirements for 100 MHz to 6 GHz

Additional Documentation:

- DASY4/5 System Handbook

Methods Applied and Interpretation of Parameters:

- Measurement Conditions:** Further details are available from the Validation Report at the end of the certificate. All figures stated in the certificate are valid at the frequency indicated.
- Antenna Parameters with TSL:** The dipole is mounted with the spacer to position its feed point exactly below the center marking of the flat phantom section, with the arms oriented parallel to the body axis.
- Feed Point Impedance and Return Loss:** These parameters are measured with the dipole positioned under the liquid filled phantom. The impedance stated is transformed from the measurement at the SMA connector to the feed point. The Return Loss ensures low reflected power. No uncertainty required.
- Electrical Delay:** One-way delay between the SMA connector and the antenna feed point. No uncertainty required.
- SAR measured:** SAR measured at the stated antenna input power.
- SAR normalized:** SAR as measured, normalized to an input power of 1 W at the antenna connector.
- SAR for nominal TSL parameters:** The measured TSL parameters are used to calculate the nominal SAR result.

The reported uncertainty of measurement is stated as the standard uncertainty of Measurement multiplied by the coverage factor $k=2$, which for a normal distribution corresponds to a coverage probability of approximately 95%.



Add: No.51 Xueyuan Road, Haidian District, Beijing, 100191, China
 Tel: +86-10-62304633-2079 Fax: +86-10-62304633-2504
 E-mail: ttl@chinattl.com http://www.chinattl.cn

Measurement Conditions

DASY system configuration, as far as not given on page 1.

DASY Version	DASY52	52.10.2.1495
Extrapolation	Advanced Extrapolation	
Phantom	Triple Flat Phantom 5.1C	
Distance Dipole Center - TSL	10 mm	with Spacer
Zoom Scan Resolution	dx, dy, dz = 5 mm	
Frequency	1900 MHz \pm 1 MHz	

Head TSL parameters

The following parameters and calculations were applied.

	Temperature	Permittivity	Conductivity
Nominal Head TSL parameters	22.0 °C	40.0	1.40 mho/m
Measured Head TSL parameters	(22.0 \pm 0.2) °C	41.1 \pm 6 %	1.37 mho/m \pm 6 %
Head TSL temperature change during test	<1.0 °C	---	---

SAR result with Head TSL

SAR averaged over 1 cm^3 (1 g) of Head TSL	Condition	
SAR measured	250 mW input power	9.92 mW / g
SAR for nominal Head TSL parameters	normalized to 1W	40.5 mW / g \pm 18.8 % (k=2)
SAR averaged over 10 cm^3 (10 g) of Head TSL	Condition	
SAR measured	250 mW input power	5.17 mW / g
SAR for nominal Head TSL parameters	normalized to 1W	21.0 mW / g \pm 18.7 % (k=2)

Body TSL parameters

The following parameters and calculations were applied.

	Temperature	Permittivity	Conductivity
Nominal Body TSL parameters	22.0 °C	53.3	1.52 mho/m
Measured Body TSL parameters	(22.0 \pm 0.2) °C	52.6 \pm 6 %	1.55 mho/m \pm 6 %
Body TSL temperature change during test	<1.0 °C	---	---

SAR result with Body TSL

SAR averaged over 1 cm^3 (1 g) of Body TSL	Condition	
SAR measured	250 mW input power	10.3 mW / g
SAR for nominal Body TSL parameters	normalized to 1W	40.6 mW / g \pm 18.8 % (k=2)
SAR averaged over 10 cm^3 (10 g) of Body TSL	Condition	
SAR measured	250 mW input power	5.41 mW / g
SAR for nominal Body TSL parameters	normalized to 1W	21.4 mW / g \pm 18.7 % (k=2)



Add: No.51 Xueyuan Road, Haidian District, Beijing, 100191, China
Tel: +86-10-62304633-2079 Fax: +86-10-62304633-2504
E-mail: ctdl@chinattl.com http://www.chinattl.cn

Appendix (Additional assessments outside the scope of CNAS L0570)

Antenna Parameters with Head TSL

Impedance, transformed to feed point	52.7Ω+ 8.63jΩ
Return Loss	- 23.2dB

Antenna Parameters with Body TSL

Impedance, transformed to feed point	48.5Ω+ 7.40jΩ
Return Loss	- 22.3dB

General Antenna Parameters and Design

Electrical Delay (one direction)	1.058 ns
----------------------------------	----------

After long term use with 100W radiated power, only a slight warming of the dipole near the feedpoint can be measured.

The dipole is made of standard semirigid coaxial cable. The center conductor of the feeding line is directly connected to the second arm of the dipole. The antenna is therefore short-circuited for DC-signals. On some of the dipoles, small end caps are added to the dipole arms in order to improve matching when loaded according to the position as explained in the "Measurement Conditions" paragraph. The SAR data are not affected by this change. The overall dipole length is still according to the Standard. No excessive force must be applied to the dipole arms, because they might bend or the soldered connections near the feedpoint may be damaged.

Additional EUT Data

Manufactured by	SPEAG
-----------------	-------



Add: No.51 Xueyuan Road, Haidian District, Beijing, 100191, China
 Tel: +86-10-62304633-2079 Fax: +86-10-62304633-2504
 E-mail: cttl@chinatrl.com http://www.chinatrl.cn

DASY5 Validation Report for Head TSL

Date: 10.24.2018

Test Laboratory: CTTL, Beijing, China

DUT: Dipole 1900 MHz; Type: D1900V2; Serial: D1900V2 - SN: 5d088

Communication System: UID 0, CW; Frequency: 1900 MHz; Duty Cycle: 1:1

Medium parameters used: $f = 1900$ MHz; $\sigma = 1.367$ S/m; $\epsilon_r = 41.1$; $\rho = 1000$ kg/m³

Phantom section: Center Section

DASY5 Configuration:

- Probe: EX3DV4 - SN7514; ConvF(7.73, 7.73, 7.73) @ 1900 MHz; Calibrated: 8/27/2018
- Sensor-Surface: 1.4mm (Mechanical Surface Detection)
- Electronics: DAE4 Sn1555; Calibrated: 8/20/2018
- Phantom: MFP_V5.1C ; Type: QD 000 P51CA; Serial: 1062
- Measurement SW: DASY32, Version 52.10 (2); SEMCAD X Version 14.6.12 (7450)

System Performance Check/Zoom Scan (7x7x7) (7x7x7)/Cube 0; Measurement grid:

$dx=5$ mm, $dy=5$ mm, $dz=5$ mm

Reference Value = 102.2 V/m; Power Drift = 0.05 dB

Peak SAR (extrapolated) = 19.0 W/kg

SAR(1 g) = 9.92 W/kg; SAR(10 g) = 5.17 W/kg

Maximum value of SAR (measured) = 15.7 W/kg

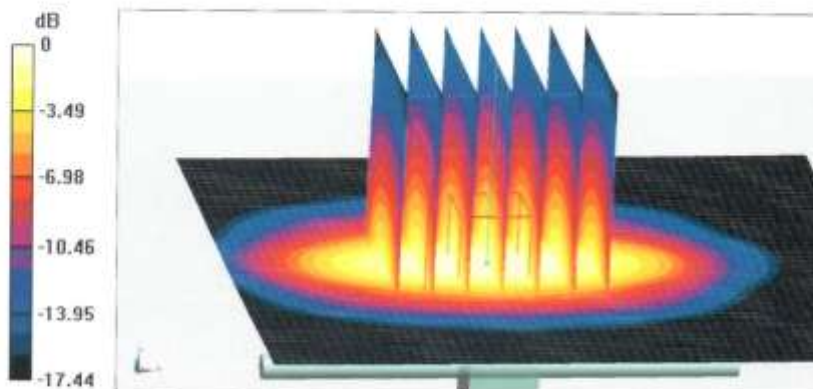

0 dB = 15.7 W/kg = 11.96 dBW/kg



Add: No.51 Xueyuan Road, Haidian District, Beijing, 100191, China
Tel: +86-10-62304633-2079 Fax: +86-10-62304633-2504
E-mail: cttl@chinattl.com http://www.chinattl.cn

Impedance Measurement Plot for Head TSL

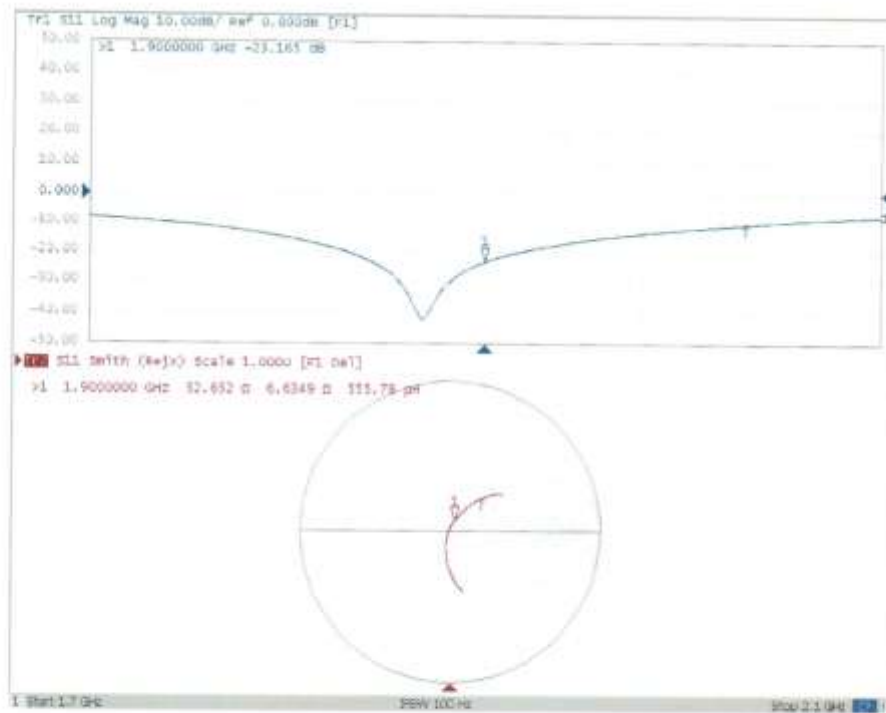



Add: No.51 Xueyuan Road, Haidian District, Beijing, 100191, China
 Tel: +86-10-62304633-2079 Fax: +86-10-62304633-2504
 E-mail: cttl@chinattl.com http://www.chinattl.cn

DASY5 Validation Report for Body TSL

Date: 10.24.2018

Test Laboratory: CTTL, Beijing, China

DUT: Dipole 1900 MHz; Type: D1900V2; Serial: D1900V2 - SN: 5d088

Communication System: UID 0, CW; Frequency: 1900 MHz; Duty Cycle: 1:1

Medium parameters used: $f = 1900$ MHz; $\sigma = 1.551$ S/m; $\epsilon_r = 52.63$; $\rho = 1000$ kg/m³

Phantom section: Right Section

DASY5 Configuration:

- Probe: EX3DV4 - SN7514; ConvF(7.53, 7.53, 7.53) @ 1900 MHz; Calibrated: 8/27/2018
- Sensor-Surface: 1.4mm (Mechanical Surface Detection)
- Electronics: DAE4 Sn1555; Calibrated: 8/20/2018
- Phantom: MFP_V5.1C ; Type: QD 000 P51CA; Serial: 1062
- Measurement SW: DASY52, Version 52.10 (2); SEMCAD X Version 14.6.12 (7450)

System Performance Check/Zoom Scan (7x7x7) (7x7x7)/Cube 0: Measurement grid:

$dx=5$ mm, $dy=5$ mm, $dz=5$ mm

Reference Value = 97.60 V/m; Power Drift = -0.02 dB

Peak SAR (extrapolated) = 19.0 W/kg

SAR(1 g) = 10.3 W/kg; SAR(10 g) = 5.41 W/kg

Maximum value of SAR (measured) = 15.9 W/kg

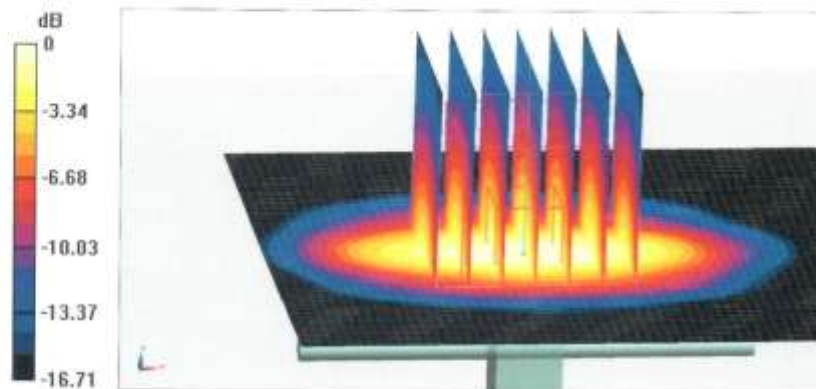

0 dB = 15.9 W/kg = 12.01 dBW/kg



Add: No.51 Xueyuan Road, Haidian District, Beijing, 100191, China
Tel: +86-10-62304633-2079 Fax: +86-10-62304633-2504
E-mail: ttl@chinattl.com http://www.chinattl.cn

Impedance Measurement Plot for Body TSL

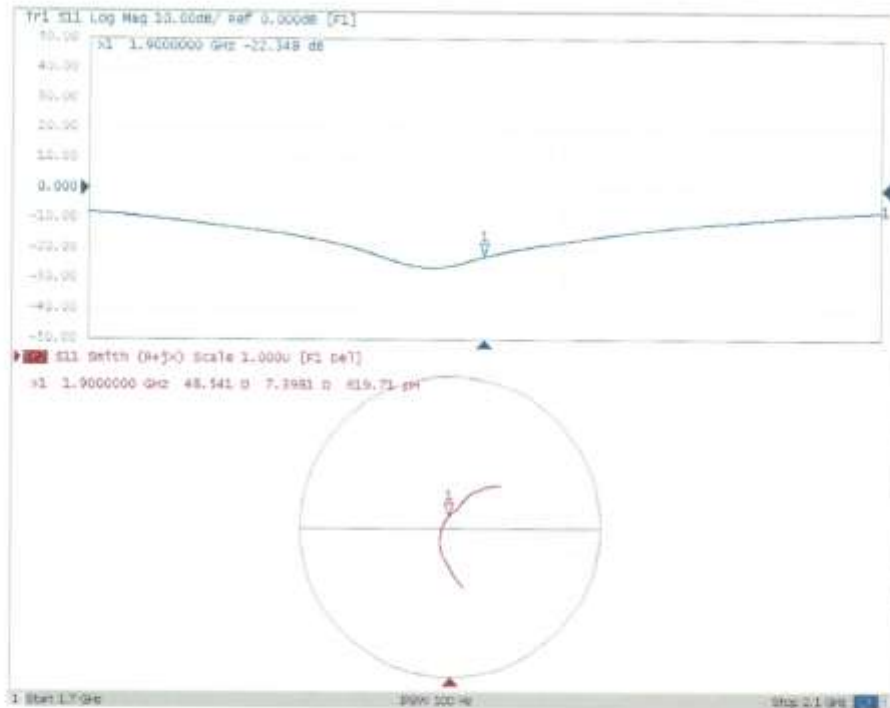



2450 MHz Dipole Calibration Certificate



In Collaboration with
s p e a g
CALIBRATION LABORATORY



中国认可
国际互认
校准
CALIBRATION
CNAS L0570

Add: No.51 Xuyuan Road, Haidian District, Beijing, 100191, China
Tel: +86-10-62304633-2079 Fax: +86-10-62304633-2504
E-mail: cttl@chinattl.com http://www.chinattl.cn

Client **CTTL(South Branch)**

Certificate No: **Z18-60388**

CALIBRATION CERTIFICATE			
Object	D2450V2 - SN: 873		
Calibration Procedure(s)	FF-Z11-003-01 Calibration Procedures for dipole validation kits		
Calibration date:	October 26, 2018		
This calibration Certificate documents the traceability to national standards, which realize the physical units of measurements(SI). The measurements and the uncertainties with confidence probability are given on the following pages and are part of the certificate.			
All calibrations have been conducted in the closed laboratory facility: environment temperature(22±3)°C and humidity<70%.			
Calibration Equipment used (M&TE critical for calibration)			
Primary Standards	ID #	Cal Date(Calibrated by, Certificate No.)	Scheduled Calibration
Power Meter NRVD	102083	01-Nov-17 (CTTL, No.J17X08756)	Oct-18
Power sensor NRV-Z5	100542	01-Nov-17 (CTTL, No.J17X08756)	Oct-18
Reference Probe EX3DV4	SN 7514	27-Aug-18(SPEAG,No.EX3-7514_Aug18)	Aug-19
DAE4	SN 1555	20-Aug-18(SPEAG,No.DAE4-1555_Aug18)	Aug-19
Secondary Standards	ID #	Cal Date(Calibrated by, Certificate No.)	Scheduled Calibration
Signal Generator E4438C	MY49071430	23-Jan-18 (CTTL, No.J18X00560)	Jan-19
NetworkAnalyzer E5071C	MY46110673	24-Jan-18 (CTTL, No.J18X00561)	Jan-19
Calibrated by:	Name Zhao Jing	Function SAR Test Engineer	Signature
Reviewed by:	Name Lin Hao	Function SAR Test Engineer	Signature
Approved by:	Name Qi Dianyuan	Function SAR Project Leader	Signature
Issued: October 29, 2018			
This calibration certificate shall not be reproduced except in full without written approval of the laboratory.			



In Collaboration with
s p e a g
CALIBRATION LABORATORY

Add: No.51 Xueyuan Road, Haidian District, Beijing, 100191, China
Tel: +86-10-62304633-2079 Fax: +86-10-62304633-2504
E-mail: cttl@chinattl.com http://www.chinattl.cn

Glossary:

TSL	tissue simulating liquid
ConvF	sensitivity in TSL / NORM _{x,y,z}
N/A	not applicable or not measured

Calibration is Performed According to the Following Standards:

- IEEE Std 1528-2013, "IEEE Recommended Practice for Determining the Peak Spatial-Averaged Specific Absorption Rate (SAR) in the Human Head from Wireless Communications Devices: Measurement Techniques", June 2013
- IEC 62209-1, "Measurement procedure for assessment of specific absorption rate of human exposure to radio frequency fields from hand-held and body-mounted wireless communication devices- Part 1: Device used next to the ear (Frequency range of 300MHz to 6GHz)", July 2016
- IEC 62209-2, "Procedure to measure the Specific Absorption Rate (SAR) For wireless communication devices used in close proximity to the human body (frequency range of 30MHz to 6GHz)", March 2010
- KDB865664, SAR Measurement Requirements for 100 MHz to 6 GHz

Additional Documentation:

- DASY4/5 System Handbook

Methods Applied and Interpretation of Parameters:

- Measurement Conditions:* Further details are available from the Validation Report at the end of the certificate. All figures stated in the certificate are valid at the frequency indicated.
- Antenna Parameters with TSL:* The dipole is mounted with the spacer to position its feed point exactly below the center marking of the flat phantom section, with the arms oriented parallel to the body axis.
- Feed Point Impedance and Return Loss:* These parameters are measured with the dipole positioned under the liquid filled phantom. The impedance stated is transformed from the measurement at the SMA connector to the feed point. The Return Loss ensures low reflected power. No uncertainty required.
- Electrical Delay:* One-way delay between the SMA connector and the antenna feed point. No uncertainty required.
- SAR measured:* SAR measured at the stated antenna input power.
- SAR normalized:* SAR as measured, normalized to an input power of 1 W at the antenna connector.
- SAR for nominal TSL parameters:* The measured TSL parameters are used to calculate the nominal SAR result.

The reported uncertainty of measurement is stated as the standard uncertainty of Measurement multiplied by the coverage factor $k=2$, which for a normal distribution Corresponds to a coverage probability of approximately 95%.



In Collaboration with
s p e a g
 CALIBRATION LABORATORY

Add: No.51 Xueyuan Road, Haidian District, Beijing, 100191, China
 Tel: +86-10-62304633-2079 Fax: +86-10-62304633-2504
 E-mail: ttl@chinattl.com http://www.chinattl.cn

Measurement Conditions

DASY system configuration, as far as not given on page 1.

DASY Version	DASY52	52.10.2.1495
Extrapolation	Advanced Extrapolation	
Phantom	Triple Flat Phantom 5.1C	
Distance Dipole Center - TSL	10 mm	with Spacer
Zoom Scan Resolution	dx, dy, dz = 5 mm	
Frequency	2450 MHz \pm 1 MHz	

Head TSL parameters

The following parameters and calculations were applied.

	Temperature	Permittivity	Conductivity
Nominal Head TSL parameters	22.0 °C	38.2	1.80 mho/m
Measured Head TSL parameters	(22.0 \pm 0.2) °C	39.2 \pm 6 %	1.80 mho/m \pm 6 %
Head TSL temperature change during test	<1.0 °C	---	---

SAR result with Head TSL

SAR averaged over 1 cm^3 (1 g) of Head TSL	Condition	
SAR measured	250 mW input power	13.0 mW / g
SAR for nominal Head TSL parameters	normalized to 1W	52.0 mW / g \pm 18.8 % (k=2)
SAR averaged over 10 cm^3 (10 g) of Head TSL	Condition	
SAR measured	250 mW input power	6.02 mW / g
SAR for nominal Head TSL parameters	normalized to 1W	24.1 mW / g \pm 18.7 % (k=2)

Body TSL parameters

The following parameters and calculations were applied.

	Temperature	Permittivity	Conductivity
Nominal Body TSL parameters	22.0 °C	52.7	1.95 mho/m
Measured Body TSL parameters	(22.0 \pm 0.2) °C	52.8 \pm 6 %	2.01 mho/m \pm 6 %
Body TSL temperature change during test	<1.0 °C	---	---

SAR result with Body TSL

SAR averaged over 1 cm^3 (1 g) of Body TSL	Condition	
SAR measured	250 mW input power	12.8 mW / g
SAR for nominal Body TSL parameters	normalized to 1W	50.5 mW / g \pm 18.8 % (k=2)
SAR averaged over 10 cm^3 (10 g) of Body TSL	Condition	
SAR measured	250 mW input power	5.91 mW / g
SAR for nominal Body TSL parameters	normalized to 1W	23.5 mW / g \pm 18.7 % (k=2)



In Collaboration with
s p e a g
CALIBRATION LABORATORY

Add: No.51 Xueyuan Road, Haidian District, Beijing, 100191, China
Tel: +86-10-62304633-2079 Fax: +86-10-62304633-2504
E-mail: cttl@chinattl.com http://www.chinattl.cn

Appendix (Additional assessments outside the scope of CNAS L0570)

Antenna Parameters with Head TSL

Impedance, transformed to feed point	53.5Ω+ 2.11 jΩ
Return Loss	- 28.0dB

Antenna Parameters with Body TSL

Impedance, transformed to feed point	51.3Ω+ 4.51 jΩ
Return Loss	- 26.7dB

General Antenna Parameters and Design

Electrical Delay (one direction)	1.024 ns
----------------------------------	----------

After long term use with 100W radiated power, only a slight warming of the dipole near the feedpoint can be measured.

The dipole is made of standard semirigid coaxial cable. The center conductor of the feeding line is directly connected to the second arm of the dipole. The antenna is therefore short-circuited for DC-signals. On some of the dipoles, small end caps are added to the dipole arms in order to improve matching when loaded according to the position as explained in the "Measurement Conditions" paragraph. The SAR data are not affected by this change. The overall dipole length is still according to the Standard. No excessive force must be applied to the dipole arms, because they might bend or the soldered connections near the feedpoint may be damaged.

Additional EUT Data

Manufactured by	SPEAG
-----------------	-------



In Collaboration with
s p e a q
 CALIBRATION LABORATORY

Add: No.51 Xueyuan Road, Haidian District, Beijing, 100191, China
 Tel: +86-10-62304633-2079 Fax: +86-10-62304633-2504
 E-mail: cttf@chinattl.com http://www.chinattl.cn

DASY5 Validation Report for Head TSL

Date: 10.26.2018

Test Laboratory: CTTL, Beijing, China

DUT: Dipole 2450 MHz; Type: D2450V2; Serial: D2450V2 - SN: 873

Communication System: UID 0, CW; Frequency: 2450 MHz; Duty Cycle: 1:1

Medium parameters used: $f = 2450$ MHz; $\sigma = 1.802$ S/m; $\epsilon_r = 39.2$; $\rho = 1000$ kg/m³

Phantom section: Right Section

DASY5 Configuration:

- Probe: EX3DV4 - SN7514; ConvF(6.95, 6.95, 6.95) @ 2450 MHz; Calibrated: 8/27/2018
- Sensor-Surface: 1.4mm (Mechanical Surface Detection)
- Electronics: DAE4 Sn1555; Calibrated: 8/20/2018
- Phantom: MFP_V5.1C ; Type: QD 000 P51CA; Serial: 1062
- Measurement SW: DASY52, Version 52.10 (2); SEMCAD X Version 14.6.12 (7450)

Dipole Calibration/Zoom Scan (7x7x7) (7x7x7)/Cube 0: Measurement grid: dx=5mm, dy=5mm, dz=5mm

Reference Value = 105.0 V/m; Power Drift = 0.09 dB

Peak SAR (extrapolated) = 26.8 W/kg

SAR(1 g) = 13 W/kg; SAR(10 g) = 6.02 W/kg

Maximum value of SAR (measured) = 21.8 W/kg

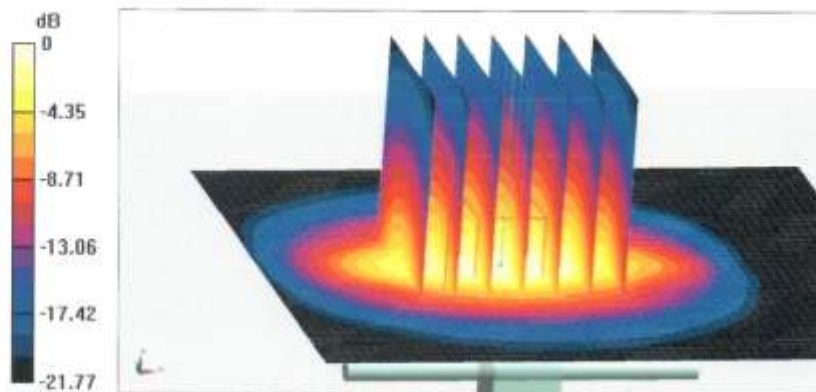

0 dB = 21.8 W/kg = 13.38 dBW/kg



In Collaboration with
s p e a g
CALIBRATION LABORATORY

Add: No.51 Xueyuan Road, Haidian District, Beijing, 100191, China
Tel: +86-10-62304633-2079 Fax: +86-10-62304633-3504
E-mail: cttl@chinattl.com http://www.chinattl.cn

Impedance Measurement Plot for Head TSL

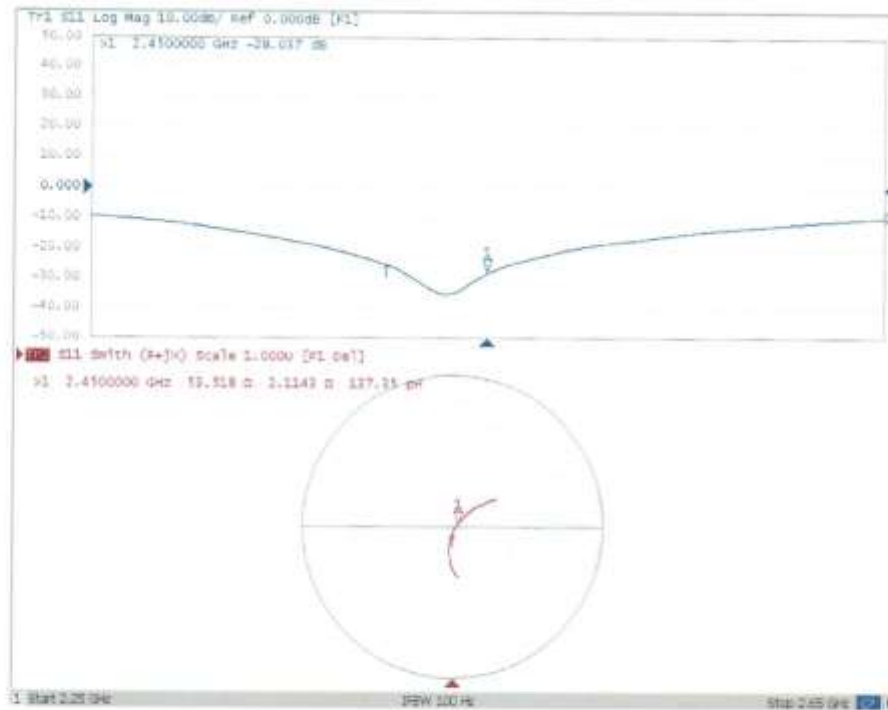



In Collaboration with
s p e a g
CALIBRATION LABORATORY

Add: No.51 Xueyuan Road, Haidian District, Beijing, 100191, China
Tel: +86-10-62304633-2079 Fax: +86-10-62304633-2504
E-mail: cttl@chinattl.com http://www.chinattl.cn

DASY5 Validation Report for Body TSL

Date: 10.26.2018

Test Laboratory: CTTL, Beijing, China

DUT: Dipole 2450 MHz; Type: D2450V2; Serial: D2450V2 - SN: 873

Communication System: UID 0, CW; Frequency: 2450 MHz; Duty Cycle: 1:1

Medium parameters used: $f = 2450$ MHz; $\sigma = 2.008$ S/m; $\epsilon_r = 52.76$; $\rho = 1000$ kg/m³

Phantom section: Center Section

DASY5 Configuration:

- Probe: EX3DV4 - SN7514; ConvF(7.13, 7.13, 7.13) @ 2450 MHz; Calibrated: 8/27/2018
- Sensor-Surface: 1.4mm (Mechanical Surface Detection)
- Electronics: DAE4 Sn1555; Calibrated: 8/20/2018
- Phantom: MFP_V5.1C ; Type: QD 000 P51CA; Serial: 1062
- Measurement SW: DASY52, Version 52.10 (2); SEMCAD X Version 14.6.12 (7450)

Dipole Calibration/Zoom Scan (7x7x7) (7x7x7)/Cube 0: Measurement grid: dx=5mm, dy=5mm, dz=5mm

Reference Value = 98.89 V/m; Power Drift = -0.03 dB

Peak SAR (extrapolated) = 26.4 W/kg

SAR(1 g) = 12.8 W/kg; SAR(10 g) = 5.91 W/kg

Maximum value of SAR (measured) = 21.3 W/kg

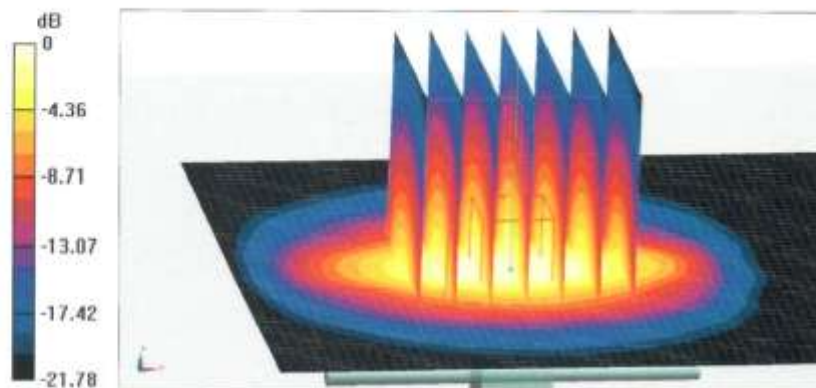

0 dB = 21.3 W/kg = 13.28 dBW/kg



In Collaboration with
s p e a g
CALIBRATION LABORATORY

Add: No.51 Xueyuan Road, Haidian District, Beijing, 100191, China
Tel: +86-10-62504633-2079 Fax: +86-10-62504633-2504
E-mail: cttf@chinattl.com http://www.chinattl.cn

Impedance Measurement Plot for Body TSL

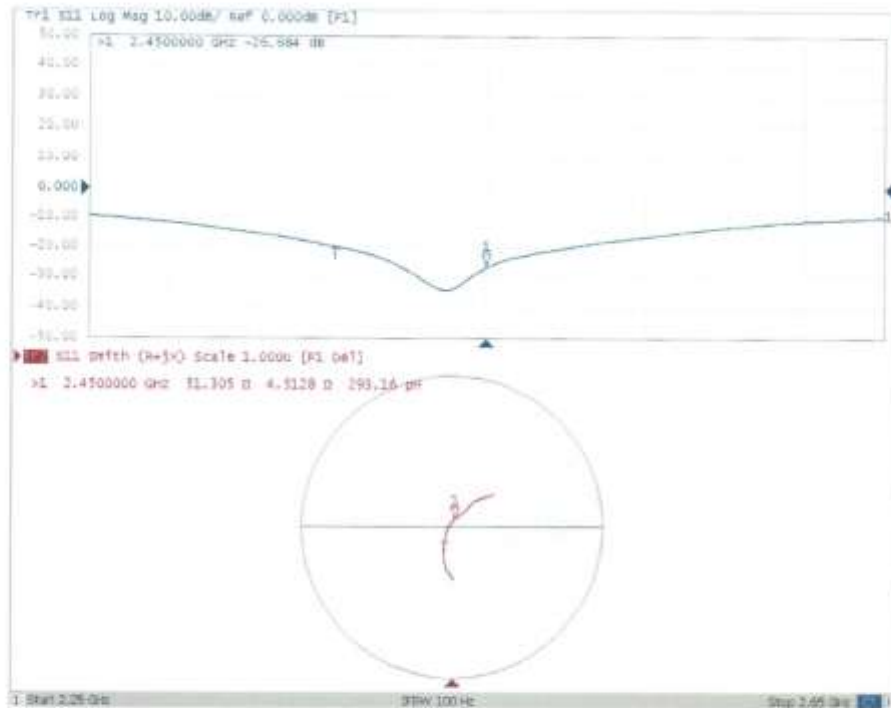

2550 MHz Dipole Calibration Certificate

Calibration Laboratory of
Schmid & Partner
Engineering AG
 Zeughausstrasse 43, 8004 Zurich, Switzerland



S Schweizerischer Kalibrierdienst
C Service suisse d'étalonnage
S Servizio svizzero di taratura
S Swiss Calibration Service

Accredited by the Swiss Accreditation Service (SAS)
 The Swiss Accreditation Service is one of the signatories to the EA
 Multilateral Agreement for the recognition of calibration certificates

Accreditation No.: SCS 0108

 Client **CTTL (Auden)**

 Certificate No: **D2550V2-1010_Aug18**

CALIBRATION CERTIFICATE			
Object	D2550V2 - SN:1010		
Calibration procedure(s)	QA CAL-05.v10 Calibration procedure for dipole validation kits above 700 MHz		
Calibration date:	August 24, 2018		
This calibration certificate documents the traceability to national standards, which realize the physical units of measurements (SI). The measurements and the uncertainties with confidence probability are given on the following pages and are part of the certificate.			
All calibrations have been conducted in the closed laboratory facility: environment temperature (22 ± 3)°C and humidity < 70%.			
Calibration Equipment used (M&TE critical for calibration)			
Primary Standards	ID #	Cal Date (Certificate No.)	Scheduled Calibration
Power meter NRP	SN: 104778	04-Apr-18 (No. 217-02672/02673)	Apr-19
Power sensor NRP-Z91	SN: 103244	04-Apr-18 (No. 217-02672)	Apr-19
Power sensor NRP-Z91	SN: 103245	04-Apr-18 (No. 217-02673)	Apr-19
Reference 20 dB Attenuator	SN: 5058 (20k)	04-Apr-18 (No. 217-02682)	Apr-19
Type-N mismatch combination	SN: 5047,2 / 08327	04-Apr-18 (No. 217-02683)	Apr-19
Reference Probe EX3DV4	SN: 7349	30-Dec-17 (No. EX3-7349_Dec17)	Dec-18
DAE4	SN: 601	26-Oct-17 (No. DAE4-601_Oct17)	Oct-18
Secondary Standards	ID #	Check Date (in house)	Scheduled Check
Power meter EPM-442A	SN: GB37480704	07-Oct-15 (in house check Oct-16)	In house check: Oct-18
Power sensor HP 8481A	SN: US37292783	07-Oct-15 (in house check Oct-16)	In house check: Oct-18
Power sensor HP 8481A	SN: MY41092317	07-Oct-15 (in house check Oct-16)	In house check: Oct-18
RF generator R&S SMT-06	SN: 100972	15-Jun-15 (in house check Oct-16)	In house check: Oct-18
Network Analyzer Agilent E8358A	SN: US41080477	31-Mar-14 (in house check Oct-17)	In house check: Oct-18
Calibrated by:	Name Manu Seitz	Function Laboratory Technician	Signature
Approved by:	Name Katja Pokovic	Function Technical Manager	Signature
			Issued: August 24, 2018
This calibration certificate shall not be reproduced except in full without written approval of the laboratory.			

Calibration Laboratory of
Schmid & Partner
Engineering AG
Zeughausstrasse 43, 8004 Zurich, Switzerland



S Schweizerischer Kalibrierdienst
C Service suisse d'étalonnage
C Servizio svizzero di taratura
S Swiss Calibration Service

Accredited by the Swiss Accreditation Service (SAS).
The Swiss Accreditation Service is one of the signatories to the EA
Multilateral Agreement for the recognition of calibration certificates.

Accreditation No.: SCS 0108

Glossary:

TSL tissue simulating liquid
ConvF sensitivity in TSL / NORM x,y,z
N/A not applicable or not measured

Calibration is Performed According to the Following Standards:

- IEEE Std 1528-2013, "IEEE Recommended Practice for Determining the Peak Spatial-Averaged Specific Absorption Rate (SAR) in the Human Head from Wireless Communications Devices: Measurement Techniques", June 2013
- IEC 62209-1, "Measurement procedure for the assessment of Specific Absorption Rate (SAR) from hand-held and body-mounted devices used next to the ear (frequency range of 300 MHz to 6 GHz)", July 2016
- IEC 62209-2, "Procedure to determine the Specific Absorption Rate (SAR) for wireless communication devices used in close proximity to the human body (frequency range of 30 MHz to 6 GHz)", March 2010
- KDB 865664, "SAR Measurement Requirements for 100 MHz to 6 GHz"

Additional Documentation:

- DASY4/5 System Handbook

Methods Applied and Interpretation of Parameters:

- Measurement Conditions:* Further details are available from the Validation Report at the end of the certificate. All figures stated in the certificate are valid at the frequency indicated.
- Antenna Parameters with TSL:* The dipole is mounted with the spacer to position its feed point exactly below the center marking of the flat phantom section, with the arms oriented parallel to the body axis.
- Feed Point Impedance and Return Loss:* These parameters are measured with the dipole positioned under the liquid filled phantom. The impedance stated is transformed from the measurement at the SMA connector to the feed point. The Return Loss ensures low reflected power. No uncertainty required.
- Electrical Delay:* One-way delay between the SMA connector and the antenna feed point. No uncertainty required.
- SAR measured:* SAR measured at the stated antenna input power.
- SAR normalized:* SAR as measured, normalized to an input power of 1 W at the antenna connector.
- SAR for nominal TSL parameters:* The measured TSL parameters are used to calculate the nominal SAR result.

The reported uncertainty of measurement is stated as the standard uncertainty of measurement multiplied by the coverage factor $k=2$, which for a normal distribution corresponds to a coverage probability of approximately 95%.

Measurement Conditions

DASY system configuration, as far as not given on page 1,

DASY Version	DASY5	V52.10.1
Extrapolation	Advanced Extrapolation	
Phantom	Modular Flat Phantom	
Distance Dipole Center - TSL	10 mm	with Spacer
Zoom Scan Resolution	dx, dy, dz = 5 mm	
Frequency	2550 MHz \pm 1 MHz	

Head TSL parameters

The following parameters and calculations were applied.

	Temperature	Permittivity	Conductivity
Nominal Head TSL parameters	22.0 °C	39.1	1.91 mho/m
Measured Head TSL parameters	(22.0 \pm 0.2) °C	37.3 \pm 6 %	1.97 mho/m \pm 6 %
Head TSL temperature change during test	< 0.5 °C	----	----

SAR result with Head TSL

SAR averaged over 1 cm ³ (1 g) of Head TSL	Condition	
SAR measured	250 mW input power	14.8 W/kg
SAR for nominal Head TSL parameters	normalized to 1W	57.8 W/kg \pm 17.0 % (k=2)

SAR averaged over 10 cm ³ (10 g) of Head TSL	condition	
SAR measured	250 mW input power	6.73 W/kg
SAR for nominal Head TSL parameters	normalized to 1W	26.5 W/kg \pm 16.5 % (k=2)

Body TSL parameters

The following parameters and calculations were applied.

	Temperature	Permittivity	Conductivity
Nominal Body TSL parameters	22.0 °C	52.6	2.09 mho/m
Measured Body TSL parameters	(22.0 \pm 0.2) °C	51.5 \pm 6 %	2.14 mho/m \pm 6 %
Body TSL temperature change during test	< 0.5 °C	----	----

SAR result with Body TSL

SAR averaged over 1 cm ³ (1 g) of Body TSL	Condition	
SAR measured	250 mW input power	13.7 W/kg
SAR for nominal Body TSL parameters	normalized to 1W	54.0 W/kg \pm 17.0 % (k=2)

SAR averaged over 10 cm ³ (10 g) of Body TSL	condition	
SAR measured	250 mW input power	6.22 W/kg
SAR for nominal Body TSL parameters	normalized to 1W	24.7 W/kg \pm 16.5 % (k=2)

Appendix (Additional assessments outside the scope of SCS 0108)
Antenna Parameters with Head TSL

Impedance, transformed to feed point	54.9 Ω - 2.3 j Ω
Return Loss	- 25.7 dB

Antenna Parameters with Body TSL

Impedance, transformed to feed point	49.6 Ω - 2.0 j Ω
Return Loss	- 33.8 dB

General Antenna Parameters and Design

Electrical Delay (one direction)	1.151 ns
----------------------------------	----------

After long term use with 100W radiated power, only a slight warming of the dipole near the feedpoint can be measured.

The dipole is made of standard semirigid coaxial cable. The center conductor of the feeding line is directly connected to the second arm of the dipole. The antenna is therefore short-circuited for DC-signals. On some of the dipoles, small end caps are added to the dipole arms in order to improve matching when loaded according to the position as explained in the "Measurement Conditions" paragraph. The SAR data are not affected by this change. The overall dipole length is still according to the Standard.

No excessive force must be applied to the dipole arms, because they might bend or the soldered connections near the feedpoint may be damaged.

Additional EUT Data

Manufactured by	SPEAG
Manufactured on	August 03, 2012

DASY5 Validation Report for Head TSL

Date: 24.08.2018

Test Laboratory: SPEAG, Zurich, Switzerland

DUT: Dipole 2550 MHz; Type: D2550V2; Serial: D2550V2 - SN:1010

Communication System: UID 0 - CW; Frequency: 2550 MHz

Medium parameters used: $f = 2550$ MHz; $\sigma = 1.97$ S/m; $\epsilon_r = 37.3$; $\rho = 1000$ kg/m³

Phantom section: Flat Section

Measurement Standard: DASY5 (IEEE/IEC/ANSI C63.19-2011)

DASY52 Configuration:

- Probe: EX3DV4 - SN7349; ConvF(7.43, 7.43, 7.43) @ 2550 MHz; Calibrated: 30.12.2017
- Sensor-Surface: 1.4mm (Mechanical Surface Detection)
- Electronics: DAE4 Sn601; Calibrated: 26.10.2017
- Phantom: Flat Phantom 5.0 (front); Type: QD 000 P50 AA; Serial: 1001
- DASY52 52.10.1(1476); SEMCAD X 14.6.11(7439)

Dipole Calibration for Head Tissue/Pin=250 mW, d=10mm/Zoom Scan (7x7x7)/Cube 0:

Measurement grid: dx=5mm, dy=5mm, dz=5mm

Reference Value = 119.6 V/m; Power Drift = -0.07 dB

Peak SAR (extrapolated) = 30.5 W/kg

SAR(1 g) = 14.8 W/kg; SAR(10 g) = 6.73 W/kg

Maximum value of SAR (measured) = 24.9 W/kg

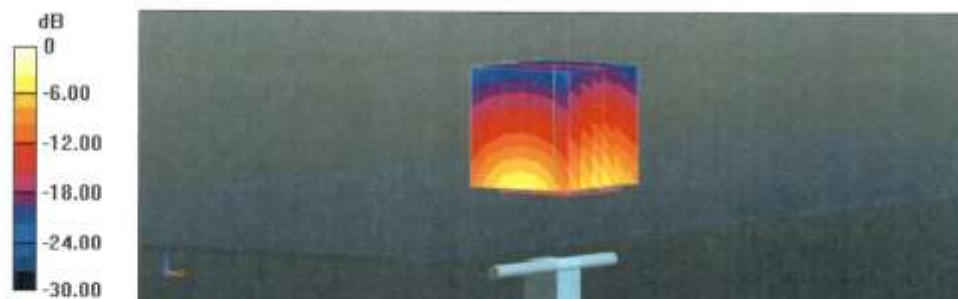

0 dB = 24.9 W/kg = 13.96 dBW/kg

Impedance Measurement Plot for Head TSL

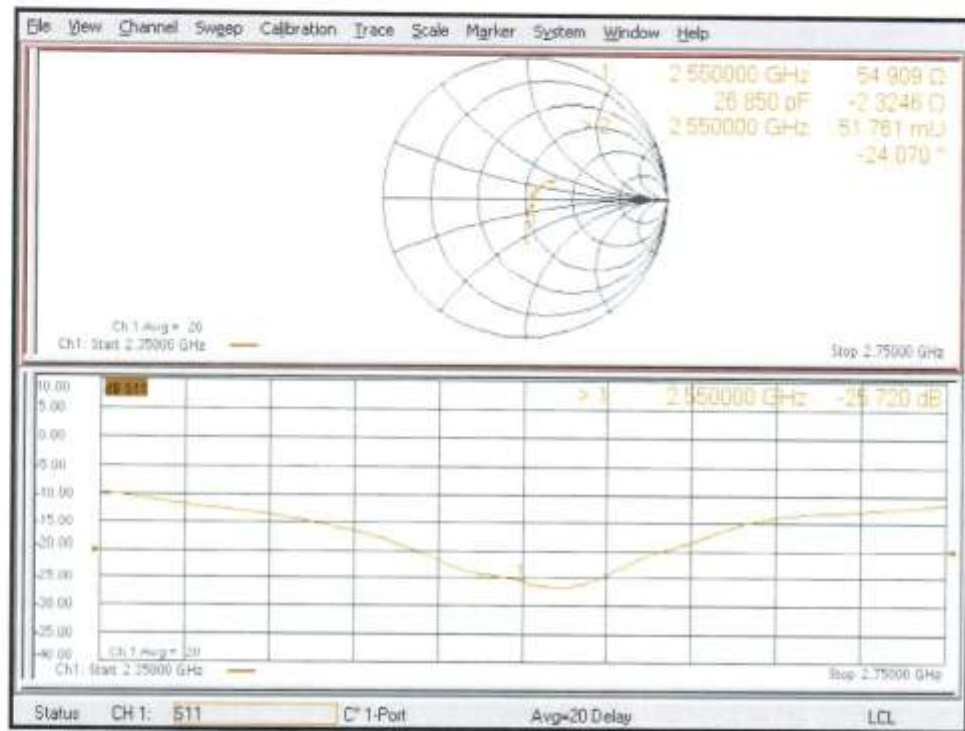

DASY5 Validation Report for Body TSL

Date: 24.08.2018

Test Laboratory: SPEAG, Zurich, Switzerland

DUT: Dipole 2550 MHz; Type: D2550V2; Serial: D2550V2 - SN:1010

Communication System: UID 0 - CW; Frequency: 2550 MHz

Medium parameters used: $f = 2550$ MHz; $\sigma = 2.14$ S/m; $\epsilon_r = 51.5$; $\rho = 1000$ kg/m³

Phantom section: Flat Section

Measurement Standard: DASY5 (IEEE/IEC/ANSI C63.19-2011)

DASY52 Configuration:

- Probe: EX3DV4 - SN7349; ConvF(7.68, 7.68, 7.68) @ 2550 MHz; Calibrated: 30.12.2017
- Sensor-Surface: 1.4mm (Mechanical Surface Detection)
- Electronics: DAE4 Sn601; Calibrated: 26.10.2017
- Phantom: Flat Phantom 5.0 (back); Type: QD 000 P50 AA; Serial: 1002
- DASY52 52.10.1(1476); SEMCAD X 14.6.11(7439)

Dipole Calibration for Body Tissue/Pin=250 mW, d=10mm/Zoom Scan (7x7x7)/Cube 0:

Measurement grid: dx=5mm, dy=5mm, dz=5mm

Reference Value = 109.2 V/m; Power Drift = -0.03 dB

Peak SAR (extrapolated) = 27.9 W/kg

SAR(1 g) = 13.7 W/kg; SAR(10 g) = 6.22 W/kg

Maximum value of SAR (measured) = 22.9 W/kg

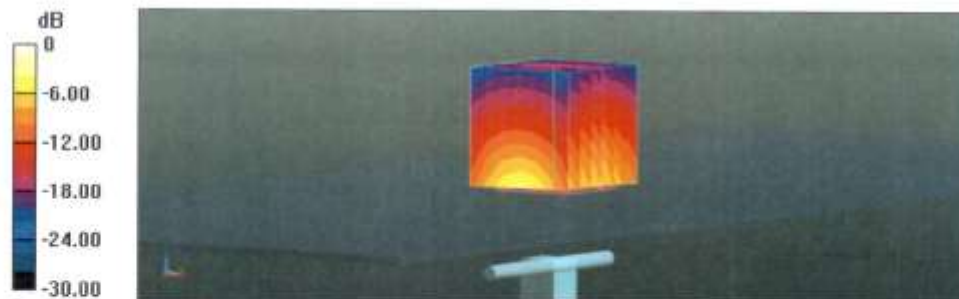

0 dB = 22.9 W/kg = 13.60 dBW/kg

Impedance Measurement Plot for Body TSL

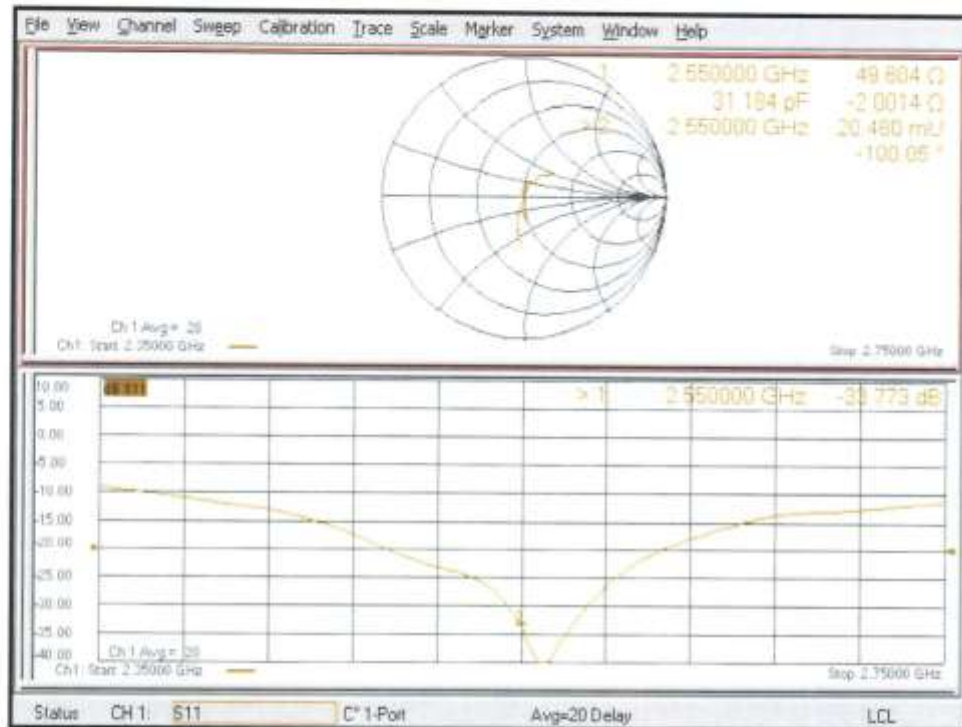

ANNEX J: Extended Calibration SAR Dipole

Referring to KDB865664 D01, if dipoles are verified in return loss (<-20dBm, within 20% of prior calibration), and in impedance (within 5 ohm of prior calibration), the annual calibration is not necessary and the calibration interval can be extended.

Justification of Extended Calibration SAR Dipole D750V3– serial no.1163

Head						
Date of Measurement	Return-Loss (dB)	Delta (%)	Real Impedance (ohm)	Delta (ohm)	Imaginary Impedance (johm)	Delta (johm)
2019-09-03	-26.9	/	50.5	/	-4.53	/
2020-09-01	-25.8	4.1	51.2	0.7	-4.29	0.24

Justification of Extended Calibration SAR Dipole D835V2– serial no.4d057

Head						
Date of Measurement	Return-Loss (dB)	Delta (%)	Real Impedance (ohm)	Delta (ohm)	Imaginary Impedance (johm)	Delta (johm)
2018-10-09	-27.7	/	49.6	/	-4.08	/
2019-10-06	-26.9	2.9	50.1	0.5	-3.95	0.13

Justification of Extended Calibration SAR Dipole D1750V2– serial no. 1152

Head						
Date of Measurement	Return-Loss (dB)	Delta (%)	Real Impedance (ohm)	Delta (ohm)	Imaginary Impedance (johm)	Delta (johm)
2019-08-30	-38.1	/	49.1	/	-0.84	/
2020-08-28	-36.5	4.2	50.2	1.1	-0.49	0.35

Justification of Extended Calibration SAR Dipole D1900V2– serial no. 5d088

Head						
Date of Measurement	Return-Loss (dB)	Delta (%)	Real Impedance (ohm)	Delta (ohm)	Imaginary Impedance (johm)	Delta (johm)
2018-10-24	-23.2	/	52.7	/	6.63	/
2019-10-22	-22.9	1.3	53.5	0.8	6.86	0.23

Justification of Extended Calibration SAR Dipole D2450V2– serial no. 873

Head						
Date of Measurement	Return-Loss (dB)	Delta (%)	Real Impedance (ohm)	Delta (ohm)	Imaginary Impedance (johm)	Delta (johm)
2018-10-26	-28.0	/	53.5	/	2.11	/
2019-10-22	-27.3	2.5	54.4	0.9	2.29	0.18



Justification of Extended Calibration SAR Dipole D2550V2– serial no.1010

Head						
Date of Measurement	Return-Loss (dB)	Delta (%)	Real Impedance (ohm)	Delta (ohm)	Imaginary Impedance (johm)	Delta (johm)
2018-08-24	-25.7	/	54.9	/	-2.30	/
2019-08-22	-24.8	3.5	55.8	0.9	-2.22	0.08
2020-08-20	-23.2	9.7	56.4	1.5	-2.13	0.17

The Return-Loss is <-20dB, and within 20% of prior calibration; the impedance is within 5 ohm of prior calibration. Therefore the value result should support extended cabration.

ANNEX K: Accreditation Certificate*****END OF REPORT*****