



SAR TEST REPORT

No. I20Z60705-SEM03

For

TCL Communication Ltd.

Tablet PC

Model Name: 9048S,9049L

With

Hardware Version: 02

Software Version: 6F6A

FCC ID: 2ACCJB126

Issued Date: 2020-9-11

Note:

The test results in this test report relate only to the devices specified in this report. This report shall not be reproduced except in full without the written approval of CTTL.

The report must not be used by the client to claim product certification, approval, or endorsement by NVLAP, NIST, or any agency of the U.S. Government.

Test Laboratory:

CTTL, Telecommunication Technology Labs, CAICT

No. 51, Xueyuan Road, Haidian District, Beijing, P. R. China 100191.

Tel:+86(0)10-62304633-2512, Fax:+86(0)10-62304633-2504

Email: ctl_terminals@caict.ac.cn, website: www.caict.ac.cn

**REPORT HISTORY**

Report Number	Revision	Issue Date	Description
I20Z60705-SEM03	Rev.0	2020-6-27	Initial creation of test report
I20Z60705-SEM03	Rev.1	2020-8-4	Update GSM1900 data
I20Z60705-SEM03	Rev.2	2020-9-11	Update Hardware Version and Model Name

TABLE OF CONTENT

1	TEST LABORATORY	5
1.1	TESTING LOCATION	5
1.2	TESTING ENVIRONMENT.....	5
1.3	PROJECT DATA.....	5
1.4	SIGNATURE	5
2	STATEMENT OF COMPLIANCE	6
3	CLIENT INFORMATION	8
3.1	APPLICANT INFORMATION	8
3.2	MANUFACTURER INFORMATION	8
4	EQUIPMENT UNDER TEST (EUT) AND ANCILLARY EQUIPMENT (AE)	9
4.1	ABOUT EUT	9
4.2	INTERNAL IDENTIFICATION OF EUT USED DURING THE TEST	9
4.3	INTERNAL IDENTIFICATION OF AE USED DURING THE TEST.....	9
5	TEST METHODOLOGY	10
5.1	APPLICABLE LIMIT REGULATIONS	10
5.2	APPLICABLE MEASUREMENT STANDARDS.....	10
6	SPECIFIC ABSORPTION RATE (SAR)	11
6.1	INTRODUCTION.....	11
6.2	SAR DEFINITION	11
7	TISSUE SIMULATING LIQUIDS	12
7.1	TARGETS FOR TISSUE SIMULATING LIQUID.....	12
7.2	DIELECTRIC PERFORMANCE	12
8	SYSTEM VERIFICATION	17
8.1	SYSTEM SETUP	17
8.2	SYSTEM VERIFICATION.....	18
9	MEASUREMENT PROCEDURES	19
9.1	TESTS TO BE PERFORMED.....	19
9.2	GENERAL MEASUREMENT PROCEDURE	21
9.3	WCDMA MEASUREMENT PROCEDURES FOR SAR	22
9.4	SAR MEASUREMENT FOR LTE	23
9.5	BLUETOOTH & WI-FI MEASUREMENT PROCEDURES FOR SAR.....	24
9.6	POWER DRIFT	24
10	AREA SCAN BASED 1-G SAR	25
10.1	REQUIREMENT OF KDB	25
10.2	FAST SAR ALGORITHMS	25

11	CONDUCTED OUTPUT POWER.....	26
11.1	GSM MEASUREMENT RESULT	26
11.2	WCDMA MEASUREMENT RESULT	28
11.3	LTE MEASUREMENT RESULT	30
11.4	WI-FI AND BT MEASUREMENT RESULT	56
12	SIMULTANEOUS TX SAR CONSIDERATIONS	60
12.1	INTRODUCTION.....	60
12.2	TRANSMIT ANTENNA SEPARATION DISTANCES.....	60
12.3	STANDALONE SAR TEST EXCLUSION CONSIDERATIONS	61
13	EVALUATION OF SIMULTANEOUS.....	62
14	SAR TEST RESULT	69
14.1	SAR RESULTS	69
14.2	SAR RESULTS FOR STANDARD PROCEDURE	78
14.3	WLAN EVALUATION FOR 2.4G	81
14.4	14.4 WLAN EVALUATION FOR 5G	83
14.5	SAR RESULTS FOR FAST BT	87
15	SAR MEASUREMENT VARIABILITY.....	88
16	MEASUREMENT UNCERTAINTY	89
16.1	MEASUREMENT UNCERTAINTY FOR NORMAL SAR TESTS (300MHZ~3GHZ).....	89
16.2	MEASUREMENT UNCERTAINTY FOR NORMAL SAR TESTS (3~6GHZ).....	90
16.3	MEASUREMENT UNCERTAINTY FOR FAST SAR TESTS (300MHZ~3GHZ).....	91
16.4	MEASUREMENT UNCERTAINTY FOR FAST SAR TESTS (3~6GHZ).....	92
17	MAIN TEST INSTRUMENTS.....	94
ANNEX A	GRAPH RESULTS.....	95
ANNEX B	SYSTEM VERIFICATION RESULTS	113
ANNEX C	SAR MEASUREMENT SETUP	123
ANNEX D	POSITION OF THE WIRELESS DEVICE IN RELATION TO THE PHANTOM	129
ANNEX E	EQUIVALENT MEDIA RECIPES.....	132
ANNEX F	SYSTEM VALIDATION	133
ANNEX G	PROBE CALIBRATION CERTIFICATE.....	134
ANNEX H	DIPOLE CALIBRATION CERTIFICATE	157
ANNEX I	SENSOR TRIGGERING DATA SUMMARY.....	228
ANNEX J	ACCREDITATION CERTIFICATE	233

1 Test Laboratory

1.1 Testing Location

Company Name:	CTTL(Shouxiang)
Address:	No. 51 Shouxiang Science Building, Xueyuan Road, Haidian District, Beijing, P. R. China100191
(if applicable) SAR test lab number	12389A-1

1.2 Testing Environment

Temperature:	18°C~25 °C,
Relative humidity:	30%~ 70%
Ground system resistance:	< 0.5 Ω
Ambient noise & Reflection:	< 0.012 W/kg

1.3 Project Data

Project Leader:	Qi Dianyuan
Test Engineer:	Lin Xiaojun
Testing Start Date:	June 15, 2020
Testing End Date:	June 23, 2020

1.4 Signature



Lin Xiaojun

(Prepared this test report)

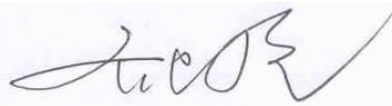

Qi Dianyuan

(Reviewed this test report)



Lu Bingsong

Deputy Director of the laboratory
(Approved this test report)

2 Statement of Compliance

The maximum results of SAR found during testing for TCL Communication Ltd. Tablet PC 90 is as follows:

Table 2.1: Highest Reported SAR (1g)

Exposure Configuration	Technology Band	Highest Reported SAR 1g (W/Kg)	Equipment Class
Hotspot(body)	GSM 850	0.82	PCE
	PCS 1900	0.97	
	UMTS FDD 2	1.17	
	UMTS FDD 4	1.00	
	UMTS FDD 5	0.88	
	LTE Band 2	1.08	
	LTE Band 5	0.97	
	LTE Band 7	1.04	
	LTE Band 12	1.09	
	LTE Band 13	0.95	
	LTE Band 66	1.15	
	WLAN 2.4 GHz	0.80	DTS
	WLAN 5 GHz	0.80	

The SAR values found for the Mobile Phone are below the maximum recommended levels of 1.6 W/kg as averaged over any 1g tissue according to the ANSI C95.1-1992.

For body worn operation, this device has been tested and meets FCC RF exposure guidelines when used with any accessory that contains no metal and which provides a minimum separation distance from 0/9/10/14 mm between this device and the body of the user. Use of other accessories may not ensure compliance with FCC RF exposure guidelines.

The EUT battery must be fully charged and checked periodically during the test to ascertain uniform power output.

The measurement together with the test system set-up is described in annex C of this test report. A detailed description of the equipment under test can be found in chapter 4 of this test report.

The highest reported SAR value is obtained at the case of **(Table 2.1)**, and the values are: **1.17 W/kg (1g)**.

Table 2.2: The sum of reported SAR values for main antenna and WiFi 2.4G

	Position	Band	Main antenna	WiFi	Sum
Highest reported SAR value for Body	Rear 0mm	GSM850	0.82	0.80	1.62
		GSM1900	0.97	0.80	1.77
		W850	0.88	0.80	1.68
		W1700	1.00	0.80	1.80
		W1900	1.17	0.80	1.97
		LTE B2	1.08	0.80	1.88
		LTE B5	0.97	0.80	1.77
		LTE B7	1.04	0.80	1.84
		LTE B12	1.09	0.80	1.89
		LTE B13	0.95	0.80	1.75
LTE B66	1.15	0.80	1.95		

Table 2.3 The sum of reported SAR values for main antenna and WiFi 5G

	Position	Band	Main antenna	WiFi	Sum
Highest reported SAR value for Body	Rear 0mm	GSM850	0.82	0.80	1.62
		GSM1900	0.97	0.80	1.77
		W850	0.88	0.80	1.68
		W1700	1.00	0.80	1.80
		W1900	1.17	0.80	1.97
		LTE B2	1.08	0.80	1.88
		LTE B5	0.97	0.80	1.77
		LTE B7	1.04	0.80	1.84
		LTE B12	1.09	0.80	1.89
		LTE B13	0.95	0.80	1.75
LTE B66	1.15	0.80	1.95		

According to the KDB 447498 D01, when the sum of SAR is larger than the limit, SAR test exclusion is determined by the SAR to peak location separation ratio. The ratio is determined by $(SAR1 + SAR2)^{1.5}/R_i$, rounded to two decimal digits, and must be ≤ 0.04 for all antenna pairs in the configuration to qualify for 1-g SAR test exclusion. The ratio ≤ 0.04 , The detail for simultaneous transmission consideration is described in chapter 13.

Table 2.3: The sum of reported SAR values for main antenna and BT

	Position	Main antenna	BT	Sum
Maximum reported SAR value for Body	Rear 0mm	1.17	<0.01	1.17

According to the above tables, the highest sum of reported SAR values is **1.97 W/kg (1g)**. The detail for simultaneous transmission consideration is described in chapter 13.



3 Client Information

3.1 Applicant Information

Company Name:	TCL Communication Ltd.
Address /Post:	5/F, Building 22E, 22 Science Park East Avenue, Hong Kong Science Park, Shatin, NT, Hong Kong
Contact Person:	Gong Zhizhou
E-mail:	zhizhou.gong@tcl.com
Telephone:	0086-755-36611722
Fax:	0086-755-36612000-81722

3.2 Manufacturer Information

Company Name:	TCL Communication Ltd.
Address /Post:	5/F, Building 22E, 22 Science Park East Avenue, Hong Kong Science Park, Shatin, NT, Hong Kong
Contact Person:	Gong Zhizhou
E-mail:	zhizhou.gong@tcl.com
Telephone:	0086-755-36611722
Fax:	0086-755-36612000-81722

4 Equipment Under Test (EUT) and Ancillary Equipment (AE)

4.1 About EUT

Description:	Tablet PC
Model name:	9048S,9049L
Operating mode(s):	GSM 850/900/1800/1900 WCDMA850/1700/1900/900/2100 LTE B2/3/4/5/7/12/13/20/28/66/ BT, WLAN
Tested Tx Frequency:	825 – 848.8 MHz (GSM 850)
	1850.2 – 1910 MHz (GSM 1900)
	826.4–846.6 MHz (WCDMA 850 Band V)
	1712.4 – 1752.6 MHz (WCDMA 1700 Band IV)
	1852.4–1907.6 MHz (WCDMA1900 Band II)
	1860 – 1900 MHz (LTE Band 2)
	824.7 – 848.3 MHz (LTE Band 5)
	2502.5 – 2567.5 MHz(LTE Band 7)
	699.7 – 715.3 MHz (LTE Band 12)
	779.5 –784.5 MHz (LTE Band 13)
	1710.7 – 1779.3 MHz (LTE Band 66)
	2412 – 2462 MHz (Wi-Fi 2.4G)
5.15 – 5.35 GHz 5.725 – 5.825 GHz(Wi-Fi 5G)	
GPRS/EGPRS Multislot Class:	12
Device type:	Tablet
Antenna type:	Embedded
Hotspot mode:	Support
Product dimension	Long 210.1mm ;Wide 125.3mm ; Diagonal 244.63mm

4.2 Internal Identification of EUT used during the test

EUT ID*	IMEI	HW Version	SW Version
EUT1	015759000002489	02	6F6A
EUT2	015759000001044	02	6F6A
EUT3	015759000002497	02	6F6A
EUT4	015759000002901	02	6F6A

*EUT ID: is used to identify the test sample in the lab internally.

Note: It is performed to test SAR with the EUT3 to 4 and conducted power with the EUT1 to 2.

4.3 Internal Identification of AE used during the test

AE ID	Description	Model	SN	Manufactory
AE1	Battery	TLp053C1 CAC5360006C1	/	BYD

5 TEST METHODOLOGY

5.1 Applicable Limit Regulations

ANSI C95.1–1992: IEEE Standard for Safety Levels with Respect to Human Exposure to Radio Frequency Electromagnetic Fields, 3 kHz to 300 GHz.

It specifies the maximum exposure limit of **1.6 W/kg** as averaged over any 1 gram of tissue for portable devices being used within 20 cm of the user in the uncontrolled environment.

5.2 Applicable Measurement Standards

IEEE 1528–2013: Recommended Practice for Determining the Peak Spatial-Average Specific Absorption Rate (SAR) in the Human Head from Wireless Communications Devices: Measurement Techniques.

KDB447498 D01 General RF Exposure Guidance v06: Mobile and Portable Devices RF Exposure Procedures and Equipment Authorization Policies.

KDB616217 D04 SAR for laptop and tablets v01r02 SAR Evaluation Considerations for Laptop, Notebook, Notebook and Tablet Computers.

KDB648474 D04 Handset SAR v01r03: SAR Evaluation Considerations for Wireless Handsets.

KDB941225 D01 SAR test for 3G devices v03r01: SAR Measurement Procedures for 3G Devices

KDB941225 D05 SAR for LTE Devices v02r05: SAR Evaluation Considerations for LTE Devices

KDB248227 D01 802.11 Wi-Fi SAR v02r02: SAR GUIDANCE FOR IEEE 802.11 (Wi-Fi) TRANSMITTERS

KDB865664 D01 SAR measurement 100 MHz to 6 GHz v01r04: SAR Measurement Requirements for 100 MHz to 6 GHz.

KDB865664 D02 RF Exposure Reporting v01r02: RF Exposure Compliance Reporting and Documentation Considerations

6 Specific Absorption Rate (SAR)

6.1 Introduction

SAR is related to the rate at which energy is absorbed per unit mass in an object exposed to a radio field. The SAR distribution in a biological body is complicated and is usually carried out by experimental techniques or numerical modeling. The standard recommends limits for two tiers of groups, occupational/controlled and general population/uncontrolled, based on a person's awareness and ability to exercise control over his or her exposure. In general, occupational/controlled exposure limits are higher than the limits for general population/uncontrolled.

6.2 SAR Definition

The SAR definition is the time derivative (rate) of the incremental energy (dW) absorbed by (dissipated in) an incremental mass (dm) contained in a volume element (dv) of a given density (ρ). The equation description is as below:

$$SAR = \frac{d}{dt} \left(\frac{dW}{dm} \right) = \frac{d}{dt} \left(\frac{dW}{\rho dv} \right)$$

SAR is expressed in units of Watts per kilogram (W/kg)

SAR measurement can be either related to the temperature elevation in tissue by

$$SAR = c \left(\frac{\delta T}{\delta t} \right)$$

Where: C is the specific heat capacity, δT is the temperature rise and δt is the exposure duration, or related to the electrical field in the tissue by

$$SAR = \frac{\sigma |E|^2}{\rho}$$

Where: σ is the conductivity of the tissue, ρ is the mass density of tissue and E is the RMS electrical field strength.

However for evaluating SAR of low power transmitter, electrical field measurement is typically applied.

7 Tissue Simulating Liquids

7.1 Targets for tissue simulating liquid

Table 7.1: Targets for tissue simulating liquid

Frequency(MHz)	Liquid Type	Conductivity(σ)	$\pm 5\%$ Range	Permittivity(ϵ)	$\pm 5\%$ Range
750	Head	0.89	0.85~0.93	41.94	39.8~44.0
835	Head	0.90	0.86~0.95	41.5	39.4~43.6
1750	Head	1.37	1.30~1.44	40.08	38.1~42.1
1900	Head	1.40	1.33~1.47	40.0	38.0~42.0
2450	Head	1.80	1.71~1.89	39.2	37.2~41.2
5250	Head	4.71	4.47~4.95	35.93	34.13~37.73
5600	Head	5.07	4.82~5.32	35.53	33.8~37.3
5750	Head	5.22	4.96~5.48	35.36	33.59~37.13

7.2 Dielectric Performance

Table 7.2: Dielectric Performance of Tissue Simulating Liquid

Measurement Date yyyy/mm/dd	Frequency	Type	Permittivity ϵ	Drift (%)	Conductivity σ (S/m)	Drift (%)
2020/6/15	750 MHz	Body	42.5	1.34	0.89	0.00
2020/6/16	835 MHz	Body	40.69	-1.95	0.888	-1.33
2020/6/17	1750 MHz	Body	40.2	0.30	1.354	-1.17
2020/6/18	1900 MHz	Body	39.38	-1.55	1.411	0.79
2020/6/19	2450 MHz	Body	39.83	1.61	1.818	1.00
2020/6/20	2600 MHz	Body	39.01	0.00	1.956	-0.20
2020/6/21	5250 MHz	Body	36.07	0.39	4.729	0.40
2020/6/22	5600 MHz	Body	35.75	0.62	5.153	1.64
2020/6/23	5750 MHz	Body	35.73	1.05	5.201	-0.36

Note: The liquid temperature is 22.0°C



Picture 7-1 Liquid depth in the Flat Phantom (750 MHz)

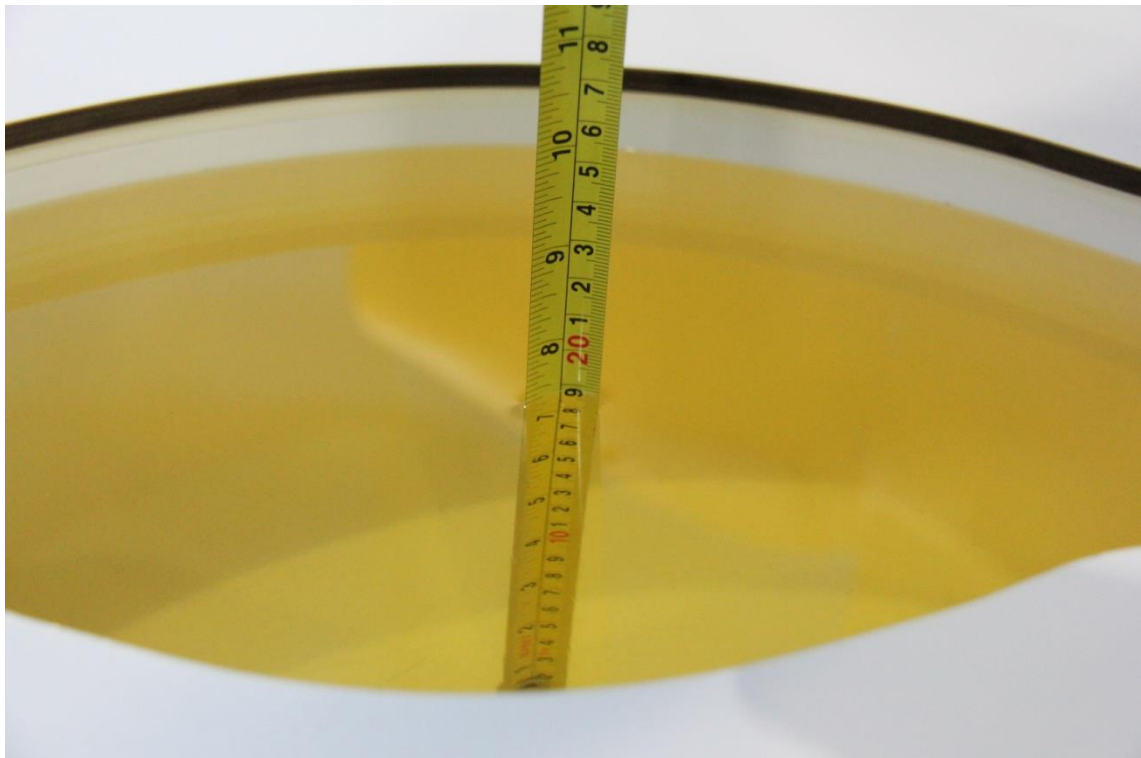

Picture 7-2 Liquid depth in the Flat Phantom (835MHz)

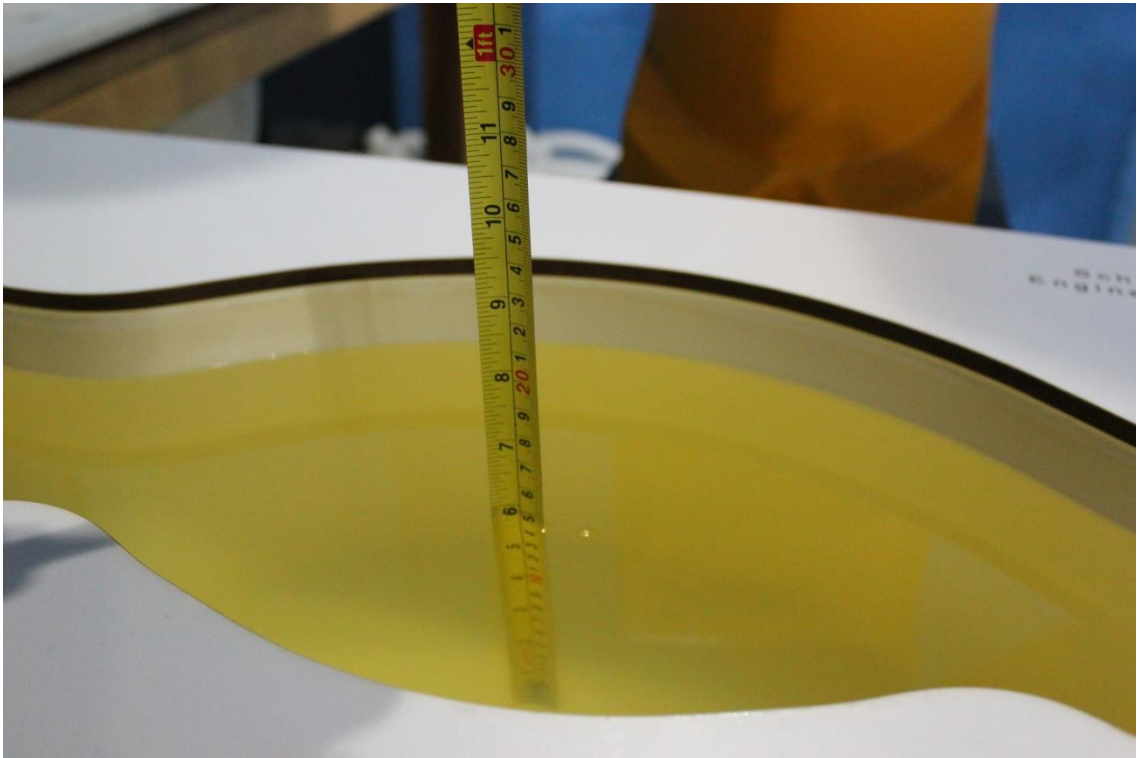

Picture 7-3 Liquid depth in the Flat Phantom (1750MHz)

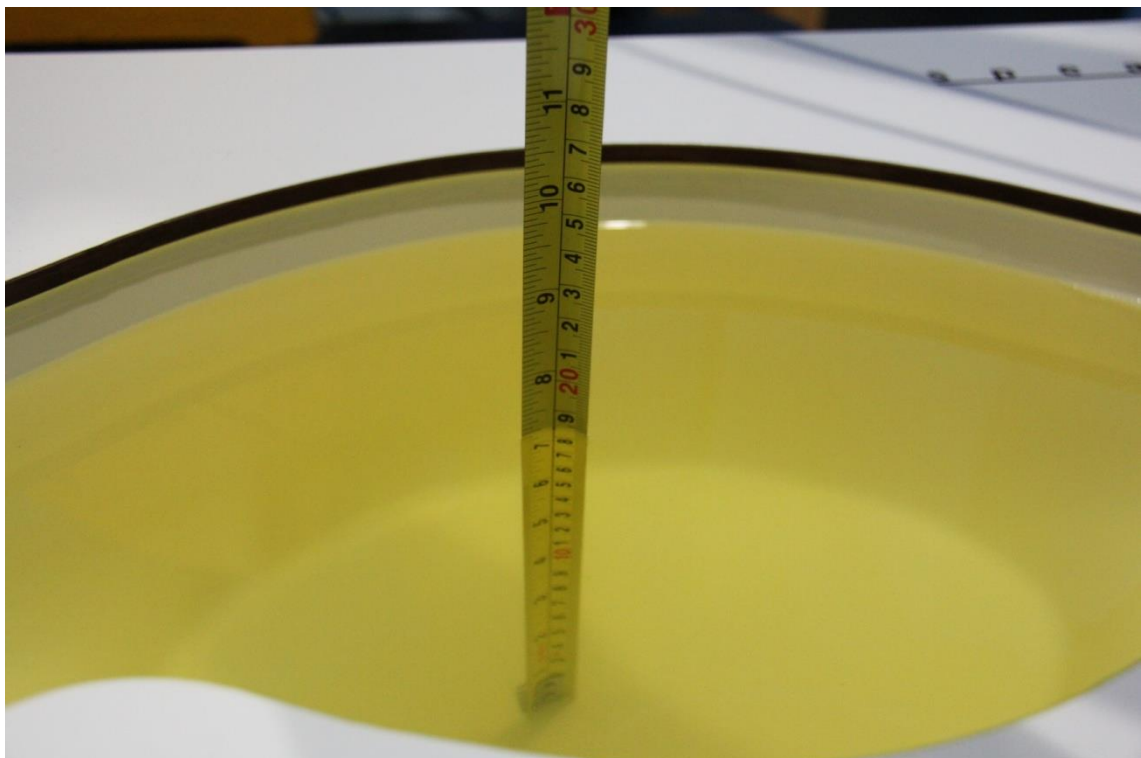

Picture 7-4 Liquid depth in the Flat Phantom (1900MHz)

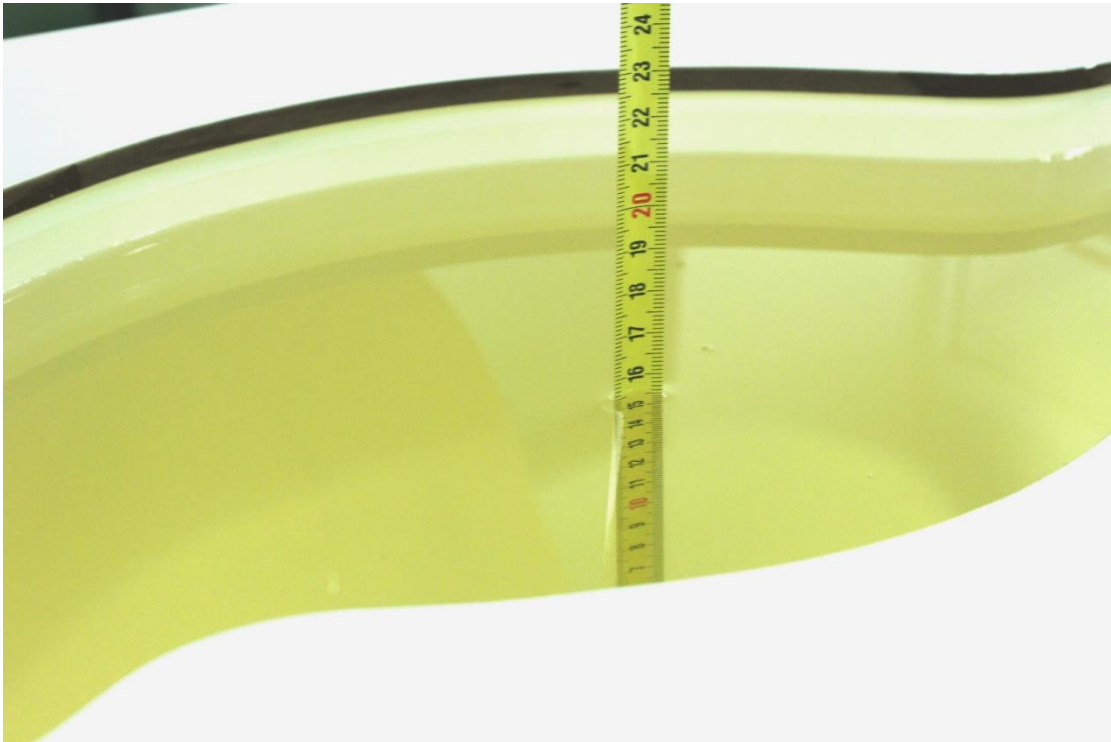

Picture 7-5 Liquid depth in the Flat Phantom (2450MHz)

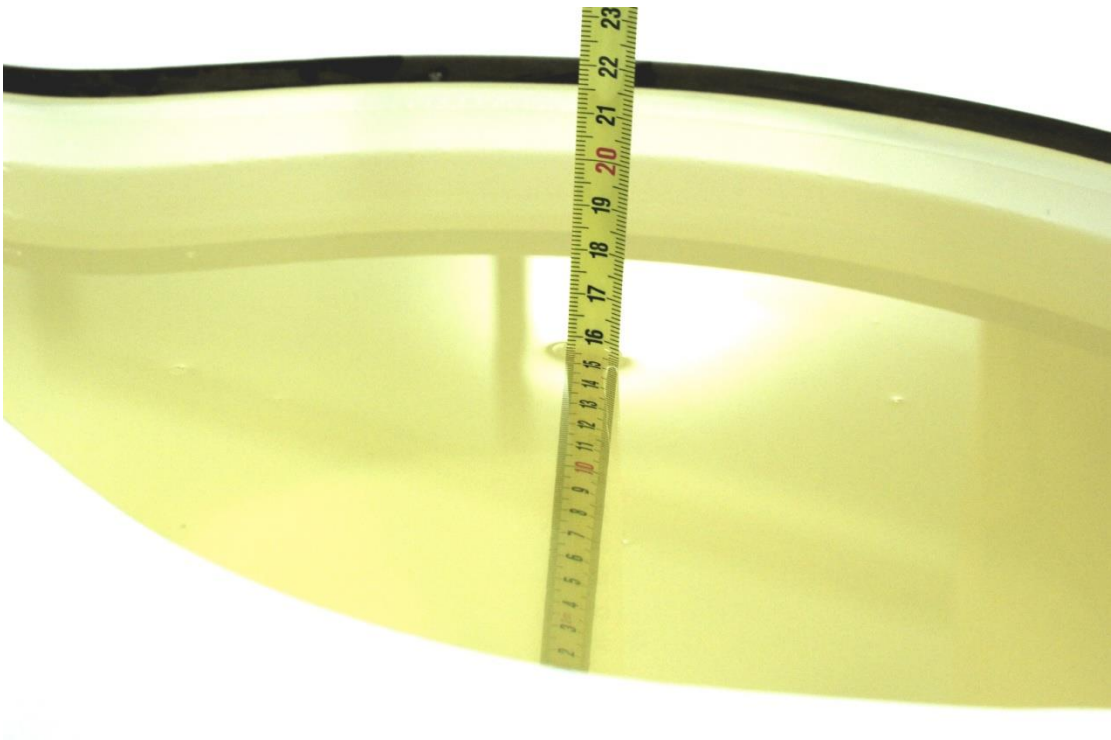

Picture 7-6 Liquid depth in the Flat Phantom (2600MHz)

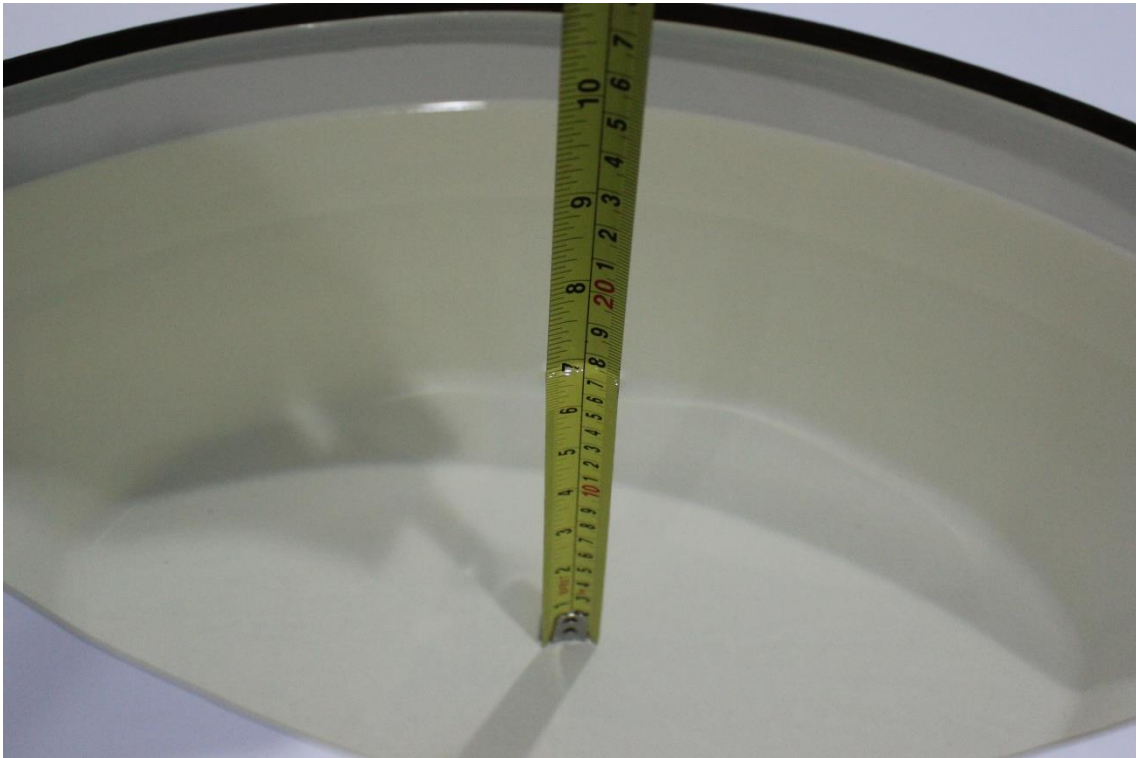

Picture 7-7 Liquid depth in the Flat Phantom (5GHz)

8 System verification

8.1 System Setup

In the simplified setup for system evaluation, the DUT is replaced by a calibrated dipole and the power source is replaced by a continuous wave that comes from a signal generator. The calibrated dipole must be placed beneath the flat phantom section of the SAM twin phantom with the correct distance holder. The distance holder should touch the phantom surface with a light pressure at the reference marking and be oriented parallel to the long side of the phantom. The equipment setup is shown below:

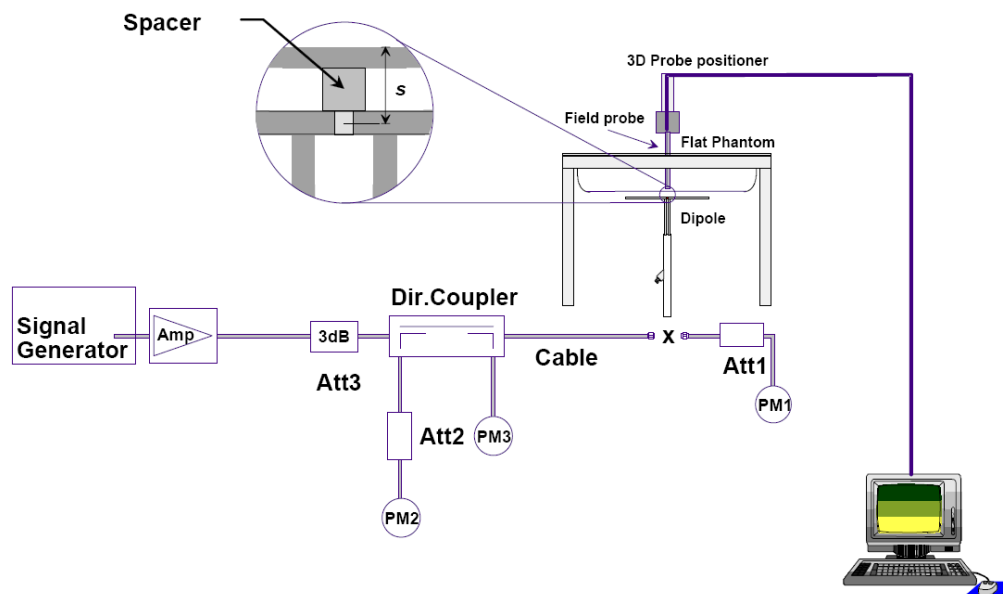

Picture 8.1 System Setup for System Evaluation



Picture 8.2 Photo of Dipole Setup
8.2 System Verification

SAR system verification is required to confirm measurement accuracy, according to the tissue dielectric media, probe calibration points and other system operating parameters required for measuring the SAR of a test device. The system verification must be performed for each frequency band and within the valid range of each probe calibration point required for testing the device.

The system verification results are required that the area scan estimated 1-g SAR is within 3% of the zoom scan 1-g SAR. The details are presented in annex B.

Table 8.1: System Verification of Body

Measurement Date (yyyy-mm-dd)	Frequency	Target value (W/kg)		Measured value (W/kg)		Deviation	
		10 g Average	1 g Average	10 g Average	1 g Average	10 g Average	1 g Average
2020/6/15	750 MHz	5.57	8.57	5.44	8.72	-2.33%	1.75%
2020/6/16	835 MHz	6.29	9.70	6.24	9.8	-0.79%	1.03%
2020/6/17	1750 MHz	19.3	36.6	19.68	36.48	1.97%	-0.33%
2020/6/18	1900 MHz	20.8	39.7	20.72	40.04	-0.38%	0.86%
2020/6/19	2450 MHz	24.2	51.6	24.48	51.12	1.16%	-0.93%
2020/6/20	2600 MHz	25.1	55.8	25.16	55.64	0.24%	-0.29%
2020/6/21	5250 MHz	23.2	80.4	23.5	79.9	1.21%	-0.60%
2020/6/22	5600 MHz	24.1	84.5	24.0	84.7	-0.41%	0.26%
2020/6/23	5750 MHz	23.0	80.4	23.3	79.6	1.22%	-1.00%

9 Measurement Procedures

9.1 Tests to be performed

In order to determine the highest value of the peak spatial-average SAR of a handset, all device positions, configurations and operational modes shall be tested for each frequency band according to steps 1 to 3 below. A flowchart of the test process is shown in picture 9.1.

Step 1: The tests described in 9.2 shall be performed at the channel that is closest to the center of the transmit frequency band (f_c) for:

- a) all device positions (cheek and tilt, for both left and right sides of the SAM phantom, as described in annex D),
- b) all configurations for each device position in a), e.g., antenna extended and retracted, and
- c) all operational modes, e.g., analogue and digital, for each device position in a) and configuration in b) in each frequency band.

If more than three frequencies need to be tested according to 11.1 (i.e., $N_c > 3$), then all frequencies, configurations and modes shall be tested for all of the above test conditions.

Step 2: For the condition providing highest peak spatial-average SAR determined in Step 1, perform all tests described in 9.2 at all other test frequencies, i.e., lowest and highest frequencies. In addition, for all other conditions (device position, configuration and operational mode) where the peak spatial-average SAR value determined in Step 1 is within 3 dB of the applicable SAR limit, it is recommended that all other test frequencies shall be tested as well.

Step 3: Examine all data to determine the highest value of the peak spatial-average SAR found in Steps 1 to 2.

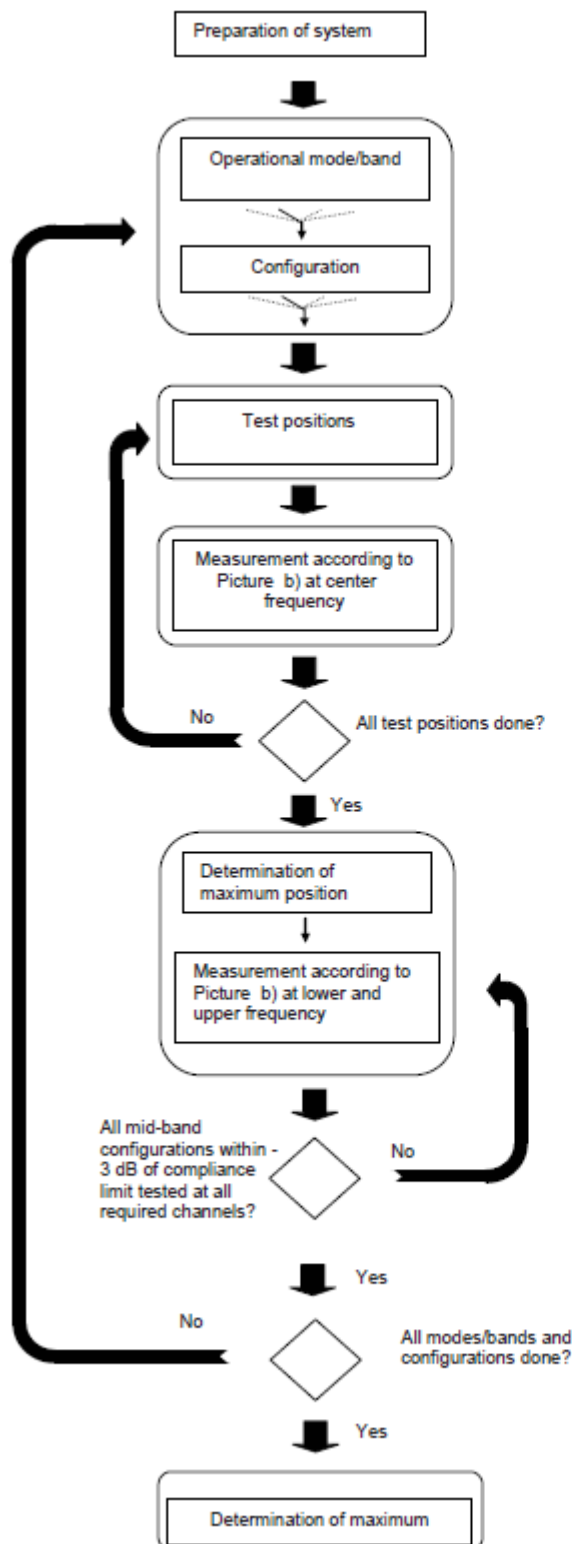

Picture a – Tests to be performed

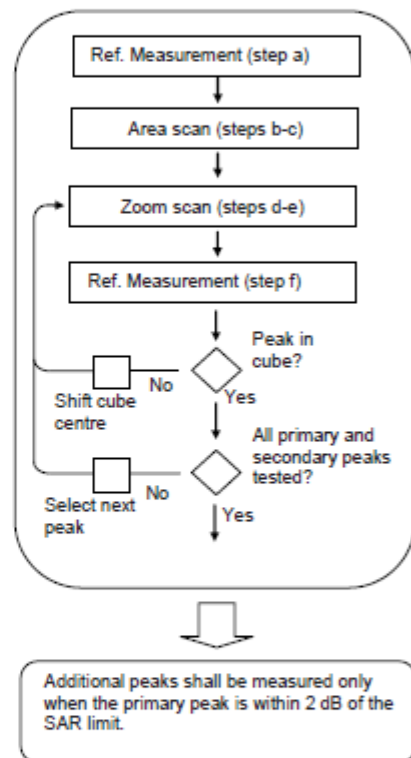

Picture b – General procedure

Additional peaks shall be measured only when the primary peak is within 2 dB of the SAR limit.

Picture 9.1 Block diagram of the tests to be performed

9.2 General Measurement Procedure

The area and zoom scan resolutions specified in the table below must be applied to the SAR measurements and fully documented in SAR reports to qualify for TCB approval. Probe boundary effect error compensation is required for measurements with the probe tip closer than half a probe tip diameter to the phantom surface. Both the probe tip diameter and sensor offset distance must satisfy measurement protocols; to ensure probe boundary effect errors are minimized and the higher fields closest to the phantom surface can be correctly measured and extrapolated to the phantom surface for computing 1-g SAR. Tolerances of the post-processing algorithms must be verified by the test laboratory for the scan resolutions used in the SAR measurements, according to the reference distribution functions specified in IEEE Std 1528-2013. The results should be documented as part of the system validation records and may be requested to support test results when all the measurement parameters in the following table are not satisfied.

		≤ 3 GHz	> 3 GHz	
Maximum distance from closest measurement point (geometric center of probe sensors) to phantom surface		5 ± 1 mm	$\frac{1}{2} \cdot \delta \cdot \ln(2) \pm 0.5$ mm	
Maximum probe angle from probe axis to phantom surface normal at the measurement location		$30^\circ \pm 1^\circ$	$20^\circ \pm 1^\circ$	
Maximum area scan spatial resolution: Δx_{Area} , Δy_{Area}		≤ 2 GHz: ≤ 15 mm 2 – 3 GHz: ≤ 12 mm	3 – 4 GHz: ≤ 12 mm 4 – 6 GHz: ≤ 10 mm	
		When the x or y dimension of the test device, in the measurement plane orientation, is smaller than the above, the measurement resolution must be \leq the corresponding x or y dimension of the test device with at least one measurement point on the test device.		
Maximum zoom scan spatial resolution: Δx_{Zoom} , Δy_{Zoom}		≤ 2 GHz: ≤ 8 mm 2 – 3 GHz: ≤ 5 mm*	3 – 4 GHz: ≤ 5 mm* 4 – 6 GHz: ≤ 4 mm*	
Maximum zoom scan spatial resolution, normal to phantom surface	uniform grid: $\Delta z_{Zoom}(n)$	≤ 5 mm	3 – 4 GHz: ≤ 4 mm 4 – 5 GHz: ≤ 3 mm 5 – 6 GHz: ≤ 2 mm	
	graded grid	$\Delta z_{Zoom}(1)$: between 1 st two points closest to phantom surface	≤ 4 mm	3 – 4 GHz: ≤ 3 mm 4 – 5 GHz: ≤ 2.5 mm 5 – 6 GHz: ≤ 2 mm
		$\Delta z_{Zoom}(n>1)$: between subsequent points	$\leq 1.5 \cdot \Delta z_{Zoom}(n-1)$	
Minimum zoom scan volume	x, y, z	≥ 30 mm	3 – 4 GHz: ≥ 28 mm 4 – 5 GHz: ≥ 25 mm 5 – 6 GHz: ≥ 22 mm	
Note: δ is the penetration depth of a plane-wave at normal incidence to the tissue medium; see draft standard IEEE P1528-2011 for details. * When zoom scan is required and the <i>reported</i> SAR from the area scan based 1-g SAR estimation procedures of KDB 447498 is ≤ 1.4 W/kg, ≤ 8 mm, ≤ 7 mm and ≤ 5 mm zoom scan resolution may be applied, respectively, for 2 GHz to 3 GHz, 3 GHz to 4 GHz and 4 GHz to 6 GHz.				

9.3 WCDMA Measurement Procedures for SAR

The following procedures are applicable to WCDMA handsets operating under 3GPP Release99, Release 5 and Release 6. The default test configuration is to measure SAR with an established radio link between the DUT and a communication test set using a 12.2kbps RMC (reference measurement channel) configured in Test Loop Mode 1. SAR is selectively confirmed for other physical channel configurations (DPCCH & DPDCH_n), HSDPA and HSPA (HSUPA/HSDPA) modes according to output power, exposure conditions and device operating capabilities. Both uplink and downlink should be configured with the same RMC or AMR, when required. SAR for Release 5 HSDPA and Release 6 HSPA are measured using the applicable FRC (fixed reference channel) and E-DCH reference channel configurations. Maximum output power is verified according to applicable versions of 3GPP TS 34.121 and SAR must be measured according to these maximum output conditions. When Maximum Power Reduction (MPR) is not implemented according to Cubic Metric (CM) requirements for Release 6 HSPA, the following procedures do not apply.

For Release 5 HSDPA Data Devices:

Sub-test	β_c	β_d	β_d (SF)	β_c / β_d	β_{hs}	CM/dB
1	2/15	15/15	64	2/15	4/15	0.0
2	12/15	15/15	64	12/15	24/25	1.0
3	15/15	8/15	64	15/8	30/15	1.5
4	15/15	4/15	64	15/4	30/15	1.5

For Release 6 HSPA Data Devices

Sub-test	β_c	β_d	β_d (SF)	β_c / β_d	β_{hs}	β_{ec}	β_{ed}	β_{ed} (SF)	β_{ed} (codes)	CM (dB)	MPR (dB)	AG Index	E-TFCI
1	11/15	15/15	64	11/15	22/15	209/225	1039/225	4	1	1.5	1.5	20	75
2	6/15	15/15	64	6/15	12/15	12/15	12/15	4	1	1.5	1.5	12	67
3	15/15	9/15	64	15/9	30/15	30/15	$\beta_{ed1}:47/15$ $\beta_{ed2}:47/15$	4	2	1.5	1.5	15	92
4	2/15	15/15	64	2/15	4/15	4/15	56/75	4	1	1.5	1.5	17	71
5	15/15	15/15	64	15/15	24/15	30/15	134/15	4	1	1.5	1.5	21	81

Rel.8 DC-HSDPA (Cat 24)

SAR test exclusion for Rel.8 DC-HSDPA must satisfy the SAR test exclusion requirements of Rel.5 HSDPA. SAR test exclusion for DC-HSDPA devices is determined by power measurements according to the H-Set 12, Fixed Reference Channel (FRC) configuration in Table C.8.1.12 of 3GPP TS 34.121-1. A primary and a secondary serving HS-DSCH Cell are required to perform the power measurement and for the results to qualify for SAR test exclusion.

9.4 SAR Measurement for LTE

SAR tests for LTE are performed with a base station simulator, Rohde & Schwarz CMW500. Closed loop power control was used so the UE transmits with maximum output power during SAR testing. All powers were measured with the CMW 500.

It is performed for conducted power and SAR based on the KDB941225 D05.

SAR is evaluated separately according to the following procedures for the different test positions in each exposure condition – head, body, body-worn accessories and other use conditions. The procedures in the following subsections are applied separately to test each LTE frequency band.

1) QPSK with 1 RB allocation

Start with the largest channel bandwidth and measure SAR for QPSK with 1 RB allocation, using the RB offset and required test channel combination with the highest maximum output power among RB offsets at the upper edge, middle and lower edge of each required test channel. When the reported SAR is ≤ 0.8 W/kg, testing of the remaining RB offset configurations and required test channels is not required for 1 RB allocation; otherwise, SAR is required for the remaining required test channels and only for the RB offset configuration with the highest output power for that channel. When the reported SAR of a required test channel is > 1.45 W/kg, SAR is required for all three RB offset configurations for that required test channel.

2) QPSK with 50% RB allocation

The procedures required for 1 RB allocation in 1) are applied to measure the SAR for QPSK with 50% RB allocation.

3) QPSK with 100% RB allocation

For QPSK with 100% RB allocation, SAR is not required when the highest maximum output power for 100 % RB allocation is less than the highest maximum output power in 50% and 1 RB allocations and the highest reported SAR for 1 RB and 50% RB allocation in 1) and 2) are ≤ 0.8 W/kg. Otherwise, SAR is measured for the highest output power channel; and if the reported SAR is > 1.45 W/kg, the remaining required test channels must also be tested.

9.5 Bluetooth & Wi-Fi Measurement Procedures for SAR

Normal network operating configurations are not suitable for measuring the SAR of 802.11 transmitters in general. Unpredictable fluctuations in network traffic and antenna diversity conditions can introduce undesirable variations in SAR results. The SAR for these devices should be measured using chipset based test mode software to ensure that the results are consistent and reliable.

Chipset based test mode software is hardware dependent and generally varies among manufacturers. The device operating parameters established in a test mode for SAR measurements must be identical to those programmed in production units, including output power levels, amplifier gain settings and other RF performance tuning parameters. The test frequencies should correspond to actual channel frequencies defined for domestic use. SAR for devices with switched diversity should be measured with only one antenna transmitting at a time during each SAR measurement, according to a fixed modulation and data rate. The same data pattern should be used for all measurements.

9.6 Power Drift

To control the output power stability during the SAR test, DASY4 system calculates the power drift by measuring the E-field at the same location at the beginning and at the end of the measurement for each test position. These drift values can be found in section 14 labeled as: (Power Drift [dB]). This ensures that the power drift during one measurement is within 5%.

10 Area Scan Based 1-g SAR

10.1 Requirement of KDB

According to the KDB447498 D01 v05, when the implementation is based the specific polynomial fit algorithm as presented at the 29th Bioelectromagnetics Society meeting (2007) and the estimated 1-g SAR is ≤ 1.2 W/kg, a zoom scan measurement is not required provided it is also not needed for any other purpose; for example, if the peak SAR location required for simultaneous transmission SAR test exclusion can be determined accurately by the SAR system or manually to discriminate between distinctive peaks and scattered noisy SAR distributions from area scans.

There must not be any warning or alert messages due to various measurement concerns identified by the SAR system; for example, noise in measurements, peaks too close to scan boundary, peaks are too sharp, spatial resolution and uncertainty issues etc. The SAR system verification must also demonstrate that the area scan estimated 1-g SAR is within 3% of the zoom scan 1-g SAR (See Annex B). When all the SAR results for each exposure condition in a frequency band and wireless mode are based on estimated 1-g SAR, the 1-g SAR for the highest SAR configuration must be determined by a zoom scan.

10.2 Fast SAR Algorithms

The approach is based on the area scan measurement applying a frequency dependent attenuation parameter. This attenuation parameter was empirically determined by analyzing a large number of phones. The MOTOROLA FAST SAR was developed and validated by the MOTOROLA Research Group in Ft. Lauderdale.

In the initial study, an approximation algorithm based on Linear fit was developed. The accuracy of the algorithm has been demonstrated across a broad frequency range (136-2450 MHz) and for both 1- and 10-g averaged SAR using a sample of 264 SAR measurements from 55 wireless handsets. For the sample size studied, the root-mean-squared errors of the algorithm are 1.2% and 5.8% for 1- and 10-g averaged SAR, respectively. The paper describing the algorithm in detail is expected to be published in August 2004 within the Special Issue of Transactions on MTT.

In the second step, the same research group optimized the fitting algorithm to an Polynomial fit whereby the frequency validity was extended to cover the range 30-6000MHz. Details of this study can be found in the BEMS 2007 Proceedings.

Both algorithms are implemented in DASY software.

11 Conducted Output Power

There are two sets of tune-up power, Normal power and Low power, for GSM850,1900, WCDMA B2,4,5 LTEB2,5,7,12,13,66 by proximity sensor. The detail of proximity sensor is presented in annex I.

11.1 GSM Measurement result

During the process of testing, the EUT was controlled via Agilent Digital Radio Communication tester (E5515C) to ensure the maximum power transmission and proper modulation. This result contains conducted output power for the EUT. In all cases, the measured peak output power should be greater and within 5% than EMI measurement.

Table 11.1-1: The conducted power measurement results for GSM- Normal power

GSM 850 GPRS (GMSK)	Measured Power (dBm)				calculation	Averaged Power (dBm)		
	251	190	128			251	190	128
1 Txslot	32.82	32.80	32.71	33.50	-9.03	23.79	23.77	23.68
2Txslots	31.29	31.22	31.01	31.50	-6.02	25.27	25.20	24.99
3Txslots	29.04	28.90	28.74	29.50	-4.26	24.78	24.64	24.48
4Txslots	27.42	27.23	27.03	28.00	-3.01	24.41	24.22	24.02
GSM 850 EGPRS (GMSK)	Measured Power (dBm)				calculation	Averaged Power (dBm)		
	251	190	128			251	190	128
1 Txslot	32.82	32.78	32.69	33.50	-9.03	23.79	23.75	23.66
2Txslots	31.25	31.17	30.95	31.50	-6.02	25.23	25.15	24.93
3Txslots	28.97	28.82	28.66	29.50	-4.26	24.71	24.56	24.40
4Txslots	27.33	27.14	26.94	28.00	-3.01	24.32	24.13	23.93
GSM 850 EGPRS (8PSK)	Measured Power (dBm)				calculation	Averaged Power (dBm)		
	251	190	128			251	190	128
1 Txslot	27.02	26.95	26.85	28.00	-9.03	17.99	17.92	17.82
2 Txslots	25.63	25.60	25.59	27.00	-6.02	19.61	19.58	19.57
3Txslots	24.34	24.34	24.58	25.00	-4.26	20.08	20.08	20.32
4 Txslots	23.13	23.43	23.14	24.00	-3.01	20.12	20.42	20.13
PCS1900 GPRS (GMSK)	Measured Power (dBm)				calculation	Averaged Power (dBm)		
	810	661	512			810	661	512
1 Txslot	30.05	29.76	29.73	30.50	-9.03	21.02	20.73	20.70
2Txslots	28.02	27.98	27.99	29.00	-6.02	22.00	21.96	21.97
3Txslots	25.88	25.81	25.68	27.00	-4.26	21.62	21.55	21.42
4Txslots	24.11	24.17	24.12	25.50	-3.01	21.10	21.16	21.11
PCS1900 EGPRS (GMSK)	Measured Power (dBm)				calculation	Averaged Power (dBm)		
	810	661	512			810	661	512
1 Txslot	30.03	29.77	29.72	30.50	-9.03	21.00	20.74	20.69
2Txslots	28.02	27.99	27.98	29.00	-6.02	22.00	21.97	21.96
3Txslots	25.88	25.81	25.65	27.00	-4.26	21.62	21.55	21.39
4Txslots	24.12	24.18	24.11	25.50	-3.01	21.11	21.17	21.10

PCS1900 EGPRS (8PSK)	Measured Power (dBm)				calculation	Averaged Power (dBm)		
	810	661	512			810	661	512
1 Txslot	25.84	25.95	25.81	27.00	-9.03	16.81	16.92	16.78
2 Txslots	24.56	24.62	24.50	26.00	-6.02	18.54	18.60	18.48
3Txslots	23.42	23.30	23.20	24.50	-4.26	19.16	19.04	18.94
4 Txslots	22.49	22.61	22.41	23.50	-3.01	19.48	19.60	19.40

NOTES:

1) Division Factors

To average the power, the division factor is as follows:

1TX-slot = 1 transmit time slot out of 8 time slots=> conducted power divided by (8/1) => -9.03dB

2TX-slots = 2 transmit time slots out of 8 time slots=> conducted power divided by (8/2) => -6.02dB

3TX-slots = 3 transmit time slots out of 8 time slots=> conducted power divided by (8/3) => -4.26dB

4TX-slots = 4 transmit time slots out of 8 time slots=> conducted power divided by (8/4) => -3.01dB

According to the conducted power as above, the body measurements are performed with 2Txslots for GSM850 and GSM1900.

Table 11.1-2: The conducted power measurement results for GSM- Low power

GSM 850 GPRS (GMSK)	Measured Power (dBm)				calculation	Averaged Power (dBm)		
	251	190	128			251	190	128
1 Txslot	28.29	28.28	28.10	28.50	-9.03	19.26	19.25	19.07
2Txslots	28.21	28.19	27.99	28.50	-6.02	22.19	22.17	21.97
3Txslots	27.90	27.94	27.75	28.50	-4.26	23.64	23.68	23.49
4Txslots	27.42	27.36	27.12	28.00	-3.01	24.41	24.35	24.11
GSM 850 EGPRS (GMSK)	Measured Power (dBm)				calculation	Averaged Power (dBm)		
	251	190	128			251	190	128
1 Txslot	28.20	28.19	28.04	28.50	-9.03	19.17	19.16	19.01
2Txslots	28.12	28.10	27.94	28.50	-6.02	22.10	22.08	21.92
3Txslots	27.90	27.87	27.67	28.50	-4.26	23.64	23.61	23.41
4Txslots	27.32	27.27	27.05	28.00	-3.01	24.31	24.26	24.04
GSM 850 EGPRS (8PSK)	Measured Power (dBm)				calculation	Averaged Power (dBm)		
	251	190	128			251	190	128
1 Txslot	26.83	27.04	27.16	28.00	-9.03	17.80	18.01	18.13
2 Txslots	26.02	25.91	26.03	27.00	-6.02	20.00	19.89	20.01
3Txslots	24.55	24.74	24.65	25.50	-4.26	20.29	20.48	20.39
4 Txslots	23.37	23.56	23.67	24.50	-3.01	20.36	20.55	20.66
PCS1900 GPRS (GMSK)	Measured Power (dBm)				calculation	Averaged Power (dBm)		
	810	661	512			810	661	512
1 Txslot	17.49	17.24	17.02	18.00	-9.03	8.46	8.21	7.99
2Txslots	17.44	17.21	17.00	18.00	-6.02	11.42	11.19	10.98
3Txslots	17.37	17.15	16.93	18.00	-4.26	13.11	12.89	12.67
4Txslots	17.29	17.08	16.86	18.00	-3.01	14.28	14.07	13.85
PCS1900	Measured Power (dBm)				calculation	Averaged Power (dBm)		

EGPRS (GMSK)	810	661	512			810	661	512
1 Txslot	17.38	17.16	16.94	18.00	-9.03	8.35	8.13	7.91
2Txslots	17.36	17.13	16.92	18.00	-6.02	11.34	11.11	10.90
3Txslots	17.29	17.07	16.86	18.00	-4.26	13.03	12.81	12.60
4Txslots	17.26	17.00	16.79	18.00	-3.01	14.25	13.99	13.78
PCS1900	Measured Power (dBm)				calculation	Averaged Power (dBm)		
EGPRS (8PSK)	810	661	512			810	661	512
1 Txslot	16.77	16.54	16.35	17.50	-9.03	7.74	7.51	7.32
2 Txslots	16.66	16.43	16.24	17.50	-6.02	10.64	10.41	10.22
3Txslots	16.46	16.30	16.14	17.50	-4.26	12.20	12.04	11.88
4 Txslots	16.28	16.06	16.04	17.50	-3.01	13.27	13.05	13.03

NOTES:

1) Division Factors

To average the power, the division factor is as follows:

1TX-slot = 1 transmit time slot out of 8 time slots=> conducted power divided by (8/1) => -9.03dB

2TX-slots = 2 transmit time slots out of 8 time slots=> conducted power divided by (8/2) => -6.02dB

3TX-slots = 3 transmit time slots out of 8 time slots=> conducted power divided by (8/3) => -4.26dB

4TX-slots = 4 transmit time slots out of 8 time slots=> conducted power divided by (8/4) => -3.01dB

According to the conducted power as above, the body measurements are performed with 4Txslots for GSM850 and GSM1900.

11.2 WCDMA Measurement result

Table 11.2-1: The conducted Power for WCDMA- Normal power

Item	band	FDDV result			Tune up
	ARFCN	4233 (846.6MHz)	4182 (836.4MHz)	4132 (826.4MHz)	
WCDMA	\	23.05	23.04	23.11	24.00
HSUPA	1	22.42	22.45	22.62	23.00
	2	20.41	20.43	20.56	22.00
	3	21.43	21.37	21.59	22.00
	4	20.37	20.36	20.54	21.00
	5	22.41	22.32	22.54	23.00
HSPA+		21.96	22.02	22.05	23.00
DC-HSDPA	1	21.54	21.46	21.72	23.00
	2	21.55	21.48	21.73	23.00
	3	21.07	21.02	21.26	23.00
	4	21.04	21.00	21.29	23.00
Item	band	FDDIV result			
	ARFCN	1513 (1752.6MHz)	1412 (1732.4MHz)	1312 (1712.4MHz)	
WCDMA	\	23.17	23.10	23.16	24.00
HSUPA	1	22.49	22.55	22.42	23.00

	2	20.47	20.54	20.49	22.00
	3	21.5	21.58	21.47	22.00
	4	20.52	20.55	20.42	21.00
	5	22.47	22.58	22.43	23.00
HSPA+		22.08	22.12	21.99	23.00
DC-HSDPA	1	21.65	21.74	21.62	23.00
	2	21.63	21.72	21.60	23.00
	3	21.15	21.23	21.13	23.00
	4	21.14	21.24	21.15	23.00
Item	band	FDDII result			
	ARFCN	9538 (1907.6MHz)	9400 (1880MHz)	9262 (1852.4MHz)	Tune up
WCDMA	\	23.22	23.32	23.25	24.00
HSUPA	1	22.74	22.81	22.78	23.00
	2	20.75	20.78	20.77	22.00
	3	21.75	21.81	21.73	22.00
	4	20.71	20.69	20.67	21.00
	5	22.71	22.76	22.79	23.00
HSPA+		22.23	22.37	22.16	23.00
DC-HSDPA	1	21.94	21.89	21.86	23.00
	2	21.95	21.90	21.87	23.00
	3	21.45	21.41	21.39	23.00
	4	21.43	21.40	21.37	23.00

Table 11.2-2: The conducted Power for WCDMA- Low power

Item	band	FDDV result			Tune up
	ARFCN	4233 (846.6MHz)	4182 (836.4MHz)	4132 (826.4MHz)	
WCDMA	\	21.63	21.67	21.89	22.00
HSUPA	1	20.38	20.35	20.59	21.00
	2	18.38	18.46	18.51	20.00
	3	19.35	19.30	19.49	20.00
	4	18.34	18.39	18.61	20.00
	5	20.28	20.30	20.64	21.00
HSPA+		19.92	19.86	20.06	21.00
DC-HSDPA	1	20.41	20.35	20.56	21.00
	2	20.44	20.37	20.61	21.00
	3	19.96	19.83	20.11	21.00
	4	19.95	19.88	20.10	21.00
Item	band	FDDIV result			
	ARFCN	1513 (1752.6MHz)	1412 (1732.4MHz)	1312 (1712.4MHz)	
WCDMA	\	14.88	14.98	14.83	15.00
HSUPA	1	13.92	14.05	13.91	15.00

	2	12.03	12.05	12.02	14.00
	3	12.94	13.01	12.86	14.00
	4	12.03	12.02	12.01	14.00
	5	13.96	14.03	13.93	15.00
HSPA+		13.48	13.55	13.50	15.00
DC-HSDPA	1	14.01	14.01	14.02	16.00
	2	14.02	14.02	14.01	16.00
	3	13.45	13.54	13.46	15.00
	4	13.43	13.49	13.42	15.00
Item	band	FDDII result			
	ARFCN	9538 (1907.6MHz)	9400 (1880MHz)	9262 (1852.4MHz)	Tune up
WCDMA	\	15.20	15.22	15.19	16.00
HSUPA	1	14.22	14.18	14.14	15.00
	2	12.21	12.20	12.23	14.00
	3	13.27	13.21	13.15	15.00
	4	12.23	12.22	12.20	14.00
	5	14.24	14.23	14.16	15.00
HSPA+		13.78	13.80	13.81	14.00
DC-HSDPA	1	14.22	14.20	14.16	16.00
	2	14.23	14.21	14.17	16.00
	3	13.74	13.72	13.68	15.00
	4	13.72	13.73	13.69	15.00

11.3 LTE Measurement result

Table 11.3-1: Maximum Power Reduction (MPR) for LTE

Modulation	Channel bandwidth / Transmission bandwidth configuration [RB]						MPR (dB)
	1.4 MHz	3 MHz	5 MHz	10 MHz	15 MHz	20 MHz	
QPSK	> 5	> 4	> 8	> 12	> 16	> 18	1
16 QAM	≤ 5	≤ 4	≤ 8	≤ 12	≤ 16	≤ 18	1
16 QAM	> 5	> 4	> 8	> 12	> 16	> 18	2

Table 11.3-2: The tune up for LTE- Normal power

Band	Tune up
LTE Band 2	23.5
LTE Band 5	24
LTE Band 7	24
LTE Band 12	24
LTE Band 13	23.5
LTE Band 66	23.5

Table 11.3-3: The tune up for LTE- Low power

Band	Tune up
LTE Band 2	16
LTE Band 5	22
LTE Band 7	15.5
LTE Band 12	22
LTE Band 13	21.5
LTE Band 66	15.5

Normal power

Band 2					
Bandwidth (MHz)	RB allocation	Frequency (MHz)	QPSK	16QAM	
	RB offset (Start RB)		Actual output power (dBm)	Actual output power (dBm)	
1.4 MHz	1RB High (5)	1909.3	22.88	23.10	
		1880	22.82	22.86	
		1850.7	22.81	22.76	
	1RB Middle (3)	1909.3	22.92	23.16	
		1880	22.93	22.90	
		1850.7	22.85	22.80	
	1RB Low (0)	1909.3	22.87	23.13	
		1880	22.83	22.81	
		1850.7	22.81	22.78	
	3RB High (3)	1909.3	22.84	22.90	
		1880	22.77	22.97	
		1850.7	22.73	22.73	
	3RB Middle (1)	1909.3	22.91	22.96	
		1880	22.85	23.05	
		1850.7	22.76	22.81	
	3RB Low (0)	1909.3	22.81	22.91	
		1880	22.76	22.95	
		1850.7	22.70	22.72	
	6RB (0)	1909.3	22.94	22.82	
		1880	22.93	23.03	
		1850.7	22.80	22.89	
	3 MHz	1RB High (14)	1908.5	22.74	23.17
			1880	22.84	22.83
			1851.5	22.72	22.56
		1RB Middle (7)	1908.5	22.81	23.27
			1880	22.92	22.99
			1851.5	22.73	22.73
1RB Low (0)		1908.5	22.87	23.18	
		1880	22.90	22.91	
		1851.5	22.73	22.59	

	8RB High (7)	1908.5	22.83	22.96	
		1880	22.93	22.96	
		1851.5	22.82	22.88	
	8RB Middle (4)	1908.5	22.93	22.99	
		1880	22.88	22.99	
		1851.5	22.89	22.97	
	8RB Low (0)	1908.5	22.89	22.95	
		1880	22.85	23.00	
		1851.5	22.84	22.92	
	15RB (0)	1908.5	22.82	22.91	
		1880	22.88	22.86	
		1851.5	22.75	22.77	
5 MHz	1RB High (24)	1907.5	22.82	22.99	
		1880	22.90	23.33	
		1852.5	22.76	22.81	
	1RB Middle (12)	1907.5	22.89	23.02	
		1880	22.95	23.41	
		1852.5	22.78	22.89	
	1RB Low (0)	1907.5	22.87	23.02	
		1880	22.89	23.36	
		1852.5	22.80	22.84	
	12RB High (13)	1907.5	22.88	22.93	
		1880	22.89	23.02	
		1852.5	22.80	22.80	
	12RB Middle (6)	1907.5	22.92	22.96	
		1880	22.94	23.05	
		1852.5	22.84	22.85	
	12RB Low (0)	1907.5	22.94	22.96	
		1880	22.93	23.05	
		1852.5	22.81	22.83	
	25RB (0)	1907.5	22.89	22.87	
		1880	22.91	22.92	
		1852.5	22.77	22.70	
	10 MHz	1RB High (49)	1905	22.95	23.14
			1880	22.77	22.87
			1855	22.62	22.70
1RB Middle (24)		1905	22.94	23.17	
		1880	22.70	22.93	
		1855	22.55	22.66	
1RB Low (0)		1905	22.89	23.14	
		1880	22.72	23.02	
		1855	22.66	22.75	
25RB High (25)		1905	22.55	22.89	
		1880	22.58	22.96	
		1855	22.46	22.79	
25RB Middle (12)		1905	22.61	22.93	
		1880	22.63	22.99	

	25RB Low (0)	1855	22.48	22.79	
		1905	22.60	22.86	
		1880	22.60	22.98	
		1855	22.46	22.77	
	50RB (0)	1905	22.60	22.81	
		1880	22.59	22.92	
1855		22.49	22.75		
15 MHz	1RB High (74)	1902.5	22.95	23.12	
		1880	22.86	23.08	
		1857.5	22.69	22.62	
	1RB Middle (37)	1902.5	22.95	23.23	
		1880	22.95	23.21	
		1857.5	22.76	22.64	
	1RB Low (0)	1902.5	22.83	23.15	
		1880	22.87	23.19	
		1857.5	22.75	22.59	
	36RB High (38)	1902.5	22.98	23.03	
		1880	22.96	22.99	
		1857.5	22.81	22.92	
	36RB Middle (19)	1902.5	22.82	22.99	
		1880	23.00	23.05	
		1857.5	22.85	22.94	
	36RB Low (0)	1902.5	22.77	22.94	
		1880	22.95	23.02	
		1857.5	22.82	22.87	
	75RB (0)	1902.5	22.83	22.96	
		1880	22.92	23.02	
		1857.5	22.79	22.88	
	20 MHz	1RB High (99)	1900	23.10	23.24
			1880	23.16	23.25
			1860	23.10	23.34
		1RB Middle (50)	1900	22.97	23.31
			1880	23.27	23.35
			1860	23.01	23.29
1RB Low (0)		1900	22.99	23.23	
		1880	23.16	23.37	
		1860	23.01	23.34	
50RB High (50)		1900	23.12	23.11	
		1880	23.21	23.19	
		1860	23.31	23.24	
50RB Middle (25)		1900	23.16	23.18	
		1880	23.23	23.22	
		1860	23.17	23.20	
50RB Low (0)		1900	23.13	23.17	
		1880	23.21	23.24	
		1860	23.08	23.09	
100RB		1900	23.11	23.13	

	(0)	1880	23.23	23.24
		1860	23.21	23.20

Band 5					
Bandwidth (MHz)	RB allocation RB offset (Start RB)	Frequency (MHz)	QPSK	16QAM	
			Actual output power (dBm)	Actual output power (dBm)	
1.4 MHz	1RB High (5)	848.3	22.99	22.30	
		836.5	23.26	22.26	
		824.7	23.24	22.46	
	1RB Middle (3)	848.3	23.02	22.36	
		836.5	23.26	22.29	
		824.7	23.29	22.49	
	1RB Low (0)	848.3	22.97	22.28	
		836.5	23.23	22.23	
		824.7	23.27	22.46	
	3RB High (3)	848.3	22.88	22.09	
		836.5	23.17	22.36	
		824.7	23.30	22.39	
	3RB Middle (1)	848.3	23.00	22.18	
		836.5	23.31	22.47	
		824.7	23.31	22.42	
	3RB Low (0)	848.3	22.91	22.15	
		836.5	23.20	22.39	
		824.7	23.30	22.41	
	6RB (0)	848.3	21.94	20.95	
		836.5	22.25	21.49	
		824.7	22.29	21.49	
	3 MHz	1RB High (14)	847.5	23.07	22.38
			836.5	23.27	22.26
			825.5	23.21	22.28
		1RB Middle (7)	847.5	23.16	22.44
			836.5	23.25	22.38
			825.5	23.28	22.38
1RB Low (0)		847.5	23.11	22.38	
		836.5	23.38	22.34	
		825.5	23.45	22.32	
8RB High (7)		847.5	21.99	21.13	
		836.5	22.36	21.39	
		825.5	22.36	21.52	
8RB Middle (4)		847.5	22.05	21.16	
		836.5	22.37	21.43	
		825.5	22.39	21.60	
8RB Low (0)		847.5	22.04	21.16	
		836.5	22.37	21.44	
		825.5	22.41	21.55	
15RB		847.5	22.05	21.13	

	(0)	836.5	22.32	21.34	
		825.5	22.34	21.45	
5 MHz	1RB High (24)	846.5	22.96	22.17	
		836.5	23.36	22.78	
		826.5	23.31	22.50	
	1RB Middle (12)	846.5	22.99	22.18	
		836.5	23.36	22.79	
		826.5	23.36	22.51	
	1RB Low (0)	846.5	23.04	22.20	
		836.5	23.39	22.86	
		826.5	23.37	22.52	
	12RB High (13)	846.5	22.02	21.16	
		836.5	22.30	21.49	
		826.5	22.35	21.46	
	12RB Middle (6)	846.5	22.09	21.16	
		836.5	22.36	21.55	
		826.5	22.43	21.52	
	12RB Low (0)	846.5	22.07	21.16	
		836.5	22.38	21.55	
		826.5	22.36	21.48	
	25RB (0)	846.5	22.02	21.08	
		836.5	22.31	21.43	
		826.5	22.35	21.38	
	10 MHz	1RB High (49)	844	23.02	22.34
			836.5	22.98	21.93
			829	23.08	21.96
1RB Middle (24)		844	23.06	22.35	
		836.5	23.01	22.02	
		829	23.00	21.97	
1RB Low (0)		844	23.04	22.28	
		836.5	22.92	22.03	
		829	22.96	21.92	
25RB High (25)		844	22.07	21.14	
		836.5	22.00	21.14	
		829	22.15	21.21	
25RB Middle (12)		844	22.07	21.15	
		836.5	22.07	21.18	
		829	22.11	21.18	
25RB Low (0)		844	22.01	21.03	
		836.5	22.08	21.21	
		829	22.10	21.16	
50RB (0)		844	21.97	20.99	
		836.5	22.03	21.11	
		829	22.02	21.09	

Band 7				
Bandwidth	RB allocation	Frequency	QPSK	16QAM

(MHz)	RB offset (Start RB)	(MHz)	Actual output power (dBm)	Actual output power (dBm)	
5 MHz	1RB High (24)	2567.5	23.48	22.56	
		2535	23.37	22.55	
		2502.5	23.59	22.87	
	1RB Middle (12)	2567.5	23.43	22.52	
		2535	23.34	22.55	
		2502.5	23.55	22.98	
	1RB Low (0)	2567.5	23.42	22.52	
		2535	23.34	22.49	
		2502.5	23.53	22.94	
	12RB High (13)	2567.5	22.57	21.64	
		2535	22.39	21.53	
		2502.5	22.54	21.76	
	12RB Middle (6)	2567.5	22.53	21.65	
		2535	22.47	21.54	
		2502.5	22.57	21.73	
	12RB Low (0)	2567.5	22.51	21.62	
		2535	22.44	21.53	
		2502.5	22.56	21.70	
	25RB (0)	2567.5	22.46	21.52	
		2535	22.40	21.48	
		2502.5	22.50	21.65	
	10 MHz	1RB High (49)	2565	23.51	22.85
			2535	23.42	22.42
			2505	23.51	22.39
		1RB Middle (24)	2565	23.39	22.75
			2535	23.40	22.35
			2505	23.49	22.35
1RB Low (0)		2565	23.35	22.69	
		2535	23.35	22.39	
		2505	23.47	22.32	
25RB High (25)		2565	22.52	21.60	
		2535	22.47	21.62	
		2505	22.53	21.60	
25RB Middle (12)		2565	22.52	21.61	
		2535	22.43	21.59	
		2505	22.55	21.61	
25RB Low (0)		2565	22.46	21.55	
		2535	22.39	21.55	
		2505	22.54	21.59	
50RB (0)		2565	22.30	21.55	
		2535	22.45	21.50	
		2505	22.50	21.53	
15 MHz		1RB High (74)	2562.5	23.49	22.36
			2535	23.47	22.77
			2507.5	23.51	22.87

	1RB Middle (37)	2562.5	23.33	22.31	
		2535	23.42	22.71	
		2507.5	23.55	22.83	
	1RB Low (0)	2562.5	23.29	22.27	
		2535	23.42	22.74	
		2507.5	23.52	22.77	
	36RB High (38)	2562.5	22.52	21.60	
		2535	22.46	21.55	
		2507.5	22.51	21.60	
	36RB Middle (19)	2562.5	22.46	21.54	
		2535	22.47	21.55	
		2507.5	22.54	21.58	
	36RB Low (0)	2562.5	22.38	21.50	
		2535	22.42	21.57	
		2507.5	22.57	21.61	
	75RB (0)	2562.5	22.45	21.58	
		2535	22.41	21.57	
		2507.5	22.55	21.60	
	20 MHz	1RB High (99)	2560	23.32	22.63
			2535	23.18	22.81
			2510	23.28	22.81
		1RB Middle (50)	2560	23.19	22.57
			2535	23.28	22.76
			2510	23.32	22.76
		1RB Low (0)	2560	23.14	22.64
			2535	23.26	22.83
			2510	23.31	22.66
50RB High (50)		2560	22.34	21.37	
		2535	22.42	21.46	
		2510	22.39	21.48	
50RB Middle (25)		2560	22.42	21.45	
		2535	22.40	21.46	
		2510	22.47	21.55	
50RB Low (0)		2560	22.28	21.35	
		2535	22.35	21.43	
		2510	22.39	21.44	
100RB (0)		2560	22.33	21.40	
		2535	22.33	21.43	
		2510	22.34	21.42	

Band 12				
Bandwidth (MHz)	RB allocation	Frequency (MHz)	QPSK	16QAM
	RB offset (Start RB)		Actual output power (dBm)	Actual output power (dBm)
1.4 MHz	1RB High (5)	715.3	23.35	22.54
		707.5	23.24	22.13
		699.7	23.15	22.04
	1RB	715.3	23.39	22.55

	Middle (3)	707.5	23.27	22.15	
		699.7	23.19	22.07	
		715.3	23.35	22.55	
	1RB Low (0)	707.5	23.22	22.12	
		699.7	23.20	22.00	
		715.3	23.10	22.20	
	3RB High (3)	707.5	23.03	22.25	
		699.7	22.80	21.98	
		715.3	23.21	22.39	
	3RB Middle (1)	707.5	23.14	22.28	
		699.7	22.99	21.95	
		715.3	23.16	22.31	
	3RB Low (0)	707.5	23.01	22.20	
		699.7	22.85	21.90	
		715.3	22.35	21.23	
	6RB (0)	707.5	22.25	21.34	
		699.7	22.13	21.16	
		714.5	23.45	22.60	
3 MHz	1RB High (14)	707.5	23.31	22.16	
		700.5	23.26	22.00	
		714.5	23.49	22.69	
	1RB Middle (7)	707.5	23.37	22.25	
		700.5	23.26	22.02	
		714.5	23.28	22.55	
	1RB Low (0)	707.5	23.29	22.22	
		700.5	23.17	21.92	
		714.5	22.42	21.43	
	8RB High (7)	707.5	22.28	21.29	
		700.5	22.24	21.30	
		714.5	22.40	21.43	
	8RB Middle (4)	707.5	22.35	21.32	
		700.5	22.16	21.20	
		714.5	22.24	21.30	
	8RB Low (0)	707.5	22.29	21.32	
		700.5	22.16	21.21	
		714.5	22.23	21.28	
	15RB (0)	707.5	22.25	21.22	
		700.5	22.23	21.21	
		713.5	23.43	22.72	
	5 MHz	1RB High (24)	707.5	23.31	22.27
			701.5	23.31	22.28
			713.5	23.27	22.64
1RB Middle (12)		707.5	23.29	22.25	
		701.5	23.30	22.27	
		713.5	23.27	22.67	
1RB Low (0)		707.5	23.21	22.16	
		701.5	23.27	22.19	

	12RB High (13)	713.5	22.19	21.33
		707.5	22.22	21.28
		701.5	22.15	21.28
	12RB Middle (6)	713.5	22.25	21.42
		707.5	22.31	21.35
		701.5	22.23	21.27
	12RB Low (0)	713.5	22.28	21.37
		707.5	22.29	21.29
		701.5	22.14	21.27
	25RB (0)	713.5	22.20	21.32
		707.5	22.25	21.20
		701.5	22.19	21.19
10 MHz	1RB High (49)	711	23.08	22.29
		707.5	23.01	21.91
		704	23.12	21.87
	1RB Middle (24)	711	23.08	22.30
		707.5	23.02	21.97
		704	23.08	21.91
	1RB Low (0)	711	23.08	22.33
		707.5	22.94	21.91
		704	23.01	21.82
	25RB High (25)	711	21.99	21.07
		707.5	22.00	21.12
		704	22.08	21.06
	25RB Middle (12)	711	22.04	21.13
		707.5	22.07	21.15
		704	22.11	21.10
	25RB Low (0)	711	22.02	21.08
		707.5	22.05	21.15
		704	22.05	21.10
	50RB (0)	711	22.00	21.06
		707.5	22.01	21.07
		704	22.01	21.04

Band 13				
Bandwidth (MHz)	RB allocation	Frequency (MHz)	QPSK	16QAM
	RB offset (Start RB)		Actual output power (dBm)	Actual output power (dBm)
5 MHz	1RB High (24)	784.4	22.57	22.14
		782	22.53	21.65
		799.5	22.61	21.73
	1RB Middle (12)	784.4	22.58	22.15
		782	22.55	21.64
		799.5	22.54	21.61
	1RB Low (0)	784.4	22.51	22.04
		782	22.60	21.60

	12RB High (13)	799.5	22.59	21.59
		784.4	21.60	20.81
		782	21.53	20.65
		799.5	21.54	20.67
	12RB Middle (6)	784.4	21.56	20.74
		782	21.57	20.67
		799.5	21.62	20.74
	12RB Low (0)	784.4	21.56	20.72
		782	21.58	20.69
		799.5	21.48	20.57
	25RB (0)	784.4	21.56	20.62
		782	21.54	20.57
799.5		21.53	20.65	
10 MHz	1RB High (49)	782	22.60	22.47
	1RB Middle (24)	782	22.54	22.45
	1RB Low (0)	782	22.47	22.37
	25RB High (25)	782	22.56	22.28
	25RB Middle (12)	782	22.59	22.60
	25RB Low (0)	782	22.59	22.56
	50RB (0)	782	22.55	22.54

Band 66				
Bandwidth (MHz)	RB allocation	Frequency (MHz)	QPSK	16QAM
	RB offset (Start RB)		Actual output power (dBm)	Actual output power (dBm)
1.4 MHz	1RB High (5)	1779.3	23.11	23.11
		1745	22.93	23.04
		1710.7	22.86	23.17
	1RB Middle (3)	1779.3	23.17	23.13
		1745	23.01	23.11
		1710.7	22.94	23.23
	1RB Low (0)	1779.3	23.11	23.10
		1745	22.94	23.01
		1710.7	22.86	23.18
	3RB High (3)	1779.3	23.03	23.25
		1745	22.88	23.02
		1710.7	22.87	23.03
	3RB Middle (1)	1779.3	23.17	23.35
		1745	22.96	23.09
		1710.7	22.94	23.08
	3RB Low (0)	1779.3	23.07	23.26
		1745	22.91	23.02
		1710.7	22.90	23.02
6RB (0)	1779.3	23.24	23.34	
	1745	22.93	23.10	

		1710.7	22.86	22.83
3 MHz	1RB High (14)	1778.5	23.22	23.03
		1745	22.93	23.32
		1711.5	22.87	22.88
	1RB Middle (7)	1778.5	23.28	23.14
		1745	23.08	23.44
		1711.5	22.97	23.01
	1RB Low (0)	1778.5	23.18	23.08
		1745	22.93	23.31
		1711.5	22.89	22.91
	8RB High (7)	1778.5	23.22	23.30
		1745	22.98	23.09
		1711.5	22.93	22.98
	8RB Middle (4)	1778.5	23.25	23.36
		1745	23.00	23.12
		1711.5	22.97	23.04
	8RB Low (0)	1778.5	23.21	23.34
		1745	22.97	23.09
		1711.5	22.91	22.99
15RB (0)	1778.5	23.23	23.21	
	1745	22.96	23.03	
	1711.5	22.92	22.90	
5 MHz	1RB High (24)	1777.5	23.26	23.32
		1745	22.93	23.15
		1712.5	22.91	23.02
	1RB Middle (12)	1777.5	23.31	23.36
		1745	22.96	23.24
		1712.5	22.95	23.01
	1RB Low (0)	1777.5	23.17	23.29
		1745	22.98	23.25
		1712.5	22.93	22.97
	12RB High (13)	1777.5	23.18	23.28
		1745	23.00	23.18
		1712.5	22.94	23.00
	12RB Middle (6)	1777.5	23.27	23.35
		1745	23.05	23.19
		1712.5	22.98	23.05
	12RB Low (0)	1777.5	23.14	23.23
		1745	23.03	23.15
		1712.5	22.96	23.02
25RB (0)	1777.5	23.14	23.18	
	1745	22.98	23.08	
	1712.5	22.93	22.91	
10 MHz	1RB High (49)	1775	23.23	23.09
		1745	23.05	23.20
		1715	22.90	23.03
	1RB	1775	23.08	23.08

	Middle (24)	1745	22.99	23.35
		1715	22.88	23.00
		1775	23.09	23.03
	1RB Low (0)	1745	23.03	23.31
		1715	22.88	22.88
		1775	23.14	23.18
	25RB High (25)	1745	22.97	23.10
		1715	23.00	23.16
		1775	23.16	23.22
	25RB Middle (12)	1745	23.00	23.08
		1715	22.95	23.12
		1775	23.17	23.22
	25RB Low (0)	1745	22.98	23.07
		1715	22.95	23.04
		1775	23.14	23.17
	50RB (0)	1745	22.98	23.02
		1715	23.02	23.12
		1772.5	23.16	23.12
15 MHz	1RB High (74)	1745	23.04	23.15
		1717.5	22.89	22.87
		1772.5	23.18	23.45
	1RB Middle (37)	1745	23.00	23.34
		1717.5	22.84	22.85
		1772.5	23.09	23.35
	1RB Low (0)	1745	23.00	23.25
		1717.5	22.85	22.78
		1772.5	23.11	23.29
	36RB High (38)	1745	23.02	23.03
		1717.5	23.02	23.09
		1772.5	23.16	23.36
	36RB Middle (19)	1745	22.99	23.07
		1717.5	23.07	23.13
		1772.5	23.09	23.25
	36RB Low (0)	1745	23.04	23.05
		1717.5	22.92	23.00
		1772.5	23.14	23.31
75RB (0)	1745	23.01	23.09	
	1717.5	23.02	23.16	
	1770	23.14	23.39	
20 MHz	1RB High (99)	1745	22.99	23.29
		1720	22.92	23.34
		1770	23.10	23.36
	1RB Middle (50)	1745	22.97	23.26
		1720	23.16	23.34
		1770	23.07	23.26
	1RB Low (0)	1745	22.83	23.07
		1720	22.86	23.25

	50RB High (50)	1770	23.03	23.17
		1745	22.96	23.04
		1720	22.98	23.06
	50RB Middle (25)	1770	23.07	23.14
		1745	23.03	23.04
		1720	23.04	23.19
	50RB Low (0)	1770	23.06	23.01
		1745	22.97	23.00
		1720	23.10	23.10
	100RB (0)	1770	23.05	23.03
		1745	22.94	23.01
		1720	22.99	23.09

Low power

Band 2					
Bandwidth (MHz)	RB allocation	Frequency (MHz)	QPSK	16QAM	
	RB offset (Start RB)		Actual output power (dBm)	Actual output power (dBm)	
1.4 MHz	1RB High (5)	1909.3	15.47	15.63	
		1880	15.59	15.72	
		1850.7	15.42	15.81	
	1RB Middle (3)	1909.3	15.56	15.67	
		1880	15.64	15.78	
		1850.7	15.49	15.87	
	1RB Low (0)	1909.3	15.51	15.58	
		1880	15.59	15.72	
		1850.7	15.42	15.83	
	3RB High (3)	1909.3	15.49	15.73	
		1880	15.50	15.61	
		1850.7	15.43	15.64	
	3RB Middle (1)	1909.3	15.54	15.78	
		1880	15.56	15.70	
		1850.7	15.49	15.72	
	3RB Low (0)	1909.3	15.47	15.72	
		1880	15.48	15.62	
		1850.7	15.41	15.66	
	6RB (0)	1909.3	15.56	15.78	
		1880	15.58	15.79	
		1850.7	15.43	15.42	
	3 MHz	1RB High (14)	1908.5	15.58	15.98
			1880	15.59	15.66
			1851.5	15.40	15.38
		1RB Middle (7)	1908.5	15.62	15.96
			1880	15.70	15.78
			1851.5	15.54	15.57
1RB		1908.5	15.52	15.98	

	Low (0)	1880	15.60	15.70	
		1851.5	15.43	15.41	
	8RB High (7)	1908.5	15.59	15.70	
		1880	15.60	15.70	
		1851.5	15.50	15.63	
	8RB Middle (4)	1908.5	15.62	15.77	
		1880	15.63	15.77	
		1851.5	15.51	15.66	
	8RB Low (0)	1908.5	15.61	15.72	
		1880	15.60	15.73	
		1851.5	15.51	15.65	
	15RB (0)	1908.5	15.60	15.70	
1880		15.62	15.61		
1851.5		15.47	15.58		
5 MHz	1RB High (24)	1907.5	15.61	15.78	
		1880	15.56	15.93	
		1852.5	15.42	15.62	
	1RB Middle (12)	1907.5	15.68	15.83	
		1880	15.63	15.98	
		1852.5	15.49	15.68	
	1RB Low (0)	1907.5	15.64	15.86	
		1880	15.60	15.99	
		1852.5	15.44	15.64	
	12RB High (13)	1907.5	15.67	15.72	
		1880	15.60	15.79	
		1852.5	15.48	15.59	
	12RB Middle (6)	1907.5	15.71	15.76	
		1880	15.61	15.84	
		1852.5	15.53	15.62	
	12RB Low (0)	1907.5	15.71	15.74	
		1880	15.61	15.83	
		1852.5	15.48	15.62	
	25RB (0)	1907.5	15.69	15.68	
		1880	15.62	15.70	
		1852.5	15.46	15.53	
	10 MHz	1RB High (49)	1905	15.61	15.96
			1880	15.66	15.71
			1855	15.55	15.53
1RB Middle (24)		1905	15.73	15.98	
		1880	15.70	15.73	
		1855	15.51	15.50	
1RB Low (0)		1905	15.56	15.89	
		1880	15.80	15.80	
		1855	15.69	15.53	
25RB High (25)		1905	15.72	15.71	
		1880	15.60	15.74	
		1855	15.50	15.57	

	25RB Middle (12)	1905	15.70	15.73	
		1880	15.64	15.77	
		1855	15.53	15.62	
	25RB Low (0)	1905	15.52	15.58	
		1880	15.64	15.76	
		1855	15.47	15.58	
	50RB (0)	1905	15.50	15.56	
		1880	15.63	15.72	
		1855	15.53	15.58	
15 MHz	1RB High (74)	1902.5	15.57	15.53	
		1880	15.64	15.97	
		1857.5	15.37	15.88	
	1RB Middle (37)	1902.5	15.57	15.60	
		1880	15.66	15.94	
		1857.5	15.42	15.90	
	1RB Low (0)	1902.5	15.45	15.49	
		1880	15.70	15.93	
		1857.5	15.42	15.83	
	36RB High (38)	1902.5	15.63	15.71	
		1880	15.58	15.71	
		1857.5	15.43	15.48	
	36RB Middle (19)	1902.5	15.52	15.61	
		1880	15.62	15.80	
		1857.5	15.45	15.50	
	36RB Low (0)	1902.5	15.44	15.59	
		1880	15.59	15.73	
		1857.5	15.40	15.45	
	75RB (0)	1902.5	15.50	15.60	
		1880	15.59	15.74	
		1857.5	15.40	15.47	
	20 MHz	1RB High (99)	1900	15.48	15.78
			1880	15.60	15.75
			1860	15.53	15.76
		1RB Middle (50)	1900	15.39	15.97
			1880	15.59	15.98
			1860	15.40	15.78
1RB Low (0)		1900	15.39	15.95	
		1880	15.57	15.99	
		1860	15.42	15.96	
50RB High (50)		1900	15.50	15.58	
		1880	15.60	15.66	
		1860	15.61	15.67	
50RB Middle (25)		1900	15.50	15.66	
		1880	15.62	15.71	
		1860	15.53	15.67	
50RB Low (0)		1900	15.51	15.62	
		1880	15.60	15.70	

		1860	15.49	15.57
	100RB (0)	1900	15.47	15.61
		1880	15.61	15.68
		1860	15.59	15.66

Band 5				
Bandwidth (MHz)	RB allocation	Frequency (MHz)	QPSK	16QAM
	RB offset (Start RB)		Actual output power (dBm)	Actual output power (dBm)
1.4 MHz	1RB High (5)	848.3	20.91	20.06
		836.5	21.15	20.55
		824.7	21.17	20.35
	1RB Middle (3)	848.3	20.97	20.12
		836.5	21.21	20.61
		824.7	21.27	20.38
	1RB Low (0)	848.3	20.93	20.02
		836.5	21.19	20.62
		824.7	21.19	20.35
	3RB High (3)	848.3	20.82	20.01
		836.5	21.20	20.45
		824.7	21.23	20.48
	3RB Middle (1)	848.3	20.89	20.05
		836.5	21.26	20.50
		824.7	21.23	20.55
	3RB Low (0)	848.3	20.84	19.99
		836.5	21.23	20.46
		824.7	21.18	20.49
	6RB (0)	848.3	19.89	19.09
		836.5	20.18	19.14
		824.7	20.24	19.43
3 MHz	1RB High (14)	847.5	20.91	19.86
		836.5	21.21	20.63
		825.5	21.18	20.36
	1RB Middle (7)	847.5	20.99	19.95
		836.5	21.32	20.73
		825.5	21.32	20.47
	1RB Low (0)	847.5	20.92	19.92
		836.5	21.25	20.68
		825.5	21.29	20.41
	8RB High (7)	847.5	19.92	19.08
		836.5	20.25	19.32
		825.5	20.23	19.40
	8RB Middle (4)	847.5	19.93	19.14
		836.5	20.28	19.39
		825.5	20.32	19.40
	8RB Low (0)	847.5	19.92	19.09
		836.5	20.27	19.38

		825.5	20.31	19.38	
	15RB (0)	847.5	19.89	19.04	
		836.5	20.21	19.36	
		825.5	20.27	19.32	
5 MHz	1RB High (24)	846.5	20.88	20.49	
		836.5	21.23	20.36	
		826.5	21.30	20.47	
	1RB Middle (12)	846.5	20.91	20.51	
		836.5	21.30	20.37	
		826.5	21.36	20.46	
	1RB Low (0)	846.5	20.94	20.48	
		836.5	21.26	20.44	
		826.5	21.38	20.51	
	12RB High (13)	846.5	19.93	19.09	
		836.5	20.24	19.32	
		826.5	20.22	19.41	
	12RB Middle (6)	846.5	19.93	19.15	
		836.5	20.33	19.39	
		826.5	20.28	19.46	
	12RB Low (0)	846.5	19.93	19.16	
		836.5	20.29	19.41	
		826.5	20.31	19.45	
	25RB (0)	846.5	19.92	19.07	
		836.5	20.27	19.26	
		826.5	20.32	19.36	
	10 MHz	1RB High (49)	844	20.91	19.93
			836.5	21.26	20.59
			829	21.24	20.38
1RB Middle (24)		844	20.97	19.95	
		836.5	21.30	20.68	
		829	21.20	20.38	
1RB Low (0)		844	21.08	20.08	
		836.5	21.32	20.75	
		829	21.30	20.38	
25RB High (25)		844	19.98	19.08	
		836.5	20.25	19.38	
		829	20.34	19.53	
25RB Middle (12)		844	20.01	19.08	
		836.5	20.42	19.39	
		829	20.31	19.58	
25RB Low (0)		844	20.13	19.23	
		836.5	20.31	19.45	
		829	20.31	19.50	
50RB (0)		844	20.10	19.19	
		836.5	20.33	19.36	
		829	20.40	19.48	

Band 7					
Bandwidth (MHz)	RB allocation	Frequency (MHz)	QPSK	16QAM	
	RB offset (Start RB)		Actual output power (dBm)	Actual output power (dBm)	
5 MHz	1RB High (24)	2567.5	14.91	14.10	
		2535	14.79	14.03	
		2502.5	15.01	14.49	
	1RB Middle (12)	2567.5	14.88	14.04	
		2535	14.79	14.01	
		2502.5	14.99	14.48	
	1RB Low (0)	2567.5	14.82	14.01	
		2535	14.76	14.02	
		2502.5	14.92	14.47	
	12RB High (13)	2567.5	13.92	13.03	
		2535	13.87	12.95	
		2502.5	14.04	13.21	
	12RB Middle (6)	2567.5	13.95	13.06	
		2535	13.85	12.98	
		2502.5	14.03	13.19	
	12RB Low (0)	2567.5	13.91	13.00	
		2535	13.82	12.94	
		2502.5	13.98	13.14	
	25RB (0)	2567.5	13.92	12.91	
		2535	13.81	12.93	
		2502.5	13.95	13.13	
	10 MHz	1RB High (49)	2565	15.03	13.93
			2535	14.85	14.26
			2505	14.97	13.99
1RB Middle (24)		2565	14.93	13.80	
		2535	14.83	14.20	
		2505	15.02	14.04	
1RB Low (0)		2565	14.72	13.78	
		2535	14.68	14.19	
		2505	14.54	13.99	
25RB High (25)		2565	13.95	13.00	
		2535	13.91	12.93	
		2505	13.95	13.11	
25RB Middle (12)		2565	13.90	12.98	
		2535	13.90	12.92	
		2505	14.05	13.14	
25RB Low (0)		2565	13.88	12.89	
		2535	13.84	12.92	
		2505	13.98	13.10	
50RB (0)		2565	13.88	12.92	
		2535	13.93	12.93	
		2505	13.94	13.01	
15 MHz		1RB	2562.5	14.93	14.40

	High (74)	2535	14.82	13.82
		2507.5	15.04	14.37
		2562.5	14.77	14.28
	1RB Middle (37)	2535	14.75	13.76
		2507.5	15.08	14.41
		2562.5	14.72	14.22
	1RB Low (0)	2535	14.81	13.74
		2507.5	15.00	14.32
		2562.5	13.76	12.96
	36RB High (38)	2535	13.80	12.92
		2507.5	13.94	13.11
		2562.5	13.82	12.95
	36RB Middle (19)	2535	13.84	12.94
		2507.5	13.95	13.06
		2562.5	13.80	12.86
	36RB Low (0)	2535	13.85	12.90
		2507.5	13.96	13.11
		2562.5	13.82	12.92
	75RB (0)	2535	13.85	12.92
		2507.5	13.88	13.05
		2560	14.95	14.31
20 MHz	1RB High (99)	2535	14.73	14.40
		2510	14.89	14.37
		2560	14.68	14.18
	1RB Middle (50)	2535	14.70	14.35
		2510	14.85	14.36
		2560	14.71	14.12
	1RB Low (0)	2535	14.81	14.41
		2510	14.86	14.34
		2560	13.93	12.91
	50RB High (50)	2535	13.95	12.93
		2510	13.94	13.03
		2560	13.92	12.93
	50RB Middle (25)	2535	13.84	12.91
		2510	13.85	12.99
		2560	13.82	12.84
	50RB Low (0)	2535	13.81	12.88
		2510	13.90	12.95
		2560	13.88	12.89
	100RB (0)	2535	13.84	12.92
		2510	13.90	12.95

Band 12				
Bandwidth (MHz)	RB allocation	Frequency (MHz)	QPSK	16QAM
	RB offset (Start RB)		Actual output power (dBm)	Actual output power (dBm)
1.4 MHz	1RB High (5)	715.3	21.37	20.72
		707.5	21.29	20.34

	1RB Middle (3)	699.7	21.14	20.27	
		715.3	21.41	20.75	
		707.5	21.36	20.40	
	1RB Low (0)	699.7	21.24	20.29	
		715.3	21.40	20.74	
		707.5	21.19	20.34	
	3RB High (3)	699.7	21.17	20.25	
		715.3	21.32	20.54	
		707.5	21.28	20.52	
	3RB Middle (1)	699.7	21.10	20.22	
		715.3	21.38	20.62	
		707.5	21.39	20.55	
	3RB Low (0)	699.7	21.18	20.30	
		715.3	21.34	20.55	
		707.5	21.33	20.52	
6RB (0)	699.7	21.09	20.22		
	715.3	20.30	19.33		
	707.5	20.22	19.53		
3 MHz	1RB High (14)	699.7	20.08	19.30	
		714.5	20.99	20.77	
		707.5	21.35	20.37	
	1RB Middle (7)	700.5	21.27	20.19	
		714.5	21.03	20.84	
		707.5	21.42	20.46	
	1RB Low (0)	700.5	21.26	20.20	
		714.5	21.25	20.72	
		707.5	21.35	20.41	
	8RB High (7)	700.5	21.17	20.09	
		714.5	20.39	19.55	
		707.5	20.33	19.44	
	8RB Middle (4)	700.5	20.23	19.42	
		714.5	20.48	19.60	
		707.5	20.38	19.48	
	8RB Low (0)	700.5	20.17	19.39	
		714.5	20.34	19.44	
		707.5	20.33	19.45	
	15RB (0)	700.5	20.20	19.35	
		714.5	20.36	19.42	
		707.5	20.34	19.33	
	5 MHz	1RB High (24)	700.5	20.23	19.36
			713.5	20.94	20.50
			707.5	20.72	20.48
1RB Middle (12)		701.5	20.73	20.79	
		713.5	20.78	20.45	
		707.5	20.77	20.48	
1RB		701.5	20.74	20.79	
		713.5	20.79	20.39	

	Low (0)	707.5	20.65	20.38
		701.5	20.65	20.69
		713.5	20.32	19.41
	12RB High (13)	707.5	20.31	19.44
		701.5	20.25	19.48
		713.5	20.33	19.49
	12RB Middle (6)	707.5	20.32	19.46
		701.5	20.28	19.51
		713.5	20.32	19.46
	12RB Low (0)	707.5	20.35	19.47
		701.5	20.28	19.47
		713.5	20.32	19.36
	25RB (0)	707.5	20.31	19.42
		701.5	20.23	19.40
		711	21.51	20.40
10 MHz	1RB High (49)	707.5	21.44	20.79
		704	21.31	20.33
		711	21.38	20.39
	1RB Middle (24)	707.5	21.33	20.74
		704	21.17	20.28
		711	21.33	20.26
	1RB Low (0)	707.5	21.19	20.64
		704	21.12	20.18
		711	20.46	19.51
	25RB High (25)	707.5	20.37	19.44
		704	20.37	19.53
		711	20.35	19.46
	25RB Middle (12)	707.5	20.39	19.45
		704	20.40	19.55
		711	20.32	19.42
25RB Low (0)	707.5	20.34	19.49	
	704	20.25	19.45	
	711	20.34	19.41	
50RB (0)	707.5	20.36	19.43	
	704	20.36	19.46	

Band 13				
Bandwidth (MHz)	RB allocation	Frequency (MHz)	QPSK	16QAM
	RB offset (Start RB)		Actual output power (dBm)	Actual output power (dBm)
5 MHz	1RB High (24)	784.4	20.98	20.23
		782	20.97	20.47
		799.5	20.99	20.18
	1RB Middle (12)	784.4	21.11	20.27
		782	20.98	20.54
		799.5	20.90	20.06

	1RB Low (0)	784.4	20.96	20.15
		782	21.01	20.56
		799.5	20.91	20.07
	12RB High (13)	784.4	20.09	19.23
		782	19.98	19.20
		799.5	20.01	19.11
	12RB Middle (6)	784.4	19.99	19.17
		782	20.00	19.23
		799.5	20.06	19.12
	12RB Low (0)	784.4	20.00	19.15
		782	20.02	19.19
		799.5	19.93	19.02
25RB (0)	784.4	19.99	19.06	
	782	19.98	19.10	
	799.5	20.05	19.03	
10 MHz	1RB High (49)	782	21.00	21.13
	1RB Middle (24)	782	20.99	21.08
	1RB Low (0)	782	20.88	20.94
	25RB High (25)	782	20.99	21.15
	25RB Middle (12)	782	21.03	21.23
	25RB Low (0)	782	21.04	21.18
	50RB (0)	782	21.05	21.12

Band 66				
Bandwidth (MHz)	RB allocation	Frequency (MHz)	QPSK	16QAM
	RB offset (Start RB)		Actual output power (dBm)	Actual output power (dBm)
1.4 MHz	1RB High (5)	1779.3	14.87	14.86
		1745	14.81	15.01
		1710.7	14.79	14.71
	1RB Middle (3)	1779.3	14.94	14.92
		1745	14.91	14.97
		1710.7	14.84	14.75
	1RB Low (0)	1779.3	14.90	14.86
		1745	14.80	14.96
		1710.7	14.74	14.71
	3RB High (3)	1779.3	14.76	14.78
		1745	14.77	14.87
		1710.7	14.75	14.85
	3RB Middle (1)	1779.3	14.84	14.81
		1745	14.83	14.97
		1710.7	14.79	14.91
	3RB Low (0)	1779.3	14.74	14.76
		1745	14.81	14.91
		1710.7	14.74	14.79

	6RB (0)	1779.3	14.85	14.92	
		1745	14.84	14.71	
		1710.7	14.84	14.86	
3 MHz	1RB High (14)	1778.5	14.91	14.70	
		1745	14.87	14.95	
		1711.5	14.82	14.76	
	1RB Middle (7)	1778.5	14.96	14.83	
		1745	14.98	14.98	
		1711.5	14.97	14.88	
	1RB Low (0)	1778.5	14.85	14.75	
		1745	14.88	14.99	
		1711.5	14.82	14.81	
	8RB High (7)	1778.5	14.86	14.94	
		1745	14.88	14.86	
		1711.5	14.84	14.86	
	8RB Middle (4)	1778.5	14.93	14.94	
		1745	14.92	14.94	
		1711.5	14.89	14.89	
	8RB Low (0)	1778.5	14.88	14.95	
		1745	14.87	14.90	
		1711.5	14.86	14.85	
	15RB (0)	1778.5	14.89	14.85	
		1745	14.84	14.83	
		1711.5	14.89	14.74	
	5 MHz	1RB High (24)	1777.5	14.94	14.96
			1745	14.83	15.06
			1712.5	14.89	14.90
1RB Middle (12)		1777.5	14.98	14.97	
		1745	14.89	15.08	
		1712.5	14.90	14.88	
1RB Low (0)		1777.5	15.01	14.98	
		1745	14.87	15.02	
		1712.5	14.89	15.07	
12RB High (13)		1777.5	14.88	14.91	
		1745	14.87	14.95	
		1712.5	14.87	14.81	
12RB Middle (6)		1777.5	14.94	14.94	
		1745	14.92	14.99	
		1712.5	14.91	14.90	
12RB Low (0)		1777.5	14.91	14.95	
		1745	14.91	14.97	
		1712.5	14.92	14.87	
25RB (0)		1777.5	14.92	14.84	
		1745	14.87	14.84	
		1712.5	14.86	14.77	
10 MHz		1RB High (49)	1775	14.87	14.74
			1745	14.85	15.02

	1RB Middle (24)	1715	14.88	14.85
		1775	14.91	14.79
		1745	14.88	14.95
	1RB Low (0)	1715	14.81	14.80
		1775	14.82	14.67
		1745	14.91	14.96
	25RB High (25)	1715	14.84	14.79
		1775	14.89	14.88
		1745	14.87	14.81
	25RB Middle (12)	1715	14.97	14.96
		1775	14.98	14.87
		1745	14.92	14.89
	25RB Low (0)	1715	14.91	14.91
		1775	14.88	14.75
		1745	14.91	14.85
	50RB (0)	1715	14.91	14.87
		1775	14.83	14.69
		1745	14.86	14.80
15 MHz	1RB High (74)	1715	14.99	14.93
		1775	14.83	14.69
		1745	14.86	14.80
	1RB Middle (37)	1772.5	14.79	14.67
		1745	14.78	14.88
		1717.5	14.90	14.98
	1RB Low (0)	1772.5	14.88	14.76
		1745	14.85	15.01
		1717.5	14.85	14.97
	36RB High (38)	1772.5	14.86	14.64
		1745	14.87	14.94
		1717.5	14.84	14.94
	36RB Middle (19)	1772.5	14.92	14.84
		1745	14.85	14.87
		1717.5	14.90	14.81
	36RB Low (0)	1772.5	14.87	14.76
		1745	14.90	14.87
		1717.5	14.92	14.90
75RB (0)	1772.5	14.85	14.75	
	1745	14.82	14.84	
	1717.5	14.85	14.78	
20 MHz	1RB High (99)	1772.5	14.81	14.76
		1745	14.86	14.81
		1717.5	14.88	14.89
	1RB Middle (50)	1770	14.89	15.28
		1745	14.78	15.27
		1720	14.81	15.30
	1RB	1770	14.82	15.26
		1745	14.83	15.28
		1720	14.87	15.23
1770	14.80	15.24		

	Low (0)	1745	14.75	15.11
		1720	14.73	15.21
	50RB High (50)	1770	14.96	14.84
		1745	14.88	14.87
		1720	14.87	14.95
	50RB Middle (25)	1770	14.83	14.93
		1745	14.81	14.97
		1720	14.83	15.06
	50RB Low (0)	1770	14.87	14.86
		1745	14.86	14.94
		1720	14.90	15.02
	100RB (0)	1770	14.79	14.87
1745		14.82	14.92	
1720		14.87	14.99	

The conducted power measurement results of downlink LTE CA Conduced Power are as below (2CA)

Normal power														
DL LTE CA Class	PCC								SCC			Power		Tune-up
	PCC Band	PCC Bandwidth (MHz)	PCC UL RB size	PCC UL RB offset	PCC DL RB size	PCC DL RB offset	PCC UL Channel	PCC DL Channel	SCC Band	SCC Bandwidth (MHz)	SCC DL Channel	Rel 8 LTE Tx Power(dBm)	Rel 10 DL LTE CA Tx Power(dBm)	
2C	2	20	50	25	100	0	18700	700	2	20	898	23.31	23.17	23.5
2A-2A	2	20	50	25	100	0	18700	700	2	20	1100	23.31	23.14	23.5
2A-4A	2	20	50	25	100	0	18700	700	4	20	2175	23.31	23.23	23.5
2A-5A	2	20	50	25	100	0	18700	700	5	10	2525	23.31	23.21	23.5
2A-13A	2	20	50	25	100	0	18700	700	13	10	5230	23.31	23.19	23.5
2A-66A	2	20	50	25	100	0	18700	700	66	20	66786	23.31	23.2	23.5
5B	5	5	1	0	25	0	20425	2425	5	3	2464	23.37	23.3	24
5A-2A	5	3	1	0	15	0	20415	2415	2	20	900	23.45	23.29	24
5A-4A	5	3	1	0	15	0	20415	2415	4	20	2175	23.45	23.39	24
5A-5A	5	5	1	0	25	0	20425	2425	5	5	2625	23.37	23.32	24
5A-66A	5	3	1	0	15	0	20415	2415	66	20	66786	23.45	23.31	24
13A-2A	13	5	1	24	25	0	23205	5205	2	20	900	22.61	22.46	23.5
13A-4A	13	5	1	24	25	0	23205	5205	4	20	2175	22.61	22.56	23.5
13A-66A	13	5	1	24	25	0	23205	5205	66	20	66786	22.61	22.53	23.5
66A-2A	66	5	1	12	25	0	132647	67111	2	20	900	23.31	23.21	23.5
66A-5A	66	5	1	12	25	0	132647	67111	5	10	2525	23.31	23.16	23.5
66A-13A	66	5	1	12	25	0	132647	67111	13	10	5230	23.31	23.15	23.5
66A-66A	66	5	1	12	25	0	132647	67111	66	20	66536	23.31	23.21	23.5
66B	66	5	1	12	25	0	132647	67111	66	5	67195	23.31	23.17	23.5
66C	66	5	1	12	25	0	132647	67111	66	20	67228	23.31	23.14	23.5

Low power														
DL LTE CA Class	PCC								SCC			Power		
	PCC Band	PCC Bandwidth (MHz)	PCC UL RB size	PCC UL RB offset	PCC DL RB size	PCC DL RB offset	PCC UL Channel	PCC DL Channel	SCC Band	SCC Bandwidth (MHz)	SCC DL Channel	Rel 8 LTETx Power(dBm)	Rel 10 DL LTE CA Tx Power(dBm)	Tune-up
2C	2	15	36	38	75	0	19125	1125	2	15	975	15.63	15.57	16
2A-2A	2	10	1	24	50	0	19150	1150	2	10	650	15.73	15.64	16
2A-4A	2	10	1	0	50	0	18900	900	4	20	2175	15.8	15.62	16
2A-5A	2	10	1	0	50	0	18900	900	5	10	2525	15.8	15.7	16
2A-13A	2	10	1	0	50	0	18900	900	13	10	5230	15.8	15.7	16
2A-66A	2	10	1	0	50	0	18900	900	66	20	66786	15.8	15.68	16
5B	5	5	1	0	25	0	20425	2425	5	3	2464	21.38	21.32	22
5A-2A	5	5	1	0	25	0	20425	2425	2	20	900	21.38	21.3	22
5A-4A	5	5	1	0	25	0	20425	2425	4	20	2175	21.38	21.21	22
5A-5A	5	5	1	0	25	0	20425	2425	5	5	2625	21.38	21.3	22
5A-66A	5	5	1	0	25	0	20425	2425	66	20	66786	21.38	21.24	22
13A-2A	13	5	1	12	25	0	23255	5255	2	20	900	21.11	21.03	21.5
13A-4A	13	5	1	12	25	0	23255	5255	4	20	2175	21.11	20.95	21.5
13A-66A	13	5	1	12	25	0	23255	5255	66	20	66786	21.11	21	21.5
66A-2A	66	5	1	0	25	0	132647	67111	2	20	900	15.01	14.87	15.5
66A-5A	66	5	1	0	25	0	132647	67111	5	10	2525	15.01	14.91	15.5
66A-13A	66	5	1	0	25	0	132647	67111	13	10	5230	15.01	14.96	15.5
66A-66A	66	15	1	74	75	0	132597	67061	66	20	66536	15.01	14.92	15.5
66B	66	15	1	74	75	0	132597	67061	66	15	67204	15.01	14.89	15.5
66C	66	5	1	0	25	0	132647	67111	66	20	67228	15.01	14.91	15.5

11.4 Wi-Fi and BT Measurement result

Table 11.4-1 Bluetooth Power (dBm)

Mode	Channel	Tune up	Measured
GFSK	0	11	10.3
	39	11	9.9
	78	11	9.99
EDR2M-4_DQPSK	0	10	9.53
	39	10	9.13
	78	10	9.46
EDR3M-8DPSK	0	10	9.48
	39	10	9.46
	78	10	9.66
BLE 1M	0	6	4.87
	19	5	3.56
	39	6	5.57
BLE 2M	0	6	4.94
	19	5	3.73
	39	6	5.79



WiFi 2.4G-Normal power

802.11b	Channel\data	1Mbps	2Mbps	5.5Mbps	11Mbps				
WLAN2450	11(2462MHz)	19.26							
	6(2437(MHz)	20.71	20.12	20.18	20.12				
	Tune up	21.00	21.00	21.00	21.00				
	1(2412MHz)	18.48							
Tune up		20.00							
802.11g	Channel\data	6Mbps	9Mbps	12Mbps	18Mbps	24Mbps	36Mbps	48Mbps	54Mbps
WLAN2450	11(2462MHz)	18.00			18.15				
	6(2437(MHz)	18.30	18.21	18.19	19.65	19.40	18.53	18.07	18.03
	1(2412MHz)	18.00			18.01				
	Tune up	20.00	20.00	20.00	20.00	20.00	20.00	20.00	20.00
802.11n-20MHz	Channel\data	MCS0	MCS1	MCS2	MCS3	MCS4	MCS5	MCS6	MCS7
WLAN2450	11(2462MHz)	17.20			17.44				
	6(2437(MHz)	17.29	17.32	18.27	18.86	18.57	18.05	18.07	17.62
	Tune up	19.00	19.00	19.00	19.00	19.00	19.00	19.00	19.00
	1(2412MHz)	16.67			16.76				
Tune up		18.50							
802.11n-40MHz	Channel\data	MCS0	MCS1	MCS2	MCS3	MCS4	MCS5	MCS6	MCS7
WLAN2450	9(2452MHz)	14.10	13.55	14.04	13.95	13.85	13.78	13.79	13.71
	6(2437MHz)	13.97							
	3(2422MHz)	13.51							
	Tune up	Tune up	15.50	15.50	15.50	15.50	15.50	15.50	15.50

WiFi 5G- Normal power

5G 802.11a(dBm)									
Channel\data rate	6Mbps	9Mbps	12Mbps	18Mbps	24Mbps	36Mbps	48Mbps	54Mbps	
	2200	3400	4500	6000	9000	13000	15000	16000	
36(5180 MHz)	16.58			18.08	17.17				
40(5200 MHz)	16.96	16.27	16.22	18.71	17.57	15.16	14.57	15.33	
44(5220 MHz)	16.65			18.25	17.25				
48(5240 MHz)	16.58			17.91	17.18				
Tune up	18.00	18.00	18.00	19.00	19.00	16.50	16.50	16.50	
52(5260 MHz)	16.63			17.44					
56(5280 MHz)	16.99			17.14					
60(5300 MHz)	17.52			17.66					
64(5320 MHz)	17.81	17.11	17.08	18.69	18.47	16.69	16.11	16.08	
Tune up	18.50	18.50	18.50	19.00	19.00	17.50	17.50	17.50	
100(5500 MHz)	16.96			17.74					
104(5520 MHz)	16.19			16.96					
108(5540 MHz)	16.67			17.45					
112(5560 MHz)	16.55			17.34					
116(5580 MHz)	16.56			17.33					
120(5600 MHz)	17.15			17.93					
124(5620 MHz)	17.69			17.89					
Tune up	18.00			18.50					
128(5640 MHz)	18.43			19.11					
132(5660 MHz)	18.82			18.86					
136(5680 MHz)	18.84	18.05	18.01	19.66	19.54	17.01	16.52	16.46	
140(5700 MHz)	18.94	18.03	17.99	19.59	19.40	16.93	16.44	16.41	
144(5720 MHz)	18.35			19.09					
Tune up	19.50	19.50	19.50	20.00	20.00	17.50	17.50	17.50	
149(5745 MHz)	18.07			18.80					
153(5765 MHz)	18.13			18.86					
157(5785 MHz)	18.47			19.20					
161(5805 MHz)	18.98			19.67					
165(5825 MHz)	18.85	19.22	19.16	19.99	19.78	18.19	17.75	17.68	
Tune up	20.00	20.50	20.50	20.50	20.50	19.00	19.00	19.00	

WiFi 2.4G-Low power

802.11b	Channel\data rate	1Mbps	2Mbps	5.5Mbps	11Mbps				
WLAN2450	11(2462MHz)	14.04		14.56					
	6(2437(MHz)	14.86	14.91	14.94	14.88				
	Tune up	15.50	15.50	15.50	15.50				
	1(2412MHz)	13.50		14.11					
Tune up	Tune up	15.00		15.00					
802.11g	Channel\data rate	6Mbps	9Mbps	12Mbps	18Mbps	24Mbps	36Mbps	48Mbps	54Mbps
WLAN2450	11(2462MHz)	12.81				13.29			
	Tune up	14.5				14.50			
	6(2437(MHz)	12.99	12.93	12.91	13.67	13.99	12.84	12.36	12.34
	Tune up	14.50	14.50	14.50	14.50	14.50	13.50	13.50	13.50
	1(2412MHz)	11.77				12.28			
Tune up	13.50								
802.11n-20MHz	Channel\data rate	MCS0	MCS1	MCS2	MCS3	MCS4	MCS5	MCS6	MCS7
WLAN2450	11(2462MHz)	11.54		12.23					
	Tune up	13		13					
	6(2437(MHz)	12.90	12.20	13.11	13.07	12.91	12.37	12.41	12.41
	Tune up	14.00	14.00	14.00	14.00	14.00	13.00	13.00	13.00
	1(2412MHz)	11.07		12.57					
Tune up	13.00		13.00						
802.11n-40MHz	Channel\data rate	MCS0	MCS1	MCS2	MCS3	MCS4	MCS5	MCS6	MCS7
WLAN2450	9(2452MHz)	12.58		12.61					
		13.5		13.5					
	6(2437MHz)	13.05	13.09	13.59	12.95	12.80	13.34	13.28	13.25
	Tune up	14.00	14.00	14.00	14.00	14.00	14.00	14.00	14.00
	3(2422MHz)	12.39		13.06					
Tune up	13.50		13.50						



WiFi 5G-Low power

802.11a(dBm)								
Channel\data rate	6Mbps	9Mbps	12Mbps	18Mbps	24Mbps	36Mbps	48Mbps	54Mbps
	2200	3400	4500	6000	9000	13000	15000	16000
36(5180 MHz)	9.91	9.10	9.84	10.49	10.46	8.85	7.62	7.57
40(5200 MHz)	9.77			9.81				
44(5220 MHz)	9.36			9.34				
48(5240 MHz)	8.16			8.96				
Tune up	10.00	10.00	10.00	10.50	10.50	9.50	9.50	9.50
52(5260 MHz)	7.78			8.59				
56(5280 MHz)	8.49			8.53				
60(5300 MHz)	8.78			8.83				
64(5320 MHz)	9.19	8.38	8.35	9.20	9.01	8.09	6.94	6.91
Tune up	9.50	9.50	9.50	10.50	10.50	8.50	8.50	8.50
100(5500 MHz)	8.70			8.69				
104(5520 MHz)	8.38			9.17				
108(5540 MHz)	8.46			10.10				
112(5560 MHz)	8.22			9.86				
116(5580 MHz)	7.92			8.75				
120(5600 MHz)	8.69			8.77				
124(5620 MHz)	8.85			9.62				
128(5640 MHz)	9.46			10.27				
Tune up	10.00			10.50				
132(5660 MHz)	10.16			10.95				
136(5680 MHz)	11.04	11.03	10.23	11.85	10.92	9.93	8.69	8.68
140(5700 MHz)	11.64			11.71				
144(5720 MHz)	11.49			11.57				
Tune up	12.00	12.00	12.00	12.50	12.50	10.50	10.50	10.50
149(5745 MHz)	10.27			11.07				
153(5765 MHz)	9.91			10.73				
157(5785 MHz)	9.78			11.39				
161(5805 MHz)	10.74			10.74				
165(5825 MHz)	11.03	10.23	10.19	11.85	11.66	9.09	8.65	8.61
Tune up	11.50	11.50	11.50	12.50	12.50	10.50	10.50	10.50

12 Simultaneous TX SAR Considerations

12.1 Introduction

The following procedures adopted from “FCC SAR Considerations for Cell Phones with Multiple Transmitters” are applicable to handsets with built-in unlicensed transmitters such as 802.11 a/b/g and Bluetooth devices which may simultaneously transmit with the licensed transmitter. For this device, the BT and Wi-Fi can transmit simultaneous with other transmitters.

12.2 Transmit Antenna Separation Distances

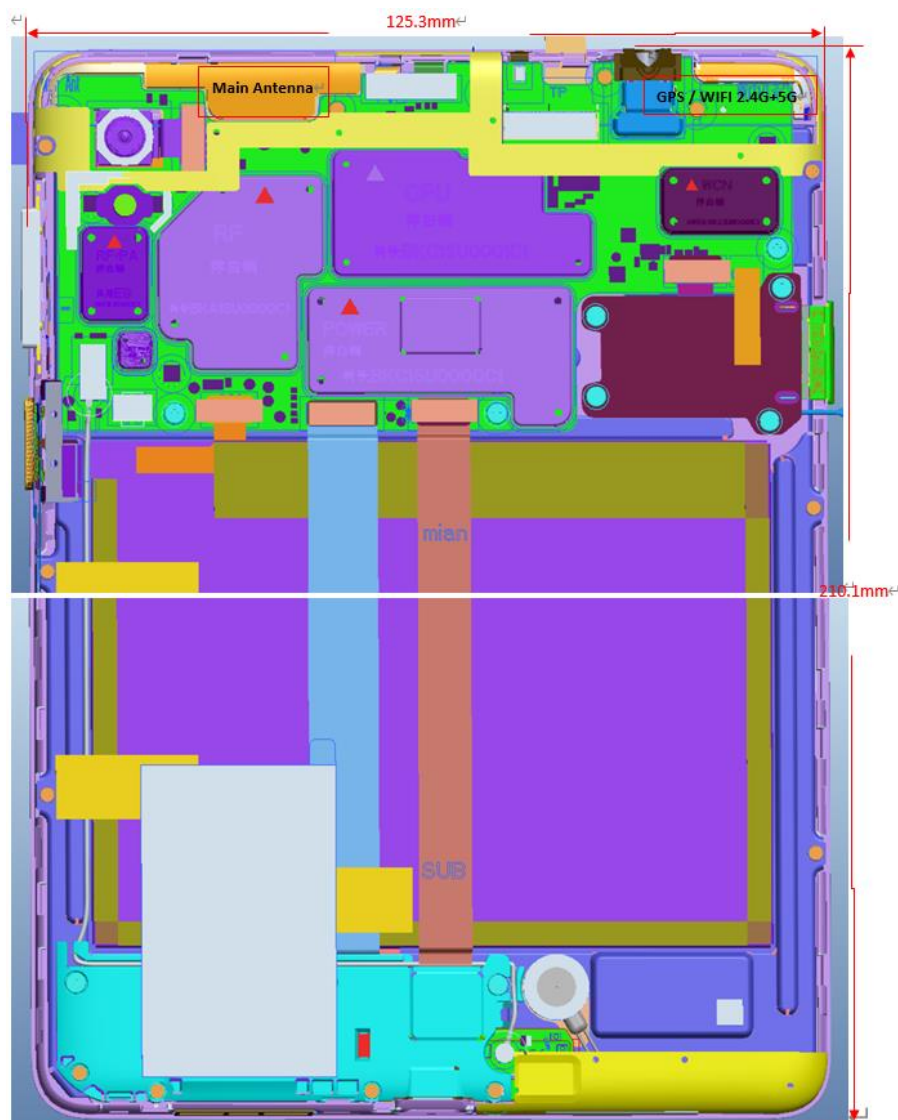

Picture 12.1 Antenna Locations

12.3 Standalone SAR Test Exclusion Considerations

Standalone 1-g head or body SAR evaluation by measurement or numerical simulation is not required when the corresponding SAR Exclusion Threshold condition, listed below, is satisfied. The 1-g SAR test exclusion threshold for 100 MHz to 6 GHz at test separation distances ≤ 50 mm are determined by:

$[(\text{max. power of channel, including tune-up tolerance, mW}) / (\text{min. test separation distance, mm})] \cdot [\sqrt{f(\text{GHz})}] \leq 3.0$ for 1-g SAR, where

- $f(\text{GHz})$ is the RF channel transmit frequency in GHz
- Power and distance are rounded to the nearest mW and mm before calculation
- The result is rounded to one decimal place for comparison

Table 12.1: Standalone SAR test exclusion considerations

Band/Mode	F(GHz)	Position	SAR test exclusion threshold(mW)	RF output power		SAR test exclusion
				dBm	mW	
Bluetooth	2.441	Body	9.60	11	13	NO
2.4GHz WLAN	2.45	Body	9.58	21	126	NO
5GHz WLAN	5.2	Body	6.58	19	79	NO
	5.3	Body	6.52	19	79	NO
	5.6	Body	6.34	20	100	NO
	5.8	Body	6.23	20.5	112	NO

13 Evaluation of Simultaneous

Table 13.1: The sum of reported SAR values for main antenna and WiFi 2.4G

	Position	Band	Main antenna	WiFi	Sum	Distance	Ratio
Highest reported SAR value for Body	Rear 0mm	GSM850	0.82	0.80	1.62	69.78	0.030
		GSM1900	0.97	0.80	1.77	80.72	0.029
		W850	0.88	0.80	1.68	71.15	0.031
		W1700	1.00	0.80	1.80	82.72	0.029
		W1900	1.17	0.80	1.97	86.1	0.032
		LTE B2	1.08	0.80	1.88	87.5	0.029
		LTE B5	0.97	0.80	1.77	72.89	0.032
		LTE B7	1.04	0.80	1.84	103.7	0.024
		LTE B12	1.09	0.80	1.89	74.31	0.035
		LTE B13	0.95	0.80	1.75	69.88	0.033
		LTE B66	1.15	0.80	1.95	87.39	0.031

Table 13.2 The sum of reported SAR values for main antenna and WiFi 5G

	Position	Band	Main antenna	WiFi	Sum	Distance	Ratio
Highest reported SAR value for Body	Rear 0mm	GSM850	0.82	0.80	1.62	66.52	0.031
		GSM1900	0.97	0.80	1.77	77.47	0.030
		W850	0.88	0.80	1.68	67.92	0.032
		W1700	1.00	0.80	1.80	79.54	0.030
		W1900	1.17	0.80	1.97	82.91	0.033
		LTE B2	1.08	0.80	1.88	84.24	0.031
		LTE B5	0.97	0.80	1.77	69.63	0.034
		LTE B7	1.04	0.80	1.84	100.62	0.025
		LTE B12	1.09	0.80	1.89	74.31	0.035
		LTE B13	0.95	0.80	1.75	66.61	0.035
		LTE B66	1.15	0.80	1.95	84.14	0.032

According to the KDB 447498 D01, when the sum of SAR is larger than the limit, SAR test exclusion is determined by the SAR to peak location separation ratio. The ratio is determined by $(SAR1 + SAR2)^{1.5}/R_i$, rounded to two decimal digits, and must be ≤ 0.04 for all antenna pairs in the configuration to qualify for 1-g SAR test exclusion.

Find distance of maxima	
<input type="checkbox"/> Maxima and position w.r.t. Grid Reference Point	associated 1g averages
<input type="checkbox"/> Zoom Scan (D:\2020\I20Z60705(FCC)\GSM850 Body Rear 0mm 55a GFS.da53:0/Rear 0mm 2TX)	
Max. 1 at (-97.80, -20.90, -0.96) mm	0.70 W/kg
<input type="checkbox"/> Zoom Scan (D:\2020\I20Z60705(FCC)\WLAN 11b CH6 Body Rear 0mm 5.5M 13dB 55a GFS.da53:0/Rear 0mm...	
Max. 2 at (-91.60, 48.60, -1.30) mm	0.69 W/kg
<input type="checkbox"/> Distances and Separation Ratios	
Max. 1 - Max. 2	Distance [mm]: 69.78 / Separation ratio [W/kg/mm]: 0.02

Picture 13.1 Distance evaluation for GSM850 and WiFi 2.4G 0mm

<input type="checkbox"/> Maxima and position w.r.t. Grid Reference Point	associated 1g averages
<input type="checkbox"/> Zoom Scan (D:\2020\I20Z60705(FCC)\GSM1900 Body 55a SYF 8.4.da53:0/Rear 0mm)	
Max. 1 at (-97.60, -31.90, -1.27) mm	0.82 W/kg
<input type="checkbox"/> Zoom Scan (D:\2020\I20Z60705(FCC)\WLAN 11b CH6 Body Rear 0mm 5.5M 13dB 55a GFS.da53:0/Rear 0mm...	
Max. 2 at (-91.60, 48.60, -1.30) mm	0.69 W/kg
<input type="checkbox"/> Distances and Separation Ratios	
Max. 1 - Max. 2	Distance [mm]: 80.72 / Separation ratio [W/kg/mm]: 0.02

Picture 13.2 Distance evaluation for GSM1900 and WiFi 2.4G 0mm

Find distance of maxima	
<input type="checkbox"/> Maxima and position w.r.t. Grid Reference Point	associated 1g averages
<input type="checkbox"/> Zoom Scan (D:\2020\I20Z60705(FCC)\WCDMA1900 Body Rear 0mm 55a 0617 GFS.da53:0/Rear 0mm)	
Max. 1 at (-91.40, -37.50, -0.94) mm	0.98 W/kg
<input type="checkbox"/> Zoom Scan (D:\2020\I20Z60705(FCC)\WLAN 11b CH6 Body Rear 0mm 5.5M 13dB 55a GFS.da53:0/Rear 0mm...	
Max. 2 at (-91.60, 48.60, -1.30) mm	0.69 W/kg
<input type="checkbox"/> Distances and Separation Ratios	
Max. 1 - Max. 2	Distance [mm]: 86.10 / Separation ratio [W/kg/mm]: 0.03

Picture 13.3 Distance evaluation for WCDMA1900 and WiFi 2.4G 0mm

Find distance of maxima	
<input type="checkbox"/> Maxima and position w.r.t. Grid Reference Point	associated 1g averages
<input type="checkbox"/> Zoom Scan (D:\2020\I20Z60705(FCC)\WCDMA 850 Body Rear 0mm 55a GFS.da53:0/WCDMA 850 CH4132 Re...	
Max. 1 at (-94.20, -22.50, -0.81) mm	0.86 W/kg
<input type="checkbox"/> Zoom Scan (D:\2020\I20Z60705(FCC)\WLAN 11b CH6 Body Rear 0mm 5.5M 13dB 55a GFS.da53:0/Rear 0mm...	
Max. 2 at (-91.60, 48.60, -1.30) mm	0.69 W/kg
<input type="checkbox"/> Distances and Separation Ratios	
Max. 1 - Max. 2	Distance [mm]: 71.15 / Separation ratio [W/kg/mm]: 0.03

Picture 13.4 Distance evaluation for WCDMA850 and WiFi 2.4G 0mm

Find distance of maxima	
<input type="checkbox"/> Maxima and position w.r.t. Grid Reference Point	associated 1g averages
<input type="checkbox"/> Zoom Scan (D:\2020\I20Z60705(FCC)\WCDMA1700 Body Rear 0mm 55a 0617 GFS.da53:0/Rear 0mm)	
Max. 1 at (-89.90, -34.10, -0.93) mm	0.97 W/kg
<input type="checkbox"/> Zoom Scan (D:\2020\I20Z60705(FCC)\WLAN 11b CH6 Body Rear 0mm 5.5M 13dB 55a GFS.da53:0/Rear 0mm...)	
Max. 2 at (-91.60, 48.60, -1.30) mm	0.69 W/kg
<input type="checkbox"/> Distances and Separation Ratios	
Max. 1 - Max. 2	Distance [mm]: 82.72 / Separation ratio [W/kg/mm]: 0.03

Picture 13.5 Distance evaluation forWCDMA1700 and WiFi 2.4G 0mm

Find distance of maxima	
<input type="checkbox"/> Maxima and position w.r.t. Grid Reference Point	associated 1g averages
<input type="checkbox"/> Zoom Scan (D:\2020\I20Z60705(FCC)\LTE Band2 Body Rear 0mm 55a GFS.da53:0/Rear 0mm)	
Max. 1 at (-99.90, -38.50, -0.88) mm	0.99 W/kg
<input type="checkbox"/> Zoom Scan (D:\2020\I20Z60705(FCC)\WLAN 11b CH6 Body Rear 0mm 5.5M 13dB 55a GFS.da53:0/Rear 0mm...)	
Max. 2 at (-91.60, 48.60, -1.30) mm	0.69 W/kg
<input type="checkbox"/> Distances and Separation Ratios	
Max. 1 - Max. 2	Distance [mm]: 87.50 / Separation ratio [W/kg/mm]: 0.02

Picture 13.6 Distance evaluation forLTEB2 and WiFi 2.4G 0mm

Find distance of maxima	
<input type="checkbox"/> Maxima and position w.r.t. Grid Reference Point	associated 1g averages
<input type="checkbox"/> Zoom Scan (D:\2020\I20Z60705(FCC)\LTE Band5 Body Rear 0mm 55a GFS.da53:0/Rear 0mm)	
Max. 1 at (-98.10, -24.00, -1.05) mm	0.83 W/kg
<input type="checkbox"/> Zoom Scan (D:\2020\I20Z60705(FCC)\WLAN 11b CH6 Body Rear 0mm 5.5M 13dB 55a GFS.da53:0/Rear 0mm...)	
Max. 2 at (-91.60, 48.60, -1.30) mm	0.69 W/kg
<input type="checkbox"/> Distances and Separation Ratios	
Max. 1 - Max. 2	Distance [mm]: 72.89 / Separation ratio [W/kg/mm]: 0.03

Picture 13.7 Distance evaluation forLTEB5 and WiFi 2.4G 0mm

Find distance of maxima	
<input type="checkbox"/> Maxima and position w.r.t. Grid Reference Point	associated 1g averages
<input type="checkbox"/> Zoom Scan (D:\2020\I20Z60705(FCC)\LTE Band7 Body Rear 0mm 55a GFS 0622.da53:0/Rear 0mm)	
Max. 1 at (-79.60, -54.40, -1.02) mm	0.88 W/kg
<input type="checkbox"/> Zoom Scan (D:\2020\I20Z60705(FCC)\WLAN 11b CH6 Body Rear 0mm 5.5M 13dB 55a GFS.da53:0/Rear 0mm...)	
Max. 2 at (-91.60, 48.60, -1.30) mm	0.69 W/kg
<input type="checkbox"/> Distances and Separation Ratios	
Max. 1 - Max. 2	Distance [mm]: 103.70 / Separation ratio [W/kg/mm]: 0.02

Picture 13.8 Distance evaluation forLTEB7 and WiFi 2.4G 0mm

Find distance of maxima	
Maxima and position w.r.t. Grid Reference Point associated 1g averages	
Zoom Scan (D:\2020\I20Z60705(FCC)\LTE Band12 Body Rear 0mm 55a GFS.da53:1/Rear 1RB-High 0mm)	
Max. 1 at (-95.70, -25.60, -1.16) mm	0.98 W/kg
Zoom Scan (D:\2020\I20Z60705(FCC)\WLAN 11b CH6 Body Rear 0mm 5.5M 13dB 55a GFS.da53:0/Rear 0mm...	
Max. 2 at (-91.60, 48.60, -1.30) mm	0.69 W/kg
Distances and Separation Ratios	
Max. 1 - Max. 2	Distance [mm]: 74.31 / Separation ratio [W/kg/mm]: 0.03

Picture 13.9 Distance evaluation forLTEB12 and WiFi 2.4G 0mm

Find distance of maxima	
Maxima and position w.r.t. Grid Reference Point associated 1g averages	
Zoom Scan (D:\2020\I20Z60705(FCC)\LTE Band13 Body Rear 0mm 55a GFS.da53:0/Rear 0mm)	
Max. 1 at (-99.80, -20.80, -1.09) mm	0.86 W/kg
Zoom Scan (D:\2020\I20Z60705(FCC)\WLAN 11b CH6 Body Rear 0mm 5.5M 13dB 55a GFS.da53:0/Rear 0mm...	
Max. 2 at (-91.60, 48.60, -1.30) mm	0.69 W/kg
Distances and Separation Ratios	
Max. 1 - Max. 2	Distance [mm]: 69.88 / Separation ratio [W/kg/mm]: 0.03

Picture 13.10 Distance evaluation forLTEB13 and WiFi 2.4G 0mm

Find distance of maxima	
Maxima and position w.r.t. Grid Reference Point associated 1g averages	
Zoom Scan (D:\2020\I20Z60705(FCC)\LTE Band66 Body 55a 617 SYF.da53:1/Rear 50RB-High 0mm 2)	
Max. 1 at (-97.30, -38.60, -0.86) mm	1.00 W/kg
Zoom Scan (D:\2020\I20Z60705(FCC)\WLAN 11b CH6 Body Rear 0mm 5.5M 13dB 55a GFS.da53:0/Rear 0mm...	
Max. 2 at (-91.60, 48.60, -1.30) mm	0.69 W/kg
Distances and Separation Ratios	
Max. 1 - Max. 2	Distance [mm]: 87.39 / Separation ratio [W/kg/mm]: 0.03

Picture 13.11 Distance evaluation forLTEB66 and WiFi 2.4G 0mm

Find distance of maxima	
Maxima and position w.r.t. Grid Reference Point associated 1g averages	
Zoom Scan (D:\2020\I20Z60705(FCC)\GSM850 Body Rear 0mm 55a GFS.da53:0/Rear 0mm 2TX)	
Max. 1 at (-97.80, -20.90, -0.96) mm	0.70 W/kg
Zoom Scan (D:\2020\I20Z60705(FCC)\WIFI5G Body 9dB 51a SYF 6.23.da53:0/Rear 18M 9dB 0mm CH165)	
Max. 2 at (-92.40, 45.40, -1.17) mm	0.68 W/kg
Distances and Separation Ratios	
Max. 1 - Max. 2	Distance [mm]: 66.52 / Separation ratio [W/kg/mm]: 0.02

Picture 13.12 Distance evaluation forGSM850 and WiFi 5G 0mm

<input type="checkbox"/> Maxima and position w.r.t. Grid Reference Point associated 1g averages	
<input type="checkbox"/> Zoom Scan (D:\2020\I20Z60705(FCC)\WIFI5G Body 9dB 51a SYF 6.23.da53:0/Rear 18M 9dB 0mm CH165)	Max. 1 at (-92.40, 45.40, -1.17) mm 0.68 W/kg
<input type="checkbox"/> Zoom Scan (D:\2020\I20Z60705(FCC)\GSM1900 Body 55a SYF 8.4.da53:0/Rear 0mm)	Max. 2 at (-97.60, -31.90, -1.27) mm 0.82 W/kg
<input type="checkbox"/> Distances and Separation Ratios	
Max. 1 - Max. 2	Distance [mm]: 77.47 / Separation ratio [W/kg/mm]: 0.02

Picture 13.13 Distance evaluation for GSM1900 and WiFi 5G 0mm

<input type="checkbox"/> Maxima and position w.r.t. Grid Reference Point associated 1g averages	
<input type="checkbox"/> Zoom Scan (D:\2020\I20Z60705(FCC)\WCDMA 850 Body Rear 0mm 55a GFS.da53:0/WCDMA 850 CH4132 Re...	Max. 1 at (-94.20, -22.50, -0.81) mm 0.86 W/kg
<input type="checkbox"/> Zoom Scan (D:\2020\I20Z60705(FCC)\WIFI5G Body 9dB 51a SYF 6.23.da53:0/Rear 18M 9dB 0mm CH165)	Max. 2 at (-92.40, 45.40, -1.17) mm 0.68 W/kg
<input type="checkbox"/> Distances and Separation Ratios	
Max. 1 - Max. 2	Distance [mm]: 67.92 / Separation ratio [W/kg/mm]: 0.03

Picture 13.14 Distance evaluation for WCDMA850 and WiFi 5G 0mm

<input type="checkbox"/> Maxima and position w.r.t. Grid Reference Point associated 1g averages	
<input type="checkbox"/> Zoom Scan (D:\2020\I20Z60705(FCC)\WCDMA1700 Body Rear 0mm 55a 0617 GFS.da53:0/Rear 0mm)	Max. 1 at (-89.90, -34.10, -0.93) mm 0.97 W/kg
<input type="checkbox"/> Zoom Scan (D:\2020\I20Z60705(FCC)\WIFI5G Body 9dB 51a SYF 6.23.da53:0/Rear 18M 9dB 0mm CH165)	Max. 2 at (-92.40, 45.40, -1.17) mm 0.68 W/kg
<input type="checkbox"/> Distances and Separation Ratios	
Max. 1 - Max. 2	Distance [mm]: 79.54 / Separation ratio [W/kg/mm]: 0.03

Picture 13.15 Distance evaluation for WCDMA1700 and WiFi 5G 0mm

<input type="checkbox"/> Maxima and position w.r.t. Grid Reference Point associated 1g averages	
<input type="checkbox"/> Zoom Scan (D:\2020\I20Z60705(FCC)\WCDMA1900 Body Rear 0mm 55a 0617 GFS.da53:0/Rear 0mm)	Max. 1 at (-91.40, -37.50, -0.94) mm 0.98 W/kg
<input type="checkbox"/> Zoom Scan (D:\2020\I20Z60705(FCC)\WIFI5G Body 9dB 51a SYF 6.23.da53:0/Rear 18M 9dB 0mm CH165)	Max. 2 at (-92.40, 45.40, -1.17) mm 0.68 W/kg
<input type="checkbox"/> Distances and Separation Ratios	
Max. 1 - Max. 2	Distance [mm]: 82.91 / Separation ratio [W/kg/mm]: 0.03

Picture 13.16 Distance evaluation for WCDMA1900 and WiFi 5G 0mm

Find distance of maxima	
<input type="checkbox"/> Maxima and position w.r.t. Grid Reference Point associated 1g averages	
<input type="checkbox"/> Zoom Scan (D:\2020\I20Z60705(FCC)\LTE Band2 Body Rear 0mm 55a GFS.da53:0/Rear 0mm)	
Max. 1 at (-99.90, -38.50, -0.88) mm	0.99 W/kg
<input type="checkbox"/> Zoom Scan (D:\2020\I20Z60705(FCC)\WIFI5G Body 9dB 51a SYF 6.23.da53:0/Rear 18M 9dB 0mm CH165)	
Max. 2 at (-92.40, 45.40, -1.17) mm	0.68 W/kg
<input type="checkbox"/> Distances and Separation Ratios	
Max. 1 - Max. 2	Distance [mm]: 84.24 / Separation ratio [W/kg/mm]: 0.03

Picture 13.17 Distance evaluation for LTEB2 and WiFi 5G 0mm

Find distance of maxima	
<input type="checkbox"/> Maxima and position w.r.t. Grid Reference Point associated 1g averages	
<input type="checkbox"/> Zoom Scan (D:\2020\I20Z60705(FCC)\LTE Band5 Body Rear 0mm 55a GFS.da53:0/Rear 0mm)	
Max. 1 at (-98.10, -24.00, -1.05) mm	0.83 W/kg
<input type="checkbox"/> Zoom Scan (D:\2020\I20Z60705(FCC)\WIFI5G Body 9dB 51a SYF 6.23.da53:0/Rear 18M 9dB 0mm CH165)	
Max. 2 at (-92.40, 45.40, -1.17) mm	0.68 W/kg
<input type="checkbox"/> Distances and Separation Ratios	
Max. 1 - Max. 2	Distance [mm]: 69.63 / Separation ratio [W/kg/mm]: 0.03

Picture 13.18 Distance evaluation for LTEB5 and WiFi 5G 0mm

Find distance of maxima	
<input type="checkbox"/> Maxima and position w.r.t. Grid Reference Point associated 1g averages	
<input type="checkbox"/> Zoom Scan (D:\2020\I20Z60705(FCC)\LTE Band7 Body Rear 0mm 55a GFS 0622.da53:0/Rear 0mm)	
Max. 1 at (-79.60, -54.40, -1.02) mm	0.88 W/kg
<input type="checkbox"/> Zoom Scan (D:\2020\I20Z60705(FCC)\WIFI5G Body 9dB 51a SYF 6.23.da53:0/Rear 18M 9dB 0mm CH165)	
Max. 2 at (-92.40, 45.40, -1.17) mm	0.68 W/kg
<input type="checkbox"/> Distances and Separation Ratios	
Max. 1 - Max. 2	Distance [mm]: 100.62 / Separation ratio [W/kg/mm]: 0.02

Picture 13.19 Distance evaluation for LTEB7 and WiFi 5G 0mm

Find distance of maxima	
<input type="checkbox"/> Maxima and position w.r.t. Grid Reference Point associated 1g averages	
<input type="checkbox"/> Zoom Scan (D:\2020\I20Z60705(FCC)\LTE Band12 Body Rear 0mm 55a GFS.da53:1/Rear 1RB-High 0mm)	
Max. 1 at (-95.70, -25.60, -1.16) mm	0.98 W/kg
<input type="checkbox"/> Zoom Scan (D:\2020\I20Z60705(FCC)\WLAN 11b CH6 Body Rear 0mm 5.5M 13dB 55a GFS.da53:0/Rear 0mm...)	
Max. 2 at (-91.60, 48.60, -1.30) mm	0.69 W/kg
<input type="checkbox"/> Distances and Separation Ratios	
Max. 1 - Max. 2	Distance [mm]: 74.31 / Separation ratio [W/kg/mm]: 0.03

Picture 13.20 Distance evaluation for LTEB12 and WiFi 5G 0mm

Find distance of maxima	
<input type="checkbox"/> Maxima and position w.r.t. Grid Reference Point associated 1g averages	
<input type="checkbox"/> Zoom Scan (D:\2020\I20Z60705(FCC)\LTE Band13 Body Rear 0mm 55a GFS.da53:0/Rear 0mm)	
Max. 1 at (-99.80, -20.80, -1.09) mm	0.86 W/kg
<input type="checkbox"/> Zoom Scan (D:\2020\I20Z60705(FCC)\WIFI5G Body 9dB 51a SYF 6.23.da53:0/Rear 18M 9dB 0mm CH165)	
Max. 2 at (-92.40, 45.40, -1.17) mm	0.68 W/kg
<input type="checkbox"/> Distances and Separation Ratios	
Max. 1 - Max. 2	Distance [mm]: 66.61 / Separation ratio [W/kg/mm]: 0.03

Picture 13.21 Distance evaluation for LTEB13 and WiFi 5G 0mm

Find distance of maxima	
<input type="checkbox"/> Maxima and position w.r.t. Grid Reference Point associated 1g averages	
<input type="checkbox"/> Zoom Scan (D:\2020\I20Z60705(FCC)\LTE Band66 Body 55a 617 SYF.da53:1/Rear 50RB-High 0mm 2)	
Max. 1 at (-97.30, -38.60, -0.86) mm	1.00 W/kg
<input type="checkbox"/> Zoom Scan (D:\2020\I20Z60705(FCC)\WIFI5G Body 9dB 51a SYF 6.23.da53:0/Rear 18M 9dB 0mm CH165)	
Max. 2 at (-92.40, 45.40, -1.17) mm	0.68 W/kg
<input type="checkbox"/> Distances and Separation Ratios	
Max. 1 - Max. 2	Distance [mm]: 84.14 / Separation ratio [W/kg/mm]: 0.03

Picture 13.22 Distance evaluation for LTEB66 and WiFi 5G 0mm

Table 13.3: The sum of reported SAR values for main antenna and BT

	Position	Main antenna	BT	Sum
Maximum reported SAR value for Body	Rear 0mm	1.17	<0.01	1.17

[1] – The Body SAR of BT is too low to get it, so the “<0.01” is used to indicate the SAR of BT.

14 SAR Test Result

It is determined by user manual for the distance between the EUT and the phantom bottom. The distance are 0mm, 9mm, 10mm, 12mm and 14mm, and just applied to the condition of body worn accessory.

It is performed for all SAR measurements with area scan based 1-g SAR estimation (Fast SAR). A zoom scan measurement is added when the estimated 1-g SAR is the highest measured SAR in each exposure configuration, wireless mode and frequency band combination or more than 1.2W/kg.

The calculated SAR is obtained by the following formula:

$$\text{Reported SAR} = \text{Measured SAR} \times 10^{(P_{\text{Target}} - P_{\text{Measured}})/10}$$

Where P_{Target} is the power of manufacturing upper limit;

P_{Measured} is the measured power in chapter 11.

Mode	Duty Cycle
GPRS&EGPRS for GSM850/1900 with normal power	1:4
GPRS&EGPRS for GSM850/1900 with low power	1:2
WCDMA<E	1:1

14.1 SAR results

Table 14.1-1: SAR Values (GSM 850 MHz Band - Body)

Ambient Temperature: 22.9°C Liquid Temperature: 22.5°C											
Frequency		Mode (number of timeslots)	Test Position	Figure No.	Conducted Power (dBm)	Max. tune-up Power (dBm)	Measured SAR(10g) (W/kg)	Reported SAR(10g) (W/kg)	Measured SAR(1g) (W/kg)	Reported SAR(1g) (W/kg)	Power Drift (dB)
Ch.	MHz										
190	836.6	GPRS (2)	Rear	Note1	31.22	31.5	0.061	0.07	0.082	0.09	-0.12
251	848.8	GPRS (2)	Top	Note2	31.29	31.5	0.222	0.23	0.331	0.35	0.11
190	836.6	GPRS (2)	Top	Note2	31.22	31.5	0.235	0.25	0.338	0.36	0.04
128	824.2	GPRS (2)	Top	Note2	31.01	31.5	0.217	0.24	0.321	0.36	0.03
190	836.6	GPRS (2)	Right	Note2	31.22	31.5	0.078	0.08	0.113	0.12	-0.12
251	848.8	GPRS (4)	Rear	/	27.42	28	0.279	0.32	0.537	0.61	-0.09
190	836.6	GPRS (4)	Rear	Fig.1	27.36	28	0.317	0.37	0.704	0.82	0.06
128	824.2	GPRS (4)	Rear	/	27.12	28	0.326	0.40	0.632	0.77	0.17
190	836.6	GPRS (4)	Top	/	27.36	28	0.346	0.40	0.614	0.71	-0.16
190	836.6	GPRS (4)	Right	/	27.36	28	0.156	0.18	0.281	0.33	0.06
190	836.6	EGPRS (4)	Rear	/	27.27	28	0.296	0.35	0.658	0.78	0.05

Note: The distance between the EUT and the phantom bottom is 0mm.

Note1: The distance between the EUT and the phantom bottom is 14mm.