

**Table 13.11: SAR Values (LTE Band 2 - Head)**

Frequency		Test Mode	Test Position	Figure No. / Note	Ambient Temperature: 22.5°C		Liquid Temperature: 22.0°C		
MHz	Ch.				Conducted Power (dBm)	Max. tune-up Power (dBm)	Measured SAR(1g) (W/kg)	Reported SAR(1g) (W/kg)	Power Drift(dB)
1900	19100	1RB_99	Left Touch	11	22.54	23	<b>0.882</b>	<b>0.98</b>	0.02
1900	19100	50RB_50	Left Touch	/	21.99	22.5	0.842	0.95	0.04
1900	19100	1RB_99	Left Tilt	/	22.54	23	0.392	0.44	-0.09
1900	19100	50RB_50	Left Tilt	/	21.99	22.5	0.341	0.38	0.08
1900	19100	1RB_99	Right Touch	/	22.54	23	0.667	0.74	-0.03
1900	19100	50RB_50	Right Touch	/	21.99	22.5	0.548	0.62	-0.02
1900	19100	1RB_99	Right Tilt	/	22.54	23	0.367	0.41	0.01
1900	19100	50RB_50	Right Tilt	/	21.99	22.5	0.323	0.36	-0.02
1880	18900	1RB_0	Left Touch	/	22.22	23	0.694	0.83	0.13
1860	18700	1RB_0	Left Touch	/	22.45	23	0.682	0.77	0.03
1880	18900	50RB_0	Left Touch	/	21.78	22.5	0.693	0.82	0.02
1860	18700	50RB_0	Left Touch	/	21.97	22.5	0.651	0.74	-0.05
1900	19100	100RB	Left Touch	/	21.93	22.5	0.786	0.90	0.08
1900	19100	1RB_99	Left Touch	B2	22.54	23	0.766	0.85	0.11

**Table 13.12: SAR Values (LTE Band 2 - Body)**

Frequency		Test Mode	Test Position	Figure No. / Note	Ambient Temperature: 22.8°C		Liquid Temperature: 22.2°C		
MHz	Ch.				Conducted Power (dBm)	Max. tune-up Power (dBm)	Measured SAR(1g) (W/kg)	Reported SAR(1g) (W/kg)	Power Drift(dB)
<b>Body-Worn Test Data (15mm)</b>									
1900	19100	1RB_99	Front	/	22.54	23	0.604	0.67	0.03
1900	19100	50RB_50	Front	/	21.99	22.5	0.564	0.63	0.10
1900	19100	1RB_99	Rear	/	22.54	23	0.738	0.82	-0.01
1900	19100	50RB_50	Rear	/	21.99	22.5	0.717	0.81	0.08
1880	18900	1RB_0	Rear	/	22.22	23	0.641	0.77	-0.11
1860	18700	1RB_0	Rear	/	22.45	23	0.658	0.75	-0.05
1880	18900	50RB_0	Rear	/	21.78	22.5	0.609	0.72	0.05
1860	18700	50RB_0	Rear	/	21.97	22.5	0.615	0.69	0.02
1900	19100	100RB	Rear	/	21.93	22.5	0.706	0.81	0.09
1900	19100	1RB_99	Rear	12/B2	22.54	23	<b>0.787</b>	<b>0.87</b>	-0.05

**Table 13.13: SAR Values (LTE Band 4 - Head)**

Frequency		Ambient Temperature: 22.5°C			Liquid Temperature: 22.0°C				
MHz	Ch.	Test Mode	Test Position	Figure No. / Note	Conducted Power (dBm)	Max. tune-up Power (dBm)	Measured SAR(1g) (W/kg)	Reported SAR(1g) (W/kg)	Power Drift(dB)
1745	20300	1RB_99	Left Touch	13	23.68	24.5	0.971	1.17	0.09
1745	20300	50RB_0	Left Touch	/	23.27	24	0.779	0.92	0.08
1745	20300	1RB_99	Left Tilt	/	23.68	24.5	0.317	0.38	0.02
1745	20300	50RB_0	Left Tilt	/	23.27	24	0.277	0.33	0.05
1745	20300	1RB_99	Right Touch	/	23.68	24.5	0.834	1.01	0.10
1745	20300	50RB_0	Right Touch	/	23.27	24	0.731	0.86	0.12
1745	20300	1RB_99	Right Tilt	/	23.68	24.5	0.505	0.61	0.09
1745	20300	50RB_0	Right Tilt	/	23.27	24	0.457	0.54	0.04
1732.5	20175	1RB_50	Left Touch	/	23.67	24.5	0.792	0.96	0.17
1720	20050	1RB_99	Left Touch	/	23.57	24.5	0.766	0.95	0.14
1732.5	20175	50RB_25	Left Touch	/	23.24	24	0.715	0.85	0.05
1720	20050	50RB_0	Left Touch	/	23.10	24	0.583	0.72	0.05
1745	20300	100RB	Left Touch	/	23.22	24	0.818	0.98	0.12
1732.5	20175	1RB_50	Right Touch	/	23.67	24.5	0.814	0.99	0.10
1720	20050	1RB_99	Right Touch	/	23.57	24.5	0.750	0.93	0.08
1732.5	20175	50RB_25	Right Touch	/	23.24	24	0.638	0.76	0.09
1720	20050	50RB_0	Right Touch	/	23.10	24	0.560	0.69	0.02
1745	20300	100RB	Right Touch	/	23.22	24	0.748	0.90	0.06
1745	20300	1RB_99	Left Touch	B2	23.68	24.5	0.865	1.04	-0.02

**Table 13.14: SAR Values (LTE Band 4 - Body)**

Frequency		Test Mode	Test Position	Figure No. / Note	Ambient Temperature: 22.8°C		Liquid Temperature: 22.2°C		
MHz	Ch.				Conducted Power (dBm)	Max. tune-up Power (dBm)	Measured SAR(1g) (W/kg)	Reported SAR(1g) (W/kg)	Power Drift(dB)
<b>Body-Worn Test Data (15mm)</b>									
1745	20300	1RB_99	Front	/	23.68	24.5	0.825	1.00	0.10
1745	20300	50RB_0	Front	/	23.27	24	0.716	0.85	0.03
1745	20300	1RB_99	Rear	<b>14</b>	23.68	24.5	<b>1.020</b>	<b>1.23</b>	-0.14
1745	20300	50RB_0	Rear	/	23.27	24	0.891	1.05	0.08
1732.5	20175	1RB_50	Front	/	23.67	24.5	0.789	0.96	0.07
1720	20050	1RB_99	Front	/	23.57	24.5	0.709	0.88	0.02
1732.5	20175	50RB_25	Front	/	23.24	24	0.657	0.78	0.03
1720	20050	50RB_0	Front	/	23.10	24	0.629	0.77	0.08
1745	20300	100RB	Front	/	23.22	24	0.664	0.79	0.05
1732.5	20175	1RB_50	Rear	/	23.67	24.5	0.969	1.17	0.16
1720	20050	1RB_99	Rear	/	23.57	24.5	0.911	1.13	0.12
1732.5	20175	50RB_25	Rear	/	23.24	24	0.855	1.02	0.01
1720	20050	50RB_0	Rear	/	23.10	24	0.812	1.00	0.15
1745	20300	100RB	Rear	/	23.22	24	0.882	1.06	0.01
1745	20300	1RB_99	Rear	B2	23.68	24.5	0.981	1.18	0.05
1745	20300	1RB_99	Rear	Headset	23.68	24.5	0.995	1.20	0.02

**Table 13.15: SAR Values (LTE Band 5 - Head)**

Frequency		Ambient Temperature: 22.5°C			Liquid Temperature: 22.0°C				
MHz	Ch.	Test Mode	Test Position	Figure No. / Note	Conducted Power (dBm)	Max. tune-up Power (dBm)	Measured SAR(1g) (W/kg)	Reported SAR(1g) (W/kg)	Power Drift(dB)
829	20450	1RB_49	Left Touch	/	21.79	22.5	0.923	1.09	-0.02
829	20450	25RB_25	Left Touch	/	21.45	22	0.829	0.94	0.03
829	20450	1RB_49	Left Tilt	/	21.79	22.5	0.520	0.61	-0.04
829	20450	25RB_25	Left Tilt	/	21.45	22	0.458	0.52	0.09
829	20450	1RB_49	Right Touch	<b>15</b>	21.79	22.5	<b>0.969</b>	<b>1.14</b>	0.06
829	20450	25RB_25	Right Touch	/	21.45	22	0.855	0.97	0.08
829	20450	1RB_49	Right Tilt	/	21.79	22.5	0.522	0.61	0.06
829	20450	25RB_25	Right Tilt	/	21.45	22	0.484	0.55	0.02
844	20600	1RB_49	Left Touch	/	21.68	22.5	0.748	0.90	0.06
836.5	20525	1RB_49	Left Touch	/	21.69	22.5	0.862	1.04	0.10
844	20600	25RB_25	Left Touch	/	21.44	22	0.847	0.96	0.07
836.5	20525	25RB_25	Left Touch	/	21.30	22	0.784	0.92	-0.15
829	20450	50RB	Left Touch	/	21.42	22	0.815	0.93	0.11
844	20600	1RB_49	Right Touch	/	21.68	22.5	0.811	0.98	0.01
836.5	20525	1RB_49	Right Touch	/	21.69	22.5	0.889	1.07	0.14
844	20600	25RB_25	Right Touch	/	21.44	22	0.735	0.84	0.06
836.5	20525	25RB_25	Right Touch	/	21.30	22	0.824	0.97	0.02
829	20450	50RB	Right Touch	/	21.42	22	0.814	0.93	0.11
829	20450	1RB_49	Right Touch	B2	21.79	22.5	<b>0.878</b>	1.03	0.08

**Table 13.16: SAR Values (LTE Band 5 - Body)**

Frequency		Ambient Temperature: 22.8°C			Liquid Temperature: 22.2°C				
MHz	Ch.	Test Mode	Test Position	Figure No. / Note	Conducted Power (dBm)	Max. tune-up Power (dBm)	Measured SAR(1g) (W/kg)	Reported SAR(1g) (W/kg)	Power Drift(dB)
<b>Body-Worn Test Data (15mm)</b>									
829	20450	1RB_49	Front	/	21.79	22.5	0.553	0.65	-0.02
829	20450	25RB_25	Front	/	21.45	22	0.518	0.59	-0.08
829	20450	1RB_49	Rear	/	21.79	22.5	0.548	0.65	-0.05
829	20450	25RB_25	Rear	/	21.45	22	0.503	0.57	-0.02
829	20450	1RB_49	Front	<b>16/B2</b>	21.79	22.5	<b>0.578</b>	<b>0.68</b>	0.11

**Table 13.17: SAR Values (LTE Band 7 - Head)**

Frequency		Test Mode	Test Position	Figure No. / Note	Ambient Temperature: 22.5°C		Liquid Temperature: 22.0°C		
MHz	Ch.				Conducted Power (dBm)	Max. tune-up Power (dBm)	Measured SAR(1g) (W/kg)	Reported SAR(1g) (W/kg)	Power Drift(dB)
2560	21350	1RB_99	Left Touch	/	21.91	22.5	0.890	1.02	0.13
2560	21350	50RB_50	Left Touch	/	21.32	22	0.797	0.93	0.05
2560	21350	1RB_99	Left Tilt	/	21.91	22.5	0.502	0.58	0.18
2560	21350	50RB_50	Left Tilt	/	21.32	22	0.452	0.53	0.02
2560	21350	1RB_99	Right Touch	/	21.91	22.5	0.713	0.82	0.08
2560	21350	50RB_50	Right Touch	/	21.32	22	0.655	0.77	0.02
2560	21350	1RB_99	Right Tilt	/	21.91	22.5	0.464	0.53	0.02
2560	21350	50RB_50	Right Tilt	/	21.32	22	0.421	0.49	0.06
2535	21100	1RB_0	Left Touch	<b>17</b>	21.42	22.5	<b>1.050</b>	<b>1.35</b>	0.06
2510	20850	1RB_0	Left Touch	/	21.67	22.5	0.750	0.91	0.11
2535	21100	50RB_25	Left Touch	/	20.90	22	0.894	1.15	-0.06
2510	20850	50RB_25	Left Touch	/	21.12	22	0.669	0.82	0.08
2560	21350	100RB	Left Touch	/	21.20	22	0.732	0.88	0.09
2535	21100	1RB_0	Right Touch	/	21.42	22.5	0.777	1.00	-0.06
2510	20850	1RB_0	Right Touch	/	21.67	22.5	0.570	0.69	0.08
2560	21350	100RB	Right Touch	/	21.20	22	0.559	0.67	0.03
2535	21100	1RB_0	Left Touch	B2	21.42	22.5	0.868	1.11	-0.10

**Table 13.18: SAR Values (LTE Band 7 - Body)**

Frequency		Test Mode	Test Position	Figure No. / Note	Ambient Temperature: 22.8°C		Liquid Temperature: 22.2°C		
MHz	Ch.				Conducted Power (dBm)	Max. tune-up Power (dBm)	Measured SAR(1g) (W/kg)	Reported SAR(1g) (W/kg)	Power Drift(dB)
<b>Body-Worn Test Data (15mm)</b>									
2560	21350	1RB_99	Front	/	21.91	22.5	0.252	0.29	0.11
2560	21350	50RB_50	Front	/	21.32	22	0.226	0.26	0.07
2560	21350	1RB_99	Rear	/	21.91	22.5	0.221	0.25	0.07
2560	21350	50RB_50	Rear	/	21.32	22	0.206	0.24	0.02
2560	21350	1RB_99	Front	<b>18/B2</b>	21.91	22.5	<b>0.262</b>	<b>0.30</b>	0.13

**Table 13.19: SAR Values (LTE Band 28 - Head)**

Frequency		Test Mode	Test Position	Figure No. / Note	Ambient Temperature: 22.5°C		Liquid Temperature: 22.0°C		
MHz	Ch.				Conducted Power (dBm)	Max. tune-up Power (dBm)	Measured SAR(1g) (W/kg)	Reported SAR(1g) (W/kg)	Power Drift(dB)
738	27560	1RB_99	Left Touch	19	22.29	23	0.903	1.06	-0.15
738	27560	50RB_50	Left Touch	/	21.69	22.5	0.783	0.94	0.90
738	27560	1RB_99	Left Tilt	/	22.29	23	0.439	0.52	0.01
738	27560	50RB_50	Left Tilt	/	21.69	22.5	0.432	0.52	0.05
738	27560	1RB_99	Right Touch	/	22.29	23	0.747	0.88	0.07
738	27560	50RB_50	Right Touch	/	21.69	22.5	0.732	0.88	0.01
738	27560	1RB_99	Right Tilt	/	22.29	23	0.416	0.49	0.07
738	27560	50RB_50	Right Tilt	/	21.69	22.5	0.404	0.49	0.05
728	27460	1RB_99	Left Touch	/	22.21	23	0.742	0.89	0.16
713	27310	1RB_99	Left Touch	/	21.72	23	0.613	0.82	0.03
728	27460	50RB_50	Left Touch	/	21.65	22.5	0.444	0.54	0.11
713	27310	50RB_50	Left Touch	/	21.57	22.5	0.491	0.61	-0.05
738	27560	100RB	Left Touch	/	21.61	22.5	0.504	0.62	0.08
728	27460	1RB_99	Right Touch	/	22.21	23	0.660	0.79	0.02
713	27310	1RB_99	Right Touch	/	21.72	23	0.550	0.74	0.10
728	27460	50RB_50	Right Touch	/	21.65	22.5	0.387	0.47	0.13
713	27310	50RB_50	Right Touch	/	21.57	22.5	0.443	0.55	0.11
738	27560	100RB	Right Touch	/	21.57	22.5	0.462	0.57	0.05
738	27560	1RB_99	Right Touch	B2	22.29	23	0.900	1.06	0.01

**Table 13.20: SAR Values (LTE Band 28 - Body)**

Frequency		Test Mode	Test Position	Figure No. / Note	Ambient Temperature: 22.8°C		Liquid Temperature: 22.2°C		
MHz	Ch.				Conducted Power (dBm)	Max. tune-up Power (dBm)	Measured SAR(1g) (W/kg)	Reported SAR(1g) (W/kg)	Power Drift(dB)
<b>Body-Worn Test Data (15mm)</b>									
738	27560	1RB_99	Front	/	22.29	23	0.547	0.64	0.08
738	27560	50RB_50	Front	/	21.69	22.5	0.488	0.59	0.06
738	27560	1RB_99	Rear	/	22.29	23	0.634	0.75	-0.06
738	27560	50RB_50	Rear	/	21.69	22.5	0.544	0.66	-0.02
738	27560	1RB_99	Rear	20/B2	22.29	23	0.638	0.75	-0.03

**Table 13.21: SAR Values (Bluetooth - Head)**

Ambient Temperature: 22.5°C      Liquid Temperature: 22.0°C									
Frequency		Test Mode	Test Position	Figure No. / Note	Conducted Power (dBm)	Max. tune-up Power (dBm)	Measured SAR(1g) (W/kg)	Reported SAR(1g) (W/kg)	Power Drift(dB)
MHz	Ch.								
2480	78	3DH5	Left Touch	/	8.78	10	0.005	<b>0.01</b>	0.04
2480	78	3DH5	Left Tilt	/	8.78	10	<0.001	<0.01	0.13
2480	78	3DH5	Right Touch	<b>21</b>	8.78	10	<b>0.009</b>	<b>0.01</b>	0.05
2480	78	3DH5	Right Tilt	/	8.78	10	<0.001	<0.01	0.11
2480	78	3DH5	Right Touch	/	8.78	10	0.007	<b>0.01</b>	0.06

## 14. SAR Measurement Variability

SAR measurement variability must be assessed for each frequency band, which is determined by the SAR probe calibration point and tissue-equivalent medium used for the device measurements. When both head and body tissue-equivalent media are required for SAR measurements in a frequency band, the variability measurement procedures should be applied to the tissue medium with the highest measured SAR, using the highest measured SAR configuration for that tissue-equivalent medium.

The following procedures are applied to determine if repeated measurements are required.

- 1) Repeated measurement is not required when the original highest measured SAR is  $< 0.80$  W/kg; steps 2) through 4) do not apply.
- 2) When the original highest measured SAR is  $\geq 0.80$  W/kg, repeat that measurement once.
- 3) Perform a second repeated measurement only if the ratio of largest to smallest SAR for the original and first repeated measurements is  $> 1.20$  or when the original or repeated measurement is  $\geq 1.45$  W/kg (~ 10% from the 1-g SAR limit).
- 4) Perform a third repeated measurement only if the original, first or second repeated measurement is  $\geq 1.5$  W/kg and the ratio of largest to smallest SAR for the original, first and second repeated measurements is  $> 1.20$ .

**Table 14.1: SAR Measurement Variability for Head – GSM850**

Frequency		Test Position	Original	1 <sup>st</sup> Repeated	Ratio	2 <sup>nd</sup> Repeated
MHz	Ch.		SAR (W/kg)	SAR (W/kg)		SAR (W/kg)
836.6	190	Left Touch	1.19	1.16	1.03	/

**Table 14.2: SAR Measurement Variability for Body – GSM1900**

Frequency		Test Position	Original	1 <sup>st</sup> Repeated	Ratio	2 <sup>nd</sup> Repeated
MHz	Ch.		SAR (W/kg)	SAR (W/kg)		SAR (W/kg)
1909.8	810	Rear	0.805	0.796	1.01	/

**Table 14.3: SAR Measurement Variability for Body – WCDMA Band 2**

Frequency		Test Position	Original	1 <sup>st</sup> Repeated	Ratio	2 <sup>nd</sup> Repeated
MHz	Ch.		SAR (W/kg)	SAR (W/kg)		SAR (W/kg)
1880	9400	Rear	0.829	0.821	1.01	/

**Table 14.4: SAR Measurement Variability for Body – WCDMA Band 4**

Frequency		Test Position	Original	1 <sup>st</sup> Repeated	Ratio	2 <sup>nd</sup> Repeated
MHz	Ch.		SAR (W/kg)	SAR (W/kg)		SAR (W/kg)
1752.6	1513	Rear	1.01	0.996	1.01	/

**Table 14.5: SAR Measurement Variability for Head – WCDMA Band 5**

Frequency		Test Position	Original	1 <sup>st</sup> Repeated	Ratio	2 <sup>nd</sup> Repeated
MHz	Ch.		SAR (W/kg)	SAR (W/kg)		SAR (W/kg)
826.4	4132	Left Touch	1.05	1.02	1.03	/



**Table 14.6: SAR Measurement Variability for Head – LTE Band 2**

Frequency		Test Position	Original	1 <sup>st</sup> Repeated	Ratio	2 <sup>nd</sup> Repeated
MHz	Ch.		SAR (W/kg)	SAR (W/kg)		SAR (W/kg)
1900	19100	Left Touch	0.882	0.876	1.01	/

**Table 14.7: SAR Measurement Variability for Body – LTE Band 4**

Frequency		Test Position	Original	1 <sup>st</sup> Repeated	Ratio	2 <sup>nd</sup> Repeated
MHz	Ch.		SAR (W/kg)	SAR (W/kg)		SAR (W/kg)
1745	20300	Rear	1.02	1.01	1.01	/

**Table 14.8: SAR Measurement Variability for Head – LTE Band 5**

Frequency		Test Position	Original	1 <sup>st</sup> Repeated	Ratio	2 <sup>nd</sup> Repeated
MHz	Ch.		SAR (W/kg)	SAR (W/kg)		SAR (W/kg)
829	20450	Right Touch	0.969	0.961	1.01	/

**Table 14.9: SAR Measurement Variability for Head – LTE Band 7**

Frequency		Test Position	Original	1 <sup>st</sup> Repeated	Ratio	2 <sup>nd</sup> Repeated
MHz	Ch.		SAR (W/kg)	SAR (W/kg)		SAR (W/kg)
2535	21100	Left Touch	1.05	1.03	1.02	/

**Table 14.10: SAR Measurement Variability for Head – LTE Band 28**

Frequency		Test Position	Original	1 <sup>st</sup> Repeated	Ratio	2 <sup>nd</sup> Repeated
MHz	Ch.		SAR (W/kg)	SAR (W/kg)		SAR (W/kg)
738	27560	Left Touch	0.903	0.895	1.01	/

## 15. Measurement Uncertainty

### 15.1. Measurement Uncertainty for Normal SAR Tests (300MHz~3GHz)

No.	Error Description	Type	Uncertainty value	Probably Distribution	Div.	(Ci) 1g	(Ci) 10g	Std. Unc. (1g)	Std. Unc. (10g)	Degree of freedom
<b>Measurement system</b>										
1	Probe calibration	B	12	N	2	1	1	6.0	6.0	∞
2	Axial isotropy	B	4.7	R	$\sqrt{3}$	$\sqrt{0.5}$	$\sqrt{0.5}$	4.3	4.3	∞
3	Hemispherical isotropy	B	9.6	R	$\sqrt{3}$	1	1	4.8	4.8	∞
4	Boundary effect	B	1.1	R	$\sqrt{3}$	1	1	0.6	0.6	∞
5	Linearity	B	4.7	R	$\sqrt{3}$	1	1	2.7	2.7	∞
6	Detection limit	B	1.0	R	$\sqrt{3}$	1	1	0.6	0.6	∞
7	Modulation response	B	4.0	R	$\sqrt{3}$	1	1	2.3	2.3	∞
8	Readout electronics	B	1.0	N	1	1	1	1.0	1.0	∞
9	Response time	B	0.8	R	$\sqrt{3}$	1	1	0.5	0.5	∞
10	Integration time	B	1.7	R	$\sqrt{3}$	1	1	1.0	1.0	∞
11	RF ambient conditions-noise	B	3.0	R	$\sqrt{3}$	1	1	1.7	1.7	∞
12	RF ambient conditions-reflection	B	3.0	R	$\sqrt{3}$	1	1	1.7	1.7	∞
13	Probe positioned mech. restrictions	B	0.35	R	$\sqrt{3}$	1	1	0.2	0.2	∞
14	Probe positioning with respect to phantom shell	B	2.9	R	$\sqrt{3}$	1	1	1.7	1.7	∞
15	Post-processing	B	1.0	R	$\sqrt{3}$	1	1	0.6	0.6	∞
<b>Test sample related</b>										
16	Test sample positioning	A	3.3	N	1	1	1	3.3	3.3	5
17	Device holder uncertainty	A	3.4	N	1	1	1	3.4	3.4	5
18	Drift of output power	B	5.0	R	$\sqrt{3}$	1	1	2.9	2.9	∞
<b>Phantom and set-up</b>										
19	Phantom uncertainty	B	1.0	R	$\sqrt{3}$	1	1	0.6	0.6	∞
20	Liquid conductivity (target)	B	5.0	R	$\sqrt{3}$	0.64	0.43	1.8	1.2	∞
21	Liquid conductivity (meas.)	A	1.3	N	1	0.64	0.43	0.83	0.56	9
22	Liquid permittivity (target)	B	5.0	R	$\sqrt{3}$	0.6	0.49	1.7	1.4	∞
23	Liquid permittivity (meas.)	A	1.6	N	1	0.6	0.49	0.96	0.78	9
Combined standard uncertainty		$u_c' = \sqrt{\sum_{i=1}^{23} c_i^2 u_i^2}$						11.3	11.2	95.5
Expanded uncertainty (Confidence interval of 95 %)		$u_e = 2u_c$						22.6	22.4	

## 16. Main Test Instruments

**Table 16.1: List of Main Instruments**

No.	Name	Type	Serial Number	Calibration Date	Valid Period
01	Network analyzer	Agilent E5071C	MY46103759	2019-11-15	One year
02	Dielectric probe	85070E	MY44300317	/	/
03	Power meter	E4418B	MY50000366	2019-12-14	One year
04	Power sensor	E9304A	MY50000188		
05	Power meter	NRP	101460	2020-01-15	One year
06	Power sensor	NRP-Z91	100553		
07	Signal Generator	E8257D	MY47461211	2019-06-03	One year
08	Amplifier	VTL5400	0404	/	/
09	E-field Probe	ES3DV3	3151	2020-01-03	One year
11	DAE	DAE4	786	2020-03-03	One year
12	Dipole Validation Kit	D750V3	1163	2019-09-03	One year
13	Dipole Validation Kit	D835V2	4d057	2018-10-09	Three year
14	Dipole Validation Kit	D1750V2	1152	2019-08-30	One year
15	Dipole Validation Kit	D1900V2	5d088	2018-10-24	Three year
16	Dipole Validation Kit	D2450V2	873	2018-10-26	Three year
17	Dipole Validation Kit	D2550V2	1058	2018-08-24	Three year
18	Radio Communication Analyzer	Anristu MT8820C	6201341853	2020-01-15	One year
19	Software	DASY5	52.8.8.1222	/	/

## ANNEX A: Graph Results

### GSM850 Head

Date: 2020-4-12

Electronics: DAE4 Sn786

Medium: Head 835MHz

Medium parameters used (interpolated):  $f = 836.6$  MHz;  $\sigma = 0.919$  S/m;  $\epsilon_r = 41.025$ ;  $\rho = 1000$  kg/m<sup>3</sup>

Ambient Temperature: 22.0°C      Liquid Temperature: 21.5°C

Communication System: UID 0, GSM (0) Frequency: 836.6 MHz Duty Cycle: 1:8.3

Probe: ES3DV3 – SN3151 ConvF (6.41, 6.41, 6.41);

**Left Cheek Middle /Area Scan (51x61x1):** Interpolated grid:  $dx=1.500$  mm,  $dy=1.500$  mm

Maximum value of SAR (interpolated) = 1.43 W/kg

**Left Cheek Middle 6aa/Zoom Scan (5x5x7)/Cube 0:** Measurement grid:  $dx=8$ mm,  $dy=8$ mm,  $dz=5$ mm

Reference Value = 10.29 V/m; Power Drift = 0.04 dB

Peak SAR (extrapolated) = 1.63 W/kg

**SAR(1 g) = 1.19 W/kg; SAR(10 g) = 0.841 W/kg**

Maximum value of SAR (measured) = 1.28 W/kg

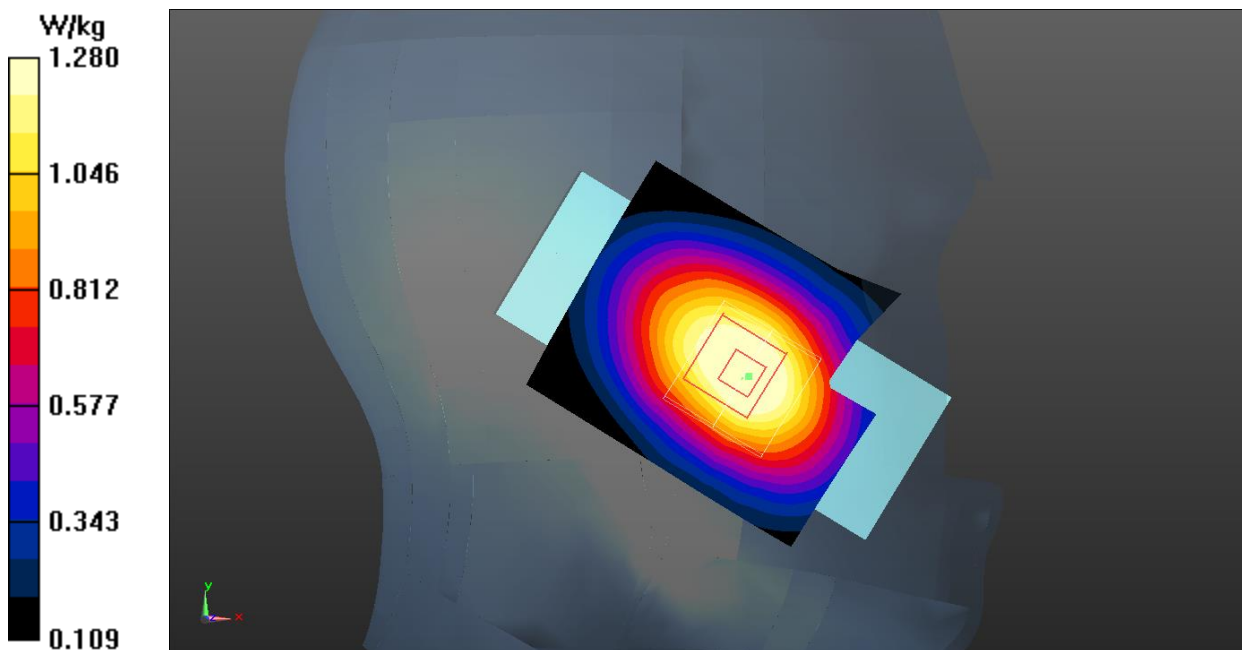

Fig.1 GSM 850 Head

**GSM850 Body**

Date: 2020-4-12

Electronics: DAE4 Sn786

Medium: Head 835MHz

Medium parameters used (interpolated):  $f = 836.6$  MHz;  $\sigma = 0.919$  S/m;  $\epsilon_r = 41.025$ ;  $\rho = 1000$  kg/m<sup>3</sup>

Ambient Temperature: 22.0°C      Liquid Temperature: 21.5°C

Communication System: UID 0, GPRS 2Txslot (0) Frequency: 836.6 MHz Duty Cycle: 1:4

Probe: ES3DV3 – SN3151 ConvF (6.41, 6.41, 6.41);

**Rear Side Middle /Area Scan (51x61x1):** Interpolated grid: dx=1.500 mm, dy=1.500 mm

Maximum value of SAR (interpolated) = 1.17 W/kg

**Rear Side Middle 06aa/Zoom Scan (5x5x7)/Cube 0:** Measurement grid: dx=8mm, dy=8mm, dz=5mm

Reference Value = 30.57 V/m; Power Drift = -0.02 dB

Peak SAR (extrapolated) = 1.34 W/kg

**SAR(1 g) = 0.964 W/kg; SAR(10 g) = 0.680 W/kg**

Maximum value of SAR (measured) = 1.16 W/kg

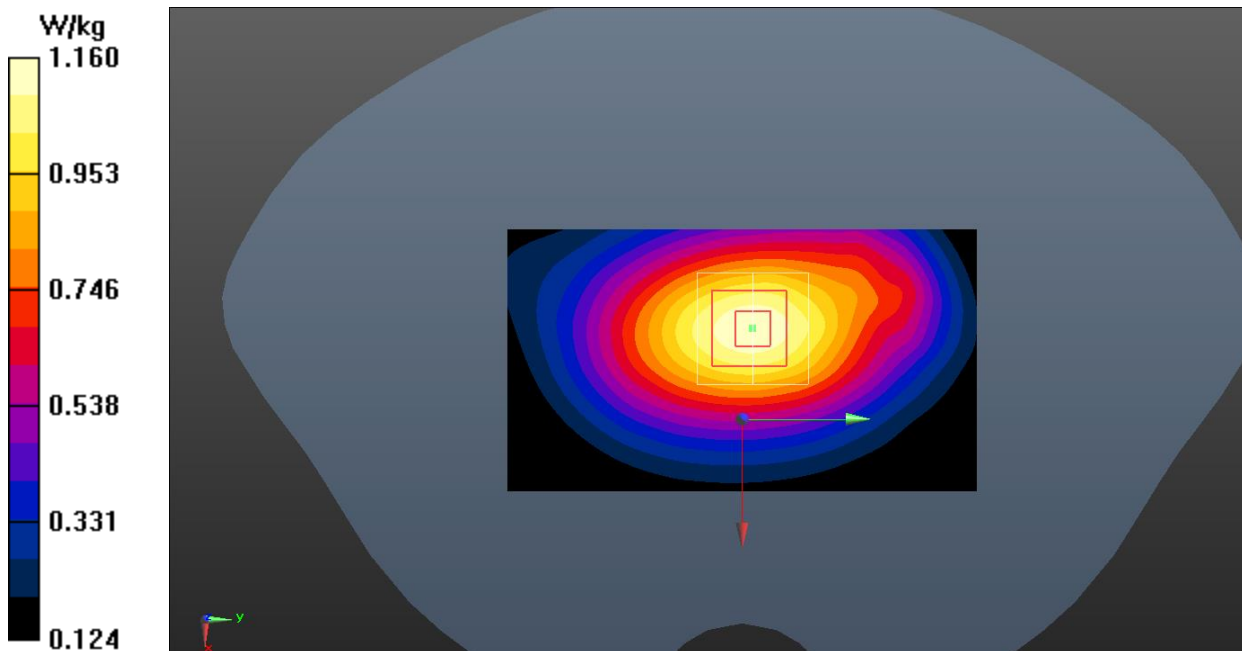
**Fig.2 GSM 850 Body**

**GSM1900 Head**

Date: 2020-4-11

Electronics: DAE4 Sn786

Medium: Head 1900MHz

Medium parameters used:  $f = 1880$  MHz;  $\sigma = 1.399$  S/m;  $\epsilon_r = 39.13$ ;  $\rho = 1000$  kg/m<sup>3</sup>

Ambient Temperature: 22.0°C      Liquid Temperature: 21.5°C

Communication System: UID 0, GSM (0) Frequency: 1880 MHz Duty Cycle: 1:8.3

Probe: ES3DV3 – SN3151 ConvF (5.11, 5.11, 5.11);

**Right Cheek Middle/Area Scan (51x101x1):** Interpolated grid: dx=1.500 mm, dy=1.500 mm

Maximum value of SAR (interpolated) = 0.435 W/kg

**Right Cheek Middle/Zoom Scan (5x5x7)/Cube 0:** Measurement grid: dx=8mm, dy=8mm, dz=5mm

Reference Value = 5.128 V/m; Power Drift = -0.06 dB

Peak SAR (extrapolated) = 0.518 W/kg

**SAR(1 g) = 0.312 W/kg; SAR(10 g) = 0.191 W/kg**

Maximum value of SAR (measured) = 0.372 W/kg

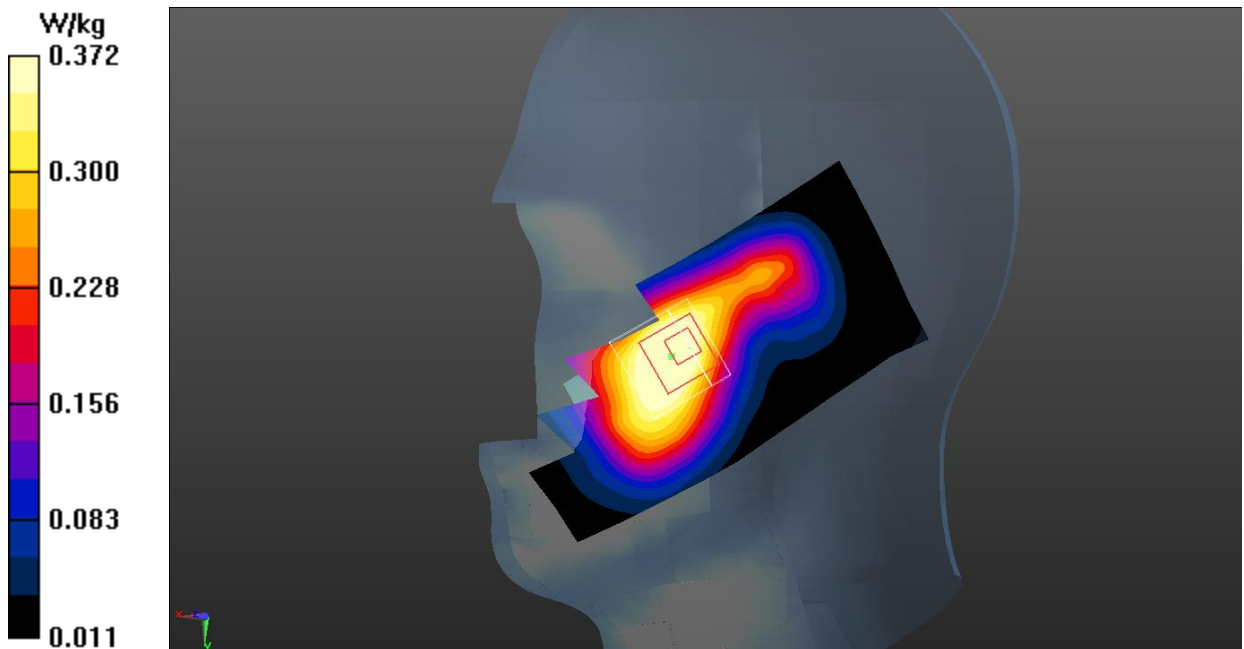
**Fig.3 GSM 1900 Head**

**GSM1900 Body**

Date: 2020-4-11

Electronics: DAE4 Sn786

Medium: Head 1900MHz

Medium parameters used:  $f = 1910 \text{ MHz}$ ;  $\sigma = 1.426 \text{ S/m}$ ;  $\epsilon_r = 39.013$ ;  $\rho = 1000 \text{ kg/m}^3$

Ambient Temperature:  $22.0^\circ\text{C}$       Liquid Temperature:  $21.5^\circ\text{C}$

Communication System: UID 0, GPRS 3Txslot (0) Frequency:  $1909.8 \text{ MHz}$  Duty Cycle: 1:2.67

Probe: ES3DV3 – SN3151 ConvF (5.11, 5.11, 5.11);

**Rear Side High /Area Scan (51x61x1):** Interpolated grid:  $dx=1.500 \text{ mm}$ ,  $dy=1.500 \text{ mm}$

Maximum value of SAR (interpolated) =  $1.09 \text{ W/kg}$

**Rear Side High /Zoom Scan (5x5x7)/Cube 0:** Measurement grid:  $dx=8\text{mm}$ ,  $dy=8\text{mm}$ ,  $dz=5\text{mm}$

Reference Value =  $7.998 \text{ V/m}$ ; Power Drift =  $-0.05 \text{ dB}$

Peak SAR (extrapolated) =  $1.31 \text{ W/kg}$

**SAR(1 g) =  $0.805 \text{ W/kg}$ ; SAR(10 g) =  $0.482 \text{ W/kg}$**

Maximum value of SAR (measured) =  $1.07 \text{ W/kg}$

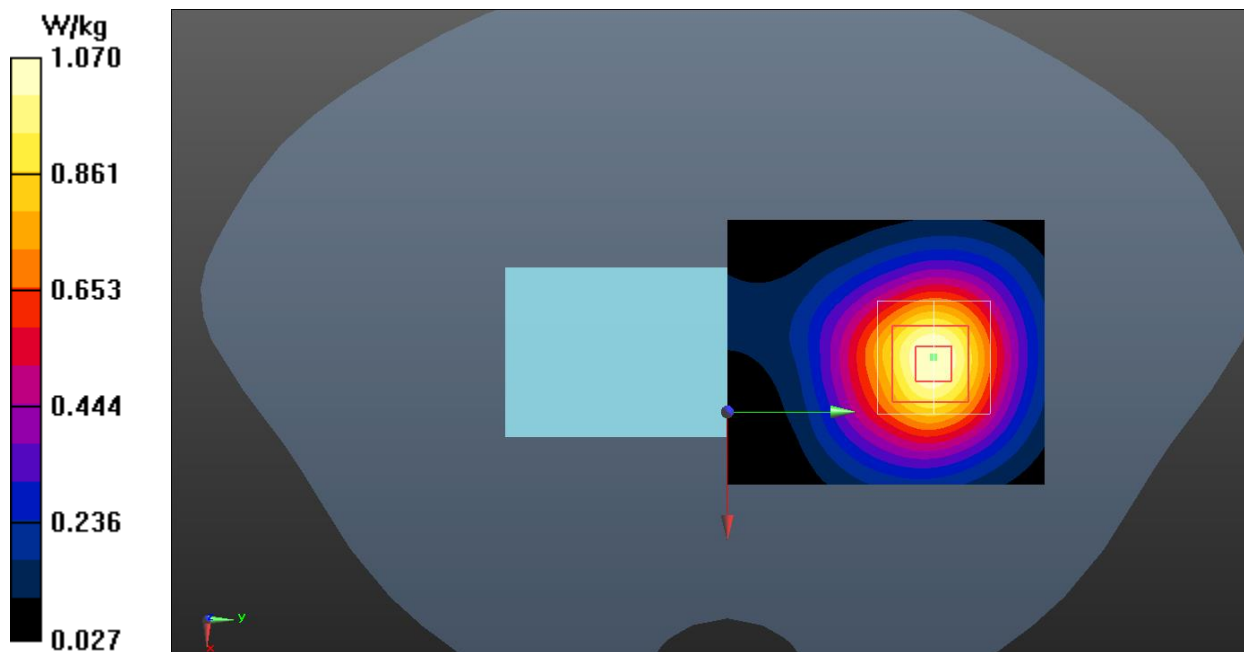

**Fig.4 GSM 1900 Body**

**WCDMA Band 2 Head**

Date: 2020-4-11

Electronics: DAE4 Sn786

Medium: Head 1900MHz

Medium parameters used:  $f = 1908$  MHz;  $\sigma = 1.424$  S/m;  $\epsilon_r = 39.021$ ;  $\rho = 1000$  kg/m<sup>3</sup>

Ambient Temperature: 22.0°C      Liquid Temperature: 21.5°C

Communication System: UID 0, WCDMA (0) Frequency: 1907.6 MHz Duty Cycle: 1:1

Probe: ES3DV3 – SN3151 ConvF (5.11, 5.11, 5.11);

**Left Cheek High/Area Scan (51x81x1):** Interpolated grid: dx=1.500 mm, dy=1.500 mm

Maximum value of SAR (interpolated) = 0.973 W/kg

**Left Cheek High/Zoom Scan (5x5x7)/Cube 0:** Measurement grid: dx=8mm, dy=8mm, dz=5mm

Reference Value = 5.579 V/m; Power Drift = 0.04 dB

Peak SAR (extrapolated) = 1.22 W/kg

**SAR(1 g) = 0.765 W/kg; SAR(10 g) = 0.456 W/kg**

Maximum value of SAR (measured) = 0.834 W/kg

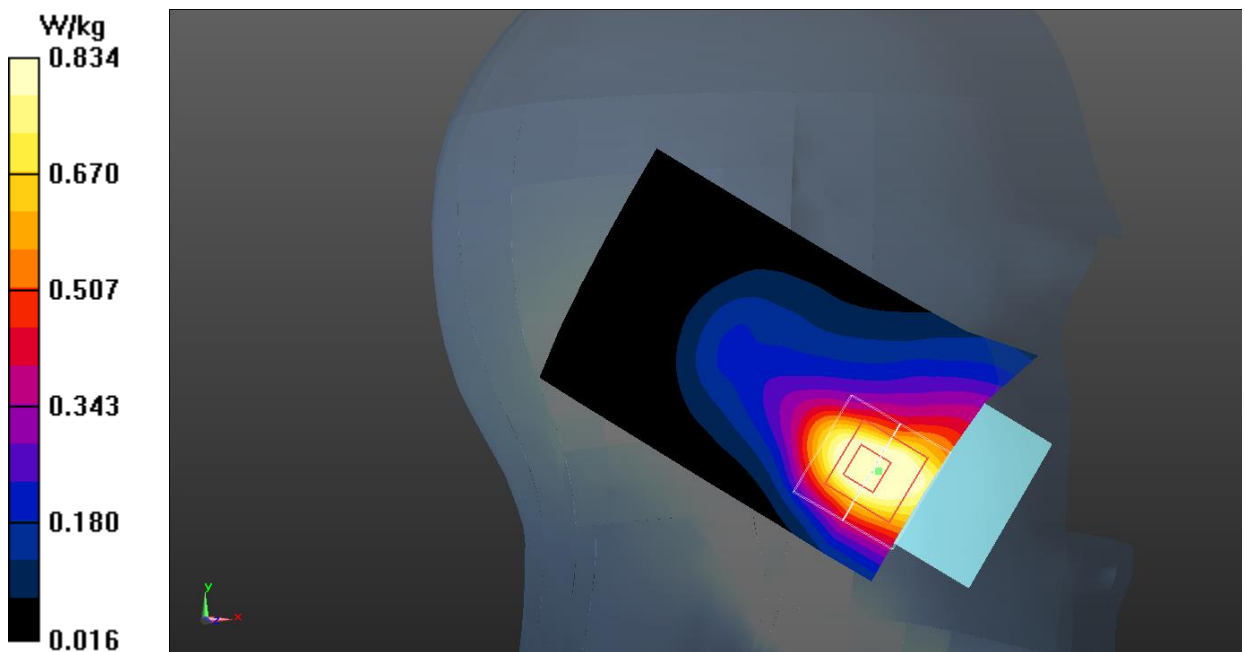

Fig.5 WCDMA Band 2 Head



**WCDMA Band 2 Body**

Date: 2020-4-11

Electronics: DAE4 Sn786

Medium: Head 1900MHz

Medium parameters used:  $f = 1880$  MHz;  $\sigma = 1.399$  S/m;  $\epsilon_r = 39.13$ ;  $\rho = 1000$  kg/m<sup>3</sup>

Ambient Temperature: 22.0°C      Liquid Temperature: 21.5°C

Communication System: UID 0, WCDMA (0) Frequency: 1880 MHz Duty Cycle: 1:1

Probe: ES3DV3 – SN3151 ConvF (5.11, 5.11, 5.11);

**Rear Side Middle/Area Scan (51x61x1):** Interpolated grid: dx=1.500 mm, dy=1.500 mm

Maximum value of SAR (interpolated) = 1.12 W/kg

**Rear Side Middle /Zoom Scan (5x5x7)/Cube 0:** Measurement grid: dx=8mm, dy=8mm, dz=5mm

Reference Value = 8.534 V/m; Power Drift = 0.03 dB

Peak SAR (extrapolated) = 1.33 W/kg

**SAR(1 g) = 0.829 W/kg; SAR(10 g) = 0.498 W/kg**

Maximum value of SAR (measured) = 1.09 W/kg

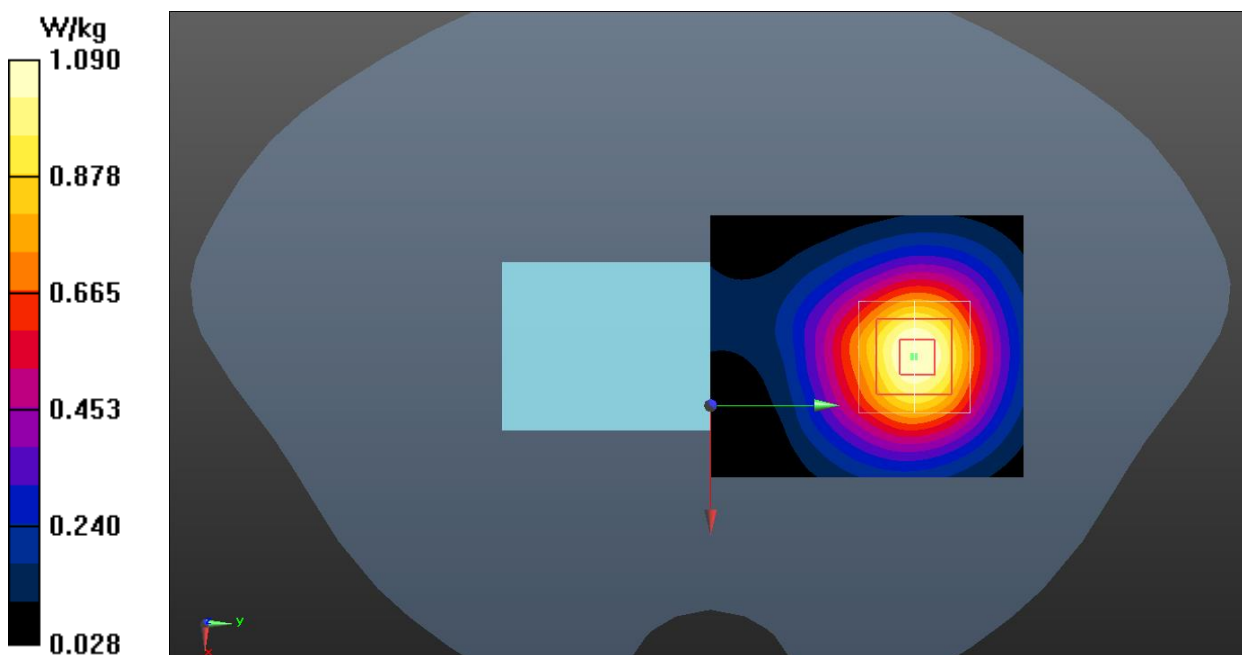
**Fig.6 WCDMA Band 2 Body**

**WCDMA Band 4 Head**

Date: 2020-4-13

Electronics: DAE4 Sn786

Medium: Head 1750MHz

Medium parameters used:  $f = 1753 \text{ MHz}$ ;  $\sigma = 1.359 \text{ S/m}$ ;  $\epsilon_r = 39.519$ ;  $\rho = 1000 \text{ kg/m}^3$ Ambient Temperature:  $22.0^\circ\text{C}$       Liquid Temperature:  $21.5^\circ\text{C}$ Communication System: UID 0, WCDMA (0) Frequency:  $1752.6 \text{ MHz}$  Duty Cycle: 1:1

Probe: ES3DV3 – SN3151 ConvF (5.23, 5.23, 5.23);

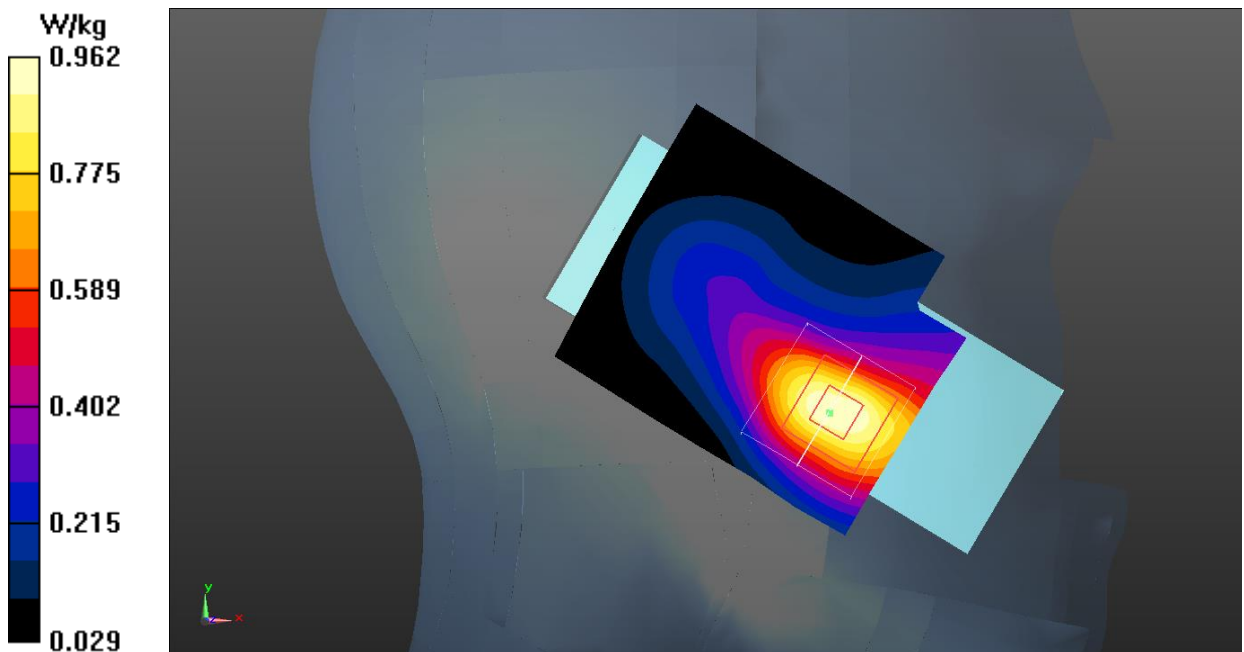
**Left Cheek High/Area Scan (51x61x1):** Interpolated grid:  $dx=1.500 \text{ mm}$ ,  $dy=1.500 \text{ mm}$ Maximum value of SAR (interpolated) =  $0.953 \text{ W/kg}$ **Left Cheek High/Zoom Scan (5x5x7)/Cube 0:** Measurement grid:  $dx=8\text{mm}$ ,  $dy=8\text{mm}$ ,  $dz=5\text{mm}$ Reference Value =  $7.176 \text{ V/m}$ ; Power Drift =  $0.04 \text{ dB}$ Peak SAR (extrapolated) =  $1.34 \text{ W/kg}$ **SAR(1 g) =  $0.868 \text{ W/kg}$ ; SAR(10 g) =  $0.507 \text{ W/kg}$** Maximum value of SAR (measured) =  $0.962 \text{ W/kg}$ **Fig.7 WCDMA Band 4 Head**

**WCDMA Band 4 Body**

Date: 2020-4-13

Electronics: DAE4 Sn786

Medium: Head 1750MHz

Medium parameters used:  $f = 1753 \text{ MHz}$ ;  $\sigma = 1.359 \text{ S/m}$ ;  $\epsilon_r = 39.519$ ;  $\rho = 1000 \text{ kg/m}^3$

Ambient Temperature:  $22.0^\circ\text{C}$       Liquid Temperature:  $21.5^\circ\text{C}$

Communication System: UID 0, WCDMA (0) Frequency:  $1752.6 \text{ MHz}$  Duty Cycle: 1:1

Probe: ES3DV3 – SN3151 ConvF (5.23, 5.23, 5.23);

**Rear Side High/Area Scan (51x61x1):** Interpolated grid:  $dx=1.500 \text{ mm}$ ,  $dy=1.500 \text{ mm}$

Maximum value of SAR (interpolated) =  $1.35 \text{ W/kg}$

**Rear Side High/Zoom Scan (5x5x7)/Cube 0:** Measurement grid:  $dx=8\text{mm}$ ,  $dy=8\text{mm}$ ,  $dz=5\text{mm}$

Reference Value =  $9.076 \text{ V/m}$ ; Power Drift =  $0.08 \text{ dB}$

Peak SAR (extrapolated) =  $1.60 \text{ W/kg}$

**SAR(1 g) =  $1.01 \text{ W/kg}$ ; SAR(10 g) =  $0.604 \text{ W/kg}$**

Maximum value of SAR (measured) =  $1.32 \text{ W/kg}$

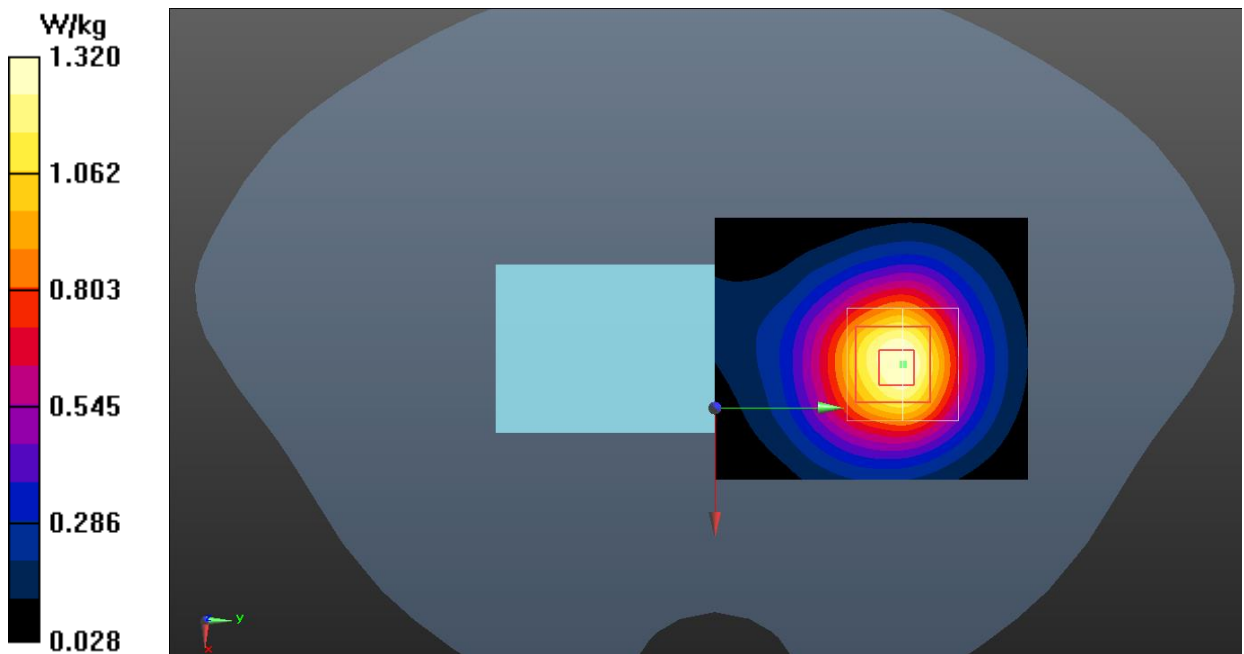

**Fig.8 WCDMA Band 4 Body**

**WCDMA Band 5 Head**

Date: 2020-4-12

Electronics: DAE4 Sn786

Medium: Head 835MHz

Medium parameters used (interpolated):  $f = 826.4$  MHz;  $\sigma = 0.91$  S/m;  $\epsilon_r = 41.147$ ;  $\rho = 1000$  kg/m<sup>3</sup>

Ambient Temperature: 22.0°C      Liquid Temperature: 21.5°C

Communication System: UID 0, WCDMA (0) Frequency: 826.4 MHz Duty Cycle: 1:1

Probe: ES3DV3 – SN3151 ConvF (6.41, 6.41, 6.41);

**Left Cheek Low/Area Scan (61x61x1):** Interpolated grid: dx=1.500 mm, dy=1.500 mm

Maximum value of SAR (interpolated) = 1.30 W/kg

**Left Cheek Low /Zoom Scan (5x5x7)/Cube 0:** Measurement grid: dx=8mm, dy=8mm, dz=5mm

Reference Value = 10.39 V/m; Power Drift = -0.01 dB

Peak SAR (extrapolated) = 1.45 W/kg

**SAR(1 g) = 1.05 W/kg; SAR(10 g) = 0.743 W/kg**

Maximum value of SAR (measured) = 1.27 W/kg

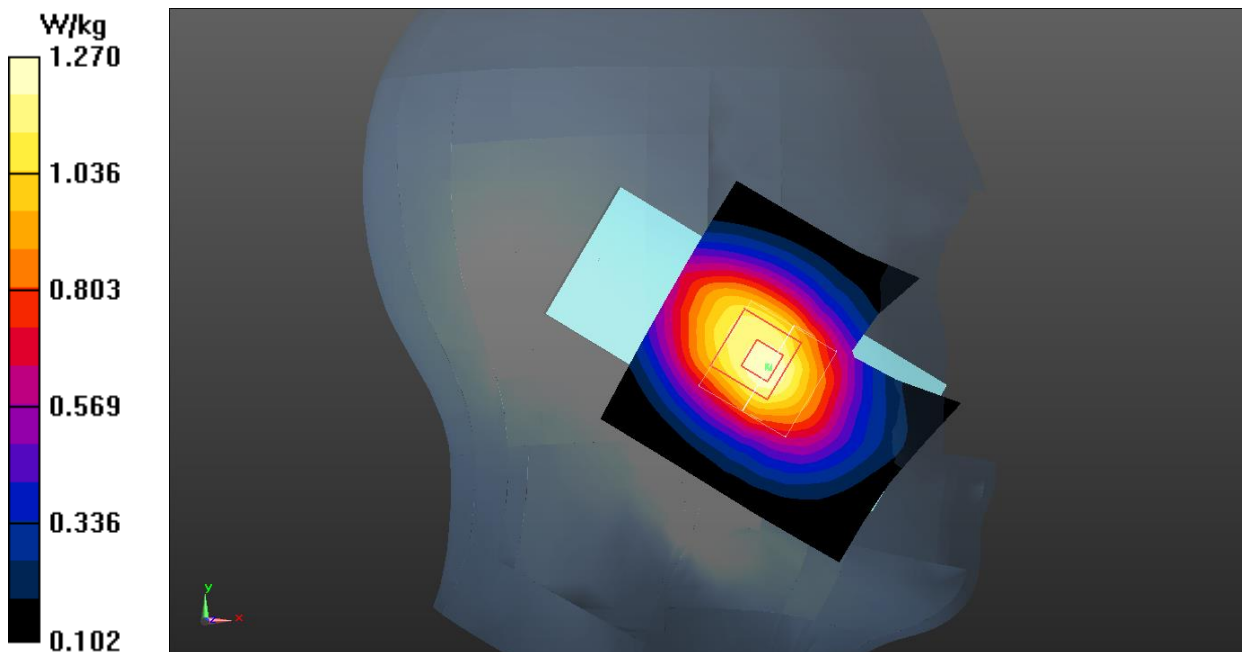
**Fig.9 WCDMA Band 5 Head**

**WCDMA Band 5 Body**

Date: 2020-4-12

Electronics: DAE4 Sn786

Medium: Head 835MHz

Medium parameters used (interpolated):  $f = 836.4$  MHz;  $\sigma = 0.919$  S/m;  $\epsilon_r = 41.027$ ;  $\rho = 1000$  kg/m<sup>3</sup>

Ambient Temperature: 22.0°C      Liquid Temperature: 21.5°C

Communication System: UID 0, WCDMA (0) Frequency: 836.4 MHz Duty Cycle: 1:1

Probe: ES3DV3 – SN3151 ConvF (6.41, 6.41, 6.41);

**Rear Side Middle/Area Scan (51x91x1):** Interpolated grid:  $dx=1.500$  mm,  $dy=1.500$  mm

Maximum value of SAR (interpolated) = 0.434 W/kg

**Rear Side Middle/Zoom Scan (5x5x7)/Cube 0:** Measurement grid:  $dx=8$ mm,  $dy=8$ mm,  $dz=5$ mm

Reference Value = 19.11 V/m; Power Drift = 0.11 dB

Peak SAR (extrapolated) = 0.495 W/kg

**SAR(1 g) = 0.363 W/kg; SAR(10 g) = 0.256 W/kg**

Maximum value of SAR (measured) = 0.437 W/kg

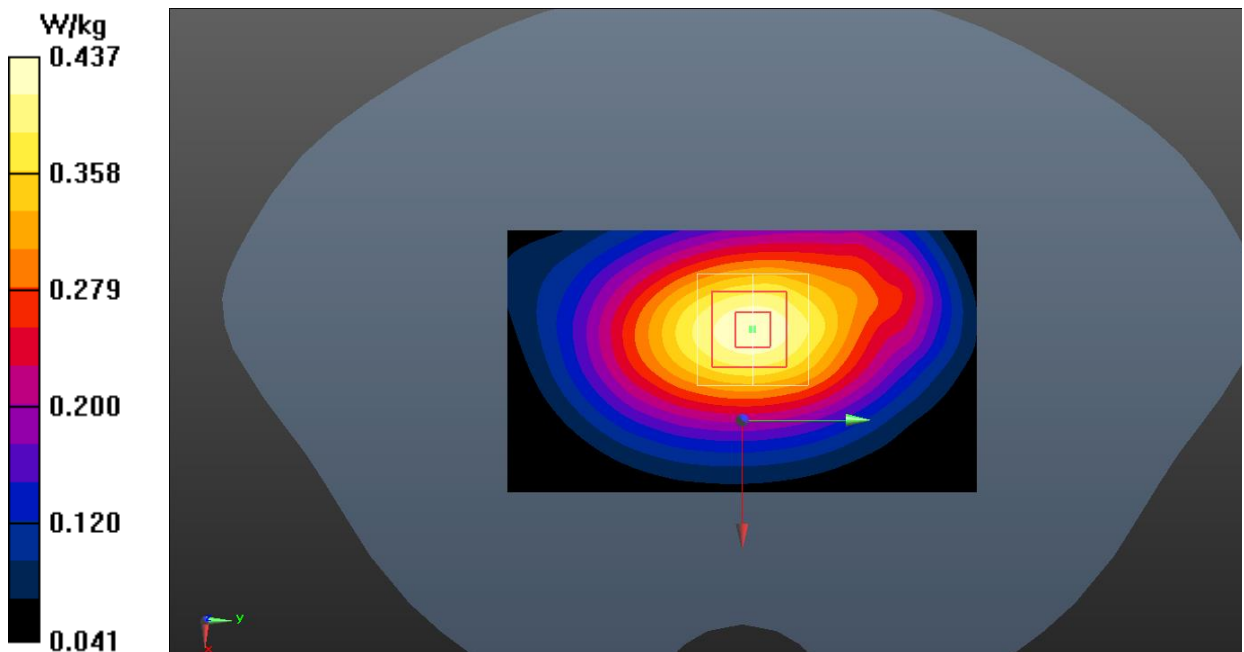

Fig.10 WCDMA Band 5 Body

**LTE Band 2 Head**

Date: 2020-4-11

Electronics: DAE4 Sn786

Medium: Head 1900MHz

Medium parameters used:  $f = 1900$  MHz;  $\sigma = 1.417$  S/m;  $\epsilon_r = 39.052$ ;  $\rho = 1000$  kg/m<sup>3</sup>

Ambient Temperature: 22.0°C      Liquid Temperature: 21.5°C

Communication System: UID 0, LTE\_FDD (0) Frequency: 1900 MHz Duty Cycle: 1:1

Probe: ES3DV3 – SN3151 ConvF (5.11, 5.11, 5.11);

**Left Cheek High 1RB\_99/Area Scan (51x61x1):** Interpolated grid: dx=1.500 mm, dy=1.500 mm

Maximum value of SAR (interpolated) = 1.18 W/kg

**Left Cheek High 1RB\_99/Zoom Scan (5x5x7)/Cube 0:** Measurement grid: dx=8mm, dy=8mm, dz=5mm

Reference Value = 6.694 V/m; Power Drift = 0.02 dB

Peak SAR (extrapolated) = 1.40 W/kg

**SAR(1 g) = 0.882 W/kg; SAR(10 g) = 0.522 W/kg**

Maximum value of SAR (measured) = 1.14 W/kg

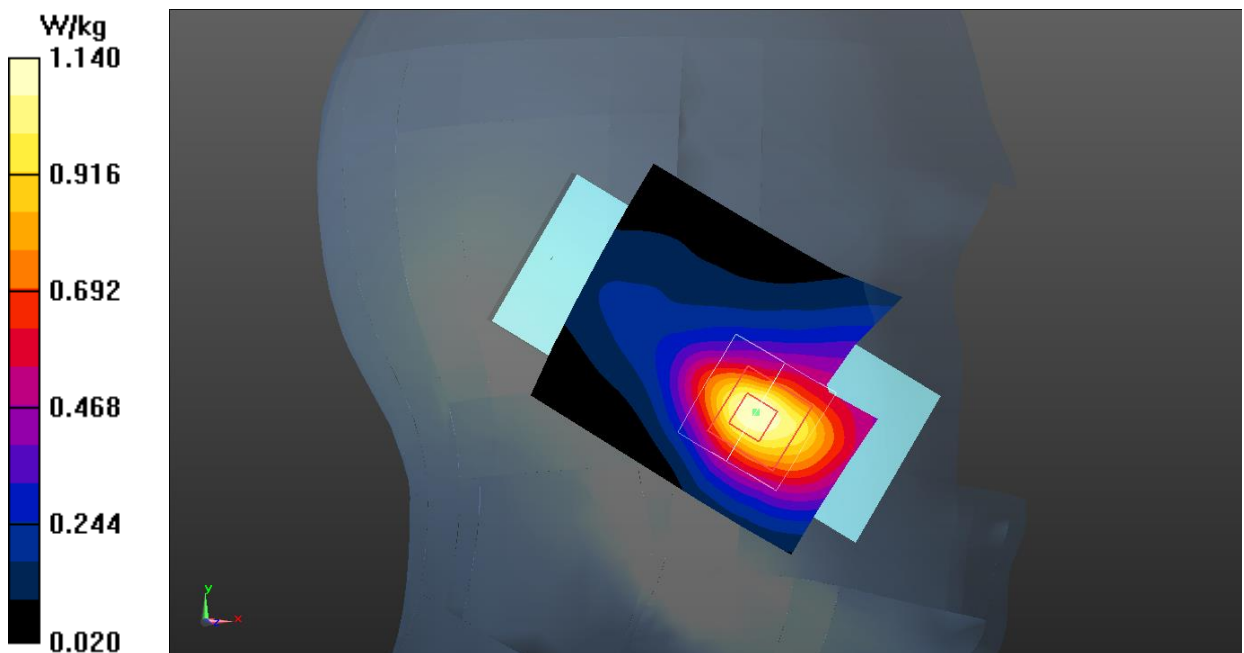
**Fig.11 LTE Band 2 Head**

**LTE Band 2 Body**

Date: 2020-4-11

Electronics: DAE4 Sn786

Medium: Head 1900MHz

Medium parameters used:  $f = 1900 \text{ MHz}$ ;  $\sigma = 1.417 \text{ S/m}$ ;  $\epsilon_r = 39.052$ ;  $\rho = 1000 \text{ kg/m}^3$

Ambient Temperature:  $22.0^\circ\text{C}$       Liquid Temperature:  $21.5^\circ\text{C}$

Communication System: UID 0, LTE\_FDD (0) Frequency: 1900 MHz Duty Cycle: 1:1

Probe: ES3DV3 – SN3151 ConvF (5.11, 5.11, 5.11);

**Rear Side High 1RB\_99/Area Scan (51x61x1):** Interpolated grid:  $dx=1.500 \text{ mm}$ ,  $dy=1.500 \text{ mm}$

Maximum value of SAR (interpolated) =  $1.07 \text{ W/kg}$

**Rear Side High 1RB\_99/Zoom Scan (5x5x7)/Cube 0:** Measurement grid:  $dx=8\text{mm}$ ,  $dy=8\text{mm}$ ,  $dz=5\text{mm}$

Reference Value =  $16.11 \text{ V/m}$ ; Power Drift =  $-0.05 \text{ dB}$

Peak SAR (extrapolated) =  $1.26 \text{ W/kg}$

**SAR(1 g) =  $0.787 \text{ W/kg}$ ; SAR(10 g) =  $0.473 \text{ W/kg}$**

Maximum value of SAR (measured) =  $1.04 \text{ W/kg}$

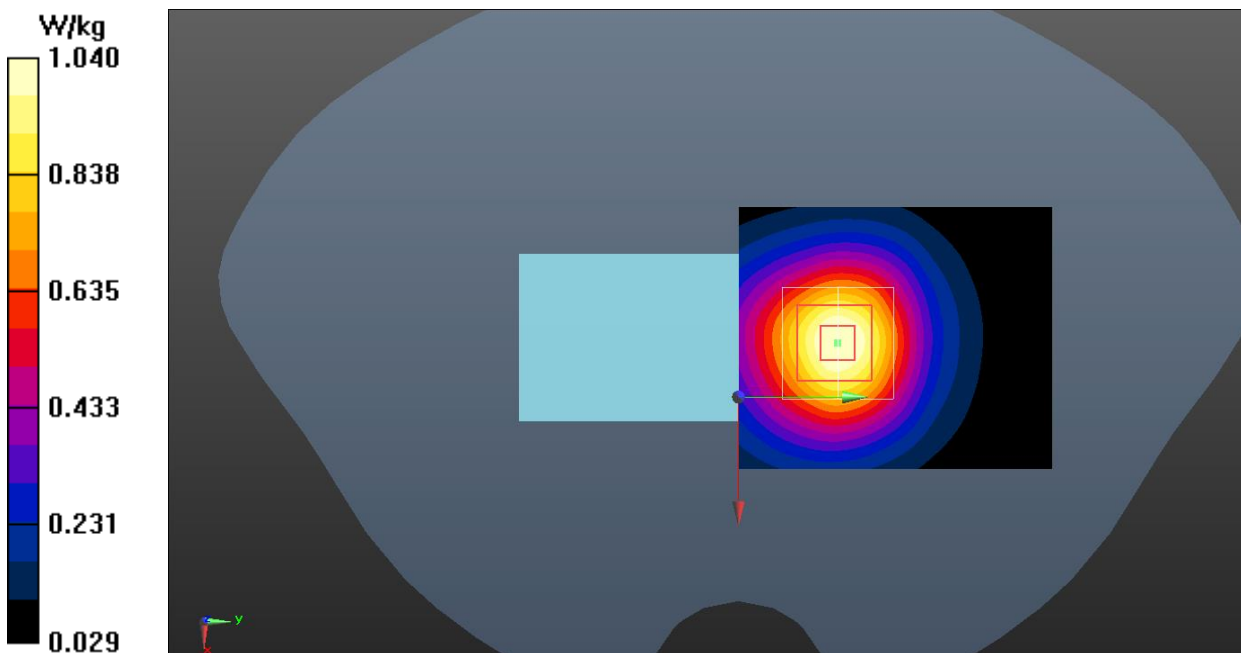

**Fig.12 LTE Band 2 Body**

**LTE Band 4 Head**

Date: 2020-4-13

Electronics: DAE4 Sn786

Medium: Head 1750MHz

Medium parameters used:  $f = 1745$  MHz;  $\sigma = 1.352$  S/m;  $\epsilon_r = 39.551$ ;  $\rho = 1000$  kg/m<sup>3</sup>

Ambient Temperature: 22.0°C      Liquid Temperature: 21.5°C

Communication System: UID 0, LTE\_FDD (0) Frequency: 1745 MHz Duty Cycle: 1:1

Probe: ES3DV3 – SN3151 ConvF (5.23, 5.23, 5.23);

**Right Cheek High 1RB\_99/Area Scan (61x61x1):** Interpolated grid: dx=1.500 mm, dy=1.500 mm

Maximum value of SAR (interpolated) = 1.59 W/kg

**Right Cheek High 1RB\_99/Zoom Scan (5x5x7)/Cube 0:** Measurement grid: dx=8mm, dy=8mm, dz=5mm

Reference Value = 10.92 V/m; Power Drift = 0.09 dB

Peak SAR (extrapolated) = 1.68 W/kg

**SAR(1 g) = 0.971 W/kg; SAR(10 g) = 0.596 W/kg**

Maximum value of SAR (measured) = 1.23 W/kg

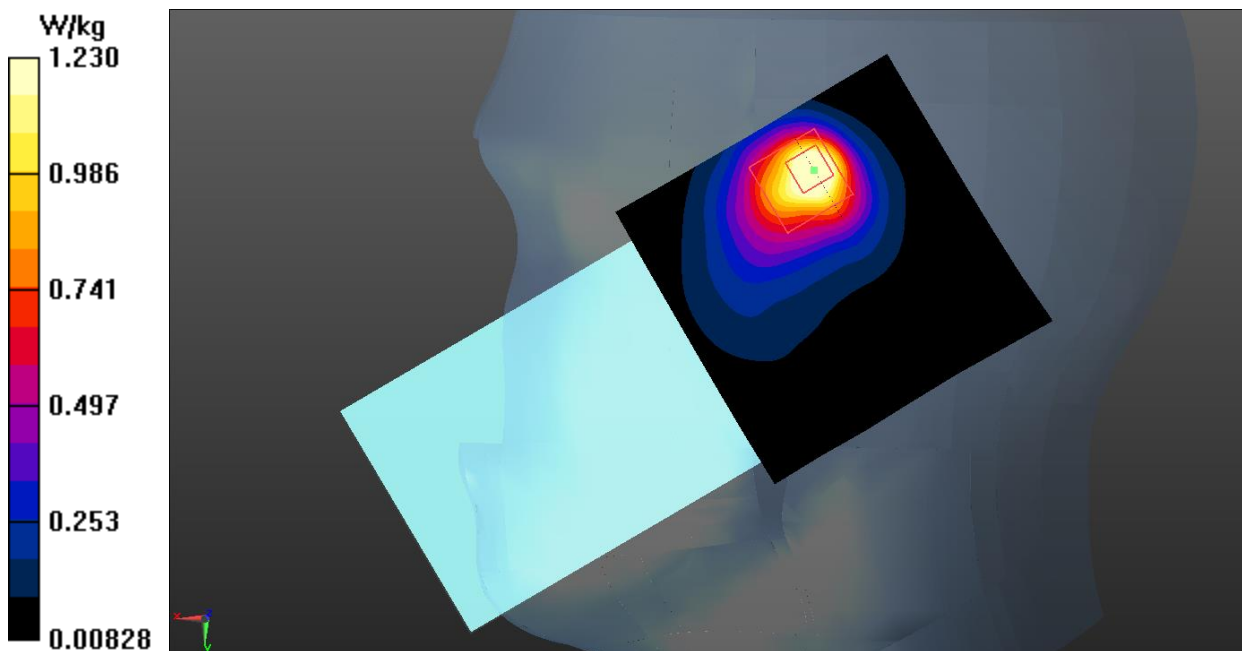
**Fig.13 LTE Band 4 Head**



**LTE Band 4 Body**

Date: 2020-4-13

Electronics: DAE4 Sn786

Medium: Head 1750MHz

Medium parameters used:  $f = 1745$  MHz;  $\sigma = 1.352$  S/m;  $\epsilon_r = 39.551$ ;  $\rho = 1000$  kg/m<sup>3</sup>

Ambient Temperature: 22.0°C      Liquid Temperature: 21.5°C

Communication System: UID 0, LTE\_FDD (0) Frequency: 1745 MHz Duty Cycle: 1:1

Probe: ES3DV3 – SN3151 ConvF (5.23, 5.23, 5.23);

**Rear Side High 1RB\_99/Area Scan (51x61x1):** Interpolated grid: dx=1.500 mm, dy=1.500 mm

Maximum value of SAR (interpolated) = 1.10 W/kg

**Rear Side High 1RB\_99/Zoom Scan (5x5x7)/Cube 0:** Measurement grid: dx=8mm, dy=8mm, dz=5mm

Reference Value = 14.01 V/m; Power Drift = -0.14 dB

Peak SAR (extrapolated) = 1.34 W/kg

**SAR(1 g) = 1.02 W/kg; SAR(10 g) = 0.617 W/kg**

Maximum value of SAR (measured) = 0.802 W/kg

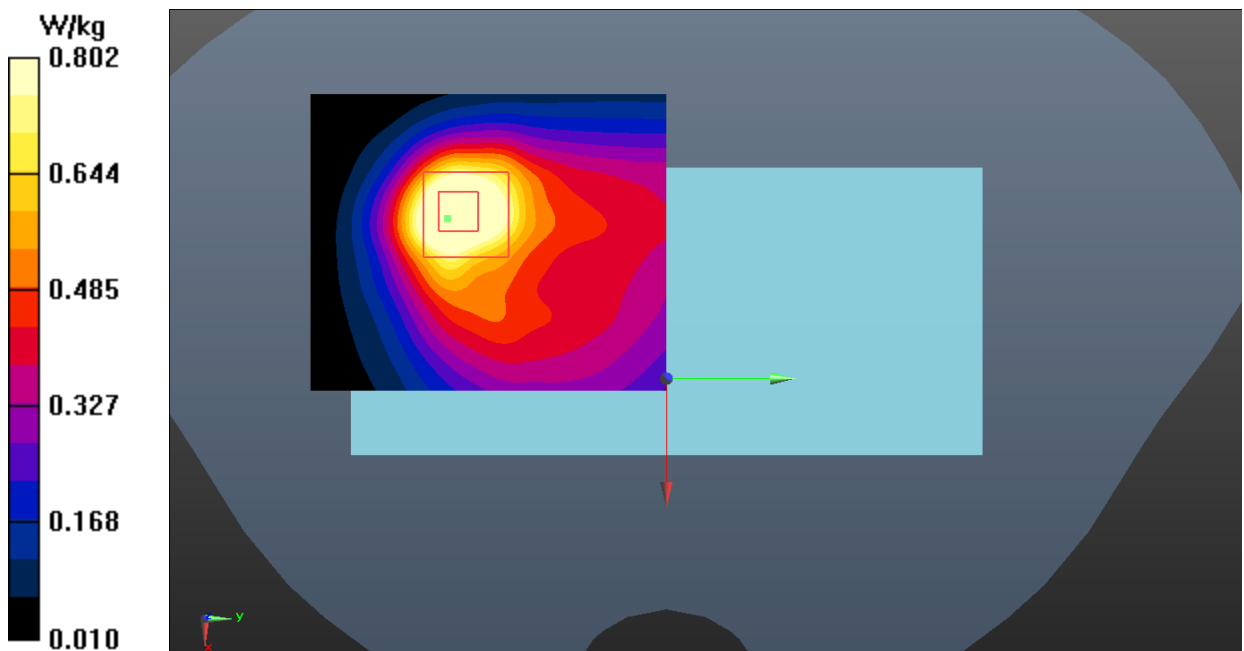
**Fig.14 LTE Band 4 Body**

**LTE Band 5 Head**

Date: 2020-3-12

Electronics: DAE4 Sn786

Medium: Head 835MHz

Medium parameters used (interpolated):  $f = 829$  MHz;  $\sigma = 0.913$  S/m;  $\epsilon_r = 41.116$ ;  $\rho = 1000$  kg/m<sup>3</sup>

Ambient Temperature: 22.0°C      Liquid Temperature: 21.5°C

Communication System: UID 0, LTE\_FDD (0) Frequency: 829 MHz Duty Cycle: 1:1

Probe: ES3DV3 – SN3151 ConvF (6.41, 6.41, 6.41);

**Right Cheek Low 1RB\_49/Area Scan (51x101x1):** Interpolated grid: dx=1.500 mm, dy=1.500 mm  
Maximum value of SAR (interpolated) = 1.16 W/kg

**Right Cheek Low 1RB\_49/Zoom Scan (5x5x7)/Cube 0:** Measurement grid: dx=8mm, dy=8mm, dz=5mm

Reference Value = 11.19 V/m; Power Drift = 0.06 dB

Peak SAR (extrapolated) = 1.30 W/kg

**SAR(1 g) = 0.969 W/kg; SAR(10 g) = 0.680 W/kg**

Maximum value of SAR (measured) = 1.13 W/kg

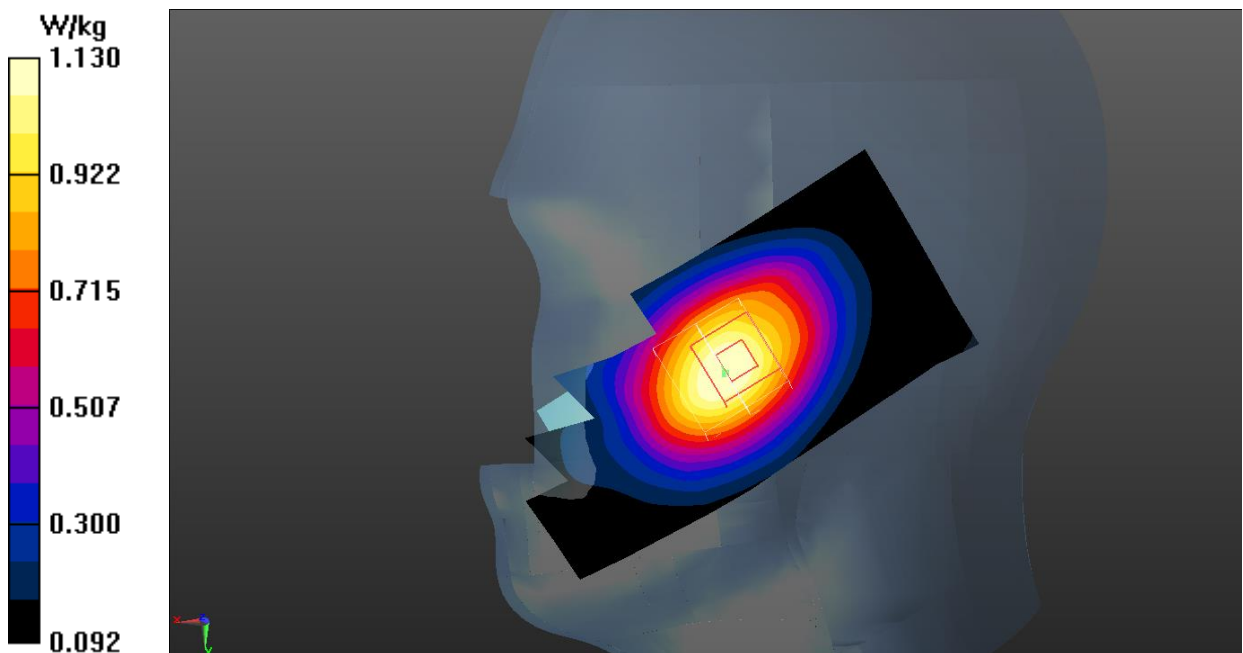

**Fig.15 LTE Band 5 Head**

**LTE Band 5 Body**

Date: 2020-3-12

Electronics: DAE4 Sn786

Medium: Head 835MHz

Medium parameters used (interpolated):  $f = 829$  MHz;  $\sigma = 0.913$  S/m;  $\epsilon_r = 41.116$ ;  $\rho = 1000$  kg/m<sup>3</sup>

Ambient Temperature: 22.0°C      Liquid Temperature: 21.5°C

Communication System: UID 0, LTE\_FDD (0) Frequency: 829 MHz Duty Cycle: 1:1

Probe: ES3DV3 – SN3151 ConvF (6.41, 6.41, 6.41);

**Front Side Low 1RB\_49/Area Scan (51x61x1):** Interpolated grid: dx=1.500 mm, dy=1.500 mm

Maximum value of SAR (interpolated) = 0.681 W/kg

**Front Side Low 1RB\_49/Zoom Scan (5x5x7)/Cube 0:** Measurement grid: dx=8mm, dy=8mm, dz=5mm

Reference Value = 25.14 V/m; Power Drift = 0.11 dB

Peak SAR (extrapolated) = 0.796 W/kg

**SAR(1 g) = 0.578 W/kg; SAR(10 g) = 0.407 W/kg**

Maximum value of SAR (measured) = 0.694 W/kg

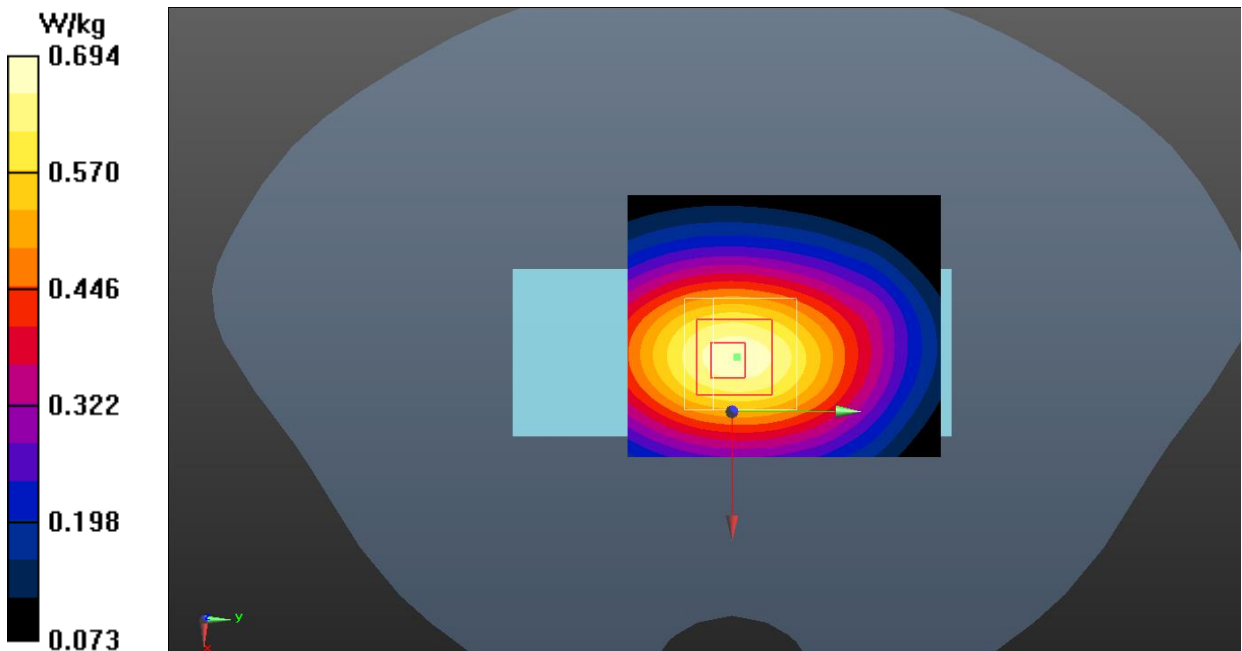

**Fig.16 LTE Band 5 Body**

**LTE Band 7 Head**

Date: 2020-4-14

Electronics: DAE4 Sn786

Medium: Head 2550MHz

Medium parameters used (interpolated):  $f = 2535$  MHz;  $\sigma = 1.931$  S/m;  $\epsilon_r = 38.335$ ;  $\rho = 1000$  kg/m<sup>3</sup>

Ambient Temperature: 22.0°C      Liquid Temperature: 21.5°C

Communication System: UID 0, LTE\_FDD (0) Frequency: 2535 MHz Duty Cycle: 1:1

Probe: ES3DV3 – SN3151 ConvF (4.53, 4.53, 4.53);

**Left Cheek Middle 1RB\_0/Area Scan (51x61x1):** Interpolated grid: dx=1.500 mm, dy=1.500 mm

Maximum value of SAR (interpolated) = 1.34 W/kg

**Left Cheek Middle 1RB\_0/Zoom Scan (5x5x7)/Cube 0:** Measurement grid: dx=8mm, dy=8mm, dz=5mm

Reference Value = 8.343 V/m; Power Drift = 0.06 dB

Peak SAR (extrapolated) = 1.77 W/kg

**SAR(1 g) = 1.05 W/kg; SAR(10 g) = 0.602 W/kg**

Maximum value of SAR (measured) = 1.38 W/kg

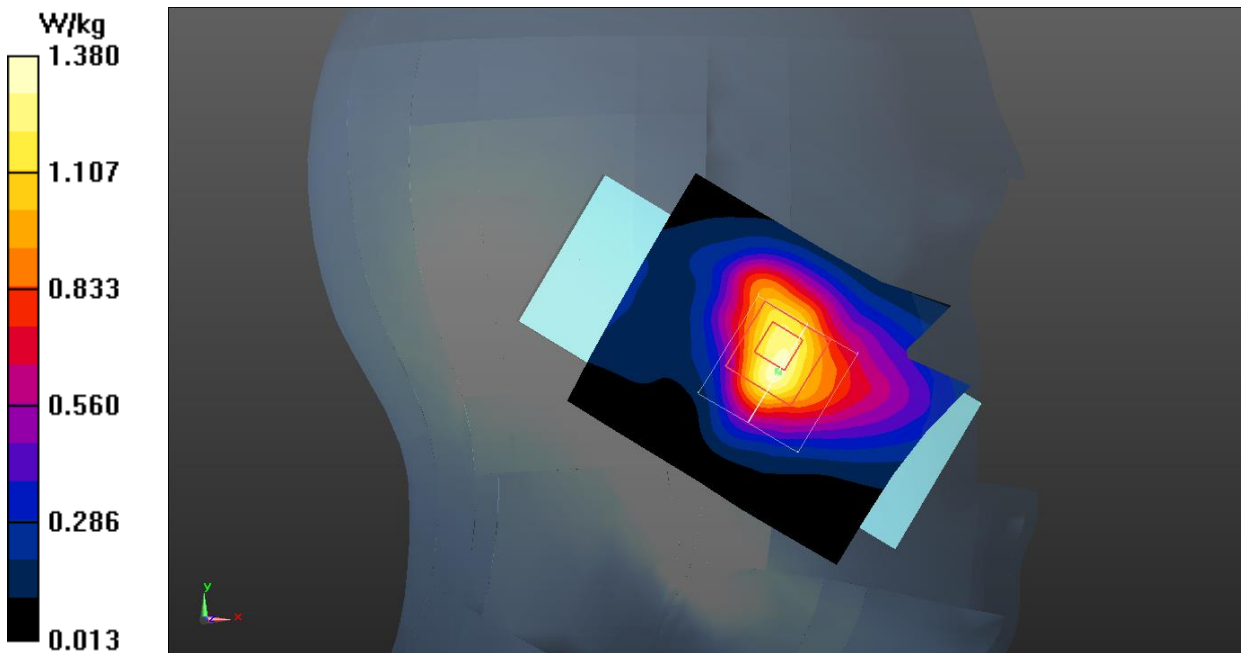

**Fig.17 LTE Band 7 Head**

**LTE Band 7 Body**

Date: 2020-4-14

Electronics: DAE4 Sn786

Medium: Head 2550MHz

Medium parameters used:  $f = 2560$  MHz;  $\sigma = 1.961$  S/m;  $\epsilon_r = 38.252$ ;  $\rho = 1000$  kg/m<sup>3</sup>

Ambient Temperature: 22.0°C      Liquid Temperature: 21.5°C

Communication System: UID 0, LTE\_FDD (0) Frequency: 2560 MHz Duty Cycle: 1:1

Probe: ES3DV3 – SN3151 ConvF (4.53, 4.53, 4.53);

**Front Side High 1RB\_99/Area Scan (51x61x1):** Interpolated grid: dx=1.500 mm, dy=1.500 mm

Maximum value of SAR (interpolated) = 0.372 W/kg

**Front Side High 1RB\_99/Zoom Scan (5x5x7)/Cube 0:** Measurement grid: dx=8mm, dy=8mm, dz=5mm

Reference Value = 8.924 V/m; Power Drift = 0.13 dB

Peak SAR (extrapolated) = 0.498 W/kg

**SAR(1 g) = 0.262 W/kg; SAR(10 g) = 0.143 W/kg**

Maximum value of SAR (measured) = 0.371 W/kg

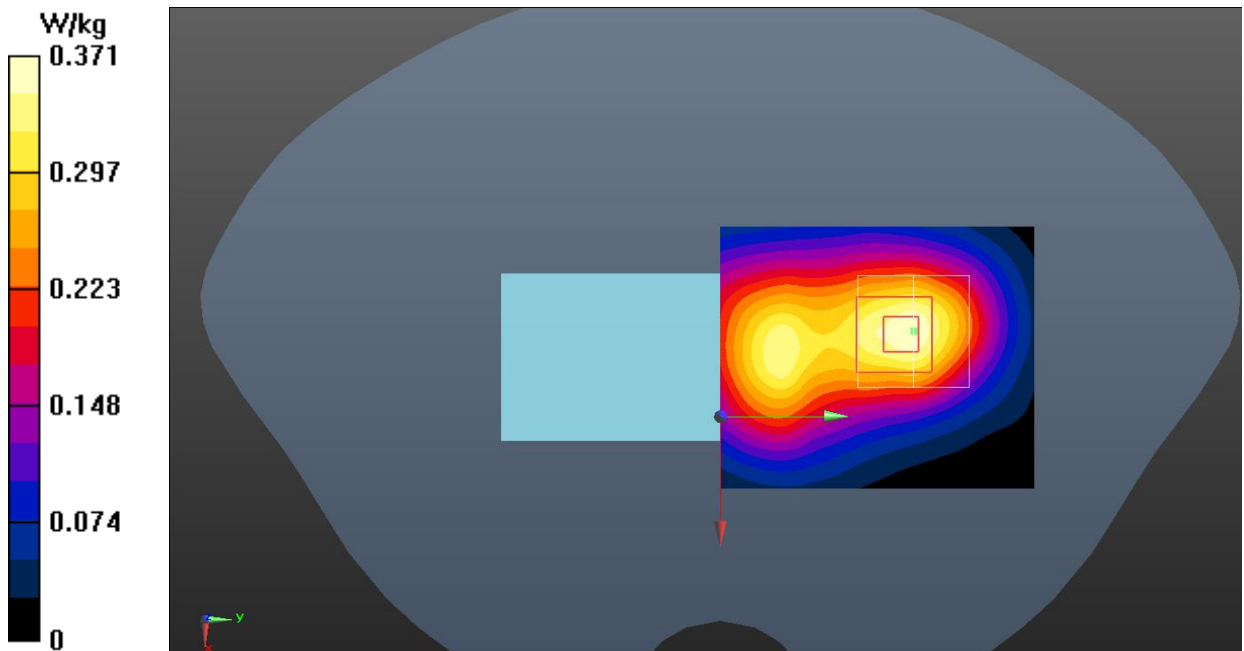
**Fig.18 LTE Band 7 Body**

**LTE Band 28 Head**

Date: 2020-4-13

Electronics: DAE4 Sn786

Medium: Head 750MHz

Medium parameters used:  $f = 738$  MHz;  $\sigma = 0.893$  S/m;  $\epsilon_r = 41.46$ ;  $\rho = 1000$  kg/m<sup>3</sup>

Ambient Temperature: 22.0°C      Liquid Temperature: 21.5°C

Communication System: UID 0, WCDMA (0) Frequency: 738 MHz Duty Cycle: 1:1

Probe: ES3DV3 – SN3151 ConvF (6.41, 6.41, 6.41);

**Left Cheek High 1RB\_99/Area Scan (51x61x1):** Interpolated grid: dx=1.500 mm, dy=1.500 mm

Maximum value of SAR (interpolated) = 1.03 W/kg

**Left Cheek High 1RB\_99/Zoom Scan (5x5x7)/Cube 0:** Measurement grid: dx=8mm, dy=8mm, dz=5mm

Reference Value = 8.078 V/m; Power Drift = -0.15 dB

Peak SAR (extrapolated) = 1.23 W/kg

**SAR(1 g) = 0.903 W/kg; SAR(10 g) = 0.637 W/kg**

Maximum value of SAR (measured) = 1.07 W/kg

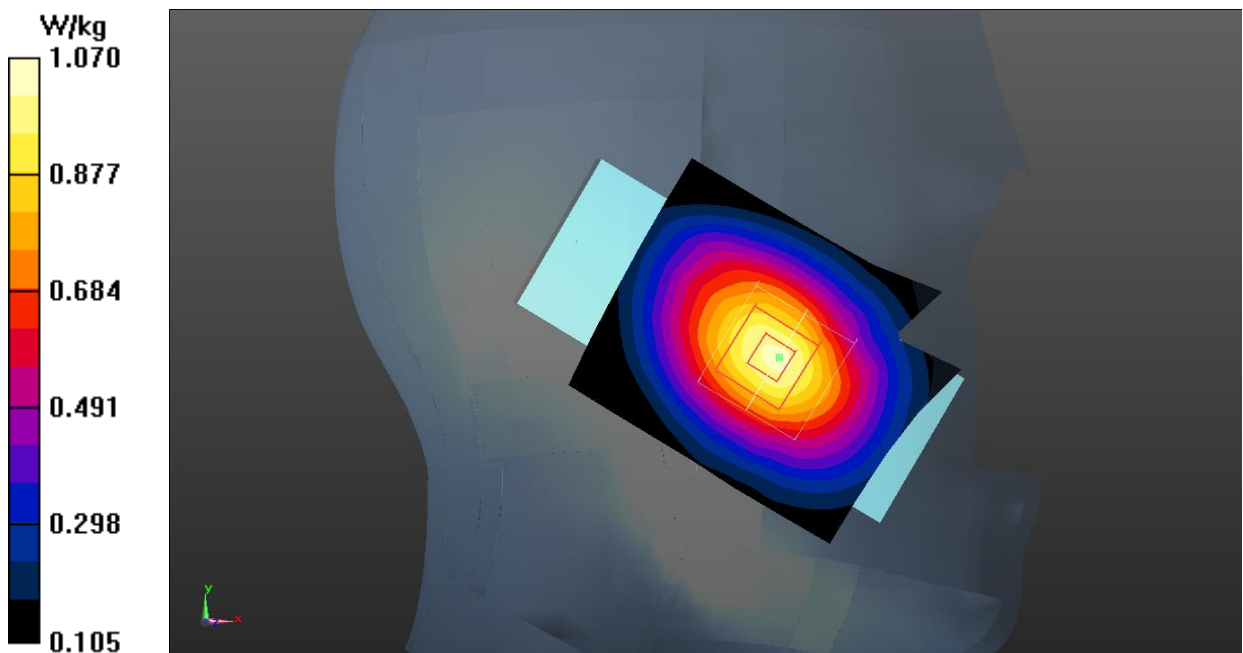
**Fig.19 LTE Band 28 Head**

**LTE Band 28 Body**

Date: 2020-4-13

Electronics: DAE4 Sn786

Medium: Head 750MHz

Medium parameters used:  $f = 738 \text{ MHz}$ ;  $\sigma = 0.893 \text{ S/m}$ ;  $\epsilon_r = 41.46$ ;  $\rho = 1000 \text{ kg/m}^3$

Ambient Temperature:  $22.0^\circ\text{C}$       Liquid Temperature:  $21.5^\circ\text{C}$

Communication System: UID 0, WCDMA (0) Frequency: 750 MHz Duty Cycle: 1:1

Probe: ES3DV3 – SN3151 ConvF (6.41, 6.41, 6.41);

**Rear Side High 1RB\_99/Area Scan (51x61x1):** Interpolated grid:  $dx=1.500 \text{ mm}$ ,  $dy=1.500 \text{ mm}$

Maximum value of SAR (interpolated) =  $0.773 \text{ W/kg}$

**Rear Side High 1RB\_99/Zoom Scan (5x5x7)/Cube 0:** Measurement grid:  $dx=8\text{mm}$ ,  $dy=8\text{mm}$ ,  $dz=5\text{mm}$

Reference Value =  $26.38 \text{ V/m}$ ; Power Drift =  $-0.03 \text{ dB}$

Peak SAR (extrapolated) =  $0.890 \text{ W/kg}$

**SAR(1 g) =  $0.638 \text{ W/kg}$ ; SAR(10 g) =  $0.450 \text{ W/kg}$**

Maximum value of SAR (measured) =  $0.772 \text{ W/kg}$

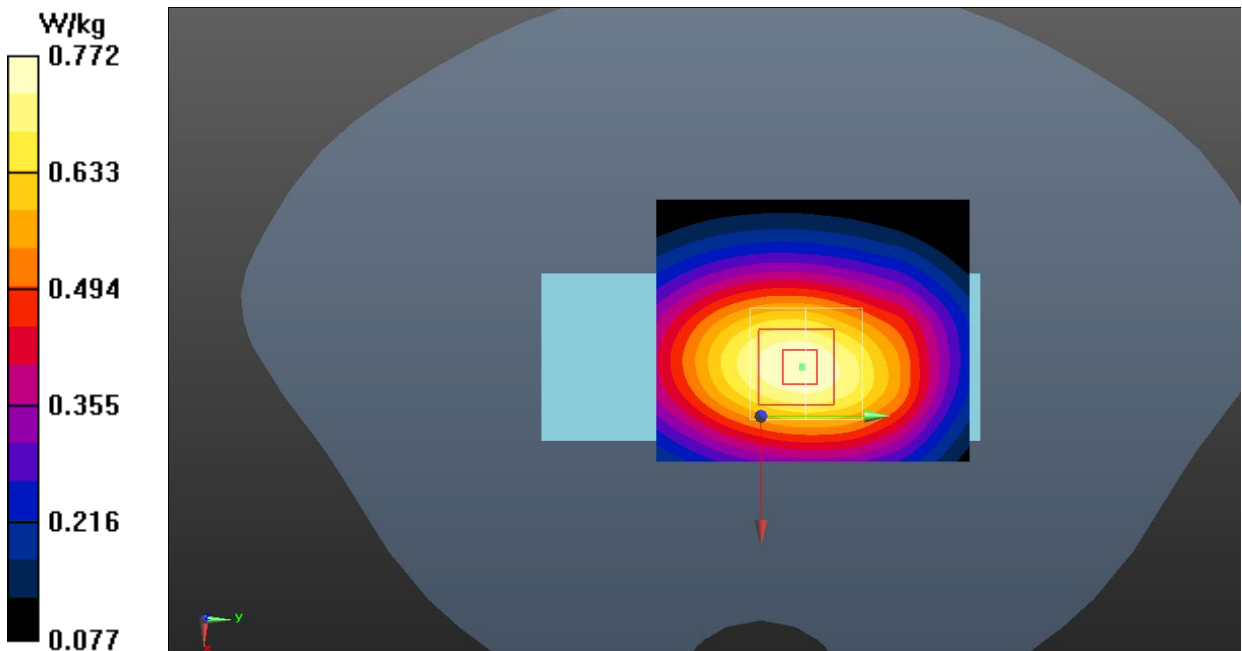

**Fig.20 LTE Band 28 Body**

**Bluetooth Head**

Date: 2020-4-14

Electronics: DAE4 Sn786

Medium: Head 2450MHz

Medium parameters used:  $f = 2480$  MHz;  $\sigma = 1.81$  S/m;  $\epsilon_r = 39.563$ ;  $\rho = 1000$  kg/m<sup>3</sup>

Ambient Temperature: 22.0°C      Liquid Temperature: 21.5°C

Communication System: UID 0, BT (0) Frequency: 2480 MHz Duty Cycle: 1:1

Probe: ES3DV3 – SN3151 ConvF (4.68, 4.68, 4.68);

**Right Cheek High/Area Scan (91x161x1):** Interpolated grid: dx=1.000 mm, dy=1.000 mm

Maximum value of SAR (interpolated) = 0.068 W/kg

**Right Cheek High /Zoom Scan (7x7x7)/Cube 0:** Measurement grid: dx=5mm, dy=5mm, dz=5mm

Reference Value = 0.238 V/m; Power Drift = 0.05 dB

Peak SAR (extrapolated) = 0.089 W/kg

**SAR(1 g) = 0.009 W/kg; SAR(10 g) = 0.004 W/kg**

Maximum value of SAR (interpolated) = 0.077 W/kg

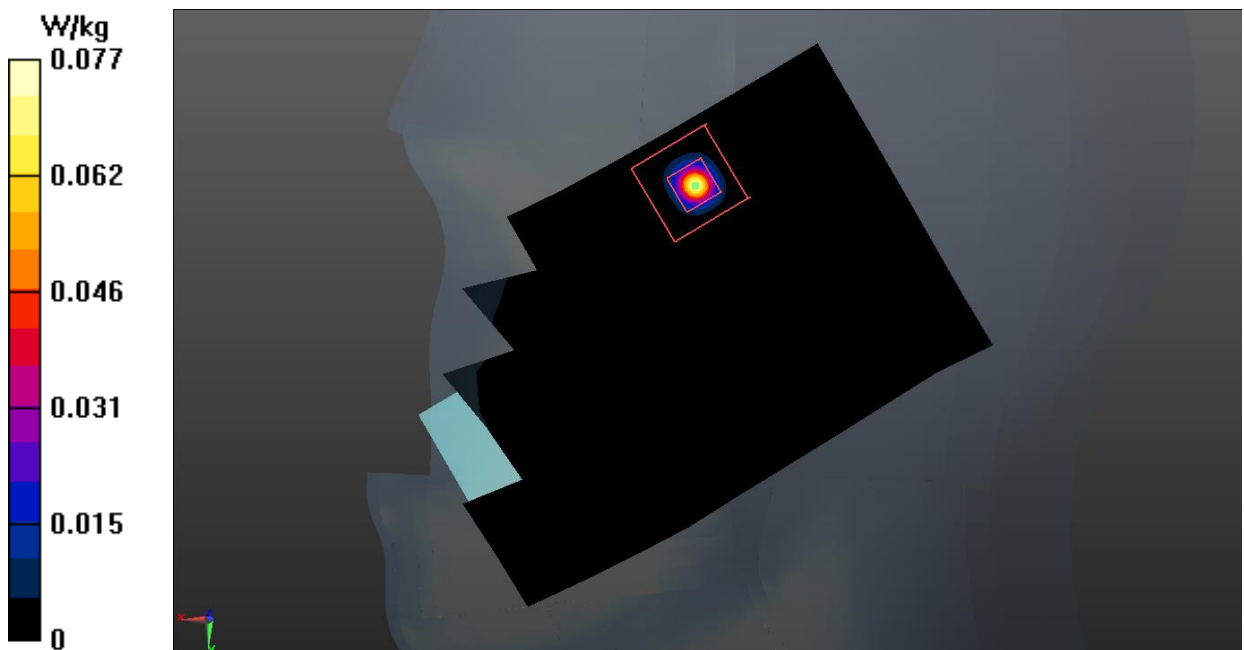

Fig.21 Bluetooth Head



## ANNEX B: System Verification Results

### 750MHz

Date: 2020-4-13

Electronics: DAE4 Sn786

Medium: Head 750MHz

Medium parameters used:  $f = 750 \text{ MHz}$ ;  $\sigma = 0.904 \text{ S/m}$ ;  $\epsilon_r = 41.316$ ;  $\rho = 1000 \text{ kg/m}^3$

Ambient Temperature:  $22.5^\circ\text{C}$       Liquid Temperature:  $22.0^\circ\text{C}$

Communication System: CW\_TMC Frequency: 750 MHz Duty Cycle: 1:1

Probe: EX3DV4 – SN3633 ConvF (9.51, 9.51, 9.51);

**System Validation /Area Scan (81x191x1):** Interpolated grid:  $dx=1.000 \text{ mm}$ ,  $dy=1.000 \text{ mm}$

Reference Value =  $59.824 \text{ V/m}$ ; Power Drift =  $0.01 \text{ dB}$

**SAR(1 g) =  $2.14 \text{ W/kg}$ ; SAR(10 g) =  $1.42 \text{ W/kg}$**

Maximum value of SAR (interpolated) =  $2.45 \text{ W/kg}$

**System Validation /Zoom Scan (7x7x7)/Cube 0:** Measurement grid:  $dx=5\text{mm}$ ,  $dy=5\text{mm}$ ,  $dz=5\text{mm}$

Reference Value =  $59.824 \text{ V/m}$ ; Power Drift =  $0.01 \text{ dB}$

Peak SAR (extrapolated) =  $2.84 \text{ W/kg}$

**SAR(1 g) =  $2.18 \text{ W/kg}$ ; SAR(10 g) =  $1.44 \text{ W/kg}$**

Maximum value of SAR (measured) =  $2.48 \text{ W/kg}$

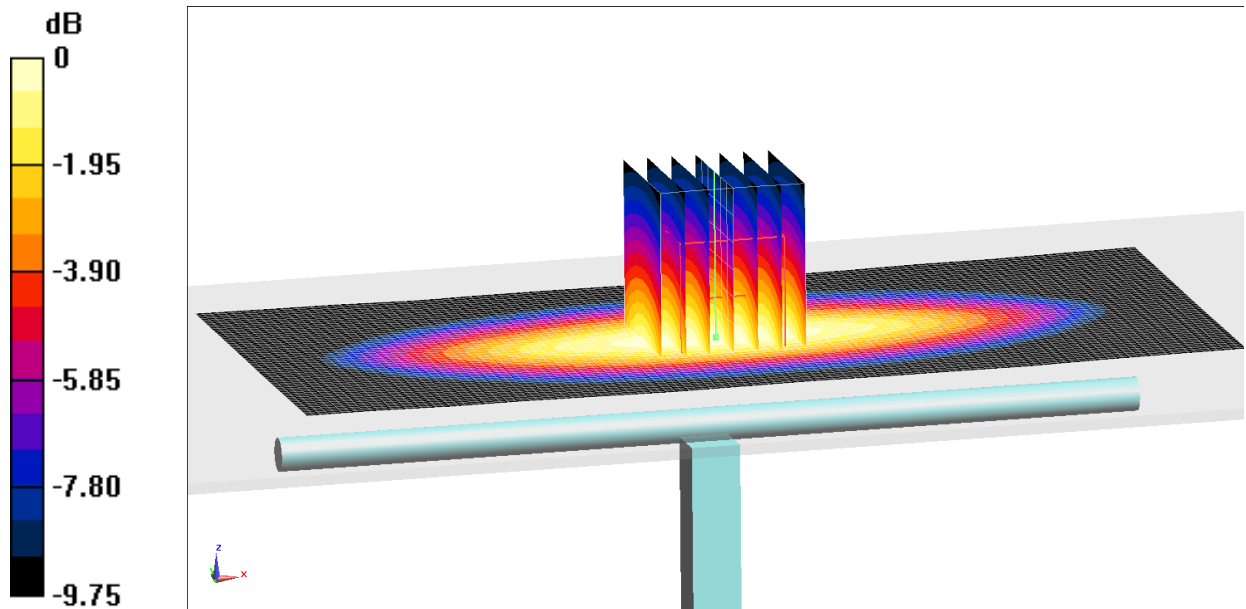

0 dB =  $2.48 \text{ W/kg}$  =  $3.95 \text{ dB W/kg}$

**Fig.B.1. validation 750MHz 250mW**

**835MHz**

Date: 2020-4-12

Electronics: DAE4 Sn786

Medium: Head 835MHz

Medium parameters used:  $f = 835 \text{ MHz}$ ;  $\sigma = 0.918 \text{ S/m}$ ;  $\epsilon_r = 41.044$ ;  $\rho = 1000 \text{ kg/m}^3$

Ambient Temperature:  $22.5^\circ\text{C}$       Liquid Temperature:  $22.0^\circ\text{C}$

Communication System: CW Frequency: 835 MHz Duty Cycle: 1:1

Probe: ES3DV3 – SN3151 ConvF (6.41, 6.41, 6.41);

**System Validation /Area Scan (81x161x1):** Interpolated grid:  $dx=1.000 \text{ mm}$ ,  $dy=1.000 \text{ mm}$

Reference Value =  $61.567 \text{ V/m}$ ; Power Drift =  $0.08 \text{ dB}$

**SAR(1 g) =  $2.45 \text{ W/kg}$ ; SAR(10 g) =  $1.59 \text{ W/kg}$**

Maximum value of SAR (interpolated) =  $2.68 \text{ W/kg}$

**System Validation /Zoom Scan (7x7x7)/Cube 0:** Measurement grid:  $dx=5\text{mm}$ ,  $dy=5\text{mm}$ ,  $dz=5\text{mm}$

Reference Value =  $61.567 \text{ V/m}$ ; Power Drift =  $0.08 \text{ dB}$

Peak SAR (extrapolated) =  $3.45 \text{ W/kg}$

**SAR(1 g) =  $2.49 \text{ W/kg}$ ; SAR(10 g) =  $1.61 \text{ W/kg}$**

Maximum value of SAR (measured) =  $2.72 \text{ W/kg}$

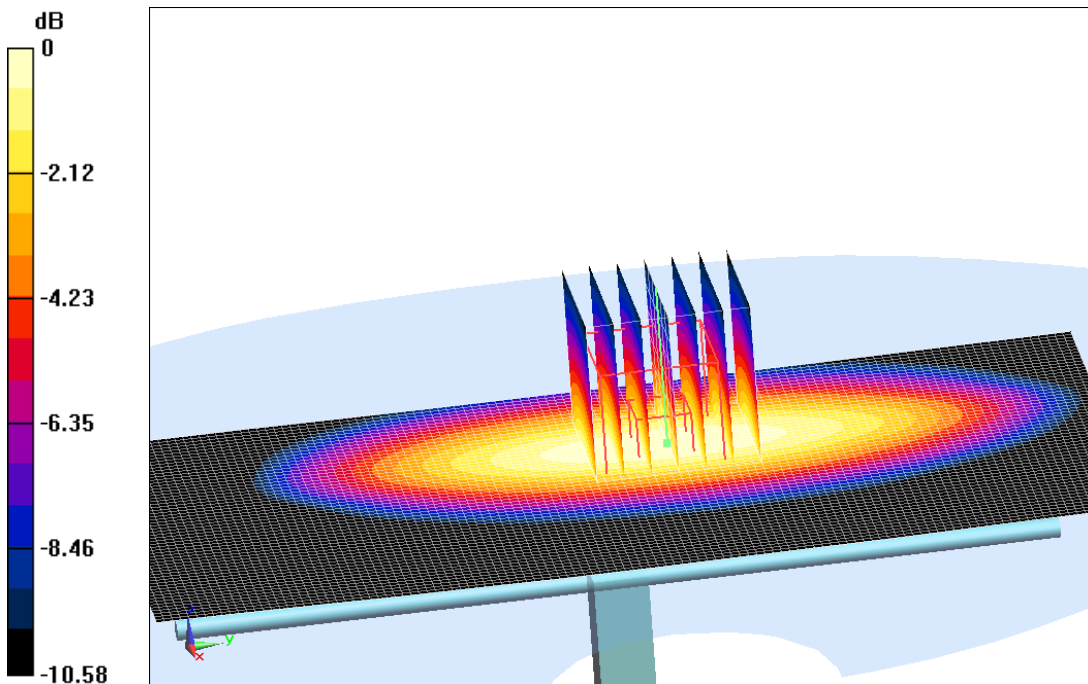

0 dB =  $2.72 \text{ W/kg}$  =  $4.35 \text{ dB W/kg}$

**Fig.B.2. Validation 835MHz 250mW**

**1750MHz**

Date: 2020-4-13

Electronics: DAE4 Sn786

Medium: Head 1750MHz

Medium parameters used:  $f = 1750 \text{ MHz}$ ;  $\sigma = 1.356 \text{ S/m}$ ;  $\epsilon_r = 39.531$ ;  $\rho = 1000 \text{ kg/m}^3$

Ambient Temperature:  $22.5^\circ\text{C}$       Liquid Temperature:  $22.0^\circ\text{C}$

Communication System: CW Frequency: 1750 MHz Duty Cycle: 1:1

Probe: ES3DV3 – SN3151 ConvF (5.23, 5.23, 5.23);

**System Validation/Area Scan (61x121x1):** Interpolated grid:  $dx=1.000 \text{ mm}$ ,  $dy=1.000 \text{ mm}$

Reference Value =  $77.223 \text{ V/m}$ ; Power Drift =  $-0.05 \text{ dB}$

**SAR(1 g) =  $8.98 \text{ W/kg}$ ; SAR(10 g) =  $4.76 \text{ W/kg}$**

Maximum value of SAR (interpolated) =  $11.1 \text{ W/kg}$

**System Validation/Zoom Scan (7x7x7)/Cube 0:** Measurement grid:  $dx=5\text{mm}$ ,  $dy=5\text{mm}$ ,  $dz=5\text{mm}$

Reference Value =  $77.223 \text{ V/m}$ ; Power Drift =  $-0.05 \text{ dB}$

Peak SAR (extrapolated) =  $17.1 \text{ W/kg}$

**SAR(1 g) =  $8.85 \text{ W/kg}$ ; SAR(10 g) =  $4.73 \text{ W/kg}$**

Maximum value of SAR (measured) =  $10.9 \text{ W/kg}$

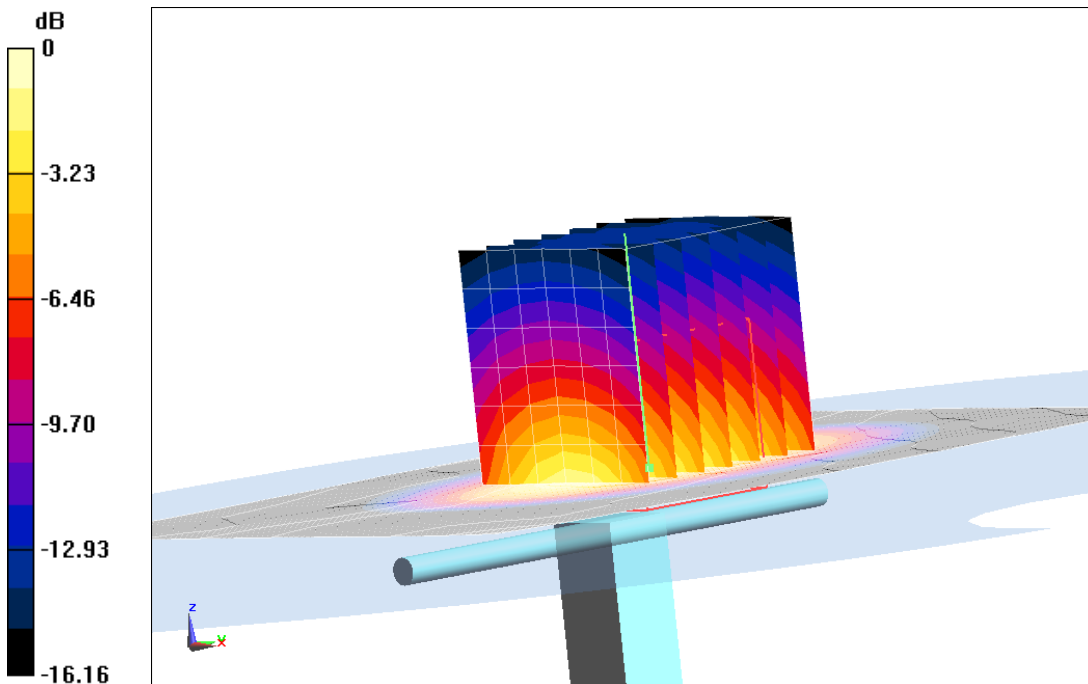

0 dB =  $10.9 \text{ W/kg}$  =  $10.37 \text{ dB W/kg}$

**Fig.B.3. Validation 1750MHz 250mW**

**1900MHz**

Date: 2020-4-11

Electronics: DAE4 Sn786

Medium: Head 1900MHz

Medium parameters used:  $f = 1900 \text{ MHz}$ ;  $\sigma = 1.417 \text{ S/m}$ ;  $\epsilon_r = 39.052$ ;  $\rho = 1000 \text{ kg/m}^3$

Ambient Temperature:  $22.5^\circ\text{C}$       Liquid Temperature:  $22.0^\circ\text{C}$

Communication System: CW Frequency: 1900 MHz Duty Cycle: 1:1

Probe: ES3DV3 – SN3151 ConvF (5.11, 5.11, 5.11);

**System Validation /Area Scan (81x121x1):** Interpolated grid:  $dx=1.000 \text{ mm}$ ,  $dy=1.000 \text{ mm}$

Reference Value =  $91.015 \text{ V/m}$ ; Power Drift =  $0.11 \text{ dB}$

**SAR(1 g) =  $10.2 \text{ W/kg}$ ; SAR(10 g) =  $5.26 \text{ W/kg}$**

Maximum value of SAR (interpolated) =  $13.0 \text{ W/kg}$

**System Validation /Zoom Scan (7x7x7)/Cube 0:** Measurement grid:  $dx=5\text{mm}$ ,  $dy=5\text{mm}$ ,  $dz=5\text{mm}$

Reference Value =  $91.015 \text{ V/m}$ ; Power Drift =  $0.11 \text{ dB}$

Peak SAR (extrapolated) =  $22.4 \text{ W/kg}$

**SAR(1 g) =  $10.4 \text{ W/kg}$ ; SAR(10 g) =  $5.35 \text{ W/kg}$**

Maximum value of SAR (measured) =  $13.3 \text{ W/kg}$

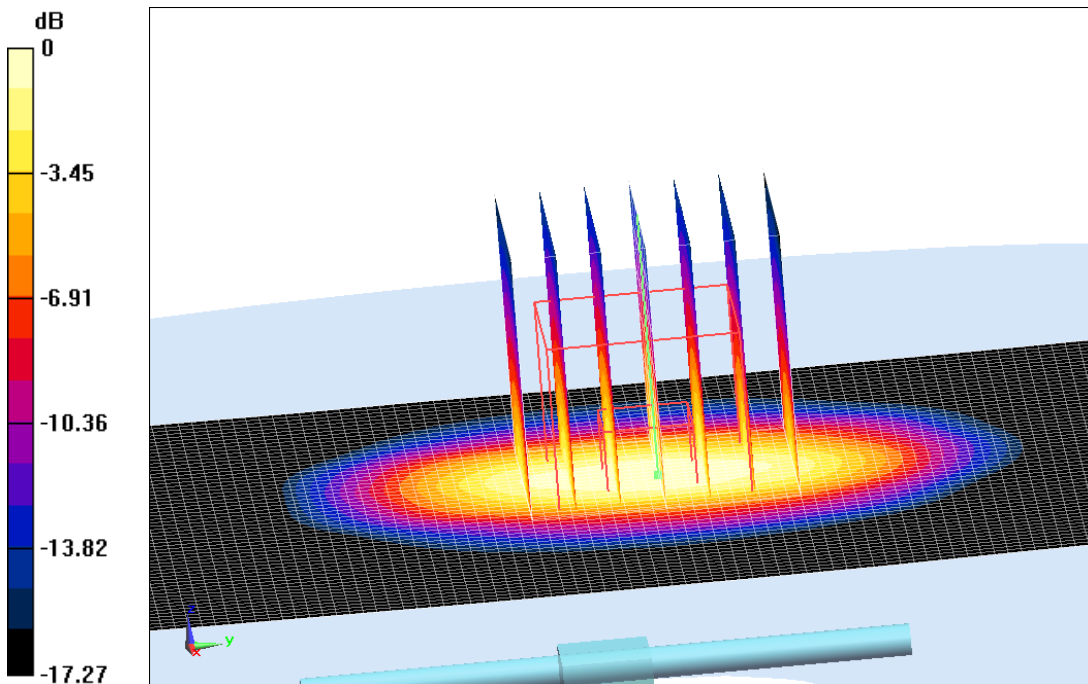

0 dB =  $13.3 \text{ W/kg}$  =  $11.24 \text{ dB W/kg}$

**Fig.B.4. Validation 1900MHz 250mW**

**2450MHz**

Date: 2020-4-14

Electronics: DAE4 Sn786

Medium: Head 2450MHz

Medium parameters used:  $f = 2450 \text{ MHz}$ ;  $\sigma = 1.775 \text{ S/m}$ ;  $\epsilon_r = 39.662$ ;  $\rho = 1000 \text{ kg/m}^3$

Ambient Temperature:  $22.5^\circ\text{C}$       Liquid Temperature:  $22.0^\circ\text{C}$

Communication System: CW Frequency: 2450 MHz Duty Cycle: 1:1

Probe: ES3DV3 – SN3151 ConvF (4.68, 4.68, 4.68);

**System Validation /Area Scan (61x81x1):** Interpolated grid:  $dx=1.000 \text{ mm}$ ,  $dy=1.000 \text{ mm}$

Reference Value =  $92.745 \text{ V/m}$ ; Power Drift =  $-0.02 \text{ dB}$

**SAR(1 g) =  $13.0 \text{ W/kg}$ ; SAR(10 g) =  $6.08 \text{ W/kg}$**

Maximum value of SAR (interpolated) =  $15.5 \text{ W/kg}$

**System Validation /Zoom Scan (7x7x7)/Cube 0:** Measurement grid:  $dx=5\text{mm}$ ,  $dy=5\text{mm}$ ,  $dz=5\text{mm}$

Reference Value =  $92.745 \text{ V/m}$ ; Power Drift =  $-0.02 \text{ dB}$

Peak SAR (extrapolated) =  $26.6 \text{ W/kg}$

**SAR(1 g) =  $12.7 \text{ W/kg}$ ; SAR(10 g) =  $5.96 \text{ W/kg}$**

Maximum value of SAR (measured) =  $15.1 \text{ W/kg}$

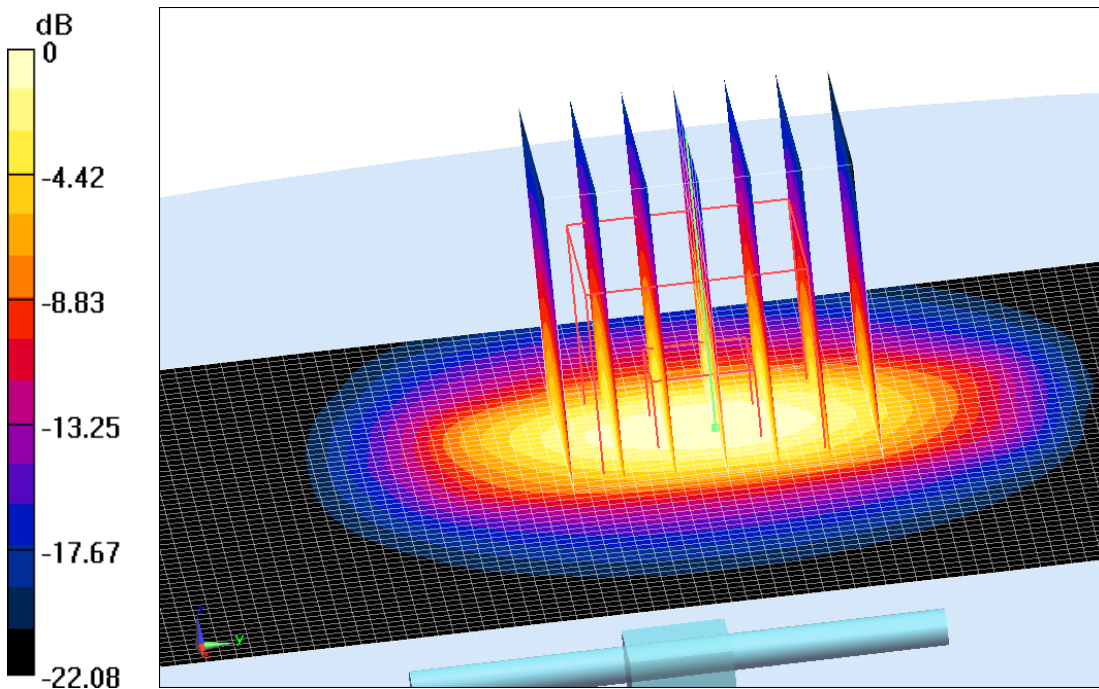

0 dB =  $15.1 \text{ W/kg}$  =  $11.79 \text{ dB W/kg}$

**Fig.B.5. Validation 2450MHz 250mW**

**2550 MHz**

Date: 2020-4-14

Electronics: DAE4 Sn786

Medium: Head 2550MHz

Medium parameters used:  $f = 2550$  MHz;  $\sigma = 1.949$  S/m;  $\epsilon_r = 38.286$ ;  $\rho = 1000$  kg/m<sup>3</sup>

Ambient Temperature: 22.5°C      Liquid Temperature: 22.0°C

Communication System: CW\_TMC Frequency: 2550 MHz Duty Cycle: 1:1

Probe: ES3DV3 – SN3151 ConvF (4.53, 4.53, 4.53);

**System Validation/Area Scan (61x121x1):** Interpolated grid: dx=1.000 mm, dy=1.000 mm

Reference Value = 93.588 V/m; Power Drift = 0.09 dB

**SAR(1 g) = 14.9 W/kg; SAR(10 g) = 6.69 W/kg**

Maximum value of SAR (interpolated) = 16.2 W/kg

**System Validation/Zoom Scan (7x7x7)/Cube0:** Measurement grid: dx=5mm, dy=5mm, dz=5mm

Reference Value = 93.588 V/m; Power Drift = 0.09 dB

Peak SAR (extrapolated) = 32.1 W/kg

**SAR(1 g) = 15.0 W/kg; SAR(10 g) = 6.77 W/kg**

Maximum value of SAR (measured) = 16.6 W/kg

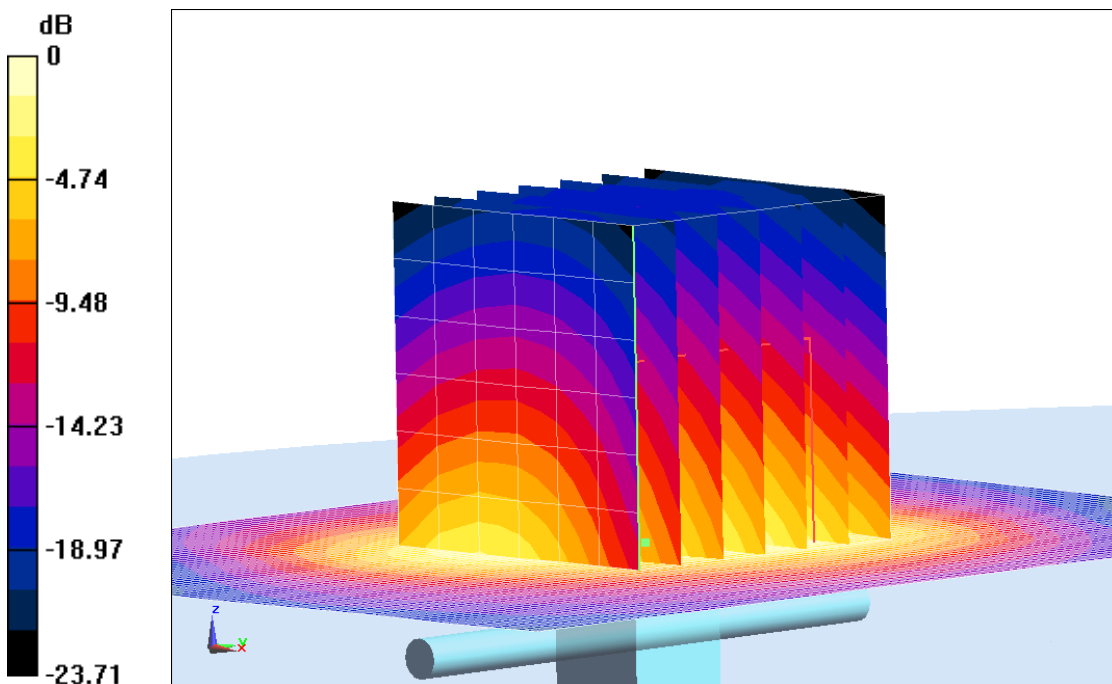

0 dB = 16.6 W/kg = 12.20 dB W/kg

**Fig.B.6. validation 2550MHz 250mW**

## ANNEX C: SAR Measurement Setup

### C.1. Measurement Set-up

DASY5 system for performing compliance tests is illustrated above graphically. This system consists of the following items:

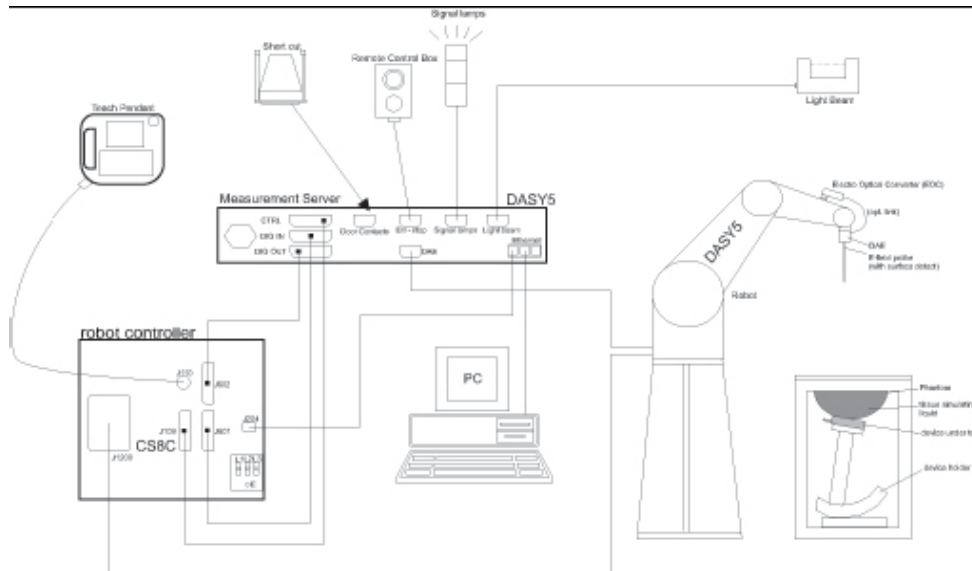

Picture C.1 SAR Lab Test Measurement Set-up

- A standard high precision 6-axis robot (Stäubli TX=RX family) with controller, teach pendant and software. An arm extension for accommodating the data acquisition electronics (DAE).
- An isotropic field probe optimized and calibrated for the targeted measurement.
- A data acquisition electronics (DAE) which performs the signal amplification, signal multiplexing, AD-conversion, offset measurements, mechanical surface detection, collision detection, etc. The unit is battery powered with standard or rechargeable batteries. The signal is optically transmitted to the EOC.
- The Electro-optical converter (EOC) performs the conversion from optical to electrical signals for the digital communication to the DAE. To use optical surface detection, a special version of the EOC is required. The EOC signal is transmitted to the measurement server.
- The function of the measurement server is to perform the time critical tasks such as signal filtering, control of the robot operation and fast movement interrupts.
- The Light Beam used is for probe alignment. This improves the (absolute) accuracy of the probe positioning.
- A computer running WinXP and the DASY5 software.
- Remote control and teach pendant as well as additional circuitry for robot safety such as
- warning lamps, etc.
- The phantom, the device holder and other accessories according to the targeted measurement.



## C.2. DASY5 E-field Probe System

The SAR measurements were conducted with the dosimetric probe designed in the classical triangular configuration and optimized for dosimetric evaluation. The probe is constructed using the thick film technique; with printed resistive lines on ceramic substrates. The probe is equipped with an optical multifiber line ending at the front of the probe tip. It is connected to the EOC box on the robot arm and provides an automatic detection of the phantom surface. Half of the fibers are connected to a pulsed infrared transmitter, the other half to a synchronized receiver. As the probe approaches the surface, the reflection from the surface produces a coupling from the transmitting to the receiving fibers. This reflection increases first during the approach, reaches maximum and then decreases. If the probe is flatly touching the surface, the coupling is zero. The distance of the coupling maximum to the surface is independent of the surface reflectivity and largely independent of the surface to probe angle. The DASY5 software reads the reflection during a software approach and looks for the maximum using 2<sup>nd</sup> order curve fitting. The approach is stopped at reaching the maximum.

### Probe Specifications:

<b>Model:</b>	<b>ES3DV3, EX3DV4</b>
<b>Frequency</b>	<b>10MHz — 6.0GHz(EX3DV4)</b>
<b>Range:</b>	<b>10MHz — 4GHz(ES3DV3)</b>
<b>Calibration:</b>	<b>In head and body simulating tissue at Frequencies from 835 up to 5800MHz</b>
<b>Linearity:</b>	<b>± 0.2 dB(30 MHz to 6 GHz) for EX3DV4 ± 0.2 dB(30 MHz to 4 GHz) for ES3DV3</b>
<b>Dynamic Range:</b>	<b>10 mW/kg — 100W/kg</b>
<b>Probe Length:</b>	<b>330 mm</b>
<b>Probe Tip</b>	
<b>Length:</b>	<b>20 mm</b>
<b>Body Diameter:</b>	<b>12 mm</b>
<b>Tip Diameter:</b>	<b>2.5 mm (3.9 mm for ES3DV3)</b>
<b>Tip-Center:</b>	<b>1 mm (2.0mm for ES3DV3)</b>
<b>Application:</b>	<b>SAR Dosimetry Testing Compliance tests of mobile phones Dosimetry in strong gradient fields</b>



Picture C.2 Near-field Probe



Picture C.3 E-field Probe

## C.3. E-field Probe Calibration

Each E-Probe/Probe Amplifier combination has unique calibration parameters. A TEM cell calibration procedure is conducted to determine the proper amplifier settings to enter in the probe parameters. The amplifier settings are determined for a given frequency by subjecting the probe to a known E-field density ( $1 \text{ mW/cm}^2$ ) using an RF Signal generator, TEM cell, and RF Power Meter.

The free space E-field from amplified probe outputs is determined in a test chamber. This calibration can be performed in a TEM cell if the frequency is below 1 GHz and in a waveguide or



other methodologies above 1 GHz for free space. For the free space calibration, the probe is placed in the volumetric center of the cavity and at the proper orientation with the field. The probe is then rotated 360 degrees until the three channels show the maximum reading. The power density readings equates to 1 mW/ cm<sup>2</sup>:

E-field temperature correlation calibration is performed in a flat phantom filled with the appropriate simulated brain tissue. The E-field in the medium correlates with the temperature rise in the dielectric medium. For temperature correlation calibration a RF transparent thermistor-based temperature probe is used in conjunction with the E-field probe.

$$SAR = C \frac{\Delta T}{\Delta t}$$

Where:

$\Delta t$  = Exposure time (30 seconds),

C = Heat capacity of tissue (brain or muscle),

$\Delta T$  = Temperature increase due to RF exposure.

$$SAR = \frac{|E|^2 \cdot \sigma}{\rho}$$

Where:

$\sigma$  = Simulated tissue conductivity,

$\rho$  = Tissue density (kg/m<sup>3</sup>).

## C.4. Other Test Equipment

### C.4.1. Data Acquisition Electronics (DAE)

The data acquisition electronics consist of a highly sensitive electrometer-grade preamplifier with auto-zeroing, a channel and gain-switching multiplexer, a fast 16 bit AD-converter and a command decoder with a control logic unit. Transmission to the measurement server is accomplished through an optical downlink for data and status information, as well as an optical uplink for commands and the clock.

The mechanical probe mounting device includes two different sensor systems for frontal and sideways probe contacts. They are used for mechanical surface detection and probe collision detection.

The input impedance of the DAE is 200 MOhm; the inputs are symmetrical and floating. Common mode rejection is above 80 dB.



PictureC.4: DAE

#### C.4.2. Robot

The SPEAG DASY system uses the high precision robots (DASY5: RX160L) type from Stäubli SA (France). For the 6-axis controller system, the robot controller version from Stäubli is used. The Stäubli robot series have many features that are important for our application:

- High precision (repeatability 0.02mm)
- High reliability (industrial design)
- Low maintenance costs (virtually maintenance free due to direct drive gears; no belt drives)
- Jerk-free straight movements (brushless synchron motors; no stepper motors)
- Low ELF interference (motor control fields shielded via the closed metallic construction shields)



Picture C.5 DASY 5

#### C.4.3. Measurement Server

The Measurement server is based on a PC/104 CPU board with CPU (DASY5: 400 MHz, Intel Celeron), chipdisk (DASY5:128MB), RAM (DASY5:128MB). The necessary circuits for communication with the DAE electronic box, as well as the 16 bit AD converter system for optical detection and digital I/O interface are contained on the DASY I/O board, which is directly connected to the PC/104 bus of the CPU board.

The measurement server performs all real-time data evaluation of field measurements and surface detection, controls robot movements and handles safety operation. The PC operating system cannot interfere with these time critical processes. All connections are supervised by a watchdog, and disconnection of any of the cables to the measurement server will automatically disarm the robot and disable all program-controlled robot movements. Furthermore, the measurement server is equipped with an expansion port which is reserved for future applications. Please note that this expansion port does not have a standardized pinout, and therefore only devices provided by SPEAG can be connected. Devices from any other supplier could seriously damage the measurement server.



Picture C.6 Server for DASY 5

#### C.4.4. Device Holder for Phantom

The SAR in the phantom is approximately inversely proportional to the square of the distance between the source and the liquid surface. For a source at 5mm distance, a positioning uncertainty of  $\pm 0.5\text{mm}$  would produce a SAR uncertainty of  $\pm 20\%$ . Accurate device positioning is therefore crucial for accurate and repeatable measurements. The positions in which the devices must be measured are defined by the standards.

The DASY device holder is designed to cope with the different positions given in the standard. It has two scales for device rotation (with respect to the body axis) and device inclination (with respect to the line between the ear reference points). The rotation centers for both scales is the ear reference point (ERP). Thus the device needs no repositioning when changing the angles.

The DASY device holder is constructed of low-loss POM material having the following dielectric

parameters: relative permittivity  $\epsilon = 3$  and loss tangent  $\delta = 0.02$ . The amount of dielectric material has been reduced in the closest vicinity of the device, since measurements have suggested that the influence of the clamp on the test results could thus be lowered.

<Laptop Extension Kit>

The extension is lightweight and made of POM, acrylic glass and foam. It fits easily on the upper part of the Mounting Device in place of the phone positioner. The extension is fully compatible with the Twin-SAM and ELI phantoms.



Picture C.7-1: Device Holder

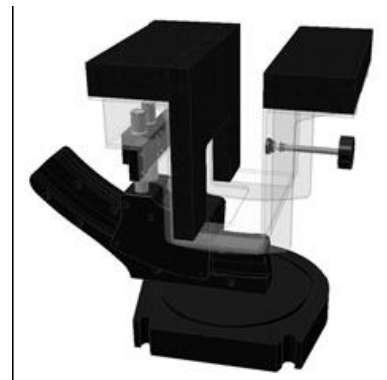

Picture C.7-2: Laptop Extension Kit

#### C.4.5. Phantom

The SAM Twin Phantom V4.0 is constructed of a fiberglass shell integrated in a table. The shape of the shell is based on data from an anatomical study designed to

Represent the 90<sup>th</sup> percentile of the population. The phantom enables the dissymmetric evaluation of SAR for both left and right handed handset usage, as well as body-worn usage using the flat phantom region. Reference markings on the Phantom allow the complete setup of all predefined phantom positions and measurement grids by manually teaching three points in the robot. The shell phantom has a 2mm shell thickness (except the ear region where shell thickness increases to 6 mm).



Shell Thickness:  $2 \pm 0.2$  mm  
Filling Volume: Approx. 25 liters  
Dimensions: 810 x 1000 x 500 mm (H x L x W)  
Available: Special



**Picture C.8: SAM Twin Phantom**

## ANNEX D: Position of the wireless device in relation to the phantom

### D.1. General considerations

This standard specifies two handset test positions against the head phantom – the “cheek” position and the “tilt” position.

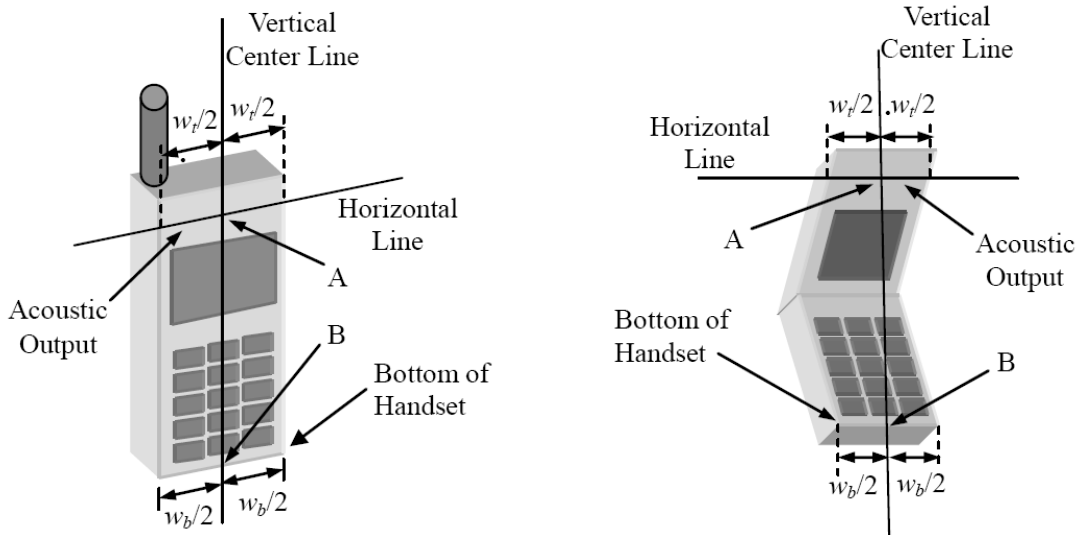

- $w_t$  Width of the handset at the level of the acoustic
- $w_b$  Width of the bottom of the handset
- A Midpoint of the width  $w_t$  of the handset at the level of the acoustic output
- B Midpoint of the width  $w_b$  of the bottom of the handset

Picture D.1-a Typical “fixed” case handset      Picture D.1-b Typical “clam-shell” case handset

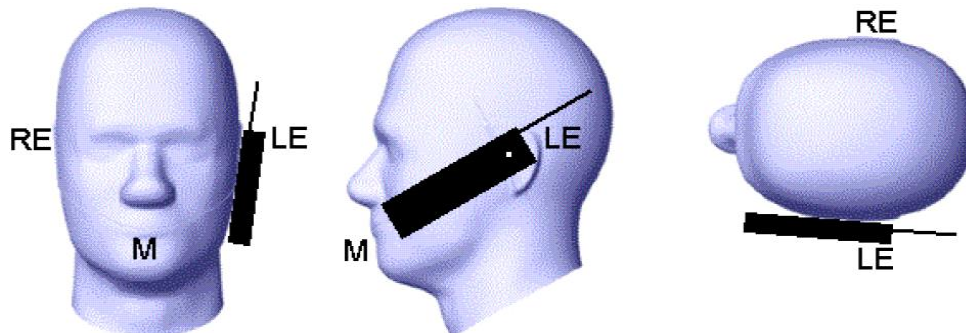

Picture D.2 Cheek position of the wireless device on the left side of SAM

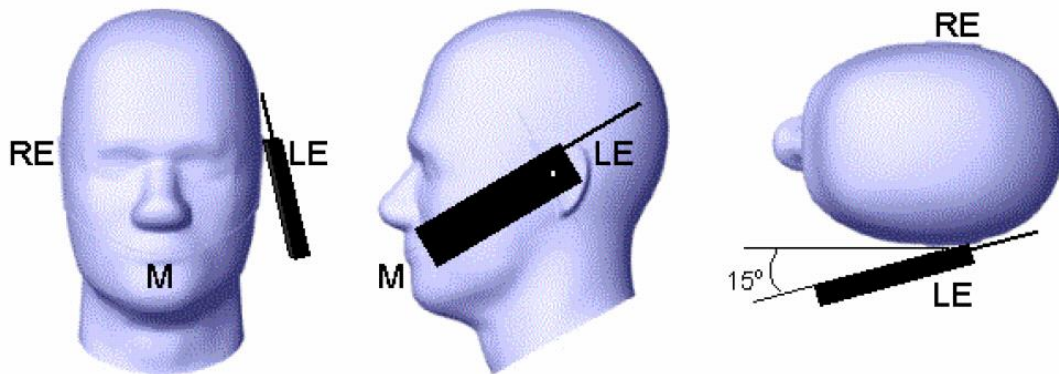

Picture D.3 Tilt position of the wireless device on the left side of SAM

## D.2. Body-worn device

A typical example of a body-worn device is a mobile phone, wireless enabled PDA or other battery operated wireless device with the ability to transmit while mounted on a person's body using a carry accessory approved by the wireless device manufacturer.

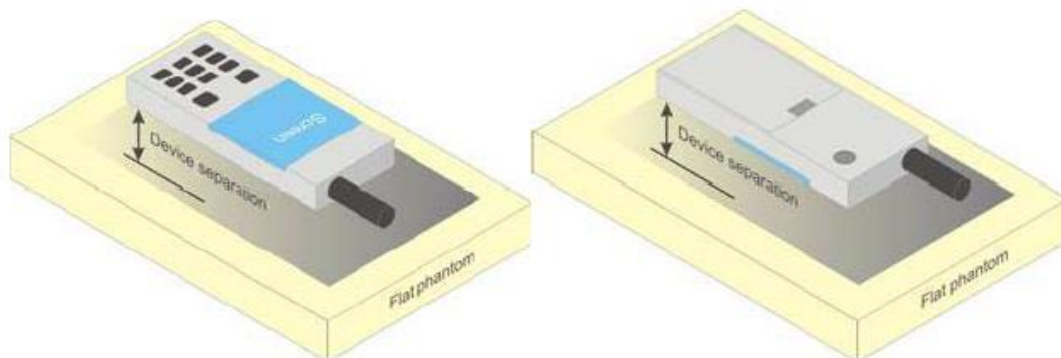

Picture D.4 Test positions for body-worn devices

## D.3. Desktop device

A typical example of a desktop device is a wireless enabled desktop computer placed on a table or desk when used.

The DUT shall be positioned at the distance and in the orientation to the phantom that corresponds to the intended use as specified by the manufacturer in the user instructions. For devices that employ an external antenna with variable positions, tests shall be performed for all antenna positions specified. Picture 8.5 show positions for desktop device SAR tests. If the intended use is not specified, the device shall be tested directly against the flat phantom.



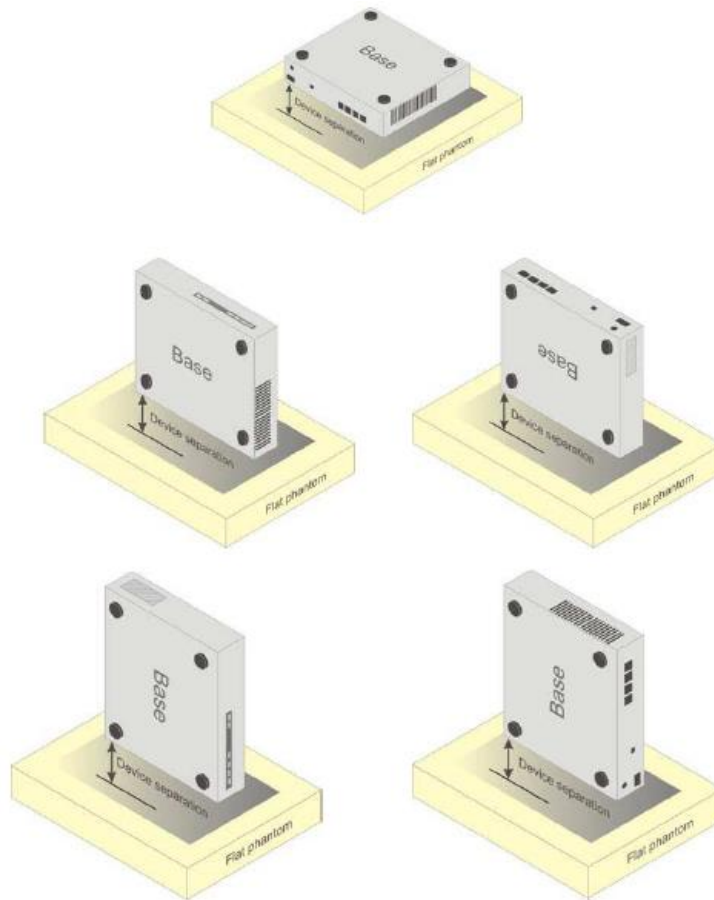

Picture D.5 Test positions for desktop devices

#### D.4. DUT Setup Photos



Picture D.6

## ANNEX E: Equivalent Media Recipes

The liquid used for the frequency range of 700-6000 MHz consisted of water, sugar, salt, preventol, glycol monobutyl and Cellulose. The liquid has been previously proven to be suited for worst-case. The Table E.1 shows the detail solution. It's satisfying the latest tissue dielectric parameters requirements proposed by the IEEE 1528 and IEC 62209.

**Table E.1: Composition of the Tissue Equivalent Matter**

Frequency (MHz)	835 Head	835 Body	1900 Head	1900 Body	2450 Head	2450 Body	5800 Head	5800 Body
Ingredients (% by weight)								
Water	41.45	52.5	55.242	69.91	58.79	72.60	65.53	65.53
Sugar	56.0	45.0	\	\	\	\	\	\
Salt	1.45	1.4	0.306	0.13	0.06	0.18	\	\
Preventol	0.1	0.1	\	\	\	\	\	\
Cellulose	1.0	1.0	\	\	\	\	\	\
Glycol Monobutyl	\	\	44.452	29.96	41.15	27.22	\	\
Diethylenglycol monoheylether	\	\	\	\	\	\	17.24	17.24
Triton X-100	\	\	\	\	\	\	17.24	17.24
Dielectric Parameters Target Value	$\epsilon=41.5$ $\sigma=0.90$	$\epsilon=55.2$ $\sigma=0.97$	$\epsilon=40.0$ $\sigma=1.40$	$\epsilon=53.3$ $\sigma=1.52$	$\epsilon=39.2$ $\sigma=1.80$	$\epsilon=52.7$ $\sigma=1.95$	$\epsilon=35.3$ $\sigma=5.27$	$\epsilon=48.2$ $\sigma=6.00$

**Note: There is a little adjustment respectively for 750, 1800, 2600, 5200, 5300, and 5600, based on the recipe of closest frequency in table E.1**





## ANNEX F: System Validation

The SAR system must be validated against its performance specifications before it is deployed. When SAR probes, system components or software are changed, upgraded or recalibrated, these must be validated with the SAR system(s) that operates with such components.

**Table F.1: System Validation**

Probe SN.	Liquid name	Validation date	Frequency point	Status (OK or Not)
3151	Head 750MHz	2020-01-06	750 MHz	OK
3151	Head 835MHz	2020-01-06	835 MHz	OK
3151	Head 1750MHz	2020-01-07	1750 MHz	OK
3151	Head 1900MHz	2020-01-07	1900 MHz	OK
3151	Head 2450MHz	2020-01-08	2450 MHz	OK
3151	Head 2550MHz	2020-01-08	2550 MHz	OK
3151	Body 750MHz	2020-01-06	750 MHz	OK
3151	Body 835MHz	2020-01-06	835 MHz	OK
3151	Body 1750MHz	2020-01-07	1750 MHz	OK
3151	Body 1900MHz	2020-01-07	1900 MHz	OK
3151	Body 2450MHz	2020-01-08	2450 MHz	OK
3151	Body 2550MHz	2020-01-08	5200 MHz	OK



# ANNEX G: DAE Calibration Certificate

## DAE4 SN: 786 Calibration Certificate



Add: No.51 Xueyuan Road, Haidian District, Beijing, 100191, China  
Tel: +86-10-62304633-2512 Fax: +86-10-62304633-2504  
E-mail: cttl@chinattl.com Http://www.chinattl.cn



中国认可  
国际互认  
校准  
CALIBRATION  
CNAS L0570

Client : CTTL(South Branch)

Certificate No: Z20-60101

### CALIBRATION CERTIFICATE

Object DAE4 - SN: 786

Calibration Procedure(s) FF-Z11-002-01  
Calibration Procedure for the Data Acquisition Electronics (DAEx)

Calibration date: March 03, 2020

This calibration Certificate documents the traceability to national standards, which realize the physical units of measurements(SI). The measurements and the uncertainties with confidence probability are given on the following pages and are part of the certificate.

All calibrations have been conducted in the closed laboratory facility: environment temperature(22±3)°C and humidity<70%.

Calibration Equipment used (M&TE critical for calibration)

Primary Standards	ID #	Cal Date(Calibrated by, Certificate No.)	Scheduled Calibration
Process Calibrator 753	1971018	24-Jun-19 (CTTL, No.J19X05126)	Jun-20

	Name	Function	Signature
Calibrated by:	Yu Zongying	SAR Test Engineer	
Reviewed by:	Lin Hao	SAR Test Engineer	
Approved by:	Qi Dianyuan	SAR Project Leader	

Issued: March 05, 2020

This calibration certificate shall not be reproduced except in full without written approval of the laboratory.



Add: No.51 Xueyuan Road, Haidian District, Beijing, 100191, China  
Tel: +86-10-62304633-2512 Fax: +86-10-62304633-2504  
E-mail: [cttl@chinattl.com](mailto:cttl@chinattl.com) [Http://www.chinattl.cn](http://www.chinattl.cn)

**Glossary:**

DAE data acquisition electronics  
Connector angle information used in DASYS system to align probe sensor X to the robot coordinate system.

**Methods Applied and Interpretation of Parameters:**

- *DC Voltage Measurement:* Calibration Factor assessed for use in DASYS system by comparison with a calibrated instrument traceable to national standards. The figure given corresponds to the full scale range of the voltmeter in the respective range.
- *Connector angle:* The angle of the connector is assessed measuring the angle mechanically by a tool inserted. Uncertainty is not required.
- The report provide only calibration results for DAE, it does not contain other performance test results.



Add: No.51 Xueyuan Road, Haidian District, Beijing, 100191, China  
Tel: +86-10-62304633-2512 Fax: +86-10-62304633-2504  
E-mail: cttl@chinattl.com Http://www.chinattl.cn

**DC Voltage Measurement**

A/D - Converter Resolution nominal

High Range: 1LSB = 6.1μV , full range = -100...+300 mV

Low Range: 1LSB = 61nV , full range = -1.....+3mV

DASY measurement parameters: Auto Zero Time: 3 sec; Measuring time: 3 sec

Calibration Factors	X	Y	Z
High Range	404.081 ± 0.15% (k=2)	404.251 ± 0.15% (k=2)	404.649 ± 0.15% (k=2)
Low Range	3.97247 ± 0.7% (k=2)	3.97408 ± 0.7% (k=2)	3.95771 ± 0.7% (k=2)

**Connector Angle**

Connector Angle to be used in DASY system	229.5° ± 1 °
---	--------------

**ANNEX H: Probe Calibration Certificate****Probe ES3DV3-SN: 3151 Calibration Certificate**

In Collaboration with  
**s p e a g**  
CALIBRATION LABORATORY



中国认可  
国际互认  
校准  
CALIBRATION  
CNAS L0570

Add: No.51 Xueyuan Road, Haidian District, Beijing, 100191, China  
Tel: +86-10-62304633-2512 Fax: +86-10-62304633-2504  
E-mail: cttl@chinattl.com [Http://www.chinattl.cn](http://www.chinattl.cn)

Client **CTTL(South Branch)**Certificate No: **Z20-60021****CALIBRATION CERTIFICATE**

Object **ES3DV3 - SN : 3151**

Calibration Procedure(s) **FF-Z11-004-01**  
**Calibration Procedures for Dosimetric E-field Probes**

Calibration date: **January 03, 2020**

This calibration Certificate documents the traceability to national standards, which realize the physical units of measurements(SI). The measurements and the uncertainties with confidence probability are given on the following pages and are part of the certificate.

All calibrations have been conducted in the closed laboratory facility: environment temperature(22±3)°C and humidity<70%.

Calibration Equipment used (M&TE critical for calibration)

Primary Standards	ID #	Cal Date(Calibrated by, Certificate No.)	Scheduled Calibration
Power Meter NRP2	101919	18-Jun-19(CTTL, No.J19X05125)	Jun-20
Power sensor NRP-Z91	101547	18-Jun-19(CTTL, No.J19X05125)	Jun-20
Power sensor NRP-Z91	101548	18-Jun-19(CTTL, No.J19X05125)	Jun-20
Reference 10dBAttenuator	18N50W-10dB	9-Feb-18(CTTL, No.J18X01133)	Feb-20
Reference 20dBAttenuator	18N50W-20dB	9-Feb-18(CTTL, No.J18X01132)	Feb-20
Reference Probe EX3DV4	SN 7307	24-May-19(SPEAG, No.EX3-7307_May19/2)	May-20
DAE4	SN 1525	26-Aug-19(SPEAG, No.DAE4-1525_Aug19)	Aug-20

Secondary Standards	ID #	Cal Date(Calibrated by, Certificate No.)	Scheduled Calibration
SignalGenerator MG3700A	6201052605	18-Jun-19(CTTL, No.J19X05127)	Jun-20
Network Analyzer E5071C	MY46110673	24-Jan-19(CTTL, No.J19X00547)	Jan-20

	Name	Function	Signature
Calibrated by:	Yu Zongying	SAR Test Engineer	
Reviewed by:	Lin Hao	SAR Test Engineer	
Approved by:	Qi Dianyuan	SAR Project Leader	

Issued: January 05, 2020

This calibration certificate shall not be reproduced except in full without written approval of the laboratory.





Add: No.51 Xueyuan Road, Haidian District, Beijing, 100191, China  
Tel: +86-10-62304633-2512 Fax: +86-10-62304633-2504  
E-mail: cttl@chinattl.com [Http://www.chinattl.cn](http://www.chinattl.cn)

**Glossary:**

TSL	tissue simulating liquid
NORM <sub>x,y,z</sub>	sensitivity in free space
ConvF	sensitivity in TSL / NORM <sub>x,y,z</sub>
DCP	diode compression point
CF	crest factor (1/duty_cycle) of the RF signal
A,B,C,D	modulation dependent linearization parameters
Polarization $\Phi$	$\Phi$ rotation around probe axis
Polarization $\theta$	$\theta$ rotation around an axis that is in the plane normal to probe axis (at measurement center), i $\theta=0$ is normal to probe axis

Connector Angle information used in DASY system to align probe sensor X to the robot coordinate system

**Calibration is Performed According to the Following Standards:**

- IEEE Std 1528-2013, "IEEE Recommended Practice for Determining the Peak Spatial-Averaged Specific Absorption Rate (SAR) in the Human Head from Wireless Communications Devices: Measurement Techniques", June 2013
- IEC 62209-1, "Measurement procedure for the assessment of Specific Absorption Rate (SAR) from hand-held and body-mounted devices used next to the ear (frequency range of 300 MHz to 6 GHz)", July 2016
- IEC 62209-2, "Procedure to determine the Specific Absorption Rate (SAR) for wireless communication devices used in close proximity to the human body (frequency range of 30 MHz to 6 GHz)", March 2010
- KDB 865664, "SAR Measurement Requirements for 100 MHz to 6 GHz"

**Methods Applied and Interpretation of Parameters:**

- NORM<sub>x,y,z</sub>:** Assessed for E-field polarization  $\theta=0$  ( $f \leq 900$  MHz in TEM-cell;  $f > 1800$  MHz: waveguide). NORM<sub>x,y,z</sub> are only intermediate values, i.e., the uncertainties of NORM<sub>x,y,z</sub> does not effect the  $E^2$ -field uncertainty inside TSL (see below ConvF).
- NORM(f)<sub>x,y,z</sub> = NORM<sub>x,y,z</sub>\* frequency\_response** (see Frequency Response Chart). This linearization is implemented in DASY4 software versions later than 4.2. The uncertainty of the frequency response is included in the stated uncertainty of ConvF.
- DCP<sub>x,y,z</sub>:** DCP are numerical linearization parameters assessed based on the data of power sweep (no uncertainty required). DCP does not depend on frequency nor media.
- PAR:** PAR is the Peak to Average Ratio that is not calibrated but determined based on the signal characteristics.
- A<sub>x,y,z</sub>; B<sub>x,y,z</sub>; C<sub>x,y,z</sub>; VR<sub>x,y,z</sub>; A,B,C** are numerical linearization parameters assessed based on the data of power sweep for specific modulation signal. The parameters do not depend on frequency nor media. VR is the maximum calibration range expressed in RMS voltage across the diode.
- ConvF and Boundary Effect Parameters:** Assessed in flat phantom using E-field (or Temperature Transfer Standard for  $f \leq 800$  MHz) and inside waveguide using analytical field distributions based on power measurements for  $f > 800$  MHz. The same setups are used for assessment of the parameters applied for boundary compensation (alpha, depth) of which typical uncertainty valued are given. These parameters are used in DASY4 software to improve probe accuracy close to the boundary. The sensitivity in TSL corresponds to NORM<sub>x,y,z</sub>\* ConvF whereby the uncertainty corresponds to that given for ConvF. A frequency dependent ConvF is used in DASY version 4.4 and higher which allows extending the validity from  $\pm 50$  MHz to  $\pm 100$  MHz.
- Spherical isotropy (3D deviation from isotropy):** in a field of low gradients realized using a flat phantom exposed by a patch antenna.
- Sensor Offset:** The sensor offset corresponds to the offset of virtual measurement center from the probe tip (on probe axis). No tolerance required.
- Connector Angle:** The angle is assessed using the information gained by determining the NORM<sub>x</sub> (no uncertainty required).



No. I20N00775-SAR



Add: No.51 Xueyuan Road, Haidian District, Beijing, 100191, China  
Tel: +86-10-62304633-2512 Fax: +86-10-62304633-2504  
E-mail: [ctl@chinatl.com](mailto:ctl@chinatl.com) [Http://www.chinatl.cn](http://www.chinatl.cn)

# Probe ES3DV3

## SN: 3151

Calibrated: January 03, 2020

Calibrated for DASY/EASY Systems

(Note: non-compatible with DASY2 system!)



Add: No.51 Xueyuan Road, Haidian District, Beijing, 100191, China
Tel: +86-10-62304633-2512 Fax: +86-10-62304633-2504
E-mail: cttl@chinattl.com Http://www.chinattl.cn

DASY/EASY – Parameters of Probe: ES3DV3 – SN:3151

Basic Calibration Parameters

Table with 5 columns: Sensor X, Sensor Y, Sensor Z, Unc (k=2). Rows include Norm(µV/(V/m)²) and DCP(mV).

Modulation Calibration Parameters

Table with 9 columns: UID, Communication System Name, A dB, B dB·µV, C, D dB, VR mV, Unc (k=2). Includes CW system and X, Y, Z modulation parameters.

The reported uncertainty of measurement is stated as the standard uncertainty of Measurement multiplied by the coverage factor k=2, which for a normal distribution Corresponds to a coverage probability of approximately 95%.

A The uncertainties of Norm X, Y, Z do not affect the E²-field uncertainty inside TSL (see Page 5).
B Numerical linearization parameter: uncertainty not required.
E Uncertainty is determined using the max. deviation from linear response applying rectangular distribution and is expressed for the square of the field value.





Add: No.51 Xueyuan Road, Haidian District, Beijing, 100191, China  
 Tel: +86-10-62304633-2512 Fax: +86-10-62304633-2504  
 E-mail: cttl@chinattl.com [Http://www.chinattl.cn](http://www.chinattl.cn)

## DASY/EASY – Parameters of Probe : ES3DV3 – SN:3151

### Calibration Parameter Determined in Head Tissue Simulating Media

f [MHz] <sup>C</sup>	Relative Permittivity <sup>F</sup>	Conductivity (S/m) <sup>F</sup>	ConvF X	ConvF Y	ConvF Z	Alpha <sup>G</sup>	Depth <sup>G</sup> (mm)	Unct. (k=2)
750	41.9	0.89	6.41	6.41	6.41	0.40	1.35	±12.1%
900	41.5	0.97	6.23	6.23	6.23	0.40	1.46	±12.1%
1450	40.5	1.20	5.50	5.50	5.50	0.33	1.67	±12.1%
1750	40.1	1.37	5.23	5.23	5.23	0.54	1.35	±12.1%
1900	40.0	1.40	5.11	5.11	5.11	0.65	1.27	±12.1%
2000	40.0	1.40	5.07	5.07	5.07	0.60	1.35	±12.1%
2300	39.5	1.67	4.86	4.86	4.86	0.90	1.08	±12.1%
2450	39.2	1.80	4.68	4.68	4.68	0.90	1.08	±12.1%
2600	39.0	1.96	4.53	4.53	4.53	0.90	1.10	±12.1%

<sup>C</sup> Frequency validity above 300 MHz of ±100MHz only applies for DASY v4.4 and higher (Page 2), else it is restricted to ±50MHz. The uncertainty is the RSS of ConvF uncertainty at calibration frequency and the uncertainty for the indicated frequency band. Frequency validity below 300 MHz is ± 10, 25, 40, 50 and 70 MHz for ConvF assessments at 30, 64, 128, 150 and 220 MHz respectively. Above 5 GHz frequency validity can be extended to ± 110 MHz.

<sup>F</sup> At frequency below 3 GHz, the validity of tissue parameters ( $\epsilon$  and  $\sigma$ ) can be relaxed to ±10% if liquid compensation formula is applied to measured SAR values. At frequencies above 3 GHz, the validity of tissue parameters ( $\epsilon$  and  $\sigma$ ) is restricted to ±5%. The uncertainty is the RSS of the ConvF uncertainty for indicated target tissue parameters.

<sup>G</sup> Alpha/Depth are determined during calibration. SPEAG warrants that the remaining deviation due to the boundary effect after compensation is always less than ± 1% for frequencies below 3 GHz and below ± 2% for the frequencies between 3-6 GHz at any distance larger than half the probe tip diameter from the boundary.



Add: No.51 Xueyuan Road, Haidian District, Beijing, 100191, China  
Tel: +86-10-62304633-2512 Fax: +86-10-62304633-2504  
E-mail: [cttl@chinattl.com](mailto:cttl@chinattl.com) [Http://www.chinattl.cn](http://www.chinattl.cn)

### Frequency Response of E-Field (TEM-Cell: ifi110 EXX, Waveguide: R22)

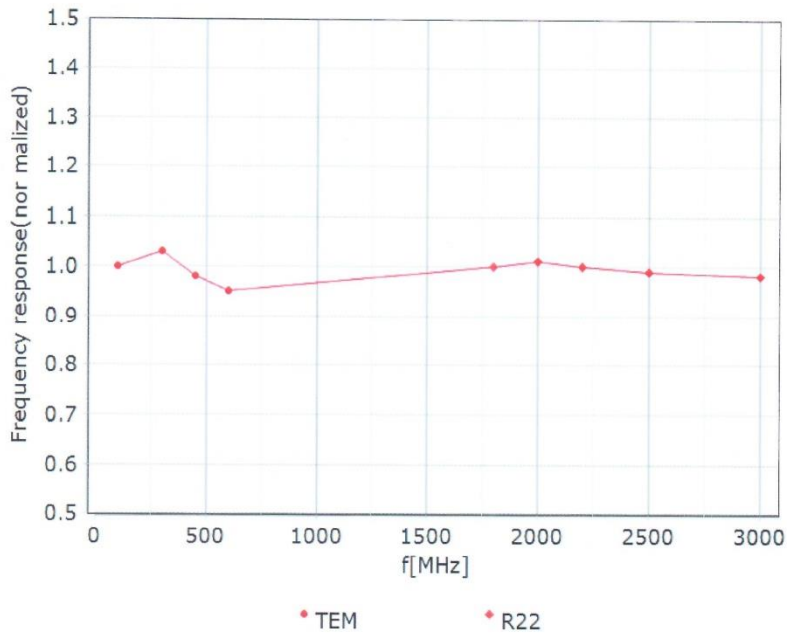

Uncertainty of Frequency Response of E-field:  $\pm 7.4\%$  (k=2)



Add: No.51 Xueyuan Road, Haidian District, Beijing, 100191, China  
 Tel: +86-10-62304633-2512 Fax: +86-10-62304633-2504  
 E-mail: cttl@chinattl.com [Http://www.chinattl.cn](http://www.chinattl.cn)

### Receiving Pattern ( $\Phi$ ), $\theta=0^\circ$

**f=600 MHz, TEM**

**f=1800 MHz, R22**

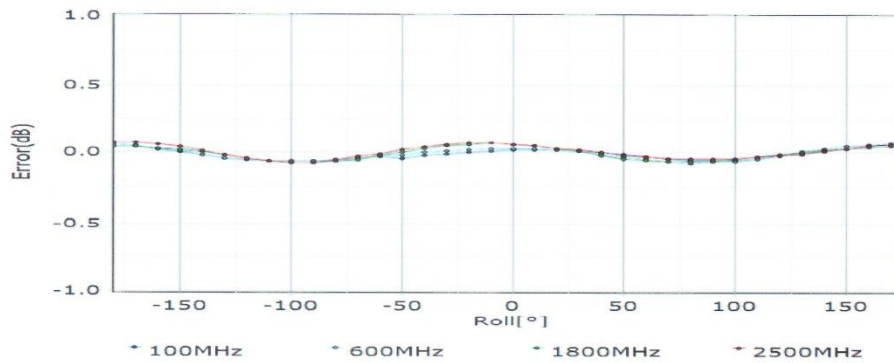
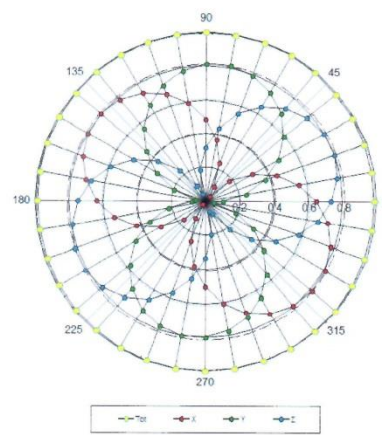
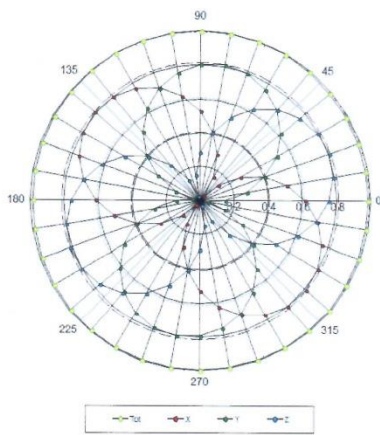

Uncertainty of Axial Isotropy Assessment:  $\pm 1.2\%$  (k=2)